

# BYTE

THE SMALL SYSTEMS JOURNAL

JULY 1985 VOL. 10, NO. 7

\$3.50 IN UNITED STATES  
\$4.25 IN CANADA / £2.10 IN U.K.  
A MCGRAW-HILL PUBLICATION  
0360-5280

TELECOMMUNICATIONS  
AND SPACE

ROBERT  
ESTINNEY



# IBM is finally talking to us.

And we're finally talking to them.  
Thanks to The Macintosh™ Office.

Using our AppleLine protocol converter and MacTerminal™ software, Macintosh can speak IBM® 3270 like a native. Not to mention DEC® VT100™, VT52™ and TTY.

In English, that means you can find almost anything that's stored in your company's mainframe. Just the same as if your Macintosh was an IBM terminal.

Say, for instance, you want to know how sales are going as of yesterday. Where your inventory stands. Or if receivables are staying ahead of payables.

With a Macintosh on your desk, all that information is right at your fingertip. Even if your mainframes are on the other side of the building. Or the other side of the world.

Now if you think that's impressive, you haven't read anything yet.

Once you've located the data you want, you can "cut" it out of the mainframe and "paste" it directly into a spreadsheet program like Lotus® Jazz™\* Or Microsoft® Multiplan®. Then turn the numbers into a chart with a business graphics program. Such as Microsoft Chart. And last, but certainly not least, print out a publication-quality report, memo or presentation with our LaserWriter printer.

Total elapsed time: about 20 minutes.

And if you need to know something that's not in your mainframe—like up-to-the-minute stock quotes—you can use MacTerminal and an Apple Modem to tap into a number of commercial information services. Including

Dow Jones News/Retrieval®  
NEXIS® LEXIS®  
And The Official Airline Guide®.  
So you can use Macintosh for everything from scanning *The Wall Street Journal* to making airline reservations.

All of which means you should finally be talking to us.

Call 800-446-3000, and we'll tell you more about how well The Macintosh Office will fit into the one you're in now.

Even if there's a big blue box in one corner.

## The Macintosh Office

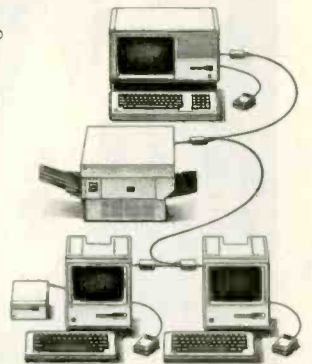

*In The Macintosh Office, workgroups of 5 to 25 people will talk to each other over our AppleTalk™ Personal Network.*



# C·O·N·T·E·N·T·S

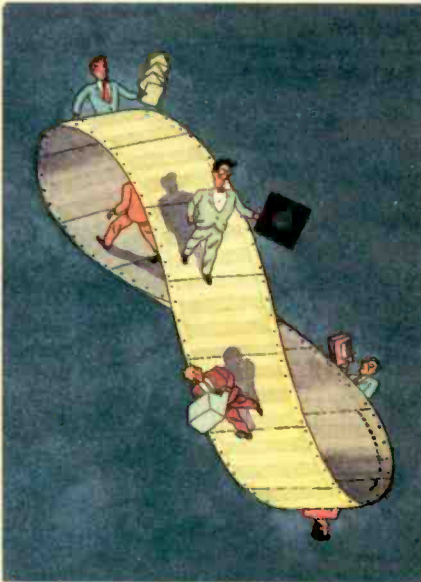

104



176

## FEATURES

- INTRODUCTION** ..... 104
- PROGRAMMING PROJECT: NEW PERSPECTIVES ON NEARBY STARS**  
*by Bruce Webster* ..... 106
- This program, developed on a Macintosh using MacAdvantage:UCSD Pascal, takes a list of stars and shows you where they are in respect to one another.
- LIQUID-CRYSTAL DISPLAYS FOR PORTABLES** *by Glenn J. Adler* ..... 119
- The author presents an in-depth look into the workings of LCDs.
- PRODUCT DESCRIPTION: THE GRIDCASE** *by Rich Malloy* ..... 129
- One member of this family of portables has a gas-plasma display.
- CIARCIA'S CIRCUIT CELLAR: LIVING IN A SENSIBLE ENVIRONMENT**  
*by Steve Ciarcia* ..... 141
- Steve looks into his junk box for items to use with the Home Run Control System.
- PROGRAMMING INSIGHT: TRAVESTY REVISITED** *by Murray Lesser* ..... 163
- Travesty is rewritten in compiled BASIC.
- PROGRAMMING INSIGHT: REAL-NUMBER FORMATTING YOUR APPLE**  
*by Brent Daviduck* ..... 171
- Specify the decimal length of any real number.

## THEMES

- INTRODUCTION** ..... 176
- UPDATING THE OLDEST SCIENCE** *by Russell M. Genet* ..... 179
- Observers around the globe are using microcomputers in a variety of astronomical applications.
- MICROCOMPUTERS IN NASA'S SIR-B** *by Richard Wilton* ..... 192
- The Shuttle Imaging Radar experiment employs a network of personal computers for data acquisition and analysis.
- COMET LINES IN FORTRAN** *by David S. Dixon* ..... 203
- The program described calculates the positions of asteroids and comets.
- TRACKING EARTH SATELLITES** *by E. H. Weiss* ..... 215
- The Stumpff program can help you calculate earth-orbiting satellite positions with high precision.
- AUTOMATING A TELESCOPE** *by Louis J. Boyd* ..... 227
- A codirector of the Fairborn Observatory describes ways of computerizing the repetitious tasks in variable-star photometry.
- ASTRONOMICAL COMPUTING WITH MICROS**  
*by Richard Bochonko and William T. Peters* ..... 239
- Small systems increase the amateur astronomer's reach.
- ASTRONOMY SOURCES** ..... 244
- AN ASTRONOMY GLOSSARY** ..... 245

## REVIEWS

- INTRODUCTION** ..... 248
- REVIEWER'S NOTEBOOK** *by Glenn Hartwig* ..... 251
- TEXAS INSTRUMENTS' PRO-LITE PROFESSIONAL COMPUTER**  
*by Richard Grehan and Eva White* ..... 252
- A briefcase-size machine that runs MS-DOS.

BYTE (ISSN 0360-5280) is published monthly with one extra issue per year by McGraw-Hill Inc. Founder: James H. McGraw (1860-1948), Executive, editorial, circulation, and advertising offices: 70 Main St., Peterborough, NH 03458, phone (603) 924-9281. Office hours: Mon-Thur 8:30 AM - 4:30 PM, Friday 8:30 AM - 1:00 PM, Eastern Time. Address subscriptions to BYTE Subscriptions, POB 590, Martinsville, NJ 08836. Postmaster: send address changes, USPS Form 3579, undeliverable copies, and fulfillment questions to BYTE Subscriptions, POB 590, Martinsville, NJ 08836. Second-class postage paid at Peterborough, NH 03458 and additional mailing offices. Postage paid at Winnipeg, Manitoba, Registration number 9321. Subscriptions are \$21 for one year, \$38 for two years, and \$55 for three years in the USA and its possessions. In Canada and Mexico, \$23 for one year, \$42 for two years, \$61 for three years. \$69 for one year air delivery to Europe, 17,100 yen for one year surface delivery to Japan, \$37 surface delivery elsewhere. Air delivery to selected areas at additional rates upon request. Single copy price is \$3.50 in the USA and its possessions, \$3.95 in Canada and Mexico, \$4.50 in Europe, and \$5 elsewhere. Foreign subscriptions and sales should be remitted in United States funds drawn on a U.S. bank. Please allow six to eight weeks for delivery of first issue. Printed in the United States of America.

<b>NCR PERSONAL COMPUTER MODEL 4</b> by Elaine Holden .....	258
An IBM PC-compatible with a RAM-disk utility.	
<b>MONITORING HALLEY'S COMET</b> by John E. Mosley .....	265
Three programs for tracking the return of the celestial visitor.	
<b>SPACE-FLIGHT SIMULATORS</b> by Benjamin Bernar .....	269
Link up with a space station or travel to Saturn.	
<b>MAXTHINK</b> by William Hershey .....	279
An outline processor for the IBM PC.	
<b>THE ANCHOR AUTOMATION SIGNALMAN MARK XII MODEM</b> by George V. Kinal .....	287
It's similar to the Hayes Smartmodem but not fully compatible.	
<b>REVIEW FEEDBACK</b> .....	295
Readers respond to previous reviews.	

## KERNEL

<b>INTRODUCTION</b> .....	306
<b>COMPUTING AT CHAOS MANOR: COME TO THE FAIRE</b> by Jerry Pournelle .....	309
Trips to shows and a visit with Niklaus Wirth highlight Jerry's month.	
<b>CHAOS MANOR MAIL</b> conducted by Jerry Pournelle .....	338
Jerry's readers write, and he replies.	
<b>BYTE WEST COAST: SNOBOL AND ICON</b> by Ezra Shapiro .....	341
Our West Coast staff interviewed one of SNOBOL4's authors, Ralph E. Griswold, who has gone on to create a new language called Icon.	
<b>BYTE U.K.: STARLIT SPECTRUM</b> by Dick Pountain .....	353
Dick reports on an astronomical application for the Sinclair Spectrum.	
<b>BYTE JAPAN: PERIPHERALS, CHIPS, AND NEW COMPUTERS</b> by William M. Raiké .....	363
Bill looks at the Silver-Reed EB50, Fujitsu's new optical-disc coating material, and more.	
<b>ACCORDING TO WEBSTER: STARTUP</b> by Bruce Webster .....	367
The debut of this column covers an assortment of Macintosh products.	
<b>MATHEMATICAL RECREATIONS: PARSING AND SOLVING LINEAR EQUATIONS</b> by Robert T. Kurosaka .....	385
Set up and solve simultaneous linear equations.	
<b>CIRCUIT CELLAR FEEDBACK</b> conducted by Steve Ciarcia .....	391
Steve answers project-related queries from readers.	
<b>BYTELINES</b> conducted by Sol Libes .....	393
News and speculation about personal computers.	

### EDITORIAL:

<b>EQUAL ACCESS TO COMPUTERS:</b>		<b>CLUBS &amp; NEWSLETTERS</b> .....	58
<b>SCRUPLES OR RUBLES?</b> .....	6	<b>BOOK REVIEWS</b> .....	65
<b>MICROBYTES</b> .....	9	<b>EVENT QUEUE</b> .....	85
<b>LETTERS</b> .....	14	<b>BOOKS RECEIVED</b> .....	395
<b>FIXES AND UPDATES</b> .....	33	<b>UNCLASSIFIED ADS</b> .....	461
<b>WHAT'S NEW</b> .....	39, 406	<b>BYTE'S ONGOING MONITOR BOX</b> <b>BOMB RESULTS</b> .....	462
<b>ASK BYTE</b> .....	48	<b>READER SERVICE</b> .....	463

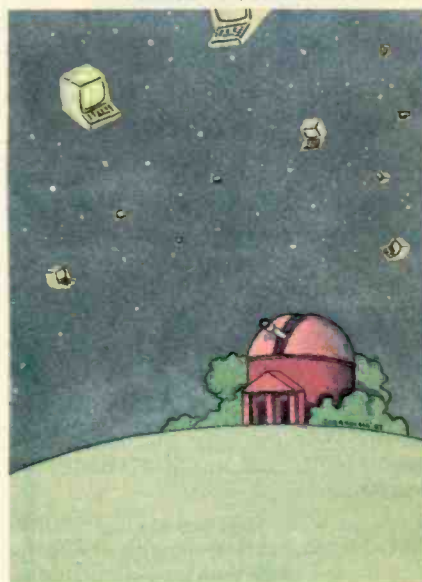

248



306

Address all editorial correspondence to the Editor, BYTE, POB 372, Hancock, NH 03449. Unacceptable manuscripts will be returned if accompanied by sufficient first-class postage. Not responsible for lost manuscripts or photos. Opinions expressed by the authors are not necessarily those of BYTE. Copyright © 1985 by McGraw-Hill Inc. All rights reserved. Trademark registered in the United States Patent and Trademark Office. Where necessary, permission is granted by the copyright owner for libraries and others registered with the Copyright Clearance Center (CCC) to photocopy any article herein for the flat fee of \$1.50 per copy of the article or any part thereof. Correspondence and payment should be sent directly to the CCC, 29 Congress St., Salem, MA 01970. Specify ISSN 0360-5280/85. \$1.50. Copying done for other than personal or internal reference use without the permission of McGraw-Hill Inc. is prohibited. Requests for special permission or bulk orders should be addressed to the publisher, BYTE is available in microform from University Microfilms International, 300 North Zeeb Rd., Dept. PR, Ann Arbor, MI 48106 or 18 Bedford Row, Dept. PR, London WC1R 4EJ England. Subscription questions or problems should be addressed to: BYTE Subscriber Service, POB 328, Hancock, NH 03449





## Can You Name a Dual-Drive Color PC That Runs Lotus 1,2,3 and Costs Under \$1500?

### Hints

- It comes with a 14" RGB monitor much like the 14" monitor that comes with the \$2495 Leading Edge PC.
- It has dual 800K disk drives much like the \$2495 Tandy 2000, but it also has the ability to read and write to popular 160K, 320K, and 360K IBM-PC formats.
- It's an 8088, MS-DOS system with 256K of RAM, but it comes with a better free software bundle than the 8-bit Kaypro including MS-DOS 2.11, HAGEN-DOS, DOS-TUTOR, WordStar 3.3, Easy Writer, Spell, Mail Track, PC File III, FILE-BASE, CalcStar, games, graphics, utilities, and two BASIC languages.
- Although it's not PC-DOS compatible it will run hundreds of the same programs as the IBM including dBASE II, Multiplan, the PFS series, Lotus 1,2,3 and even Flight Simulator.
- During the dog days of summer computer sales, we've lowered the prices of both our color and monochrome systems. You can receive a free booklet on these systems by calling our machine at 1-800-FOR A FOX, and leaving your name and address at the beep.

Your time is up the answer is:

Color Fox ..... \$1497  
 also  
 Fox Jr. ... \$899 Silver Fox .. \$1297



**Scottsdale Systems, Ltd.**  
 617 N. Scottsdale Rd. #B, Scottsdale, AZ 85257  
 (602) 941-5856

The Silver Fox is sold exclusively by Scottsdale Systems Ltd., 617 N. Scottsdale Road #B, Scottsdale, AZ 85257. Trademarks: Silver Fox, HAGEN-DOS, and Datamate, Scottsdale Systems Ltd., WordStar and CalcStar, Micropro International: MS-DOS, and Multiplan, Microsoft Corporation: FILEBASE, EWDP Software, Inc.: dBASE II, Ashton-Tate, IBM-PC, and IBM-PC DOS. International Business Machines Corporation. Ordering: Telemarketing only. Silver Fox price is for cash, F.O.B. Scottsdale, prices subject to change, product subject to limited supply. We accept purchase orders from Fortune 1000 companies and major universities with good credit add 2% Visa, Mastercard add 3%, AZ residents add 6%. Returned merchandise subject to a 20% restocking fee. Personal or company checks take up to 3 weeks to clear. No COD's or APO's.

# BYTE

## EDITOR IN CHIEF

PHILIP LEMMONS  
**MANAGING EDITOR**  
 GENE SMARTE

## CONSULTING EDITORS

STEVE CIARCIA  
 JERRY POURNELLE  
 BRUCE WEBSTER

## SENIOR TECHNICAL EDITORS

G. MICHAEL VOSE, *Themes*  
 GREGG WILLIAMS

## TECHNICAL EDITORS

THOMAS R. CLUNE  
 ION R. EDWARDS  
 RICHARD GREHAN  
 GLENN HARTWIG, *Reviews*  
 KEN SHELDON  
 RICHARD S. SHUFORD  
 JANE MORRILL TAZELAAR  
 EVA WHITE  
 STANLEY WSZOLA  
 MARGARET COOK GURNEY, *Associate*

ALAN EASTON, *Drafting*

## WEST COAST EDITORS

EZRA SHAPIRO, *Bureau Chief, San Francisco*  
 JOHN MARKOFF, *Senior Technical Editor, Palo Alto*  
 PHILLIP ROBINSON, *Senior Technical Editor, Palo Alto*  
 DONNA OSGOOD, *Associate Editor, San Francisco*  
 BRENDA McLAUGHLIN, *Editorial Assistant, San Francisco*

## NEW YORK EDITOR

RICHARD MALLOY, *Senior Technical Editor*

## MANAGING EDITOR

## ELECTRONIC PUBLISHING AND COMMUNICATIONS

GEORGE BOND  
**USER NEWS EDITOR, EAST COAST**  
 ANTHONY I. LOCKWOOD, *What's New*  
**USER NEWS EDITOR, WEST COAST**  
 MARK WELCH, *Microbytes*

## CONTRIBUTING EDITORS

JONATHAN AMSTERDAM, *programming projects*  
 MARK DAHMKE, *video, operating systems*  
 MARK HAAS, *at large*  
 RIK JADRNICKE, *CAD, graphics, spreadsheets*  
 MARK KLEIN, *communications*  
 ALASTAIR J. W. MAYER, *software*  
 ALAN MILLER, *languages and engineering*  
 JOHN C. NASH, *scientific computing*  
 DICK POUNTAIN, *U.K.*  
 WILLIAM M. RAIKE, *Japan*  
 PERRY SAIDMAN, *computers and law*  
 ROBERT STERNE, *computers and law*

## COPY EDITORS

BUD SADLER, *Chief*  
 DENNIS BARKER  
 ELIZABETH COOPER  
 ANNE L. FISCHER  
 NANCY HAYES  
 LYNNE M. NADEAU  
 PAULA NOONAN  
 JOAN VIGNEAU ROY  
 WARREN WILLIAMSON

## ASSISTANTS

PEGGY DUNHAM  
 MARTHA HICKS  
 BEVERLY JACKSON  
 LISA JO STEINER

## ART

ROSSLYN A. FRICK, *Art Director*  
 NANCY RICE, *Assistant Art Director*

## PRODUCTION

DAVID R. ANDERSON, *Production Director*  
 DENISE CHARTRAND  
 MICHAEL J. LONSKY  
 JAN MULLER

## SENIOR VICE PRESIDENT/PUBLISHER

HARRY L. BROWN  
**PUBLISHER'S ASSISTANT**  
 DORIS R. GAMBLE

## PERSONNEL

CHERYL HURD, *Office Manager*  
 PATRICIA BURKE, *Personnel Coordinator*

## ADVERTISING SALES (603-924-6137)

I. PETER HUESTIS, *Sales Manager*  
 SANDRA FOSTER, *Administrative Assistant*  
**ADVERTISING/PRODUCTION (603-924-6448)**  
 LISA WOZMAK, *Supervisor*  
 ROBERT D. HANNINGS, *Senior Account Manager*  
 MARION CARLSON  
 KAREN CILLEY  
 LYDA CLARK  
 MICHELE GILMORE  
 DENISE PROCTOR  
 WAI CHIU LI, *Quality Control Director*  
 JULIE NELSON, *Advertising/Production Coordinator*

## CIRCULATION (800-258-5485)

GREGORY SPITZFADEN, *Director*  
 ANDREW JACKSON, *Subscriptions Manager*  
 CATHY A. RUTHERFORD, *Assistant Manager*  
 LAURIE SEAMANS, *Assistant Manager*  
 SUSAN BOYD  
 PHIL DECHERT  
 MARY EMERSON  
 LOUISE MENEGUS  
 AGNES E. PERRY  
 JENNIFER PRICE  
 JAMES BINGHAM, *Single-Copy Sales Manager*  
 LINDA RUTH, *Assistant Manager*  
 CAROL AHO  
 CLAUDETTE CARSWELL  
 KAREN DESROCHES

## MARKETING COMMUNICATIONS

HORACE T. HOWLAND, *Director (603-924-3424)*  
 VICKI REYNOLDS, *Marketing Production Manager*  
 PRISCILLA ARNOLD, *Marketing Assistant*  
 STEPHANIE WARNESEY, *Marketing Art Director*  
 SHARON PRICE, *Assistant Art Director*  
 DOUG WEBSTER, *Director of Public Relations (603-924-9027)*  
 WILBUR S. WATSON, *Operations Manager, Exhibits*

## PLANNING AND DEVELOPMENT

MICHELE P. VERVILLE, *Manager*  
 PATRICIA AKERLEY, *Research Manager*  
 CYNTHIA DAMATO SANDS, *Reader Service Coordinator*  
 FAITH KLUNTZ, *Copyrights Coordinator*

## MANUFACTURING/FINANCE/SERVICES

DANIEL RODRIGUES, *Director*

## ACCOUNTING

KENNETH A. KING, *Assistant Controller*  
 VICKI WESTON, *Accounting Manager*  
 LINDA SHORT, *D/P Manager*  
 EDSON WARE, *Credit*  
 MARIE CAGGIANI  
 MARILYN HAIGH  
 DIANE HENRY  
 VERN ROCKWELL  
 JOANN WALTER

## TYPOGRAPHY

SHERRY MCCARTHY, *Chief Typographer*

NAN FORNAL

LEN LORETTE

KATHY OUIST

DONNA SWEENEY

## BUILDING SERVICES/TRAFFIC

ANTHONY BENNETT, *Building Services Manager*

BRIAN HIGGINS

MARK MONKTON

## RECEPTIONISTS

L. RYAN MCCOMBS

CHERYL CASTRO, *Assistant*

**Editorial and Business Office:** 70 Main Street, Peterborough, New Hampshire 03458, (603) 924-9281

**West Coast Offices:** McGraw-Hill, 425 Battery St., San Francisco, CA 94111, (415) 362-4600

**New York Office:** 1000 Ellwell Court, Palo Alto, CA 94303, (415) 964-0624

**New York Office:** 1221 Avenue of the Americas, New York, NY 10020, (212) 512-2000

Officers of McGraw-Hill Information Systems Company: President: Richard B. Miller. Executive Vice Presidents: Frederick P. Jannott. Construction Information Group; Russell C. White. Computers and Communications Information Group; J. Thomas Ryan. Marketing and International. Senior Vice Presidents: Francis A. Shinal. Controller: Robert C. Violette. Manufacturing and Technology. Senior Vice Presidents and Publishers: Harry L. Brown. Computers and Communications; David J. McGrath. Construction. Group Vice President: Peter B. McCuen. Communications. Vice Presidents: Fred O. Jensen. Planning and Development; Margaret L. Dagner. Human Resources.

Officers of McGraw-Hill, Inc.: Chairman: Joseph L. Donno. President and Chief Executive Officer: Robert N. Landes. Executive Vice President and Secretary: Ralph J. Webb. Vice President and Treasurer: Donald L. Frueling. Executive Vice President, Publishing Operations Group: Ralph R. Schulz. Senior Vice President, Editorial: Walter D. Serwaika. Senior Vice President, Manufacturing and Circulation Services: Vice Presidents: Shel F. Asen, Manufacturing; George R. Elisinger, Circulation.

# Great Giff™ suggestion for under \$9,000:



It's the MC-186/EL™, Gifford's four-user entry level system—just \$8,995.

It's a complete multiuser system with a 23 megabyte hard disk. Just add terminals, turn it on, and start using over 100 Gifford productivity tools and utilities. You even get word processing, electronic mail, and telecommunications.

You can also run thousands of CP/M® programs (single and multiuser, 8- and 16-bit), and use it as a building block in a fast local area network with IBM PCs, compatibles, and other MC-186 family members.

Call 415/895-0798 for your nearest dealer. Or write to us at 2446 Verna Court, San Leandro, CA 94577.

The features make it a Giff. The price makes it a present.

 **GIFFORD**  
**COMPUTER SYSTEMS**  
A subsidiary of Zitel Corporation  
**THE MULTIUSER COMPANY™**

2446 Verna Court, San Leandro, CA 94577 / 415/895-0798 Telex 704521 2050 North Loop West, Suite 116 Houston, TX 77018 713/680-1944  
In Europe: London (01)878-9111 Telex 28106 (UK)

MC-186 and MC-186/EL are trademarks of Gifford Computer Systems. IBM PC is a trademark of International Business Machines, Inc.  
CP/M is a registered trademark of Digital Research, Inc.

## EQUAL ACCESS TO COMPUTERS: SCRUPLES OR RUBLES?

Computer inequity emerges as a genuine problem when you consider how hard it would be for a child without a word-processing program to compete with a student who does have a word processor. The student with the word processor can revise and polish far more than the student without. All other things being equal, a once-revised essay handwritten on notebook paper can't compete with a tenth-draft essay neatly printed by machine. Of course, word processing is only one of the many ways in which computers can make schoolchildren more productive and therefore give some children a competitive advantage in school and in life.

Is there, in fact, inequity in access to computers? The answer is "yes," and the inequity is a function of both income and race. The 12,000 most affluent schools are four times more likely to have personal computers than the 12,000 poorest schools (Quality Education Data report, 1983, quoted in *Electronic Learning*, February 1985). Predominantly white schools have twice as many computers as do schools whose students come primarily from ethnic minorities (Johns Hopkins study, 1983, also quoted in *Electronic Learning*, February 1985).

Soon after taking power, Soviet Communist party chief Mikhail Gorbachev called for the introduction of small computers throughout the Soviet school system. Clearly the new Soviet leader believes that the Soviet Union will be unable to compete with the West unless Soviet students have equal access to computers. The Soviet electronics industry is far from ready to meet the needs of Soviet students. The Soviet Apple clone known as AGAT (see the November 1984 BYTE,

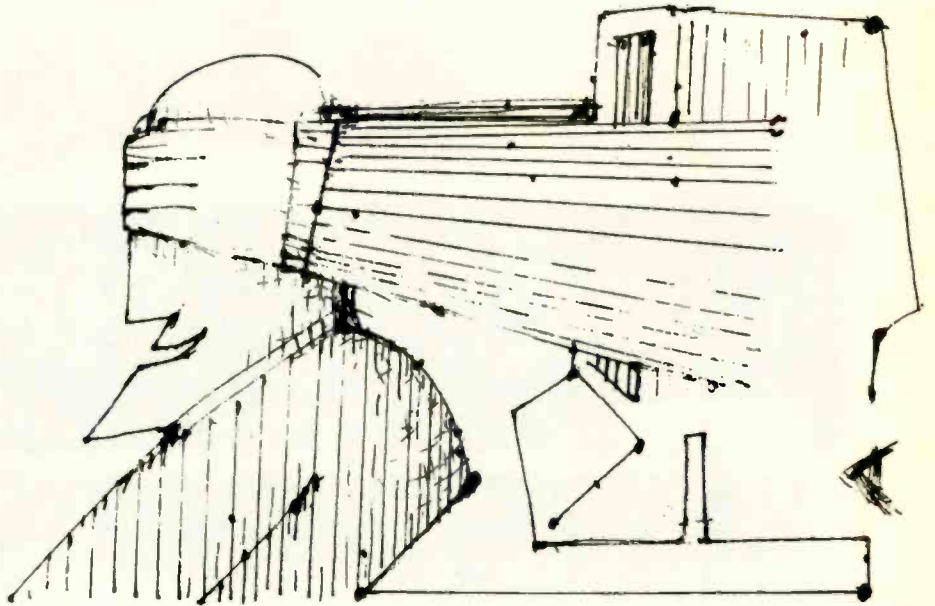

page 134), an inferior copy of a 10-year-old computer, is reportedly being manufactured in very small volume and with significant reliability problems, and it is said to sell for the equivalent of \$17,000. But some news reports have indicated that Apple and IBM may be negotiating large sales of personal computers to the Soviet Union.

If the American electronics industry is to solve the problem of computer inequity for the Soviet Union, why not for the disadvantaged of the West as well? DEC, Apple, IBM, Zenith, Tandy, and other companies have already made significant and commendable contributions to the American educational system. But many of these donations and subsidies have gone to organizations such as the Apple University consortium, made up mostly of expensive universities attended by the children of the affluent. IBM's joint projects with MIT and Carnegie-Mellon face the same criticism.

### PLAYING TO WIN

At the opposite extreme from industry-sponsored programs in prominent universities is an organization called

Playing to Win (106 East 85th St., New York, NY 10028). Playing to Win is a nonprofit organization dedicated to "promoting educational computer use among socially, economically, and geographically disadvantaged people." Antonia Stone, the director of Playing to Win, believes that there should be public access to computers just as there is public access to books and magazines in libraries. Playing to Win operates a community computer center in East Harlem.

We urge companies in the computer industry to support organizations such as Playing to Win. Supporting equal access will benefit the industry as well as the disadvantaged. Ms. Stone points out that providing public access to computers not only promotes equal opportunity, but also builds a larger long-term market for computer products.

Furthermore, overcoming computer inequity in the West makes much more sense in the long term than bringing the Soviet Union up to speed in computer technology. This is clearly a case in which scruples should outweigh rubles.

—Phil Lemmons, Editor in Chief





# Maxell Gold.

The floppy disk that  
packs more facts  
into Compaq,  
sets HP free,  
and takes IBM<sup>®</sup>  
Portable where it's  
never gone before.

It's great to have a portable computer. Especially when your data stays put. For error-free performance at home or abroad, trust Maxell. The Gold Standard in floppy disks. There's a Maxell disk for virtually every computer made. Each is backed by a lifetime warranty. Maxell. Accepted everywhere, without reservation.

**maxell**<sup>®</sup>  
IT'S WORTH IT.

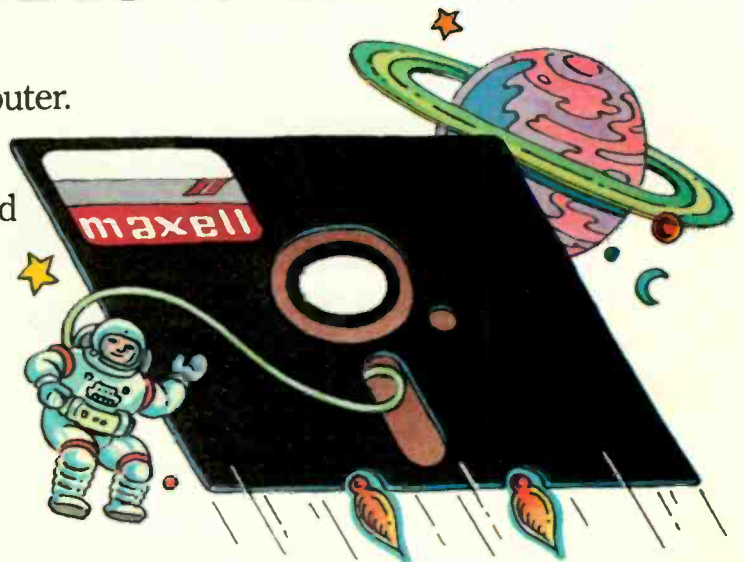

## YOUR DAYS OF BUYING TERMINALS ARE OVER!

Now there's SmarTerm terminal emulation software for your IBM\* PC, XT, AT or compatible system. All SmarTerm products offer comprehensive and exact terminal emulation, powerful ASCII and binary file transfer facilities, and include TTY mode to link you to The Source, CompuServe, Dow Jones, Easylink, Tymnet or other popular services. We've included features such as multiple setup configurations, XMODEM and PDIP\*

protocol support, "smart" softkeys, plus European DOS support.

# AFTER SMARTERM®, WHAT DO YOU DO WITH YOUR OBSOLETE TERMINAL?

**NEW! SmarTerm 220** supports A-to-Z and other software which requires DEC\* VT220 terminals. It includes the full capabilities of **SmarTerm 100**: DEC VT102, VT100, and VT52 emulation. If you need VT125 ReGIS graphics support, choose **SmarTerm 125**. For Data General Dasher\* D400, D200 or D100 emulation you need **SmarTerm 400**.

**SmarTerm 100** now available for:

- DATA GENERAL/One • IBM PCjr
- TANDY 2000 • TI Professional

More than 25,000 users are already "hooked" on SmarTerm. Try it for 30 days with full refund privileges, and you will be too.

Persoft, Inc. - Madison, WI  
(608) 273-6000 - TELEX 759491



**ORIGINAL FISH AD:** Back by popular demand! See your name in print! The best ideas for uses of obsolete terminals replaced by SmarTerm will be used in future ads. Write Persoft, Dept. FISH II, 2740 Ski Lane, Madison, WI 53713.

\*SMARTERM is a registered trademark of Persoft, Inc. \*PDIP is a trademark of Persoft, Inc. \*IBM is a registered trademark of International Business Machines Corp. \*DEC, VT and ReGIS are trademarks of Digital Equipment Corp. \*DASHER is a registered trademark of Data General Corp. \*DATA GENERAL/One is a trademark of Data General Corp. \*TI is a trademark of Texas Instruments Inc. \*TANDY is a trademark of Tandy Corp./Radio Shack

# persoft

# M·I·C·R·O·B·Y·T·E·S

---

Staff-written highlights of late developments in the microcomputer industry.

## **New Multiuser UNIX Systems**

---

Symmetric Computer Systems, San Jose, CA, is selling a 20-pound computer with a 32016 16/32-bit processor, one parallel port, four serial ports for up to four terminals, a 50-megabyte hard disk, a 1-megabyte floppy disk, and 2 megabytes of RAM. Included in the Model 375's price of \$9950 are compilers or interpreters for C, Pascal, FORTRAN, BASIC, LISP, Prolog, Crystal, and APL. It also includes SPICE, Ingres, and a number of UNIX/GENIX utilities. Although the machine is now available with National Semiconductor's GENIX implementation of Berkeley 4.1 or 4.2 UNIX, Symmetric plans to offer UNIX System V and Berkeley 4.3 versions later this year.

Cadmus Computer Systems, Lowell, MA, announced CadMac, a 68010-based workstation with a 17-inch 1024- by 1024-pixel display, a 65-megabyte hard disk, tape backup, a megabyte of RAM, and a Macintosh-compatible UNIX environment for \$23,300.

Digital Equipment Corp. introduced its expected MicroVAX II, which reportedly outperforms DEC's low-end VAX products. Prices for the MicroVAX II, while much lower than comparable VAX computers, still start at about \$20,000.

## **AT&T Offers 32-bit Processor to Other Companies**

---

AT&T announced that its WE32100 32-bit microprocessor, floating-point chips, memory-management chips, and other peripheral chips are now available to other companies. AT&T will also sell board-level evaluation systems based on the chips.

The WE32100 is an enhanced version of the WE32000 chip used in AT&T's 3B2/300 computer; the chip family was originally called Bellmac-32 when developed by AT&T's Bell Labs subsidiary before divestiture. The 132-pin WE32100 chip features a 64-word on-chip cache, a 4-gigabyte address space, 15 interrupt levels, 16 32-bit registers, and a full 32-bit bus. All of the new chips are available in 10- and 14-MHz versions. AT&T's chip is not related to National Semiconductor's 32000-series processors.

## **New 80286 Systems Flood COMDEX**

---

Late spring saw the introduction of many new IBM PC AT-compatible computers. By mid-May, new 80286-based systems had been announced by Kaypro, ITT, Compaq, TeleVideo, Corona, Texas Instruments, Zenith, NCR, Tomcat, and Basic Time. Another multiuser AT-compatible computer, available from MAD Computer in both floor and desktop models, will be sold only to other manufacturers. Wang also disclosed that it is developing an AT-compatible system.

Intertec, West Columbia, SC, has redesigned its HeadStart computer, replacing its 8086 processor with an 80286 and eliminating its 3½-inch disk drive. The HeadStart ATS's standard 256K bytes of RAM can be expanded to 3 megabytes; the computer also includes serial, parallel, and network interfaces. The basic HeadStart ATS is priced at \$1895 without disk drives. A dual 5¼-inch disk-drive add-on unit is \$495 extra. Intertec also announced several 80186-based file servers for its MultiLAN proprietary polling network; a \$695 interface card also allows IBM PCs to be attached to the network.

## **Network Products Announced**

---

IBM PCs and Macintoshes can communicate using two new networking products. 3Com announced EtherMac, which allows Macintoshes and IBM PCs to link 3Com's 3Server Ethernet network file server to AppleTalk networks. Another product, IBMacBridge from Tangent, is a \$595 expansion card with software linking the IBM PC to the AppleTalk network and Apple's LaserWriter printer.

Separately, Vianetics announced ViaNet, which links MS-DOS- and UNIX-based computers. Rather than requiring a central file server, ViaNet simply treats each node on the network as a separate disk subdirectory, addressable using standard MS-DOS or UNIX path names. ViaNet will be available only to other manufacturers; Tandy, Wang, and several other firms have already licensed the software.

(continued)

## Add-on Makers Support Expanded-Memory Specification

---

Many of the companies that make expansion cards for the IBM PC have announced memory cards that meet the expanded-memory-interface specification announced by Lotus and Intel in late April. Maynard Electronics, STB, Quadram, Tecmar, Mega-Omega Systems, Emulex/Persyst, and AST Research all announced boards supporting the specification, which uses bank switching to allow application programs to directly address up to 4 megabytes of RAM. Most cards will be available in midsummer. They will be priced from \$349 to \$399 with the first bank of memory installed and can be expanded to 2 megabytes each.

## Mosaic Unveils 1-2-3 Twin

---

Mosaic Software, Cambridge, MA, unveiled a \$145 spreadsheet it says is compatible with Lotus 1-2-3. Mosaic's Twin has a user interface and features similar to those in the Lotus product, but initial versions of the product will not be able to read and write 1-2-3 spreadsheet files. Rather than offering graphics identical to Lotus 1-2-3, Twin's graphics module is derived from earlier products the company developed.

Two other companies—Borland International and Paperback Software—are reportedly developing low-cost spreadsheet programs compatible with 1-2-3, but neither company has formally announced or set availability dates for those products.

## NANOBYTES

---

Congress has repealed a law requiring home computer owners to keep a complete daily log of computer use in order to claim business-use tax deductions. The law still requires some record keeping of computer use to support business-use claims. . . . **Novix Corp.**, Cupertino, CA, has unveiled the NC4000, an 8-MHz 16-bit microprocessor that executes FORTH words as its machine language. . . . **MicroPro** plans to introduce a new word processor in midsummer, priced at less than \$200. The company says the new program will have a user interface unlike those of WordStar and WordStar 2000. . . . **Acuity Computer**, Austin, TX, announced The Shell, a \$100 program that can either replace or enhance the Finder. . . . **Franz Inc.**, Berkeley, CA, planned to begin shipping Franz LISP for AT&T's UNIX PC this month. Franz also expects to provide a complete Common LISP for the UNIX PC by late August. . . . **Prometheus** unveiled a 512K-byte buffer plug-in card for its ProModem, which can be used to buffer incoming and outgoing electronic mail or as a printer buffer; the buffer also provides password and callback security features. The buffer card without memory is \$149 and can use 16K-, 64K-, or 256K-bit chips. . . . **Intel** is now providing samples of 10- and 12-MHz versions of the 80286 processor. . . . **Brother** unveiled the TwinWriter, a \$1300 printer with both daisy-wheel and dot-matrix print elements. . . . **ITT** and **NEC** both introduced new speech-recognition products for the IBM PC and compatible computers. ITT's \$1350 Voice Communications System can recognize up to 200 different words and also features voice playback and phone features. NEC's SAR-10 Voice Plus supports a 250-word vocabulary for \$1495. . . . **Apple** announced in April that it would stop production of the Macintosh XL, originally introduced as the Lisa in January 1983. . . . **Canon** announced the A-200, a \$2995 20-pound IBM-compatible transportable computer with an 80-character by 25-line LCD. Standard features include a built-in 300/1200-bps modem, composite video output, two 5¼-inch disk drives, parallel and serial ports, and 256K bytes of RAM. . . . **Linguistic Products**, The Woodlands, TX, announced two language-translation programs for the IBM PC. English/Spanish and Spanish/English programs are \$490 each or \$790 together. . . . **Kyocera**, which manufactures computer products for several other companies, announced its first retail product: a 1200-bps modem. The \$665 KM1200S will include a copy of Microsoft's Access communications program. Kyocera also announced a 10-page-per-minute, 300-dot-per-inch laser printer that it will sell to other manufacturers. . . . **Personal Touch**, San Jose, CA, announced a touchscreen that can be added to Apple IIs and IBM PCs through a standard joystick port. The Touch Window will cost \$200 for the Apple II and \$225 for the IBM PC when it is shipped later this year. . . . **Datran Corp.**, Los Angeles, CA, announced the Modem Accelerator, a \$795 card that encodes English words into tokens. Files encoded with the IBM PC expansion card are reduced to about one-third the original size. . . . **Micro Focus** has announced a Japanese-language version of its COBOL compiler for the IBM PC 5550 and PC AT. In Japan, the compiler is priced at about \$500. . . . **Edsun Laboratories**, Wayland, MA, offers a signal-converter VLSI chip that converts the Intel 80286's signals to work with less expensive 8088 peripherals. The CMOS EL286-88 allows the 80286 to operate at 8 MHz while interacting with 4.77-MHz IBM PC chips. In quantity, the chip costs \$44.



## If you buy a TI 855 printer now, you won't have to upgrade to one later.

Don't tack just any printer on your new PC for now, thinking that you'll get what you really need later. Start with the best, a TI 855 or TI 865 printer. That way you can put the money you'd have spent on a needless upgrade on some other smart investment.

You see, our OMNI 800™ Model 855 is actually three printers in one. For word processing, it delivers letter-quality printing that rivals the best daisy wheel printers around. For data processing, it prints at 150 characters per second. And for your graphics, it reproduces screen or

OMNI 800 is a trademark of Texas Instruments, Incorporated.

monitor images in the finest detail.

Of course, these advantages are all true of our TI 865 wide-carriage printer, too.

What's more, since our printers are among the easiest to use, you can utilize all the capabilities built into your PC and software right from the start. Instead of sometime later. You even have a choice of over 30 different plug-in type fonts, any three of which can be printed on the same page without ever stopping the printer! Just touch the control panel and it happens. Simple. So every document looks just the way you want it to. Professional.

As for reliability, TI printers are legendary. Just ask any major airline.

So don't downgrade your PC's performance with a printer you'll outgrow in a month. Get yourself a TI 855 or TI 865 printer now. It's easy. Just call 1-800-527-3500, ext. 801, for the TI Dealer near you.

  
**TEXAS  
INSTRUMENTS**

Creating useful products  
and services for you.



**If you own an Apple IIc,  
you'd have to add three more Apple IIc's,  
an Extra Keypad,  
30 Block Graphic Sets,  
Color Sprites,  
two more voices,  
four instruments,  
a Cartridge Port, a Joystick Port,  
and a Commodore 64...**



**to match the versatility, expandability  
and higher intelligence of the  
new Commodore 128**  
(and it costs less too).

The new Commodore 128™ personal computer is breakthrough technology at a breakthrough price. It outshines the Apple® IIc in performance capability, performance quality and price. It is expandable to 512K RAM. The IIc

doesn't expand. Commodore 128 has a numeric keypad built into its keyboard that makes crunching numbers a lot easier. And graphic and sound capabilities that far exceed those of the Apple IIc. But the most important news is that

Commodore 128 jumps you into a new world of business, productivity, education and word processing programs while still running over 3,000 programs designed for the Commodore 64™. That's what we call a higher intelligence.

**COMMODORE 128 PERSONAL COMPUTER**  
A Higher Intelligence

© Commodore 1985

# L·E·T·T·E·R·S

## AN INFRARED PYROMETER

In the process of completing a master's degree in engineering at the University of Tennessee at Chattanooga, we sought an interesting project for a thesis topic. The answer to this search was the Micro D-Cam that Steve Ciarcia presented in his Circuit Cellar column ("Build the Micro D-Cam Solid-State Camera"; Part 1, September 1983, page 20; Part 2, October 1983, page 67). We decided to use the Micro D-Cam as the basis for an optional infrared pyrometer. The results of our investigation were interesting, and we thought we would share them with you and your readers.

We used an Apple IIe and an infrared filter that was opaque to visible light with the Micro D-Cam. A heating element served as an infrared source. Thermocouples with a digital thermocouple meter measured the temperature of the heating element. The only real modification to the Micro D-Cam hardware was the optical filter that we attached to the lens that was supplied with the kit.

When we obtained the hardware we conducted a few experiments that showed that focusing the Micro D-Cam's lens with the optical filter on a hot object produced an infrared image. The exposure time was shortened as the object's temperature increased. The lowest temperature from which an infrared image could be produced was about 650° Fahrenheit.

After we tested the hardware, we modified the software that was supplied with the Micro D-Cam to display the percent of pixels that are on versus the total number of pixels (light-level percent) in an area of 56 by 64 pixels located in the center of the image. This area of the image was that where a temperature measurement of the object would be made. We then used the software to develop a calibration curve to relate temperature to light-level percent and exposure time. This calibration curve showed a nonlinear relationship between temperature and exposure time. For these measurements the light-level percent was kept between 45 and 55 percent. Once the calibration curve was obtained, an equation was developed using polynomial regression that would produce a temperature output based on

an exposure-time input.

When the calibration work had been completed, we modified the software for the Micro D-Cam so that on a real-time command the program would go to a pyrometer subroutine and loop, adjusting the exposure times until the light-level percent for the 56-by-64-pixel array area was between 45 and 55 percent. Once the light-level percent fell within the range established, the calculated temperature was displayed on the screen and the control of the Micro D-Cam was returned to the basic operating program.

The results of the exercise showed that the Micro D-Cam could be used as an optical infrared pyrometer when used in conjunction with an infrared filter. Due to the limitations of the laboratory equipment available, the calibration was for a temperature range of 750° to 900° F and the resulting equation was as follows: temperature of object F =  $9.12 \times 10^{-7} \times ET^2 - (.02815 \times ET) + 966.89$ , where ET is the exposure time in milliseconds. Later testing of the accuracy of the system yielded results within 6° of the actual temperature.

For anyone wishing to try this type of experiment a few items should be noted, based on our experiences. The development of the calibration curve is dependent on keeping the aperture and the distance between the lens and the object constant. The second item is that great care must be exercised in measurement of the object's temperature when developing the calibration curve. Due to the relatively long exposure time required for the infrared system, the temperature of the object tends to vary a few degrees; therefore the object needs to be thermally stable before the exposure is made.

Conclusions from our work indicate that the optic RAM encased in the lens assembly is capable of being used as an infrared detector, and when used with the Micro D-Cam it can serve as an optical infrared pyrometer. It is obvious from looking at other types of infrared pyrometers that there are other pyrometers available that are already calibrated and cost about the same as the Micro D-Cam. The Micro D-Cam, however, offers the hobbyist or experimenter a vision system that can, with

the use of an infrared filter, be turned into an infrared pyrometer.

VIRGIL THOMASON  
GERALD A. CAUDILL  
*Univ. of Tennessee at Chattanooga*

## MACINTOSH BASIC AVAILABLE?

The April 1984 BYTE carried an article by Scot Kamins about Macintosh BASIC (page 318) that excited me, so I called an Apple dealer and asked him when the product would be released. He informed me that it was scheduled for release in June 1984. This sounded reasonable, so I purchased a Macintosh. In the meantime, I've waited, and waited, and waited. Still no Macintosh BASIC.

Dealers do not seem to be able to get any information about Macintosh BASIC from Apple Computer. I've even purchased a nice book titled *Introduction to Macintosh BASIC* by Scot Kamins (Rochelle Park, NJ: Hayden Book Co.), which includes the following statement: "Apple believes that good books are important to successful computing. The Apple Press imprint is your assurance that this book has been published with the support and encouragement of Apple Computer Inc., and is the type of book we would be proud to publish ourselves."

The unavailability of Macintosh BASIC leaves me puzzled. Could Apple have purposefully delayed the introduction of its BASIC in order to allow Microsoft a chance to get wide distribution of its BASIC? Microsoft BASIC allows you about 15,000 bytes of space for a program, and the company has no compiler for it. The multiply/divide operates in double precision, which is too slow for my use. So, you

*(continued)*

**LETTERS POLICY:** To be considered for publication, a letter must be typed double-spaced on one side of the paper and must include your name and address. Comments and ideas should be expressed as clearly and concisely as possible. Listings and tables may be printed along with a letter if they are short and legible.

Because BYTE receives hundreds of letters each month, not all of them can be published. Letters will not be returned to authors. Generally, it takes four months from the time BYTE receives a letter until it is published.



# LEAVE THE COMPUTER... TAKE THE DRIVE!



## With Maynard's Transport™ — the Original Portable Hard Drive!

Now you can leave that heavy "portable" computer on the desk where it belongs and carry up to 20MB of data between home and office. Transport™ comes with easy-release cable and convenient carrying handle. Call or write today for product specifics.

### Your Assurance of Quality:

- plated media, double shock-mounted drive
- extensively tested against rigorous performance standards
- backed by industry-leading 1-year warranty

Available in 10MB or 20MB.

Purchase your Transport™ and receive a carrying case at no cost (limited time offer).



**TRANSPORT**  
PORTABLE HARD DRIVES BY MAYNARD ELECTRONICS

 **Maynard Electronics**

Shaping Tomorrow's Technology

430 E. SEMORAN BLVD., CASSELBERRY, FL 32707

305/331-6402

Inquiry 227



## A FULL C COMPILER FOR

# \$4995

The Ecosoft Eco-C88 compiler for the 8088 and MSDOS is going to set a new standard for price and performance. Consider the evidence:

Compiler	Eco-C88	Lattice (1)	C86 (1)
Seive	13	11	13
Fib	44	58	46
Deref	13	13	-
Matrix	21	29	27
Price	\$49.95	\$500.00	\$395.00

(1) *Computer Language*, Feb., 1985, pp.73-102. Reprinted by permission.

The Eco-C88 compiler is a full K&R C compiler that supports all data types and operators (except bit fields). Now look at the other features we offer:

- \* 8087 co-processor support using a single library. If you install an 8087 later, the software will use it without having to recompile.
- \* A robust standard library with over 150 functions, including transcendental, color, and others.
- \* OBJ output for linking with the MSDOS linker (LINK).
- \* Error messages in English - no cryptic numbers to look up. A real plus especially if you're just getting started with C.
- \* Easy-to-read and complete user's manual.
- \* Works with all IBM and compatibles running MSDOS 2.0 (or later).
- \* Plus many other features.

For \$10.00 more, we will include the source code for the C library functions (excluding transcendental). For an additional \$15.00, we will include our ISAM file handler in OBJ format (as published in the *C Programmer's Library*, Que Publishing). The discount prices for the library source and ISAM only apply at the time the compiler is purchased. Please add \$4.00 to cover postage and handling. To order, call or write:

**Ecosoft Inc.**  
6413 N. College Avenue  
Indianapolis, IN 46220  
(317) 255-6476





Eco-C (Ecosoft), MSDOS (Microsoft), UNIX (Bell Labs), CP/M (Digital Research), Z80 (Zilog), 8086, 8087, 8088 (Intel).

# TOTAL CONTROL:

## FORTH: FOR Z-80®, 8086, 68000, and IBM® PC

Complies with the New 83-Standard

### GRAPHICS • GAMES • COMMUNICATIONS • ROBOTICS DATA ACQUISITION • PROCESS CONTROL

- **FORTH** programs are instantly portable across the four most popular microprocessors.
- **FORTH** is interactive and conversational, but 20 times faster than BASIC.
- **FORTH** programs are highly structured, modular, easy to maintain.
- **FORTH** affords direct control over all interrupts, memory locations, and i/o ports.
- **FORTH** allows full access to DOS files and functions.
- **FORTH** application programs can be compiled into turnkey COM files and distributed with no license fee.
- **FORTH** Cross Compilers are available for ROM'ed or disk based applications on most microprocessors.

Trademarks: IBM, International Business Machines Corp.; CP/M, Digital Research Inc.; PC/Forth+ and PC/GEN, Laboratory Microsystems, Inc.



**Laboratory Microsystems Incorporated**  
Post Office Box 10430, Marina del Rey, CA 90295  
Phone credit card orders to (213) 306-7412



## LETTERS

can see I'm still waiting. Could you ask Apple if it would pay me interest on the money?

FRANK HARDISON  
Memphis, TN

## PUBLIC-KEY PATENT

As part of his article titled "Implementing Cryptographic Algorithms on Microcomputers" (October 1984, page 126), Charles Kluepfel described an implementation of the RSA Public Key algorithm and the BASIC code required. Unfortunately, he did not reference that this RSA Public Key Cryptosystem was patented by the Massachusetts Institute of Technology in 1983 (U.S. Patent 4,405,829). The worldwide exclusive license to this patent was then purchased from MIT by RSA Security Inc., a company founded by the inventors of the RSA algorithm to develop this technology.

Because the RSA algorithm has been published in academic journals, most people assume that it is in the public domain, similar to the DES algorithm. Unfortunately, some people have developed software and other products based upon the RSA algorithm without researching this point. Nevertheless, the patent exists and, in the opinion of our corporate attorneys, will be easily defended. As RSA Security Inc. paid a great deal of money for the exclusive patent rights, we plan to actively police the commercial use of the RSA algorithm.

The purpose of this letter is not to criticize either Mr. Kluepfel or BYTE for his article. Rather, the purpose is to make you aware of our patent position and ask for your help in educating your readership as to its existence. Based on Mr. Kluepfel's article, more people are going to start expending money and effort developing RSA-based software for commercial purposes. Regrettably, their effort will be wasted unless they obtain a sublicense from us. Therefore, we suggest you publish a reference to our patent in a future issue of BYTE to protect your readers from this lack of knowledge.

RALPH BENNETT  
President  
RSA Security Inc.  
Sunnyvale, CA 94087

## FOURIER RIPPLE

The article "Fourier Smoothing Without the Fast Fourier Transform" by Eric E. Aubanel and Keith B. Oldham (February, page 207) recalled my own experience with Fourier transforms as a graduate student in chemistry. In particular, the identification of the high-frequency terms as

(continued)

# The IBM-PC...

# HOT-LINE

## Two Exceptional Modems For Your IBM-PC

### Internal

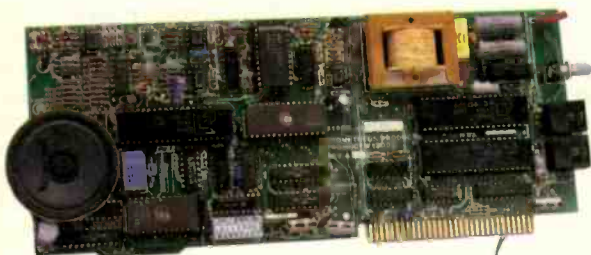

**Our ProModem 1200B  
Gives You A 3rd Serial  
Comport Free**

**\$399**

When you plug our \$399 1200/300 baud modem card into your IBM or Compatible PC, you suddenly have an additional serial Comport available to use.

This means you don't have to disconnect your printer, plotter or other serial device from Comport 1 or 2 when you use our ProModem 1200B to communicate with the outside world.

And that's just the beginning. The unit has a host of features such as auto answer and auto dial, programmable intelligent dialing, built-in speaker with volume control, help commands, extensive diagnostics, separate voice and data jacks, and Hayes command set compatibility.

If you check prices, you'll find our \$399 ProModem card costs less than modems that don't do nearly as much. ProModem 1200B comes with a sophisticated communications package from Mycroft Labs called "MITE" which provides for transfer of any type of text and binary files, with five error checking protocols including X-Modem. You can't lose. Buy our ProModem 1200B and get a Comport free!

### External

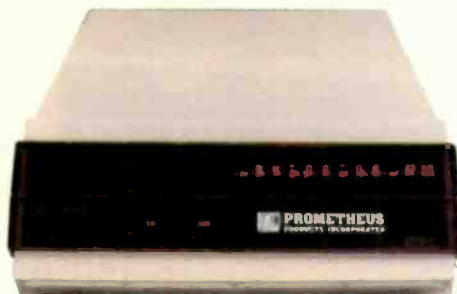

**Transfer 50 Pages Of Text  
Without Tying Up Your PC**

**\$495**

Priced at just \$495, our Hayes Compatible ProModem 1200 is the best 1200/300 baud standalone modem you can buy. It runs rings around Hayes and the rest.

One reason is our optional Communications Buffer and Alphanumeric Display which turn our ProModem into a veritable genius.

Imagine, unplugging your computer, taking it home for the weekend, and while you're gone having ProModem 1200 answer the phone, collect messages, send out electronic mail, and when you return, review all messages sent and received, and the exact time of each event. And we're talking about 50 pages of text or data!

Our \$99 Communications Buffer is a card that plugs into ProModem 1200's motherboard. It comes with 2K of CMOS battery backed-up memory, expandable to 64K. Part of the memory is used as a dialing directory, with the balance reserved as a buffer. Plus, for \$99 more an Alphanumeric Display can show time, date, and status and help messages.

Whether you go internal or external you'll be the winner if you choose Prometheus.



*The Hot Line*

**PROMETHEUS  
PRODUCTS INCORPORATED**

4545 Cushing Pkwy. • Fremont CA 94538

Call Now For  
Complete Info...  
**415/490-2370**

# Brainy Buffer.

**Do you press print and wait? And wait? And wait?**

Your waiting is over with the Universal Data Buffer — it frees your computer in seconds while it handles the printing of your file.

And the Universal Data Buffer from HanZon is smarter than the average buffer. For one thing it has two inputs—one serial and one parallel, and two outputs—one serial and one parallel. Since all the ports are active, it means the Universal Data Buffer can interface between serial and parallel devices — even at different speeds and protocols. All that is a bonus to

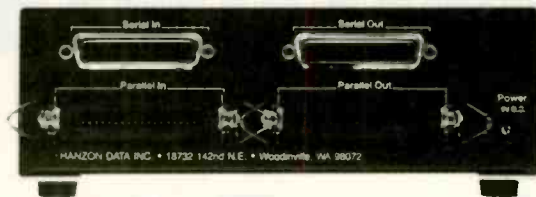

its standard function — as a 64K buffer expandable to 256K. The buffer also has operator controls for selecting additional copies, and pausing.

Call HanZon today for your nearest dealer: (206) 487-1717.



Suggested Retail Price: \$385 - 64K Buffer  
\$59 - 64K Expansion Module

HANZON DATA INC. • 18732 142nd Ave NE • Woodinville, WA 96072

## LETTERS

noise (I note that this is qualified with the word "usually") is not justified in the case of crystal x-ray scattering.

The noise in the examples Aubanel and Oldham discuss is typical Fourier ripple, which roughly centers around the function measured. Although this noise is a factor in x-ray structures, the more important noise is termination error caused by significant unmeasured high-frequency terms. Such noise does not generally interfere with obtaining atomic coordinates but can cause many spurious effects in an electron-density map. The high-frequency terms, in fact, primarily represent the innermost electrons; when they are missing, the unpresented electron density can, in principle, appear (i.e., be randomly smeared) anywhere in space, either under real atomic peaks or between atoms. Ironically, these innermost electrons are the least interesting, but the absence of the terms that represent them interferes with a good representation of the outer electrons.

The more general point, however, is that when using Fourier transforms, it is important to develop a "feel" for how they work. The integral of a function is entirely contained in the zero-order term. All the other Fourier terms add and subtract precisely equal quantities (because they are sine and cosine functions) of area or volume "under the function," thus "shifting" peaks and troughs. If the function has high narrow peaks or discontinuities, such as those in a molecular electron-density distribution, high-frequency terms will be necessary to adequately represent it. If the function is relatively smooth, such as those in your examples, low-frequency terms will represent it and high-frequency terms can, with some confidence, be attributed to noise. A caveat, however, is that there ought also to be noise, in principle, in the low-frequency terms. This noise will be expressed not as ripple around the function but in shifts of the peaks, either in height or position. Thus "smooth" functions may misrepresent the reality they describe, albeit hopefully by statistically small degrees of error.

STEVE GOLDFIELD  
San Francisco, CA

### CONVERSION CORRECTION

I have received a number of letters regarding my article "A Unit-Conversion Algorithm" (March, page 151). There were two problems with the published listing, and there is one point that I should clarify.

Line 310 of the listing on page 154 reads,

(continued)

## ULTIMATE PLACE FOR YOUR COMPUTER SOFTWARE AND COMPONENTS

### LOOK WHO WE SELL TO

Hughes Aircraft

Northrop

Rockwell International

IBM

Price Waterhouse

TRW

Plus Many More . . .

### AND WHAT WE SELL

Lotus 1-2-3

dBASE III

Hayes 1200B

Microsoft

Epson

Okidata

Anchor

Orchid Technology

Paradise

Plus Many More . . .

Call today for our quote — You'll be glad you did!

TOLL FREE OUTSIDE CALIF.

1-800-423-6326

IN CALIFORNIA

(213) 827-1851



## SOFTWARE GALORE, INC.

4079 GLENCOE AVENUE • MARINA DEL REY, CALIFORNIA 90292

# 4 Out Of 5 PC-AT™ Expansion Board Buyers Own Advantage!™

The overwhelming choice of IBM® PC-AT users, Advantage! from AST sets the standard in high-powered multifunction enhancement. Advantage! was the first multifunction board for the PC-AT. And it remains the leader by providing millions of characters of memory capacity, two serial ports, a parallel port and a game port. All in a single expansion slot.

**First In Memory.** All it takes is Advantage! There's no need to add other cards or hard-to-find chips on your system board. Whether you have an 256K, 512K or 640K AT, our unique memory addressing technique lets you add up to 3 Megabytes of parity checked user memory efficiently and economically. For flexibility, Advantage! can use either 64K or 256K memory chips. And of course, it supports your AT's high performance 16-bit bus and faster program processing speed.

Now you can have the extra memory to run integrated business software such as Symphony™ and

Framework™ To make full use of new concept windowing software such as DESQ™ To utilize multitasking programs such as IBM's TopView™ or multiuser operating systems such as XENIX™ To handle larger amounts of data, faster. Or for RAM disks.

**First In I/O.** Here's all the I/O capability you need now, even if you're starting with a base model AT. Every Advantage! card includes an AT compatible serial port and a parallel port so you can connect printers, plotters, mice and modems. Or with the appropriate software, you can connect other terminals to create multiuser environments.

With our optional second serial port you can attach even more peripherals, while our optional game port lets you plug in joysticks and other cursor-control devices for business or just for fun.

**First In Quality.** AST's reputation is built on quality products, quality support and quality service. Our complete documentation means Advantage! is exceptionally easy

to install and use, but if it's not enough we're always here to help.

Four out of five buyers agree, the choice is Advantage!—only from AST. Ask your dealer, or call our Customer Information Center (714) 863-1333 for more information. AST Research, Inc., 2121 Alton Avenue, Irvine, CA 92714 TWX: 753699ASTR UR

## FEATURES

### Memory Expansion

- 128Kb to 3.0Mb in a single slot
- User Upgradeable with either 64K or 256K memory chips
- Split Memory Addressing rounds out AT's system memory to 640K and continues memory expansion at 1Mb

### I/O Expansion

- Up to 2 Serial Ports (1 optional)
- Parallel Printer Port
- Optional Game Port

**Advantage!**  
**Supports AT's Full Program Processing Speed**

Advantage! trademark of AST Research, Inc. IBM PC-AT and TopView trademarks of International Business Machines Corp. Framework trademark of Ashton-Tate. Symphony trademark of Lotus Development Corp. DESQ trademark of Quarterdeck Office Systems. XENIX trademark of Microsoft Corp.

**AST**  
**RESEARCH INC.**



Inquiry 9 for End-Users.  
Inquiry 10 for DEALERS ONLY.



**INTRODUCING 5**

**WE INTERRUPT  
PRODUCT  
BRING**



# THIS MAJOR INTRODUCTION TO YOU SOMETHING REALLY IMPORTANT.

## THE BIG NEWS IN DISK/TAPE IS PC/T, A SENSIBLE NEW APPROACH TO ARCHIVAL STORAGE.

We've tamed tape. And made it docile. By making it DOS-like.

So, while this started as an ad for our five new HardFile™ subsystems, which deliver 25 to 80 megabytes of hard disk storage and 60 megabytes of tape backup, instead we want to introduce you to PC/T.™

PC/T is a new format that makes tape a more sensible storage solution for personal computers. It puts tape on line, in real time, for instant access. And frees your hard disk for your most current data.

You already know how to use PC/T. Because it responds to standard DOS commands.

Here's the big news: just like any DOS-controlled hard or floppy disk, PC/T enables you to create directories and files on tape. Then you can call up the exact file you need, and change a portion of the tape without having to erase and overwrite the entire cartridge.

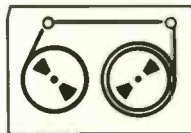

*Without PC/T, you have to rewrite the entire 60 MB cartridge each time you make a single change.*

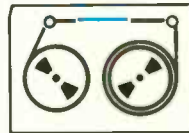

*With PC/T, you create and directly access files on tape, just like with floppy or hard disk.*

PC/T formats each new tape cartridge, just like you format any hard or floppy disk, locking out bad blocks to assure that every bit of data you write to tape is recorded with utter accuracy.

What's more, PC/T gives tape true error correction capability. 50% redundancy during write operations ensures 100% reconstruction of data lost because of operator error, dust and dirt, or everyday wear and tear.

There is a catch. You can get your hands on PC/T just one way: Buy one of our powerful new HardFile subsystems. With disk plus tape. Or tape alone. Which brings us back to where we started. And gives you a place to start. Just call 1-800-228-DISK for the Tallgrass dealer nearest you.

**TALLGRASS SELLS MORE HARD DISK  
STORAGE WITH CARTRIDGE TAPE  
BACKUP THAN ANYONE IN THE  
WORLD.**



**TALLGRASS®  
TECHNOLOGIES**

COMMITTED TO MEMORY

Inquiry 348

HardFile™ and Tallgrass™ are trademarks  
of Tallgrass Technologies Corporation  
© 1985 Tallgrass Technologies



# NUMBER SMASHER

**Speeds Up Everything...Especially 1-2-3™!**

The MicroWay NUMBER SMASHER triples the speed of all cpu bound software while doubling the speed of 8087 bound software. When combined with MicroWay's FASTBREAK™ it results in an increase in the speed of 1-2-3™ of up to 80 to 1! If you're tired of WAITing, the SMASHER is the card for you!

The heart of the NUMBER SMASHER is a 9.54 mhz 8086 working with a matched high speed 8087. The card comes standard with 512K of 16 bit RAM and can be expanded to 640K. It triples the throughput of your original 8088 by doubling the system clock speed and quadrupling the data bus bandwidth.

Software compatibility is guaranteed by the nature of our card. It does not augment the 8088, but replaces it with a special 8086 that runs as a true 16-bit processor in the first 640K of ram and as an 8-bit processor everywhere else.

Examples of software which show dramatic speed-ups include AUTOCAD, 1-2-3™ worksheets which depend heavily on financial or transcendental functions, and multi-user operating systems. Any program written with an MS-DOS compiler that supports the 8087, such as MS-FORTRAN or 87BASIC, will run on the NUMBER SMASHER at least a factor of 2.5 times faster! Software that comes with the card also increases the throughput of I/O bound programs and includes a disk cache routine, ram disk and print spooler.

The NUMBER SMASHER is an upgrade product for 8088 based PCs and compatibles. It works on the IBM-PC and XT, the COMPAQ and compatibles manufactured to the IBM-PC hardware standard. Contact MicroWay or your local MicroWay Installation Center for technical specifications and supporting benchmarks.

**Micro  
Way**

*The World Leader in 8087 Support*

P.O. Box 79, Kingston, Mass. 02364 USA (617) 746-7341

NUMBER SMASHER and FASTBREAK are trademarks of MicroWay, Inc. LOTUS and 1-2-3 are trademarks of Lotus Development Corp.

Inquiry 248



## LETTERS

in part. OR X + LEN(I\$). This should be OR X > LEN(I\$). The program will not work at all without this correction. Most of the letters I received indicated this error.

The PRINT CHR\$(12) that occurs in lines 10, 130, and 4000 deserves some clarification. First of all, in most versions of BASIC, the CLS statement is preferable. Unfortunately, the version of the BASIC compiler that I was using did not accept the CLS statement. The PRINT CHR\$(12) worked with both interpreter and compiler. As I prefer to have only one active version of the program, and I don't like distributing what I don't run, the PRINT statement was submitted to BYTE. Also, line 130 is unnecessary in the MS-DOS version. The TRS-80 version prints some material between lines 10 and 130 that is not needed with MS-DOS. I left the line in to minimize the differences between the two versions.

I hope these comments are useful to you.

DAVID L. KAHN  
Newton Highlands, MA

### TERSE, TERSE, TERSE

Permit me to comment on Robert Kong Win Chang's one-page article "Build a Serial Card" (March, page 129) on building a serial card for the Sanyo MBC 550 computer.

Yes, BYTE, you did not title the article "Adding a Serial Card (to the Sanyo)." You verily said only "Build" a serial card. How we are supposed to actually add this to our Sanyos is obfuscated but may hopefully become the subject of a multipage article in a future BYTE.

How does the author expect us to get +12 volts, -12 volts, and +5 volts? From where? Do we simply plug the CN1 connector into the Sanyo and automatically get these voltages? Do we have to solder wires to the Sanyo? If so, where? (I am somewhat reluctant to attack *my* Sanyo with a soldering iron, with such an inadequate set of instructions from Mr. Chang!) How about sockets for the chips? Where does the perf board mount? How about a photograph? (Didn't Confucius say some time ago that a picture is worth a thousand words?) What kind of decoupling capacitors are used? (An electronic-supply catalog I have in my hand lists tantalum, polyester, metallized film, aluminum electrolytic, axial lead, radial lead, resin-dipped solid tantalum, high-frequency aluminum electrolytic, metallized polyester, stacked metallized film.

(continued)

# Data communication problem?

## Solve it with a BayTech multiport controller

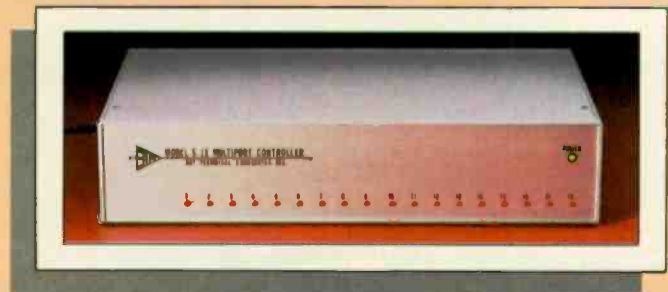

Fifty easy-to-use models for cost-effective, RS-232C serial port expansion.

- Adapt your micro to industrial control and data acquisition applications.
- Add more terminals to your existing computer system.
- Allow your computer to share or select printers.
- Enable your computers to use the same data communication lines by multiplexing.
- Simplify your network with any-device-to-any-device communication.

These intelligent multiports feature many user-programmable functions and are available in 5, 9, 12 and 18-port sizes, \$279 to \$1,795.

Call or write for complete details.



**BAY TECHNICAL ASSOCIATES, INC.**  
DATA COMMUNICATIONS PRODUCTS

800/523-2702 or 601/467-8231

Highway 603, P.O. Box 387, Bay Saint Louis, Mississippi 39520  
Telex: 910-333-1618 EasyLink: 6277-1271

and disc capacitors, all in a bewildering array of voltages, tolerances, and prices!) Additionally, I find literally dozens of different types of DB-25 connectors offered by as many manufacturers.

How is an ordinary reader—and you have hundreds of thousands of readers who are not experts—expected to follow such extremely abbreviated instructions (a total of only 84 words!)?

I am not being picky. It is just that as shown and as printed, your article leaves a lot to the imagination and leaves an unsophisticated reader up the proverbial estuary without a utensil for propulsion!

The article is bound to attract many readers. Obviously Sanyo (using typical contemporary marketing strategy) did not include a serial port as standard equipment so as to advertise a low come-on

price to attract buyers. And since the Sanyo 55X series computers have such a good price/performance ratio anyway, they will probably sell by the millions.

However, having a serial interface to enable connection of a modem is becoming more and more indispensable in computing. The Sanyo RS-232C board, even at discounters, is still around \$75. So, a probable high percentage of Sanyo owners, who bought a Sanyo in the first place because it did offer a lot for a low price, will want to add serial capability, and at a cost lower than Sanyo's \$75 to \$100.

Do your readers a favor, though, and make it easier and simpler to construct this good-idea serial card!

BERNARD A. MCILHANY  
Marble Hill, GA

Robert Kong Win Chang replies:

I would like to make a number of comments. First, there is absolutely no need to attack or otherwise mistreat the Sanyo with a soldering iron; once the board has been built (preferably some distance from the Sanyo to avoid eventual solder splashes!), follow the instructions detailed in the Sanyo Operator's Guide, chapter 6; page 6-3 describes how to remove the cabinet cover, whereas pages 6-15 to 6-18 show how to install the RS-232C board and how to program the correct data rate. Instead of the "blue line" mentioned in the manual, read "wire 1," i.e., the wire connecting pin 8 of ICI to pin 1 of the CNI connector.

As can be seen from the schematic of figure 1 in my article, all the pin assignments of the CNI connector on the motherboard are listed; in particular, they show that all voltages and signals required for the correct operation of the serial card are provided through this connector by the Sanyo—all that is required for installing the serial card in the Sanyo is to screw the card to the rear panel of the machine and then to plug the ribbon header socket onto the CNI connector on the motherboard as described in the manual. It is as simple as that!

As far as the actual building of the card is concerned, I am afraid that I assumed wrongly that all readers interested enough to build the card would have the required background to do so. However, I tend to believe that Mr. McIlhany is somewhat too harsh in his criticism about the lack of details for nontechnical readers; no recent article in BYTE describing a hardware project has given the low-level details that he seems to require.

(continued)

## Swap diskettes with popular CP/M\* computers!

Just \$69.95 turns one of your PC's floppy drives into a CP/M computer "look-alike" with UniForm-PC.

Imagine a software breakthrough that gives your IBM PC, PC-XT, PC-AT or compatible the ability to *directly* read, write and format diskettes from most popular CP/M computers—8 or 16 bit! Remarkable UniForm-PC actually reconfigures your floppy drive to emulate the selected CP/M format, allowing your applications programs and utilities to directly access data files that were previously out of reach.

Menu-driven UniForm-PC is easy-to-use and inexpensive. Simply load, select the proper diskette format and go! DOS procedures are unchanged when you use the CP/M diskette. You can even start a project on a PC at work and finish it on a CP/M machine at home without the need for additional hardware or modifications! At just \$69.95, CP/M compatibility never cost so little!

UniForm-PC is available now from your local computer dealer or Micro Solutions.



For CP/M computer owners, UniForm bridges the gap between non-compatible CP/M formats, as well as providing access to MS-DOS\*\* files. It's also just \$69.95.

Trademarks:  
\*Digital Research  
\*\*Microsoft Corporation

### MicroSolutions

125 South Fourth St.  
DeKalb, IL 60115  
815/756-3411

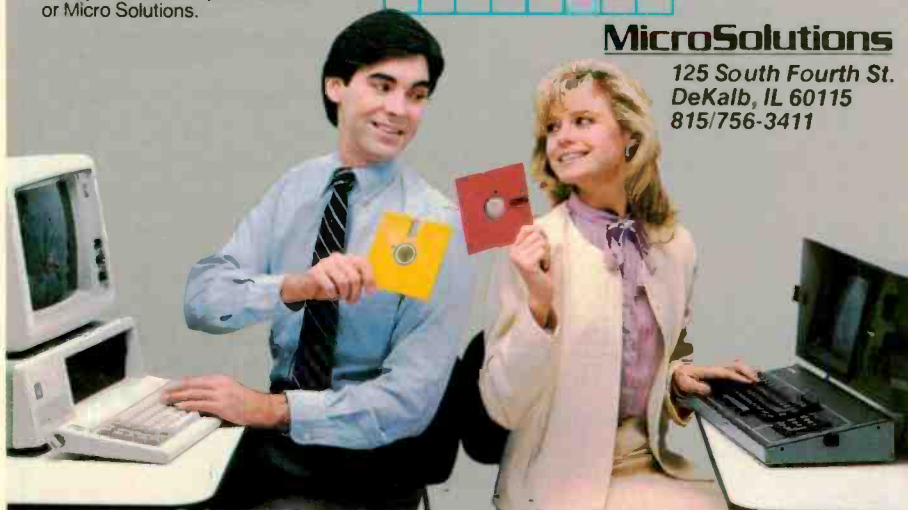



Hook up different types of computers so users can exchange information and transfer files. Share expensive resources like disks and printers. Let several people use a PC at the same time.

Keep your favorite DOS applications. With The CONNECTOR™ you can run DOS and UNIX™ applications at the same time.

For a standalone PC UNIX solution, try VENIX/86™. This lean, clean UNIX engine offers the best cost/performance system available for personal computers. Including IBM's Compatibles, AT&T 6300's, and DEC PC's.

Bogged down scheduling appointments? The Skeduler™ will find a common available time and notify everyone. It also tracks and reminds you of personal appointments.

In-house typesetting can save you time and money. With LaserLink™ it's a breeze. There's no programming to learn or long, complicated codes to key in.

Choose from a quality selection of Multi-user business applications—like UNIFY™—which give you powerful productivity software even a non-programmer can use. And we provide total support with an 800-user hotline.

All this from a single source—Unisource—your complete Unix software solution company.

Call 617-491-1264

**UNISOURCE**

Getting UNIX Software  
Down To Business  
Unisource Software Corp.,  
71 Bent Street  
Cambridge, MA 02141  
Inquiry 364

# Our software ties don't bind your personal computer.

And they're knot just for  
networking, multi-tasking,  
sharing and typesetting...



Nevertheless, I do sympathize with him, and I wish I could refer him to a good manual or article. As a service to BYTE readers, I am prepared to mail to interested hobbyists an assembled serial card upon receipt of a check for \$25 (write to me at the computer science department of Brandeis University, Ford Hall, Waltham, MA 02254). The extra \$10 should enable me to cover shipping expenses and to pay a computer science student to build and test the interface.

Sockets for the integrated circuits were not mentioned, though I did socket mine; the reason is that opinions differ on the usefulness/inconvenience of sockets and I preferred to leave the decision to the reader. I personally would recommend using sockets for all ICs so as to minimize the chances of damaging them by overheating during soldering. Besides, troubleshooting is made easier should any problem arise later on.

Almost any small low-voltage capacitors may be used in this project; I used small ceramic disc capacitors rated at  $0.01\mu\text{F}/16\text{V}$ —I bought 100 of these for \$6 as

these are commonly used components in digital circuits.

The choice of the DB-25 connector is not critical; however, the most convenient connector to use is a female one, of the "right angle PC solder" type. JDR Micro-devices sells them under the reference DB25SR. JDR also sell the 20-pin ribbon header socket under the reference IDS20.

One thing I did forget to mention was the location of pin 1 of the CNI connector on the motherboard to enable plugging the socket the right way. The orientation is the same as for all ICs on the motherboard, namely that, looking from the top and from the front of the Sanyo, pin 1 is the last one on the left row of pins.

MS-DOS 1.25 and 2.11 for the Sanyo do not provide adequate support for interrupt-driven serial input/output. Unless the user writes his/her own software to handle interrupts coming from the serial card, interrupt requests from the card should be disabled; the most convenient way to do this would be to

leave out the 74LS32 quad 2-input OR gate. Failure to disable interrupts (particularly from TxRDY) would cause the Sanyo to "hang up" when a modem is connected to the interface.

Finally, I would like to say that I agree with Mr. McIlhany that a picture is worth a thousand words; this is why the article contained a minimum number of words (only 84, as he pointed out) and conveyed (tersely, I must admit) most of its technical information in figure 1. Note that about 20 of the 84 words that make up the article convey a lot of implied information: "The card plugs into the Sanyo's serial-interface connector on the motherboard and works exactly like Sanyo's version."

#### RIGHTWRITER REBUKE

In the March Reviewer's Notebook column (page 245), Glenn Hartwig dismissed RightWriter because it did not like Hamlet or the Gettysburg Address. He missed the point. RightWriter is a tool to help make business writing strong, concise, and to

(continued)

## SLICER — THE SYSTEM THAT GROWS TO FIT YOUR NEEDS

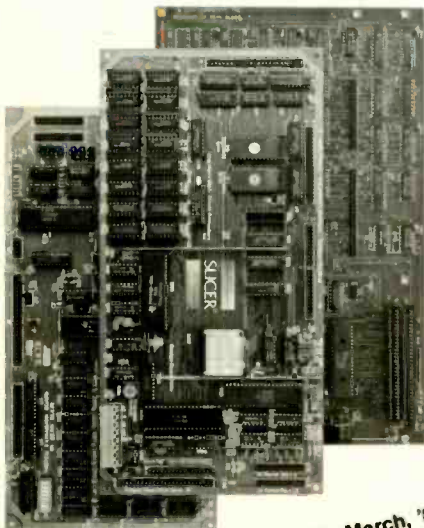

see BYTE, March, '85  
page 193

#### THE SLICER Real 16 Bit Power on a Single Board— Featuring the Intel 80186

- Complete 8 MHz 16-bit micro-processor on a 6" x 12" board
- 256K RAM, plus up to 64K EPROM
- SASI port for hard disk controller
- Two full function RS232C serial ports with individually programmed transmission rates—50 to 38.4K baud
- Software compatibility with the 8086 and 8088.
- 8K of EPROM contains drivers for peripherals, commands for hardware checkout and software testing
- Software supports most types and sizes of disk drives
- Source for monitor included on disk
- Bios supports Xebec 1410 and Western Digital WD 1002 SHD controller for hard disks

Fully assembled and tested only \$995  
Also available in several kit forms

#### THE SLICER SYSTEM EXPANSION BOARD For expanded memory, additional ports, and real time clock

- Up to 256K additional dynamic RAM
- 2 RS232C asynchronous ports with baud rates to 38.4K for serial communication



**Slicer Computers, Inc.**  
2543 Marshall St. N.E., Minneapolis, MN 55418  
612/788-9481 • Telex 501357 SLICER UD

- 2 additional serial ports for asynchronous RS232C or synchronous communication (Zilog 8530 SCC)
  - Real Time Clock with battery backup for continuous timekeeping
  - Centronics type parallel printer port
- Fully assembled and tested only \$750  
Available in several kit forms also

#### THE SLICER PC EXPANSION BOARD Gives your Slicer high performance video capability

- IBM compatible monochrome video
  - Video memory provides 8 pages of text or special graphics capability
  - 2 IBM type card slots for color video, I/O expansion, etc.
  - IBM type keyboard port
- Fully assembled and tested only \$600  
Available in several kit forms also

**Also available:** The  $\mu$ SLICER 188 \$700; 8087 Math Co-Processor Bd. (call); 10 MB Hard Disk \$700; W.D. 1002-SHD H.D.C. Bd. \$200; Enclosures, Power Supply, and Support Hardware.

Operating systems are CP/M 86 by Digital Research, Inc. (\$85), and MS DOS by Microsoft Corporation (\$175).

MasterCard, Visa, Check, Money Order, or C.O.D. Allow four weeks for delivery. Prices subject to change without notice.

The SLICER Bulletin Board at 300/1200 Baud 612/788-5909

# Ven-Tel's Half Card™ modem is in all the best computers. Here's why...

Ven-Tel gives you lots of reasons to buy our Half Card™ modem for your IBM PC or compatible. The Half Card™ is a complete system that lets you communicate with other PCs, mainframes, and databases effortlessly. It includes Crosstalk-XVI® software. It's reliable. It's got all of the features you want. And it's a good value.

## Do You Own One of These Computers?

Chances are you do. And if you're thinking of buying a modem, consider the Half Card™. Because of its small size, the Half Card™ fits in more computers, including all of the models we've listed here. The Half Card™ is small, so it fits in short slots or long. That means you can save your long slots for other expansion uses.

## Effortless Communication

Each Half Card™ comes with Crosstalk-XVI® communications software, by Microstuf. It's the easiest to use, whether you're a beginner or an old hand, and the most powerful. A full on-line help menu makes using Crosstalk® for the first time a snap. It can turn your PC into a terminal on a mainframe computer with its powerful terminal emulation feature. It will even operate your PC when you're not there. You can call into an information service such as The Source or Dow Jones News Retrieval, or transfer files and electronic mail, all at the touch of a button. The Half Card™ connects your computer to the world. Effortlessly.

## More Modem for Your Money

When you buy the Half Card™ you don't need anything else. The Half Card™ is a complete communications package that includes a full-featured modem and the best known software on the market. Complete easy-to-understand instructions with full technical support on installation and use. And a very competitive price. The Half Card™ with Crosstalk-XVI® software, retails for only \$549.

## Features

- 1200/300 baud auto-dial, auto-answer.
- Uses the industry standard "AT" command set.
- Runs with virtually all communications software, including Smartcom II and PC Talk III and integrated packages such as Symphony and Framework.
- Includes Crosstalk-XVI® software.
- On-board speaker and extra phone jack for easy switching from voice to data mode.
- Selective tone or pulse dialing; full or half duplex.
- Automatic answer on any ring.
- True ring or busy signal detection.

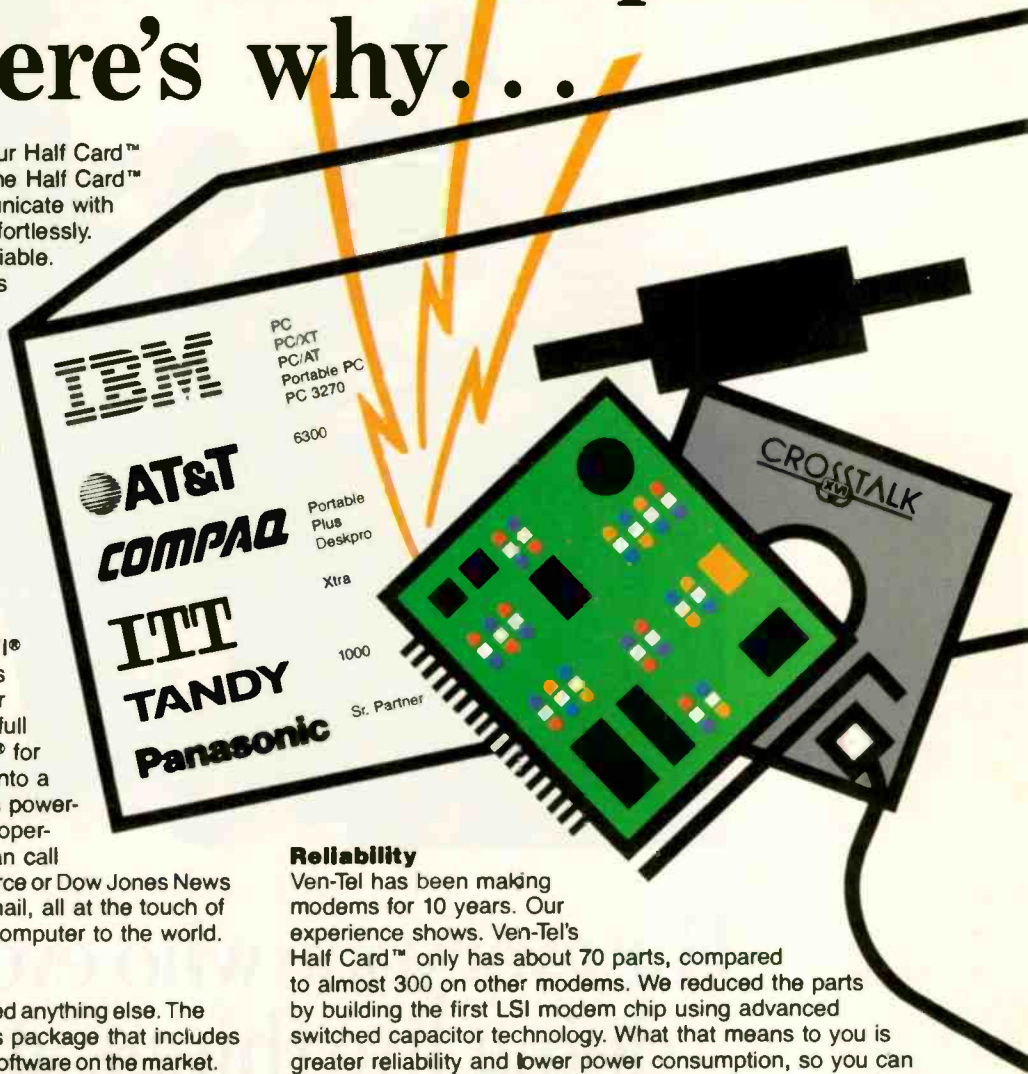

## Reliability

Ven-Tel has been making modems for 10 years. Our experience shows. Ven-Tel's Half Card™ only has about 70 parts, compared to almost 300 on other modems. We reduced the parts by building the first LSI modem chip using advanced switched capacitor technology. What that means to you is greater reliability and lower power consumption, so you can load up your PC with expansion boards and not worry about heat or power problems. And we back the Half Card™ with a full two-year warranty on parts and labor.

## You Can Buy the Half Card™ Anywhere

You can get the Half Card™ at Computer-Land, Businessland, the Genra Group, Entré Computer Centers, Macy's Computer Stores and other fine dealers nationwide. Also from Ven-Tel: the 1200 Plus™, an external modem and the PC Modem 1200™, an IBM internal with V.22 international capability.



## Effortless Communication

# Ven-Tel Inc.

2342 Walsh Avenue  
Santa Clara, CA 95051  
(408) 727-5721



## For everyone who ever tried doing five things at once

**The perfect computer program for someone as busy as you. It lets you keep several other programs working at once.**

Do you ever go in so many directions so fast not even a computer can keep up with you?

Well, now an IBM Personal Computer can—thanks to IBM TopView.

TopView is a new kind of software that lets you switch between other programs as quickly as you can change your mind, even run several programs at the same time.

Once you load TopView into your computer, you load the other programs you use most—as many as your computer's memory will permit.

After that, the greatest distance between two programs is just a couple of

keystrokes, or (optional) mouse moves.

There's no waiting and a lot less diskette swapping.

But when you're *really* busy is when TopView really shines, letting you do many jobs simultaneously.

For example, you can print a letter, while you search a file, while you analyze a spreadsheet, while your clock/calendar reminds you that your automatic dialer is about to place a call for you.



## ...IBM presents TopView.

And you can see everything through on-screen "windows" and control it all with easy-to-use pop-up menus.

You can even make unrelated programs work together; say a "Brand Y" spreadsheet with a "Brand Z" word processor.

But simplest of all is a certain "Brand IBM", namely the IBM Assistant Series—for filing, writing, planning, reporting and graphing.

Many other popular programs also work with TopView, and the number is growing.

Naturally, the more computer memory you have, the more TopView can help you. At least 512K is recommended.

And the price is only \$149\*.

Beyond that, all you need is to be the kind of person who never does a single thing all day, but who wants to do everything, at once.

To learn more, call an IBM marketing representative, or visit an IBM Product Center or Authorized IBM PC or Software Dealer.

For the store nearest you, and a free brochure, call 800-447-4700. (In Alaska and Hawaii, 800-447-0890.)

Personal Computer Software

\*IBM Product Center price.

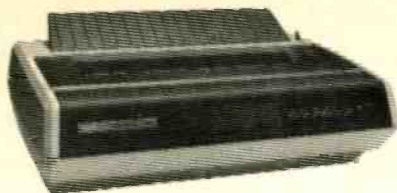

Xerox D25 Diablo daisywheel printer - **\$545**  
**Get daisywheel letter quality  
 at dot matrix prices with  
 the new Diablo D25 from MTI.**

This quiet, 25 cps daisywheel printer performs a full range of word and data processing tasks. Its all-purpose interface makes the Diablo D25 compatible with virtually any microcomputer on the market.

Diablo printers are known for their reliability, and the D25 is no exception. MTI is an authorized distributor for Diablo printers, so we can get these high-quality, inexpensive beauties to you quickly. Whether you buy, lease or rent, MTI is the one source for all the equipment you'll ever need. Call MTI and save.



A SUBSIDIARY OF DUCOMMUN INCORPORATED

**Computer & Data Communications Equipment  
 Sales / Leasing / Service / Systems Integration**

Digital Equipment Corp., Intel, Texas Instruments, AT&T, ADDS, Qume, HP\* Dataproducts, Diablo, Epson, Lear Siegler, Esprit, Wyse, Link, C.Itoh, PCI Rascal-Vadic, MICOM, Ven-Tel, Develcon, Control Data, Emulex, U.S.Design

<b>New York:</b> 212/226-2337 516/621-6200 518/449-5959	<b>New Jersey:</b> 201/227-5552 <b>Pennsylvania:</b> 412/931-9351	<b>Ohio:</b> 216/464-6688 513/891-7050 *Franchised areas only.	<b>Kentucky:</b> 502/449-6656 <b>California:</b> 818/883-7633
--	--	---	--

**All other areas: 800/645-6530**

XEROX®, DIABLO®, and the identifying numbers herein are trademarks of XEROX CORPORATION.

**The Dream,  
 Knee-top PC with APL Productivity  
 and Voice Networking too!**

**WS-1**  
 AMPERE



- Battery operation
- 8MHz 68000 CPU
- Up to 448K bytes of RAM
- 128K bytes of ROM
- 25x80 character LCD
- Bit-mapped graphics
- Multiple windowing
- Multitask, multitask OS for powerful networking
- Coherent DB-WP-CALC-Graphic software
- Intelligent phone function
- Microcassette voice/data storage

FOR DISTRIBUTORSHIP INFORMATION AND PRODUCT DETAILS PLEASE CONTACT

**ampere**  
 INCORPORATED

Asahi Bldg. 5-20, 7-chome Nishi-Shinjuku, Shinjuku-ku, Tokyo Japan  
 Phone: 03-365-0825, Telex: 03-365-0999, Telex J33101 AMPERE  
 IP, Sharp Mail Box Code AMP (Group Code APLW3)

U.S. Representative Office  
**WORK SPACE  
 COMPUTER INC.**

3848 Carson St Suite 301 Torrance California 90503, U.S.A.  
 Phone: 213-540-1553, Telex: 322800 WORK SPACE

**LETTERS**

the point. It will help produce better manuals, reports, and business correspondence. It is not meant for poetry or great works of literature. Would you want to see a user manual written in iambic pentameter? Would you write a report saying fourscore and seven more employees are needed for a project?

How about a real review on an important new product? I think your readers deserve it.

ROBERT W. DEPREE  
 Longboat Key, FL

*Glenn Hartwig replies:*

*Mr. DePree accuses us of missing the point of his product. In fact, we stated that the program could be used to advantage in "ordinary correspondence and reports."*

**WANT MY BUSINESS?**

The vast array of computer hardware and software now being marketed is so overwhelming that anyone venturing out to buy a computer system is soon overcome by a feeling of helplessness. The biggest and most frustrating problem encountered by the prospective buyer is the failure of companies in the computer field to provide any kind of information on their products.

A case in point: I have written to more than two dozen computer hardware and software companies for general and specific information, and only four saw fit to send me some literature. The rest did not even bother to acknowledge receipt of my inquiry. Apparently it doesn't matter that I am willing to spend up to \$13,000 for a CAD system. Hardly anyone seems to want my business. Why?

MANFRED F. KIRCHNER  
 Redmond, WA

**ELEGANT LOGIC**

In spite of many very bad experiences in responding to articles I have read in April issues of magazines, I am compelled to write in comment to Marvin Minsky's article "Communication with Alien Intelligence" (April, page 126).

I don't believe in the existence of intelligent civilizations other than ours in the universe; I have never seen any evidence or heard any argument in favor of them that I find embraceable; but Mr. Minsky's article is a delightful, optimistic viewpoint that makes me hopeful that we may, at least, yet find and be able to communicate with intelligent life here on earth. Mr. Minsky's article, though couched in the

(continued)



# HOW TO CONTROL THE RISE AND FALL OF POWER.

Your small business computer can give you the power to raise your productivity. But first you have to control the power you give it. Because even the slightest dip or surge of electricity can result in a shocking surprise. An instant loss of important data or misinformation. Even worse, a total power line failure can create department devastation... a total system crash. You can't afford errors, delays and other problems. After all, you've invested in a computer to increase efficiency. But now there's a solution you can afford. The Sola SPS. This economical, UL listed Standby Power System is designed to protect personal, micro and mini computers from AC line disturb-

ances and failures. Sola SPS provides clean, regulated AC power to your computer when your power line experiences irregular voltage. Line dips or line surges are immediately converted to proper voltage. When the AC line is present, the SPS filters power to eliminate electrical noise. And when the AC line fails, the SPS goes into full action, providing precise AC power to the load from its internal battery. So the only noise you'll hear is the sound of performance. There's no maintenance. No installation. No kidding. Just plug it in and turn it on. Why let your productivity rise and fall with your power? The solution is as simple as SPS. The standby system that Sola stands behind.



Write for free literature. 1717 Busse Hwy., Elk Grove Village, IL 60007 (312) 439-2800

**GS**  
A UNIT OF GENERAL SIGNAL  
**SOLA**

complex, esoteric rhetoric required of academic communication, makes its case with the same sparse, incredibly simple logic that is the core of its very argument: The simplest thing will always happen first. After reading Mr. Minsky's arguments, I am reminded of another bit of elegant logic which, strangely, now seems to be very wise: Anything that can happen will happen.

Mr. Minsky's article is typical of the kind of interesting, thought-inspiring, entertaining (though sometimes difficult) reading by which BYTE transcends the label "computer mag" and through which BYTE's readers can aspire to transcend the epithet "hacker."

There is, of course, also a very practical side to Mr. Minsky's article. If, some day, I turn to speak to an intelligent alien, I will

be able to do so from the reference point of similarity, rather than polarity. There is a world of difference.

ZACK T. HINCKLEY  
Rockledge, FL

**HONEST INTERPRETER**

The development and impact of computer hardware and software is so dazzling that one hardly knows which way to turn.

During calm moments I convince myself that if I had to select one and only one software utility (beyond the operating system), I would opt for an *honest*, easy-to-interact-with BASIC interpreter, one that would never take a single-precision value for  $\sqrt{2}$ , tack eight arbitrary numbers onto it, and fob it off as a double-precision number in a double-precision calculation.

HAL FALK  
New York, NY

**MAGIC SQUARES**

I read with interest Robert T. Kurosaka's Mathematical Recreations column ("Magic Squares," March, page 383) regarding magic squares and his computer program for generating odd-sided magic squares. Although his technique is powerful with respect to generating such squares for consecutive number entries, it is not able to generate squares for any desired magic number.

A number of years ago I was intrigued with the question as to whether a general solution exists for a magic square of order  $n$ . With the help of a college text on linear algebra—*Elementary Linear Algebra* by J. R. Munkres (Reading, MA: Addison-Wesley, 1964)—I was able to find the general solution of a magic square of order 3.

The general solution for a magic number equal to  $-a$  is

$$x_1 \quad x_2 \quad x_3$$

$$x_4 \quad x_5 \quad x_6$$

$$x_7 \quad x_8 \quad x_9$$

$$x_1 = -x_9 - \frac{2a}{3}$$

$$x_2 = -x_8 - \frac{2a}{3}$$

$$x_3 = x_8 + x_9 + \frac{a}{3}$$

$$x_4 = x_8 + 2x_9 + \frac{2a}{3}$$

$$x_5 = \frac{-a}{3}$$

$$x_6 = -x_8 - 2x_9 - \frac{4a}{3}$$

$$x_7 = -x_8 - x_9 - a$$

(continued on page 401)

# TATUNG

Terminals and monitors known by the companies they keep.



TVT-7220  
(VT-220 emulation)

CM-1370  
13" RGBI High Resolution

For quite some time we've been making terminals and monitors for some of the world's best known, most reliable and best selling computer systems. And we're proud of it! We're happy that our level of quality has become an accepted industry standard; that in almost every instance we've been able to exceed specifications without exceeding cost requirements. And we're delighted the quality of our CRT imagery has made

Tatung Terminals and Monitors an outstanding value. Now you can buy Tatung Terminals and Monitors with our name right up front. Compatible with all popular systems. With superior resolution, operational flexibility and day-in-day-out reliability. But, even more important to you, is that Tatung Terminals and Monitors are now priced to make them the most exceptional value you can buy.



U.C.M. COMPUTER PRODUCTS  
CANADA LIMITED  
7225 Woodbine Ave., Unit 119  
Markham, Ontario L3R 1A3  
(Canada only) 1-800-387-9678/  
1-416-475-1209 Telex: 06-986222

**TATUNG**

WESTERN MICRO SYSTEMS  
A Quality Distributor  
Serving the 13 Western States  
Western States 1-800-544-0020  
In California 1-800-338-1600

SEE US AT NCC — BOOTH 6380-6277

For complete information call toll free: 1-800-421-2929. In California, call (213) 979-7055.  
TATUNG COMPANY OF AMERICA, INC., 2850 El Presidio, Long Beach, California 90810.

COMPAQ doesn't make  
compromises. That's why we're  
still making history.

**COMPAQ**<sup>®</sup>



# Presenting the most capable

No other computer company has ever grown as fast as COMPAQ, because no computer company makes computers as powerful, as complete and as useful as COMPAQ. That's why the original COMPAQ Portable, COMPAQ PLUS,<sup>™</sup> and COMPAQ DESKPRO<sup>™</sup> became worldwide best sellers overnight. Now COMPAQ is introducing two new computers that advance the state of the art even further. While the original COMPAQ products remain cost-efficient cornerstones of business and professional use, especially for first-time buyers, the new products represent the utmost in performance for second-time buyers, or anyone who needs exceptional power and speed.

## Triumphs of advanced technology

The new COMPAQ PORTABLE 286<sup>™</sup> and COMPAQ DESKPRO 286<sup>™</sup>. Advanced technology puts them in a class all their own. With power, performance, speed, and expandability that exceed even the IBM<sup>®</sup> Personal Computer-AT.<sup>™</sup> They represent a new standard that makes others look

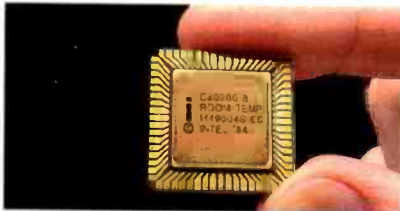

The new 80286 "chip" in COMPAQ 286 Computers processes data faster.

like what they are—the products of compromise. In fact, the new COMPAQ 286 Personal Computers can be considered the most useful in the world.

## Power with a bonus—portability

The COMPAQ PORTABLE 286 redefines portable computers. We gave it power to match IBM's most powerful desktop computer, the IBM PC-AT. Then we designed it to run all the popular programs and hardware designed for the IBM PC-AT. But we didn't stop there. COMPAQ pushed the technology further.

The COMPAQ PORTABLE 286

runs 30% faster. It can give you up to 20 Megabytes of internal fixed disk drive storage. And can come with features to make it even more useful. Like our *internal* fixed disk drive back-up system that protects 10 Megabytes of information on a single, pocket-sized tape cartridge.

But the most amazing thing about the COMPAQ PORTABLE 286 is that all these features come attached to a handle.

## Our most advanced desktop computer

Like the COMPAQ PORTABLE 286, the new COMPAQ DESKPRO 286 runs all the popular programs designed for the IBM PC-AT, 30% faster. And it can also come with our convenient *internal* fixed disk drive back-up system for added data protection.

But we didn't stop there. We weren't content to compromise. We wanted to make the new COMPAQ DESKPRO 286 a more powerful, more efficient stand-alone personal



# personal computers in the world.

computer, as well as a faster, more powerful, more useful file server. So we gave the COMPAQ DESKPRO 286 far more memory and storage capacity—over 8 Megabytes of RAM and 70 Megabytes of high-performance fixed disk storage.

## The legends continue

Not everyone will need the extra performance of the newest COMPAQ Computers. That's why we built our original line to last a long time.

These workhorses—the COMPAQ Portable, COMPAQ PLUS and COMPAQ DESKPRO Computers — are essential to many professional and business users. They run thousands of industry-standard programs developed for the IBM PC and PC/XT.™ They're indispensable tools in use on all seven continents (yes, even the South Pole!).

## Above all, no compromises

The unprecedented success of COMPAQ came as no accident. While

others built limited computers, COMPAQ built expandable computers.

While others took two screens to display high-resolution text and graphics, COMPAQ was the first to do it on one.

While others were looking for ways to cut corners, COMPAQ looked for ways to eliminate downtime by building the most rugged, reliable computers in the world.

The COMPAQ commitment to a philosophy of "no compromise" made the COMPAQ Portable and COMPAQ PLUS the world's best-selling 16-bit portable personal computers. In 1983 COMPAQ sold \$111 million worth of computers to achieve the most successful first-year sales of any company in American business history.

In 1984, we introduced the COMPAQ DESKPRO. In only four months, it became the second-best-selling 16-bit desktop business system in U.S. retail computer stores. And as a result, we've concluded the most successful second year of any computer company, with sales of \$329 million.

The reason for this success is simple.

COMPAQ computers have been recognized worldwide. Awards include:

- COMPAQ PLUS selected and voted Europe's 1984 Computer of the Year in the portable category.
- COMPAQ PLUS voted by readers of *PC WORLD* as their favorite product in its category in the "1984 World Class PC Contest."
- COMPAQ PLUS selected as the first-place winner in its category in the *Creative Computing Top 12 Computers of 1984 Awards*.
- COMPAQ Portable rated best personal business computer in overall user satisfaction by the Yankee Group market research firm opinion poll.
- COMPAQ DESKPRO named by *PC Week* magazine as one of the top ten products of 1984.

We offer people personal computers that simply work better. And make no compromises doing so.



# Introducing the new COMPAQ PORTABLE computer helps you

*Anyone can make a portable computer. But to make one that runs all the popular programs designed for the IBM PC-AT, 30% faster—in a package almost half the size—was no small challenge. But one COMPAQ welcomed.*

## **Go faster, go further**

The COMPAQ PORTABLE 286 is paced by the advanced technology of the 8-MHz, Intel 80286 microprocessor. This advanced technology has numerous advantages. One advantage is the flexibility to work with several different operating systems so you're not forced to choose a personal computer solely on that basis.

The advanced capabilities of this microprocessor become even more

apparent when you run complex programs. You can operate as part of a network. Or you can operate more than one program at the same time using multi-tasking software like IBM TopView™. And you can handle the most difficult problems with breathtaking speed.

For many scientific and engineering programs you have the ability to add an 80287 coprocessor, which offers even more speed.

Both offer dramatic speed increases over earlier microprocessors. The faster response time means less waiting, and more productivity.

## **Power in a package**

The COMPAQ PORTABLE 286 has the power of the IBM PC-AT. But the IBM PC-AT doesn't have a handle. Ours does. So it goes where you go. Works where you work. Whenever and wherever necessary. And it's easy to share with co-workers.

That's full-function portability, pure and simple.



*A COMPAQ PORTABLE 286 can leave the office when you do. Take your work wherever you go.*

## **Expandability without getting bigger**

All the devices that increase the capabilities of the COMPAQ PORTABLE 286 go on the inside—not the outside—of the computer.

You can get it with one or two half-



# 286. Our fastest, most powerful portable do more – anywhere.

height 1.2-Megabyte diskette drives. Although they can “read” diskettes formatted for 360-K byte diskette drives, they cannot “write” to them. Therefore, as an option, COMPAQ offers a 360-K byte diskette drive to let you exchange data with other industry-standard personal computers.

There’s an additional slot for a 20-Megabyte fixed disk drive. All COMPAQ Portable Computers offer fixed disk drive systems that fit *inside* the computer.

Another of our options: An *internal* fixed disk drive back-up system keeps a safety copy of your work, reducing the chance of losing your data. COMPAQ pioneered the system first in desktop computers, and now in portables.

The COMPAQ PORTABLE 286 even comes with a security lock feature that locks “on” to prevent interruption of a file transfer, or “off” to deny access to confidential information.

Because it’s a portable, self-contained unit, the computer can be easily stored away after use.



*Two data protection features from COMPAQ: an internal fixed disk back-up system that stores data on tape cartridges, and a security lock for locking keyboard access to your system on or off.*

## Who can use it?

If you’re an experienced user, you may be ready to upgrade your current equipment. The COMPAQ PORTABLE 286 gives you the latest technology.

For some, power is all-important: Speed, performance, and the ability to handle the most powerful software. All are leading qualities of the COMPAQ PORTABLE 286.

Starting a business? The COMPAQ PORTABLE 286 has tremendous data base capabilities to help you keep track of your inventory, your customers, your employees, your finances. Its exceptional storage capabilities make it ideal for the complexities of accounting. Its exceptional speed means greater networking ability. Its tremendous power enables you to get the edge on the competition.

In addition, large corporations can place several of these computers with field representatives to provide clients immediate information on current prices, product availability, even shipping dates and routing. So delivery shortages can be anticipated and avoided.

The COMPAQ PORTABLE 286 can also travel within the company. From office to office. Desk to desk. From accounting, to marketing, to research.

It’s powerful and versatile enough to do almost any job. Light enough to carry. And tough enough to survive lots of users.

## Established reliability

Despite its newness, the COMPAQ PORTABLE 286 is in many respects a proven product. It’s based on the rugged, reliable design of the original COMPAQ Portable and COMPAQ PLUS. Many of the construction techniques like cross-bracing components and shock-mounting disk drives are identical. All of which goes to prove our point: No other portable computer can measure up to the advanced power and potential of the uncompromising COMPAQ PORTABLE 286.

### The COMPAQ PORTABLE 286 Specifications

**Processor:** 16-bit 80286; 6 or 8 MHz clock speed. **Software:** Fully compatible with all major software applications written for the IBM PC-AT. **Expansion Slots:** 3 available slots in base configuration. **Memory:** 256-K bytes RAM, expandable to 2.6 Megabytes. **Storage Devices:** 360-K byte or 1.2-Megabyte diskette drives, 20-Megabyte fixed disk drive, fixed disk drive back-up (10 Megabytes per tape). **Interfaces:** RGB color monitor, RF modulator, composite video, parallel printer, and asynchronous communications interfaces. **Keyboard:** Standard IBM PC-AT layout (84-key). **Display:** 9-inch diagonal green monochrome dual-mode monitor, high-resolution text characters, high-resolution graphics. **Security:** Locks in operating and non-operating mode to prevent unauthorized keyboard access. **Physical Specifications:** 20"W x 8½"H x 16"D. **Options:** Technical reference guide, MS-DOS™/BASIC Version 3, 512/2048-K byte memory board.

# Introducing the new COMPAQ DESKPRO 286. offers more expansion,

*The capabilities of the new COMPAQ DESKPRO 286 represent a personal desktop computer as practical as it is technically advanced. Plus, it maintains compatibility with the IBM PC-AT.*

## **Utmost expandability**

That's no exaggeration. The COMPAQ DESKPRO 286 can expand to give you massive storage and memory.

Without clutter. Expansion is *internal*.

It comes with a single, half-height, 1.2-Megabyte diskette drive. You

can add a second drive of the same capacity, or a 360-K byte diskette drive so you can exchange information with other personal computers.

For fixed disk storage, an internal 20-Megabyte system is available. You can also choose a 30- or 70-Megabyte high-performance internal fixed disk drive system. The storage capacity of each is equivalent to 10,240, 15,360, or 35,840 pages of double-spaced data.

One expansion board works with all the fixed disk drives. When you upgrade to a larger fixed disk storage system, a new board is not required.

To back up data, use the COMPAQ internal fixed disk drive back-up system. It's also a safe and convenient way to store information for record keeping.

## **Hardworking, networking**

Alone, the COMPAQ DESKPRO 286 is a tremendously useful computer. It doesn't limit you to using software under any one operating system. It runs all the popular programs designed for the IBM PC-AT. It can be configured for advanced color graphics display using a color monitor and the IBM Enhanced Graphics Adapter.





# Our most powerful desktop personal computer more speed and more flexibility.



An enhanced keyboard layout, with shift keys in easy reach for touch typists, is standard on the COMPAQ PORTABLE 286 and COMPAQ DESKPRO 286.

The modular design of the computer also lets you configure RAM and storage to the exact needs of any individual. So you never have to buy more computer than you need. Or worry about obsolescing your investment because you bought less computer than you need.

The COMPAQ DESKPRO 286 also makes the ideal hub of a local area network. Using networking packages, your computers (and your people) can share information and software, and can communicate with one another. With 70 Megabytes, the COMPAQ DESKPRO 286 becomes a powerful, high-performance file server. You

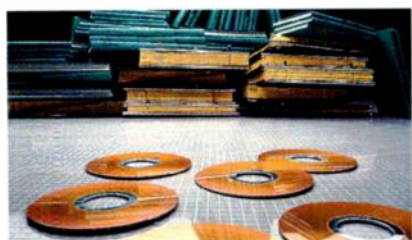

A fixed disk can store enough programs and data to handle all the accounting for most businesses.

can store lots of data, as well as store several programs you can run simultaneously when using software programs like IBM TopView. Your computer will perform at lightning speeds. And other configurations can make economical "nodes" of the network.

## Where to start

The flexibility of the COMPAQ DESKPRO 286 allows you to begin at any level of computing power and reach beyond the IBM PC-AT.

You can use your computer for writing extensive documents, preparing professional graphics for presentations, and for doing complicated financial studies. Chances are, however, you'll not want to stop there. You'll discover new ways for streamlining your work. You'll want to do customer lists, accounting tasks and business taxes, product inventory, annual sales projections on spreadsheets. You have the option of adding a second diskette drive, a fixed disk drive, more memory, even a

fixed disk drive back-up system. All are available and can be added to the inside of your COMPAQ DESKPRO 286—easily, affordably, without losing your initial investment in hardware, software, or training.

## A proven heritage

The COMPAQ DESKPRO 286 is of tested lineage. It has many of the reliable construction and design qualities of the COMPAQ DESKPRO. It has further conveniences like a dual-function security lock to prevent unauthorized access. As well as greater performance, power, and speed. The COMPAQ DESKPRO 286 stretches the limits of personal computing—without any compromises.

## The COMPAQ DESKPRO 286 Specifications

**Processor:** 16-bit 80286; 6 or 8 MHz clock speed. **Software:** Fully compatible with all major software applications written for the IBM PC-AT. **Expansion Slots:** 5 slots available in base configuration. **Memory:** 256-K bytes RAM, expandable to 8.2 Megabytes. **Storage Devices:** 360-K byte or 1.2-Megabyte diskette drives; 20-(half-height), 30-, or 70-Megabyte fixed disk drives; fixed disk drive back-up (10 Megabytes per tape). **Interfaces:** RGB color monitor, RF modulator, composite video, parallel printer, and asynchronous communications interfaces. **Keyboard:** Standard IBM PC-AT layout (84-key). **Display:** 12-inch diagonal green or amber dual-mode monitor, high-resolution text characters, high-resolution graphics. **Security:** Locks in operating and non-operating mode to prevent unauthorized access; cover lock to protect internal components. **Physical Specifications:** System unit—19.8"W x 6.4"H x 16.5"D, Keyboard unit—18.0"W x 1.5"H x 7.0"D, Display unit—14.75"W x 10.25"H x 13.75"D, **Weight:** 57-64 lbs., depending on configuration. **Options:** MS-DOS/BASIC Version 3, Tilt & Swivel Monitor Stand, Desk-Saver, Technical Reference Guide, 512/2048-K byte memory board.

# COMPAQ makes full-function portability a full-fledged reality.

*If you're anxious to put a computer to work for you, but don't need the extra power and added performance of our most advanced portable computer, we have the answer.*

## Lots of software, lots of uses

The COMPAQ Portable and COMPAQ PLUS are based on the 8088 microprocessor, one of the most popular computer technologies, so software is abundant. Integrated business programs, personal productivity, learning tools, even educational thoughtware to sharpen your business skills. Literally thousands of programs, compatible with the IBM PC and IBM PC/XT, will run on the COMPAQ Portable and COMPAQ PLUS.

Many businesses put the COMPAQ Portable or COMPAQ PLUS to work as a full-time computer for part-time users. Carry it from desk to desk. Office to office. Let several people use it for one or more hours a day. Or one person use it a few days a week.



For heavy users, a COMPAQ Portable or COMPAQ PLUS can become a "second computer" for computing power away from the office.

With their rugged, uncompromising construction, they're built tough enough to pass around—something that's impractical to do with desktop computers. And because you stretch its use, you stretch your budget as well.

## If you need more, it does more

How can one computer be so versatile?

One reason is the ability of the COMPAQ Portable to become a COMPAQ PLUS with the addition of a 10-Megabyte fixed disk drive. This expands storage capacity to the equivalent of 5,120 double-spaced pages of information.



*Expansion boards let you add memory and extra functions inside, not out.*

There are other ways to improve on your COMPAQ. Hundreds of industry-standard expansion boards are available. They fit neatly inside your COMPAQ. So you can run more advanced programs. Communicate over telephone lines. Network with other computers.

It's this kind of versatility and ease of use that makes COMPAQ Personal Computers second to none.

## SPECIFICATIONS

### The COMPAQ Portable

Processor: 16-bit 8088, 4.77 MHz clock speed.  
Software: Fully compatible with all major software applications written for the IBM PC/XT.  
Storage Devices: One or two 320-K byte diskette drives. Expansion Slots: 3 available slots.  
Memory: 128-K bytes RAM expandable to 640-K bytes. Display: 9-inch green diagonal monochrome dual-mode monitor, high-resolution text characters, high-resolution graphics. Interfaces: RGB color monitor, RF modulator, composite video, and parallel printer. Keyboard: Standard IBM PC layout (83-key). Physical Specifications: 20"W x 8 1/2"H x 16"D.

### The COMPAQ PLUS

Specifications the same with the exception of: One 360-K byte diskette drive, one 10-Megabyte fixed disk drive, 2 available expansion slots, and full compatibility with all major software applications written for the IBM PC and PC/XT.



*Many companies use a COMPAQ Portable as a full-time computer for part-time users.*

# Lasting value led to instant success for the COMPAQ DESKPRO.

*If you don't need all the extra performance of the COMPAQ DESKPRO 286, you can buy the popularly priced COMPAQ DESKPRO and still get many advanced features.*

## A command performance at every level

The COMPAQ DESKPRO Series allows you to buy as *much* computer as you need—not *more* computer than you need.

It's a polished performer, from entry level to advanced computing, in one totally expandable unit. Its plug-in, modular design accepts up to four separate storage devices. You select almost any combination of diskette or fixed disk drives you desire. And there's the practical, internal fixed disk drive back-up system to protect and store your data. So as your needs grow, the DESKPRO grows.

In fact it will grow from an IBM PC to far beyond the IBM PC/XT level of functionality. The COMPAQ



DESKPRO will run all the popular programs written for both the IBM PC and PC/XT, two to three times *faster*, without sacrificing compatibility.

## Power? It's got what it takes.

The COMPAQ DESKPRO can be easily configured for scientific, engineering, and advanced business applications.

A high-performance, 30-Megabyte fixed disk drive provides added storage capacity.

The ability to add a high-speed 8087-2 coprocessor lets you deal with complex scientific calculations and economic models.



*Internal expandability saves desk space.*

## SPECIFICATIONS

### The COMPAQ DESKPRO

**Processor:** 16-bit 8086; 4.77 or 7.14 MHz clock speed. **Software:** Fully compatible with all major software applications written for the IBM PC and PC/XT. **Expansion Slots:** 6 slots available in base configuration. **Memory:** 128-K bytes RAM, expandable to 640-K bytes. **Storage Devices:** One or two 360-K byte diskette drives, 10-(half-height) or 30-Megabyte fixed disk drives, fixed disk drive back-up (10 Megabytes per tape). **Interfaces:** RGB color monitor, RF modulator, composite video, parallel printer, and asynchronous communications interfaces. **Keyboard:** Standard IBM PC layout (83-key). **Display:** 12-inch diagonal green or amber dual-mode monitor, high-resolution text characters, high-resolution graphics. **Physical Specifications:** System unit—19.8"W x 5.8"H x 16.5"D, Keyboard unit—18.0"W x 1.5"H x 7.0"D.

# Features common to COMPAQ in most other

*It's been easy for COMPAQ to recognize the compromises other personal computer makers have been making.*

*It's been just as easy to avoid them.*

*That's why performance, expandability, compatibility, durability, and versatility are features you'll find in the entire COMPAQ family of computers.*

## **How advanced technology affects the choice you make**

There's an ever-growing library of fast, powerful programs designed for the IBM PC-AT and compatible with the COMPAQ PORTABLE 286 and COMPAQ DESKPRO 286. These programs will utilize the full potential of the computer "nerve center"—the Intel 80286 microprocessor.

If you own a COMPAQ Portable, COMPAQ PLUS, or COMPAQ DESKPRO, you may discover that

these newer programs are simply too big to run on your computer.

Therefore you have a choice: the extra power and speed of the 80286 or the popular COMPAQ Personal Computers that use the 8088 and 8086 microprocessors. Remember that the COMPAQ PORTABLE 286 and COMPAQ DESKPRO 286 offer more power, speed and performance than any other personal computer. If your needs don't require the advanced technology, or you need a second computer to complement the one you have now, consider the COMPAQ Portable, COMPAQ PLUS, or COMPAQ DESKPRO. All three are hardware and software compatible with the IBM PC and PC/XT. Our intention is to give you a choice without forcing you to invest in more, or less, computing power than you think you need.

Of course, COMPAQ Personal Computers maintain compatibility with the add-on devices and expansion boards available for industry-standard personal computers, without any alteration or modification.

## **Increased power without increased size**

All COMPAQ Personal Computers can take on more memory and storage without taking up more space. The COMPAQ Portable becomes a



*Internal add-on devices add greatly to the capabilities of a COMPAQ Computer.*

COMPAQ PLUS when you add a 10-Megabyte fixed disk drive. The COMPAQ PORTABLE 286 can accept a 20-Megabyte fixed disk drive. The fixed disk drive fits neatly beside the diskette drive inside the unit.

With the COMPAQ DESKPRO and COMPAQ DESKPRO 286, you can install almost any available combination of diskette or fixed disk drives you desire to achieve the level of performance you need. The COMPAQ DESKPRO and COMPAQ DESKPRO 286, along with the COMPAQ PORTABLE 286, can accept the fixed disk drive back-up system as one of the internal storage devices.

There are slots inside each COMPAQ Computer for optional expansion boards. These boards greatly enhance the functionality and versatility of your computer. Literally hundreds are available to plug right in. Each lets you do something different. Like expanding the amount of memory in your computer. Or communicating with other personal computers. Or



# Computers are features uncommon personal computers.

even communicating with mainframe computers.

## Built tough to take it

COMPAQ Portable Computers are expected to take some hard knocks. A specially designed shock isolation system protects the diskette drives from jolts and vibration.

Their inner components are surrounded by a cross-braced aluminum frame. Those equipped with fixed disk drives are protected by a triple shock mount system. Plus, the outer case is molded from high-impact plastic, the same kind used to make bulletproof windows and space helmet faceplates. COMPAQ Portable Computers are tough, protecting your data from every angle.

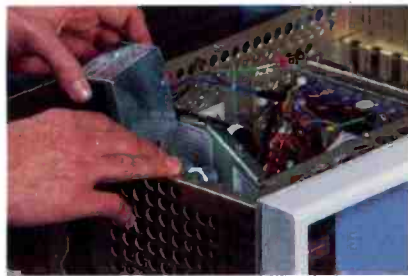

COMPAQ DESKPRO Computers are no pushovers, either. They're surrounded by a protective steel shell.

They're the only desktop computers made with protective shock mounts, isolating the disk drive compartments from those unexpected but inevitable bumps and knocks that can cause downtime.

## Even our monitors do more

COMPAQ Computers display data on high-quality monitors. All models can display high-resolution text and graphics on the same screen. The dual-mode display saves you the cost and clutter of a second monitor. COMPAQ DESKPRO Computers give you a



*High-resolution text and graphics on one screen eliminates the need for a second monitor.*

choice of an amber or green display.

## From pinstripe suits to flight jumpsuits

The structure and design of COMPAQ Computers best characterize their widespread usefulness and respected capabilities. COMPAQ attentiveness to construction details and concern for functionality under stressful conditions are why these computers have received worldwide acceptance.

That's why you'll find a COMPAQ Computer on the bench of a major league baseball team tracking player performance.

At the South Pole monitoring weather conditions for the research team of a major university.

On tour with famous rock stars to help plan concerts, keep up with the finances, and receive electronic mail.

On motion picture sound stages scheduling production and maintaining equipment inventory.

On military surveillance planes logging information five miles aboveground.

In the halls of the Supreme Court answering complex questions on environmental issues.

## Computers people believe in

It didn't take long for the public to recognize COMPAQ Computer quality. No one builds them the way we do. Which is why no other computer company has grown the way we have.

As personal computers become more and more commonplace, more and more people have come to appreciate that quality. Our commitment to providing a product that's beyond compromise assures a product beyond compare. We like to think of it in a simple phrase that bears repeating: It simply works better.



*COMPAQ Portable Computers have the ruggedness and durability for almost any work environment.*

# The Authorized COMPAQ Computer Dealer Network. For sales and service, there are over 2,200 worldwide.

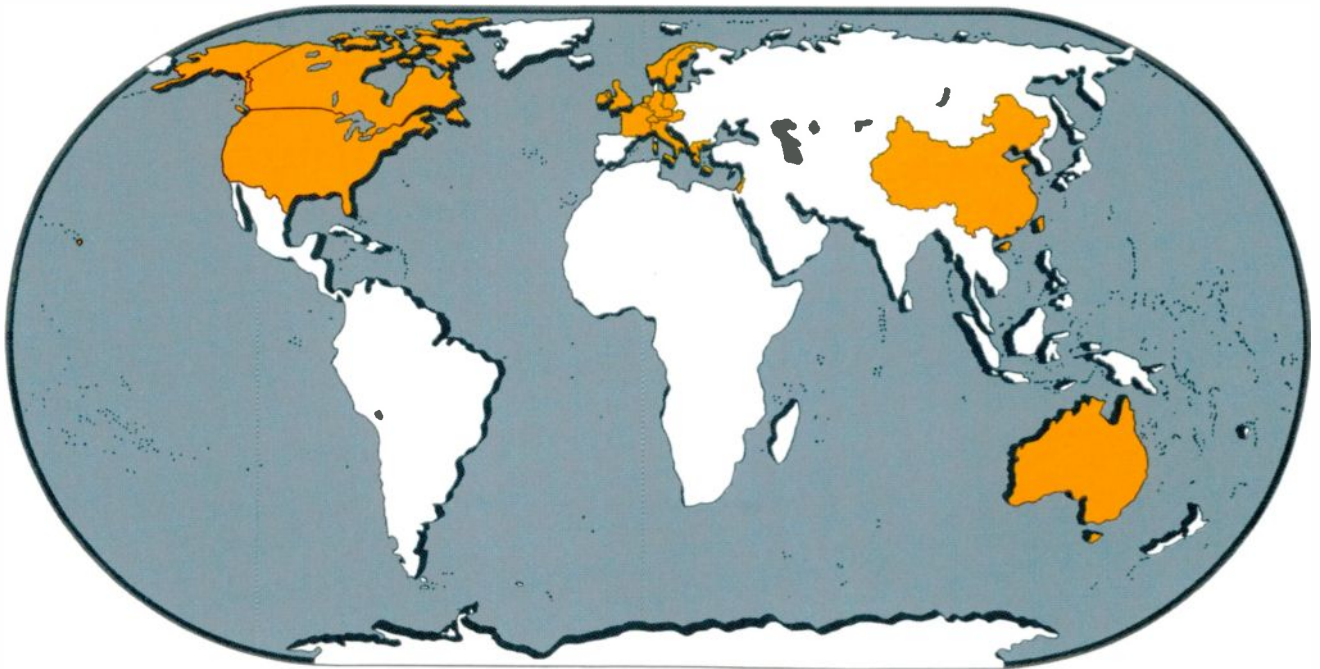

Authorized COMPAQ Computer Dealers are carefully selected by a special review process. We make sure they are established business professionals with the expertise to provide technical service for every COMPAQ Computer they sell. Dealer technicians

receive rigorous training by COMPAQ engineers.

No matter whether you're a professional on the move, or an international corporation with branch offices in dozens of states and countries, you'll find help readily available.

When you purchase your COMPAQ Computer, you'll be buying from the best in the business. Authorized COMPAQ Computer Dealers work hard to earn your respect. Because they had to work even harder to earn ours.

## Authorized COMPAQ Computer Dealers, U.S. and Canada

A-Com-Plus	Chester Inc.	Computer Source Inc.	Entre Computer Centers	Light Computer Centre	PAX Computer Center
A-VIDD Electronics Company	Cincinnati Computer Store	The Computer Store	First National Computer Center	Logic Tree Computer	Personal Business Computers
ABACUS Computer Center	Clancy-Paul, Inc.	Computer Superstores	Forsythe Computers	The Logical Choice	Personal Computer Centre
Agraplex Computer	Command Performance Computers	Computer Systems Resources	Future Information Systems	Lycum Computers	Personal Computer Institute
All Things Computers	Compaq Computer Centers	Computer Systems Specialists	Future Systems	M. C. W. Computers	Photo & Sound Company
Allied Computer Centers	Compa Group	Computer Techniques	Future Visions Computer Store	Malken Computer Services	Pittsburgh Computer Store
Amerisource	Compu Net Computer Solutions	Computer Town	Garland Mears Irrigation	The Math Box	Prology Computer Center
The AMS Computer Store	Compucentre	Computer Trends International	Gateway Computer	MBI Business Center	Professional Computer Centre
The Answer	CompuLink	Computer Utility	General Macrocomputer, Inc.	Micro Center	Professional Computer Systems
Applied Data Systems	CompuMan Macro Center	Computer Ware	Hamilton Computer Business Centre	Micro Mart	Quantum Computer Store
Arendt & Sons Inc.	CompuShop Inc.	Computer Works	Hamilton Rentals	MicroAge Computer Stores	RAC Computers
ASAP Computer Products	Computer Applications Business Center	ComputerCraft	H.A. Computers	Microcomputer Solutions	Rainbow Computing Inc.
Bamberger's	Computer Center of Boca Raton	COMPUTERease	ICA Business Center	Micromac Computer Centre Ltd.	Sears Business Systems Centers
Bandstra Computer Center	Computer Center/Palm Beaches	ComputerLand	Idex Business Computer Center	Microsource/Financial	Sherman Howe Computer Centers
Basic Computer Shop	The Computer Centre	Computerware	Illinois Business Computer Center	Muda Corporation	Silver Creek Computers
Bell & Howell	Computer Concepts	Computerware	Illini Macrocomputers Inc.	Midwest Computer Center	Snyder Computer Center
Blumenthal's Photo & Sound	Computer Depot	Computerworks	Inacomp Computer Centers	Miss-Lou Computer Center	Societe Parmac Limitee
Blumenthal's Computers	The Computer Edge	Compuque	Inacomp Computer City	Moore Business Centers	Solutions Inc.
Businessland, Inc.	The Computer Factory	CompuUtopia	Infomax Computers	Morris Decision Systems	Southwest Automation
Byte Shop	Computer Gallery	Comvans-Center South	Information Computer Systems	Mr. Micro	Spectrum Computers
C.C.C. Computer Center	Computer House	Connolly Data Systems Inc.	International Connection	MSC Computer Store	Star Business Computers
C.T.I. Business Products Center	Computer Innovations	Contact Office Automation Centers	Interdynamics Data Systems	Nabih's Inc.	Sun Computers
Calculator and Computer Center	The Computer Learning Tree	Custom Computing Systems	International Computer Systems	Neeco of Needham	Tankforce Business Centres
Carolina Computer Store	Computer Nook	Data File, The	J.W. Kerns, Inc.	Northbrook Computers, Inc.	Universal Computers
Casterline Computer Center	Computer Plaza	DATAGO	Jonathan's Computer Center	Office Management Systems Inc.	Valcom Computer Center
CBM Computer Center	Computer Pro	Data Systems of New Jersey	Khalas	Olsen Computing	Varsity Computing
Central Computers	The Computer Room	Data Terminal Mart	Le Magasin Xerox	Omni Computer Center	Wabash Computer Systems
Central Valley Computer Center	The Computer Shoppe	DRA Computer Center	Legacy Computer Systems	Onanfax Computer Stores	Waldeck Computer Center
Century Microcenters	Computer Solutions	Endata Business Products Cntr.	Lexington Computer Store	Online Computers Plus	The Xerox Store
Champlain Computer Systems					

**COMPAQ®**

COMPAQ® is a registered trademark; COMPAQ PLUS™, COMPAQ DESKPRO™, COMPAQ PORTABLE 286™, and COMPAQ DESKPRO 286™ are trademarks of COMPAQ Computer Corporation. IBM® is a registered trademark; IBM Personal Computer-AT™, IBM TopView™ and IBM Personal Computer XT™ are trademarks of International Business Machines Corporation. MS-DOS™ is a trademark of Microsoft Corporation. ©1985 COMPAQ Computer Corporation. Printed in the U.S.A. All rights reserved.

# FIXES AND UPDATES

## BYTE'S BUGS

### ROMDISK Pricing Lowered

We provided some out-of-date prices in an article in the May What's New section. (See "ROMDISK PC Accessory Card," page 468.) The new prices are lower than those we quoted.

Curtis Inc., manufacturer of the ROMDISK line of disk emulator boards for Apple and IBM computers, reports that it recently received new quotations for the

EPROMS and other semiconductors used in its products. A company spokesperson stated that its price reductions, especially for its PC-2 board, are due to the availability of 27C256 EPROMs. Previously, Curtis had to rely on 27128 EPROMs and a piggybacked board to achieve large storage capacities.

The suggested retail price for the ROM-

DISK A for the Apple IIe is now \$349. The ROMDISK PC-1, which is equivalent to a 180K-byte single-sided disk, is \$495. Both are \$100 lower than before. Providing 360K bytes of storage, the PC-2 is \$595, which is \$400 less than reported in May.

Curtis Inc. is located at 22 Red Fox Rd., St. Paul, MN 55110, (612) 484-5064.

### Statement Amplified

A discussion in the June Fixes and Updates requires some explanation. (See page 33.)

In the item "Upgrade to Lowercase Descenders," the first sentence in the second paragraph could be interpreted as saying that the Gorilla Banana printer is

manufactured by DAK Industries, which it is not.

The Gorilla Banana Printer was produced by Leading Edge Products Inc., 225 Turnpike St., Canton, MA 02021, (617) 828-8150. The printer, however, is no longer manufactured.

DAK Industries Inc. sells electronic parts and instrumentation. One of the products sold by DAK Industries is the Gorilla Banana Printer. DAK Industries is located at 8200 Remmet Ave., Canoga Park, CA 91304.

We apologize for the confusion.

### Some Fixes for Sunfix

An error crept into the references that accompanied Frederic N. Rounds's Sunfix navigation article, which appeared in the March BYTE. (See "Navigation: Putting the Microcomputer to Work at Sea," page 141.)

The first reference should read as follows:

Maloney, Elbert S., ed. *Dutton's Navigation and Piloting*. Naval Institute Printing, 1978.

Mr. Rounds also would like to emphasize that the Sunfix program takes the place of almanacs and reduction tables by computing the position of the sun for any time and date. The only data inputs it requires are your sextant's readings and the measurements used to make sextant corrections. Details, such as RA and SHA, are transparent to users of the Sunfix program.

It's also advisable to keep in mind the fact that microcomputers can aid sailors, but, like ham radios and other electronic navigation equipment, they are susceptible to the sea's environment.

For those who are interested, Mr. Rounds will supply a printout of the Sunfix program for \$5. You can write Mr. Rounds at 894 Persimmon Ave., Sunnyvale, CA 94087.

### Bugs in Frequency Analyzer

A trio of bugs in Vince Banes's article "Audio-Frequency Analyzer" have been reported. (See page 223 of the January BYTE.) Two of the bugs are in the accompanying diagrams, and the third bug is in a program listing.

In figure 3 on page 227, the labels of

the two ports are switched.

On page 230, you'll find a mix-up in the pin numbers in figure 4b. Pin 25 of the 8255 integrated circuit should be connected to pin 13 of IC8.

In the program that determines the endpoints of the VCO ranges (listing 5, page

236), change line 40 to read:

```
OUT 1921,CC
```

Our thanks to David R. Butler of Cameron, West Virginia, and Mark Pinkerton of Salem, Wisconsin, for reporting these errors to us.

### Name Corrected

In "Factfinder" by John Markoff (March, page 113), the name of a database service was incorrectly presented. NEXIS is a full-text database of general and business news produced by Mead Data Central Inc., a wholly owned subsidiary of The Mead Corporation.

### Servo Listing Misserves a Line

John deLaubenfels, a BYTE reader in Duluth, Georgia, found a bug in the program listing that accompanied Don Stauffer's article "Simulate a Servo System." (See page 147 of the February BYTE.)

In the TRS-80 Level II BASIC program on

page 150 (listing 1), line 2040, EM=ER is not correct. It should read

```
EM = EM + ER * DT
```

Our thanks to Mr. deLaubenfels for sending this correction.

(continued)

# MidWest Micro-Peripherals

Gigantic Sale!

Star - Brother - Epson - Sanyo - Zenith

### PRICE GUARANTEE

We at MidWest Micro guarantee that we can save you up to 49% or more on your purchase of new fully warranted equipment and supplies. And we will still give you friendly, courteous service. Call today and Save With Confidence!

Get great hard copy and near letter quality with...

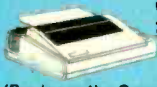

**star**  
SG-10  
Price too Low  
to Advertise!  
List \$299

(Replaces the Gemini 10X)

The SG-10 gives you enough versatility for home or office use. It operates bi-directionally at 120 cps and includes many special features such as near letter quality printing, easy access format switches for a wide range of character modes, friction feed for single sheets and tractor feed for fanfold paper, and even hex dump. Another special feature is the IBM character sets available at the flip of a switch. You get all of this plus a 2k memory buffer and Star's full 1 year warranty at a price you can afford!

Complete STAR Line..... SCALLS



**brother**  
printer's give you all the  
features of a letter quality

**NEW!** and more with... HR-15XL  
List \$599 Save \$15XL

The HR-15XL gives you Daisywheel printing and added attractions such as text reprinting, red printing, attachable cut sheet feeder and the exclusive Brother keyboard attachment.

Complete BROTHER Line	List	Your Price
HR-10 (12CPS)	\$399	SCALLS
HR-15XL (17 cps, 13.5" carriage, 3k Buffer)	599	SCALLS
HR-15 & HR-15XL Keyboard Attachment	200	SCALLS
HR-25 (23 cps, 16.5" carriage, 3k Buffer)	895	SCALLS
HR-35 (32 cps, 16.5" carriage, 7k Buffer)	1245	SCALLS
Brother 2024 (160 cps, 24 pin head, NLQ Mode)	1495	SCALLS

Don't spend a fortune to own the world's most popular printer...

**NEW!**

**EPSON**  
LX-80 \$349



The new EPSON LX-80 prints smoothly and quietly at a speed of 100 cps. With the superb near letter quality mode and full graphic capabilities as standard, your correspondence will be letter perfect. The LX-80 comes complete with a parallel interface to quickly connect it to virtually all computers. There are 160 typesets that are switch selectable and the LX-80 comes with EPSON'S full 1 year warranty. Friction feed is standard and an optional tractor feed is available. Let the EPSON LX-80 print your next business letter or report.

Complete EPSON Line	List	Your Price
LX-80 (100 cps, NLQ Mode, 80 Col.)	349	SCALLS
RX-100 (100 cps, 136 Col.)	895	399
FX-80 (160 cps, 80 Col, 2k Buffer)	699	389
FX-100 (160 cps, 136 Col, 2k Buffer)	999	589
LQ-1500 (200 cps, NLQ Mode, 136 Col.)	1395	SCALLS

Complete Systems

**SANYO**

Free Software



LOW AS \$899



**ZENITH**

SAVE up to 49% off!

Computer Systems

Get IBM compatibility, improved keyboard, faster processing speed, more memory capacity, free software, more expansion capability and unbelievable savings! Call today!

Prices subject to change and type errors

FREE CARD USE  
Call Today!

Information - Ordering  
1-800-423-8215  
In Ohio 1-800-321-7731

CUSTOMER SERVICE (513) 663-4992

CASH PRICES Cert. Check, Money Orders, VISA or MC  
CODs (Add \$5) AMEX (Add 4%) P.O.s (Add 5%)

MidWest Micro-Peripherals  
(Division of Inlotel, Inc.)  
135 South Springfield St  
St. Paris, Ohio 43072

## FIXES & UPDATES

### Knowledge Index Numbers Change

In the December 1984 BYTE article "The On-Line Search" by Suzana Lisanti (page 215), the telephone numbers for the Knowledge Index database service were incorrect.

The correct numbers are (800) 227-1927 and (415) 858-3785. Knowledge Index is a service of Dialog Information Services Inc., 3460 Hillview Ave., Palo Alto, CA 94303.

## BYTE'S BITS

### BYTE Index Produced

A comprehensive index of all the articles that appeared in BYTE from January 1983 through December 1984 is available. The BYTE '83-84 Index is 48 pages long and cross-references articles alphabetically by subject.

For your copy, write to *BYTE '83-84 Index*, BYTE Publications, POB 372, Hancock, NH 03449. Please enclose \$1 to cover shipping and handling, as well as a piece of paper with your name and address clearly legible.

### Author's Guide Available

The latest edition of the BYTE author's guide has just been produced.

*Writing for BYTE* describes how to submit an article to BYTE, the types of articles we seek, where to go and whom to turn to when writing a BYTE article, and other

information.

For your copy, send a self-addressed stamped business envelope to *Writing for BYTE*, BYTE Publications, POB 372, Hancock, NH 03449. Please note that we cannot honor telephone requests.

### Public-Domain Software Offering

John Morse has written and introduced into the public domain a number of programs. Mr. Morse developed these BASICA programs on the IBM PC XT under PC-DOS.

The programs include a graphics editor, a utility that displays every character of any file with its hexadecimal and ASCII code as well as its position in a record, a drawing-pattern generator, three versions of the game Mastermind, and a char-

acter analyzer in which particular characters in a file can be omitted, highlighted, or changed.

You are free to distribute the programs, with the stipulation that you include Mr. Morse's name in each program. The programs are available from Mr. Morse for \$10, which includes the disk and instructions within the program. For more information, write to John W. Morse, 274 State St., Albany, NY 12210.

## FEEDBACK

### Serial Version of Printer Buffer

Keith Alexander, a BYTE reader "since the dark ages of 1976," recently wrote us to say how intrigued he had been with Jon Bono's printer buffer and with Richard Carlsen's comments on the project. (See "Build a Printer Buffer" in the June 1984 BYTE, page 142, and "Printer Buffer Messaged" on page 33 of the April 1985 BYTE.)

Mr. Alexander reports that he, too, built the buffer and that he had to make a number of hardware and software modifications to suit his system, a Southwest Technology's 6809-based unit.

The main problem, according to Mr. Alexander, was connecting his serial printer to a single RTS (request to send) line. After corresponding with Mr. Bono and learning a lot about UARTs, Mr. Alexander got the circuit to work. His SWTPc 6809 now sends data to the buffer at 38,400 bps and the buffer, in turn, drives his Heath H-14 printer at 4800 bps.

Mr. Alexander has graciously offered to correspond with BYTE readers interested in his serial version of Jon Bono's printer buffer. You can write to Mr. Alexander at 20426 Lichfield, Detroit, MI 48221. ■





# Draw Your Way to the Top

*PC-Draw Will Increase Your Office Productivity.  
And Upward Mobility.*

Imagine. You now have the capability to graphically depict your best ideas, plans, designs and proposals. *In color or black & white.* Accurately. Completely. Dramatically. Concepts presented so forcefully—yet so simply—that you leave that critical meeting with upper management... *totally* confident of success.

And you win. Your secret weapon? PC-Draw. A powerful interactive graphics program for the IBM PC or XT™—*unlike anything else* on the market. Using PC-Draw you create virtually anything that can be drawn with pencil and paper. Quickly. Easily. With far greater detail.

PC-Draw is ideal for presentation graphics, proposals,

**10 DAY  
TRIAL  
PERIOD**

systems design, forms, diagrams... and an endless variety of charts, graphs and illustrations. PC-Draw allows you to produce drawings *up to 99 pages* long. Several templates come with PC-Draw including Flowcharting, Electrical Design, Office Layout, and Alternate Text. In addition you create and store your *own* unlimited supply of user defined symbols.

PC-Draw includes an *easy-to-follow* interactive tutorial. Requires IBM PC or XT™ or compatible, graphics adapter and graphics monitor. Version for PCjr available. Graphic boards, plotters at competitive prices.

Shhh! Don't tell your office competition about PC-Draw. They'll catch on soon enough. For free brochure or to order call 800/2PC-DRAW. In Texas or for customer service call 214/234-1769. Micrografx, Inc., 1701 N. Greenville Ave., Suite 305, Richardson, Texas 75081.

## MICROGRAFX

The Picture of Success.

(Most popular plotters and printers supported.)

Inquiry 240

# Discover what 50,000

**Q**UBIE' delivers the finest peripheral available in terms of features, reliability and price/performance. That's why corporations like IBM, GM and Exxon buy peripheral equipment from Qubie', and have for years. Check some of your old back issues of PC — we've been satisfying PC owners since 1982.



Select products at low prices, with service and support unparalleled in the microcomputer industry. Our 30 day No Risk Guarantee and 48 Hour Repair Service during the 12 month warranty period is proof our products are first rate. We stand behind everything we sell. No "call the manufacturer" responses when you have a question. We also offer our exclusive Preferred Customer Plan\*<sup>1</sup> with 24 hour repairs and 24 months of coverage.

Our low, money-saving prices are the total prices. No small print telling you to add up for credit card charges or shipping and handling. Our prices include surface UPS charges and insurance. In a hurry? 2-day air UPS service is available.\*<sup>2</sup>



At Qubie', customer satisfaction is one of the cornerstones of our philosophy. Ask your friends, business associates and colleagues about Qubie'. Chances are they are one of our fifty thousand satisfied customers.

## STANDBY POWER SUPPLY

**SB200 \$329**  
**XT300 \$429**  
**AT800 \$779**



Noise Filtering/Surge Suppression • Powers Your Computer For Up To 30 Minutes In The Event Of A Blackout Or Brown-out • SB200 (200 Watt) For Floppy-Based Systems, XT300 (300 Watt) For Hard Disk Based Systems, AT800 (800 Watt) For Multi-User Systems

## HIGH RESOLUTION MONOCHROME MONITORS

**HR 39 \$149**  
**HR 134 \$159**

Plugs Into The IBM Monochrome or Compatible Adapter Card • 720 x 350 Resolution • 12" Diagonal Screen • Super Crisp Text Capability • High Resolution TTL • Includes Tilt/Swivel Base and Interface Cable • HR 134 (Amber) HR 39 (Green)



## MULTIFUNCTION CARD

**BT6Plus (OK) \$195**  
**BT6Plus (384K) \$299**

Memory Sockets For Adding Up To 384K • Parallel Printer Port • Asynchronous Serial Communications Port • Battery-powered Clock / Calendar • BTPak Software — BTDrive

## INTERNAL MODEM

**PC212A/1200 \$249**

Auto-dial, Auto-Answer • 300/1200 Baud Operation • Runs Hayes Compatible Software Like Crosstalk, Smartcom II, and Sidekick • Two Phone Jacks Allow You To Hook Up Desk Phone • Includes PC-

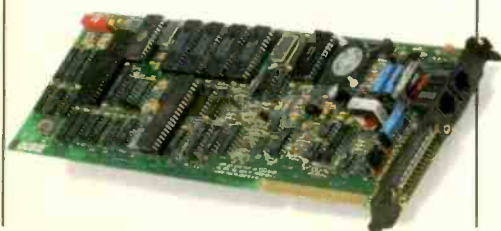

TALK III Software (Complete Communications Package), Modular Phone Cord, User's Manual / Installation Instructions • Optional Serial Port (\$30) Allows You To Use Port For Other Peripherals When Modem Is Not Being Used.

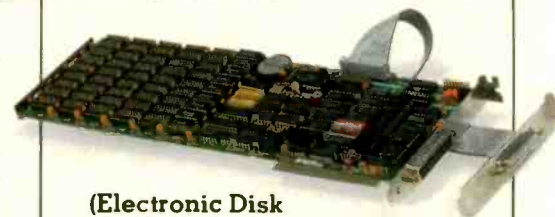

(Electronic Disk Emulation) and BTSpool (Print Spooling Software) •

# PC owners now know.

Optional Game Port – Chips, Dual Mounting Bracket and Cable (\$20) • 64K Memory – Installed and Tested (\$25) • Includes Cable, Single Slot Mounting Bracket, Installation Instructions / User's Manual

## INTERNAL HARD DISK SUBSYSTEMS

**PC10 \$649**  
**PC20 \$699**

Boot From The Hard Disk – No Software Patches or Drivers To Install • Runs All The Popular Software •



Low Power Consumption • High Reliability And Durability – Specially Plated Drives • Faster Access Time Than XT • Includes 1dir "Visual Shell" Software, Cables, Mounting Hardware, Installation Instructions/User's Manual, Full-Height Bezel – Optional Half-Height Bezel (\$15) • Auxiliary Power Supply And External Models Are Also Available.

Adjustment • Keys In Standard Typewriter Positions • Separate Cursor Control and Numeric Keypads • Easy-To-Read Key Legends • LED Indicators On All Lock Keys • Extra-Wide Left-Hand Control Key Adjacent To "A" • Control/Reset Replaces Awkward Control/Alt/Delete • Plugs Into IBM PC, PC/XT and Compaq Desktop



## EXTERNAL MODEM

**212A/1200E \$299**

Auto-dial, Auto-Answer • 300/1200 Baud Operation • Runs Hayes Compatible Software Like Crosstalk, Smartcom II, And Sidekick • Two Phone Jacks Allow You To Hook Up Desk Phone • RS-232C Compatible • Includes 8' Shielded Cable (Specify Male Or Female) • Eight Status Indicator Lamps • External Volume Control Knob

## HIGH RESOLUTION COLOR MONITOR

**HR31 200 \$439**

14" Diagonal Screen • Black Matrix Picture Tube • Dot Pitch .31mm • Plugs Into IBM Color/Graphics Or Compatible Adapter Card • 640 x 200 Resolution • Includes Interface Cable And Tilt / Swivel Base

	*1 PREFERRED CUSTOMER PLAN	*2 UPS BLUE LABEL
PC10 and PC20 ....	\$150.00	\$12.00
Modems .....	50.00	5.00
ff5151 .....	35.00	7.50
BT6Plus .....	50.00	5.00
HR 39 and HR 134 ....	50.00	NA
HR31 200 .....	95.00	NA

### No Risk Guarantee

If you are not completely satisfied with your purchase, you may return it within 30 days for a full refund, including the cost to send it back.

### The Acid Test

If you can get any dealer or competitor to give you the same No Risk Guarantee, buy both products and return the one you don't like.

For fastest delivery, send cashier's check, money order, or order by Mastercard/Visa. Personal checks, allow 18 days to clear. Company purchase orders accepted, call for prior authorization. California residents, add 6% sales tax.

Hours: M-F 8 am-5 pm PTZ  
Sat 9 am-1 pm PTZ

London (01) 223-4569  
Paris (01) 321-5316  
Sydney (02) 579-3322



Outside California

**1-800-821-4479**

Inside California

**1-805-987-9741**

4809 Calle Alto  
Camarillo, California 93010

# QUBIE'

Order Today,  
Shipped Tomorrow!™

## KEYBOARD

**ff5151 \$159**

Solid State Capacitive Key Switches • 3-Position Height



# FOR PEOPLE WHO THOUGHT THEY'D NEVER MEET THE PERFECT 10

We've got one to knock your socks off. The StarWriter™ F10 from C. Itoh.

What sets this daisy wheel apart is its fabulous figure of 58 letter perfect characters per second, at a price of up to \$1,000 /ess than other leading printers in its class.

It's compatible with most of the popular PCs and offers a full line of accessories, including a cut sheet feeder and tractor feed.

And like the rest of C. Itoh's printers, the F10 acts without acting up.

It has been thoroughly tested and proven on the job to assure reliability. Plus, you get a full year's warranty, backed by over 350 authorized service centers coast to coast.

The F10 is one hot printer for the money. But that's not surprising when you consider that C. Itoh's been producing superior printers for over a decade, thanks to the strong backing of our 126-year-old parent company with over \$60 billion in sales annually.

Little wonder C. Itoh printers are the best selling printers in the world.

To meet your Perfect 10, just see your local C. Itoh dealer. Or for more information, call toll free 1-800-423-0300.

Or write C. Itoh Digital Products, Inc., 19750 South Vermont Avenue, Suite 220, Torrance, CA 90502.

™ StarWriter is a Trademark of C. Itoh Digital Products, Inc.  
© 1985 C. Itoh Digital Products, Inc.

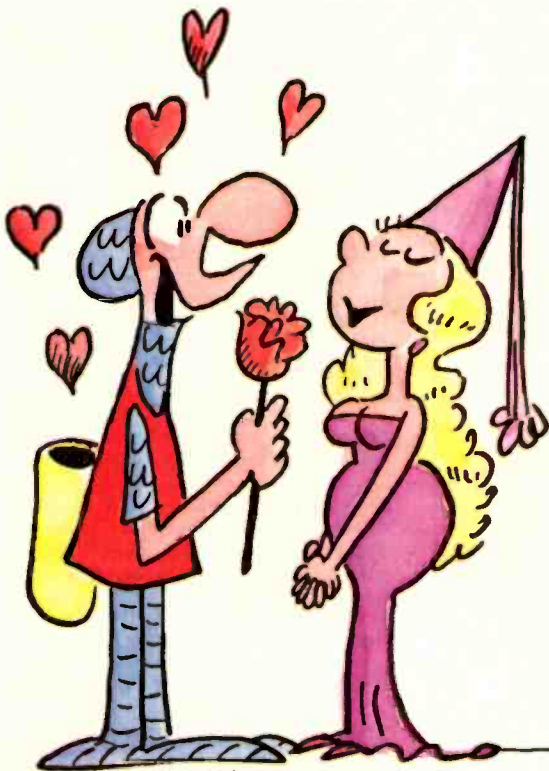

*hart* © 1984 News Group Chicago, Inc.

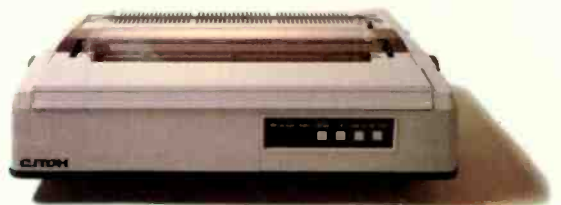

## C. ITOH

Printers

## Xerox Products

**X**erox recently announced the 6085 microcomputer, a line of personal microcomputers, and a laser printer.

The Xerox 6085 is offered in models for network, remote, and stand-alone operation. The networked and remote models can share resources linked by Ethernet.

The 6085 is founded upon Xerox's Mesa processor, an 8-MHz device. The Mesa processor has 256 auxiliary registers and executes 48-bit-wide instructions. The 6085 also uses an 80186 chip as an auxiliary processor.

The basic 6085 comes with 1.1 megabytes of memory, a 10-megabyte hard-disk drive, two serial ports, and a 15-inch high-resolution (880- by 697-pixel) monochrome display. You can expand it to include 3.7 megabytes of memory and up to 80 megabytes of hard-disk storage.

Xerox offers hard-disk drives with 20, 40, or 80 megabytes of storage, and a 360K-byte floppy-disk drive is also available. An optional board gives the 6085 the ability to run software prepared for IBM PC-DOS.

System software includes the ViewPoint windowing package, which uses icons and is controlled with an optical mouse. ViewPoint is \$125. A variety of applications software, including a software-development package, is planned.

The 6085 begins at \$4995.



The Xerox 6085.



The Xerox 4045 Laser CP.

The Xerox 6060 family of PCs comprises four computers: a pair of IBM PC work-alikes, the Xerox 6064 and 6065, and two dedicated word-processing systems, the Xerox 6067 and

6068. The 6067 and 6068 keyboards have been modified for word processing. Both systems come bundled with Xerox's word-pro-

cessing software and can run MS-DOS applications software.

Each Xerox 6060 comes with ScreenMate, a menu-based shell program for interacting with MS-DOS.

The general-purpose 6064, with two 360K-byte floppy-disk drives and 256K bytes of memory, retails for \$2885. The hard-disk-based 6065 lists for \$4485.

At \$2985, the 6067 includes dual floppy-disk drives and 384K bytes of RAM. The 6068, which is equipped with a 10-megabyte hard disk and 512K bytes of memory, costs \$5150. Both the 6067 and the 6068 use a 640- by 400-pixel monochrome display.

Xerox rates its 4045 Laser CP "lasographic" printer at 10 pages per minute and 5000 pages a month. It comes with 128K bytes of memory, two fonts, and your choice of Centronics or Dataproducts parallel ports or an RS-232C asynchronous connection. Additional cartridge-based fonts are offered.

If you choose to expand the 4045 Laser CP to its full 512K bytes of memory, you can reproduce a 5- by 7-inch image in a 300- by 300-dot-per-inch format. You can reproduce a full-page graphic at 150 by 150 dots per inch. The 4045 Laser CP has a 250-sheet paper cassette, and cassettes for European paper are available. It's compatible with the Diablo 630 daisy-wheel printer.

A copier option lets the 4045 Laser CP function as a standard photocopier. Other

*(continued)*

options include an envelope cassette, an interface that permits four PCs to share its resources, and a network interface for linking the 4045 Laser CP to IBM 3274/3276 networks and Systems 34/36/38 environments. The suggested list price for the 4045 Laser CP is \$4995.

Contact Xerox Corp., Xerox Square 006, Rochester, NY 14644, (716) 423-5078. Inquiry 600.

### IBM PC XT, PC AT-Compatible Computers

**N**CR's PC8 and PC6 are compatible with IBM PC AT and IBM PC XT computers, respectively.

The PC8 can serve as a stand-alone computer, as a 16-member multiuser system, or as a network server for up to 63 nodes. In its single-user configuration, the PC8 runs under NCR-DOS 3.1. The multiuser operating system is XENIX.

Featuring Intel's 6-MHz 80286 microprocessor, the PC8 is reportedly able to run virtually any software designed for the IBM PC AT without modification. It can also use AT-compatible hardware.

Standard are 256K bytes of RAM, a 1.2-megabyte floppy-disk drive, six expansion slots for devices with 8-/16-bit data paths, two expansion slots for devices with 8-bit data paths, and a battery-backed system clock. The keyboard has LED indicators and 30 programmable function keys.

Optional are a monochrome monitor with a non-glare 80-character by 25-line display and 640- by 400-pixel resolution and a



The NCR PC8.

14-inch color monitor with 16-color capabilities. GW-BASIC is available, and internal memory is expandable up to 4 megabytes.

The basic PC8 begins at \$3795. A configuration with 512K bytes of RAM, a floppy-disk drive, and a 20-megabyte hard-disk unit is \$5505.

The PC6 is supplied with Intel's dual-speed (i.e., 4.77/8-MHz) 8088-2 microprocessor, 256K bytes of RAM, twin 360K-byte floppy-disk drives, RS-232C and parallel interfaces, and eight expansion slots. It comes with NCR-DOS, which provides compatibility with the IBM PC XT. An on-line help program, GW-BASIC, and a pair of tutorial software packages are also standard.

A number of mass-storage configurations are offered, including 20 megabytes of hard-disk storage and 10 megabytes of streaming-tape backup.

Options include monochrome and color monitors. PC6 pricing begins at \$2583.

Contact NCR Corp., Dayton, OH 45479, (513) 445-2075. Inquiry 601.

### Visual Environment for C Programmers

**L**iving C—Personal is a visual programming environment for C-language programmers. It facilitates the design, development, maintenance, and debugging of C programs by showing you exactly what happens at each step of a program's execution.

You can use Living C—Personal to animate your source code during execution. You can do this statement by statement within user-specified breakpoints or through the entire program. When a bug is found during compilation, Living C—Personal does not force you

to abandon the environment because its full-screen editor is still available.

With Living C—Personal, your program's output is separated from the debugging information by on-screen windows. You can use the window facility to continuously display a variable's value or to examine and alter the variable.

Living C—Personal provides help facilities and explicit error diagnostics, and it conforms to the Kernighan & Ritchie C standard. It runs under PC-DOS and is priced at \$99. Contact Living Software, London House, 243-253 Lower Mortlake Rd., Richmond, Surrey, England; tel: 44 1 948 5166; Telex: 946 240 cweasy. Inquiry 602.

### IBM Jetprinter and Proprinter

**I**BM has announced a color ink-jet printer and a replacement for its dot-matrix Graphics Printer.

The ink-jet Color Jetprinter can produce hard copy in seven colors. Its dot resolution is 100 by 96 pixels per inch. The Color Jetprinter sells for \$745.

The dot-matrix printer, called the Proprinter, is compatible with the Graphics Printer but is faster, with an advertised speed of 200 cps in draft mode and 40 cps in near-letter-quality mode. It has a maximum horizontal resolution of 240 pixels per inch. The Graphics Printer, which Epson manufactured, is being discontinued. The Proprinter is made by IBM and sells for \$549.

Contact IBM Corp., Information Systems Group, 900 King St., Rye Brook, NY 10573.

Inquiry 603.

(continued)

**MOST SIGNIFICANT PRODUCT OF THE YEAR - PC WEEK**

# They said it couldn't be done. Borland Did It. Turbo Pascal 3.0

## The industry standard

With more than 250,000 users worldwide Turbo Pascal is the industry's de facto standard. Turbo Pascal is praised by more engineers, hobbyists, students and professional programmers than any other development environment in the history of microcomputing. And yet, Turbo Pascal is simple and fun to use!

COMPILATION SPEED
EXECUTION SPEED
CODE SIZE
BUILT-IN INTERACTIVE EDITOR
ONE STEP COMPILE (NO LINKING NECESSARY)
COMPILER SIZE
TURTLE GRAPHICS
BCD OPTION
PRICE

	TURBO 3.0	TURBO 2.0	MS PASCAL
8.1	16	206	
9 <sup>sec</sup>	13 <sup>sec</sup>	20 <sup>sec</sup>	
12 K	12 K	35 K	
YES	YES	NO	
YES	YES	NO	
39K	35K	300K+	
YES	NO	NO	
YES	NO	YES	
YES	NO	YES	
YES	\$54 <sup>55</sup>	\$295 <sup>00</sup>	
\$69 <sup>95</sup>			

## The best just got better: Introducing Turbo Pascal 3.0

We just added a whole range of exciting new features to Turbo Pascal:

- First, the world's fastest Pascal compiler just got faster. Turbo Pascal 3.0 (16 bit version) compiles twice as fast as Turbo Pascal 2.0! No kidding.
- Then, we totally rewrote the file I/O system, and we also now support I/O redirection.
- For the IBM PC versions, we've even added "turtle graphics" and full tree directory support.
- For all 16 Bit versions, we now offer two additional options: 8087 math coprocessor support for intensive calculations and Binary Coded Decimals (BCD) for business applications.
- And much much more.

### The Critics' Choice.

**Jeff Duntemann, PC Magazine:** "Language deal of the century . . . Turbo Pascal: It introduces a new programming environment and runs like magic."

**Dave Garland, Popular Computing:** "Most Pascal compilers barely fit on a disk, but Turbo Pascal packs an editor, compiler, linker, and run-time library into just 39K bytes of random-access memory."

**Jerry Pournelle, BYTE:** "What I think the computer industry is headed for: well documented, standard, plenty of good features, and a reasonable price."

## Portability.

Turbo Pascal is available today for most computers running PC DOS, MS DOS, CP/M 80 or CP/M 86. A XENIX version of Turbo Pascal will soon be announced, and before the end of the year, Turbo Pascal will be running on most 68000 based microcomputers.

(\*) Benchmark run on an IBM PC using MS Pascal version 3.2 and the DOS linker version 2.6. The 179 line program used is the "Gauss-Seidel" program out of Alan R. Miller's book: *Pascal programs for scientists and engineers* (Sybex, page 128) with a 3 dimensional non-singular matrix and a relaxation coefficient of 1.0.

## An Offer You Can't Refuse.

Until June 1st, 1985, you can get Turbo Pascal 3.0 for only \$69.95. Turbo Pascal 3.0, equipped with either the BCD or 8087 options, is available for an additional \$39.95 or Turbo Pascal 3.0 with both options for only \$124.95. As a matter of fact, if you own a 16-Bit computer and are serious about programming, you might as well get both options right away and save almost \$25.

## Update policy.

As always, our first commitment is to our customers. You built Borland and we will always honor your support.

So, to make your upgrade to the exciting new version of Turbo Pascal 3.0 easy, we will accept your original Turbo Pascal disk (in a bend-proof container) for a trade-in credit of \$39.95 and your Turbo87 original disk for \$59.95. This trade-in credit may only be applied toward the purchase of Turbo Pascal 3.0 and its additional BCD and 8087 options (trade-in offer is only valid directly through Borland and until June 1st, 1985).



**Software's Newest Direction**  
4585 Scotts Valley Drive  
Scotts Valley, CA 95066  
TELEX 172373

Turbo Pascal is a registered trademark of Borland International, Inc.  
PC Week is a trademark of Ziff-Davis Pub. Co.  
Inquiry 55 for End-Users. Inquiry 56 for DEALERS ONLY.

TURBO PASCAL

NOT COPY-PROTECTED

Available at better dealers nationwide. Call (800) 556-2283 for the dealer nearest you. To order by Credit Card call (800) 255-8008, CA (800) 742-1133

Carefully Describe your Computer System!

Mine is:  8 bit  16 bit  MS-DOS  
I Use:  PC-DOS  CP/M 86  
My computers' name/model is: \_\_\_\_\_

The disk size I use is:  
 3 1/2"  5 1/4"  8"

Name: \_\_\_\_\_  
Shipping Address: \_\_\_\_\_  
City: \_\_\_\_\_ Zip: \_\_\_\_\_  
State: \_\_\_\_\_ Telephone: \_\_\_\_\_

For update:  
original Turbo  
disk must  
accompany  
order.

YES! I want the Best! Please send: \_\_\_\_\_ Quantity \_\_\_\_\_

Pascal 3.0 \$ 69.95 \_\_\_\_\_  
Pascal w/8087 \$109.90 \_\_\_\_\_  
Pascal w/BCD \$109.90 \_\_\_\_\_  
Pascal w/8087 & BCD \$124.95 (SAVE \$24.90) \_\_\_\_\_  
\*These prices include shipping to all U.S. cities. All foreign orders add \$10 per product ordered.

Subtotal (CA 6% tax) \_\_\_\_\_  
Trade-in Credit Claimed: \_\_\_\_\_

Amount Enclosed: \_\_\_\_\_  
Payment: VISA MC BankDraft Check  
Credit Card Expir. Date: \_\_\_\_\_  
Card #: \_\_\_\_\_

15

COD's and Purchase Orders WILL NOT be accepted by Borland. California residents: add 6% sales tax. Outside USA: add \$10 and make payment by bank draft, payable in US dollars drawn on a US bank.

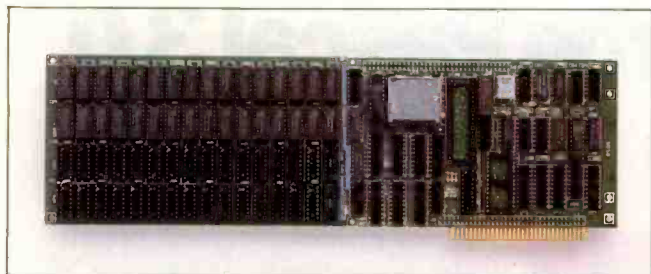

Pfaster286, an 80286 add-in board for the IBM.

### 80286 Add-in Board for IBM PC and PC XT

Phoenix Computer Products' Pfaster286 is an 8-MHz 80286-based add-in board that gives the IBM PC and PC XT the ability to process data at a faster rate than the IBM PC AT. It does not impair the functionality of the PC's or PC XT's resident 8088 microprocessor; rather Pfaster286 reassigns the 8088's intelligence to I/O management.

Pfaster286 can run MS-DOS 2.0, 2.1, and 3.1 programs, and applications designed for the IBM PC and PC AT will operate with it. Pfaster286 has software switches that let you jump back and forth into the native 8088 mode for those applications requiring that chip's performance characteristics.

The basic Pfaster286 is supplied with 1 megabyte of RAM, expandable to 2 megabytes, and an empty socket for an 80287 floating-point processor. Your operating system and applications software can use approximately 704K bytes of this board's RAM. Some of its miscellaneous features are disk caching, diagnostics, four DMA channels,

eight levels of priority interrupts, and 16K bytes of EPROM expandable to 256K bytes.

Pfaster286 is \$2395, which includes an 8088 service program to call up the board and to load Pfaster286's AT ROM BIOS-emulation software. The 80287 mathematics coprocessor is \$350, and 512K-byte RAM increments are \$400. Contact Phoenix Computer Products Corp., Suite 115, 1420 Providence Highway, Norwood, MA 02062, (800) 344-7200; in Massachusetts, (617) 762-5030. Inquiry 604.

### High-Speed Modem

An asynchronous 9600-bps modem, the UPTA 96, comes in an internal, piggyback version for the IBM Personal Computer and in a stand-alone configuration with an RS-232C connector for a variety of computers. The suggested retail price for the add-in card is \$795, and the stand-alone UPTA 96 is \$895.

This intelligent half-duplex modem operates over standard dial-up telephone lines or through computer-to-computer links. Its data-rate selectable for 4800-, 7200-, and 9600-bps transmission speeds, with automatic fallback to 7200 or 4800 bps when noisy lines are encountered during 9600-bps communications. Standard

are automatic adaptive equalization to ensure data integrity, auto-dial, auto-answer, full-duplex emulation, and compatibility with the Hayes command set.

The UPTA 96 comes with proprietary error-detection/correction circuitry firmware known as EDI (Ensured Data Integrity). EDI organizes data into numerically sequenced packets, with each byte subject to a cyclic-redundancy check and packet-check generation dur-

ing transmission. The protocol also offers selective automatic request for transmission (ARQ).

The UPTA 96 supports asynchronous 3270 and VT-100 emulation software. It's FCC-certified for direct connection to the public-switched telephone network by means of a USOC RJ11 jack. Contact Electronic Vaults Inc., Suite 714, 8350 Greensboro Dr., McLean, VA 22102, (703) 883-0331. Inquiry 605.



The Zenith Z-200 is compatible with IBM's PC AT.

### Zenith's Z-200 Advanced PC

Zenith Data Systems' Z-200 Advanced PC, an IBM PC AT-compatible computer, uses Intel's 6-MHz 80286 microprocessor and no-wait-state technology for increased processing speed. The standard model comes with 512K bytes of dynamic RAM, a single 1.2-megabyte floppy-disk drive, six expansion slots that can accommodate AT hardware, and MS-DOS 3.1. It costs \$3999.

RS-232C, Centronics parallel, and video interface ports are provided on this computer. A choice of video cards is offered. The Z-200 Advanced PC also comes with a combination Winchester/floppy-disk controller

board that can handle two floppy- and three hard-disk drives.

The Z-200 Advanced PC's keyboard features enlarged backspace, delete/insert, caps lock, scroll lock, and system request keys. Impression marks on the home-row keys have been included.

The Z-200 Advanced PC's dynamic RAM can be expanded to 16 megabytes in 1.5-megabyte increments. XENIX is available for multiuser, multitasking environments. The Z-200 Advanced PC can be obtained with a 20-megabyte hard disk for \$5599.

Contact Zenith Data Systems Corp., 1000 Milwaukee Ave., Glenview, IL 60025, (800) 842-9000, ext. 1; in Illinois, (312) 391-8949. Inquiry 606.

(continued)



# Borland's SideKick™ Will Clear Your Desk In 30 Minutes And Increase Your Productivity By 50%

SideKick is a combination of seven desktop accessories, which makes SideKick the single most effective business tool. Just a keystroke suspends your application program, giving you a window into SideKick. Another keystroke brings you back to where you were. Instantly. It's that easy.

**A FULL-SCREEN WORDSTAR™-LIKE EDITOR**

You may jot down notes and edit files up to 25 pages long.

**AN ASCII TABLE** for easy reference.

**AN AUTODIALER** for all your phone calls. It will look up and dial telephone numbers for you. (A modem is required to use this function.)

**A PHONE DIRECTORY** for your names, addresses and telephone numbers. Finding a name or a number becomes a snap.

**A MONTHLY CALENDAR** functional from year 1901 through year 2099.

**A DATEBOOK** to remind you of important meetings and appointments.

**A FULL-FEATURED CALCULATOR** ideal for business use. It also performs decimal to hexadecimal to binary conversions.

COPY-PROTECTED  
**\$54.95**

NOT COPY-PROTECTED  
**\$84.95**

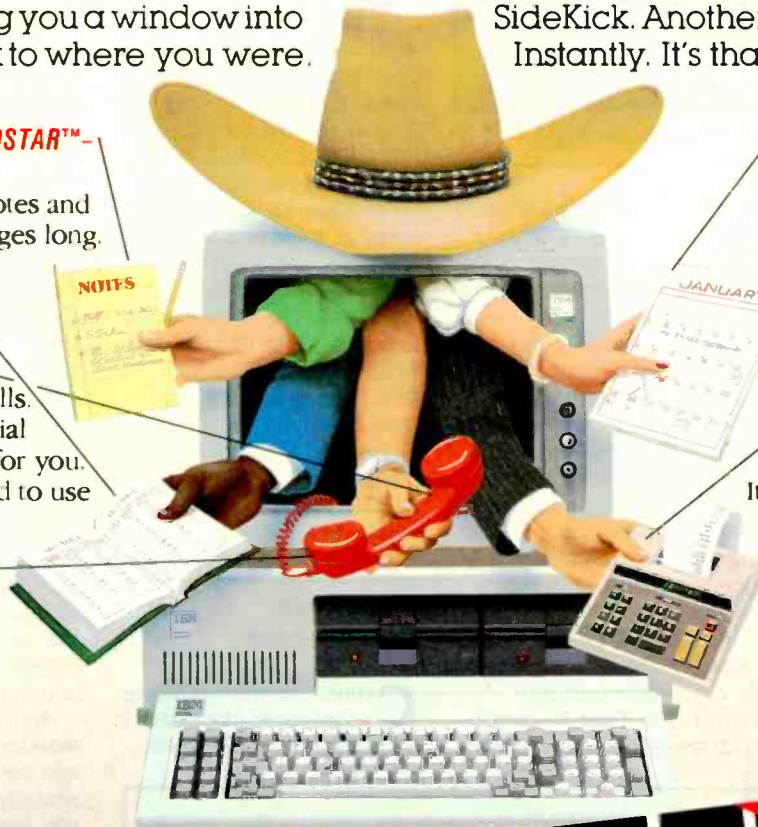

4585 Scotts Valley Drive  
Scotts Valley, CA 95066  
(408) 438-8400 Telex: 172373

**THE CRITICS' CHOICE**

"In a simple, beautiful implementation of WordStar's™ block copy commands, SIDEKICK can transport all or any part of the display screen (even an area overlaid by the notepad display) to the notepad." Charles Petzold, PC MAGAZINE

"SIDEKICK deserves a place in every PC." Gary Ray, PC WEEK

"SIDEKICK is by far the best we've seen. It is also the least expensive." Ron Mansfield, ENTREPRENEUR

"If you use a PC, get SIDEKICK. You'll soon become dependent on it." Jerry Pournelle, BYTE

Copyright 1985 Borland International BI-1008

SideKick is a trademark of Borland International, Inc. IBM and PC-DOS are registered trademarks of International Business Machines Corp. Infoworld is a trademark of Popular Computing, Inc. a subsidiary of CW Communications, Inc. WordStar is a registered trademark of Micropro International Corp.

Inquiry 57 for End-Users. Inquiry 58 for DEALERS ONLY.

SIDEKICK

NOT COPY-PROTECTED

Available at better dealers nationwide. Call (800) 556-2283 for the dealer nearest you. To order by Credit Card call (800) 255-8008, CA (800) 742-1133

Yes, I want the Best.  
Please send me SideKick!

Copy-Protected **\$54.95**  
(CA res. add \$3.30 tax per copy)  
Quantity: \_\_\_\_\_ at \$54.95

Not Copy-Protected **\$84.95**  
(CA res. add \$5.10 tax per copy)  
Quantity: \_\_\_\_\_ at \$84.95

Software for your IBM®PC, XT, AT, jr. and true compatibles.

PCjr requires not copy-protected version

These prices include shipping to all US cities. All foreign orders add \$10 per product ordered.

Name: \_\_\_\_\_

Shipping Address: \_\_\_\_\_

City: \_\_\_\_\_

State: \_\_\_\_\_ Zip: \_\_\_\_\_

Telephone: \_\_\_\_\_

Amount: (CA 6% tax) \_\_\_\_\_

Payment: VISA MC BankDraft Check

Credit Card Expir. Date: \_\_\_\_\_ / \_\_\_\_\_

Card # \_\_\_\_\_

COD's and Purchase Orders WILL NOT be accepted by Borland. California residents add 6% sales tax. Outside USA add \$10 and make payment by bank draft, payable in US dollars drawn on a US bank.

S15

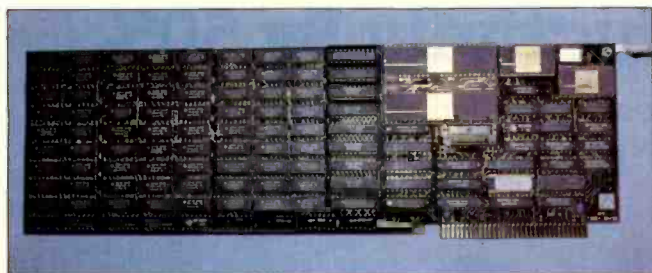

The Tiger-32 accommodates 2 megabytes of no-wait-state RAM.

### NS32032 Add-in Board for IBM

The Tiger-32 is a 32-bit add-in board for IBM PC, PC XT, and PC AT computers. It has a 6- or 10-MHz National Semiconductor NS32032 or NS-32016 central processor, an NS32082 demand-paged virtual-memory manager, and from 512K bytes to 2 megabytes of no-wait-state RAM. Tiger-32 comes with Microsoft-Logica's XENIX-32 version 3.0, a two-user operating system.

The Tiger-32 can execute large programs, but it does not execute IBM PC code

directly. It can function as expansion memory or as a disk emulator. Among its hardware specifications are two RAM ports, parity error checking, and 150-nano-second access time.

The board has both linear and window modes. In its linear mode, the Tiger-32 acts as an expansion memory. The window mode lets your PC access the Tiger-32's RAM through any one of sixteen 128K-byte windows.

With XENIX-32, this board uses PC-DOS 2.0 or higher as an input/output processor. The Tiger-32 comes with a visual shell interface,

software-development utilities with C and assembly language, and communications, text-processing, installation, interfacing, and test software.

Up to 2 megabytes of RAM and a 32-bit floating-point mathematics unit are optional. Software options include remote user capability, BASIC, COBOL, FORTRAN, and Pascal.

The Tiger-32 with 512K bytes of RAM, a 6-MHz NS32016, and XENIX-32 is \$2495. With the NS32032, it's \$2795. The mathematics unit is \$425 at 10 MHz and \$275 at 6 MHz. Contact DFE Electronic Data Systems, Suite 115, 5820 Stoneridge Mall Rd., Pleasanton, CA 94566, (415) 847-2024, Inquiry 607.

### Macintosh Spreadsheet

Crunch for the 512K-byte, single-drive Macintosh is an integrated spreadsheet

program with graphics, data-management, and notekeeping capabilities. The suggested retail price is \$295.

Crunch's spreadsheet gives you a 250-column by 9999-row work area, and it can be linked with other worksheets. Depending upon the font used, you can display up to 31 rows on the screen. Wide spreadsheets can be printed out sideways.

Seventy-four mathematics, trigonometric, statistics, logic, financial, table, and date functions are built into Crunch. In addition, it has three special functions and gives you the ability to define up to 1000 functions.

Crunch can perform both natural-order and row-wise calculations. You can hide or password-protect cells containing sensitive data. Other features include audit trails, variable-width columns, adjustable cell alignment, and the ability to assign names to cells, ranges, formulas, and constants.

You can link graphs to worksheets, and four graphs can be displayed simultaneously. Crunch produces pie, line, bar, and area graphs.

Crunch's data manager organizes worksheet rows into database records anywhere within the worksheet. You can use it to perform calculations on records, and you can sort records. Crunch's notepad can be used for merging information with other programs and to keep 2½ pages of worksheet documentation.

Crunch uses icons, windows, and a consistent set of commands. It works with the Apple Numeric Keypad and supports the LaserWriter and the Imagewriter. Contact Paladin Software Corp., 2895 Zanker Rd., San Jose, CA 95134, (408) 946-9000, Inquiry 608.

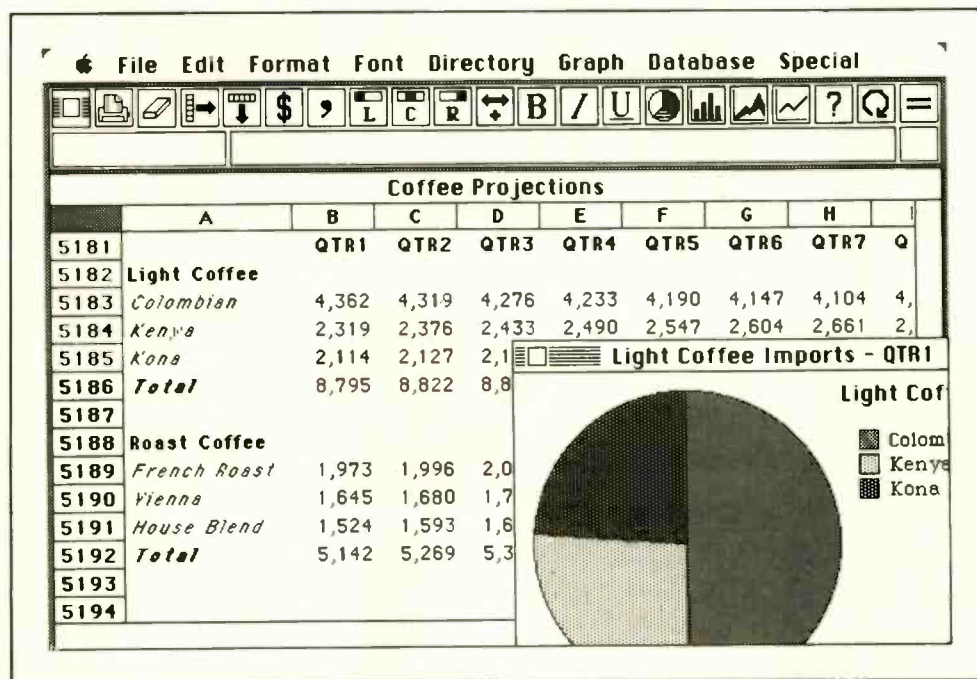

Sample multiwindow display produced by Crunch.

(continued)

ATTENTION SIDEKICK USERS: SUPERKEY IS  
SIDEKICK'S BEST COMPANION. GET SUPERKEY TODAY!

# Borland's SuperKey™

## lets one powerful keystroke do the work of hundreds and helps keep your confidential files ... confidential!

**SUPERKEY TURNS 1,000 INTO 1!** Yes, SuperKey can record lengthy keystroke sequences and play them back at the touch of a single key. Instantly. Like Magic. Say, for example, you want to add a column of figures in 1-2-3. Without SuperKey you'd have to type seven keystrokes just to get started. ["shift-@-s-u-m-shift-(")]. With SuperKey you can turn those 7 keystrokes into 1.

**SUPERKEY HELPS PROTECT YOUR CAPITAL INVESTMENT.** SuperKey, at your convenience, will make your screen go blank after a predetermined time of screen/keyboard inactivity. You've paid hard-earned money for your PC. SuperKey will protect your monitor's precious phosphor ... and your investment. This feature alone justifies your SuperKey purchase!

**SUPERKEY KEEPS YOUR 'CONFIDENTIAL' FILES ... CONFIDENTIAL!** Time after time you've experienced it: anyone can walk up to your PC, and read your confidential files (tax returns, business plans, customer lists, personal letters ...). With SuperKey you can encrypt any file, even while running another program. As long as you keep the password secret, only YOU can decode your file. SuperKey implements the U.S. government Data Encryption Standard (DES).

**SUPERKEY PROTECTS YOUR WORK FROM INTRUDERS WHILE YOU TAKE A BREAK.** Now you can lock your keyboard at any time. Prevent anyone from changing hours of work. Type in your secret password and everything comes back to life ... just as you left it.



**BORLAND**  
INTERNATIONAL

4585 Scotts Valley Drive  
Scotts Valley, CA 95066  
(408) 438-8400 Telex: 172373

Inquiry 59 for End-Users. Inquiry 60 for DEALERS ONLY.

### THE CRITICS' CHOICE

"While most people only talk about low-cost personal computer software, Borland has been doing something about it. And Borland provides good technical support as part of the price."

John Markoff & Paul Freiberger, syndicated columnists

"What I think the computer industry is headed for: well-documented, standard, plenty of good features, and a reasonable price."

Jerry Pournelle, BYTE

Copyright 1985 Borland International BI-1009

SuperKey is a trademark of Borland International, Inc.  
1-2-3 is a trademark of Lotus Development Corp.  
IBM is a registered trademark of International Business Machines Corp.

**NOT COPY PROTECTED**

# SuperKey

Get your IBM PC or compatible a SuperKey today.

Available at better dealers nationwide. Call (800) 556-2283 for the dealer nearest you. To order by Credit Card call (800) 255-8008. CA (800) 742-1133

**\$69<sup>95</sup>**

This price includes shipping to all U.S. cities. All foreign orders add \$10 per product ordered.

**60 DAY MONEY-BACK GUARANTEE**

YES! Please rush SuperKey to me. Send me \_\_\_\_\_ copies.

Subtotal \_\_\_\_\_  
(CA res. add 4.20 tax per copy)

Amount Enclosed: \_\_\_\_\_  
Payment VISA MC Bank Draft Check  
Credit Card Exp. Date \_\_\_\_\_  
Card # \_\_\_\_\_

Name \_\_\_\_\_  
Shipping Address: \_\_\_\_\_  
City \_\_\_\_\_  
State: \_\_\_\_\_ Zip: \_\_\_\_\_  
Telephone: \_\_\_\_\_

COD's and Purchase Orders WILL NOT be accepted by Borland. California residents: add 6% sales tax.  
Outside USA: add \$10 and make payment by bank draft, payable in US dollars drawn on a US bank

K15

**Spectravideo Product Line**

**S**pectravideo recently introduced four computers: two IBM PC-compatibles, a laptop, and a dedicated word processor. In a related announcement, Spectravideo said that it will begin delivering its MSX Express (Model SVI-738) computer in September. This computer has a 3½-inch floppy-disk drive, a 73-key keyboard, 64K bytes of RAM, and an 80-column-display capability. The MSX Express will sell for \$595.

Spectravideo's Bondwell 34 and 36 are 16-bit desktop computers that are compatible with the IBM Personal Computer. The 256K-byte Spectravideo Bondwell 34 comes with dual 5¼-inch double-sided double-density floppy-disk drives, an 80-column monochrome-monitor interface, and a Centronics-type parallel interface. GW-BASIC and MS-DOS are bundled with this system. The planned release date is in October, and the suggested retail price will be \$1795.

The Spectravideo Bondwell 36 carries most of the features of the Bondwell 34, except that its storage system comprises a 10-megabyte hard-disk drive and a single floppy-disk unit. It, too, is scheduled for an October release. The Spectravideo Bondwell 36 will retail for \$2995.

An 11-pound, battery-rechargeable device, the Spectravideo Bondwell 2 laptop computer runs under CP/M 2.2. It's built around the Z80L microprocessor and offers an integral 3½-inch single-sided double-density floppy-disk drive and

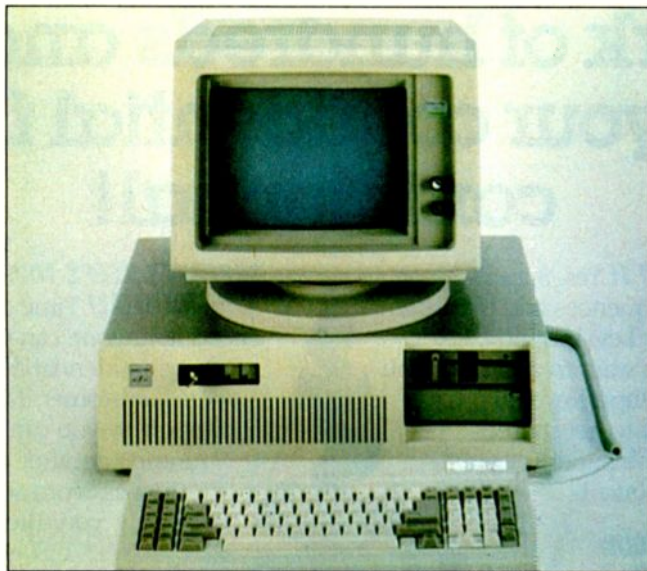

The BT/AT is hardware- and software-compatible with the AT.

an 80-column by 25-line LCD screen. The screen resolution is 640 by 200 pixels, and the formatted floppy-disk storage capacity is 360K bytes.

Six MicroPro software packages come with this computer: WordStar, ReportStar, CalcStar, MailMerge, DataStar, and Scheduler Plus. Options include an external 3½-inch disk drive and a carrying case. The Spectravideo Bondwell 2 should retail for less than \$1000 when it's released in September.

The Spectravideo Bondwell 22 is a 16-bit, 8088-based word-processing system with dual monitors for text and menu displays. Its 97-key keyboard has 31 software-programmable function keys and a trackball cursor controller. The Spectravideo Bondwell 22 comes with a pair of floppy-disk drives, a hard-disk interface, a real-time clock, two RS-232C ports, a Centronics-type parallel interface, and a daisy-wheel printer.

This system's word-processing software offers document merge and forms generation, as well as a con-

version program for accessing WordStar files from other computers. A clock program with an alarm, calendar, and reminder functions is provided. Shipments are to begin in January 1986. Pricing had not been determined at press time.

Contact Spectravideo Inc., 3300 Seldon Court #10, Fremont, CA 94539, (415) 490-4300. Inquiry 609.

**BT/AT Computer Is Compatible with PC AT**

**T**he BT/AT from Basic Time is compatible with hardware and software designed for the IBM PC AT computer.

Based on Intel's 16-bit 80286 microprocessor, which runs at 6 MHz, the BT/AT comes with 640K bytes of RAM, eight expansion slots, and two serial and two parallel ports. Its monochrome graphics adapter card is compatible with the Hercules card, and

the display resolution is 720 by 348 pixels. The BT/AT's 12-inch green monitor is mounted on a tilt-and-swivel base.

Mass storage is provided by a 44-megabyte hard-disk drive and a 1.2-megabyte floppy-disk drive that can read and write 360K-byte floppy disks. The average access time for the hard disk is 30 milliseconds.

The BT/AT comes with MS-DOS 3.1 and GW-BASIC, and it has an open socket for an 80287 mathematics coprocessor. Options include a multifunction board, a high-resolution monitor, and a color graphics adapter. A 70-megabyte hard-disk drive and a 60-megabyte streaming-tape backup are also available.

The suggested retail price for the BT/AT is \$4495. Contact Basic Time, Building 52, 3350 Scott Blvd., Santa Clara, CA 95054, (408) 727-0877. Inquiry 610.

**Programmable Logic Chips**

**A**ltera's EP310 is an erasable programmable-logic chip that uses Intel's CHMOS technology for low power consumption. You can program this chip to have the equivalent of 300 logic gates.

The EP310 is a 20-pin DIP device that can be programmed using Altera's PLDS2 (Programmable Logic Development System), a \$2500 software/hardware combination that attaches to an IBM PC. You can erase the EP310 with an ultraviolet eraser.

The EP310 chips cost \$11.79 in 100-unit quantities. Contact Altera Corp., 3525 Monroe St., Santa Clara, CA 95051, (408) 984-2800. Inquiry 611.

(continued on page 406)

# Speed, Power, Price.

# Borland's Turbo Pascal Family.

**The industry standard.** With more than 250,000 users worldwide Turbo Pascal is the industry's de facto standard. Turbo Pascal is praised by more engineers, hobbyists, students and professional programmers than any other development environment in the history of microcomputing. And yet, Turbo Pascal is simple and fun to use!

**Jeff Duntemann, PC Magazine:** "Language deal of the century . . . Turbo Pascal: It introduces a new programming environment and runs like magic."

**Dave Garland, Popular Computing:** "Most Pascal compilers barely fit on a disk, but Turbo Pascal packs an editor, compiler, linker, and run-time library into just 29K bytes of random-access memory."

**Jerry Pournelle, BYTE:** "What I think the computer industry is headed for: well documented, standard, plenty of good features, and a reasonable price."

**Portability.** Turbo Pascal is available today for most computers running PC DOS, MS DOS, CP/M 80 or CP/M 86. A XENIX version of Turbo Pascal will soon be announced, and before the end of the year, Turbo Pascal will be running on most 68000 based microcomputers.

**\$69.95**

## High resolution monochrome graphics for the IBM PC and the Zenith 100 computers

**Dazzling graphics and painless windows.** The Turbo Graphix Toolbox will give even a beginning programmer the expert's edge. It's a complete library of Pascal procedures that include:

- Full graphics window management.
- Tools that will allow you to draw and hatch pie charts, bar charts, circles, rectangles and a full range of geometric shapes.
- Procedures that will save and restore graphic images to and from disk.
- Functions that will allow you to precisely plot curves.
- Tools that will allow you to create animation or solve those difficult curve fitting problems, and much, much more . . .

**No sweat and no royalties.** You may incorporate part, or all of these tools in your programs, and yet, we won't charge you any royalties. Best of all, these functions and procedures come complete with commented source code on disk ready to compile!



**\$54.95**

**NEW**

## Searching and sorting made simple

**The perfect complement to Turbo Pascal.** It contains: *Turbo-Access*, a powerful implementation of the state-of-the-art B+ tree ISAM technique; *Turbo-Sort*, a super efficient implementation of the fastest data sorting algorithm, "Quicksort on disk". And much more.

**Jerry Pournelle, BYTE:** "The tools include a B+ tree search and a sorting system; I've seen stuff like this, but not as well thought out, sell for hundreds of dollars."

**Get started right away: free database!** Included on every Toolbox disk is the source code to a working data base which demonstrates how powerful and easy to use the Turbo-Access system really is. Modify it to suit your individual needs or just compile it and run.

**Remember, no royalties!**

**\$54.95**

**From Start to Finish in 300 pages.** Turbo Tutor is for everyone, from novice to expert. Even if you've never programmed before, Turbo Tutor will get you started right away. If you already have some experience with Pascal or another programming language, Turbo Tutor will take you step by step through topics like data structures and pointers. If you're an expert, you'll love the sections detailing subjects such as "how to use assembly language routines with your Turbo Pascal programs."

**A must.** You'll find the source code for all the examples in the book on the accompanying disk ready to compile. Turbo Tutor might be the only reference on Pascal and programming you'll ever need.

**\$34.95**

## TURBO PASCAL FAMILY

Available at better dealers nationwide. Call (800) 556-2283 for the dealer nearest you. To order by Credit Card call (800) 255-8008, CA (800) 742-1133

Carefully Describe your Computer System!  
 Mine is:  8 bit  16 bit  
 I use:  PC-DOS  MS-DOS  
 CP/M 80  CP/M 86  
 My computer's name/model is: \_\_\_\_\_

The disk size I use is:  
 3 1/2"  5 1/4"  8"

Name: \_\_\_\_\_  
 Shipping Address: \_\_\_\_\_  
 City: \_\_\_\_\_ Zip: \_\_\_\_\_  
 State: \_\_\_\_\_  
 Telephone: \_\_\_\_\_



Pascal 3.0 \$ 69.95  
 Pascal w/8087 \$109.90  
 Pascal w/BCD \$109.90  
 Pascal w/8087 & BCD \$124.95  
 Turbo Toolbox \$ 54.95  
 Turbo Graphix \$ 54.95  
 Turbo Tutor \$ 34.95

Amount: (CA 6% tax) \_\_\_\_\_  
 Payment: VISA MC BankDraft Check  
 Credit Card Expir. Date: \_\_\_\_\_  
 Card #: \_\_\_\_\_



**Software's Newest Direction**  
 4585 Scotts Valley Drive  
 Scotts Valley, CA 95066  
 TELEX 172373

Inquiry 61 for End-Users. Inquiry 62 for DEALERS ONLY.

Turbo Pascal is a registered trademark of Borland International, Inc.

F15  
 COD's and Purchase Orders WILL NOT be accepted by Borland. California residents add 6% sales tax. Outside USA: add \$10 and make payment by bank draft, payable in US dollars drawn on a US bank.

## Conducted by Steve Ciarcia

**BIBLICAL SPEECH SYNTHESIZER**

Dear Steve,

Being interested in the teaching of English as a foreign language, I would like to take from a disk, as input, a previously computerized text like the Bible and output it through a speech synthesizer, meanwhile delaying the video-screen readout to appear following the speech output, phrase by phrase or sentence by sentence.

Among your many circuits, is there one that could be used or adapted for this purpose?

G. KAYE  
Paxton, IL

*The Microvox text-to-speech synthesizer will serve your purpose with some additional software. The controlling computer needs a small program to read a line or phrase from the disk, send it to the Microvox, wait for the designated time while the phrase is spoken, and then print it to the screen. This is a simple job for the computer, and the Microvox will speak the line as it is received.*

*The problem with this concept is that the text-to-speech algorithm does not handle all pronunciations adequately. This could be handled with a little extra work by editing the text to correct the improper pronunciations, using the methods described in my October 1982 Circuit Cellar article.*

*A more sophisticated system was described in the article "Three Tiered Software and VLSI Aid Developmental System to Read Text Aloud" by Edward Bruckert, Martin Minow, and Walter Tetschner in the April 21, 1983, issue of Electronics magazine. This system uses basically the same conversion algorithm as the Microvox, but it has more memory, a faster processor (MC68000), and tests against more rules. Write to Digital Equipment Corp. (HL2-1/E10, 77 Reed Rd., Hudson, MA 01749) for information on availability and price.—Steve*

**HOW ABOUT THE SANYO?**

Dear Steve,

I want to buy an IBM PC-compatible system, and the Sanyo MBC 555 looks very promising. I am having great problems finding out the extent of the compatibili-

ty. Scottsdale Systems states that the MBC 555 will run many programs written for the IBM PC, while National Computer Products says the MBC will run all software currently available for the PC. What is the truth?

Second, does the Sanyo have IBM PC-compatible slots?

SIGNOR SHAFIK  
Yonkers, NY

*The Sanyo MBC 555 will run a lot of IBM PC software. The May 1984 issue of Microcomputing magazine lists 29 programs written for the IBM PC that will run on the Sanyo. Most of these are business and word-processing packages, including dBASE II, Bottom Line Strategist, and Financial Planner from Ashton-Tate; Volkswriter from Lifetree; Type Faces from Alpha Software; and Perfect Filer and Calc from Perfect Software. Three of the programs listed in the magazine require double-sided drives, which are not yet available.*

*Generally, any IBM PC program that uses only MS-DOS functions can be expected to run on the Sanyo, but programs that use IBM PC hardware-specific functions or interrupts defined in the IBM PC ROM BIOS probably won't. Unfortunately, there isn't any way to tell which programs will run except to try them.*

*An example of the incompatibility is that the versions of the Information Unlimited Software Easy-series programs bundled with the machine won't run on the IBM PC, even though the same programs are available in IBM PC and MS-DOS versions.*

*The Sanyo BASIC is somewhat different from both the IBM and generic versions of Microsoft BASIC. IBM BASIC programs will run when none of the IBM hardware-specific BASIC instructions are used.*

*Lastly, the Sanyo does not have IBM PC-compatible expansion slots, but double-sided disk drives commonly used in IBMs, like the TEAC 55B half-height drives, apparently will work.—Steve*

**VICTOR SOFTWARE**

Dear Steve,

Thank you again for your reply to my letter about Ukrainian word processing. I

have taken your advice and purchased the Victor 9000. I am quite pleased with the machine. I only regret that the company has gone bankrupt. Now I am using Multi-Mate word processing. I also ordered the Programmer's Toolkit to be able to create my Ukrainian character set, but I am still waiting for delivery. Perhaps Victor will still be able to come through.

Victor has come out with a special controller board that permits the use of IBM software, but it costs about \$900. If I had that much to spend, I would save up a little more and simply get another computer.

Do you know if it would be possible to connect another drive to the Victor 9000 so I would be able to use either IBM or Apple software? Perhaps the expense would not be worth the trouble. In any event, I would appreciate your advice.

MAXIM M. KOBASUK  
Glen Cove, NY

*Victor did file for bankruptcy, but the company is still in business. You may still be able to get the Programmer's Toolkit from them. If it turns out that they cannot deliver, you may be able to obtain the program from United Software Co. of Tulsa, Oklahoma, a company that specializes in software for the Victor 9000 and other IBM PC clones. There are more than 100,000 Victor 9000 computers out there, so there are still interested software producers and distributors. It was recently reported in InfoWorld that the Victor dealers have a catalog of 1000 or so software packages currently available in the U.S. and about 1500 overseas.*

*Changing disk drives won't help you run Apple or IBM software. The drives on the Victor are mechanically able to read these disks, but the machine has a completely different architecture from the Apple II series and would require either an emulation program or special hardware similar to the QuadLink board available for the IBM PC.—Steve*

**CHEAP LONG DISTANCE**

Dear Steve,

In search for a reliable high-speed link for microcomputers, I read "Communica-

(continued)

*Imagine  
dBASE III™  
running up  
to 20 times  
faster.*

*The time  
for Clipper  
has arrived.*



## *Clipper introduces you to the time of your life.*

Time is your most valuable commodity. Because how you spend your time, is how you live your life.

At Nantucket, we believe you should live life to the fullest.

Clipper, the first true compiler for dBASE III™ is a timely example. Now, dBASE compiled by Clipper runs 2 to 20 times faster than dBASE with its standard interpreter. A dBASE interpreter painstakingly checks and executes your source code one line at

a time, every time you run a program. With Clipper, once you've debugged your source code, it's compiled into more efficient machine code. Your program runs without the time-consuming overhead of redundant translation. Clipper compiles all your existing and future dBASE III programs.

Developing a compiler for dBASE III was just a matter of time. Call your dealer or our toll free 800 number and ask for Clipper.

Then go make the most of your life time.



Nantucket

# Golden

• COMPUTERS • VIDEO • ELECTRONICS • PHOTOGRAPHY  
FOR INFO CALL (212) 725-1234 FOR ORDERS (800) 221-3160

### IBM PC & COMPAT.

- IBM PC w/drive, monitor ..... Call
- IBM PC w/256k (2) 360 drives, keyboard, monitor & monitor adaptor ..... Call
- IBM PC w/1) 360k floppy & 20Mb disc drive ..... 2295
- IBM PC as above w/RGB color monitor ..... Call
- IBM PC XT w/256k ..... Call
- IBM AT Enhanced ..... Call
- CANON Athena ..... Call
- COMPAQ PORTABLE w/256k (2) 360 disc drives, DOS & basic ..... 2099
- COMPAQ PLUS ..... 2099
- COMPAQ Desk Pro ..... Call
- LEADING EDGE PC w/256k (2) 360 disc drives, monitor & adaptor, basic DOS 2.11 ..... 1499
- LEADING EDGE PC w/256k as above, but RGB color ..... 1995
- LEADING EDGE XOMB hard disc system ..... 2395
- SANYO MBC 650 2 ..... 699
- SANYO MBC 550 2 ..... 679
- ZENITH 2150 w/2) 360k disc drives, 128k RAM, IBM compatible, w/free Microsoft Word & free Microsoft Multiplan & Color graphics card ..... 1599
- ZENITH 7W 1515E as above, but w/color monitor & XOMB hard disc system ..... 3495
- ZENITH 3 COM Local Area Network ..... Call

### LAP COMPUTERS

- HP 110 w/272k RAM, Lotus 123, 80 col display, 9.5lbs ..... 2295
- MORROW w/2) 360k disc drives, 130k, 256k, IBM compatible ..... 1995

### Apple II

- APPLE IIe w/drive ..... 849
- APPLE IIc ..... 895
- APPLE IIe Macintosh ..... 1699
- APPLE IIe professional system w/128k (2) duo disc drives & 80 col card ..... 1429
- APPLE Image Writer ..... 499

### PRINTERS & PLOTTERS

EPSON:

- RX 80 ..... 229
- LQ 1500 ..... 1069

JUKI:

- 6100 ..... 374
- 6300 ..... 6300
- 779 ..... 779

HP: Laser Printer ..... 2795

HP: Plotter ..... Call

Sweet Pea Plotter ..... Call

NEC: 3550 ..... 239

OKIDATA: NEW! '82 ..... 1099

NEW! 192, 349, 84 ..... 579

NEW! 193, 569, 2410 ..... Call

OLYMPIA: RO ..... 319

SILVER REED: 400 ..... 249

500 ..... 500

550 ..... 449

770 ..... 769

TOSHIBA: 340 ..... 598

351 ..... 1239

### MONITORS

- AMDEK 310A ..... 179
- LEADING EDGE RGB Color ..... 399
- TTL Green, 139 ..... TTL Amber 149

PRINCETON GRAPHICS:

- HX 12 ..... 449
- Max 12 E ..... 174
- SR 12 w/Scan Doubler ..... 499
- TAXAN 410 IBM RGB ..... 349
- TAXAN 420 Hi Res RGB IBM419 ..... 349
- XTRON 1000 Lines Hi Res Amber IBM TTL ..... 149
- ZENITH: ZVM 124 IBM Compatible ..... 139

### MODEMS

HAYES:

- 300 ..... 159
- 1200 ..... 349
- 1200B w/Smartcom II ..... 359
- SMARTCOM III ..... 99
- 2400 ..... Call
- Micro Modem IIe ..... 249

NOVATION SMARTCAT:

- Internal ..... 349
- Ext'l ..... 349

US ROBOTICS: Password 1200 ..... 329

### MODEMS

HAYES:

- 300 ..... 159
- 1200 ..... 349
- 1200B w/Smartcom II ..... 359
- SMARTCOM III ..... 99
- 2400 ..... Call
- Micro Modem IIe ..... 249

NOVATION SMARTCAT:

- Internal ..... 349
- Ext'l ..... 349

US ROBOTICS: Password 1200 ..... 329

### DISKETTES

Verbatim Data Life 10021	29
MAXELL (10) .....	24
MAXELL (10) .....	19
MAXELL (10) .....	28
MAXELL (10) .....	23
IBM (10) .....	22
IBM (10) .....	29
FAMOUS MAKE .....	13
FAMOUS MAKE .....	19
SPECIAL TOK	
Quantities of 100 ea 1.35 ea 1.55	

### TYPEWRITERS

- CANON Typewriter 5 ..... 148
- CANON Typewriter 6 ..... 196
- BROTHER CE 58 ..... 458
- OLYMPIA Compact II ..... 384
- SMITH CORONA 350M ..... 318

After Manufacturer's Repair

### CANON COPIERS

- PC 10 ..... 469
- PC 20 ..... 665
- PC 25 ..... 884
- Stand ..... 99

### IBM PC

- W/64k (1) 360 Disc Drive & Keyboard ..... 1299
- IBM PC w/256k (2) 360 Disc Drives, Graphics Monitor Card, Mon., Keyboard & Software Kit ..... Call
- IBM PC AT ..... Call

### SANYO 550-2

- Now Runs Lotus 123
- 804 PC Compatible
- 360k Disc Drive
- 128k RAM Word Star Calc Star & Easy Writer
- RGB VIDEO CARD ..... 699
- 149

### LEADING EDGE PC

- W/128k, Leading Edge Monitor, Keyboard, Monitor & Printer Adapter ..... 1499

### OLYMPIA RO

- Daisy Wheel Letter Quality
- 14 Cps w/Parallel & Serial Ports w/Built In Factor Feed
- 3 Pitch ONLY! ..... 319

### ZENITH Z 150

- W/2) 360k Drives, Microsoft Word, Multiplan Keyboard ..... 1599
- as above w/2) w/10mb Hard Disk and (1) 360k Floppy ..... 2395

### COMPAG

- Portable W/2) 360k Disc Drives, DOS & Basic Keyboard ..... 2099
- COMPAG Plus w/Hard Disc ..... Je Stock

1265 Broadway at 32nd Street New York 10001

CORPORATE ACCOUNTS WELCOME! Minimum Shipping Order \$50. Minimum Service Charge for Orders Under \$50. Minimum Shipping \$1.95. Some Prices Vary. Order Only. We Reserve the Right to Limit Quantities.

## ASK BYTE

tion Without Wires" in the June 1984 Ask BYTE. The system you suggest there may be inexpensive, but it does not satisfy my requirement of a long-distance, reliable, and inexpensive link for my IBM PC. I believe my best bet would be a high-speed modem to be used with normal long-distance calls. However, a 1200-bps modem would yield only about 120 words per minute, which makes this system very expensive when one has to pay \$1.50 for those 120 words.

Do you have knowledge of a truly fast, reliable modem not so expensively priced? Or perhaps an idea of another system for a reliable long-distance link for micros?

Thank you very much for whatever ideas you can give me.

AL VILLACRES  
Quito, Ecuador

There essentially aren't any long-distance data-communication links meeting all your requirements. Cost is the problem. Amateur radio is an inexpensive method, but bandwidth restrictions limit speed, and, of course, you can send only to other hams.

There is hope in the form of a new service expected to be introduced in 1985 by AT&T. This service, based on pulse-coded modulation, will allow full-duplex communication at up to 56,000 bps over regular phone lines. See "AT&T Breaks the Speed Barrier" in the September 1984 Computers and Electronics magazine. No word on cost, but it may be some time before inexpensive equipment is available.—Steve

### FILE TRANSFERS

Dear Steve,

My problem is trying to swap data files (mostly, but not entirely, WordStar) from 8-inch double-density disks on an Altos 8002 to either the hard disk or 5¼-inch disks on a TI Professional Computer.

I do not have a modem on either computer. I plan to add one to the TI eventually but don't see much need for one

at present. I still have the Altos up and running.

JOHN W. JUECHTER  
East Greenwich, RI

If you have RS-232C serial ports in both computers and they are located in close proximity to each other (20 feet or so), you don't need modems to set up a communication link. Make or buy a cable configured as a null modem, as shown in table 1. You may also need a program to facilitate data transmission in one or both computers.

If you are running MS-DOS on your TI, you can use the COPY command to copy directly from the communication port to a disk file. Simply set up the communication protocol using the DOS MODE command, e.g., MODE COM1:96,n,8,1 to set for data transfer at 9600 bps, no parity check, 8-bit words, and 1 stop bit. See your DOS manual for other options. Follow this with the command COPY COM1: d:filename.ext (you may have to say AUX instead of COM1:). The computer will wait for data to come in.

I assume you are using CP/M on your Altos. Some implementations of CP/M include a similar function in the PIP command. If yours doesn't, you will need a program to read your files and transmit the data. An inexpensive one for 8-bit CP/M systems is MODEM7, which can be obtained from CP/M Users Group, 1651 Third Ave., New York, NY 10028.—Steve

### MX-80 SUPERSCRIPTS

Dear Steve,

I teach a course in word processing using the Apple II+ and Apple Writer. We have an Epson MX-80 printer.

Can you please explain to me how to get superscript numbers for footnotes using this equipment?

I have called both the Apple people and the Epson people, and both told me to contact the other. Help!

BETTYE JO MARTIN  
Atlanta, GA

Certain special characters must first be sent to an Epson MX-80 to enable it to print superscripts. These consist of the ESC(ape) and Control-N characters. They are simply commands that tell the printer to change to the superscript print mode. When using Apple Writer, these characters should be placed immediately before the text you wish to be superscripted. Of course, you will eventually wish to turn off the superscript mode.

Table 1: Null-modem connections.

PIN	PIN
2	3
3	2
4	5
5	4
6	20
20	6

(continued)



# DECLARE YOUR DATA INDEPENDENCE.

THE NEW STANDARD OF  
MODERN OFFICE DATA STORAGE.



Free yourself from the limitations of shared and finite hard disk storage. Your dynamic and expanding business data needs demand a more versatile way to deal with critical information.

The Bernoulli Box,™ with its totally interchangeable 5- and 10-megabyte cartridges, lets you manage data the way you manage your business—directly, efficiently, by job function and application. You create, update, store, and back up

software and data bases on individual cartridges. You expand your capacity infinitely, by adding more cartridges, not more disk drives. You enjoy the convenience of taking or mailing cartridges anywhere—and the security of putting them under lock and key.

The Bernoulli Box works with the IBM PC, XT, AT, most compatibles, and the Macintosh.™ For your nearest dealer, call 1-800-556-1234 ext. 215. In California, call 1-800-441-2345 ext. 215.



**I-MEGA**

IOMEGA Corporation  
1821 West 4000 South  
Roy, Utah 84067

# BERNOULLI BOX™

# Forecasting and Statistical Analysis for Professionals

## StatPac™ the proven statistical analysis package

StatPac is convenient. Comprehensive. Inexpensive. Tested in the field for more than five years, StatPac has been updated, debugged and enhanced. So it's well established and easy to use. StatPac is the answer for researchers, statisticians, scientists, and educators. Handles 5,000 cases and 253 variables on a standard IBM PC.

## Forecast Plus™ a forecasting tool for the non-statistician

A combination of data management, exploratory graphics, and over a dozen forecasting techniques, make Forecast Plus the most powerful time-series package available. It works fast, accurately and automatically. If you can read a picture, you can use Forecast Plus!

Call Now for Free Comprehensive Brochures

### WALONICK ASSOCIATES

6500 Nicollet Ave. S., Minneapolis, MN 55423  
(612) 866-9022 1-800-328-4907

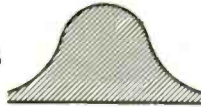

## ASK BYTE

This is done by placing the characters ESC and Control-O at the end of the text to be superscripted.

To enter the special characters mentioned above, you must use the Apple Writer Control-V command. This will cause ESC or any control characters that you now type to be inserted directly into the text at the location of the cursor, instead of being interpreted as a possible command. Control-V must be used since ESC, Control-N, and Control-D are all commands to the Apple Writer program itself. Press Control-V again to exit this special insertion mode.

The characters that must be sent to the printer to control its various printing styles can be found in the manual that came with the printer. The same technique described in the above paragraph may be utilized to print in elite, emphasized, boldface, or other styles. Simply insert the correct characters into the text using the Control-V command.—Steve

### OSMOSIS ON THE OSBORNE I

Dear Steve,

I have installed an Osmosis double-density modification in my Osborne I. Even after making the circuit-board changes they recommend, I still do not get reliable double-density operation. Can you supply a reference that goes into detail about the difference between single and double density?

ROBERT E. FALKOSKI  
Richland, WA

A principal difficulty encountered with storing data on floppy disks is the phenomenon of bit shifting, which refers to the physical movement of the location of a recorded bit due to the influence of neighboring bits. If left uncorrected, this shifting could cause unreliable retrieval of recorded information. While these bit-shifting influences exist on single-density disks, the effects are small enough to ignore.

On double-density disks, the effects are magnified, and the techniques to record and decipher information must become more sophisticated. One technique uses write precompensation logic to adjust the spacing of the bits as they are written to disk, so that they will be evenly spaced during subsequent read operations. Such logic is usually handled by the disk-controller circuitry.

An excellent, and very readable, discussion of these techniques, as well as a source of some practical circuit examples,

(continued)

## INSTANT FINANCIAL PICTURE!

Corporate Financial Simulation Model on your IBM PC, XT or AT with Lotus 1-2-3, Multiplan, SuperCalc, VisiCalc or PeachCalc.

Also available on most CP/M & all Apple systems. A \$6,000 value for \$295.



## Bottomline V

A Financial Decision Support System - budgeting, planning, analysis, and five-year forecasting.

FREE! SuperCalc Electronic Spreadsheet with Bottomline V purchase. (Offer expires 8/31/85).

Fill out this card and mail for complete details, or call 1-800-828-7257, CA only 1-800-523-7201, or 714-476-2842 for UPS COD delivery.

- Send more information
- My check for \$10 is enclosed. Please send me a (circle one) **black and white/color** Demo for my IBM PC.
- Please send me Bottomline V for \_\_\_\_\_ Spreadsheet on the \_\_\_\_\_ computer. My check for \$295 plus \$5 for shipping and handling is enclosed.

Name \_\_\_\_\_ Title \_\_\_\_\_

Company \_\_\_\_\_ Phone \_\_\_\_\_

Street \_\_\_\_\_

City \_\_\_\_\_ State \_\_\_\_\_ Zip \_\_\_\_\_

Mail to: ILAR Systems, Inc. • 1300 Dove St., Suite 105 • Newport Beach, CA 92660



# The Most Powerful C

for the IBM AT • MACINTOSH • MS DOS • CP/M-80 • ROM APPLICATIONS  
IBM PC/XT • APPLE II • CP/M-86 • TRSDOS • CROSS DEVELOPMENT

## Why Professionals Choose Aztec C

AZTEC C compilers generate fast, compact code. AZTEC C is a sophisticated development system with assemblers, debuggers, linkers, editors, utilities and extensive run time libraries. AZTEC C is documented in detail. AZTEC C is the most accurate and portable implementation of C for microcomputers. AZTEC C supports specialized professional needs such as cross development and ROM code development. MANX provides qualified technical support.

### AZTEC C86/PRO

#### — for the IBM AT and PC/XT

AZTEC C86/PRO provides the power, portability, and professional features you need to develop sophisticated software for PC DOS, MS DOS AND CP/M-86 based microsystems. The system also supports the generation of ROM based software for 8088/8086, 80186, and 80286 processors. Options exist to cross develop ROM code for 65xx, 8080, 8085, and Z80 processors. Cross development systems are also available that target most micro computers. Call for information on AZTEC C86/PRO support for XENIX and TOPVIEW.

**POWERFUL** — AZTEC C86/PRO 3.2 outperforms Lattice 2.1 on the DHRSTONE benchmark 2 to 1 for speed (17.8 secs vs 37.1) while using 65% less memory (5.8k vs 14k). The AZTEC C86/PRO system also compiles in 10% to 60% less time and supports fast, high volume I/O.

**PORTABLE** — MANX Software Systems provides real portability with a family of compatible AZTEC C software development systems for PC DOS, MS DOS, CP/M-86, Macintosh, CP/M-80, APPLE II+, IIe, and IIc (NIBBLE - 4 apple rating), TRSDOS (80-MICRO - 5 star rating), and Commodore C64 (the C64 system is only available as a cross compiler - call for details). AZTEC C86/PRO is compatible with UNIX and XENIX.

**PROFESSIONAL** — For professional features AZTEC C86/PRO is unparalleled.

- Full C Compiler (8088/8086 - 80186 - 80286)
- Macro Assembler for 8088/8086/80186/80286
- Linkage Editor with ROM support and overlays
- Run Time Libraries - object libraries + source DOS 1.x; DOS 2.x; DOS 3.x; screen I/O; Graphics; UNIX I/O; STRING; simulated float; 8087 support; MATH; ROM; CP/M-86
- Selection of 8088/8086, 80186, or 80286 code generation to guarantee best choice for performance and compatibility

- Utility to convert AZTEC object code or libraries to Microsoft format. (Assembly + conversion takes less than half the time as Microsoft's MASM to produce MS object)
- Large memory models and sophisticated memory management
- Support products for graphics, DB, Screen, & ...
- ROMable code + ROM support + separate code and data + INTEL Hex Converter
- Symbolic Debugger & Other Utilities
- Full Screen Editor (like Vi)
- CROSS Compilers are available to APPLE II, Macintosh, CP/M-80, TRSDOS, COMMODORE C64, and ROM based 65xx, and 8080/8085/Z80
- Detailed Documentation

AZTEC C86/PRO-AT .....\$500  
(configured for IBM AT - options for 8088/8086)

AZTEC C86/PRO-PC/XT .....\$500  
(configured for IBM PC/XT - options for 80186/80286)

AZTEC C86/BAS includes C compiler (small model only), 8086 MACRO assembler, overlay linker, UNIX, MATH, SCREEN, and GRAPHICS libraries, debugger, and editor.

AZTEC C86/BAS .....\$199  
 AZTEC C86/BAS (CP/M-86) .....\$199  
 AZTEC C86/BAS (DOS + CP/M-86) .....\$299  
 UPGRADE to AZTEC C86/PRO .....\$310  
 C-TREE Database with source .....\$399  
 C-TREE Database (object) .....\$149

### CROSS COMPILERS

Cross Compilers for ROM, MS DOS, PC DOS, or CP/M-86 applications.

VAX -> 8086/80xxx cross .....\$5000  
 PDP-11 -> 8086/80xxx cross .....\$2000

Cross Compilers with PC DOS or CP/M-86 hosts are \$750 for the first target and \$500 for each additional target. Targets: 65xx; CP/M-80; C64; 8080/8085/Z80; Macintosh; TRSDOS; 8086/8088/80186/80286; APPLE II.

### AZTEC C88K

#### — for the Macintosh

For power, portability, and professional features AZTEC C88K-c is the finest C software development system available for the Macintosh.

The AZTEC C88K-c system includes a 68000 macro assembler, a linkage editor, a source editor, a mouse based editor, a SHELL development environment, a library of UNIX I/O and utility routines, full access and support of the Macintosh TOOLBOX routines, debugging aides, utilities, make, diff, grep, TTY simulator with upload & download (source supplied), a RAM disk (for 512K Mac), a resource maker, and a no royalty license agreement. Programming examples are included. (Over 600 pages of documentation).

AZTEC C88K-c requires a 128K Macintosh, and two disk drives (frugal developers can make do with one drive). AZTEC C88K supports the 512K Macintosh and hard disks.

AZTEC C88K-c (commercial system) .....\$500  
 AZTEC C88K-p (personal system) .....\$199  
 AZTEC C88K-p to AZTEC C88K-c upgrade .....\$310

Mac C-tree database .....\$149  
 Mac C-tree database with source .....\$399  
 Lisa Kit (Pascal to AZTEC C88K object converter) ..\$ 99

### AZTEC C65

#### — for the APPLE II

"...The AZTEC C-system is one of the finest software packages I have seen..." NIBBLE review, July 1984.

The only commercial C development system available that runs native on the APPLE II+, IIc, and IIe, the AZTEC C65 development system includes a full floating point C compiler compatible with UNIX C and other MANX AZTEC C compilers, a 6502 relocating assembler, a linkage editor, a library utility, a SHELL development environment, a full screen editor, UNIX I/O and utility subroutines, simple graphics, and screen functions.

AZTEC C65 (Apple DOS 3.3) .....\$199  
 AZTEC C65/PRO (Apple DOS + ProDos) .....\$350  
 (call for availability)

### AZTEC C II/PRO

#### — for CP/M-80

The first member of the AZTEC C family was the CP/M-80 AZTEC C compiler. It is "the standard" compiler for development on CP/M-80. The system includes the AZTEC C II C compiler, an 8080 assembler, a linkage editor, an object librarian, a full library of UNIX I/O and utility routines, CP/M-80 run time routines, the SMALL library (creates modules less than 3K in size), the fast linker for reduced development times, the ROM library, RMAC and M80 support, library source, support for DRI's SID/ZSID symbolic debugger, and more.

AZTEC C II/PRO .....\$349  
 AZTEC C II/BAS .....\$199  
 C-TREE Database with source .....\$399  
 C-TREE Database in AZTEC object form .....\$149

### AZTEC C80

#### — for TRSDOS (Radio Shack Model III & 4)

"I've had a lot of experience with different C compilers, but the Aztec C80 Compiler and Professional Development System is the best I've seen." 80-Micro, December, 1984, John B. Harrell III

This system has most of the features of AZTEC C II for CP/M. It is perhaps the best software development system for the Radio Shack Model III and IV.

AZTEC C80 model 3 (no floating point) .....\$149  
 AZTEC C80 model 4 (full) .....\$199  
 AZTEC C80/PRO (full for model 3 and 4) .....\$299

To order or for information call:

# 800-221-0440

(201) 530-7997 (NJ and outside U.S.A.) Or write: MANX SOFTWARE SYSTEMS, P.O. Box 55, Shrewsbury, N.J. 07701.



For Technical Support  
(Bug Busters) call: 201-530-6557

TRS 80 RADIO SHACK TRS DOS is a trademark of TANDY.  
APPLE DOS MACINTOSH is a trademark of APPLE.

SHIPPING INFORMATION - Standard U.S. shipment is UPS ground (no fee). In the U.S. one day shipment is \$20, two days is \$10. Canadian shipment is \$10. Two days shipment outside the U.S. is by courier and is freight collect.

# IBM AT THE OFFICE APPLE AT HOME NO PROBLEM!

A "Wireless file transfer" package for the IBM PC® to Apple II and back. **APPLE TURNOVER™** is a firmware board which fits into any slot in the IBM PC and some compatibles. NO modems, NO serial links, NO hassles, NO problems. **APPLE TURNOVER™** will format Apple CP/M® and Apple DOS 3.3 disks. Leave your IBM and Apple computers where they are. Simply bring your Apple disk to work and transfer your file to a PC-DOS disk. Allows for modifications to text and data files. It's a simple, inexpensive, high performance alternative to complicated serial links and modems.

"NEW!" **APPLE TURNOVER™** version 2.0 will read, write and format PRO-DOS and Apple P-System Too.

See your dealer or call  
for information:

**(213) 938-0857**

**Vertex**  
systems Inc.

Innovation in microcomputer products 6022 W. Pico Blvd., Los Angeles, CA 90035

## ASK BYTE

can be found in *Microcomputer Interfacing* by Harold S. Stone (Addison-Wesley, 1982). Another reference that discusses aspects of the disk-recording process and that may help you is "IBM Compatible Disk Drives" by Jefferson H. Harman, which appeared on page 100 of the October 1979 *BYTE*.

Manufacturers' service manuals for disk drives often discuss the theory of operation and outline the necessary timing considerations for the disk drive and computer. These manuals can usually be obtained from the drive manufacturer's field offices.—Steve

### VIC-20-CONTROLLED ROBOT

Dear Steve,

I tried to interface a simple robot I made to my VIC-20 via the communications port. The robot is run by small DC motors. Where can I find information about the software needed to control pulses from the port (what to poke and where) and the hardware needed to convert these pulses to a current and voltage to drive the motors? Thanks for any help that you can provide.

MICHAEL LEVIN  
Swampscott, MA

An excellent series of articles by Joel Swank on interfacing to the VIC-20 ("The Enhanced VIC-20") appeared in the February through May 1983 issues of *BYTE*. This series should give you the necessary information about the VIC-20 and how to interface to it. You should also read my article on page 105 of the December 1984 *BYTE*, "Build the Power I/O System," for information on how to connect real-world peripherals to a system. This article will give you a good understanding of optoisolators, which should be used in computer real-world applications.—Steve ■

## VIA WEST DATA SWITCHES MAKE ANY PC SYSTEM MORE PRODUCTIVE.

With a touch of a button, these data transparent switches let you switch from dot matrix to letter-quality printing. Or, two computers can share modems, printers, plotters, networks, terminals, etc. Serial or parallel models available. Saves time and frustration of plugging and unplugging cables. No power required. Just plug into your system. You'll wonder how you ever

got along without them. And the price is right. Write or call for factory-direct shipment.

We also stock a complete line of cables and connector adapters.

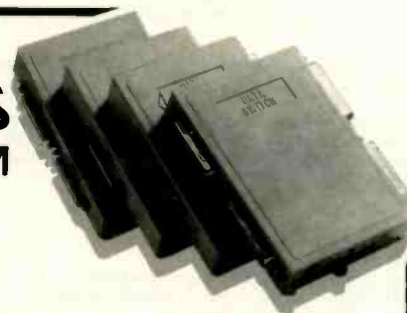

### DSS \$4200\* RS232 Applications

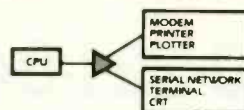

### DSP \$4900\* Centronics Compatible



### XSS \$5500\* RS232 Applications

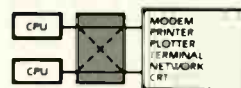

### XSP \$6900\* Parallel Applications



\*Shipped freight-collect. Add \$4.00 per product for postpaid delivery. Checks, Visa and MasterCard

accepted. Quantity discounts available. AZ residents add 7%. Dealer inquiries invited.

**VIA WEST, Inc.**  
"The Interface Company"

534 North Stone Ave., Tucson, Arizona 85705

To order by phone, call  
**(602) 623-5717**

IN ASK BYTE, Steve Ciarla answers questions on any area of microcomputing. The most representative questions received each month will be answered and published. Do you have a nagging problem? Send your inquiry to

Ask BYTE  
c/o Steve Ciarla  
POB 582  
Glastonbury, CT 06033

Due to the high volume of inquiries, personal replies cannot be given. All letters and photographs become the property of Steve Ciarla and cannot be returned. Be sure to include "Ask BYTE" in the address.

The Ask BYTE staff includes manager Harv Weiner and researchers Bill Curlew, Larry Bregoli, Dick Sawyer, Robert Stek, and Jeannette Dojan.

# Introducing the first IBM™ AT Compatible Kit!

## Building your own AT is as easy as it looks.

Now, it's easy to have the IBM AT that you want by building your own from ADTEK's SERIES 286AT™ compatible, board-level kit. Choose from a complete kit (chassis, motherboard, cables, disk controller, keyboard and enhancement boards) and add your own monitor and disk drives. Or buy just the parts you need for your project. Either way, all series 286AT products are hardware and software AT compatible.

But you won't be on your own. The ADTEK SERIES 286AT comes with illustrated, step by step instructions that even a beginner can follow. (Some basic knowledge of electronics will be helpful.) With just a few simple household tools you can put your new computer together in a Saturday afternoon. And you'll feel confident about your SERIES 286AT because every ADTEK product is protected by a full, one year factory warranty.

## And amazingly frugal.

If you're ready for AT power and speed, but don't want to pay IBM's premium price, rest easy. A complete ADTEK SERIES 286AT kit is priced significantly less than a comparably assembled IBM AT. That's engineering excellence at a real bargain! Call or write today for a detailed brochure and price list on the SERIES 286AT and other fine ADTEK products.



Fixed disk and floppy disk controller.



AT compatible, switchable power supply.



AT compatible keyboard. LED on cap, num and scroll lock keys.

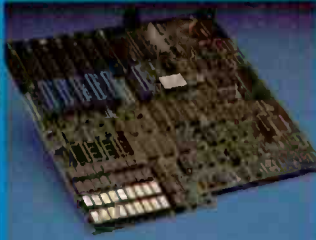

80286 motherboard, 256K standard memory, upgradable to 1M. Clock upgradable to 8MHz.



Fully AT compatible chassis, optional lock. Mounts standard floppy and fixed disk drives.



User supplied disk drives. Kit supplied with list of compatible drive suppliers.

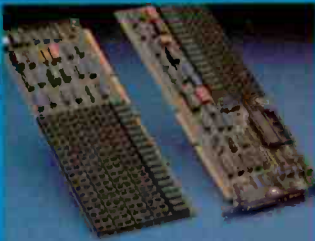

I/O expansion and user expandable memory cards.



User supplied monitor. Kit supplied with list of recommended CRTs.

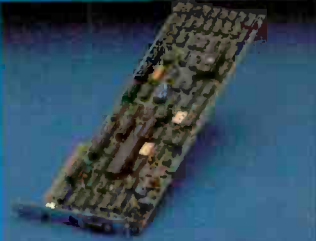

Video display and printer adaptor boards are fully interfaced with SERIES 286AT system.

Manufacturers of Personal Computers/Peripherals/Accessories

3001 LBJ Freeway Suite 213 Dallas, Texas 75234

(214) 386-6554

Inquiry 16

**ADTEK**

IBM is a registered trademark of International Business Machines Corporation and SERIES 286AT is a registered trademark of ADTEK Corporation.

# COMBINE POWER AND ENHANCE YOUR PC-AT

Quadram introduces the smart way to enhance your IBM PC-AT. Quadmeg-AT and Quadport-AT. Smart because Quadmeg-AT and Quadport-AT make the most of your AT system today and expand to meet your system's growing needs in the future.

Quadmeg-AT comes socketed for memory expansion from 128K to 2 Megabytes. Harness this power to create megabyte-sized RAM drives, access

## QUADMEG-AT™

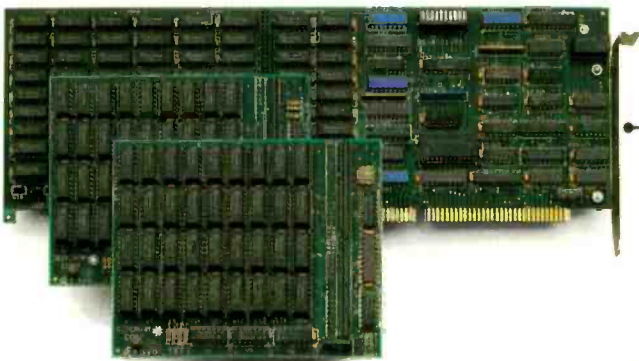

greater amounts of information, and process data faster and more efficiently than ever before. Plus, with "split memory mapping," Quadmeg-AT lets you expand the AT's base system memory to 640K without buying a space-wasting 128K card.

## Advance to 4 Megabytes

When you need more than 2Mbytes, Quadmeg-AT adapts with two Quadmeg-AT Expansion Cards. Each packs 512K or 1Mbyte extra RAM.

Both cards filled give Quadmeg-AT a powerful 4Mbyte capacity. Quadmeg-AT delivers the power you need to take full advantage of the AT's capabilities.

**Maximum Performance in Minimum Space**  
Quadmeg-AT and Quadport-AT fit snugly side by side to deliver a powerful 4Mb RAM and multiple I/O expansion in just two AT expansion slots.

**Add a Second Quadport**  
Two Quadport-ATs give your AT system a total of 2 parallel ports and 10 serial ports. Add peripheral devices or workstations for the ultimate in PC-AT performance.

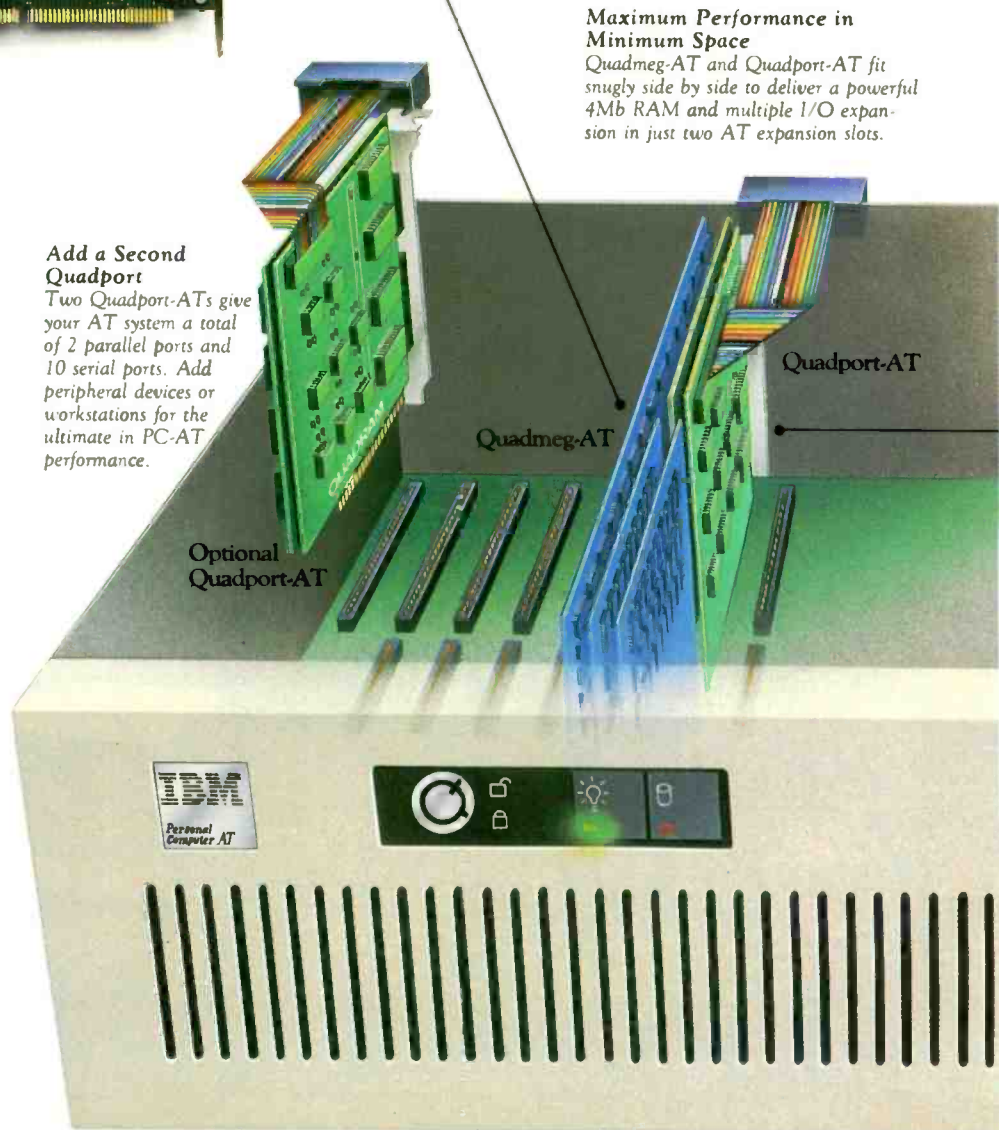

Look for this seal. It's the mark of dependability and performance from the leader in microcomputer enhancements.

IBM PC-AT is a registered trademark of International Business Machines Corporation.

# EXPANDABILITY TO THE SMART WAY.

## QUADPORT-AT™

Quadport-AT combines a parallel printer port and a serial port to give your AT the features found on IBM's Serial Parallel Adapter. But at a lower cost and with

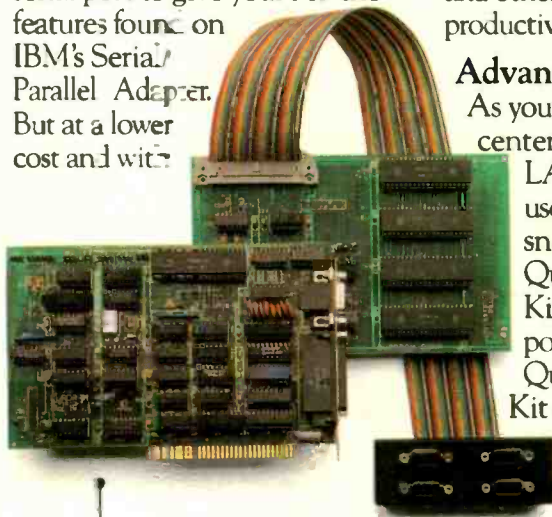

built-in expandability. Connect printers, plotters, modems, and other devices for increased productivity.

### Advanced Port Expansion

As your AT becomes the center of a high-performance LAN or growing multi-user, multi-tasking system, snap on the optional Quadport-AT Expansion Kit and add 4 more serial ports to your system. The Quadport-AT Expansion Kit comes with software to access these ports, making it easy to add shared peripherals or workstations.

### Enhance the smart way with Quadram.

For basic AT expansion, Quadmeg-AT and Quadport-AT work together to provide 128K memory expansion, a serial port, and a parallel port. Then, as your system grows, Quadmeg-AT and Quadport-AT give you up to 4MB RAM, 1 parallel port, and up to 5 serial ports in just two PC AT expansion slots. Only Quadram combines so much power and expandability. That's PC AT enhancement the smart way.

### Features

**Quadmeg-AT:** RAM expansion from 128K to 2Mbytes. Expandable in 512K increments. Split memory mapping assigns 128K or 384K to base memory.  
**Total RAM Capacity:** 4Mbytes.

**Expansion Cards:** Two cards available. Each comes with 512K or 1Mbyte RAM installed.

**QuadMaster-AT Software:** RAM Drives and Spooling for extended memory.

**Quadport-AT:** Port expansion with 1 Centronics parallel port and 1 RS-232C serial port.

**Quadport-AT Expansion Kit:** (optional) 4 RS-232C serial ports. Software to access ports.

For a free demonstration visit the Quadram dealer nearest you. Or, for information, write us at 4355 International Blvd., Norcross, Georgia 30093 (404) 923-6666.

**QUADRAM**  
An Intelligent Systems Company

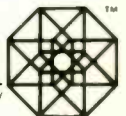

Inquiry 293

# C·L·U·B·S & N·E·W·S·L·E·T·T·E·R·S

## ● THE SILENT SPEAK

A quarterly newsletter about electronic aids for the handicapped, *Current Expressions*, contains letters written with the aid of special computers from victims of otherwise disabling diseases. Profiles, a calendar of events, new products, and advertisements all relate to easing communication for the disabled. Article submissions are welcome. Contact Susanne Shealey, *Current Expressions*, Prentke Romich Co., 1022 Heyl Rd., Wooster, OH 44691, (216) 262-1984.

## ● DRBBS FREE FOR ALL

The DRBBS Technical Bulletin Board System at (402) 896-3537 is free to all personal computer users 24 hours a day at 300 or 1200 bps. General messages, electronic mail, on-line information, public-domain file transfer, and special-interest sections are featured. Call the BBS or contact J. Winslade, DRBBS Technical Bulletin Board System, 14725 Emiline St., Omaha, NE 68138, (402) 895-1379.

## ● SEPARATE BUT EQUAL

The Federation of Computer Users in Medicine (FOCUS-MD) and the Federation of Computer Users in Dentistry (FOCUS-DDS) are two separate organizations staffed by qualified volunteers and run by the same nonprofit institution. Each group welcomes prospective health professionals who use computers. The annual membership fee of \$100 for each group includes a newsletter. Each group maintains a consultant registry for which applicants must pay an additional fee to cover the cost

of testing. Separate seminars are scheduled the first Sunday of each month across the country; nonmembers pay \$10 to attend. For locations and membership services, contact Specific Technology Center, POB 15579, San Francisco, CA 94115, (415) 626-4600.

## ● ACTRIX IN ACTION

Actrix Users Southeast supports users of the Actrix computer and its built-in software. A newsletter is available, as are purchase discounts and updates. Contact Irv Koch, 1954 Stanton Rd., EastPoint, GA 30344, (404) 767-7360.

## ● FRIENDS IN THE SE

People on the Southeast AMIS bulletin-board service are on line 24 hours a day to answer questions about Atari, Macintosh, and Radio Shack computers. The BBS at (704) 541-3306 carries Newsoft news net, and plans include a national user-group listing. Contact Southeast AMIS, POB 1041, Matthews, NC 28106.

## ● TWO SYSTEMS GROUP

The benefits of joining the Micropolis/Vector Graphic Users Group (MUG) include a monthly newsletter, library disks of public-domain CP/M and MS-DOS software, and directions for obtaining parts, service, and commercial software for Micropolis drives and Vector Graphic systems. The annual mem-

bership is \$18. Contact Buzz or Lynn Rudow, Micropolis/Vector Graphic Users Group, 604 Springwood Circle, Huntsville, AL 35803, (205) 881-1697.

## ● SIG FOR CP/M

The Wayne County CP/M Support Group (WCCPMSG) of Williamson, New York, sponsors training programs in CP/M applications software. Members' interests include BASIC programming, databases, and word processing at all levels. Computer-literacy lectures are open to the community. Club members meet at 7 p.m. on the second Wednesday of each month at the Williamson Public Library. Contact the WCCPMSG, POB 34, Williamson, NY 14589.

## ● COMMODORE IN NW PA

The main chapter of the North Coast Commodore Users Group (NCCUG) of Erie, Pennsylvania, meets on the third Tuesday of every month. The Edinboro chapter meets the first Thursday of every month. Both chapters enjoy the privileges of a public-domain library, a monthly newsletter, discounted blank disks, and special-interest groups. An annual membership is \$20; a subscription to the newsletter is an additional \$6. Contact the NCCUG, POB 6117, Erie, PA 16512, (814) 866-1625 for the Erie chapter or 398-8146 for the Edinboro chapter.

## ● SCAN THE MBC

The Sanyo Canadian Users Group, devoted to the Sanyo MBC 550/555 computer, welcomes American participation. Members maintain a network for resource sharing, a public-domain software exchange library, and a newsletter, *SCAN lines*. A BBS is planned. Contact Eric Lillius, Sanyo Canadian Users Group, Box 210 Mountain St., Haliburton, Ontario KOM 1S0, Canada, (705) 457-2774.

## ● COMPUTER FILE

**BLUEGRASS STYLE**—The Central Kentucky Computer Society produces a monthly newsletter, *Computer File*, containing ads and articles, a calendar, and membership information. Membership is \$20 annually. Contact the Central Kentucky Computer Society Inc., Suite 100, Security Trust Building, Lexington, KY 40507.

## ● AN INDUSTRY FIRST

The International MIDI Association (IMA) is a nonprofit organization dedicated to promoting musical-instrument digital interface (MIDI) and music/computing interfacing. An electronic library, a database, and a newsletter, *The IMA Bulletin*, containing MIDI-related product and news announcements are included with IMA membership. Contact the International MIDI Association, 4128 Wilkinson Ave., Studio City, CA 91604, (818) 505-8964.

## ● BIRD IN HAND

The Robin Owners' Group is for users of the DEC VT-180. A software library is main-

(continued)

---

*CLUBS & NEWSLETTERS is a forum for letting BYTE readers know what is happening in the microcomputing community. Emphasis is given to electronic bulletin-board services, club-sponsored classes, community-help projects, field trips, and other activities. We will continue to list new clubs and newsletters. Allow at least four months for your club's mention to appear. Send information to BYTE, Clubs & Newsletters, POB 372, Hancock, NH 03449.*



# Circuit-Board-Artwork Software for the Design Engineer in a Hurry

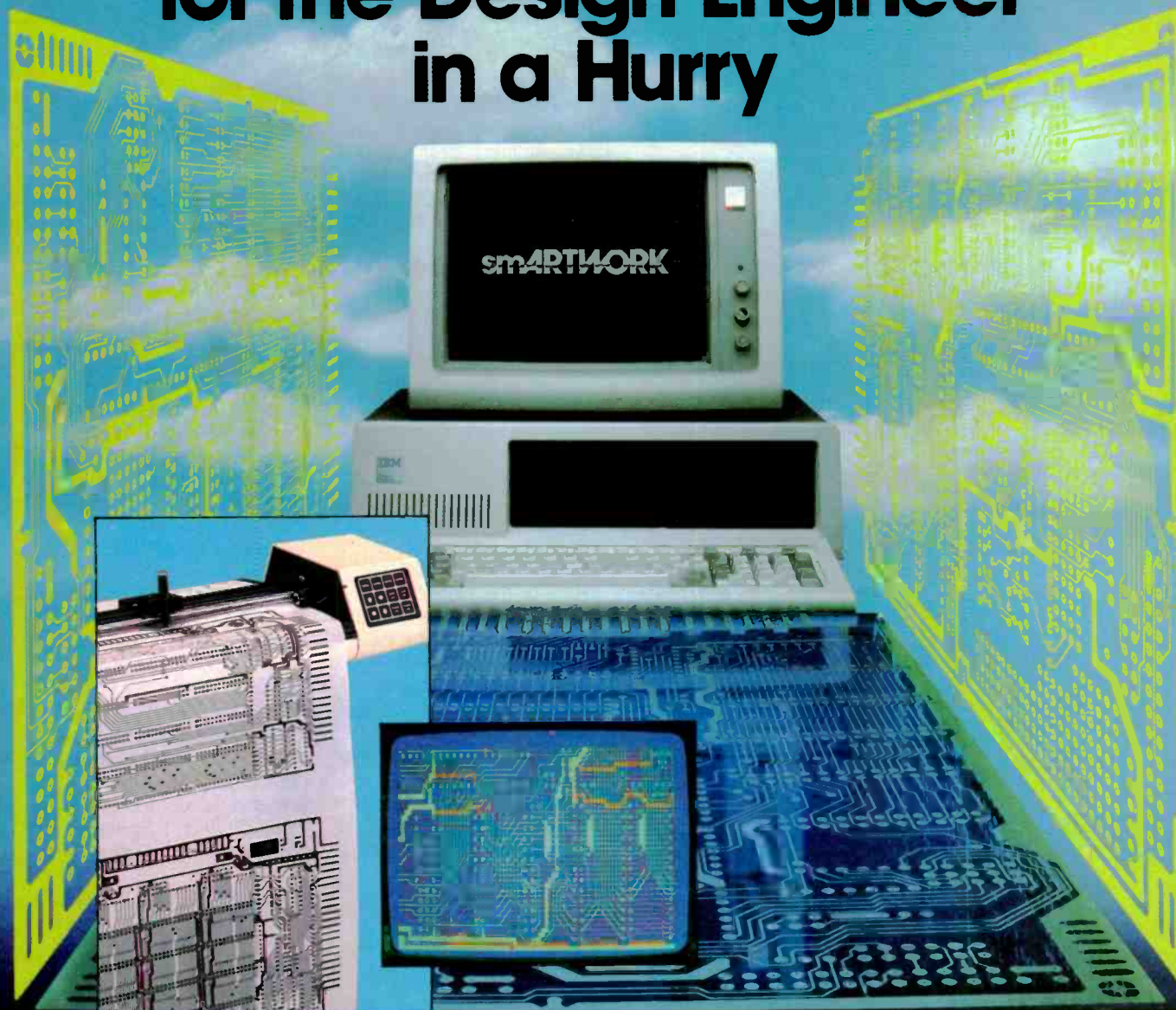

For only \$895, smARTWORK® lets the design engineer create and revise printed-circuit-board artwork on the IBM Personal Computer. You keep complete control over your circuit-board artwork — from start to finish.

Forget the tedium of taping it yourself or waiting for a technician, draftsman, or the CAD department to get to your project.

smARTWORK® is the only low-cost printed-circuit-board artwork editor with all these advantages:

- Complete interactive control over placement and routing
- Quick correction and revision
- Production-quality 2X artwork from a pen-and-ink plotter
- Prototype-quality 2X artwork from a dot-matrix printer

- Easy to learn and operate, yet capable of sophisticated layouts
- Single-sided and double-sided printed circuit boards up to 10 x 16 inches
- Multicolor or black-and-white display

#### System Requirements:

- IBM Personal Computer, XT, or AT with 256K RAM, 2 disk drives, and DOS Version 2.0 or later
- IBM Color/Graphics Adapter with RGB color or black-and-white monitor
- IBM Graphics Printer or Epson FX/MX/RX series dot-matrix printer
- Houston Instrument DMP-41 pen-and-ink plotter
- Optional Microsoft Mouse

#### The Smart Buy

At \$895, smARTWORK® is proven, convenient, fast, and a sound value. Call us today. And put it to work for yourself next week.

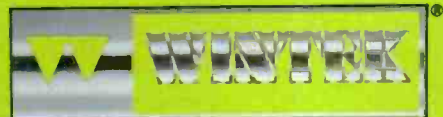

Wintek Corporation  
1801 South Street  
Lafayette, IN 47904-2993  
Telephone: (317) 742-8428  
Telex: 70-9079 W/INTEK CORP UD

Inquiry 380

In Europe contact RIVA Terminals Limited,  
Woking Surrey GU21 5JY ENGLAND,  
Telephone: 04862-71001, Telex: 859502

smARTWORK®, "Wintek" and the Wintek logo are registered trademarks of Wintek Corporation.

# Q.

Why did **basic time**<sup>™</sup> and **QUBIE**<sup>™</sup> — two of the largest and most respected distributors of Quality IBM PC peripherals — both license the ALR Challenger! as their PC AT multifunction card?

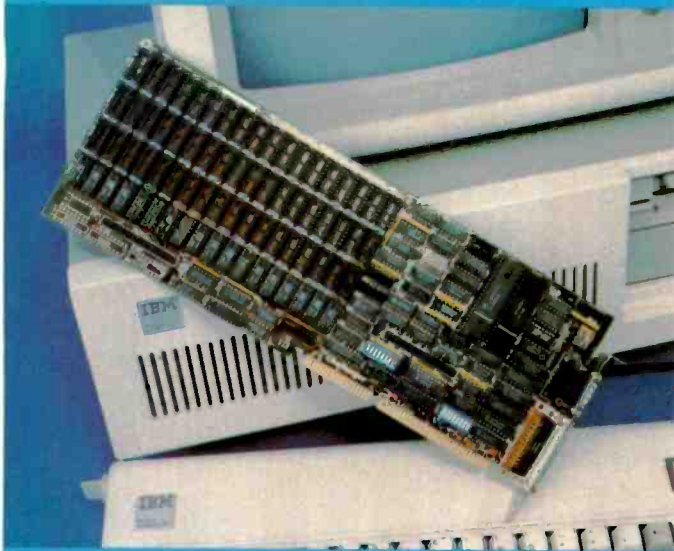

For the same reason that many Computerlands, On-Line Computer Centers and Entre' Computer stores have become dealers for Advanced Logic Research's Challenger!

# A.

## Advanced Logic Research Offers:

- \$375 for the standard Challenger!\*
- Quality and Reliable Products
- Friendly Responsive Technical Support
- Maximum Price/Performance Ratio
- Product Features:
  - 4 Mega bytes memory (128K standard)
  - 4 Serial Ports (1 standard)
  - 1 Printer Port Standard
  - 1 Game Port (Optional)
  - VSpool Standard

\*\$225.00 less than AST's similar product

# ALR

## Advanced Logic Research, Inc.

15455 Red Hill Ave., Suite B, Tustin, CA 92680  
(714) 832-7808

basic time and Qubie' are registered trademarks of Basic Time, Inc., AST is a registered trademark of AST Research, Inc. VSpool copyright of Almos Systems.

## CLUBS & NEWSLETTERS

tained, and a newsletter contains members' contributions, product reviews, and programming ideas. Contact Jim O'Connor, Robin Owners' Group, POB 492, Rollinsford, NH 03869-0492.

### ● NEW FIG FORMS

Members of the Central Arkansas FORTH Interest Group (CAFIG) meet twice monthly at the National Education Center at the Arkansas College of Technology in Little Rock. For more information, contact Gary Smith, POB 7668, Little Rock, AR 72217. (501) 227-7817.

### ● FOR THE PEOPLE

Users of the Kaypro 16 can join a special-interest group, SIG-16, sponsored by the National Kaypro Users Group (NATKUG). *The NATKUG 4 Bits x 4 National Newsletter* is produced for users of the IBM-compatible Kaypro. Membership in SIG-16 is \$15 a year; membership in People's Computer (NATKUG) is \$12 annually. Contact Steven Bender, People's Computer (NATKUG), POB 28360, Queens Village, NY 11428. (212) 776-2909.

### ● PAIR AND REPAIR

Users and owners of the Otrona Attache computer can find a listing of repair centers and users groups from the Boston Computer Society (BCS). A \$24 annual membership entitles you to receive both the Otrona monthly newsletter and one other BCS newsletter. Contact the Boston Otrona User Group, 1 Center Plaza, Boston, MA 02108.

### ● MEET FOR FREE

Participants of the North Jersey TRS-80 Users' Group discuss TRS-80 computers, programming techniques, and programs. The group meets at 7:30 p.m. on the second Friday of the month

at Fairleigh Dickinson University in Teaneck, New Jersey. Dues are not collected. Contact Dr. Howard Silver, Electrical Engineering Department, Fairleigh Dickinson University, Teaneck, NJ 07666.

### ● SINGLE USERS

The Sytek Network Users Group (SNUG) encourages communication between owners and users of Sytek's LocalNet products. Funded by membership dues, the club meets informally once every nine months. Contact Greg Scott, Tektronix Inc., POB 500, MS 50-454, Beaverton, OR 97077. (503) 627-5007.

### ● FRENCH FIDONET

A Fidonet BBS in Paris, France, is available at 300 full CCITT on 18764.5.6.7. The team of ARTS, a non-profit organization, is composed of people involved in radio, video, videotex, and teleservices. Contact ARTS, POB 100, 94123 Fontenay Sous Bois, Paris, France.

### ● MINNESOTA MEETINGS

The Central Minnesota Users Group convenes in St. Cloud. The general meetings are not limited to a specific brand of computer but are followed by special-interest-group meetings. Information on public-domain software is available. Contact Lee Larkey, Central Minnesota Users Group, Rt. 1, Box 106, Avon, MN 56310. (612) 356-7402.

### ● A WORD EVERY

QUARTER—A word-processing newsletter, *The Quarterly Report*, is devoted to the latest in word processors, issues for businesses concerning word processing, and research information. The introductory subscription rate is \$30 a year. Contact *The Quarterly Report*, POB 1060, Mercer Island, WA 98040. ■

# IBM PC/XT Compatibility AT Performance OEM Price

## High Speed

4.7 or 8 MHZ

8088-2 Processor  
With 8087-2 Option

## Highly Compatible

IBM PC/XT Form, Fit & Function

## Highly Integrated

Built-In Disk Controllers

- Up To 4 Floppies
- SASI Hard Disk Interface

1 Megabyte On-Board Memory

Parallel Port

2 Serial Ports

Time of Day Clock

54K User Definable ROM

### NEW! More Memory Same Price!

We have now made 256K memory chips standard, raising the memory in our entry level board to 256K. This makes room for your expansion up to One Megabyte.

To make that memory work even harder, we're including RAM Disk software to extend memory addressing to 832K.

### SEIZE CONTROL OF YOUR HARDWARE DESTINY

The switchable 4.7 or 8 MHZ speed of the ACS-1000 SuperComputer coupled with the optional 8087-2 number cruncher provides AT-like performance without sacrificing PC/XT compatibility ... or price!

If your company is using board level microcomputers as a part of your own product, you can increase profits and improve reliability by using the ACS-1000 single board SuperComputer.

The ACS-1000 is compatible with both software and hardware designed for the IBM PC/XT. It even has the same mounting holes and the same power supply connections. The difference is that the ACS-1000 offers a much higher level of integration and—costs less than \$500 in OEM quantities.

Disk controllers, I/O ports and extensive memory are already built-in, simplifying production and freeing the 6 expansion slots to take on the specialized work of your process control, CAD/CAM or office automation applications.

There's even a special port for a low cost piggyback modem.

A 256K evaluation board is available to qualified OEM's for \$595. Power supplies, packaging, keyboards and other system support available on request. To order, call or write:

ACS International, Inc.  
2105 Luna Road, Suite 330  
Carrollton, Texas 75006  
214-247-5151

In Canada:  
Soltech Industries  
9274 194th St.  
Surrey, B.C. V2T4W2  
604-888-2606



ADVANCED COMPUTER SOLUTIONS  
INTERNATIONAL, INC.

# In the 92 seconds it find any file you need



Ampex 20 MB hard disk with 25 MB tape backup.

<sup>™</sup>PC Megastore is a trademark of Ampex Corporation. <sup>®</sup>IBM-PC is trademark of International Business Machines. <sup>†</sup>Apple II and IIe are trademarks of Apple Computer.

# takes to read this ad, on our backup streamer.

⌚ In the 1 hour, 4 minutes other streamers take, you could call your broker. Linger over coffee. Wade through the Wall Street Journal. ⌚ And read this PC Megastore™ ad too. ⌚ So take the time.

You'll more than make it up with a PC Megastore hard disk and tape hooked to your IBM-PC\* or compatible, Apple II or IIe† because all the files you need—both current and archive—will always be right where you need them.

⌚ Just a keystroke away. ⌚ The secret? Only Ampex backs up a 20 MB hard disk with another 25 megabytes\* of addressable storage—a unique, bootable streamer with cache memory. That not only means you can address a file in 92 seconds, you can backup files offline just by touching a couple of buttons. ⌚ Without tying up your computer. ⌚ Your time. ⌚ Or a small fortune in floppies. (In fact, our 45 megabytes of available storage cost about half the price per MB of other hard disks.) So consider your time, money and convenience. ⌚ And our quality. The PC Megastore system is backed by a full year warranty from Ampex, a company known for manufacturing quality computer peripherals for over 20 years. ⌚ Take a moment. Contact: Ampex Computer Products Division, Marketing Communications, 10435 N. Tantau Ave., Cupertino, CA 95014. 800 421-6863, 213 640-0150 in CA. We'll give you a dealer's name so you can buy a PC Megastore system. ⌚ Then in no time at all, you'll make up for the 92 seconds you spent reading this ad.

**AMPEX**  
Ampex Corporation • One of The Signal Companies

\*PC Megastore is upgradeable and comes in four models: 20 MB with 25 MB tape, 10 or 20 MB disk, or 25 MB tape.



**THE AT&T PC.  
THE COMPUTER WITH  
THE FUTURE BUILT IN.**



Before you buy a personal computer for your business you should ask yourself two essential questions. One: What do you need today? Two: What will you need tomorrow?

The AT&T PC 6300 is the answer to both. Today, you'll get a high performance computer that's competitively priced. A computer that not only runs the broadest selection of software available, but has the power and speed to make the most of it. A computer with superb graphics in monochrome or color. And a high resolution screen that's easy on the eyes.

For tomorrow, you'll get a computer with the future built in. With its modular architecture and seven expansion



slots, it's ready now to work with future technology, and meet your future needs. From additional power to multi-tasking capabilities, even to features yet to come, it can be easily enhanced as time goes by.

That's a commitment from AT&T. And the AT&T PC, the computer with the future built in.

For more information, call your AT&T Account Executive, visit an authorized AT&T dealer, or call 1-800-247-1212.



**AT&T**

The right choice.

# B·O·O·K R·E·V·I·E·W·S

## PERSONAL COMPUTERS AND SPECIAL NEEDS

Frank G. Bowe  
Sybex  
Berkeley, CA: 1984  
171 pages, \$9.95

## DIGITAL IMAGE PROCESSING: A PRACTICAL PRIMER

Gregory A. Baxes  
Prentice-Hall  
Englewood Cliffs, NJ: 1984  
192 pages, \$14.95

## PASCAL APPLICATIONS FOR THE SCIENCES

Richard E. Crandall  
John Wiley & Sons  
New York: 1984  
256 pages, \$16.95

---

## PERSONAL COMPUTERS AND SPECIAL NEEDS

Reviewed by John Wilke

In 1977, a group of activists with a variety of disabilities staged a symbolic sit-in at the Department of Health, Education, and Welfare to demonstrate support for a bill frequently called "the civil rights act for the disabled."

Since that legislation became law, engineers and city planners must design public buildings that are accessible to all people. The young man who led the HEW demonstration and lobbied successfully for the new law has turned his attention to overcoming another set of barriers: software, computers, and communications equipment that, by design, shut out the disabled.

Frank G. Bowe is quick to point out in *Personal Computers and Special Needs* that just as new technology is beginning to make it possible for disabled individuals to not only communicate more effectively but also pursue meaningful employment in the information industry, there is a lack

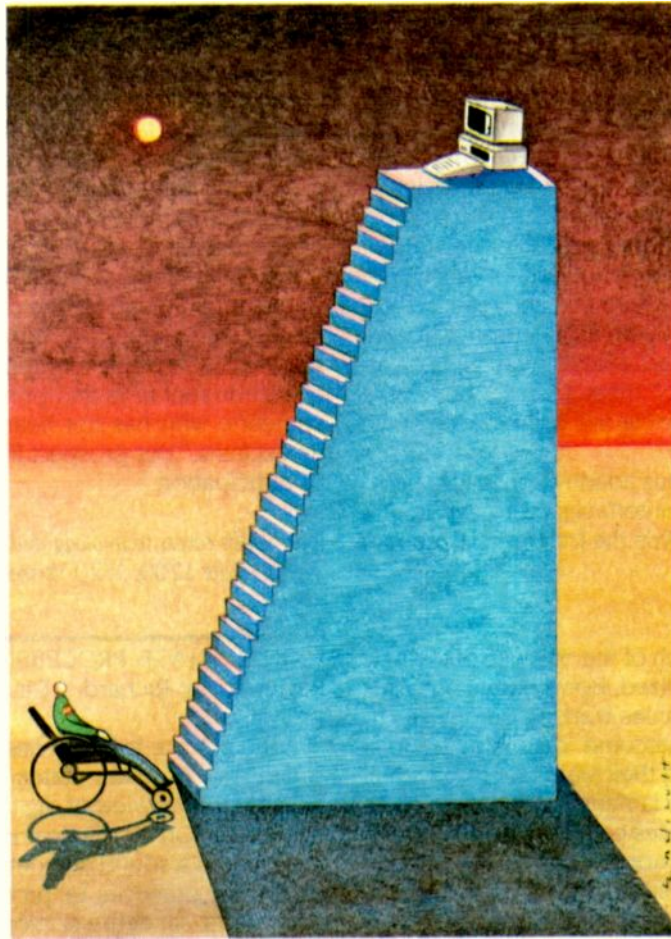

ASSEMBLY COOKBOOK FOR THE APPLE II/IIe  
Don Lancaster  
Howard W. Sams & Co.  
Indianapolis, IN: 1984  
368 pages, \$21.95

1985 PROGRAMMER'S MARKET  
Brad M. McGehee, editor  
Writer's Digest Books  
Cincinnati, OH: 1984  
343 pages, \$16.95

of physically compatible and affordable computer interfaces. This paradox is an underlying theme in Bowe's book, a survey of personal computer peripherals and communications

protheses available to people whose hearing or vision is impaired or who are unable to manage normal movement.

Bowe takes what might have been little more than a listing of the latest in speech synthesizers and keyboard emulators and peoples it with firsthand accounts of how the devices are making life more productive for disabled people. Unifying this effort is his concern that with the transition to an increasingly information-based economy—with its obvious promise of fuller participation for the disabled—the danger remains that a new set of barriers will prevent them from participating.

The book, then, addresses both how-to and why. It was written first for the nearly 30 million Americans who might

(continued)

benefit from the use of microcomputers for writing, "reading," and "hearing" or handling the everyday tasks that can be daunting for even the most determined disabled person. Bowe offers handicapped people and their families, teachers, and friends a practical guide containing prices, sources, and descriptions of scores of specialized interfaces designed to close the gap between disabled people and their computers. These details weave through the text and are then gathered together in an appendix for quick reference.

The products Bowe surveys range from speech-recognition units and speech synthesizers to optical text readers and software such as Logo (used increasingly by educators for their dyslexic and developmentally disabled students). The Information Through Speech Unit (from Maryland Computer Services Inc., Forest Hill, Maryland), for example, allows the blind aural access to the popular NEXIS and LEXIS databases. Bowe explores the state of the art in optical character recognition: an extraordinary unit that can scan almost any printed text and read it aloud in synthesized voice. The \$29,000 machine (from Kurzweil Computer Products, Cambridge, Massachusetts) is clearly beyond the fiscal reach of most people, but Bowe reports that engineering advances will bring prices down dramatically on similar units.

Beyond just describing various adaptive products, Bowe visits with people using these interfaces every day, letting them describe in their own words the frustrations and joys the new technologies bring.

### THE ROLE OF COMPANIES

Despite such adaptations, much of the promise of the new technology remains to be realized, Bowe points out. This is true in part because companies working on devices to help the disabled must overcome discouraging diseconomies of scale, producing their wares for just a small slice of the market. Indeed, he laments, many of the most significant technological advances come not from research meant to make computers more accessible to handicapped people but from industry efforts to develop talking vending machines, say, or devices allowing a businessperson to dictate letters without a secretary.

Another problem, Bowe writes, is that use of the adaptive systems now available is often hampered by incompatibility with popular applications software. Most of the software designed for disabled people is limited to addressing a specific need, such as keyboard emulation for people with severely limited mobility. But this software frequently does not then work with widely used software such as spreadsheets and word processors, which are often "locked" to prevent modification. For example, the popular Echo II speech synthesizer (from Street Electronics, Carpinteria, California) does not yet work with such protected programs as MicroPro's WordStar. Hardware, too, must often be altered to function with special devices for the disabled.

Bowe is optimistic that at least some computer makers

will respond to these concerns. Toward this goal of making manufacturers more aware of the difficulties of the disabled, last year the author conceived and carried out a conference on computer accessibility, under the auspices of the White House Office of Private Sector Initiatives. The conference, which Bowe describes briefly, brought together experts on the needs of the disabled with representatives from AT&T Bell Laboratories, International Business Machines, Apple Computer, Tandy, and Honeywell. Approaches to enhancing accessibility involved relatively simple accommodations, including the introduction of standard ports for adaptive interfaces. Some companies expressed concern that the computer market is too fast paced and competitive to meet the needs of such a small market segment. Bowe answers with convincing demographic data suggesting potential market opportunities for firms willing to respond to the special-needs buyer.

Bowe's excitement when he considers what microcomputers might mean for the disabled in the not-too-distant future illuminates his book. Within a decade, Bowe believes, affordable computers will be able to "hear" speech in real time and print out what is being said. "As someone who has not heard a word in three decades," he explains, "this prospect fills me with a wonderful sense of anticipation."

*John Wilke covers technology and telecommunications for Business Week (Suite 1200, 1120 Vermont Ave., Washington, DC 20005).*

### DIGITAL IMAGE PROCESSING: A PRACTICAL PRIMER Reviewed by Richard J. Cass

In the preface to *Digital Image Processing: A Practical Primer*, Gregory A. Baxes states his intention to provide "an elementary overview of digital image processing at a practical level." On a technical level, he succeeds admirably. The book is a sound and detailed introduction to the concepts and practices of processing images using digital computers. An entire section on the hardware considerations related to image processing would be helpful for those who are interested in designing and configuring systems for digital image processing. A practical advantage of this book is a section that contains entries for each of the most commonly used digital image processing operations; a catalog format makes this section most useful as a reference for the beginner and the experienced reader alike.

In part I, the author defines image processing in general and discusses methods of image processing other than digital, such as optical and analog. He also details the historical development of digital image processing, from the early 1960s and the space program's attempts to gather pictures of the moon's surface to the later work done by NASA in the Mariner and Pioneer projects. Baxes

*(continued)*



# BIT FOR BIT THE BEST MODEM ON THE MARKET.

Other people make modems for telecommunications. But our new Courier 2400™ modem is made for business. This modern modem transmits, over the phone, 240 characters a second, enabling you to upload or download data at twice the speed of a 1200 bps modem. You'll cut phone costs, save precious hours and increase productivity.

## BEING FASTER IS IMPORTANT, BUT BEING BETTER WAS OUR GOAL.

The Courier 2400 features auto-dial and auto-answer ... and is fully CCITT and Bell compatible. It responds to the full AT command set, allowing you to use any of the popular telecom software packages, including Telpac™ by USRobotics, Crosstalk™, PC Talk™, Smartcom™ and many others. And the entire AT command set and S-register functions are displayed on "help screens" and again summarized for you on the underside of the unit.

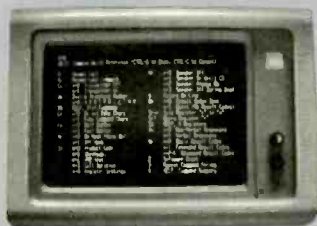

*Help Screens*

It lets you know the length of each call, tells you (on screen) the status of a call in progress, and even features an adjustable speaker to provide audio phone

Courier 2400 is accom-

modating in other ways too.



*Microlink 2400™*

will deliver the same superior performance at the same affordable price. And to get the most out of either Courier or Microlink, ask for new, improved Telpac telecommunications software with easy to use windows.

We set out to build the best modem on the market. Now, it's ready. Once you try Courier or Microlink, we think you'll agree — we're not exaggerating one bit.

line monitoring. Courier can test itself in both answer and originate modes, and automatically adjusts from 2400 bps to 1200 or 300 bps. And a powerful automatic equalizer assures nearly perfect performance on every call.

## BEST OF ALL, COURIER IS COMPATIBLE WITH YOUR BUDGET.

At \$699, you'll not find more modem for the money. If you prefer an internal slot modem for IBM-PC and compatible computers, our new Microlink 2400™

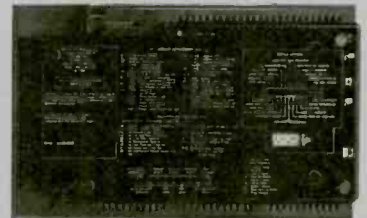

*Bottom of Courier*



**courier 2400**

**USRobotics™**

The Intelligent Choice  
in Data Communications.  
Inquiry 361

**HARMONY VIDEO & COMPUTERS**

2357 CONEY ISLAND AVE., BROOKLYN, NY 11223  
800-VIDEO84 OR 800-441-1144 OR 718-627-1000



**IBM PC 256K**  
\$1309.95  
**STAR SG 10**  
\$212.50

**PANASONIC 1091**  
\$241.99  
**APPLE 2E w/DRIVE**  
\$819.95

**"PRINTER SPECIALS"**

Brother HR15 XL	328	Juki 8100 Telex/econ	344	Panasonic KXP 1093	449
Brother HR 35	739	Mannesman Spirit 80	177	Panasonic KXP 3151	379
Citizen MSP 10	296	NEC 2050	606	PowerType	275
Citizen MSP 15	468	NEC 3550	979	Star SG10	299
Corona Laser	2481	NEC 7730	1612	Star SG15	347
Daisywriter	728	NEC 8850	1383	Star SD10	318
Epson LX80	218	Nec: p3 or p2	707	Star SD15	411
Epson RX 80 FT +	249	Okidata 92	309	Star SR10	457
Epson RX 100	194	Okidata 93	559	Star SR15	587
Epson FX 80	369	Okidata 102	333	Star S910	671
Epson FX 80	323	Okimate 10	125	Silver Reed Exp 550	364
Epson JX80	548	Olympai Compact 2	338	Silver Reed Exp 500	334
Epson FX 100 +	514	Olympai r	297	Silver Reed Exp 770	650
Epson LQ 1500	910	Panasonic KXP 1091	242	Toshiba 1340	515
HP Laser Jet	2749	Panasonic KXP 1090	187	Toshiba 351	1113
		Panasonic KXP 1092	333		

**WOW! WOW! WOW!**

IBM	APPLE	MONITORS
PC 256K	2E w/Disk Drive	Amdex 300 Green
PC XT	Apple 2C	Amdex 300 Amber
IBM Drive	Imagewriter	310 Amber
AST Six Pack	Addtl. Drives	Color 300
Taligraas 25 Meg	from 119	Color 500
Quad Board		Color 600
Keytronics		Color 700
Handi 1		Color 710
Hercules Color		Princeton HX12
Hercules Monochrome		Princeton Max 12
Paradise Graphics		Taxan 122A
Paradise Multi Display		Taxan 420
STB Graphics + 2		
Tecmar Graphics		
Tecmar Captain		
Persyst Monocard		
Bernouli Box		
10 Meg Drive		
Joystick		
Tandon 100-2		
ZENITH		
Zenith PC 2150		
Zenith PC 15152		
Zenith PC181-52		

**800-441-1144**

Items reflect cash discount. For your protection we check for stolen credit cards.

**BOOK REVIEWS**

moves on to an overview of some of the more recent business applications that have been made possible by image processing, including factory automation and computer graphics.

**THE IMAGE**

Part II covers the characteristics of the digital image—how it is formed, how brightness and resolution affect the way the image looks—and explains such terms as digitizing, pixel, frequency, and frame rate. One chapter concentrates on the image histogram, a tool used to measure and assess digital images. The histogram provides a graphic representation of the contrast qualities of the digital image by plotting the number of elements in an image against their brightness levels. Manipulating an image's histogram can affect the image, as the author demonstrates.

Baxes discusses the concept of "point processing," where each element of an image can be modified by a mathematical or logical process to create a new image. He also discusses operations such as contrast enhancement, and corrections for photometric and geometric distortions, and applications for these techniques in graphic arts, as well as the fundamentals of processing picture elements in group relationships.

The chapter on image data handling describes, in great technical detail, the major functions that a hardware system must accomplish. Baxes provides examples of hardware specifications from several manufacturers to illustrate the types of hardware used to perform these functions. Digitization, storage, display of images, and the internal interface between where the memory is stored and the hardware image processor, as well as the system's interface to the host computer, are covered. The author goes into the mechanics of the hardware device that actually processes the digital image data, with block diagrams and product-specification sheets. He discusses the characteristics of single- and dual-pixel point processors, group processors, and frame processors.

**IMAGE PROCESSES**

The catalog of 19 digital image-processing operations concisely explained in part IV is extremely useful. It provides a detailed explanation, with images from before and after processing, of the most commonly used image-processing operations. The section includes more specific examples of histogram manipulation, as well as discussions of contrast enhancement, filtering, and edge enhancement. Each entry in this section contains a description of the purpose of the operation, possible applications for it, and practical hints on how to implement the process. The image that accompanies each piece reinforces the reader's understanding of the associated operation.

**COMMENTS**

With a few exceptions, the book is well structured. The author introduces terms and concepts only as necessary.

(continued)



**HERE'S THE BEEF!**  
**MAINFRAME TAPE SUBSYSTEM**  
**FOR THE IBM PC/XT/AT**  
**WITH FREE BACK-UP**

All the data your PC could possibly consume from corporate, commercial and proprietary data bases. With 9-track 1/2" IBM compatible tape you have a universally acceptable medium which provides for worldwide data interchange.

- Automatic tape loading
- High-speed hard disk back-up FREE
- Dual density at 800 or 1600 BPI
- Allows direct tape access under any language supported by DOS 2.0 (A Telebyte exclusive)

(800) 835-3298  
(516) 423-3232

**TELEBYTE**  
TECHNOLOGY INC.

TWX 510-226-0449

270 E. Pulaski Road Greenlawn, NY 11740 A Public Company

# \$29.95 SOFTWARE!

**POWERFUL**  
**NEVADA™**  
SOFTWARE FOR CPM™-80

NEVADA  
**COBOL™**

**NEW**

Rev. 3.0. Based on ANSI-74 standards with powerful level 2 features, including compound conditionals & full CALL CANCEL. A classroom favorite. Requires 32K RAM. Package includes diskette, 165-page manual, many examples & 16 complete COBOL source code programs. ~~\$29.95~~.

COBOL Application Package, Book 1: \$9.95.

NEVADA  
**FORTRAN™**

Based on ANSI-66 standards (FORTRAN IV) with some 1977 level features. Advanced features include: IF...THEN...ELSE statement; COPY (Include); CHAINing with COMMON; TRACE debugging. Requires 48K RAM. Package includes diskette, 214-page manual, 5 sample programs & an 8080 assembler. ~~\$29.95~~.

NEVADA  
**EDIT™**

A full-screen, video-display text editor designed specifically for computer program text preparation. Completely user-changeable, it can be configured to almost any terminal & takes only 12K disk space. Requires 32K RAM. Package includes diskette & 59-page manual. ~~\$29.95~~.

NEVADA PASCAL™ ~~\$29.95~~ NOW \$19.95!  
Diskette & 184-page manual. Requires 64K RAM & 2 disk drives with at least 90K storage.

NEVADA BASIC™ \$29.95  
Diskette & 220-page manual. Requires 48K RAM.

NEVADA PILOT™ \$29.95  
Diskette & 131-page manual with 10 sample programs. Requires 32K RAM.

BIG PRINT™ DISKETTE \$19.95  
Great for making signs. Requires 132-print position printer.

**POWERFUL**  
**UTAH™**  
SOFTWARE FOR PC-DOS/MS™-DOS

UTAH  
**PASCAL™**

Has many advanced features including: 14 digit precision, BCD math (no round-off errors), floating point +63 - 64, TRACE debugging, Arrays up to 8 dimensions, 64 strings, External procedures & Dynamic Module loading. Requires 128K RAM. Package includes diskette & 134-page manual. ~~\$29.95~~.

NOW \$19.95!

UTAH  
**BASIC™**

Has advanced BASIC features such as full matrix operations, Single- & Multi-Line functions, BCD math (no round-off errors). And Utah BASIC has a built-in, full-screen text editor that makes programming a real pleasure. Requires 128K RAM. Package includes diskette & 220-page manual. ~~\$29.95~~.

UTAH  
**PILOT™**

Written by Prof. J. Starkweather, the language's creator, Utah PILOT exceeds all PILOT-73 standards. And it has an integrated full-screen text editor for easy program development. Ideal for classroom instruction, business training & home study. Requires 128K RAM. Package includes diskette, 125-page manual & 10 sample programs. ~~\$29.95~~.

UTAH EDIT™ \$29.95  
Diskette & 55-page manual. Requires 128K RAM.

BIG PRINT™ DISKETTE \$19.95  
Great for making signs. Requires 132-print position printer.

UTAH software requires 128K RAM (i.e., 90K user RAM) an IBM-PC, XT, AT, PCjr, or compatible (16-bit) micro with MS-DOS or PC-DOS Operating System, Rev. 2.0 or higher.

NEVADA Software requires 32K RAM (unless otherwise indicated above), a CP/M Operating System & an 8080, 8085, or Z-80 (8-bit) processor.

**SATISFACTION GUARANTEED!** If for any reason you're not completely satisfied, just return the Nevada or Utah package within 15 days—in good condition, with the sealed diskette unopened—and we'll refund your money! There's absolutely no risk to you, so why wait?—order today! We welcome C.O.D.s and (PLEASE NOTE: In-store prices are \$39.95. Prices shown here are valid only by mail order with this coupon; offer expires Aug. 31, 1984.)



NEVADA Please send me these NEVADA Software packages:

- COBOL  FORTRAN  EDIT  PASCAL  BASIC  PILOT  BIGPRINT  
(Extra manuals—\$14.95 each; diskettes alone—\$19.95 each. Specify number & formats of manuals and/or diskettes required.)

Please specify the diskette format you want:

- 8" SSSD (Standard CP/M IBM 3740)  
 5 1/4" Diskette for:  Access/Actrix;  Apple CPM;  DEC VT 180, or  Rainbow;  Epson QX-10;  Heath Hard Sector (Z-89), or  Soft Sector (Z-90, Z-100);  IBM-PC (requires Z-80, Baby Blue II Card);  Kaypro DD (NCR);  Micropolis Mod II;  NEC PC 8001;  North Star DD;  Osborne SD;  Sanyo 1000, 1050;  Superbrain DD 3.X;  Televideo;  Xerox 820 SD.)

UTAH Please send me these UTAH Software packages (IBM-PC diskette):

- PASCAL  BASIC  PILOT  EDIT  BIGPRINT  
(Extra manuals—\$14.95 each; diskettes alone—\$19.95 each. Specify number & formats of manuals and/or diskettes required.)

Send me \_\_\_\_\_ software packages: TOTAL \_\_\_\_\_

Other: extra manuals, extra diskettes, Nevada COBOL application Book 1, BIGPRINT: TOTAL \_\_\_\_\_

California residents add sales tax (6% or 6 1/2%) \_\_\_\_\_

Handling/shipping: add \$5 for first package or manual, \$2 each additional. OVERSEAS: add \$15 for first package or manual, \$5 each additional. \_\_\_\_\_

Check  MasterCard  VISA \_\_\_\_\_

Checks must be in U.S. Dollars, drawn on a U.S. bank \_\_\_\_\_

C.O.D. (add \$4) \_\_\_\_\_

Enclosed: TOTAL \_\_\_\_\_

CARD # \_\_\_\_\_ Exp. \_\_\_\_\_

SIGNATURE \_\_\_\_\_

SHIP TO NAME \_\_\_\_\_

STREET \_\_\_\_\_

CITY STATE/ZIP \_\_\_\_\_

Send your order to:

**ELLIS COMPUTING, INC.**  
3917 Noriega Street, San Francisco, CA 94122

Phone (415) 753-0186

SINCE 1977



CP/M is a Digital Research TM. MS is a Microsoft Corp. TM. Apple II is an Apple Computer, Inc. TM. Osborne is an Osborne Computer Corp. TM. Xerox 820 is a Xerox Corp. TM. Kaypro is a Non-linear Sys. TM. Heath/Zenith is a Heath Corp. TM. IBM is an International Business Machines, Corp. TM. Nevada BASIC, Nevada COBOL, Nevada FORTRAN, Nevada PILOT, Nevada PASCAL, Nevada EDIT, Utah BASIC, Utah PASCAL, Utah PILOT, Utah EDIT, BIGPRINT & Ellis Computing, Inc. are Ellis Computing TMs. © 1985 Ellis Computing, Inc.

# As a programmer, you're already respected.

ABC Computer Company New Client Information List		
Account #:	Salesman:	Today's Date:
12345678		
Company:	Billing Date:	
Infranco Office Systems	5/10/85	
Contact:	Telephone:	
John Smith	(212)555-1212	
Title:		
President		
Address:		
123 South Street		
City:	State:	Zip:
New York	NY	10345
Referred By:	New Account(Y or N):	Auth Code:
		0012

## With better-looking screens, you could be loved.

You write wonderful programs.

Their logic is elegant. Their organization is solid. They work like a charm.

But how do they look?

Maybe appearance shouldn't count, but it does. Because not only is a well-designed screen impressive to look at—it also makes the program easier to work with. And that makes you look good, too.

It takes you days, perhaps weeks of effort to make a program right. Isn't it worth a few minutes to make it beautiful?

A few minutes. That's all it takes for you and Screen Sculptor to create a glorious-looking screen. And once it's done, Screen Sculptor automatically writes the program—in IBM Basic, IBM Pascal, or Turbo Pascal—to display the screen and allow the user to enter data.

There's no limit to what you can do with Screen Sculptor. Design a screen you like and rearrange it whenever you like. Select colors from a mouth-watering menu. Choose special characters, draw lines and boxes, paint in areas, repeat a character in any direction!

Specify input fields, variable names, data types, acceptable data ranges and more. Then Screen Sculptor generates actual program source code based on your screen design.

You'll need an IBM PC, XT, PCjr, PC AT or 100% compatible, 128K, DOS, one 320K disk drive and any 80-column display.

Screen Sculptor does more than design screens. For \$125, it will enhance your creative reputation and thoroughly impress your users.

Because people don't expect a beautiful screen. But they sure do appreciate it when they see it.



**SOFTWARE  
BOTTLING  
COMPANY**

**Try it FREE for 30 days!**

Here's a no-risk offer. Order now and you'll also get a full demo disk. Use the demo and the manual for 30 days. If you don't love it, return the package for a full refund!

Credit card orders only call 24 hours a day, 1-800-824-7888, operator 268.  
For all other orders and inquiries call or write: The Software Bottling Company of New York, 6600 L.I. Expwy, Maspeth, NY 11378.  
(718) 458-3700. If we're shipping to a NYS address, please add 8¼% sales tax.

and each discussion of technical material builds logically upon the information and terms already explained. Definitions and explanations of the intricacies of image processing are lucid enough to instruct the beginner without insulting a more knowledgeable reader. The book is, as promised, a practical introduction to digital image processing.

I have only one serious misgiving about the book: All the technical information is presented in clear, coherent prose, but the rest of the writing could have used better editing.

Richard J. Cass (29 High St., Peterborough, NH 03458) is a technical writer for Apollo Computer in Chelmsford, Massachusetts.

PASCAL APPLICATIONS FOR THE SCIENCES

Reviewed by Steven H. Rogers

In *Pascal Applications for the Sciences*, Richard E. Crandall tackles the problem of teaching scientific programming in a minimal amount of time. The book is intended to be used largely in a self-paced manner; to get the most out of it you should have ready access to a computer running Pascal. It is organized with short blocks of text followed by exercises illustrating the important points just covered. I found this technique effective in keeping my interest.

The first five chapters provide the basic tools for writing scientific programs in Pascal. Crandall then presents more advanced examples of scientific applications. The balance of the book consists of five appendixes containing libraries of functions and procedures for scientific programming.

SCIENTIFIC PROGRAMMING

Crandall begins with an intentionally brief review of the fundamentals of Pascal programming. Those readers with a background in Pascal can skip the review without missing anything; readers new to the language will need a standard Pascal text as a supplement. Exercises relate to scientific applications.

Next, the reader is introduced to mathematical programming. The author demonstrates numerical methods for approximating the derivatives and integrals of a function, proceeds to coverage of differential equations, and then moves on to the use of matrices to solve systems of simultaneous linear equations. One example and several exercises that I found quite enjoyable involved modeling a satellite orbiting the earth.

Crandall's coverage of probability presents a concise explanation of the problems involved with modeling probabilistic phenomena on computers, which are by nature deterministic. This means a given input will always yield the same output, though some people maintain that their computers don't fit this description. Examples range from population biology to card games. An introduction to the statistical analysis of data concludes this chapter.

(continued)

64K S100 STATIC RAM

\$139<sup>00</sup>  
KIT

NEW!

LOW POWER!

150 NS ADD \$10

BLANK PC BOARD  
WITH DOCUMENTATION  
\$49.95

SUPPORT ICs + CAPS  
\$17.50

FULL SOCKET SET  
\$14.50

FULLY SUPPORTS THE  
NEW IEEE 696 S100  
STANDARD  
(AS PROPOSED)

FOR 56K KIT \$125

ASSEMBLED AND  
TESTED ADD \$50



FEATURES: **PRICE CUT!**

- Uses new 2K x 8 (TMM 2016 or HM 6116) RAMs.
- Fully supports IEEE 696 24 BIT Extended Addressing.
- 64K draws only approximately 500 MA.
- 200 NS RAMs are standard. (TOSHIBA makes TMM 2016s as fast as 100 NS. FOR YOUR HIGH SPEED APPLICATIONS.)
- SUPPORTS PHANTOM (BOTH LOWER 32K AND ENTIRE BOARD).
- 2716 EPROMs may be installed in any of top 48K.
- Any of the top 8K (E000 H AND ABOVE) may be disabled to provide windows to eliminate any possible conflicts with your system monitor, disk controller, etc.
- Perfect for small systems since BOTH RAM and EPROM may co-exist on the same board.
- BOARD may be partially populated as 56K.

256K S-100 SOLID STATE DISK SIMULATOR!  
WE CALL THIS BOARD THE "LIGHT-SPEED-100" BECAUSE IT OFFERS AN ASTOUNDING INCREASE IN YOUR COMPUTER'S PERFORMANCE WHEN COMPARED TO A MECHANICAL FLOPPY DISK DRIVE.

**PRICE CUT!**

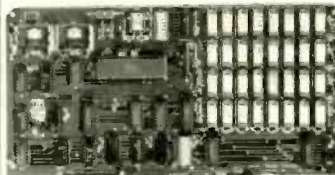

BLANK PCB  
(WITH CP/M\* 2.2  
PATCHES AND INSTALL  
PROGRAM ON DISKETTE)  
\$69.95  
(8203-1 INTEL \$29.95)

- FEATURES:
- 256K on board, using + 5V 64K DRAMS.
  - Uses new Intel 8203-1 LSI Memory Controller.
  - Requires only 4 Dip Switch Selectable I/O Ports.
  - Runs on 8080 or Z80 S100 machines.
  - Up to 8 LS-100 boards can be run together for 2 Meg. of On Line Solid State Disk Storage.
  - Provisions for Battery back-up.
  - Software to mate the LS-100 to your CP/M\* 2.2 DOS is supplied.
  - The LS-100 provides an increase in speed of up to 7 to 10 times on Disk Intensive Software.
  - Compare our price! You could pay up to 3 times as much for similar boards.

#LS-100 **\$169<sup>00</sup>**  
(FULL 256K KIT)  
(ADD \$50 FOR A&T)

ALL SALES SUBJECT TO THE TERMS OF OUR 90 DAY LIMITED WARRANTY. FREE COPY UPON REQUEST.

THE NEW ZRT-80

**CRT TERMINAL BOARD!**

A LOW COST Z-80 BASED SINGLE BOARD THAT ONLY NEEDS AN ASCII KEYBOARD, POWER SUPPLY, AND VIDEO MONITOR TO MAKE A COMPLETE CRT TERMINAL. USE AS A COMPUTER CONSOLE OR WITH A MODEM FOR USE WITH ANY OF THE PHONE-LINE COMPUTER SERVICES.

- FEATURES:
- Uses a Z80A and 6845 CRT Controller for powerful video capabilities.
  - RS232 at 16 BAUD Rates from 75 to 19,200.
  - 24 x 80 standard format (60 Hz).
  - Optional formats from 24 x 80 (50 Hz) to 64 lines x 96 characters (60 Hz).
  - Higher density formats require up to 3 additional 2K x 8 6116 RAMS.
  - Optional N.S. INS 8250 BAUD Rate Gen. and USART combo IC.
  - 3 Terminal Emulation Modes which are Dip Switch selectable. These include the LSI-ADM3A, the Heath H-19, and the Beehive.
  - Composite or Split Video.
  - Any polarity of video or sync.
  - Inverse Video Capability.
  - Small Size: 6.5 x 9 inches.
  - Upper & lower case with descenders.
  - 7 x 9 Character Matrix.
  - Requires Par. ASCII keyboard.

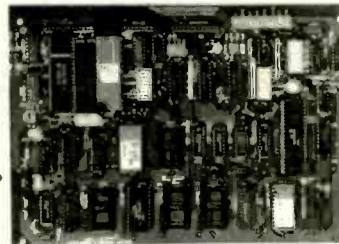

**\$89<sup>95</sup>**  
#ZRT-80  
(COMPLETE KIT, 2K VIDEO RAM)

BLANK PCB WITH 2716  
CHAR. ROM. 2732 MON. ROM  
**\$49.95**  
SOURCE DISKETTE - ADD \$10  
SET OF 2 CRYSTALS - ADD \$7.50

FOR 8 IN.  
SOURCE DISK  
(CP/M COMPATIBLE)  
ADD \$10

Digital Research Computers

P.O. BOX 461565 • GARLAND, TEXAS 75046 • (214) 225-2309

Call or write for a free catalog on Z-80 or 6809 Single Board Computers, SS-50 Boards, and other S-100 products.

TERMS: Add \$3.00 postage. We pay balance. Orders under \$15 add 75¢ handling. No C.O.D. We accept Visa and MasterCard. Texas Res. add 5-1/8% Tax. Foreign orders (except Canada) add 20% P & H. Orders over \$50 add 85¢ for insurance.

# WE'RE BUILDING A NETWORK FOR SALES,

## NO ONE BACKS IT UP LIKE WE DO.

From first-time user to seasoned pro. From national telemarketing to local retail stores. Whoever you are, and whatever your microcomputer needs, for sales, service and support, you can count on Micro Mart.

## CUSTOMIZED SYSTEMS, CUSTOMIZED SUPPORT.

Micro Mart customizes personal and business computers because we have the expertise to do it right. Our specialties include advanced memory systems like hard disk drives and multifunction boards. And much more.

Now you can depend on Micro Mart for customized service and support. Our service center is the largest in the Southeast, and it backs up every telemarketing sale we make, nationwide. Our retail sales are supported by the best in-store Techs in the business. So our service is on-line, on site or on-the-spot. And we do it on time. Try us and see.

## MICRO MART NATIONAL. ALWAYS UP-TO-DATE.

Micro Mart is the place to find the latest products. Our state-of-the-art mainframe-to-inventory connection puts every buyer on-line with our ten million dollar inventory. Instantly.

Our telemarketing salespeople are highly trained consultants, constantly up-to-date, so you don't have to be. And we offer equally innovative financing, like the Micro Mart Blue Chip Credit Card. Call us today for systems, sales and support, and discover why Micro Mart is way out in front.

Orders only

**1-800-241-8149**

For information or the store location nearest you, call

**(404) 449-8089**



Micro Mart has financing options available. Ask for a Micro Mart Blue Chip Credit Card application, today.

### Service & Repairs

- On-Site— We have hundreds of service locations nationally.
- Depot— Our National Service Center is one of the fastest in the U.S.
- We have— A wide variety of services available. Please call us.

© Copyright Micro Mart 1985  
Technology Corporate Campus  
3159 Campus Drive  
Norcross, Georgia 30071

**MICRO MART HAS OVER 20 STORE LOCATIONS. CALL FOR THE ONE NEAREST YOU.**

# NATIONAL REFERRAL SERVICE AND SUPPORT.

## Computers

**LEADING EDGE** Complete systems. FROM \$1495  
AT&T Color and Mono systems. In stock!!

**COMPUTER SPECIAL OF THE MONTH!**  
Call for Low, Low Price!  
CALL FOR DETAILS!

## Networking/Protocol Conversion

**SNA & BISYNC** 3780, 5251 Mod 12 & Mod 11, 3274, 3278.  
**PC TURBO** 186 by ORCHID, 80186 coprocessor board. \$599  
**IRMA** Complete line. FROM \$799  
**FORTEGRAPH** for IRMA, upgrades IRMA to 3279 S3G graphics.  
**PCnet ORCHID's** new complete line. FROM \$299  
**TECHLAND SYSTEMS Blue Lynx** 5251 Mod 12 & 3276 Emulators and 3270 Keyboard.

## Printers & Plotters

We have thousands in stock.  
**PRINTER SPECIAL OF THE MONTH!**  
CALL FOR DETAILS!

**HOUSTON INSTRUMENTS** Plotters & Digitizers.

## Dot Matrix

**EPSON FX80 Plus/100 Plus.**  
**EPSON LX80/100, RX80/100.**  
**EPSON LQ1500.**  
**EPSON JX80, color printer.**  
**COMREX 420, 400 cps.** Epson compatible. \$1795  
**OKIDATA 192 & 193, ML84, Pacemark 2410.** CALL  
**OKIDATA** Color printers. Complete line.  
**TOSHIBA P-351 & 1340.** New Low Prices!  
**TEXAS INSTRUMENTS 855, 865 & 850XL.** FROM \$729

## Letter Quality

**NEC Spinwriters 2050, 3550, 8850.** New Low Price!  
**JUKI 6100/6300.** \$419/\$749  
**COMREX CR II E, CR III & CR IV.**  
**DIABLO** New LQ printers. CALL

We carry a full range of form handling options.

## Floppy Disk Drives

**TANDON TM 100-2, DDIDS, 360K.**  
New Low, Low Price!  
**1/2 HEIGHT DISK DRIVES** From SHUGART, MITSUBISHI, TEAC, PC, XT & AT comp. FROM \$119  
**ISPECIAL! Two 1/2 HEIGHT DRIVES, "Y" cables & brackets** \$229

## Hard Discs

Micro Mart carries all the major brands. If you don't see it—ask for it.  
**PEACHTREE TECHNOLOGIES P-10, 20, 30 & 50,** int. & ext. For your PC, XT, AT, AT&T, COMPAQ or others. FROM \$695  
**PEACHTREE TECHNOLOGIES,** New 1/2 Height tape and Winchester back-up system.  
**SYSGEN 10 & 20 Meg w/streamer tape.**  
NEW MODELS—CALL!  
**SYSGEN Image & Quickfile,** streamer tape back-up for your IBM XT & AT. New Low Price!  
**BERNOULLI TECHNOLOGY** Hard Disc Subsystems. CALL  
**DAVONG** New line of hard discs. 21 & 32Mb w/tape. Start @ \$2495

## Chips

We guarantee the lowest price for chips! Call us!  
**INTEL 8087, 80287** High speed coproc. FROM \$129  
**64K RAMCHIPS.** Call For Market Price  
**256K RAMCHIPS.** Call For Market Price  
**128K PIGGY-BACK** Chips for your AT. Call For Market Price

## Multifunction Boards

We have a complete line of multifunction boards compatible with the Portable, AT, XT, & Jr.  
**THE BOARD SPECIAL OF THE MONTH!**  
CALL FOR DETAILS

**SIX PACK 64-384K,** multifunc.  
**MPII RAMboards,** for PC & PC compatibles. CALL  
**I/O MINNIE,** I/O shortboard for Portable & AT.  
**ADVANTAGE 128K-3Mb,** expansion for AT. CALL  
**QUADRAM QUADBOARD,** 64-384K, multifunction. \$259  
**TECMAR CAPTAIN,** 0-384K multifunc. \$185  
**TALLTREE J-RAM II, III, IV.** New Low Price!  
**STB RIO GRANDE & GRANDE BYTE,** Expansion for AT, 128K. FROM \$259

## Graphic Cards

**PREVIEW** Monochrome graphics. Hercules look-alike for less. CALL  
**HERCULES** Mono & color graphics cards.  
**TECMAR Graphics Master,** HiRes color & mono supports Lotus. \$459  
**QUADRAM Quadcolor I & II,** color cards.  
**PARADISE SYSTEM** Multi-display or Modular Graphics Cards, color & mono, par. port. FROM \$249  
**SIGMA Color 400,** HiRes color board. New Low Price!

## Software

**SOFTWARE SPECIAL OF THE MONTH!**  
CALL FOR DETAILS

**Accounting**  
**SORCIMI/US** Complete line including windows. FROM \$289/EA.  
**CYMA** Complete business series.

## Spreadsheets & Integrated Packages

**ASHTON-TATE Framework.**  
**MICROSOFT MultiPlan,** w/templates.  
**SORCIM SuperCalc 3,** vers. 2.0. New Low Price!

## Enhancements & Utilities

**FOX & GELLER** Complete line of enhancements for DBase II, III & Rbase 4000.  
**NORTON Utilities 3.0.** \$69  
**ROSEOFF ProKey 3.0.** \$89  
**CENTRAL POINT SOFTWARE Copy II PC.** \$35  
**ATI Training.** \$55  
**SOFTSTYLE Sat FX + and Printworks.** Printer control pkgs. \$45  
**SEIDWAYS** Inverts printout. \$45  
**BORLAND SideKick and SuperKey.**  
**LIVING VIDEO TEXT Think Tank.** \$125

## Compilers & Language Tools

**LATTICE C-Compilers.** \$299  
**MICROSOFT** Complete line.  
**BORLAND Turbo Pascal, Turbo Toolbox** and more. FROM \$35/EA.

## Graphics & CAD

Micro Mart carries all major CAD packages. Call if you don't see it.  
**Zsoft PC Paint Brush,** mouse driven graphics. \$95  
**DECISION RESOURCES ChartMaster/ Sign-Master** pkgs.

**MICROPRO ChartStar.**  
**MICROSOFT Chart.**

## Communications

**MICROSTUF CROSSTALK XVI.** Latest version. \$99  
**HAYES SMARTCOM II.**

## Word Processors

**MULTIMATE** w/Spelling checker & tutorial. Low Price  
**SAMNA +** word processor.  
**MICROSOFT Word.** New Version.  
**LIFETREE Volkswriter Deluxe.** \$169  
**SSI WordPerfect.** New version.  
**MICROPRO WordStar Professional Series.** New Low Price

## Office & Project Planning

**HARVARD Total Project Manager.** \$299  
**SORCIMI/US Super Project.**  
**MICROSOFT Project.**

## Data Base Managers

Call for our unadvertised Data Bases.  
**MICRORIM 4000 or 6000,** Report Writer & Clout options. New low price!  
**WARNER SOFTWARE** The desk organizer. \$145  
**ASHTON-TATE dBase II & III.** AT compatible.  
**MICROSTUF Infoscope.**

## Modems

**HAYES Smartmodem 300, 1200, 1200B & 2400.** The best stock in the U.S. CALL  
**PROMETHEUS Modems.**  
**VEN-TEL 1200 BAUD Half Card w/ Crosstalk.** \$419  
**POPCOM Popcom,** int. & ext. w/voice and data communications.

## Miscellaneous

**DYSAN DISKETTES** PC, XT, & AT compatible. GUARANTEED LOWEST PRICE IN THE U.S. CALL!  
**MOUSE SYSTEMS PC Mouse,** optical w/software. CALL!  
**MICROSOFT MOUSE** Bus or serial mechanical mouse.  
**KEYTRONICS 5150 & 5151.** Keyboards for PC and Jr.  
**KENSINGTON MICROWARE Master Piece.** \$119  
**CURTIS** Accessories. Pedestals, cables, etc.  
**HAYES Mach II & Mach III Joysticks.**  
**QUADRAM Microlazer.** Printer buffer 8-128K. FROM \$129

**TRIPPELITE** Back-up power supply, 200-1000 watts, and ISOBAR surge protectors, 4 & 8 plug. \$1345  
**POLAROID Palette.**

## Monitors and CRT's

**PGS Max12 (E), Amber,** Monochrome that also runs on color card. New Special Prices  
**PGS HX-12 & SR-12,** Color RGB's. New Special Prices  
**QUADRAM Quadchrome,** 690 Dot RGB. \$429  
**QUADRAM Amberchrome.** Amber monochrome. \$159  
**AMDEK Color 300, 500, 600, 700, 710, 722.**  
**AMDEK 300A/300G** Composite monitors. \$129/\$119  
**AMDEK 310A,** Amber monochrome. In Stock!!  
**WYSE 50 Terminal.** \$475  
**TAXAN** RGB Color Monitors. Complete line at low, low prices. CALL!

## America's PC Specialist

# MICRO MART

Prices are subject to change without notice and are similar, but vary at Micro Mart Retail Stores. IBM is a registered trademark of International Business Machines Corporation.

# BANC \$AFE

**LOWEST PRICES ANYWHERE! ANYTIME! ANYPLACE!**

THOUSANDS OF AVAILABLE ITEMS. CALL FOR COMPLETE PRICING.

<b>IBM PC</b> Starter System <b>\$2059</b> 2 drives, 256K, Mono-Cord Parallel/Monitor	<b>IBM PC</b> Deluxe <b>\$2999</b> 20MB/2 drs/256K Monocord/Parallel Monitor	<b>IBM PC/AT</b> <b>\$5559</b> 360K 1.2 Meg Floppies 2.0 Meg Hard 512K Ram
--	---	---

IBM PC/AT BASE ..... CALL	IBM PC/AT DRIVES/BOARDS ..... CALL
IBM PC/AT ENHANCED ..... CALL	IBM XT ..... CALL

IBM SOFTWARE	
ASHTON TATE Framework	359.00
dBASE II	280.00
dBASE III	269.00
ENCRAPHERICS	269.00
FOX & GELLER Quickcode	139.00
dGraph	149.00
ASCII PRO Comm Software	99.00
In-House Accountant	99.00
Word Perfect	249.00
MICROPRO Wordstar	249.00
2000	269.00
Professional	359.00
MICROSOFT Word	229.00
Multiplan	139.00
Project	159.00
MICROIM Abuse: 4000	295.00
MULTIMATE	249.00
PC Mouse W/Software	139.00
PFS Write, File, Report	89.00
Proof, Access	79.00

IBM HARDWARE	
AST Six Pack Plus 64K	259.00
MegaPlus II	249.00
AT Ram to 1.5 MB	CALL
FRANKLIN TELECOM	
10 Meg Harddisk	659.00
HERCULES Mono Graphics	316.00
Color Card	159.00
IBM Floppy 1.2 Meg	CALL
IRWIN Tape Drive	539.00
MICROSCIENCE	
10MB Winchester	659.00
MOUSE SYSTEMS Optical Mouse	169.00
ORCHID Turbo	CALL
Pc Net Starter Kit	CALL
QUADRAM Quadboard O-K	219.00
Quadcolor I or Microfazer 64K	205.00
STB Rio plus 64K	245.00
Super Rio	255.00
TALL GRASS II NEW	245.00
TALL GRASS W/Tape	CALL
TANDON TM 100-2	169.00
TEAC 55B	119.00
EPSON 1.2 Meg Dr.	199.00
ALSO — PERSYST, ORCHID, PARADISE, TITAN AND OTHERS	

MODEMS	
ANCHOR Mark X	109.00
Mark XII	239.00
Volksmodem 1200	199.00
HAVES 1200	395.00
200B	349.00
2400	CALL
Micromodem II/e	219.00
PROMETHEUS Promodem 1200	308.00
1200B W/Software	289.00
Promodem 1200B	259.00
Promodem 1200A	329.00
Promodem Mac Pac Kit	111.00

WE SUPPORT THESE FINE SYSTEMS:	
MONITORS	
AMDEX 300	129.00
300A	145.00
310A	169.00

NEC 1201 Hi Res Green	115.00
1260 Green	79.00
JC 1215 Composite Color w/audio	215.00
PRINCETON GRAPHICS HX-12	469.00
SR-12	625.00
MRX-12	189.00
TARXAN 121/122	149.00
420 (AGB)	439.00
415 (AGB)	489.00
PANASONIC DT-S101 Composite	199.00
DT-H103 10" Composite Color	529.00
DT-D1300D 13" AGB Color	329.00
DT-M140 14" AGB Color	489.00

PRINTERS	
BROTHER HA-10	CALL
HA-15	353.00
HA-25	599.00
HA-35	599.00
2024LQ	915.00
Twinwriter	CALL
EPSON AX-80 F/T	329.00
FX-80 +	389.00
FX-100 +	595.00
LO1500	CALL
NEC2030	659.00
2050	699.00
3530	1139.00
3550	1449.00
OKIDATA ML 182P	244.00
ML192P	410.00
ML193P	569.00
PANASONIC 1091	CALL
STAR MICRONICS	CALL
TOSHIBA	CALL

APPLE PRODUCTS	
APPLIED ENGR Mega Ram	CALL
APPLE Compatible Drive	145.00
APPLEWORKS	215.00
APPLEMOUSE II	129.00
APRICOIN Serial	69.00
80col /64 //e only	99.00
Graphics Card	79.00
ASCII Express Professional	89.00
MACINTOSH 3 1/4 drive	159.00
Harddrive	CALL
MACINTOSH Software Jazz	CALL
MICROSOFT Softcard II	229.00
Multi-plan //e & Mac	129.00
Basic (Mac)	109.00
THE DESK ORGANIZER (Mac)	133.00
MICRO SCI R2 drive //e	169.00
//e drive	169.00
HAVES Mach III Joystick	39.00
SYSTEMS SERVER Fan	69.00
TEAC //e drive	169.00
Titan Accelerator	239.00
VIDEX Ultraterm	179.00
Videoterm	159.00
WESPER Graphics Interface	69.00
Buffered Graphics Interface	139.00
APRICOIN (Lifetime Warranty)	
Super Serial Imager	99.00
Graphics Interface	99.00
80 Column/64K	89.00
Extend II 64K	89.00

Apple, Compaq, IBM, and many more.

TELEX #550757/ANSWER BACK—COMPUTERBANK UD

VISA  
  
**Orders Only**  
**800/332-BANC**  
OUTSIDE CALIFORNIA  
**COMPUTERBANC**

16783 Beach Blvd., Huntington Beach, CA 92647  
 714/841-6160

Cash prices indicated. All products are in factory sealed packages. We guarantee of items for 30 days. Within this period, defective merchandise returns must be accompanied by item number. All other returns will be subject to a 10% restocking fee. For prepaid orders, there will be a 3% shipping charge, 5% for UPS Blue Label, \$5.00 minimum, all orders outside U.S.A. at 15% shipping. California residents add 6% sales tax. Prices subject to change without notice.

©Copyright 1985 COMPUTERBANC. All Rights Reserved

## BOOK REVIEWS

Graphics programming in Pascal is covered in sufficient detail for most scientific and engineering applications. Crandall provides a graphics library of two- and three-dimensional graphics procedures for the Tektronix 4012 graphics terminal and the Hewlett-Packard HP 7470A plotter. These procedures would have to be modified for use with other systems. I found this to be fairly straightforward for Turbo Pascal version 2.0 running on my Hyperion.

### ADVANCED TECHNIQUES

The last four chapters are devoted to more advanced applications in mathematics, chemistry, physics, and biology. Most readers will want to be selective about the exercises they do from these chapters. Many of them are exploratory in nature and take on the character of a major project. Because the methods illustrated in a particular application area can be used in other fields, I advise against completely skipping a chapter that may fall outside your specialty. Advanced examples from mathematics include fast Fourier transforms for signal analysis and a method for doing arithmetic of arbitrary precision.

Chemistry applications include modeling chemical reactions and graphical modeling of molecular structure. Examples from quantum mechanics appear as both chemistry and physics applications. An interesting illustration of computer graphics in physics models the perturbation of Saturn's rings by the gravitational field of one of its moons. Biological applications vary from ecology to biological signal processing.

In addition to the graphics library, this book furnishes functions and procedures for matrix manipulation, statistics, special functions (Bessel functions and the like), and dynamic models. Many people would find these libraries alone sufficient justification to buy this book.

Developed in parallel with a course for undergraduate science students, *Pascal Applications for the Sciences* also meets the needs of graduate students, practicing scientists, and technically oriented hobbyists. Richard Crandall does a generally good job of presenting the material clearly and concisely. This book has something of the flavor of a travel guide, especially in the advanced section. It gives you the information that you need to go exploring on your own.

Steven H. Rogers (108 Brook Lane, Midwest City, OK 73130) flies F-4s for the USAF Reserves when not occupied as a graduate student in industrial engineering.

ASSEMBLY COOKBOOK  
 FOR THE APPLE II/IIe  
 Reviewed by Roger Ccx

Most programmers find a need for doing at least some assembly-language programming. For Apple users this usually means venturing beyond Applesoft's PEEKs and POKEs to acquire the knowledge needed to

(continued)



# Does your C compiler understand you're only human?

Mark Williams knows that programmers are like everyone else: you tend to put your pants on one leg at a time.

But you still have to get your programs up and running as fast as possible. With all the buttons buttoned and all the zippers zipped.

That's why we developed the C Programming System. So you don't get caught with your pants down.

## To err is human—to debug, superhuman.

Normally, nothing is more frustrating for a programmer than the debugging process. You've spent months just getting the code written, but you know it's going to take at least that much more time to get the program running right.

That's where our C Source Debugger (*csd*) can be a big help.

*csd* lets you debug like a human being—in C, not assembler—looking right at your code through the *csd* window, an exclusive Mark Williams feature. You can set trace-points to stop program execution at particular program lines, trace and display the value of any C expression or variable, and much more.

With *csd* you can run the target program a line at a time, continue to the next tracepoint, or even restart the whole program right in the middle of debugging. Meanwhile, you're squashing bugs as you find them. And your program will run without modification.

## Get a leg up on the competition.

Every company says its compiler produces the fastest, densest code. But Mark Williams actually proves it. Take a look at the benchmark tests below and see if you don't agree.

Now imagine just how much more competitive this kind of performance could make your products.

The C Programming System supports the complete C language as defined by Kernighan & Ritchie. But it also goes on to include void and enumerated data types, register variables, structure assignments, Berkeley structure rules, and the biggest C library available. With support for a wide variety of third-party C libraries and utilities.

You also get MS-DOS compatibility, large and small memory models, 8087 in-line support, and one-step compiling. A full range of options increases your flexibility, letting you compile without linking, link without compiling, and more.

With all these advantages, it's no wonder Intel, DEC, Wang, and

many others have made MWC86 their compiler of choice. (After all, they're only human.)

## A human interest story with a happy ending.

All right, you're interested—which proves you're not only human, but smart. So what do you do now?

Easy. Just call 1-800-MWC-1700. You'll talk to another human being who'll answer any questions you have. And if you want to order, we'll send you the complete system, including MWC86 compiler, *csd* debugger, complete library of functions, and more. All for just \$495.

The sooner you call, the sooner you can be winning the race to get your products out the door. Which is, after all, a very human race.

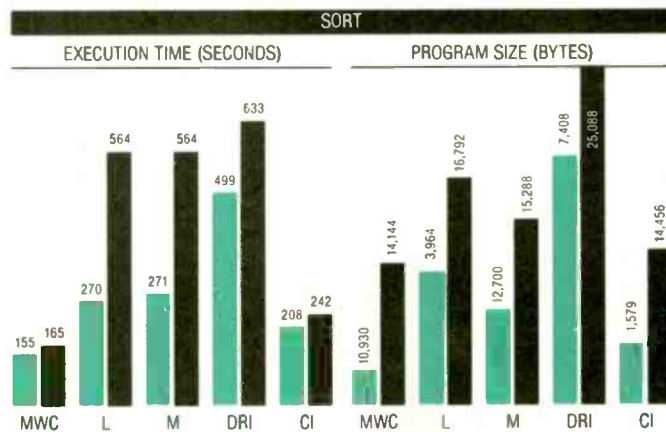

NOTE: Sort program as in *Byte*, August 1983, p. 91. Register declaration added. Further information on these benchmarks available from Mark Williams Company upon request.



1430 West Wrightwood Avenue  
Chicago, Illinois 60614

**Call 1-800-MWC-1700 To order.**

IN ILLINOIS CALL 312-472-6659. VISA/MC ACCEPTED

**Three more firsts  
from the people who  
invented the wheel.**



**Xerox Advantage  
D-80IF Diablo Printer**

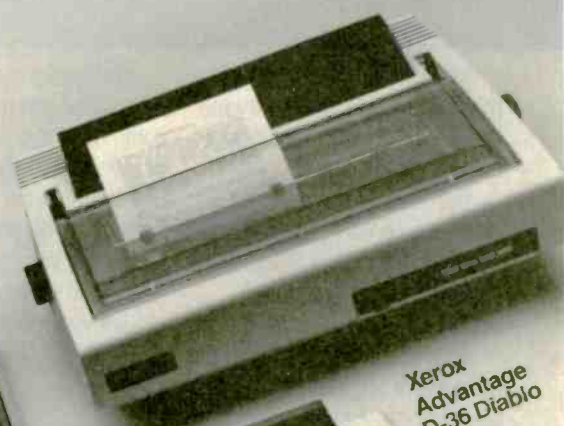

**Xerox  
Advantage  
D-36 Diablo  
Printer**



**Diablo Advantage**

# XEROX

From day one, Xerox and Diablo have been known as the two best names in daisywheel printers. And now there are three more in the Xerox line to choose from.

The Xerox Advantage D-25 Diablo printer turns out letter quality documents quickly and quietly. And it does all that for the price of a dot matrix printer.

At 80

c.p.s., the D-80IF is the fastest daisywheel printer ever made by Xerox. It has a built-in double bin sheet feeder. As well as the capacity to handle up to 16 computers at once.

And the D-36 spells reliability. It averages 4,000 hours of printing between maintenance calls.

But Xerox didn't stop there. Each of these new machines is compatible with most computers on the market, including the IBM-PC. And they're all easy to use.



They're also a part of Team Xerox, so they can be serviced by the national Xerox service force and authorized service locations across the country.

So if you're looking for the latest in daisywheel printing technology, go with the people who've been in the business the longest. Call 1-800-833-2323, ext. 25, your local Xerox office, an authorized Diablo or Xerox dealer or send your business card to Xerox Corporation, Dept. 25192, P.O. Box 24; Rochester, NY 14692.

For more information from Xerox, Circle 382 on the Reader Service card.

Xerox Advantage  
D-25 Diablo Printer

**For All IBM PC & XT & Compatibles . . .  
ELIMINATE NUM-LOCK !**

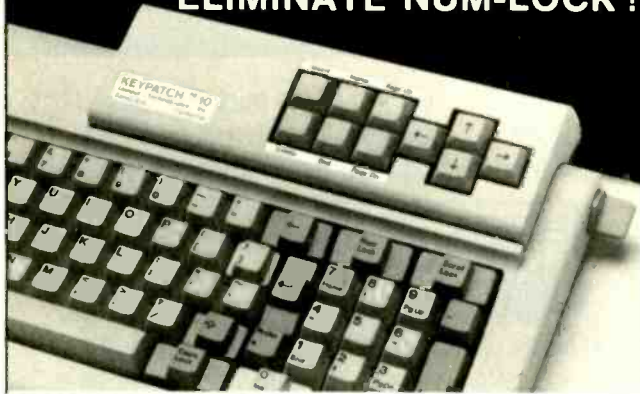

**KEYPATCH™ -10** - A full travel mini-keyboard. Plugs between keyboard connector and CPU. Automatically activates NUM-LOCK placing your IBM™ keyboard into the number pad mode while **KEYPATCH™ -10** provides separate cursor and screen control functions without the use of the NUM-LOCK key. Saves time — eliminates errors. **KEYPATCH™ -10** requires no software. A must for spread sheets; word processing; graphics; etc.

For Immediate Shipment **IBM PC/XT . . . . . \$84.00**  
**Genest Technologies, Inc. Compatibles\* . . . . . \$89.00**  
 1331 E. Edinger Ave.  
 Santa Ana, Calif. 92705  
**(714) 547-0880**  
\*Patents Pending  
 KEYPATCH™ is a trademark of Genest Technologies, Inc.  
 IBM™ is a trademark of International Business Machines Corp

\*Zenith - ITT - Columbia - NCR  
 Leading Edge - Sperry - Desk Pro  
 — PLEASE SPECIFY SYSTEM—  
 (Cal. Res. Add 6% Sales Tax)  
 Visa Master Card, Check, Money Order  
 Plus \$2.00 Shipping

# What IBM™ left out . . .

**The Enhancer offers:**

- **BIOS Enhancer** reduces eye-strain with flicker-free scroll\*, adjustable rate of display, touch a key to see text that has scrolled away\* (or other display pages\*), optionally pause at screen full, choose an attribute (color) for input, switch to non-blinking reverse-video block cursor, more
  - **Keyboard Device** expands keyboard buffer (variable up to thousands of keystrokes), open KBD device to read, write, and flush the buffer, supply input to interactive programs from batch files
  - **Status Line** reserves bottom line of screen for status information: displays keyboard buffer and allows simple editing, displays Caps-Lock, NumLock, and Hold (ctrl-NumLock) states; avoids conflict with full-screen applications, can expand display and use a 26th line\*
  - **Resident Clock** time display at the touch of a key or on status line, optionally chimes on the hour and half-hour, reminds you of important events with alarm and message
  - **Character Menu** eases entry of special/graphics characters
- \* with Color Graphics Adapter

**\$50**

For IBM PC and PC/XT with DOS 2.0 or later.  
 Not copy protected. Make check/MO payable to:

**GENERAL SOFTWARE**  
 Dept. 47 P.O. Box 3272  
 Boulder, CO 80307-3272

Color res. add 3.6% Foreign orders please inquire  
 IBM™ is a registered trademark of IBM Corp.

## BOOK REVIEWS

write efficient assembly-language code. *Assembly Cookbook for the Apple II/IIe* is written for people who want to learn assembly-language skills and some of the tricks specific to the Apple itself.

As "cookbook" implies, Don Lancaster approaches his subject matter from a practical point of view. The book serves two audiences—Apple programmers looking for education and challenge and people interested in writing profitable commercial software. The "fun and profit" theme begins in the introductory chapter and continues throughout the book.

The two obvious advantages of assembly-language programs are high execution speed and small size. Yet another primary reason for programming in machine language, according to the author, is economics. He makes the rather convincing argument that nearly all commercial programs sold for the Apple today consist at least partially of machine-language code to achieve the high performance standards of the software marketplace. A would-be developer of commercial software, Lancaster contends, must learn assembly-language skills to be competitive.

### GETTING STARTED

This book begins with a brief explanation of how assemblers work and contrasts the types of assemblers available: miniassemblers, macroassemblers, disassemblers, cross-assemblers, and assemblers that generate relocatable code. After this introduction, Lancaster emphasizes how to get started; he provides lists of recommended hardware, software tools, reference books, and other programming aids. Since assembly-language programming is so machine-dependent, the author also introduces the newcomer to the broader resources of the Apple community. An appendix in the book lists magazines specializing in Apple machine-language programming, article reprints, users groups, newsletters, and bulletin boards.

Chapter 2 explores the anatomy of an assembler source-code line: line number, label, operation or pseudo opcode, operand, and comment fields. Lancaster uses Apple's EDASM assembler (from Apple's DOS Tool Kit package) in all examples, but most assemblers are similar enough that the owner of any software package should benefit from most of the discussion. While the author assumes that the reader is already familiar with the 6502's operation codes, he does offer a clear, concise review of the chip's addressing modes along with suggestions to help eliminate confusion when specifying a particular address mode. The book was released just before the announcement of the Apple IIc and, unfortunately, does not include the additional operation codes and address modes of the IIc's 65C02 processor.

In chapter 3, Lancaster encourages the assembly-language programmer to structure source code to improve readability and maintainability. He suggests how to organize equate and constant statements and the various subroutines into a large program. He then explores the

*(continued)*

**NEW!**  
**Zorro AT™**



**Power, Performance, and Price  
Zorro is where it's AT**

Our new Zorro AT systems give you an 80286 CPU operating at a quick 6 Mhz., eight expansion slots, a clock/calendar with battery backup, a 1.2 Megabyte 5 1/4" floppy disk drive, and IBM-AT compatibility.

Zorro AT's also come with a 360K drive for PC/XT media compatibility and 512K of RAM, features that would cost you hundreds of dollars from big blue.

Zorro AT-20's feature a 20 Mb. Winchester drive from NEC, and you still have room to add a fourth drive or tape backup.

To be quite frank, we believe our Zorro AT's are built better, and we back each system with a limited warranty for a full year. Our quality and features invite comparison, our prices speak for themselves.

Zorro AT .....	\$2695
Zorro AT-20 .....	\$3895



**The Silver Fox Trots  
Through Lotus Like 1,2,3**

The Silver Fox is not IBM-PC compatible yet it runs hundreds of MS-DOS programs including Lotus 1,2,3, dBASE II, Multiplan, and even Flight Simulator.

The Silver Fox does not have IBM compatible expansion slots but you can economically add printers, serial ports, modems, 10-40 Mb. hard disks, clock/calendar cards, RAM, joysticks, an 8087 co-processor, and more.

What makes the Silver Fox unique, however, isn't what you can add to it, but what comes with it. Each Silver Fox comes with an 8083 CPU, 256K of RAM, four video ports, and a printer port. Plus you get more than twice the storage of a standard PC, 1.6 Megabytes on dual 5 1/4" floppies, and the Fox will read and write to standard 160K, 320K, and 360K IBM-PC formats.

Standard equipment also includes a better keyboard, a 12" high resolution monitor with a full 25x80 display, and we back each Silver Fox with the best free software bundle in the business including: MS-DOS 2.11/HAGEN-DOS 2.11, DOS Tutor, Wordstar 3.0, Easy Writer, Spell, Mail Track, PC File III, FILEBASE, CalcStar, games, graphics, utilities, and two BASIC languages.

Were this not enough, each Silver Fox comes with a one year limited warranty.

Because computer sales usually slow down during the summer we've given you an extra incentive to buy a Fox by lowering our prices. If you want to get the most for your computer dollar, call our machine at 1-800-FORAFox, leave your name and address at the beep, and we'll send you a Silver Fox booklet that will tell you how it can.

Silver Fox .....	\$1297
Color Fox .....	\$1497



**Altos**  
High-performance, Xenix-based, multi-user systems from Altos-world leaders in multi-user systems and applications software.

As part of TRW's marketing support group we can have your Altos system installed on your site (additional charge).

Altos systems are easy to expand and with shared printers and hard disks are cost competitive with multiple single user systems. Call for additional pricing and availability.

486-20 .....	\$4539
586-40 .....	\$7249
986-40 .....	\$8829
Altos Acc't .....	\$2779

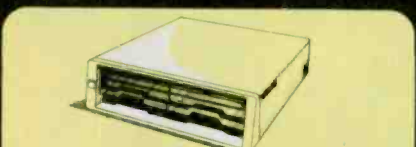

**The Bernoulli Box™**

- Hard disk capacity and performance
  - Removable cartridge economy
  - Cartridge convenience
  - Winchester capacity
  - Flexible disk economy
  - Unparalleled reliability
- |                 |        |
|-----------------|--------|
| 10 Mb .....     | \$1839 |
| 20 Mb .....     | \$2529 |
| 5 Mb./Moc ..... | \$1379 |

**Fox Jr.**

8088•Dual 360K Drives  
128K•Keyboard•Software  
**\$899**

**PRINTERS**



Star 5G-10 .....	\$326
Star SR-15 .....	\$599
EpsonFX-80+ .....	<del>\$141</del> off
LX-80 .....	<del>\$60</del> off
Okidata 182 .....	\$225
Okidata 192 .....	\$374
Olympia NP .....	\$329
Panasonic 1091 .....	\$269
Citizen MSP-10 .....	\$295
Toshiba 1340 .....	\$579
Toshiba 351 .....	\$1198

**Columbia 4220 or 2220 \$1698**

**Scottsdale Systems Ltd**  
617 N. Scottsdale Road, Suite B, Scottsdale, Arizona 85257

**(602) 941-5856**

Call 8-5 Mon.-Fri.

We participate in arbitration for business and customers through the Better Business Bureau of Maricopa County.

**SINCE 1980**

**CLOSED WEEK OF JULY 4th**

**OLYMPIA**



**IS IT SICK TO LOVE A PRINTER?**

If you love your Okidata 92 or Epson FX80 don't read any further because the new Olympia NP is rarer as faster, is noticeably quieter and has a near letter quality mode that is much superior to anything in its price class.

Plus, unlike the Okidata or the Epson the Olympia comes with adjustable tractor feed (as well as friction feed) as standard equipment. The tractor feed is the "punch-type" and the NP has a tear bar so that it works great with continuous forms.

The NP uses standard Epson type ribbons, comes with the quality that has made Olympia world leader in typewriters and is backed by nationwide service.

To quote PC magazine, "The (NP) printer is so sure thing if it falls into your price range and even if it doesn't it may be worth considering..."

If you're considering the purchase of an Okidata, an Epson, or even a Toshiba, give us a call and let us send you an actual print sample from the Olympia NP and additional information.

Because if you were to buy an Epson FX-80 or an Okidata 92 with tractors and a cable for the lowest advertised prices, you would pay about \$50 more for an inferior printer. Scottsdale Systems sells the Olympia NP with a 10' shielded cable for a mere:

**\$344**

**LETTER QUALITY**

Olympia RO .....	\$329
Juki 6100 .....	\$399
Juki 6300 .....	\$719
Silver Reed 500 .....	\$299
Silver Reed 550 .....	\$409
Silver Reed 770 .....	\$724
Diablo .....	Call
NEC .....	Call
Daisywriter 2000 .....	\$824

**HOUSTON INSTRUMENTS**

DMP-29 .....	\$1795
DMP-40 .....	\$745
DMP-41 .....	\$2340
other models .....	Call

**TERMINALS**

Gume VT101 .....	\$298
Wyse 50 .....	\$449
ADD5 Viewpoint 60 .....	\$479

**120C BPS Modems**

Volkmodem 12 .....	\$199
Password .....	Call
Prometheus .....	\$315
Hoyes 300/1200 .....	\$429

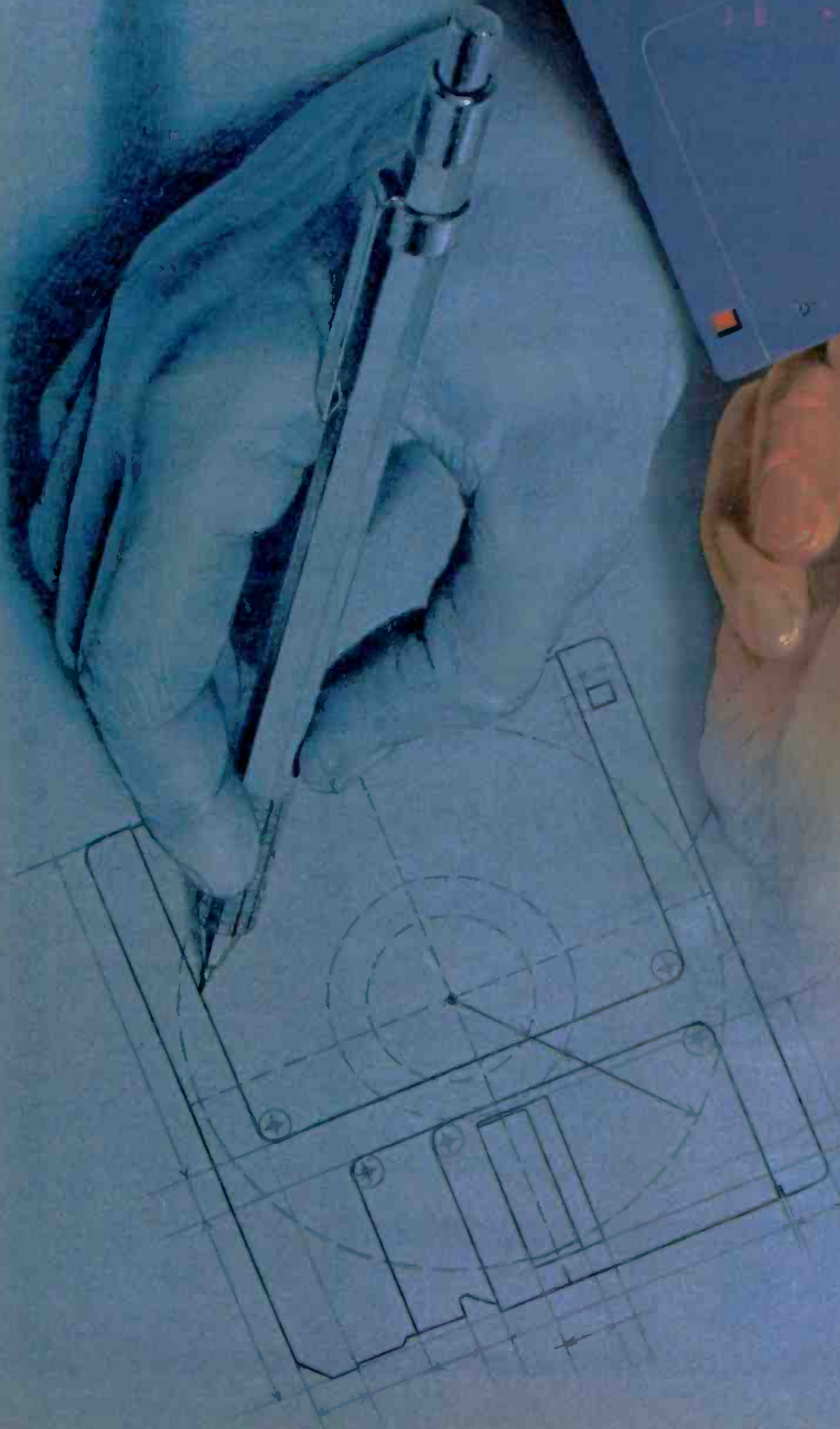

# WHO MAKES THE HIGHEST QUALITY 3.5" DISK? ASK SONY. WE INVENTED IT.

Long before there was a market for 3.5" disks, in fact, four years before, there was Sony.

And while every single 3.5" disk manufacturer has duplicated the Sony design, there's one thing they haven't been able to duplicate. Sony quality.

Such error-suppressing materials as VIVAX™ magnetic particles (the very core of the disk itself) have been developed by Sony. As is the case for our manufacturing process. It includes a burnishing technique that eliminates projections as small as 1/1,000,000 of a millimeter from the disk's surface.

The result? Every time you use a Sony 3.5" disk you're assured you're using the best magnetic medium you can buy.

With somebody else's, you can only guess.

**SONY.**

# ATTENTION BERNOULLI BOXERS Give your IOMEGA a Boot!

FiXT/B PLUS for  
IBM AT, XT, PC and compatibles

FiXT/B PLUS gives you the utility of a bootable  
hard disk while preserving the performance of  
your Bernoulli Box.  
You can have it all  
with FiXT/B PLUS!

## Golden Bow Systems

\$95-\$110  
Add \$3 for shipping/  
handling  
California residents add  
6% sales tax



3368 Second Ave., Suite F  
San Diego, CA 92103  
(619) 298-9349

# IBM COPY PROTECTION

MultiGuard provides maximum protection for your PC software at a reasonable price. Ten disks or thousands—formatted or fully duplicated. Call today for complete information.

# DISK COPYING

Whether you need 50 disks or thousands, we have years of experience in creating the highest quality copies. Reasonable prices—fast turnaround. Call today for our free booklet on software duplication and packaging.

Call ALF first  
1-800-321-4668  
in Colorado (303) 234-0871

**ALF** ALF Products • Denver, CO

## BOOK REVIEWS

questions of programming technique and style. His discussion of speed-optimization techniques covers straight-line code, shared loops, table-lookup methods, and minimal use of subroutines in time-critical sections.

With the Apple (as with any other computer), the ability to create the smallest possible program is often important. Lancaster discusses several techniques for doing this, such as custom interpreters, memory overlays, compressed text and picture files, and options for building relocatable code modules; he illustrates many of these concepts with examples from commercial programs.

Lancaster devotes two chapters to the mechanics of editing assembler source-code files. He deals with the use of the line-oriented editor supplied in the EDASM package and extols the advantages of the screen-oriented Apple Writer word processor for source-code editing. I found this discussion repetitive and wordy. Lancaster belabors the differences between the two approaches; one short chapter would have been sufficient.

The eight assembly-language modules presented in the remainder of the text amply demonstrate efficient programming techniques. The reader is treated to Lancaster's humorous style as his analysis of these routines reveals the secrets of writing quick and compact Apple programs. Each programming example highlights several specific techniques, many of which are further illustrated through examples of similar methods used in actual commercial programs. Lancaster has obviously spent many hours digging into the innards of several popular software packages.

The actual code examples Lancaster presents include subroutines for generating random numbers, sound effects, and music; handling message strings; and selecting program options using a table-driven subroutine. Lancaster includes complete source listings and flowcharts for all the routines. He also includes an additional module, called an "empty shell," that lists about 200 label names equated to base-page locations, entry points to DOS and Applesoft routines, soft switches, and other hardware-specific memory locations.

*Assembly Cookbook for the Apple II/IIe* is written with a free-wheeling, irreverent style. If you approach personal computer programming from an academic perspective and are looking for a computer science textbook, you will be disappointed. Lancaster writes using both slang and humor, and many of the commercial programming examples are from games rather than business applications. If you are new to the Apple culture, the anecdotes and examples make the learning process more interesting and concrete. Besides developing the fundamentals of assembly-language programming, the book provides good insight into many of the practical issues that must be addressed when writing commercial software.

*Assembly Cookbook* succeeds in addressing the needs of programmers new to assembly language as well as those considering writing commercial software for the Apple. The two groups obviously have different needs, but Lancaster emphasizes techniques of interest to both.



Roger Cox (POB 45, Pitkin, CO 81241) is a consulting engineer specializing in computer technology and signal processing.

1985 PROGRAMMER'S MARKET  
Reviewed by E. Francis Avila

Writer's Digest Books has for many years produced popular guides for writers and artists in many fields. Like the annual *Writer's Market*, the *1985 Programmer's Market* is a gold mine of information. Freelance programmers and technical writers could benefit from the data and advice on selling software creations in the competitive microcomputer marketplace.

Edited by Brad M. McGehee, author of *The Complete Guide to Writing Software User Manuals* (Cincinnati, OH: Writer's Digest Books, 1984), this book is patterned after the other publications in the "market" series.

Under one cover you will find a comprehensive listing of more than 700 software publishers from across the country that are looking to buy commercially marketable programs. McGehee includes with each publisher's entry: a name to contact (very important); hardware specifics and operating systems; the publisher's software needs; procedures for submitting your software idea; payment schedules; types of contract work; examples of the company's published programs; need for technical writers; and tips on how to break into the market.

**GOOD NEWS AND BAD NEWS**

The *1985 Programmer's Market* reads like a "Who's Who" in the software industry. It purports to list those microcomputer software publishers (from the famous to the obscure) that claim to be actively seeking freelance software and technical writing expertise. That's the good news.

Here's the bad news. I sent query letters to four well-known software houses and four I'd never heard of. In choosing these companies, I tried to match my expertise with their needs (as described in *Programmer's Market*). I included stamped self-addressed envelopes. Well, more than six months has passed and I've heard not a word. I'm not encouraged.

Obviously, polling 8 out of 700-plus entries cannot be considered a representative sampling of software publishers. Certainly I recognize the possibility that my qualifications did not interest those that I queried. At minimum, I expected to get back my stamped envelopes.

In the *1985 Programmer's Market*, McGehee paints an optimistic, albeit cautious, picture of the current state of freelance programming and technical writing. Given his encouragement, to say that I was disappointed in the response to my query letters is an understatement. Nevertheless, experience in the world of publishing tells me to give it another try. ■

E. Francis Avila (POB 4401, Auburn, CA 95604) is a freelance writer/programmer working on a degree in mathematics.

# SuperSoft Diagnostics

## When Reliability Counts

Protect yourself from time-robbing system failure. Pinpoint costly hardware problems before they cause serious trouble. Diagnostics II from SuperSoft can help you eliminate hardware problems, service calls, and data loss due to system failure.

### End Users

Diagnostics II is the finest set of system diagnostics available for microcomputers. It thoroughly checks memory, CPU, terminal, printer, and disk drives — isolating many problems to the chip level. It checks both standard and non-standard components, including non-IBM add-ons. The memory test is particularly powerful; incorporating a quick test, walking bit test, bum-in test, and speed test to make sure every bit of memory is completely reliable.

### Manufacturers

Hardware manufacturers, systems houses, and service organizations — we can tailor our diagnostics software to your specific needs. We have developed custom diagnostics for companies such as NCR, XEROX, MORROW DESIGNS, and SONY. From easy to operate user level diagnostics to exhaustive service level tests, we can provide the expertise you need.

So whether you're an end user, service technician, or system manufacturer, get SuperSoft's Diagnostics II for yourself and keep your system in great shape.

Diagnostics II  
(for all PC DOS, MS DOS, CP/M-86, and  
CP/M-80 systems): \$125  
Call for pricing on customized versions.

**TO ORDER CALL  
800-762-6629**

(in Illinois call 217-359-2112)

or SEND YOUR CHECK OR CREDIT CARD  
INFORMATION TO THE ADDRESS BELOW.  
Add \$3 shipping (U.S.), \$6 Canada, \$20 all other  
areas. Please specify your computer and operating  
system. (C.O.D. orders also accepted)

# SuperSoft

SuperSoft, Inc. P.O. Box 1628,  
Champaign, IL 61820  
Telex: 270365 SUP ACI CHM

# THE FORTH SOURCE™

## MVP-FORTH

Stable - Transportable - Public Domain - Tools

You need two primary features in a software development package . . . a stable operating system and the ability to move programs easily and quickly to a variety of computers. MVP-FORTH gives you both these features and many extras. This public domain product includes an editor, FORTH assembler, tools, utilities and the vocabulary for the best selling book "Starting FORTH". The Programmer's Kit provides a complete FORTH for a variety of computers. Other MVP-FORTH products will simplify the development of your applications.

## MVP Books A Series

- Vol. 1, *All about FORTH* by Haydon, MVP-FORTH glossary with cross references to fig-FORTH, *Starting FORTH*, and FORTH-79 Standard. 2nd Ed. \$25
- Vol. 2, *MVP-FORTH Assembly Source Code*. Includes IBM-PC®, CP/M®, and APPLE® listing for kernel \$20
- Vol. 3, *Floating Point Glossary* by Springer \$10
- Vol. 4, *Expert System* with source code by Park \$15
- Vol. 5, *File Management System* with interrupt security by Moreton. \$25
- Vol. 6, *Expert Tutorial for Volume 4* by M & L Derick \$15
- NEW Vol. 7, *FORTH GUIDE*, to MVP-FORTH by Haydon \$20

## MVP-FORTH Software A Transportable FORTH

- MVP-FORTH Programmer's Kit including disk, documentation, Volumes 1, 2 & 7 of MVP Series, and Starting FORTH. CP/M, CP/M 86, Z100, Apple, STM PC, IBM PC/XT/AT & compatibles, PC/MS-DOS, Osborne, Kaypro, MicroDecisions, DEC Rainbow, NEC 8201, TRS-80/100 HP150 \$175
- NEW **MACINTOSH MVP-FORTH**
- NEW **MVP-FORTH Enhancement Package** for IBM-PC/XT/AT Programmer's Kit. Includes full screen editor, MS-DOS file interface, disk, display and assembler operators. \$110
- MVP-FORTH Floating Point and Matrix Math** for IBM PC/XT/AT with 8087 or Apple with Applesoft \$85
- MVP-FORTH Graphics Extension** for IBM PC/XT/AT or Apple \$65
- MVP-FORTH Programming Aids** for CP/M, IBM or APPLE Programmer's Kit. Extremely useful tool for decompiling, callfinding, translating, and debugging. \$200
- MVP-FORTH Cross Compiler** for CP/M Programmer's Kit. Generates headerless code for ROM or target CPU. \$300
- MVP-FORTH Meta Compiler** for CP/M Programmer's kit. Use for applications on CP/M based computer. Includes public domain source. \$150
- MVP-FORTH PADS (Professional Application Development System)** for IBM PC/XT/AT or PCjr or Apple II, IIB or IIE. An integrated system for customizing your FORTH programs and applications. The editor includes a bi-directional string search and is a word processor specially designed for fast development. PADS has almost triple the compile speed of most FORTH's and provides fast debugging techniques. Minimum size target systems are easy with or without heads. Virtual overlays can be compiled in object code. PADS is a true professional development system. Specify Computer. \$500
  - MVP-FORTH MS-DOS file interface for IBM PC PADS \$80
  - MVP-FORTH Floating Point & Matrix Math see above \$85
  - MVP-FORTH Graphics Extension see above \$65
- MVP-FORTH EXPERT-2 System** for learning and developing knowledge based programs. Both IF-THEN procedures and analytical subroutines are available. Source code is provided. Specify Apple, IBM, or CP/M. Includes MVP Books, Vol. 4 & 6. \$100
- NEW **FORTH-Writer**, A Word Processor for the IBM PC/XT/AT with 256K. MVP-FORTH compatible kernel with Files, Edit and Print systems. Includes Disk and Calculator systems and ability to compile additional FORTH words.

## FORTH DISKS

- APPLE by MM \$100
- APPLE by MM,F, & G \$180
- ATARI® valFORTH \$60
- ATARI by PNS, F.G, & X \$90
- C64 by HES Commodore 64 cartridge \$40
- NEW C64 with EXPERT-2 by PS. MVP,G,F & X \$99
- CP/M by MM \$100
- CP/M by MM, F \$140
- HP-75 by Cassidy \$150
- HP-85 by Lange \$90
- IBM-PC by LM \$100
- NEW IBM-PC by MM \$125
- Macintosh by MM \$125
- Timex by HW, cassette \$25
- T/S 1000/ZX-81 \$25
- 2068 \$30
- Z80 by LM \$100
- 8086/88 by LM \$100
- 68000 by LM \$250
- VIC FORTH by HES, VIC20 Cartridge \$40
- Extensions for LM Specify IBM, Z80, or 8086
  - Software Floating Point \$100
  - 8087 Support (IBM-PC or 8086) \$100
  - 9511 Support (Z80 or 8086) \$100
  - Color Graphics (Z80 or 8086) \$100
  - Data Base Management \$200

## Key to Vendors:

- HW Hawg Wild Software
- LM Laboratory Microsystems
- MM MicroMotion
- PNS Pink Noise Studio
- PS ParSec

## Codes:

- F - Floating Point
- G - Graphics
- T - Tutorial
- X - Other Extras

## FORTH MANUALS, GUIDES & DOCUMENTS

- Thinking FORTH** by Leo Brodie, author of best selling "Starting FORTH" \$16
- ALL ABOUT FORTH** by Haydon, MVP Glossary \$25
- FORTH Encyclopedia** by Derick & Baker \$25
- NEW **FYS FORTH** from the Netherlands
  - User Manual \$25
  - Source Listing \$25
- NEW **FORTH Tools and Applic.** by Feierbach \$19
- The Complete FORTH** by Winfield \$16
- NEW **Learning FORTH** by Armstrong \$17
- Understanding FORTH** by Reymann \$3
- NEW **FORTH, An Applications Approach** by Toppen \$20
- NEW **FORTH Applications** by Weber \$13
- Mastering FORTH** by Anderson & Tracy \$18
- Beginning FORTH** by Chirlian \$17
- FORTH Encycl. Pocket Guide** \$7
- And So FORTH** by Huang A college level text. \$25
- FORTH Programming** by Scanlon \$17
- STARTING FORTH** by Brodie. Best instructional manual available. (soft cover) \$20
- 68000 fig-Forth** with assembler \$25
- FORML Proceedings**
  - 1980  1981 Vol 1
  - 1981 Vol 2  1982
  - 1983  1984 each \$25
- NEW **1981 Rochester Proceedings**
  - 1981  1982  1983
  - 1984 each \$25
- Bibliography of FORTH** \$17
- The Journal of FORTH Application & Research**
  - Vol 1/1  Vol 1/2
  - Vol 2/1  Vol 2/2
  - Vol 2/3 each \$15
- NEW **METAFORTH** by Cassidy \$30
- Threaded Interpretive Languages** \$25
- Systems Guide to fig-FORTH** by Ting \$25
- NEW **Inside F83 Manual** by Ting \$25
- FORTH Notebook** by Ting \$25
- Invitation to FORTH** \$20
- PDP-11 User Man.** \$20
- 6502 User's Manual** by Rockwell Intl. \$10
- FORTH-83 Standard** \$15
- FORTH-79 Standard** \$15
- Installation Manual for fig-FORTH** \$15
- Source Listings of fig-FORTH**, Specify CPU or Computer \$15

**Ordering Information:** Check, Money Order (payable to MOUNTAIN VIEW PRESS, INC.), VISA, MasterCard, American Express. COD's \$5 extra. Minimum order \$15. No billing or unpaid PO's. California residents add sales tax. Shipping costs in US included in price. Foreign orders, pay in US funds on US bank. Include for handling and shipping by Air \$5

for each item under \$25, \$10 for each item between \$25 and \$99 and \$20 for each item over \$100. All prices and products subject to change or withdrawal without notice. Single system and/or single user license agreement required on some products.

# MOUNTAIN VIEW PRESS, INC.

PO BOX 4656

MOUNTAIN VIEW, CA 94040

(415)961-4103

# E·V·E·N·T Q·U·E·U·E

## July 1985

● **GOVERNMENTAL COMPUTING**—Managing Microcomputers in Government, various sites throughout the U.S. Two seminars, "Managing Microcomputer Usage in Government" and "Using Micros for Government Management," are offered. Fees range from \$415 to \$795, depending upon duration and governmental or nongovernmental affiliation. Contact U.S. Professional Development Institute, 1620 Elton Rd., Silver Spring, MD 20903. (301) 445-4400. *July*

● **PBX SEMINAR**  
New Generation PBX: The Path to Voice/Data Integration, various sites throughout the U.S. This three-day seminar covers computer to PBX interfaces, signaling, new products, PBX selection and economics, and a comparison of selected vendors. The full registration fee is \$745. Contact Data-Tech Institute, Lakeview Plaza, POB 2429, Clifton, NJ 07015. (201) 478-5400. *July*

● **LOTUS, SYMPHONY SEMINAR**—Seminars on Lotus 1-2-3 and Symphony, various sites throughout the U.S. A focus on the concepts and features of these programs. Contact Data-Tech Institute, Lakeview Plaza, POB 2429, Clifton, NJ 07015. (201) 478-5400. *July*

● **CAD COURSE**  
Computer-Aided Design, Colorado State University, Fort Collins. Three-week courses with participants using a high-performance dynamic graphics machine. The fee is \$800. Contact Professor

Gearold Johnson, Center for Computer Assisted Engineering, Colorado State University, Fort Collins, CO 80523. (303) 491-5543. *July-August*

● **ENGINEERING CONFERENCES**—Engineering Summer Conferences, Chrysler Center for Continuing Engineering Education, University of Michigan, Ann Arbor. Conferences in such areas as biomedical, chemical, civil, computer, electrical, and environmental engineering. Contact Engineering Summer Conferences, 200 Chrysler Center, North Campus, University of Michigan, Ann Arbor, MI 48109. (313) 764-8490. *July-August*

● **COMPUTER SHORT COURSES**—The Fifteenth Annual Institute in Computer Science, University of California, Santa Cruz. Among the offerings are "Relational Database Management," "Data Storage," and "Computer-Aided Geometric Design." Contact Sally Thomas, University of California Extension, Santa Cruz, CA 95064. (408) 429-4534. *July-August*

● **SOFTWARE COURSES**  
Software Short Courses, various sites throughout the U.S. Among the courses are "UNIX: A Hands-on Introduction," "Programming in C: A Hands-on Workshop," and "Software Requirements, Specifications, and Tests." Contact Integrated Computer Systems, 6305 Arizona

Place, POB 45405, Los Angeles, CA 90045. (800) 421-8166; in California, (800) 352-8251 or (213) 417-8888; in Canada, (800) 228-6799. *July-August*

● **COMPUTER TRAINING**  
Computer Training Programs, Wintergreen Learning Institute, Wintergreen, VA. Hands-on training in word processing, information management, spreadsheets, and graphics. Contact Dr. M. D. Corcoran, Wintergreen Learning Institute, POB 7, Wintergreen, VA 22958. (804) 325-1107. *July-September*

● **DEVELOPMENT SEMINARS**—Professional Development Seminars, various sites around Boston, MA. A brochure describing one- and two-day seminars on computer competence, management, sales, and finance is available. Contact Boston University Metropolitan College, 755 Commonwealth Ave., Boston, MA 02215. (800) 255-1080; in Massachusetts, (617) 738-5020. *July-September*

● **SME CONFERENCES, EXPOS**—Conferences and Expositions from the Society of Manufacturing Engineers, various sites throughout the U.S. For a calendar, contact the Society of Manufacturing Engineers, Public Relations Department, One SME Dr., POB 930, Dearborn, MI 48121. (313) 271-0777. *July-November*

● **SNA SEMINAR**  
IBM's Systems Network Architecture (SNA) Seminar, various sites throughout the U.S. Covers such topics as local-area networks, SNA distribution services, and personal computer connections. Contact Communications Solutions Inc., 992 South Saratoga-Sunnyvale Rd., San Jose, CA 95129. (408) 725-1568. *July-December*

● **PICK EDUCATION**  
Pick System Educational Series, various sites throughout the U.S. and Europe. Seminars and workshops on the Pick operating system. Contact JES & Associates Inc., POB 19274, Irvine, CA 92713. (714) 786-2211. *July-December*

● **PERSONAL COMPUTER COMMUNICATIONS**—Data Communications and Networking for the IBM PC and Other Personal Computers, Atlanta, GA. Topics to be addressed include asynchronous connections, synchronous mainframe connections, data integrity, and personal computer networking. The fee is \$695. Group discounts are offered. Contact Software Institute of America Inc., 8 Windsor St., Andover, MA 01810. (617) 470-3880. *July 8-9*

● **ADVANCED AUTOMATION**—Robot Manipulators, Computer Vision, and Automated Assembly, Cambridge, MA. Contact Director of the Summer Session, Room E19-356, Massachusetts Institute of Technology, Cambridge, MA 02139. *July 8-12*

IF YOU WANT *your organization's public activities listed in BYTE's Event Queue, we need to know about them at least four months in advance. Send information about computer conferences, seminars, workshops, and courses to BYTE, Event Queue, POB 372, Hancock, NH 03449.*

(continued)

## DISK DRIVE SUBSYSTEMS

PC-INSIDER OR PC-OUTSIDER  
HARD DISK SERIES FOR IBM

10 TO 116 Mb FORMATTED w/ Controller  
And All Necessary Cables, Hardware And  
Power Supply Or PC Style Cabinet.....From \$595

60Mb WANGTEK 1/2 HT 5 1/4" STREAMING  
TAPE DRIVE OPTION For IBM-PC \$1,525

26Mb CIPHER STD HT 5 1/4" CARTRIDGE  
DRIVE w/ Cabinet, Cables & Software \$775

CALL FOR DEALER AND/OR  
QUANTITY PRICING ON HARD DISKS:

Amcodyne ~~Maxtor~~ Microscience QUANTUM  
MITSUBISHI MICROPOLIS RODIME Tandon

CompuPro / VASYN 27-120Mb 5 1/4"

EXTERNAL SUBSYSTEMS.....From \$1,525

IMPROVE DISK I/O BY 10 TIMES

Over The Fastest 5 1/4" Drives With The  
50Mb AMCODYNE SUBSYSTEM

Available For COMPUPRO CONCURRENT

DOS 8-16, TURBODOS, And MS-DOS

w/ 25Mb Removable Cartridge For 5 Min. Back-Up,  
Ultimate Data Security/ Archival And A Very

Efficient Networking Solution.....From \$4,795

**S=100** (800) SEE PAGE 431  
528-3138 FOR OTHER MDSE

## EVENT QUEUE

● **COMPUTATIONAL LINGUISTICS**—The Twenty-Third Annual Meeting of the Association for Computational Linguistics, University of Chicago, IL. Papers, demonstrations, and tutorials. Contact Don Walker (ACL), Bell Communications Research, 445 South St., Morristown, NJ 07960, (201) 829-4312. July 8-12

● **SYMPHONY TIPS** Advanced Symphony, Georgia Institute of Technology, Atlanta. Areas covered include auto-dialing to remote computers and "smart" spreadsheets using artificial-intelligence concepts to preanalyze numeric outputs. The fee is \$390. Contact Trish Stolton, Department of Continuing Education, Georgia Institute of Technology, Atlanta, GA 30332, (404) 894-2547. July 9-10

● **CONSULTANT TRAINING** Learn How to Be a Successful Independent Computer Consultant, Honolulu, HI. The risks and rewards of consulting, planning and marketing, legal considerations, and resources are covered. Contact Education Technology Center Inc., Suite 1042, 485 Fifth Ave., New York, NY 10017, (212) 505-6148. July 13

● **AWC CONFERENCE** The Fourth Annual National Conference of the Association for Women in Computing, Allerton Hotel, Chicago, IL. Workshops and sessions on technical and career-enhancement topics. For more information, contact Joan Wallbaum, AWCC '85, 407 Hillmore Dr., Silver Spring, MD 20901. July 13-14

● **THE NCC** The 1985 National Computer Conference: NCC '85, McCormick Place, Chicago, IL. Exhibits, technical ses-

sions, and development seminars. This year's theme is "Technology's Expanding Horizons." Contact Helen Mugnier, AFIPS, 1899 Preston White Dr., Reston, VA 22091, (703) 620-8926. July 15-18

● **IRMX USERS MEET** The iRUG Annual International Conference, Palmer House, Chicago, IL. The theme is "The Future Direction of RealTime Software Applications." iRUG is a non-profit organization made up of Intel iRMX operating system users. Contact Catherine Moon, MS/HF2-57, Intel Corp., 5200 Northeast Elam Young Parkway, Hillsboro, OR 97123, (503) 640-7038. July 17

● **DATA SWITCHING** Distributed Data Switching Seminar Washington, DC. A one-day seminar on the technology and application of distributed data switching in telecommunications. The fee is \$395. Contact Timeplex Seminars, 400 Chestnut Ridge Rd., Woodcliff Lake, NJ 07675, (201) 930-4600. July 18

● **PERSONAL COMPUTER COMMUNICATIONS**—Data Communications and Networking for the IBM PC and Other Personal Computers, New York, NY. See July 8-9 for details. July 22-23

● **SIMULATION** The 1985 Summer Computer Simulation Conference: SCSC '85, Westin Hotel, Chicago, IL. Contact Charles Pratt, Society for Computer Simulation, POB 2228, La Jolla, CA 92038, (619) 459-3888. July 22-26

● **COMPUTER WORKSHOPS**—Personal Computer Workshops, Aspen and Colorado Springs, CO. Tutorials, including an introduction to personal com-

(continued)

## The \$59.95 Data Switch



DATA SPEC presents the affordable data switch. At \$59.95\* you can conveniently switch between your peripherals without the need for expensive equipment. You also gain outstanding durability with the following quality features:

- Full metal construction
- Complete shielding (Exceeds F.C.C. requirements)
- Reinforced printed circuit boards
- Anti-skid feet
- All 25 pins switched
- Gold plated connector pins
- Safe "break before make" operation
- One year warranty

Isn't it about time you benefit from high performance at affordable prices? The \$59.95 data switch from DATA SPEC. Ask for it at your nearest authorized DATA SPEC dealer.

**DATA SPEC®**

FROM ALLIANCE RESEARCH CORPORATION  
20120 Plummer Street • Chatsworth, CA 91311 • 1-818-993-1202

\*Manufacturer's suggested retail price for model AB-25. A/B switch. A/B/C (25 or 36 pin configurations) and cross matrix data switches are also available.

© Copyright 1985 Alliance Research Corporation

Inquiry 395 for End-Users.  
Inquiry 396 for DEALERS ONLY.

# THE PROFESSIONAL'S CHOICE

<b>Lotus 1-2-3 Call</b>	<b>Lotus Symphony Call</b>	<b>dBase III \$349</b>	<b>FrameWork \$349</b>	<b>MultiMate \$249</b>	<b>Word Perfect \$209</b>
---------------------------------	------------------------------------	----------------------------	----------------------------	----------------------------	-----------------------------------

## Software

### Word Processing Editors

FANCY FONT	\$139
FINAL WORD	\$189
MICROSOFT WORD	\$229
MULTIMATE	\$249
OFFICE WRITER/ SPELLER	\$279
PFS: WRITE	\$ 95
SAMNA WORD III	\$279
VOLKSWRITER DELUXE	\$159
VOLKSWRITER SCIENTIFIC	\$279
THE WORD PLUS (OASIS)	\$105
WORD PERFECT	\$209
WORDSTAR	\$199
WORDSTAR 2000	\$265
WORDSTAR 2000+	\$309
WORDSTAR PRO	\$259
XYWRITE III	\$199

### Spreadsheets/ Integrated Packages

ELECTRIC DESK	\$209
ENABLE	\$359
FRAMEWORK	\$349
LOTUS 1-2-3	\$Call
MULTIPLAN	\$135
OPEN ACCESS	\$359
SAMNA PLUS	\$379
SMART SYSTEM SPREADSHEET	\$559
AUDITOR	\$ 79
SUPERCALC 3	\$179
SYMPHONY	\$Call
TKI SOLVER	\$269

### Languages/Utilities

CONCURRENT DOS	\$189
C86 C COMPILER	\$299
DIGITAL RESEARCH C COMPILER	\$219
DR FORTRAN 77	\$219
LATTICE C COMPILER	\$299
MICROSOFT C COMPILER	\$249
MS BASIC COMPILER	\$249
MS FORTRAN	\$239
NORTON UTILITIES	\$ 69
TURBO PASCAL	\$ 59

### Database Systems

ALPHA DATA BASE MANAGER II	\$179
CLIPPER	\$Call
CLOUT V 2.0	\$139
CONDOR III	\$299
CORNERSTONE	\$329
DBASE II	\$299
DBASE III	\$349
INFOSTAR+	\$319
KNOWLEDGEMAN.	\$269
PFS: FILE/PFS: REPORT	\$169
POWERBASE	\$319
QUICKCODE III	\$169
QUICKREPORT	\$169
R BASE 4000	\$249

### Project Management

HARVARD PROJECT MANAGER	\$209
HARVARD TOTAL PROJECT MANAGER	\$269
MICROSOFT PROJECT	\$159
PERTMASTER	\$549
SCITOR PROJECT 5000 W/GRAPHICS	\$259
SUPERPROJECT	\$199
TIME LINE	\$259

### Desktop Environments

DESK ORGANIZER	\$129
SIDEKICK	\$ 45
SPOTLIGHT	\$109

### Accounting

BPI	\$329
GREAT PLAINS	\$479
IUS EASYBUSINESS	\$279
ONE WRITE PLUS	\$199
OPEN SYSTEMS	\$379
PEACHTREE	\$299
REAL WORLD	\$469
STATE OF THE ART STAR ACCOUNTING PARTNER	\$389
STAR ACCOUNTING PARTNER II	\$249

### Personal Finance

DOLLARS AND SENSE	\$119
HOWARD TAX PREPARER 85	\$195
MANAGING YOUR MONEY	\$129

### Graphics/Statistics

ABSTAT	\$279
AUTOCAD	\$1475
BPS BUSINESS GRAPHICS	\$229
CHARTMASTER	\$239
CHARTSTAR	\$209
DR DRAW	\$199
ENERGRAPHICS W/ PLOTTER	\$279
EXECUVISION GRAPHWRITER	\$259
COMBO	\$359
MS CHART	\$159
OVERHEAD EXPRESS	\$139
PC DRAW	\$259
PC PAINTBRUSH	\$ 89
PFS: GRAPH	\$ 95
SIGNMASTER	\$179
STATPAK-NWA	\$329
STATPAC- WALONICK	\$349
SYSTAT	\$419

### Professional Development

EXPERTEASE	\$Call
MANAGEMENT EDGE	\$159
SALES EDGE	\$159
THINK TANK	\$119

### Communications/ Productivity Tools

CROSSTALK	\$105
PROKEY	\$ 89
RELAY	\$ 99
SMARTCOM II	\$109

## Hardware\*

### Displays

AMDEK 310A	\$169
PRINCETON HX-12	\$459
PRINCETON MAX-12	\$179
PRINCETON SR-12	\$599
QUADRAM	\$179
AMBERCHROME	\$179
TAXAN 122 AMBER	\$159
TAXAN 420/440	\$399/\$599
ZENITH 124 AMBER	\$145
ZENITH 135 COLOR	\$Call

### Display Boards

EVEREX GRAPHICS EDGE	\$329
MERCULES GRAPHICS CARD	\$299
MERCULES COLOR CARD	\$169
PARADISE MODULAR GRAPHICS	\$275
PARADISE MULTIDISPLAY CARD	\$295
PERSYST BOB	\$449
PRINCETON SCAN DOUBLER	\$Call
SIGMA COLOR 400	\$559
STB GRAPHICS PLUS II	\$309
TECMAR GRAPHICS MASTER	\$479
TSENG ULTRA PAK	\$399
TSENG ULTRA PAK-S	\$349

### Networks

AST PC NET	\$Call
CORVUS NET	\$Call
ORCHID PC NET	\$Call
3 COM	\$Call

### Mass Storage/Backup

IOMEGA BERNOULLI BOX	\$2695
MT25 TAPE BACKUP	\$885
TALLGARSS TG5025	\$2945
SYSGEN IMAGE	\$850
SYSGEN QICFILE	\$Call

### Printers/Plotters

C. ITOH	\$Call
DIABLO 620/630	\$Call
EPSON FX-80+	\$345
EPSON FX-100+	\$495
EPSON LQ-1500	\$995
HP 7475A PLOTTER	\$Call
JUKI 6100	\$418
NEC P3 COLOR	\$1095
NEC P3	\$795
NEC 2050	\$765
NEC 3650	\$1135
OKIDATA 84P/93P	\$729/\$515
PANASONIC	\$Call
QUME SPRINT 1155	\$1565
STAR SG/SR/SD	\$Call
TOSHIBA P1340	\$776
TOSHIBA P351	\$1276

### Input Devices

KEYTRONIC 5151	\$179
KOALA	\$Call
MICROSOFT MOUSE	\$139
PC MOUSE W PAINT	\$159

### Emulation Boards

AST	\$Call
CXI 3278/9	\$950
IRMA	\$799
IRMALINE	\$999
IRMAPRINT	\$Call
QUAD 3278	\$949

### Modems

AST REACH 1200	\$Call
HAYES 1200	\$389
HAYES 1200B	\$365
HAYES 2400	\$609
VENTEL 1200 HALF CARD	\$379

### Multifunction Boards

AST ADVANTAGE	\$375
AST 6 PAK PLUS (64K)	\$259
AST 6 PAK PLUS (384K)	\$339
ORCHID BLOSSOM (64K)	\$289
ORCHID PC TURBO	\$739
PERSYST TIME SPECTRUM (64K)	\$259
QUADBOARD (0K)	\$229
QUADBOARD (384K)	\$329
TECMAR CAPTAIN (64K)	\$Call
TECMAR JR CAPTAIN (128K)	\$329
TECMAR JR WAVE (64K)	\$249
TECMAR MAESTRO	\$429
TECMAR WAVE (64K)	\$209

### Accessories

CURTIS SURGE PROTECTORS	\$Call
DATASHIELD BACKUP POWER	\$Call
GILTRONIX A/B SWITCH	\$Call
MICROBUFFER INLINE (64K)	\$264
MICROFAZER INLINE (84K)	\$219
64K RAM SET	\$25
256K RAM SET	\$ 79
8087 MATH CHIP	\$150

\* CALL FOR SHIPPING COSTS

<b>Samna Word III \$279</b>	<b>Chart-Master \$239</b>	<b>Quadboard 384K \$329</b>	<b>Tseng Ultra Pak \$399</b>	<b>Smartmodem 1200B \$365</b>	<b>Smartmodem 2400 \$609</b>
-------------------------------------	-------------------------------	-------------------------------------	--------------------------------------	---------------------------------------	--------------------------------------



## LOWEST PRICE GUARANTEE!!

We will match current nationally advertised prices on most products. Call and compare.

free!

Diskette Library Case with your order

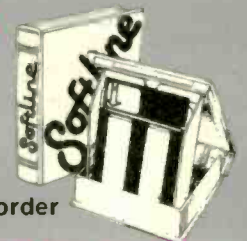

# 1-800-221-1260

In New York State call (718) 438-6057

### TERMS:

Checks—allow 14 days to clear. Credit processing—add 3%. COD orders—cash, M.O or certified check—add \$3.00. Shipping and handling UPS surface—add \$3.00 per item (UPS Blue \$6.00 per item). NY State Residents—add applicable sales tax. All prices subject to change.



MON.-THURS. 9:00 AM-8:00 PM  
SUN. & FRI. 9:00 AM-4:00 PM

# Softline

Softline Corporation  
P.O. Box 729, Brooklyn, N.Y. 11230  
TELEX: 421047 ATLN UI



## Finally A Video Board That Leaves The Confusion Behind.

On an IBM™ monochrome monitor (or equivalent), STB's Chauffeur displays color/graphics software in full-screen format and no software modifications are necessary.

Of course, we built the Chauffeur to work with the family of IBM PCs and compatibles. Our new video board is software compatible with the IBM Color/Graphics Adapter, as well as hardware and software compatible with the IBM Monochrome/Printer Adapter.

### No More Confusion

No more mixing and matching hardware with software. The

Chauffeur converts graphics display into a format compatible with the IBM monochrome monitor.

For you, that means no more worries about preboot software. Best of all, you don't have to deal with those drivers anymore.

### Follow The Leader

STB's Chauffeur is clearly the leader in video boards. It converts colors to a 16 level grey scale, and gives you a graphics display that fills a monochrome screen.

For graphics, the Chauffeur supports the same resolutions as the IBM Color/Graphics Adapter.

For text, our board produces a high quality monochrome character set.

STB's Chauffeur includes a parallel port, an optional clock/calendar and our exclusive PC Accelerator™, for print spooling and high speed disk emulation. You also get our one year warranty and an illustrated manual with thorough instructions.

### Relax And Enjoy The View

Buy the Chauffeur now. Put it in your system and enjoy watching graphics on your monochrome monitor.

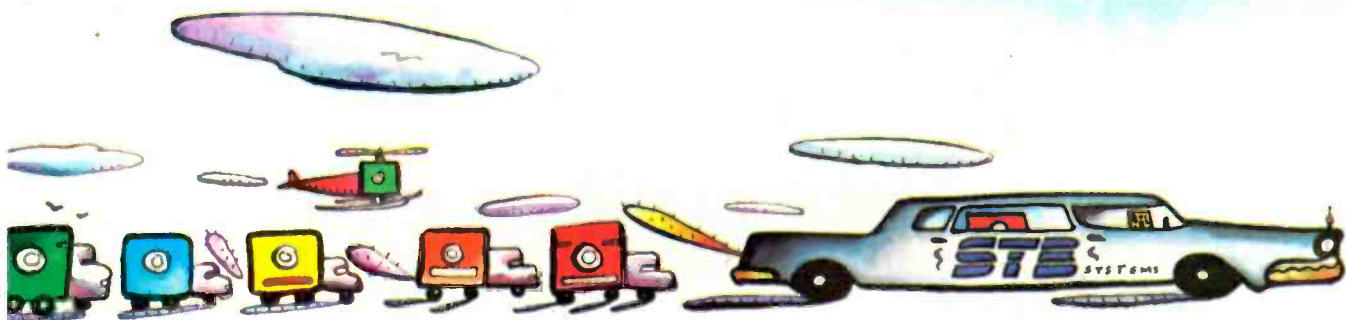

# Avoid The Crazy Drivers In The Graphics Jam With STB's Chauffeur<sup>TM</sup>



Flight Simulator<sup>TM</sup>

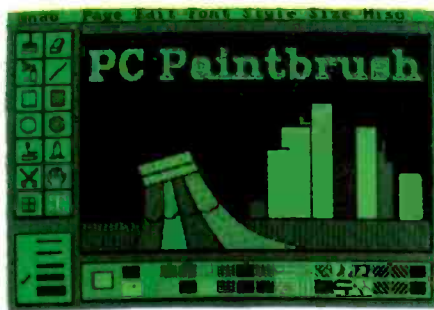

PC Paintbrush<sup>TM</sup>

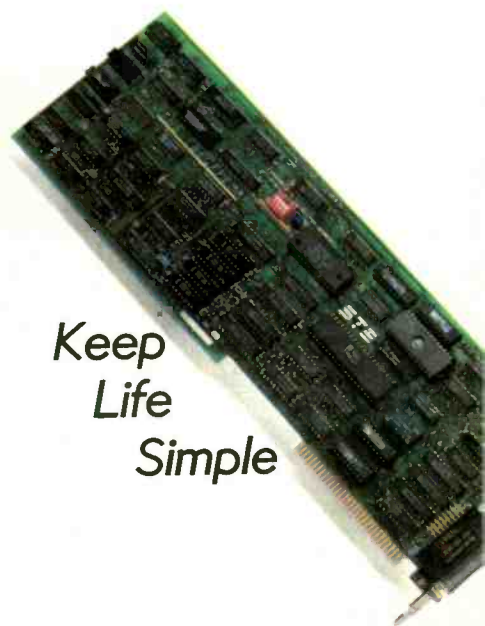

Keep  
Life  
Simple

**Finally you can buy the most popular IBM color/graphics software with no worries about hardware compatibility. STB's Chauffeur video board produces monochrome display without preboot software or those crazy drivers.**

Write For A Free Info Pack Today.  
STB Systems, Inc., 601 North Glenville, Richardson, Texas 75081

Inquiry 341

**STB**  
STB Systems, Inc.

# Now Showing In Black And White

**i**f you own an IBM-PC or PC work-alike, Roland's new MB-142 monitor lets you show off your text and graphics in today's hottest colors—black and white. That's right! The MB-142 gives you black characters on a paper-white background—just like people have been reading for centuries. You can also have white characters on a black background with just the touch of a button.

Both of these black and white display formats are easier on the eyes and less fatiguing than the green or amber phosphor used in standard monochrome monitors. The MB-142's large 14-inch screen, combined with its ultra-high 720 x 350 resolution, can display characters that are larger and more legible than what you can get with ordinary monochrome monitors. Another great plus is that the MB-142 plugs directly into the monochrome board of your IBM or compatible—just like your present monochrome monitor, with nothing more to buy.

Because of the MB-142's advanced electronic circuitry, you even have the ability to mix graphics and text on the same display when using graphics and text boards from leading manufacturers such as Persyst, STB, Paradise, Hercules, AST and many others. What makes it all possible? The same sophisticated technology used in color monitors.

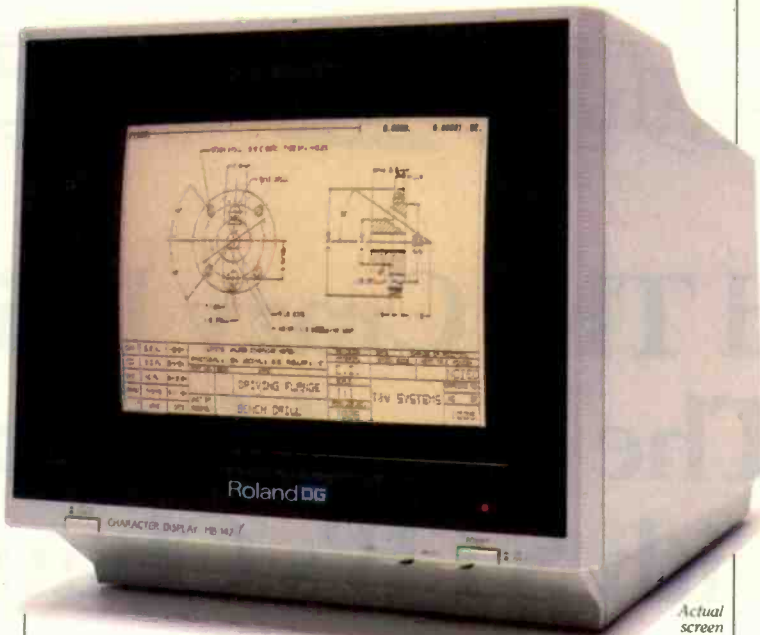

Actual screen image

MODEL  
MB-142



**p**ush a button for instant reverse screen

**t**he MB-142 supports all the winning cards



**f**or business, black and white makes more sense than green and black

**t**he big difference is that the MB-142 monitor does the job for significantly less money. The MB-142 is designed to interface economically, too. Imagine seeing your favorite business graphics or CAD/CAM packages, such as Lotus 1-2-3, Energraphics, Chart-Master, AutoCAD, CADDraft and VersaCAD, in ultra-high resolution black and white. Also, take full advantage of your program's windowing capability using the large 14-inch screen.

Take a good look at the differences that set the MB-142 apart from the rest.

No other monochrome monitor gives you the fatigue-free black and white viewing, text and graphics capabilities and easy interface.

Naturally enough, the MB-142 is from Roland DG—the new computer peripherals company that's pointing the way to the future. Look for this and other Roland products at fine computer dealers everywhere.

For more information, contact: Roland DG, 7200 Dominion Circle, Los Angeles, CA 90040. (213) 685-5141.

The software programs listed are trademarks of the following companies: AutoCAD, AUTODESK, Inc.; CADDraft, Personal CAD Systems, Inc.; Chart-Master, Decision Resources, Inc.; Energraphics, Enertronic Research, Inc.; Lotus 1-2-3, Lotus Development Corp.; VersaCAD, T&W Systems, Inc.

**Roland DG**



## EVENT QUEUE

puters, word processing, spreadsheets, and database management. Contact Rocky Mountain Institute of Software Engineering, 1670 Bear Mountain Dr., POB 3521, Boulder, CO 80303, (303) 499-4782. *July 22-26*

### ● SIGGRAPH

SIGGRAPH '85: The Twelfth Annual Conference on Computer Graphics and Interactive Techniques. Moscone Center, San Francisco, CA. Contact SIGGRAPH '85, Conference Services Office, Smith, Bucklin and Associates Inc., 111 East Wacker Dr., Chicago, IL 60601, (312) 644-6610. *July 22-26*

### ● AIRBORNE COMPUTING SAFETY

Meeting of the Radio Technical Commission for Aeronautics, Washington, DC. Special Committee 156 convenes at 9:30 a.m. to discuss the possible hazards posed by the use of lap-top computers in airplanes. Contact Radio Technical Commission for Aeronautics, Suite 500, 1425 K St., Washington, DC 20005, (202) 682-0266. *July 23-24*

### ● INTELLIGENT MACHINES

Logic Programming & Expert Systems. The Turing Institute, Edinburgh, Scotland. Lectures, demonstrations, and sessions on programming techniques, system structure, and Prolog. Contact The Turing Institute, 2 Hope Park Square, Edinburgh EH8 9NW, Scotland; tel: 031-668-1737. *July 24-25*

### ● TECH CONFERENCE

Semi-Official Get-together: SOG IV, Central Oregon Community College, Bend, OR. Sponsored by Micro Cornucopia, this conference features forums on communications and single-board systems design. Admission is free. Contact Micro Cornucopia Inc., POB 223, Bend, OR 97709, (503) 382-8048. *July 25-28*

● CHEMICAL ENGINEERING—The Seventh C.C.C.E. National Computer Workshops-East, Clarkson University, Potsdam, NY. Sponsored by the American Chemical Society Division of Chemical Education's Committee on Computers in Chemical Education and Project SERAPHIM. Advanced registration is \$100. Contact Dr. Donald Rosenthal, Department of Chemistry, Clarkson University, Potsdam, NY 13676, (315) 268-6647. *July 28-August 1*

### ● PUBLIC COMPUTING

The Twenty-Third Annual Conference of the Urban and Regional Information Systems Association, Westin Hotel, Ottawa, Ontario, Canada. The conference theme is "Computers in Public Agencies. Sharing Solutions." Contact URISA Secretariat, Suite 300, 1340 Old Chain Bridge Rd., McLean, VA 22101, (703) 790-1745. *July 28-August 1*

### ● AI, EXPERT SYSTEMS BRIEFING

Artificial Intelligence and Expert Systems: What Users and Suppliers Must Know Today to Deploy These Technologies as Profitable Strategic Corporate Resources Tomorrow, Park Plaza, Boston, MA. A one-day executive briefing. The fee is \$790. Contact Ms Lee Burgess, Professional Development Programs, Rensselaer Polytechnic Institute, Troy Building, Troy, NY 12180-3590, (518) 266-6589. *July 29*

● COMPUTERS AND EDUCATION—The 1985 World Conference on Computers in Education, SCOPE Convention Center, Norfolk, VA. Exhibits, papers, panel sessions, tutorials, and preconference workshops. Contact WCCE/85, AFIPS, 1899 Preston White Dr.,

(continued)

**"Switch boxes are sold by many suppliers, but by far the two best values are from MFJ Enterprises."**



**"The MFJ RS-232 Transfer Switch. Buy it before the manufacturer comes to his senses!"**

Joe Campbell, *The RS-232 Solution*  
Sybex Computer Books

Now you can have *reliable and affordable* port expansion. Don't keep plugging and unplugging cables. You can easily switch your computer to your high-speed printer, letter-quality printer, modem, terminal — any RS-232 peripheral device. MFJ's range of Transfer Switches includes one to fit your needs at a price you can afford. Look at these choices; then look at their prices. Compare others at any price! Then ask them for their reviews. When they won't show you, call MFJ...

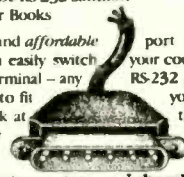

**When you need to switch between two peripherals... or you need to have two computers sharing the same peripheral... Model 1240/\$79.95**

Never unplug a cable again. Now, with the push of a button you can go from dot matrix to letter-quality printing, or go from your printer to your modem. MFJ's Model 1240 Transfer Switch features a built-in transmit/receive switch allowing you two-way information flow. LEDs monitor important data lines while a built-in surge protector guards them. The 1240 also acts as a null modem. All this for just \$79.95. No wonder its MFJ's No. 1 seller!

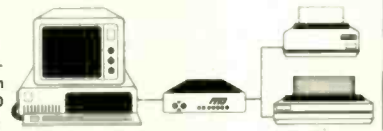

**When you need 1-to-4 computers to share one peripheral or 1-to-4 peripherals to share a common computer... Model 1243/\$119.95**

The perfect office Transfer Switch. Don't buy multiple printers or modems. Just buy MFJ's Model 1243. Then you can connect one or all your computers to a single printer or modem. Or let your one computer share up to four peripherals. Think of the money you'll save. LEDs monitor important data lines while a built-in surge protector guards them. Two-way communication is allowed with no complicated software to learn: just push a button!

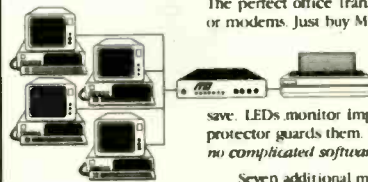

Seven additional models to choose from. Each unit's casing is constructed from high-quality aluminum. Printed circuit boards assure maximum reliability by eliminating crosstalk, line interference and any need for wiring. All MFJ switches have LEDs to monitor data lines and MOV surge protectors. Enhance the investment you've already made in your computer by choosing from the finest line of Transfer Switches on the market, including MFJ's IBM & Centronics Parallel Switches.

**You've got a lot of money tied up in your computer. Don't blow it!**

Your valuable computer and peripheral equipment can be damaged by electrical surges much smaller than you've been led to believe. Far more likely to happen is having your important data wiped out. These disasters, and others, can be prevented with MFJ's Power Centers. Relay latches power off during power dropouts (Model 1108). Multi-filters isolate equipment, eliminate interaction, noise and hash. MOVs suppress spikes and surges. MFJ's Power Centers also have 3 isolated, switched socketpairs, with at least one unswitched socket (so you can add a clock, etc.), lighted power switch, fast-acting fuse, 3-wire, 6-foot cords, 15A, 125V, and 1875 watts. Although each model is attractively housed in a protective aluminum casing, these are heavy-duty, commercial-quality power centers.

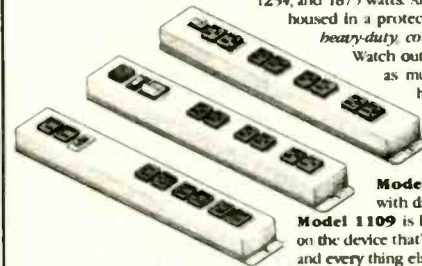

**Model 1107** 8 sockets, 2 unswitched, \$79.95

**Model 1108** 7 sockets, 1 unswitched, with dropout relay, \$99.95

**Model 1109** is like 1107 but intelligent (switch on the device that's plugged into the control socket and every thing else comes on) \$129.95

There are other RS-232 Switches, Power Centers, and Computer Peripheral Products available from MFJ. Call and talk with us about all your computing needs, and when you do, ask for our latest catalog. Both the call and the catalog are free.

**1-800-647-1800**

For technical/repair information, or in Mississippi, or outside the Continental United States, please telephone...

**1-(601)323-5869** or telex **53-4590 MFJSTKV**

All MFJ products come with a double guarantee we think is unmatched. Order from MFJ and try any product for 30 days. If it doesn't satisfy your needs, just return it for a full refund, less shipping. If you keep it you can be assured of continued service with our One Year Unconditional Guarantee.

Call toll-free 1-800-647-1800 and charge the products you need to your VISA or MasterCard, or send a check or money order, plus \$5.00 shipping, and our shipping department will promptly have your computer peripheral on its way to you.

**MFJ Enterprises Inc.**  
921 Louisville Road  
Starkville, MS 39759

High performance to cost ratio...

# Programming Chips?

Projects develop profitably with development hardware /software from GTEK.



**MODEL 7956** .....  
(with RS232 option) .... \$1099.  
**MODEL 7956 (stand alone)** \$ 979.  
GTEK's outstanding Gang Programmer with intelligent algorithm can copy 8 EPROMS at a time! This unit is used in a production environment when programming a large number of chips is required. It will program all popular chips on the market through the 27512 EPROMS. It also supports the Intel 2764A & 27128A chips. It will also program single chip processors.



**MODEL 7228** - \$599  
This model has all the features of Model 7128, plus *Intelligent Programming Algorithms*. It supports the newest devices available through 512Kbits; programs 6x as fast as standard algorithms. Programs the 2764 in one minute! Supports Intel 2764A & 27128A chips. Supports Tektronics, Intel, Motorola and other formats.

EPROM & PAL

## PROGRAMMERS

—These features are standard from GTEK—

Compatible with all RS232 serial interface ports • Auto select baud rate • With or without handshaking • Bidirectional Xon/Xoff • CTS/DTR supported • Read pin compatible ROMS • No personality modules • Intel, Motorola, MCS86 Hex formats • Split facility for 16 bit data paths • Read, program, formatted list commands • Interrupt driven — program and verify real time while sending data • Program single byte, block, or whole EPROM • Intelligent diagnostics discern bad and/or erasable EPROM • Verify erasure and compare commands • Busy light • Complete with Textool zero insertion force socket and integral 120 VAC power (240 VAC/50Hz available) •



**MODEL 7324** - \$1499  
This unit has a built-in compiler. The Model 7324 programs all MMI, National and TI 20 and 24 pin PALs. Has non-volatile memory. It operates stand alone or via RS232. Model 7322 PAL Programmer ..... \$1249



**MODEL 7128** - \$429  
This model has the highest performance-to-price-ratio of any unit. *This is GTEK's most popular unit!* It supports the newest devices available through 256Kbits.

**MODEL 7316 Pal Programmer** ..... \$ 749  
Programs Series 20 PALs. Built-in PALASM compiler.

## DEVICES SUPPORTED

by GTEK's EPROM Programmers

NMOS		NMOS		CMOS	EEPROM		MPU'S	
2758	2764A	2508	68764	27C16	5213	12816A	8748	8741H
2716	27128	2516	8755	27C16H	5213H	12817A	8748H	8744
2732	27128A	2532	5133	27C32H	52B13		8749H	8751
2732A	27256	2564	5143	27C64	X2816		8741	68705
2764	27512	68766		27C256	48016		8742H	

## UTILITY PACKAGES

GTEK's PGX Utility Packages will allow you to specify a range of addresses to send to the programmer, verify erasure and/or set the EPROM type. The PGX Utility Package includes GHEX, a utility used to generate an Intel HEX file.

PALX Utility Package — for use with GTEK's Pal Programmers — allows transfer of PALASM\* source file or ASCII HEX object code file.

Both utility packages are available for CPM,\* MSDOS,\* PCDOS,\* ISIS\* and TRSDOS\* operating systems. Call for pricing.

## CROSS ASSEMBLERS

These assemblers are available to handle the 8748, 8751, Z8, 6502, 68X and other microprocessors. They are available for CPM and MSDOS computers. When ordering, please specify processor and computer types.

## ACCESSORIES

Model 7128-L1, L2, L2A (OEM Quantity) \$259.	XASM (for MSDOS) .....	\$250.
Model 7128-24 .....	U/V Eraser DE-4 .....	\$ 80.
Cross Assemblers .....	RS232 Cables .....	\$ 30.
	8751 Adapter .....	\$174.
PGX Utilities .....	8755 Adapter .....	\$135.
PALX .....	48 Family Adapter .....	\$ 98.
	68705 Programmer .....	\$299.



Development Hardware/Software  
P.O. Box 289, Waveland, MS 39576  
601/467-8048  
INC.

GTEK, PALASM, CPM, MSDOS, PCDOS, ISIS, and TRSDOS are all registered trademarks.

## EVENT QUEUE

Reston, VA 22091. (800) 522-1985; in Virginia, (703) 620-8900. July 29–August 2

(\$495 for educators). Contact Professor Theodore J. Crovello, Biocomputing Short Courses, Department of Biology, University of Notre Dame, Notre Dame, IN 46556. (219) 239-7031. August 4–9

## August 1985

● **PROFESSIONAL EDUCATION SEMINARS**—Advanced Professional Education Seminars, various sites throughout the U.S. and Canada. Among the titles on the agenda are "UNIX/XENIX," "The IBM Personal Computer," "Networking the IBM Personal Computer," and "SNA and Teleconcepts." Contact the Center for Advanced Professional Education, Suite 110, 1820 East Garry St., Santa Ana, CA 92705. (714) 261-0240. August

● **IBM PC SEMINAR**  
IBM PC Seminar, various sites throughout the U.S. A three-day seminar covering PC hardware, PC-DOS, IBM PC work-alikes, and software selection. Contact Data-Tech Institute, Lakeview Plaza, POB 2429, Clifton, NJ 07015. (201) 478-5400. August

● **ENGINEERING CONFERENCE, EXPO**—The 1985 ASME International Conference and Exhibition, Sheraton Boston Hotel, Boston, MA. The theme is "Expert Systems: A New Dimension in Computer Engineering." Contact The American Society of Mechanical Engineers, 345 East 47th St., New York, NY 10017. (212) 705-7100. August 4–8

● **COMPUTERS IN BIOLOGY**—Computers in Biology, University of Notre Dame, Notre Dame, IN. Concurrent, one-week courses on computers in bioeducation, the classroom and laboratory, research, and biological modeling and simulation. Tuition is \$595

● **PREPARE FOR FACTORY AUTOMATION**—How To Plan for Factory Automation, Center for Continuing Engineering Education, University of Wisconsin-Extension, Milwaukee. The strategy, technology, systems, and control implications are explored. A working knowledge of computer systems, group technology, CAD/CAM, and manufacturing management is recommended. The fee is \$890. Contact Center for Continuing Engineering Education, University of Wisconsin-Extension, Civic Center Campus, 929 North Sixth St., Milwaukee, WI 53203. (414) 224-4191. August 5–9

● **MACROS AND SYMPHONY**—Advanced Application Techniques: Using Symphony Macros, Dallas, TX. A workshop emphasizing a building-block approach to learning the sequence of macro instructions and how they can be used to solve everyday application needs. Contact Data-Tech Institute, Lakeview Plaza, POB 2429, Clifton, NJ 07015. (201) 478-5400. August 7–8

● **EVENT FOR TRAINERS** COMTRED '85: The National Computer Training and Education Conference and Exhibition, Civic Center, Philadelphia, PA. Seminars and conferences for educators, computer trainers, retailers, and distributors. More than 50 exhibits. Pre-conference workshops on August 6. Contact National Computer Education Expositions Inc., Suite 200, 1411

(continued)



# NEW

## A powerful multfile database with a programming language for only \$99

**V**ersaform's new XL database isn't just promises—it's here now! And it offers—YES, FOR ONLY \$99—all the features you'd expect in a database costing 4 times as much.

Accounting applications are XL's strength. Invoicing, purchasing, receivables, and shipping almost create themselves as you design the forms—and XL transfers data between them. There's an Invoicing, A/R and Inventory application—source code included—in the package that shows how it's done. The power's there. And unlike packaged accounting programs, you can do them YOUR way.

	VersaForm XL	dBASE III*	R-BASE 4000*
PRICE	99	695	495
STRUCTURED LANGUAGE	Y	Y	Y
MULTI-FILE	Y	Y	Y
COLUMNS WITHIN DATA RECORD	Y	N	N
DATA ENTRY CHECKING	BUILT-IN	MUST WRITE PROGRAM	BUILT-IN
ON-SCREEN CALC	BUILT-IN	MUST WRITE PROGRAM	MUST WRITE PROGRAM
FORMS OUTPUT	BUILT-IN	MUST WRITE PROGRAM	MUST WRITE PROGRAM
DATE ARITHMETIC	Y	Y	N
DATA TYPES	DYNAMIC	FIXED	FIXED
COLUMN TOTAL OPERATOR	Y	N	N
QUERY BY EXAMPLE	Y	N	EXTRA
MAX FILE SIZE	4 MB	OPEN	OPEN
MAX RECORD SIZE	4000	4000	1530

\*dBASE III is a registered trademark of Ashton-Tate. R-BASE 4000 is a trademark of Microrim, Inc.

- XL's structured language can access multiple files. 48 built-in functions give control of file access, printing, and user dialogues. You'll develop transaction-based applications with an ease you've never experienced before. And all at this unheard-of low price.
- VersaForm XL's unique form-oriented data structures let you easily set up forms and ledgers—even those with columns! Application development is FAST, FAST, FAST. And since forms are the way that businesses already store their data, the transition is smooth. That's why VersaForm XL is so easy to operate even for high-turnover clerical people—it starts from where they are now.
- Automatic data entry checking and on-screen calculation make transactions error-free. Stored print formats make output formatting a snap—you can quickly match existing paper forms. VersaForm XL's report generator is clear and intuitive. Designers can pre-install reports,

users can set up their own.

- Query-by-forms (at no extra cost) lets users go right to the data they need. No query language to learn—forms are the natural language of business.

### Ironclad Money-Back Guarantee

Try VersaForm XL for 30 days. If you're not fully satisfied, return it. We'll gladly refund your money.

Order now, and have the pleasure of using the right tool at the right price. You can't lose!

VersaForm XL runs on IBM PC, XT, AT and compatibles. Requires 192K, two 360KB drives, DOS 2.0 or later. Hard disk recommended.

Standard VersaForm (single file, no language) available for 64K, 2-drive Apple II or 128K IBM PC. \$69.

## VersaForm™ XL

Applied Software Technology, Dept 785, 1350 Dell Ave., Suite 206, Campbell, CA 95008 (408) 370-2662

Yes! Rush me Versaform XL for the IBM PC (\$99) \_\_\_\_\_  
 Standard Versaform (Single file, no language) for the IBM PC (\$69) \_\_\_\_\_  
 Apple II (+,E,C) (\$69) \_\_\_\_\_

Credit card members can order by phone.  

**Toll-Free: 1-800-824-8145**

In California

**Toll-Free: 1-800-854-4448**

Enclose check or money order with coupon. Include \$4.50 for U.S. Shipping and handling. \$7.00 for C.O.D. California residents add 6.5% tax.

\_\_\_\_ My check or money order is enclosed \_\_\_\_\_ Send C.O.D.

Charge my \_\_\_\_\_ MasterCard \_\_\_\_\_ Visa

Account No. \_\_\_\_\_ Expires \_\_\_\_\_

PLEASE PRINT CLEARLY 785

Name \_\_\_\_\_

Address \_\_\_\_\_

City \_\_\_\_\_ State \_\_\_\_\_ Zip \_\_\_\_\_

Phone \_\_\_\_\_ Signature \_\_\_\_\_

# LOTUS USES FRAMEWORK.

John Spiech, President  
Lotus Performance Cars, L.P.



Framework and Ashton-Tate are trademarks of Ashton-Tate. *Software Digest* is a registered trademark of Software Digest, Inc.

Lotus is a registered trademark of Group Lotus Car Companies, PLC.

©Ashton-Tate 1985. All rights reserved.

# HERE'S HOW:

Lotus® travels in the fast lane. They can't settle for second best in business software. That's exactly why they went out and bought Framework™ software.

Framework's a winner. In their "Overall Evaluation" category, *Software Digest*, December, 1984, rated Framework the best integrated package. And when 10 teams of Wharton MBA candidates squared off against each other with different business software, the Framework team won hands down. Lotus likes a winner.

The future of Lotus is mapped out on Framework where a powerful spread-

sheet works with a critically-acclaimed word processor. It's a combination that only Framework has. The Framework out-line function—built in, not added on—lets Lotus see what's up the road ahead. And a data management function helps Lotus keep track of their fast-moving products.

Lotus came to two conclusions after looking for software. One: a symphony is something you listen to on the highway with the radio turned up loud. And two: Framework may well be all the business software a fast-moving company needs.

For a dealer near you call (800) 437-4329, ext. 222. In Colorado (303) 799-4900, ext. 222.



Software from

# ASHTON·TATE™

We'll put you in control.

Inquiry 41

## COMPETITIVE EDGE

P.O. Box 556 — Plymouth, MI 48170 — 313-451-0665  
 Compupro®, LOMAS, EARTH, TELETEK, Macrotech  
**S-100 CIRCUIT BOARDS**

CompuPro 286 CPU**	\$750	Lomas 286	\$821	Macrotech 286/280H	\$795
CompuPro SPU Z™ 8MHz	261	Lomas 8086	420	Lomas 10MHz 8086	520
CompuPro 8085/88™	245	Lomas Octaport™ 8Serial	320	Lomas 4 serial	200
CompuPro Disk 1A™	347	Lomas LDP™ 72	206	Macrotech 256K Dram	499
CompuPro Disk 3™	417	Lomas 256K Dram	556	Macrotech 512K Dram	799
CompuPro Ram 22™	850	Lomas 512K Dram	821	Macrotech 512K static	1595
CompuPro Ram 23™	277	Lomas Ram 67™	725	Macrotech 256K static	795
CompuPro Ram23 128	487	Thunder 186™	244	Lomas Color Magic™ 16K	476
CompuPro CPU Z™	189	Lomas CCP/M®86™	1095	Lomas MSDOS™ 2.11	200
CompuPro CCP/M®86™	250	Lomas CCP/M®86™	280	CompuPro MDrive H*512K	495
System Support One™	245	CompuPro I/O 4	245	CompuPro I/O 3 8 port	459
Teletek HD/	375	Teletek SBC-1	525	Teletek SBC 1 6MHz 128	699
Teletek Systemmaster®	557	Systemmaster II®	899	Turbodocs® for Teletek	650

Lomas 2 Megabyte Ram-(2048K) just \$1595.

**Earth Computer TURBO SLAVE 18MHz 128K \$395.**  
 Turbo Slave I runs with Teletek, North Star Horizon, Advanced Digital and Others under Turbos™

### SYSTEMS

CompuPro 85/88, 256K, CDOS, SS1, I/O 4, 2-96TPI DRS, 10 Slot	\$3095
CompuPro 85/88, 256K, CDOS, SS1, I/O 4, 1-96TPI, 20MB, 10 Slot	\$4295
286 280H, 1024K, Static, CDOS, SS1, I/O 4, 1-96TPI, 40MB, 10 Slot	\$7495
286, 1024K, 20MB, AutoCad 2 System — Ready to Run	\$8395
Lomas 286, 1024K, 20MB HD, 1-5", CDOS, 6 SERIAL, 2 Par, 10 Slot	\$4995
Lomas Thunder 186, 256K, 20 MB HD, 1-5", CDOS, 4 Slot	\$2895
Teletek 8MHz Master, 4-8MHz 128K SLVS, 1-5", 20 MB HD, TDOS	\$4495

### UPGRADE YOUR IBM® PC™ !!

MONITORS	GRAPHIC BOARDS	HARD DRIVE KITS
Amdis 310A	Hercules Monochrome	PC 10MB PC
Taxan Color 440	Hercules Color Card	PC 21MB PC
Princeton Color HFR-12	Tecmar Graphics Master	AT 21MB AT
Princeton Color SF-12	Paradise Graphics	AT 36MB AT
	STB Graphics, II	AT 70MB AT
		AT 80MB AT
		AT 113MB AT
MULTI-FUNCTION BOARDS	FLOPPY DRIVES	
AST 6 Pak 64K	TEAC 1/2 HT FD55B	\$119
Quadram Expanded Quadboard 0K	Mitsubishi 96 TPI	\$125
Tecmar Captain 64K	5" DSDD Color Diskettes	\$ 21

#### ALL PRICES SUBJECT TO CHANGE AND STOCK ON HAND

CompuPro is a Registered Trademark of Viasyn; CPU 2, Disk 1A, Disk 3, Interfacer 3, Interfacer 4, CPU 286, CPU 8085/88, System Support 1, MDRIVE-H, Ram 22, Ram 23 are trademarks or registered trademarks of Viasyn; CP/M 2.2, CCP/M, are registered trademarks of Digital Research Inc; MSDOS is a registered trademark of Microsoft; Systemmaster & Systemmaster II are registered trademarks of Teletek Enterprises; Turbos is a registered trademark of Software 2000; IBM is a registered trademark of International Business Machines; AutoCad 2 is a registered trademark of AutoDesk, Inc.

## The Ultimate Cable Assembly

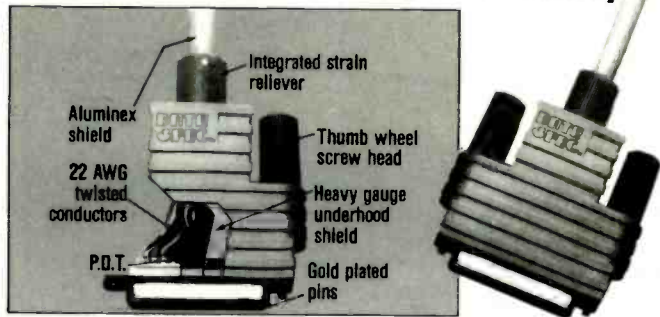

### Inside and Out

You've never seen a cable that looks or works quite like this. The result of extensive research into functional design, the DATA SPEC cable assembly not only visually enhances your computer equipment, but provides superior quality with the following features:

- Full shielding (Exceeds F.C.C. EMI/RFI emission requirements)
- Positive strain relief
- Large convenient thumbscrews
- Gold plated pins
- Exclusive P.D.T. underhood for maximum integrity
- Lifetime warranty

DATA SPEC makes cable assemblies for all your interface needs: printers, modems, disk drives and monitors. For your IBM, Apple, AT&T and other popular PC's. Ask for DATA SPEC cables at your nearest authorized DATA SPEC dealer.

**DATA SPEC®**

FROM ALLIANCE RESEARCH CORPORATION  
 20120 Plummer Street • Chatsworth, CA 91311 • 1-818-993-1202

IBM, Apple and AT&T are registered trademarks respectively of International Business Machines Corp, Apple Computer Inc and AT&T Information Systems. Patent PND. ©Copyright 1985 Alliance Research Corporation

## EVENT QUEUE

Walnut St., Philadelphia, PA  
 19102. (215) 972-8792.  
 August 7-9

● **COMPUTER. ELECTRONIC EVENT**—Computerfest '85, Building 7, Sinclair Community College, Dayton, OH. Seminars, flea-market areas, speakers, users-group meetings, and club booths and displays are some of the highlights. Admission is \$1.50. Contact Mark Hanslip, Computerfest '85, 143 Schloss Lane, Dayton, OH 45418-2931. (513) 268-7225.  
 August 10-11

● **TOMORROW'S COMPUTERS**—International Symposium on New Directions in Computing, Norwegian Institute of Technology, Trondheim, Norway. Contact New Directions in Computing, IEEE Computer Society, POB 639, Silver Spring, MD 20901.  
 August 12-14

● **GRAPHICS**  
 Ausgraph '85, Brisbane, Queensland, Australia. Australia's first international conference and exhibition on computer graphics. Contact Conference Secretariat, Ausgraph '85, POB 29, Parkville, Victoria 3052, Australia; tel: (03) 387 9955; Telex: AA 33761.  
 August 12-16

● **MACROS AND SYMPHONY**—Advanced Application Techniques: Using Symphony Macros, Chicago, IL. See August 7-8 for details. August 14-15

● **COMPUTER SWAP**  
 Northwest Computer Swap Number 9, Fiesta Exhibit Hall, San Mateo County Fairgrounds, San Mateo, CA. Admission is \$5. Contact Northwest Computer Swap, 4883 Tonino Dr., San Jose, CA 95136, or call Robert Kushner, (408) 978-7927.  
 August 17

● **AI INVESTIGATED**  
 IJCAI-85: The International Joint Conferences on Artificial Intelligence, University of California, Los Angeles. Topics include AI architectures and languages, intelligent CAI, automated reasoning, and expert systems. Tutorials. Contact IJCAI-85, American Association for Artificial Intelligence, 445 Burgess Dr., Menlo Park, CA 94025. (415) 321-1118.  
 August 18-24

● **FOR EDUCATORS**  
 Innovative Applications of Microcomputer Technology in Vocational Education, University of Wisconsin, Madison. The emphasis will be on interactive video, networking, hard-disk systems and storage backup devices, and telecommunications for agriculture, education, and health applications. Contact Dr. Judith Rodenstein, Vocational Studies Center, 964 Educational Sciences Building, University of Wisconsin-Madison, 1025 West Johnson St., Madison, WI 53706. (608) 263-4367.  
 August 19-21

● **MACROS AND SYMPHONY**—Advanced Application Techniques: Using Symphony Macros, Philadelphia, PA. See August 7-8 for details. August 21-22

● **INTERFACING WORKSHOP**—Personal Computer and STD Computer Interfacing for Scientific Instrument Automation, Washington, DC, area. A hands-on workshop with participants wiring and testing interfaces. The fee is \$450. Contact Dr. Linda Leffel, C.E.C., Virginia Polytechnic Institute and State University, Blacksburg, VA 24061. (703) 961-4848.  
 August 22-24

● **EUROPEAN MEDICAL INFORMATICS**—The Sixth International Congress of

TEAR AND COMPARE! TEAR AND COMPARE! TEAR AND COMPARE! TEAR AND COMPARE!

**LOGICSOFT INCREDIBLE  
NEW SERVICE BREAKTHROUGH**

**FREE  
OVERNIGHT  
DELIVERY!**

On Orders Totalling  
Over \$100. Shipped  
UPS FREE If  
Under \$100

VA... **Purolator  
courier**



**PLUS... We'll Continue To Beat  
Any Price \$10  
By.....**

**THAT'S RIGHT! OUR LOWEST PRICE GUARANTEE IS STILL EFFECTIVE!**  
Tell us the advertiser and price of any software or hardware item on these pages currently advertised in any popular computer publication and we'll beat that price by \$10. This offer does not apply to items under \$100 or where the price is not lower than Logicsoft's.

**SOFTWARE for IBM PC**

DATA BASE MANAGEMENT	GRAPHICS (cont.)	LANGUAGES/UTILITIES (cont.)	WORD PROCESSING (cont.)
KNOWLEDGEMAN \$259	BPS Graphics \$289	Business Basic (MS) \$299	Wordstar Pro Pac \$265
Clout 2 145	SIGNMASTER 195	FORTAN COMPILER (MS) 229	Wordstar Pro Plus 345
Tim IV 279	pfs: graph 85	C86 C Compiler	<b>WORD PERFECT</b> (New Release) 245
R:Base 4000 265	Graphwriter 319	(Computer Innovations) 329	Microsoft Word 245
R:Base 5000 <b>Lowest Price</b>	Graphwriter Extension 319	<b>INTEGRATED/SPREADSHEETS</b>	MULTIMATE 249
DB Master 475	Graphwriter Combo Pak 485	LOTUS 1-2-3 \$305	Volkswriter Deluxe 165
d BASE III 365	Microsoft Chart 175	Enable 305	Peachtext 5000 199
Quickcode III 159	<b>ENERGRAPHICS</b>	Smart Series 579	Easywriter II/Speller/Mailer 199
d Base II (New Release) 269	Energraphics (w/plotter opt.) 325	<b>FRAMEWORK</b> 355	Edix & Wordix 255
Condor III 349	PC Draw 295	Open Access 395	Finalword 225
Data Base Mgr. II (alpha) 175	<b>LANGUAGES/UTILITIES</b>	Electric Desk 229	Samna III 325
Extended Report Writer 119	<b>CONCURRENT PC DOS</b> (with DOS) \$175	<b>SYMPHONY</b> 429	Xy Write II Plus 255
Friday 169	Pascal MT + (PC DOS) 349	Supercalc 3 175	Think Tank 125
pfs: file & pfs: report 165	PL/1 (DR) 489	Multiplan 129	pfs: write 85
<b>REVELATION</b> 745	Display Manager (DR) 359	TK! Solver 279	<b>MISCELLANEOUS UTILITIES</b>
Powerbase 309	Access Manager (DR) 269	pfs: plan 85	<b>PROKEY 3.0</b> \$89
Easyfiler 235	<b>LATTICE C COMPILER</b> 305	<b>PROJECT SCHEDULERS</b>	Norton Utilities (New Release) 65
<b>FINANCIAL</b>	C-Food Smorgasbord 119	<b>MICROSOFT PROJECT</b> \$165	<b>SIDEKICK (unprotected)</b> 65
<b>DOLLARS AND SENSE</b> \$115	CIS Cobol 86 (DR) 479	SuperProject (IUS) 245	Crosstalk XVI (New Release) 115
Market Mgr. Plus (Dow Jones) 179	Pascal Compiler (MS) 245	HARVARD TOTAL PROJECT MGR. 285	Sideways 45
<b>MANAGING YOUR MONEY</b> 119	C Compiler (MS) (New Release) 305	<b>WORD PROCESSING</b>	Copy II PC 39
<b>GRAPHICS</b>	Microsoft Sort 159	Wordstar 2000 \$259	<b>DESK ORGANIZER</b> 129
<b>CHARTMASTER</b> \$275	Cobol Compiler (MS) 479	<b>WORDSTAR 2000 PLUS</b> 309	

**HARDWARE for IBM PC**

GRAPHICS BOARDS	GRAPHICS BOARDS (cont.)	MODEMS (INTERNAL) (cont.)	MULTI-FUNCTION BOARDS (cont.)
AST	<b>PARADISE SYSTEMS</b>	<b>VEN-TEL</b>	<b>AST RESEARCH (cont.)</b>
Preview <b>Lowest Price</b>	Multi-Display Card \$279	PC Commom Half Card \$439	Advantage (128k) \$429
<b>EVEREX</b>	Modular Graphics Card 289	<b>COMMUNICATIONS BOARDS</b>	<b>QUADRAM</b>
Graphics Edge <b>Lowest Price</b>	Options A&B <b>Lowest Price</b>	AST	Quadboard (64k) \$259
<b>HERCULES</b>	<b>MODEMS (INTERNAL)</b>	AST 5251-11 or 12 \$629	STB
Graphics Card \$325	<b>PROMETHEUS</b>	AST 3780 749	Rio-Plus II (64k) \$259
Color Card 169	Pro-modem 1200B \$319	I/O Plus II 135	Rio Grande <b>Lowest Price</b>
<b>PLANTRONICS/FREDERICK</b>	<b>QUADRAM</b>	<b>DCA</b>	Grande Byte <b>Lowest Price</b>
Colorplus \$385	Asher \$395	IRMA Board \$949	<b>TECMAR</b>
<b>STB</b>	<b>HAYES</b>	<b>QUADRAM</b>	Captain \$235
Graphics Plus II \$315	Smartmodem 1200B (with software) \$385	Quadlink \$449	<b>KEYBOARDS</b>
<b>TECMAR</b>	<b>NOVATION</b>	<b>MULTI-FUNCTION BOARDS</b>	<b>KEYTRONIC</b>
Graphics Master \$459	Smart-Cat Plus \$355	<b>AST RESEARCH</b>	5150 \$159
<b>TSENG LABORATORIES</b>	<b>RACAL-VADIC</b>	Six Pak Plus (64k) \$259	5151 (Deluxe) 179
Ultra Pak \$545	Maxwell 1200PC \$395	Mega Plus II (64k) 275	5152 B or L <b>Lowest Price</b>

Prices subject to change without notice.

Immediate Replacement on any Defective Product.

• NO SURCHARGE for VISA or MasterCard • No Sales Tax on Orders Outside N.Y. State • Purchase Orders Welcomed from Qualified Institutions • NO SURCHARGE! (Please call for price verification) • Please add 2% for handling and insurance (Int'l orders add 1) • Payment MasterCard VISA American Exp. C.O.D. Money Order or Check



National Sales Hot Line **1-800-645-3491**

Customer Service 1-800-431-9037

New York State...516-249-8440 Canada.....416-283-2354 Domestic/International Telex...286905 Soft UR

**LOGICSOFT**

THE LOGICAL CHOICE  
A Member of The Logic Group  
110 Bi-County Blvd., Farmingdale, N.Y. 11735

SEE REVERSE SIDE FOR:  
• MACINTOSH SOFTWARE & HARDWARE  
• GENERAL HARDWARE • AND MORE!

WE WILL BEAT ANY PRICE BY **\$10**

**NEW! Expanded Special Order Dept.**  
We know there are many products that simply cannot be found through mail order. We've solved that problem...just ask for our **SPECIAL ORDER** department...We've got the suppliers...still at low mail order prices!

**FREE**  
Overnight Delivery  
See Other Side for Details

**SOFTWARE for Macintosh**

DATABASE		GRAPHICS		MANAGEMENT/FINANCE		MANAGEMENT/FINANCE	
DB Master	\$125	Davinci Commercial Int	149	Home Accountant Plus	\$89	General Financial Analysis	\$70
Filevision	105	Davinci Building Blocks	45	MacManager	35	Real Estate Dev. (Comm. or Res.)	70
1st Base	105	McPic	35	MacProject	Lowest Price	<b>SPREADSHEETS/INTEGRATED</b>	
Habadex	115	Microsoft Chart	85	Management Edge	125	Jazz	Lowest Price
Heflx	249	Click Art Series		Market Analyzer	Lowest Price	Multiplan	\$125
Mainstreet Filer	185	(Pers. Graphics, Pub's, Letters)	100	Market Manager (Dow Jones)	119	Microplanner	Lowest Price
Megafile	135	<b>LANGUAGES/UTILITIES</b>		Peachtree Back To		TKI Solver	169
Microsoft File	140	Basic Interpreter (MS)	\$95	Basics Accounting	Lowest Price	Ensemble	185
Omnis 2	169	MacForth (Level 1)	95	Sales Edge	185	<b>WORD PROCESSING</b>	
Omnis 3	275	MacForth (Level 2)	149	Straight Talk	369	Bank St. Writer	Lowest Price
Overview	179	Smoothtalker	115	Financial Planning (Apropos)	60	Microsoft Word	\$149
pfs: File & Report	105	Softmaker II	119	Investment Planning (Apropos)	60	Think Tank (128k)	85
MacIcon	245	Softworks "C"	275	Communications Edge	110	Mac*Spell*Right	55
Factfinder	95	PC to Mac & Back	85	Negotiation Edge	175	MacSpell +	50
<b>GRAPHICS</b>		Hippo C (Level 1)	115	Tax Manager (Microtab)	110	Hayden: Speller	45
Animation Tool Kit	\$39	<b>MANAGEMENT/FINANCE</b>		Forecast	45	Think Tank (512k)	135
Davinci Series		Dollars & Sense	\$79	Electric Checkbook	50	TECH (Linquist)	70
(Buildings, Interiors, Landscapes)	100	Front Desk	85	MacCalendar	60	Megaform	185

**HARDWARE for Macintosh**

ASSIMILATION PROCESS		HAYES		MICROCOM		OPTIMUM	
Mac Daisywheel Connection	\$75	Smartmodem 300	\$195	MacModem	\$450	MacTote	\$65
Mac Turbo Touch	85	Smartmodem 1200	\$425	<b>MICRON TECHNOLOGY</b>		<b>PROMETHIUS</b>	
<b>CURTIS SURGE PROTECTOR</b>		<b>INTERMATRIX</b>		Micron Eye	\$325	Promodem 1200	\$375
Diamond	\$39	Macphone	\$159	<b>MICROSOFT</b>		<b>DISKS</b>	
Emerald	49	<b>KENSINGTON</b>		MacEnhancer	\$170	Maxell 3 1/2" (Box of 10)	\$35
Sapphire	59	300 Baud Modem	\$95	<b>NOVATION</b>		Memorex 3 1/2" (Box of 10)	39
Ruby	69	Surge Suppressor	39	Cat	\$375	3M 3 1/2" (Box of 10)	39

**GENERAL HARDWARE**

PRINTERS*		PRINTERS* (cont.)		VIDEO TERMINALS* (cont.)		MODEMS (External)	
DIABLO		SILVER REED (Cont.)		ALTDOS		PROMETHEUS	
36**	\$1229	550	\$449	Smart II	\$695	Pro-modem 1200	\$395
D25**	619	770	795	QUME		QUADRAM	
630-API	1529	TOSHIBA		QVT 102 Green	\$395	Quadmodem 1100	\$555
630-ECS**	1799	1351 Tractor	\$159	QVT 102 Amber	415	HAYES	
EPSON		P351	1375	QVT 103 Green	810	Smartmodem 300	\$205
LQ1500	\$1199	1340	779	QVT 103 Amber	845	Smartmodem 1200	445
Parallel Interface	Lowest Price	<b>CITIZEN</b> Lowest Price		QVT 108 Green	445	Smartmodem 2400	719
JK-80	599	<b>PRINTER/PLOTTERS*</b>		QVT 108 Amber	515	NOVATION	
RX-80	239	<b>HEWLETT PACKARD</b>		TELEVIDEO		Access 1-2-3	\$475
LX-80**	265	HP 747DA	\$945	800	\$1220	Professional 2400	835
RX-100	399	HP 7475	1595	800A	975	PRENTICE	
FX-80**	379	<b>HOUSTON INSTRUMENT</b>		910	420	Popcom X100	\$379
FX-100**	599	PC Plotter	\$475	910 +	555	Popcom C100	355
<b>C. ITD#</b>		<b>MONITORS*</b>		921	445	RACAL-VADIC	
Prowriter 8510 BPI	\$375	AMDEK		922	750	Maxwell 1200 V	\$439
Starwriter A10P	529	Color 300	\$255	924	635	2400 PC	635
Starwriter F10-40P	869	Color 500	389	925	695	VEN-TEL	
Printmaster F10-55P	1249	Color 600	479	925E Green	595	PC Modem 1200	\$399
JUKI		Color 710	579	WYSE		1200 Plus	399
6100	\$439	12" Green 300G	135	50	\$485	<b>BACK-UP DEVICES</b>	
6300	799	12" Amber 300A	145	75	560	ALLOY	
MANNESMANN TALLY		12" Amber 310A	169	ZENITH		Tape Backup	Lowest Price
Sprint	\$279	MEC		Z-22	\$465	SYSGEN	
160	579	JB 1201	\$159	Z-29	695	Tape Backup	Lowest Price
180	849	JB 1205	149	Z-49	Lowest Price	<b>MOUSE INPUT DEVICES</b>	
<b>NEC</b>		JC 1215	239	<b>AST RESEARCH</b>			
2030**	\$719	JC 1216	399	Mega Pak (256k)	\$369	MOUSE SYSTEMS	
8027**	349	<b>PRINCETON GRAPHICS</b>		IDEA		PC Mouse w/paint	\$139
2050**	695	RGB HX-12	\$489	IDEAmax 384 (64k)	\$269	MICROSOFT	
3530	1329	RGB SR-12	599	ORCHID		Microsoft Mouse (Serial)	149
3550	1395	Scan Doubler Board (for SR 12)	185	Blossom (0 k)	\$235	Microsoft Mouse (Buss)	149
8850**	1785	Amber Max 12	185	<b>COMMUNICATIONS BOARDS</b>			
Pinwriter P2**	675	QUADRAM		AST-SNA	\$699	<b>SURGE PROTECTORS</b>	
Pinwriter P3**	895	Quadchrome 12"	\$485	AST-BSC	899	KENSINGTON MICROWARE	
OKIDATA		Quadscreen 17"	1595	<b>GRAPHICS BOARDS</b>			
182-IBM	\$239	Quadchrome II 14"	465	AST		Masterpiece	\$115
84-IBM	799	Amberchrome 12"	185	AST-SNA	\$699	CURTIS	
192-IBM	409	<b>TAXAN</b>		AST-BSC	899	Diamond	\$39
93-IBM	639	100G	\$125	<b>MOUSE SYSTEMS</b>			
2410P	2295	105A	135	MA SYSTEMS		Emerald	49
<b>QUADRAM</b>		121	149	Peacock Color Board	\$245	Sapphire	59
Quadjet	\$789	122	149	PERSYST		Ruby	69
<b>QUME</b>		210	269	Monochrome Card	\$199	<b>MEMORY CHIPS</b>	
Sprint 11/40**	\$1299	420	409	QUADRAM		(200ns) 64k	\$35
Sprint 11/55**	1595	440	699	Quadcolor I	\$195	<b>DISKETTES</b>	
Sprint 11/90**	2295	<b>VIDEO TERMINALS*</b>		Quadcolor II	465	LOGICTRAK 5 1/4"	
<b>SILVER REED</b>		A-2 Green	\$485	100% Guaranteed, Double side, double density			
400	\$279	A-3	\$485	10 per box			
500	349						

\* Due to weight restrictions, Printers and Monitors are shipped UPS...FREE! \*\* Parallel interface req...Ask sales agent

NO SURCHARGE for VISA or MasterCard • No Sales Tax on Orders Outside N.Y. State • Purchase Orders Welcomed from Qualified Institutions • NO SURCHARGE! (Please call for price verification) • Please add 2% for handling and insurance (intl orders add 1) • Payment MasterCard, VISA, American Exp, C.O.D. Money Order or Check



National Sales Hot Line **1-800-645-3491**

Customer Service **1-800-431-9037**

New York State...516-249-8440 Canada...416-283-2354 Domestic/International Telex...286905 Soft UR



THE LOGICAL CHOICE  
A Member of The Logic Group  
110 Bi-County Blvd., Farmingdale, N.Y. 11735

TEAR AND COMPARE! TEAR AND COMPARE! TEAR AND COMPARE! TEAR AND COMPARE!



## EVENT QUEUE

the European Federation for Medical Informatics, Helsinki, Finland. Topics include medical-record management and classification problems, expert systems, medical and clinical research and evaluation, and personal computers. Contact MIE-85 Secretary General, Raija Trevo-Pelikka, The Finnish Hospital League, Toimen Linja 14, SF-00530 Helsinki, Finland; tel: 358-0-7712640. August 25-29

● **INFORMATION TECHNOLOGY CONFERENCE**—The Integrated Information Technology Conference and Exposition: INTECH '85, Moscone Center, San Francisco, CA. Topics to be addressed include integrating personal computers, networks, information security, integrated voice and data, and managing information technology. An Applications Center will provide attendees the opportunity to observe applications in action. Contact INTECH '85, National Trade Productions Inc., Suite 400, 2111 Eisenhower Ave., Alexandria, VA 22314, (800) 638-8510; in the metropolitan Washington, DC, area, call (703) 683-8500. August 26-29

● **VIDEODISC CONFERENCE**—The Fifth Annual Nebraska Videodisc Symposium, University of Nebraska, Lincoln. The theme is "Videodisc—The Industry Comes of Age." Panel discussions, presentations, and exhibits. Registration is \$375. Contact Videodisc Design/Production Group, KUON-TV/University of Nebraska-Lincoln, POB 83111, Lincoln, NE 68501, (402) 472-3611. August 27-30

● **NEW ZEALANDERS CONVENTION**—The Ninth New Zealand National Computer Conference, Sheraton, Auckland, New Zealand.

Speakers, panel sessions, and exhibits. For details, contact Conference Committee, POB 3839, Auckland, New Zealand. August 27-31

## September 1984

● **TRADE CONFERENCE SERIES**—The Fifteenth United States Invitational Computer Conference, various sites throughout the U.S. A series of one-day, regional conferences designed to bring original equipment manufacturers together with systems integrators and quantity end-users. Exhibits and technical seminars. Fees begin at \$1600 each for one to four conferences. Contact B. J. Johnson & Associates Inc., 3151 Airway Ave. #C-2, Costa Mesa, CA 92626, (714) 957-0171. September-November

● **INFO MANAGEMENT SEMINARS**—NYU Seminars on Information Management, various sites throughout the U.S. On the agenda are "Legal Issues in Acquiring and Using Computers" and "Networking Personal Computers." Contact School of Continuing Education, Seminar Center, New York University, 575 Madison Ave., New York, NY 10022, (212) 580-5200. September-November

● **COMMUNICATIONS WORKSHOPS**—Data Communications Workshops, various sites throughout the U.S. and Canada. For a catalog, contact Rhonda Carney, Intel Corp., Westford Corporate Center, Three Carlisle Rd., Westford, MA 01880, (617) 256-1374. September-December

● **IBM SHOW**  
IBM System User Show, Olympia 2, London, England. A series of sessions focusing on all aspects (continued)

Inquiry 386 for End-Users.  
Inquiry 387 for DEALERS ONLY.



**MAX. IBM® AT/PC COMPATIBILITY**

Made in USA

**\$995**  
PC-2001\* COMPLETE SYSTEM

- \*OEM BASIC System \$555 (Minimum Order 10 Units)
- \*PC-2001 Complete System \$995 (Dealers at Quantity 2)
- \*XT-2001 10 MB Complete System \$1695 (Dealers at Quantity 2)
- \*AT-7000 Call For Evaluation Unit \$ (Approx. \$2000 Off IBM Pricing)

PC-2001 Partial Features: (Dealers Please Call For Details)

- Mother Board • RAM Memory Upgradable to 640K • K-8400 or K-9600 Keyboard • TEAC Drive & Controller • Parallel Port • Runs Lotus 1-2-3, Symphony, Flight Simulator and thousands more

**\*DEALER INQUIRIES INVITED**

**PLEASE CALL FOR DEALERS NEAREST YOU**



Other OEM Accessories:

- \*20 MB HARD DISK
- \*TAPE BACK UP
- \*8 SLOT MOTHER BOARD
- \*AT-7000 MOTHER BOARD

IBM is a trademark of IBM Corporation

**IBM CORPORATION**

2700 E. IMPERIAL HWY. - BLDG. A  
BREA, CA 92621  
(714) 579-0680, 579-0691  
TELEX 753197

## COVER STORY

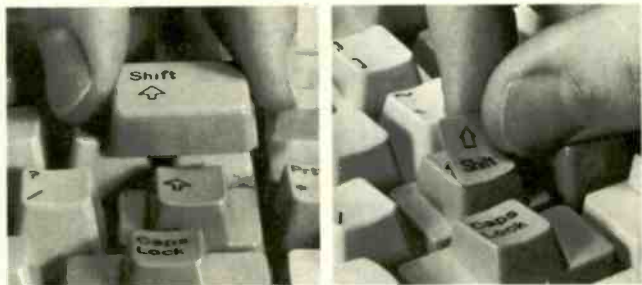

*Touchdown™ Key Overlays provide new or additional PC keyboard commands for compatibility with your software programs. Made of heavy, non-glare material similar to the original keytops, with commands printed on the underside for durability... These are not ordinary stick-on labels! Hooleon also makes custom overlays to your exact specs, including foreign language and special symbols. Touchdown™ Keytop Expanders enlarge small keys (Return, Shift, etc.) on the IBM PC and most look-alikes. They fasten securely over existing keys with a special adhesive provided, yet are easily removed without damage to the keyboard.*

**P. O. Box 201, Dept. B, Cornville, AZ 86325**

*CUSTOM KEY OVERLAYS can be made to your exact specs, at a much lower cost than engraving the keys.*

KEYTOP EXPANDERS		Qty	Price*
Qty.	Blk. Price*	Grey Price*	
___ IBM PC, PC/XT, PC Port (12 keys)	\$21.95	___ Corona, Eagle Spirit, Cubie, Keytronic (10 keys)	\$21.95
___ IBM 5291 Display Station (13 keys)	21.95	___ IBM 3270 PC "Enter" (1 keytop)	3.95
___ Compaq, Columbia (10 keys)	21.95	___ Individual Expanders (blank)	2.75
KEY OVERLAYS			
___ 5250/5251 (48 keytops/fronts)	\$21.95	___ Control Key English (5 keytops)	6.95
___ 5520 (101 keytops)	29.95	___ Blank Overlays (99 keytops)	21.95
___ 3270 (32 key fronts)	21.95	___ Do-it-yourself Kit (200+ pieces)	29.95
___ DisplayWrite 2 (36 keytops)	21.95	___ MultiMate (44 keytops)	29.95
___ DisplayWrite 3 (38 keytops)	21.95	___ EasyWriter II (29 keytops/Handy Card)	29.95
___ Dvorak (43 keytops)	26.95	___ Lotus 1-2-3 (24 keytops/Handy Card)	29.95
___ Wordstar (29 keytops)	26.95	___ WordPerfect (32 keytops/Handy Card)	29.95
<input type="checkbox"/> Visa <input type="checkbox"/> MasterCard    Exp. Date _____		TOTAL (Min. order \$10.00) \$ _____	
Card # _____		All prices include first class postage.	
Visa or MC orders phone 602-634-7517		(All orders shipped within 24 hours.)	
Custom Overlay, Other Software Kits. Write for Information.		Arizona residents add 5% tax	
		TOTAL ENCLOSED \$ _____	

Inquiry 172 for End-Users.

Inquiry 173 for DEALERS ONLY.



## UNLOCK THE SECRETS OF MACHINE LANGUAGE.

Our Visible Computer teaching systems do more than tell you about machine language, they show you—by turning your computer into an animated simulation of its microprocessor chip. You'll actually see the registers change as the processor executes instructions; you'll see how instructions are executed, not just the result.

The extensive manual may just be the clearest tutorial on machine language ever written. You'll work "hands-on-keyboard," at your own pace, as you progress through 30 demonstration programs stored on disk.

Apple II version: \$49.95. Commodore 64 version: \$39.95.  
**NEW!** The Visible Computer: 8088 (IBM PC): \$69.95. At better software dealers or direct from Software Masters, 3330 Hillcroft, Suite BB, Houston, Texas 77057. (713) 266-5771. MC/Visa accepted. Mail orders enclose \$3.00 shipping.

**Software Masters™**

Seventh Annual Conference on

# INTERACTIVE VIDEODISC

## In Education and Training

August 21-23, 1985  
 J. W. Marriott Hotel  
 Washington, D. C.

### Presentations Cover

- *Current Applications*
- *Emerging Technology*
- *Methodology Implementation*

Pre-conference tutorials are scheduled for August 19 and 20.

### Included among exhibitors are:

3M	U.S. Video
DEC	GWF Associates
NCR	OnLine Computer Systems
WICAT	MetaMedia Systems, Inc.
Sony	Digital Controls, Inc.
JVC	Applied Science Associates
Pioneer	

For further information contact:  
**Society for Applied Learning Technology**  
 50 Culpeper St. Dept. B  
 Warrenton, VA 22186 (703) 347-0055

## EVENT QUEUE

of the IBM computer market. Exhibits. Contact Julian Taylor, Peter Walker Associates, 32 Fitzroy Square, London W1P 5HH, England; tel: 01-388-9871. *September 3-5*

### ● EUROMICRO

Euromicro '85, Brussels, Belgium. Addresses, tutorials, and exhibitions. An electronic mouse race and a robot ping-pong tournament will be held. Contact Euromicro Office, p/a TH Twente, Dept. Inf., Room A 306, POB 217, 7500 AE Enschede, The Netherlands, Attn: Mrs. C. Snippe-Marlis. *September 3-6*

### ● OFFICE AUTOMATION

Third Annual Conference of the Office Automation Society International, Radisson South Hotel, Bloomington, MN. The theme is "The Integrated Office—How Soon?" Contact Office Automation Society International, 2108 C Gallows Rd., Vienna, VA 22180, (703) 790-0490. *September 3-6*

### ● PERSONAL COMPUTER FAIRE

The Third Personal Computer Faire, Civic Auditorium and Brooks Hall, San Francisco, CA. Conference program and exhibitions of hardware, software, and microcomputer services. Contact Computer Faire Inc., 181 Wells Ave., Newton, MA 02159, (617) 965-8350. *September 5-7*

### ● ROBOTICS CONGRESS

The Second International Personal Robot Congress and Exposition (IPRC), Moscone Center, San Francisco, CA. Seminars on personal robot software, hardware, human services, robots in space, education, and business. Exhibits and displays. Contact Robotic Industries Association, POB 1366, Dearborn, MI 48121, (313) 271-7800. *September 6-8*

### ● COMPUTER-AIDED TECHNOLOGIES—COMPINT

'85: The First International Conference on Computer-Aided Technologies, Palais de Congres, Montreal, Quebec, Canada. The theory, design, and implementation of computer-aided technologies. Contact Stephen G. Leachey, POB 577, Desjardins Postal Station, Montreal, Quebec H5B 1B7, Canada, (514) 870-3526. *September 9-12*

### ● AUTOFACT EUROPE

AUTOFACT Europe '85, Swiss Industries Fair, Basel, Switzerland. Workshops on computer-integrated manufacturing and factory automation. Held in conjunction with SwissData '85/Ineltec '85 Exhibits. Contact Susan Gretchko, AUTOFACT Europe '85 Administrator, Society of Manufacturing Engineers, One SME Dr., POB 930, Dearborn, MI 48121, (313) 271-1500, ext. 373. *September 10-13*

### ● DOCUMENTATION CONFERENCE

The 43rd Conference and Congress of the International Federation for Documentation, Montreal, Quebec, Canada. The theme is "Information, Communications, and Technology Transfer." Contact Mr. E. V. Smith, Canada Institute for Scientific and Technical Information, National Research Council of Canada, Ottawa, Ontario K1A 0S2, Canada. *September 14-18*

### ● C SEMINAR/WORKSHOP

C Language Seminar and Workshop, Sheraton-Com-mander Hotel, Cambridge, MA. The fee is \$695. Contact Beatrice Blatteis, CL Publications, 131 Townsend St., San Francisco, CA 94107, (415) 957-9353. *September 16-18*

### ● DATA STORAGE

The Fourth Annual DataStor-  
*(continued)*



*"Put more performance in less space"*

**Look into the new Princeton HX-9 Series**

See high-resolution RGB color with the Princeton HX-9 and HX-9E Color Monitors.

Observe exceptionally sharp high resolution graphics and text created by color phosphor dots which are within a mere .28mm of one another.

Enjoy Princeton performance on a 9-inch screen in less desk space than most any other monitor on the market today.

**Display images of clearly superior quality**

Flicker-free technology enables you to view colorful images with clear, sharp definition. Dark-glass, non-glare screens further enhance viewing clarity.



A built-in green/amber switch allows you to switch from multi-color to either a green or amber mode. It's like owning both a color and a monochrome monitor.

The Princeton HX-9 Color Monitor is perfect for viewing up to 16 vivid colors with the IBM Color/Graphics Monitor Adapter (or equivalent).

And, the enhanced member of the HX-9 Series, the Princeton HX-9E Color Monitor, offers one big extra: It also allows you to use the IBM Enhanced Graphics Adapter (or equivalent) to view up to 64 brilliant colors.

What's more, they tilt. They swivel. Both have a built-in base to adjust your monitor to a comfortable viewing angle.

**Princeton quality is built in**

Both monitors in the Princeton HX-9 Series are manufactured to provide years of reliable use. Verified by tough quality-control procedures. And backed by a full one-year warranty.

**Visit your local computer store today**

See the HX-9 Series and all other products bearing the world-respected Princeton name. To find the Princeton dealer nearest you, call: **800-221-1490 (Extension 404)**, 609-683-1660 (NJ only), Telex: 821402 PGS PRIN.

Princeton Graphic Systems, 601 Ewing Street, Bldg. A, Princeton, NJ 08540.

**PRINCETON™**

**GRAPHIC SYSTEMS**  
AN INTELLIGENT SYSTEMS COMPANY

IBM is a registered trademark of International Business Machines Corp.

*Why So Long?* We've specialized in Vertical Markets...

<b>Medical / Dental</b>	<b>Construction / Job Cost</b>
• Appointments	• Payroll
• Patient Billing	• General Ledger
• Claim Preparation	• Estimating
• Patient Data Base	
<b>Educational Administration</b>	
• Scheduling	
• Attendance	
• Grading	
• Computer Literacy	

... Since 1977  
Now over 110 machines including:

IBM™  
WANG™ MS-DOS™  
Apple

**CMA**  
MICRO COMPUTER DIVISION  
55722 Santa Fe Trail  
Yucca Valley, CA 92284  
(619) 365-9718

## UNLOCK™ Removes Copy Protection!

Runs on IBM® PC, XT, AT, and Many Compatibles

New UNLock (4.0) provides the user with: 1) reliable archival back-up copies, and 2) ease of program use. Because UNLock removes copy protection, you can conveniently run protected software from a hard disk, RAM disk or a Data General/One™. Often you can combine two disks into one, saving disk swaps on floppy systems.

UNLock runs on DOS 2.0 or higher and requires 256K of memory. To utilize the UNLock copy requires no co-resident software. UNLock does not risk or change your original distribution disk.

**New UNLock (4.0) Disk Produces Non-Protected DOS Copies from:**

- LOTUS 1-2-3™ (1.A & 1.A\*)
- dBASE III™ (1.0 & 1.1)
- FRAMEWORK™ (1.0 & 1.1)
- SYSTAT™ (1.3 & 2.0)
- SPOTLIGHT™ (1.0)
- GRAPHWRITER™ (4.3)
- REALIA COBOL (1.20)

**\$49.95**

Version 4.0

(PLUS \$4.00 SHIPPING AND HANDLING)



**ORDER TODAY BY TELEPHONE!**  
**(305) 474-7548**  
OR USE COUPON BELOW

TranSec Systems, Inc.  
701 E. Plantation Circle, Plantation, FL 33324

Please send me \_\_\_\_\_ copies of UNlock (4.0) @ \$49.95 ea. plus \$4.00 Ship/Handl.

Check enclosed  MC  VISA

Card No. \_\_\_\_\_

Exp. Date \_\_\_\_\_

Name \_\_\_\_\_

Title \_\_\_\_\_

Company \_\_\_\_\_

Address \_\_\_\_\_

City \_\_\_\_\_ State \_\_\_\_\_ Zip \_\_\_\_\_

Tel. No. \_\_\_\_\_ Signed \_\_\_\_\_ B7

TRADEMARKS. (OWNER) IBM, PC, XT, AT (International Business Machines), Lotus 1-2-3 (Lotus Development Corp.), dBase III and Framework (Ashton-Tate), Systat (Systat, Inc.), Spotlight (Software Arts), Graphwriter (Graphwriter Communications, Inc.), Data General/One (Data General Corp.), Relia Cobol, (Relia, Inc.)

## EVENT QUEUE

age International Forum. Red Lion Inn, San Jose, CA. Data-storage issues and applications explored. Executive focus. Contact Cartledge & Associates Inc., Suite M-259, 1101 South Winchester Blvd., San Jose, CA 95128, (408) 554-6644. *September 16-18*

• **SOFTWARE CONGRESS**  
The Sixteenth Convention Informatique, Palais des Congres, Paris, France. Said to be the largest European software congress. The theme is "Data Processing: Opportunities and Drawbacks." Contact Convention Informatique, 4 Place de Valois, 75001 Paris, France; tel: (1) 261 52 42; Telex: 212 597 F. *September 16-20*

• **SOFTWARE EXPO**  
The Sixth Annual Software/Expo, Infomart, Dallas, TX. A trade show for MIS/DP managers and corporate executives. Contact Professional Exposition Management Co. Inc., Suite 205, 2400 East Devon Ave., Des Plaines, IL 60018, (800) 323-5155; in Illinois, (312) 299-3131. *September 17-19*

• **UNIX EXPO**  
UNIX Expo: The UNIX Operating System Exposition and Conference, New York Hilton and Sheraton Centre Hotels, New York City. More than 400 exhibitors complement the conference. Contact Robert Birkfeld, National Expositions Co. Inc., 14 West 40th St., New York, NY 10018, (212) 391-9111. *September 18-20*

• **MANUFACTURING EXPO**  
Eastern Computer Manufacturing Expo, Charlotte, NC. Contact Great Southern Shows, POB 655, Jacksonville, FL 32201, (904) 743-8000. *September 19-21*

• **INTERFACING WORKSHOP—Personal Computer and STD Computer Interfac-**

ing for Scientific Instrument Automation, Greensboro, NC. A hands-on workshop with participants wiring and testing interfaces. The fee is \$450. Contact Dr. Linda Lef-fel, C.E.C., Virginia Polytechnic Institute and State University, Blacksburg, VA 24061, (703) 961-4848. *September 19-21*

• **TIDEWATER FAIR**  
The Tidewater Tenth Annual Computer Fair, Radio Amateur Hamfest—Electronic Flea Market, Virginia Beach Pavilion, VA. Displays, forums, and flea market. Advance tickets are \$5 for both days or \$6 at the door. Contact Jim Harrison, Tidewater Radio Conventions Inc., 1234 Little Bay Ave., Norfolk, VA 23503, (804) 587-1695. *September 21-22*

• **NEW FRONTIER**  
Space Tech '85 Conference and Exposition, Disneyland Hotel, Anaheim, CA. A focus on engineering solutions required to make the use of outer space practical and economical. Contact Society of Manufacturing Engineers, One SME Dr., POB 930, Dearborn, MI 48121, (313) 271-1500. *September 23-25*

• **AI, FIFTH GENERATION**  
The Artificial Intelligence and Fifth Generation Computer Technology Conference and Exhibition: AI/Europa, Rhein-Main-Halle, Wiesbaden, West Germany. Contact Jim Hay, Tower Conference Management Co., 331 West Wesley St., Wheaton, IL 60187, (312) 668-8100. *September 24-26*

• **BOSTON COMPUTING**  
The Eighth Northeast Computer Faire, Bayside Exposition Center, Boston, MA. Product displays and conference program. Contact Computer Faire Inc., 181 Wells Ave, Newton, MA 02159, (617) 965-8350. *September 26-29* ■

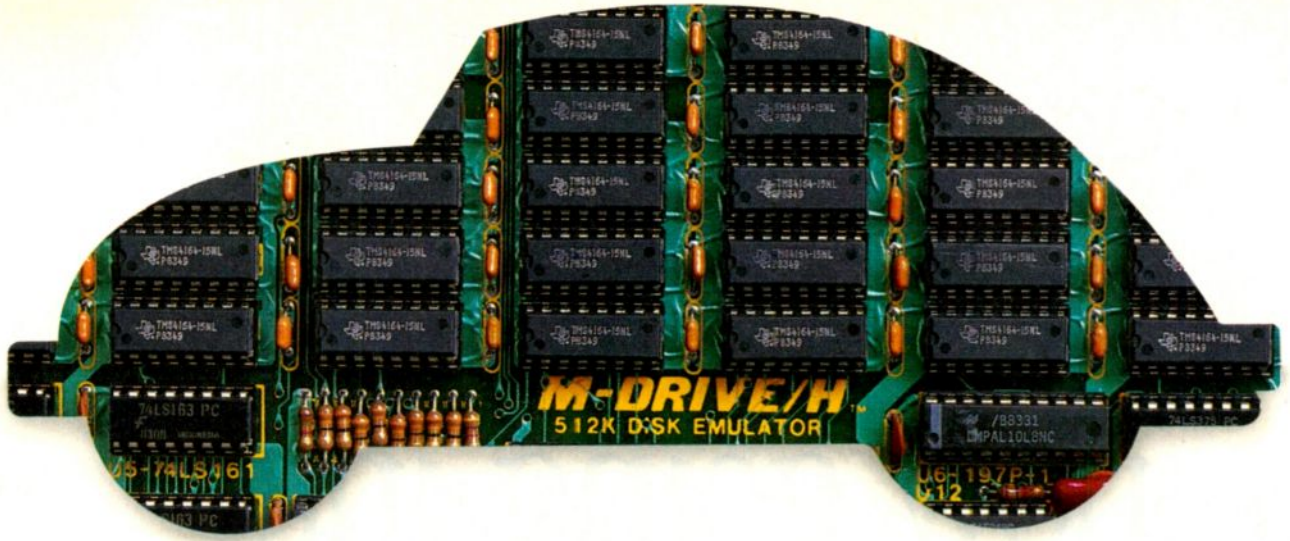

## You can still buy quality and dependability at a reasonable price.

That's exactly what we drive home at Viasyn. We offer you a whole line of CompuPro® IEEE 696/S-100 Bus boards. Along with single- and multi-user systems compatible with over 3,000 standard business applications, plus a wide variety of scientific and industrial programs. Each one's a value our competition finds hard to beat.

You can choose from a broad range of CPU boards, memory boards, disk controllers, network and interface boards, plus PC Video, in color or black and white. You can mix or match 8-bit and 16-bit software on the same machine or on different machines. And pick just the power and memory you need. Object: to grow and multiply in capabilities, at optimum cost efficiencies. Without sacrificing quality or dependability.

If that's what you're driving for, write us for our new short-form catalog or simply call our toll-free number.

# VIASYN™

The CompuPro People

## Where Computers Grow

3506 Breakwater Court, Hayward, CA 94545  
Call 800/VIASYN-1. In CA, 800/VIASYN-2. TWX: 510-100-3288 VIASYN CORP

CompuPro is a registered trademark of Viasyn Corporation.

# IBM's best efforts are now going into Macintosh.

Macintosh and IBM PC software. Compatible at last, thanks to MacCharlie, a rather innovative coprocessing system.

And imagine the consequences.

Nearly 10,000 IBM PC software programs designed for general business and specific applications in real estate, insurance, law, medicine, banking, etcetera, can now join forces with Macintosh's own popular programs.

And, the myriad of IBM PC-compatible software adopts Macintosh's many beloved features, including desktop utilities such as the clipboard and the calculator.

In addition, MacCharlie allows

IBM PC and Macintosh data files to be exchanged. Talk about flexibility.

But the good news gets better.

You see, MacCharlie delivers hardware compatibility, as well. For example, IBM letter-quality printers can be easily used with Macintosh.

Furthermore, MacCharlie

now allows Macintosh to perform virtually any networking an IBM PC can perform. Even to the extent of tying in with IBM mainframes.

In other words, your networking capability goes beyond the Apple family.



The Macintosh keyboard slides right into MacCharlie's keyboard. About as easy as slipping a letter in an envelope.



Macintosh sets snugly beside MacCharlie, on a custom-fit pedestal.



Once you plug in MacCharlie's power and keyboard cords, you're ready to enjoy a very happy marriage.

How does it happen? As easily as slipping on penny loafers.

In mere moments, MacCharlie combines the best features of the world's premier personal computers.

And despite the fact that it turns one computer into two:

MacCharlie adds but a handful of square inches to Macintosh's physique.

In short, one of life's most perplexing decisions—whether to buy a Macintosh or an IBM PC—can now be made with the greatest of ease.

Ask for MacCharlie at your local computer store. Suggested retail price for the 256K single disk drive model is only \$1195, and just \$1895 for the 640K dual disk drive version.

For more information, call Operator 14 toll-free, 1-800-531-0600. (In Utah, call 801-531-0600.)

MacCharlie offers 256K RAM, with optional upgrade to 640K RAM; 360KB disk drive, and optional second disk drive.



# MacCharlie<sup>TM</sup>

THE BEST OF BOTH WORLDS.

MacCharlie is a product of Dayna Communications,  
50 S. Main, Salt Lake City, Utah 84144

Inquiry 120

Apple is a trademark of Apple Computer, Inc. Macintosh is a trademark licensed to Apple Computer, Inc. IBM is a registered trademark of International Business Machines Corporation.

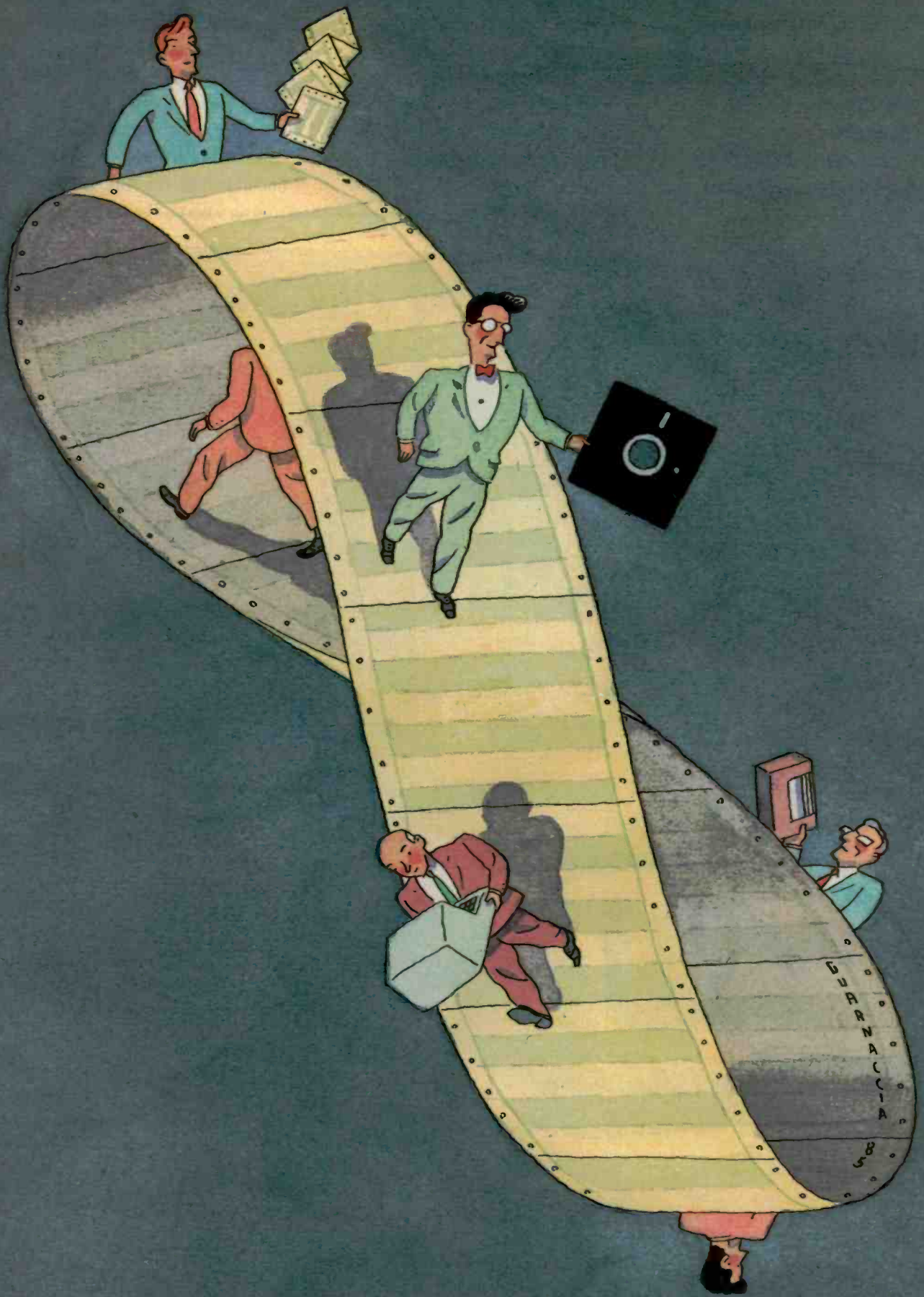



# Features

---

<b>PROGRAMMING PROJECT: NEW PERSPECTIVES ON NEARBY STARS</b> <i>by Bruce Webster</i> . . . . .	106
<b>LIQUID-CRYSTAL DISPLAYS FOR PORTABLES</b> <i>by Glenn J. Adler</i> . . . . .	119
<b>PRODUCT DESCRIPTION: THE GRIDCASE</b> <i>by Rich Malloy</i> . . . . .	129
<b>CIARCIA'S CIRCUIT CELLAR: LIVING IN A SENSIBLE ENVIRONMENT</b> <i>by Steve Ciarcia</i> . . . . .	141
<b>PROGRAMMING INSIGHT: TRAVESTY REVISITED</b> <i>by Murray Lesser</i> . . . . .	163
<b>PROGRAMMING INSIGHT: REAL-NUMBER FORMATTING ON YOUR APPLE</b> <i>by Brent Daviduck</i> . . . . .	171

---

IN THIS MONTH'S Features section BYTE presents the first Programming Project, a new monthly column that will be written by various software experts. Bruce Webster designed the first project in keeping with the Computers and Space theme. He describes StarMap, a Pascal program for the Macintosh, which takes a list of stars with Cartesian or astronomical coordinates and shows you where they are in relation to one another.

"Liquid-Crystal Displays for Portables" by Glenn Adler takes a look at the technology behind twisted-nematic liquid-crystal displays, which enable computers to be battery-operated, lightweight, and affordable.

Rich Malloy presents a product description of the GRiDCase family of portable computers from GRiD Systems Corporation. The GRiDCase is IBM PC-compatible and offers a range of display options; one version even has a high-contrast gas-plasma display.

This month's Circuit Cellar presents a number of devices that can be used with the Home Run Control System. Steve has included interrupted-beam detectors, various environmental sensors, and alarm signaling devices—all from his junk box.

As a follow-up to "A Travesty Generator for Micros" by Hugh Kenner and Joseph O'Rourke in last November's BYTE, "Travesty Revisited" by Murray Lesser redoes this lexical processor in compiled BASIC. The author believes this language is a better choice for handling a task consisting mostly of string manipulation.

In "Real-Number Formatting on Your Apple," Brent Daviduck has written a program that lets you specify the decimal length of any real number. This machine-language subroutine uses only a small amount of memory.

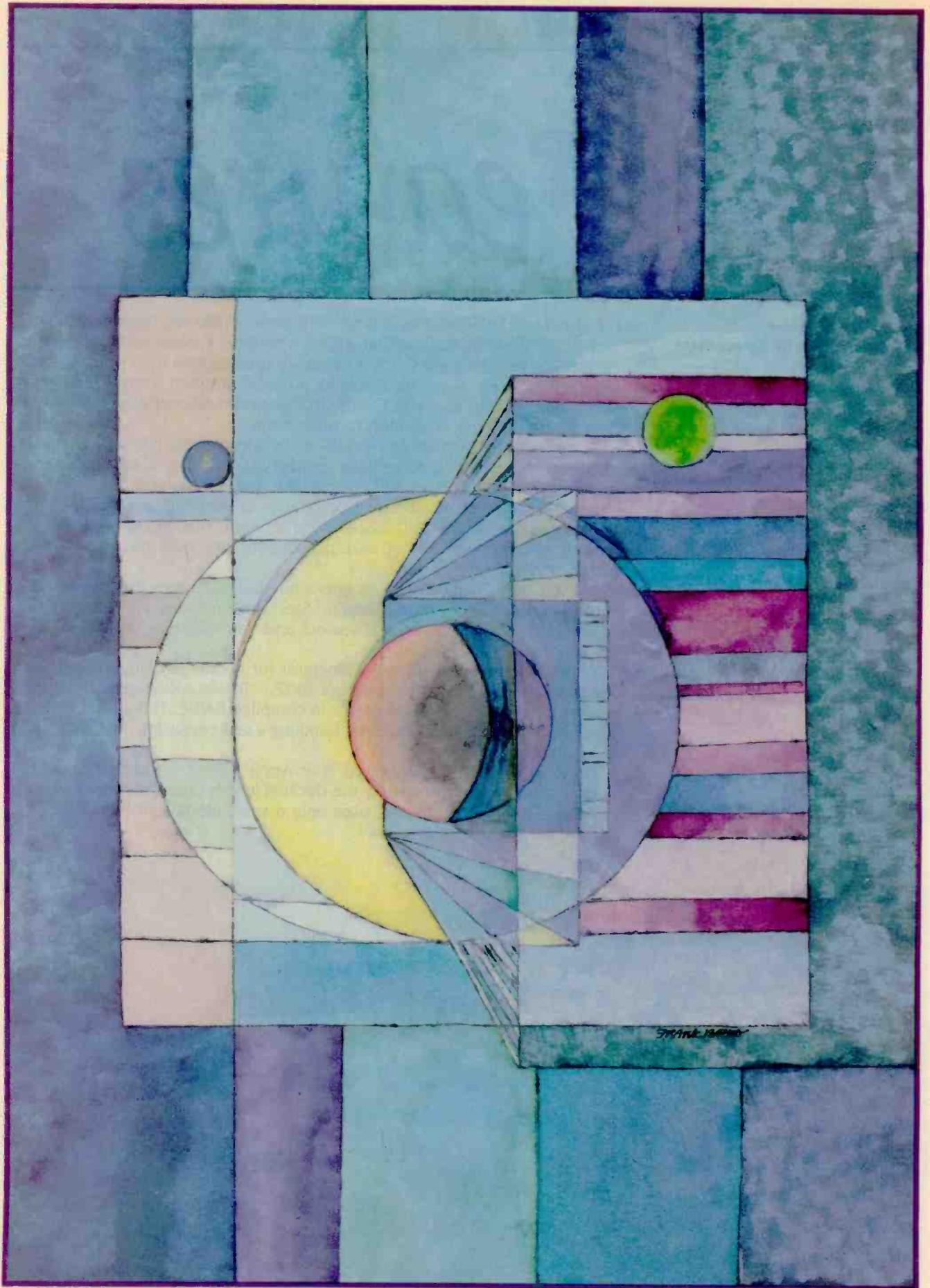

# NEW PERSPECTIVES ON NEARBY STARS

BY BRUCE WEBSTER

*A Macintosh programming  
project in Pascal*



To use an already over-used cliché, a picture is worth a thousand words (at least). This is especially true when the words are being employed to describe the real world.

Let's say you wanted to describe the physical layout of Europe. You could talk about figures and angles, explaining the size and shape of each country and where each country is in relation to all the others. Or you could use a map. Which one would convey that information more quickly and clearly? The map, of course. We perceive the universe primarily through our eyes, and we are comfortable processing information visually. In fact, if you tried to describe Europe using the figures-and-words approach, your listener would probably try to mentally "draw" a map to understand your description.

This problem—the difficulty of comprehending alphanumeric data—is common in scientific work. For example, look at table 1. This is a list of the 75 stars nearest the earth, along with their right ascension, declination, parallax, and stellar (star) classification (see "An Astronomy Glossary" on page 245 for definitions of these and other terms). Try to picture all those stars hanging in space, each in its correct position relative to all the others. In many

respects, this is more difficult than the "map of Europe" problem because the coordinate system is not an easy one to decipher and because you have to deal with three dimensions, not just two.

Now look at figure 1. It presents a subset of the information in table 1 in a graphical form. The arrow is pointing at our own sun, Sol. Around it hang the nearby stars, each in its proper position, each shaded according to its stellar classification. Multistar systems are indicated by lines dividing the circles into two or three sections, each section representing a star. Figure 2 relates this cluster of stars to its approximate position in our galaxy.

Even though you don't know the names of those stars, their classes, or even their distances from Sol, you now have a much better idea of how this region of space looks than you got from reading table 1. And that's from two static figures. Now, what if you could rotate the angle of view, change the scale of the display, or make any star the center? What if you could filter out stars of a certain class, or distance from Sol, or number? What if you could point at any star and get more information about it?

In this article, I'll describe StarMap, a program for the Macintosh that lets you do just

*(continued)*

Bruce Webster (6215 Thorn St., San Diego, CA 92115) is a contributing editor for BYTE.

that. StarMap takes a list of stars, with either Cartesian ( $x,y,z$ ) or astronomical (RA, Dec, Par) coordinates and shows you where they are with respect to one another. You can perform all the manipulations described above: limited rotation, scaling, and translation, as well as filtering. I'll first look at the basic concepts behind the StarMap program and then at some of the specific techniques it uses. I'll discuss the program itself and finish by talking about possible applications and improvements.

StarMap was developed on a Macintosh using MacAdvantage:UCSD Pascal, a Pascal development system that runs under the Finder and gives you access to most of the Toolbox routines (see the text box entitled "Development Using MacAdvantage:UCSD Pascal" on page 114). Information on how to obtain the source code for StarMap appears at the end of this article.

### BASIC CONCEPTS

StarMap reads in and displays a list of stars; you view them as if from a point beyond any of them. The stars then appear to form a cluster. Each star is shown as a circle filled with a pattern that indicates its stellar classification (O,B,A,F,G,K,M). Since the computer's display is only two-dimensional, the circle's diameter indicates the third dimension (depth): the smaller the circle, the farther away the star is; the larger the circle, the closer it is. StarMap displays multistar systems by subdividing the circle into two (binary) or three (ternary) sections. Each section contains the pattern corresponding to that component's stellar classification. You can select any star (by pointing and clicking with a mouse) and get a pop-up window with the star's name, its distance from Sol (or the current origin), and the class of each of its components.

You can manipulate this display by rotating it, translating the coordinates, and scaling it up. You can rotate it by choosing to look along any of the three axes ( $x$ ,  $y$ , or  $z$ ), either from the positive end or the negative end.

(Figure 3 depicts these axes relative to the Macintosh screen.) Admittedly, this is limited rotation; I chose this method because of its speed and simplicity, especially since it makes the detection of a click on a star easy. You can choose any star on the display as the origin (translation). Furthermore, you can then add an offset (plus or minus) to any one (but only one) of the three axes. Scaling lets you decide how much of the display is on the screen; it's as if you were sitting somewhere out in space with a high-

powered telescope and you cranked up the magnification. Stars get bigger; the screen covers a smaller area, so fewer stars show up.

You can also filter out stars so that not all of them appear. For example, you can set which classes of stars will (or won't) be shown. I often choose to get rid of all the M-class stars because they tend to clutter the display. You can even eliminate all classes but one, restricting your view to, say, all G-class stars, which includes Sol. Finally, you can screen stars

Table 1: The 75 stars closest to the earth. As the text file *RawStars*, this list is converted by the program *ReadStar* into a binary file that can be used by *StarMap*. (This list is taken from, among other sources, *Astrophysical Quantities*, 3rd ed., by C. W. Allen, London: The Athlone Press, 1973.)

Name of System	Right Ascension		Declination		Parallax microseconds	Stellar Class(es)
	hours	minutes	degrees	minutes		
Sol	0	0	0	0	0	G2
Proxima Centauri	14	26	-62	28	762	M5
Alpha Centauri	14	36	-60	38	745	G2 K5
Barnard's Star	17	55	4	33	552	M5
Wolf 359	10	54	7	19	429	M8
Lalande 21185	11	1	36	18	401	M2
Sirius	6	43	-16	39	377	A1 dA5
UV Ceti	1	36	-18	13	367	M5 M6
Ross 154	18	47	-23	53	345	M4
Ross 248	23	39	43	55	317	M6
L789-6	22	36	-15	36	303	M7
Epsilon Eridani	3	31	-9	38	303	K2
Ross 128	11	45	1	6	301	M5
61 Cygni	21	5	38	30	294	K5 K7
Epsilon Indi	22	0	-47	0	291	K5
Procyon	7	37	5	21	286	F5 dF0
7 2398	18	42	59	33	283	M4 M5
Groombridge 34	0	15	43	44	282	M1 M6
Lacaille 9352	23	3	-36	8	279	M2
Tau Ceti	1	41	-16	12	276	G8
BD +5° 1668	7	25	5	23	268	M5
Cordoba 29191	21	14	-39	4	260	M0
Kapteyn's Star	5	10	-45	0	256	M0
Kruger 60	22	26	57	27	253	M3 M4
Ross 614	6	27	-2	46	250	M7 M0
BD -12° 4523	16	28	-12	32	249	M5
van Maanen's Star	0	46	5	9	236	dG5
Wolf 424	12	31	9	18	230	M6 M7
BD -37°	0	2	-37	36	225	M4
BD +50°	10	8	49	42	219	K7
CD -46° 11540	17	25	-46	51	216	M4
CD -49°	21	30	-49	13	214	M1
CD -44° 11909	17	33	-44	17	213	M5
AD Leonis	1	57	12	50	212	M8
BD +68°	17	37	68	28	209	M4
Ross 780	22	51	-14	31	207	M5
CC 658	11	43	-64	33	206	dA5

## PERSPECTIVES ON STARS

based on the number of components in a system (one, two, or three). If you just want to see single-star systems or if you just want to see binary systems, etc., you can do so.

### COORDINATE CONVERSION

A number of minor hurdles have to be overcome to get StarMap working. First, most star catalogs give stellar coordinates as right ascension, declination, and parallax. This is just a disguised polar-coordinate system. Right ascension is equivalent to theta,

the equatorial or longitudinal angle. It starts in the constellation Aries and runs eastward through the 12 signs of the zodiac. Right ascension is usually expressed as hours, minutes, and seconds (rather than degrees), ranging from 00<sup>h</sup> 00<sup>m</sup>.00 to 23<sup>h</sup> 59<sup>m</sup>.59.

Declination is equivalent to phi, the latitudinal angle; it's simply the angle up or down from the equator, going from 90 degrees (the north pole), through 0 (the equator), and down to -90 degrees (the south pole).

Parallax is an indirect measure of

distance; it's the apparent shift (in fractions of a second) of a star's position as the earth travels around the sun. If you divide 1 by the parallax, you get the distance of the star in parsecs (where 1 parsec equals 3.26161 light-years). Note that in table 1, the parallax value 762 represents 0.762 second.

For display purposes, I chose to convert the stars' coordinates to the rectangular (or Cartesian) coordinates *x*, *y*, and *z*. To allow separation of close systems (such as Alpha Centauri and Proxima Centauri), I used 0.1 light-year as the grid-unit size. Thus, a star at (10,0,0) would be exactly 1 light-year (10 × 0.1) away from Sol. The positive *x*-axis goes out through a right ascension of 00<sup>h</sup> 00<sup>m</sup>.00; the positive *y*-axis, through 06<sup>h</sup> 00<sup>m</sup>.00. The positive *z*-axis goes up through a declination of 90 degrees. I used a two-step conversion process—from astronomical to true polar, then from polar to rectangular. Figure 4 illustrates the relationship between the different coordinate systems.

For both right ascension and declination, we have two values: hours and minutes, and degrees and minutes. Our very first step is to convert both into real values, for example, converting 05<sup>h</sup> 30<sup>m</sup>.00 to 5.5 hours. Assuming that the two values are read in as integers, the function shown in listing 1 will do the conversion. Note that the sign must be propagated to the minutes, because in table 1 only the degrees have negative signs.

Having done this, you then need to multiply the right ascension by 15, to convert it from hours (0 to 23) to degrees (0 to 359). Furthermore, since the Pascal used for this program expects radians (as do most Pascal implementations), you must convert from degrees to radians by multiplying both by the value  $(2 \times \pi) / 360.0$ , which is equal to 0.01745329. You have now converted right ascension and declination to theta and phi. To convert parallax to distance, you need to divide the value into 1000 (remember that the table values are in

*(continued)*

Name of System	Right Ascension		Declination		Parallax microseconds	Stellar Class(es)	
	hours	minutes	degrees	minutes			
Lalande 25372	13	43	15	10	205	M4	
Keid	4	13	-7	44	205	K1	dA0 M4
BD +20°	10	17	20	7	203	M4	
Altair	19	48	8	44	197	A7	
70 Ophiuchi	18	3	2	31	195	K0	K5
AC +79°	11	45	78	58	195	M4	
EV Lacertae	22	45	44	5	194	M4	
AC +58°	4	26	58	53	192	M4	M4
WX Ursae Majoris	11	3	43	47	186	M2	M8
36 Ophiuchi	17	12	-26	32	184	K1	K1 K5
CD -20° 4125/4123	14	55	-21	12	180	K5	M2
CD -36°	20	8	-36	14	177	K3	M5
Sigma Draconis	19	32	69	35	176	K0	
Lalande 46650	23	47	2	8	175	M2	
Delta Pavonis	20	4	-66	19	175	G6	
L374 -14	19	17	-45	37	175	M7	
CD -21°	6	8	-21	51	174	M1	
BD +4° 4048	19	14	5	6	173	M4	M5
Luyten 97 -12	7	53	-67	38	173	dM5	
Luyten 674 -15	8	10	-21	24	171	M5	
UC 48	17	42	-57	17	170	M5	
CD -3°	5	29	-3	41	170	M1	
Eta Cassiopeiae	0	46	57	33	170	G0	M0
CD -40° 9712	15	29	-41	6	169	M4	
Ross 986	7	7	38	38	169	M5	
Wolf 294	6	52	33	20	168	M4	
Ross 47	5	39	12	29	168	M6	
BD +53° 1320/1321	9	11	52	54	166	M0	M0
LP 658 -2	5	53	-4	8	166	dK5	
Ross 882	7	42	3	41	165	M4	
CD -45°	20	10	-45	19	164	M0	
Wolf 629/630	16	53	-8	15	161	M4	M4 M5
82 Eridani	3	17	-43	16	161	G5	
CD -11°	14	32	-12	19	160	M4	
Beta Hydri	0	23	-77	32	159	G1	
BD +19°	23	20	19	40	155	M4	M6
BD +45° 2505	17	11	45	45	155	M3	

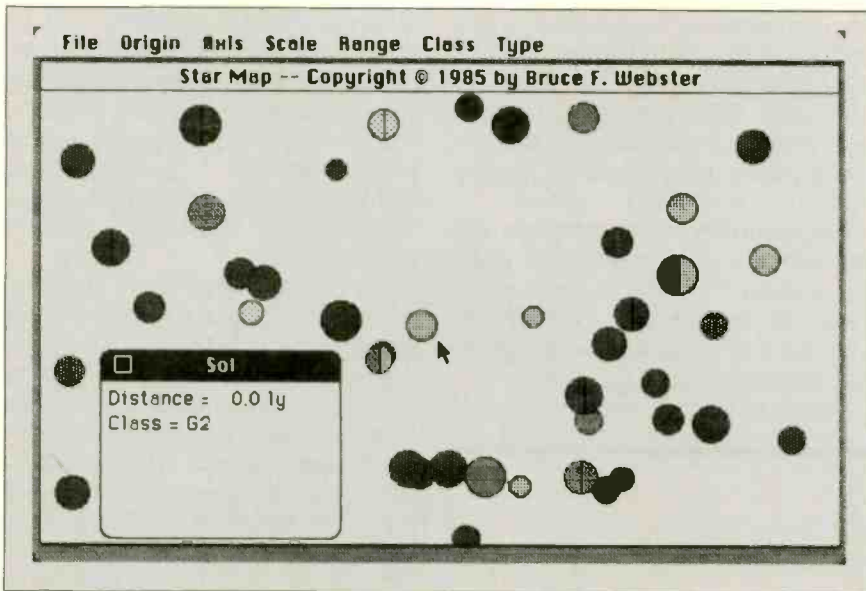

Figure 1: The stars closest to the earth, as presented by StarMap.

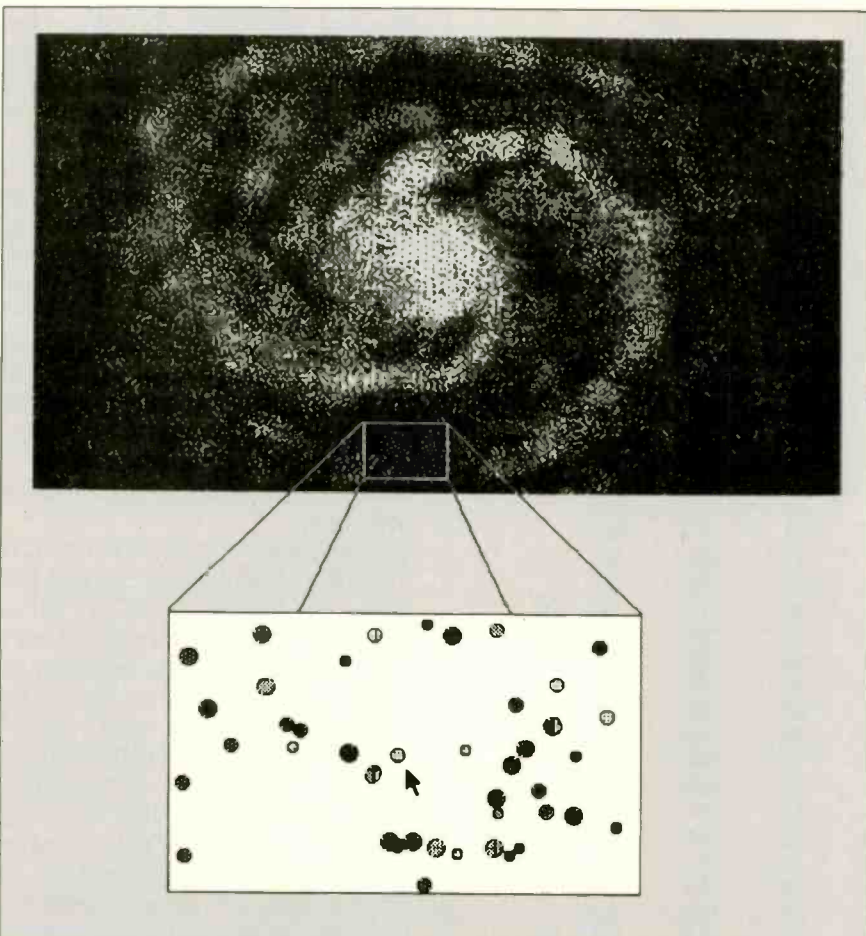

Figure 2: The approximate location of the star cluster from figure 1 in the galaxy.

thousandths of a second), then multiply it by 3.26161 (ParToLY, the number of light-years in a parsec). Assuming that the right-ascension values are RAH (right-ascension hours) and RAM (right-ascension minutes), the declination values are DecD (declination degrees) and DecM (declination minutes), Par is the parallax, and the constant DegToRad equals 0.01745329, then the statements in listing 2 complete the conversion to polar coordinates, with the unit distance being 0.1 light-year. Note that if we change ParToLY to 32616.1, you can rewrite the third statement as

```
Dist := ParToLY/Par;
```

The more drawn-out version is just for clarity's sake.

Conversion from polar to rectangular coordinates is well defined. Assuming the integer variables *x*, *y*, and *z*, the statements in listing 3 convert from polar to rectangular form, where the function Round takes a real value and rounds it to the nearest integer. This lets you do your calculations with real numbers and convert at the end, maximizing precision.

### STELLAR DATA STRUCTURE

The conversion from astronomical to rectangular coordinates just described is performed by a program called ReadStar. ReadStar also converts the data file RawStars (containing the list of stars) from a text file to a binary file called Stars. That way, StarMap can read in the data faster, avoiding any sort of text-to-numbers conversion. The data types used by StarMap and ReadStar are given in listing 4.

Note that StarClass is an enumerated data type (EDT), *not* a character data type. Each star system can have up to three components, or three different stars. For example, the star system Keid actually contains three stars, with stellar classes K1, dA0, and M4. Keid's data structure would then have the values shown in figure 5.

Note that the record type Component is declared as being "packed." This is to make it as small as possible. Since each of the three fields—Dwarf, Class, and SubClass—have very small

ranges of values, the MacAdvantage compiler can pack all three into just 2 bytes, the smallest possible size of a UCSD Pascal record. This keeps the size of the Stars record down to 38 bytes. If the program didn't declare Component to be packed, it would use 2 bytes for each field, for a total size of 6 bytes, and the array Comp would go from 6 to 18 bytes, kicking Stars up to 50 bytes per record. In a list of 200 stars, that's a difference of more than 2K bytes.

**ORGANIZING THE STARS**

After you've created the data file with ReadStar, you can now run StarMap to display and manipulate it. A few subtly-related questions arise. First, in what data structure will the stars be stored? The program could just read them into an array[1..n] of Stars, but n has to be fixed when the program is compiled. This limits the number of stars that can be read in and also forces the program to use more memory than it might otherwise need.

Second, having read in the stars, in what order should you have the program draw them? Since stars will overlap on the display, this becomes an important question. The program should draw from the farthest star to the nearest, so that those closer to your viewpoint will cover up (when necessary) those farther away. One solution, of course, is to sort the array (if that's what you're using) along the axis being viewed. But that means the program would have to sort the list again every time you change the viewing axis, which would add a fair amount of time and overhead.

Third, if you point at a star and click the mouse, the program must detect the closest star and not any that are hidden behind it. This is similar to the second problem; again, a sorted list of stars will solve the problem. The challenge is to avoid constantly resorting.

Many solutions are possible; each has good and bad points. The approach I've chosen provides a large degree of flexibility while reducing the storage of redundant information.

(continued)

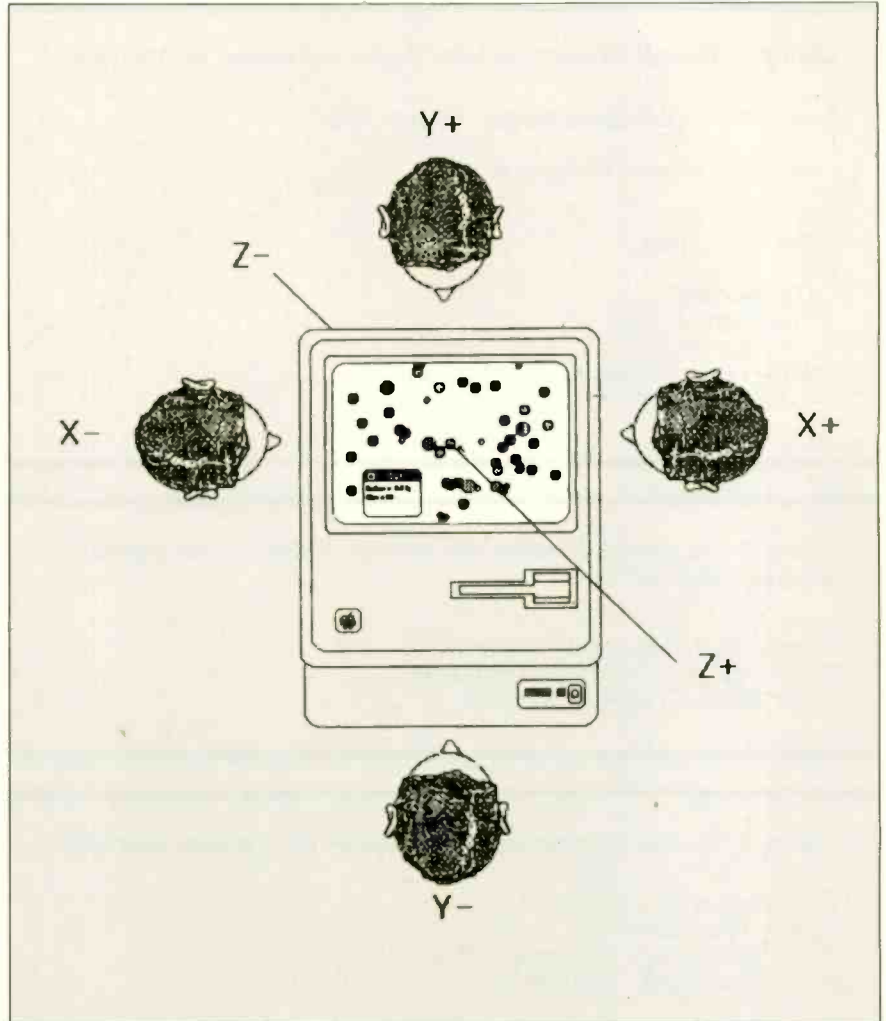

Figure 3: The x-, y-, and z-axes for StarMap, as related to the Macintosh screen.

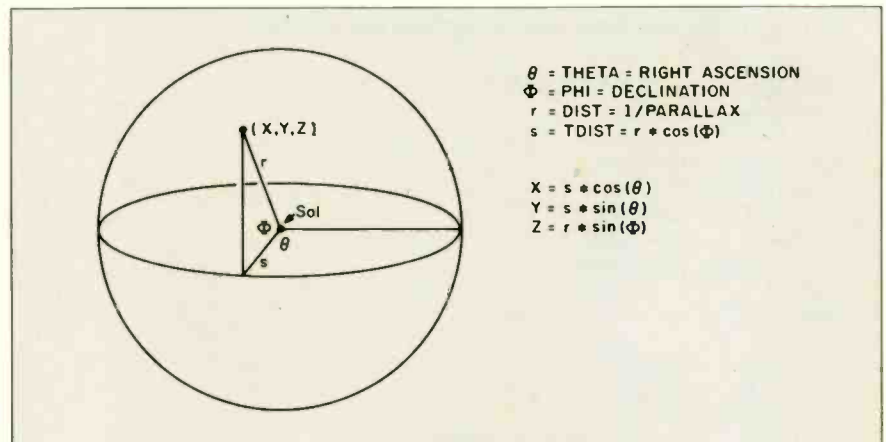

Figure 4: The relationship between the three coordinate systems discussed in the article: stellar (right ascension, declination, and parallax), polar (theta and phi), and Cartesian (x, y, and z).

Listing 1: The code for converting hours, degrees, and minutes into real values.

```
function MinToFrac(Degrees, Minutes : Integer) : Real;
{
  purpose    converts dd mm to dd.xx
}
var
  Sign      : Real;
begin
  if Degrees < 0.0
  then Sign := -1.0
  else Sign := 1.0;
  MinToFrac := Degrees + Sign*(Minutes/60.0)
end; { of func MinToFrac }
```

Listing 2: The code for converting right ascension, declination, and parallax into polar coordinates.

```
Theta := DegToRad * MinToFrac(RAH, RAM) * 15.0;
Phi := DegToRad * MinToFrac(DecD, DecM);
Dist := ParToLY * (1000.0/Par) * 10.0;
```

Listing 3: The code for converting polar coordinates into Cartesian coordinates.

```
Z := Round(Dist * Sin(Phi));
TDist := TDist * Cos(Phi);
Y := Round(TDist * Sin(Theta));
X := Round(TDist * Cos(Theta));
```

Listing 4: The data types used by StarMap and ReadStar.

```
StarClass = (O,B,A,F,G,K,M);
SubRange = 0..9;

Component =
  packed record
    Dwarf : Boolean;
    Class : StarClass;
    SubClass : SubRange;
  end;
Stars =
  record
    Name : string[23];
    X,Y,Z : Integer;
    NumComp : 0..3;
    Comp : array[1..3] of Component;
  end;
```

Each star occupies a location in a large three-dimensional grid, specified by its coordinates (x,y,z). Since you want to sort the stars along each axis, start by linking together all stars with the same x-coordinate, the same y-coordinate, and the same z-coordinate. To do this, define the data types as shown in listing 5.

Each star that is read in will have its own node; that is, the data will go into the field Star. The three pointers—Node[AX], Node[AY], and Node[AZ]—will each point at the next star sharing the same x-, y-, or z-coordinate, respectively. Of course, if there are no more stars with the same given coordinate, the respective pointer will contain the null pointer value, nil.

With this method, the program can read in as many stars as there is memory for; likewise, you allocate only as much memory as is needed. There is an additional overhead of 6 bytes per node (for the three pointers), which brings the size of each node up to 44 bytes, but we've gained a lot of flexibility with those pointers.

Now that all these stars are linked together, how do you get to the first star of each list? Use a header list. The data structures for the headers are shown in listing 6.

The array Next points to lists of stars sharing the same x-, y-, or z-coordinate. AVAl tells what that coordinate

Name	Keid
X	71
Y	141
Z	-21
NumComp	3
Comp[1]	
Dwarf	False
Class	K
SubClass	1
Comp[2]	
Dwarf	True
Class	A
SubClass	0
Comp[3]	
Dwarf	False
Class	M
SubClass	4

Figure 5: The data structure for the star system Keid, which consists of three stars.



is. Note that there is one header for a given value along all three axes. For example, if *AVal* were 71, then *Next[AX]* would point to all stars with an *x*-coordinate of 71, *Next[AY]* would point to those with a *y*-coordinate of 71, and *Next[AZ]*, to those with a *z*-coordinate of 71.

As I mentioned, you want the stars sorted along each axis. You can accomplish this by simply maintaining a sorted linked list of headers. The pointer *Link[Front]* points to the header with the next highest *AVal*; *Link[Back]* points to the next lowest header. Both ends of the list point to a special header called *Head* (and vice versa). To traverse the list, the program starts at one end and follows *Link* until it runs into *Head*. The procedure in listing 7, when given an axis and a direction, traverses the entire list of stars in the order you requested and writes out the name of each star. You won't find this procedure in *StarMap*, but the routines to draw the map and to find which star has been selected use code that is similar to *StarMap*'s.

*HPtr* moves through the list of headers until it runs into *Head*. *TPtr* checks all the stars at each header for the given axis. For example, if *HPtr*.*Aval* = 15 and *Axis* = *AY*, then *TPtr* will point at all the stars (if any) with a *y*-coordinate of 15.

### TRANSFORMING THE DISPLAY

*StarMap* lets you transform the display by rotating it, translating the coordinates, and scaling it up. Rotation is limited to your fixing the position of the axis (*x*, *y*, or *z*) you're looking along and choosing to look from the positive or negative end. The program simply changes the values of *Axis* and *Direction* (global variables with the same data types shown in listing 7, *WriteNames*). The list of stars is now automatically "sorted" along that axis, while *Direction* fixes the direction.

Translation takes a couple of forms. First, you can change the map's origin to any star; it doesn't have to be *Sol*. This is done by clicking the star and then pulling down the *Origin* menu. The name of that star will appear in

the menu; just select it to move. *Sol* always appears in the menu, so you can easily recenter the display. You also can add an offset of plus or minus 15 light-years to the origin along any axis. The name of the cur-

rent origin always appears at the top so that you can remove the offset. It also reminds you what the current origin is. One more effect: When you click a star to get information, the

(continued)

Listing 5: Definition of the data types for linking together stars with the same *x*-, *y*-, or *z*-coordinates.

```
AxisType      = (AX,AY,AZ);
NodePtr       = ^Node;
NodeList      = array[AxisType] of NodePtr;
Node          =
  record
    Next      : NodeList;
    Star      : Stars;
  end;
```

Listing 6: Data structures for the header list.

```
DirType       = (Front,Back);
HeadPtr       = ^Header;
Header        =
  record
    Aval       : Integer;
    Link       : array[DirType] of HeadPtr;
    Next       : NodeList;
  end;
```

Listing 7: The procedure that traverses the entire list of stars in the order requested and writes out the name of each star.

```
procedure WriteNames(Axis : AxisType; Direction : DirType);
{
  purpose      traverses all stars
  last update  09 Mar 85
}
var
  TPtr        : NodePtr;
  HPtr        : HeadPtr;
begin
  HPtr := Head^.Link[Direction]; { start at one end }
  while HPtr <> Head do begin
    TPtr := HPtr^.Next[Axis]; { check specific axis }
    while TPtr <> nil do begin { look at all stars }
      WriteLn(TPtr^.Star.Name); { at that coordinate }
      TPtr := TPtr^.Next[Axis]
    end;
    HPtr := HPtr^.Link[Direction]
  end
end; { of proc WriteNames }
```

distance given is always with respect to the current origin. If you select Groombridge 34 as your origin, then look at Beta Hydri: the distance shown is that from Groombridge 34.

Scaling is basically a zoom function. You are not moving "into" the cluster; you are just increasing the magnification of your mythical telescope. Each

level of scaling represents a twofold increase over the previous level.

#### FILTERING STARS

You have three filtering functions at your disposal. First, you can screen stars according to their *stellar class* (O,B,A,F,G,K,M). The program maintains a set (DisplaySet) containing the

currently allowed classes. For multiple stars, if any component is in DisplaySet, then all components are displayed.

The second filter is *distance*. Note that this is the distance *from the current origin*. If you set Groombridge 34 to be the origin, then limit the range to 8 light-years, you will see all stars within

## DEVELOPMENT USING MACADVANTAGE:UCSD PASCAL

MacAdvantage:UCSD Pascal represents something of a first for SofTech Microsystems Inc.; it's a UCSD Pascal compiler running under something other than the UCSD p-System operating system. True, SofTech had released an MS-DOS hosted version of the p-System, but that isn't quite the same as this.

MacAdvantage is simply a UCSD Pascal compiler (and assorted tools) running under the Macintosh Finder. The editor is a standard Macintosh-style editor, developed by Bill Duvall at Consulair and found in other software-development packages (MDS, MacModula-2, Megamax C, etc.). The resource maker is Apple's standard resource compiler, again found in many of the other systems. The compiler produces applications that you can start by double-clicking an icon. However, those applications don't stand alone: you have to have the MacAdvantage P-machine and run-time files somewhere on the disk. The application loads these in before executing.

Program development under MacAdvantage is a pleasure. The package comes with a little executive program that takes you out of the Finder and gives you a Macintosh-like menu bar across the top. The menu bar contains selections to let you compile, run the resource maker, edit a file, run the library or set-options utilities, or exit to the Finder. When you go from the editor or the compiler into the executive program, it only takes a second or two to bring the display up, a great

improvement over the 15 to 25 seconds it can take to return to the Macintosh Finder. And the Set menu lets you define where (and what) the different utility files are.

Since UCSD Pascal is basically a 16-bit language and the Macintosh is a 32-bit environment, SofTech had to make a number of changes and enhancements to fit the two together. MacAdvantage has a 32-bit integer data type (Integer2), which is heavily used in the Toolbox units, usually to represent 32-bit addresses. A new function, *Locate*, returns the 32-bit address of a given variable or procedure. Other functions help conversion between the 16-bit p-code pointers and the Macintosh's 32-bit addresses. Other bridges include functions to convert between the two Macintosh Boolean types and the UCSD Pascal Boolean type.

The Toolbox implementation is fairly complete. One library (with a large number of units) lets you use just the routines and definitions that you want. Most are identical or almost identical to those defined in *Inside Macintosh* (Cupertino, CA: Apple Computer Inc., 1985), although, again, some modifications have been made to bridge the different environments.

If MacAdvantage has one major drawback, it is its lack of speed. Like MacModula-2 and the Mac p-System, MacAdvantage uses pseudo-machine code running on a p-code interpreter. This makes it anywhere from 20 to 40 times slower than assembly language, although heavy use of Toolbox rou-

tines can significantly close that gap. A minor drawback is that it is necessary to copy both the application and the support files (P-machine, run-time file) in order for the application to run.

With the recent announcements of SofTech, MacAdvantage now has some strong points to balance against problems. First and foremost is price: at \$119, MacAdvantage is a real bargain. On top of that, of course, is word that SofTech has completely dropped all licensing fees for MacAdvantage. This means that programmers can freely give away or sell any products developed with MacAdvantage, including the two support files needed to run them.

Even if developers don't want to release a final product in MacAdvantage form, they can still make use of the package. MacAdvantage and Lisa Pascal are similar enough that conversion from one to the other is fairly straightforward. This means that programmers could experiment and develop new programs on the Macintosh (using MacAdvantage), then produce a final version using Lisa Pascal.

Finally, MacAdvantage represents the next step after MacPascal (from Apple). MacPascal has a nice environment for beginning programs, but its speed (over 15 times slower than MacAdvantage), its copy protection, and its lack of full, direct Toolbox support severely limit it as a serious development tool. Educational institutions in particular might be interested in switching to MacAdvantage after a semester of MacPascal.

8 light-years of Groombridge 34.

The third filter is *number of components*: one, two, or three stars, or any combination of these. As with the stellar class filter, the program uses a set (CountSet) to keep track of the allowed values.

All three filters are cumulative. If you only want to see all binary K-class stars within 8 light-years of Groombridge 34, you can. As it turns out, there is one such system: 61 Cygni (6.9 light-years away; components are K5 and K7).

### SELECTING STARS

To get more information about a star, you point at it with the mouse and click. The program must then determine which (if any) star you selected. Remember that StarMap draws the stars from the farthest away to the closest. StarMap detects stars in the opposite direction, so that you select what you see and not some star hidden behind it. For each star that meets your selection criteria (i.e., passes through all your filters), StarMap generates its enclosing rectangle, then checks to see if the mouse was clicked within that area. If it was, the rectangle is momentarily inverted to indicate which star was selected, and then the information window is updated. The information window, which gives the name, distance from current origin, and class of components, is shown in figure 1. If another star is selected, the information window is changed accordingly.

### APPLICATIONS AND ENHANCEMENTS

The obvious application of StarMap is educational, although it can be fun to play with as well. Most important, it displays the data in a more interesting and memorable manner than table 1. This program is sure to liven up any astronomy (or general science) class.

Numerous changes and enhancements are obvious. Since you can substitute your own star list, you can create a larger star map. For example, proper motion information could be added to the star list (in table 1) as

*The obvious application of StarMap is educational, although it can be fun to play with as well.*

well as to the Stars data structure (in listing 4). A time menu could then be used to track the stars in relation to one another. Other information, such as the absolute magnitude of the components, could be added and displayed. My own plans include a "universe construction set," which will let me create planets in each of those systems.

You can obtain the StarMap listings from BYTEnet Listings at (617) 861-9774. You will also need BinHex, a public-domain program available on BYTEnet Listings, which changes the binary files into executable applications. The listings are STARMAP.HOXB, the actual program; STARS.HOXB, the data file of stars; READSTAR.HOXB, only necessary if you want to create a new data file; and PRUNTIME.HOXB and PMACHINE.HOXB, the run-time files needed to run the program. If you have the MacAdvantage development system and want to make adaptations to the program, the necessary files are STARMAP.PAS, SMAP.R, RAWSTARS.DOC, and READSTAR.PAS. ■

### ACKNOWLEDGMENTS

A number of people went to some trouble to help me locate a decent star list. Among those are Linda Hume at San Diego State University; Dr. Barbara Jones, UCSD; Mike Caplinger, Rice University; David Gehrt, NASA/Ames; Michael Hart-sough, USC; Edward Olson, JPL; Josh Knight, IBM Watson Research Labs; Dick Munro, High Altitude Observatory; Ted Anderson, moderator of the Info-Space discussion on ARPANET/uucp; and the rest of the Info-Space contributors. My thanks to all.

## Which Master Would Your Slaves Recommend?

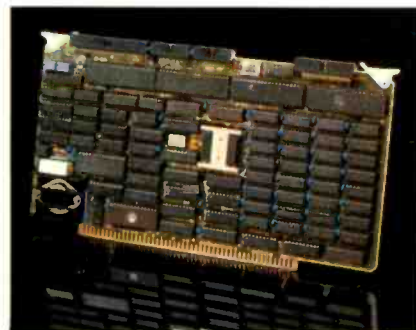

### Our New CPZ-186 Has It All

Intercontinental Micro Systems, the leader in the 8-bit single board computer world, has done it again. The CPZ-186, based on the 80186 CPU with integrated 2 channel Direct Memory Access Controller, has a 4-drive floppy controller, 2 serial I/O ports, 2½ parallel I/O ports, Memory Management Unit, Interrupt Controller, up to 1 Megabyte of Dynamic RAM, and up to 8K EPROM, all on a single IEEE S-100 Bus Board.

**Talk about speed and flexibility.** The CPZ-186 runs at 8 MHz and can be used for single user systems or in powerful multi-user applications. As a Network Master (File Server), the CPZ-186 can network 8-bit and 16-bit S-100 Bus Slaves as well as PC's using Intercontinental's complete line of hardware and software networking products.

**Find out what support really is.** Everyone talks about support, but at Intercontinental you deal directly with our hardware and software design team. Who else could know more about solving your problems?

Best of all, we're delivering now, and our price allows building cost effective systems and networks.

Circle the bingo number below or contact us directly, and ask about our complete line of S-100 Bus and Local Area Networking Boards.



4015 Leaverton Ct., Anaheim, Ca 92807.  
(714) 630-0964, TELEX 821375 SUPPORT UD

Inquiry 189 for End-Users.  
Inquiry 190 for DEALERS ONLY.

# CONROY

TELEX 910 380 3980

**ALL MAIL: 12060 SW Garden Place, Portland, OR 97223**

## FOR YOUR APPLE

MACINTOSH		COMPUTERS		BUSINESS SOFTWARE		UTILITIES SOFTWARE	
							
<b>MACINTOSH</b>		<b>COMPUTERS</b>		<b>BUSINESS SOFTWARE</b>		<b>UTILITIES SOFTWARE</b>	
ASSIMILATION, Turbo Touch	\$ 129 \$ 89	IIe, IIc, Mac, Mac XL	IN STOCK, CALL	ALS, Word or List Handler, ea.	\$ 80 \$ 36	EPSON, Graphics Dump	\$ 15 \$ 7
BLUECHIP, Millionaire, Barron, Tycoon, ea.	\$ 60 \$ 37	<b>FLOPPY DISK DRIVES</b>		Handler Pak (Word/List/Spell)	\$ 170 \$ 73	FUNK, Sideways	\$ 60 \$ 37
CENTRAL POINT, Copy II Mac or MacTos, ea.	\$ 40 \$ 24	MICRO-SCI, A2 Disk Drive, 143K	\$ 345 \$ 169	APPLE, Appletworks	\$ 250 \$ 215	HAYES, Terminal Prog. for Smartmodem	\$ 99 \$ 65
CONROY-LA POINTE, Diskettes,		A2 Controller Card	\$ 100 \$ 60	ASHTON-TATE, dBase II (Req CP/M 80)	\$ 495 \$ 289	MICROSOFT, Full Line in Stock	CALL
10 pak. SS/DD, w/Flip-Pak	\$ 60 \$ 25	Half Height Drive for IIe	\$ 269 \$ 169	BPI, AR, AP, PR or INV, each	\$ 395 \$ 240	OMEGA, Locksmith	\$ 100 \$ 70
CONTINENTAL, Home Accountant	\$ 100 \$ 65	Half Height Drive for IIc	\$ 299 \$ 189	BRODERBUND, Print Shop	\$ 50 \$ 29	PENGUIN, Complete Graphics System II	\$ 80 \$ 49
CREATIVE SOLUTIONS, MacForth Level I	\$ 149 \$ 95	RANA, Elite I, 163K, 40 Track	\$ 299 \$ 189	Print Shop Graphics Library	\$ 25 \$ 18	Graphics Magician	\$ 60 \$ 40
CREIGHTON, Home Pak or Mac Office, ea.	\$ 39 \$ 26	Elite Controller	\$ 145 \$ 79	Bank St. Writer or Speller, ea.	\$ 70 \$ 45	QUALITY, Bag of Tricks	\$ 40 \$ 29
Mac Spell +	\$ 99 \$ 60	TEAC, T40 Half Ht, 163K, Direct	\$ 249 \$ 169	Bank St. Combo (Writer & Speller)	\$ 140 \$ 85	UNITED SWI, ASCII Express-The Pro	\$ 130 \$ 82
CSD, MacLion	\$ 379 \$ 239	Controller Card for T40 by ComX	\$ 79 \$ 45	DOW JONES, Market Manager	\$ 249 \$ 159	UTILICO, Essential Data Duplicator III	\$ 80 \$ 49
DOW JONES, Market Manager Plus	\$ 249 \$ 159	<b>HARD DISKS</b>		Market Analyzer or Microscope, ea.	\$ 349 \$ 219	<b>HOME &amp; EDUCATIONAL</b>	
EXPERTTELLIGENCE, ExperLogo	\$ 150 \$ 95	QUARK, QC10 for IIc/IIe/III/IV	\$ 1995 \$ 1595	HOWARD SOFT, Tax Preparer 85	\$ 250 \$ 165	BEAGLE BROS., Full line IN STOCK	CALL
FIRST BYTE, Smooth Talker	\$ 150 \$ 95	<b>OTHER HARDWARE</b>		HUMAN EDGE, Sales or Mgmt Edge, ea.	\$ 250 \$ 165	BRODERBUND, Print Shop	\$ 50 \$ 29
FORETHOUGHT, Fact Finder	\$ 150 \$ 95	CCS, 7711 or 7710-A Interface, ea.	\$ 115 \$ 85	LIVING VIDEOTEXT, Think Tank	\$ 145 \$ 89	CONTINENTAL, Home Accountant	\$ 75 \$ 43
HABA, DS/DD Ext. Disk Drive, 800K	\$ 550 \$ 479	CPS/EASTSIDE, Wild Card II (copier, +e)	\$ 140 \$ 79	MECA, Managing Your Money	\$ 199 \$ 125	KOALA, Full line IN STOCK	CALL
HAYDEN, Sargon III	\$ 50 \$ 31	COMX, 16K RAM Card (II +), 1 yr ftd wty	\$ 119 \$ 29	MEGAHAUS, Megaworks	\$ 125 \$ 80	MICROSOFT, Typing Tutor II	\$ 25 \$ 17
HUMAN EDGE, Mind Prober	\$ 50 \$ 29	HAYES, Mach II, III Joysticks (II +/Ile)	CALL	MICRO PRO, WordStar	\$ 350 \$ 189	MONOGRAM, Dollars & Sense (Ile)	\$ 100 \$ 59
INFOCOM, Hitchhiker's Guide	\$ 40 \$ 25	KENSINGTON, System Saver Fan	\$ 90 \$ 65	WordStar w/ Starcard	\$ 495 \$ 265	Dollars & Sense (Ic)	\$ 120 \$ 69
INNOVATIVE, Flip-n-File, 40	\$ 30 \$ 19	KEY TRONIC, KB200 Keyboard (+)	\$ 298 \$ 179	WordStar Professional, 4 Pak	\$ 495 \$ 265	Forecast	\$ 60 \$ 38
KOALA, Mac Vision	\$ 400 \$ 229	KOALA, Muppet Keys	\$ 80 \$ 44	MailMerge, SpellStar, or StarIndex, ea.	\$ 99 \$ 54	SCARBOROUGH, MasterType	\$ 40 \$ 25
LIVING VIDEOTEXT, Think Tank	\$ 145 \$ 83	Touch Tablet w/Micro Illustrator (+e)	\$ 130 \$ 75	InfoStar and StarCard Combo	\$ 595 \$ 295	Build-A-Book	\$ 40 \$ 25
LOTUS, Jazz	\$ 595 \$ 395	KRAFT, Joystick (III +/Ile)	\$ 50 \$ 35	Your Personal Net Worth	\$ 80 \$ 50	SIERRA/ON-LINE, Homeword	\$ 70 \$ 45
MEGAHAUS, Megafiler	\$ 125 \$ 80	MICRO-SCI, 80 Col. Card + 64K RAM Card (Ile)	\$ 199 \$ 89	SIERRA/ON-LINE, Screen Writer II	\$ 130 \$ 79	SIMON & SCHUSTER, Typing Tutor III	\$ 60 \$ 37
Megamerge	\$ 595 \$ 395	MICROSOFT, Premium Softcard (Ile)	\$ 395 \$ 275	SOFTWARE PUBL., PFS:File or Write, each	\$ 125 \$ 79	PLUS: BARRONS, CBS, DAVIDSON, EDU-WARE, MARCOURT, LEARNING CO., TERRAPIN	
MICROSOFT, Business Pak	\$ 195 \$ 125	ORANGE MICRO, Buffered Grappler Plus, 16K	\$ 200 \$ 159	PFS:Graph or Report, each	\$ 125 \$ 79	<b>RECREATIONAL SOFTWARE</b>	
Multiplan, Word, or File, each	\$ 39 \$ 25	16K Buffer Board for Grappler Plus	\$ 99 \$ 59	SPRINGBOARD, Newsroom	\$ 50 \$ 32	BLUECHIP, Millionaire or Barron, ea.	\$ 50 \$ 32
MILES, Mac the Knife, v. 1	\$ 150 \$ 89	PCPI, Applicard, 6 MHz, 14 features	\$ 375 \$ 250	STONEWARE, DB Master, v. 4 +	\$ 350 \$ 225	DATASECT, Aztec or Zaxxon, each	\$ 40 \$ 27
MONOGRAM, Dollars & Sense	\$ 499 \$ 349	RH ELECT., Super Fan II w/surge protector	\$ 89 \$ 59	<b>UTILITIES SOFTWARE</b>		ELECTRON. ARTS, Sky Fox & others, ea.	\$ 40 \$ 29
NOVATION, Smartcat Plus Modem w/Software	\$ 395 \$ 259	TITAN, Accelerator IIe	\$ 319 \$ 219	BEAGLE, GPLe or Alpha Plot, ea.	\$ 50 \$ 27	HAYDEN, Sargon III (Chess)	\$ 50 \$ 30
ODESTA, Helix	\$ 50 \$ 32	128K RAM Card (II +)	\$ 269 \$ 189	ProtoDOS, Desk Outk, Ap. Mech. or I/O, Silver, ea.	\$ 30 \$ 19	INFOCOM, Zork I, II, or III, ea.	\$ 40 \$ 25
PENGUIN, Graphics Magician	\$ 295 \$ 185	TRACKHOUSE, Numeric Key Pad (Ile)	\$ 100 \$ 50	Full line IN STOCK	CALL	ORIGIN, Ultima III	\$ 60 \$ 37
PROVUE, Overvue	\$ 249 \$ 159	TG, Select-a-Port	\$ 40 \$ 26	BORLAND, Turbo Pascal	\$ 55 \$ 33	PENGUIN, Transylvania	\$ 35 \$ 24
SIMON & SCHUSTER, Typing Tutor III	\$ 175 \$ 105	VIDEO 7, V Color 7 RGB Card	\$ 150 \$ 99	3 Pak (Pasc, Turbo Tut, Toolbox) NEW	\$ 105 \$ 59	SPECTRUM HOLOBYTE, Gato	\$ 40 \$ 25
SOFTW. PUBL., PFS: File & Report Combo	\$ 249 \$ 159	V Color IIc	\$ 200 \$ 139	CENTRAL POINT Copy II Plus (bit copier)	\$ 40 \$ 23	SPINNAKER, FULL LINE IN STOCK	CALL
SOFTWARE ARTS, T/K Solver	\$ 80 \$ 50	V Color IIe	\$ 250 \$ 169			SUB LOGIC, Flight Simulator II	\$ 50 \$ 30
STATE OF THE ART, Electronic Checkbook	\$ 195 \$ 125	VIDEX, UltraTerm (II +/Ile)	\$ 379 \$ 229			PLUS: BRODERBUND, DATAMOST, MUSE, SIR-TECH	
STONEWARE, DB Master	\$ 195 \$ 115	VideoTerm 80 Col. Card (II +/Ile)	\$ 279 \$ 175				
TELOS, File Vision	\$ 149 \$ 99	WICO, Smartcard (spec. II/II +/Ile)	\$ 199 \$ 159				
WARNER, Desk Organizer							

DISKETTES		MODEMS		PRINTERS		PRINTER INTERFACES AND BUFFERS	
<b>* CONROY-LAPOINTE™ DISKETTES *</b>		<b>ANCHOR, Signalmat Mark XII</b>		<b>DOT MATRIX:</b>		<b>CALL</b>	
We guarantee these top quality products with our name. 5 YEAR LIMITED WARRANTY.		HAYES, 2400B External Modem		APPLE, Imagewriter		LIST CONROY PRICE PRICE	
10 ea. SS/SD, (Apple, etc) 35 Trk. W/FLIP BOX	\$ 12	Smartmodem 1200B (IBM)	\$ 899 \$ 699	Laserwriter	\$ 6995 \$ 6500	ARBO, IBM-PC to Para Printer Cable	\$ 60 \$ 30
100 ea. SS/SD, (Apple, etc) 35 Trk	\$ 99	Smartmodem 1200 (IBM/MAC)	\$ 549 \$ 379	EPSON, RX / FX Series - In Stock	CALL	ASSIMILATION, Mac to Epson Conn I/F	\$ 89 \$ 69
1000 ea. SS/SD, (Apple, etc) 35 Trk	\$ 840	Micromodem 1200 (External)	\$ 599 \$ 419	FX80 - Color Printer, 160 cps	\$ 699 CALL	Daisywheel Connection	\$ 99 \$ 79
10 ea. DS/DD, (IBM, H/P) 48 Trk. W/FLIP BOX	\$ 15	Micromodem 1200 (Smartmodem AP)	\$ 329 \$ 239	LQ1500 - 200 cps DQ/87 cps LQ	\$ 1295 CALL	EPSON, Parallel Interface for LQ1500	\$ 100 \$ 79
100 ea. DS/DD, (IBM, H/P) 48 Trk	\$ 119	NOVATION, Apple Cat II 300 Baud (AP)	\$ 389 \$ 219	OKIDATA, Okimate 20 - Color, Hi Res	\$ 268 \$ 208	Serial Interface Board	\$ 130 \$ 110
1000 ea. DS/DD, (IBM, H/P) 48 Trk	\$ 859	212 Apple Cat, 1200 Baud (AP)	\$ 595 \$ 419	182 - 120 cps/80 col/para.	\$ 299 \$ 239	MPC, Apple II I/F & Cable for Epson & Gemini	\$ 90 \$ 49
10 ea. SS/DD, 3 1/2" (MAC, H/P), W/FLIP BOX	\$ 25	SmartCat Plus w/software (MAC)	\$ 499 \$ 349	92 - 160 cps/80 col/para.	\$ 499 \$ 399	OKIDATA, Plug'n Play, Tractor, Diagraph, ea.	CALL
50 ea. SS/DD, 3 1/2" (MAC, H/P)	\$ 115	ACCESS 1-2-3 1200B Modem + Crosstalk (IBM)	\$ 595 \$ 369	2410 Pacemark - 350 cps/para.	\$ 799 \$ 639	ORANGE MICRO, Grappler Plus for Apple	\$ 145 \$ 99
100 ea. SS/DD, 3 1/2" (MAC, H/P)	\$ 229	PROMETHEUS, 1200 Standalone Modem	\$ 495 \$ 345	PI092 - 180 cps/10"	\$ 349 \$ 249	Serial Grappler	\$ 119 \$ 79
<b>CONROY-LAPOINTE™ IBM PRE-FORMATTED</b>		ProModem 1200 w/software (MAC)	\$ 549 \$ 429	QUADRAM, Quadjet - Inkjet Color	\$ 895 \$ 395	Buffered Grappler Plus, 16K	\$ 209 \$ 159
10 ea. DS/DD, 48 Trk W/FLIP BOX	\$ 19	ProModem 1200A (AP)	\$ 449 \$ 349	STAR MICRO, SG10 - 120 cps DQ/30 cps NLO	\$ 299 \$ 249	QUADRAM, Microfazers, full line IN STOCK	CALL
100 ea. DS/DD, 48 Trk	\$ 149	ProModem 1200B (IBM)	\$ 399 \$ 289	SG15 - 120 cps DQ, 30 cps NLO, 16K	\$ 499 \$ 419	Microfazers 8K, P-P, w/copy	\$ 189 \$ 139
1000 ea. DS/DD, 48 Trk	\$ 959	QUADRAM, Quadmodem, Internal (IBM)	\$ 595 \$ 425	SD10 - 160 cps DQ, 40 cps NLO	\$ 449 \$ 379	STAR MICRO, Serial I/F & Cable	\$ 144 \$ 119
<b>SINGLE-SIDED, DOUBLE DENSITY</b>		Quadmodem, External, (IBM)	\$ 695 \$ 495	SD15 - 160 cps DQ, 40 cps NLO, 16K	\$ 599 \$ 509	Mac/Star Interface	\$ 100 \$ 88
CDC, 10 ea. SS/DD, 40 Trk (Apple, etc)	\$ 45 \$ 19	<b>MONITORS</b>		SR10 - 200 cps DQ, 50 cps NLO	\$ 649 \$ 549		
DYSAN, 10 ea. SS/DD, (Apple, etc.)	\$ 40 \$ 27	AMDEK, Color 300 - Comp/Audio	\$ 349 \$ 249	SR15 - 200 cps DQ, 50 cps NLO, 16K	\$ 799 \$ 679	<b>ACCESSORIES</b>	
MAXELL, 10 ea. SS/DD, MD1 (Apple)	\$ 47 \$ 19	Color 500 - Comp/VCR/RGB/Audio	\$ 525 \$ 375	TOSHIBA, 351 - 288 cps	\$ 1185 \$ 1369	CURTIS, Diamond, 6 outlets, switched	\$ 50 \$ 29
VERBATIM, 10 ea. SS/DD, MD5S-01, (Apple)	\$ 49 \$ 19	Color 600 - Hi Res/RGB/Audio	\$ 599 \$ 399			Emerald, 6 outlets, 6' cord	\$ 60 \$ 35
<b>DOUBLE-SIDED, DOUBLE DENSITY</b>		300A - 12" Amber	\$ 199 \$ 135			Ruby, 6 outlets, 6' cord, filter	\$ 90 \$ 52
CDC, 10 ea. DS/DD, 40 Trk (IBM, H/P)	\$ 59 \$ 23	300G, 12" Green	\$ 179 \$ 119	<b>LETTER-QUALITY:</b>		Sapphire, 3 outlets, w/filter	\$ 80 \$ 46
DYSAN, 10 ea. DS/DD, (IBM, H/P)	\$ 69 \$ 35	310A, 12" Amber/Comp (IBM)	\$ 230 \$ 159	JUKI, 6300 - 40cps/para.	\$ 995 \$ 795	EPD, Lemon, 6 outlets/wall	\$ 45 \$ 29
MAXELL, 10 ea. DS/DD, MD2 (IBM)	\$ 71 \$ 26	PRINCETON, HX-12 - Hi Res/RGB	\$ 795 \$ 489	6100 - 18 cps/para/3 pitch	\$ 599 \$ 439	Lime, 6 outlets/cord	\$ 70 \$ 45
VERBATIM, 10 ea. DS/DD, MD34 (IBM)	\$ 75 \$ 24	SR-12 - Hi Res/RGB	\$ 799 \$ 599	Sheet Feeder for 6300 (single)	\$ 275 \$ 225	Orange, 6 outlets/cord	\$ 100 \$ 60
<b>3 1/2" MICRO DISKETTES</b>		MAX-12 - Amber (IBM)	\$ 249 \$ 179	PANASONIC, CP3151 - 22 cps/15 1/2"	\$ 699 \$ 539	Peach, 3 outlets/wall	\$ 60 \$ 39
CONROY-LAPOINTE, 10 ea. DS/DD, w/Flip Box	\$ 29	QUADRAM, Amberchrome, 12"	\$ 250 \$ 159	TOSHIBA, Prop. spacing & hi-res graphics:		INNOVATIVE, Flip-n-File 50 (disk holder)	\$ 22 \$ 15
MAXELL, 10 ea. SS/DD (MAC, H/P)	\$ 60 \$ 35	ZENITH, ZVM122 - 12" Amber	\$ 159 \$ 95	1351 - 192 cps DQ & 100 cps LQ	\$ 1895 \$ 1369	KENSINGTON, Printer Stand	\$ 30 \$ 19
MEMOREX, 10 ea. SS/DD (MAC, H/P)	\$ 60 \$ 33	ZVM123 - 12" Green	\$ 149 \$ 89	1340 - 144 cps DQ & 54 cps LQ	\$ 799 \$ 619	NETWORX, Wiretree, 4 outlet, w/ft & surge	\$ 70 \$ 39
VERBATIM, 10 ea. SS/DD (MAC, H/P)	\$ 65 \$ 32	ZVM124 & ZVM 135	20-30% OFF	Bi-direction Tractor Feed	\$ 195 \$ 175	Wiretree Plus	\$ 100 \$ 59
<b>HIGH DENSITY DISKETTES FOR IBM-AT</b>		<b>CABLES</b>		<b>PLOTTERS:</b>		PROD TECH INTL., Uninterruptible Power Supply	
MAXELL, 10 ea. DS/DD (IBM-AT)	\$ 77 \$ 49	ARBO, IBM-PC to Modem Cable	\$ 31 \$ 19	EPSON, 4 Pen Plotter	\$ 599 CALL	200 Watts, PC200 for IBM-PC	\$ 359 \$ 229
MEMOREX, 10 ea. DS/DD (IBM-AT)	\$ 77 \$ 49	ASTAR, RF Modulator for T.V. (Apple)	\$ 35 \$ 20	<b>PRINTER SUPPLIES:</b>		300 Watts, XT300 for IBM-XT	\$ 499 \$ 379
<b>* GENERIK DISKETTES *</b>		COMPUABLE, Mac/Hayes Smartmodem Cable	\$ 32 \$ 25	PAPER: White, Colored, Laser Cut, etc.		800 Watts, AT800 for IBM-AT, 72 lbs.	CALL
Top quality, w/jackets, no labels. Quantity discounts. 90 day "No hassle, money back guarantee."		CURTIS, Monitor Extension Cable (IBM)	\$ 50 \$ 35	RIBBONS, DAISYWHEELS	CALL		
100 ea. SS/SD, 35 Track (Apple, etc.)	\$ 80	3'-9" Keyboard Extens. Cable (IBM)	\$ 40 \$ 30				
100 ea. DS/DD, 48 Track, (IBM, H/P)	\$ 95	RCA, Monitor Cable	\$ 15 \$ 9				

**CONROY-LAPOINTE CREDIT CARD**

Send me a Conroy-LaPointe credit application form, so I can get cash discount prices with credit card convenience. \$400 Minimum initial purchase.

NAME \_\_\_\_\_

ADDRESS \_\_\_\_\_

CITY \_\_\_\_\_ STATE \_\_\_\_\_ ZIP \_\_\_\_\_

MAIL TO: 12060 SW Garden Place, Portland, OR 97223

**ORDERING INFO & TERMS:** MAIL TO: 12060 SW Garden Place, Portland, OR 97223 - Include telephone number. Check your figures for Shipping, Insurance and Handling (SIH). All items usually in stock. NO C.O.D. Cashiers checks, money orders, Fortune 1000 checks and government checks honored immediately. Personal and other company checks - allow 20 days to clear. Prices reflect 3% cash & Conroy-LaPointe Credit Card discount, so ADD 3% to above prices for VISA/MasterCard/American Express. Your cards NOT charged if we ship. Add SIH CHARGES: U.S. Mainland, 3% (\$5 minimum) for standard UPS ground; UPS Blue, 6% (\$10 min); for U.S. Postal APO or FPO or Alaska, 6% (\$10 min). Canada, 12% (\$15 min). Foreign orders except Canada, 18% (\$25 min). Monitors by Postal or to foreign countries, 30% (\$50 min). Orders received with insufficient SIH will be refunded. All prices, availability and specifications subject to errors or change without notice, so call to verify. All goods are new, include warranty and are guaranteed to work. Due to our low prices and our assurance that you will get new, unused products - ALL SALES ARE FINAL. We do not guarantee compatibility. Call before returning goods for repair or replacement. ORDER DESK HOURS - 8AM to 6PM PST, Monday through Friday, Saturday 10 to 4, EconoRAM™, Fastrax™, and Genetik™ are trademarks of ComX Corporation.

# -LA POINTE INC. SM

© 1984 by Conroy-LaPointe, Inc. All Rights Reserved

LOW PRICES TO PROFESSIONALS WHO KNOW WHAT THEY WANT AND KNOW HOW TO USE IT!

**(TO ORDER, CALL (800) 547-1289)**

FOR YOUR IBM-PC, XT, AT or JR

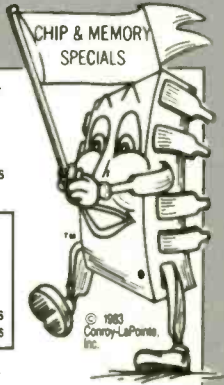

**COMPUTER SYSTEMS**

— Call for Details —

**256K IBM-PC** SM

360K Disk Drives by CDC

90 Day Limited Warranty By Us

**COMPAQ** Portable. 256K, 2 360K Disk Drives

**ZENITH** Z150, 256K, 2 320K Disk Drives, MS DOS 2.1, 8088 Chip, 2 S/P

**OTHER HARDWARE**

AST, **SixPak Plus, 64K \$259**

SixPak Plus, 256K, S/P/CC + S/W \$ 695 \$ 295  
 SixPak Plus, 384K, S/P/CC + S/W \$ 895 \$ 329  
 Preview™ Graphics Card w/para, 64K \$ 399 \$ 299  
 Advantage™ Multif. Bd. for AT, 126K \$ 595 \$ 445  
 I/O Plus II, S/P/CC \$ 215 \$ 199  
 I/O Plus II, S/P/CC/G \$ 265 \$ 185  
 I/O Plus II, 2S/P/CC/G \$ 315 \$ 215  
 Port Kits - ser, para, or game, ea \$ 50 \$ 35  
 MonoGraphPlus™ P/CC (for Lotus) \$ 495 \$ 345

COMX, NEW **EconoRAM™ Plus, 384K board, S/P/CC/G Fastrak & Spooler \$265**

EconoRAM™, full 384K board \$ 295 \$ 195

**OTHER HARDWARE**

LIST CONROY PRICE PRICE

MICROSOFT, Mouse (for PC) \$ 195 \$ 135  
 Serial Mouse \$ 195 \$ 135  
**MOUSE SYSTEMS, PC Mouse & Paint \$ 220 \$ 140**  
**PARADISE, Modular Graphics Card \$ 395 \$ 285**  
 Parallel or Serial Port, ea. \$ 95 \$ 65

**PERSYST, NEW**  
 PC/Mono Board, w/para port \$ 250 \$ 195  
 PC/Color Graphics Bd w/light pen & VF \$ 244 \$ 176

**QUADRAM, Quadboard 64K, to 384K, S/P/CC/G \$239**

Quadboard, no RAM, expand to 384K \$ 295 \$ 225  
 Quadboard 256K, to 384K, S/P/CC \$ 675 \$ 269  
 Quadboard, 384K (full), S/P/CC/3 \$ 795 \$ 295  
 Quadboard II, no RAM, to 256K \$ 295 \$ 215  
 Quadboard II, 64K, to 256K, 2S/CC \$ 395 \$ 265  
 Quadboard II, 256K, 2S/CC \$ 595 \$ 395  
 Quad 512 + 64K w/serial port \$ 325 \$ 245  
 Quadcolor board, 4 colors \$ 295 \$ 195  
 Upgrade Quadcolor I to II kit \$ 275 \$ 199  
 Quadvue, board, Mono, S/P/CC \$ 345 \$ 269  
 Quad 3278 \$1195 \$1050  
 Quadnet VI \$1995 \$1545  
 Quadnet IX \$2295 \$1745  
 Quadlink \$ 495 \$ 385  
 Quadspint \$ 645 \$ 495

**TG PRODUCTS, Joystick \$ 30 \$ 22**  
**WICO, Smartboard Keyboard \$ 400 \$ 279**

**★ 256K ★ CHIP KIT \$67**

9 each, 4256 chips  
150 ns

**★ 64K ★ CHIP KIT \$10**

9 each, 4164 chips  
90 Day Warranty by us

**★ 128K ★ CHIP KIT \$79**

9 each, 4128 chips  
Piggyback for AT

**HARD DISKS & TAPE BACKUP**

LIST CONROY CALL PRICE PRICE

CDC, Internal 20 meg for AT \$ 895 \$ 729  
**KAMERMAN, Internal 10 meg kit \$ 1295 \$1049**  
 External 10 meg kit w/power MF-10/10, H Disk, tape back, cont, power \$2690 \$2090  
**MICRO SCIENCE, 10 meg w/controller \$ 795 \$ 625**  
**RANA, External 10 meg w/controller \$1495 \$1095**  
 Internal 10 meg w/controller \$ 995 \$ 689  
**TALLGRASS, 25 meg disk, 55 meg tape, intf. \$3660 \$3160**

**HAUPPAGE (HCW), 8087 Chip \$ 175 \$ 125**  
 8087 Math Pak (Chip & softw.) \$ 295 \$ 235  
**HAYES, Mach II Joystick \$ 45 \$ 29**  
 Mach III (PC or Jr.) \$ 55 \$ 35  
**HERCULES, Color Card w/para. \$ 245 \$ 159**  
 Mono Graphics Card \$ 499 \$ 305  
**KENSINGTON, Masterpiece™ \$ 140 \$ 99**  
**KEY TRONIC, KB5151, Std. Keyboard \$ 255 \$ 195**  
**KOALA, Speed Key System \$ 100 \$ 63**  
 Speed Key Tablet w/software \$ 200 \$ 115  
 Koala Pad w/PC Design \$ 150 \$ 85

**★ ★ FOR YOUR PC-JR ★ ★**

**HAYES, Mach III Joystick \$ 55 \$ 35**  
**KEY TRONIC, KB5151 Jr. Keyboard \$ 255 \$ 195**  
 Numeric Keypad \$ 100 \$ 77  
**KOALA, Touch Tablet for Jr. \$ 125 \$ 75**  
**MICROSOFT, Booster 128K w/Mouse \$ 495 \$ 329**  
**MOUSE SYSTEMS, Mouse w/software \$ 195 \$ 125**  
**QUADRAM, Expansion Chassis \$ 695 \$ 540**  
**Memory Expansion Board 128K \$ 275 \$ 215**  
**RACORE, Expansion Chassis \$ 695 \$ 449**  
**128K Expansion Board \$ 275 \$ 189**  
**TECMAR, Jr. Captain \$ 395 \$ 295**

**★ ComX ★ EconoRAM Plus™ \$265**

**384K Multifunction RAM Board**

Works like AST SixPakPlus™ with game port  
 Fastrak™ RAM Disk and Spooler Software  
 (Fastrak for up to 384K).

**FLOPPY DISK DRIVES**

CDC, Limited 30 day warranty. Call for quantity prices

**SALE!**

Full Height \$109  
 Half Height \$ 89

**MAYNARD, SAND STAR SERIES**

Multifunction (6) Card \$ 89 \$ 79  
 Memory Card no RAM \$ 122 \$ 89  
 Memory Card 256K \$ 495 \$ 309  
 Floppy Cont. Card (accepts 3 modules) \$ 265 \$ 195  
 Hard Disk 1/2 Module \$ 499 \$ 359  
 Hard Disk Cable \$ 30 \$ 27  
 Serial Port Module \$ 95 \$ 79  
 Para or Clock Cal. Module, ea. \$ 59 \$ 49  
 Game Adapter Module \$ 49 \$ 39  
 Memory Module, OK \$ 122 \$ 99  
 Memory Module 256K \$ 422 \$ 357

**★ ★ FOR YOUR PC-JR ★ ★**

**HAYES, Mach III Joystick \$ 55 \$ 35**  
**KEY TRONIC, KB5151 Jr. Keyboard \$ 255 \$ 195**  
 Numeric Keypad \$ 100 \$ 77  
**KOALA, Touch Tablet for Jr. \$ 125 \$ 75**  
**MICROSOFT, Booster 128K w/Mouse \$ 495 \$ 329**  
**MOUSE SYSTEMS, Mouse w/software \$ 195 \$ 125**  
**QUADRAM, Expansion Chassis \$ 695 \$ 540**  
**Memory Expansion Board 128K \$ 275 \$ 215**  
**RACORE, Expansion Chassis \$ 695 \$ 449**  
**128K Expansion Board \$ 275 \$ 189**  
**TECMAR, Jr. Captain \$ 395 \$ 295**

**EconoRAM™ 384K Single Function Board \$195**

With Fastrak™ and Spooler  
 Fully Compatible, 1 Year Limited Warranty.  
 Works on DOS 1.1, 2.0 or 2.1  
 Prices and availability subject to change. Call.

## SOFTWARE FOR YOUR IBM-PC, XT, AT or JR

**BUSINESS**

LIST CONROY PRICE PRICE

**ASHTON-TATE, Framework \$ 695 \$ 359**  
 dBase III \$ 695 \$ 359  
 dBase II, (freq. PC-DOS & 128K) \$ 495 \$ 279

**ATI, Training Programs—Large Inventory \$ 75 \$ 48**

**BPI, General Acctg. AR, AP, or PR, ea. \$ 595 \$ 365**

**BRODERBUND, Bank St. Writer (PC or Jr.) \$ 80 \$ 49**

**CDEX, Training Programs—Large Inventory \$ 70 \$ 45**

**CONTINENTAL, Ultrafile \$ 195 \$ 115**  
 Tax Advantage \$ 70 \$ 40  
 Property Management \$ 495 \$ 295

**DATA TRANS., Fontrix \$ 125 \$ 79**

**DOW JONES, Investment Evaluator \$ 149 \$ 97**

**Market Manager Plus \$ 249 \$ 159**  
 Market Analyzer or Market Microscope \$ 349 \$ 219  
 Spread Sheet Link \$ 249 \$ 159

**FOX & GELLER, Quickcode III \$ 295 \$ 185**

**HARVARD, Total Project Manager \$ 495 \$ 295**

**HOWARDSOFT, Tax Preparer '85 \$ 295 \$ 195**

**HUMAN EDGE, Mind Prober (PC or Jr.) \$ 50 \$ 29**  
 Sales Edge or Management Edge, ea. \$ 250 \$ 159  
 Negotiation Edge \$ 295 \$ 185

**INFOCOM, Cornerstone \$ 495 \$ 319**

**KENSINGTON, Easy Link Mail Manager \$ 95 \$ 59**

**LIFETREE, Voikswriter Deluxe \$ 295 \$ 159**

**LIVING VIDEOTEXT, Think Tank \$ 195 \$ 95**

**LOTUS, 1-2-3 \$ 495 \$ 309**  
 Symphony \$ 695 \$ 449

**MDBS, Knowledgeman \$ 500 \$ 275**

**MECA, Managing Your Money (PC) \$ 199 \$ 125**  
 Managing Your Money Cartridge (Jr) \$ 199 \$ 179

**BUSINESS**

LIST CONROY PRICE PRICE

**MICROPRO, WordStar (PC) \$ 350 \$ 189**  
 WordStar (Jr) \$ 195 \$ 109  
 WordStar 2000 (copiable) \$ 495 \$ 265  
 WordStar 2000 Plus (copiable) \$ 595 \$ 295  
 WordStar Professional Plus \$ 695 \$ 395  
 WordStar Professional, 4 Pak \$ 495 \$ 265  
 MailMerge, SpellStar or StarIndex, ea. \$ 99 \$ 54  
 InfoStar Plus (+Starburst) \$ 595 \$ 315  
 Correct Star \$ 145 \$ 77

**MICROIM, R-Base Series 5000 NEW \$ 695 \$ 395**  
 Upgrade 4000 to 5000 \$ 245 \$ 145  
 R-Base 4000 \$ 495 \$ 255  
 R-Base Clout \$ 249 \$ 129  
 Extended Report Writer \$ 150 \$ 85  
**MICROSOFT, Spell \$ 50 \$ 32**  
 Multiplan (PC or Jr) \$ 195 \$ 125  
 Chart or Project, each \$ 250 \$ 159  
 Word \$ 375 \$ 235

**MULTIMATE, Multimate Ver. 3.3 \$ 495 \$ 295**  
**PEACHTREE, Back to Basics \$ 395 \$ 239**  
 Peach Pak (GLI/AR/AP) \$ 395 \$ 219

**QUE, Using 1-2-3 \$ 18 \$ 14**  
 1-2-3 for Business \$ 17 \$ 13  
 Using Symphony \$ 20 \$ 15

**SAMNA, Word Plus \$ 695 \$ 439**  
 Word III \$ 550 \$ 279

**SATELLITE, WordPerfect (PC) \$ 495 \$ 209**  
 WordPerfect (Jr) \$ 69 \$ 39

**SOFTW. ARTS, Spotlight \$ 150 \$ 95**  
 T/K Solver (specify DOS) \$ 399 \$ 269  
**SOFTWARE GROUP, Enable \$ 695 \$ 459**

**BUSINESS**

LIST CONROY PRICE PRICE

**SOFTWARE PUBL. PFS:Report \$ 125 \$ 75**  
 PFS:Write, File or Graph, each \$ 140 \$ 82  
 PFS:Plan or Access, each \$ 140 \$ 82  
 PFS:Proof \$ 95 \$ 57

**SORCIM, SuperCalc III \$ 395 \$ 245**

**STONEWARE, Advanced DB Master \$ 595 \$ 375**

**THORN EM, Perfect Pak (Jr) (Write/Spell/Thesaurus) \$ 139 \$ 89**  
 UNISON, Print Master \$ 60 \$ 35

**WARNER, Desk Organizer (PC or Jr) \$ 195 \$ 125**  
**XANARO, Ability \$ 495 \$ 309**

**UTILITIES**

LIST CONROY PRICE PRICE

**MICROSTUF, Crosstalk XVI (PC or Jr) \$ 195 \$ 109**

**MOUSE SYSTEMS, PC Paint \$ 140 \$ 82**

**NORTON, Utilities (14 prgms) v 3.0 \$ 100 \$ 59**

**ROSESOFT, Prokey \$ 130 \$ 79**

**WESTERN UNION, Easy Link Mail Mgr \$ 95 \$ 59**

**UTILITIES**

**BORLAND, Sidekick or Toolbox, ea. \$ 55 \$ 29**  
 Sidekick Copiable (PC or Jr) \$ 85 \$ 49  
 Super Keys or Turbo Pascal, ea. \$ 70 \$ 39  
 Turbo Pascal w/8087 Support \$ 110 \$ 66  
 3 Pak (Pascal, Toolbox, Turbo Turbo) \$ 105 \$ 65

**CENTRAL POINT, Copy II PC \$ 40 \$ 23**

**COMX, Fastrak™, RAM/Disk emul & spooler. \$ 100 \$ 39**

**DIGITAL RES., Gem Draw NEW \$ 150 \$ 95**  
 CP/M-86™ (PC/XT) \$ 100 \$ 64  
 DR LOGO-86 (CP/M-86) \$ 150 \$ 99

**FUNK SOFTWARE, Sidesways \$ 60 \$ 37**

**LIFEBOAT, Lattice C \$ 500 \$ 279**  
 Dr. Halo \$ 100 \$ 50

**MICROSOFT, Macro Assembler \$ 150 \$ 99**  
 BASIC Compiler or C Compiler, ea. \$ 395 \$ 259  
 Business BASIC Compiler \$ 450 \$ 295  
 COBOL Compiler \$ 700 \$ 459  
 FORTRAN Compiler \$ 350 \$ 229  
 PASCAL Compiler \$ 300 \$ 199

**HOME & EDUCATIONAL**

**BPI, Personal Accounting \$ 99 \$ 63**

**CONTINENTAL, Home Accountant (Jr) \$ 75 \$ 45**  
 Home Accountant Plus (PC) \$ 150 \$ 90

**DOW JONES, Home Budget \$ 139 \$ 92**

**ELECTRONIC ARTS, Get Organized \$ 95 \$ 75**

**MONOGRAM, Dollars & Sense w/forecast \$ 180 \$ 99**

**SCARBOROUGH, MasterType (PC or Jr) \$ 40 \$ 25**  
 Your Personal Net Worth \$ 100 \$ 63

**SIMON & SCHUSTER, Typing Tutor III \$ 50 \$ 33**

**RECREATIONAL**

**BLUECHIP, Millionaire, Barron, Tycoon, ea. \$ 60 \$ 39**

**BRODERBUND, Large Inventory in Stock CALL**

**ELECTRONIC ARTS, Large Inventory in Stock CALL**

**HAYDEN, Sargon III (Chess) \$ 50 \$ 34**

**INFOCOM, Large Inventory in Stock CALL**  
 Hitchhiker's, Zork I, II, or III, each \$ 40 \$ 25

**MICROSOFT, Flight Simulator (PC or Jr) \$ 50 \$ 33**

**ORIGIN, Ultima III (PC or Jr) \$ 60 \$ 39**

**SIERRA/ON-LINE, Ultima II (PC or Jr.) \$ 60 \$ 40**

**SPECTRUM HOLOBYTE, Gato \$ 40 \$ 25**

**SPINNAKER, President's Choice, Amazon Fahrenheit, Rendezvous, Dragon, each \$ 40 \$ 25**

**CASH-n-CARRY COMPUTER STORES, INC.**

Retail Sales only. Store prices may vary.

**SAN FRANCISCO** — 550 Washington Street (at Montgomery, opposite the Pyramid), Interstate 80, to Highway 480; take Washington Street Exit. CALL (415) 982-6212.

**PORTLAND, OREGON** — At Park 217, Tigard at intersection of Highways 217 and 99W. CALL (503) 620-5595.

**SEATTLE, WASH.** — 3540 128th Ave. SE, Bellevue 98006, in Lochmann's Plaza near Factoria Square, SE of Highway 405 & 90 and at SE 36th and Richards. CALL 641-4736.



**OUR REFERENCES:**

We have been in computers and electronics since 1958, a computer dealer since 1978 and in computer mail order since 1980. Banks: 1st Interstate Bank, (503) 643-4678. We belong to the Chamber of Commerce (503) 228-9411, and Direct Marketing Association; call Dun and Bradstreet if you are a subscriber. Recipient of OREGON BUSINESS MAGAZINE's 1984 Enterprise Award.

MasterCard VISA

CONROY-LAPOINTE CARD

NO SALES TAX

**CALL (800) 547-1289**

In Oregon: (800) 451-5151 (503) 620-9877

**QUESTIONS (503) 620-9878**

**ORDER DESK HOURS**  
 Mon-Fri 6am to 6pm (PST)  
 Saturday 10am to 4pm (PST)  
 Weekdays Only (8 am here is 9 am in New York)

Foreign & Portland Residents Call

# BASF QUALIMETRIC™ FLEXYDISKS®. A GUARANTEED LIFETIME OF OUTSTANDING PERFORMANCE.

*BASF Qualimetric FlexyDisks feature a unique lifetime warranty,\* firm assurance that the vital information you enter on BASF FlexyDisks today will be secure and unchanged tomorrow. Key to this extraordinary warranted performance is the BASF Qualimetric standard... a totally new set of criteria against which all other magnetic media will be judged.*

*You can count on BASF FlexyDisks because the Qualimetric standard reflects a continuing BASF commitment to perfection in magnetic media. One example is the unique two-piece liner in our FlexyDisk jacket. This BASF feature traps damaging debris away from the disk's surface and creates extra space in the head access area for optimum media-head alignment. The result is a guaranteed lifetime of outstanding performance.*

*For information security that bridges the gap between today and tomorrow, look for the distinctive BASF package with the Qualimetric seal. Call 800-343-4600 for the name of your nearest supplier.*

\*Contact BASF for warranty details.  
Inquiry 47

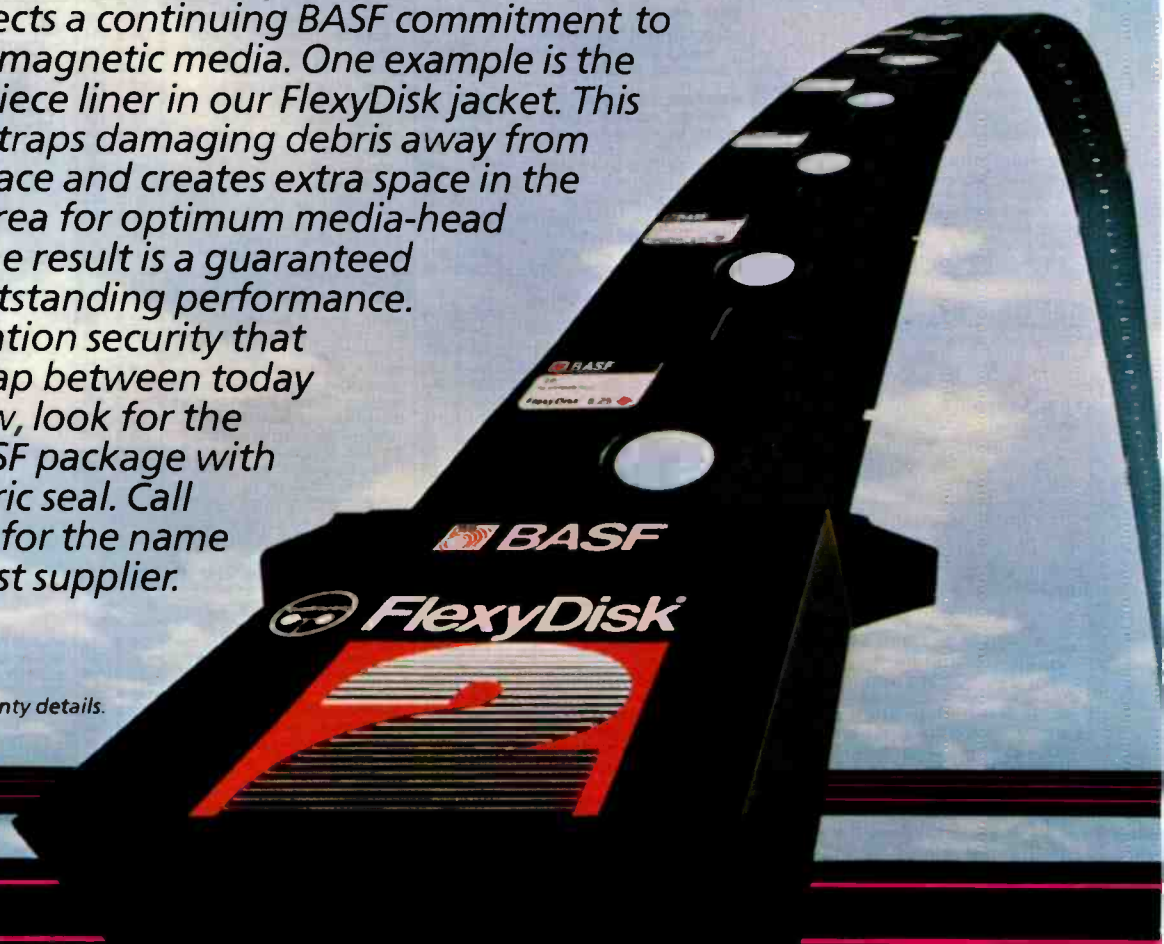

ENTER TOMORROW ON BASF TODAY.

© 1983 BASF Systems Corp., Bedford, MA



**BASF**

# LIQUID-CRYSTAL DISPLAYS FOR PORTABLES

*Inside the display  
technology that  
has made portable  
computers portable*

**S**everal months ago I got into a discussion with a computer enthusiast about which portable computer to buy. I quickly whipped out my portable and began preaching its merits and demonstrating how powerful it is. I could see the display perfectly, but the fellow standing next to me was having difficulty reading what I had typed. Poor display quality is a common limitation in portable computers. Most portables (not to be confused with transportables) have twisted-nematic liquid-crystal displays (TN-LCDs), with restricted viewing angles and limited contrast. They must be operated under proper ambient lighting conditions.

In mid-1982, there were only a few low-profile displays on the market. Of the available technologies, TN-LCD was the only one that had acceptable power requirements for battery operation. A typical 16-line LCD module dissipates approximately  $\frac{1}{8}$  watt (W). Other available flat-panel technology

*(continued)*

Glenn Adler has a B.S. in electrical engineering and does VLSI design work for Hewlett-Packard's portable computer division. He can be contacted c/o Hewlett-Packard, 1000 Northeast Circle Blvd., Corvallis, OR 97330.



gies use too much power for battery operation (see "Two Flat-Display Technologies" by Richard Shuford, March BYTE, page 130). Electroluminescent (EL), gas-plasma (GP), and flat-panel CRT (cathode-ray tube) displays with 25 lines dissipate 30 to 200 times the power of LCDs.

Portable computers must be lightweight, compact, and battery-operated. This necessitates a flat-panel display that uses low power. Since these microcomputers compete directly with desktops, they need to handle applications that run on the leading personal computers. Their screens must have features equivalent to standard monochrome displays: 80-character, multiple-line alphanumeric displays with full graphics capability.

Limited contrast, brightness, and viewing angle are the drawbacks associated with multiple-line TN-LCDs. These disadvantages are attributable to the fundamental electro-optical characteristics of these panels. The

use of TN-LCDs requires different circuit architecture than a standard video interface and requires some unique mechanical designs to overcome their physical limitations.

### VISUAL PERCEPTION

Your eyes and visual cortex are stimulated to a great extent by the edges of objects. Edge detection occurs where there is a step difference in brightness (also termed luminance in the case of a monochrome image) between adjacent objects in the visual field. For the purpose of measurement, you can define contrast ratio (CR) as the quotient of luminance of a light picture element (pixel) to a dark pixel's luminance. (Luminance is measured in foot-lamberts.)

$$CR = L_1 / L_2$$

$L_1$  = luminance of light pixel

$L_2$  = luminance of dark pixel

Contrast ratios of 2 to 1 form what you can easily detect as an edge. This

CR is about the minimum acceptable for easy reading of LCDs. Typical CRT displays have CRs ranging up to 20 to 1, but once the ratio approaches 10 to 1 your eye saturates and can no longer differentiate changes in relative brightness.

Your eye samples the visual field at roughly 30 Hz and your brain integrates the information to form a continuous picture. The perception of flicker in a display is a function of this phenomenon, the persistence of the display material, and the rate at which information is refreshed. Aside from this temporal integration of information, your eye also performs a spatial integration. You can see an example of this by looking closely at the characters displayed on a CRT screen. The characters are made up of discrete pixels, but seen from a distance they appear to form a continuous item. Your brain fills in the gaps, but the perceived object has lower brightness overall than each individual dot. Furthermore, if the separation between dots increases beyond the eye's limit of resolution at a typical viewing distance (1½ to 2 feet), your brain will interpret adjacent dots as belonging to separate objects. This constraint physically limits the useful pixel-separation distance for displays such as LCDs.

### TWISTED-NEMATIC LCDS

Today's LCDs use the properties of plane polarizers and ordered nematic liquid crystals to modulate light. Polarizers are light filters that selectively allow incident light through their "passing axis." Light oriented in any other direction is absorbed (see figure 1).

Some organic compounds exist in a phase called the mesophase, which is stable at temperatures between the liquid and solid phases. Liquid crystals (LCs) exhibit three such phases: smectic, nematic, and cholesteric. In the nematic phase, the long axes of the LC molecules align in parallel orientation. The alignment of LCs in this phase is sensitive to several stimuli, including temperature, surface

*(continued)*

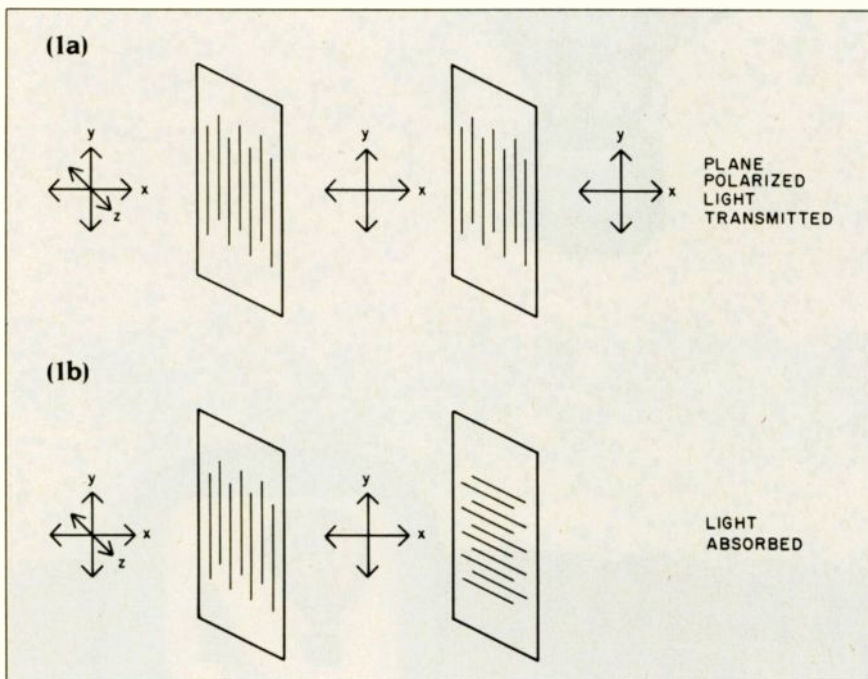

Figure 1: This figure depicts the effects of two polarizers on noncoherent light. (a) Light passing through the first polarizer is polarized in the Y and X plane. Since the polarizer's passing axes are aligned, the light continues through the second polarizer. (b) Here, the polarizer's passing axes are oriented orthogonally, and the plane polarized light that has passed through the first polarizer is absorbed by the second.



# Buy Mouse, Paint Free.

Now when you buy the Microsoft® Mouse, you get a dazzling new color paint program, PC Paintbrush™, free.

PC Paintbrush supports a host of graphics cards (including the new IBM® EGA and Hercules™ Graphics Card) and over 30 printers and plotters.

Microsoft Mouse is the high performance mouse for the IBM Personal Computers. It puts the power to run Microsoft Multiplan®, Lotus® 1-2-3®, Microsoft Word and other popular programs in the palm of your hand. It's available in serial and bus versions.

So why monkey around with any other mouse. Call (800) 426-9400 for your nearest Microsoft dealer. In Washington State, Alaska, Hawaii and Canada, call (206) 828-8088.



**MICROSOFT**  
The High Performance Software™

A hand holding a large, stylized 'MICROSOFT' logo. The letters are thick and blocky, with a hand gripping the bottom right corner of the 'T'.

Microsoft and Multiplan are registered trademarks and The High Performance Software is a trademark of Microsoft Corporation. Lotus and 1-2-3 are registered trademarks of Lotus Development Corporation. IBM is a registered trademark of International Business Machines Corporation. Hercules is a trademark of Hercules Computer Technology. PC Paintbrush is a trademark of ZSoft Corporation.

# GET SERIOUS!

\*\*\* JULY MODEM SPECIAL \*\*\*

PROMETHEUS PROMODEM 1200 ..... \$299.95

**\* SYSTEMS \***

**ITT EXTRA PC-256K**

Two 1/2 Ht. 360K Dr's, Monochrome Board, 12" Amber/Green Monochrome Monitor, Serial & Parallel Port, DOS 2.1 ..... **\$1,495.95**

\*Exact same features in IBM PC ONLY ..... **\$1,995.95**

**IBM XT 256K**

One IBM 360K Floppy Dr., One 10 Meg Hard Disk, Monochrome Board, Amber/Green Monochrome Monitor, DOS 2.1 ONLY ..... **\$2,895.95**

**IBM PC-256K**

Two TEAC 360K Dr's, Color/Monochrome Graphics Board, Parallel Printer Port, Monochrome Display, DOS 2.1 ONLY ..... **\$2,045.95**

10 MEG Hard Disk Upgrade ..... **\$624.95**

20 MEG Hard Disk Upgrade ..... **\$824.95**

**\* TOP TEN SOFTWARE \***

dBASE III IBM ..... **\$374.95**

Print Shop APPLE ..... **34.95**

Bankstreet Writer IBM/APPLE ..... **49.95**

Managing Your Money IBM/APPLE ..... **115.95**

Dollars & Sense IBM ..... **113.95**

Norton Utilities 3.0 IBM ..... **59.95**

PFS Write/File/Report ..... **85.95**

Sideways IBM/APPLE ..... **39.95**

Multimate IBM ..... **269.95**

Crosstalk IBM ..... **104.95**

Microsoft Word IBM/MAC ..... **249.95/119.95**

**\* HARDWARE \***

AST Six Pack Plus 64K ..... **\$259.95**

STB Rio Plus II 64K ..... **249.95**

PARADISE 5-Pack 64K ..... **179.95**

QUADRAM Quadboard 64K ..... **249.95**

Monochrome Graphics Card ..... **199.95**

Monochrome Board With Parallel Port ..... **159.95**

HERCULES Monochrome Graphics ..... **329.95**

HERCULES Color Card ..... **179.95**

**\* PRINTERS DOT MATRIX \***

PANASONIC 1091 120CPS ..... **\$269.95**

PANASONIC 1092 180CPS/NLQ 33CPS ..... **379.95**

EPSON FX-80+ 160CPS ..... **395.95**

EPSON FX-100+ 160CPS ..... **644.95**

OKIDATA 92P 160CPS ..... **389.95**

BROTHER 2024L 200CPS/NLQ 96CPS ..... **995.95**

**\* PRINTERS LETTER QUALITY \***

BROTHER HR-15 17CPS ..... **\$369.95**

BROTHER HR-25 24CPS ..... **609.95**

BROTHER HR-35 36CPS ..... **849.95**

DIABLO Advantage 25CPS ..... **589.95**

**\* MONITORS \***

TAXAN 121/122 Monochrome ..... **\$145.95**

PRINCETON HX-12 ..... **469.95**

PRINCETON MAX-12 ..... **179.95**

ZENITH Amber/Green Composite ..... **85.95**

NEC 1260 Green Composite ..... **85.95**

IBM Monochrome Display Amber/Green ..... **114.95**

**\* MODEMS \***

HAYES 1200B Internal w/Smartcomm 2 ..... **\$369.95**

HAYES Micromodem IIe ..... **169.95**

HAYES 2400 ..... **649.95**

ANCHOR Volkmodem 300 ..... **54.95**

ANCHOR Volkmodem 1200 ..... **199.95**

**\* APPLE \***

80 COLUMN 64K IIe Only ..... **\$99.95**

80 COLUMN Card II+ Only ..... **58.95**

VIDEX Ultraterm ..... **178.95**

ASCII Express ..... **79.95**

Z-80 Card ..... **49.95**

APRICORN Serial Card ..... **59.95**

MICRO SCI A2 Drives ..... **159.95**

APPLE Compatible Drive for IIC ..... **169.95**

16K Card ..... **49.95**

THOUSANDS OF ITEMS AVAILABLE.  
CALL FOR COMPLETE PRICING.



**714/840-2406**

Se Habla Espanol



# CALIFORNIA MICRO HOUSE

16835 Algonquin St., Huntington Beach, CA 92649

Corporate accounts welcomed, purchase orders accepted with net 30 day terms, subject to credit approval. All prices represent cash prices. All items shipped next day in factory sealed packages. We guarantee all items for 30 days. California residents please add 6% sales tax. Prices subject to change without notice.

## LCDs FOR PORTABLES

tension, pressure, and electric and magnetic fields. These stimuli also affect the optical properties of the material.

The optical properties of twisted-nematic LCs were first demonstrated by Schadt and Helfrich in 1970. (See *Voltage Dependent Optical Activity of a Twisted Nematic Crystal* by S. M. Schadt and W. Helfrich, Applied Physics Letters, number 18, 1971, page 127.) By now, several firms have developed an efficient process for fabricating displays. The key in producing this display is to create a twisted nematic by sandwiching an LC material between two plates whose surfaces are grooved, the top plate in one direction and the bottom in a perpendicular orientation. Layers of LC adjacent to each surface align in parallel with the texturing. Layers between form a helix that twists the plane polarized light. A twisted nematic can be visualized as a polarizer with a 90-degree rotation. Next, this sandwich is placed between two polar-

izers, each with its passing axis in parallel with the grooves on the adjacent glass (see figure 2). Thus, a light valve can be created by applying a voltage across the LC. With voltage applied, the nematic LC molecules no longer twist the incident light but rather pass it parallel to their long axis. The planerized light entering through the top polarizer is absorbed by the lower, thus making the pixel appear dark. In the inactive state the LC is relaxed and light is passed through the helix. The panel can be used in transmissive mode (similar to a transparency) by adding a backlight source. Or the manufacturer can create a low-power, nonemissive (having no light source) LCD by adding a reflective layer.

The conductors deposited on the LCD glass are usually composed of indium-tin-oxide (ITO). Since the index of refraction of ITO is different from that of glass, this would ordinarily result in an aberrant image. Therefore

(continued)

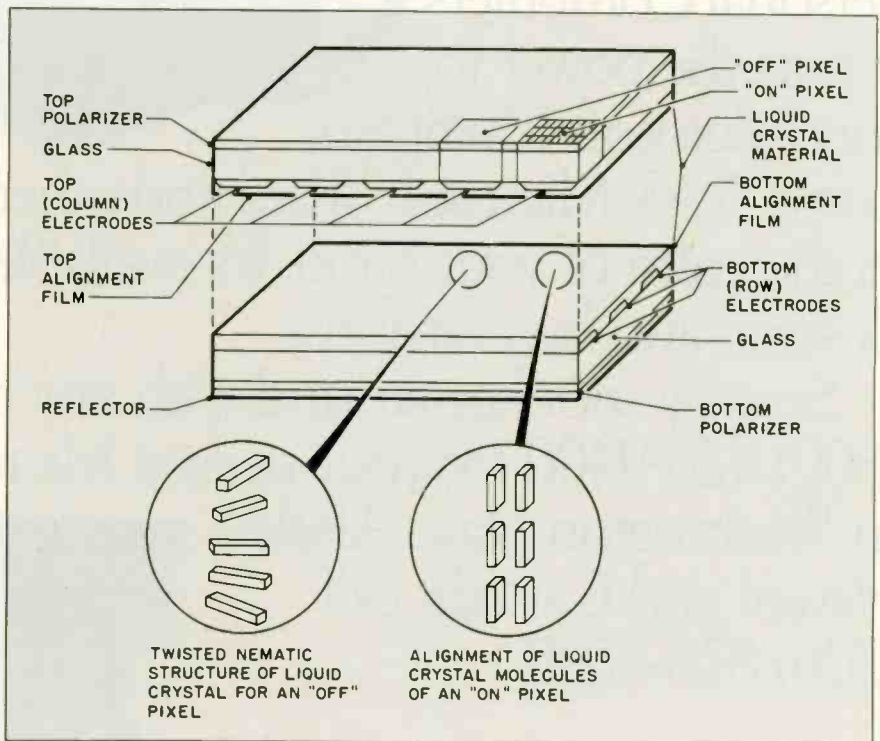

Figure 2: A cross section of a reflective liquid-crystal panel is shown. In the "off" state the LC molecules form a helix. In the "on" state (potential applied) the molecules align in the direction of the electric field.

# Introducing the Most Powerful Business Software Ever!

TRS-80™ (Model I, II, III, or 16) • APPLE™ • IBM™ • OSBORNE™ • CP/M™ • XEROX™



## The VERSABUSINESS™ Series

Each VERSABUSINESS module can be purchased and used independently, or can be linked in any combination to form a complete, coordinated business system.

### VERSARECEIVABLES™ \$99.95

VERSARECEIVABLES™ is a complete menu-driven accounts receivable, invoicing, and monthly statement-generating system. It keeps track of all information related to who owes you or your company money, and can provide automatic billing for past due accounts. VERSARECEIVABLES™ prints all necessary statements, invoices, and summary reports and can be linked with VERSALEGGER II™ and VERSAINVENTORY™.

### VERSAPAYABLES™ \$99.95

VERSAPAYABLES™ is designed to keep track of current and aged payables, keeping you in touch with all information regarding how much money your company owes, and to whom. VERSAPAYABLES™ maintains a complete record on each vendor, prints checks, check registers, vouchers, transaction reports, aged payables reports, vendor reports, and more. With VERSAPAYABLES™, you can even let your computer automatically select which vouchers are to be paid.

### VERSAPAYROLL™ \$99.95

VERSAPAYROLL™ is a powerful and sophisticated, but easy to use payroll system that keeps track of all government-required payroll information. Complete employee records are maintained, and all necessary payroll calculations are performed automatically, with totals displayed on screen for operator approval. A payroll can be run totally, automatically, or the operator can intervene to prevent a check from being printed, or to alter information on it. If desired, totals may be posted to the VERSALEGGER II™ system.

### VERSAINVENTORY™ \$99.95

VERSAINVENTORY™ is a complete inventory control system that gives you instant access to data on any item. VERSAINVENTORY™ keeps track of all information related to what items are in stock, out of stock, on backorder, etc., stores sales and pricing data, alerts you when an item falls below a preset reorder point, and allows you to enter and print invoices directly or to link with the VERSARECEIVABLES™ system. VERSAINVENTORY™ prints all needed inventory listings, reports of items below reorder point, inventory value reports, period and year-to-date sales reports, price lists, inventory checklists, etc.

### VERSALEGGER II™ \$149.95

VERSALEGGER II™ is a complete accounting system that grows as your business grows. VERSALEGGER II™ can be used as a simple personal checkbook register, expanded to a small business bookkeeping system or developed into a large corporate general ledger system **without any additional software.**

- VERSALEGGER II™ gives you almost unlimited storage capacity (300 to 10,000 entries per month, depending on the system),
- stores all check and general ledger information forever,
- prints tractor-feed checks,
- handles multiple checkbooks and general ledgers,
- prints 17 customized accounting reports including check registers, balance sheets, income statements, transaction reports, account listings, etc.

VERSALEGGER II™ comes with a professionally-written 160 page manual designed for first-time users. The VERSALEGGER II™ manual will help you become quickly familiar with VERSALEGGER II™, using complete sample data files supplied on diskette and more than 50 pages of sample printouts.

### SATISFACTION GUARANTEED!

Every VERSABUSINESS™ module is guaranteed to outperform all other competitive systems, and at a fraction of their cost. If you are not satisfied with any VERSABUSINESS™ module, you may return it within 30 days for a refund. Manuals for any VERSABUSINESS™ module may be purchased for \$25 each, credited toward a later purchase of that module.

**To Order: Write or call Toll-free (800) 431-2818 (N.Y.S. residents call 914-425-1535)**

- \* add \$3 for shipping in UPS areas
- \* add \$4 for C.O.D. or non-UPS areas
- \* add \$5 to CANADA or MEXICO
- \* add proper postage elsewhere

Inquiry 164

DEALER INQUIRIES WELCOME

All prices and specifications subject to change / Delivery subject to availability.



# COMPUTRONICS

50 N. PASCACK ROAD, SPRING VALLEY, N.Y. 10977

a passivation layer (coating) is deposited after the conductor to match the indices of refraction. For dot-matrix LCDs, isolated rows of conductor are formed on one glass surface, and orthogonal columns are produced on the other by selectively etching ITO. The row and column conductors form the plates of a capacitor whose dielectric is the LC media. These capacitive elements are the discrete pixels.

When the reflective LCD panel is in the "off" state, pixels that appear bright consist of light that is polarized in one plane, although it passes through both filters twice. The intensity of light reflected off the screen is reduced by approximately 60 percent from incident light (50 percent due to the filtering effect, 10 percent due to losses in the remainder of the system). This makes the "off" pixels appear gray rather than white.

### INDIVIDUAL PIXEL CONSIDERATIONS

As TN-LCDs get larger, several considerations come into play regarding the quality of the image. To examine these, you need to understand the effects of applying potential to individual picture elements.

Each pixel can be modeled as a capacitor ( $C_p$ ) with a parasitic resistance ( $R_p$ ) in parallel (see figure 3). The row and column lines have sheet resistances  $R_{sr}$  and  $R_{sc}$ , respectively. In order to ensure consistent contrast throughout the screen, it is necessary that all pixels see nearly the same voltages. The voltage needed to turn a pixel on to an acceptable contrast level is a function of the electrical properties of the particular LC used and the distance between glass plates. The typical cell gap (plate separation distance) is between 5 and 10 microns. Variances in the glass cause variance in the LC thicknesses, which results in "rainbowing." Larger cell gaps require higher threshold potentials and reduce the viewing angle of the LC media.

The magnitude of local voltage a pixel sees is highly dependent on voltage drops due to sheet resistance.

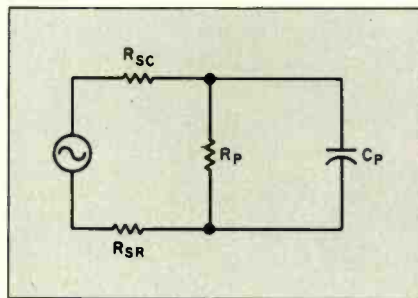

Figure 3:  $C_p$  and  $R_p$  represent the capacitance and resistance, respectively, of a pixel: Typical values are  $2\text{ nF/cm}^2$  for  $C_p$  and  $12\text{ Mohm/cm}^2$  for  $R_p$ .  $R_{sc}$  and  $R_{sr}$  are sheet resistances of the row and column conductors. For indium-tin-oxide their value lies between 10 and 300 ohms per square.

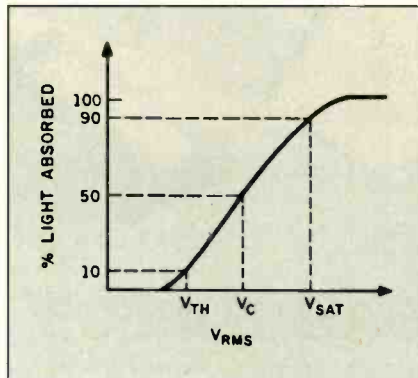

Figure 4: The threshold voltage is the rms voltage at which 10 percent absorption of incident light occurs.  $V_c$  is the voltage at which "on" pixels reach acceptable contrast (usually 2:1) to "off" pixels (those at  $V_{th}$ ) occurs.  $V_{sat}$  (saturation voltage) is the potential at which 90 percent of the light is absorbed.

The value of this resistance depends on the physical distance of the pixel from the drive circuit and the properties of conductor deposition. Because of the tight gap requirement between the plates and sheet resistance effects, it is essential that LCDs use glass that is very flat. Presently there are only a few suppliers producing glass acceptable for large display applications.

A typical response curve for an LC is shown in figure 4. LCDs with fewer pixels (specifically, fewer dot rows) can

use materials that exhibit shallow slope in their response curves and have threshold voltages ( $V_{th}$ ) near 1.2 volts (V) rms (root mean square). The use of multiplexing (described later) in the larger LCDs used today requires less voltage margin between contrasting pixels. Materials currently used do have steeply sloped response curves but consequently have higher threshold potential due to their chemical properties.

### MULTIPLEXING AND BIAS

For a multiple-line LCD, turning dots on and off is not simply a matter of applying a constant potential to each pixel. An 80-character by 16-line display (480 by 128 dots) would require more than 61,000 separate conductors to form a static drive scheme in which each dot is electrically isolated. The current photolithographic technique used to reliably etch ITO is limited to a minimum conductor spacing of 50 microns for good production yields. The actual conductor width itself is limited by the resistance per square of ITO. Ignoring the conductors altogether, the spacing constraint alone would necessitate a panel perimeter of greater than 3 meters to bring in all the connections. Also, producing some 61,000 minute connections reliably is no trivial problem. LCDs that use narrow conductors and spacings are under investigation. Presently the application of this technology to large pieces of glass in volume production is impractical because of processing defect problems and sheet resistance effects.

To overcome the interconnect problem, large TN-LCDs use a multiplexing scheme that is similar to a keyboard scan. In a multiplexed panel with  $n$  rows (duty panel), each "on" pixel only experiences peak voltage,  $V_p$ , for  $1/n$ th of the time. Along with duty cycle, the other electrical parameter that affects contrast is bias ( $B$ ). The number of bias levels is the amount of discrete, uniform steps of voltage into which the LCD's supply is divided.  $B$  is usually expressed as the reciprocal of this number of levels.

(continued)



## Why people choose an IBM PC in the first place is why people want IBM service...in the first place.

After all, who knows your IBM Personal Computer better than we do?

That's why we offer an IBM maintenance agreement for every member of the Personal Computer family. It's just another example of blue chip service from IBM.

An IBM maintenance agreement for your PC components comes with the choice of service plan that's best for you—at the price that's best for you.

Many customers enjoy the convenience and low cost of our carry-in service. That's where we exchange a PC display, for example, at any of our Service/Exchange Centers.

And for those customers who prefer it, we offer IBM on-site service, where a service representative comes when you call.

No matter which you choose for your PC, an IBM maintenance agreement offers you fast, effective service.

Quality. Speed. Commitment. That's why an IBM maintenance agreement means blue chip service. To find out more about the specific service offerings available for your PC, call 1 800 IBM-2468, Ext. 104 and ask for PC Maintenance.

Inquiry 175

Blue chip service from 

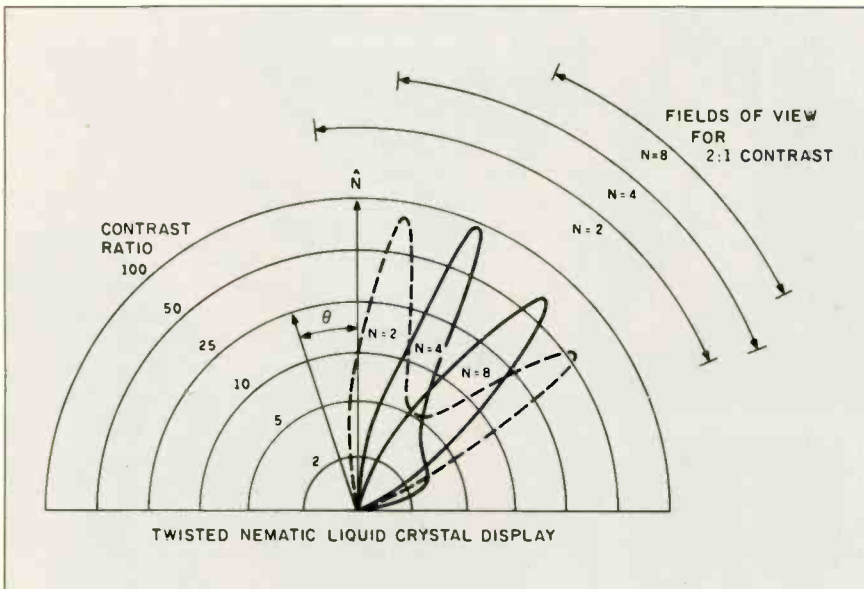

Figure 5: Multiplexing as it relates to contrast and viewing angle for a transmission mode LCD. Concentric rings represent measured contrast ratio (CR) of "off" to "on" pixels. Theta,  $\theta$ , is the displacement of viewing angle from the normal direction,  $\hat{N}$ . The response of a liquid-crystal medium for three different levels of multiplexing,  $N$ , is shown.

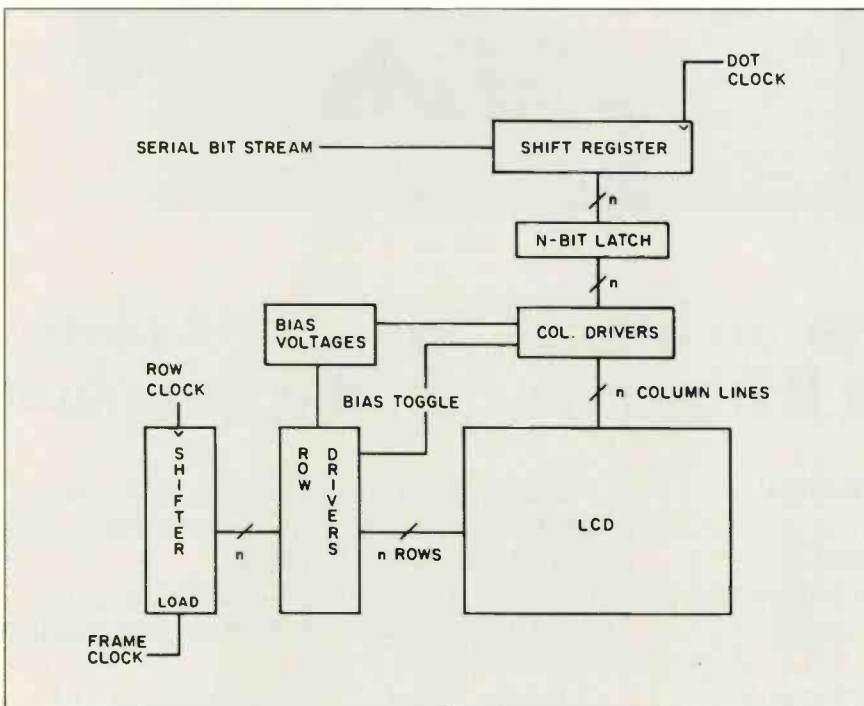

Figure 6: Circuit schematic for an LCD quadrant. Dots are shifted on the fall of dot clock. Values are moved from the serial shifter to the n-bit latch and a new row is selected by the fall of row clock. Frame clock resets the row sequencer and initiates the next frame. The bias toggle along with the dot value determines the voltages driven on the row and column lines.

(For example, if the peak voltage delivered to the panel is 18 V and it is divided into 2-V steps for use by the drive circuitry, then  $B=1/9$ .)

The time-averaged DC voltage applied to each dot is resolved by calculating the rms voltage applied to it over the course of a single refresh period. This value reflects the energy delivered to each capacitive pixel by the applied AC waveform.

For simplicity let's assume you turn on a pixel in the first dot row of an  $n$  row display to  $V_p$ . During the next  $n$  rows of refresh, this dot experiences the "off" voltage ( $= B \cdot V_p$ ). The rms voltage seen by a selected pixel ( $V_s$ ) is given by

$$V_s = (V_p) \left( \frac{1^2 + (n-1)(B)^2}{n} \right)^{1/2}$$

On the other hand, nonselected pixels experience "off" voltage constantly throughout the refresh period. The voltage they experience is

$$V_{ns} = B \cdot V_p$$

By plugging through the mathematics you will find that, given a fixed value of  $B$ , the ratio of  $V_s/V_{ns}$ , which is related to CR (see figure 4), decreases as  $n$ , the number of rows, increases. Contrast gets worse as more rows are multiplexed. Conversely, as the number of bias levels increases (up to a theoretical limit) for a fixed number of rows, the CR improves for a fixed viewing angle.

In the case of multiplexed LCDs, the best number of bias levels is given by  $B=1/(n)^{1/2} + 1$ . This rule optimizes the contrast for a given value of  $n$ . For a 64-dot row display, the bias value chosen would be 1/9. In practical applications this number is not always used, but a convenient bias value is chosen.

### THE EFFECTS OF VIEWING ANGLE

Application of an electric field to LC media causes alignment of the long axis of the molecules in the direction of the field lines. When a pixel is activated in a multiplexed display, the rms value of selected voltage is of lesser magnitude than the saturation value ( $V_{sat}$ ) (see figure 4) for the material.

The closer the value of  $V_s$  is to the  $V_{sat}$ , the greater the rotation the LC dipoles in the direction of applied field. (Perpendicular to the surface of the glass.) Maximum contrast is achieved when the viewing direction is coincident with the alignment of the long axis of the molecules. Thus, as duty cycle decreases ( $V_s$  decreases) the optimal viewing angle moves away from the normal.

An increase in multiplexing also implies a lower voltage margin between selected and nonselected pixels. With a small voltage margin the orientation of molecules in an "on" pixel relative to an "off" pixel is only slightly different angularly. Thus, acceptable contrast is only perceivable over a narrow field of view for LCD panels with multiplexed lines (see figure 5).

### AS DISPLAYS GET LARGER

In early 1982 the practical limit for multiplexing was 32 rows, and now, because of improvements in LC materials, this number has been raised to 128.

Due to the matrix design used in TN-LCDs (shared rows and columns), crosstalk between selected and nonselected pixels can occur. The visual implications of crosstalk are reduced contrast and dark streaking called "shadowing." To minimize shadowing, a design using three different biases is implemented. For a 64-row display, dots on rows that are not undergoing refresh experience a potential of  $1/9(V_p)$ . During a given row's refresh, the "on" and "off" dots are driven to  $V_p$  and  $7/9(V_p)$ , respectively. Calculating  $V_{rms}$  for these conditions using a value of  $V_p = 18V$  yields  $V_s = 3V$  and  $V_{ns} = 2.65V$ . (This is a simplified example. Actual biases chosen depend on the ease of design.) Although the voltage margin in this biasing scheme is smaller than the voltages resolved using the equations that were previously explained, crosstalk effects are reduced by decreasing potential differences between neighboring pixels.

The rms voltage experienced by an "on" pixel (for a fixed multiplexing value) is directly affected by the magnitude of peak voltage applied to

it. Presently the CMOS (complementary metal-oxide semiconductor) circuitry used to drive the row and column lines is only capable of 18 to 20 volt swings. Low-power drivers are being developed that are capable of tolerating up to 30 V. These drivers will improve the optical qualities of the panels and allow for a greater number of dot rows.

### MECHANICAL DESIGNS

To compensate for the viewing angle restrictions and the glare of overhead lighting, the display assembly of most portables offers variable tilt. Pressure sensitivity of the LCD and ruggedness requirements make it necessary for the panel to have a protective cover. By texturing the plastic, glare can be minimized but some image sharpness is lost.

Portables must endure harsh treatment: being carried to and from work, dropped on the floor, and often mistaken for outlets of aggression; their fragile displays must be protected when not in use. Many portables use a display assembly that pivots into a closed position above the keyboard. This design, along with proper mounting and cushioning, protects the panel from direct contact with the environment when being transported and forms a compact portable package.

### LIMITATIONS OF TN-LCDs

No matter how adjustable the display assembly is, in low lighting situations reflective TN-LCDs become illegible. Adding a backlight source to these normally nonemissive displays is costly in terms of power (an additional 1 to 2 W is needed), but the range of acceptable lighting for readability is improved.

LCDs also limit the temperature range in which a portable can be used. Below 0° and above 50° Celsius, typical LC media undergo phase changes and the displays become unusable (although they are not permanently damaged). The LC's response time and threshold characteristics also vary with temperature. Some portables use a compensation circuit that adjusts bias voltages according to

operating temperature. In purchasing TN-LCDs for portable systems it is necessary to specify the interreaction of viewing angle and temperature before they affect contrast and, therefore, readability.

### CIRCUIT ARCHITECTURE

To overcome limitations of the multiplexed technology, some manufacturers play tricks in the fabrication of LCD modules. For character fonts that are 8 pixels tall the existent 64-dot row limit originally allowed for only 8 lines of alphanumeric display. To overcome this and produce a 16-line panel, two 64-way multiplexed systems are adjoined. Separate column lines enter the glass from both the top and bottom. The need for 80 characters per line causes further complications in designing LCD panels. Early in the the development of LCDs, CMOS shifters with limited clock speeds were used. Their low frequency led to flicker problems in wide displays. To alleviate this, the top and bottom halves were again divided, forming a total of four quadrants, each requiring its own serial bit stream.

Time multiplexing is handled by the digital circuitry incorporated in the drive circuits. An approach is to save a series of digital pixel states that represents the pattern for a given row. Once the potentials corresponding to these states are set up at the column lines, the row line is scanned by altering its drive voltage. During the selection of one row, the upcoming row's values are being shifted and saved for its refresh cycle. The analog voltages used to bias the display are derived by dividing the voltage supplied to the module through a resistor ladder. By periodically toggling a control line that ties to both the row and column drivers, the polarity of signals applied across the pixels is reversed, eliminating any net DC bias. The application of a net DC bias to the LC media will cause long-term damage to the display. A schematic representation of the digital circuitry is depicted in figure 6.

Portability dictates the need for a

*(continued)*

*Without TN-LCDs,  
powerful, affordable,  
portable computers  
would not be  
available today.*

low-power and highly integrated circuit to interface the LCD with a micro-processor bus. For example, the custom controller that handles both refresh and update in the HP 110 was designed for lack of an industry standard part. To avoid wiring the system bus to the display assembly, the controller integrated circuit (IC) and display RAM (random-access read/write memory) are positioned inside the main case and the LCD interface

signals (four data lines, dot clock, row clock, frame clock, and bias toggle [M-clock]) and power lines are connected to the controller via a cable hidden in the display arm.

The magnitude of the supply sent to the panel can be regulated under software control. Changing this voltage affects the magnitude of each bias level and thus regulates display contrast.

**THE FUTURE**

Although twisted nematics currently offer the only practical, low-power solution for portable displays, several new technologies are on the forefront. Guest-host displays that use a liquid crystal doped with a dye offer brilliant contrast and do not require the use of polarizers. These panels have been demonstrated but are not yet produced with high multiplexing. Active matrix technologies have also been

demonstrated, but due to cost and yield considerations their use for large panels is several years in the future.

With improvement in LC materials and the CMOS drivers used to run multiplexed displays, the visual aspects of large TN-LCDs will undoubtedly improve. Now that the age of the backlit LCD is upon us, the work environment in which a portable will be useful will be greatly expanded. Another advance being made is in the use of plastic rather than glass for the panel's plates. Using plastic makes the display lightweight, rugged, and thinner than what is currently available, although controlling the cell gap is difficult because of plastic's flexibility.

Even though TN-LCDs may be difficult for your neighbor to read, they offer a perfectly adequate solution for a single user. Without them, powerful, affordable, portable computers would not be available today. ■

# STEAL AN INDUSTRIAL SECRET.

American companies trust their most important computer information to special premium grade unbranded "industrial quality" diskettes. These diskettes, manufactured by select American and Japanese firms, must meet or surpass stringent specifications.

You can now purchase these 5¼" diskettes from Holmes & Company. Even better, you can buy them at the low price paid by the big corporations . . . as low as \$.80 each (SS/DD, with reinforced hub ring, TYVEC sleeve, write protects, labels). Each diskette has been tested prior to shipment and carries a lifetime replacement warranty.

To order today, call toll-free 1-800-4-HOLMES (In California 408-241-1505). Ask about quantity discounts and special prices on hardware and supplies. **Holmes & Co., 900 Lafayette Street, Suite 605, Santa Clara, California 95050**

Quant.	Description	Price	Total	Name _____
	SS/DD	\$1.00		Address _____
	DS/DD	\$1.30		City _____ State _____ ZIP _____
	Subtotal:	_____		Phone (____) _____
	CA Res. Add 7% Tax:	_____		Signature _____
	Handling Charge:	\$2.50		MC _____ VISA _____ Card # _____ Exp. date _____
	Total:	_____		

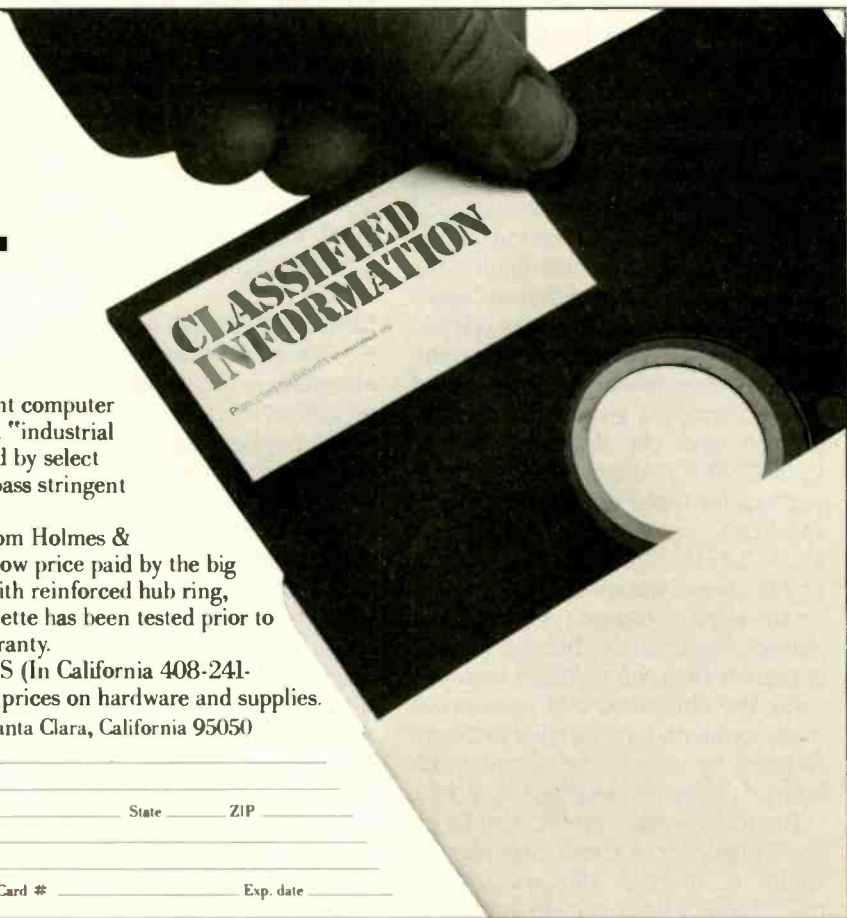



Introducing  
the new  
and improved  
IBM PC.

# Introducing

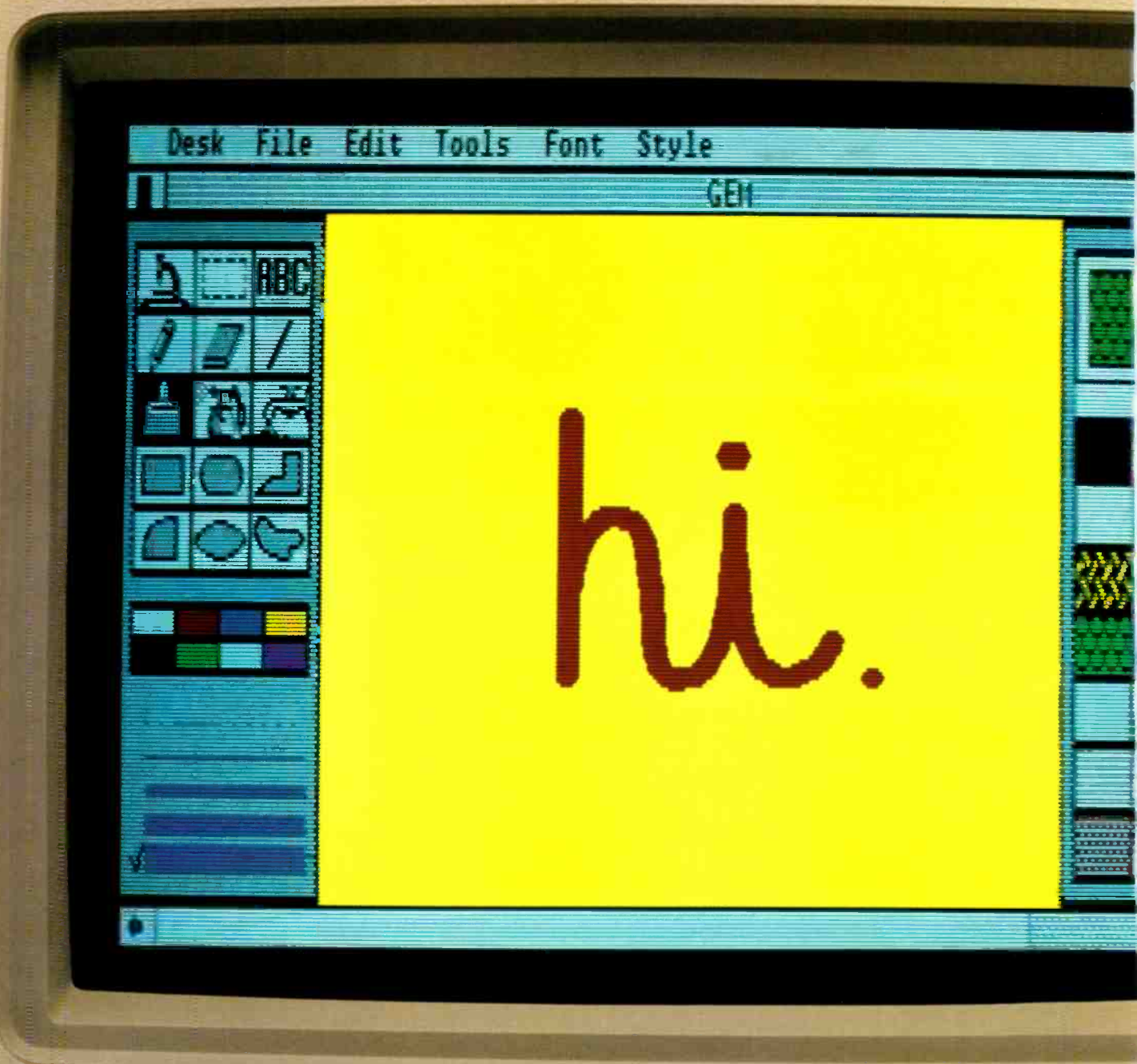

# GEM.

Congratulations.

You just found the perfect way to get a brand new and improved IBM® PC without buying one.

Get GEM™\* software from Digital Research instead.

And *voilà*, your IBM PC, PC/XT, AT or compatible will become something it's never been before.

Easy to use.

Now instead of getting lost in PC DOS, you can actually use your PC to get something done. (An astonishing idea, if ever there was one.)

Just slip a GEM diskette into your disk drive. And the rigmarole of PC DOS is replaced by a way of working that's easy, effortless and altogether personable.

You see, GEM lets you work with a simple descriptive header menu, icons, drop-down menus, windows and a pointer.

Which means you can now use your computer to write, figure, draw and even think the way you used to. Before less-than-friendly computers made you change your way of thinking.

In other words, your tool for modern times has finally become a tool for modern times.



To see how easy  
it is to use GEM,  
take this simple  
screen test.

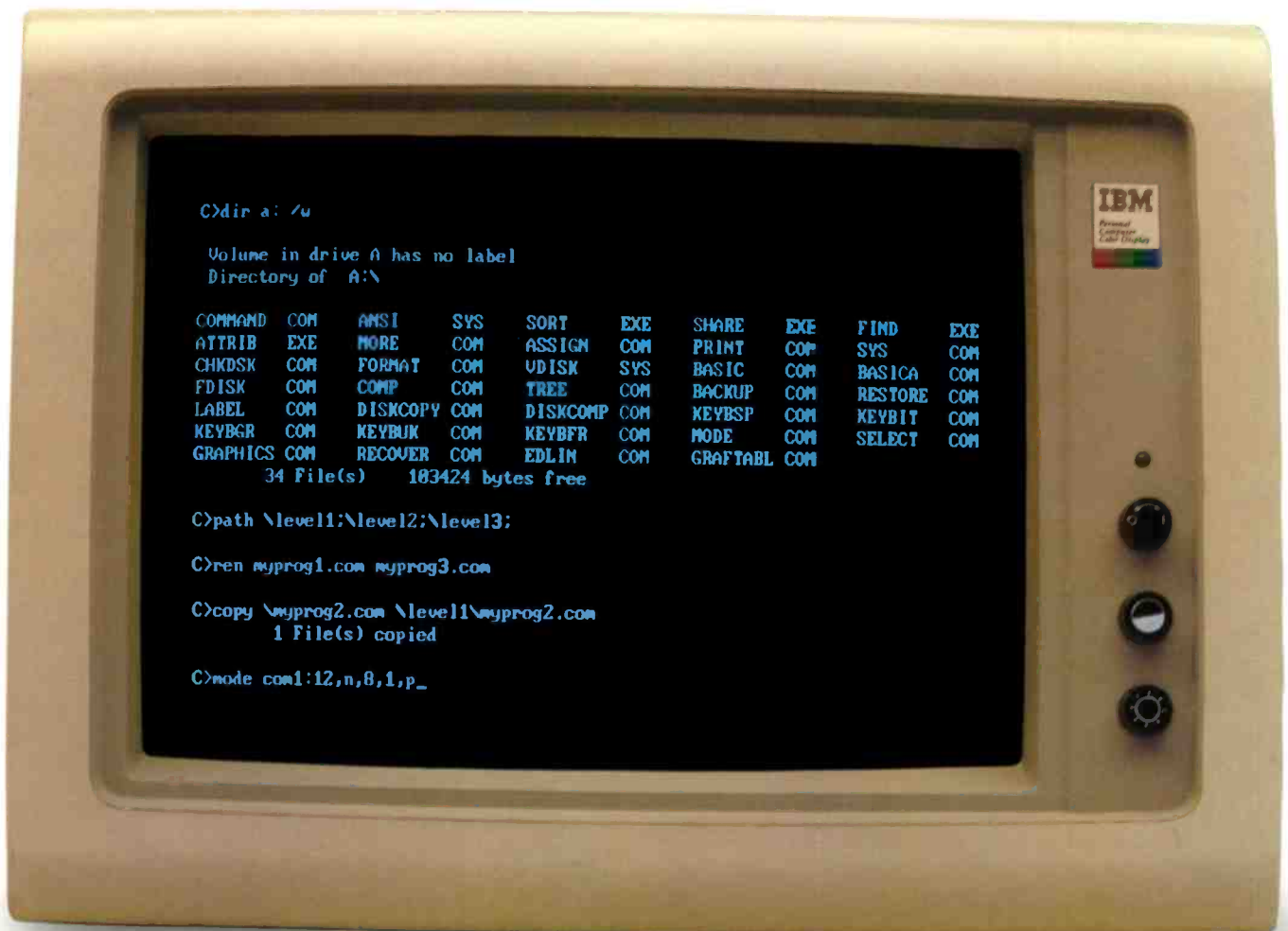

OK. Take a close look at these two screens.

One is an IBM PC with PC DOS. The other is an IBM PC with GEM.

You get to figure out which is which.

The PC DOS screen is the one that seems to be designed for an engineer. Or someone with a photographic memory.

It requires you to type and memorize nonsensical terminology like *c>copy\myprog2.com\level1\myprog2.com*. All just to copy a file.

But most people think in ideas. Words. And pictures.

Which brings us to the GEM screen.

It's the one with pictures of the things you use in your office. Like file folders.

Diskettes. And a wastebasket.

Plus words describing the kinds of things you do in your office. Like OPEN FOLDER. SAVE FOLDER. And QUIT.

Copying a file is as easy as pointing with a mouse (or cursor key—if mice make you uneasy) to the file you want to copy. Then you just slide the file across the screen to the diskette you want to put it on.

Well, by now we've probably given it away.

If you guessed that GEM is on the right-hand screen, you're absolutely right. And if you think GEM looks easy to use, you're right again.

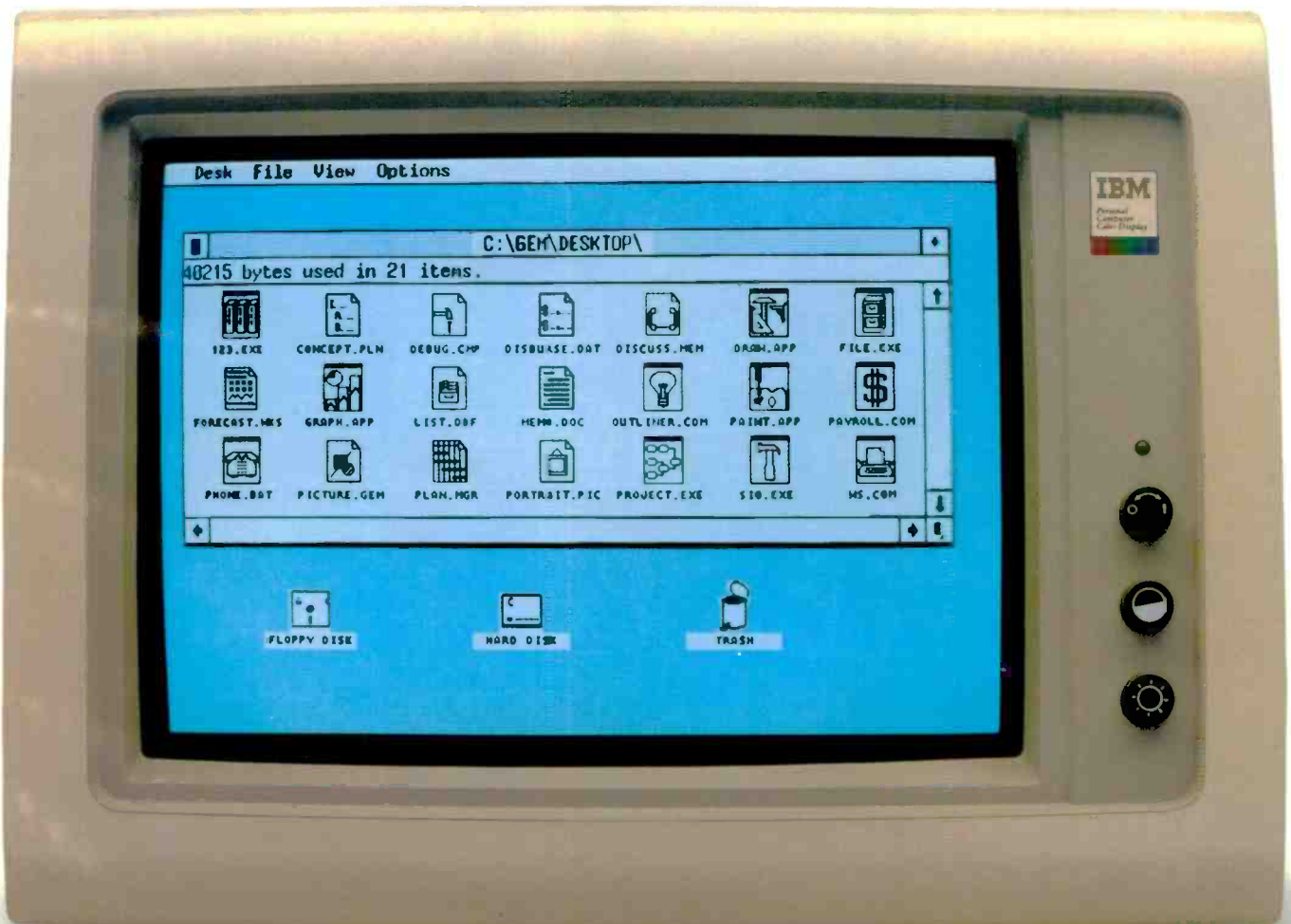

Now, given  
a few pointers,  
anyone can use  
an IBM PC.



Have you ever noticed how people in your company get up from their PCs looking rather dazed?

That's called PC DOS anxiety.

And it goes away when GEM enters the picture.

Because with GEM everybody already knows everything they need to know to run a PC.

Like how to point.

Click.

Read a menu.

Open a file folder.

Or pitch a bad idea in the wastebasket.

Who knows, GEM software could even turn people with deep-rooted PC-phobia into absolute PC-enthusiasts.

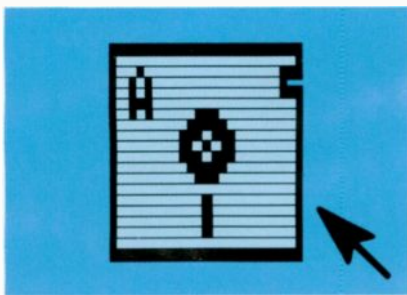

*With GEM software you don't have to switch gears to switch drives. You can just point and click your way from drive to drive. No matter how many drives or diskettes you're using.*

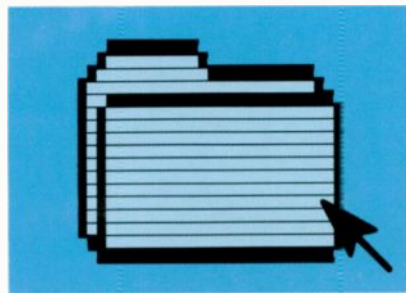

*GEM file folders hold whatever you put on a diskette. From entire software programs to reports, pictures and presentations.*

*In fact, GEM file folders can even hold other file folders. And so on.*

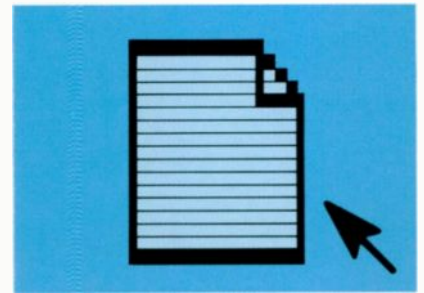

*GEM software even includes "generic" file folders, places to hold random ideas, memos, numbers and the like until you're ready to file them in a GEM folder. Or in the wastebasket.*

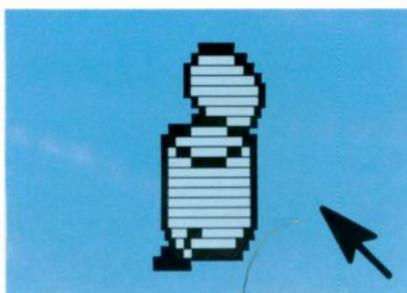

*Part of getting organized is knowing when to let go of outdated files.*

*GEM can't tell you which files to get rid of. But it can help get rid of them.*

*And should you toss a file before its time, you even get a chance to change your mind.*

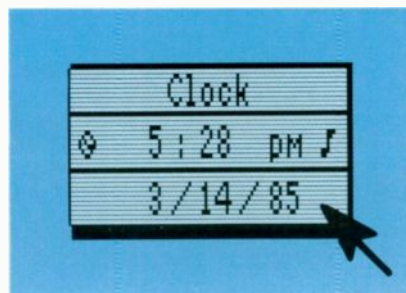

*If you're clever enough to read these words, you've no doubt figured out what the GEM clock is for. Staying on schedule, for instance. Keeping track of the time it takes to do specific projects. Or getting to your airplane on time.*

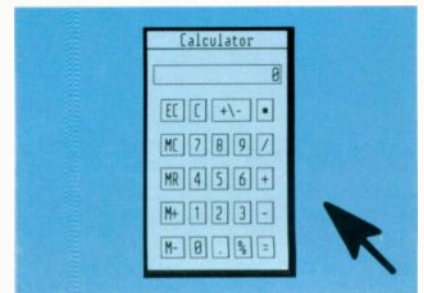

*GEM even includes a calculator, so you can tally up all kinds of important things.*

*Like the time and keystrokes you save by working with GEM software.*

GEM already  
works with most  
of the software you  
already have.

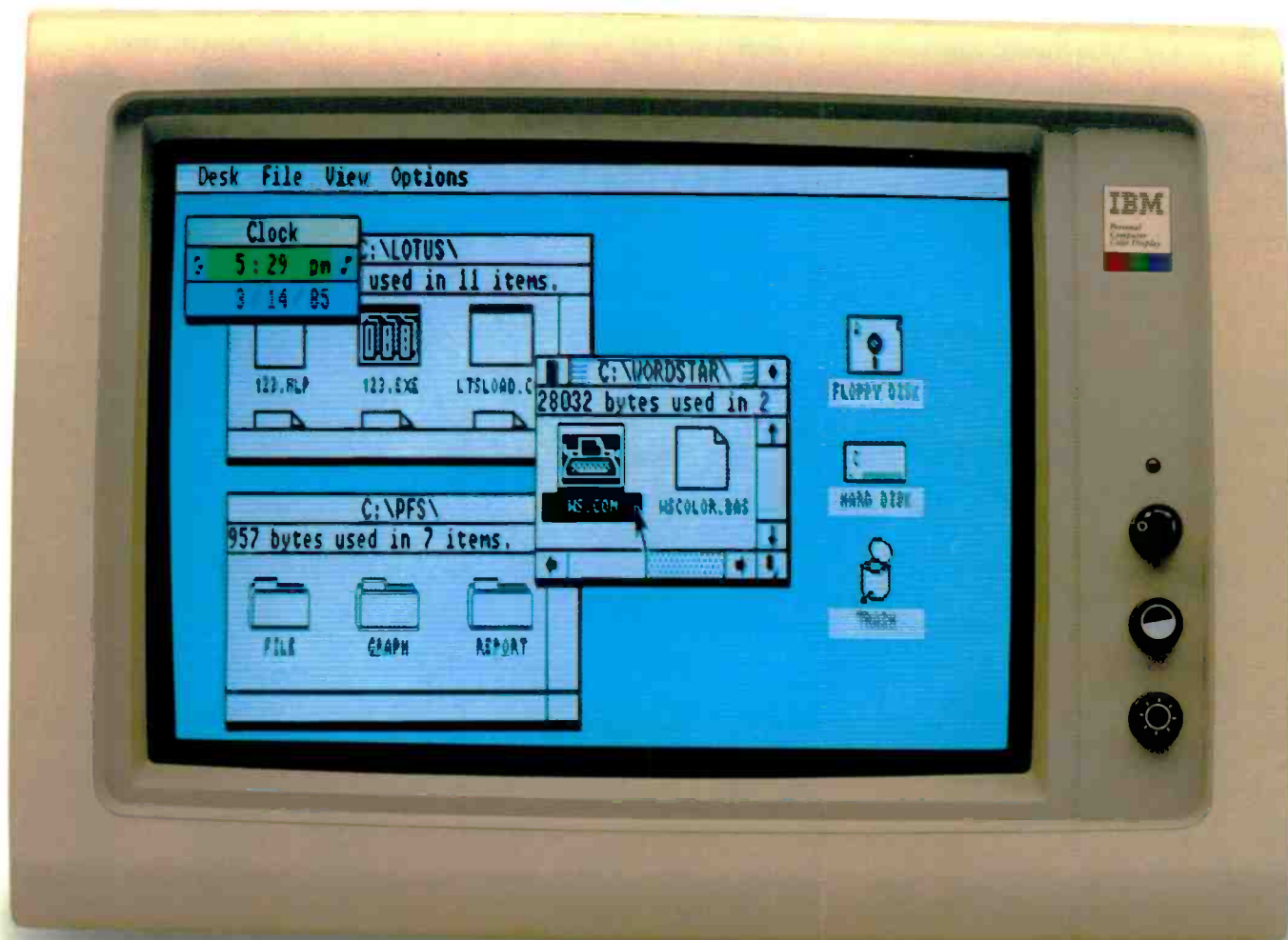



We know what you're wondering.  
If GEM software is going to change  
the way you work with your IBM PC,  
will you still be able to work with your  
existing software?

Of course.

GEM works with most important  
programs that work with the IBM PC.  
Like Lotus 1-2-3™ Symphony™

Multiplan® dBASE III.™ Framework™  
And thousands more.

Technically, you see, GEM software  
doesn't actually change PC DOS. It just  
hides it.

So your software works just the way  
it always has. But without the long and  
cryptic PC DOS start-up procedures.



# But the best software for GEM is GEM software.

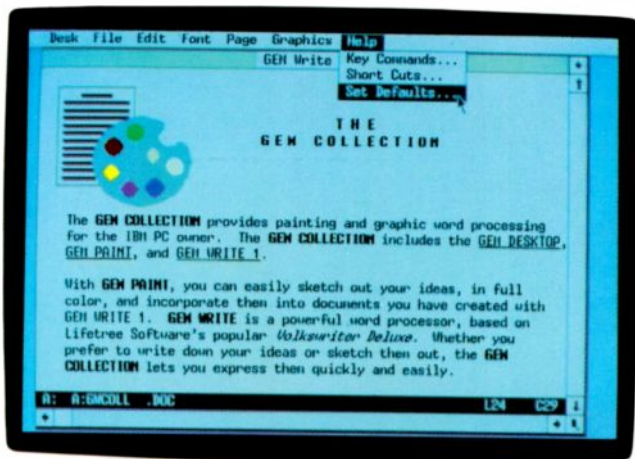

The GEM COLLECTION™ is a bundle of three programs, GEM DESKTOP™, GEM WRITE™, and GEM PAINT™.

A part of all GEM software, GEM DESKTOP\* is the mask that hides PC DOS. It includes the GEM pointer, menu headings, icons and drop-down menus.

So you can point and click your way through anything you'll ever want to use a computer for.

GEM WRITE, by Lifetree Software, Inc., is a word processing program featuring fast, clear and comprehensive editing. It lets you cut and paste, make multiple block moves or even create columns. All without memorizing a single command.

And when words alone won't express what you have to say, GEM PAINT gives you the tools to turn your ideas into pictures. Up to sixteen colors. Paintbrushes, pencils and a straightedge. Plus dozens of shapes and patterns.

Best of all, GEM WRITE and GEM PAINT work together. So you can work

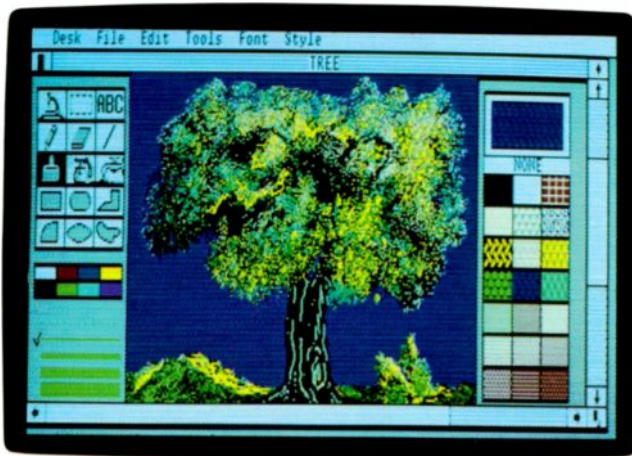

**The GEM COLLECTION**  
*Now you can work with words and pictures together.*

\*GEM DESKTOP is also available as a stand-alone product.

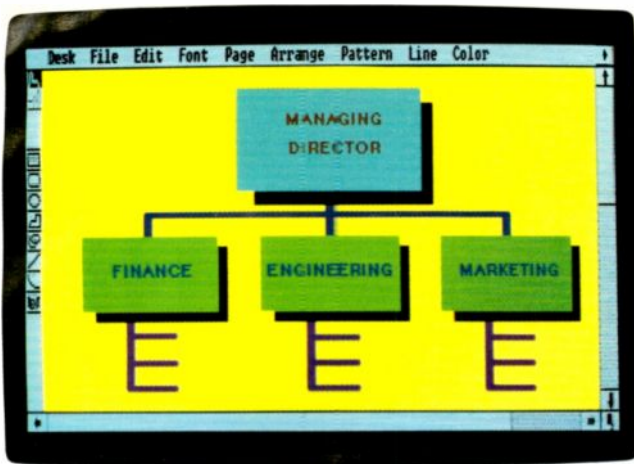

### GEM DRAW

*A perfect illustration of the power of GEM software.*



### GEM WORDCHART

*Present it with style.*

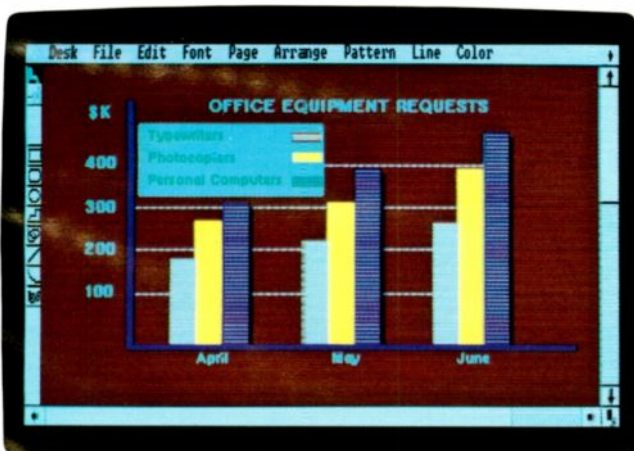

### GEM GRAPH

*Let's look at the numbers.*

with words and pictures on the same page.

You can also create anything from fine art to line art, whether you can draw or not.

Just put your hand on your mouse and point.

GEM DRAW™ gives you all the tools you need.

Like pencils, geometric patterns, a full palette of colors and an extensive gallery of art to use as you like.

And once you've created a GEM DRAW image, you can stretch it. Shrink it. Duplicate it. Or add text to explain it.

GEM WORDCHART™ is the perfect way to make your point in a big way.

With a choice of several type styles and sizes, plus up to sixteen colors, you can build charts that can be read from across your desk or from the far end of the conference room.

And to really drive your point home, your words can be combined with pictures from GEM DRAW.

The business of creating business graphics just got a whole lot easier.

GEM GRAPH lets you turn numbers into something more tangible. Like pie charts. Bar graphs. Line plots. Even maps. All through the use of simple, well-designed templates.

Where do you get the numbers?

Directly from the business programs you're already using, like Lotus 1-2-3, Symphony, dBASE III or what have you.

# Where to find a GEM.

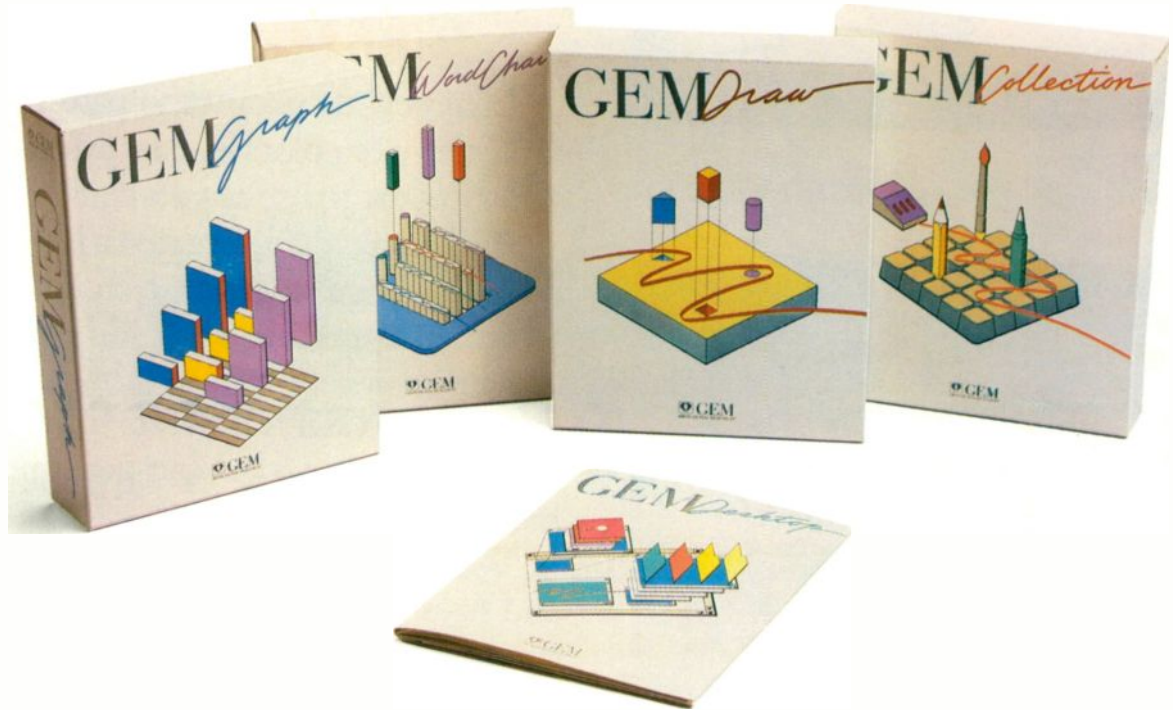

In the months ahead you'll be seeing GEM software on a lot of familiar faces. And not just IBM PCs or compatibles.

Several leading computer manufacturers are building GEM software right into their hardware.

And with so many systems working with GEM, you'll soon see important GEM programs coming from a host of other major software houses.

GEM. From Digital Research.

It's not just software. It's a movement.

And it's as easy to find as it is to use.

Just call our GEMLINE. (800) 443-4200. Ask for our GEM brochure. The name

of your GEM software dealer. Or simply place an order.

Because with GEM, the best new computer on the market isn't a computer at all.

## GEM PRICE LIST

GEM DESKTOP	\$ 49.95	Available April
GEM DRAW	149.00*	Available April
GEM COLLECTION (includes GEM DESKTOP, GEM PAINT, GEM WRITE)	199.00	Available June
GEM WORDCHART	149.00	Available August
GEM GRAPH	199.00	Available August

Also available:

HERCULES GRAPHICS CARD™ \$499.00

PC MOUSE™ BY MOUSE SYSTEMS™ \$195.00

Sales or use tax where applicable will be added.

Suggested retail prices subject to change without notice. \*Introductory price.

 **GEM™**  
FROM DIGITAL RESEARCH®

\*GEM requires that your computer have appropriate graphics capability and that the pointing device be compatible. Call for exact requirements. GEM, GEM COLLECTION, GEM DESKTOP, GEM WRITE, GEM PAINT, GEM DRAW, GEM GRAPH and GEM WORDCHART are trademarks and Digital Research is a registered trademark of Digital Research Inc. Other computer and software names are tradenames and/or trademarks of their respective manufacturers. Copyright 1985, Digital Research Inc. All rights reserved.

## PRODUCT DESCRIPTION

## THE GRIDCASE

*These new portables  
are IBM PC-compatible  
and one version has  
a gas-plasma display*

*Editor's note: The following is a BYTE product description. It is not a review. We provide an advance look at this new product because we feel it is significant. A complete review will follow in a subsequent issue.*

**R**ecently, GRiD Systems Corporation brought its portable systems into the mainstream of microcomputers. The new GRiDCase computers are about the same size (briefcase-size) and feature the same magnesium case as GRiD's Compass computer, but they forgo the Compass's expensive and power-hungry electroluminescent display and bubble memory. Instead, the GRiDCase computers offer a range of display options. The GRiDCase I features a utilitarian and affordable liquid-crystal display (LCD). The GRiDCase II has an "enhanced" LCD. And, in keeping with GRiD's emphasis on what its representatives call "portable displays that more than one person can read," the GRiDCase III offers a high-contrast gas-plasma display (see photo 1). For users who like the more traditional cathode-ray tube displays, GRiD has provided an optional interface to connect an IBM Personal Computer (PC)-compatible RGB (red-green-blue) monitor (see photo 2) to the GRiD-

Case computers.

Other evidence of the GRiDCase family's new mainstream character include its compatibility with IBM PC software and its price. Although the GRiDCase III with the gas-plasma display sells for a hefty \$4350, the LCD-based GRiDCase I has a list price of \$2975, which is fairly competitive with that of the Data General/One. The GRiDCase II sells for \$3150.

**THE DISPLAY**

All three GRiDCases are almost identical except for their displays. Despite its high cost, GRiD Systems is most proud of the gas-plasma display. The company had investigated using an

electroluminescent display as it had in the Compass, but all such displays were designed using a 512- by 256-pixel matrix, which would make compatibility with the 640- by 200-pixel screen of the IBM PC's graphics adapter impossible. GRiD therefore decided in favor of the gas-plasma display. The GRiDCase III's display presents a stable, sharp, high-contrast image. GRiD expects that many people will prefer it over a high-contrast cathode-ray tube screen. The display

*(continued)*

Rich Malloy is the New York editor for BYTE. He can be reached at BYTE, 43rd floor, 1221 Avenue of the Americas, New York, NY 10020.



Photo 1: The GRiDCase III with the gas-plasma display. GRiDPlot, GRiD's proprietary graphics package, is shown on the screen.

**IN BRIEF**

**Computer**

GRiDCase I, II, and III

**Manufacturer**

GRiD Systems Corp.  
2535 Garcia Ave.  
Mountain View, CA 94043  
(415) 961-4800

**Physical Characteristics**

2¼ by 11½ by 15 inches; weighs under 12 pounds

**Microprocessor**

80C86, 16-bit at 4.77 MHz; optional 8087 80-bit arithmetic coprocessor

**Features**

Options for 128K-byte, 256K-byte, and 512K-byte CMOS RAM; up to 512K bytes of user-installable ROM sockets; 3½-inch 720K-byte floppy-disk drive; built-in speaker

**Display**

LCD or gas-plasma; 80 characters by 25 lines; 640- by 200-pixel bit-mapped display (IBM PC-compatible)

**Keyboard**

57-key IBM PCjr-compatible with tactile feedback

**Interfaces**

RS-232C serial port; Centronics-type parallel port; 50-pin external expansion bus; RGB video-out option; 5-pin DIN plug for external IBM PC keyboard; RJ11 phone jack

**Options**

Internal Hayes Smartmodem-compatible 1200-bps modem

**Power Source**

External AC supply; optional internal rechargeable battery pack

**Software**

MS-DOS v. 2.11, GW-BASIC

**Compatibility**

Runs all tested popular IBM PC software

**Price**

GRiDCase I with LCD	\$2975
GRiDCase II with enhanced LCD	\$3150
GRiDCase III with gas-plasma display	\$4350

is also fairly fast. I did not do any scroll tests on it, but it seemed to run Microsoft's Flight Simulator as fast as I've seen it run on any other system. Of course, the screen cannot display colors or shades of gray. It displays gray as a texture of vertical lines.

The gas-plasma screen eats up a large amount of power. The battery module can power the GRiDCase III for only about one hour. Nonetheless, for certain applications this screen may well be worth the extra cost.

For users who can forgo the extra clarity of the gas-plasma display and who may spend appreciable amounts of time away from electrical power outlets, the GRiDCase I's LCD screen could be a reasonable alternative. Although this screen does not have the speed or contrast of the gas-plasma display, it is readable. Based on my brief experience with it, I would judge it to have slightly better contrast than the LCD screen on the original Data General/One. And when you are not traveling, you can connect the GRiDCase I to an IBM PC-compatible RGB monitor. The GRiDCase II is said to have an enhanced LCD, but I did not get a chance to test it. The GRiDCase computers do not have a jack for a composite monitor, but GRiD repre-

sentatives said they were investigating the possibility of producing an optional RGB/composite adapter that would allow you to connect a composite monitor to the RGB port.

**KEYBOARD**

The GRiDCase computers have the dubious distinction of being among the first computers to be compatible with the IBM PCjr keyboard. The main reason for this is the small size of the GRiDCase. Because some keys were going to have to double as function keys, GRiD decided to follow the example IBM set with its small home computer. The result is acceptable but confusing for those whose are used to the large IBM PC keyboard. Some users may take exception to the location of the backspace key (in the lower right-hand corner). Of course, keyboard replacement programs like ProKey and SmartKey may let you rearrange the keyboard as you like. The keyboard felt reasonably good. The typewriter keys were in their standard places, and key action seemed acceptable. Tactile feedback was provided by a key click similar to that on the IBM PC. IBM PC owners may appreciate the fact that they are not tied in to the

(continued)



Photo 2: The GRiDCase III with the video-out option hooked up to an IBM color monitor. Ashton-Tate's Framework package is displayed on the screens. PC Master/Slave software allows easy cable connection from the GRiDCase to the IBM PC.

# WHAT ARE YOU WAITING FOR?



OUTPUT BINS

## SYSTAT ON YOUR MICRO NOW OUTPERFORMS THE MAINFRAME STATISTICS PACKAGES.

SYSTAT computes regressions more accurately than SAS.<sup>™</sup> It tabulates faster than SPSS.<sup>™</sup> It has more statistical routines than BMDP.<sup>™</sup> And SYSTAT includes a full-screen spreadsheet data editor, online help and simple commands.

Compared to other micro statistics packages, SYSTAT's scope is unrivaled. In every published review, SYSTAT has been at the top of the list.

Need proof? If you don't believe a micro statistics package can solve *your* mainframe problems, call or write us today.

Or wait in line.  
SYSTAT,<sup>™</sup> Inc.  
603 Main Street  
Evanston, IL 60202  
(312) 864-5670

**SYSTAT**<sup>™</sup>

IBM-PC/XT/AT<sup>™</sup>

APPLE MACINTOSH<sup>™</sup>

MS-DOS<sup>™</sup>

CP/M<sup>™</sup>

UNIX<sup>™</sup>

THE SYSTEM FOR STATISTICS

## THE GRIDCASE



Photo 3: The GRiDCase back panel (left to right): the DIN connector for the IBM PC keyboard or 10-key keypad, the built-in 300/1200-bps modem (Hayes Smartmodem-compatible), RS-232C serial interface, external bus connector for external GRiD peripherals and access to the IBM PC expansion chassis, Centronics parallel interface, color (RGB) video-out for external monitors, built-in rechargeable/exchangeable battery pack.

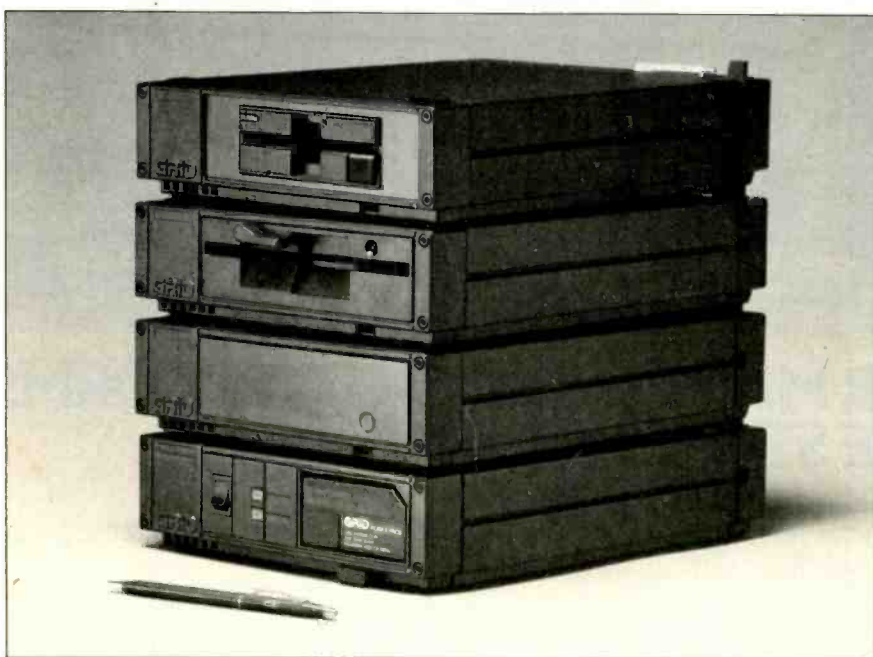

Photo 4: The GRiDCase stackable portable peripherals (from top to bottom): 3 1/2-inch floppy-disk drive, 5 1/4-inch floppy-disk drive, 10-megabyte hard-disk system, base station battery charger/power source.

GRiD keyboard if they don't want to be. Each GRiDCase lets you plug in an IBM PC keyboard and use that instead.

### POWER

All GRiDCase models have two power modules available—a rechargeable battery pack and an AC (alternating current) transformer. Both are the same size (about the size of a box of ten 5 1/4-inch floppy disks cut in half), and both fit in the large socket on the rear panel of the machine. When traveling, you can carry several battery packs and insert them as you need to. Each battery pack lasts four to five hours for the LCD models, and one hour with the plasma model. The batteries can be recharged in about eight hours. For now, the batteries will sell for about \$60. GRiD claims that it went to considerable trouble to ensure that its power supply could work with two displays having vastly different power-consumption rates.

### SILICON

The GRiDCase family of computers uses a low-power version of the 8086 microprocessor with a clock speed of 4.77 MHz. As in many portables, GRiD achieved the low-power capability by using CMOS (complementary metal-oxide semiconductor) technology. An 8087 numeric processor option is also available. A standard GRiDCase system comes with 128K bytes of CMOS memory chips. Memory configurations of 256K bytes and 512K bytes are also available for approximately \$600 and \$1200, respectively.

The GRiDCase computers also come with eight sockets for ROM (read-only memory), although only four of these sockets can be accessed by the user. GRiD will offer programs such as MS-DOS 2.11, GW-BASIC, and Lotus's 1-2-3 on ROM chips.

### INTERFACES

Each GRiDCase computer comes with a serial RS-232C port with a standard DB-25 connector and a Centronics-type parallel printer port (see photo

(continued)



# MICRO CAP and MICRO LOGIC put your engineers on line... not in line.



## MY OWN WORKSTATION

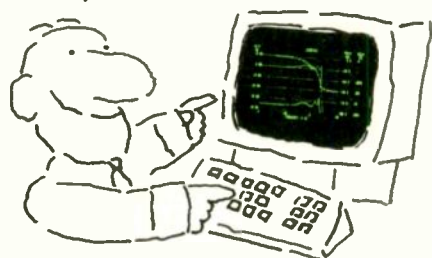

How many long unproductive hours have you spent "in line" for your simulation? Well, no more. MICROCAP and MICROLOGIC can put you on line by turning your PC into a productive and cost-effective engineering workstation.

Both of these sophisticated engineering tools provide you with quick and efficient solutions to your simulation problems. And here's how.

## MICROCAP: Your Analog Solution

MICROCAP is an interactive analog circuit drawing and simulation system. It allows you to sketch a circuit diagram right on the CRT screen, then run an AC, DC, or Transient analysis. While providing you with libraries for defined models of bipolar and MOS devices, Opamps, transformers, diodes, and much more, MICROCAP also includes features not even found in SPICE.

MICROCAP II lets you be even more productive. As an advanced version, it employs sparse matrix techniques for faster simulation speed and larger net-

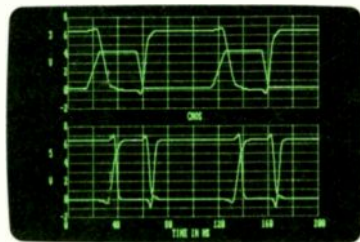

"Typical MICROCAP Transient Analysis"

works. In addition, you get even more advanced device models, worst case capabilities, temperature stepping, Fourier analysis, and macro capability.

## MICROLOGIC: Your Digital Solution

MICROLOGIC provides you with a similar interactive drawing and analysis environment for digital work. Using standard PC hardware, you can create logic diagrams of up to 9 pages with each containing up to 200 gates. The system automatically creates the netlist required for a timing simulation and will handle networks of up to 1800 gates. It provides you with libraries for 36 user-defined basic gate types, 36 data channels of 256 bits each, 10 user-defined clock waveforms, and up to 50 macros in each network. MICROLOGIC produces high-resolution timing diagrams showing selected waveforms and associated delays, glitches, and spikes—just like the real thing.

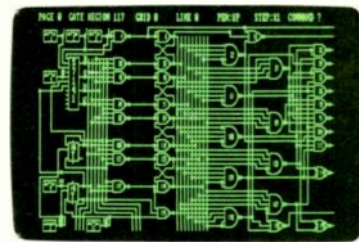

"Typical MICROLOGIC Diagram"

## Reviewers Love These Solutions

Regarding MICROCAP... "A highly recommended analog design program" (PC Tech Journal 3/84). "A valuable tool for circuit designers" (Personal Software Magazine 11/83).

Regarding MICROLOGIC... "An efficient design system that does what it is supposed to do at a reasonable price" (Byte 4/84).

MICROCAP and MICROLOGIC are available for the Apple II (64k), IBM PC (128k), and HP-150 computers and priced at \$475 and \$450 respectively. Demo versions are available for \$75.

MICROCAP II is available for the Macintosh, IBM PC (256k), and HP-150 systems and is priced at \$895. Demo versions are available for \$100.

Demo prices are credited to the purchase price of the actual system.

Now, to get on line, call or write today!

## Spectrum Software

1021 S. Wolfe Road, Dept. B  
Sunnyvale, CA 94087  
(408) 738-4387

Inquiry 337

3). An optional 1200-bps (bits per second) modem is also available for \$795. GRiD claims that it purposely avoided using low-power CMOS chips in the serial port and modem because these chips were not 100 percent compatible with the IBM PC. Also, the need for CMOS chips did not seem a high priority because most phone

lines and serial devices are near electrical outlets.

### THE DISK DRIVE

The GRiDCase comes with one Sony-type 3½-inch floppy-disk drive. Each disk can hold 720K bytes of data, or about the same amount as a two-drive IBM PC. GRiD claims that the

disks use Microsoft's standard 3½-inch MS-DOS format, but they would not confirm that the GRiDCase could read disks used by the Data General/One. GRiD representatives claim that most major software publishers will soon begin distributing 3½-inch versions of their top-selling software products.

Just in case, however, GRiD will be offering an external 5¼-inch drive for \$895. The drive can be set up as the primary drive, allowing you to run copy-protected software like the 5¼-inch version of Lotus's 1-2-3 and Microsoft's Flight Simulator. The unit is about the size of a box of ten 8-inch disks, and it is connected to the main unit by a short thick cable that attaches to the machine's expansion port. Two connectors are available on the drive, allowing you to "daisy-chain" the computer to yet another drive or another expansion peripheral.

Two other peripherals are available. One is a base station battery charger/power source (\$450), which can hold certain GRiD expansion cards, keep the portable unit powered, and, according to GRiD, recharge the portable's batteries in about four hours. GRiD is also making available a 10-megabyte hard-disk drive (for \$2250) that is approximately the same size as the 5¼-inch floppy-disk drive (see photo 4).

GRiD representatives say that they plan to supply a second 3½-inch drive and a cable and adapter card that will let you connect a GRiDCase to IBM's expansion chassis for the IBM PC. The card apparently would let you connect a GRiDCase to any IBM expansion board. As yet there is no price information available for this option.

Since the plasma and LCD models are practically identical, owners of the LCD model have the option of upgrading their units to a plasma model by sending the unit back to GRiD to have the display replaced.

### SOFTWARE

Like the Compass, a GRiDCase has the option of running two operating

*(continued)*

# ZeroDisk ZeroDisk ZeroDisk

## Run Protected Software from a Hard Disk.

ZeroDisk lets you run dozens of popular business software packages without floppies. Call us for the latest list of software it handles. ZeroDisk needs an IBM PC or XT or AT or compatible, running under DOS version 2.0 or higher. It occupies 10k bytes of memory. ZeroDisk is not copy-protected.

ZeroDisk is revised monthly. You may get revisions for an \$18 US trade-in fee.

To order ZeroDisk, send a check for \$75 US, or call us with your credit card. We will ship the software within a day.



Quaid Software Limited

45 Charles Street East  
Third Floor  
Toronto, Ontario M4Y 1S2  
(416) 961-8243

# THE ARK 24K IS THE FIRST UNIVERSAL FDX 2400 DIAL MODEM

## THE ARK 24K HAS IT ALL!

### MULTIPLE MODEMS IN ONE

- State-of-the-ARK MODE: User friendly help commands, Sync/Async operation, DTE buffer to 9600 bps, Separate Sync/Async connectors, Extensive diagnostic capabilities, and much more.
- ARQ Error Free Transmission based on MNP\*
- Hayes™ "AT" Mode Compatible
- Front Panel Operation

On-Site Service Available Nationwide

### DEALER INQUIRIES INVITED

### INTRODUCTORY OFFERS

The ARK 24K...multiple modems in one... **\$595<sup>00†</sup>**  
2400 bps FDX...

*Quantity discounts available.*

The ARK 1200 bps FDX Compatible Version...  
**NOW \$365.00.** At a later date factory upgrade to 2400 bps—\$275.00

To order call 800 228-0914. For more information call (305) 724-5260 or write ARK Electronic Products, Inc., Dept. A, P.O. Box 2169, Melbourne, FL 32902-2169 for your brochure about the most versatile modem on the market today.

 **ARK™** ELECTRONIC PRODUCTS, INC.  
A PARADYNE COMPANY





2

# GPIB

IEEE-488 Interfaces and  
Bus Extenders For:

IBM PC, PCjr  
& COMPATIBLES

DEC UNIBUS, Q-BUS  
& RAINBOW 100

MULTIBUS, VMEbus  
STD & S-100

Full IEEE-488 functionality, with the most comprehensive language and operating system coverage in the industry. It takes experience to make IEEE-488 systems work with nearly 4000 devices available from more than 500 different manufacturers, and experience is what enables National Instruments to take the GPIB to the second power and beyond.



2

Your personal guarantee of unsurpassed customer support and satisfaction. CALL 1-800-531-GPIB for instant access to 100+ man-years of GPIB experience.

**NATIONAL  
INSTRUMENTS**

12109 Technology Blvd.  
Austin, TX 78727  
1-800-531-5066 512/250-9119  
Telex: 756737 NAT INST AUS

IBM and PCjr are trademarks of International Business Machines. MULTIBUS is a trademark of Intel, DEC, UNIBUS, Q-BUS, and Rainbow 100 are trademarks of Digital Equipment Corporation.

## THE GRIDCASE

### THE GRID SERVER

When GRiD first came out with the Compass, it instituted a novel but controversial software-distribution scheme. All software would be sent out over the phone lines from GRiD Central, the company's central computer, which GRiD has now made available to customers. These systems, called GRiD Servers, are based around two 80186 processor chips and can directly connect up to 48 computers in the office and access up to 320 megabytes of hard-disk space. It can also support up to 10 modems and a number of printers. A small system with about 40 megabytes of disk space and the ability to connect to about 8 computers and 2 modems costs about \$16,500.

In the office, the GRiD Server functions as a regular local-area network (LAN) using twisted-pair cables with a data-transfer rate of 250K bits per second. Each GRiD computer has a utility program that allows it to connect to the central server and use the hard disk as if it were its own. Programs and adapter cards are also available for the IBM PC that will allow it to connect with this network.

When you take your portable out into the field, the GRiD Server becomes what GRiD calls a RAN, a remote-access network. All you have to do is connect your modem-equipped system to a phone line. Then, just as in the office, your machine can directly access the central server's hard-drive disk. Whenever you access the hard drive, your system automatically calls up the central computer and begins communicating with it. The system includes its own error-checking protocol to protect against telephone-line noise. Text files and machine-language programs supposedly can be transmitted very easily. The problem is speed. The phone-line limit of 1200 bps (bits per second) is much slower than the usual disk-access time.

One advantage of this system is that application programs such as spreadsheets running on the remote systems can directly use data files on the central hard disk. This seems to be an ideal way to ensure that everyone in a small, scattered work force is using the same data, but the transfer times for large data files may be uncomfortably slow.

systems. One is MS-DOS, which has been made highly IBM PC-compatible. The other is a proprietary system called GRiD-OS, which GRiD claims is multitasking. They have developed a number of business-productivity software packages for this system.

The GRiDCase comes bundled with only MS-DOS version 2.11 and GW-BASIC. As of this writing, it is unclear whether this software will be provided on disk or on ROM chips. GRiD's version of MS-DOS includes a special utility that lets you connect easily to one of GRiD's RANs (remote-access networks) (see the text box "The GRiD Server" on this page).

#### SERVICE

GRiD is apparently taking advantage of the GRiDCase computers' small size by instituting a novel service arrangement. For an additional fee, between \$540 and \$720, depending on

your configuration, you can arrange to have next-day replacement service. Under this policy, if your machine breaks down, GRiD claims that it will send you a new machine by Federal Express to keep until the company repairs your machine.

#### SUMMARY

The GRiDCase computer seems to be a potent competitor in the briefcase computer market. I only had a brief chance to look at the machines, but I was impressed. Some questions remain, however: Do the machines really run all IBM PC software? How comfortable is the LCD screen after long hours of use? Are the serial and printer ports compatible with most peripherals? BYTE will try to answer these questions in a full system review in a later issue. For now, I look forward to seeing gas-plasma displays on more machines. ■

# THE DUAL HEAD PRINTER

## THE FORTIS DH45, THE START OF A NEW BUSINESS GENERATION

DAISY OR DOTS... Have it your way. Don't settle for one or the other... get both.

The revolutionary FORTIS DH45 dual head printer combines the speed and bit image graphics of a dot matrix with a high quality daisy wheel for crisp letters. All this in one compact unit that saves desk space and at a price that is less than you would pay for one printer. It is also compatible with IBM\* PC and most other personal computers.

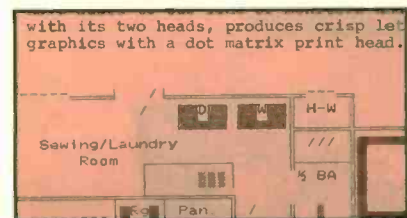

Imagine the advantage of having two heads in one printer. Need graphics or condensed print spreadsheets or a rough draft of a long letter, just touch the control panel. How about important correspondence to impress a potential client, again, just touch the control panel to switch to the letter quality daisy wheel.

Indeed, the old saying **TWO HEADS ARE BETTER THAN ONE**, really holds true in the DH45.

\*IBM is a registered trademark of IBM Corp.



**FORTIS** **Dynax, Inc.**<sup>TM</sup>

### DYNAX, INC. OFFICES

- HEADQUARTERS 6070 Rickenbacker Rd., Commerce, CA 90040 • (213) 727-1227
- NEW JERSEY One Madison St., East Rutherford, NJ 07073 • (201) 471-0100
- TEXAS 6012 Campus Circle, Suite 250, Irving, TX 75062 • (214) 257-1700
- ILLINOIS 533 West Golf Rd., Arlington Heights, IL 60005 • (312) 228-0707
- MASSACHUSETTS 400 W. Cummings Park, Suite 5300, Woburn, MA 01801 • (617) 933-8162
- N. CALIFORNIA 1255 Oakmead Parkway, Sunnyvale, CA 94086 • (408) 730-1712

Inquiry 135

YES! Please send me more information on the FORTIS DH45 Dual Head Printer

Name	Title		
Company	Phone		
Address	City	State	Zip

Mail to: DYNAX, INC. Customer Service / FORTIS DH45  
6070 Rickenbacker Road, Commerce, CA 90040

# The Avocet family tree



# Avocet turns an ordinary PC into an extraordinary development system.

## And saves you \$20,000 in the process.

Now, there's a way to see all your best microprocessor designs take root, easily and effectively. Avocet cross-assemblers, simulators,

to use. We provide you with everything you need to develop microprocessor software, from data entry through assembly, debugging and final EPROMs.

lets you control emulation and download code from your terminal or PC. Priced from \$498.

### THE AVOCET CROSS-ASSEMBLER FAMILY.

Avocet Cross-assembler	Target Micro-processor	CP/M*-80	CP/M-86 IBM PC, MSDOS**
XASM04	6804	\$250.00	\$250.00
XASM05	6805	200.00	250.00
XASM09	6809	200.00	250.00
XASM18	1802/1805	200.00	250.00
XASM48	8048/8041	200.00	250.00
XASM51	8051	200.00	250.00
XASM65	6502/65C02	200.00	250.00
XASM68	6800/01,6301	200.00	250.00
XASM75	NEC 7500	500.00	500.00
XASM85	8085	250.00	250.00
XASM400	COP400	300.00	300.00
XASMF8	F8/3870	300.00	300.00
XASMZ8	Z8	200.00	250.00
XASMZ80	Z80	250.00	250.00
<b>NEW!</b>			
XASM6811	68HC11	250.00	250.00
<b>NEW!</b>			
XASM180	HD64180	250.00	250.00
XMAC682	68200	595.00	595.00
XMAC68K	68000/68010	595.00	595.00

### Now "debug" on your PC.

Avocet has realistic answers for users who want low cost debugging capability.



Until now, engineers have been very much on their own in the area of testing. But now Avocet simulators

and emulators virtually eliminate the frustrating and often costly "crash and burn" method.

### New AVSIM family of full screen simulators.

Avocet's new software simulator/debuggers let you test your code in a crashproof, interactive environment, without additional hardware. Your PC's screen becomes a "window" into the simulated target CPU. Extensive break point, I/O, and interrupt facilities make AVSIM a truly useful development tool. Price \$299.

### New TRICE in-circuit emulator.

At last, an affordable in-circuit emulator! With the self-powered TRICE, you can examine target memory and register, set break points, single-step, trace and more; TRICE recognizes 34 different commands. Its serial interface

### AVPROM programmer works with any PC.

The AVPROM programs over 37 different devices, including EPROMS through 27512, CMOS and E<sup>2</sup> PROMS, and MPU/EPROM combos, using fast "adaptive" algorithms. Intelligent, self-contained units work with any personal computer, using Avocet's GDX driver software... from \$429. Gang programmers from \$979.

To find out more about Avocet software development tools and accessories, call us toll-free:

# 1-800-448-8500

(In the U.S. except Alaska and Hawaii.)

VISA and Mastercard accepted. All popular disc formats now available—please specify. Prices do not include shipping and handling—call for exact quotes. OEM INQUIRIES INVITED. Avocet Systems Inc., P.O. Box 490 B, Rockport, Maine 04856, (207) 236-9055. Telex: 467210 AVOCET CI.

emulators and EPROM programmers turn your personal computer into a sophisticated development system. No more searching for the ever inaccessible mainframe. Or, wondering how to pay for a \$20,000 dedicated development system. Avocet products save time and money, and provide the most flexible development system available.

Avocet allows you to develop software for practically any microprocessor without switching development systems. And equally important, Avocet development tools are easy to install and easy

# AVOCET SYSTEMS INC.™



## Feel right at home with the stock market.

Now you can use your personal computer and modem to help make investment decisions with confidence. Right in your own home.

Dow Jones News/Retrieval® is the surprisingly affordable, online financial news resource with exclusive electronic access to *The Wall Street Journal*. The combination of News/Retrieval and Dow Jones™ Software makes personal investment decisions easier by giving you a clear, organized picture of the facts.

Use News/Retrieval to check on your stocks or read up on companies and industries that interest you. Get tomorrow's business news today—90 seconds after it appears on the Dow Jones News Service® (the broadtape). See what impact government or world news is having on the marketplace.

Measure stock performance—past and present—with Dow Jones Quotes. And to round out the picture, review economic and earnings forecasts or SEC, Merrill Lynch and Standard & Poor's reports. It's all here in one place.

Then use Dow Jones Software to display trends, organize your portfolio and give you the entire picture in clear graphics.

After you've checked your investments, the whole family can use News/Retrieval to get hot sports news, shop at home, look up articles in the encyclopedia and much, much more.

For more information on how Dow Jones News/Retrieval can help *you* feel at home with the stock market, call **800-345-8500 Ext. 144\***.

## Dow Jones News/Retrieval & Software

*Keeping you a step ahead.*

\*Alaska, Hawaii and foreign, call 1-215-789-7008 Ext. 144.

© 1985 Dow Jones & Company, Inc. All rights reserved. Dow Jones News/Retrieval and Dow Jones News Service are registered service marks of Dow Jones & Company, Inc. Dow Jones is a trademark of Dow Jones & Company, Inc.



# LIVING IN A SENSIBLE ENVIRONMENT

BY STEVE CIARCIA

*A collection of alarm and  
environmental monitoring circuits*



Generally speaking, I try to present projects that are commercial-quality designs. Occasionally, they get a bit grandiose when the former aerospace engineering mentality in me says, "Damn the expense" and "Who cares about chip count?"

For the most part, I work on the basis of cost-effectiveness rather than absolute expense. Since I was on a very tight schedule and the Home Run Control System (HCS) of the past three months itself was the main emphasis of my efforts, I neglected user-constructed sensors and opted entirely for commercially available units (motion detectors, contact switches, etc.). Testing the HCS was hard enough without debugging perimeter sensors and motion sensors and wasting a lot of time by stringing wire. I bought off-the-shelf detectors and had them professionally installed. This raised overall design cost but reduced the installation and checkout time considerably.

While this technique was expedient, it neglected a very important contingent of the BYTE readership. The hundreds of letters and pictures I receive each month indicate that many readers roll their own, even on complicated projects like the HCS. Deep down, behind the aerospace engineer, I am a computer hacker at heart and

empathize with experimenters who want to know how to build the environmental sensors, alarm horns, and signaling devices for use with the HCS.

As an addendum to the previous articles on building the HCS, this month I've dug through the junk box for a bunch of circuits that sense, immobilize, and anesthetize a perpetrator. The same sensors can be used to provide convenience features like automatic lighting and environmental control if you are less paranoid. Among the circuits I've included are infrared and ultrasonic interrupted-beam detectors; water, temperature, voltage, and light sensors; and a variety of alarm signaling devices.

These circuits are presented for experimenters who revel in the pleasure and agony of homebrew projects. If you don't want to spend the time building these circuits, order the necessary components from the local alarm installer instead.

## A CONTACT-CLOSURE WORLD

The HCS and alarm systems in general are designed to perform designated control

*(continued)*

Steve Ciarcia (pronounced "see-ARE-see-ah") is an electronics engineer and computer consultant with experience in process control, digital design, nuclear instrumentation, and product development. He is the author of several books about electronics. You can write to him at POB 582, Glastonbury, CT 06033.

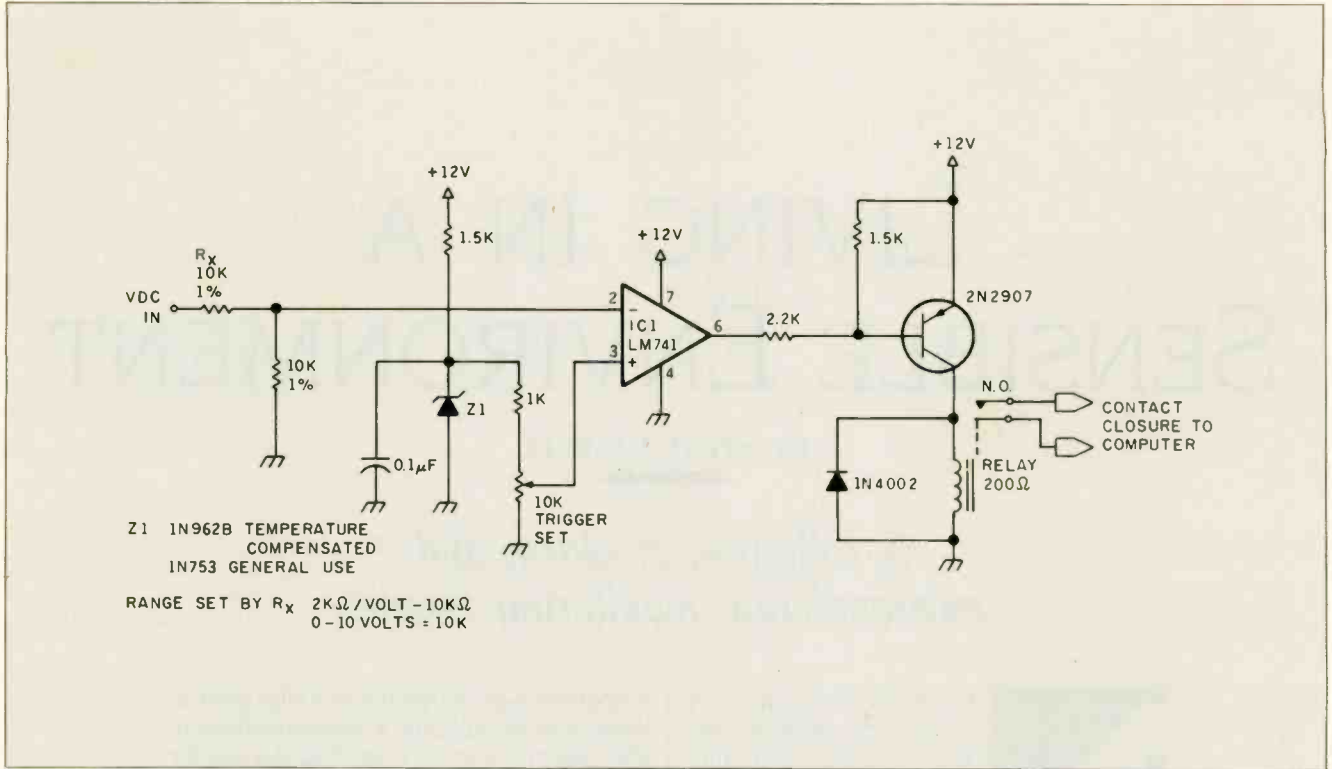

Figure 1: An overvoltage sensor. Undervoltage can be detected by reversing the connections of IC1 pins 2 and 3.

functions as the result of specific input activities. They rely upon contact closures to communicate these activities. Rather than monitor the physical surroundings in absolute terms, contact-closure-type alarm and control systems respond by sensing "limits."

A limit sensor is just that. If an event is to occur when the temperature in a room exceeds  $85^\circ$  (perhaps turning on the air conditioner), we could employ a temperature limit switch set at  $85^\circ$ . Knowing that it is presently  $71.45^\circ$  in the room is unnecessary information. Only when the temperature is at or above  $85^\circ$  will it indicate that the set-point limit has been reached. This simple limit switch is called a thermostat and functions much like the one you probably have on your wall. Below  $85^\circ$  it is open, and above  $85^\circ$  it is closed (neglecting hysteresis). In situations involving a temperature span, two devices are employed, one sensing high limit and the other sensing low limit. The

(continued)

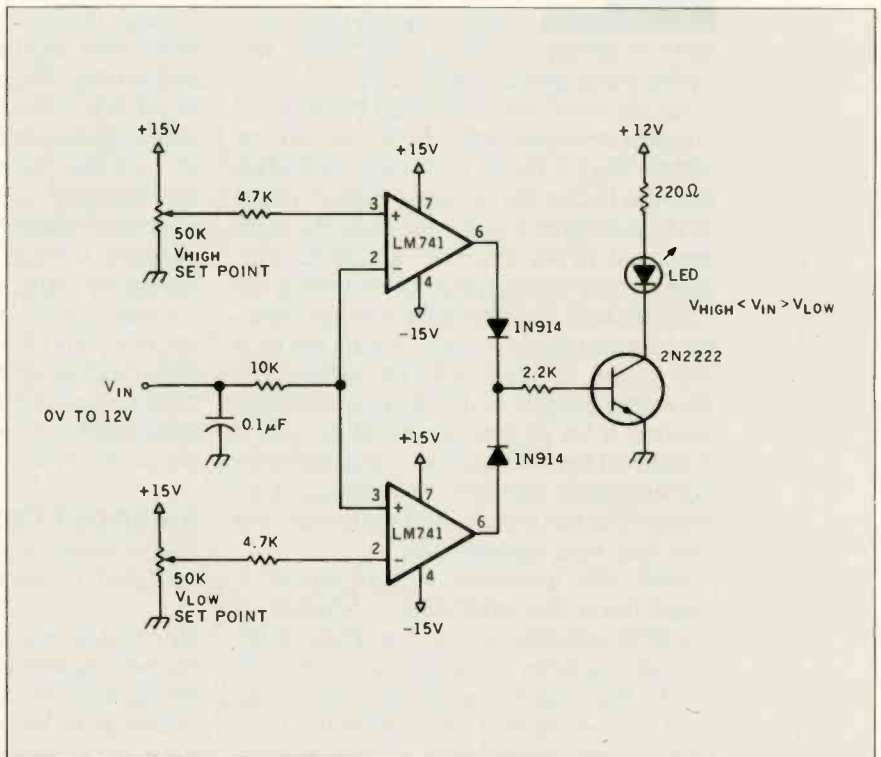

Figure 2: A window-comparator voltage monitor.

# CIRCUIT CELLAR

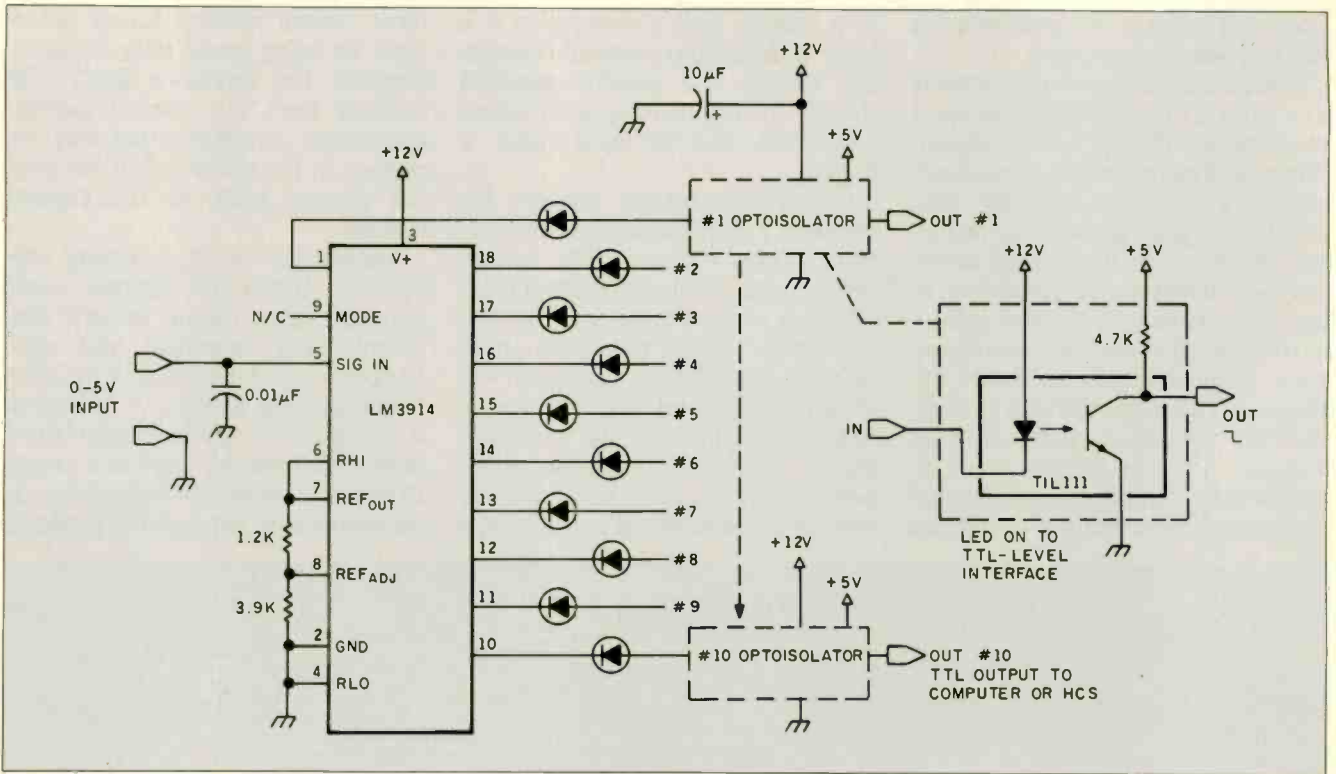

Figure 3: A dot/bar-graph generator used as a multiple window comparator for analog inputs.

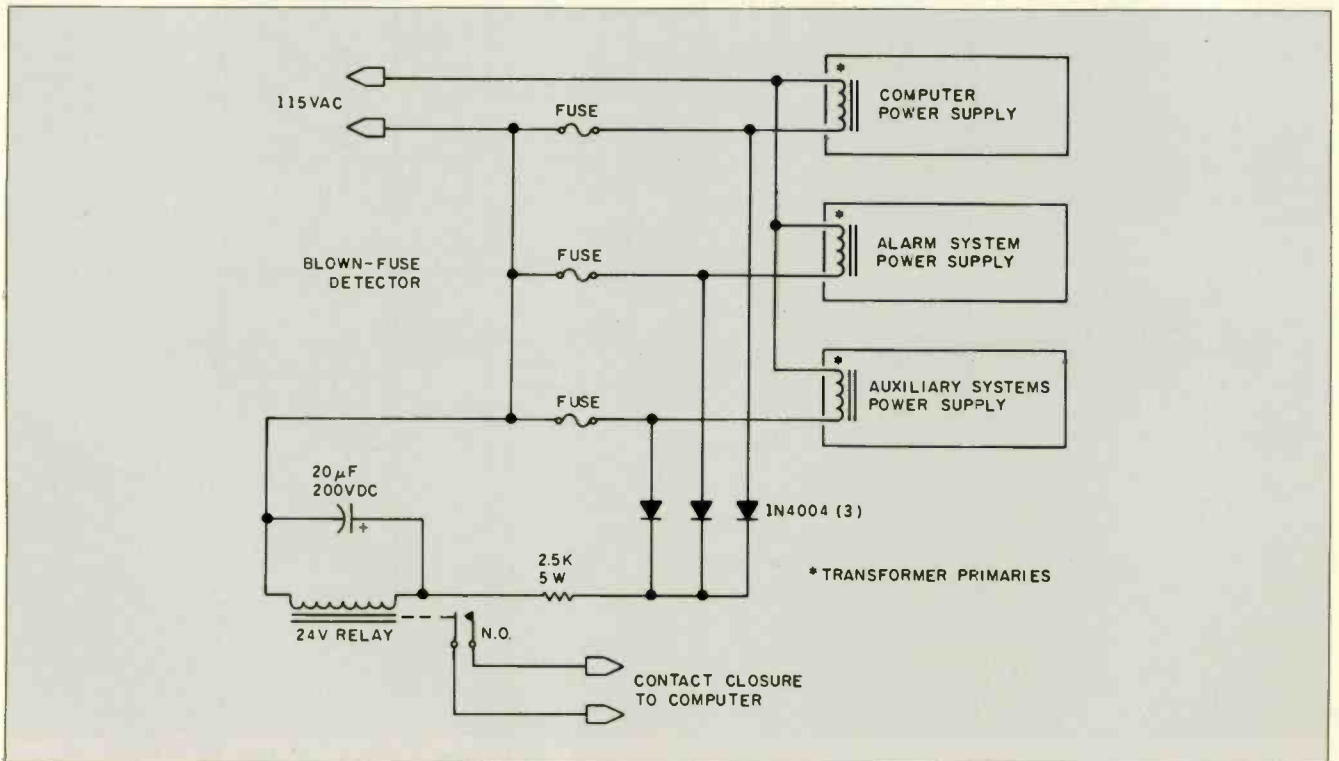

Figure 4: A blown-fuse detector.



0–21.2 V to indicate 0–212°). If, by using a voltage comparator, we compare and switch logic states when the varistor-circuit output is equal to or exceeds 8.5 V, we have produced an 85° limit switch. The control system knows only that it is above or below this limit but not how much. If the control system's action is also a simple contact-closure output (light on/off, fan on/off, alarm dialer and horn on/off, etc.), perhaps how much is unimportant.

When the application dictates that we continuously modify the control decision as a function of how much, we must use something other than the discrete limit sensor. If the air-conditioning fans can be run slowly at 80° and increasingly faster at higher temperatures, a proportional control loop using a high-resolution analog-to-digital (A/D) converter could be used to monitor the thermistor's absolute value and control the fans.

Resolution is the bottom line. Contact-closure output devices are single-bit low-resolution items. Reading the thermistor through an A/D converter merely designates more discrete points of knowledge where control actions may be triggered. If you are making simple control decisions based on a few set points that are not continuously changing, however, it hardly makes

sense to read a thermistor through a 12-bit A/D converter and compare the readings to a few limit values. It makes sense to compare an analog output value with an analog set-point level in the hardware of the monitoring device. In an age of computer overkill, not everything needs to be digitized.

### WINDOW COMPARATORS

The majority of the circuits I've included in this article are of this type. Some are designed to continuously

monitor conditions in the environment (heat, light, moisture, etc.) and close or open contacts at presettable limits. A number of the sensing circuits are simply analog monitors that have output voltages proportional to the input stimulus. To acquire these signals with a discrete input-level controller like the HCS, they are connected to a separate voltage comparator, which compares the output with a preset limit.

(continued)

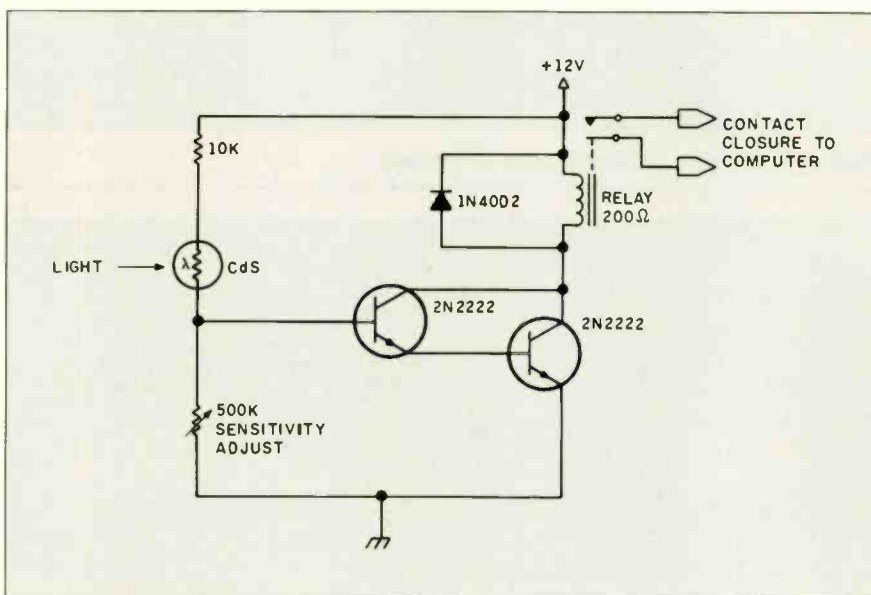

Figure 6: A light sensor.

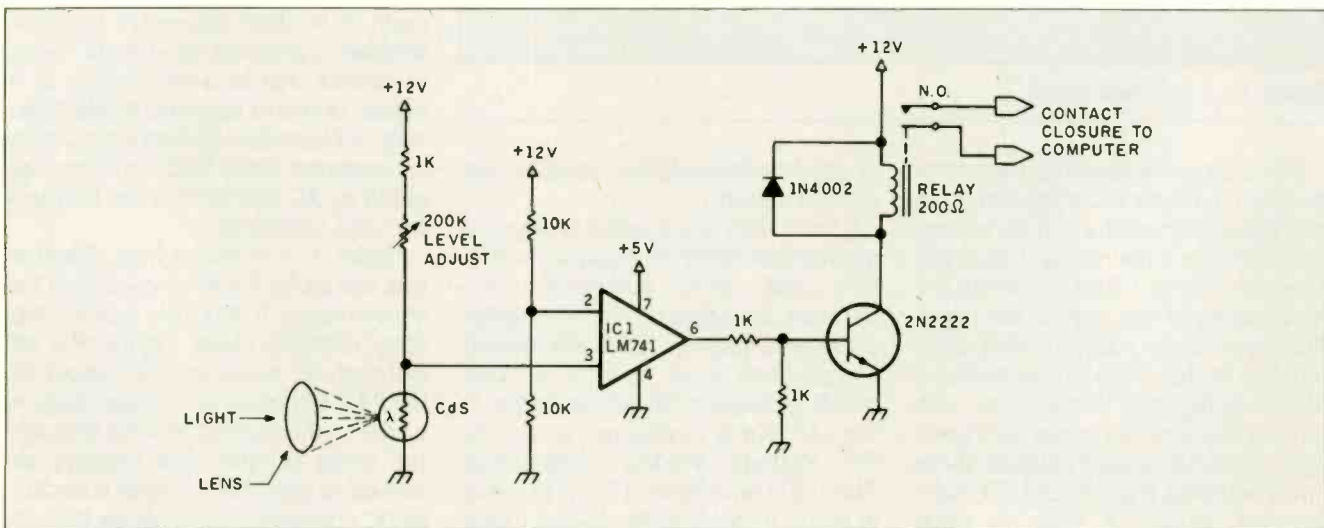

Figure 7: A high-sensitivity light detector.

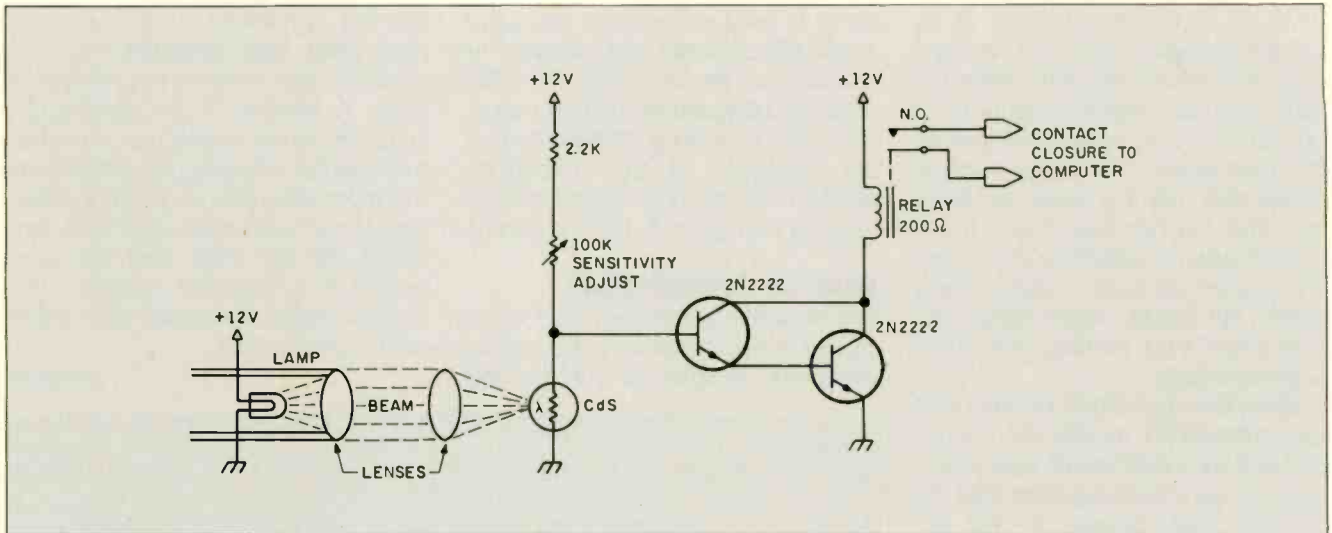

Figure 8: A simple light-beam alarm for doorways.

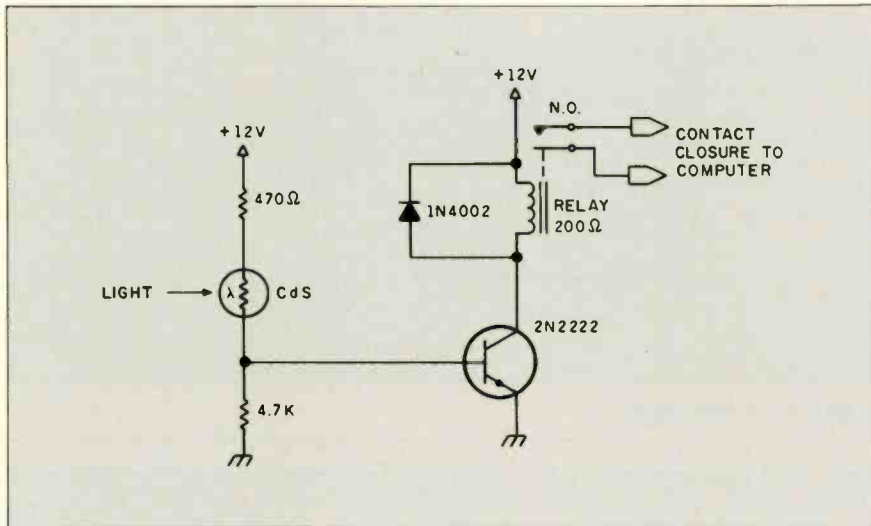

Figure 9: A day/night sensor.

The least complicated comparator is shown in figure 1. Configured as an overvoltage detector (or undervoltage if you reverse a few wires), the circuit closes the output contacts when the input exceeds the trigger set point. The next more sophisticated comparator is the window comparator. Shown in figure 2, the window comparator has both an upper and lower limit. An input voltage between these limits activates the output LED (light-emitting diode). A relay or optoisolator can be substituted in place of the LED to provide a contact-closure

or discrete-level-shifted input to the control system.

If more than one window is required (perhaps different things occur at 50°, 85°, and 120°), additional comparators are needed. A conveniently packaged source of 10 linearly spaced comparators is an LM3914 dot/bar-graph generator. Shown in figure 3, the LM3914 is configured as a 0- to 5-V 10-stage window comparator. Each LED represents a 0.5-V increase in input. If the desired set-point limit is 3.5 V from a temperature monitor (shown later in figure 18), the HCS

would be connected to LED #7, which comes on at 3.5 V (an optoisolator in series with the indicating LED level shifts the output so that it is compatible with the HCS).

Whatever the source of the analog signal in the remaining circuits, you now have the means to convert it to a contact-closure or discrete-level input required by the HCS and other alarm/control systems.

### POWER MONITORING

An important consideration in industrial-control applications is power monitoring. At the very minimum, it is often necessary to know whether a piece of equipment is out of service due to a blown fuse or if power demand exceeds a desirable limit. A blown-fuse detector can notify an operator, while limit switches triggered by AC line current can be used for load shedding.

Figure 4 is a blown-fuse detector that can be built into a power strip for convenience. If any fuse opens, the relay contacts close. Figure 5 is an isolated AC monitor. The output of the 284J will be an AC voltage proportional to the current flowing through the shunt resistor. The circuitry attached to the 284J's output is an AC-to-DC converter, which allows this circuit to be connected to one of the

(continued)

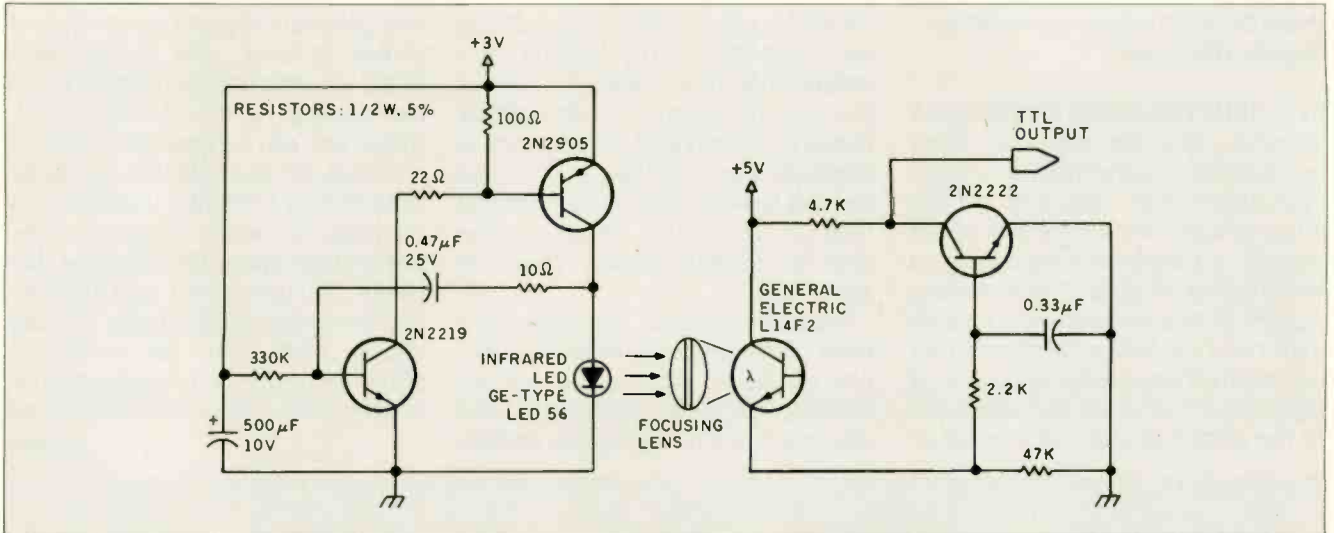

Figure 10: An infrared intrusion alarm. The system can be used over a range of 10 to 50 feet.

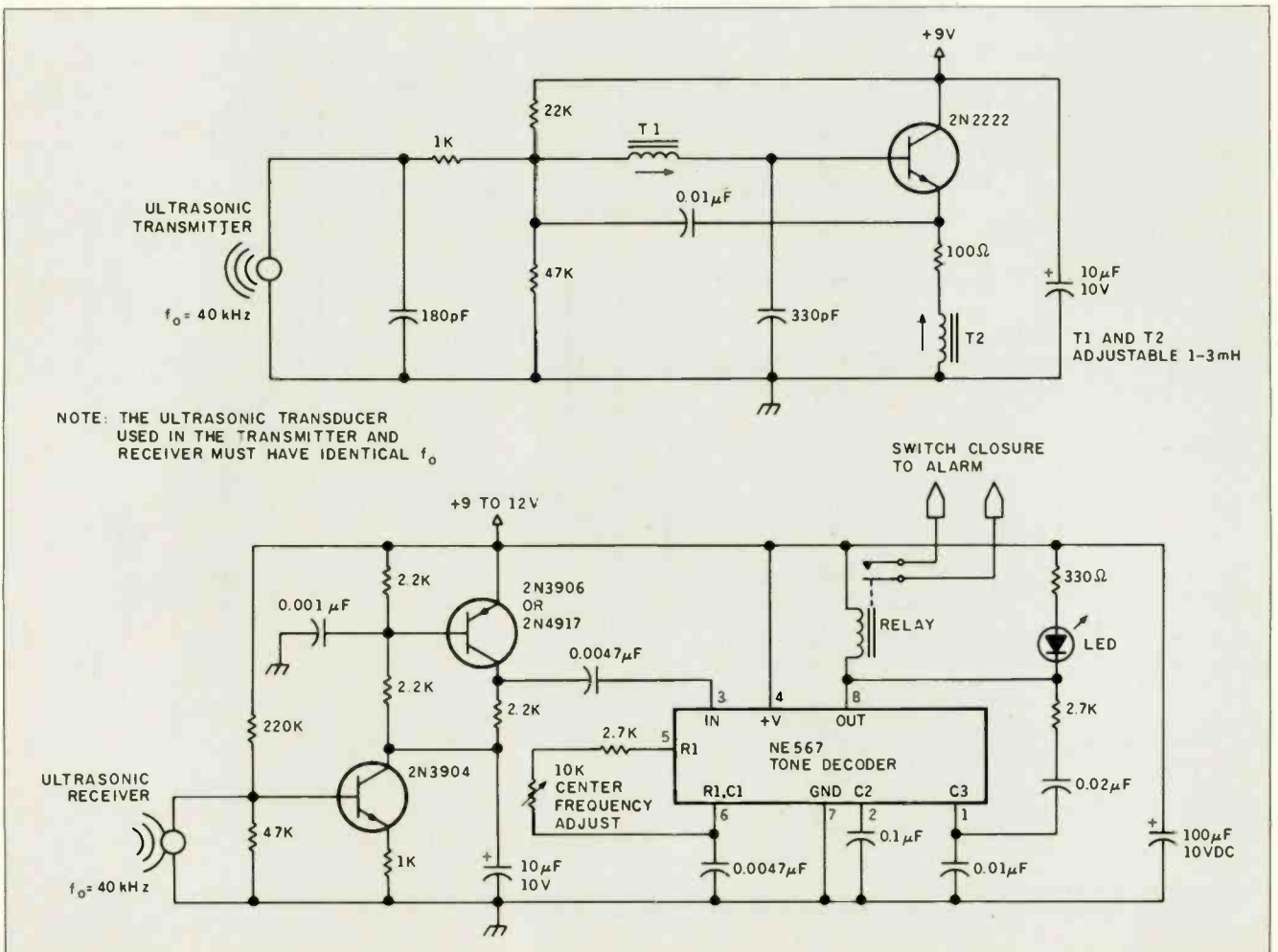

Figure 11: An ultrasonic transmitter and receiver.

three DC-input window comparators already discussed.

**INTERRUPTED-BEAM DETECTORS**

Whether they are used for alarm monitoring or convenience control, interrupted-beam detectors are the most reliable sensors for perceiving objects or people moving through a specific line of sight. These devices consist of two components: a transmitter and a receiver. The transmitter and receiver are located within line of sight of each other on opposite sides of the protected area. An infrared or

ultrasonic beam is then directed from the transmitter to the receiver. Provided that the receiver always receives this beam, its alarm output remains unenergized. If the beam is interrupted by something or someone passing between the transmitter and receiver, the output contacts close and a control action may be generated.

Interrupted-beam detectors are most often infrared or ultrasonic (motion detectors, which I am not addressing, use infrared, ultrasonic, and microwave technologies). The applica-

tion generally dictates which type of sensor is used, with ambient-light levels, acoustic pollution, and cost the determining factors. A low-cost infrared unit can be mounted across a doorway, for example, but would be saturated by sunlight if used across a driveway to sense incoming cars. Depending upon the distance between the transmitter and receiver and the ambient-light levels, you can choose from items like simple resistive photo cells, phototransistors, photodiodes, lenses, and LED or in-

*(continued)*

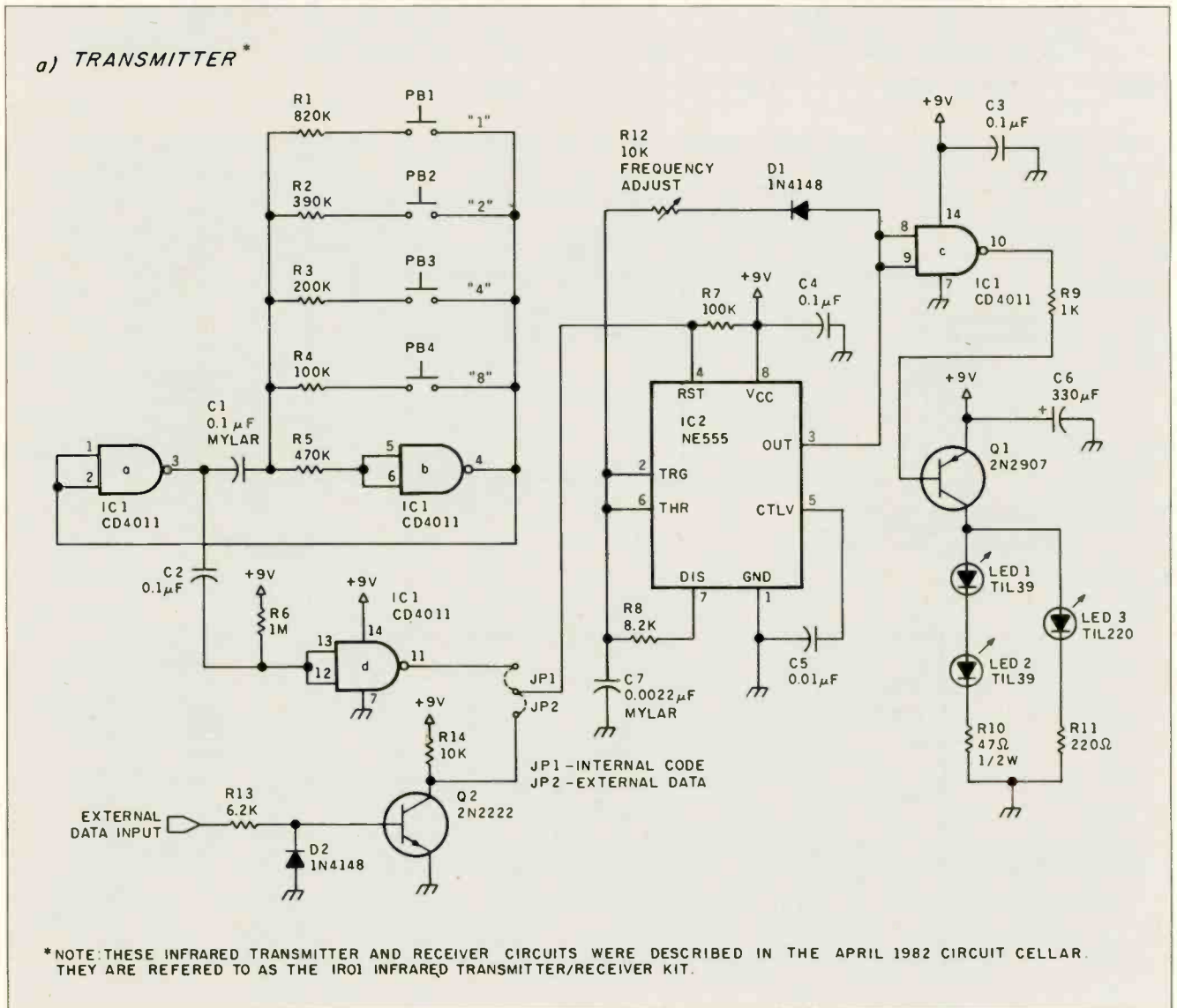
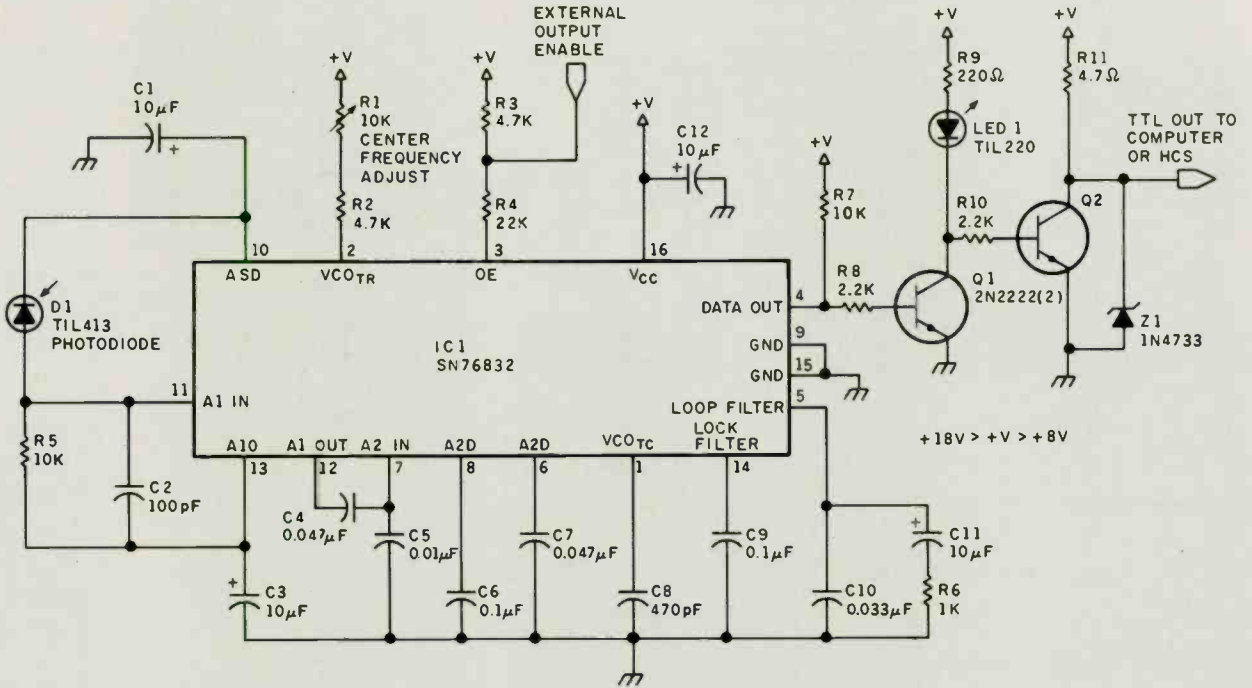

Figure 12: The IRO1 Infrared Transmitter/Receiver.



# CIRCUIT CELLAR

## b) RECEIVER\*



\*SEE NOTE ON FIGURE 12a

## c) ALTERNATE TRANSMITTER CIRCUIT

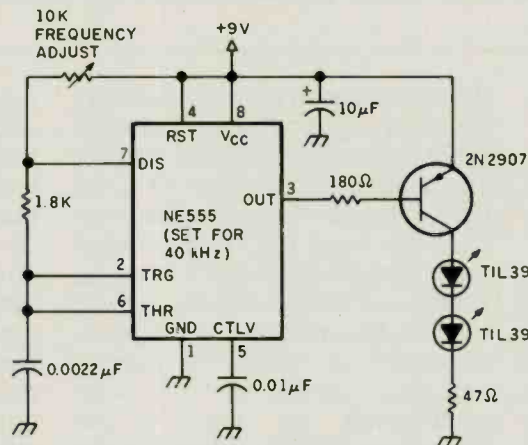



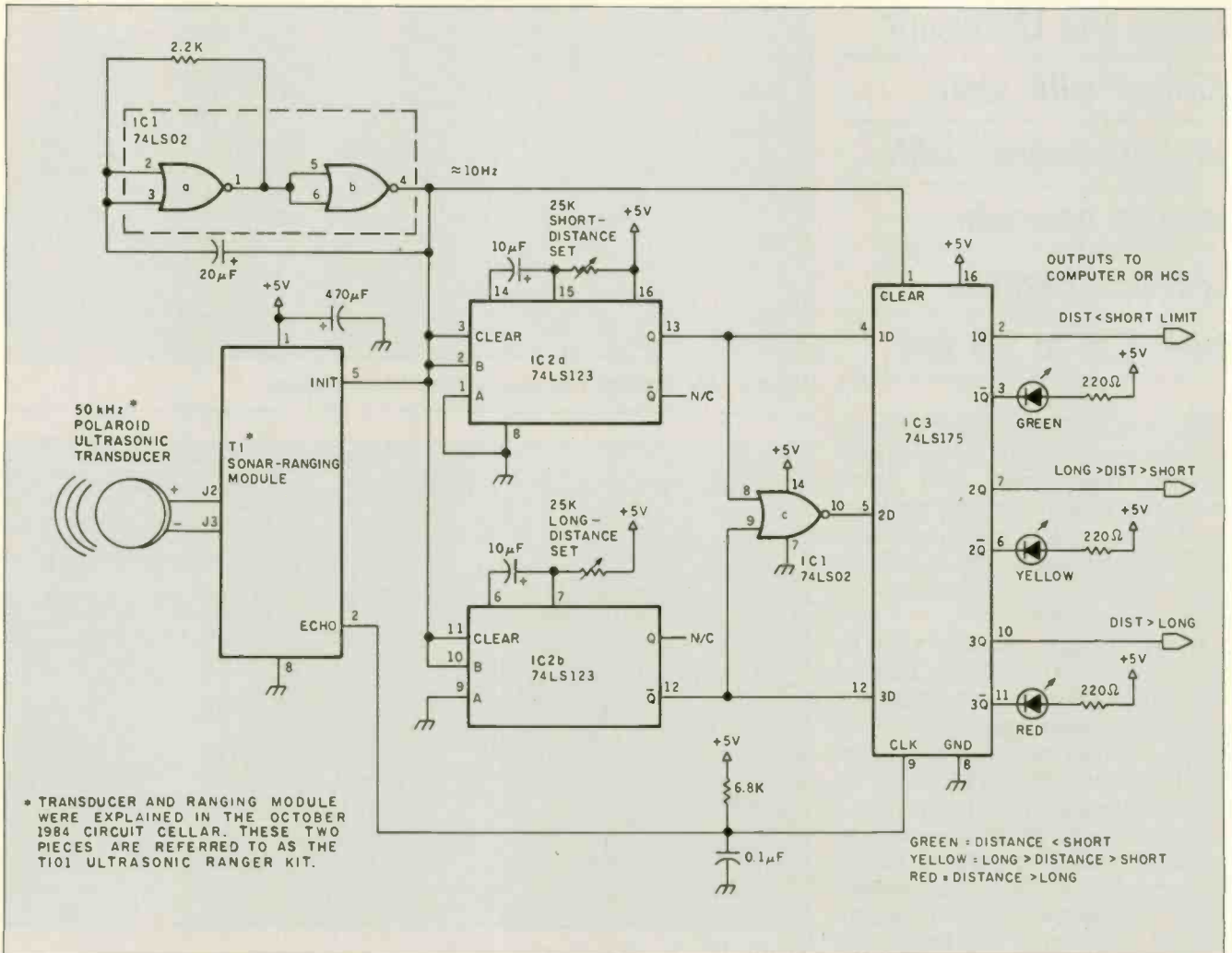

Figure 14a: The TI01 Ultrasonic Ranger.

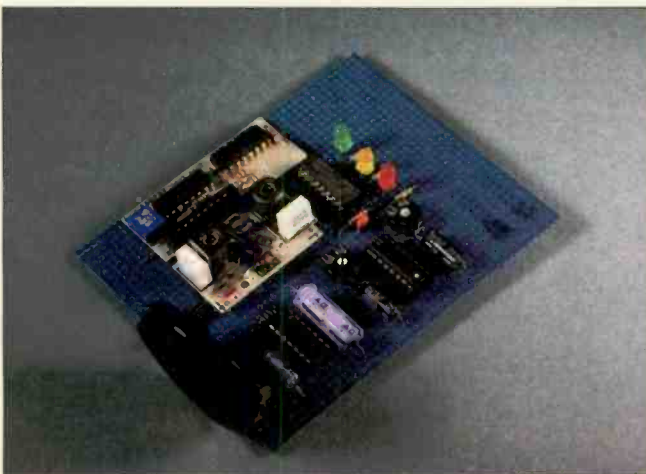

Photo 1a: The Ultrasonic Ranger project with added components in figure 14 is configured as a discrete-level distance detector.



Photo 1b: The circuit in photo 1a enclosed in a box over a doorway to detect people or small animals walking through it.

*Using the Ultrasonic Ranger with some timing windows added, we can ascertain specific distances from 1.5 to 35 feet.*

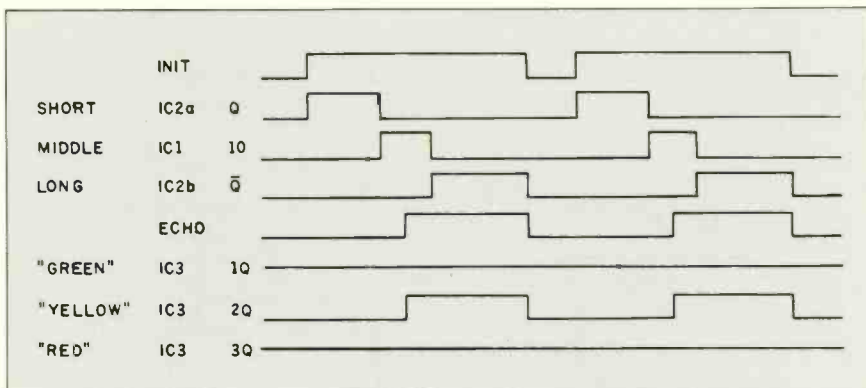

Figure 14b: High/low-limit ranging-sensor timing diagram.

T101 Ultrasonic Ranger, which is based on a Texas Instruments sonar-ranging module. Using these basic components and adding timing windows to sense limit points, we can ascertain and indicate specific distances (the ranging module can detect distances from 1.5 to 35 feet).

Shown in figure 14a, the circuit is relatively uncomplicated. A 10-hertz oscillator (IC1) initializes the ultrasonic transmission and triggers the two one-shots. IC2a has its period set to the short-distance limit, and IC2b is set to the long-distance limit (1.8 milliseconds per foot). When the echo is received, its leading edge clocks the outputs of the one-shots into register IC3. If the distance out and back to the object is farther than the period of the one-shots, they time out and indicate a zero. This timing is shown in figure 14b. The three resulting outputs are distance < short limit, distance > long limit, and long limit > distance > short limit.

If the circuit is mounted in the top of a 7-foot doorway, with the short limit set for 2 feet (5 feet from the floor) and the long limit set for 4½ feet (2½ feet from the floor), we can obtain significant information about the movement through the doorway (see photos 1a and 1b). If a person taller than 5 feet passes through the sensor, we will get an indication of distance < short limit since the person's head will be less than 2 feet from the 7-foot-high sensor. If a 4-foot child walks through the doorway, the long limit > distance > short limit

(continued)

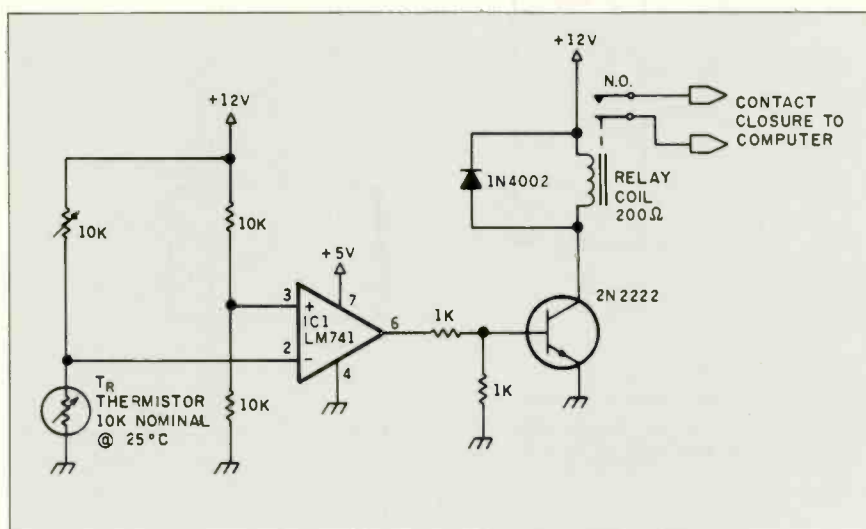

Figure 15: An over-temperature detector.

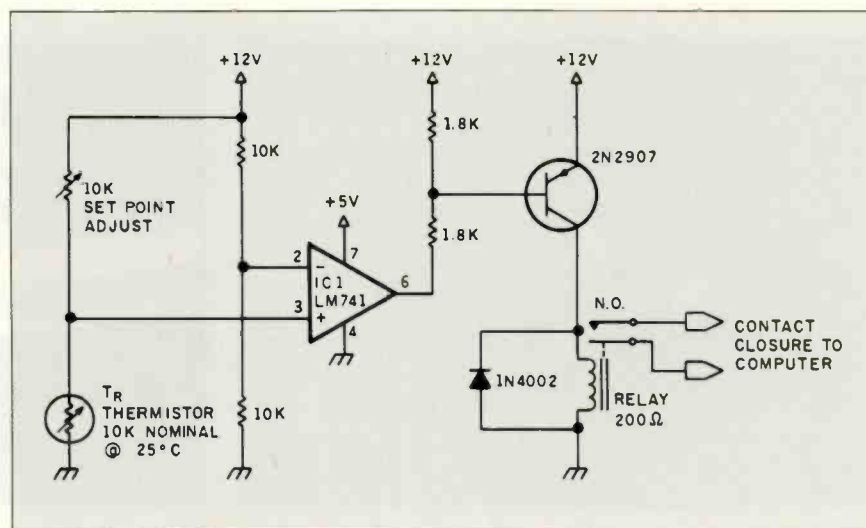

Figure 16: An under-temperature alarm.

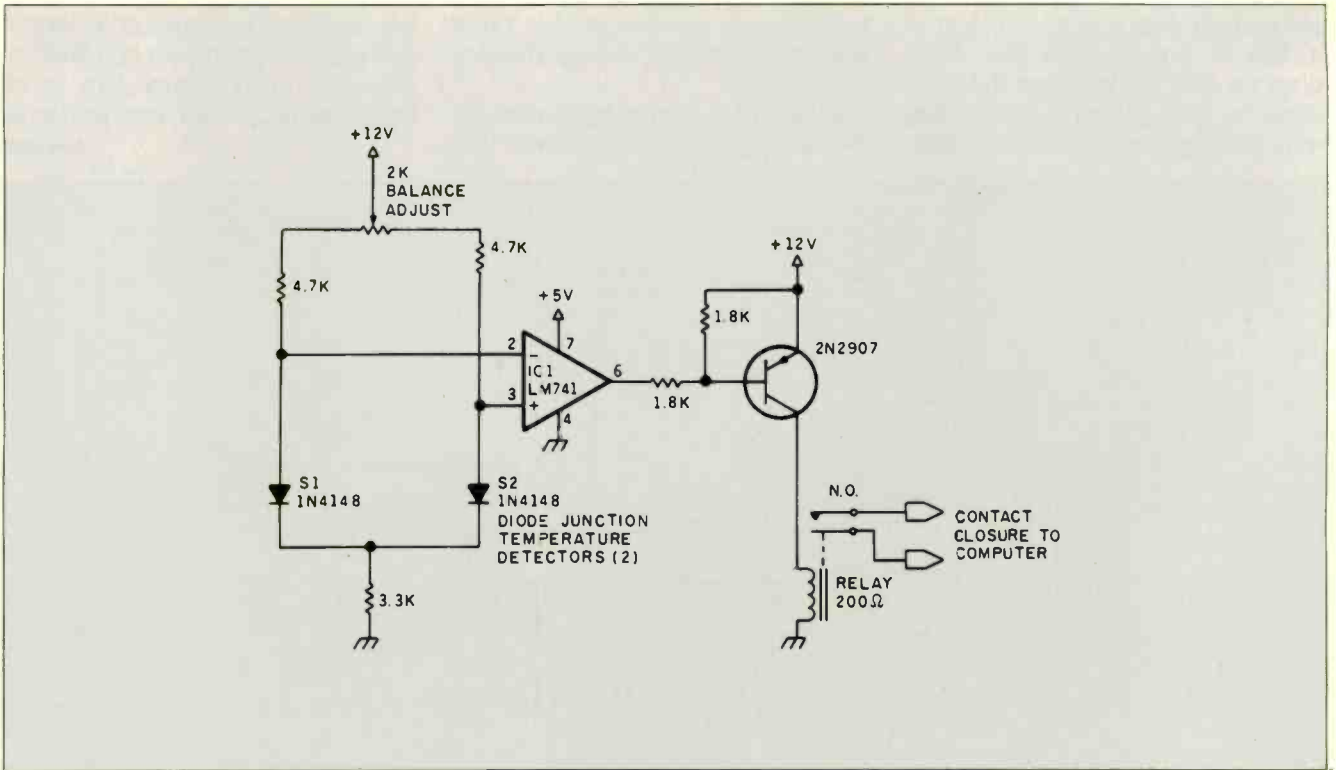

Figure 17: A differential-input temperature detector.

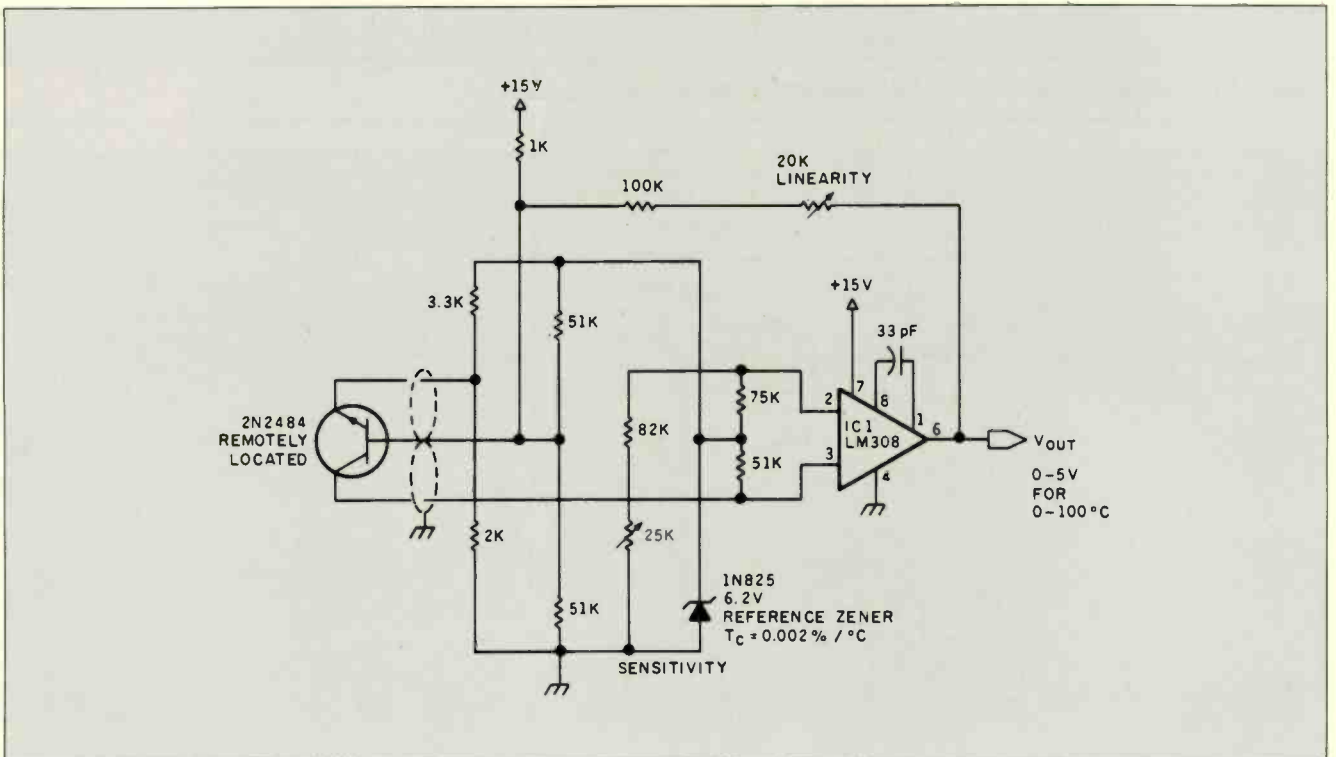

Figure 18: A solid-state temperature sensor.

## CIRCUIT CELLAR

will go high since the child's height of 4 feet is greater than the short-distance limit yet less than the long-distance limit. When a 2-foot dog walks through (indicated by the inter-

rupted-beam sensors at the 2-foot level), the output will indicate distance > long limit.

While this is a cute application for the ranging sensor, I anticipate that

this limit-switch modification would find greater application as a level indicator in grain storage bins or oil tanks. Few people are motivated to in-

*(continued)*

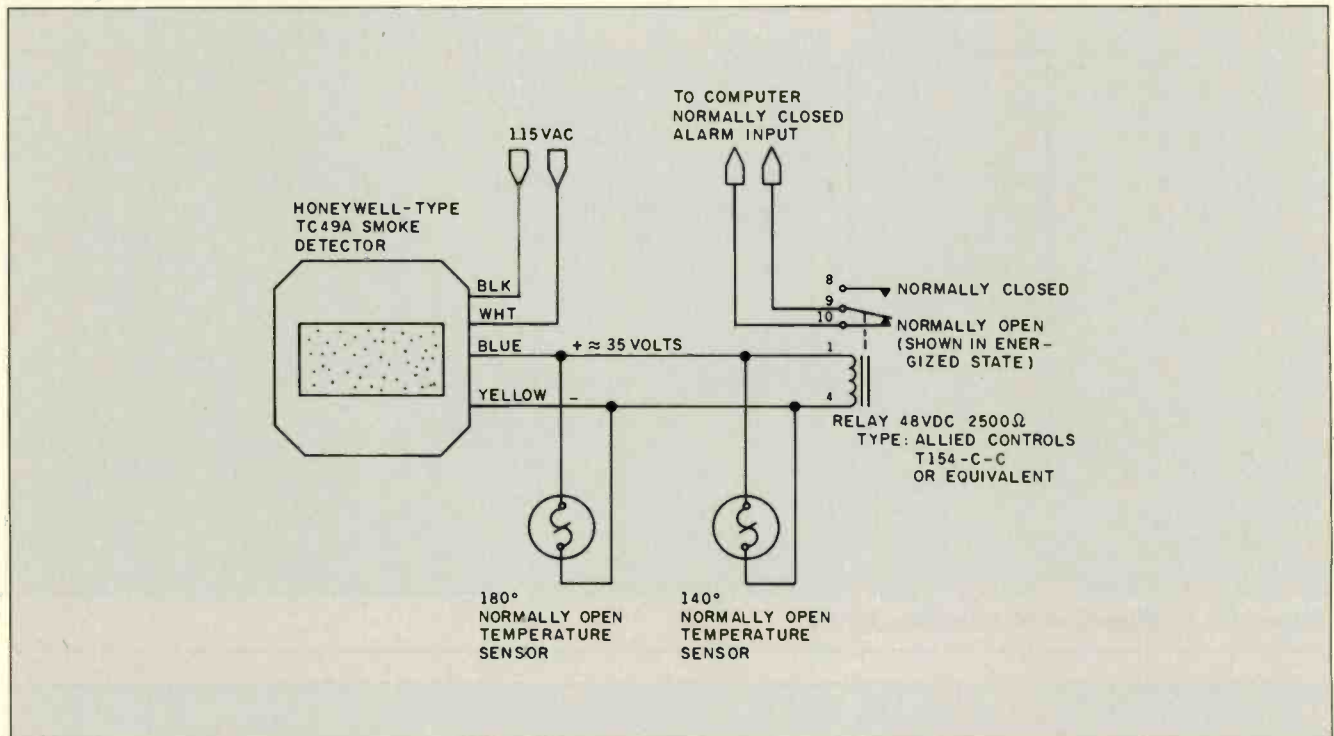

Figure 19: A smoke-and-heat detector. Additional sensors can be added in parallel.

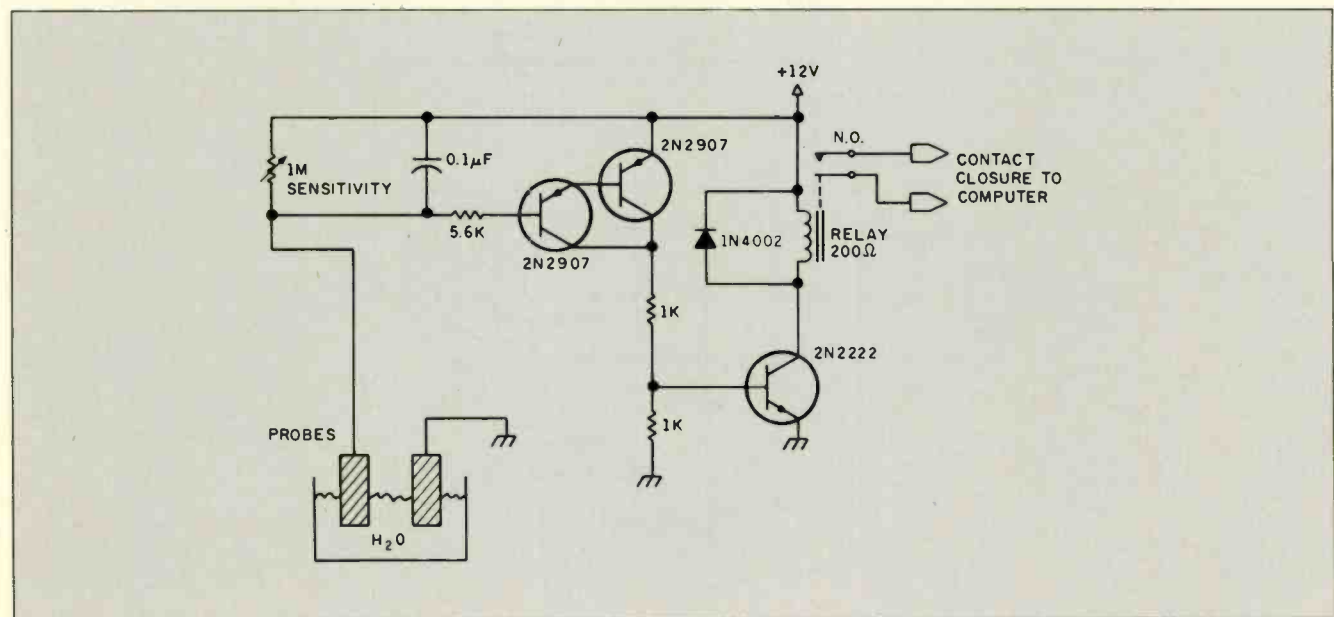

Figure 20: A water-activated sensor.

# CIRCUIT CELLAR

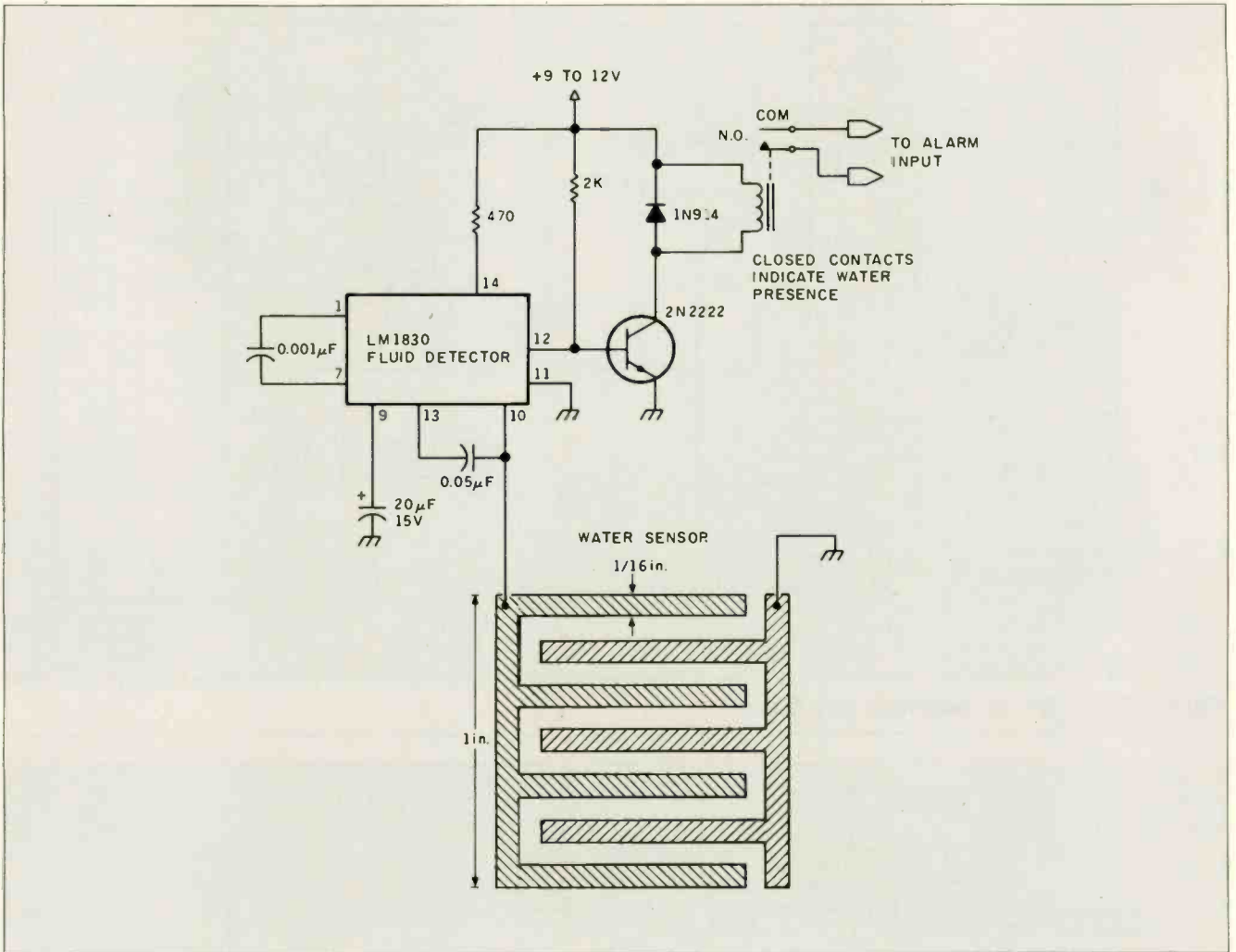

Figure 21: This fluid-level sensor uses an LM1830 fluid-level detector chip. The detector grid can be cut from a sheet of copper.

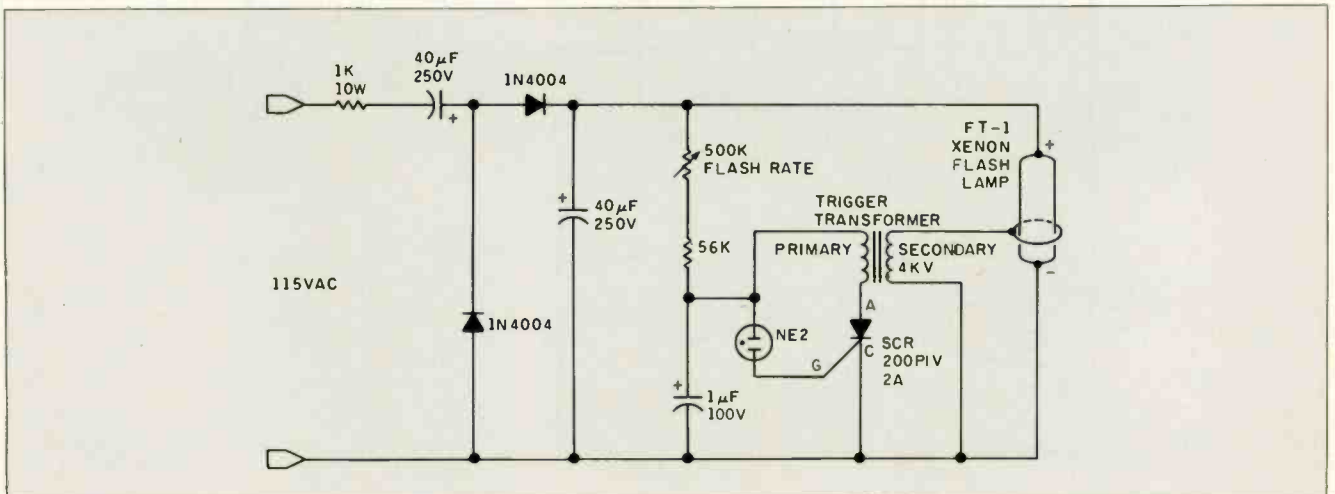

Figure 22: A 115-V AC xenon strobe light.

# CIRCUIT CELLAR

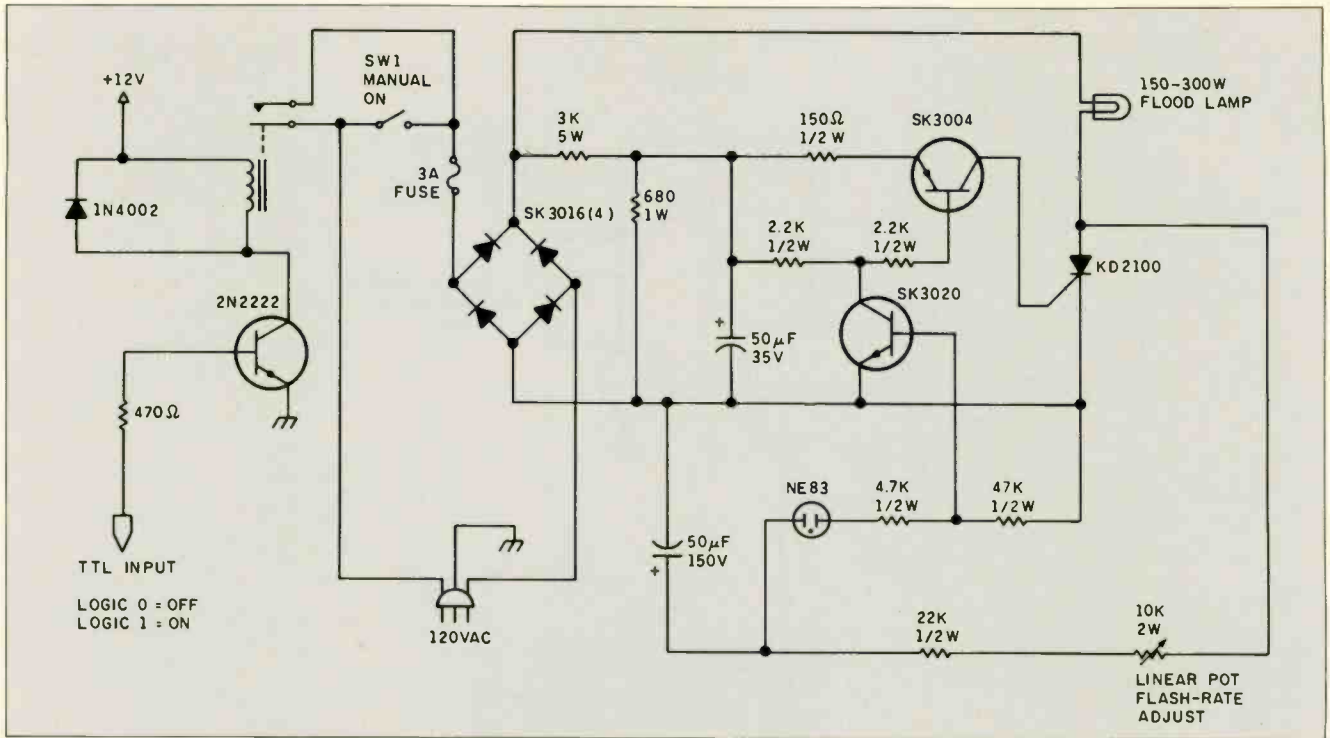

Figure 23: A 115-V AC incandescent lamp flasher.

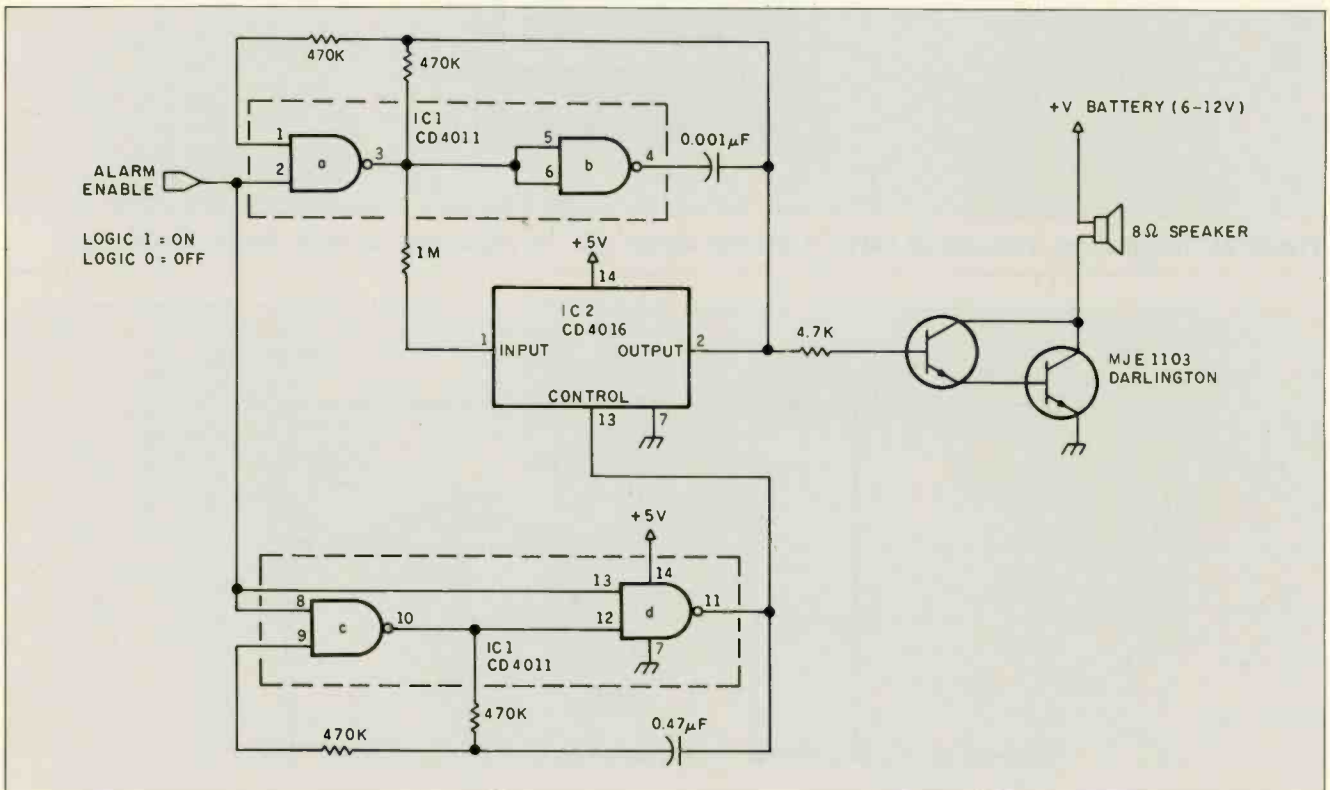

Figure 24: A high/low-frequency beeper.



# CIRCUIT CELLAR

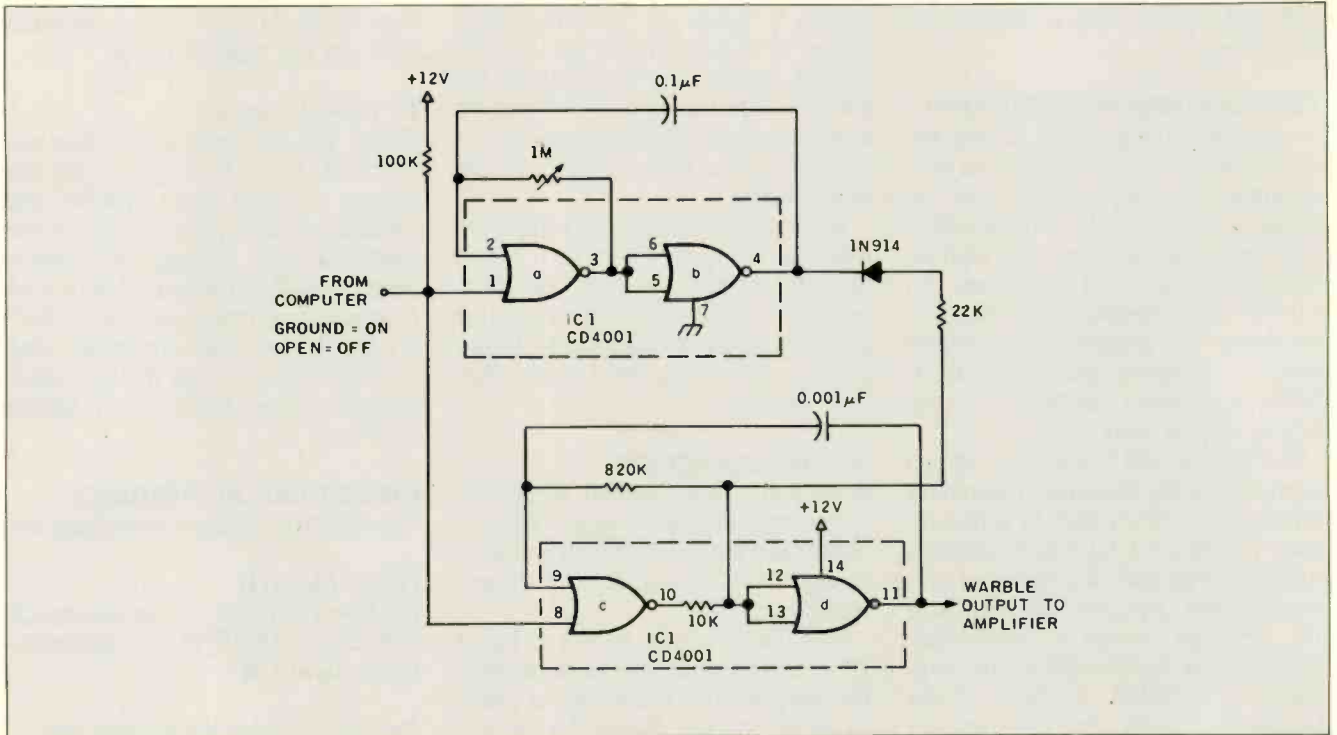

Figure 25: A warble tone generator.

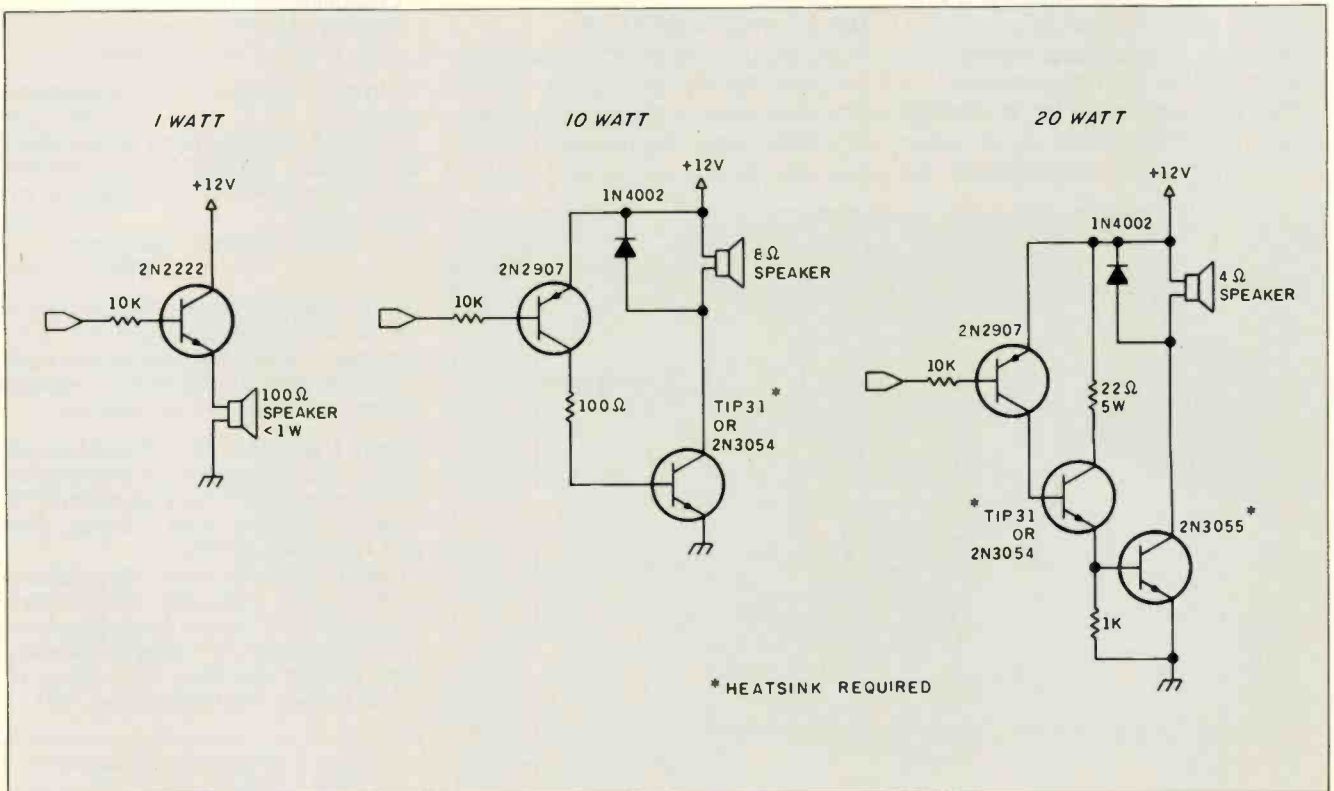

Figure 26: Power output stages for the design in figure 25.

stall automatic control systems for their dogs.

**TEMPERATURE MEASUREMENT**

An important ingredient in any environmental control system is temperature monitoring. While you can always use bimetallic thermostats, they are gross-measurement devices that exhibit a lot of hysteresis. An alternative to bimetallic switches is a thermistor that triggers a relay closure when a temperature is above or below a precisely selected limit (see figures 15, 16, and 17).

Thermistors and bimetallic junctions are not the only materials that exhibit predictable effects due to temperature. Diode and transistor junction voltages (typically 0.7 V) vary with temperature. Using two diodes (figure 17), we can create a differential-temperature switch. When the temperature applied to one diode becomes greater (by the amount determined in the balance adjustment) than the other, the output relay closes. A typical application is a window fan that automatically turns on when the temperature inside becomes greater than that outside.

This technique can be expanded even more to produce an accurate solid-state measuring instrument. As

shown in figure 18, the circuit produces a 0-5-V output for 0-100° Celsius. Connecting this circuit to the window detector in figure 3 allows the control system to take a variety of control actions depending upon the temperature.

While on the subject of temperature measurement, we shouldn't forget fires, since they produce high temperatures and are definitely cause for a control system to take action. Figure 19 illustrates a combined smoke-and-heat detector.

**WATER DETECTORS**

If you live in New England, springtime is synonymous with water. While a worst-case water-sensing technique is to step into it, one variation is a water-detector circuit.

The simple circuit shown in figure 20 senses lowered resistance between the probes when immersed in water. A better circuit, figure 21, uses a special LM1830 fluid-level detector chip.

**BELLS AND WHISTLES**

If you are using your HCS primarily as an alarm system, getting the proper attention when it triggers is a necessity. After triggering the silent alarm, you may decide not to be so silent.

Figures 22 through 27 will definitely liven up the neighborhood.

**IN CONCLUSION**

Thank you for helping me clean out my junk box. Now you have the means to bend, fold, spindle, and mutilate anything exceeding 5½ feet high and 98.6° passing from east to west through a doorway. Alternatively, anything shorter than 2 feet at 101° should trigger the automatic dog-biscuit dispenser. I say this somewhat tongue in cheek, but you don't get the mail I get.

**CIRCUIT CELLAR FEEDBACK**

This month's feedback is on page 391.

**NEXT MONTH**

I'll show you how to construct the Circuit Cellar BASIC-52 computer/controller board. ■

The following items are available from

The Micromint Inc.  
561 Willow Ave.  
Cedarhurst, NY 11516  
(800) 645-3479 for orders  
(516) 374-6793 for information

1. Infrared remote-control transmitter/receiver kit.....IR01, \$49
2. Ultrasonic-ranging system experimenter's kit, including SN28827 ranging module, 50-kHz Polaroid electrostatic transducer, and data manual.....TI01, \$60
3. A 40-kHz ultrasonic transducer.....XDR01, \$6 each

All the above items are shipped postpaid in the continental United States. Add \$6 for overseas. New York residents please include 8 percent sales tax. Connecticut residents please include 7.5 percent sales tax.

**Editor's Note:** Steve often refers to previous Circuit Cellar articles. Most of these past articles are available in book form from BYTE Books, McGraw-Hill Book Company, POB 400, Hightstown, NJ 08250.

*Ciarcia's Circuit Cellar, Volume I* covers articles in BYTE from September 1977 through November 1978. *Volume II* covers December 1978 through June 1980. *Volume III* covers July 1980 through December 1981. *Volume IV* covers January 1982 through June 1983.

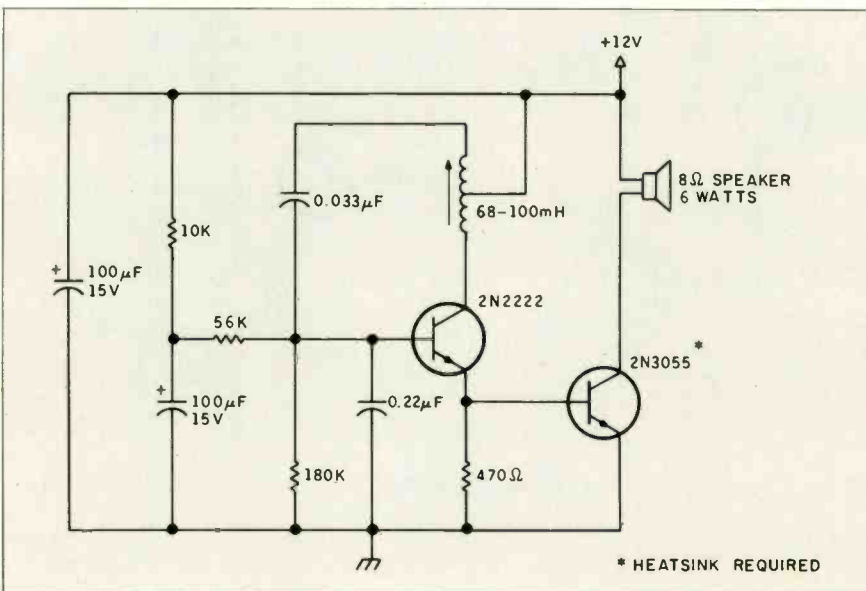

Figure 27: A siren.

To receive a complete list of Ciarcia's Circuit Cellar project kits, circle 100 on the reader-service inquiry card at the back of the magazine.

# AMAZING DAISY

NOW! FULL SIZE, FULL FEATURE, LETTER QUALITY AT ONLY \$353

If you have been searching for a letter quality printer you have probably found the flood of claims and counterclaims to be a real roadblock in your search. Not long ago we were in the same position. We tried to determine which daisy wheel printer had all the features our customers wanted, yet would not set them back a month's salary. Recently several manufacturers have introduced machines that had features we were searching for. After a thorough assessment, we eliminated one model after the other for lack of one feature or another until we only had one left.

## THE RESULTS ARE IN

We found the printer which has all the features anyone could want. The winner is the Arotek Daisy 1120, a real heavy-duty workhorse printing at 20 characters per second. The manufacturer is Olympic Co. Ltd., a highly respected Japanese firm.

## FEATURES GALORE

This printer has it all. To start with, it has a front panel Pitch Selector button with indicators which allows 10, 12, 15 characters per inch (CPI) or Proportional Spacing. There is a Select (Online) button (with indicator) and a Line Feed button. You can also set Top-of-Form or Form Feed with the touch of the TOF button. Other front panel indicators include Power and Alarm.

To load a sheet of paper, simply place it in the feed slot and pull the paper bail lever. PRESTO! The paper feeds automatically to a 1 inch top margin and the carriage aligns to the selected left margin. In this manner, each page can have identical margins automatically. You can continue to compute while the Daisy 1120 is

printing. The built in 2K buffer frees up your computer while printing a page or two allowing you to go to your next job.

To really put your printer to work, the Cut Sheet Feeder option is great for automatic printing of those long jobs. Also available is the adjustable Tractor Feed option. Compare our option prices! Best of all the Daisy 1120 is quiet: only 57 dB-A (compare with an average of 62-65 dB-A for others).

## COMPLETE COMPATIBILITY

The Daisy 1120 uses industry standard Diablo® compatible printwheels. Scores of typeface styles are available at most computer or stationary stores. You can pop in a 10, 12, 15 pitch or proportional printwheel and use paper as wide as 14". At 15 CPI you can print 165 columns—great for spreadsheets.

The Daisy 1120 uses the Diablo Hytype II® standard ribbon cartridges. Again universally available.

Not only is the hardware completely compatible, the control codes recognized by the Daisy 1120 are Diablo 630® compatible (industry standard). You can take advantage of all the great features of word processing packages like Wordstar®, pfs: Write®, Microsoft Word® and most others which allow you to automatically use superscripts, subscripts, automatic underlining, bold-face (shadow printing) and doublestrike.

The printer has a set of rear switches which allow the use of standard ASCII as well as foreign character printwheels. Page length can be set to 8, 11, 12, or 15". The Daisy 1120 can also be switched to add automatic line feed if required.

## THE BEST PART

When shopping for a daisy wheel printer with all these features (if you could find one), you could expect to pay \$600 or \$700 dollars. The options would add much more. *Not now!* We have done our homework. We can now offer this printer for only \$353. Order yours today!

## NO RISK OFFER

Try the Daisy 1120 for 2 weeks. If you are not satisfied for ANY reason we will refund the full price—promptly. A full 1-year parts and labor warranty is included.

## THE BOTTOM LINE

Arotek Daisy 1120 (Order#1120) \$353 w/standard Centronics parallel interface and 2K buffer.

## Options

Auto Cut Sheet Feeder (#1110) \$188

Tractor Feed (#1112) \$77

## Accessories

8' Cable for IBM PC® and compatibles (#1103) \$26

Interface with cable: •TI-99/4A (#106) \$66

•Apple II or IIe (#1104) \$76

•All Commodore (except Pet) (#1105) \$44

•All Atari (#1107) \$66

Shipping is \$11—UPS-continental USA. If you are in a hurry, UPS Blue or Air Parcel Post (second day air) is \$25. Canada, Alaska, Mexico and Hawaii are \$30 (air). Other foreign is \$60 (air). California residents add 6% tax. Prices are cash prices—VISA and M/C add 3% to total. We ship promptly on money orders, cashier's checks, and charge cards. Allow 14 day clearing for checks. No C.O.D.'s. Payment in US dollars only.

TO ORDER ONLY CALL TOLL FREE

(800) 962-5800 USA (8-8 PST)

(800) 962-3800 CALIF.

Or send payment to address below:

Technical Information & Customer

Service: (805) 987-2454 (8-5 PST)

Dealer Inquiries Invited

© 1985 APROTEK. All rights reserved.  
Trademarks: Diablo, Hytype II, 630, Xerox Corp., Wordstar-Micropro Corp., PFS-Software Publishing Corp., Microsoft Word-Microsoft Corp., Apple, II, IIe-Apple Computer, Inc., IBM-PC-IBM Corp., PET, CBM.



**APROTEK**

1071-A Avenida Acaso, Camarillo, CA 93010

# What's a database system doing with a

```
ONLY-RELATED-RECORDS
Relate to which of the following groups of records in the file?
CURRENT-RECORD ALL PLACED
FILE COMPANIES 15 Records 00000
-----
Company Name Billing Rate
Rilled Accounting Assoc 1 50.00
Easy Charters 1 45.00
Family Nursing Centers 1 50.00
P Flower Power 1 50.00
BILLOTTE Sandwich Shops, Inc 1 40.00
Massachusetts Metal Products 1 50.00
Reluquant Technology 1 55.00
Robert Barnum & Associates 1 50.00
S P I, Inc 1 50.00
SAC Press 1 50.00
Stage Two Research 1 45.00
The Tribune 1 50.00
TIP Construction Co 1 50.00
File: COMPANIES Previous mode: Initial Files viewed: 1
```

1. Relational capabilities.

```
Enter values for the record.
FILE CLIENT_HISTORY DATE 0001
-----
NOTES HISTORY DATE
Spoke with Marcia today for 2 hours. She's interested
in Cornerstone. Call back Friday. 4/19/85
Called Marcia back. She wants to arrange a meeting
with her purchasing department to discuss licensing
agreements and support requirements. They may be
interested in purchasing 50 copies. --Don't forget
to bring software for demo!! 4/26/85
Date to Call: Next Wednesday
File: CLIENT_HISTORY Previous mode: Update Files viewed: 1
```

2. Variable-length fields.

```
Select a grouping from the menu. Use arrow keys or type the command
FILE UPDATE SELECT VIEW COLUMN DETAILED
FILE PEOPLE 11 Records 000000000
-----
Full Name Company Name Work Phone
Mitchell Canone 3-2-1 Associates, Inc 603-942-8101
David Green Massachusetts Retail Products 395-1774
Dan Wörner Robert Barnum & Associates 503-574-3000
617-492-6000
Floyd Flathead Infocore, Inc 492-1031
James Richardson Easy Charters 702-555-1212, #1234
772-740-4900
212-734-9900
File: PEOPLE Previous mode: Initial Files viewed: 1
```

3. Multi-valued fields.

```
Enter values for the record.
FILE ORDER PART NUMBER QUANTITY PRICE TOTAL
-----
PART NUMBER PART DESCRIPTION QTY PRICE TOTAL
1-5002 Mercedes Bearing Car Repair 30 12.00 3 720.00
7-5003 Governor Support Bushing In 30 5.00 3 150.00
7-2006-2 Stator Shaft Rear Bushing I 40 5.00 3 100.00
7-2182 Extension Housing Seal Inst 40 5.00 3 200.00
7-2193 Fuse Seal Installer 50 4.00 3 200.00
*****
DISCOUNT: 5% PRICE AFTER DISCOUNT: 1,339.50
File: ORDER Previous mode: Update Files viewed: 1
```

4. Subrecords.

```
REPORT SUBTOTAL
Select an AGGREGATE function or press (ENTER) to recompute subtotal:
FILE ORDER QUANTITY SUBTOTAL
-----
Customer Name Quantity Total Purchases
4 Orders from Hubner Mill Garage 416 4,599.00
3 Orders from Emberson Lumber Co 110 2,263.55
3 Orders from Concord Bus Line 493 4,831.64
3 Orders from Hal's Foreign Auto Repair 141 963.10
4 Orders from Hanover Service Station 470 6,244.30
4 Orders from Lexington Auto Service 423 2,530.00
3 Orders from Roanoke Olds Dealers 701 2,055.00
2 Orders from T Motors 200 1,899.00
3 Orders from Tom's Service Center 242 1,942.00
*****
2,979 127,382.01
File: ORDER Previous mode: View Files viewed: 2
```

5. Interactive report writer.

```
Enter values into the form.
FILE Derivation Derivation 0001
-----
ABS EXP DAY DAY_OF_WEEK
INTERVAL_DATE INTERVAL_TIME INTEREST
LOG10 MINUTES MONTH
PART PERIOD REP
*****
Derivation: 1.69e,compression,ratio * LOG10 (Temperature)
File: Machine_Monitoring Previous mode: Define Files viewed: 1
```

6. Calculations.

```
Enter values into the form.
FILE ORDER Attribute name 00000
-----
Attribute name ORDER_DATE
Description: The date the order was taken
Type: DATE
Default display width: 17
Display style for date: F 31 Dec 84
Display year? Short (e.g. 84)
Display day of week? Short (e.g., Fri)
Display day and month in uppercase? Yes
Minimum date value
Maximum date value
Maximum number of values: 1
Unique values? No
Indexed? No
Random? No
Changeable? Yes
File: ORDER Previous mode: Define Files viewed: 1
```

7. Sophisticated data features.

```
Enter values for the record.
FILE CLIENT_HISTORY COMPANY NAME 0001
-----
The value you enter in this field must match one of the following values
listed on what you've typed so far, before the cursor position:
ALLIED ACCOUNTING ASSO EASY CHARTERS FAMILY NURSING CENTERS
FLOWER POWER BILLOTTE SANDWICH SHO MASSACHUSETTS METAL PR
RELUQUANT TECHNOLOGY ROBERT BARNUM & ASSOCI S P I, INC
SAC PRESS STAGE TWO RESEARCH THE TRIBUNE
TIP CONSTRUCTION CO VONY ASSOCIATES WINDA TONING CO
Use the scrolling keys to view text at the top.
Company Name
File: CLIENT_HISTORY Previous mode: Update Files viewed: 1
```

8. Options key.

```
CONVERT FROM
Choose the foreign file format to convert FROM
FILE CONVERT FROM FROM TO DEF
-----
dBASE II PFS 1-2-3 dIF MailMerge
TEXT
File: Previous mode: Initial Files viewed: 1
```

9. File conversion.



Cornerstone is a trademark of Infocom, Inc. IBM is a registered trademark of International Business Machines Corporation. 1-2-3 is a registered trademark of Lotus Development Corporation. Tandy is a registered trademark of Tandy Corporation. dBASE II is a registered trademark of Ashton-Tate. Micro/Answer is a trademark of Informatics General Corporation. PFS is a registered trademark of Software Publishing Company.

# Power for non-programmers All this power?

## Cornerstone makes it easy to build sophisticated applications.

Whether you program or not, you expect your personal computer to handle a wide variety of complex jobs. Simply and easily. That's why we designed Cornerstone™ to deliver all the power of a high-end relational (1) database system into the hands of professionals who don't want to spend needless time programming.

## The key is flexibility.

To begin with, Cornerstone will grow with you as your needs change. Which means you don't have to plan every last detail of your database in advance. Instead, you can quickly and easily make changes anywhere and at any time—even with data already in the database. You can add a file, field or index, change a report or relationship, or do countless other things.

And Cornerstone's remarkable flexibility also applies to data handling. For instance, variable-length fields (2) let you add notes of any length anywhere in the database—without determining the length of the field in advance. Cornerstone just makes room as you need it. Which means efficient storage, too.

In addition, any Cornerstone field can be multi-valued (3). So you can type in distinct, multiple entries in the same field. Whether five different phone numbers or 200 different notes. You can even have repeating groups of information, like line items in an order form (4).

The flexibility extends to reporting, too. There's no limit to the number or kind of reports you can create with Cornerstone's interactive report

writer (5). You can design complex reports with titles, headers, subtotals and totals, and instantly see what your report will look like. Hundreds of reports can be saved for every file and modified at any time.

And Cornerstone has no artificial constraints. You can sort on any field, search on any field.

## The calculating power is built in.

Cornerstone has impressive calculating power (6). Mathematical, scientific, statistical, financial, date, time and string functions are built right in. And because it's a full-featured relational database system, new data can be calculated and reported from multiple files. Cornerstone can also perform sophisticated data validation—checking for minimum, maximum, mandatory, unique or restricted values (7).

## Easy access for all.

Cornerstone's power is designed to be easily accessible. On-line support, including menus and a Help key, allow even unsophisticated users to handle complex jobs. Experienced users can hide the menus entirely.

What's more, Cornerstone's exclusive Options key (8) always shows you what can be entered next—even if it's a restricted data value from a related field.

You can also use Cornerstone with other software and hardware (9). For example, you can easily convert files

from 1-2-3,® PFS,® dBASE® II and word processors (ASCII) directly into Cornerstone. And you can convert Cornerstone files to a wide variety of file formats, including Mailmerge,™ DIF, 1-2-3, SDF and ASCII. You can even download data from most IBM® mainframe databases, using Micro/Answer™ for Cornerstone.

Cornerstone is a different kind of database system. Created by a company committed to eliminating the barriers between computers and people. It's now available for the IBM PC, PC XT,™ PC AT™ and compatibles, and soon for the Tandy® 1000, 1200 HD and 2000. Suggested retail price \$495.

## Send for your free demo disk.

To fully appreciate how different Cornerstone really is, you have to try it yourself. For a free demo disk and brochure, call 617-574-0644, or write to Infocom, Inc., Dept. D., 125 CambridgePark Drive, Cambridge, MA 02140. Or see your local Infocom™ dealer.

**INFOCOM™**



# Cornerstone.

## The sophisticated database system for the non-programmer.

Last year, Tina Ferguson was Sales Representative of the Year for E.R. Squibb and Sons Animal Health Division.

This year, she's planning a repeat performance—even though her quotas are higher.

She'll probably succeed. After all, Tina recently teamed up with KnowledgeMan.

"KnowledgeMan was very easy to get to know," says Tina, who had no previous experience with software. "You can start doing things right away. I began using it for territory management. Now I'm getting into account management. It seems the more I demand, the more it responds.

"The integration is a real time-saver. It's so natural and flexible. You don't have to exit one function before entering another, so I can work with data bases, statistics, spreadsheets and graphics all at the same time—and even incorporate them into programs.

"With KnowledgeMan, I can keep close track of the sales numbers for each account—when they buy, what they buy and how close I am to meeting my quotas. It's helped me work more effectively and improve service to my customers."

If you're interested in forming a great partnership with KnowledgeMan, contact Micro Data Base Systems, Inc., P.O. Box 248, Lafayette, IN 47902 (317) 463-2581.

A variety of KnowledgeMan options, including K-Text™, K-Graph™, K-Paint™ and K-Report™ are available from MDBS.

Current version is 1.07 as of 9/10/84. Operating systems: PC DOS, MSDOS, CP/M-86. Minimum RAM required is 256K.

MDBS, KnowledgeMan, and their logos are registered trademarks of Micro Data Base Systems, Inc.



**KNOWLEDGE  
man**

The Knowledge Management Software  
from MDBS®

LAN Versions Now Available

Inquiry 233



*Tina Ferguson*  
AND KNOWLEDGEMAN



# TRAVESTY REVISITED

BY MURRAY LESSER

*The Travesty generator is recast  
in compiled BASIC*

AS A WRITER, I was intrigued by the possibilities in Hugh Kenner and Joseph O'Rourke's lexical processor (described in "A Travesty Generator for Micros," November 1984 BYTE, page 129). While the procedure can't quite produce an adequate first draft of a new manuscript, it is a small step on the way to the complete automation of the writer's craft.

Unfortunately, Kenner and O'Rourke picked the wrong programming language to illustrate their point. Pascal

just isn't the proper tool for handling a task consisting mostly of string manipulation. One of the Microsoft 16-bit BASIC compilers is a much better choice. They permit strings of more than 30,000 bytes (if you have enough string space) and allow all the usual Microsoft string operations to be performed on long string variables.

Listing 1 shows Travesty rewritten for the IBM PC version of the BASIC compiler. [Editor's note: The source code for this program, TRAVPC1.BAS, is available

for downloading via BYTEnet Listings. The telephone number is (617) 861-9774.] I have followed the structure of the original Travesty (leaving out those parts made unnecessary by BASIC's string-handling capabilities). Since no programmer likes to leave well enough alone, I have added a couple of extra goodies. The result is a fast program that is slightly more user-friendly than the original, requiring only about half the number of lines of code.

I added the line numbers followed by colons to the listing for discussion purposes, and they are not part of the source code.

The compiler /N switch (line 9) serves two purposes: It tells the compiler not to check for monotonic increasing line numbers and allows the underscore to be used as a logical-line continuation symbol. (Incidentally, programs containing unnecessary line numbers run slower due to a lower level of compiler optimization.) The compiler /E switch is necessary

(continued)

Murray Lesser received his B.S. degree in engineering from Caltech in 1942. He can be reached at 2474 Hunter Brook Rd., Yorktown Heights, NY 10598.

```

1 Twas in that bird, and thought head, and hand:
2 Long
3     back!
4 He while in his joy:
5
6 "And the boy!
7 O frabe.
8 'Twas brillig, and withy the Jabberwock, my son!
9 The Jabberwock?
10 Come that bite, the frumious day!"
11
12 He claws the son!
13 The sough
14 The stood awwhiffling
15     time raths outgrabe:
16 All mimsy went snicker-snatch!
17 Beware
  
```

Figure 1: An order-4 verse scan of the poem "Jabberwocky."



Since 1976

# ABSOLUTELY THE LOWEST PRICES!

We will beat any price advertised in this magazine!

## Let AB Build You a Super System



### ZENITH data systems

- Zenith Data Systems  
More than IBM compatible
- 2-DS DD 36K Disk Drives
  - 320K Ram
  - Amber 20 MHz Monitor-P3
  - Microsoft Software Package includes MS-DOS 2.1, Word, Multiplan
  - Pearl Database, \$100 with system

**\$1,850**

10-20Mg Hard Disk Systems starting at \$2,590



**AB DISKETTES**

with Media Mate  
30 - 3.5" ..... 125  
100 - 5" 05/00 ..... 160

**DATA TECH**  
one of the leading manufacturers

SS/DD ..... 1.00  
OS/DD ..... 1.05  
AT ..... 4.40

## AB Computers' own PC



100% IBM Compatible

- 256K RAM
- 2 - 360K Disk Drives
- Serial & Parallel Ports
- Your choice of 20 MHz Amber or Green Monitor
- Pearl Database only \$100 w/system
- Lotus 123 only \$250 w/system

Introductory Offer ..... **\$1,595**

10-20Mg Hard Disk Systems starting at \$2,350

### Panasonic



Friction & Tractor Feed  
With IBM Cable and Software disk to change type size & style

1090 80 cps ..... 219  
1091 120 cps ..... 299

Specify computer  
Two Reliable Workhorses

### OKIDATA

82, 83, 84, 92, 93, 182, 2350, 2410, Okimate-20 ..... *Call*  
Okimate (Specify C64 or Atari) ..... 199

**STAR**

SG10/SG15 (120 cps) ..... 239/399  
S010 (160 cps) ..... 359  
S015 (160 cps) ..... 479  
SR10 (200 cps) ..... 499  
SR15 (200 cps) ..... 639  
PowerType Letter Quality ..... 319

### daisywriter

LETTER QUALITY  
When you want your letter to look like a million \$ 40 cps ..... 700  
REGULARLY ..... 1,495  
Factory reconitioned, 90 Day guarantee

**Canon**  
Canon Dot Matrix  
This one a Special Purchase Commercial Quality Very Limited Quantity Hi Speed 160 cps IBM Clear Comp  
Only ..... 379

### CITICOR

Prowriter 7500 ..... 219  
Prowriter 8510P ..... 299  
Prowriter 1550P ..... 469  
Son of Starwriter A10P ..... 459  
Hot Dot Matrix ..... 459  
F10-40P Starwriter ..... 899  
F10-55 Printmaster ..... 1049

**EPSON**  
RX-80, FX-80+, LX-80, JX-80 ..... *Call*  
FX-100+, RX-100, LQ1500 ..... *Call*  
Homewriter 10 ..... *Call*

### MicroFazer Printer Buffers

ME parallel Epson 8K 135 16K 145  
32K 165 64K 195

MP parallel 8K 145 16K 155  
32K 175 64K 205

MSP ser-parallel 8K 165 16K 175  
32K 195 64K 225

MSS ser-serial 8K 165 16K 175  
32K 195 64K 225

MPS par-serial 8K 165 16K 175  
32K 195 64K 225

### USI



Hi Res. Metal Cabinet  
1-9 ..... 79 Large Qty.  
10-19 ..... 70 *Call*  
20 up ..... 68

### AMDEK

300 Green/Amber ..... 129/149  
300 Color/Audio ..... 259  
310 Amber IBM-Plug ..... 169  
Color 500 Composite/RGB ..... 389  
Color 600 Hi-Res(640x240) ..... 439  
Color 700 Hi-Res(720x240) ..... 499  
Color 710 Long Phosphor ..... 579

### TAXAN

115/116 12" Grn/Amb Mono ..... 99  
121 Green TTL ..... 139  
122 Amber TTL ..... 149  
210 Color RGB ..... 239  
400 Med-Res RGB ..... 319  
415 Hi-Res RGB ..... 439  
420 Hi-Res RGB (IBM) ..... 429  
440 Ultra Hi-Res RGB ..... 589

### ZILTON

ZVM 122/123 Amb/Grn ..... 89  
ZVM 124 IBM Amber ..... 149  
ZVM 131 Color ..... 299  
ZVM 133 RGB ..... 429  
ZVM 135 RGB/Color ..... 459  
ZVM 136 RGB/Color ..... 629

**BMC**  
9191U Color ..... 199

### HARD DISKS

10 Mg Add-in ..... 629  
20 MG Add-in ..... 850  
Atasi 53 Mg AT Kit ..... *Call*

**TEAC**  
OS 00 Disk Drive ..... 120  
64K RAM Kit ..... 20

### AST

Six Pack Plus ..... 239  
Mega Plus II ..... 269  
I/O Plus II ..... 139  
Memory MB II ..... 249  
Advantage AT ..... 399  
Preview Monograph ..... 299  
Graph Pak Mono/64K ..... 599  
MonoGraph Plus ..... 399  
5251 ..... 579  
3780 ..... 639

### Software Macintosh

Typing Tutor III ..... 40  
Hitchhikers Guide to Galaxy ..... 28  
Multiplan ..... 129  
Mind Probe ..... 35  
Millionaire ..... 40  
Ensemble ..... 230  
Jazz ..... *Call*  
Helix dBase ..... *Call*

### IBM

**Software**  
dBase III ..... 458  
Lotus 123 ..... 290  
Prokey 3.0 ..... 87  
Millionaire ..... 40  
Summer Games ..... 28  
Typing Tutor III ..... 35  
Hitchhikers Guide Galaxy ..... 28  
Multiplan ..... 129  
Copy II PC ..... 35  
Mind Probe ..... 35  
Turbo Pascal 3.0 ..... 54  
PFS Graft/Report ..... 79  
PFS Write/file/plan ..... 89

**Utility Programs**  
Slide Kick ..... 36  
Norton Utilities ..... 75  
Copy II PC IBM install Lotus dBase etc. on hard disk ..... 30

### AMRAY



Media Mate ..... 8.95  
Flip N File/25 ..... 18.50  
Flip N File/50 ..... 22.95

### 3M Certified Data Cartridges

DC 100A H-P, etc. .... 14.25 10/13 50  
OC 300A ..... 19.25 10/18 25  
OC 300XL ..... 22.45 10/21 45  
OC 600HC 600 ..... 27.00 10/25 90  
OC 615HC 150 ..... 20.00 10/18 90  
OC 600A 600 ..... 25.00 10/23 85  
OC 615A 150 ..... 18.40 10/17 45

### QUADRAM

Quadboard II ..... 229  
Expanded Quadboard ..... 239  
Quad 512+ ..... 249  
Quad 2 Meg ..... 879  
Memory Board ..... 229  
Quad Jr. Exp. Chassis ..... 539  
Quad Jr. Exp. Memory ..... 219  
Quad Memory Jr. .... 229  
Chronograph ..... 89

### Software Apple

Typing Tutor III ..... 35  
Hitchhikers Guide to Galaxy ..... 28  
Multiplan ..... 84  
Copy II ..... 35  
Mind Probe ..... 35  
Turbo Pascal 3.0 ..... 54  
Corner Stone ..... *Call*  
Millionaire ..... 35

### IBM

**Utility Programs**  
Slide Kick ..... 36  
Norton Utilities ..... 75  
Copy II PC IBM install Lotus dBase etc. on hard disk ..... 30

### Hayes

2400 ..... *Call*  
1200/300 ..... 489  
1200B w/Smartcom St. .... 419

**ANCHOR**  
2400 ..... *Call*  
Mark XII ..... 269  
Volks 12 w/cable ..... 199  
Volks 3 w/cable ..... 68

### NOBODY BEATS OUR PRICE ON DISKS!



Over 100,000 in stock at all times  
3 1/2 AT HDENS disks for all models

### PARADISE

Modular Graphics Card ..... 279  
Multi Display Card ..... 299  
Five Pack C.S. .... 169

### Hercules

Graphics ..... 319  
Color ..... 169

### AB SATISFACTION GUARANTEE

Every product sold by AB Computers is factory packed and comes with the manufacturer's warranty. However, if an item is defective when received, you may return it to us within 15 days for repair, adjustment or replacement at our option. Returns must be accompanied with copy of your invoice, letter detailing defect, blank warranty card and all original factory packing. To expedite handling, please call for return authorization number. (Sorry, no return on computer software once opened.)

Some store prices slightly higher.

### POWER DEVICES

Datashield back-up power source  
200 PC-200 watt ..... 265  
300 XT-300 watt ..... 390  
Trip 425 ..... 433  
Brooks 6 Outlet-Surge Suppressor/Noise Filter ..... 54

### CABLES

Parallel Cable (36pin/36pin) ..... 23  
RS232 Male to Male 6' ..... 17  
RS232 Male to Female 6' ..... 18  
Parallel Cable for Columbia ..... 25  
IBM Cable ..... 19



Use  
TOLL FREE  
Order Line  
Mon. - Sat.  
9am - 6pm EST

# 800-822-1211

In PA: 215-822-7727

252 BETHLEHEM PIKE, COLMAR, PENNSYLVANIA 18915

We support Apple,  
Macintosh,  
Commodore,  
IBM & compatibles



Customer Service  
215-822-7727



TRAVESTY REVISITED

Listing 1: Travesty written for the IBM PC version of the BASIC compiler.

```

1: * .....
2: * *** TRAVPC1.BAS ***
3: * .....
4:
5: * Based on the article and Pascal program Travesty by Hugh Kenner
6: * and Joseph O'Rourke, in BYTE for November 1984.
7:
8: * Written by M. L. Lesser, November 26, 1984
9: * Compiled with IBM PC BASIC Compiler, v 1.00, switches /N/E/O
10: * (patches to May 1984 have been installed)
11:
12: * TRAVESTY scans a standard ASCII text file and generates an n-order
13: * simulation of its letter combinations. For order n, the relation of
14: * output to input is: "Any pattern n characters long in the output has
15: * occurred somewhere in the input and at about the same frequency."
16: * If the verse flag is set, line-end symbols will be replaced by "|",
17: * which will generate line ends when they occur in the output text.
18: * Otherwise, output lines will average 50 characters in length.
19: * The output will be displayed during operation and will be filed in
20: * the standard ASCII file TRAVESTY.DOC.
21:
22:   DEFINT F,I - N           'FLAG,B, FLAG,E, FLAG,V, I, K, L,
23:                           'LETTER(), MAX.IN, MAX.OUT, MAX.PAT,
24:                           'N.OUT, N.PAT
25:   DEFSTR O - Z           'PASS, PATTERN, SOURCE, STRING,
26:                           'OUT.CHAR
27:   DIM LETTER(124)
28:   ON ERROR GOTO 5000
29:
30: * Default values:
31:   LET MAX.IN = 30000      'Maximum input-string length
32:   LET MAX.PAT = 9        'Maximum scan-order length
33:
34: * User input data:
35:   RANDOMIZE               'Get randomizing seed
36:   INPUT "Number of characters to be output"; MAX.OUT
37: 0100 PRINT "Scan order ( 2 - " MAX.PAT ")"; 'Simulated repeat
38:   INPUT N.PAT
39:   IF N.PAT < 2 OR N.PAT > 9 THEN GOTO 100 'until
40:   LET N.PAT = N.PAT - 1   'Convenience correction
41: 0200 INPUT "Name of input file"; SOURCE   'Error RESUME point
42:   OPEN SOURCE FOR INPUT AS #1           'Trap if no file
43:   INPUT "Prose or verse"; PASS
44:   IF LEFT$(PASS,1) = "V" OR LEFT$(PASS,1) = "v"__
45:       THEN LET FLAG.V = - 1             'Set verse flag
46: * Scan input text, deleting unwanted symbols:
47: * (NOTE: If in verse mode, <SP>'s following line end will be deleted)
48:   PRINT
49:   WHILE NOT EOF(1)
50:       LET PASS = INPUT$(1,#1)           'Read input file one
51:       IF PASS <> CHR$(13)___           'character at a time
52:           THEN PRINT PASS;             'Bug trap while
53:           ' displaying input
54:       IF PASS = CHR$(13)___           'Change any <CR>
55:           THEN LET PASS = ""           'to <NUL>
56:       IF PASS = CHR$(10)___           'Change any <LF>
57:           THEN LET PASS = ""___       'to <SP>
58:       IF FLAG.V___                     'or (if verse)
59:           THEN LET PASS = "|"         'to special line end
60:       IF PASS = CHR$(9)___             'Change any <HT>
61:           THEN LET PASS = ""         'to <SP>

```

(continued)

# CLOSEOUT CORNER

## CPM Special ALSPA ACI

64K, 2 SS/DD 8" Half Height Drives  
 Original Price \$1,995; **AB Closeout \$499**  
 Freedom 110 CRT intelligent terminal  
 with above system ..... only \$500

## HP Calculators and Accessories

**Below Cost - Limited Supplies**

Electrohome RGB Monitors w/IBM Cable ..... \$235  
 Panasonic Monitor 12" green w/sound ..... \$99  
**AMDEK** Daisey Wheel Printers 25CPS ..... \$499  
**MSD** Disk Drives for CBM & 64 ..... **Call**

## ATTENTION

### Commodore User Groups

Price Break Through  
 C64 Modem Auto Dial/Auto Answer w/Free Software  
 110/\$40 50/\$45 10/\$56 Sample/\$50  
**AMRAY Media Mate 5** holds 50 disks  
 110/\$7.50 48/\$7.75 24/\$8.00 Sample/\$8.95

## 8" DISK RIOT

Maxell Sentinel BASF Wabash SS/DD  
 10110 \$1.00 500 \$1.10 100 \$1.25

### Commodore Close Outs 50% to 80% OFF

Comsense C64 ..... **Call**  
 Comclock C64 ..... **Call**  
 Comvoice C64 ..... **Call**  
 Promqueen C64 Programmer ..... \$121

### C64 Programming Aids by SM

SM Text ..... \$34  
 SM Adreva ..... \$24  
 SM Kit ..... \$29  
 SM ISM ..... \$30  
**ALL FOUR ONLY ..... \$99**

## NEW! JUST ARRIVED

SUMICOM Hi Quality Daisy Wheel Printer  
 18 CPS QUME Print Wheels, Parallel Interface  
 13" Paper Width Introductory Offer ..... \$399

### Software Close Out for C64 Over 100 Titles Up to 70% OFF

We carry full software lines by Electronic Arts, Scholastic, Scarborough, PFS, Spinnaker, Batteries Included and many others. If you don't see the program you want listed, call our TOLL-FREE order phone number 1-800-822-1211.

### BUSINESS EDUCATIONAL

Wordpro 3+ ..... 85 Agent USA ..... 21  
 Microsoft MultiPlan ..... 69 Spell Diver ..... 21  
 Omnivrit/speller ..... 45 Secret Flier ..... 14  
 Bank Street Writer ..... 49 Kinder Comp. .... 20

### ENTERTAINMENT

Lode Runner ..... 26 Flight Simulator ..... 41  
 Mind Proger ..... 20 Zaxxon ..... 30



Use our Toll FREE Order Line Mon-Sat 9am-6pm

CUSTOMER SERVICE  
215-822-7727

**800-822-1211**

In PA 215-822-7727

252 BETHLEHEM PIKE, COLMAR, PA 18915

**WHY WAIT FOR  
ANSWERS FROM YOUR  
IBM PC/AT/XT  
NOW THERE'S  
MEGA-MATH™**

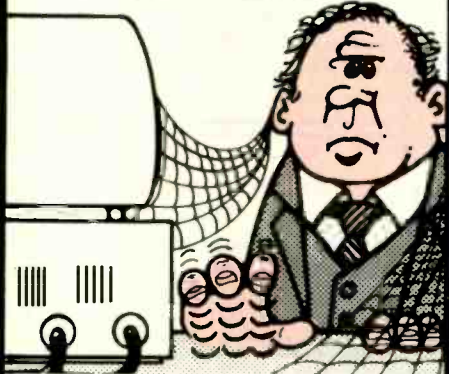

Engineers, scientists and statisticians are discovering the time saving capability of New "Mega Math" II. A library of over 45 assembly language subroutines for fast numeric calculations, up to 11 times faster than your present compiler.

The pretested routines use the 8087 or 80287 coprocessor for optimum performance. The routines reduce development time, code size and testing time.

"Mega Math" II Includes:

- MATRIX OPERATIONS**
- VECTOR OPERATIONS**
- VECTOR SCALAR OPERATIONS**
- STATISTICAL OPERATIONS**
- FAST FOURIER TRANSFORM**
- CONVOLUTION**
- SOLUTION OF LINEAR EQUATIONS**

The library is callable from Microsoft Fortran, Basic, "C" and Pascal compilers. Also IBM Professional Fortran and Macro Assembler.

Get "Mega Math" II Performance for only

**\$299.00 (U.S.)**

Also available is the "Mega Math" A.T. "Booster". A single PC board, designed to reduce execution time in numeric processing applications.

If your IBM AT is equipped with the 80287 coprocessor, the "Booster" will enhance its performance by up to 50%.

**PRICE \$349.00 (U.S.)**

For increased performance of Mega Math Routines, inquire about Micray's high performance floating point processor for the IBM AT or compatibles.

**MICRAY  
ELECTRONICS LTD.**

(403) 250-1437  
Bay 1, 4001A - 19 Street N.E.  
Calgary, Alberta, Canada T2E 6X8



DEALER INQUIRIES WELCOME

TRADEMARKS:

(IBM, PC/XT/AT)

INTERNATIONAL BUSINESS MACHINES  
(MICROSOFT) MICROSOFT CORPORATION  
(MEGA MATH) MICRAY

**TRAVESTY REVISITED**

```

61:         IF PASS <> "" AND PASS <> " " 'Unless <SP> or <NUL>
62:             THEN LET FLAG.B = 0 ' reset blank flag
63:         IF NOT FLAG.B ' If "blank" flag clear
64:             THEN LET STRING = STRING + PASS ' add to string
65:         IF (FLAG.V AND PASS = "|") ' Set blank flag to
66:             OR (PASS = " ") ' delete following
67:             THEN LET FLAG.B = -1 ' <SP> characters
68:         IF LEN(STRING) >= MAX.IN ' If full string:
69:             THEN GOTO 300 ' break out of loop
70:         WEND ' End of input loop
71: 0300 LET STRING = STRING + LEFT$(STRING,N.PAT) 'End around
72: ' Report string space usage and force garbage collection:
73:     PRINT: PRINT
74:     PRINT "Input string contains" LEN(STRING) "bytes"
75:     PRINT "There are" FRE(" ") "bytes remaining in string space"
76:     CLOSE #1
77:     PRINT: PRINT
78: ' Open output file:
79:     OPEN "TRAVESTY.DOC" FOR OUTPUT AS #2
80: ' Initial pattern:
81:     LET PATTERN = LEFT$(STRING,N.PAT)
82:     PRINT PATTERN;
83:     PRINT #2, PATTERN;
84:     LET N.OUT = N.PAT
85: 0400 ' Start of major "repeat until" loop
86: ' Clear letter array (this compiler doesn't have ERASE):
87:     FOR K = 0 TO 124
88:         LET LETTER(K) = 0
89:     NEXT K
90: ' Match current pattern:
91:     LET I = INSTR(STRING,PATTERN)
92:     WHILE I > 0 AND I <= LEN(STRING) - N.PAT 'Don't run off end
93:         LET PASS = MID$(STRING,I+N.PAT,1) 'Next character
94:         LET LETTER(0) = LETTER(0) + 1 'Update total count
95:         LET K = ASC(PASS)
96:         LET LETTER(K) = LETTER(K) + 1 'Update character count
97:         LET I = INSTR(I+1,STRING,PATTERN) 'For next match
98:     WEND 'And around again
99: ' Choose next output letter based on use frequency:
100:    LET L = INT(1 + LETTER(0) * RND) 'Random-choice index
101:    FOR K = 32 TO 124 'Scan the letter array
102:        LET L = L - LETTER(K)
103:        IF L <= 0 ' This is it
104:            THEN LET OUT.CHAR = CHR$(K) 'Break out of loop
105:        GOTO 500
106:    NEXT K
107: 0500 'Housekeeping for output character:
108:    LET N.OUT = N.OUT + 1 'Increment count
109:    IF N.OUT MOD 50 = 0 ' If average line length
110:        THEN LET FLAG.E = -1 ' set "line-end" flag
111: ' Establish next pattern:
112:    LET PATTERN = MID$(PATTERN,2) + OUT.CHAR
113: ' Display and store character found:
114:    IF NOT (FLAG.V AND OUT.CHAR = "|")
115:        THEN PRINT OUT.CHAR;
116:        PRINT #2, OUT.CHAR;
117: ' Check for line break:
118:    IF (FLAG.V AND OUT.CHAR = "|") 'Verse line end
119:        OR (FLAG.E AND OUT.CHAR = " ") 'Force line end
120:        THEN PRINT: ' Display <EOL>
121:        PRINT #2: ' File <EOL>
122:        LET FLAG.E = 0: 'Reset forced-end flag
    
```

(continued)

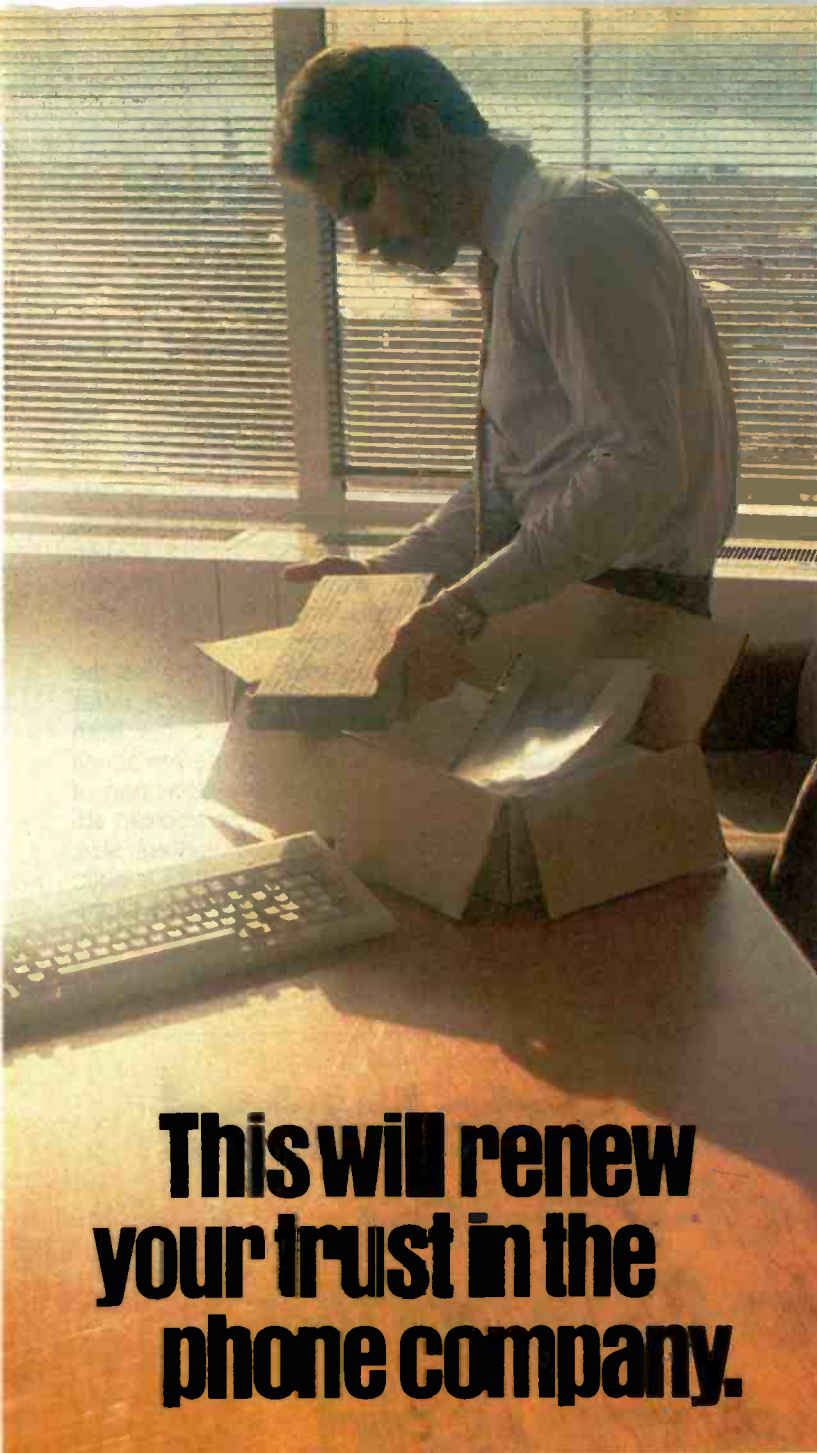

## This will renew your trust in the phone company.

**A**nycbody who's ever sent data over phone lines knows the problems it can present.

Information gets mumble-jumbled. \$4,000 invoices become \$40,000 invoices. And soon your company's lost a pretty penny over some modem foul-up.

Well, now you can say good-bye to all that.

™MNP is a trademark of Microcom, Inc. ©Copyright 1985 Codex Corp.

At NCC, see us at the Motorola Information Systems booth #5541.

Because Codex just came out with a modem that overcomes the inadequacies of phone line performance.

(Codex, as your friends in data processing will tell you, is the industry's acknowledged leader in state-of-the-art products, in service, in just about everything that has to do with networking.)

The Codex error-correcting pc modem is a serious business modem.

It gives you data transmissions more than 10,000 times more reliable than most other modems. Over anybody's phone lines.

A sophisticated error-correction system called MNP™ detects breakdowns in phone line performance and retransmits data. And the beauty is all this happens without you ever knowing it.

Just think. Data you can trust.

Now don't you feel better about those crazy phone lines?

If you're a data

communications manager responsible for purchasing modems, call 800-426-1212. Extension 225.

Or write Codex Corporation,  
Department  
707-225,  
20 Cabot  
Boulevard,  
Mansfield,  
MA 02048.



# codex

 MOTOROLA

JULY 1985 • B Y T E 167

```

123:           IF FLAGV AND OUTCHAR = " " 'Forced verse break
124:           THEN PRINT SPACES$(5); ' indents next line
125:           PRINT #2, SPACES$(5);
126:           IF INKEY$ = CHR$(3) THEN END 'Emergency exit
127: ' Check for end of output:
128:           IF N.OUT < MAX.OUT OR OUT.CHAR <> " "
129:           THEN GOTO 400 'End of major loop
130: END
131:
132: 5000 'Error trap (on "File not found" or "Bad filename"):
133:           IF ERR = 53 OR ERR = 64
134:           THEN PRINT CHR$(34) SOURCE CHR$(34) " does not exist. ";
135:           PRINT "Try again";
136:           RESUME 200
137:           ON ERROR GOTO 0
138: ' End of source code
    
```

the same input file.

Each character of the input file is displayed as it is scanned. Then, if it is valid, it is concatenated to the end of STRING, the string variable. A two-line subterfuge in lines 51-52 is included to get around a bug in the IBM PC BASIC that treats either CHR\$(13) or CHR\$(10) as an EOL symbol when printing. Without it, the program would display an extra blank row after the end of every input line.

I have somewhat arbitrarily set the maximum input-string length (after compression) at 30,000 bytes. Both the string length and the remaining string space are displayed as part of the run (lines 74-75), so you can adjust MAX.IN for your system size. Because of the way STRING is built, the total string space must be slightly greater than twice the length of STRING. If you have enough memory, the full 64K-byte data segment will

because I included error trapping, and the /O switch causes linking to the stand-alone support library—resulting in a smaller run-time program with more string space.

If you select the verse option (lines 44-45), the input parsing routine

(lines 46-71) will substitute the vertical-line separator for the DOS (disk operating system) ASCII (American Standard Code for Information Interchange) text EOL (end of line) symbol, [CRLF]. Consequently, you can run either a verse or prose travesty from

# Last year the experts tested the top-of-the-line Toshiba 3-in-One™ printer. Here's what they said.

“When Toshiba America called to see if there were problems testing their printers, I responded, ‘You bet—I can’t get the P1351 off Bill Machrone’s desk long enough to get its picture taken!’ It’s that good.”

(Bill Machrone is the editor of PC Magazine.)

PC Magazine  
November 27, 1984

“It is setting new standards for quality and performance in the dot matrix arena.”

Computers & Electronics Magazine  
November 1984

allow about 62,000 bytes of string space. Since the code segment is just under 18K bytes, you will have a full data segment if you have at least 82K bytes of available memory.

Output is quite fast, almost as fast as input. The scan loop (lines 92-98) uses BASIC's built-in INSTR() function to find all the occurrences of the desired pattern in the input STRING. Each "next character" is both displayed and written to the file TRAVESTY.DOC on the disk in the default drive.

While playing with my program, I found that an order-4 scan was the most interesting to use. Shorter patterns produced mostly nonsense; longer patterns repeated large chunks of the original input.

The whole mood of a piece can be modified by changing the randomizer seed. For example, the heroic joy of Lewis Carroll's "Jabberwocky" can be

```

' .....
' Initial line-end at a time
INPUT
    " )_ 'Rand aroutil" long input of loop
END 'And
    one
LET PASS, PASS = " " " _
THEN PRINT STRINT PASS,1)
    'Next patterse break output character next major
    'Bad index
FOR (PAT,
'OUT.CHAR;:_
GOTO 124
LET
    N.OUTPUT AS .....
' or <NUL>
IF L = "
"
'LET
    
```

Figure 2: An order-4 verse scan of the program's own source code.

converted to tragedy (see figure 1). As one might expect, Travesty is at its best when dealing with the soul of

the computer. Figure 2 shows a travesty (in verse form) of its own source code. ■

“

”

# Imagine what they will say about its successor.

**The New Toshiba P351 3-in-One printer.** They could say that inside the sleek new Toshiba P351 you'll find the ultimate 3-in-One printer. Because it offers a combination of:

Letter-quality printing. Perfectly translated graphics. And speed. (100 cps letter. And draft speed improved to 288 cps.)

They could say you'll appreciate the 24-pin dot matrix head that gives the P351 its exemplary letter and graphic quality.

They could say the new P351 gives you an almost unlimited number of ways to express yourself. With both downloadable software fonts and new plug-in font cartridges.



And they could say the new P351 is not only the best looking printer in the \$1,000 to \$2,000 range. But also the most reliable.

Of course, we're not putting words in their mouths. Just the ultimate 3-in-One printer in their hands. And yours.

For complete information call 1-800-457-7777, Operator 32.

In Touch with Tomorrow

**TOSHIBA**

TOSHIBA AMERICA, INC. Information Systems Division

# The Drive Warriors

Restoring order to the mass memory market!



- A. 10 & 20 Mbyte Internal (Half Height series)
- B. P-10RC 10 Mbyte Removable Cartridge
- C. P-60TB 60 Mbyte Tape Back-up
- D. P-30I & P-20I 30 & 20 Mbyte Internal (Full Height series)
- E. P-10I Port 10 Mbyte Internal for Portable
- F. P-10e & P-20e 10 & 20 Mbyte External series

The mass memory market has become a real battle zone! Chaos, confusion and buyer uncertainty have resulted from too many products and not enough answers.

The truth of the matter is, anyone can sell a winchester disk drive. The problem is that hard drives, by their own nature, are sensitive devices that require appropriate handling and customer support.

Don't be misled into believing that a disk drive can be sold and booted around the country, without any risk.

There is no room for the weak, when it comes to delivering a product you can depend on!

Peachtree Technology Inc. has cleared the path of confusion with a comprehensive line of mass memory expansion systems that have established themselves as leaders in advanced hard drive technology, backed by strong customer support. Every Peachtree Technology Inc. product has been through stringent diagnostic testing as a complete system. To assure they not only meet, but surpass specifications (On the outside of every box is a documented certificate of inspection signed by our techni-

cian). Plus we stand behind our products with a complete one year parts & labor warranty.

**FLEXIBILITY AND COMPATIBILITY A MUST!** To eliminate frustration, Peachtree Technology Inc. has provided a complete line of mass memory storage systems. They are fully compatible with IBM PC, XT, & PORTABLE, AT&T, CORONA PORTABLE, COMPAQ DESK PRO & PORTABLE, COLUMBIA, TAVA, ZENITH 150 AND MANY MORE. (If your computer is not listed, please contact us for further information).

We offer a complete line of products including:

- External winchester hard drives • 10, 20, and 30 megabyte (formatted capacity). Our 10 and 30 megabyte drives utilize a hard carbon coating on the disk platter surface.
- Internal mounted winchester hard drives • 10, 20 and 30 megabyte (formatted capacity)
- Removable hard disk • Half height winchester, 10 megabyte, utilizing new and advanced head positioning technology.
- Cartridge tapesystems • Capacity - up to 60 mbytes • Half high 5.25" form factor add-in/add-on to IBM-PC and compatibles.

- A 135 watt internal power supply that replaces the standard unit in the PC.

We'll supply everything you need to give your micro new speed and storage capacity: Disk drive, controller, cables, software, and associated custom firmware.

**One stop shopping for your mass memory requirements.**

Don't become a victim! The frustration and inconvenience of not having customer support may not be worth the few dollars you save buying from an unreliable source. There is no substitute for a complete hands on demonstration and face to face commitment to customer service from a reputable dealer. So don't be left standing in the smoke. To find out more about Peachtree Technology Inc. and our complete line of memory expansion systems, ask your local computer dealer for a complete demonstration. If he does not have our products have him call 404-662-5556, and we will deliver a demonstration unit & literature within 24 hours!

## Peachtree Technology, Inc.

3020 Business Park Drive, Norcross, Georgia 30071, Telephone (404) 662-5158 Sales (404) 662-5556

IBM - A Registered Trademark of International Business Machines Inc. AT&T - A Registered Trademark of Bell Laboratories. Corona - A Registered Trademark of Corona Data Systems. Compaq - A Registered Trademark of Compaq Computer Corp. Columbia - A Registered Trademark of Columbia Data Products. Tava - A Registered Trademark of Tava Corp. Zenith - A Registered Trademark of Zenith Data

# REAL-NUMBER FORMATTING ON YOUR APPLE

BY BRENT DAVIDUCK

*This subroutine lets you specify the decimal length of any real number*

IF YOU HAVE EVER written a BASIC program to format real numbers, you probably know your program can become cumbersome and its run time intolerably slow. (A real number may include a fractional portion, such as 3.14.) The machine-language subroutine described here uses only 116 bytes of memory and allows you to specify the decimal length of any real number.

If you have worked with FORTRAN, you may have used a statement that looked something like 100 FORMAT(F5.2). This statement formats a real number with a total length of five characters: two digits before the decimal, the decimal point, and two digits following the decimal. The BASIC program in listing 1 uses a similar syntax in line 90. The total length of the number is in the variable *L*; the number of decimal places is in the variable *D*. These parameters are then passed to the Format subroutine, listing 3, by line 10 of listing 1. (Note: The POKE statements must be present if you intend to use the ampersand, "&".)

To begin, you must determine the

maximum length of any number that the program will handle. Let's say the subroutine must handle numbers as large as 9999.99. You will want *L* to equal 7 and *D* to equal 2. As an example, the number to be formatted (*N*) will be 123.8765. Once the parameters have been passed to the subroutine, here's what takes place. [Editor's note: Unless otherwise specified, all addresses are in hexadecimal.]

1. The number in *N* is converted to an ASCII (American Standard Code for Information Interchange) string: 31 32 33 2E 38 37 36 35 00.

2. The number of digits before and after the decimal point are counted, including the decimal place, and they are subtracted from the number's total allowable length. The result is the number of leading spaces to be left blank preceding the number.

3. For the above example, a single space is followed by the numbers before the decimal point, the decimal point, and the number of places after the decimal point, giving the number 123.87. If in this example you want to produce rounded results, add a

rounding constant to the number you are passing: *L,D,N + 0.005*.

Since Applesoft BASIC cannot print a number with a length greater than 15, the subroutine in listing 1 will give you an ?ILLEGAL QUANTITY ERROR if you pass a length greater than this. The same error message is given if the number of places following the decimal point is less than 1 or greater than 8. Also, trying to print a number that contains a length greater than the length parameter passed will cause an ?ILLEGAL QUANTITY ERROR.

## OTHER NOTES

Table 1 lists all the ROM (read-only memory) routines used in the program and their function. You can either use the monitor to enter the machine-language routine at location 300 from the dump of the Format subroutine in listing 2 or assemble and load the assembly-language rou-

(continued)

Brent Daviduck (311 Silverthorn Way NW, Calgary, Alberta T3B 4E8, Canada) is a student at the Southern Alberta Institute of Technology.



**\$255**

MODEM SMARTCAT  
+ 1200 w/MITE

**\$79 \$669**

HH DRIVE JUKI 6300

**WAREHOUSE EXPRESS**

<b>\$259</b> LEGEND 160CPS	<b>\$544</b> 10 MEG DISK	<b>\$1500</b> IBM SYS.
<b>\$149</b> PARADISE	<b>\$222</b> ENABLE	<b>\$255</b> HAYES EXACT

**PRINTERS • PLOTTERS**

<b>CITIZEN</b>	
MSP-10 160cps	\$279
MSP-15 160cps	389
<b>C. ITOH</b> (Rileman, Epson Exacts)	CALL
<b>EPSON</b> (All Models)	LOW
<b>ENTER</b> (Sweet-P 6 Pen Plotter, HP Comp.)	\$729
<b>JUKI</b> (Letter Quality)	
6100	\$372
6300 40cps	669
<b>LEGEND</b> (Sqr Dot, Head w/Life Time Warr. EPSON Comp)	
880 100cps	\$189
1080 140cps	229
1380 160cps (IBM)	259
1385 160cps 15" (IBM)	319
<b>SILVER REED</b> (Letter Quality)	
EXP400	\$229
EXP500	274
EXP550	389
EXP770 36cps	LOW
<b>TOSHIBA</b> (1340, 1351)	LOW

**MODEMS • MONITORS • DRIVES**

<b>ANCHOR AUTOMATION</b>	
Volkmodem 12 (1200 Baud)	\$169
Express 1200 (HAYES Exact)	255
<b>HAYES</b> (1200, 1200B)	CALL
<b>NOVATION</b> (HAYES Compatible)	
SmartCat- 2400 IBM & MAC	\$499
SmartCat- 1200 w/Mite IBM	265
<b>TAXAN</b> (122, 420L)	
116 Amber	\$115
220 14"	234
420 RGB IBM HI-RES w/cable	379
425 RGB IBM HI-RES	399
440 RGB IBM ULTRA HI-RES	513
<b>PRINCETON GRAPHICS</b>	LOW
<b>DRIVES</b> (E-Z Install)	
5.25 hh/ds/dd IBM	\$ 79
Controller Card (w/drive only)	69
10 Meg HD PC	544
20 Meg HD PC	699
20 Meg HD AT	599
Macintosh 10 Meg HD	1049
3.5 ds/dd MAC Drive Ext.	350

**COMPUTERS • CARDS • CHIPS**

<b>IBM SYSTEMS</b> (Start @ \$1500)	CALL
<b>LEADING EDGE</b>	CALL
<b>MAC's</b>	CALL
<b>NEC</b>	
APC III	CALL
8401	LOW
8201	\$279
AC or BATTERY Adaptor	17
RAM 32K	199
<b>PANASONIC</b> (SR. Partner)	CALL
<b>PARADISE</b>	
Modular Graphics Card	\$259
5-Pack	149
Parallel or Serial Port	65
<b>RAM</b> 64K 150 NSEC	LOW

**SOFTWARE • DISKETTES**

<b>AUTO CAD</b> (Software, Digitizers, Plotters)	CALL
<b>CPA*</b> (For LOTUS 1-2-3) GL, AP, AR, PR	\$350
<b>ENABLE</b>	\$322
<b>1-2-3</b>	\$289
<b>SYMFONY</b>	\$390
<b>MICROPRO</b>	
WordStar	\$169
WordStar Professional	225
WordStar 2000	235
WordStar 2000*	285
<b>MAXELL &amp; OTHERS</b> (100 QTY) IBM, MAC, HP	LOW

Please make checks payable to: M.H.I.  
5021 N. 20th Street #10261  
Phoenix, AZ 85064

**ORDER LINE 1-800-428-7979**  
Other Information: (602) 890-0596



Prices reflect 3-5% Cash Discount. Shipping on most items \$8.00. Prices and availability subject to change without notice. Send cashier's check or money order. All other checks delay shipping 2 weeks. ADD #185

**FORMATTING**

Listing 1: This BASIC program will let you test the Format subroutine. You must specify the length of your number and the number of decimal places to be used.

```
10 HOME : POKE 1014,0 : POKE 1015,3
20 INPUT "Number of loops: ";E
30 INPUT "Format length: ";L
40 INPUT "Decimal places: "D
50 PRINT:PRINT
60 PRINT "Unformatted: "; TAB(25);"Formatted:"
70 FOR X = 1 TO E
80 N = RND(1) * (RND(1)*500)
90 PRINT N; TAB(24); & L,D,N : PRINT
100 NEXT
```

Table 1: A list of the ROM routines used in the Format subroutine.

SDD67—Converts an expression to a floating-point number stored in locations 9D to A3. This routine lets you pass a variable, variable expression, or simple number to your machine-language subroutine: & 7.2.123.8765.

SE6FD—Converts the number stored in locations 9D to A3 to a single-byte number in the X register. If the number is less than 0 or greater than 255, an ?ILLEGAL QUANTITY ERROR is printed. The routine will then return to the Applesoft BASIC prompt.

SDEBE—Checks for a comma. If one is not found, ?SYNTAX ERROR is printed, followed by a return to the Applesoft BASIC prompt.

SED34—Converts the number stored in locations 9D to A3 to an ASCII string that is stored starting at location 0100 on.

SE199—This routine will print ?ILLEGAL QUANTITY ERROR and return to the Applesoft BASIC prompt.

SF94a—Prints the number of spaces in the X register.

SDB5C—Prints the character in the A register.

Listing 2: A dump of the Format subroutine will let you check the values you have stored in memory.

```
]CALL-151
*300.373

0300- 20 67 DD 20 FB E6 E0 10
0308- 90 03 20 99 E1 86 06 20
0310- BE DE 20 67 DD 20 FB E6
0318- E0 09 B0 EE E0 00 F0 EA
0320- 86 07 20 BE DE 20 67 DD
0328- 20 34 ED A2 FF E8 BD 00
0330- 01 F0 04 C9 2E D0 F6 86
0338- 08 A5 06 38 E5 07 E5 08
0340- AA CA F0 05 30 C4 20 4A
0348- F9 A4 07 A2 00 BD 00 01
0350- F0 0A C9 2E F0 11 20 5C
0358- DB E8 D0 F1 A9 2E 20 5C
0360- DB A9 30 88 10 F8 60 20
0368- 5C DB E8 BD 00 01 F0 F1
0370- 88 10 F4 60
```



## FORMATTING

**Listing 3: The Format subroutine rounds any real number to a specified decimal place. All you have to do is supply the parameters.**

```

ORG $300
JSR $DD67      ;Get the format length
JSR $E6FB      ;Convert format length to single byte in X register
CPX #$10       ;Is the length greater than or equal to 16?
BCC $030D      ; No... continue on
JSR $E199      ;Print ?ILLEGAL QUANTITY ERROR, go to Applesoft
STX $06        ;Store the format length
JSR $DEBE      ;Check for a comma (,)
JSR $DD67      ;Get the number of places following the decimal
JSR $E6FB      ;Convert to a single byte in the X register
CPX #$09       ;Is the number of decimal places greater than 8?
BCS $030A      ; Yes... go print error
CPX #$00       ;Is the number of decimal places equal to 0?
BEQ $030A      ; Yes... go print error
STX $07        ;Store number of decimal places
JSR $DEBE      ;Check for comma (,)
JSR $DD67      ;Get the number to be formatted, store at $9D to $A3
JSR $ED34      ;Convert number to an ASCII string starting at $0100
LDX #$FF       ;Initialize X as index
INX            ;Increment index
LDA $0100,X    ;Get an ASCII character
BEQ $0337      ;End of string? Yes... go calculate leading spaces
CMP #$2E       ;Found a decimal point?
BNE $032D      ; No... continue counting
STX $08        ;Store number of characters before decimal point
LDA $06        ;Get the format length
SEC           ;Subtract from the length, the number of
SBC $07        ; places after the decimal and the number of
SBC $08        ; characters in front of the decimal
TAX           ;Store the result in X and decrement to
DEX           ; allow for the decimal point
BEQ $0349      ;If equal to 0 continue on...
BMI $030A      ;If less than 0 go print error
JSR $F94A      ;Print number of spaces in the X register
LDY $07        ;Get back number of decimal places in the Y register
LDX #$00       ;Initialize X as index
LDA $0100,X    ;Get an ASCII character
BEQ $035C      ;If end of string go print the decimal point
CMP #$2E       ;Is character a decimal point?
BEQ $0367      ; Yes... go print number of places after decimal
JSR $DB5C      ;Print the character in the A register
INX           ;Increment index to point to next ASCII character
BNE $034D      ;Go get next character
LDA #$2E       ;Load A register with ASCII value for decimal point
JSR $DB5C      ;Print the decimal point
LDA #$30       ;Load A register with ASCII value for a zero (0)
DEY           ;Decrement number of decimal places to be printed
BPL $035E      ;Continue printing decimal places until done
RTS           ;Return to calling routine
JSR $DB5C      ;Print the decimal point
INX           ;Increment index to point to next ASCII character
LDA $0100,X    ;Get an ASCII character
BEQ $0361      ;If end of string go finish printing
DEY           ;Decrement number of decimal places to be printed
BPL $0367      ;Continue printing decimal places until done
RTS           ;Return to calling routine
    
```

tine of listing 3. If you don't feel like typing them in, the assembly-language routine and the BASIC program

can be downloaded from BYTEnet Listings at (617) 861-9774 as Format.bas and Format.asm. ■

## Available, Reliable, Affordable Solutions for Computerization

### Little Board™/186 . . . \$499 <sup>with</sup> (128K)

Single Board 16-Bit Computer with SCSI/PLUS™ Bus

- Data and file compatible with IBM PC
- Three times the COMPUTING POWER of a PC
- Boots PC-DOS 2.10, 3.00
- Runs most MS-DOS generic software
- Mounts directly to a 5-1/4 inch disk drive
- Includes: 8 MHz 80186 CPU, 128K or 512K RAM, 16K-128K EPROM, 2 RS232C Serial Ports, Centronics Printer Port, Floppy Disk Controller, SCSI/PLUS™ Multi-Master bus for: hard disk / networking / I/O expansion
- Available with 512K RAM

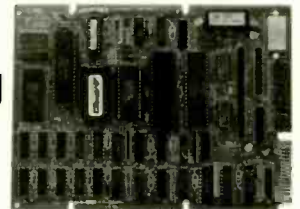
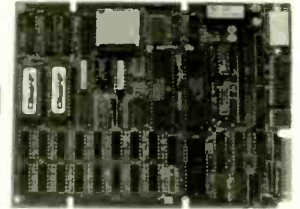

### Little Board™/PLUS . . . \$349

Single Board 64K CP/M Computer with SCSI/PLUS™ Bus

Same as Little Board/186 except:

- 4 MHz Z80A (8-bit) CPU
- 64K RAM, 4K to 16K EPROM
- CP/M 2.2 included

### Little Board™ (original) now \$289

same as Little Board/PLUS except no SCSI, 4K EPROM

### Bookshelf™ Series

Cost Effective, Compact, Versatile computer systems

Choice of Little Board CPUs, 1 or 2 floppy drives (48 or 96 tpi); 10MB internal hard disk option. 6 1/4" high, 7 1/4" wide, 10 1/4" deep, 12 1/4 lbs.

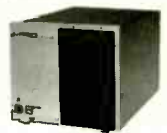

### DISTRIBUTORS

- |                                       |                |
|---------------------------------------|----------------|
| Argentina-Factorial, S.A.             | 1-41-0018      |
| Australia-ASP Microcomputers          | 613-500-0628   |
| Belgium-Centre Electronique Lempereur | 041-23-45-41   |
| Canada-Electronic Sales Assoc         | (604) 986-5447 |
| Denmark-Danbit                        | 03-66-20-20    |
| England-Quant Systems                 | 01-534-3158    |
| Finland-Symmetric OY                  | 358-0-585-322  |
| France-EGAL+                          | 1-502-1800     |
| Israel-Alpha Terminals                | 03-491695      |
| Spain-Xenios Informatica              | 3-593-0822     |
| Sweden-AB AKTA                        | 08-54-20-80    |
| USA:                                  | CALL AMPRO     |

IBM is a registered trademark of Intl. Bus. Mach.  
MS-DOS is a registered trademark of Microsoft.  
Z80A is a registered trademark of Zilog, Inc.  
CP/M is a registered trademark of Digital Research.

**AMPRO**  
COMPUTERS, INCORPORATED  
67 East Evelyn Ave. • Mountain View, CA 94041  
(415) 962-0230 • TELEX 4940302

# Discover the most powerful

---

## The IBM Personal Computer AT.

---

Hold on to your hat.

The IBM Personal Computer AT (for Advanced Technology) is based on the advanced 80286 16-bit microprocessor. This remarkable computer will run many of the programs written for the IBM PC, up to three times faster. You'll be able to recalculate large spreadsheets in seconds and retrieve files in a flash. And it's ideal for IBM TopView, the new kind of software program that lets you run and "window" several other programs at once.

The IBM Personal Computer AT has got the power (and price) to surprise you. In many ways.

---

### Compatibility, expandability, networking too.

---

With the IBM Disk Operating System, the IBM Personal Computer AT can use many programs from the fastest-growing library in the personal computer software industry.

The IBM Personal Computer AT is also available with up to 3 million bytes of user memory to run multiuser, multitasking operating systems such as XENIX™. Volume upon volume of information is available at your fingertips. You can customize your system to store up to 20,000 pages of information at one time. And its keyboard helps you use all of this computing power more easily.

This member of the IBM PC Family is a powerful stand-alone computer that can also be both the

primary file server and a station on your network. With the IBM PC Network (which is so easy to

#### IBM Personal Computer AT Specifications

<b>User Memory</b> 256KB-3MB*	<b>Diagnostics</b> Power-on self-testing* Parity checking* CMOS configuration table with battery backup*
<b>Microprocessor</b> 16/24-bit 80286* Real and protected modes*	<b>Languages</b> BASIC, Pascal, FORTRAN, APL, Macro Assembler, COBOL
<b>Auxiliary Memory</b> 1.2MB and 360KB diskette drives* 20MB fixed disk drive* 41.2MB maximum auxiliary memory*	<b>Printers</b> Supports attachment of serial and parallel devices
<b>Keyboard</b> Enlarged enter and shift keys 84 keys 10-foot cord* Caps lock, num lock and scroll lock indicators	<b>Permanent Memory</b> (ROM) 64KB Clock/calendar with battery*
<b>Display Screen</b> IBM Monochrome and Color Displays	<b>Color/Graphics</b> Text Mode Graphics Mode
<b>Operating Systems</b> DOS 3.0, XENIX,* PC/IX 1.1	<b>Communications</b> RS-232-C interface
	<b>Networking</b> High-performance, high-capacity station on the IBM PC Network*

\*Advanced Features for Personal Computers

connect you can do it yourself), the IBM Personal Computer AT can share information with IBM PCs, PC/XTs and IBM *Portable* PCs.

---

### Get a hands-on, hats-off demonstration.

---

The IBM Personal Computer AT has the power, compatibility and expandability many PC users need, at a very appealing price.

For more information contact your authorized IBM PC dealer, IBM Product Center or IBM marketing representative. For a store near you call 1-800-447-4700. In Alaska or Hawaii call 1-800-447-0890.



personal computer IBM has ever made.



Little Tramp character licensed by Bubbles Inc., s.a.  
XENIX™ is a registered trademark of Microsoft Corporation.  
UNIX is a trademark of AT&T Bell Laboratories. PC/IX is based on UNIX System III, which is licensed to IBM by AT&T Technologies, Inc. Developed for IBM by INTERACTIVE Systems Corp.

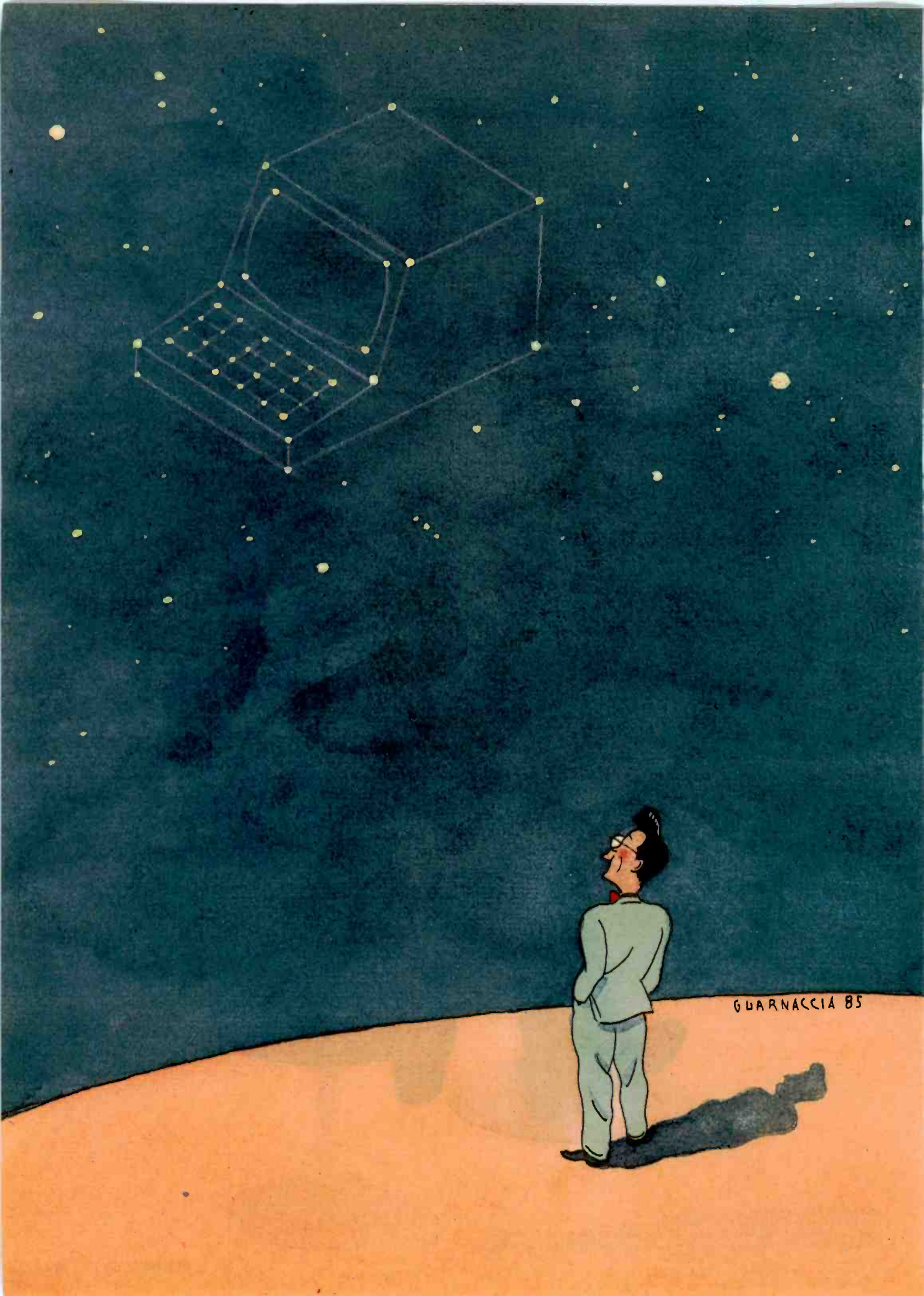

GUARNACCIA 85

# Computers and Space

---

<b>UPDATING THE OLDEST SCIENCE</b> <i>by Russell M. Genet</i> .....	179
<b>MICROCOMPUTERS IN NASA'S SIR-B</b> <i>by Richard Wilton</i> .....	192
<b>COMET LINES IN FORTRAN</b> <i>by David S. Dixon</i> .....	203
<b>TRACKING EARTH SATELLITES</b> <i>by E. H. Weiss</i> .....	215
<b>AUTOMATING A TELESCOPE</b> <i>by Louis J. Boyd</i> .....	227
<b>ASTRONOMICAL COMPUTING WITH MICROS</b> <i>by Richard Bochonko and William T. Peters</i> ..	239
<b>ASTRONOMY SOURCES</b> .....	244
<b>AN ASTRONOMY GLOSSARY</b> .....	245

---

ASTRONOMY IS UNIQUE among the physical sciences in that it continues to benefit from the discoveries and observations of serious amateurs. The cost of instrumentation necessary to participate in astronomy is still relatively modest, so you don't need the support of a major research institute to come aboard. Of course, huge reflector telescopes and phased-array radio telescopes are beyond the reach of individuals. But a lot of scientifically significant original research can be performed on equipment that is within the price range of serious amateurs. And the microcomputer revolution is expanding the reach of this low-end equipment.

In this issue, we take a look at some of the ways that microcomputers are used in astronomy and space exploration. We begin with a "Who's who" of astronomy by Russell Genet, codirector of the Fairborn Observatory. He seems to know everyone involved in astronomy and was instrumental in putting this issue together. He mentions a number of professional astronomers who are looking for assistance in their research. For example, Fred Franklin of the Harvard Smithsonian Center for Astrophysics is seeking amateur astronomers from all over the world to aid in his study of Jupiter's moons. If you are looking for ways to use your telescope to advance the science, this article is a very good place to start your search.

In part, we decided to do an astronomy issue because of the impending return of Halley's comet. So, of course, we have articles on tracking the comet. David Dixon's article discusses the Encke method of calculating ephemerides. He includes a FORTRAN program that can be used for comets, including Halley's (for which he gives the necessary orbital elements), and for asteroids. E. H. Weiss discusses refinements to the Encke method that improve the level of precision substantially. His sample BASIC program tracks space vehicles in earth orbit, but his discussion of the methodology will allow you to switch coordinate systems to solar orbits if you are so inclined.

We couldn't have an issue on astronomy without including a FORTH article. Richard Wilton, from Laboratory Microsystems Inc. (the PC/FORTH people), discusses his company's work designing a local-area network for the Jet Propulsion Laboratory. The LAN was used for real-time analysis of imaging radar data from the space shuttle. Be sure to read the captions to the imaging radar pictures; they'll give you a good idea of the uses of such technology.

Louis Boyd is the other codirector of Fairborn Observatory. He writes about automating an observatory, from telescope control to opening the observatory at night and selecting what to observe. He also reports on some of the original research performed at the Fairborn Observatory with its automated telescope.

Astronomy covers a lot of territory. Two things that will come in handy when you're exploring the universe are a portable computer and a good library. An article by Richard Bochonko and William Peters suggests some of the better books available in astronomy. You'll find three articles elsewhere in the issue that discuss subjects related to portable computers—a review of the TI Pro-Lite, a preview of the GRiDCase, and a feature on LCD technology.

# Golden Common LISP

## Gold Hill Computers brings the language of Artificial Intelligence to Your Personal Computer.

Why every Computer Professional should know COMMON LISP.

You know how frustrating it is to deal with programs that are stupid and inflexible like those buried inside automated bank teller machines and airline reservation systems. You also know how frustrating it is to engineer solutions to today's information-processing problems with languages designed mainly for number crunching. *It doesn't have to be this way.*

Programs based on the ideas of Artificial Intelligence and implemented in COMMON LISP can be intelligent, flexible, and human-like. When you use COMMON LISP in combination with artificial intelligence techniques, you will be able to *solve problems you could never solve before*. You will be able to write powerful programs that can accommodate naive computer users who want intelligible answers to questions quickly.

The best way to get started is to buy GOLDEN COMMON LISP™, the first COMMON LISP for personal computers.

### GOLDEN COMMON LISP: The AI Tutor

GOLDEN COMMON LISP makes it easy for you to learn to use COMMON LISP, on your personal computer, by yourself, at your own pace. The San Marco LISP Explorer™, a 1000-frame interactive software slide show developed by Patrick H. Winston and San Marco Associates, takes you through COMMON LISP and exciting *artificial intelligence applications* like expert systems, intelligent data-access systems, and natural language interfaces.



### GOLDEN COMMON LISP: The Complete LISP Environment

The GOLDEN COMMON LISP package includes:

- the GCLISP interpreter
- the GMACS editor
- the San Marco LISP Explorer
- the On-line Help system
- LISP, 2nd edition by Winston and Horn
- the COMMON LISP Reference Manual by Steele
- the GOLDEN COMMON LISP User's Manual

### GOLDEN COMMON LISP: The Powertool for Personal Computing

GOLDEN COMMON LISP is an extensive subset of COMMON LISP, supporting more than 400 LISP primitives. Advanced features of GOLDEN COMMON LISP include co-routines for multi-tasking, macros for code clarity, streams for I/O, closures for object-centered programming, and multiple-value-returning functions for efficiency.

GOLDEN COMMON LISP requires an IBM, PC XT, PC AT, or 100% IBM PC compatible computer with 512K bytes of memory and PC-DOS 2.0 or higher. More memory is recommended for applications development.

ORDER GCLISP TODAY using the coupon below. Or call our Sales Department at:

**617-492-2071**

Gold Hill Computers		B1-85	
163 Harvard Street Cambridge, MA 02139			
Name _____			
Title _____			
Department _____			
Organization _____			
Address _____			
Phone _____		Today's Date _____	
Type of computer _____			
<input type="checkbox"/> Enclosed is a check to Gold Hill Computers for GCLISP.			
<input type="checkbox"/> Please bill my <input type="checkbox"/> MasterCard <input type="checkbox"/> VISA card.			
Card # _____		Expiration Date _____	
Signature _____			
Quantity	Description	Unit Price	Total Price
	GOLDEN COMMON LISP	\$495	
			Subtotal _____
MA residents add 5% Sales Tax			
Total Amount			_____
We welcome inquiries about volume discounts, dealer discounts, and educational discounts for university-affiliated purchasers.			
<input type="checkbox"/> Please send me more information.			

G O L D H I L L C O M P U T E R S

163 Harvard Street, Cambridge, Massachusetts 02139

Inquiry 161

GOLDEN COMMON LISP and GCLISP are trademarks of Gold Hill Computers. The San Marco LISP Explorer is a trademark of San Marco Associates. LISP is copyrighted by Addison-Wesley Publishing Company, Inc. The COMMON LISP Reference Manual is copyrighted by Digital Equipment Corporation. IBM PC, PC XT, PC AT, and PC-DOS are trademarks of International Business Machines.

# UPDATING THE OLDEST SCIENCE

BY RUSSELL M. GENET

---

*Astronomers are using microcomputers  
in a variety of applications*

IN THE PAST FIVE YEARS, microcomputers have had a revolutionary impact on astronomy, the oldest of the sciences. The revolution has, perhaps, been most visible in the area of optical astronomy at smaller observatories. This is not surprising, since it is the young hackers at small colleges and amateur observatories who have most quickly embraced microcomputers with the greatest effect. We begin with that most traditional task in astronomy, computations.

## **ASTRONOMICAL COMPUTATIONS**

At the very beginnings of civilization, astronomical calculations were made to predict the lunar cycles and seasons and—somewhat crudely—eclipses of the sun. The positions of the planets, appropriately called “the wanderers” by the Greeks, were somewhat more difficult to predict, although Claudius Ptolemaeus (Ptolemy), a Greek living in Alexandria, had by A.D. 140 devised a rather complex but fairly accurate method of mathematical prediction. Nicolaus Copernicus (1473–1543) devised a sun-centered model that, while no more accurate, was conceptually more appealing. Based on unusually

accurate observations of Mars made by the Danish nobleman Tycho Brahe (1546–1601), Johannes Kepler (1571–1630) was able to establish, after years of laborious hand calculations, that the orbit of Mars was an ellipse with the sun at one of the foci. It did not take Isaac Newton (1642–1727) long to generalize this to the motion of all objects great and small, and astronomical calculations came into their own.

As the major astronomical observatories were established, each initiated its own computer division. The computer division was often housed in a single large room filled with work tables and the *computers*—the people who made the mathematical calculations. An astronomer or mathematician was in charge. When logarithms were devised, one of their first applications, via detailed tables, was astronomical calculations, and when the mechanical Friden calculators became available, they too were applied to astronomical calculations by the roomful. Mainframe digital computers were applied to this natural arena, and when microcomputers appeared, they too were quickly put to use by astronomers. While some

older astronomers miss the smoothly clicking Fridens, digital computers—especially microcomputers—have made astronomical computations affordable to all observatories. The tiniest college or amateur observatory can, with an IBM PC, an Apple II, or even a Commodore VIC-20, make more calculations in an hour than a roomful of people and Friden calculators could in a week, or Johannes Kepler or Isaac Newton in an entire lifetime. And just what is this newfound power at smaller observatories being applied to?

Some microcomputer-based computations are the traditional astronomical tasks, such as conversion from Gregorian to Julian calendar date, conversion from civil to sidereal time, and determining times for the rising and setting of the sun and moon. Thanks to formulas in the *Almanac for Computers*, quite precise predictions of planetary positions can be easily made by microcomputers in a flash. (For a list of books and periodicals mentioned in this and other articles,

*(continued)*

Russell M. Genet (629 North 30th St., Phoenix, AZ 85008) is codirector of the Fairborn Observatory.

see the "Astronomy Sources" text box on page 244.) Certainly Jean Meeus, *Vereniging voor Sterrenkunde*, Belgium, is widely recognized as an expert in various positional calculations. Determining the orbital equations for asteroids and comets from just a few observations has always been tricky business. Carl Friedrich

Gauss (1777-1855) put such determinations on a sound mathematical footing when he invented the "least squares" method to make such astronomical calculations more accurate. Today's expert is Brian G. Marsden, an astronomer at the Harvard Smithsonian Center for Astrophysics, and it is to him that observa-

tions on newly discovered comets (or newly reappearing ones such as Halley's) are reported. (See the "Further Contacts" text box for the addresses of many of the astronomers mentioned in this article.)

Microcomputers are now heavily used by astronomers for the reduction and analysis of scientific observations. At smaller observatories, such observations are predominantly photometric—determining the brightness and color of astronomical objects. Stars that vary their brightness over time are particular research favorites because we can learn much from such observations about the inherent nature of many types of stars. Douglas S. Hall, an astronomer at Dyer Observatory, has long coordinated photoelectric observations of spotted binary stars from smaller observatories around the world. He is always glad to hear from interested observers. The American Association of Variable Star Observers (AAVSO) also assists new observers (see the "Helpful Organizations" text box on page 181). Reduction software programs take the raw observational data and use it to account for the dimming of the light by the earth's atmosphere, the background light from nearby cities or the moon, and nonstandard color sensitivity of some particular photometer. Various microcomputer programs have been devised to calculate the exact instant of minimum light, given a series of brightness measurements. An eclipsing binary star will change its time of minimum light because, as mass is transferred between the two stars, the change in momentum changes the rotational period. Small backyard telescopes equipped with photometers can easily make such observations, and even the smallest microcomputers can accomplish the reductions and analysis.

Some astronomical problems are too complex, even with microcomputers, to solve directly, but simulations are possible. A famous case is the "*n*-body gravitational problem" where *n* is 3 or greater. Given initial positions and velocities, the future

## FURTHER CONTACTS

Thomas Borlik  
7239 North Butler Ave.  
Indianapolis, IN 46250

David Dunham  
COMPUTER SCIENCE CORP.  
8728 Colesville Rd.  
Silver Spring, MD 20910

David S. Evans  
DEPARTMENT OF ASTRONOMY  
UNIVERSITY OF TEXAS  
Austin, TX 78712

Fred A. Franklin  
HARVARD SMITHSONIAN CENTER  
FOR ASTROPHYSICS  
60 Garden St.  
Cambridge, MA 02138

Robert E. Fried  
BRAESIDE OBSERVATORY  
POB 906  
Flagstaff, AZ 86002

Douglas S. Hall  
DYER OBSERVATORY  
VANDERBILT UNIVERSITY  
Nashville, TN 37235

William Herbst  
VAN VLECK OBSERVATORY  
WESLEYAN UNIVERSITY  
Middletown, CT 06457

R. Kent Honeycutt  
ASTRONOMY DEPARTMENT  
INDIANA UNIVERSITY  
Swain Hall West  
Bloomington, IN 47401

Mercedes Jaschek  
CENTRE DE DONNÉES STELLAIRES  
11 rue de Université  
F-67000  
Strasbourg, France

Brian G. Marsden  
HARVARD SMITHSONIAN CENTER  
FOR ASTROPHYSICS  
60 Garden St.  
Cambridge, MA 02138

R. Edward Nather  
DEPARTMENT OF ASTRONOMY  
UNIVERSITY OF TEXAS  
Austin, TX 78712

Tim Persinger  
DEPARTMENT OF ASTRONOMY  
VANDERBILT UNIVERSITY  
Nashville, TN 37235

Manfred Stoll  
INSTITUTE FOR ASTRONOMY  
UNIVERSITY OF VIENNA  
Vienna, Austria

Mark Trueblood, Director  
WINER MOBILE OBSERVATORY  
10912 Broad Green Terrace  
Potomac, MD 20854

Wayne H. Warren Jr.  
ASTRONOMICAL DATA CENTER  
NASA-GODDARD SPACE FLIGHT  
CENTER  
Code 601  
Greenbelt, MD 20771

Nathaniel M. White  
LOWELL OBSERVATORY  
POB 1269  
Flagstaff, AZ 86002

Michael Zeilik II  
DEPARTMENT OF PHYSICS AND  
ASTRONOMY  
UNIVERSITY OF NEW MEXICO  
Albuquerque, NM 87131



courses over time of a number of gravitationally interacting bodies, such as planets, stars, or galaxies, can be simulated by a microcomputer. An interesting microcomputer simulation (with an Apple II) was devised by Clint Poe, while a graduate student at Vanderbilt University, to determine the effects of large starspots on the light intensity versus time (light curves) of binary stars as viewed from the earth. As the spots rotate in and out of the line of sight from earth, the brightness goes up and down, but in a very complex way that depends on the number, sizes, and positions of the spots. You can change the microcomputer simulation parameters until the simulated light curve matches the actually observed light curve, thus deriving information about the sizes and locations of the starspots and their changes over time. Some simulations, such as the nuclear evolution of stars, can be difficult for microcomputers, but microcomputers have now been applied to even these and other difficult astrophysical simulations.

### CATALOGS AND ATLASES

Man early on noted that, except for the sun, moon, "wandering" planets, and an occasional comet, the stars pretty much stayed put on the celestial sphere. Soon the brighter stars were broken into natural groups in the sky (constellations), and the brighter stars in each constellation were assigned Greek letters. John Flamsteed (1646-1719), the first astronomer royal at England's Royal Greenwich Observatory, determined the position and brightness of 3000 stars. Edmond Halley (of comet fame, 1656-1742) and Isaac Newton rushed Flamsteed's catalog into publication in 1712 while it still contained some errors. An angry Flamsteed managed to locate and burn the 300 published copies, and he eventually published his own version. Friedrich Argelander (1799-1875) made observations of the position and brightness of more than 300,000 stars, which he published as the *Bonner Durchmusterung*.

Catalogs available in computerized form are of special interest. The *Yale*

*Bright Star Catalog* by Dorrit Hoffleit contains all the stars visible by the naked eye, with a margin for even the darkest skies and keenest eyes. The *Henry Draper Catalog* contains spectral types and other useful information on over 200,000 stars, while the *Smithsonian Astrophysical Observatory* (SAO)

*Catalog* contains detailed information on over 300,000 stars. And there are many specialized catalogs such as the *General Catalog of Variable Stars*, and others on such specific classes of objects as binary stars, planetary nebulae, galaxies, etc. The repository

*(continued)*

## HELPFUL ORGANIZATIONS

**AMERICAN ASSOCIATION OF VARIABLE STAR OBSERVERS (AAVSO).** Photoelectric Photometry Committee. Contact Howard J. Landis, 50 Price Rd. West, Locust Grove, GA 30248. Organized program for photoelectric photometry at amateur observatories. Inquiries on getting started in photometry are welcome. Nice newsletter.

**AMERICAN ASTRONOMICAL SOCIETY (AAS).** Special Interest Group for Microcomputer Use in Astronomy (SIGMUA). Contact Daniel B. Caton, Department of Physics and Astronomy, Appalachian State University, Boone, NC 28608. The AAS is a society of professional astronomers. SIGMUA helps to exchange ideas on microcomputer use in astronomy. Newsletter and semi-annual meetings.

**ASTROMEDIA CORP.,** 625 East St. Paul Ave., Milwaukee, WI 53202. Publishes *Astronomy* magazine and *Telescope Making*, both of which occasionally have articles on the use of microcomputers in astronomy. Also has helpful books.

**ASTRONOMICAL LEAGUE.** Contact Donald Archer, Executive Secretary, POB 12821, Tucson, AZ 85732. National (U.S.) Organization of Astronomy. Annual national meeting, quarterly journal. Microcomputer users group.

**ASTRONOMICAL SOCIETY OF THE PACIFIC.** Contact Andrew G. Fraknoi, 1240 24th Ave., San Francisco, CA 94122. Society of professional and amateur astronomers. Annual meeting. Monthly scientific journal, quarterly general-interest journal (*Mercury*).

**AUTOMATIC PHOTOELECTRIC TELESCOPE SERVICE, FAIRBORN OBSERVATORY,**

629 North 30th St., Phoenix, AZ 85008. Provides automatic telescope systems and their operation and maintenance at a first-class Arizona site as a service for universities and research organizations.

**BRITISH ASTRONOMICAL ASSOCIATION (BAA).** Contact Andrew J. Hollis, Ormada Observatory, 85 Forest Rd., Cuddington, Northwich, Cheshire CW8 2ED, England. Focal point for British and European small observatory photometrists. Occasional European meetings.

**INTERNATIONAL AMATEUR PROFESSIONAL PHOTOELECTRIC PHOTOMETRY (IAPPP) Association.** Contact Robert C. Reisenweber, Rolling Ridge Observatory, 3621 Ridge Parkway, Erie, PA 16510. International organization of amateur and professional astronomers interested in photometry. Several meetings in various countries each year. Quarterly journal devoted to photometry, including microcomputer use.

**INTERNATIONAL OCCULTATION TIMING ASSOCIATION (IOTA).** POB 596, Tinley Park, IL 60477. International organization devoted to visual and photoelectric timing of asteroid and lunar occultations. Occasional meetings. Nice newsletter.

**SKY PUBLISHING CORP.,** 49 Bay State Rd., Cambridge, MA 02238. Publishes *Sky & Telescope* magazine, which has a monthly feature on microcomputer use in astronomy. Source for catalogs and atlases, as well as books. Free catalog.

**WILLMANN-BELL INC.,** POB 3125, Richmond, VA 23235. Source for catalogs and atlases. Also source for books in mathematical astronomy and optical design. Request their lists in these areas. Catalog available.

for such computerized catalogs in the United States is the Astronomical Data Center, directed by Wayne H. Warren Jr. The worldwide center is directed by Mercedes Jaschek at the Centre de Données Stellaires in Strasbourg, France.

Atlases are essentially "maps" of the stars. They are generated from

catalog data by plotting stars and other objects on large pieces of paper. Some of the nicest atlases have been made in Czechoslovakia by Antoni Becvar. The *Borealis*, *Eclipticalis*, and *Australis* atlases cover the entire sky with brightness depicted by the size of each star, while the spectral type (temperature) is indicated by the

printed color. Somewhat less detailed but popular atlases are Will Tiron's *Sky Atlas 2000* and the *Sky Catalog 2000* by Alan Hirshfeld and Roger Sinnott. Just as you use a map to guide your car to a specific house in a particular city, you use a sky atlas to direct your telescope to a specific star or other object in a particular constellation. Often, for convenience, observers make a small sketch on a larger scale of just a small part of the atlas to help locate a specific star while at the telescope eyepiece. Trying to hold up a big atlas with fine print while looking through a telescope in the dark is tough! These sketches are very helpful and are called "finder charts."

The early microcomputers (and even many of the modern ones) were not well suited for working with catalogs and atlases. Catalogs require the storage of very large amounts of information with quick access to it. Atlases require significant graphics capabilities to be effective. However, with 16- and 32-bit processors, hard-disk storage, and high-resolution bit-mapped graphics, some modern microcomputers have the needed capabilities. While most of the computerized catalogs are on 9-track tapes, versions are becoming increasingly available on disks of various formats.

There are a number of advantages to microcomputer-based catalogs. You can search entire catalogs for specific objects or classes of objects. This is very helpful in formulating observing programs and in conducting various statistical studies. One class of objects easily extracted from a catalog are all objects in a certain small area that have more than a given brightness. You can then plot those selected on the screen to form an instant custom finder chart. A small computer monitor near the telescope is much easier to see than an atlas, and you can display only the information you need, avoiding confusion. Printed atlases only look at the stars from one fixed vantage point—that of earth. With a catalog contain-

(continued)

# INFOSCRIBE means business



## The printer used when performance is *paramount*

**We meant business** this year when we became a member of the Eurotherm International family of companies, to bring you the best in sales, service, and worldwide support.

**We meant business** when we relocated to expanded facilities in Reston, Virginia, to bring you a reliable printer designed and manufactured in the U.S. Our MTBF exceeds 4000 hours and our head life is over 500 million characters. We also help maintain a quiet, professional working environment, with less than 54 DBA even when printing 6-part forms.

**We mean business** with a well established product line proven in over 14,000 installations.

- The Model 700—150 CPS demand document printer

- The Model 1000—Entry level data processing with 200 CPS and graphics
- The Model 1100—NLQ and 144 X 144 graphics
- The Model 1200—Adds 4 color capability

**We mean business** with our continuing development program. Enhancements for 1985 include:

- The Model 800—Our Model 700 upgrades to 200 CPS with graphics
- The Model 1100T—A TEMPEST version of the 1100 meets NACSIM 5100A
- The Model 1400—A 400 CPS version of the 1000
- The Model 2000—A word processing station with 3 bin paper and envelope feeder



A Eurotherm International Company

**Manufacturing facilities:**

In Europe: Sackville Trading Estate, Sackville Road, Hove, East Sussex, BN3-7AN England. Telephone: Brighton 0273-25992

In the U.S.: 1808 Michael Faraday Court, Reston, Virginia 22090. Telephone: 703-689-2805



## Double your IBM PC's processing speed for under \$650.

### AT speed for your IBM PC, with QuadSprint by Quadram.

Quadram introduces a rapid advancement in IBM PC performance. QuadSprint. The innovative expansion board that doubles the processing speed of your personal computer. Just plug the totally transparent QuadSprint into your system and watch **all** your PC programs (Lotus 1-2-3, dBASE III, Wordstar, and more\*) run faster and more efficiently than ever before... without special commands or interface software.

But best of all, you can pick up QuadSprint without running up a huge bill. At less than \$650, QuadSprint is about half the price of other accelerator (turbo) cards and turns your PC into a machine that's virtually as fast as the new PC AT.

So make your own rapid advancement. To the Quadram dealer closest to you. And see how to double the processing speed of your IBM PC. With QuadSprint by Quadram.

**QUAD***Sprint*<sup>™</sup>

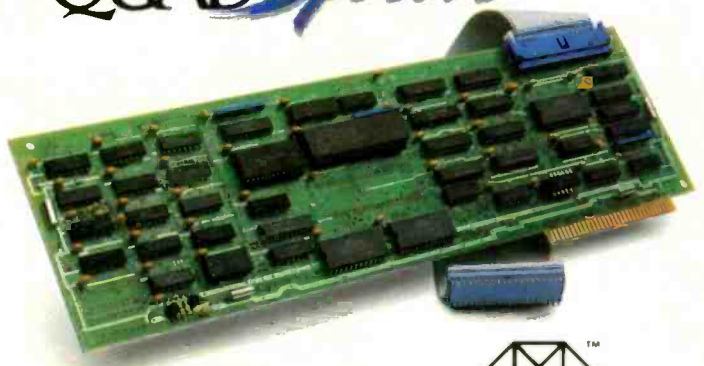

**QUADRAM**<sup>™</sup>  
An Intelligent Systems Company

4355 International Blvd./Norcross, Ga. 30093  
(404) 923-6666/TWX 810-766-4915 (QUADRAM NCRS)

Inquiry 294

*Photometric  
data-logging systems  
have been developed  
for many types  
of microcomputers  
in many countries.*

ing three-dimensional coordinates and a microcomputer with some computational and graphics capabilities, you can calculate and display a vantage point from anywhere in space.

**DATA LOGGING**

While casual visual observers may not record what they see, the serious researcher is always writing down instrument readings. Although the popular literature gives the impression that telescopes are used either to take pretty pictures or for visual observing by research astronomers, both of these activities are rarities in real research. Telescopes are light buckets for the researcher's instru-

ments—mainly photometers and spectrometers. Because photometers are especially appropriate instruments for smaller telescopes, let's consider how microcomputers are taking over photometric data-logging tasks.

In the days before microcomputers, photometry was often a two-person operation. One person would operate the telescope and the photometer while the other recorded the results. In variable-star photometry, for instance, the sequence of observations is rigidly fixed so that the data can be reduced in a standard manner. While the task is relaxing and peaceful, I must admit that I find making photometric observations and manually recording them a bit on the boring side. In 1979, I bought a Radio Shack TRS-80 Model I to reduce and analyze variable-star photometric data (see photo 1). It seemed wasteful to manually record the data and then re-record it into the TRS-80. To avoid this, I fed the photometer output through a voltage-to-frequency converter to a programmable counter tied to the TRS-80's bus (see photo 2). A clock/calendar chip for recording the date and time and a remote hexadecimal keypad for control were also

tied to the bus. Prompts on a monitor in the observatory suggested what to do next (very handy at 3 a.m.), and the data was displayed in neat rows and columns as it was gathered. (This made it easy to compare the latest data point with all the previous similar ones and correct any mistakes.) After observations on a given star were completed, reduction, display, and printout of the results took only seconds.

In photometric data logging, the amounts of data handled are very modest, allowing the use of high-level languages and microcomputers with small memories. Yet the improvement in the observational environment and the reduction in errors is outstanding. With photometry as the main scientific concern at smaller observatories, it is not surprising that photometric data-logging systems have been developed for many types of microcomputers in many countries. An English amateur astronomer, Andrew Hollis, has done a particularly capable job on a low-cost Sinclair ZX81.

Thomas Borlik has developed a straightforward data-logging system based on the Commodore VIC-20. However, the Apple is the favorite of many data loggers with nice systems, such as Tim Persinger of Vanderbilt University, Michael Zeilik II of the University of New Mexico, and Robert E. Fried of Braeside Observatory. Some of the fancier photometric data-logging systems are LSI-11-based, such as those by William Herbst of Van Vleck Observatory and Nathaniel M. White of Lowell Observatory.

In some types of astronomical photometry, the event of interest happens so fast that a human can't record the results. However, a microcomputer can easily record brightness readings every millisecond. An occultation of a star by the dark limb of the moon occurs when the moon (which, compared to the stars in the sky, travels east) catches up with and passes over or "occults" a star. The star winks out in a few hundredths of a second. Not only is the exact timing of the "wink out" useful in estab-

*(continued)*



Photo 1: Laboratory testing of an early (1979) data-logging system for photoelectric astronomy. Developed by the author (right), this system used an early Radio Shack TRS-80 Model I microcomputer with 16K bytes of RAM. Programs and data were stored on cassette tape. The four electronic boxes on the right contained the computer interface, photometer DC amplifier, and high- and low-voltage power supplies.

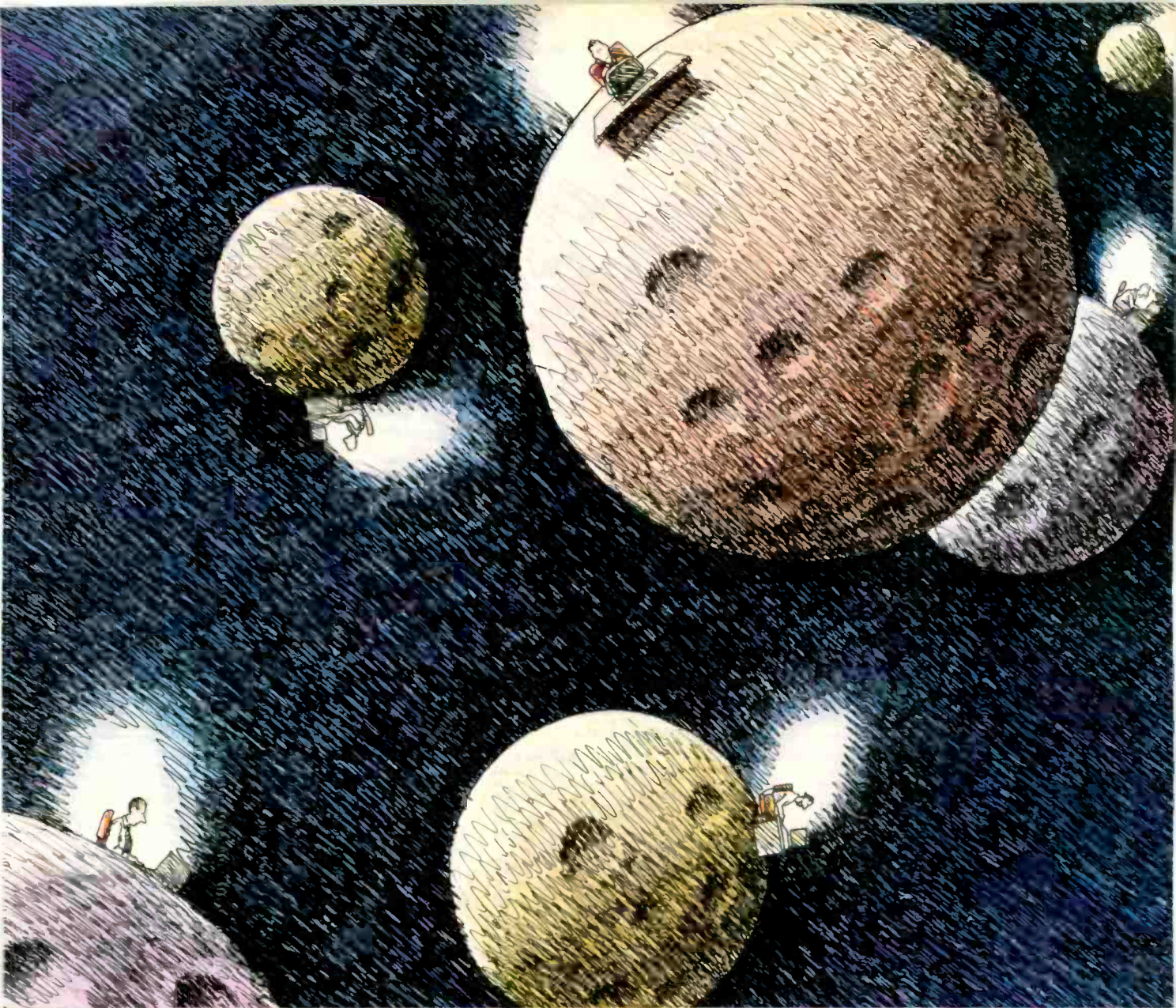

## With Network Revelation,<sup>®</sup> you're not alone.

Span the void that separates you from other PC's. Be as one with a universe of data. Be a true network with Network Revelation.<sup>®</sup>

Network Revelation is more than a relational database management system. It's a complete applications environment for most microcomputer networks. That's not dreaming about the future. It's low-key raving about a capability of the present.

With Network Revelation, you can send and receive data on local area networks and remote file servers. Rev's data dictionaries let you add or restruc-

ture fields at will, saving ages of programming time. And our menu-driven applications generator and procedural language are eons ahead of other databases.

The possibilities are infinite. Distributed processing systems linking worlds. Accounting, inventory and order entry systems connected for instant access to data by a galaxy of users. And your data is secure with complete file or record locking.

REVELATION co-exists with MS-DOS.<sup>™</sup> So you can transport Lotus 1-2-3,<sup>™</sup> Multiplan<sup>®</sup> or other data from

PC to PC—using popular routes like Novell, Ethernet or 3 Com.<sup>™</sup> You can even evolve files from primitive, single-user databases into a powerful Rev application.

Encounter the future of distributed data processing today. Revelation costs just \$950.00\* Network Revelation starts at only \$1495.00\* for a complete four-user system. So call us and we'll arrange for an unforgettable demonstration with a Cosmos rep in your area.

MS<sup>™</sup> and Multiplan<sup>®</sup> of Microsoft Corporation. 1-2-3<sup>™</sup> of Lotus Development Corporation. 3 Com<sup>™</sup> of 3 Com Corporation.

\*Suggested U.S. list price.

Cosmos, Inc., 19530 Pacific Highway S.

Inquiry 110

# COSMOS<sup>™</sup>

Seattle, WA 98188, 206-824-9942

JULY 1985 • BYTE 185

TOLL FREE ORDERS ONLY! **800-631-0962**  
 (INSIDE CALIFORNIA) **800-521-6162**

Customer Service HOTLINE  
 (408) 559-6555

# GUARANTEED the LOWEST!

OUR PRICE GUARANTEE - It's Simple! We'll beat any ad in this magazine - same terms - call TOLL FREE for details!

**DCC DISCOUNT COMPUTER CENTERS**  
 OUR CUSTOMER SATISFACTION GUARANTEE: If for any reason your DCC purchase fails to meet manufacturers specifications within 30 days of purchase, please return it to us for a full refund or exchange of your choice! Sorry, software excluded due to copyright laws.

**EPSON all models!**  
 RX/FX and L01500  
 also NEW JX80  
 (7 colors)

**PRINTER SALE!!!**

models 82/83/84 and 92/93!!  
 also 2410 (350 cps!)

**OKIDATA**

**IBM PC \$1650** 2 drvs 256K  
 or 2 drives/256K,  
 10 mg hard disk

**\$2295**

**IBM XT \$3395**  
 10 mg. hard disk  
 256K, 1-360Kb drive only

new models!!

**HR-15 XL \$359**  
**BROTHER**  
 \*\*LETTER QUALITY\*\*  
 High Speed 36 cps  
 7K Buffer

**HR-35**

**COMPUTERS**

IBM PC & XT See special above!!!

PC with 1 drive/64K 1395  
 PC with 2 drives/256K 1650  
 XT with 10 mg HD 128K 3350  
 XT with 2 drives/10MG 3475

Call for details - Compatible brand portables and desktops

**NOW IN STOCK**

**PRINTERS**

\*\*\*\*DOT MATRIX\*\*\*\*

EPSON RX 80 100 cps 235  
 RX 80 FT 100 cps 279  
 RX 100 100 cps, 132 col. 399  
 FX 80 or JX 80 best price  
 FX 100 160 cps, 132 col. in  
 LO 1500 200 cps NEW! magazine

OKIDATA 82A,83,84 Save

92P Models All  
 2410 Drastically Reduced!!!

GEMINI 10-X 239  
 15-X 349  
 DELTA 10 or 15 Special  
 RADIX 10 or 15 \$Call

**IBM SOFTWARE**

TEAC 1/2 HI-360 KB 119  
 SHUGART 1/2 HI-360 KB 109  
 COGITO 10 MG H.D. W/CONTROL 665  
 ATARI INDUS GT 349

\*\*\*\*SPREADSHEET\*\*\*\*

FRAMEWORK Monthly Special 355  
 FRIDAY 195  
 SUPERCALC 3 228  
 MULTIPLAN 136

\*\*\*\*IBM WORDPROCESSORS\*\*\*\*

WORDSTAR PRO PACK 249  
 PFS WRITE 84  
 MULTIMATE 249  
 WORD W/MOUSE 269  
 VOLKSWRITER DELUXE 159  
 PFS PROOF 84

**IBM - BOARDS**

HERCULES GRAPHICS 305  
 HERCULES COLOR New! 165  
 AST SIX PAK W/64K 249  
 MEGAPLUS 259  
 STB GRAPHIX PLUS 309  
 EVEREX GRAPHIC EDGE 379  
 H.D. CONTROLLER 299  
 MAGIC CARD 199  
 QUADRAM QUADBOARD W/64K 269  
 QUADLINK 449  
 IBM MONOCHROME 249  
 COLOR GRAPHICS 219  
 PLANTRONICS COLOR PLUS 375  
 TECMAR GRAPHICS MASTER 475  
 PARADISE COLOR 279

**APPLE - BOARDS**

ORANGE MICRO GRAPPLER + 113  
 BUFFERED W/64K 168  
 MICROMAX GRAPHMAX 99  
 VIEWMAX 80 139  
 VIEWMAX 80E W/64K 189  
 MAC DISKETTES 48  
 IIC PRINTER INTERFACE 59  
 SUPER COOLING FAN 49

**MONITORS**

IBM MONOCHROME 249  
 COLOR 569  
 AMDEK 300G 135  
 300A 145  
 310A 165  
 COLOR 600 419  
 COLOR 710 NEW 515  
 TAXAN 12" Green 114  
 12" Amber 117  
 420 RGB 439  
 PRINCETON HX-12 459  
 SR-12 649  
 MAX-12 168  
 ZENITH 122 - 12" G 93  
 12" A 93  
 124 MONO - IBM 169  
 135 RGB COMP 475  
 POLO 16 COLOR RGB!! 350

\*\*\*\*DAISY WHEEL\*\*\*\*

PRIMAGE I 55 cps, SER/PARR 1395  
 w/Cut Sheet Feeder 1695

BROTHER DAISY WHEEL

HR-15 XL 359  
 HR-25 599  
 HR-35 (36 cps) 799

JUKI 6100 389  
 JUKI 6300 724

DIABLO 620 829  
 36 1276  
 630 1689  
 DYNAX DX-15 359

NEC all models \$Call  
 QUME all models \$Call

\*\*\*\*IBM DATA BASE\*\*\*\*

dBASE II 284  
 dBASE III 355  
 PFS FILE 84  
 CONDOR III 249  
 R-BASE 4000 279  
 R-BASE CLOUT 129

\*\*\*\*IBM MISC\*\*\*\*

SIDEKICK 39  
 COPY II PC 29  
 THINKTANK 129  
 PROKEY 3.0 79  
 HARVARD PROJECT MGR 245  
 SIDEWAYS 45  
 NORTON UTILITIES 55  
 PFS REPORT 79  
 DOW JONES ANALYST 219  
 SET FX + 47

FLIGHT SIMULATOR 34

**IBM ACCESSORIES**

64K RAM CHIPS 200ns 35  
 150ns 35  
 IBM KEYBOARDS 159  
 KEYTRONICS 5151 NEW! 179  
 5150 159  
 MICRO-SOFT MOUSE 129  
 MOUSE SYSTEM MOUSE 124  
 KOALA PAD 85  
 JOYSTICKS - KRAFT/HAYES 45

**ACCESSORIES**

PRINTER RIBBONS all makes Low!!!  
 64K RAM chips SALE 35  
 VERBATIM SS/DD diskettes 21  
 DS/DD diskettes 27  
 DYSAN SS/DD diskettes 26  
 DS/DD diskettes 34  
 DISK WINDER-PLEXI (75) 19  
 DISK WINDER W/KEY (100) 24  
 SURGE PROTECTOR Compugard 59  
 PTI POWER BACK-UP 200 w 275  
 300 w 355

FINGERPRINTS - EPSON all models 48  
 PRINTER DUST COVER all models 10  
 MONI-BASE Monitor Stands 19  
 COMPUTER PAPER all makes Low!!!  
 PRINTER STANDS Plexiglass 29/39  
 SURGE PROTECTORS \$Call

**MODEMS**

HAYES 300 195  
 1200 459  
 1200B IBM INTERNAL 389  
 MICROMODEM II E 209  
 ANCHOR MARK XII 244

**DRIVES**

IBM 360 KB 219  
 TANDON 100-2 360KB 165  
 APPLE DRIVES SALE 135

**WORDSTAR**  
 All new-easy to use  
 "Windows" 2000  
 Footnotes  
 Spell Checker  
 Much, much more

**\$259**

mouse systems' w/PC PAINT **\$124**

**MOUSE \$129** micro-soft

Color graphics card **\$165**

**HERCULES \$309** mono graphics card

**AST \$229**  
**SIX PAK PLUS**  
 w/64K RAM **\$249**

**10 MG 1/2 HI Internal \$665**  
**HARD DISK**  
 \*\*\*\*SPECIAL\*\*\*\*  
 w/controller card and cables!!!  
**\$1099** 20 MG Internal

**DCC DISCOUNT COMPUTER CENTERS**  
 an established mail order/retail distribution network

BUYER FRIENDLY TERMS! • DELIVERY We ship immediately! Most orders delivered within 5 days! Add 3% (15¢ min) for UPS shipping, handling, insurance. Calif. residents add 6.5% sales tax. 2<sup>nd</sup> day UPS available at extra charge. • PAYMENT Visa, M.C., cashiers checks, money orders, personal checks accepted. (Allow 10 business days for personal/company checks to clear). WE NEVER CHARGE EXTRA FOR CREDIT CARDS! C.O.D.'s welcome (20% pip deposit) with cash, certified check or money order. • WARRANTY All items shipped are new, include FACTORY WARRANTY and are GUARANTEED TO WORK. DCC is an AUTHORIZED DEALER and SERVICE CENTER for most major brands. • RETURNS Must be accompanied by RMA number (supplied by DEALER) and may be subject to a 20% restocking fee. Prices and availability subject to change without notice. All items limited to stock on hand. • MAIL ORDER PRICES NOT VALID AT RETAIL OUTLETS DUE TO REGIONAL PRICING RESTRICTIONS. Minimum order \$50.

1707 S. BASCOM AVE • CAMPBELL, CA 95008 • (408) 559-6555  
 1243 W. EL CAMINO • SUNNYVALE, CA 94087 • (415) 965-4494  
 1341 FULTON AVE • SACRAMENTO, CA 95825 • (916) 971-3503

**FREE - VISA/MC!**

**VISIT OUR DISCOUNT SHOWROOMS!**

lishing the exact position of the moon and the occulted star, but if the star is binary, the light has an intermediate brightness value for a fraction of a second as one star is occulted but the other isn't yet.

For bright stars with large diameters, a fringe pattern is created when the moon, acting like a giant "knife edge," sweeps across the star in a fraction of a second. A microcomputer high-speed recording of the brightness fringes enables us to determine the diameter of the star. David S. Evans and R. Edward Nather at the University of Texas have long been recognized as experts in such high-speed photometry.

Asteroids occasionally pass in front of stars, casting "asteroid shadows" along narrow paths on the earth's surface. Exact, high-speed photometric measurements of the time at the beginning and end of the shadow enable us to determine the size of the asteroid. David Dunham, an astronomer at Computer Science Corporation, is an expert in knowing where these shadows will fall. He runs about the world to record them and is always looking for some help. Dunham heads up the International Occultation Timing Association (IOTA).

During 1985 and 1986, Jupiter's system of moons will be edge-on as viewed from earth, resulting in many mutual occultations and eclipses of these moons. High-speed photometry made from amateurs' backyards will contribute to much more precise determinations of their orbits. Fred A. Franklin, another astronomer at the Harvard Smithsonian Center for Astrophysics, has predictions of when the Jupiter events will take place and is anxious for data. He welcomes inquiries. These photometric observations of Jupiter's moons can be easily made with a Meade Instruments (1675 Toronto Way, Costa Mesa, CA 92626) 8-inch Schmidt-Cassegrain telescope that costs about \$1000, an Optec Inc. (199 Smith, Lowell, MI 49331) SSP-3 solid-state photometer that costs about \$800, and a microcomputer such as the Commodore

VIC-20. Optec sells a cable to connect the SSP-3 photometer to the VIC-20 together with the subroutine software to make the basic measurement for \$25. Interfacing to other microcomputers is readily accomplished. Heath-kit makes a very accurate clock that

can be interrogated by a microcomputer via an RS-232C interface.

### TELESCOPE CONTROL

Telescopes are actually a lot of fun to operate manually. Moving a telescope

*(continued)*

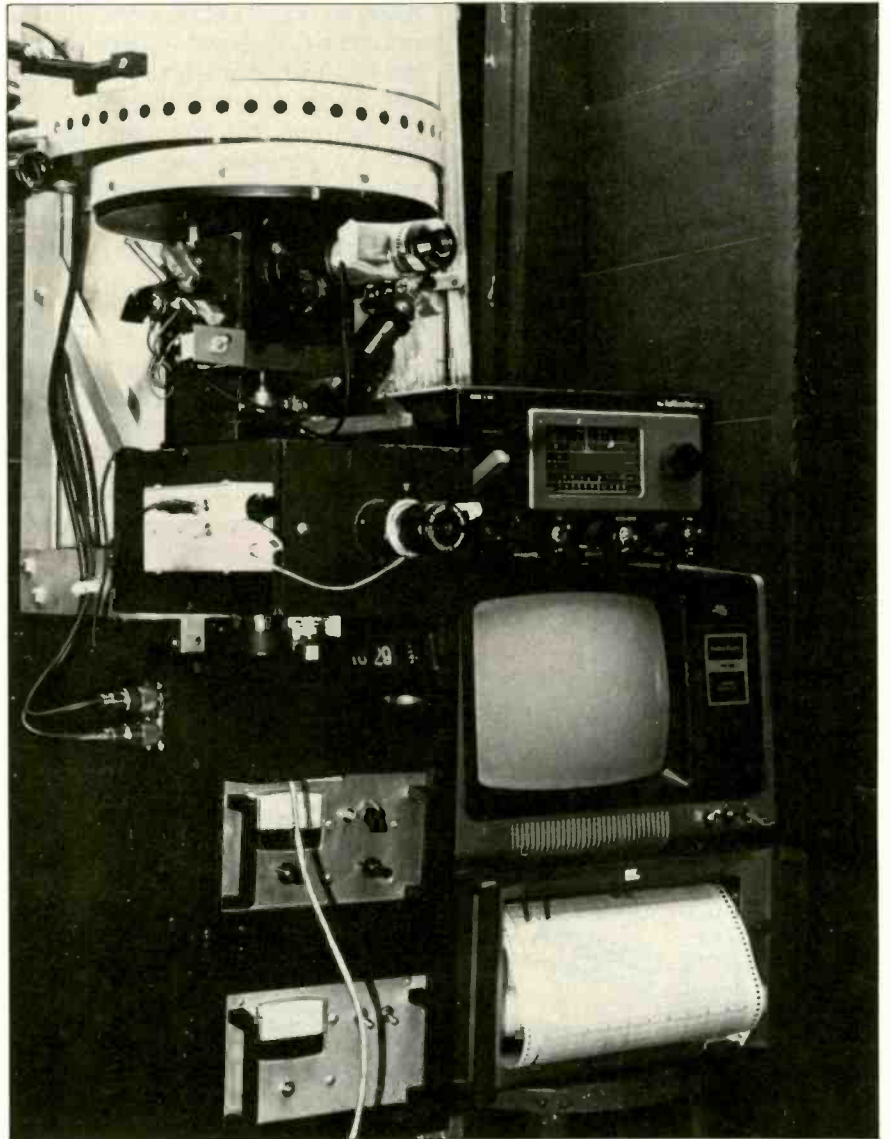

Photo 2: The early data-logging system as installed at the Fairborn Observatory (East) in 1979. The photometer, mid-left, was attached to the telescope, upper left. Photometer electronics are on the lower left. The video monitor on the right was tied to the Radio Shack TRS-80 located some distance away in a warm room. We communicated with the computer via a hand-held hexadecimal keypad. The system was used for several years to make observations of spotted RS Canum Venaticorum binary stars for Douglas Hall at Vanderbilt University. It has been superseded by a fully automatic system that was recently moved from Ohio to Arizona, the location of the Fairborn Observatory (West).

quickly and efficiently to a specific star in the sky is a traditional skill of which many observational astronomers are rightly proud. However, by about 3 a.m. on only the second night of a two-month observing run, even the hardest astronomers start thinking about supervising computerized telescope control from a warm room, with their feet propped up and soft music running in the background. While minicomputers control some of the larger telescopes, modern microcomputers are fully capable of telescope control and are increasingly being so used.

Microcomputer-controlled stepper motors can move smaller telescopes about, controlling two orthogonal axes. One axis is usually aligned parallel to the earth's axis to provide the ability to compensate for the earth's rotation by rotating just this single axis. If you start the telescope

out at a low speed and continually increase this speed (a process called "ramping"), you can bring the telescope to a relatively high speed for long movements across the sky and then "ramp" it back down to a gentle stop just where you want it. Given the angular distance to be traveled between an object just observed and the next to be observed, you can calculate exactly how many steps the stepper should take, just how to execute the ramp up and down, and how to actually generate the steps themselves. (This last is a machine-language task as the steps must be made quickly, typically several thousand per second at top speed.)

Larger telescopes generally take more muscle to move about than steppers can generate and often use large DC motors in a servo-loop arrangement. Such systems must sense the position of the telescope on each

axis; incremental optical shaft-angle encoders are often used for this. While reading the encoders and closing the servo loop complicates the control task somewhat, it still remains within the grasp of the more capable microcomputers. Because computer control tended to be applied first to the larger telescopes, most of the initial applications used DC motors and angle encoders in servo configurations. Only recently, as control has moved to smaller telescopes, has the simpler stepper system become popular.

One of the first microcomputer-controlled telescopes was the 36-inch telescope at Indiana University. R. Kent Honeycutt used an Intel 8080-based microcomputer, DC motors, and optical encoders in a classical servo control system. Another early system was the 24-inch telescope at the Institute for Astronomy at the University of Vienna in Austria, where Manfred Stoll used a Motorola 6800-based microprocessor in the control system. The 6502, another early microprocessor, was used by Lloyd Robinson, Robert Kibrick, and others for telescope control at Lick Observatory.

The 16-inch system from DFM Engineering (1035 Delaware Ave., Unit D, Longmont, CO 80501) is a good example of a recent stepper-controlled smaller telescope. It uses zero-backlash friction drives in each axis and an Apple II-based "open-loop" control system. DFM Engineering welcomes inquiries about this system.

Designing a microcomputer-based telescope-control system combines positional astronomy computation with real-time control. Mark Trueblood and I recently completed a book called *Microcomputer Control of Telescopes* that includes descriptions of all the needed parts (motors, angle encoders, etc.), astronomical and control-system formulas, and descriptions of actual systems. Mark Trueblood is the director of the Winer Mobile Observatory and is working on a 30-inch trailer-mounted telescope controlled by an LSI-11 micro-

(continued)

**IF POWER FAILS, DATASAVER® TAKES OVER!**

**PROTECTION** - saves data during power failures.  
 - saves hardware from overvoltage transients.

**PORTABILITY** - allows mobile or extended holdup time using auxiliary 12 volt battery.

**FEATURES** - internal battery provides 5 min. + operating time - AC line conditioning  
 - audible and visual alarms, interrupt signal - compact, desktop styling  
 - no installation required.

200 WATT - \$495 / 90 WATT - \$350  
 For special applications and product information, call 805-541-4160.

Instant power order line  
**805-541-4161**

**CUESTA SYSTEMS, INC.**  
 3440 Roberto Court, San Luis Obispo, California 93401

**INSTANT AC POWER**





# Star demonstrates how to build up your spreadsheet figures without pumping up your budget.

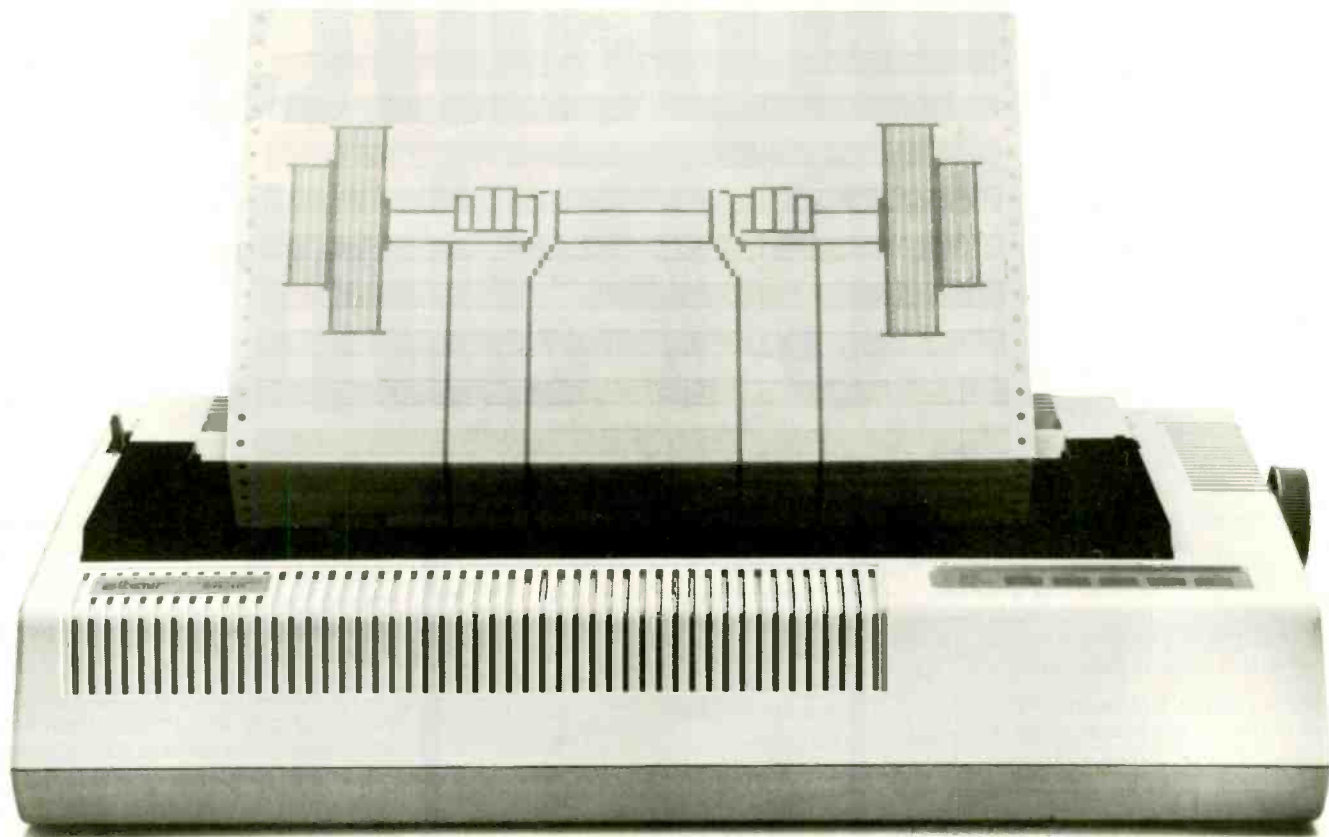

**W**atch those numbers work out! With Star's beefed-up business printers you'll see a physical difference in your figures.

For strength of characters, there's the outstanding near-letter-quality printing of our "S" series. Just flip a switch and each "S" printer kicks into a faster speed that changes from NLO to draft. Every letter and number, in either mode, in excellent shape. It's a standard feature you'd pay extra for elsewhere.

Plus, with the muscle of our

20% increased throughput, these Star printers don't take breaths. They can print on and on using up to an unbeatable 16K memory for storage.

Now, if nothing less than letter-quality definition will do, there's the classic PowerType daisy-wheel printer. Or the SB-10, Star's letter-quality printer built with a second mode for high-speed draft and full graphics capability.

And of course every printer has Star's hefty one year warranty. And very lean price.

A powerful printer and a trim budget. Now that's the shape you should be in.



**star**

THE POWER BEHIND THE PRINTED WORD®

200 Park Avenue, New York, NY 10166  
Chicago, IL (312) 773-3717 • Boston, MA (617) 329-8560  
Irvine, CA (714) 586-8850

# PC Paintbrush<sup>T.M.</sup> outpaints PC Paint

The names may sound alike.

Yet, when it comes to enhancing business graphs, creating graphic presentations, or designing greeting cards, there is only one choice. To see why, just look at the chart.

For example, notice that PC Paintbrush will run on most 320 x 200 graphics cards plus 19 higher resolution ones including the IBM Enhanced Graphics Adapter, PCjr., Tecmar Graphics Master, and Hercules monochrome and color boards. PC Paint runs on just 3.

It's the same with text enhancements. With PC Paintbrush, you have a choice of 14 fonts in 15 styles (boldface, italics, etc.) and 9 sizes. With PC Paint, you get only 5 fonts and a "choice" of exactly 3 styles.

With PC Paintbrush, you have a choice of 9 different input devices (4 mice, joystick, touchscreen, and 3 tablets). With PC Paint you can use one mouse —period. PC Paintbrush supports 30 printers and plotters. With PC Paint you're limited to 3.

PC PAINTBRUSH PC PAINT		
	720x704	320x200
Max resolution	720x704	320x200
Compatible		
Graphics Cards	19	3
Printers/Plotters	30	3
Input Devices	9	1
On-Screen Colors	16	16
Number of Fonts	14	5
Font Sizes	9	3
Text Styles	15	3
Drawing Line Widths	10	4
Enlargement/ Reduction	Yes	No
Slide Show Presentation	Yes	No
Area Fill	Yes	No
Zoom	2	1

Despite all its options, PC Paintbrush is easy to use. You have drawing tools, drop-down menus, and a range of shapes, colors and brush widths to draw with (10 widths vs. only 4 for PC Paint).

PC Paintbrush lets you capture graphs, charts, and images from any other graphics software (like Lotus 1-2-3) and enhance them with text, colors, and textures.

Compare them and we think you'll agree. There is no comparison.

So be sure to get PC Paintbrush. After all, it just doesn't make sense to paint without a paintbrush.

You can buy PC Paintbrush with a choice of mice, with a PC Tablet, or by itself. For your nearest dealer call MicroD, First Software, Software Resources, Softeam, Softsel or call 800-556-2283. Or stop by any Entre or Computerland. Dealers and Distributors call 800-222-GRAF or 800-562-GRAF (in CA).

PC Paintbrush is a trademark of ZSoft Corporation.  
PC Tablet is a trademark of IMSI.

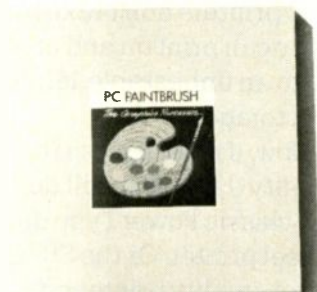

INTERNATIONAL MICROCOMPUTER SOFTWARE, INC.  
1299 Fourth Street • San Rafael, CA 94901 • 415/454-7101

Paint Program Owners:  
See our special purchase offer for  
PC Paintbrush on the facing page.

computer. The intent of this book is to encourage hackers with an astronomical bent to design their own telescope-control systems.

**AUTOMATIC ASTRONOMY**

Of course the microcomputer pièce de résistance has been saved for last. It combines (1) a microcomputer-based catalog of stars, (2) microcomputer selection of the stars to be observed, (3) microcomputer control of the telescope to move it to the vicinity of the desired star, (4) a microcomputer-controlled photometer to actually find, center, and measure the stars, (5) a microcomputer-based photometric data-logging system, and, of course, (6) microcomputer data reduction and analysis. And these are not separate microcomputers. One single-board microcomputer does it all!

The first completely automatic system was built by Arthur D. Code and his associates at the Washburn Observatory in the mid-1960s. It used a DEC PDP-8. While technically a minicomputer with only 4K bytes of RAM (random-access read/write memory), the PDP-8 today would not be considered even a modestly capable microcomputer. It was built around a Titan missile-alignment system found in a junkyard and an 8-inch optical system built for a space telescope. It used optical angle encoders for position sensing and a permanently mounted photometer to sense the stars and make the measurements.

The fixed-sequence observing program was stored on punched paper tape. When the sky became dark, the system started itself up, opened its roof, and went looking for the first star. This process continued all night until the last star was observed or the sky became cloudy.

While a number of semiautomatic or remotely controlled telescopes have been built over the years, the coming of capable and low-cost microcomputers and a persistent electrical engineer, Louis J. Boyd, put microcomputer-based "automatic astronomy" on a truly sound production-line basis. He began development of his Motorola 6809-based system in 1979; I was visiting him in Phoenix in November 1983 when it first ran by itself all night long. The system found, centered, and measured hundreds of stars without making a single mistake.

It is interesting to speculate about the future of microcomputer-based automatic astronomy. Since an experienced engineer can keep many automatic telescopes operating, it seems likely that a number of such systems owned by various institutions will be placed at a single top site where clouds are a rarity. A list of objects to be observed will be sent via phone or disk by an astronomer; after all the requested observations are made automatically, the results will be sent back to the requesting astronomer in a similar fashion. In fact, such an "Automatic Photoelectric Telescope

*The first completely automatic system was built at the Washburn Observatory in the mid-1960s.*

Service" has been established in Arizona with Louis Boyd as the engineer minding the automatic systems.

For some types of observation, the best vantage point would be from space, where there are no atmospheric problems to contend with. In fact, the space station might make a good platform for a contingent of fully automatic, microcomputer-controlled telescopes.

**GETTING STARTED**

While it is only recent, the published literature on the use of microcomputers in astronomy is growing rapidly. There are a number of books that will be useful for further research in the "Astronomy Sources" text box on page 244. And, in the "Helpful Organizations" text box on page 181, I have suggested a number of organizations worth contacting. You, like many others, may have fun exploring and creating connections between the oldest science and the newest machines. ■

INTERNATIONAL MICROCOMPUTER SOFTWARE, INC. • 1299 Fourth Street • San Rafael, CA 94901

**REPLACE YOUR PAINT PROGRAM WITH PC PAINTBRUSH**

**SAVE \$89!**

(Offer expires August 15, 1985)

Paint program owners (PC Paint™, Dr. Halo™, PCjr Color Paint™, etc.) save \$89 on a copy of PC Paintbrush. Just fill out the coupon below and send it along with a check for \$50 and your paint program's master diskette to IMSI. Or simply take the coupon, check and program to your nearest Computerland or Entre store and redeem it for a copy of PC Paintbrush. Make sure you have the best paint program on the market today — PC Paintbrush!

PC Paint is a trademark of Mouse Systems Corporation. Dr. Halo is a trademark of Media Cybernetics Inc.. PCjr ColorPaint is a trademark of International Business Machines Corporation.

Name \_\_\_\_\_ Title \_\_\_\_\_  
 Company \_\_\_\_\_ Phone \_\_\_\_\_  
 Address \_\_\_\_\_  
 City \_\_\_\_\_ State \_\_\_\_\_ Zip \_\_\_\_\_  
 Paint Program Owned \_\_\_\_\_



GENERAL LYMAN FIELD  
(AIRPORT)

HAWAII

# MICROCOMPUTERS IN NASA'S SIR-B

BY RICHARD WILTON

*A network of personal  
computers in the space program*

SINCE 1978, SCIENTISTS at the Jet Propulsion Laboratory (JPL) have been producing remarkable images of the earth's surface using orbiting radar systems (photos 1-3). The images generated by orbiting synthetic-aperture radars are of high resolu-

*Photo 1: This image of Hawaii was acquired on October 11, 1984, by the Shuttle Imaging Radar-B (SIR-B) during space shuttle mission 41-G. Artificial colors were used to enhance differences in surface characteristics in this computer-processed image. Red areas represent areas of smooth ash cover, dark green is smooth pahoehoe lava, light green is rough aa (cg) lava, and blue represents vegetation cover. The resolution of this image is about 30 meters (100 feet). The area covered is about 26 kilometers wide and 110 kilometers long (about 16 by 70 miles). The image was acquired by SIR-B at a rate of about 7.5 kilometers per second (4.6 miles per second) at an angle of 27.5 degrees. The radar was part of a package of experiments flown on the shuttle for NASA's Office of Space Science and Applications (OSSA). SIR-B was developed by JPL for NASA. Photo courtesy of JPL.*

tion and are unaffected by cloud cover. They are of particular interest to geologists, oceanographers, and other students of the earth's surface.

The shuttle imaging radar experiment, called SIR-B, was the third synthetic-aperture radar developed at JPL to be placed in earth orbit. It flew aboard the space shuttle *Challenger* from October 4 to 12, 1984. The SIR-B team at JPL is still analyzing many of the results of the experiment.

Of course, a great deal of engineering and computing effort went into the design of the radar hardware and into generating visual images from the raw radar data. However, this article focuses on two other essential aspects of the SIR-B experiment: planning where and when the radar would be used and monitoring the status of the radar during the mission itself.

## **HARDWARE**

The SIR-B mission-planning team at JPL put a great deal of thought and discussion into choosing the right computers for the complex task of planning the mission. The team made the decision to use several microcomputers, rather than a single mainframe

or mini, as far back as 1982. The team felt that microcomputers provided the most cost-effective and flexible computational base for fulfilling the SIR-B mission-design requirements.

The overriding considerations were for microcomputers that met the following criteria:

- availability of hardware and software support
- flexibility in hardware options (including memory expansion, communications interfacing, and networking)
- floating-point arithmetic capability

Considering the diversity of software and the large quantity of numeric data to be processed, it was clear that no existing 8-bit processor would have been sufficient. Although a 68000-based microcomputer might have been faster or able to address more RAM, the availability of the Intel 8087 arithmetic coprocessor—and of programming languages that took advantage of its speed and flexibility—

*(continued)*

*Richard Wilton is a software consultant with Laboratory Microsystems Inc., 3007 Washington Blvd., Marina del Rey, CA 90292.*

was a big advantage of an 8086- or 8088-based system. The ease with which additional memory, communications hardware, and a local network could be installed on IBM PCs finally led to their use during the SIR-B experiment.

All of the IBM PCs and Compaqs that were used for SIR-B mission planning were equipped with Intel 8087 floating-point coprocessors, video graphics displays, dot-matrix printers, and lots of RAM—512K bytes was considered a minimum workable amount of memory.

#### SOFTWARE

A lot of new software was required from the outset of the planning phase of the SIR-B mission. Mission-planning software included a great deal of arithmetic computation as well as a fair amount of hardware-dependent programming for graphics and networking. Real-time communications and data-management software was critically hardware-dependent. It integrated machine-level code, such as port-addressed I/O and interrupt handlers, with fairly sophisticated file-management routines.

Both the SIR-B mission-planning software and the real-time communications software were written primarily in FORTH. The off-the-shelf FORTH implementation (PC/FORTH by Laboratory Microsystems) included fast display graphics for the IBM PC, a standard PC-DOS file interface, and high-level support for the 8087 coprocessor. Again, speed, adaptability, and readily available support were major considerations in choosing the programming language.

#### PLANNING THE SIR-B EXPERIMENT

By mid-1983, most of the planning software had been written, including an orbit propagator and world-map display graphics. The calculated orbital path of the space shuttle and the part of the earth at which the imaging radar might be aimed could be rapidly drawn on either a plotter or a video display (photo 4).

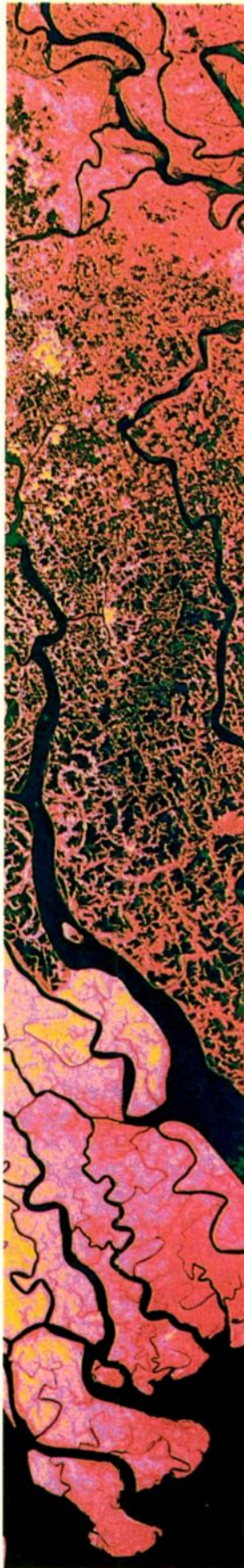

In order that the radar beam could be directed toward a specific location on the earth's surface, the calculations included the orbiter's attitude (roll, pitch, and yaw) and constraints on the way the radar antenna could be aimed at the earth (the width of the radar beam, the angle at which the radar antenna was tilted, etc.)

SIR-B mission planners could then display, print, or plot arbitrary portions of the orbital track of the spacecraft. Many complex orbit and attitude calculations were translated interactively into accurate graphical representations on the video display and on printers and plotters. Prior to the SIR-B experiment, these problems in orbital mechanics and spherical geometry had been accurately solved only on mainframe computers.

Plans for the SIR-B experiment were encapsulated in a detailed database of control commands. During the ac-

*Photo 2: The Ganges floodplain in Bangladesh. SIR-B observations in this area are being used to study the ability of imaging radar to detect standing water in a tropical environment to aid in locating and eradicating habitats of malaria-carrying mosquitoes. Artificial colors in this computer-processed image enhance differences in vegetation and terrain. Pink and yellow represent forested areas, seen most vividly in the coastal forest preserve of Sundarban on the Indian Ocean at the bottom. The textured green and pink area in the center shows cultivated fields connected by extensive irrigation and drainage channels. The more uniform rose-hued area at the top is an area of the Ganges floodplain subject to flooding and major rework during the monsoon season. The city of Ihalakat on the Bishkhali River is the yellow spot in the center, and Barisal is at the upper left center. The area covered in this image is approximately 23 kilometers wide and 155 kilometers long (about 15 by 95 miles). The image has a resolution of 20 meters (65 feet) and was acquired by SIR-B at a rate of about 7.5 kilometers per second (4.6 miles per second) at an angle of 45.6 degrees. Photo courtesy of JPL.*

tual mission, sequences of these commands were transmitted from the ground to the SIR-B radar apparatus located in the shuttle's payload bay (photo 5). Each command sequence initiated a specific function, such as aiming the radar antenna, adjusting its power, or turning the radar transmitter on and off.

### COMMUNICATIONS SOFTWARE

Monitoring the status of the SIR-B radar equipment during the mission produced a large amount of telemetry data that had to be processed in real time. Data from two separate telemetry streams (serial-bit streams) was archived. Information concerning the status of the radar equipment (voltages, temperatures, and so on) as well as the position, velocity, and attitude of the spacecraft itself was recorded. Changes in the status of the radar were "logged" in print and on disk for reference during the mission and afterward.

Programming for the telemetry communications interface began in June 1984. The use of FORTH greatly accelerated the development of reliable hardware interfaces. Assembly-language code was easy to incorporate into high-level FORTH programs. Because of the interpretive nature of the FORTH language, the communications software was easily tested and debugged on the hardware.

### DURING THE MISSION

For the duration of the actual mission, four IBM PCs and two Compaqs were combined on an Ethernet local-area network (figure 1). The equipment was assembled in a user-support room at the Mission Control Center in Houston.

The data pertinent to the SIR-B experiment was extracted from the shuttle's telemetry streams by mainframe computers at the Mission Control Center. The radar telemetry data was formatted in blocks. Each block of data contained a date and time code, the attitude and orbital position of the spacecraft, and a sequence of engi-

neering telemetry values.

A 68000-based computer, designed and built by SIR-B engineers, converted the raw telemetry data into several formats for further processing. This custom-built machine was programmed in C and cross-compiled to ROM from a VAX. The output from this machine included a 4800-bps (bits per second) asynchronous data stream.

A separate telemetry stream was processed by another mainframe computer at Mission Control. This data was provided as a 4560-bps binary synchronous bit stream.

These two serial telemetry streams, one asynchronous and one binary synchronous, were received on a single Compaq. The data was reformatted on the Compaq and transferred across the network to the network server, an IBM PC XT with a 10-megabyte hard disk. All of the machines on the network, including a 60-megabyte cassette tape drive, had access to the telemetry data as soon as it was saved on the server. Three color graphics displays, two dot-

(continued)

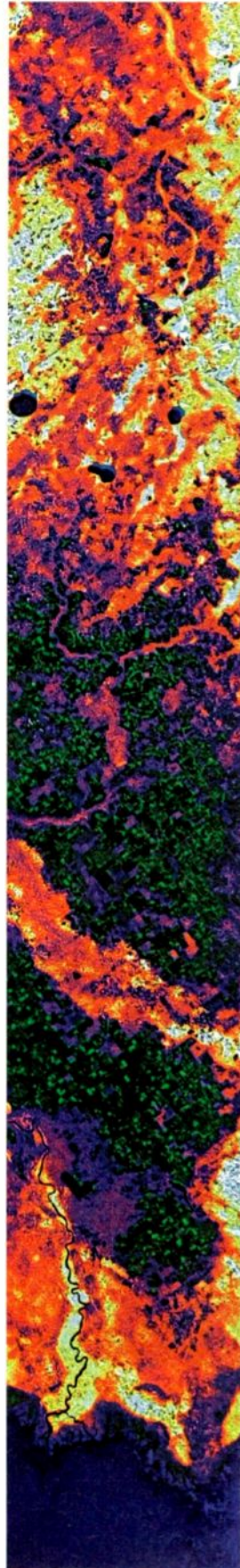

Photo 3: This image of northeastern Florida will be used to assess coniferous timber stands and management practices in conjunction with extensive ground measurements at experimental forests and test sites in the area. Artificial colors in this computer-processed image enhance differences in vegetation and terrain. Yellowish-green areas are generally stands of cypress drenched in early morning dew (the image was taken at 3:59 a.m. local time). Three prominent bodies of water (from left to right) are Ocean Pond, Palestine Lake, and Swift Creek Pond. At the bottom is the Gulf of Mexico. Dark green and purple areas are agricultural fields, and bright orange regions denote drainage channels. The image was acquired at an angle of 28.4 degrees at a rate of about 7.5 kilometers per second (4.6 miles per second). The area covered is approximately 29 kilometers wide and 174 kilometers long (about 18 by 106 miles). The resolution of the image is 28 meters (90 feet). Photo courtesy of JPL.



Photo 4: The path of five orbits of the space shuttle is superimposed on a map of the world. Photo by Su Kim.



Photo 5: The SIR-B radar antenna in the payload bay of the spacecraft during the mission. The antenna, at the left, was built in three rectangular segments that were folded together when not in use. This was the case when this photo was taken. You can see most of the antenna's triangular support base, one of the hinges on which the segments of the antenna unfold, and, at the far left, a clasp that locked the antenna closed. The entire apparatus is covered with a white thermal fabric. Photo courtesy of NASA.

*All the commercially available hardware was used "as is"; no special hardware modifications were needed for the system.*

matrix printers, and a line printer were used as output devices.

All of this commercially available hardware was used "as is"; that is, no special hardware modifications were needed to configure the system. Throughout the mission, the networked system performed reliably 24 hours a day.

When a KU-band communications antenna failure aboard the spacecraft compromised one of the essential telemetry links, a great deal of contingency planning was required. Because the SIR-B mission-planning software was easily accessible on the microcomputer network, the SIR-B planning team was able to work around some of the problems created by the loss of the communications antenna.

Also, because it was possible to "replay" events from the telemetry stream over the network shortly after they occurred, the SIR-B engineers were able to keep a close eye on the performance of the radar and its subsystems.

#### **CONCLUSIONS**

All in all, the networked microcomputer system that was created for SIR-B planning and data archiving performed remarkably well. The advantages of using networked micros in this real-time engineering application were clear: hardware redundancy, distributed processing, and reliability and ease of use of off-the-shelf components.

(continued)



**Kimtron**

# MULTI-USER SOLUTION for IBM PC, XT, AT

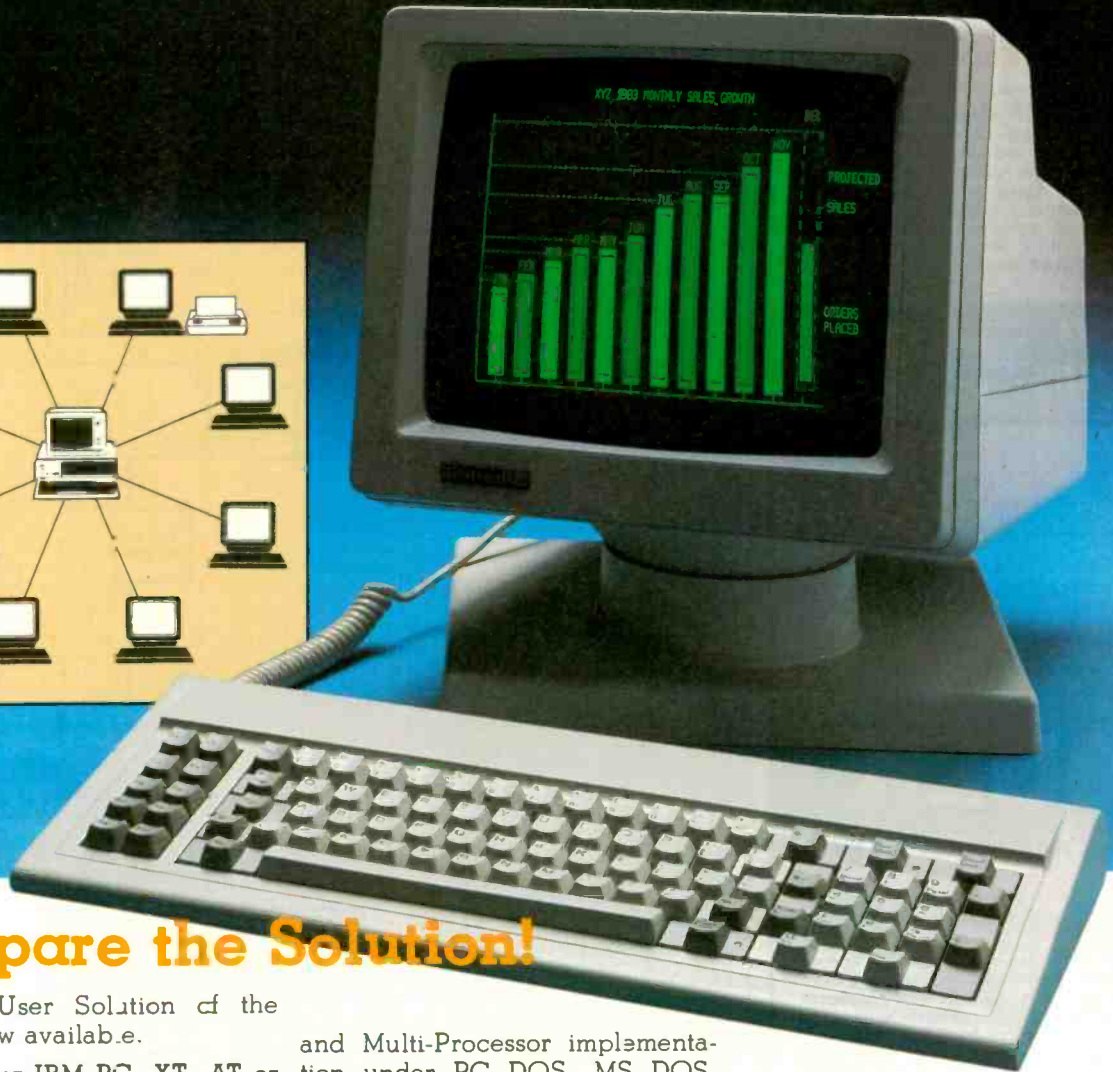
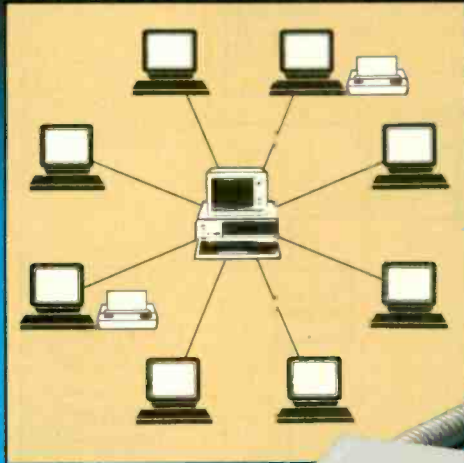

## Compare the Solution!

The Multi-User Solution of the future is now available.

Convert your IBM PC, XT, AT or Compatibles to a true multi-user system while maintaining display, keyboard and software compatibility.

Since the KT-7/PC display is the same as your PC monochrome monitor, with its look-alike keyboard, operators will feel they're using an IBM PC and can also use the same software manual. Kimtron's multi-user solution includes file and record locking, shared data access, and communication between users. It is the intelligent alternative.

The KT-7/PC supports Time Sharing, Enhanced Time Sharing

and Multi-Processor implementation under PC DOS, MS DOS, UNIX, XENIX, CPM 86, Multilink, Concurrent PC DOS, and other compatible multi-user operating systems.

Kimtron's multi-user solution may be tailored for cost effectiveness; as low as \$1095 for an additional user, and for speeds more than ten times faster than LAN. You can add one or as many as 31 additional users per PC. Kimtron delivers the future now by allowing an ever-widening network of multi-user PC's.

The KT-7/PC may be complemented with one (or more) I/O Card, Memory Card, 8086 Speed

Enhancer Card, 80286 AT Card, 8088 Multi-Processor Card, 80186 Speed Enhancer Card, 68000 Card, and related software.

For more information about Kimtron's Multi-User Solution, or general video data terminals for other mini or micro multi-user systems, call your local computer dealers, distributors or Kimtron Corporation Today!

**(408) 727-1510**



1705 Junction Court  
Building #160  
San Jose, CA 95112

**Kimtron**

NOTE: IBM PC, XT, AT, PC DOS, MS DOS, UNIX, XENIX, CPM 86, Multi-Link, Concurrent PC DOS are registered trademarks of IBM Corporation, Microsoft Corp., Bell Labs., Digital Research Inc., Software Link Inc. respectively.

# CENTech

The Colorful Solution to Data Organization™

SS-DD DS-DD  
**\$120** — 5 1/4" QTY 50 — **\$149**  
 BULK  
**\$149** — 5 1/4" QTY 20 — **\$199**  
 BOXED  
**\$228** — 96 TPI — **\$284**

**TIMELESS WARRANTY**  
**COLOR DISKETTES—LOWEST PRICE EVER!**  
 100% error-free and free of manufacturing defects or we will replace it at no charge. Available in 13 useful colors. Double density and reinforced hubs. Includes tyvek sleeves, user ID labels, write-protect tabs. As an introductory offer we will send a **FREE LIBRARY CASE** with each order of boxed diskettes.

**\*FREE 3M Flip 'n' File™ Offer...**



SS-DD DS-DD  
**\$149** — 5 1/4" QTY 20 — **\$199**  
**\$228** — 96 TPI — **\$284**  
**\$288** — 35" 135 TPI

Factory fresh and pre-packaged with a **Free Flip 'n' File™** for every 50 3M diskettes order. Includes tyvek sleeves, reinforced hubs, user ID labels and write-protect tabs.  
**3M Headcleaning Kit** ..... **\$795**

ECONOMICAL PRICE American-Made EXCELLENT QUALITY

## BULK DISKETTES

**LIFETIME WARRANTY**  
 SS-DD DS-DD  
**90¢** 5 1/4" QTY 50 **98¢**

Includes white tyvek sleeves, reinforced hubs, user ID labels and write-protect tabs. Every track, every sector, every diskette tested at 163% of industry standards. Certified 100% error-free and free of all manufacturing defects or we will replace it at no charge. American made by a leading manufacturer of magnetic media to surpass the best the world has to offer.

### DISK STORAGE

Amaray Media Mate 50 ..... **\*9.95**  
 Disk Minder II-75 ..... **\*11.95**  
 Micro Disk Minder-36 ..... **\*8.75**

### PRINTER RIBBONS

Epson MX 70/80 ..... **\*3.53**  
 Epson MX-100 ..... **\*4.90**  
 Okidata 80, 82, 83, 92, 93 ..... **\*1.45**  
 Okidata 84 ..... **\*3.50**

**PRICE PROMISE:** We will better any lower delivered price on the same products and quantities advertised nationally.

**TERMS:** FREE USE OF VISA & MASTERCARD American Express also accepted. C.O.D. orders add \$3.00. **Shipping:** Add \$3.00 per 100 diskettes or fraction thereof. Other items add \$2.00 for disk storage or headcleaning kit or each multiples of 8 ribbons. P.O. accepted. Utah residents add 5 1/2% sales tax. Minimum order \$30.00.

TOLL FREE ORDER LINE:

**1-800-233-2477**  
**(1-800-AFFAIRS)**  
 INFORMATION AND INQUIRIES:  
**1-801-942-6717**



2028 E. FT. UNION BLVD., #105  
 SALT LAKE CITY, UTAH 84121  
 CALL: 1-800-AFFAIRS  
 HOURS: 8AM-5PM M-F (Min. Time)

## SIR-B

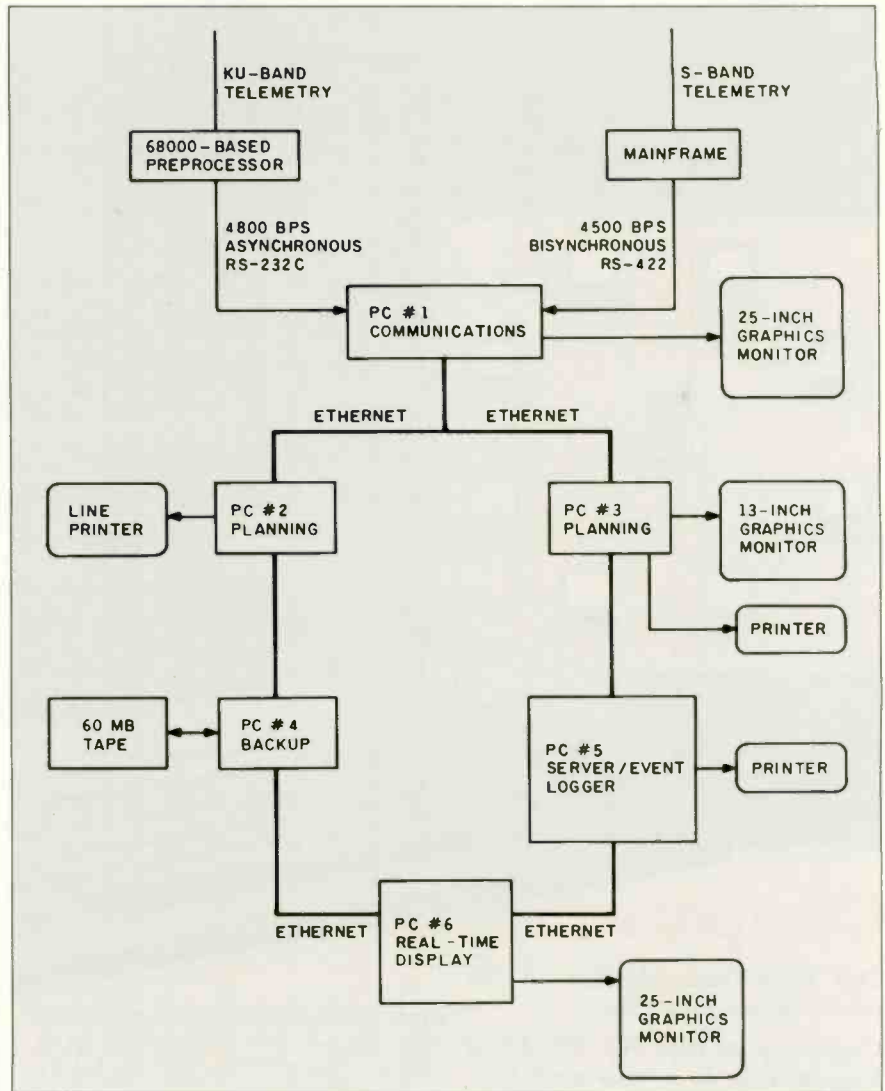

Figure 1: This diagram illustrates the flow of telemetry data during the SIR-B experiment.

The experience gained from SIR-B (as well as the hardware and software) will be used in upcoming imaging radar missions. The SIR-B experiment itself will be repeated on a space shuttle flight in early 1987. A more sophisticated experiment called SIR-C is currently planned for the late 1980s.

The type of network microprocessing system that was created for this particular experiment will find increasingly widespread use in similar environments: hospitals, laboratories, and industrial data-gathering systems, for example. In such settings, distributed microprocessors will be the

most reliable and cost-effective way to gather data and use it flexibly. ■

### BIBLIOGRAPHY

- Elachi, Charles. "Radar Images of the Earth from Space." *Scientific American*, December 1982.
- Ford, J. P. "Space Shuttle Columbia Views the World with Imaging Radar: The SIR-A Experiment." Jet Propulsion Laboratory publication 82-95, January 1983.
- Harris, Henry. "SMDOS: SIR-B Mission Design and Operations Software." Jet Propulsion Laboratory document D-1081, 1984.
- "The SIR-B Science Investigation Plan." Jet Propulsion Laboratory publication 84-3, July 1984.

# Look to the Leader

I<sup>2</sup> has been delivering low-cost storage products since 1978



For affordable, expanded storage for your IBM PC or PC compatible, look to the leader—I<sup>2</sup> Interface, Inc. With I<sup>2</sup> Interface Winchester DiskSystems, you can have levels of storage typically associated with larger, more expensive computer systems. Our DiskSystems are available with formatec storage capacities of 10, 15, 22, 33, 55, 87 and 119 megabytes. These DiskSystems are bootable from the Winchester

on some PCs. Plus, I<sup>2</sup> Interface has more to offer:

- Internal-mounted

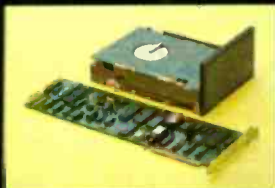

Internal Winchester DiskSystem

Winchester system with 10 megabytes

- Removable cartridge DiskSystem with 10 megabytes
- Cartridge TapeSystems with 10 to 60 megabytes
- Plus an array of other peripheral products

### Simple and fully compatible

I<sup>2</sup> DiskSystems and TapeSystems are simple to install and have proven reliability. All are FCC Class B approved and undergo an extensive 48 hour test period prior to



Cartridge TapeSystem

shipment. All are backed by a 90-day warranty that covers parts and labor with an extended one-year warranty available. I<sup>2</sup> Interface products are compatible with IBM PC, XT and portable models, plus other popular PC compatible computers.

See your dealer today to get the affordable means to expand the capabilities of your IBM PC and PC compatible. Look to the leaders—look to I<sup>2</sup> Interface.



Removable Cartridge DiskSystem

See us at  
Comdex Atlanta  
Booth #4355



**Interface, Inc.**

21101 Osborne Street  
Canoga Park, CA 91304  
(818) 341-7914 Telex 662949 CNPK

megabyte hard disk with 18 msec of average access speed.

### Compatibility

To be sure that your hard disk is 100 percent compatible with the IBM XT you don't need to buy the same hard disk that's in the XT. You can't even be sure what brand hard disk it is because IBM, like Express Systems, goes into the marketplace and buys hard disks from several vendors. However, they buy their XT hard disk controller from only one vendor—the same one we do.

You can buy the IBM XT controller from IBM for \$495 or you can buy from us, the functional equivalent, manufactured by the same company that makes it for IBM for only \$195. Is it the exactly identical IBM XT controller? No, it's better. First, it takes less power, and secondly, it can control from 5 to 32 megabytes—the IBM controller can work with only 10 megabytes. It is 100 percent IBM XT compatible, and 100 percent is 100 percent. If you want to save a slot, we carry a version that lets you operate two hard disks and two floppy disk drives.

### More than 32 Megabytes

You can operate with more than 32 megabytes (the limit of DOS) through the use of "device drivers." Express Systems can supply you with device drivers for our hard disks for over 32 megabytes formatted. But, if you don't have individual files, or databases that are large, you might want to consider one of our controllers that can divide our 65 megabyte (formatted) hard disk into two equal volumes of 32 megabytes each.

### Reliability

We offer you a choice between iron oxide and plated media—the stuff that covers the hard disk and gives it its magnetic properties. Iron oxide is, well, it's rust. If you inadvertently joust your disk, you may cause the low flying head to dig out some iron oxide. A little rust flake can ruin your whole day. Plated media is more resistant to damage, and if it happens, less data is lost.

We offer both types of hard disks. The iron oxide is older

# If you believe these simple facts about hard disks, you'd be willing to pay more for ours.... fortunately, you won't have to

## Avoiding hard disk failures and loss of data is just one of the reasons to buy our hard disks.

Hard disks can fail—there's really no other nice way to say it. Even IBM has problems delivering ATs with hard disks that work. We're not talking about nice, clean, clear-cut failures where the drive seizes up, coughs, and rolls over and dies. We're talking about the insidious little creeping failures that sneak up over time—like a missing sector here or a lost sub-directory there.

There are precautions you can take to protect against failure and ultimate loss of data. Here is what we contribute toward minimizing the potential loss of your data.

### Best Drives Available

First, we buy the best drives available. Sounds trite, doesn't it? I mean, a drive's a drive—right? Hardly. You should see some of the junk we get in our labs. Some have such high failure rates that we even questioned our own \$10,000 hard disk tester. But when we tested other manufacturers' drives we were assured that our equipment was fine, which just confirmed that the bad hard disks were not only bad—they were real bad.

But that's just the weeding out process. We then take each drive that we've put through our tester and test it again with the controller you've requested. We call this a "tested pair."

### DOS Doesn't Do It

In case you're thinking that all

this is an unnecessary duplication of what DOS does for you, let me explain the disk facts of life.

If DOS did what you may think it is supposed to do when you format the disk, DOS would map around these bad areas. Unfortunately, DOS doesn't do this.

DOS 2.0 and 2.1 can't enter the bad tracks. DOS 3.0 can, but only on the IBM AT. Unfortunately, as the press has so well documented, the AT's hard disk develops bad tracks later on.

### We do what DOS can't

We believe the problem is so bad, we use a software program that performs a powerful test of your disk drive on all of the IBM or IBM compatible computers—PCs, XTs, and ATs. Our format takes hours to analyze the disk. But when we finish, you know that the bad tracks are really mapped out so you won't write good data that will disappear into a black hole. We even send you a printed statement of our test results.

Our software allows you to type in the bad track locations from the list supplied by the manufacturers, so you'll never write good data to them—even if DOS didn't identify them as bad. The software even lets you save the location of these bad sections to a file, so that you can reformat your disk without spending hours retesting.

We even include a program that will give you continuous comments on the status of your hard disk. No more waiting for that catastrophic failure.

### Average Access Time

As you might suspect, some hard disks are faster than others in their ability to move from one track of data to another. The time it takes the hard disk to move one-half way between the beginning of the disk to the end is called the "average access time."

The first generation of 10 megabyte hard disks had average access times of 80-85 milliseconds (msec). But computer users love speed, and guess what—the average access time for the new 20 megabyte hard disk in the IBM AT is only 40 msec. (We sell an AT equivalent with only 30 msec access time!)

There are some legitimate reasons for the shorter access time. It's particularly helpful when there are multiple users on the same hard disk. It's also important when running a compiler. But remember, before you get too wrapped up in the access speed, there's always that ST 506 interface which won't let data transfer from the hard disk to the computer any faster than 5 megabits/second. We've bypassed that choke hole, too. If you want the functional equivalent of a Ferrari with a turbocharger, order our 10 Mbit per second 108



technology, and quite frankly, manufacturers understand it better. Their better understanding, combined with some of the special head locking mechanisms, gives us peace of mind when we sell you one.

### Power

Hard disks consume power. Our small, half-high hard disks consume so little power that you can use them with your existing IBM PC power supply. If you plan to use lots of slots, you'll want to increase your power supply to be safe. We offer the same amount of power for your PC that comes in the XT.

### Our Customers

Some folks just never feel comfortable buying mail order. They forget that Sears began as a mail order house or that IBM is now into mail order. But, if it helps, here is a partial list of customers who have felt comfortable to buy from us.

IBM	Sears
American Express	Honeywell
U.S. Army	MIT
AT&T (Bell Labs)	RCA
Bausch & Lomb	Lockheed
Xerox	Sperry

### Easy to Install

If you're like most of us, raised on the boob tube rather than the Great Books, you'd rather see the movie than read the book. Well, now you can choose to read our installation manual or for only \$9.95 more, you can get a VHS or Beta video cassette showing the simple steps for installation.



Our VHS or Beta Cassettes make installation easy.

### Warranty

We offer you a one year warranty on our hard disks—the same as IBM on the AT and 90 days on the tape drives. (It's all the manufacturer gives us.)



### Complete Hard Disk Kits

Formatted Storage Capacity in Mbytes	Height	Plated Media	Average Access	Transfer Rate	PC or PC/XT	AT
10	1/2	yes	85 msec	5 Mbits/s	\$ 625	\$ 430
10	Full	yes	85 msec	5 Mbits/s	\$ 625	\$ 430
21	1/2	yes	85 msec	5 Mbits/s	\$ 825	\$ 630
21	Full	no	30 msec	5 Mbits/s	\$ 1,535	\$ 1,340
32	1/2	yes	85 msec	5 Mbits/s	\$ 1,095	\$ 895
32	Full	no	30 msec	5 Mbits/s	\$ 1,775	\$ 1,575
65	Full	no	30 msec	5 Mbits/s	\$ 2,295	\$ 2,070
108	Full	yes	18 msec	10 Mbits/s	\$ 4,995	\$ 4,995



### Removable Hard Disk

10	1/2	no	90 msec	5 Mbits/s	\$ 1,095	N/A
----	-----	----	---------	-----------	----------	-----



### Tape Systems and Subsystems

Formatted Storage Capacity	Height	Data Transfer Rate (k/sec)	PC or PC/XT	AT
60 Mbytes	1/2	88	\$ 995	\$ 995
60 Mbytes Subsystem		88	\$ 1,295	\$ 1,295
17.6 Mbytes Start/stop Subsystem		24	\$ 795	\$ 795



### Controllers

All of our hard disk and tape controllers are available separately: Please call for prices.

### Subsystem Chassis

Any of our disk or tape units are available in an external subsystem for an additional \$250.00. You can mix & match any of our 1/2 high hard disks or tape drives together or add any single full height hard disk.



### Tape Cartridges

Express Certified 555 foot 310 Hci 1/4-inch Data Cartridge \$ 35.00

### Power Supply

130 Watt Power supply \$ 99.50\*

\*with the purchase of any drive

### More questions?

Because we spend so much attention on the front end with ensuring that our disks will arrive in working order, we have a customer service department that, unlike many of our competitors, has little to do. When you need us, you won't get a constant busy signal.

Call our friendly, knowledgeable customer service staff to get answers to your questions—before or after the sale. Our people, who know the PC, can talk you through the sticky parts, and they'll respond to you quickly. Just call us.

### How to order

Pick up the telephone and call 1-800-341-7549, to order. We accept Master Card, VISA, American Express and Diners Club. Or send a cashier's check or



money order (We'll take a check, but you'll have to wait for it to clear) and tell us if you want one of our recommended configurations or you want to mix and match yourself. Corporations with a DUNS number may send purchase orders for quantities over five.

### Comes complete

All Express Systems products come complete with the appropriate software, tape and/or hard disk controllers, and cables where required. Hard disks are formatted and tested with the PC DOS of your choice. All drive sizes are formatted capacities.

If your application requires a stacking kit, power splitter cables, daisy chain cable, or some other variation, we'll supply these items at a nominal charge. We even ship our hard disks with Command Assist™ an on-line DOS-like manual to give you help with your DOS commands.

# EXPRESS SYSTEMS

Call Toll Free 1-800-341-7549 Ext. 500  
In Illinois call (312) 882-7733 Ext. 500

Express Systems, Inc., 1254 Remington, Schaumburg, IL 60195

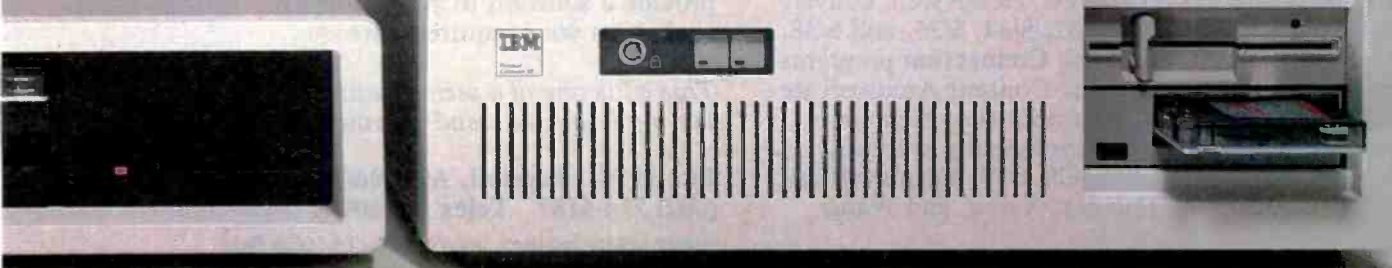

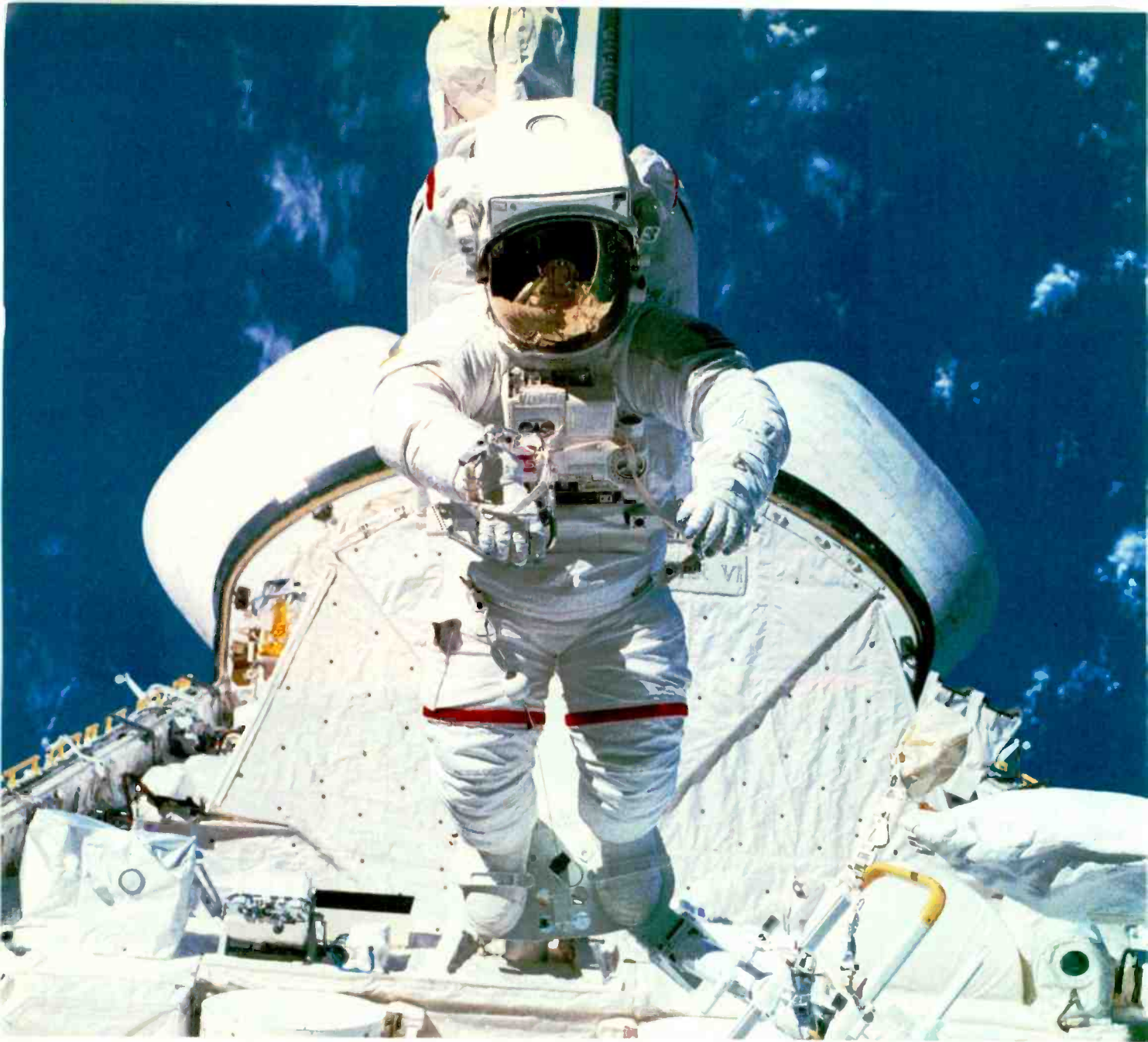

## MAKE THE CONNECTION . . .

Our **Connection** systems will solve your problem of trying to read and write diskettes or tapes from almost any computer system using your PC.

The **Diskette Connection** is a hardware system that enables the IBM PC or compatible to read and write most 8 inch, 5¼ inch, or 3½ inch diskettes.

With our **File Connection** software programs you can transfer data files between most computer systems, including CP/M, DEC, Honeywell, Univac, IBM 3740, S/1, S/3, S/23, S/32, S/34, S/36, and S/38.

Our **Word and Typesetting Connection** programs use IBM standard Document Content Architecture (DCA-RFT) to transfer document files between most word processing and typesetting systems, including Compugraphic MCS, CPT, Displaywriter, OS/6, Multiset, NBI, Quadex, Xerox, and Wang.

Our **Tape Connection** system will read and write IBM or ANSI standard ½ inch 1600 BPI magnetic tape. A full size 2400 foot tape can store a 45 MByte file and be written in 6 minutes.

Since 1982, we have supplied thousands of systems to customers around the world, including IBM, NASA, AT&T, Kodak, and General Motors.

Our specialty is conversion systems and we can provide a solution to your problem. Call us today to discuss your requirements.

*This ad is one of a series featuring NASA missions. For a free poster, send us your written request.*

**Box 1970 Flagstaff, AZ 86002  
(602) 774-5187 Telex 705609**

Inquiry 149 for End-Users. Inquiry 150 for DEALERS ONLY.

## . . . FLAGSTAFF ENGINEERING

# COMET LINES IN FORTRAN

BY DAVID S. DIXON

*The program described calculates  
the positions of asteroids and comets*

THE PROGRAM DISCUSSED in this article is intended to allow amateur astronomers to calculate the positions of asteroids or comets with greater accuracy than the programs previously published in general literature. Written in FORTRAN IV, the program should be translatable to any BASIC that supports double-precision calculation. But be advised that this is a number-crunching program; it may run for hours if rewritten in interpreted BASIC.

Asteroids are a very challenging target for the observer: they appear as points of light just like the stars. Depending on the asteroid's position relative to earth, it may or may not demonstrate detectable motion against the background stars. Frequently, several nights of observation are required to see displacement and identify the asteroid. Successfully hunting a particular asteroid usually means having a good idea of the asteroid's position at the intended time of observation and having a good set of star charts.

The problem is that accurate tables of locations for asteroids, known as ephemerides, are not easy to come by. The United States Naval Obser-

vatory publishes ephemerides for the four major asteroids in *The Astronomical Almanac* each year, but there are thousands of named asteroids. (For a list of books and periodicals mentioned in this and other articles, see the "Astronomy Sources" text box on page 244.) The Soviet Union's Institute of Theoretical Astronomy publishes the *Ephemerides of Minor Planets*, which gives ephemerides for thousands of asteroids, but only for a few weeks at opposition, and it is a difficult publication to obtain. Both the Russian and the Naval Observatory publications, however, also give the orbital elements for a large number of asteroids, and with the elements it is possible to calculate the ephemerides of an asteroid yourself.

Many of the books and magazine articles that address calculating the position of a planet solve the problem by the model devised by Johannes Kepler in 1609. The method models the motion of a body in the solar system as involving only the sun and the body in question. This means that to find the relative positions of Earth and Mars in a common coordinate system you solve the two-body sun-Mars problem, solve the two-body sun-

Earth problem, and, using spherical trigonometry, combine the two results to solve the Earth-Mars problem. The method can produce results satisfactory for use in finding planets, but the accuracy for use on asteroids is frequently inadequate. Kepler's model is a remarkable achievement since he derived it by geometry as an empirical solution based on position measurements made by Tycho Brahe. Kepler's model is summarized in his first two laws:

*First Law:* The orbit of each planet is an ellipse, with the sun at one of the two foci.

*Second Law:* The line joining the planet to the sun sweeps over equal areas of the ellipse in equal intervals of time.

It was not until more than 50 years after Kepler's work was published that the work of Sir Isaac Newton explained the process that Kepler's model described and how the model was incomplete. Newton's law of gravi-

*(continued)*

David S. Dixon is a quality engineer at a NASA test facility. His hobbies include micro-computing and amateur astronomy. He can be reached at 3208 Jupiter Rd., Las Cruces, NM 88001.

ty showed that the orbit of a body in the solar system is not just a function of the sun and the body but involves every mass in the system, i.e., not a two-body problem but an  $n$ -body problem. And Newton's three laws of motion allowed mathematical derivation of what Kepler had deduced from empirical data and geometry. An  $n$ -body celestial mechanics problem is not trivial. It involves evaluating the mutually perturbing effects of the planets, asteroids, satellites of planets, and the sun. In practice one usually restricts the calculations to the sun and the planets.

The two main classes of perturbation techniques used to attack the  $n$ -body problem are referred to as either general perturbations (absolute solutions) or special perturbations (solutions using iterative numerical techniques). Special perturbation techniques fall into two categories, Cowell's model and Encke's model, with numerous variations of each. Both use similar numeric integration methods, but because of the differences in the models, one model or the other may have an advantage in solving a particular type of problem. Cowell's model can be derived by direct application of Newton's laws.

In Cowell's model, which was developed in the early 1900s, all gravitational attractions by all  $n$  bodies are summed and integrated to give the motion of the body in question. Encke's model was developed in 1857 (before Cowell's) and is a very straightforward result of combining Kepler's first two laws and Newton's laws of motion and gravity. Starting at a given point in time, Encke's model describes the motion of a body as the combination of a Keplerian two-body orbit between the body and the primary (the sun) and the integration of all the other perturbing accelerations. In figure 1,  $p$  is the radius vector of the Keplerian orbit,  $r$  is the radius vector of the true orbit, and  $e$  is the difference between the Keplerian and true orbits due to perturbation.

Encke's model is therefore a little more complex than Cowell's, but I chose it for my program because,

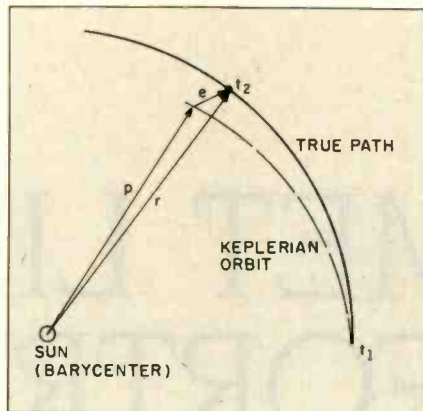

Figure 1: Illustration of Encke's model for calculating orbits around the sun;  $p$  is the radius vector of the Keplerian orbit,  $r$  is the radius vector of the true orbit, and  $e$  is the perturbation (the difference between  $p$  and  $r$ ).

when used on problems dealing with elliptic motion, it usually allows larger integration steps and controls the growth of truncation errors somewhat better than Cowell's model.

What Encke's model provides is an expression for the second order differential equation of  $e$ . I don't know of any closed-form solutions to Encke's model or any of the other special perturbation models of the  $n$ -body problem. In other words, there is no equation or formula that is the solution of the problem. Since there is no closed-form solution, an iterative numerical integration technique is used. The program uses a Runge-Kutta numerical integration method that, while not the fastest calculating method, is easy to program, is easy to change step size, and provides good stability and accuracy. The accuracy I was trying to obtain was about 0.1 right-ascension minute (6 RA seconds) and 1 minute in declination. The program will generally satisfy this accuracy for periods of calculation of two years or more if the initial osculating orbital elements are accurate. For comets and for asteroids with extremely eccentric orbits, I would not expect accuracy this good, but fortunately the images for comets are generally different than the background stars. The program employs

several simplifications that restrict the time over which the perturbations can be integrated and accuracy can be maintained.

During my research for writing this program, I had the opportunity to examine several perturbation programs used by professional astronomers. These programs were substantially longer and used either tabular data and interpolation for the positions of the planets or a program that calculates perturbed motion for the planets as well as the asteroid. The former requires large amounts of data entry or access to data in machine-readable form. The latter increases the amount of calculation further still. This program uses a series of polynomials that are calculated and gives the orbital elements of each of the planets considered to be perturbation sources. The planetary positions derived from these orbital elements are not as accurate as the other methods. This error, and several others, leads to restrictions on the period of time over which the perturbations can be integrated by this program to about 800 days before the error exceeds the desired accuracy.

One perturbing acceleration has been left out of the program. This is the acceleration resulting from the displacement of the body from the Keplerian path about the primary. The Keplerian path is a force-balanced path only so long as the body is on the path. When the asteroid is perturbed off the path, an additional acceleration due to the primary comes into effect. Equation 1 is the expression for the acceleration, and as long as  $e$  is small then this term is very small. The program forces a recomputing of the osculating elements of the asteroid whenever  $e$  reaches a predetermined small value. For the desired accuracy, this perturbation term can be ignored. This is the major mathematical departure of the program from Encke's model. Encke's model includes this acceleration and still requires a routine to compute new osculating elements, but it allows  $e$  to grow to much greater size before

(continued)



New Version

# Classic COBOL.

True mainframe COBOL for your microcomputer. Validated by the GSA at the highest possible level of compliance with the ANSI '74 standard. With Microsoft COBOL, mainframe programmers can be productive on MS-DOS™ and Microsoft XENIX® micro-computers immediately.

### Speed and Beauty.

High performance in a COBOL program comes mostly from the speed of the ISAM. And Microsoft COBOL 2.0 has the fastest ISAM on the market.

And our advanced screen handling capability lets you create the highly interactive programs that end users prefer.

### We wrote the book.

It's no surprise that IBM®, DEC®, AT&T, H-P and Wang® all chose Microsoft COBOL for their MS-DOS machines. We know how to get the most out of their micro-computers. After all, we designed the operating system.

So call (800) 426-9400. In Washington State, Alaska, Hawaii and Canada, call **MICROSOFT** (206) 828-8080. **The High Performance Software™** We'll give you the name of your nearest Microsoft dealer or help you update to Microsoft COBOL 2.0.

#### Certified High Level Compiler:

- ♦ GSA validation at the Federal High Level of compliance with the ANSI '74 standard.
- ♦ Built in sort-merge, chaining, dynamic calling, and overlays.

#### Fast multi-key ISAM:

- ♦ Split-keys and duplicate keys.
- ♦ Benchmark results of 5000 reads and writes to an ISAM file:

Microsoft COBOL 2.0	Realia COBOL	MicroFocus® Native Code	Ryan-McFarland® COBOL 2.0
hours: minutes 1:32	1:56	2:58	3:30

#### Interactive extended screen section:

- ♦ Cursor positioning, auto skip, automatic data field formatting.
- ♦ ACCEPT and DISPLAY data by the screen full.

#### Productivity utilities:

- ♦ Interactive Symbolic Debugger.
- ♦ Rebuild file recovery utility restores corrupted ISAM files.

#### Price:

- ♦ \$700 for compiler and utilities.
- ♦ No runtime royalty fees.

#### Minimum System requirements:

- ♦ MS-DOS 2.0 or later, 192K RAM, and one disk drive.
- ♦ Xenix 286, 512K RAM, and one disk drive.



Microsoft and Xenix are registered trademarks and The High Performance Software is a trademark of Microsoft Corporation. IBM is a registered trademark of International Business Machines. DEC is a registered trademark of Digital Equipment Corp. Wang is a registered trademark of Wang Laboratories, Inc. MicroFocus is a registered trademark of MicroFocus. Ryan-McFarland is a registered trademark of Ryan-McFarland.

rectifying the orbit.

$$a = m \cdot |p/p|^3 - r/|r|^3 \quad (1)$$

The differential equation on which the program is based is given in equation 2. If equation 1 and equation 2 are added you have the differential equation of Encke's model.

$$d^2e/dt^2 = \sum_{k=1}^N -m_k \cdot |(s_a - s_k)/|s_a - s_k|^3 + (s_k/|s_k|^3)| \quad (2)$$

Subscripts *a* and *k* in equation 2 refer to the asteroid and perturbing body; *N* is the number of perturbing bodies; *s* is the position vector of the body corresponding to the subscript, relative to the solar system barycenter; *m* is the gravitational parameter of body *k*.

The program consists of the main code and four subroutines. The main program handles initial parameter input for the asteroid number, dates and increment for the ephemeris, and

an initial integration step size. As written, the program expects to find a file of asteroid osculating orbital elements on disk. The short program DSKPRP is an example of a program used to initialize this file. The main program integrates the perturbations from the beginning epoch of the asteroid orbital elements to the first date of the ephemeris. When the integration has reached the first date in the ephemeris, the main program continues the integration at whatever time interval was specified for the ephemeris and calculates the coordinate transformation from heliocentric ecliptic coordinates to equatorial coordinates and prints the ephemeris. Subroutine KEPLER solves Kepler's equation for the asteroid, Earth, and the other planets. This calculation is done in polar coordinates and then transformed to heliocentric rectangular coordinates. Subroutine NEWTON accepts the rectangular coordinates of the asteroid and a perturbing body

and calculates the perturbing acceleration due to the body. Subroutine ENCKE calculates a new set of osculating orbital elements for the asteroid from the old set and the perturbations that have occurred to the asteroid. The last subroutine in the program, subroutine ORBIT, calculates the orbital elements of the Earth and other perturbing planets by a set of polynomials and the Julian date.

Using the program is not difficult. The program first prompts for the date on which you want the ephemeris table to start, the interval of the table, and the length of time to be covered in the ephemeris. The unit of time is in days, i.e., 0.01 day or 10 days. The time scale is universal time, which for the purposes of the program can be considered coordinated universal time, which is broadcast by WWV and other time stations. The program then prompts for an integration step size. This generally should be between 5 and 40 days, with a maximum of about 2 percent of the orbital period and a minimum of about 0.1 percent of the orbital period. The closer the epoch of the orbital elements is to the first date in the ephemeris, the longer the integration step may be. The objective in selecting the integration step size is to pick an interval small enough to make the truncation errors in the integration small and have an interval large enough to keep round-off buildup minimized. The program then prompts for the asteroid number and fetches the asteroid's orbital elements stored on disk. The asteroid's orbital elements from the file are displayed. If more recent elements are available, the elements are entered and the file updated. The program then calculates an ephemeris for the dates and time interval entered.

Table 1 contains the osculating orbital elements from the 1980 *Ephemerides of Minor Planets* for asteroid number 90, named Antiope. Table 2 is the ephemeris calculated by the program for a 0.1-day period on August 13, 1983. This period was chosen because it coincides with the

(continued)

Table 1: Osculating orbital elements for asteroid 90 for epoch 27.0, December 1980, in the order they would be entered in the program.

Julian date	2444600.5
Inclination (i)	2.23553 Deg.
Longitude of the ascending node	70.62207 Deg.
Argument of perihelion (w)	234.84993 Deg.
Mean radius (a)	3.1477109 AU.
Daily motion (n)	0.17648663 Deg.
Eccentricity (e)	0.1659135
Mean anomaly (M)	212.56103 Deg.
Brightness B(1,0)	9.3

Table 2: The ephemeris calculated by the program for asteroid 90 in the period 13.35, September 1983 to 13.45, September 1983.

Asteroid Number 90							
Astrometric 1950.0							
D	M	Y	JD	Right Ascension	Declination	Mag.	Distance
13.35	8	1983	2445559.85	23 8 24.1	-9 16 31	12.6	1.734
13.36	8	1983	2445559.86	23 8 24.1	-9 16 31	12.6	1.734
13.37	8	1983	2445559.87	23 8 23.8	-9 16 33	12.6	1.734
13.38	8	1983	2445559.88	23 8 23.4	-9 16 35	12.6	1.734
13.39	8	1983	2445559.89	23 8 23.1	-9 16 38	12.6	1.734
13.40	8	1983	2445559.90	23 8 22.8	-9 16 40	12.6	1.734
13.41	8	1983	2445559.91	23 8 22.5	-9 16 43	12.6	1.734
13.42	8	1983	2445559.92	23 8 22.1	-9 16 45	12.6	1.734
13.43	8	1983	2445559.93	23 8 21.8	-9 16 48	12.6	1.734
13.44	8	1983	2445559.94	23 8 21.5	-9 16 50	12.6	1.734
13.45	8	1983	2445559.95	23 8 21.2	-9 16 53	12.6	1.734

New Version

# Mighty Macro Assembler.

The new Microsoft® Macro Assembler package. A complete development environment that makes you a more productive programmer. Whether you're using Macro Assembler or any Microsoft high level language.

A common calling convention lets you easily call assembly language routines from any high level Microsoft language to add an extra burst of blinding speed.

## Better Debugging.

The new Symbolic Debug Utility lets you stay close to the source. Now you can step through your assembled or compiled code by name rather than by address. Source level display for Microsoft Pascal, FORTRAN, and C allows you to view both your original source and the resulting code.

And we stuffed our package with a full set of the most useful utilities around. So that you can link, maintain and organize your programs like never before.

Who else but Microsoft could build so much into one package for \$150?

For the name of your nearest Microsoft dealer call (800) 426-9400. In

Washington State, Alaska, Hawaii and Canada, call (206) 828-8088. And if you're already using Microsoft **MICROSOFT** The High Performance Software™ or IBM® Macro Assembler, ask us how you can upgrade to the mightiest Macro of them all.

### Microsoft Macro Assembler Package:

#### Macro Assembler

- For the 8086/8087/8088 and now the 186/286/287.
- Define macros.
- Conditional Assembly.
- Case sensitivity for symbols.

#### New Interactive Symbolic Debug Utility

- Controlled testing environment for debugging.
- Source line display of Microsoft FORTRAN, Pascal and C Programs.
- Set breakpoints on line numbers and symbols.
- Single step to follow program execution.
- Disassemble object code.
- Display values.
- Make minor changes without reassembling.

#### New Program Maintenance Utility

- Rebuilds your applications after your source files have been changed.
- Similar to UNIX™ Make utility.

#### Library Manager

- Create, organize and maintain your object module libraries created with Microsoft Languages.
- Set page size (default of 16 bytes).

#### Object Code Linker

- Simple overlaying linker combines relocatable object modules created using Microsoft Languages into a single program.
- Load Map generation.
- Specify from 1 to 1024 segments.

#### Cross Reference Utility for the Macro Assembler

- Creates a cross-reference listing of the definitions and locations of all symbols used in an assembly language program.



Microsoft is a registered trademark and The High Performance Software is a trademark of Microsoft Corporation. IBM is a registered trademark of International Business Machines. UNIX is a trademark of Bell Laboratories.

## COMET LINES

period in which the Lowell Observatory made photographic plates of the asteroid and the resulting positional measurements were published in *Minor Planet Circular* #8193 (October 21, 1983) of the Smithsonian Astrophysical Observatory. The positions for asteroid 90 are as follows:

Date 13.39167 Aug. 1983  
R.A. 23 hr 8 min 17.70 sec  
Dec. -9 deg 17 min 18.8 sec

Date 13.42951 Aug. 1983  
R.A. 23 hr 8 min 16.40 sec  
Dec. -9 deg 17 min 28.6 sec

As you can see, the program satisfies the accuracy required. For a further comparison, table 3 is an ephemeris calculated by a program that uses only Keplerian motion and does not calculate the perturbations due to the major planets.

The program was originally written to calculate ephemerides of asteroids

but can also be used to calculate ephemerides of comets. When the program is used for comets it is necessary to do some minor calculation to translate the orbital elements from the conventional form for comets to elements usable by the program. Also, comets are named by several different methods: year and order of discovery, name of discoverer and subsequent rediscoverers, season of the year, or placement in the sky. Comet names just do not seem usable with the simple form of random-access file used for the numbered asteroids. I maintain separate ASTRO.DAT disks for comets and asteroids and keep a manual index of what comet is in each record. Table 4 is a set of orbital elements for Halley's comet from *Minor Planet Circular* #9214 (November 8, 1984). For this set of elements the mean anomaly ( $M$ ) is not provided. Instead, the time of perihelion ( $T$ ) is given. This

is typical of the convention for reporting comet orbital elements. The calculation of  $M$  is not complicated.  $M$  equals the daily motion times the difference between the epoch of the elements and  $T$ . Equation 3 is the mathematical expression for the calculation of  $M$ :

$$M = n \cdot (\text{Epoch of elements} - T) \quad (3)$$

The comet orbital elements generally do not include the mean anomaly ( $M$ ), the mean radius ( $a$ ), or the daily motion. Usually the time of perihelion ( $T$ ) and the perihelion distance ( $q$ ) are given instead. Like  $M$ , missing parameters can usually be calculated from what is given. For example, to calculate the mean radius from the perihelion distance  $q$  and the eccentricity, use equation 4:

$$a = q / (1 - e) \quad (4)$$

If the daily motion ( $n$ ) is not provided, you only need to have the mean radius and from equation 5 you can calculate  $n$ :

$$n = 0.985609 / (a)^{3/2} \quad (5)$$

These relationships should be sufficient to allow calculation of any orbital element parameters that are not provided. The brightness coefficient  $B(1.0)$  is not applicable to comets. I have written the program to use this coefficient as a flag to prompt for the name of the comet and to change the output format slightly. A  $B(1.0)$  greater than 1000 flags the program that the ephemeris is of a comet. Sources of comet orbital elements are numerous. Occasionally a periodical on astronomy will include orbital elements as part of an article. I expect to see this more frequently as amateur astronomers acquire and use personal computers to calculate ephemerides and indicate a desire to publishers to see orbital elements included in articles.

Because comets are made of materials that vaporize, they undergo some mass loss each time they form a *coma*, or tail. This mass loss also introduces a source of perturbation not found in asteroids. The program does not in-

*(continued)*

Table 3: The ephemeris as in table 2, but calculated using only Keplerian motion.

Asteroid Number 90									
Keplerian Motion Ephemeris				Astrometric 1950.0					
D	M	Y	JD	Right Ascension		Declination	Mag.	Radius	
13.35	8	1983	2445559.85	23	12	27.9	-8 50 53	12.6	1.732
13.36	8	1983	2445559.86	23	12	26.7	-8 51 1	12.6	1.732
13.37	8	1983	2445559.87	23	12	26.4	-8 51 4	12.6	1.732
13.38	8	1983	2445559.88	23	12	26.1	-8 51 6	12.6	1.732
13.39	8	1983	2445559.89	23	12	25.8	-8 51 8	12.6	1.732
13.40	8	1983	2445559.90	23	12	25.4	-8 51 11	12.6	1.732
13.41	8	1983	2445559.91	23	12	25.1	-8 51 13	12.6	1.732
13.42	8	1983	2445559.92	23	12	24.8	-8 51 16	12.6	1.732
13.43	8	1983	2445559.93	23	12	24.5	-8 51 18	12.6	1.732
13.44	8	1983	2445559.94	23	12	24.2	-8 51 21	12.6	1.732
13.45	8	1983	2445559.95	23	12	23.9	-8 51 23	12.6	1.732

Table 4: A set of orbital elements for Halley's comet.

Julian date	2446480.5
Time of perihelion passage ( $T$ )	9.43867 Feb. 1986
Inclination ( $i$ )	162.23932 Deg.
Longitude of the ascending node	58.14397 Deg.
Argument of perihelion ( $w$ )	111.84658 Deg.
Mean radius ( $a$ )	17.9390115 AU.
Daily motion ( $n$ )	0.01297198 Deg.
Eccentricity ( $e$ )	0.9672725
Calculated from equation 3.	
Mean anomaly ( $M$ )	0.1240284 Deg.

# Plotter graphics prevent boardroom boredom

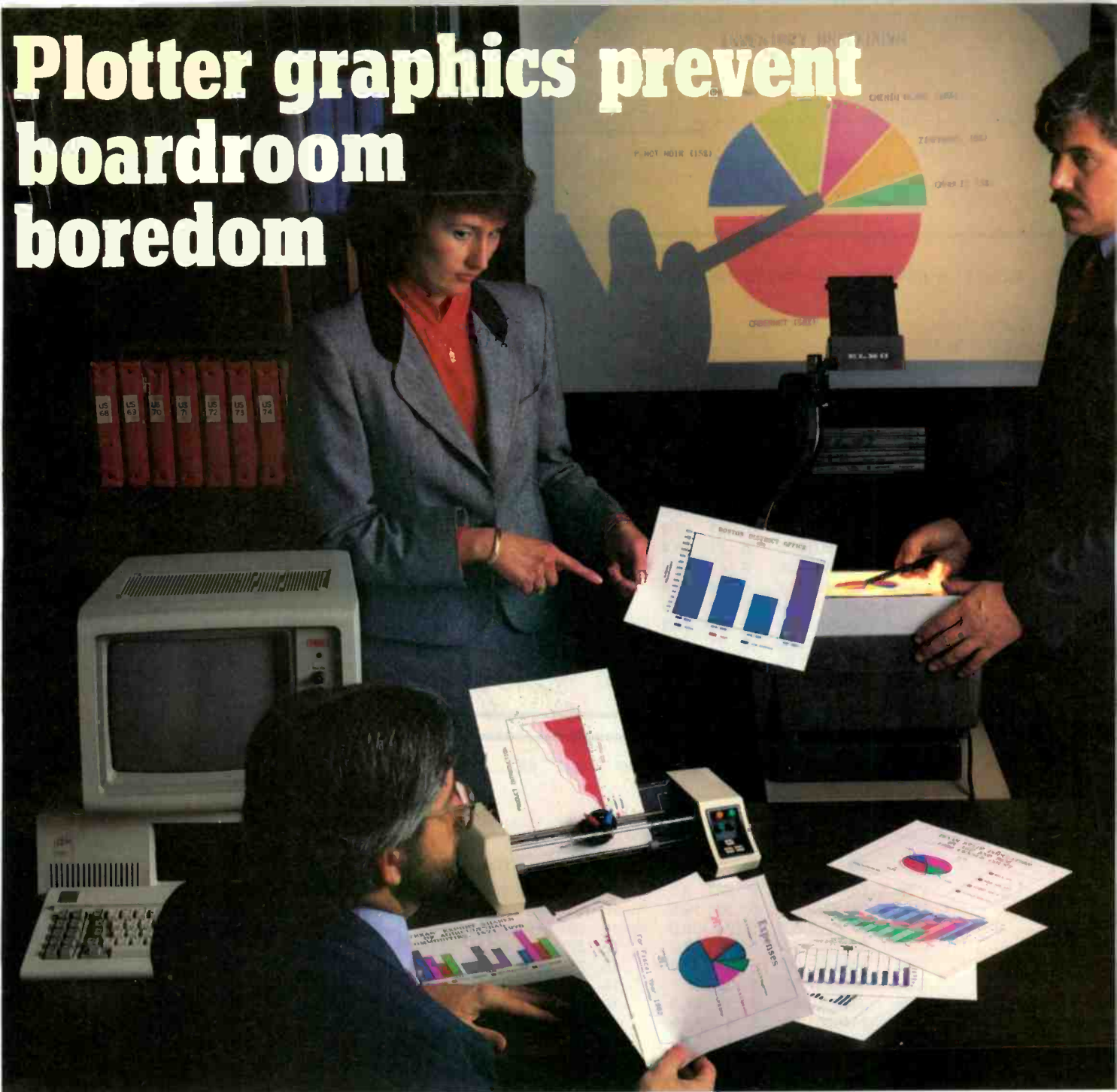

Crisp, clean, hardcopy graphics make dramatic impressions. Now, with Houston Instrument's **PC Plotter**, you have an affordable way to link the power of graphics to your personal computer. The **PC Plotter** produces quality graphics at a price you won't mind paying. It allows you to produce vibrant line, bar, and pie charts using eight different colors on either paper or overhead transparencies. And you can create either 8½" x 11" or 11" x 17" graphics.

Whether you're a computer wizard or novice, the **PC Plotter** is simple to operate and can be used with virtually any computer on the market today. Plus, your graphics software choices are unlimited. Houston Instrument products are supported by a versatile collection of more than 250 graphics software packages.

For example, just take a look at the above photo and you'll see plots created by PFS:® Graph, Lotus® 1-2-3,™ Peachtree Business Graphics System,™ Design Intelligence,™ Energraphics,™ and Smart Spreadsheet with Graphics.®

Make the most out of owning an IBM,® Apple® or other personal computer. Give it a **PC Plotter**. . . and give your presentations the visual advantage you need to win in business.

Visit your authorized Houston Instrument dealer or local computer store today and ask for a demonstration of the **PC Plotter**. For more information, call us at 800-531-5205. Texas residents may phone (512) 835-0900. Houston Instrument products are designed, marketed, and manufactured in Austin, Texas.

**houston  
instrument**

Inquiry 174

4P019

## COMET LINES

Table 5: A set of test calculations for Halley's comet.

Comet Halley Astrometric 1950.0						
D	M	Y	JD	Right Ascension	Declination	Distance
26.97	11	1984	2446031.47	6 21 49.1	11 57 4	4.739
26.98	11	1984	2446031.48	6 21 50.0	11 57 5	4.740
26.99	11	1984	2446031.49	6 21 49.5	11 57 4	4.740
27.00	11	1984	2446031.50	6 21 49.0	11 57 4	4.739
27.01	11	1984	2446031.51	6 21 48.5	11 57 4	4.739
27.02	11	1984	2446031.52	6 21 48.0	11 57 4	4.739
27.03	11	1984	2446031.53	6 21 47.4	11 57 3	4.739
27.04	11	1984	2446031.54	6 21 46.9	11 57 3	4.739
27.05	11	1984	2446031.55	6 21 46.4	11 57 3	4.739
27.06	11	1984	2446031.56	6 21 45.9	11 57 3	4.738
27.07	11	1984	2446031.57	6 21 45.4	11 57 2	4.738
27.08	11	1984	2446031.58	6 21 44.9	11 57 2	4.738
27.09	11	1984	2446031.59	6 21 44.3	11 57 2	4.738
27.10	11	1984	2446031.60	6 21 43.8	11 57 2	4.738
27.11	11	1984	2446031.61	6 21 43.3	11 57 1	4.737
27.12	11	1984	2446031.62	6 21 42.8	11 57 1	4.737

clude these nongravitational perturbations in the calculation. The accuracy of the results is acceptable for most purposes. Table 5 is an ephemeris calculated by the program using the orbital elements for Halley's comet in table 4. From *Minor Planet Circular* #9316 are measured positions for Halley's comet in the same period:

Date 26.973 Nov. 1984  
R.A. 6 hr 21 min 48.88 sec  
Dec. 11 deg 56 min 58.3 sec

Date 27.109 Nov. 1984  
R.A. 6 hr 21 min 41.80 sec  
Dec. 11 deg 56 min 55.6 sec

The accuracy for the comet ephemeris is well within the tolerance established for use in locating asteroids and should be equally satisfactory for locating comets. Table 6 is an ephemeris for Halley's comet for July and August 1985. In July the comet will be rising in the early morning in the eastern horizon about an hour before the sun.

I need to give a word of warning to users about a future complication in the process of using this program. Astronomical positions are almost invariably referenced to the Earth's equinox and ecliptic at some date. The problem is that with respect to the star field, this is a continually rotating set of coordinates. So, when you find osculating orbital elements or ephemerides for planets, asteroids, or comets, they are noted as mean ecliptic of 1950.0, or ecliptic of date, or mean ecliptic of 2000.0. The program is set up to calculate positions referenced to the equinox and ecliptic of 1950.0 and to use osculating elements referenced to this set of coordinates. The astronomical convention for comet and asteroid orbital elements and ephemerides is that the reference equinox and ecliptic will be at the century and half-century dates—1900, 1950, 2000. We are nearing a change point. Some reference sources are now using the ecliptic of 2000 as the coordinate base, while many others retain the ecliptic of 1950 as the base. If the source of orbital

(continued)

Table 6: The ephemeris for Halley's comet for July and August 1985 as calculated by the program.

Comet Halley Astrometric 1950.0						
D	M	Y	JD	Right Ascension	Declination	Distance
1.00	7	1985	2446247.50	5 32 2.0	18 13 56	4.424
3.00	7	1985	2446249.50	5 33 19.5	18 16 54	4.392
5.00	7	1985	2446251.50	5 34 38.3	18 19 51	4.358
7.00	7	1985	2446253.50	5 35 57.2	18 22 44	4.324
9.00	7	1985	2446255.50	5 37 16.1	18 25 32	4.288
11.00	7	1985	2446257.50	5 38 35.1	18 28 15	4.251
13.00	7	1985	2446259.50	5 39 54.0	18 30 55	4.214
15.00	7	1985	2446261.50	5 41 12.9	18 33 30	4.175
17.00	7	1985	2446263.50	5 42 31.5	18 36 1	4.135
19.00	7	1985	2446265.50	5 43 49.9	18 38 29	4.095
21.00	7	1985	2446267.50	5 45 7.9	18 40 52	4.053
23.00	7	1985	2446269.50	5 46 25.5	18 43 11	4.010
25.00	7	1985	2446271.50	5 47 42.7	18 45 27	3.967
27.00	7	1985	2446273.50	5 48 59.2	18 47 39	3.922
29.00	7	1985	2446275.50	5 50 15.2	18 49 48	3.876
31.00	7	1985	2446277.50	5 51 30.4	18 51 54	3.830
2.00	8	1985	2446279.50	5 52 44.8	18 53 57	3.783
4.00	8	1985	2446281.50	5 53 58.3	18 55 56	3.735
6.00	8	1985	2446283.50	5 55 10.9	18 57 53	3.686
8.00	8	1985	2446285.50	5 56 22.5	18 59 48	3.636
10.00	8	1985	2446287.50	5 57 32.8	19 1 40	3.585
12.00	8	1985	2446289.50	5 58 41.9	19 3 31	3.533
14.00	8	1985	2446291.50	5 59 49.6	19 5 19	3.481
16.00	8	1985	2446293.50	6 0 55.8	19 7 6	3.428
18.00	8	1985	2446295.50	6 2 .3	19 8 53	3.374
20.00	8	1985	2446297.50	6 3 2.9	19 10 38	3.319
22.00	8	1985	2446299.50	6 4 3.6	19 12 23	3.264
24.00	8	1985	2446301.50	6 5 2.2	19 14 8	3.207
26.00	8	1985	2446303.50	6 5 58.6	19 15 53	3.151
28.00	8	1985	2446305.50	6 6 52.5	19 17 39	3.093
30.00	8	1985	2446307.50	6 7 43.7	19 19 27	3.035

LOMAS DATA PRODUCTS PRESENTS:

IBM COMPATIBLE S100 BUS COLOR GRAPHICS

COLOR MAGIC

LOMAS DATA PRODUCTS presents COLOR MAGIC, the most complete compatibility solution for S100 bus computer products. COLOR MAGIC includes three major hardware subfunctions which allow it to emulate the IBM-PC: An entirely compatible video function, an IBM-PC keyboard interface and an IBM-PC compatible timer interface including IBM-PC sound compatibility. HOW COMPATIBLE IS IT? Currently we are running MICROSOFT's FLIGHT SIMULATOR recognized as one of the severest tests of compatibility. We can also directly boot PC-DOS for the IBM-PC with no alterations. Other programs which have been tested and function without problems are: LOTUS 1-2-3, DBASE III, WORDSTAR and VOLKSWRITER.

COLOR MAGIC

..... \$595.00

OTHER S100 BOARDS

THUNDER 186 single board computer provides a high performance 16 bit computer all on one board. It is an ideal companion to the COLOR MAGIC to provide a low cost, high performance IBM-PC compatible system. The 8Mhz 80186 offers 10Mhz 8086 performance. THUNDER 186 provides all the components necessary to form a complete system including: 256K bytes of no wait-state RAM, 2 serial ports, a parallel printer port, high performance floppy disk controller controls both 5 1/4" and 8" drives simultaneously, full IEEE 696 (S100) bus for system expansion. The COLOR MAGIC and THUNDER 186 combine to provide performance you won't find in other compatibles. The price includes the powerful Concurrent DOS operating system.

THUNDER 186 ..... \$1195.00

NV-DISK is a solid state memory with software to emulate a disk drive under MS-DOS, Concurrent DOS, and CP/M-86. NV-DISK is entirely COMPUPRO software compatible allowing COMPUPRO users to take advantage of the lower cost and battery protection support offered by NV-DISK. It offers the advantage of high speed access and no moving parts. It can be battery protected to allow data to stay even while powered down. The board is available in either 512K or 2 Megabyte configurations and multiple boards may be used to create disk drives with up to 16 Megabytes of storage.

NV-DISK ..... 512K, \$695.00 ..... 2 MBYTE, \$1995.00

MEGARAM is a high density, high performance dynamic RAM board with up to two Megabytes of storage. Megaram offers no wait state performance in 8086 systems with up to 10 Mhz processors at a fraction of the cost of comparable performance static RAM.

MEGARAM 1/4 MBYTE, \$695.00 1/2 MBYTE, \$1095.00 1 MBYTE, \$1495.00 2 MBYTE, \$2095.00

For those of you who would prefer to buy complete S100 bus IBM-PC compatible systems, LOMAS DATA PRODUCTS offers a complete line of PC compatible system with performance ranges varying from 8Mhz 8086's to the super high performance 8Mhz 80286 microprocessor. The 8Mhz 80286 offers 5 times the performance of an IBM-PC and provides IBM-PC compatibility.

IBM-PC COMPATIBLE S100-BUS SYSTEM

LOMAS DATA PRODUCTS offers IBM-PC compatible systems with performance far exceeding that available from IBM. You can purchase systems offering performance of an eight Mhz 8086 or up the performance of an 8Mhz 80286. Each system is capable of supporting 8Mhz math coprocessors. Our 8Mhz 80286 system offers IBM-PC compatibility while offering up to 2 times the performance of the IBM-PC-AT. For applications where PC compatibility is desirable but higher performance is a benefit or requirement LOMAS DATA PRODUCTS offers the only viable solution.

WHO IS LOMAS DATA PRODUCTS . . .

LOMAS DATA PRODUCTS has been shipping 16 bit microprocessor S100 bus products for five years. We have earned a strong reputation for reliability and performance over these five years. We were running MS-DOS (SCP-DOS/PC-DOS) before IBM knew the operating system existed. We offer a wide range of 16 bit operating systems including MS-DOS, CP/M-86, CONCURRENT CP/M-86 and CONCURRENT DOS. All our products are backed by a one year guarantee. We offer no 8 bit products and concentrate entirely on high performance 16 bit systems. If you are looking for the highest performance possible on the S100 bus, you can be sure LOMAS DATA PRODUCTS offers it.

Dealer inquiries invited.

We've Moved!

Yes! Lomas Data Products has moved to larger quarters, please make a note of our new address & phone number.

(LDP will be closed July 1st thru the 5th for vacation.)

LOMAS DATA PRODUCTS, INC.



182 CEDAR HILL STREET, MARLBORO, MA 01752 TEL: (617) 460-0333 TELEX: 4996272

For orders outside the U.S., contact our exclusive dealers: Australia - LAMRON PTY. LTD., (02) 808-3666 Malaysia - EXA COMPUTER (m) SENDIRIAN BERHAD, 795284 England - RATIONAL SYSTEMS, 0908-613209 or 0908-611349; SHARPBORN LTD., 018764559.

*The convention for  
comet and asteroid  
orbital elements  
and ephemerides  
is that the reference  
equinox and ecliptic  
will be at the century  
and half-century dates.*

elements you use is referenced to the ecliptic of 2000, you will need to change the parameters for planetary position that are used in subroutine ORBIT, the value for the obliquity of the ecliptic (EPSLN) in the main program, and the heading message for the printout in the main program. Values for the changes to be made can be found in *Astronomical Formulae for Calculators*.

The program was originally written on a Digital Equipment Corporation PDP-11 in DEC FORTRAN IV. Later I translated the program to Digital

Research FORTRAN-77 for the IBM PC, and that is the version available on BYTENet Listings ( (617) 861-9774). As I mentioned at the beginning of the article, the program is a number cruncher. The Digital Research FORTRAN has the option at link time of producing code for the 8087 coprocessor or linking 8087 simulation routines.

I have timed the program on a variety of PC-DOS and MS-DOS systems. If the 8087 coprocessor is not used, a single integration loop of the program will take from 60 to 130 seconds, depending on the machine. With the 8087 coprocessor the time drops to about 1 second per loop. The program in its present form is intended to be as readable as possible. At least one change to speed up execution is possible. You can reduce the number of times you call subroutine KEPLER by almost one-third by modifying the program to assign the previous values of POS(I,J,3) to POS(I,J,1) at the beginning of any integration loop in which the preceding loop did not call subroutine ENCKE and then began the loop calculating POS(I,J,2). I do not know how much this would improve execution time, but if your system does not have an 8087, it is a modification that may be

worth making. If you use the program extensively, the execution time improvement of the 8087 may be the justification for adding one to your system.

The program is written so that even if you don't have a mainframe computer and a degree in astrophysics, you can convert the program to your microcomputer's BASIC or FORTRAN and, I hope, not get lost in the process. Comments have been added to the program listings to reference the source of many of the values used for the calculations, so I am not going to discuss them further in text. I recommend that you obtain a copy of *Astronomical Formulae for Calculators* since I am confident that you will eventually need to refer to it for changes in the reference ecliptic. If you have a background in calculus and are interested in the derivation and physics behind the program, I recommend *Fundamentals of Astrodynamics* as a very readable reference on the topic. ■

*Editor's note: If you are unable to obtain the source-code listings from BYTENet Listings, Mr. Dixon will provide an IBM PC-compatible disk containing source code and compiled code for \$18. Write to David S. Dixon, 3208 Jupiter Rd., Las Cruces, NM 88001.*

## Subscription Problems?



### We want to help!

*If you have a problem with your BYTE subscription, write us with the details. We'll do our best to set it right. But we must have the name, address, and zip of the subscription (new and old address, if it's a change of address). If the problem involves a payment, be sure to include copies of the credit card statement, or front and back of cancelled checks. Include a "business hours" phone number if possible.*

**BYTE**  
Subscriber Service  
P.O. Box 328  
Hancock, NH 03449



# INDUSTRIAL GRADE IEEE-696/S-100 BOARDS

Dual Systems designs and manufactures a variety of IEEE-696/S-100 boards for 16-bit microprocessor systems running under UNIX and other operating systems. These boards bring high performance and three years of field-proven experience to your computing environment.

Each board is rigorously tested and burned-in for 168 grueling hours. If it can't bear the heat, it won't bear our name.

## High Performance System Boards

**Model WDC-SMD** The WDC-SMD Hard Disk Controller\* is specially designed for high throughput in large, heavily-loaded multi-user UNIX systems. All sectors on a track are transferred essentially within a single disk rotation regardless of where the head first settles or the order in which sectors are encountered.

The controller offers 16-bit throttled DMA data transfers and disk transfers up to 10 Mb/sec. Also features dual-ported, full-track, look ahead cache, and on-board microprocessor. Interfaces with one or two SMD drives. \$2195.

**Model SI04-DMA** The most advanced, intelligent, 4-port serial I/O board available for the IEEE-696/S-100 bus, this module features 256 bytes of FIFO buffer for input characters and provides DMA transfers for output. A built-in 8085A processor greatly reduces system overhead. \$695.

\*Patent Pending

**Model DMEM** Features 256K bytes of memory and either 8 or 16-bit data paths. 24-bit addressing, and parity checking on each byte. DMEM has no S-100 wait states. \$1395.

**Model EPROM** Capable of either 8 or 16-bit data transfers, this 32/64K EPROM offers the versatility of running with 68000, Z-8000, 8086, 16000, and other 16-bit processors. It accepts industry-standard 2732 and 2716 EPROMs. 64K RAMS may be mixed with 2716 EPROMs for use as a RAM/EPROM board. \$345.

**Model CPU-68000M** High-performance CPU board with 16-bit data path, 10 MHz CPU operation, and MC68451 MMU for multi-tasking applications. \$1195.

**Model CPU-68000** Similar to 68000M, but features 8K bytes of on-board ROM with Motorola's MacsBug monitor instead of the Memory Management Unit. \$895.

**Models M/BD-15 & 20 Back Planes** These premium quality motherboards feature four-layer construction with two internal ground planes, and Schottky-diode termination. They provide high-speed operation with true transmission line characteristics and minimum noise. M/BD-15: \$495, M/BD-20: \$545.

**Model CMEM** This non-volatile CMOS memory board provides easy-to-use 8 or 16-bit data paths and 32K bytes of memory with dynamically movable write/protect window. On-board lithium battery holds data for 3-10 years with power off. \$725.

## Data Acquisition and Control Boards

**Model CLK-24C** Clock-calendar features a LSI CMOS chip and on-board, long-life lithium battery. \$325.

**Model AIM-12** A highly reliable A-to-D converter with 35msec. maximum conversion time, 12-bit resolution and accuracy, and 32 channels single-ended/16 channels differential. \$725.

**Model AOM-12** This D-to-A converter offers I/O-mapped port address, 12-bit  $\pm 1/2$  L.S.B. accuracy (0-70°C), and voltage outputs of 0 to 10 volts,  $\pm 5$  volts, and  $\pm 10$  volts. \$675.

**Model VIC 4-20** Converts voltage outputs from AOM-12 into four separate 4-20MA current outputs. Module also provides overvoltage protection on all current output, plus transient protection per ISA standards. \$600.

For more information, call (415) 549-3854. Dual Systems Corp., 2530 San Pablo Avenue, Berkeley, CA 94702

THERE'S ONLY ONE  
**DUAL**

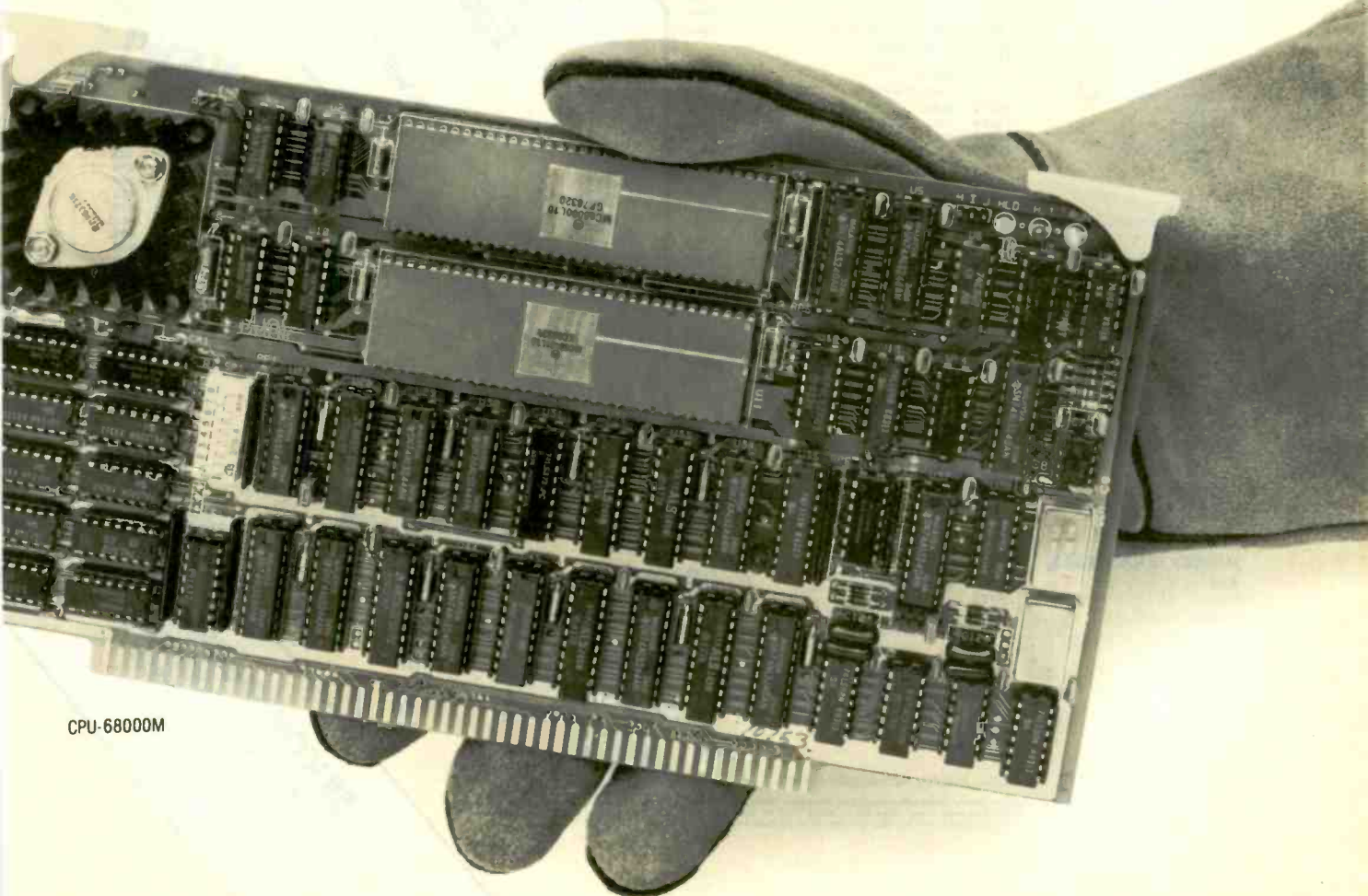

CPU-68000M

**ORDER  
LINE  
800-354-7330**

# SILICON SPECIALTIES

## COMPUTERS

### NEC

PC-8201 Computer  
PC-8401A  
8201 & 8401 Accessories  
Sanyo MBC-775 Portable  
MBC-885

### Wyse

Wyse pc Dual  
Wyse pc 10 Meg

### Zenith

Z-150 Single Drive  
Z-150 Dual Drive  
Z-150 W/10 Megabyte  
Z-160 Single Drive  
Z-160 Dual Drive

## DISK DRIVES

Alpha Omega Turbo 10  
Turbo 20  
Turbo 30

### Habo Habadisk for Macintosh

10 Megabyte  
20 Megabyte  
20 Megabyte Plus  
5 Megabyte for Macintosh

### Rana Elite I

Elite II  
Elite III  
Elite 10H/Apple  
Controller (W/Drive Only)  
1000 W/DOS for Atari

### Tallgrass TG-3020

TG-3135  
TG-4060  
Controller

## BOARDS

### AST Six Pack Plus

Hercules Color Card  
Graphic Card

Paradise Modular Graphic 06-1  
Five Pak

Quadram Quadboard EII Ck  
E-Ram 80  
Quadlink

### Tec Mar

Graphics Master  
128K Dynamic Memory  
256K Dynamic Memory  
Captain 128K  
Captain 256K

## VIDEO TERMINALS

### Altos

Smart II

### Qume

QVT Green 101  
QVT Amber 101

### Wyse 50

75  
Wyse 85

### Zenith Z-22

Z-29  
Z-49

## PRINTERS

### Anadex

All Models

### Brother

HR 10 w/Tractor  
Twinwriter 5  
HR 15RL  
HR-25  
HR-35

### Canon

LBP-8A1

### C-Itch

A-10-30  
F-10 Parallel or Serial  
55 CPS Serial or Parallel  
85 10 Parallel (Prowriter)  
85 10 SP  
85 10 SCP  
85 10 BPI

### Citizen

MSP-10  
MSP-15  
MSP-20  
MSP-25

### Comrex

CR-2E  
CR-4  
420

### DaisyLaser

PR 101

### Datasouth

DS180  
DS220  
DS-PP#1  
DS-PP#2

### Diablo

D-25  
630 API  
630 ECS  
630 ECS/IBM

### Other Printer Models

### Epson All Printer Models

### Inforunner

Riteam w/Tractor  
Riteam 15  
Riteam Blue w/Tractor

### Juki

5500  
6000  
6100  
6300

### NEC

2010, 2015, 2030, 2050  
3510, 3515, 3530, 3550  
8810, 8815, 8830, 8850  
P2, P3

### Okidata All Printer Models

### Panasonic

1091  
1092  
1093  
KRP3151

### Siemens

P1789 Inkjet  
P1789 Inkjet

### Star Micronics All Printer Models

### Silver Reed

EXP400 Parallel  
EXP500 Parallel or Serial  
EXP550 Parallel or Serial  
EXP770 Parallel or Serial

### Toshiba P1340 Parallel or Serial

P351 Parallel or Serial

## DISKETTES

### Maxell MD-1 (Qty 100)

MD-2 (Qty 100)

### Nashua

S/S D/D (Qty 100)  
D/S D/D (Qty 100)

## KEYBOARDS

### Keytronics 5151

5151 Jr

## MONITORS

### Amdek All Monitors

### Princeton Graphic HR-12

### Sanyo CRT-36

### Taxan

121 Green  
122 Amber  
420 RGB

425 RGB/Green  
440

### Call

### Zenith

ZVM-122 Amber  
ZVM-123 Green

ZVM-124  
ZVM-130

ZVM-133 Color/RGB  
ZVM-135 Color/RGB w/Audio

ZVM136

## PLOTTERS

### Enter Sweet Page \$780

### Epson HR-80

Save

Save

\$479

\$239

\$819

\$343

\$649

\$875

Call

\$469

\$869

\$1035

\$295

\$385

\$465

\$315

\$284

\$414

\$414

\$544

\$364

Save

Save

Save

Save

Save

Save

Save

Save

Save

Save

Save

Save

Save

Save

Save

Save

Save

Save

Save

Save

Save

Save

Save

Save

Save

Save

Save

Save

Save

Save

Save

Save

Save

Save

Save

Save

Save

Save

Save

Save

Save

Save

Save

Save

Save

Save

Save

Save

Save

Save

Save

Save

Save

Save

Save

Save

Save

Save

Save

Save

Save

**ZENITH-SS/EPSON**  
Zenith Z-150 Dual Drive 320K Ram  
Zenith Green or Amber Monitor  
**\$1899**  
Includes Cables  
**EPSON LX80 Printer**  
Above System with Z-160 Dual Drive Portable (No monitor)  
**\$1999**

**NEW!**

## SOFTWARE

Bank Street Writer \$48  
PFS: Write \$79  
Leading Edge Word Processor (Basic) \$59  
PFS: Proof \$55  
Flight Simulator (New Version) \$32  
Speed Reader II \$45  
Mind Prober \$29  
Typing Instructor \$30  
Typing Tutor III \$79  
PFS: Graph \$30  
PFS: Plan \$79  
PFS: Report \$71  
Copy II PC \$20  
Desk Organizer \$59  
Norton Utilities 3.0 \$53  
Prokey 3.0 \$75  
Sidekick \$30  
Sidekick (Unprotected Ver.) \$45  
Sidekick \$35  
Sidekick \$89  
Macro Assembler (Microsoft) \$21  
Turbo Pascal 3.0 \$30  
Turbo Tool Kit \$79  
CompuServe Starter Kit \$95  
PFS: Access \$98  
Dolken & Sense w/Forecast \$82  
Home Accountant Plus \$79  
Nutshell \$99  
PFS: File \$79  
Think Tank \$99

## MODEMS

### Anchor Automation

Anchor Express \$269  
Mark III \$239

### Hayes Smartmodem 300 Baud

Smartmodem 1200 Baud \$129  
Smartmodem 1200B (IBM) \$379  
Smartmodem 2400 Baud \$324  
Micromodem II (Apple) \$ave  
\$129

### Novation Smart Cat Plus

\$315

### Prametheus All Models

\$ave

### Racal-Vadic All Models

\$ave

### US Robotics Password 1200

\$209

Inquiry 408 for MS-DOS products. Inquiry 409 for all others.

Prices reflect 3% to 5% cash discount. Product shipped in factory cartons with manufacturer's warranty. Please add \$9.00 per order for UPS ground shipping. Orders 10 lbs. and under you pay for ground service, receive air service at no extra charge. Available on orders 11-20 lbs. \$15 for air service. Orders 21-30 lbs. \$20 for air service. Prices & availability subject to change without notice. Send cashier's check or money order...all other checks will delay shipping two weeks.



**SILICON SPECIALTIES**  
2034 WEST SOUTHERN  
MESA, ARIZONA 85202  
602-969-0909

# TRACKING EARTH SATELLITES

BY E. H. WEISS

*The Stumpff program can help you calculate earth-orbiting satellite positions with high precision*

THE PURPOSE OF the program Stumpff is to compute the orbit or trajectory of a body of negligible mass (spacecraft or minor planet) in the gravitational field of three massive bodies. In the point-mass problem, each body behaves as if its entire mass is concentrated at a single point. In that case the Stumpff program converges to the exact solution. Another use of Stumpff is to obtain fast approximations, especially to orbits within our solar system. In that case an accuracy on the order of one part in a thousand is usually maintained, even for lengthy and stressing cases.

The program is named in honor of professor Karl Stumpff (1895–1970), who developed the theory upon which the program is based.

The method described here has two major advantages over traditional methods. First, it is 10 to 15 times faster. Second, there is no need to store the positions of the massive bodies, called ephemerides, on disks or tapes. This point is crucial; without it a personal computer could not perform the computations.

Stumpff is written for a minimum-configuration IBM PC. An 80-column display console and a printer are re-

quired. A listing of the BASIC source code and a compiled version for the IBM PC are available for downloading from BYTEnet Listings at (617) 861-9774.

## **HISTORICAL AND TECHNICAL BACKGROUND**

The two-body problem (motion of a planet around the sun) was solved by Johannes Kepler (1571–1630). Kepler's solution to the two-body problem enabled him to compute the position of a planet at any value of time by a series of formulas. Isaac Newton (1642–1727) tested his law of universal gravitation by rederiving Kepler's laws with his own invention, the calculus. Newton found that the solutions are not only ellipses, as stated by Kepler, but also parabolas and hyperbolas (if the velocity of the less massive body is sufficient to escape the gravitational field of the more massive body).

The search for the solution of the three-body problem occupied mathematicians and astronomers until Karl G. J. Jacobi (1804–1851) proved that a closed-form (general) solution is impossible if a body is gravitationally attracted by two or more other bodies.

It is, however, possible to obtain the solution by numerical techniques.

## **NUMERICAL TECHNIQUES**

The motion of a small body is described by a set of differential equations and is traditionally computed by numerical integration. In order to perform a numerical integration, you must first know the values of all motion parameters at  $t_0$ , the start time. Then look up the coordinates of the massive bodies in a table of ephemerides. Next, numerically integrate the position of the small body to time  $t_1$ . This is possible provided that the time step  $h = t_1 - t_0$  is sufficiently small. Then, using the known values of the small body at time  $t_1$ , compute the values at  $t_2$ . The values of the motion parameters of the massive bodies are again obtained from tabulated ephemerides. Similar-

*(continued)*

E. H. Weiss, an advisory analyst for IBM, has more than 35 years of experience in government and private industry as a programmer, instructor, analyst, and manager. His Stumpff program is his alone—it was not developed by or for IBM. He can be reached at 7568 Remington Rd., Manassas, VA 22110.

ly, "march" from time  $t_2$  to  $t_3$ , then to  $t_4$ ,  $t_5$ , etc., until the values of the motion parameters at the desired end time are obtained.

What has been said so far about numerical integration is quite general. It is equally valid for the numerical integration of the equations of motion of a spacecraft and for any other differential equation. Is there a better approach for astronomical or spacecraft problems? Johann Franz Encke (1791–1865) thought so. His clever method is useful if the major contribution to the motion of the small body is caused by the gravitational attraction of just one body. (This is frequently satisfied in our solar system.) In that case, a two-body method is used to compute the spacecraft motion due to that one massive body; this is called the reference orbit. The contribution of all other effects, called the perturbation, is obtained by numerical integration. To obtain the spacecraft motion, you add the values of the reference orbit and the perturbation. Since the quantity to be integrated—the perturbation—is small relative to the reference orbit, a comparatively large time step can be used. Thus, even though the calculation time spent on one Encke time step is greater than for straightforward integration, the Encke method generally performs the entire computation in less time.

#### CONNECTION BETWEEN THE ENCKE AND STUMPF METHODS

The Stumpff method is an extension of the Encke method. The Stumpff reference orbit includes the gravitational attraction of all massive bodies and thus accounts for all point-mass effects. Furthermore—and this is crucial—the deviation between the reference and the actual orbits remains small even over protracted time intervals. Therefore, the time step for the Stumpff method can be larger than that for the Encke method, which in turn is larger than that for straightforward integration. The bottom line is that the Stumpff technique is about 10 to 15 times faster, even though the computing time per time step is

slower than for other methods.

The Stumpff method was first described in 1942 in reference 1. The article explains and proves the method and illustrates it by computing the orbit of a minor planet. References 2 and 3 provide a new and shorter proof and also include applications to artificial satellites. Reference 2 includes four FORTRAN listings of the Stumpff technique for mainframe computers.

#### A SAMPLE CASE

Stumpff can compute the orbit of any body of negligible mass in the gravitational field of any three massive bodies. The program is set up to compute a sample case; other cases require input changes, to be discussed shortly. The sample case computes the orbit of Explorer 33, which was launched on July 1, 1966. Explorer 33 describes more than 10 highly eccentric orbits around the earth and moon in 180 days. There are several close approaches to the earth and the moon.

#### NOTATION

Stumpff computes the trajectory of a spacecraft in the gravitational field of three massive bodies. The mass of  $q_0$ , the spacecraft, must be negligibly small. The sample case is set up with  $q_1$  as the earth,  $q_2$  as the moon, and  $q_3$  as the sun. The masses of the four bodies are denoted by  $m_0$ ,  $m_1$ ,  $m_2$ , and  $m_3$ .

Any coordinate system can be used, provided that the origin is at the center of body  $q_1$ . The sample case uses the standard 1950.0 coordinate system. The  $x$ -axis points to the first point of Aries (also called the vernal equinox), the  $z$ -axis points north, and the  $y$ -axis completes a right-handed orthogonal coordinate system. All input and output is in kilometers (km) for position, kilometers per second (km/sec) for velocity, and days for elapsed time.

The vector from  $q_1$  to  $q_0$  is denoted by  $p_{10}$ . That is,  $p_{10}$  is the position vector of body  $q_0$  relative to (or as measured from)  $q_1$ . The three coordinates of  $p_{10}$  along the  $x$ -,  $y$ -, and  $z$ -

axes are denoted respectively by  $Y_{10}(1)$ ,  $Y_{10}(2)$ , and  $Y_{10}(3)$ . More generally, let  $i = 0, 1, 2$ , or  $3$ ;  $j = 0, 1, 2$ , or  $3$ . Then  $p_{ij}$  is the position vector of  $q_j$  relative to  $q_i$ , and its components along the coordinate axes are  $Y_{ij}(1)$ ,  $Y_{ij}(2)$ , and  $Y_{ij}(3)$ . The time derivative of  $p_{ij}$  is a velocity vector; it is denoted by  $v_{ij}$  and its components by  $Y_{ij}(4)$ ,  $Y_{ij}(5)$ , and  $Y_{ij}(6)$ .

#### INPUT

The Stumpff program always prompts for four data entries. It prints the default parameters for the sample case, then asks "DO YOU WISH TO MODIFY ANY OF THE ABOVE CONDITIONS? Y OR N." If you respond with "N" or "n," the program immediately continues with the next of the three remaining prompts.

In response to the prompt "RESULTS WILL BE PRINTED EVERY N'TH DAY;" type the desired frequency (e.g., 10 to obtain printouts every tenth day). In response to the prompt "LARGEST VALUE OF TIME TO BE PRINTED, IN DAYS;" type 180 if the length of the mission is 180 days, and so on. The last prompt is "TIME-STEP CONTROL CRITERION, 1E-5 OR 1E-6 RECOMMENDED." Respond with an appropriate number, remembering that smaller values yield greater accuracy, but the calculations require more computer time.

If you respond to the first prompt, "DO YOU WISH TO MODIFY ANY OF THE ABOVE CONDITIONS? Y OR N;" with "Y" or "y," the program prints all initial conditions, one at a time. If no change is required, merely press Enter; to change a value, type a new value, then press Enter. The initial conditions are displayed in the following order:

```
Y10(1) . . . Y10(6)
Y12(1) . . . Y12(6)
Y13(1) . . . Y13(6)
```

The canonical unit of length  
The canonical unit of time  
The starting time, in days  
 $m_1$ ,  $m_2$ ,  $m_3$

Program lines 320 to 360 and the subroutine on lines 1930 to 2790,

(continued)

# STOP GETTING YOUR WIRES CROSSED.

One mix up, and a whole project can get thrown off. Which can mean costly delays. With Post-it<sup>™</sup> Notes, you can put important notes or directions right where they'll be seen. The unique, repositionable adhesive means they'll stay put. Then come off as easily as they went on. And the bright

color means your message is sure to get noticed. Call 1-800-328-1684 for a free sample. Then get more from your office manager, local stationer or art supply dealer.

With Post-it Notes, you'll never have problems making connections.



BILL,  
DIDN'T JIM TELL  
YOU TO CHANGE  
THIS WIRING?  
←  
SEE ME  
IMMEDIATELY!  
JOHN

**3M**

Inquiry 2

# TRACKING SATELLITES

Table 1: Printer output of Stumpff using the default sample data for Explorer 33 and 1E-5 as the time-step control criterion.

Position in km and velocity in km/sec. Origin at Q1.

Lines 1 & 2 Y10; lines 3 & 4 Y12; lines 5 & 6 Y13.

Line 1 ends with time in days. Line 7 gives spacecraft distance from Q1 and Q2.

```
+ 1.8352641E + 05  -2.4094338E + 05  -3.6452766E + 04  + 0.0000000E + 00
+ 1.0044146E + 00  -3.2081303E - 01  -1.5168001E - 01
+ 2.1384734E + 05  -2.9619053E + 05  + 1.6430464E + 05
+ 8.4600699E - 01  + 4.7626001E - 01  + 1.7218044E - 01
- 9.3856136E + 07  + 1.0949798E + 08  + 4.7486128E + 07
- 2.2920521E + 01  - 1.6789843E + 01  + 7.2817683E + 00
R10,R20          + 3.0506469E + 05  + 1.4254020E + 05
```

Canonical units of length and time are:

```
+ 6.3781650E + 03  + 8.0681366E + 02
```

Masses of bodies 1, 2, and 3 are:

```
+ 1.0000000E + 00  + 1.2299896E - 02  + 3.3295128E + 05
```

Start time, Date

08:32:41

07-01-1984

Time-step criterion

```
+ 1.0000000D - 05
```

```
+ 4.0406591E + 05  + 5.7658706E + 03  - 9.9387773E + 04  + 1.0000000E + 01
- 4.8275355E - 01  + 5.1666003E - 01  + 8.1928223E - 02
+ 1.7381369E + 05  + 3.1362872E + 05  + 1.4380152E + 05
- 9.3196988E - 01  + 3.2447833E - 01  + 2.3401709E - 01
- 1.1224846E + 08  + 9.3514536E + 07  + 4.0555028E + 07
- 1.9551346E + 01  - 2.0131100E + 01  + 8.7292433E + 00
R10,R20          + 4.1614953E + 05  + 4.5490291E + 05
```

```
+ 3.7403688E + 05  - 2.5159747E + 05  + 7.2772000E + 04  + 2.0000000E + 01
+ 5.6283206E - 01  + 1.9169375E - 01  - 1.5092811E - 01
- 3.2397141E + 05  + 1.6550636E + 05  - 5.8775484E + 04
+ 4.5049697E - 01  - 8.4750861E - 01  - 4.5995513E - 01
- 1.2746285E + 08  + 7.4866512E + 07  + 3.2467906E + 07
- 1.5571598E + 01  - 2.2928595E + 01  - 9.9447031E + 00
R10,R20          + 4.5661869E + 05  + 7.0343669E + 05
```

```
+ 3.0188719E + 05  + 1.0132476E + 05  - 7.8300773E + 04  + 3.0000000E + 01
- 9.3400902E - 01  + 3.8737997E - 01  + 1.9829461E - 01
+ 3.6786394E + 05  - 1.4087461E + 05  - 9.8210367E + 04
+ 4.1416159E - 01  + 7.9788619E - 01  + 3.7135252E - 01
- 1.3902795E + 08  + 5.4090352E + 07  + 2.3457196E + 07
- 1.1139797E + 01  - 2.5052975E + 01  - 1.0864564E + 01
R10,R20          + 3.2792316E + 05  + 2.5181314E + 05
```

```
+ 4.5098631E + 05  - 1.9036528E + 05  - 9.6550414E + 04  + 4.0000000E + 01
+ 3.2330784E - 01  + 3.2467601E - 01  - 1.0042379E - 01
- 5.6318953E + 04  + 3.2954591E + 05  + 1.7090238E + 05
- 1.0172640E + 00  - 2.3190196E - 01  - 4.1716743E - 02
- 1.4661626E + 08  + 3.1767970E + 07  + 1.3777301E + 07
- 6.3732409E + 00  - 2.6502871E + 01  + 1.1492944E + 01
R10,R20          + 4.9894850E + 05  + 7.7407838E + 05
```

```
+ 1.0722097E + 05  + 1.3195153E + 05  - 3.3376625E + 04  + 5.0000000E + 01
- 1.7199315E + 00  - 2.0821010E - 01  + 4.3421927E - 01
- 1.5787850E + 05  - 3.1072731E + 05  - 1.4608538E + 05
+ 9.0786868E - 01  - 4.1719040E - 01  - 2.7912253E - 01
- 1.4996200E + 08  + 8.5147130E + 06  + 3.6924375E + 06
- 1.3445547E + 00  - 2.7184437E + 01  - 1.1790426E + 01
R10,R20          + 1.7326725E + 05  + 5.2815294E + 05
```

(continued)

available on BYTEnet, deal with input to Stumpff.

## OUTPUT

Seven lines are printed every  $n$  days, where  $n$  is an input parameter:

Line 1: Y10(1), Y10(2), Y10(3),  
elapsed time

Line 2: Y10(4), Y10(5), Y10(6)

Line 3: Y12(1), Y12(2), Y12(3)

Line 4: Y12(4), Y12(5), Y12(6)

Line 5: Y13(1), Y13(2), Y13(3)

Line 6: Y13(4), Y13(5), Y13(6)

Line 7: "R10, R20", R10, R20

(where R10 is the distance between  $q1$  and  $q0$  and R20 is the distance between  $q2$  and  $q0$ ).

Lines 1260 to 1570 of Stumpff deal with computer output.

Table 1 shows the sample case integrated for 90 days. The time-step control criterion is  $1E-5$ .

## CANONICAL UNITS

The equations of motion include the Gaussian constant of gravitation, which involves the units of length, time, and mass and therefore assumes different numerical values for different basic units. But the constant appears in the equations of motion only as a multiplicative factor. Therefore, it need not be coded if it assumes the value of unity.

Canonical units are a set of consistent units for which the Gaussian constant equals unity. Canonical units are used in all internal computations of Stumpff. The definition of canonical units is as follows: Let  $d$  be the distance between point-mass bodies  $a$  and  $b$ . Let body  $b$  describe one complete revolution around body  $a$  due to the gravitational attraction of  $a$ , and denote the period of one complete revolution by PER. The units of mass, length, time, and the constant of universal gravitation are considered to be canonical if

- the mass of body  $a$  is the unit of mass
- the distance  $d$  is the unit of length
- the period PER, divided by  $(2 \cdot$

(continued)

# Save

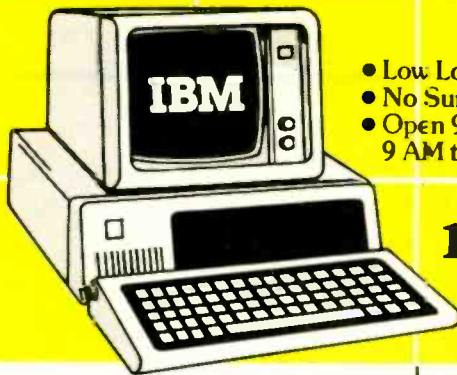

- Low Low Prices
- No Surcharge for Credit Cards
- Open 9 AM to 7 PM Eastern (Mon-Fri)  
9 AM to 2 PM Eastern (Sat)

**1-800-237-4048**  
(ORDERS ONLY)

## COMPUTERS

IBM ENHANCED AT	5395
IBM ENTRY LEVEL AT	3895
IBM PC, 1 DSDD DR, 256K	1559
IBM PC, 2 DSDD DR, 256K	1689
IBM PC, NO DRIVES, 64K	1269
IBM PC, 2 HALF/HYTES, 256K	1689
IBM XT, 1DSDD DR/10MB, 256K	3829
IBM XT, 1DSDD DR/MYND HD, 256K	2595
COMPAQ, 2 DSDD, 256K	2059

## MONITORS

AMDEK 300G	129
AMDEK 300A	139
AMDEK 310A	159
AMDEK 600 RGB COLOR	419
AMDEK 710 SUPER HI RES COLOR	549
IBM COLOR	629
IBM MONOCHROME	249
PRINCETON MAX-12	159
PRINCETON HX-12 RGB COLOR	469
PRINCETON SR-12/SCAN DOUBLER	879
QUADRAM AMBERCHROME	169
QUADRAM QUADCHROME II	429

## MISCELLANEOUS

MEMORY, 64K CHIPS	19
MEMORY, 256K CHIPS	99
PRINTER CABLE	25
MICROFAZER BUFFER, 8K	129

MICROFAZER BUFFER, 64K	219
VERBATIM, DSDD DISCS	27

## DISPLAY CARDS

STB SUPER HI RES 400	395
HERCULES COLOR	159
IBM MONOCHROME	239
IBM COLOR	229
EVEREX GRAPHICS EDGE	339
GENOA SPECTRUM	329
TECMAR GRAPHICS MASTER	459
PARADISE MODULAR GRAPHICS	279

## BOARDS

AST SIX PACK PLUS, 64K	259
AST MEGAPLUS, 64K	279
AST MP-2, 64K	249
AST ADVANTAGE, 128K	399
AST I/O PLUS	139
JRAM-2	169
QUADRAM QUADBOARD, ØK	239
QUADSPRINT	CALL
TECMAR CAPTAIN, ØK	219
TECMAR FIRST MATE, ØK	199
TECMAR WAVE XT, 64K	199
TECMAR JR CAPTAIN, 128K	299

## MODEMS

HAYES 2400	649
HAYES 300B	199
HAYES 300/1200	421
HAYES 1200B w/ SOFTWARE	389
HAYES 1200B	345
VEN-TEL HALF CARD	369
VEN-TEL 300/1200 INTERNAL	339
AST REACH HALF CARD 1200	359

## PRINTERS

OKIDATA 82A	299
OKIDATA 83A, WIDE CARRIAGE	559
OKIDATA 84P, WIDE CARRIAGE	669
OKIDATA 92P	379
OKIDATA 93P, WIDE CARRIAGE	599
OKIDATA 2410P	1790
OKIDATA 182	219
OKIDATA 192	359
EPSON RX-80	239
EPSON FX-80, TRACTOR	359
EPSON LX-80	249
EPSON RX-80FT PLUS	299
EPSON RX-100, WIDE CARRIAGE	399
EPSON FX-100, WIDE CARRIAGE	499
EPSON JX-80 COLOR PRINTER	499
EPSON LQ-1500 PARALLEL	999
NEC 2050	659
NEC 3550	1059
NEC 8850	1499
JUKI 6100	399
JUKI 6300	749

## ACCESSORIES

OKIDATA 82/92 TRACTOR	49
NEC BI-DIRECTIONAL TRACTOR	154
NEC CUT SHEET GUIDE	64
JUKI 6100 BI-DIRECTIONAL TRACTOR	109
JUKI 6300 BI-DIRECTIONAL TRACTOR	129

**1-800-237-4048**

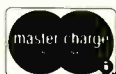

AM-EX

DINER'S  
CLUB

# COMPUTER MART

1901 S. TAMiami TRAIL, VENICE, FL 33595

Call for Non-Advertised and Lower Current Prices.  
IBM is a registered Trademark of International  
Business Machines. Prices subject to change.  
We accept MasterCard, VISA, Money Orders,  
certified and personal checks and COD shipments.  
Returns are subject to a 15% restocking fee.

**IN FLORIDA CALL 813-493-2736**

```
+ 4.2073403E + 05 - 8.1687375E + 04 - 1.3920300E + 05 + 6.0000000E + 01
- 1.6991589E - 01 + 5.4551083E - 01 - 4.0784150E - 02
+ 4.0053797E + 05 + 6.0884805E + 04 + 1.5494327E + 03
- 1.4566940E - 01 + 8.5460287E - 01 + 4.4591239E - 01
- 1.4892976E + 08 - 1.4973616E + 07 - 6.4940470E + 06
+ 3.7287424E + 00 - 2.7058577E + 01 - 1.1733729E + 01
R10,R20 + 4.5063006E + 05 + 2.0136027E + 05
```

```
+ 2.2461516E + 05 - 2.8893991E + 05 - 3.9640344E + 04 + 7.0000000E + 01
+ 8.1509495E - 01 - 6.4160638E - 02 - 2.9409379E - 01
- 2.6377850E + 05 + 2.1918655E + 05 + 1.3143569E + 05
- 7.0102608E - 01 - 7.3732376E - 01 - 3.2422194E - 01
- 1.4353605E + 08 - 3.8023476E + 07 - 1.6489461E + 07
+ 8.7413425E + 00 - 2.6167715E + 01 - 1.1348359E + 01
R10,R20 + 3.6811628E + 05 + 7.2525019E + 05
```

```
+ 3.4287069E + 05 + 6.1140590E + 04 - 1.2910519E + 05 + 8.0000000E + 01
- 6.4364934E - 01 + 5.7552481E - 01 + 1.6853730E - 01
+ 6.8223969E + 04 - 3.3873609E + 05 + 1.7829113E + 05
+ 9.9896520E - 01 + 1.2927669E - 01 - 8.4648142E - 03
- 1.3387658E + 08 - 5.9954040E + 07 - 2.6001038E + 07
+ 1.3563957E + 01 - 2.4460604E + 01 - 1.0608757E + 01
R10,R20 + 3.7143862E + 05 + 4.8759766E + 05
```

```
+ 3.2928400E + 05 - 2.8257238E + 05 - 9.0272820E + 04 + 9.0000000E + 01
+ 5.4575258E - 01 + 2.4833123E - 01 - 2.2335909E - 01
+ 3.0065381E + 05 + 2.4090578E + 05 + 1.0086758E + 05
- 6.7142922E - 01 + 6.2881094E - 01 + 3.7202370E - 01
- 1.2021711E + 08 - 8.0078016E + 07 - 3.4727984E + 07
+ 1.7979109E + 01 - 2.2009541E + 01 - 9.5437965E + 00
R10,R20 + 4.4319781E + 05 + 5.5801769E + 05
```

End time 08:39:14

3.14159), is the unit of time  
 • the universal constant of gravitation equals unity

The following canonical units are frequently used in astronomy. The unit of mass is the mass of the sun, the mean distance from the sun to the earth is the unit of length, and the unit of time equals one sidereal year divided by (2\*3.14159), or 58.132 days.

The sample case in the program uses the mass of the earth as the unit of mass and the equatorial earth radius (6378.165 km) as the unit of length. The computation of the canonical unit of time can be left to the astronomers, who have stated that its value is 806.813645 seconds.

Lines 260 to 300 of the listing initialize the canonical values for the sample case. In the program, variable CML holds the canonical unit of

length and CMT is the canonical unit of time.

**MATHEMATICAL STATEMENT OF THE PROBLEM**

There are four bodies, denoted by  $q_0$ ,  $q_1$ ,  $q_2$ , and  $q_3$ , with masses  $m_0$ ,  $m_1$ ,  $m_2$ , and  $m_3$ . The mass of body  $q_0$  is negligible. The position vector of body  $q_j$  relative to  $q_i$  is denoted by  $p_{ij}(t_n)$ , where  $i$  and  $j$  may assume numerical values 0, 1, 2, or 3; also,  $n$  is any integer,  $t$  is the abbreviation for time, and therefore  $t_n$  denotes a specific value of time. The time derivative of  $p_{ij}(t_n)$  is the velocity vector  $v_{ij}(t_n)$ .

The mathematical statement for the problem of this article is as follows. At the outset the values of the six vectors  $p_{10}(t_0)$ ,  $p_{12}(t_0)$ ,  $p_{13}(t_0)$ ,  $v_{10}(t_0)$ ,  $v_{12}(t_0)$ , and  $v_{13}(t_0)$  are known; they are called the initial conditions. The objective is to determine the value of  $p_{10}(t_f)$ , where  $t_f$  is the specified final time. This is ac-

complished by first computing the values of the six vectors at time  $t_1$ . Then, using the just-obtained values as new initial conditions, compute the vector values at  $t_2$ . Continue "marching" to  $t_3$ ,  $t_4$ , etc., until the values for  $t_f$  are determined.

It is mentioned in passing that any vector  $p_{ij}$  can be computed from the three vectors  $p_{10}$ ,  $p_{12}$ , and  $p_{13}$ . To see this, remember the obvious vector relations

$$p_{ij} = -p_{ji}$$

$$p_{ij} + p_{jk} = p_{ik} \quad (k = 0, 1, 2, \text{ or } 3)$$

$$p_{ii} = 0$$

Thus, for example,  $p_{20} = p_{21} + p_{10} = -p_{12} + p_{10}$ .

**TWO-BODY MOTION**

Suppose there are only two bodies, say  $q_0$  and  $q_1$ . As before,  $p_{10}(t_0)$  and  $v_{10}(t_0)$  denote the position and velocity vectors of  $q_0$  relative to  $q_1$  at time  $t_0$ . The corresponding values at time  $t_1$  are denoted by  $|p_{10}(t_1)|$  and  $|v_{10}(t_1)|$ , where the square brackets show that the values are the result of two-body motion. Over 100 useful procedures exist for solving two-body problems. In the days of paper-and-pencil computation, the human computer could easily switch procedures—for example, from an efficient procedure for elliptic motion to another procedure as the motion approached parabolic characteristics. Programmers for electronic computers prefer one universal method for all types of two-body motion. Stumpff uses a universal method called "sub1." See lines 1680 to 1910 of the program. Stumpff spends the bulk of its time in this subroutine.

**STUMPF REFERENCE ORBIT**

This section presents the equation for  $P_{ij}$ , the Stumpff reference orbit for position, and  $V_{ij}$ , the reference orbit for velocity. To simplify the equations, the following conventions are used:  $P_{ij}$  and  $V_{ij}$  refer to time  $t_1$ ; the two-body values, enclosed in square brackets, also refer to time  $t_1$ ; all other terms refer to time  $t_0$ ;  $h = t_1 - t_0$  is the time step.

It is easier to state the equations for

(continued)



# Finally, business computer software for the hard-nosed.



No one takes a harder look at software than small to mid-sized businesses.

So take a long, hard look at The Accounting Solution™, a new, totally integrated software package from Business Tools, Inc.™

You'll find its breakthrough features are designed to pay off where it counts—on the bottom line.

## Hard-nosed economy, \$99.\*

Contrary to popular opinion, you don't need a small business loan to buy quality software. Not if you're buying The Accounting Solution. For \$99, you get a language/data base manager with more hard-nose capabilities and speed than any program available at any price; \$249 buys the language plus accounts receivable/payable and general ledger; \$399 gets you all the above plus inventory control, sales order entry, purchase order entry and payroll. Even more good news for the budget minded—source code is included with applications.

## Easy for any hard-nose.

The Accounting Solution is easy

enough for the novice hard-nose to use within minutes of receiving the package. Yet it's also sophisticated, offering unlimited flexibility and opportunity to the hot-shot hard-nose. And it's designed to run on CP/M-80, MP/M-80, IBM PC and compatibles.\*\*

## Multi hard-nose capability.

The Accounting Solution never

stands in the way of progress. Thanks to multi-user capability, two or more hard-noses can use the same application at the same time.

## Hard-nosed flexibility.

With The Accounting Solution, it's easy to change your mind because the source code is so simple to modify. Ready to grow? Great. You can change hardware without spending a dime on new software.

## Take it from hard-nose Phil Mickelson.

Phil created The Sensible Solution™, a highly respected software package. Now he's offering the next step, another breakthrough: The Accounting Solution. It's simple. Sophisticated. Affordable. And backed by Phil's reputation and personal service. If you're looking for hard-nosed value and quality, you'll agree, The Accounting Solution is the only solution.

**BUSINESS TOOLS**<sup>TM</sup>

**Accounting  
Solution**

Write or call:

**Business Tools, Inc.  
4038-B 128th Avenue SE  
Bellevue, WA 98006**

**1-800-648-6258**

**Washington State:  
(206) 644-2015**

*Dealer inquiries welcome.*

\*Suggested retail price.  
\*\*CP/M-80 and MP/M-80 are registered trademarks of Digital Research, Inc.; IBM PC is a registered trademark of International Business Machines Corporation; The Sensible Solution trademark rights are claimed by O'Hanlon Computer Systems.

four massive bodies; therefore, the condition that  $m_0 = 0$  is temporarily removed. The equations are:

$$P_{10} = |p_{10}| + m_2/(m_1+m_2) * ((p_{12})-p_{12}-h*v_{12}) + m_2/(m_2+m_0) * ((p_{20})-p_{20}-h*v_{20}) + m_3/(m_1+m_3) * ((p_{13})-p_{13}-h*v_{13}) + m_3/(m_3+m_0) * ((p_{30})-p_{30}-h*v_{30})$$

$$V_{10} = |v_{10}| + m_2/(m_1+m_2) * ((v_{12})-v_{12}) + m_2/(m_2+m_0) * ((v_{20})-v_{20}) + m_3/(m_1+m_3) * ((v_{13})-v_{13}) + m_3/(m_3+m_0) * ((v_{30})-v_{30})$$

These equations exhibit remarkable symmetry. By interchanging the roles of subscripts 0 and 2, for example,  $P_{12}$  and  $V_{12}$  are obtained. By similar interchanges, one can obtain any Stumpff reference orbit, though the program requires only  $P_{10}$ ,  $P_{12}$ , and  $P_{13}$ , as well as  $V_{10}$ ,  $V_{12}$ , and  $V_{13}$ . Of course, the program saves time by using the condition that  $m_0 = 0$ .

$P_{ij}(t_i)$  and  $V_{ij}(t_i)$  are excellent approximations to the true orbital parameters, even for a relatively large time step. Therefore, Stumpff equates  $p_{ij}(t_i)$  and  $v_{ij}(t_i)$  with  $P_{ij}(t_i)$  and  $V_{ij}(t_i)$ .

The reference orbits are computed on lines 760 to 1330. The two-body subroutine, "sub1," which starts on line 1680, is invoked six times. Note

that the subroutine would be invoked five times to compute just one reference orbit yet is called only six times for all reference orbits.

**TIME STEP**

The time step  $h$  is defined by  $h = t_1 - t_0$ . (The program, however, uses TAU instead of  $h$ ). Considerable effort was spent in finding a good criterion for the magnitude of the time step. It should be large to reduce the computing time, yet small to prevent the truncation error from building up to an intolerable level. The criterion that was eventually chosen is based on an overestimate of the error. There exist better time-step criteria for the sample case, but the chosen criterion has the virtue of working well for all cases that were investigated.

The time step is calculated on lines 620 to 740. It equals the fourth root of  $(q/ERRERR)$ ;  $q$  is computed on line 1400 and involves the overestimate of the error; ERRERR is the user type-in following the prompt TIME-STEP CONTROL CRITERION. 1E-5 OR 1E-6 RECOMMENDED. A safeguard prevents the time step from becoming larger than 100 canonical units. Moreover, the time step is adjusted so that results are printed for the days that the user has specified.

**MATHEMATICAL THEORY OF ERRORS**

Functions encountered in the physical sciences can usually be represented as Taylor series. If a procedure agrees with the Taylor series up to and including terms of order  $n$  but not terms of order  $n+1$ , then the procedure is said to be of order  $n$  and the error of order  $n+1$ . Higher-order procedures provide a better approximation than lower-order ones. Therefore, in general, equivalent accuracy is maintained by high-order procedures with large time steps and low-order procedures with small time steps.

The reason the Stumpff method is so attractive can now be stated succinctly: For point-mass bodies, the error of the Encke reference orbit is of order two, while that of the Stumpff reference orbit is of order four. ■

**REFERENCES**

1. Stumpff, K. "Untersuchungen ueber das Problem der speziellen Stoerungen in den rechtwinkligen Koordinaten." *Astronomische Nachrichten*, vol. 273, 1942.
2. Stumpff, K., and E. H. Weiss. "A Fast Method of Orbit Computation." NASA Technical Note TN D-4470, April 1968.
3. Stumpff, K., and E. H. Weiss. "Applications of an N-body Reference Orbit" in *Astronautical Sciences*, vol. 15, number 5, September 1968.

**Quality PC Products from MULTITECH**

- CPU board with 256K memory and up to 640K on board, serial, parallel ports, socket for 8087, 6 slots. Run MS DOS CPM/86. Complete documentation ..... **\$350**
  - Power supply ..... **\$135**
  - Case for the CPU board ..... **\$90**
  - Floppy controller ..... **\$60**
  - Keyboard ..... **\$80**
  - Fully assembled IBM compatible PC with 256K, 1 serial, 1 parallel, color card, keyboard & 2(1/2) HT drives ..... **\$1150**
- OEM and dealer discount available.*

- Multifunction board (64K) ..... **\$160**  
(384K) ..... **\$240**  
1 parallel, 2 serial, clock/calendar, ramdisk & print spooler
- Memory expansion (64K) ..... **\$90**  
(384K) ..... **\$150**
- Serial card (2 ports) ..... **\$50**
- Color/graphic card ..... **\$130**
- Mono display adaptor with 1 parallel port ..... **\$120**
- Others
- 8087 math coprocessor ..... **\$120**
- Color monitor (640x500 interlaced) ..... **\$400**
- Microscience Hard disk 20 MB with controller ..... **\$800**

\* One-year warranty for all add-on cards!

CALL TOLL FREE TO ORDER (800) 538-1542  
In California call (408) 730-1795 Technical Support Service (408) 773-9400  
**U.S. SERVEX** 195 West El Camino Real  
Sunnyvale, California 94087

# Introducing the new and improved IBM PC. \$49<sup>95</sup>

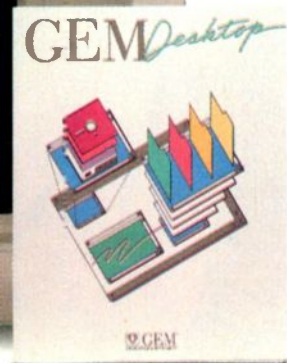
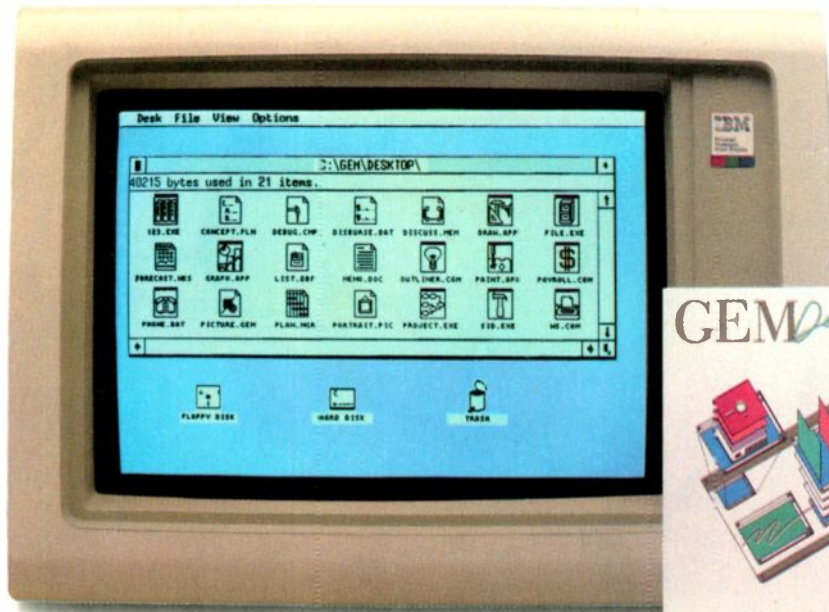

Actually, it's not a new IBM® PC. It's GEM DESKTOP™. The \$49.95 software breakthrough that makes your old IBM PC so astonishingly easy to use that it seems like a new one.

## So long PC DOS, hello GEM.™

GEM DESKTOP software looks like an ordinary floppy for your PC. But slide it into your IBM's disk drive, and the change begins.

From this moment on, you can run most of the important PC programs—but instead of typing cryptic commands to get into your program menu, you simply point and click your mouse\* or use your cursor keys to open a window. It's like a breath of fresh air compared to the complex PC DOS operating system you've been using.

## Point and click vs. stroke, stroke, stroke.

Next, instead of typing and retyping long file names, you simply point and click again at the appropriate symbols. And voila! Your file appears on screen. But it's not quite the same screen you've been used to.

Simple menu headers at the top to guide you effortlessly from one function to the next. So instead of making more complex keystrokes that can easily be mistyped, your IBM PC is easier and faster to use than ever before. There is also a clock and a calculator both built right in.

## Indispensable. And only \$49.95.

Your GEM Desktop includes all operating system interface software and comes with amazingly simple instructions. In fact, GEM DESKTOP software makes it possible, for the first time, for anyone to learn to use an IBM PC. (Who knows, maybe even the most dedicated computerphobes in your company will warm up to the PC, after this.)

And you can just as easily justify the cost—only \$49.95 for complete operating package. Which makes it affordable enough to have several.

## If you can use a phone, you can have GEM DESKTOP. Right Now.

To order GEM DESKTOP, just call toll-free (800) 443-4200. Charge your order to your Visa, MasterCard or American Express. While you're on the line ask us about GEM DRAW,™

our nifty \$149.00 graphics package with an extensive gallery of art.

Or mail this order form, along with your payment.

Name \_\_\_\_\_  
Address \_\_\_\_\_  
City \_\_\_\_\_  
State \_\_\_\_\_ ZIP \_\_\_\_\_  
Phone \_\_\_\_\_

**GEM DESKTOP**  
\$49.95 plus \$3.00 shipping and handling.

**GEM DRAW**  
\$149.00 plus \$4.00 shipping and handling.

Applicable sales or use tax will be added. COD, checks or purchase orders will not be accepted. (Outside USA add \$10.)

**Method of payment. Circle one.**

**VISA MASTERCARD AM. EX.**

Card number \_\_\_\_\_  
Exp. date \_\_\_\_\_  
Signature \_\_\_\_\_

Mail to: **GEM Software**  
**Digital Research Inc.**  
**Box DRI**  
**Monterey, CA 93942**  
**Or call (800) 443-4200.**

 **GEM™**  
FROM DIGITAL RESEARCH®

\*GEM requires that your computer have appropriate graphics capability and that the pointing device be compatible. Call for exact requirements. GEM, GEM DRAW and GEM DESKTOP are trademarks of Digital Research Inc. IBM is a registered trademark of International Business Machines Corporation. Digital Research is a registered trademark of Digital Research Inc. © 1985, Digital Research Inc. All rights reserved.

# THE ADVENTURE CONTINUES . . .

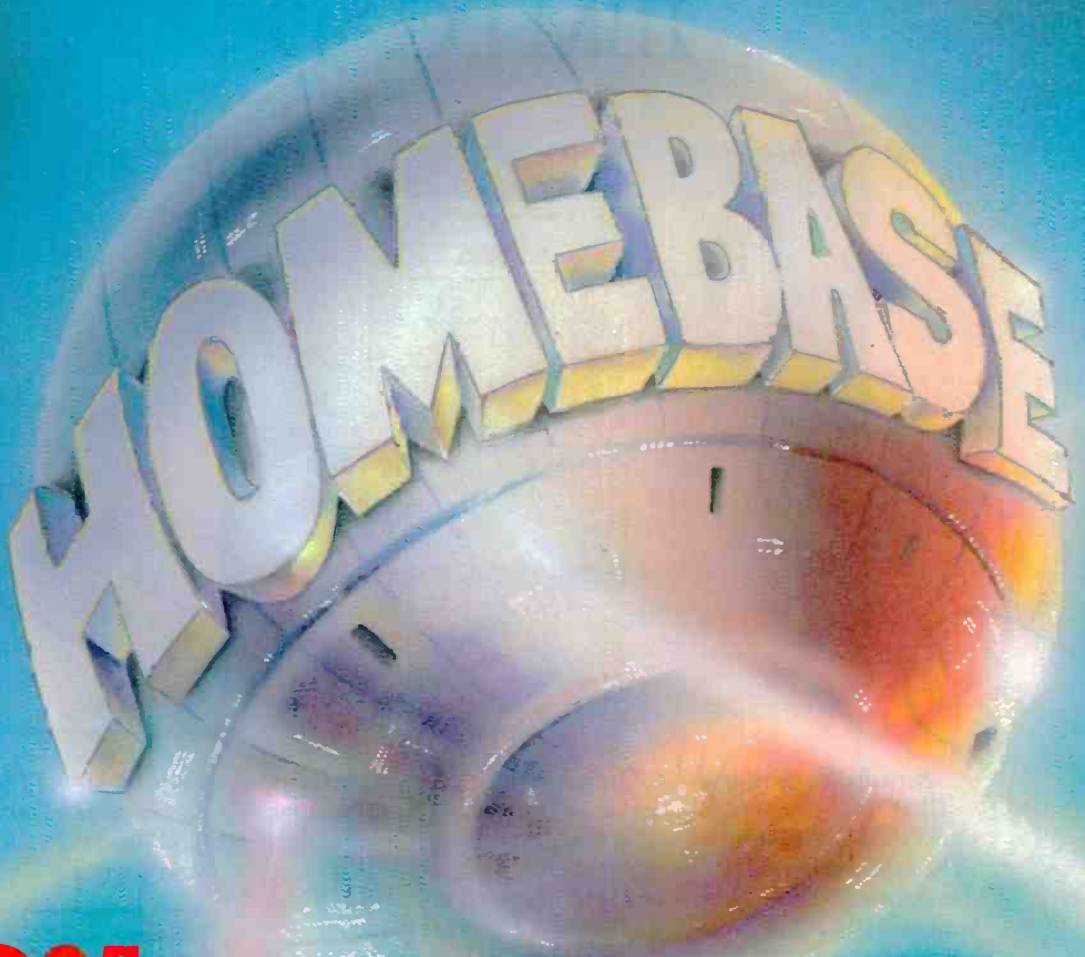

## \$49<sup>95</sup>

## SOMETHING BRAND NEW

**INSTANT DATABASES . . . BECAUSE THAT'S HOW MOST OF US NEED INFORMATION . . . INSTANTLY!**

Homebase provides you instant access to a whole realm of databases. Just hit the hotkey to freeze whatever software you're working in, and you're ready to find, insert or manipulate data.

This is much more than a simple cardfile or mini-database. You'll be able to set up your own templates, define parameters such as the length of a field, and do rapid key searches. You can have thousands of records in a database. And numerous databases on your menu.

### THE TOOLS YOU NEED.

We've included a powerful set of tools that will save you time and help you organize information, schedule, calculate and a whole lot more. All within a quick keystroke . . . regardless of the software you're running!

You may find a few of these in some "desktop" products . . . but nothing else approaches the power of Homebase!

- Instant Databases
- Phone Message Pad
- Rolodex™
- Appointment Calendar
- Calculator
- Notepad
- Time and Expense Diary
- Programmable Hotkey (You choose the key that gets you to your Homebase)
- Electronic Mail (as an automatic multi-task)
- Tables and Notes (for those things you always need to look up)
- Alarm Clock (including Musical Snooze Alarm)
- To-Do List
- Quickterm Terminal (available even when you're working in another program)
- Autodialer
- Template Maker (for designing your own databases)
- DOS Services
- Rolodex Card Printer
- Mailing Label Printer
- Data Transfer (between databases or your other software)
- Cut and Paste (great for putting together an Electronic Mail letter that combines a chunk of spreadsheet, some text from a document, and a few notes)

# THE EXCITEMENT IS BACK

With the Electronic Mailbag of Your Dreams

ELECTRONIC MAIL THAT TAKES CARE OF ITSELF . . . IN THE BACKGROUND

(While you're running WordStar, Lotus, dBase, a compiler or whatever)

We wanted electronic mail that could take care of itself while we were busy on the computer doing something else.

We always felt that there was something strange about having to play postman every time a piece of electronic mail was due.

It was always a case of loading up a communications package and either waiting for the mail or going out to fetch it.

Now, we've got it! And you can have it, too. With HOMEBASE, Electronic mail can arrive while you're working in another piece of software. Up in the corner of your screen, a signal lets you know that there's incoming mail. You can read it as it comes in, if you want. Or you can ignore it, and your mail will automatically file itself . . . to be read at your leisure.

When you're sending Electronic Mail, it's just as easy. Once you've written and addressed your letter, the rest is done for you, automatically, while you're back working in another piece of software.

## CHECK THE DIFFERENCE IN VALUE!

### WHY ARE YOU GETTING SO MUCH SOFTWARE FOR SUCH A SMALL PRICE?

Amber Systems makes tools for programmers including VSI—The Window Machine. We make mouse drivers, asynchronous drivers and electronic mail packages for a number of companies. Now, we've decided to use these tools, plus some new ones that aren't yet on the market, to produce new concepts in software. Because we make the tools ourselves, our costs, and consequently yours, are the lowest possible . . . with never a compromise in quality.

**YES! Site licenses are available** for companies . . . large and small. If you would like to order a single copy, now, to examine and show around your company, its cost can be deducted, later on, from your site license.

For further information on site licenses call 408-996-1883.

HOMEBASE	SIDEKICK	POLY WINDOWS	SPOTLIGHT
Notepad Autodialer Appointment Calendar DOS Services Calculator Rolodex Rolodex Card Printer Tables and Pages Alarm Clock Template Maker Instant Databases Data Transfer Cut and Paste Programmable HotKey Phone Message Pad Time and Expense Diary To-do List Electronic Mail Quickterm Terminal Mailing Label Printer	Notepad Autodialer Calendar Calculator ASCII Table Rolodex	Notepad Keyboard Macros Calendar Calculator Game Alarm File Cards	Notepad Calendar DOS Services Calculator Rolodex File Cards
<b>\$49.95 !</b>	<b>\$49.95</b>	<b>\$49.95</b>	<b>\$149.95</b>

Sidekick is a trademark of Borland International, Inc. Poly Windows is a trademark of Polytron Corp. Spotlight is a trademark of Software Arts.

**ORDER YOUR COPY OF HOMEBASE TODAY!**

**For VISA and MasterCard Orders Call Toll Free : 800-538-8157 Ext. 824**

**In CA 800-672-3470 Ext. 824**

**Call Mon. - Fri. 6 A.M. to 12 P.M., Sat. & Sun. 6 A.M. to 8 P.M. (P.S.T.)**

or fill in this ORDER FORM and enclose a check, money order or your VISA or MasterCard number.

**HOMEBASE** is available for the IBM PC, XT and true compatibles  
 \$49.95 + \$5 for shipping and handling\*

NAME \_\_\_\_\_  
 TITLE \_\_\_\_\_  
 COMPANY NAME \_\_\_\_\_  
 ADDRESS \_\_\_\_\_  
 CITY \_\_\_\_\_ STATE \_\_\_\_\_ ZIP \_\_\_\_\_  
 HOME PHONE ( ) \_\_\_\_\_ WORK PHONE ( ) \_\_\_\_\_  
 CHECK  MONEY ORDER  VISA  MASTERCARD Card # \_\_\_\_\_ Exp. date \_\_\_\_\_

**30-day money-back guarantee!**

SEND TO:

**AMBER**

AMBER SYSTEMS, INC.  
 1171 S. Saratoga-Sunnyvale Road  
 San Jose, CA 95129

\*California residents add 6% sales tax. Outside U.S. please add \$15. Checks must be on a U.S. bank and in U.S. dollars. Sorry, no C.O.D. or purchase orders.  
 For dealer and site license information, call 408-996-1883.

from MicroComputer Accessories, Inc.

# YOUR RIGHT ARM.

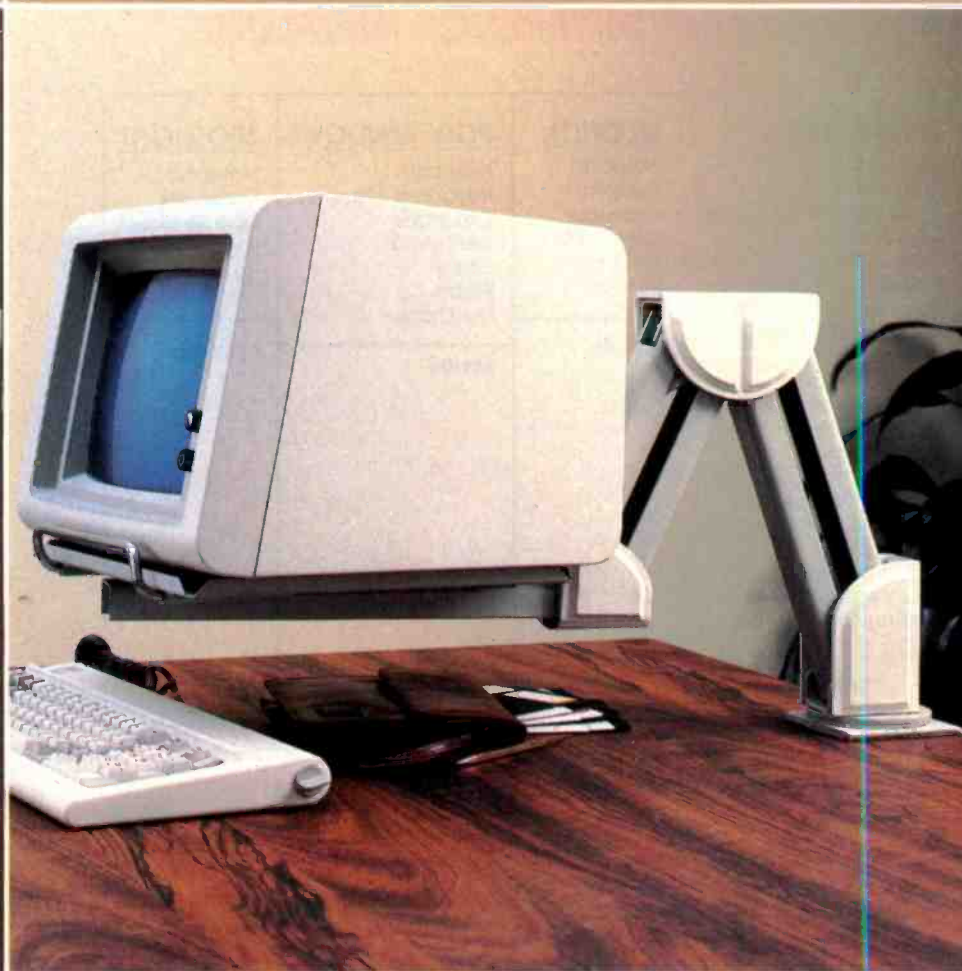

Our CRT/terminal Valet, at your service. It clears the table—extends or retracts monitors 15-1/2" horizontally and lifts from 5-1/4" to 7-1/4" above phones and other desk top objects. Serves up your CRT or terminal on a 12" x 12", 360 revolving platform with a 50 pound capacity (and can hold our Tilt'n Turn<sup>®</sup> which lets you move your CRT any which way you want). Clamps onto any surface up to 2-1/2" thick, with wall and bolting flange mount options. Handle doubles as a keyboard holder. Cables are routed through the arm. Your right arm. See? It's not so hard to find good help these days.

Inquiry 238 for End-Users.  
Inquiry 239 for DEALERS ONLY.

## MicroComputer Accessories, Inc.

5721 Buckingham Parkway  
P.O. Box 3725  
Culver City, California 90231  
Telephone 213/641-1800

N.V. Microcomputer Accessories Europe S.A.  
Rue de Florence 37  
1050 Bruxelles, Belgique  
Telephone 02/538.61.73

These and other fine products are available at Sears Business Systems Centers, Computerland, Businessland, IBM Product Centers and other computer/software retail locations.



Rolltop 100 Disk File

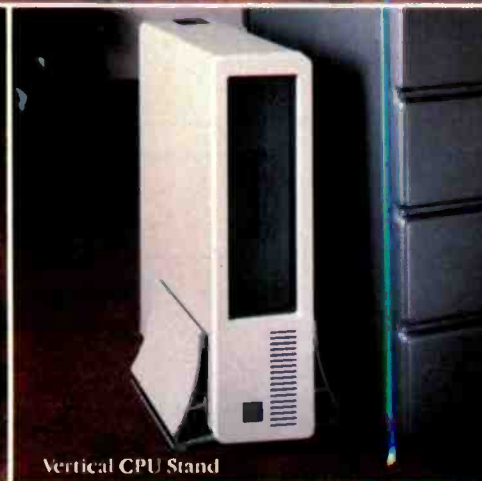

Vertical CPU Stand

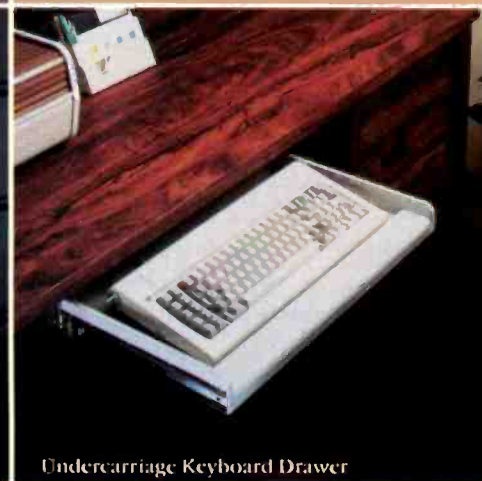

Undercarriage Keyboard Drawer

# AUTOMATING A TELESCOPE

BY LOUIS J. BOYD

## *Computerizing the repetitious tasks in variable-star photometry*

RECENTLY AT FAIRBORN Observatory West, we completed automating a telescope (photo 1) for a considerable portion of the research process of photometry of variable stars requiring long-term observation. This article will explain the entire process from one end to the other, with emphasis on what was automated, how it was automated, and what was purposely left to be done manually.

### **SELECTING THE STARS**

Much of the success of this project has been due to our making observations on the particular class of stars most suited for automation. As it is easier and less expensive to automate a small telescope than it is a large one, it was important that the type of observations being made were suitable for small telescopes.

The main difference between large and small telescopes is the number of photons they can collect from a given star. Wide-bandwidth photometry (brightness measurement) makes the most use of the meager photons available to smaller telescopes. Photometry, as compared to spectroscopy or direct imaging, also has the advantages of having a very

repetitive measurement sequence and a low data-output rate, easing automation.

Further, automation is ideally suited to the kind of research that requires observations each night for months or years on end.

Finally, it is helpful if the observed class of stars has many bright members to match the capabilities of a small automatic telescope, that there be strong current scientific interest in the results, and that there be an expert on the class of stars willing to work with an automatic system.

The RS Canum Venaticorum binaries and Dr. Douglas S. Hall fit the criteria in all respects. The RS Canum Venaticorum (or RS CVn) binaries are an exciting new class of stars that have highly active atmospheres, often with large groups of starspots that move about and change their sizes over time. These stars are similar to our own sun, but in a greatly exaggerated form. To learn how their starspots evolve and change over time, you must observe a significant number of the stars almost nightly for years. Besides the 40 or so known RS CVn binaries observable by a small telescope from the northern hemisphere,

there are a number of stars suspected of being starspotted RS CVn binaries. Until recently, the photometry needed to detect any intensity variations as the spot groups rotate in and out of the line of sight from earth had not been done. There simply is not enough telescope time or enough astronomers for such long-term observations. However, the automatic system described in this article has discovered 15 such new variables during 1984 alone. One of these newly discovered RS CVn binaries can serve as an example to illustrate the approach we took to automation. (See the text box "A New Variable Star" on page 230). Douglas Hall compiled the list of known and suspected RS CVn binaries from available data on the stars and, with the help of Russell Genet, screened the list to eliminate stars not suited to the automatic system (e.g., stars that are too dim, too far north or south, or too near other stars). For each variable (or suspected

*(continued)*

Louis J. Boyd has a BS. in electrical engineering and is codirector of the Fairborn Observatory (629 North 30th St., Phoenix, AZ 85008). He designed the automated photoelectric telescope described in this article.

*The system must first determine if the sky is dark enough to begin observing.*

variable). Hall and Genet selected two additional stars to use in comparing the brightness differentially and to assist in locating and identifying the variable by the three stars' relative positions. Information about all of these stars was obtained from appropriate catalogs and entered into a data file. The data included the coordinates of each star, the expected brightness of each star, periodic data on the variable star, if known, and coordinates of a nearby place in the sky containing no detectable star.

This group data, together with similar data on all of the other groups of stars to be observed by the system, constitutes the astronomical input to the observational process. The process of deciding what variable or suspected variable stars to observe is,

of course, a case of scientific intuition, and no attempt has been made to automate it. The selection of comparison and check stars could be based on a set of rules relating brightness, separation from the variable star, and spectral class. The selection could be automated by allowing the computer to search star catalogs, but, as it is a one-time task for each variable star, there is little incentive to do so.

#### **OBSERVING THE STARS**

Almost all of the observing process has been automated (figure 1). The part that hasn't is the simple (for a human) process of looking at the sky in the afternoon, deciding if the weather is acceptable for observing, and opening the observatory roof. This manual process takes at most two minutes per day and has been a low-priority item to automate. Because this task is repetitive, it will eventually be automated. We have made progress in that direction, but the difficulty is to reliably detect all forms of inclement weather including rain, hail, blowing dust, high wind, and heavy clouds that are likely to pro-

duce rain. We are currently testing an infrared clear-sky detector. After opening the observatory, we power up the system and compare the computer's real-time clock against the National Bureau of Standards' WWV time signals. From this point on, operation is automatic.

The system must first determine if the sky is dark enough to begin observing. A human would do this by simply looking up and making a decision. Not so for the computer. The program starts by repeatedly determining the position of the sun by calculating the orbit of the earth and its rotation, given the date and time from the clock and knowing the location of the observatory. This function could have been handled with a lookup table for each week of the year. When the sun is 10 degrees below the horizon, the telescope is initialized to the southeast limits of its allowable travel range and the related position in the sky is calculated based on the time. At that instant, a frequency generator is turned on that steps the right-ascension motor of the telescope at a rate that very accurately compensates for the rotation of the earth. Thus, the software does not have to constantly take the earth's rotation into account. Most manually operated astronomical telescopes also have a motor that compensates for the earth's rotation, even though the stars are located by an operator.

The system then decides which group it will observe first. The logic used is about the same as a human would use. Because viewing stars at low angles introduces errors due to all the air the starlight must penetrate, the maximum distance the star is from the zenith when it is observed is restricted to a 45-degree cone overhead. The program calculates the time that each group will rise and set within the defined observing cone and selects the group that will be the first to move out of the cone. The program determines whether the selected group is within 10 degrees of the moon. If it is, that group is skipped. Again, a human would simply judge the angle by looking at the

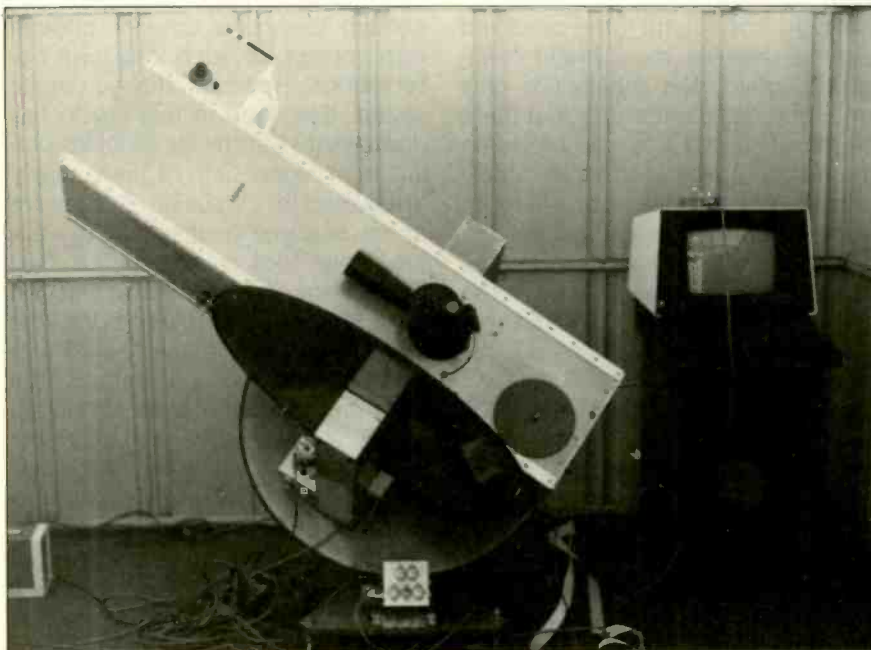

Photo 1: The automatic photoelectric telescope used to gather the measurements discussed in the article. The small box at the top of the telescope is the photometer.



moon and the selected group, but the computer must calculate the position of the moon and compare it to the position of the group.

The telescope must now be moved to the check star of the group being observed. A human observer would push the appropriate slew buttons to move the telescope to the position or release clutches and move the telescope by hand. The star is found by a combination of the use of setting circles, comparing the observed star field to "finder charts," and by simply recognizing the pattern of stars. The equivalent process for the computer is complex. First, the computer must calculate the angular distance the telescope needs to be moved to go from its present position to the sky position for the group. All star positions are corrected for precession of the earth's axis. The angles are passed to a module that breaks them into two separate moves, one with both right-ascension and declination motors being stepped together, and a second move with only one motor running. The exact number of steps required for each move is calculated and the direction and number of steps is passed to a stepper-motor driver routine. This is the only assembly-language routine used in the entire operation. It must calculate which windings of each motor need to be turned on for each step that the motors make. In addition, it must provide smooth acceleration at the beginning of each move and smooth deceleration at the end of each move. The maximum stepping rate is on the order of 4000 steps per second, which could not be done in a high-level language. The next task is to take several measurements of the sky brightness in positions near the sky position to set a threshold to use while searching for the stars. The telescope is then moved to the position where it expects to find the star. A square spiral search is then started taking  $\frac{1}{10}$ -second readings of the sky brightness and comparing this to a value calculated from the expected brightness of the star. If the reading exceeds about one-half the difference

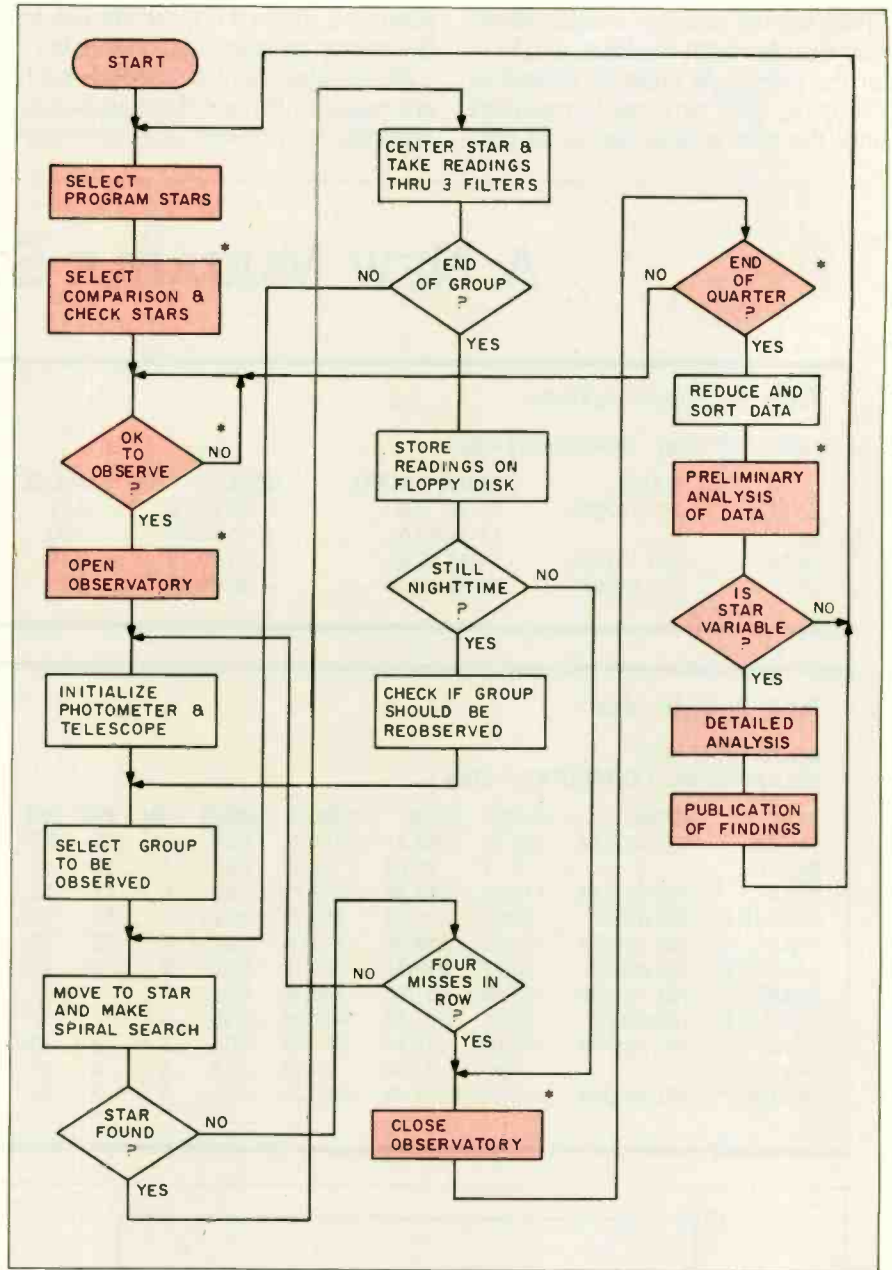

Figure 1: A diagram of the operation of the automatic photoelectric telescope described in the article. The shaded boxes were left as manual processes, while all other activities were automated. Boxes marked with an asterisk are candidates for future automation.

of the sky background and the expected value, it is assumed that the star has been found. By using an adjustable threshold, there is little chance of the system locking onto the wrong star.

The next step of the process is to center the star. A human would look through the eyepiece and make sure

that the star's image was centered, carefully adjusting the telescope's fine-motion controls. The automated system uses an iterative procedure, in which the telescope is offset to each of four positions by a little less than the radius of the diaphragm, and a reading is taken in each position.

(continued)

There are 16 possible combinations that dictate which direction and how far the telescope must be moved to center it. This process is repeated until the star is detected in all four

positions, where it is close enough to the center to take measurements.

Measurements of 10 seconds each are made in three color passbands, changing the position of a wheel with

colored glass filters between each measurement. The telescope then moves to the sky position repeating the measurements, then to the comparison, variable, etc. When all of the

## A NEW VARIABLE STAR

Table A: Program parameters.

NAME: HR 4430 DIAPHRAGM = 60"

	NAME	RIGHT ASCEN.	DECLIN.	V-MAG.
CHECK	HD 102224	11 46 3.0	+ 47 46 46	3.71
SKY		11 34 29.0	+ 46 45 44	.00
COMP	HD 101133	11 38 33.0	+ 46 50 3	6.10
VARI	HD 99967	11 30 25.0	+ 46 39 27	6.35

Table B: Sample data.

GROUP=HR 4430

HELIOCENTRIC CORRECTION=.0045

TYPE	NAME	ULTRA	BLUE	VISUAL	SECZ	HH	MM	SS
CHECK	HD 102224	308.72	2533.51	4371.71	1.05	7	56	47
SKY		9.11	21.69	24.65	1.04	7	57	21
COMP	HD 101133	176.54	619.36	515.79	1.04	7	57	58
VARIABLE	HD 99967	35.02	233.10	410.78	1.03	7	58	53
COMP	HD 101133	174.15	619.39	515.04	1.04	7	59	32
VARIABLE	HD 99967	34.47	218.37	389.12	1.03	8	0	21
COMP	HD 101133	173.12	601.62	509.49	1.04	8	1	1
VARIABLE	HD 99967	35.21	227.78	406.96	1.03	8	1	51
COMP	HD 101133	173.98	615.16	511.58	1.04	8	2	38
SKY		8.85	21.68	25.34	1.03	8	3	11
CHECK	HD 102224	313.27	2577.48	4426.84	1.04	8	3	54

HR 4430 is the number of a star in the Yale Bright Star Catalog. It is also known as HD 99967. It was found by the photometrically variable by the automatic photoelectric telescope and process described in this article. Shown in table A is all the input information needed by the system to observe this suspected variable star, as well as comparison and check stars and a sky position. Given are the positions (right ascension and declination) and the magnitude (brightness) of each star in the V (visual) band of the UBV photometric system.

Table B shows actual photometric measurements as recorded directly by the system. The check star, HD 102224, was measured in the ultraviolet, blue, and visual bands, and this was recorded along with the amount of air through which the star was observed (straight up is 1.00 air masses), which is the secant of the zenith angle (SECZ). The universal time in hours, minutes, and seconds was also recorded. Note that after moving to the check star, 10 additional moves to other stars or the sky are required to complete the sequence of 33 separate measurements. When reduced, all these measurements give but a single brightness point in each color band on a light curve.

The final product of the entire process is a light curve that shows the variations in brightness of the star, confirming its variability (figure A). As mentioned in the text, this was published in the *Information Bulletin of Variable Stars*.

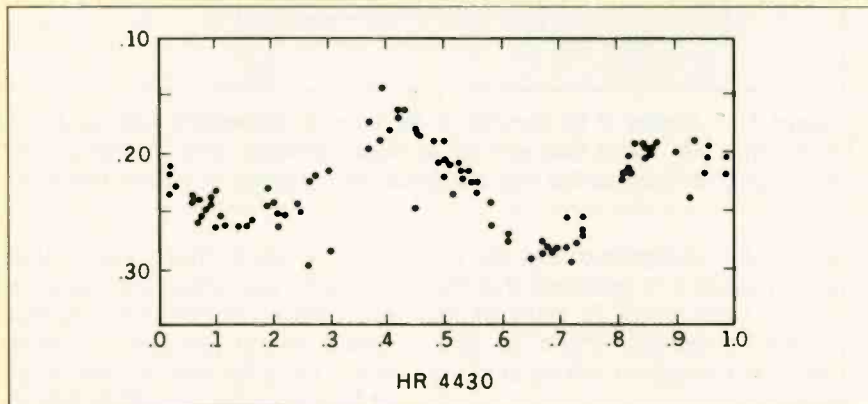

Figure A: Light curve for HR 4430.

measurements have been completed, which takes about six minutes including all of the searching and centering, the measured data is stored on floppy disk. The data that is saved includes the measured star brightness, the angle of the group from the zenith, the time, and a correction to apply as if the star had been observed from the position of the sun rather than from earth. One set of actual data taken one night on our example group, HR 4430, is shown in the text box.

The next group to be observed is then selected. It is again the group that will set first and has not yet been observed. If every group in the 45-degree cone above the telescope has already been observed once, the system will start observing them a second time. Of course, as the earth turns, new groups keep coming into the observing cone from the east. If the observing program has the optimum number of groups in it and the groups are not too highly clustered together, the system will not miss groups that come within the observing cone, but it will not observe many for a second time. Although the searching and centering appears complex, it is done considerably more quickly by the automatic system than can be done manually. (Human observers usually skip the reobserving portion of the program and go have a cup of coffee.)

Between each group the program calculates the position of the sun; if it is less than 10 degrees below the horizon, the system moves the telescope to its rest position and shuts down. If, during the course of the night, the system cannot locate a star, it reinitializes its position and moves to the next group. If this occurs four times in succession, either it is hopelessly cloudy or there is a mechanical malfunction, in which case it also shuts the system down.

#### DATA REDUCTION, ANALYSIS, AND PUBLICATION

Reduction is a highly repetitious process involving a great deal of mathematical computation. It calculates the

differences in brightness between the variable and comparison stars and between the check and comparison stars. The difference between the check and comparison star should be constant and provides a way to detect comparison stars that are variable. Corrections are applied to account for the background glow of the sky, atmospheric attenuation, nonlinearities in the detector, and deviations in the color response of the system from that of the standard system. Repeated observations within a group are averaged together. If no measurement errors have occurred and the comparison star is stable, the reduced values of the variable star minus the comparison star represent the true changes in the brightness of the variable star.

Currently, we allow the data to accumulate for three months and then reduce it all at one time. After a week's data is gathered from the telescope, it is transferred to a high-density disk that can store about one month's raw data. Other than the changing of disks, the data-reduction process has been completely automated.

The primary output of the data-reduction program is a tabulated list of the brightness differences along with the time of the measurement and the mean error in the measurement. Measurements that have excessive internal inconsistencies are automatically thrown out.

"Quick look" plots of brightness changes versus time are produced by the system, and it is on such plots that a human first knows that a suspected variable star is really variable. While useful in analyses, such plots made on a printer are not of sufficiently high quality to publish in most journals, and human graphic art must still take the final step. At the operator's request, a particular program can plot the data by phase rather than date if the period of a star's variation is known, and another program can detect periodic variations in the data.

For our example star, the final "product" was a paper coauthored by Boyd, Genet, and Hall in the July 6,

### Measurements with excessive internal inconsistencies are thrown out.

1984, issue of the *Information Bulletin of Variable Stars* (IBVS), an international publication received by all variable star researchers. The light curve of the new variable has been reproduced with the permission of the IBVS editor, Dr. Bela Szidél of Konkoly Observatory, Budapest, Hungary.

#### SOFTWARE AND HARDWARE IMPLEMENTATION

Microware's OS-9 operating system and the BASIC-09 high-level language are used in this system. BASIC-09 is a structured language with most of the good points of both BASIC and Pascal. Of the many good features of OS-9 and BASIC-09, one that was particularly important to this project was the use of position-independent code, which allows executable modules to be loaded anywhere in memory without recompiling. Also, BASIC-09 allows passing of parameters between modules and to assembly-language modules using pointers. This feature made the use of completely software-driven stepper motors practical. Further, BASIC-09 allows programs to be edited, traced, and debugged prior to compilation, easing the job of optimizing hardware performance.

The program is broken into tasks and subtasks, each with its own position-independent code module. Each module performs a specific task. For example, one module calculates the coordinates of the sun, given the date, time, and observer's location. Another calculates the number of steps required to move between specific coordinates. Modules call other modules as required, and modules may be released from memory if they are no longer needed, freeing memory space for other modules. The pro-

(continued)

*The highly productive automated observatory still requires human attention.*

gram to operate the telescope and gather data uses approximately 40 modules.

A Peripheral Technology PT-69 single-board computer forms the heart of the telescope control system. This computer features a 6809E processor, 56K bytes of RAM (random access read/write memory), a clock/calendar, two serial ports, two 8-bit parallel ports, and a 2797 floppy-disk controller. The computer is used "stock" except for replacing the PIA (peripheral interface adapter) chip

with an address decoder and bidirectional buffer on a DIP (dual in-line package) header to provide direct access to several memory locations.

The rest of the control system electronics is contained on a small wire-wrapped board that consists of a counter-timer chip to count the pulses from the photometer, output latches for the stepper motors, input buffers for the limit switches, weather detectors, and manual controls used during alignment. The power-handling circuits for the stepper motors use a switching constant-current source and allow up to a five-times overvoltage to the motor during high-speed operation.

The hardware just described is actually a third-generation design being assembled as part of a joint Vanderbilt University-Fairborn Observatory program under the auspices of the National Science Foundation. An

Optec photometer is being used because its solid-state photodiode detector, which is sensitive in the visual, red, and near-infrared portions of the spectrum, is well suited to observations of the relatively cool RS Canum Venaticorum stars. A small stepping motor changes the filters through a rack-and-pinion mechanism. The telescope being used is a 16-inch diameter DFM Engineering unit employing very rigid aluminum castings and a stiff, backlash-free friction-drive system, which is ideal for computer control.

**KEEPING IT GOING RIGHT**

While this automated observatory is highly productive, easily outproducing most manually operated observatories, it does require human attention. There are, of course, the normal housekeeping functions, such as

*(continued)*

**Classy Chassis**

**3315**  
5" Floppy/Winchester  
7 Cards \$417\*

**3310**  
5" Floppy/Winchester  
4 Cards \$387\*

**3002T**  
5" Floppy/Winchester  
10 Cards \$565\*

**3307**  
8" Floppy/5" Winchester  
7 Cards \$494\*



**MAIN/FRAMES & DISC ENCLOSURES FROM \$100**

LASER 3000 DISC/COVERS (not shown)

**3916F** 5" Floppy \$100\*      **3915** 2 ea. 5" Winchester \$199\*

(Disk drives not included)

\*1 piece; prices lower in quantity.



RESEARCH CORPORATION

8620 Roosevelt Ave./Visalia, CA 93291 209/651-1203

**AMPRO**  
**"Little Board"**  
**MAIN/FRAMES**  
6 Models from **\$125\***

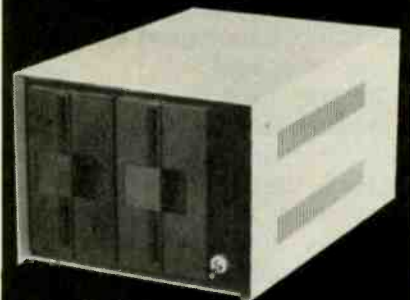

**\$150** (1 piece\*)  
**MODEL 2800**

Includes power supply & fan

(Disk Drives and Little Board not Included)

AMPRO & Little Board are TM AMPRO computers.



RESEARCH CORPORATION

8620 Roosevelt Ave./Visalia, CA 93291

209/651-1203



HELP Menu



Set Register



Phone Directory

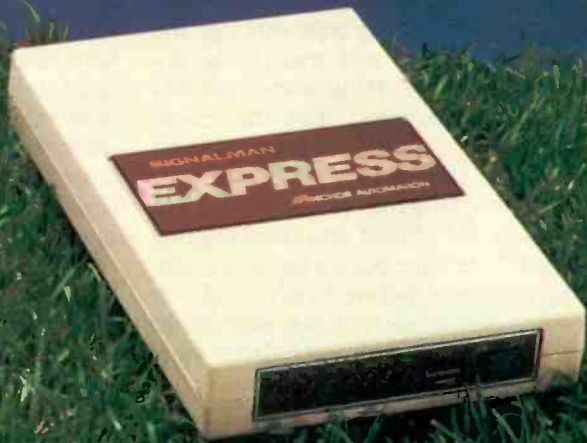

# MODEMS WITH A VIEW

Now Anchor gives you three ways to keep your eye on what our Signalman Lightning 24 or Signalman Express is up to.

**HELP Menu**—Tells you what commands are initially available to you.

**Set Register**—Shows you what the set registers and dip switches are set to.

**Phone Directory**—Allows you to store up to 10 numbers, each containing 48 characters.

Screens like these are just one more reason why Anchor modems are visibly better than the rest.

Naturally, the Lightning and the Express also include all the other performance features you expect in a smart modem—AutoAnswer/AutoDial, compatible with

CCITT V.22bis and Bell 212A respectively, self test capability, the latest in CMOS circuitry, battery back-up, Hayes™ compatible and more—but at a price that's a lot less than you expect it to be.

View Anchor modems at your local computer store today. You'll like what you see. At Anchor, we believe that quality, innovation and economy can be compatible.

Anchor Automation, 6913 Valjean Ave., Van Nuys, CA 91406 (818) 997-7758

Hayes is a trademark of Hayes Microcomputers Inc.

**ANCHOR AUTOMATION**  
A Leader in Modem Technology

Inquiry 33 for End-Users. Inquiry 34 for DEALERS ONLY.

cleaning the telescope's mirrors. Because the telescope spends so much time in operation exposed to the sky, cleaning and lubrication need to be done somewhat more often than would otherwise be the case.

While the system has been highly reliable, finding tens of thousands of stars with no known errors, it has had a few interesting problems and failures. On February 29, 1984, it refused to find any groups although the sky was clear and everything appeared to be working properly. It was finally determined that the clock/calendar (in the first-generation system) had not been set for leap year, throwing the system off 1/365 of a circle, or almost an entire degree. And there have been a few more subtle problems that were only caught on close examination by the astronomer (Douglas Hall), such as a half-day error in the initial reduction of data. The

software was corrected and the data reduced again.

It has been vital that the end user of the data take an active part in assuring that the system is doing what it is supposed to do. In spite of the fact that the system immediately started producing large amounts of very usable data, it has seemed prudent to develop self-checks of increasing sophistication. While from a superficial viewpoint the software and hardware seem simple for an essentially fully automatic system, the number of things that the astronomer using this system must do correctly is large, and thus the appearance of simplicity is perhaps deceptive. Much of what the user must learn for proper operation is learned by personal experience, and it appears that a close and continuing association between the system, its engineer, and the astronomical end user is required.

While much of the process has been automated, the need for human participation has in no way been eliminated. What, then, has been gained?

What has been gained, of course, is greatly increased productivity. Not only can an automatic system greatly outproduce nonautomatic systems, but a single experienced engineer can easily take care of a number of systems at one location with time to develop new systems and techniques. And everybody gets to sleep at night! ■

**ACKNOWLEDGMENTS**

My thanks to Russell M. Genet, who helped think through many of the fine points of this process and this article, to Richard and Helen Lines, who provided the original catalyst for the project, and to the Vanderbilt University astronomer Douglas S. Hall, whose astronomical research has primarily occupied this automatic system.

**Modula-2 for only \$150**



Modula-2, the brain child of Niklaus Wirth, is fast becoming the next major programming language. This state-of-the-art language is now available for your Apple Macintosh or IBM PC computer.

**The advantages:**

- Structured programming language
- Separate compilation with strong type checking
- Module version checking
- Optional run time range checking
- Eliminates many Pascal deficiencies

**The contents:**

- Full Wirth Modula-2 compiler
- Library modules for I/O and math routines
- Software development environment and tools
- Extensive documentation with index and sample programs

No developer fees. Disks not copy-protected.

To order, call toll-free:  
**1-800-545-4842**  
Have charge card ready.

**MODULA CORPORATION**

Modula Corporation  
950 North University Avenue  
Provo, Utah 84604  
(801) 375-7400

© 1985 Modula Corporation. Allow 4-6 weeks for delivery.

**READ AMERICA'S NUMBER 1 NON-SELLER.**



Not for sale in any bookstore! Not available at any price!  
The bold new booklet that has thousands of Americans writing to Pueblo, Colorado.  
With all the color and excitement of the last catalog, the Consumer Information Center of the U.S. Government unveils the paperback version of the newest Consumer Information Catalog.  
At last, here's the newest edition of the free catalog that lists over 200 helpful Federal publications, more than half of them free.

Publications with inside information on home repairs, money management, Nutrition. And more.  
Information that could help you to a better way of life. So don't delay! Act today! Send no money to get your free copy.  
Just write:  
**CONSUMER INFORMATION CENTER, DEPT. E PUEBLO, COLORADO 81009**

General Services Administration

# Introducing the MIX Editor

(with Split Screen - both horizontal and vertical)

A Powerful Addition To Any Programmer's Tool Box

Full Screen Editing  
WordStar Key Layout  
Custom Key Layouts  
Terminal Configuration  
Help Files  
Backup Files

Introductory Offer  
Only

# 29<sup>95</sup>

30 Day Money Back Guarantee

Programmable  
Macro Commands  
Custom Setup Files  
Mnemonic Command Mode  
Multiple File Editing  
Split Screen Editing

For PC DOS/MSDOS (2.0 and above/128K) • IBM PC/Compatibles, PC Jr., Tandy 1000/1200/2000, & others  
For CPM80 2.2/3.0 (Z80 required/64K) • 8" SSSD, Kaypro 2/4, Osborne 1 SD/DD, Apple II, & others

## Great For All Languages

A general purpose text processor, the MIX Editor is packed with features that make it useful with any language. It has auto indent for structured languages like Pascal or C. It has automatic line numbering for BASIC (255 character lines). It even has fill and justify for English.

## Terminal Configuration

A utility for defining terminal features (smart features included) allows the editor to work with any terminal. Over 30 of the most popular terminals are built-in.

## Custom Key Layouts

Commands are mapped to keys just like WordStar. If you don't like the WordStar layout, simply change it. Any key can be mapped to any command. You can also define a key to generate a string of characters, great for entering keywords.

## Split Screen

You can split the screen horizontally or vertically and edit two files simultaneously.

## Macro Commands

The MIX Editor allows a sequence of commands to be executed with a single keystroke. You can define a complete editing operation and perform it at the touch of a key.

## Custom Setup Files

Custom keyboard layouts and macro commands can be saved in setup files. You can create a different setup file for each language you use. The editor automatically configures itself using a setup file.

## Command Mode

Command mode allows any editor command to be executed by name. It is much easier to remember a command name versus a complicated key sequence. Command mode makes it easy to master the full capability of the editor. Frequently used commands can be mapped to keys. Infrequent commands can be executed by name.

## Editor Commands

The editor contains more than 100 commands. With so many commands, you might think it would be difficult to use. Not so, it is actually extremely simple to use. With command mode, the power is there if you need it, but it doesn't get in your way if you don't. Following is a list of some of the commands.

## Cursor Commands

Left/Right/Up/Down  
Tab Right/Tab Left  
Forward Word/Backward Word  
Beginning of Line/End of Line  
Scroll Up/Scroll Down  
Window Up/Window Down  
Scroll Left/Scroll Right  
Top of File/Bottom of File  
•••

## Block Commands

Copy/Move/Delete  
Read/Write  
Lower Case/Upper Case  
Fill/Justify  
Print

## File Commands

Directory (with wild cards)  
Show File/Help File  
Input/Output File  
Delete File/Save File

## Other Commands

Split Screen/Other Window  
Find String/Replace String  
Replace Global/Query Replace  
Delete Line/Undelete Line  
Delete Word/Undelete Word  
Insert Mode/Overwrite Mode  
Open Line/Join Line  
Duplicate Line/Center Line  
Set Tab/Clear Tab  
•••

**MIX** software (214) 783-6001  
2116 E. Arapaho  
Suite 363  
Richardson, Tx 75081

MSDOS is a trademark of Microsoft  
PCDOS is a trademark of IBM  
CPM80 is a trademark of Digital Research  
WordStar is a trademark of MicroPro

To Order: Call Toll Free 1-800-523-9520

Mix Editor \_\_\_ \$29.95 + shipping (\$5 USA/\$10 Foreign) Texas residents add 6% sales tax

Visa \_\_\_ MasterCard \_\_\_ Card # \_\_\_ Exp. Date \_\_\_

COD \_\_\_ Check \_\_\_ Money Order \_\_\_ Disk Format \_\_\_

Computer \_\_\_ Operating System: MSDOS \_\_\_ PCDOS \_\_\_ CPM80 \_\_\_

Name \_\_\_

Street \_\_\_

City/State/Zip \_\_\_

Country \_\_\_

Phone \_\_\_

**MIX** software  
2116 E. Arapaho  
Suite 363  
Richardson, Tx 75081  
Dealer Inquiries Welcome  
Call (214) 783-6001

BT

# COMPUTER MAIL ORDER

## THE CMO ADVANTAGE

- ✓ THE BEST PRICES!  
We will meet or beat any qualified price you find.
- ✓ Next day shipping on all in stock items.
- ✓ Free easy access order inquiry.
- ✓ Orders from outside Pennsylvania and Nevada save state sales tax.
- ✓ Free technical support with our factory trained technical staff.
- ✓ There is no limit and no deposit on C.O.D. orders.
- ✓ There's no extra charge for using your credit card. Your card is not charged until we ship.
- ✓ No waiting period for cashiers checks.
- ✓ We accept purchase orders from qualified corporations. Subject to approval.
- ✓ Educational discounts available to qualified institutions.
- ✓ FREE CATALOG MEMBERSHIP.

## ORDER LINE

**1-800-233-8950**  
In PA 1-800-242-4215  
**CUSTOMER SERVICE & TECH SUPPORT**  
1-717-327-1450  
Dept. A107

## MAILING ADDRESS

**EAST**  
Dept. A107, 477 E. Third St.  
Williamsport, PA 17701

**WEST**  
Dept. A107, P.O. Box 6689  
Stateline, NV 89449



MEMBER DIRECT MARKETING ASSOCIATION

## CREDIT CARDS

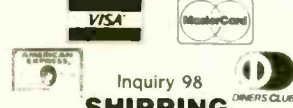

Inquiry 98  
**SHIPPING**

Add 3% minimum \$5.00 shipping and handling on all orders. Larger shipments may require additional charges.

All items subject to availability and price change.

Returned shipments may be subject to a restocking fee.

## CANADIAN ORDERS

**1-800-268-3974**  
Ontario/Quebec

**1-800-268-4559**  
Other Provinces

**1-416-828-0866**  
In Toronto

**TELEX: 06-218960**

2505 Dunwin Drive,  
Mississauga, Ontario  
Canada L5L1T1

All prices shown are for U.S.A. orders.  
Call The Canadian Office for Canadian prices.

## HOME COMPUTERS

### APPLE

APPLE IIe.....	CALL
APPLE IIc.....	CALL
MacINTOSH.....	CALL
IIc LCD Display.....	CALL

### Macintosh Software

Lotus Jazz.....	CALL
Microsoft Excel.....	CALL
Microsoft Business Pak.....	\$375.00
<b>Living Videotext</b>	
ThinkTank 512.....	\$159.00
<b>Manhattan Ready, Set, Go.....</b>	\$79.99
<b>Creighton Development</b>	
Mac Spell.....	\$69.99
<b>Monogram Dollars &amp; Sense.....</b>	\$99.99
<b>Peachtree Back to Basics - GLS.....</b>	\$109.00
<b>PFS File &amp; Report (New Version).....</b>	\$129.00
<b>Silicon Beach Airborn.....</b>	\$25.99



<b>130XE (128K).....</b>	<b>CALL</b>
<b>520ST (512K).....</b>	<b>CALL</b>

### ATARI 600XL CLOSEOUT \$49.99 WHILE SUPPLIES LAST

800XL 64K.....	CALL
850 Interface.....	\$119.00
1010 Recorder.....	\$49.99
1020 Color Printer.....	\$79.99
1025 Dot Matrix Printer.....	\$199.99
1027 Letter Quality Printer.....	\$269.99
1030 Direct Connect Modem.....	\$59.99
1050 Disk Drive.....	\$179.99
Touch Tablet.....	\$64.99
7097 Atari Logo.....	\$69.99
4018 Pilot (Home).....	\$57.99
5049 VisiCalc.....	\$49.99
4011 Star Raiders.....	\$12.99
4022 PacMan.....	\$16.99
8036 Atari Writer.....	\$79.99

### BOARDS FOR ATARI

Axton 32K.....	\$39.99
Axton 48K (400).....	\$69.99
Axton 128K.....	\$269.99
Microbits 64K (600).....	\$109.00
Bit 3 Full View 80.....	\$229.00



<b>NEW</b>	
<b>Commodore 128, LCD..CALL</b>	
SX-64 Portable.....	\$499.00
Commodore Plus 4.....	\$199.00
CBM 64.....	\$149.00
C1541 Disk Drive.....	\$199.00
C1530 Datasette.....	\$39.99
M-801 Dot Matrix Printer.....	\$189.00
M-802 Dot Matrix/Serial.....	\$219.00
MCS 803 Dot Matrix.....	\$179.00
C1802 Color Monitor.....	\$199.00
C1660 Auto Modem.....	\$59.99
DPS 1101 Daisy Printer.....	\$399.00

### Professional Software

Fleet System II w/Spell.....	\$49.99
Trivia Fever.....	\$29.99
Word Pro 4 Plus/5 Plus each.....	\$239.00
Info Pro.....	\$179.00
Administrator.....	\$399.00
Power.....	\$69.99



File (64).....	\$59.99
Report (64).....	\$49.99

### Precision Software

Superbase 64.....	\$54.99
-------------------	---------

### BATTERIES INCLUDED

PaperClip w/Spell Pack.....	\$79.99
The Consultant DBMS.....	\$69.99
Bus Card II.....	\$139.00
80 Col Display.....	\$139.00

## PORTABLE COMPUTERS



41CV.....	\$189.99
41CX.....	\$249.99
HP 71B.....	\$419.99
HP 11C.....	\$62.99
HP 12C/15C/16C.....	\$89.99
HP 75D.....	\$999.99
HPIL Module.....	\$98.99
HPIL Cassette or Printer.....	\$359.99
Card Reader.....	\$143.99
Extended Function Module.....	\$63.99
Time Module.....	\$63.99

We stock the full line of HP calculator products

### NEC

PC-8401.....	CALL
PC-8201 Portable Computer.....	\$289.00
PC-8231 Disk Drive.....	\$599.00
PC-8221A Thermal Printers.....	\$149.00
PC-8281A Data Recorder.....	\$99.99
PC-8201-06 8K RAM Chips.....	\$105.00

### SHARP

PC-1350.....	\$159.99
PC-1261.....	\$159.99
PC-1260.....	\$109.99
PC-1500A.....	\$165.99
PC-1250A.....	\$88.99
CE-125 Printer/Cassette.....	\$128.99
CE-150 Color Printer Cassette.....	\$171.99
CE-161 16K RAM.....	\$134.99

## DRIVES

### HARD ALLOY

PC Stor.....	CALL
--------------	------

### EVEREX

Hard Drives.....	CALL
Tape Back Up.....	CALL



5 meg Removable/Internal.....	\$1399.00
10 meg Fixed/Internal.....	\$1249.00
15 meg 5 Removable/10 Fixed.....	\$2149.00
25 meg 5 Removable/20 Fixed.....	\$2499.00



10 Meg Bernoulli Box.....	\$2099.00
20 meg Bernoulli Box.....	\$2649.00
5 meg "MacNoulli".....	\$1599.00



10 meg Internal.....	\$699.00
----------------------	----------



12, 25, 35, 50, 80 meg (PC)	
.....	from \$1499.00

## FLOPPY



Apple GT.....	\$209.00
Atari GT.....	\$239.00
C-64 GT.....	\$259.00



A1.5 Apple.....	\$199.00
A2 Apple.....	\$199.00



SD1 C-64 Single.....	\$219.00
SD2 C-64 Dual.....	\$469.00



320K 5 1/4" (PC).....	\$119.00
-----------------------	----------



320K 5 1/4".....	\$99.99
------------------	---------

## MODEMS



Volksmodem.....	\$59.99
Volksmodem XII.....	\$189.99
Mark II Serial.....	\$79.99
Mark VII (Auto Ans/Auto Dial).....	\$99.99
Mark XII (1200 Baud).....	\$259.00



Smartmodem 300.....	\$145.00
Smartmodem 1200.....	\$389.00
Smartmodem 1200B.....	\$359.00
Smartmodem 2400.....	\$699.00
Micromodem IIe.....	\$249.00
Smart Com II.....	\$89.99
Chronograph.....	\$199.00
Transet 1000.....	CALL



Reach 1200 Baud Half Card.....	\$399.00
--------------------------------	----------



MPP-1000E AD/AA (Atari).....	\$79.99
MPP-1064 AD/AA (C-64).....	\$69.99



Smart Cat Plus.....	\$319.00
J-Cat.....	\$99.99
Smart Cat 103/212.....	\$369.00
Novation 2400.....	CALL
212 AutoCat II.....	\$499.00
Apple Cat II.....	\$229.00
212 Apple Cat II.....	\$379.00
Apple Cat 212 Upgrade.....	\$229.00
Macmodem.....	\$319.00

### TELELEARNING

C64 300 Baud.....(Closeout).....	\$49.99
----------------------------------	---------



ZT-1.....	\$339.00
ZT-10.....	\$309.00
ZT-11.....	\$369.00
Z-22 Video Data Terminal.....	\$529.00

## DISKETTES



3 1/2" SS/DD.....	\$39.99
3 1/2" DS/DD.....	\$54.99
5 1/4" MD-1 w/Hardcase.....	\$17.99
5 1/4" MD-2 w/Hardcase.....	\$23.99
5 1/4" MD-2-HD for AT.....	\$44.99



5 1/4" SS/DD.....	\$21.99
5 1/4" DS/DD.....	\$29.99
Disk Analyzer.....	\$24.99

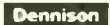

Elephant 5 1/4" SS/SD.....	\$13.99
Elephant 5 1/4" SS/DD.....	\$15.99
Elephant 5 1/4" DS/DD.....	\$16.99
Elephant EMSP 5 1/4".....	\$24.99



5 1/4" Disk Head Cleaner.....	\$14.99
-------------------------------	---------

## DISK HOLDERS

### INNOVATIVE CONCEPTS

Flip-In-File 10.....	\$3.99
Flip-In-File 50.....	\$17.99
Flip-In-File 50 w/lock.....	\$24.99
Flip-In-File (400/800 ROM).....	\$11.99



50 Disk Tub 5 1/4".....	\$9.99
30 Disk Tub 3 1/2".....	8.99

## GRAPHICS

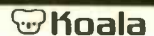

IBM.....	\$89.99
Apple/Franklin.....	\$79.99



Palette.....	\$1299.00
--------------	-----------

# CALL TOLL-FREE



**MONITORS**

**PRINTERS**

**PC COMPATIBLES**

Inquiry 98

COMPUTER MAIL ORDER

**AMDEK**

300 Green.....	\$129.00
300 Amber.....	\$139.00
310 Amber IBM-Plug.....	\$169.00
Color 300 Composite.....	\$239.00
Color 500 Composite/RGB.....	\$389.00
Color 600 Hi-Res (640x240).....	\$399.00
Color 700 Hi-Res (720x240).....	\$499.00
Color 710 Long Phosphor.....	\$579.00



12" Amber/Green Composite.....	\$99.99
12" Amber/Green TTL.....(ea.)	\$119.00

**NEC**

JB 1260 Green.....	\$59.99
JB 1201/1205 (ea.).....	\$99.99
JB 1270 Green.....	\$139.00
JB 1275 Amber.....	\$149.00
JB 1280 G TTL/1285 A TTL.....	\$149.00
JC 1215 Color.....	\$219.00
JC 1216 RGB.....	\$379.00
JC 1460 Color.....	\$269.00
JC 1410 RGB.....	\$669.00

**PRINCETON**

MAX-12 Amber.....	\$189.00
HX-12 RGB.....	\$469.00
SR-12 RGB.....	\$629.00

"CALL ON NEW MODELS"  
HX-12e, HX-9, HX-9e, SR-12P

**TAXAN**

115 12" Green Mono.....	\$119.00
116 12" Amber Mono.....	\$119.00
121 Green TTL.....	\$139.00
122 Amber TTL.....	\$149.00
210 Color RGB.....	\$239.00
400 Med-Res RGB.....	\$299.00
410 Hi-Res RGB.....	\$339.00
420 Hi-Res RGB (IBM).....	\$429.00
440 Ultra Hi-Res RGB.....	\$589.00

**QUADRAM**

8400 Quadchrome.....	\$479.00
8410 Quadchrome II.....	\$429.00
8420 Amberchrome.....	\$179.00



ZVM 122/123.....	\$89.99
ZVM 124 IBM Amber.....	\$149.00
ZVM 130 Color.....	\$279.00
ZVM 131 Color.....	\$299.00
ZVM 133 RGB.....	\$429.00
ZVM 135 RGB/Color.....	\$459.00
ZVM 136 RGB/Color.....	\$599.00
1220, 1230, 1240.....	CALL

**INTERFACES**

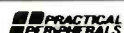

Graphcard.....	\$79.99
Serial Card.....	\$99.99
Microbuffer II +.....	\$169.00
Microbuffer 32K.....	\$189.00



Microfazer.....	from \$139.00
Efazer (Epson).....	from \$79.99

**Orange Mikro**

Grappler CD (C64).....	\$99.99
Grappler + (Apple).....	\$89.99
Grappler 16K + (Apple).....	\$159.00

**DIGITAL DEVICES**

Ape Face (Atari).....	\$49.99
U-Print A (Atari).....	\$54.99
U-A16/Buffer (Atari).....	\$74.99
U-Call Interface (Atari).....	\$39.99
U-Print C (C64).....	\$49.99
P-16 Print Buffer.....	\$74.99

**MPP MICROBITS**

MB1150 Parallel (Atari).....	\$79.99
MPP-1150 Parallel (Atari).....	\$69.99
MP-1150XL (Atari 1200XL).....	\$69.99
MicroStuffer 64K Print Buffer.....	\$109.00

**AXIOM**

AT-100 Atari Interface Printer.....	\$139.00
AT-550 Atari Dual Mode.....	\$249.00
GP-100 Parallel Interface.....	\$189.00
GP-700 Color Printer.....	\$449.00
GP-550 Parallel Printer.....	\$239.00
Elite 5 Letter Quality.....	\$239.00
Elite 5 C64 Interface.....	\$249.00
Penman 3-pen.....	\$289.00

**CITIZEN**

MSP-10 (80 col.).....	\$349.00
MSP-15 (132 col.).....	\$499.00
MSP-20 (80 col.).....	\$489.00
MSP-25 (132 col.).....	\$679.00

**C. ITOH**

Prowriter 7500.....	\$219.00
Prowriter 8510P.....	\$299.00
Prowriter 8510 NLO.....	\$329.00
Prowriter 1550P.....	\$469.00
F10-40P Starwriter.....	\$869.00
F10-55 Printmaster.....	\$1049.00
Prowriter 8510-NLO.....	\$329.00



ComWriterII Letter Quality.....	\$399.00
---------------------------------	----------

**corona**

Lazer LP-300.....	\$2799.00
-------------------	-----------

**DIABLO**

D25.....	\$599.00
630-109.....	\$1749.00



2000.....	\$749.00
-----------	----------

**EPSON**

RX-80, FX-80 +, LX-80, JX-80.....	CALL
FX-100 +, RX-100, LQ1500.....	CALL
Homewriter 10.....	CALL
NEW! LX-90, SQ-2000, DX10, DX20, HS-80.....	CALL

**JUKI**

6100 Letter Quality.....	CALL
6300 Letter Quality.....	CALL

**NEC**

8027 Transportable.....	\$299.00
2000 Series.....	\$699.00
3000 Series.....	\$1099.00
8000 Series.....	\$1499.00
ELF 360.....	\$449.00

**OKIDATA**

84, 182, 192, 193, 2410.....	CALL
Okimate 10 (Specify C64/Atari).....	\$199.00
Okimate 20 (IBM).....	CALL

**OLYMPIA**

Needlepoint Dot Matrix.....	\$299.00
Compact RO.....	\$339.00
Compact 2.....	\$369.00

**Panasonic**

KX1090.....	\$199.00
KX1091.....	\$279.00
KX1092.....	\$409.00
KX1093.....	\$599.00



Quadjet.....	\$399.00
Liberty, Silver Quadboard, 5251 Board.....	CALL

**SILVER-REED**

500 Letter Quality.....	\$279.00
550 Letter Quality.....	\$419.00
770 Letter Quality.....	\$759.00



SB/SD/SG/SR Series.....	CALL
Powertype Letter Quality.....	CALL
SG10 (120 cps).....	\$239.00
SG15 (120 cps).....	\$399.00
SD10 (160 cps).....	\$359.00
SD15 (160 cps).....	\$479.00
SR10 (200 cps).....	\$499.00
SR15 (200 cps).....	\$639.00
Powertype Letter Quality.....	\$319.00
SB10 (NEW).....	CALL

**TOSHIBA**

1340 (80 column).....	\$599.00
P351 (132 column).....	\$1299.00

**IBM PC SYSTEMS**

**Configured to your specification. Call for Best Price!**

**IBM-PC, IBM-PC II, IBM-XT, IBM-AT**



2220 Dual Portable.....	\$1899.00
4220 Dual Desktop.....	\$1899.00

**corona**

PPC22 Dual Portable.....	\$1599.00
PPCXTA 10 meg Portable.....	\$2799.00
PC40022 10 meg Desktop.....	\$2199.00

**SOFTWARE FOR IBM**



Electronic Desk.....	\$199.00
----------------------	----------



Framework.....	\$399.00
dBase II.....	\$299.00
dBase III.....	\$389.00



Turbo Pascal 3.0.....	\$49.99
Sidekick.....	\$39.99



Get Organized.....	\$69.99
Cut-n-Paste.....	\$39.99
Music Construction.....	\$29.99
One-on-One.....	\$29.99
Financial Cookbook.....	\$34.99

**Harvard Software Inc.**

Harvard Project Manager.....	\$209.00
Total Project Manager.....	\$269.00

**Human Edge™**

Communication Edge.....	\$99.99
Management Edge.....	\$119.00
Negotiation Edge.....	\$139.00
Sales Edge.....	\$119.00

**IMSI**

PC Paintbrush.....	\$94.99
--------------------	---------



Symphony.....	\$439.00
1-2-3.....	\$309.00



WordStar 2000.....	\$249.00
WordStar 2000+.....	\$319.00



Flight Simulator.....	\$39.99
MultiPlan.....	\$129.00



Crosstalk.....	\$89.99
----------------	---------



R:Base 4000.....	\$249.00
Clout 2.0.....	\$129.00

**MultiMate**

Multi Mate.....	\$249.00
-----------------	----------



PeachPack (GL/AP/AR).....	\$199.00
---------------------------	----------



Access (NEW).....	\$79.99
Write/Graph/File/Plan.....(ea.)	\$79.99
Report.....	\$74.99
Proof.....	\$59.99
Mac Software.....	CALL

**Professional Software**

PC Plus/The Boss.....	\$249.00
-----------------------	----------

**SOFTWARE GROUP**

Enable.....	\$549.00
-------------	----------



Accounting.....	\$295.00
API/AR/GL/INV/OE.....(ea.)	\$195.00
Supercalc III.....	\$195.00
EasyWriter II System.....	\$195.00
Super Project.....	\$195.00

**SMI**

Open Access.....	\$379.00
------------------	----------



Word Perfect.....	\$239.00
-------------------	----------



File Manager (IBM).....	\$39.99
-------------------------	---------

**THOUGHTWARE**

Trigger.....	\$289.00
Sell, Sell, Sell.....	\$299.00
Training.....	\$299.00
Application.....	\$179.00



PC-151-21 Single Desktop.....	CALL
PC-151-52 Dual Desktop.....	CALL
PC-151-53 10 meg Desktop.....	CALL
PC-161-21 Single Portable.....	CALL
PC-161-52 Dual Portable.....	CALL
200.....	CALL
171 (Portable).....	CALL
138 (Transportable).....	CALL
148 (DeskTop).....	CALL



Safari.....	CALL
6300.....	CALL



MBC 550-2 Single Drive.....	\$699.00
MBC 555-2 Dual Drive.....	\$969.00
MBC 775 Portable.....	CALL
MBC 511 10 meg.....	CALL
MBC 675 Portable.....	CALL
NBC 880 Desktop.....	CALL

**MULTIFUNCTION CARDS**



Six Pack Plus.....	\$239.00
Mega Plus II.....	\$269.00
I/O Plus II.....	\$139.00
Memory MBII.....	\$249.00
Advantage-AT.....	\$399.00
Preview Monograph.....	\$299.00
Graph Pak Mono/64K.....	\$599.00
MonoGraph Plus.....	\$399.00
5251/11.....	\$799.00
5251/12.....	\$579.00
3780.....	\$639.00
BSC.....	\$499.00



IRMA 3270.....	\$879.00
IRMA Print.....	\$999.00

**EAGLE**

Mono Card.....(Closeout).....	\$99.99
-------------------------------	---------



Color Card (Graphics Edge).....	\$299.00
Maglc Card.....	\$199.00



Graphics.....	\$299.00
Color.....	\$169.00

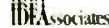

IDEAmex - ZPR, 64K, C, S, P.....	\$229.00
IDEAmini - YPR, C, S, P.....	\$189.00
IDEAminimax - MPR 128K.....	\$229.00
IDEAshare Software.....	\$219.00
IDEA 5251.....	\$699.00

**MYLEX**

The Chairman.....	\$489.00
-------------------	----------

**PARADISE**

Modular Graphics Card.....	\$274.00
Multi Display Card.....	\$289.00
Five Pack C, S.....	\$159.00



Color Plus.....	\$369.00
-----------------	----------



Captain - 64.....	\$239.00
Captain Jr. 128K.....	\$339.00
Graphics Master.....	\$469.00



Quadboard II.....	\$229.00
Expanded Quadboard.....	\$239.0

# Straight Talk.™

## The information software that keeps you on course.

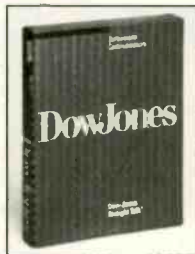

You don't go sailing without the right navigational instruments. And you don't make business decisions without the right information.

Straight Talk and your Macintosh™ give you access to a world of timely information. Fast. So you have the information you need to make informed business decisions.

### Here's what it gives you:

- Automatic log-on and log-off to major information services like, Dow Jones News/Retrieval,® The Source,™ and CompuServe.
- The latest business information and financial news, plus airline schedules and fares, an encyclopedia, electronic mail and much more.
- Ability to review, save, edit and copy data received online *after* you hang up.
- Communication with other Macintosh computers via modem or networking.

And at \$95, Straight Talk is the least expensive, most diligent electronic know-it-all you'll ever come across.

Straight Talk is the precision instrument designed to make sure your ship comes in.

### Special Offer!

For a limited time, order Straight Talk at \$95 and get 5 hours of **free time** on Dow Jones News/Retrieval (approximately \$100 value). To order, see your local computer dealer\* or call:

**1-800-257-5114**, ask for John Austin.

(In New Jersey, Alaska, Hawaii and Canada, call 1-609-452-1511)

Please have your credit card information ready, including expiration dates. VISA, MasterCard, and American Express accepted.

**Act now** — Offer expires July 31, 1985.

\*To redeem offer send proof of purchase to Dow Jones & Company, Inc., John Austin, P.O. Box 300, Princeton, N.J. 08540.

Straight Talk works with Apple® Macintosh.™

**Dow Jones**™  
**Software**  
For Informed Decisions

*"I think we turn left here."*

# ASTRONOMICAL COMPUTING WITH MICROS

BY RICHARD BOCHONKO AND WILLIAM T. PETERS

*Increasing the  
amateur astronomer's reach*

ASTRONOMERS LIVE AND DIE by computation. All aspects of astronomy deal with numbers and computations of varying degrees of complexity. Among the many problems that require a lot of computational power are the creation of models of the structure and evolution of stars, black holes, and galaxies; the synthesis of the spectra of stars; the determination of orbits of binary stars; and the determination of the positions of the sun, moon, and planets in the past, present, and future.

As astronomers, we use microcomputers by themselves and as terminals to mainframes. We use them to graphically analyze data and to prepare graphics for presentations and publication. By themselves, micros are becoming standard equipment at the telescope for equipment control, data acquisition, and initial data reduction. At our desks, we use micros for computing problems of moderate complexity, to establish and maintain databases, for teaching, and for word processing.

In addition to assisting the professional astronomer, the microcomputer has been valuable to the amateur. Until now, amateurs could not afford the powerful calculating tools that are so important to professionals. The availability of inexpensive micros with outstanding software has led to their use by amateurs at the telescope as well as at home.

If you have a micro that speaks BASIC, a good way to develop some useful programs—and to learn introductory astronomy—is with *Celestial BASIC* by Eric Burgess. (For a list of books and periodicals mentioned in this and other articles, see the "Astronomy Sources" text box on page 244.) Burgess devotes each of his 23 chapters to a brief description of an astronomical principle or phenomenon and then follows the description with a program that helps you predict or learn about the phenomenon.

*Celestial BASIC* is divided into four main sections: "Time," "The Moon," "The Planets," and "General and Tutorial." The author has chosen ex-

cellent programs, so after you have typed them in or purchased the disk with all the programs from the book's publisher, you're left with a set of utilities that replaces many of the tables in standard references like *The Observer's Handbook* and *The Astronomical Calendar*.

The "Time" section offers a perpetual calendar, a date-of-Easter program, a variety of time and date conversions, and two programs of special interest to amateur observers: Epoch, which updates star coordinates for precession (the slow change in the direction that the earth's axis points among the stars); and Pstar, which helps determine the precise position of Polaris with respect to the true North Celestial Pole. Polaris is nearly

*(continued)*

Richard Bochonko and William T. Peters are astronomers living in Winnipeg. Contact them as follows: Dr. Richard Bochonko, Department of Mathematics and Astronomy, University of Manitoba, Winnipeg, Manitoba R3T 2M8, Canada; William T. Peters, Manitoba Planetarium, 190 Rupert Ave., Winnipeg, Manitoba R3B 0N2, Canada.

## ASTRONOMICAL SOFTWARE RESOURCES

**H**ere are some of the software resources we have discovered. Keep checking the ads in astronomy magazines for new announcements, or contact the Griffith Observatory as listed for periodically compiled updates.

**BEAR CREEK SURVEY SERVICE**, 1991 Bear Creek Rd., Kerrville, TX 78028, (512) 367-4390. **Astro**: Yields altitude and azimuth of sun and 57 bright stars. (HP 41cv)

**CELESTIAL SOFTWARE**, POB 95, Dell Rapids, SD 57022. Utilities covering telescope properties, observing conditions, time, coordinates, and stellar properties.

**CELESTRON INTERNATIONAL**, POB 3578, 2835 Columbia St., Torrance, CA 90503, (213) 328-9560. Computer-controlled pointing for the Celestron line of quartz stepper-motor-controlled telescopes.

**CHESNUTT PROGRAMMING**, Rt. 5, Box 348, Fayetteville, NC 28301, (919) 588-4511. **SIDCLOCK**: Turns a Commodore 64 into an accurate sidereal clock that also displays civil and universal time. (\$15 U.S., \$18 foreign) Catalog of other astronomy programs available. (Commodore 64)

**COMMODORE BUSINESS MACHINES INC.**, 1200 Wilson Dr., West Chester, PA 19380. **Sky Travel**: Fully utilizes the Commodore 64's high-resolution graphics to display the constellations and solar system objects from any location on earth over a 20,000-year range. Available from Commodore dealers. (C-64 and disk drive)

**COMPUTER ASSIST SERVICES**, 1122 13th St., Golden, CO 80401. **The\_Sky**: Plots a graphic representation of sun, moon, planets, stars, and Messier objects given a location, time, and date. Numerous utilities included. (\$60 U.S.) (IBM PC 128K DOS 1.1 or higher; will support 8087)

**COSMIC COMPUTER WORKS**, 243 White St., Belmont, MA 02178. **Myoptics**: Optical design program generates spot diagrams for telescopes and other optical systems. **Planets**: Yields the celestial and horizon coordinates of the sun, moon, and planets, along with apparent diameter, brightness, and percentage of illumination. **Ephemeris**: Converts orbital elements for a newly discovered comet or asteroid to celestial coordinates. **Almanac**: Rising and setting information for sun and moon. Also beginning and end of twilight. **JMoons** and **SMoons**: Graphic presentations showing the positions of the moons of Jupiter and Saturn visible in small telescopes. (Apple, North Star, TRS-80, some others; disks or cassettes)

**DESIGN STUDIO SOFTWARE**, 6209 South Joshua Lane, Lantana, FL 33462. **Solar System Ephemeris**: Celestial coordinates of solar system objects to very high accuracy. (Apple)

**GRIFFITH OBSERVATORY**, 2800 East Observatory Rd., Los Angeles, CA 90027. Send a legal-size, self-addressed envelope with two first-class stamps for a directory of astronomical programs for microcomputers when this list has gone stale.

**HOPKINS PHOENIX OBSERVATORY**, 7812 West Clayton Dr., Phoenix, AZ 85033. Computerized stellar photometers and data-reduction software. (Most home computers)

**CHARLES KLUEPFEL**, 11 George St., Bloomfield, NJ 07003. **Planets**: Precise coordinates for the sun, moon, and planets. **New Orrery**: A view of the solar system looking down from the "top" for any date. Shows all nine planets. **Planetarium**: Screen plots a star map to a magnitude of 3.5 or deeper for any date and location on earth. **World Map**: Screen plot of world map shows areas experiencing daylight, darkness, moonlight. **Eclipse Map**: Accurate data for solar-eclipse paths and graphical plots of paths on

earth map. **Calendar Conversions**: Converts among Julian, Gregorian, and Jewish calendars, giving Julian Day numbers and moon phases. (Apple only)

**K & W ASTRONOMICS**, POB 2275, Orange, CA 92669. Programs to calculate coordinates of solar system objects and Messier objects. (Apple, VIC-20, Timex Sinclair, others)

**MICROTECHNIC SOLUTIONS**, POB 2940, New Haven, CT 06515, (203) 389-8383. **Astro Positions**: Provides solar, lunar, planetary, and stellar positions in geocentric, heliocentric, or topocentric coordinates. (Disk \$49.95 U.S.) (Commodore 64)

**ROBERT MOLER**, 5999 Secor Rd., Traverse City, MI 49684. Programs simulating travel at relativistic speeds, rotation of spiral galaxies, comets, and other solar system coordinates. (Timex Sinclair)

**PRENTICE-HALL INC.**, Rte. 9W, Englewood Cliffs, NJ 07632. **The Astronomy Disk**: Sheridan Simon provides 16 programs for simulating space travel, solar system and stellar phenomena. Thirty-eight-page handbook. (Apple II only)

**PUBLIC DOMAIN SOFTWARE**, POB 640, Stanley, NC 28164. **Yale Catalog of Bright Stars**: 9200 stars down to a magnitude of 6.5 with spectral, photometric, parallax, and proper-motions data. (Eight 8-inch CP/M single-sided single-density floppy disks)

**SATURN SOFTWARE**, R.R. 1, Box 673, Patterson, NY 12563. **Galilean Moons**: High-resolution simulation of Jupiter's moons. (Atari, TRS-80)

**SCHAF SOFTWARE SYSTEMS INC.**, Suite 1068, 2111-M 30th St., Boulder, CO 80301, (303) 666-5353. **TellStar II**: Solar-system object position and time conversions for amateur astronomers. Plots sun, moon, and planets on star maps. Maps include Messier objects. (Apple, IBM)

BRAD SCHAPER, 7266 Volclay Dr., San Diego, CA 92119. Public-domain astronomy disk. Lots of good stuff in every category. Good educational item. Worth study by programmers new to astronomy. (Apple only)

SCIENTIFIC COMPUTING, POB 5091, Littleton, CO 80123. *Astronomical Software I*: A menu-driven program providing date, time, and coordinate conversions. (\$19.95 U.S.) (Timex Sinclair 1000, 64K)

STARSOFT, POB 2524, San Anselmo, CA 94960. *Halley's Comet*: Coordinates for Halley's comet plus graphic views of the comet in sky and in solar system. (IBM only)

S & T SOFTWARE, 13361 Frati Lane, Sebastopol, CA 95472. *Celestial BASIC* programs as listed in the book by Eric Burgess. (Apple, Sorcerer, Timex Sinclair)

SYNERGISTIC SOFTWARE, 5221 120th Ave. S.E., Bellevue, WA 98006. *The Star Gazers' Guide*: Crude sky and constellation charts with some tests about each constellation. *The Planetary Guide*: Rough planet positions plus "pictures" plotted on the high-resolution screen and text information. (Apple II only)

UNIVERSAL MICRO PRODUCTS, POB 8067, Rolling Meadows, IL 60008-8067. Eclipse prediction, telescope mirror analysis, ray tracing, comet and minor-planet ephemerides, etc. (Commodore 64 and VIC-20)

ZEPHYR SERVICES, 306 S. Homewood Ave., Pittsburgh, PA 15208, (412) 247-5915. *Astrocalc*: Time, calendar, and coordinate conversions along with coordinates for solar-system objects. *Astro-Aid*: Forty-four data conversions and utilities including Kepler's/Newton's laws, relativity, telescope design, solar-system data, and characteristics of nearest and brightest stars. *Astrobase*: Database of 300 deep-sky objects.

a degree away from the true pole, far enough to cause problems in aligning a telescope mount if not compensated.

The "Moon" section programs yield lunar positions, phases, and eclipse dates. The "Planets" programs yield positional data, distances, angular diameters, and, where applicable, phases and elongations of the planets. Rising and setting times of the sun, moon, and planets are generated with special attention to data that will help observers find Mercury and Venus in the morning and evening twilight. *Skysat* and *Skyplot* are a particularly impressive pair of programs that use high-resolution graphics to produce horizon star maps showing the visible planets, sun, moon, and stars for a specific date, time, and location on the earth. Since this program set is highly machine-dependent, it is given in two versions (Apple and Sorcerer). Also provided is a program called *Plantf*, which locates the sun, moon, and planets among the zodiacal constellations using plots composed of ASCII (American Standard Code for Information Interchange) characters on the text screen.

Among the "General and Tutorial" programs, the ones providing information on annual meteor showers and photo-exposure information for the planets are particularly useful. There is also a pair of programs to help beginners learn the constellations.

The programs in *Celestial BASIC* are written in Applesoft, Apple's variant of Microsoft BASIC. Burgess has taken some pains to avoid using the Apple's unique features in most programs, so it isn't too hard to get them running on other machines. We know of amateur astronomers who have had good results from some of the *Celestial BASIC* programs on TRS-80s, Commodore 64s, and Ataris, although they had to make some effort to translate Applesoft's way of doing things to their machine's BASIC. Burgess originally wrote these programs on an Exidy Sorcerer. In an appendix, Burgess gives three of the more in-

teresting graphics-based programs in their Sorcerer versions. Since there is now a paucity of Sorcerer software, this book should be of special interest to Sorcerer owners interested in astronomy. *Timex/Sinclair 1000: Astronomy* is a new book from the same publisher as *Celestial BASIC* and uses similar programs that have been adapted to the T/S 1000.

The biggest advantage of *Celestial BASIC* is the open code. Burgess suggests ways to combine and modify the programs, and there is no better way to learn about something than to wade into its innards and modify it to your own purposes. In this respect, the *Celestial BASIC* programs are much better learning tools than most of the prepackaged software on the market.

While Burgess's programs are fine learning tools and information utilities for amateur astronomers, he doesn't discuss the source and quality of the algorithms in enough detail to satisfy a professional. Additionally, if you want similar programs in a language other than BASIC, trying to decipher the algorithms woven into Burgess's BASIC code can be tough going.

## ASTRONOMY FUNDAMENTALS

Until recently there was no collected source for the fundamental algorithms related to time, the calendar, and the positions and properties of solar system objects. Jean Meeus has done both amateur and professional astronomers a great service by looking through a wide variety of ancient and obscure sources and bringing the best of the material together in his *Astronomical Formulae for Calculators*. Since *Celestial BASIC* was written around the same time as *Astronomical Formulae*, Burgess didn't have access to Meeus's fine algorithms. Instead, Burgess often used algorithms of lower quality and more limited range.

Regrettably, Meeus seldom gives his source for the algorithms. However, he provides a clear and definitive discussion of the formulae with implementation hints and sample runs for Hewlett-Packard calculators. Meeus provides the formulae and general

(continued)

computational methods, rather than Hewlett-Packard listings, so these algorithms are equally accessible to everyone who can program. This book really opens the way for amateur astronomers to proceed into computational astronomy and is equally useful to the professional who needs to compute temporal, calendric, or solar system phenomena.

Many of the algorithms in *Astronomical Formulae* can be implemented in a few lines of code. However, those that yield good positions for the sun, moon, and planets can grow into complex monstrosities. Roger Sinnott, proprietor of Cosmic Computer Works, an astronomical software house in Belmont, Massachusetts, has implemented these algorithms in a very elegant program called Planets. At \$25 (last time we checked) the program is a bargain, and its open code

is well worth a careful examination. Sinnott supplies Planets and a number of other superb programs in BASIC on disks or cassettes for Apple, TRS-80, and North Star computers.

Planets yields the celestial position and apparent size, brightness, and phase (if applicable) of the sun, moon, and planets. When the user supplies the latitude and longitude, the program provides altitudes and azimuths—a handy feature, since astronomers are frequently called upon to provide solar altitudes and azimuths for other professionals. We have used Planets to provide this kind of data to architects building solar-collection features into houses, satellite-dish installers, weather scientists, and lawyers.

In addition to very well organized and structured code, Sinnott has taken great care to avoid the pitfalls

presented by the limited-precision binary floating-point numbers common to most BASICs. For example, he splits Julian Day numbers into their integer and fraction parts to effectively provide double precision. In addition, he traces the fundamental constants given in the Meeus algorithms to their sources and compares the results of the program with the standard mainframe-generated tables to verify their validity over a range exceeding 3000 years. This is one of the few really well documented astronomy programs available.

#### STAR AUTHORITY

In Canada, Great Britain, and the United States, the official source of astronomical data is the *Astronomical Almanac*. The compilers of the *Almanac* provide two publications that are a gold mine for advanced programmers. The *Explanatory Supplement* discusses in great detail, with a complete list of sources, the methods used to generate the book's superbly accurate tables. The *Almanac for Computers* is designed to help users of small computers generate positions for the sun, moon, and planets with accuracy comparable to the tables in the *Astronomical Almanac*. There is a penalty for this extreme accuracy. The equations have limited range, typically a month for the planets and five days for the moon. A different set of coefficients must be provided for the equations for each period, so programs using these equations must store quite a bit of data. Like the *Astronomical Almanac*, the *Almanac for Computers* is published yearly, and each year the data it provides for each object must be updated in the programs. However, this is the way to go if you require *Astronomical Almanac* accuracy and you don't want to flip through all the pages. In addition, the *Almanac for Computers* offers the best discussion and method for calculating sunrise and sunset that we've seen.

In the microcomputing world, a directory like the one we provide (see the "Astronomical Software Resources" text box on page 240) can go out of date rapidly. Fortunately,

## REFERENCES FOR COMPUTATION

*Compact Numerical Methods for Computers* by John C. Nash. Adam Hilger Ltd., Techno House, Redcliffe Way, Bristol, England BS1 6NX. A good section on machine and number characteristics precedes a concise discussion of problems in linear algebra, matrixes, non-linear equations, and other topics. Helps to select methods appropriate for micros.

*Computer Approximations* by John F. Hart, E. W. Cheney, Charles L. Lawson, Hans J. Maehly, Charles K. Mesztenyi, John Rice, Henry G. Thatcher Jr., and Christopher Witzgall. John Wiley & Sons Inc., 605 Third Ave., New York, NY 10158. A lot of authors, but they all deserve credit for providing the fundamental source of polynomial approximations for the standard trigonometric and mathematical functions.

*Floating-Point Computation* by Pat H. Sterbenz. Prentice-Hall Inc., Rte. 9W, Englewood Cliffs, NJ 07632. Good functions require a good underlying system of arithmetic. A must for language writers teaching machines to add, subtract, multiply, and divide.

"Improved Trigonometric Functions for CBASIC-80" by Robert Lurie. *Microsystems*, vol. 4, no. 12, December 1983, pages 130-132. Uses algorithms from *Computer Approximations* to fix CBASIC-80's very poor trigonometric functions.

*Pascal User Manual and Report* by Kathleen Jensen and Niklaus Wirth. Springer-Verlag New York Inc., 175 Fifth Ave., New York, NY 10010. The fundamental source for Pascal users.

*Software Manual for the Elementary Functions* by William J. Cody and William Waite. Prentice-Hall Inc., Rte. 9W, Englewood Cliffs, NJ 07632. Implementation notes for *Computer Approximations* with FORTRAN test programs and comments on the quality of the algorithms.

"Transcendental Functions" by Hal Hardenbergh. DTACK Grounded no. 16, January 1983, and no. 18, April 1983, *Digital Acoustics*, 1475 E. McFadden Street, Suite F, Santa Ana, CA 92705. Uses the algorithms in *Computer Approximations* to implement the standard functions to 14 digits of precision on a 68000 microprocessor.

John Mosly of the Griffith Observatory (2800 East Observatory Rd., Los Angeles, CA 90027) maintains a current list of astronomical programs. To obtain the Griffith list send him a legal-size, self-addressed envelope with two first-class stamps. He has reviewed a number of these programs in an article entitled "The Universe on a MicroComputer," published in the October 1984 issue of *Griffith Observer* (vol. 48, no. 10, available from the observatory for 75 cents plus postage). The article is illustrated with graphics and screen dumps from several of the programs along with a good discussion of their features.

The best way to stay in touch with the world of astronomy is through *Sky & Telescope* magazine. The BYTE of the astronomical community, it serves both professionals and amateurs. *Sky & Telescope* advertisements list new software, and Roger Sinnott conducts a fine monthly section called "Astronomical Computing." He frequently provides short utility programs in BASIC that are very carefully crafted and discussed, and he takes care to use a version of BASIC that can be adapted to a wide variety of machines. Frequently, the "Gleanings for ATMs" (amateur telescope makers) section of the magazine, also under the direction of Sinnott, has good hardware articles about applications like the microprocessor control of telescopes or image processing.

*Astronomy* is another good magazine, directed more to an amateur and beginning astronomer audience than *Sky & Telescope*. *Astronomy* is a fine place to look for software ads, and it frequently publishes useful BASIC programs that have been very carefully crafted to be friendly to newcomers to both astronomy and computing.

Whether they're used to control a telescope, output a graph, or chart the position of a celestial object, microcomputers are changing the way amateurs and professionals alike are approaching the study of the sky. The accompanying text boxes will give you ample information to start with.

Welcome to astronomical computing. ■

FINALLY! MAIL ORDER SERVICE YOU CAN DEPEND ON!

# EXPRESS

## BUSINESS SOFTWARE

PROFESSIONAL SUPPORT PLUS RELIABLE PERSONALIZED SERVICE  
AND WE'LL STILL BEAT MOST PRICES IN THIS MAGAZINE!

<b>WORDSTAR PROPAG</b>	<b>SYMPHONY</b>	<b>SIDEKICK (C.P.)</b>	<b>SUPERCALC 3</b>	<b>WORD PERFECT</b>	<b>LOTUS 1-2-3</b>
<b>\$239</b>	<b>\$419</b>	<b>\$35</b>	<b>\$189</b>	<b>\$235</b>	<b>\$309</b>

<b>AID</b> Typequick 85 69	<b>FUNK</b> Sideways 60 39	<b>MONOGRAM</b> Dollars and Sense (IBM) 179 109 Dollars and Sense (Mac) 149 99
<b>ALPHA SOFTWARE</b> Data Base Manager 2 295 169	<b>HARVARD SOFTWARE</b> Harvard Project Mgr 395 219 Harvard Total Project Mgr 495 279	<b>MULTIMATE INTERNATIONAL</b> Multimate 495 253
<b>ANDERSON-BELL</b> Abstat 395 267	<b>HUMAN EDGE</b> Mind Prober 50 35	<b>DASIS</b> Word Plus 150 105 Punctuation and Style 150 95
<b>ASHTON-TATE</b> D Base II 495 CALL D Base III 695 CALL Framework 695 CALL Friday 295 CALL	<b>KOALA</b> Touch Tablet (PC) 150 95 MacVision 400 249	<b>PEACHTREE</b> Peachtext 5000 425 185 Business Graphics System 295 219 Peachpak 4 395 199
<b>ATI</b> Training Word Star 75 45 Training dBase III 75 45	<b>LEXISOFT</b> Spellbinder 495 239	<b>PETER NORTON</b> Norton Utilities (Vers. 3.0) 100 65
<b>BORLAND INTERNATIONAL</b> Superkey 54 42 Turbo Graph 54 42 Toolbox 54 35 Turbo Pascal 54 35	<b>LIFETREE</b> Volkswriter Deluxe 295 158	<b>PRENTICE-HALL</b> Execuision 395 289
<b>CDEX</b> Advanced Lotus 1-2-3 70 45	<b>LIVING VIDEO TEXT INC.</b> Think Tank (IBM) 195 109 Think Tank (Mac) 245 149	<b>PRO TEM SOFTWARE</b> Notebook II 189 123 Footnote 99 84
<b>CHANG LABS</b> Rags to Riches Ledger 99 79	<b>MOBS</b> Knowledgeman 500 275 K Paint 100 65 K Graph 225 145	<b>ROSESOFT</b> Prokey 130 79
<b>CONDOR</b> Condor 3 650 239	<b>MECA</b> Managing Your Money 199 119	<b>SAMNA</b> Word III 550 279
<b>CONTINENTAL SOFTWARE</b> Home Accountant Plus 150 89	<b>MICROGRAFX</b> P C Draw 395 289	<b>SORCIM</b> SuperCalc 2 295 149 Super Project 395 209 Easy System II 395 184 General Ledger 595 289 Accounts Payable 595 289
<b>DIGITAL MARKETING</b> Writers Pak 250 165 Milestone (PC) 250 165 Datebook II 150 98 Proofreader 50 38	<b>MICROPRO</b> WordStar 350 179 SpellStar 99 55 CorrectStar 145 99 MailMerge 99 55 InfoStar 250 199	<b>SOFTWARE PRODUCTS INT'L</b> Open Access 695 349
<b>DIGITAL RESEARCH</b> Concurrent PC DOS 295 209	<b>MICROSOF</b> Multiplan 195 139 Chart (MAC) 125 99 Project 250 179	<b>SOFTWARE PUBLISHING</b> PFS File or Write 140 85 SSI Word Perfect 495 249
<b>ENERTRONICS</b> Energraphics 350 239 Plotter Option 100 55	<b>MICROSTUFF</b> Extended Report Writer 150 109 Clout 250 135	<b>TELOS</b> Television (Mac) 195 119
<b>FOX &amp; GELLER</b> DGraph 295 139 dUtil 99 58 Quickcode II or III 295 139	<b>MICROSOFT</b> Multiplan 195 139 Chart (MAC) 125 99 Project 250 179	<b>TYLOG</b> dBase Window 249 149
	<b>MICROSTUFF</b> Crosstalk 195 98	<b>WARNER SOFTWARE INC.</b> The Desk Organizer 195 129
		<b>WOLF SYSTEMS</b> Move It 150 85

Free UPS shipping on orders over \$1,000.00

CALL FOR PRODUCTS YOU DON'T SEE HERE!

CALL FOR OUR FREE CATALOG

TO ORDER CALL TOLL-FREE:

(800) 235-3020 (USA)

(800) 235-3021 (CA)

(415) 382-9085

**TERMS:**

- Call for shipping charges and support policies
  - Full guarantee against manufacturers defects
  - Allow 3 weeks for checks to clear
  - Prices may change
  - Call for availability
  - No cash refunds!
- Due to our low prices, all sales final.



448 IGNACIO BLVD., STE. 332  
NOVATO, CA 94947

- SAME DAY SHIPMENT ON MOST ORDERS
- Prompt UPS service
- Authorized purchase orders accepted
- Dealer, institutional and quantity discounts available
- No surcharge for credit card purchases
- VISA & Mastercard accepted
- COD

# ASTRONOMY SOURCES

**B**YTE would like to thank the following authors for their contributions to this listing: Richard Bochonko, David S. Dixon, Russell M. Genet, and William T. Peters.

*Astronomy* magazine. Milwaukee, WI: AstroMedia Corporation.

Superb artwork and illustrations. Easy reading for students and beginners yet satisfying to old hands. AstroMedia offers a wide selection of books via mail order.

Ball, John A. *Algorithms for RPN Calculators*. New York: John Wiley & Sons, 1978.

An astronomer's collection of general-science and astronomical methods arranged for the HP-45 and other HP calculators.

Bate, Roger R., et al. *Fundamentals of Astrodynamics*. New York: Dover Publications, 1971.

Burgess, Eric. *Celestial BASIC*. Berkeley, CA: Sybex Inc., 1982.

A fine selection of BASIC programs. Especially good for those new to astronomy and computing. Disk with programs listed in the book is available from S & T Software (13361 Frati Lane, Sebastopol, CA 95472).

Burgess, Eric, and Howard J. Burgess. *Timex/Sinclair 1000: Astronomy*. Berkeley, CA: Sybex Inc., 1984.

BASIC programs for the Timex Sinclair microcomputer. Adapts material similar to that in *Celestial BASIC* to the Timex Sinclair.

Crawford, D. *Instrumentation in Astronomy*, vols. I, II, III, IV, and V. Bellingham, WA: SPIE.

Extensive series on instrumentation instruction including the use of mini- and microcomputers.

Dickinson, Terence. *Nightwatch*. Scarborough, Ontario, Canada: Firefly Books, 1983.

Not a computing book, but an excellent guide to the night sky and the world of astronomy if you need a place to start.

Duffett-Smith, Peter. *Practical Astronomy with Your Calculator*, 2nd ed. London, England: Cambridge University Press, 1981.

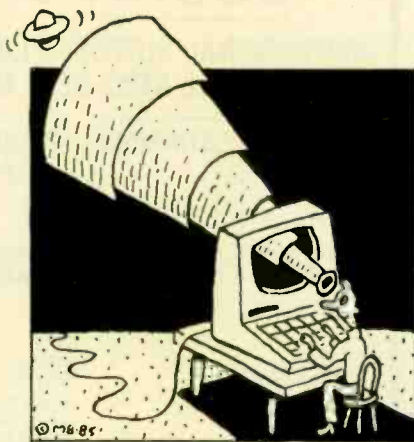

A good selection of simple algorithms that are useful when you want quick, limited-precision results.

Genet, Russell M., and Mark Trueblood. *Microcomputer Control of Telescopes*. Richmond, VA: Willmann-Bell Inc., 1985.

Genet, Russell M., ed. *Microcomputers in Astronomy*, vols. I and II. Fairborn, OH: Fairborn Observatory, 1983 and 1984. Telescope control, instrument control, data logging, and other applications. A collection of papers devoted to automatic telescope control and photometric data collection.

Genet, Russell M. *Real Time Control with the TRS-80*. Indianapolis, IN: Howard W. Sams & Co., 1982.

Data logging, instrument control, and analysis for the Radio Shack TRS-80.

Ghedini, Silvano. *Software for Photometric Astronomy*. Richmond, VA: Willmann-Bell Inc., 1982.

Reduction and analysis programs in HP BASIC. Just the thing if you want to seek meaning in the slowly varying light of pulsating or eclipsing variable stars. The HP BASIC may be a bit tough, however, to convert to other machines. Good explanations.

Hall, D., and R. Genet. *Photoelectric Photometry of Variable Stars*. Fairborn, OH: Fairborn Observatory, 1982.

Small observatory guide to photometry with some data logging and instrument control.

Henden, Arne A., and R. Kaitchuck. *Astronomical Photometry*. New York: Van Nostrand Reinhold, 1982.

Well-rounded book on photometry

including some software and interfacing.

Institute of Theoretical Astronomy. *Ephemerides of Minor Planets*. Moscow, USSR: USSR Academy of Sciences through Mezhdunarodnaja kniga, 1980, 1982, 1984.

James, M. L., et al. *Applied Numerical Methods for Digital Computation with Fortran and CSMP*, 2nd ed. New York: Harper & Row, 1977.

Jones, Aubrey. *Mathematical Astronomy with a Pocket Calculator*. New York: Halsted Press, 1979.

Keystroke sequences in both algebraic and RPN notation for problems related to time precession, proper motion, positions of solar system objects, and orbits of binary stars. Good appendix with sophisticated HP-25 and HP-67 programs mainly contributed by Jean Meeus. Methods are readily adaptable to other machines since formulae and sample problems are presented.

Klein, Fred. *Pocket Computer Programs for Astronomers*. Los Altos, CA: Klein Publications, 1983.

Handy programs for use right at the telescope. Methods for finding objects using setting circles on Dobsonian and other altazimuth-mounted telescopes. The next best thing to an automated telescope.

Marsden, Brian G. *Catalog of Cometary Orbits*. Hillside, NJ: Enslow Publishers, 1983.

Meeus, Jean. *Astronomical Formulae for Calculators*, 2nd ed. Richmond, VA: Willmann-Bell Inc., 1982.

Classic reference on the topic. There are many others, but Meeus is authoritative. The best single compendium of algorithms. Available from *Astronomy* magazine, *Sky & Telescope* magazine, and Willmann-Bell Inc.

Minor Planet Center. *Minor Planet Circulars*. Cambridge, MA: Smithsonian Astrophysical Observatory.

*The Observer's Handbook*. Toronto, Ontario, Canada: The Royal Astronomical Society of Canada (RASC). Issued annually. The standard set of tables for amateur stargazers. Many programs



seek to replace the table or offer the same type of information in a more versatile way. However, the *Handbook* is much easier to stuff into a jacket pocket than an Apple II. And its "ink-on-paper display" does not disappear at  $-40^{\circ}\text{C}$  as does a liquid-crystal display.

Ottwell, Guy. *The Astronomical Calendar*. Greenville, SC: Department of Physics, Furman University, 1983. Issued annually.

The same basic type of information as the RASC *Observer's Handbook* conveyed with Ottwell's own deep sense of appreciation for all things cosmic and their connections to our terrestrial realm. Superb hand-drawn illustrations by the author. A children's version called *The View from Earth* is also available.

*Sky & Telescope* magazine. Cambridge, MA: Sky Publishing.

A source for many of the books listed here.

Tattersfield, D. *Orbits for Amateurs with a Microcomputer*. Somerset, NJ: John Wiley & Sons (distributor), Halsted Press (publisher), 1984.

BASIC programs for orbital computations with supplemental explanations.

United States Naval Observatory, Nautical Almanac Office. *The Almanac for Computers*. Washington, DC: U.S. Government Printing Office. Available annually.

High-precision polynomial approximations for the positions of major solar system objects. Helpful introduction and discussion, though no programming examples are given. Excellent source for precise formulae for basic astronomical calculations.

United States Naval Observatory. *The Astronomical Almanac*. Washington, DC: U.S. Government Printing Office, and London, England: Her Majesty's Stationery Office. Available annually from 1981 to 1984.

Includes the standard tables referenced by astronomers and others in need of precise-time and celestial-position data. Some explanations, but refer to *The Explanatory Supplement* for all details.

United States Naval Observatory. *The Explanatory Supplement to the Astronomical Almanac*. Washington, DC: U.S. Government Printing Office, and London, England: Her Majesty's Stationery Office.

Explanations of how the official tables are made. A gold mine, but not all of the methods are adaptable to a microcomputer, and some of the explanations are hard to understand even for a professional. A scholarly work with detailed references.

Wolpert, Robert C., and Russell M. Genet. *Advances in Photoelectric Photometry*, vols. 1 and 2. Fairborn, OH: Fairborn Observatory, 1983 and 1984.

Data logging, instrument control, and some analysis.

## AN ASTRONOMY GLOSSARY

**CELESTIAL SPHERE:** Astronomy uses a coordinate system for the sky that is directly analogous to the earth's system of latitude and longitude. The celestial equator is coplanar with the earth's equator. The declination (latitude) ranges from  $+90$  degrees (north pole) to  $-90$  degrees (south pole). The celestial equator crosses the ecliptic (q.v.) at the two equinoxes. The vernal equinox serves as the prime meridian (0-hour or 24-hour) for the right ascension (longitude) of the system.

**ECLIPTIC:** The plane containing the earth's orbit around the sun, defined with respect to the first point of Aries (the vernal equinox). The ecliptic changes each year.

**EPHEMERIDES:** A table of position coordinates versus time for a celestial body.

**OBLIQUITY OF THE ECLIPTIC:** The angle between the plane containing the earth's equator and the ecliptic. The obliquity is a cyclically changing value centered on approximately 23 degrees, 27 minutes.

**ORRERY:** A mechanical model of the solar system that shows the relative positions and motions of the various bodies.

**OSCULATING ORBITAL ELEMENTS:** The Keplerian values for the theoretical orbit of a body; that is, the two-body path of an orbit. In any case where there are more than two bodies interacting in a system (such as in the solar system), the osculating orbital elements are only an approximation of the true orbital path.

**PARALLAX:** The difference in the apparent position of a celestial body due to the earth's orbiting around the sun. The major scientific argument against the Copernican model of the solar system was that there was no such observable difference in the apparent positions of stars during the year. It was not until the development of photography in the nineteenth century that the effect was measurable.

**PARSEC:** Parsec, which stands for parallax second, is a unit of astronomical distance. It is defined as the distance that a celestial body would have to be from the sun in order for an earthly observer to see a one arc-second change in its apparent position (parallax) between the vernal equinox and the autumnal equinox (or any two orbital antipodes). The value is approximately 3.26 light-years.

**RIGHT ASCENSION AND DECLINATION:** See "Celestial Sphere."

**SETTING CIRCLES:** Calibrated disks that attach to the axes of a telescope. Setting circles are an easy way to locate stars quickly. The right-ascension (see "Celestial Sphere") circle is marked in hours and minutes; the declination circle is marked in degrees. To locate a star, look up its coordinates in right ascension and declination and rotate the telescope axes to the star's indicated position.

**SIDEREAL TIME:** Sometimes called star time, sidereal time is based on the time of the earth's rotation compared to any star other than our sun. A sidereal day is divided into 24 hours, but each day is about 4 minutes shorter than a solar day. Sidereal and solar time coincide only at the instant that the sun crosses the equator at the autumnal equinox.

**STAR CLASSIFICATION:** Stars are commonly classified by spectral class as O, B, A, F, G, K, or M in order of decreasing temperature. The star's spectrum is compared to spectra in the *Yerkes Atlas of Stellar Spectra* to determine its class.

**UNIVERSAL TIME:** Another name for Greenwich Mean Time.

# PC NETWORK

## BUY HARDWARE AND SOFTWARE AT WHOLESALE + 8%, AND GET 14-30 DAY SOFTWARE RENTALS†...

In just the last few months, *The NETWORK* has saved its members more than \$24,000,000 and processed over 100,000 orders.

Listed below are just a few of the over 20,000 products available at our EVERYDAY LOW PRICES! All software below is priced in IBM-PC format.

### The nation's largest corporations depend on PC NETWORK!

On our corporate roster are some of the nation's largest financial industrial and professional concerns *including some of the most important names in the computer industry:*

- |                              |                                 |
|------------------------------|---------------------------------|
| <b>AT&amp;T</b>              | <b>General Motors</b>           |
| <b>Barclays Bank</b>         | <b>Gillette</b>                 |
| <b>Bell &amp; Howell</b>     | <b>Hewlett Packard</b>          |
| <b>Citibank</b>              | <b>Hughes Aircraft</b>          |
| <b>Columbia University</b>   | <b>IBM</b>                      |
| <b>Data General</b>          | <b>ITT</b>                      |
| <b>Exxon</b>                 | <b>Kodak</b>                    |
| <b>Farm Bureau Insurance</b> | <b>Multimate</b>                |
| <b>Frontier Airlines</b>     | <b>United Nations</b>           |
| <b>General Mills</b>         | <b>Yale University</b>          |
| <b>General Electric</b>      | <b>Veteran's Administration</b> |

plus thousands of satisfied consulting firms, small businesses, user groups, municipalities, government agencies and value-wise individuals ACROSS THE NATION! Their buyers know that purchasing or renting from PC NETWORK saves them time, money and trouble. They also count on us for product evaluation, professional consultation and the broadest spectrum of products and brands around.

## CALL TOLL FREE 1-800-621-S-A-V-E

In Illinois call (312) 280-0002

Your Membership Validation Number: **B375**

You can validate your membership number and, if you wish, place your first money-saving order over the phone by using your VISA, MASTERCARD or AMERICAN EXPRESS. Our knowledgeable service consultants are on duty Mon.-Fri. 8 AM to 7 PM, SAT. 9 AM to 5 PM CST.



**PERSONAL COMPUTER NETWORK**  
320 West Ohio  
Chicago, Illinois 60610

Call now...Join the PC NETWORK and start saving today!

### PC NETWORK • MEMBERSHIP APPLICATION

**YES!** Please enroll me as a member in the PC NETWORK™ and rush my catalog featuring thousands of computer products, all at just 8% above DEALER WHOLESALE PRICES. I will also periodically receive "THE PRINTOUT™", a special up-date on merchandise at prices BELOW even those in my wholesale catalog, and all the other exclusive, money-saving services available to Members.

**375**

I am under no obligation to buy anything. My complete satisfaction is guaranteed. Please check (✓) all boxes that apply:

- |  |  |
|--|--|
| <b>Basic Membership</b><br>With 14 Days Rental   | <b>Special V.I.P. Membership*</b><br>With 30 Days Rental.  |
| <input type="checkbox"/> One-year membership for \$8   | <input type="checkbox"/> One-year membership for \$15  |
| <input type="checkbox"/> Two-year membership for \$15 (SAVE \$1)                                       | <input type="checkbox"/> Two-year membership for \$25 (SAVE \$5)   |
| <input type="checkbox"/> Business Software Rental Library for \$25 add'l. per year—with 14 day rentals | <input type="checkbox"/> BOTH Business and Game Software Rental Libraries for \$30 add'l. per year—with 30 day rentals |
| <input type="checkbox"/> Games Software Rental Library for \$10 add'l. per year                        | *VIP members receive advance notice on limited quantity merchandise specials   |

Bill my credit card:  VISA  MasterCard  American Express

Account Number: \_\_\_\_\_

Exp. Date \_\_\_\_\_

\_\_\_\_\_ mo. \_\_\_\_\_ year

Check or money order enclosed for \$ \_\_\_\_\_

Name \_\_\_\_\_ Apt. No. \_\_\_\_\_

Address \_\_\_\_\_ City \_\_\_\_\_ State \_\_\_\_\_ Zip \_\_\_\_\_

Telephone ( ) \_\_\_\_\_

My computer(s) is:  IBM PC  IBM-XT  IBM-AT  Apple II

Macintosh  Other \_\_\_\_\_

Signature \_\_\_\_\_

(Signature required to validate membership)

Copyright © 1984, PC NETWORK, INC.

### GAMES & EDUCATIONAL SOFTWARE

(Please add \$1 shipping and handling for each title ordered from below.)

<b>Bluebush Chess (Your Toughest Opponent)</b>	Wholesale \$ 24.00*	<b>Microsoft Flight Simulator</b>	Wholesale \$ 27.00*
<b>Bluship Millionaire/Oil Baron or Tycoon</b>	31.75*	<b>Mouse Systems PC Paint-Turn your PC into A Color Macintosh!</b>	58.95*
<b>Broderbund Lode Runner</b>	19.75*	<b>Scarborough Masterype</b>	27.00*
<b>CBS Goran-Bridge Made Easy</b>	45.00*	<b>Sierra On-Line King's Quest</b>	27.00*
<b>CBS Mastering the SAT</b>	81.00*	<b>Sierra On-Line Crossin'</b>	18.00*
<b>COLEX Training for Word Star</b>	37.25*	<b>Sublogic Night Mission Pinball</b>	23.00*
<b>Comprehensive Intro to Personal Computing</b>	32.00*	<b>Spinmaker Alphabet Zoo, Kinder Comp.</b>	15.97*
<b>Davidson Math Blaster, Word Attack!</b>	28.50*	<b>Story Matching, Face Maker, Hey Diddle Diddle</b>	
<b>Hayden Sargon III</b>	28.87*	<b>Rhymes &amp; Riddles</b>	
<b>Individual Professor DOS</b>	32.50*	<b>Spinmaker Delta Drawing</b>	24.97*
<b>Individual The Instructor</b>	24.50*	<b>Spinmaker Most Amazing Thing</b>	20.77*
<b>Intocom Zork I or Witness</b>	20.50*	<b>Virtual Combines Micro Cookbook</b>	21.00*
<b>Intocom Deadline, or Suspended</b>	27.00*		

### BUSINESS SOFTWARE

(Please add \$2.50 shipping and handling for each title ordered from below.)

<b>ATI How to use Multimate</b>	\$ 42.00*	<b>Microfilm RBase 5000</b>	\$380.00*
<b>ATI How to use Microsoft, Word</b>	42.00*	<b>Micro Pro Wordstar 2000</b>	222.00*
<b>ATI How to use Lotus 1-2-3</b>	42.00*	<b>Microfilm RBase 5000</b>	380.00*
<b>Ashton-Tate dBase II</b>	310.00*	<b>Microsoft C Compiler</b>	275.00*
<b>Ashton-Tate dBase III</b>	310.00*	<b>Microsoft Word - Later Version 1.1</b>	205.00*
<b>Borland Side Kick (Protected)</b>	28.00*	<b>Microsoft Multiplan</b>	105.00*
<b>Borland Turbo Pascal</b>	25.75*	<b>Monogram Dollars &amp; Sense</b>	102.00*
<b>Borland Turbo Pascal 8087</b>	48.75*	<b>Multimate IV (Math, Latest Version)</b>	215.00*
<b>Borland Superkey</b>	34.75*	<b>Omnia The Word Plus</b>	90.00*
<b>Central Point Corp. in PC</b>	25.00*	<b>Open Systems PRO Sales AIR/INV G/L A/P Team Mgr</b>	325.00 ea.
<b>Conceptual Instruments Desk Organizer</b>	157.00*	<b>Powerbase Powerbase</b>	222.00*
<b>Digital Research CP/M-86</b>	33.00*	<b>Real World G/L A/P P/R or OE/INV</b>	345.00 ea.
<b>Digital Research DR Logo</b>	57.00*	<b>Research Prokey Version 3</b>	74.00*
<b>Digital Research Gem Desktop</b>	28.00*	<b>Rytec McFarland RM Control (Dev. System)</b>	570.00*
<b>Digital Research Gem Draw</b>	73.00*	<b>Sarnia Spring III Word Processor</b>	227.00*
<b>Emetrics Energistics with Plotter Option</b>	226.00*	<b>Satellite Software Word Perfect</b>	200.00*
<b>Funk Software Sideways</b>	34.00*	<b>Softcraft Fancy Fonts</b>	128.00*
<b>Harvard Harvard Project Manager</b>	185.00*	<b>Softstyle SET-FX</b>	35.00*
<b>Hayes Smartcom II - New VT100 Emulator</b>	88.00*	<b>Software Publishing PFS File, Write, Graph</b>	72.00*
<b>Human Edge The Management Edge</b>	137.50*	<b>Software Publishing PFS Report</b>	84.00*
<b>Human Edge The Sales Edge</b>	137.50*	<b>Sorcim SuperCalc III</b>	160.00*
<b>Human Edge Mail Processor</b>	28.75*	<b>Verbatim Disk Drive Analyzer</b>	25.00*
<b>Litewise Volkswriter Deluxe</b>	135.00*	<b>Xanoro Ability</b>	280.00*
<b>MOBS KnowledgeMan</b>	245.00*		

### HARDWARE

(Please add shipping and handling charges found in Italics next to price.)

<b>Apple Macintosh Base System</b>	CALL	<b>Apparat 256K Memory board with 64K</b>	\$ 81.00* (1.75)
<b>Apple Apple IIc</b>	CALL	<b>Apparat Combo II w/ser/print/game!</b>	115.00* (2.48)
<b>Apple Apple IIfx</b>	CALL	<b>Apparat II Ram Expansion card</b>	139.00* (2.50)
<b>Apple Apple IIc Portable Systems</b>	CALL	<b>AST Six-Pack Plus with 84K</b>	222.00* (2.50)
<b>COMPAG Hard Disk Portable</b>	\$2,285.00* (49.35)	<b>AST II/O Plus II</b>	120.00* (2.50)
<b>10MB Hard Disk/1 Floppy/256K</b>		<b>AST Advantage for AT</b>	375.00* (2.50)
<b>Compag DeskPro/Tape Backup System w/40K/1 Floppy/10MB Hard Disk/10MB Tape Drive/Monitor</b>	3,018.14* (65.20)	<b>EVEREX Magic Card 64K</b>	160.00* (2.50)
<b>DATA General DG ONE</b>	1,889.00* (43.20)	<b>Everex Six-Pack Plus - Game Port included Extra Software</b>	
<b>128K/1 Drive "The Real Portable"</b>		<b>OCHEID BIOS/Modem/4K</b>	200.00* (2.50)
<b>IBM PC Base System 205K/1 Floppy/256K</b>	1,426.02* (32.55)	<b>Quadram Improved QuadCard w/OX</b>	199.00* (2.50)
<b>IBM PC Professional Hard Disk</b>	1,888.82* (40.75)	<b>Tracker Captain Multifunction Card OX</b>	148.00* (2.50)
<b>IBM PC/AT All Configs</b>	CALL		
<b>Seymo ABC 550 "Lowest Cost Compatible"</b>	620.00* (13.30)		
<b>Seymo ABC 775 Color Portable IBM Clone</b>	1,775.00* (38.00)		
<b>2 Drives/Color Monitor/256K</b>			
<b>Texas Instruments Professional</b>	CALL		

### DISK DRIVES & CONTROLLERS

<b>Omega Bernoulli Box Dual 10MB Drives</b>	\$2,250.00* (49.14)	<b>Apparat II Ram Expansion card</b>	139.00* (2.50)
<b>PC Network 10MB Internal 1.2 Height</b>	4+9.00* (9.92)	<b>AST Six-Pack Plus with 84K</b>	222.00* (2.50)
<b>Autoboot Drive - New lower price</b>		<b>AST II/O Plus II</b>	120.00* (2.50)
<b>PC Network 10MB Internal Tape Backup</b>	475.00* (10.26)	<b>AST Advantage for AT</b>	375.00* (2.50)
<b>Same Unit used in Compag's DeskPro</b>		<b>EVEREX Magic Card 64K</b>	160.00* (2.50)
<b>Maynard WS-2 same as WS-1 but with</b>	850.00* (20.30)	<b>included Extra Software</b>	
<b>Condstar Floppy Controller (uses 1 slot)</b>		<b>OCHEID BIOS/Modem/4K</b>	200.00* (2.50)
<b>Panasonic Half Height DSDD Drive Pair</b>	145.00* (3.10)	<b>Quadram Improved QuadCard w/OX</b>	199.00* (2.50)
<b>PC Network Half Height Drives Our Volume</b>	77.50* (1.67)	<b>Tracker Captain Multifunction Card OX</b>	148.00* (2.50)
<b>Lets us Import These Brand Name Drives</b>			
<b>Direct from the Manufacturer</b>			
<b>Tandon TM 100-2 Full Height DSDD Drive</b>	83.00* (2.20)		
<b>Talgras 2MB External Hard Disk</b>	2,375.00* (51.30)		
<b>with 60MB Tape Backup</b>			
<b>Tandem TD 55-8 Half Height DSDD Drives</b>	80.00* (1.84)		
<b>Teac 1.2MB Half Height Disk Drive for AT</b>	110.00* (2.40)		

### MEMORY CHIPS

<b>64K Memory Upgrade Kits (9 chips)</b>	\$ 8.55* (1.00)	<b>Apparat II Ram Expansion card</b>	139.00* (2.50)
<b>64K Dynamic Ram Chips (Each)</b>	.95* (1.00)	<b>AST Six-Pack Plus with 84K</b>	222.00* (2.50)
<b>256K Dynamic Ram Chips (Each)</b>	5.00* (1.00)	<b>AST II/O Plus II</b>	120.00* (2.50)
<b>128K AT Mother Board Chips (Each)</b>	7.50* (1.00)	<b>AST Advantage for AT</b>	375.00* (2.50)

### MODEMS

<b>Anchor Mark XII</b>	\$ 230.00* (5.00)	<b>Apparat II Ram Expansion card</b>	139.00* (2.50)
<b>Hayes Smartmodem 300</b>	125.00* (5.00)	<b>AST Six-Pack Plus with 84K</b>	222.00* (2.50)
<b>Hayes Smartmodem 2400</b>	588.00* (5.00)	<b>AST II/O Plus II</b>	120.00* (2.50)
<b>LATEST IN COMMUNICATION TECHNOLOGY!</b>		<b>AST Advantage for AT</b>	375.00* (2.50)
<b>Hayes Smartmodem 1200 with new</b>	320.00* (2.50)	<b>EVEREX Magic Card 64K</b>	160.00* (2.50)
<b>Smartcom II VT100 Emulator</b>		<b>included Extra Software</b>	
<b>Hayes Smartmodem 1200</b>	381.25* (5.00)	<b>OCHEID BIOS/Modem/4K</b>	200.00* (2.50)
<b>Prometheus Promodem 1200</b>	279.00* (6.00)	<b>Quadram Improved QuadCard w/OX</b>	199.00* (2.50)
<b>External 100% Hayes Compatible</b>		<b>Tracker Captain Multifunction Card OX</b>	148.00* (2.50)
<b>U. S. Robotics hardware</b>	195.00* 4.00		
<b>LOWEST PR. CE 2400BPS Modem</b>			
<b>U. S. Robotics Courier 2400BPS Modem</b>	525.00* 0.00		

### MONITORS

<b>Amdel Video 300G Composite Green</b>	\$ 118.00* (3.00)	<b>Apparat II Ram Expansion card</b>	139.00* (2.50)
<b>Amdel Video 300A Composite Amber</b>	120.00* (3.00)	<b>AST Six-Pack Plus with 84K</b>	222.00* (2.50)
<b>Amdel Video 310A IBM Type Amber</b>	139.00* (3.00)	<b>AST II/O Plus II</b>	120.00* (2.50)
<b>Amdel Color 300 (NEW!) Composite</b>	215.00* (4.64)	<b>AST Advantage for AT</b>	375.00* (2.50)
<b>Amdel Color 600 (NEW!) High Res RGB</b>	386.00* (8.53)	<b>EVEREX Magic Card 64K</b>	160.00* (2.50)
<b>Amdel Color 700 (NEW!) Ultra High Res</b>	455.00* (9.83)	<b>included Extra Software</b>	
<b>Amdel Color 710 (NEW!) 700 w/infr</b>	485.00* (10.48)	<b>OCHEID BIOS/Modem/4K</b>	200.00* (2.50)
<b>Glare/Long Phosphor</b>		<b>Quadram Improved QuadCard w/OX</b>	199.00* (2.50)
<b>Princeton HX-12 RGB Monitor</b>	CALL	<b>Tracker Captain Multifunction Card OX</b>	148.00* (2.50)
<b>Princeton MAX-12E RGB/MONO</b>	CALL		
<b>Princeton SR-12 Ultra High Res RGB</b>	370.00* .8		
<b>Quadram Quadchrome - NEW</b>			
<b>640x200 RGB w/ 14" Screen</b>			
<b>Back Phosphor Mask - BM Case</b>			
<b>Samsung 12" TTL IBM Type Amber</b>	85.50* 5.00		
<b>A great looking performing monochrome</b>			
<b>from the manufacturer. IBM's own</b>			
<b>color monitor.</b>			
<b>Toscan 420 Super High Res RGB Monitor</b>	388.00* (8.21)		
<b>Toscan 440 Highest Res RGB (720x400)</b>	525.00* (11.34)		
<b>Currently Available Works With Persyst Bob Card</b>			
<b>Zenith ZVM-123 Green High Res</b>	78.00* (2.50)		
<b>(Consumer Reports Rated Best Buy!)</b>			

### VIDEO CARDS

<b>Hercules Color Card w/Parallel Port</b>	\$ 145.00* (3.20)
<b>Hercules Monochrome Graphics Cards</b>	273.00* (2.50)
<b>Paradise New Modular Multidisplay Card</b>	244.00* (2.50)
<b>Peryst Bob Card Ultra High Res Color</b>	385.00* (2.50)
<b>Card with Mono Quality, Text in Color</b>	
<b>ST Graphics Plus II NEW</b>	236.00* (5.00)
<b>(Simultaneous Mono Graphics &amp; Color)</b>	

### ACCESSORIES AND SUPPLIES

<b>Brand Name DSDD Diskettes</b>	\$ 14.00* 1.00
<b>Guaranteed for Life!! Not Generic</b>	
<b>Curious PC Restorer!</b>	32.50* (2.50)
<b>PC Network Replacement 130 Watt IBM-PC</b>	80.00* (2.70)
<b>Power Supply - Gives your PC (Old or New) the same</b>	
<b>capacity as an XT. Good for add in tape drives (without need</b>	
<b>for a piggyback unit) and large capacity disk drives</b>	
<b>SMA PC Document Keyboard Templates for 9.8"</b>	9.99* (1.00)
<b>Lotus/DBASE/Multimate and others (Each)</b>	
<b>WP Printer Paper 2600 Sheets</b>	17.00* (10.00)
<b>Microline Perfs (invisible when torn)</b>	

**TRENT BEFORE YOU BUY**—Members are eligible to join The NETWORK's Business and Game Software Rental Libraries and evaluate products for a full 14 (Regular) or 30 (VIP) days to see if it meets your needs. And The NETWORK's rental charges are far less than other software rental services—JUST 20% OF THE MEMBER WHOLESALE PRICE. We feature over 1,000 available titles in IBM Apple MAC and CP/M Formats. Hardware prices highlighted by ► reflect recent major price reductions

# COMPLETE IBM™ PC SYSTEMS

## IBM PC BASE SYSTEM IBM PC w/256K

**\$1,495.02\*** (32.55)

*Floppy Drive Controller*  
*2 Double Sided Double Density 320/360K Disk Drives*  
Your lowest cost starting point for the system of your choice. Combine it with any of the monitors, video cards, multifunction cards and accessories listed in this ad, and prove *THE NETWORK* can't be beat.

## IBM PC PROFESSIONAL HARD DISK SYSTEM IBM PC w/256K

**\$1,886.62\*** (40.75)

*Floppy Drive Controller*  
*1 Double Sided Double Density 320/360K Disk Drive*  
*w/Half Height Disk Subsystem*  
*Half Height 10MB Drive Allows Room*  
*for Addition of Tape Backup in PC!*  
*1½ times faster than XT*  
*Automatic Hard Disk Boot Feature.*

Increase productivity in any business or professional situation. The 10MB hard disk eliminates cumbersome floppy disk changes, simplifies operations and dramatically speeds program execution time. *THE NETWORK's* buying power provides you with better than XT performance at a price lower than you'd expect to pay for a standard PC.

\*PC Network Members pay just 8% above this wholesale price plus shipping. These prices have been prepared in May, 1985 and may have been changed with new product announcements. Call for latest prices.

CALL FOR  
LATEST IBM  
ANNOUNCEMENTS  
  
CUSTOM  
CONFIGURATIONS  
WELCOME

# COMPAQ™ HARD DISK SYSTEMS

## PORTABLE HARD DISK SYSTEM w/256K/1 Floppy/10MB Hard Disk

**\$2,285.00\*** (49.35)

## DESKPRO/TAPE BACKUP SYSTEM w/640K/1 Floppy/10MB Hard Disk/ 10MB Tape Drive/Monitor

**\$3,018.14\*** (65.20)

## FEATURED PRODUCTS!

▶ **64K MEMORY EXPANSION KITS** .....\$ 8.55\*  
Set of 9 chips *Guaranteed for Life. Quantity Discounts Available.*

▶ **INTERNAL PC 10MB HARD DISK** ..... 459.00\*  
*Low Power Automatic Boot works on standard PC's. Includes drive/controller cables/mounting hardware & instructions. Full one year warranty!*  
We use our clout with Brand Name suppliers like COGITO/MMI/Tandon/Fujitsu Miniscribe/Shugart and others to bring you the best products at the Lowest Price in the Business! Call on the brand of your choice.

▶ **10MB PC/COMPAQ TAPE BACKUP** ..... 475.00\*  
*The same unit as used on COMPAQ's DeskPro! Configured for internal mounting.*

▶ **LOTUS 1-2-3** ..... 265.00\*

▶ **½ HEIGHT DS/DD DISK DRIVES** ..... 77.50\*  
Just like our hard disks featured above. The Network buy's direct and makes fantastic deals with manufacturers like MPI/Tandon/CDC/Shugart/Qume/TEAC and others to bring you fantastic prices and Name Brand drives for your PC/AT/XT or Jr/or Compatible.

▶ **EPSON PRINTERS Unbelievable Low Prices!!!**  
LX-80 80COL/100CPS ..... 205.00\*  
FX-80 80COL/160CPS ..... 303.00\*  
FX-100 132COL/160CPS ..... 434.00\*

▶ **AST SIX-PACK PLUS w/64K** ..... 222.00\*

▶ **EVEREX MAGIC CARD/64K** ..... 160.00\*  
Full six Pack Features—Game Port included Extra Software *Fantastic Price!!!*

▶ **HAYES 1200B** ..... 320.00\*  
*with new Smartcom III/VT100 Emulator*

▶ **TALLGRASS TG-5025** ..... 2,375.00\*  
*25MG HARD DISK with 60 MG Tape Backup*

▶ **BRAND NAME DISKETTES** ..... 14.00\*  
DS/DD Box of 10 *Guaranteed for Life Not Generic*

▶ **TANDON TM100-2 FULL HEIGHT DRIVE** ..... 93.00\*

▶ **AMDEK V310A IBM TTL AMBER** ..... 130.00\*

\*NETWORK members pay just 8% above these wholesale prices plus shipping

CALL TOLL FREE 1-800-621-S-A-V-E (orders and memberships only)

In Illinois call (312) 280-0002 validation code B375

Inquiry 275

TM—Registered trademark of IBM and COMPAQ

# PC NETWORK

## ... WITH THESE 15 UNIQUE BENEFITS

**1 COST + 8% PRICING**—The NETWORK purchases millions of dollars in merchandise each month. You benefit in receiving the lowest price available and all at just 8% above published dealer wholesale price.

**2 OUR 600 PAGE WHOLESALE CATALOG**—Members receive our 600 page wholesale catalog containing over 20,000 hardware and software products for the IBM PC, APPLE and over 50 other popular computer systems. **THE NETWORK'S CATALOG IS THE LARGEST SINGLE COMPILATION OF PERSONAL COMPUTER PRODUCTS AVAILABLE TODAY. NOW UPDATED QUARTERLY!**

**3 IN-STOCK INSURED FAST HOME DELIVERY**—The NETWORK maintains a giant multi-million dollar inventory of most popular products, allowing us to ship many orders from stock. Non-stock items are typically maintained in local warehouses just days away from The NETWORK and YOU. We pay all insurance expenses on your shipment. **EMERGENCY OVERNIGHT SERVICE IS AVAILABLE ON REQUEST.**

**4 10 DAY RETURN POLICY**—If you are not satisfied, for any reason with any hardware component purchased from The NETWORK within 10 days of receipt, we will refund your entire purchase (less shipping) with no questions asked.

**5 MEMBERSHIP SATISFACTION GUARANTEE**—If for any reason you are not satisfied with your membership within 30 days, we will refund your dues IN FULL.

**6 EXPERIENCED CONSULTANTS**—The NETWORK hires consultants, not order takers, to aid you in product selection. Our consulting staff possesses in excess of 150 man years of personal computer product experience. **We back our consultants with our money back guarantee: IF ANY PRODUCT RECOMMENDED BY OUR CONSULTING STAFF FAILS TO PERFORM AS PROMISED—WE WILL TAKE IT BACK AT OUR EXPENSE FOR A 100% REFUND.**

**7 FREE TECHNICAL SUPPORT**—The NETWORK supports every product it sells. Our qualified TECH-SUPPORT staff will help you assemble your system, interpret vendor documentation and get your software and hardware to work. **WE WILL GIVE YOU ALL THE HELP YOU NEED, WHEN YOU NEED IT—FREE!**

† **8 OPTIONAL BUSINESS RENTAL LIBRARY**—All members can join our BUSINESS RENTAL LIBRARY featuring over 1000 available titles for just \$25 PER YEAR above the base membership fee. This entitles you to rent business software AT JUST 20% OF THE DISCOUNT PRICE FOR A 14 DAY PERIOD. If you decide to keep the software, the entire rental fee is deducted from the purchase price. **VIP MEMBERS GET A FULL 30 DAYS for just \$30 above the V.I.P. base fee. This also includes the game library privileges for a \$5 combination savings.**

† **9 OPTIONAL GAME SOFTWARE RENTAL LIBRARY**—The Game Rental library is available to members for just \$10 PER YEAR and permits evaluation (or just enjoyment) of any game or educational software product as above.

**10 SPECIAL SAVINGS BULLETINS—THE PRINTOUT**—Issued Quarterly at no charge to Network members only! The Printout contains all the New Product listings and price changes you need to keep your Catalog up to date. Also, we buy excess dealer inventories, and store bankruptcy closeouts, which we turn around and make available to our members at fantastic savings via *THE PRINTOUT.*

**11 DISCOUNT BOOK LIBRARY**—Working with numerous publishers and distributors, The NETWORK has assembled a library of over 1000 computer related books and manuals at savings of up to 75% from the normal store price.

**12 MEMBERSHIP REFERRAL BONUS**—Our most valuable source of new members is you! To date almost 40% of our members have been referred by word of mouth from other satisfied members. For those of you who refer new members, The NETWORK will credit a cash bonus to your account applicable to any future purchase.

**13 CORPORATE ACCOUNT PROGRAM**—Almost 50% of The NETWORK's members are corporate buyers and users (see opposite page left). The NETWORK can establish open account status and assign designated account managers to expedite orders, and coordinate multiple location shipments.

**14 QUANTITY DISCOUNTS**—For large corporations, clubs, and repeat or quantity buyers The NETWORK can extend additional single order discounts, when available to us from our manufacturers and distributors.

**15 PRICE PROTECTION**—The PC Industry is crazy!! Prices change not yearly or monthly or even weekly but often day by day! These changes are sometimes up but are mostly down!! **THE NETWORK GUARANTEES THAT IN THE EVENT OF A PRODUCT PRICE REDUCTION, BETWEEN THE TIME YOU PLACE YOUR ORDER AND THE TIME THE PRODUCT SHIPS YOU WILL ONLY PAY THE LOWER AMOUNT!!**

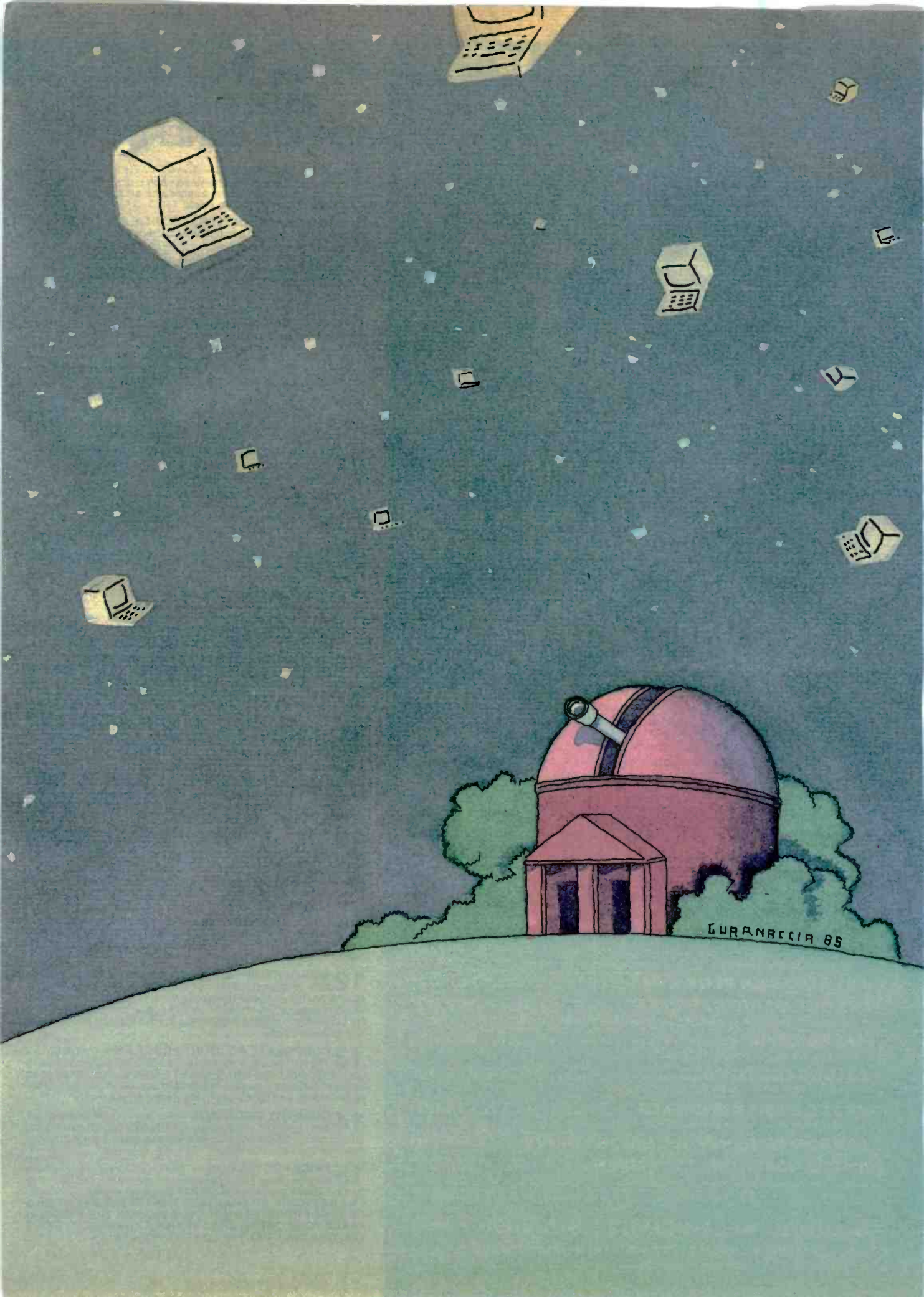

GURANACCIA 85

# Reviews

---

<b>REVIEWER'S NOTEBOOK</b> <i>by Glenn Hartwig</i> . . . . .	<b>251</b>
<b>TEXAS INSTRUMENTS' PRO-LITE PROFESSIONAL COMPUTER</b> <i>by Richard Grehan and Eva White</i> . . . . .	<b>252</b>
<b>NCR PERSONAL COMPUTER MODEL 4</b> <i>by Elaine Holden</i> . . . . .	<b>258</b>
<b>MONITORING HALLEY'S COMET</b> <i>by John E. Mosley</i> . . . . .	<b>265</b>
<b>SPACE-FLIGHT SIMULATORS</b> <i>by Benjamin Bernar</i> . . . . .	<b>269</b>
<b>MAXTHINK</b> <i>by William Hershey</i> . . . . .	<b>279</b>
<b>THE ANCHOR AUTOMATION SIGNALMAN MARK XII MODEM</b> <i>by George V. Kinal</i> . . . . .	<b>287</b>
<b>REVIEW FEEDBACK</b> . . . . .	<b>295</b>

---

ONE OF THE NEWER MEMBERS of Texas Instruments' Professional Computer line is a portable called the Pro-Lite. This briefcase-size machine uses an 80C88 processor and MS-DOS. It also features good communications capability and a number of expansion options available from TI. Richard Grehan and Eva White, two of BYTE's technical editors, team up to show you what the Pro-Lite can and cannot do.

Our other system review this month studies the NCR Personal Computer Model 4, an IBM PC-compatible that is *not* portable. You can buy the NCR in one of six configurations, choosing the one that best suits your needs. It comes bundled with several tutorial programs and features the enhanced speed of a RAM disk. Author Elaine Holden concludes that this rugged machine is a good value.

In keeping with our "Computers and Space" theme and in time for the return of Halley's comet, John E. Mosley has evaluated three comet-tracking programs. The first two packages, Starsoft's Halley and S & T Software Service's Halley's Comet, include information specific to the most famous of comets. The third program, Cosmic Computer Works' Ephemeris, is more general and very accurate. Any of these programs will give you the opportunity to practice for tracking Halley's comet this winter.

If you prefer to imagine yourself actually in space, you'll be interested in Benjamin Bernar's review of two space-flight simulation programs. Your goal in both Rendezvous and Saturn Navigator is to meet with a space station already in orbit. The decisions you have to make in these simulations mirror the complexities of space travel.

William Hershey follows up his June overview of idea processors with a review of MaxThink, an outline processor for the IBM PC. MaxThink's Thought Processing Language (TPL) is a powerful feature that lets you create programs to use as you develop a writing project.

In the communications area, our review of Anchor Automation's Signalman Mark XII indicates that this modem is not entirely Hayes Smartmodem-compatible. Although it surpasses the Smartmodem by accepting commands in upper- and lowercase and recognizing telephone signals, the Mark XII has fewer LEDs than the Hayes, no DIP switches, and only 6 of the Hayes's 17 software-loadable registers. Author George V. Kinal gives you the details.

# WordPerfect 4.0. Our highest marks yet.



Versions now available for  
**Novell Netware**  
and selected other  
Networks

**A** perfect report card. It wasn't necessarily our goal when we added the most recent enhancements to WordPerfect. We were more interested in responding to the suggestions of our users and dealers.

But a perfect report card is like icing on the cake. And it makes us more confident than ever that WordPerfect 4.0 is the most perfect WordPerfect, yet.

### Easier.

Most WordPerfect 4.0 functions require only one keystroke, a simple press of a finger. And new comprehensive documentation makes learning a breeze.

### Faster.

Document orientation means WordPerfect 4.0 never makes you

wait between pages. No matter how fast you type, WordPerfect won't slow you down.

### Better.

WordPerfect 4.0 includes several features not found on many word processors. Like a 100,000-word phonetic dictionary; multi-page footnoting capability; table of contents and index generation; automatic outlining and paragraph numbering; and a 4.0 network version.

Get the word processor that lives up to its name (and its report card):

InfoWorld

WordPerfect 4.0. For more

information, see your dealer. Or call or write:

*new version lives up to its perfect billing*

InfoWorld

SSI Software  
288 West Center Street  
Orem, Utah 84057  
Information: (801) 227-4020  
Order Desk: 1-800-321-4566,  
Toll-free

*WordPerfect 4.0 represents a new standard of excellence*



**SSI Software**  
Reaching for perfection.

When optical character recognition (OCR) equipment first came out, it was the kind of item everybody wanted to take seriously. It just seemed the next logical step. No typing, no manual input of any kind. All you had to do was pass a document over the right kind of camera and words were read from paper into memory. After that, document manipulation and output would proceed with normal electronic ease. The major problem has been the very high price of most OCR hardware/software systems. That, along with reports of poor reliability and limited capabilities for recognizing type fonts, kept relegating OCR to the wish list.

With a little luck, we may be seeing a change in the availability of lower-cost, more functional OCRs. Datacopy Corporation of Mountain View, California, showed us its new flatbed-scanner-based Model 700 Word Image Processing System (WIPS). The \$4000 unit has, as a \$695 adjunct, OCR—or CIR (character image recognition)—capabilities.

Whole pages from letters, books, or magazines (including pictures) can be entered as images into the computer in much the same way as making ordinary photocopies. You can then "edit" them in a variety of painting-program ways. This is fine if what you want to do is capture and store relatively static information. Anything that needs true editing requires an interface to a word processor; in the Datacopy product, this is where the CIR option comes in. It converts text portions of scanned documents to standard ASCII that you can then manipulate with word-processing software. The WIPS/CIR software handles pages that contain both images and text by creating windows for the text and letting you convert just the contents of the windows to ASCII. Initially, the

\$695 CIR package comes preprogrammed to recognize only the Courier 10 and Prestige Elite 12 typefaces. The company says that about 10 additional typeface-recognition modules for the software can be bought for \$195 each. The company also says that another option will be available later this year. This one, called CIR-2, will be preprogrammed for the same two fonts but is scheduled to have font-learning capabilities that will let you train it to recognize additional typefaces.

So, with the \$4000 cost of the hardware/software WIPS, the \$695 minimum investment in CIR software,

either a laser printer or an Epson printer (FX/RX series or LQ-1500), and the required IBM PC XT or AT or equivalent, Hercules Graphics Card, and Mouse Systems PC Mouse, this is not something you'll be buying just to try it out. On the other hand, at a scanning rate of 30 seconds per page, the capability to use your own word-processing software, and a relatively good resolution of 200 dots per inch, it could win a good deal of support. A lot will depend on whether it works as well as it did in a demonstration the company gave us.

—Glenn Hartwig, Technical Editor, Reviews

## SOFTWARE AVALANCHE FORCES NEW POLICY

Much as we love new software, we have finally reached our limit for handling unsolicited software packages. We try as many packages as we can, but that is a small percentage of what we receive. We receive so many unsolicited packages, in fact, that we can no longer be responsible for returning them unless they are accompanied by a prepaid return envelope. We regret the need for this change in policy, but the demands on our clerical time have become burdensome, and the shipping costs are high.

We will continue to welcome press releases and other descriptive materials about new software. We will give serious attention to any literature sent. If the written information convinces us that the software described would appeal to BYTE's readership, we will send a formal written request for a

review copy of the software.

We will continue to return at our own expense all the software packages we solicit. If we are unable to review a piece of solicited software, we will return it as soon as we arrive at that decision. If we review the package, we will return it as soon as the review is ready for publication.

When packages arrive unsolicited and unaccompanied by prepaid return envelopes, we will acknowledge receipt of them but will not return them. We will do our best to find time to use them but can make no guarantees. If we do not review unsolicited packages, we will store them for approximately one year and then destroy them. If at any time we receive a prepaid return envelope for an unsolicited software package in storage, we will return the software as soon as possible.



## Texas Instruments' Pro-Lite Professional Computer

**A briefcase-size computer compatible with the TI Professional**

BY RICHARD GREHAN  
AND EVA WHITE

**T**exas Instruments has a new addition to its TI Professional family, a briefcase-size computer called the Pro-Lite (see photo 1). Designed as a compact MS-DOS computer, it comes with an 80-column by 25-line LCD (liquid-crystal display) screen, 256K bytes of RAM (random-access read/write memory), an internal 3½-inch floppy-disk drive, a keyboard, and a parallel printer interface. This standard unit costs \$2995. The Pro-Lite's processor is an 80C88, which is a CMOS (complementary metal-oxide semiconductor) version of the 8088 for low power consumption, running at 5 MHz. It also boasts a wide variety of expansion options and some remarkable communication abilities.

Closed up, the Pro-Lite is a gray molded-plastic box measuring 2¾ by 11½ by 13 inches and weighing 10½ pounds. Some of the Pro-Lite's options add considerably to its dimensions and weight. The LCD also acts as the keyboard cover. Two slide latches on either side toward the case's front release the display, and you swing it up on a large hinge. This hinge was stiff on our machine, and opening and closing the display flexed the unit. The entire keyboard is mounted on a spring-loaded platform that tilts up when you open the unit so the keys are at a comfortable typing angle.

The power switch is near the front of the machine on the right. You slide it up to turn on the Pro-Lite. If you forget to turn the machine off when you close the top, a tab on the display's frame slips through a notch and forces the switch to the off position.

The Pro-Lite's AC/DC (alternating current/direct current) adapter lets you run the unit from an ordinary wall outlet, but it consists of an ungainly transformer box that is positioned along the length of the power cord in such a way that you have to make room for it on your desk.

### THE DISPLAY

The LCD screen working area is 9¼ by 4 inches and the text is fairly readable, al-

though, as with every other LCD screen we've seen, glare and reflection almost always overwhelm it. A contrast-control slider to the screen's right lets you adjust the intensity. Unfortunately, half of the slider's range produces a display that is too light to read.

Screen resolution is 640 horizontal by 200 vertical pixels, and an optional LCD graphics board enables bit-mapped graphics on the screen. The Pro-Lite's characters are 7 by 7 pixels right-justified in an 8- by 8-pixel grid. Thanks to the rectangular shape of the pixels (twice as tall as they are wide) the characters appear as they would on a CRT (cathode-ray tube) display. The character set comprises all the graphics (box-drawing), select Greek alphabet, and miscellaneous characters of the IBM PC's character set—including the normal and reverse-video smiling faces. Since the character definitions are downloaded into RAM from ROM (read-only memory) at boot-up time, you can define your own if you don't like the set provided.

### KEYBOARD

Texas Instruments has packed many features into the Pro-Lite's 79-key keyboard (see photo 2). The top row includes 12 programmable function keys and some keys useful for text editing. On the right side of the keyboard, 18 keys double as an embedded numeric keypad that you enable by holding down the Shift and Num Caps keys; you disable it by pressing this combination again. An LED (light-emitting diode) on the Num Caps key glows green when the embedded keypad is enabled, glows red when the capitals are locked on, and is unlit (white) when the keyboard is in lowercase.

Some compromises have been made on the keyboard's arrangement. The space bar has been shortened to accommodate a row of cursor-control keys to its right and the single open-quotation mark (') and backslash (\) keys to its left. Also, Line Feed is on the top row with the function keys.

*Richard Grehan and Eva White are technical editors for BYTE. They can be contacted at POB 372, Hancock, NH 03449.*



The keyboard has a snappy and responsive feel. We found it comfortable to work with, although the Tab key is no larger than any other and we occasionally had to search for it. We were happy to find that the J and F keytops have tactile ridges for locating the home position.

A slot that runs the length of the keyboard platform just above the function keys will hold overlay strips as they become available. This slot is narrow, hardly 1/2 inch tall, and since each function key could be programmed to do three things (Shift-function, Alt-function, and Ctrl-function) it is hard to imagine an overlay that wouldn't be hopelessly cluttered. In an apparent attempt to alleviate this problem, the Shift, Alt, and Ctrl keys have been color-coded.

### BEHIND DOOR NUMBER 1 . . .

A plastic door on the machine's right side toward the back unsnaps and swings down to reveal the disk drive and parallel printer connector (see photo 3). The drive is a 3 1/2-inch double-sided mechanism capable of storing up to 720K bytes per disk. The format is compatible with the proposed standard used by Microsoft for 3 1/2-inch disk MS-DOS systems. We were able to read and write files on a disk created on a Data General/One.

The parallel printer connector is a 25-pin female D-type plug located directly below the disk drive. It will drive any printer with a standard Centronics interface. If you own a TI Portable Printer, a connector beside the parallel port lets you power your printer directly from the Pro-Lite.

### OPTIONS

The Pro-Lite comes with a wide variety of options, most of which were unavailable at the time of this writing. They are divided into three groups determined by how they attach to the basic unit.

Identical to the floppy-disk cover door, but on the opposite side of the machine, is the option-module door (see photo 4). It

opens to a chamber of two option-module slots, and each slot can hold either a 300-bps (bits per second) modem, an RS-232C communications interface, an external monitor interface, or a Solid State Software drawer.

The modem is equipped with a standard RJ11 telephone-line jack as well as a built-in connector for an acoustic coupler. It has auto-dial and auto-answer capabilities. The RS-232C interface module lets the Pro-Lite use a serial printer or an external modem.

The external monitor interface adds the video circuitry and extra RAM necessary for attaching an RGB (red-green-blue) color monitor to the Pro-Lite. Resolution on the external monitor is 720 by 300 pixels in eight colors.

(continued)



Photo 1: The Texas Instruments Pro-Lite Professional Computer.

Solid State Software drawer is another name for a ROM cartridge. In this case, a drawer can hold up to 256K bytes of ROM software.

Yet another door in the back of the Pro-Lite leads to the rear bus connector. Here you can attach a battery pack, a second 3½-inch floppy-disk drive, or a combination disk and battery. The second drive adds 3 more

pounds to the system's weight and 5½ more inches to its depth. The battery pack provides up to eight hours of operation away from an AC outlet, depending on the options you are using. It adds 3 inches to the depth of the machine and 5½ pounds to its weight. You bolt these options to the main unit with two long flathead screws.

Be warned: You can attach only one option to the rear bus connector. If you want to use the battery and extra floppy simultaneously, you must get the combination disk/battery module (8½ pounds). The battery is packaged inside the disk-drive case.

System options attach directly to the motherboard inside the Pro-Lite's casing, and they must be installed at the factory or by an authorized TI dealer. System options include up to three RAM expansion boards of 64K or 256K bytes each, an LCD graphics board, and an 8087 numeric coprocessor chip.

The standard unit comes with 256K bytes of RAM: 128K bytes on the motherboard and two 64K-byte expansion boards. If you want the Pro-Lite with all the RAM it can hold (768K bytes), get it that way initially. A 768K-byte Pro-Lite has three 256K-byte expansion boards (the motherboard RAM is disabled) and expanding up to it would leave you with two homeless 64K-byte expansion boards.

The LCD graphics board provides bit-mapped graphics on the screen with a virtual resolution of 720 by 300 pixels. In other words, although the LCD screen can only display 640 by 200 pixels at a time, the graphics option makes the screen a window into an imaginary graphics display of 720 by 300 dots. Holding down the Alt and Shift keys and striking the arrow keys scrolls this window around on the virtual display.



Photo 2: The Pro-Lite keyboard. Note the embedded numeric keypad, the 12 programmable function keys, and the overlay slot for labeling the function keys.



Photo 3: Behind the door on the Pro-Lite's right side is the 3½-inch disk drive, parallel printer interface, and power connector for a TI Portable Printer.



Photo 4: Behind the door on the Pro-Lite's left are the two slots for plugging in options: an RS-232C interface, 300-bps modem, external color monitor interface, or Solid State Software drawer.

#### COMPATIBILITY

TI should get high marks for its efforts to keep the Pro-Lite compatible with the Professional Computer. (See "The Texas Instruments Professional Computer" by Mark Haas, December 1983 BYTE, page 286.)

The TI Professional uses three-plane bit-mapped graphics: one plane each for red, green, and blue. When you install the LCD graphics board option in the Pro-Lite, you are buying the equivalent of the blue video-memory plane. You can run graphics software on the Pro-Lite that was originally written for the Professional, with the

(continued)

## AT A GLANCE

### Name

Texas Instruments Pro-Lite  
Professional Computer

### Manufacturer

Texas Instruments Inc.  
Data Systems Group  
POB 809063  
Dallas, TX 75380-9063  
(800) 527-3500

### Size

2¾ by 11½ by 13 inches

### Components

Processor: 80C88, 5-MHz  
clock  
Memory: 256K bytes  
Mass storage: One 3½-inch  
double-sided disk drive, 720K-  
byte capacity  
Display: 80 columns by 25  
lines  
Keyboard: 79 keys including  
12 programmable function  
keys and an embedded  
numeric keypad, LED  
indicator for locked capitals  
Expansion: Two option slots

### Software

MS-DOS 2.13

### Options

Add-on floppy-disk drive (with  
or without battery), battery  
pack, 300-bps modem,  
RS-232C interface, PC  
interface cable, 8087  
coprocessor, 64K-/256K-byte  
RAM expansion boards,  
external color monitor  
interface, Solid State Software  
drawer

### Price (suggested retail)

Pro-Lite standard configuration	\$2995
Second disk drive	\$595
300-bps modem	\$300
External color monitor interface	\$499
RS-232C interface	\$225
Battery pack	\$149
PC interface cable	\$79
LCD graphics option	\$150
64K-byte memory upgrade	\$125
256K-byte memory upgrade	\$595

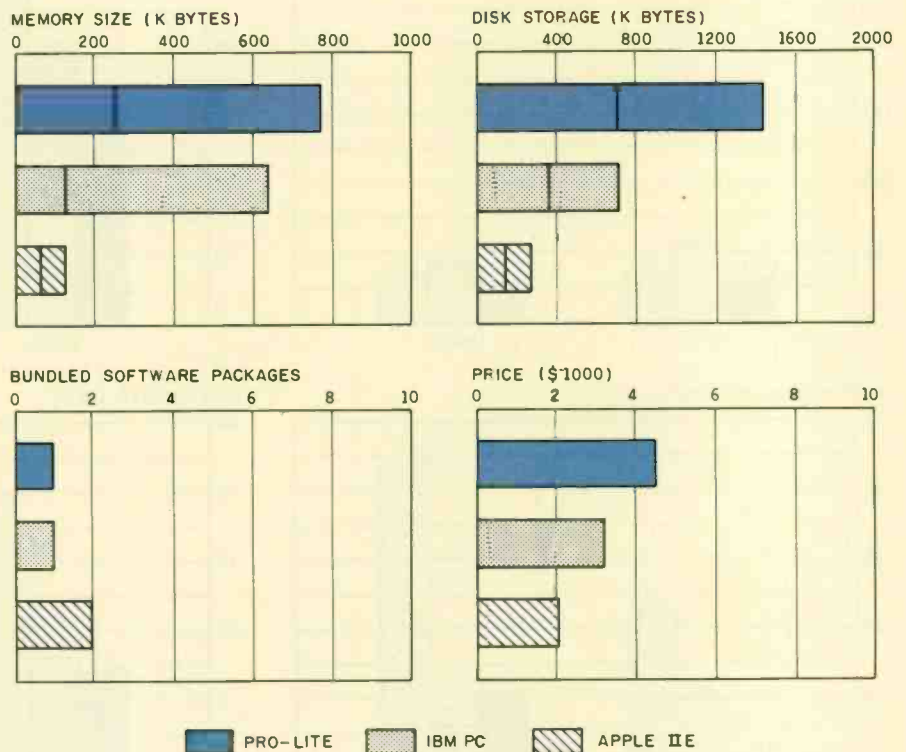

The Memory Size graph shows the standard and optional memory available for the computers under comparison. The Disk Storage graph shows the highest capacity of a single and dual floppy-disk drive for each system. The Bundled Software Packages graph shows the number of software packages included with each system. The Price graph shows the list

price of a system with two high-capacity floppy-disk drives, a monochrome monitor (an LCD screen for the Pro-Lite), graphics and color display capability, a printer port and a serial port, 256K bytes of memory (64K bytes for 8-bit systems), and the standard operating system and standard BASIC interpreter for each system.

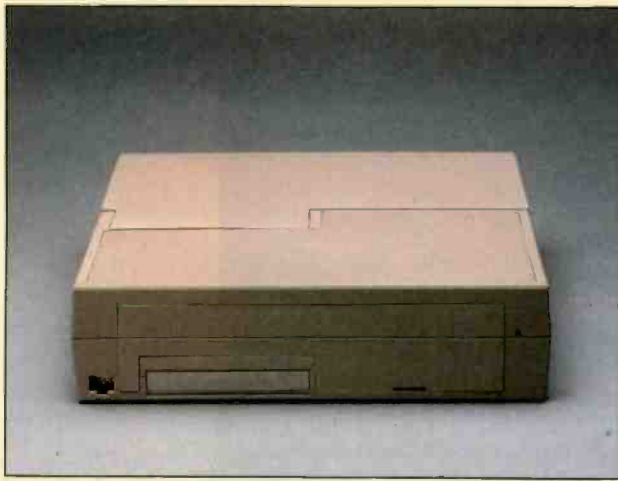

The rear panel of the Pro-Lite. Note the connector in the lower left corner for the AC/DC power adapter and the silver door that leads to the rear bus connector.

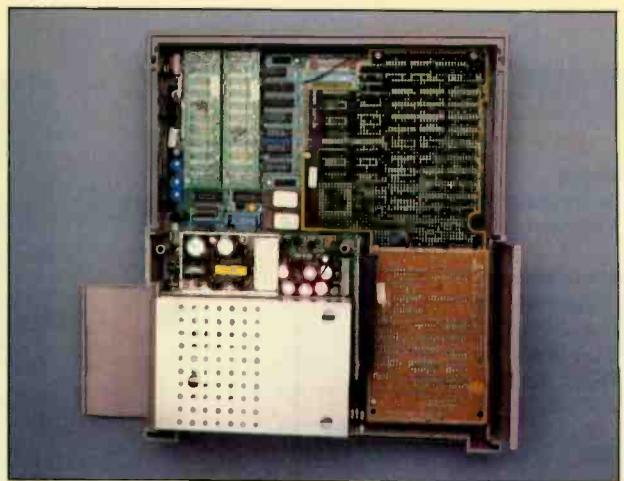

A top view inside the Pro-Lite

DISK ACCESS IN BASIC (SEC)

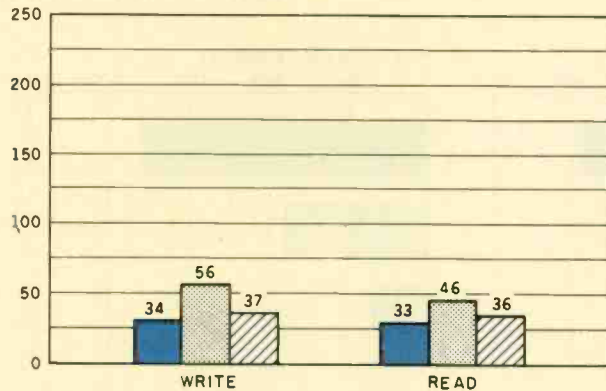

BASIC PERFORMANCE (SEC)

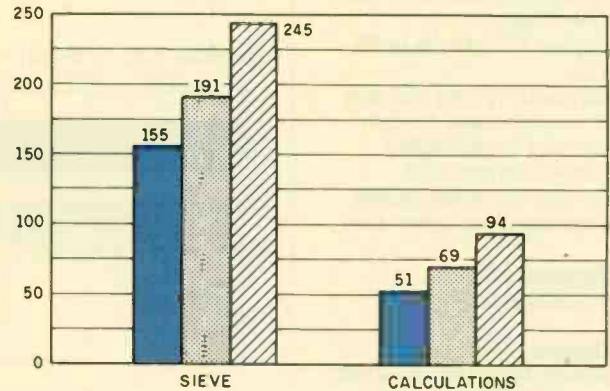

SYSTEM UTILITIES (SEC)

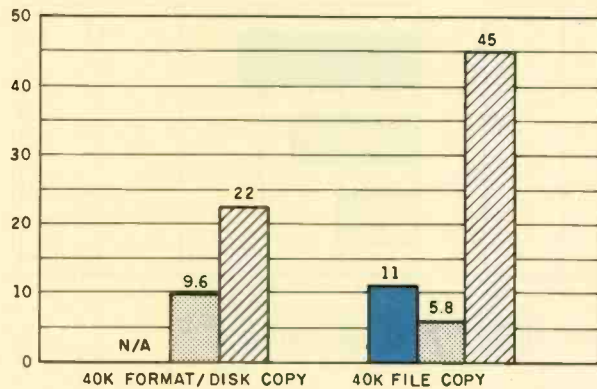

SPREADSHEET (SEC)

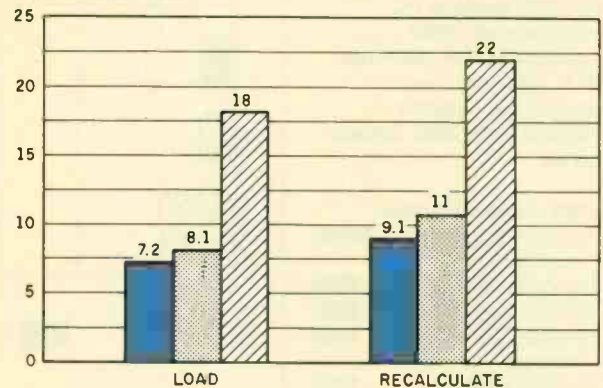

■ PRO-LITE    ■ IBM PC    ▨ APPLE IIe

The graph for Disk Access in BASIC shows how long it takes to read this file. (For the program listings, see June 1984 *BYTE*, page 327, and October 1984, page 33.) The BASIC Performance graph shows how long it takes to run one iteration of the Sieve of Eratosthenes prime-number benchmark. In the same graph, the Calculations results show how long it takes to do 10,000 multiplication and 10,000 division operations using single-precision numbers. In the System

Utilities graph, the Format/Disk Copy was not performed on the Pro-Lite since this requires a dual-floppy system. The File Copy results show how long it takes to transfer a 40K-byte file using the system utilities. The Spreadsheet graph shows how long the computers take to load and recalculate a 25- by 25-cell spreadsheet where each cell equals 1.001 times the cell to its left. The spreadsheet benchmark program is Multiplan. DOS 3.3 was used with the Apple II.

constraint that only the blue plane will be displayed on the LCD screen. (TI has modified the Pro-Lite's version of MS-BASIC so that anything drawn in a nonblack color will be displayed.)

Also, another price has to be paid for the Pro-Lite's compactness. Since a character cell on the Pro-Lite is 8 pixels wide, while a cell on the Professional is 9 pixels wide, a display generated on the Professional that contains mixed text and graphics will appear with the graphics out of place on the Pro-Lite.

Purchasing the external color monitor option gives the Pro-Lite full video compatibility with the Professional. This option includes all the memory necessary for the three video planes, as well as circuitry for displaying full Professional-size characters.

Additionally, every key on the TI Professional's keyboard has a counterpart on the Pro-Lite's keyboard. This is possible in spite of the Pro-Lite's space limitations thanks to its embedded numeric keypad.

**DRIVE-ACCESS LINK**

Getting information from one computer to another is always a problem, and you'd expect this to be especially true for the Pro-Lite with its 3½-inch drives in a 5¼-inch world. Normally, you would be faced with purchasing either the 300-bps internal modem option or the RS-232C interface option and transferring your files serially, probably over the phone lines. However, TI has taken care of this with a clever interface called the PC interface cable.

One end of the PC interface cable plugs into the rear bus connector. The other end plugs into the external drive connector found in the back of the TI Professional, the IBM PC, and some PC-compatibles. (The IBM PC's technical reference manual refers to this connector as the 5¼-inch disk-drive adapter external interface.) This drive-access link, as TI calls it, lets another PC control the Pro-Lite's floppy as if it were external drive C:.

When you use the drive-access link, the Pro-Lite's keyboard is disabled—you have what amounts to a very ex-

Table 1: The benchmark results for a word-processing test run on the Pro-Lite using WordStar. All times are in seconds.

WordStar Test	Pro-Lite	IBM PC
Document load	6.6	9.9
Document save	21.3	24.2
Search	10.3	10.5
Scroll	9.6	41.2

pensive 3½-inch floppy disk. However, the ease with which you can transfer files in this fashion beats a serial transfer any day; you simply use the standard MS-DOS Copy command. We used the drive-access link successfully with a TI Professional as well as an IBM PC.

The Pro-Lite's MS-DOS 2.13 normally formats its disks to 80 tracks per side. This is no problem for the TI Professional since its MS-DOS 2.13 is shipped along with the PC interface cable and can read this format. However, since the IBM PC expects the external drive to be formatted to 40 tracks per side, you should format the disk from the IBM PC. (The MS-DOS provided with the Pro-Lite can read disks of either capacity.) Of course, disks formatted with 40 tracks per side will hold only half the normal amount of data.

Also, a bank of DIP (dual in-line package) switches on the IBM PC's motherboard determines how many disk drives the system will recognize. Most PCs will have these switches set for only two drives so the IBM will not "see" an external drive. Before you use the drive-access link to connect the Pro-Lite to your IBM PC, you should refer to the PC's technical manual and make sure these switches are set appropriately.

**SOFTWARE AND DOCUMENTATION**

The only operating system currently available for the Pro-Lite is MS-DOS 2.13, which comes bundled with the system. Third-party application software packages available include WordStar, Volkswriter, dBASE III,

Framework, Multiplan, and many others. Generally, you can expect any packages available for the Professional to be available for the Pro-Lite.

We were even able to transfer some of the software for the Professional through the PC interface cable to the Pro-Lite and have it run successfully. You should check your software license agreement before doing this.

The benchmark results for the Pro-Lite (see the "At a Glance" box) show a significant improvement over the IBM PC for everything except system utilities. The word-processing benchmarks (see table 1) also show an improvement over the PC.

An Operating Instructions guide and two MS-DOS manuals are provided with the Pro-Lite. These manuals come in three-ring binders (8 by 9 by 2 inches) with a box to put them in. The operating guide seems geared for new users; it has clear explanations, diagrams of the computer's parts, and not too much detail to confuse a beginner. I found only one typographical error in the guide: On page 2-2 the screen, keyboard, and option-module slots' labels were interchanged.

**CONCLUSION**

The Pro-Lite performs as advertised. We found that it concealed no unpleasant surprises, and TI should be applauded for the variety of expansion options available. If you add the options that suit your needs, the Pro-Lite can be as powerful as most desktops, with the added advantage of portability. It is, however, priced noticeably higher than nonportables of comparable capabilities, and some people might find the cost of portability too high. Also, the Pro-Lite is a little awkward as a portable, especially if you add the floppy/battery option—no one wants to carry a 19-pound computer in his or her briefcase.

Systems like the Pro-Lite point in the direction of compact portable computers that are easy to use, have considerable power, and support as many options and peripherals as larger non-portables. The technology is getting there, but it hasn't arrived yet. ■



## S·Y·S·T·E·M R·E·V·I·E·W

# NCR Personal Computer Model 4

A sturdy  
IBM PC-  
compatible

BY ELAINE HOLDEN

**T**he NCR Personal Computer Model 4 is definitely not a portable—it weighs 50 pounds and measures 18 inches wide and almost 15 inches high (see photo 1). But you couldn't find a more rugged computer. And NCR dealers provide dependable service. (Each dealer has a technician trained to handle any repairs. If you're not near a dealer, you can use NCR's mail-in service.)

The NCR computer comes in six variations. Choices include monochrome or color screen, one or two double-sided double-density floppy-disk drives, or a half-height 10-megabyte Winchester drive in place of the second drive.

It is a pleasure to find the on/off switch and the volume and brightness controls located on the front of the unit. The quality of sound is excellent.

### SOFTWARE

Like all other IBM Personal Computer (PC) clones, the NCR Personal Computer cannot have BASIC in ROM (read-only memory) as it is in the IBM PC. In order not to violate copyright restrictions, an IBM PC-compatible BASIC must be on a floppy disk. The NCR version of GW-BASIC is easy to use, and the documentation provides excellent support. But the need to have BASIC on a disk almost necessitates the use of two drives; constantly switching disks can be annoying.

I was impressed by the exceptional compatibility of the NCR with the IBM PC. I was able to run Lotus 1-2-3, the Leading Edge word processor, and other packages for the IBM without any problems.

The software that comes with the NCR computer includes self-teaching programs: NCR Tutor, NCR Pal, and an on-disk help facility, NCR Help. I found these programs to be well designed. The disks provide examples of spreadsheets, word processing, games such as blackjack (I'm into the machine for five grand), program-development software (editors, compilers, etc.), and

system software (operating systems, run-time interpreters, and utilities). NCR-DOS 2.11, part of the same package, boots easily and is operationally compatible with MS-DOS and PC-DOS systems found on other personal computers. A good feature for novice users is the control placed on the master disk. NCR has designed it to be copied only and not ever used. Once you make the copy, you store the original master and use the copy. This is excellent insurance against accidental loss of the master disk and also gets the user comfortable with making backup copies.

### RAM Disk

Another interesting piece of software provided by NCR is the RAM (random-access read/write memory) disk utility. While not to be confused with a plug-in card with lots of memory and the software to use the memory as a disk, this program is an attempt to use internal memory for the same function. Basically, the RAM-disk utility lets you partition the RAM and use part of it for information or programs normally stored on the floppy disk. The information or the program is kept completely in internal memory and can thus speed the functioning of the computer because it has to reference only the information held in RAM rather than go to the external floppy. It is like having a third, very fast, disk drive.

Other microcomputers have lacked this convenience, and it does increase the speed considerably. And when using a word processor, the machine processes directly through the RAM disk and saves time by not referring constantly to the floppy disk for program instructions. The only drawback I see is the need for a large amount of memory to begin with. In order to fully utilize this feature, you would need almost all the memory NCR has to offer.

If you have less than maximum memory in your Model 4, you will have to take my or the company's word for the feature since the RAM Disk Demo does not perform well

*Elaine Holden (22 Elm St., Peterborough, NH 03458), formerly an assistant professor of computer science, is doing advanced graduate work at the University of Lowell.*

with less memory. The example included with the documentation clocks the time it takes to run a multiplication table with and without the RAM disk. Nice benchmark test—only they both took the same amount of time (11 seconds): no difference noted with only the 128K bytes or up to 256K bytes of memory.

#### DISPLAY

I found the monochrome display to have excellent resolution, competitive with any on the market. The green-phosphor screen has an 80-character by 25-line display. All characters are clear and easily read. I was equally impressed with the clarity of the color display. This 16-color screen also has a display of 80 by 25 and 640 by 200 pixels.

#### KEYBOARD

Weighing in at 4½ pounds, the keyboard tilts forward or lies flat (see photo 2). NCR sells the keyboard separately. It's plug-compatible with the IBM PC and the Compaq Deskpro. The keyboard connection is easily accessible at the back of the unit. Layout is compatible with the IBM PC, but NCR designers have added a separate cursor-control pad as well as separate Control, Page Up, Page Down, Delete, End, and Insert keys to the numeric keypad. I found this convenient because I could control functions in word processing while the numeric keypad was still on. Business users will find this a most important feature when jumping from one application to another.

LED (light-emitting diode) indicators on the Caps Lock and Num Lock keys are also an improvement over the standard IBM keyboard. They are not distracting but serve as gentle reminders.

#### PROCESSOR BOARD

The NCR Model 4 is controlled by an Intel 8088 microprocessor. This unit functioned well through all the benchmarks.

Standard for the NCR is 128K bytes of RAM, expandable to 640K bytes. Expan-

sion from 128K bytes to 256K bytes is accomplished by adding extra chips to the main board in increments of 64K bytes. This board is located behind the adapter boards. To add memory, you remove the back of the machine and all of the boards and insert the chips one at a time. If your fingers have been genetically programmed to resemble needle-nose pliers, you won't have any problem. However, I suspect the workspace may be cramped for the larger-handed members of our species.

Another step in the process calls for the resetting of toggle switches located at the very top of the main board. I did not have a problem with this task, but I suspect that a novice user might, especially since the documentation is insufficient here. NCR should provide a clearer explanation and a set of diagrams.

*(continued)*



Photo 1: The NCR Model 4 with two vertical disk drives.

# Computers For The Blind

**Talking computers give blind and visually impaired people access to electronic information. The question is how and how much?**

**The answers can be found in "The Second Beginner's Guide to Personal Computers for the Blind and Visually Impaired" published by the National Braille Press. This comprehensive book contains a Buyer's Guide to talking microcomputers and large print display processors. More importantly it includes reviews, written by blind users, of software that works with speech.**

**This invaluable resource book offers details on training programs in computer applications for the blind, and other useful information on how to buy and use special equipment.**

Send orders to:

**National Braille Press Inc.  
88 St. Stephen Street  
Boston, MA 02115  
(617) 266-6160**

**\$12.95 for braille or cassette,  
\$14.95 for print. (\$3 extra for  
UPS shipping)**

NBP is a nonprofit braille printing and publishing house.

You can further expand the system to the full 640K bytes of RAM by inserting a 384K-byte memory board. But if you want extra memory by using the memory board, the 128K-byte expansion chips must first be in place. Once again you have to reset the toggle switches and then replace the boards.

This unit has five third-party-compatible expansion slots and three ports: keyboard, integrated RS-232C asynchronous interface, and a Centronics parallel interface for the printer.

## DISK DRIVES

The NCR Personal Computer is available with one or two 360K-byte double-sided double-density floppy-disk drives. An optional 10-megabyte Winchester drive can also be added in place of one of the floppy-disk drives, an obvious advantage for business users who demand extensive external storage. The 5¼-inch TEAC drives are positioned vertically to the right of the screen. This makes disk exchange very convenient. Initially, though, these drives seemed noisier than those on any of my other computers.

Maybe the positioning of the drives is to blame, though vertical positioning should not be a factor in more noise or vibration. Engineering of

either horizontal or vertical disk drives provides for proper bearing placement and counterbalancing of the read/write head, which would preclude any extra noise.

Rather than condemn vertical drives in general, I would rather say these particular drives are noisier. This may be related to the choice of manufacturer; some companies *do* make noisier drives, particularly if they use metal drive bands. When I dismantled the computer I noted that the drives' magnetic-head carriage is moved along the guide shafts by a motor controlled by a steel belt. The drives are secured to a metal housing by three screws (two on the top and one on the bottom), and they rest on a metal plate that may act inadvertently as a sound board. Future engineering changes should deal with the source of the extra vibration and perhaps eliminate the sound board or cushion the assembly with a gasket to absorb more of the vibration encountered by the drive movement.

## DOCUMENTATION

The documentation for the Model 4 is, for the most part, excellent. Since setup is not complicated, a first-time user will feel at once comfortable and in control. The manuals are accurate, and they provide material ranging

*(continued)*



Photo 2: The keyboard, sold separately by NCR, is plug-compatible with the IBM PC and the Compaq Deskpro.



## AT A GLANCE

### Name

NCR Personal Computer

### Manufacturer

NCR Corporation  
1700 South Patterson Blvd.  
Dayton, OH 45479  
(513) 445-5000

### Size

14.8 by 14.6 by 18 inches;  
50 pounds

### Components

Processor: Intel 8088,  
4.77 MHz

Memory: 128K system  
memory, expandable to 256K;  
board expansion to 640K

Mass storage: One or two  
360K double-sided double-  
density 5¼-inch TEAC floppy-  
disk drives; optional half-  
height 10-megabyte  
Winchester hard-disk drive or  
dual 8-inch flexible-disk drives

Display: 80 characters by 25  
lines, monochrome green  
(optional color), 640 by 200  
pixels

Keyboard: IBM PC-  
compatible, plus separate  
cursor-control pad

Expansion: Three IBM PC-  
compatible slots available in  
dual-disk system

I/O Interfaces: RS-232C port,  
parallel printer port

### Software

GW-BASIC, NCR-DOS 2.11,  
NCR Tutor, NCR Pal, NCR  
Help, diagnostics

### Documentation

Owner's manual, GW-BASIC  
manual, NCR-DOS manual

### Price

Monochrome screen, one  
drive, and 128K RAM, \$2400;  
second drive, \$425;  
64K RAM, \$90;  
128K RAM, \$180;  
parallel or serial  
printer cable, \$45;  
10-megabyte hard disk, \$2195



MEMORY SIZE (K BYTES)

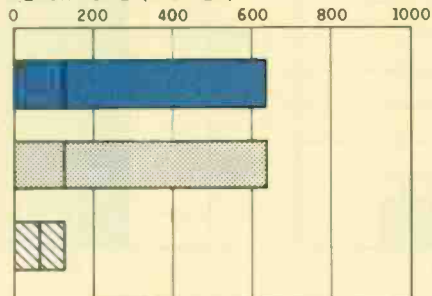

DISK STORAGE (K BYTES)

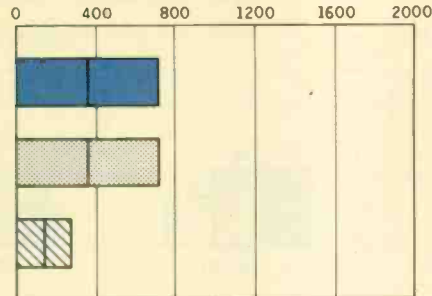

BUNDLED SOFTWARE PACKAGES

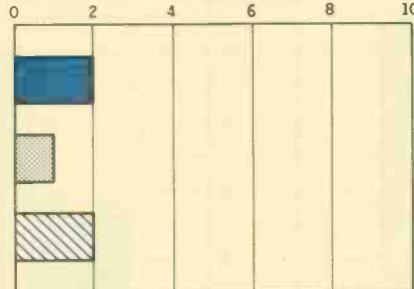

PRICE (\$ 1000)

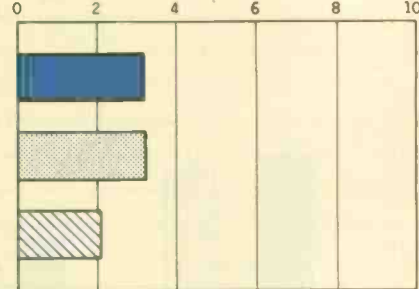

■ NCR PC    ■ IBM PC    ■ APPLE II

The Memory Size graph shows the standard and optional memory for the computers under comparison. The Disk Storage graph shows the highest capacity of one and two floppy-disk drives for each system. The Bundled Software Packages graph shows the number of packages included with each system. The Price

graph shows the list price of a system with two high-capacity floppy-disk drives, a monochrome monitor, graphics and color-display capability, a printer port and a serial port, 256K bytes of memory (64K for 8-bit systems), the standard operating system for the computers, and their standard BASIC interpreters.

502004

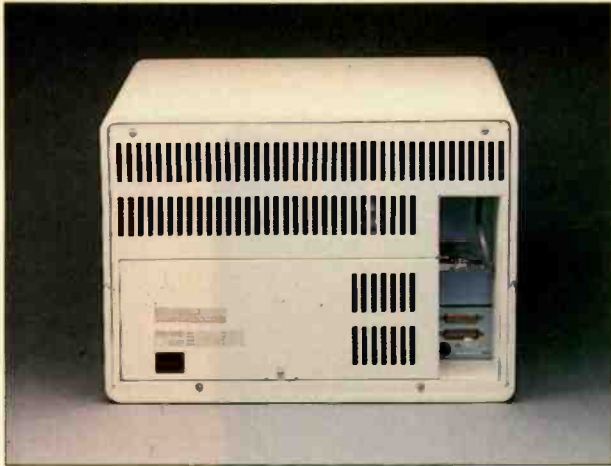

The rear of the NCR PC Model 4. The power supply is at left, the RS-232C and parallel ports are at right.

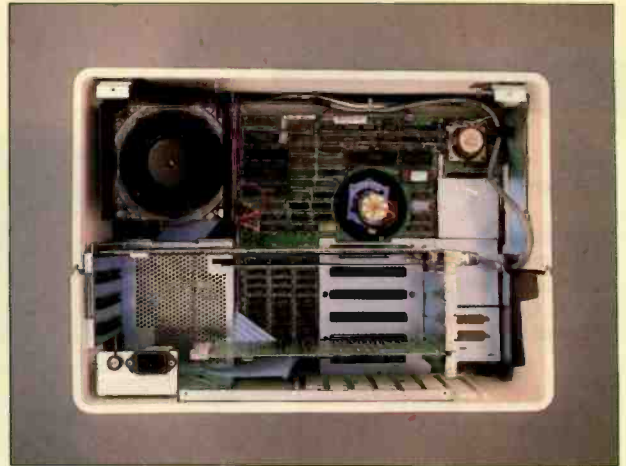

Inside the Model 4. The main CPU board is visible behind the expansion slots.

DISK ACCESS IN BASIC (SEC)

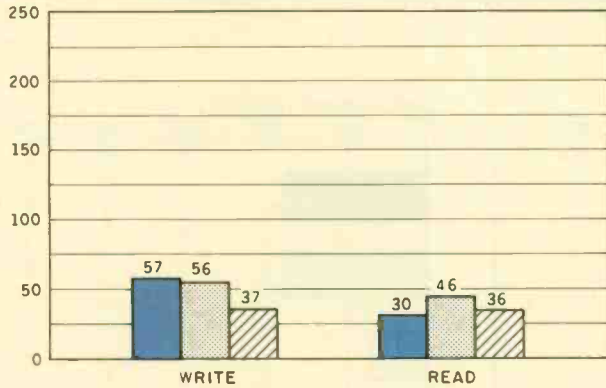

BASIC PERFORMANCE (SEC)

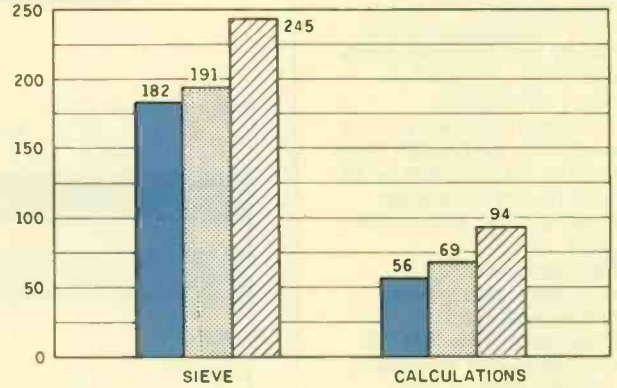

SYSTEM UTILITIES (SEC)

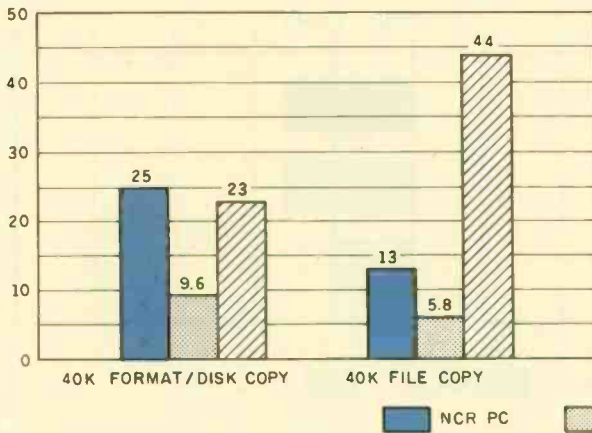

SPREADSHEET (SEC)

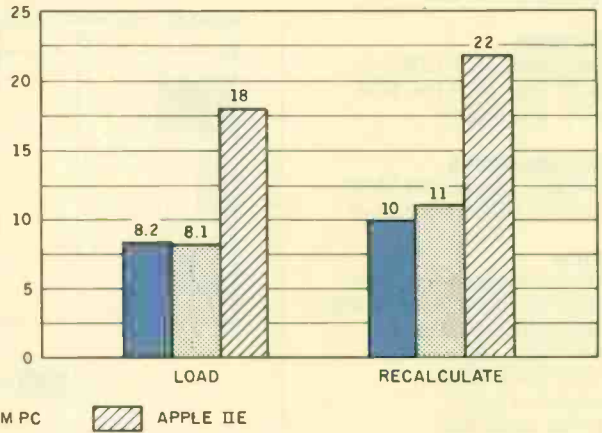

■ NCR PC    ■ IBM PC    ▨ APPLE II E

In the Disk Access in BASIC graph, a 64K-byte sequential text file was written to a blank floppy disk and then read. (For the program listings, see June 1984 BYTE, page 327, and October 1984, page 33.) In the BASIC Performance graph, the Sieve column shows how long it takes to run one iteration of the Sieve of Eratosthenes. The Calculations column shows how long it takes to do 10,000 multiplication and 10,000 division operations using single-precision numbers. The System Utilities graph shows how long it takes to format and

copy a disk (adjusted time for 40K bytes of disk data) and to transfer a 40K-byte file using the system utilities. The Spreadsheet graph shows how long the computers take to load and recalculate a 25-by-25-cell spreadsheet where each cell equals 1.001 times the cell to its left. The spreadsheet program used was Microsoft Multiplan. The tests for the Apple IIe were done with the ProDOS operating system (except for the spreadsheet test, which was done with DOS 3.3). The IBM PC was tested with PC-DOS 2.0.

*The technical manual is impressive with its detail. The only section that could use revision is the one on installation of additional memory.*

from a history of computers to the sort of technical information appreciated by long-time computer users. The technical manual is impressive with its detail. Again, the only area that could use revision is the section that describes installation of additional memory.

Support from the company is also notable. All dealers are trained to provide technical assistance and troubleshoot. The manuals, tutorials, and integrated help package should get you through most crises. The manuals make frequent mention of contacting the local dealer if problems arise.

#### CONCLUSION

Although the NCR Personal Computer is not very portable and has the few imperfections I mentioned, it is still a good value. Ease of setup, documentation, tutorials, company backing, and solid engineering make this machine worthwhile. Other features include the choice between two excellent displays, terrific graphics, a RAM-disk utility that runs programs faster than most IBM PC-compatibles, and moderately easy memory expansion.

Having taught computer science to college students, I know the punishment that hardware must withstand. After giving the Model 4 the same type of rough treatment, I can say it is built like a tank. For heavy computer use and business purposes, this durability is a very important consideration. ■

# How to go from UNIX to DOS without compromising your standards.

It's easy. Just get an industry standard file access method that works on both.

C-ISAM™ from RDS.

It's been the UNIX™ standard for years (used in more UNIX languages and programs than any other access method), and it's fast becoming the standard for DOS. Why?

Because of the way it works. Its B+ Tree indexing structure offers unlimited indexes. There's also automatic or manual record locking and optional transaction audit trails. Plus index compression to save disk space and cut access times.

How can we be so sure C-ISAM works so well?

We use it ourselves. It's a part of INFORMIX®, INFORMIX-SQL and File-it!™, our best selling database management programs.

For an information packet, call (415) 424-1300. Or write RDS, 2471 East Bayshore Road, Palo Alto, CA 94303.

You'll see why anything less than C-ISAM is just a compromise.

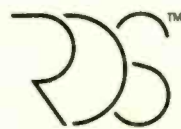

**RELATIONAL DATABASE SYSTEMS, INC.**

© 1985, Relational Database Systems, Inc. UNIX is a trademark of AT&T Bell Laboratories. INFORMIX is a registered trademark and RDS, C-ISAM and File-It! are trademarks of Relational Database Systems, Inc.

# JUKI®



## FILET-MIGNON PRINTERS AT A BURGER PRICE!

Leave it to JUKI® to serve up a hearty selection of letter-quality printers at a "fast-food" price that has sent the competition back to its recipes.

For home or office use, the JUKI 6100. Fast, letter-quality printing for under \$600! Prints 18 cps, performs all the word processing functions you need most, and has a 2K buffer memory (expandable to 8K). Even handles your graphics! No wonder it's becoming an industry standard.

For business use, you can't do better than the JUKI 6300. This one is even wide enough to handle your spreadsheets—along with graphics and all the requisite word-processing functions, at a zippy speed of 40 cps. Cost? Under \$995! You also get a 3K buffer memory (expandable to 15K) in a high-tech machine that's built for many years of reliable printing. And like the 6100, it fits almost any p.c.

Mmm. Delicious!



### JUKI®

The workers.

JUKI OFFICE MACHINE CORP.

#### EAST COAST:

299 Market St., Saddle Brook, NJ 07662  
(800) 932-0590

#### WEST COAST:

23844 Hawthorne Blvd., Suite 101, Torrance, CA 90505  
(800) 325-6134 • (800) 435-6315 (California)



## Monitoring Halley's Comet

Three  
programs  
for tracking  
the celestial  
visitor

BY JOHN E. MOSLEY

In 1910 Halley's comet swept past the earth. People everywhere marveled at this heavenly visitor. The comet will be back this winter, and of course we'll all want to see it. Some of us will view it from our yards only; some of us will lug a telescope or newly purchased "comet hunter" binoculars to the dark countryside; and some of us will pay a month's wages to take a cruise to the "land down under" to see the comet high and bright in the southern sky. Some of us are already watching it on little green monitors.

It's fun to keep track of what is happening in the sky and be able to anticipate celestial events. The motions of objects in the solar system, Halley's comet included, are generally too slow to perceive except by looking at them night after night. However, with a computer you can control what you see; you can speed up time and peer into the future (or past), you can see celestial motions graphically and from different perspectives, and you can find relationships that printed tables do not show. Of course, the important thing is to see Halley's comet with your own eyes—nothing else counts—and with a microcomputer and some clever programs, you can be an informed participant as well as an enthusiastic observer.

Although you could create microcomputer programs that would tell you how and where to observe the comet, people have already done the work for you and made their programs commercially available. Some are surprisingly sophisticated, and we're fortunate that such software exists—just in time for Halley's return visit.

Of the three good comet programs available, two are tailored specifically to demonstrate a variety of aspects of Halley's coming appearance. There's also a new book on how to calculate comet orbits.

### HALLEY

The most sophisticated of the three programs is named after the English

astronomer, Halley. It's distributed by Starsoft and is available on disk for the IBM Personal Computer (PC). The program has four main parts. The first part plots the comet as it moves through the solar system from an imaginary vantage point high above the circling planets. It displays the sun and up to all nine planets at a scale you select. This allows you to see how the comet moves relative to the earth and other planets and how it accelerates as it approaches the sun and passes the inner planets.

The second part of the program plots Halley's comet on a standard rectangular star chart and shows how it moves through the constellations. These two parts of the program show not only the comet but the length and orientation of its tail—a fairly tricky feat.

The third part is numerical rather than graphical and calculates Halley's celestial coordinates and distances from the earth and the sun on a given date or series of dates, allowing you to plot it accurately on a star chart and find it with a telescope even while it is still relatively faint. The accuracy is surprising: positions are to within 1 minute of arc (one-thirtieth the diameter of the moon). The final part of Halley lets you change the orbital parameters and substitute values for any other comet (or any object that orbits the sun) and plot the motions of new comets as they are discovered. You can use the disk beyond 1986, which is especially valuable because several comets are discovered each year.

The first three parts in Halley can show the comet during the coming months as well as any appearances back to ancient times, although with decreasing accuracy as you travel backward. Using the program, you can see why the comet's appearance in A.D. 732 was so spectacular (on this occasion, it came to within 4 million miles of the earth), how it appeared on the eve of the Norman conquest of England in 1066 (when it inspired terror in the English

(continued)

John E. Mosley works at the Griffith Observatory (2800 East Observatory Rd., Los Angeles, CA 90027), where he produces the planetarium show and is in charge of educational activities.

## AT A GLANCE

<b>Name</b>	Halley	Halley's Comet	Ephemeris
<b>Type</b>	Astronomy program	Astronomy program	Astronomy program
<b>Distributor</b>	Starsoft POB 2524 San Anselmo, CA 94960 (415) 453-1372	S & T Software Service 13361 Frati Lane Sebastopol, CA 95472 (707) 874-2352	Cosmic Computer Works 243 White St. Belmont, MA 02178
<b>Computer</b>	IBM PC	Apple, Commodore 64, TI Professional	Apple, TRS-80
<b>Format</b>	5¼-inch floppy disk	5¼-inch floppy disk	5¼-inch floppy disk
<b>Price</b>	\$34.95	\$49.95	\$25

defenders), and how it will look when it returns in 2061.

### HALLEY'S COMET

Eric Burgess, author of *Celestial BASIC* (both the popular book and the disk), has created a new comet-tracking program called Halley's Comet. The package, distributed by S & T Software Service, is for Apple, Commodore 64, and Texas Instruments Professional computers.

Like Starsoft's Halley, Burgess's package is an ambitious integrated suite of short and simple programs that attempts to cover its subject thoroughly. It offers more text and options than Halley, but it's less accurate.

The first three programs in the package provide a limited amount of background, much of it historical, and include a reference list of previous appearances. Only in the fourth program, Orbit Plots, does the computer begin to make calculations. It also shows a solar system display similar to the first program in Starsoft's Halley, with the comet, Venus, Earth, and Mars as they looked at the time of any appearance since the year 1000. You can select a year and let the orrery run or select a specific date and see a static display for that date while the comet's coordinates and distances from the earth and the sun are provided numerically.

The fifth program shows the path of the comet through the constellations during its 1985-86 visit and provides a tabular printout of its positions. The entire sky is shown as it would look on a standard star chart; however,

with only about 200 stars plotted, the constellations are difficult to identify.

The last program offers observation information for a specific location on the earth's surface. You enter longitude, latitude, time, and date and are told the comet's altitude and azimuth and twilight times; you are then shown a display of the comet, complete with tail, in the appropriate part of the sky. The computer selects the proper direction to face, outlines the constellations in sufficient detail for the major constellations to be recognized immediately, and even includes the moon and planets.

Although the accuracy of Halley's Comet is limited and the displays rudimentary, it has enough clever features and options to keep a person busy for several nights. Another strength is that you can get inside the five programs and customize them to your liking. The program is ambitious, educational, and certainly worth the money.

### EPHEMERIS

A third good comet program is Ephemeris by Roger Sinnott. It's available for Apples and TRS-80s. This relatively short (one-tenth of a disk) and inexpensive program was written several years ago, when Halley's comet was still distant. Apparently Sinnott didn't think to capitalize then on the comet's return.

Ephemeris is a simple but surprisingly accurate program that requires you to enter the orbital elements of the object you are interested in—there are no default values. It then gives

you, for the dates you specify between A.D. 1800 and 2100, a printout of that object's celestial coordinates, distances, angular distance from the sun, and magnitude. The program has no graphical displays or other options, but it is straightforward and solid.

### DO IT YOURSELF

People who like to write their own programs will be interested in a new book, *Orbits for Amateurs with a Microcomputer* by D. Tattersfield. This book tells you in a no-nonsense manner all you need to know to calculate a comet's ephemeris from the orbital elements, the elements from three observations of the orbit, and how to take into account perturbations and make differential corrections. It is clearly organized and includes all necessary formulas and tables, but it is not for the casual observer of the skies.

### CONCLUSION

When Halley's comet last visited in 1910, household electricity was a novelty and science fiction authors dreamed about futuristic airships. Buck Rogers was still a generation away. Few people who saw Halley's comet then would have guessed that the next time it returned, people around the world would use undreamed-of computing power to follow its progress on little green monitors. ■

For a list of books and periodicals on astronomy, see the "Astronomy Sources" text box on page 244.

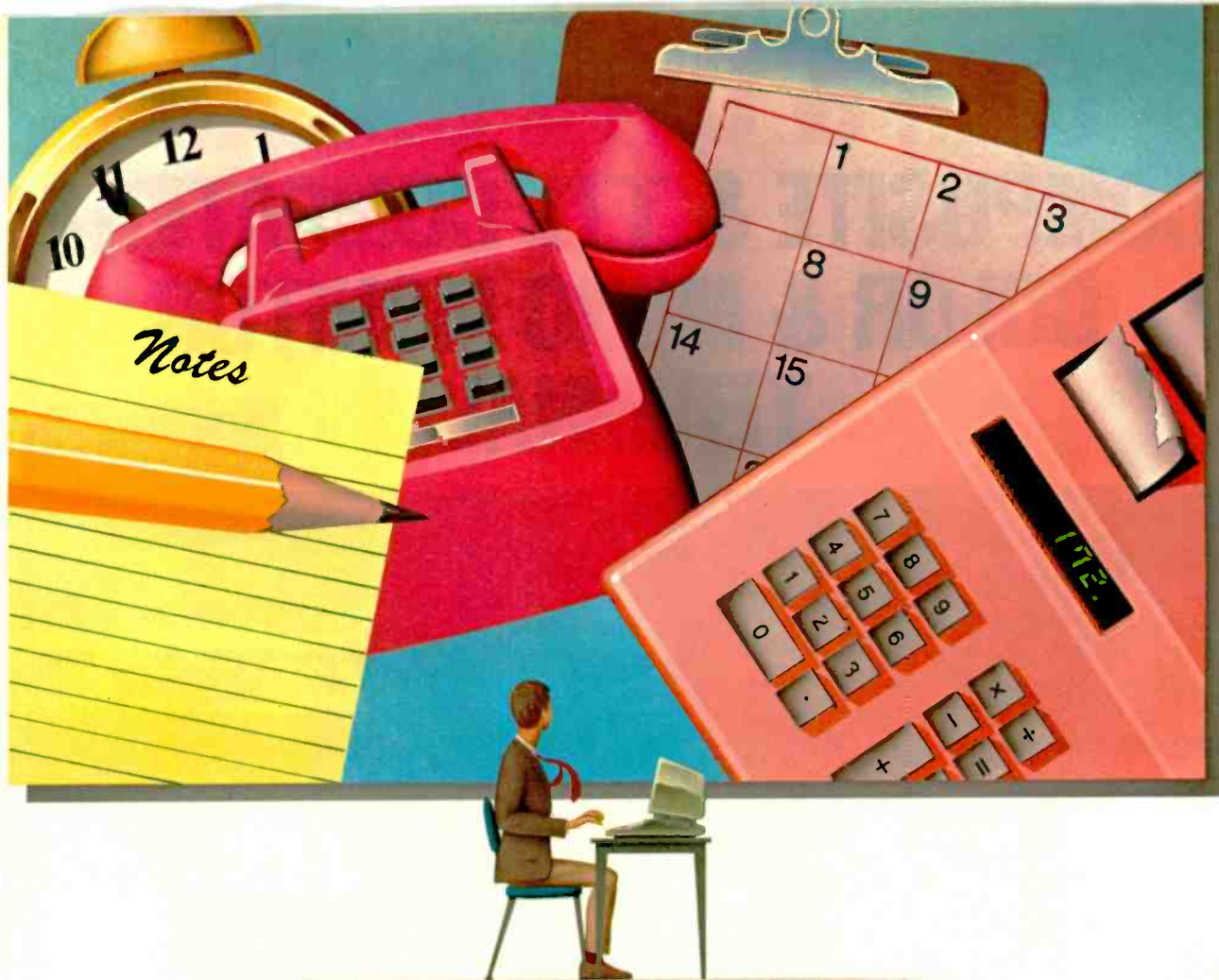

# POP ART

**Q.** What would you call a desktop software package that can Pop-Up Anything—spreadsheets, databases, or even DOS—over another application? What if it also offers a Pop-Up Standard Calculator and Financial/Statistical Calculator, Alarm Clock, Notepad, Clipboard, Calendar, plus PopDOS and Pop-Up Voice to dial your phone automatically? What would you call a single package that does all this, is non-copy protected and sells for \$69.95?

**A.** Beautiful! New Pop-Up DeskSet from Bellsoft.

#### CRITICS AGREE:

*"Bellsoft has taken the Sidekick idea a step further."*  
Infoworld, 1/14/85

#### USERS AGREE:

*"Much better than competition (know anyone who wants to buy a 'Sidekick?')"* Ivan Myers, Cummins Engine Co.

*"This is an Excellent Package. (Thanks)"* James Bondurant, ComputerLand Corporate

New Pop-Up DeskSet includes Standard and Financial Calculators, Pop-Up Anything, PopDOS, Clipboard, Notepad, Calendar, Alarm Clock and Pop-Up Voice; **\$69.95.**

New Pop-Up DeskSet Plus includes all the above plus Pop-Up TeleComm, a telecommunications program; **\$129.95.**

Inquiry 51

System requirements: IBM PC, XT, AT, 3270 PC, PCjr. or compatible. Phone dialer and telecommunications require a PC or XT and a Hayes compatible modem.

Pop-Up, Pop-Ups, DeskSet are trademarks of Bellsoft, Inc. Sidekick is a trademark of Borland International.

#### ONLY DESKSET OFFERS ALL THESE FEATURES:

	POP-UP™ DESKSET™	SIDEKICK™
"Pops-Up" any kind of application while running another	YES	No
Entirely RAM-resident	YES	No
Cut-and-paste capability	YES	No
Gets DOS commands while running another program	YES	No
Calculator with printable on-screen tape display	YES	No

#### DESKSET

Available at leading software dealers. Or for a limited time you may order direct by mail or phone. Call **1-800-44-POP-UP** (1-800-447-6787). Or mail this coupon to Bellsoft, Inc., 2820 Northup Way, Bellevue, WA 98004.

Please send the following:  
 DeskSet; \$69.95  DeskSet Plus; \$129.95  
 + \$5 shipping  
 Name: \_\_\_\_\_

Company Name: \_\_\_\_\_

Mailing Address: \_\_\_\_\_

City: \_\_\_\_\_ State: \_\_\_\_\_ Zip: \_\_\_\_\_

Phone: \_\_\_\_\_

My check is enclosed  Visa  American Express  MasterCard  
 Name on card: \_\_\_\_\_

Card #: \_\_\_\_\_ Exp date: \_\_\_\_/\_\_\_\_/\_\_\_\_

Signature: \_\_\_\_\_

**BELLSOFT** (206) 828-7282

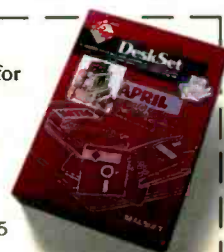

# OEM & OWN BRAND COMPOSITE & TTL COMPATIBLE COLOR & MONO MONITOR TERMINAL



TERMINAL; SD-M1201

SM-12SF 31A6; APPLE COMPATIBLE  
SM-12SF 39A7; IBM COMPATIBLE



OEM BRAND; SM-12CL 31A1



SM-CL401 SNS; 8 COLORS  
SM-C1402 SNS; 16 COLORS  
IBM COMPATIBLE



#### SEOUL OFFICE

6~8TH FL, THE JOONG-ANG DAILY  
NEWS BLDG., 7 SOONHWA-DONG,  
CHUNG-KU, SEOUL, KOREA  
TEL: 7516-955/7, 7516-959/961  
TLX: STARNEC K22596  
CABLE: "STARNEC" SEOUL  
TEL

#### LONDON OFFICE

6TH FLOOR, VICTORIA HOUSE  
SOUTHAMPTON ROW W.C.  
1 LONDON, ENGLAND  
TEL: (01) 831-6951/5  
TLX: 264606 STARS LG  
FAX: (01) 430-0096

#### SANTA CLARA OFFICE

3003 BUNKER HILL LANE,  
SUITE 201 SANTA CLARA,  
CAL. 95050, U.S.A.  
TEL: (408) 096-8441/3  
TLX: 171685 SAMSUNG SNTA

#### TOKYO OFFICE

GASUMIGASEKI BLDG., 2522  
GASUMIGASEKI 3-2-5 CHIYOTA-KU,  
TOKYO, JAPAN  
TEL: (03) 581-5804, (03) 581-9521~4  
TLX: 228009 SANSEI



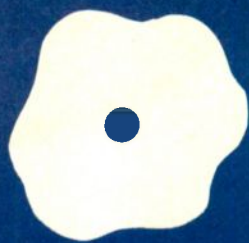

## Space-Flight Simulators

### Rendezvous with a space station or travel to Saturn

BY BENJAMIN BERNAR

**C**omputer simulations of space flight have until recently been done only on mainframes and minicomputers. In this review, I'll discuss two programs that simulate space flight on a microcomputer.

#### RENDEZVOUS

Rendezvous is a collection of simulations written by Wes Huntress, who, according to the program packaging, is a Ph.D. in chemical physics currently working for the California Institute of Technology's Jet Propulsion Laboratory. The goal of these simulations is to rendezvous with a space station in a 1990-mile circular earth orbit. The mission is divided into four flight phases, each of which you can run independently and in any order. Animated color graphics is used to display the progress of the flight, which you control with the keyboard or joystick.

Booting the Rendezvous disk brings up the mission menu and its options: earth lift-off, orbital rendezvous, approach, and alignment and docking.

The documentation describes the requirements for completing each of these flight phases as well as the space-shuttle-type vehicle you use for this simulation.

Like NASA's space shuttle, the Rendezvous vehicle has two solid rocket boosters (SRBs). A big difference is in their burn time of 90 seconds as opposed to 132 seconds for the real thing. The main engines of the space shuttle are part of the orbiter and typically burn for about 510 seconds. They augment the thrust of the SRBs during the lift-off. The main engines of the Rendezvous vehicle are attached to the external tank instead of the orbiter and are jettisoned with it. The main engines are also turned on with the SRBs and only burn for an additional 200 seconds. Like in the space shuttle, the engines of the orbital maneuvering system (OMS) in the orbiter usually provide for the final orbit-injection velocity. Unlike the OMS engines in the shuttle, they have enough additional fuel to reach an orbit almost three

times higher than the shuttle can reach.

Control of the Rendezvous vehicle during the launch phase is limited to attitude control in the pitch axis and to on/off operation of the OMS engines. The orbiter OMS engines are available after the external tank is jettisoned. You cannot control the throttle on any engine or the launch azimuth or orbit inclination. If an orbit is successfully achieved, it will be a polar orbit.

The earth lift-off option presents in the right half of the display an outside view of the launch vehicle on the pad. The lower left displays a profile of the flight path. The bottom of the screen presents flight data and a prompt for ignition to initiate the launch. The upper left is unused.

Huntress has made some simplifying design decisions in the launch simulation. Since the final orbit is polar, you don't have to worry about the launch azimuth or the effect of the earth's rotation on final vehicle velocity. One thing that does have to be determined for flight planning is the orbital altitude.

The documentation suggests a minimum altitude of 119 miles. An orbit below this altitude could decay within one or two revolutions. In fact, the launch simulation won't permit orbit injections below 119 miles; a low-altitude warning is displayed, and either you get the vehicle up by turning the OMS engines on or you lose altitude and are destroyed by aerodynamic forces.

An upper limit on orbital altitude is related to vehicle performance and mission requirements. In Rendezvous, this value is somewhere in the neighborhood of the location of the space station (1990 miles). Higher altitudes are possible, but you have to use more energy to get into them. Since the goal of these flight simulations is to rendezvous with another spacecraft, you need to get into the same orbit as the space station and time it so that the station is nearby when you match orbits. In principle, you could meet these requirements with a

(continued)

Benjamin Bernar received a B.S. in geology from Ohio University in 1976. His work with computers has led from uranium exploration in Wyoming to his current involvement with the space shuttle at Lockheed Space Operations. He can be reached at 201 South U St., #59, Lompoc, CA 93436.

# SAVE MONEY

with Flexforms.

*Flexforms are pre-written, ready to use contracts, agreements and letters designed to save your company time and money. Flexforms work with any word processor. You literally "fill in the blanks" and create customized, professional and legally-binding documents for every situation.*

*Each of the forms can be quickly tailored to suit your individual needs without wading through confusing manuals.*

*Flexforms help protect your legal rights, avoid tax problems, dramatically improve efficiency, increase profits and eliminate costly misunderstandings.*

Four Popular Series:

## BUSINESS

Ideal for expanding businesses:

*Employee Agreements & Letters, Credit & Collection Letters, Subcontractor Agreements, Lease Forms & Amendments, Buying & Selling Forms, Credit Forms & Applications, Guaranties, Loan & Debt Notices & Letters, Assignments & Transfers, Affidavits & Notices, Promissory Notes & 83 more!*

## REAL ESTATE

Designed for investors, developers, and property managers:

*Residential & Commercial Forms, Purchase & Sales Forms, Broker & Agent Contracts & Forms, Partnership Agreements, Rental Forms, Lease Forms, Tenancy Agreements & Applications, Illegal Dealner Forms, Loan Agreements, Financing Agreements, Exchange Forms & Contracts, Disclaimers & Disclosures, Contractor Agreements and 75 more!*

## CORPORATE

Exceeds State and Federal Corporate Law requirements:

*Articles of Incorporation, Shareholder & Director Meeting Minutes, Corporate By-Laws, By-Law Amendments, Shareholder & Director Resolutions, Merger Resolutions, Compensation Resolutions, Dividend Resolutions, Loan Resolutions, Fringe Benefit Resolutions, Employee Benefit Resolutions and 86 more!*

## PERSONNEL

Created for growing organizations:

*Personnel Policy Manual, Employee Safety Manual, Employment Agreements & Applications, Secrecy & Invention Forms, Confidentiality Agreements, Non-Compete Agreements, 25 Job Descriptions, Consultant Agreements, Agency Agreements, Personnel Letters, Performance Reviews and 25 more!*

*Flexforms have been prepared under legal counsel. Unlike forms written by lawyers for lawyers, they are concise and easy to understand without needless legalese. Available in IBM and Apple disk formats. Each series only*

# \$69.95

*(plus \$5 shipping), includes hard copy. All four for \$250 and we pay the shipping! Visa and Mastercard accepted.*

Inquiry 42

Atkins Associates

P.O. Box 781 • Santa Cruz, CA 95061  
(408) 426-7638

## REVIEW: SPACE FLIGHT

direct injection into the station orbit from a ground launch; in practice, however, such an approach is not used. The launch could not tolerate any error in the flight profile, and constraints on the time of launch, the so-called launch window, would be extremely tight.

The usual procedure is to get into a parking orbit above or below the target and maneuver from there. The extra energy used to reach a higher orbit has to be dumped anyway, so parking altitudes below the target are typically chosen for efficiency.

The documentation states a value of 17,550 miles per hour (mph) as the minimum horizontal velocity (VELH) required for orbit injection. This corresponds to a local circular velocity altitude of 65 miles. The 17,550-mph value seems to be a limit in the launch program since you aren't permitted to do an injection at speeds below this, regardless of your altitude. When you reach the altitude of the space station, your VELH value is 14,533 mph.

Having selected the orbit, you are ready to plan a flight profile and get off the pad. The two forces to overcome are gravity and atmospheric drag. Of the two, gravity is by far the more important, so you want a flight path that curves as quickly from vertical as possible, becoming horizontal at the orbit-injection point. You must maintain a vertical or near-vertical attitude (as well as moderate velocities) in the lower, denser portion of the atmosphere. There is a region in the flight profile where aerodynamic loads on the structure of the vehicle are largest. If the vehicle is manned, you need to keep accelerations below 8-10 G (a unit of acceleration equal to the standard acceleration of gravity, 9.80665 meters per second per second) by throttling the engines down in the terminal portion of the flight when vehicle weight is just a fraction of the launch weight.

In the transition from vertical to horizontal vehicle attitude, you should avoid having a zero angle between the thrust vector and the horizon at any time other than orbit injection. If your ship is horizontal, all propulsion

energy is used to increase VELH, and none is used to oppose gravity. In other words, you're falling, and the only time you're supposed to be falling is in orbit.

In a typical space-shuttle flight, the vehicle goes into a roll shortly after clearing the launch tower and pitches down slightly so that the crew is flying heads-down over the Atlantic. The vehicle reaches Mach 1 (about 708 mph) about 50 seconds into the flight; at SRB separation 82 seconds later, the vehicle is at an altitude of 28 miles and traveling at about Mach 4.5. During this part of the ascent, the main engines are throttled down to as low as 60 percent of their rated thrust to limit aerodynamic loads and to keep accelerations below 3 G. The main engines are turned off at an altitude of about 70 miles. The OMS engines take you the rest of the way to the first orbit-injection point, about 12.5 minutes from lift-off.

The Rendezvous vehicle can't be rolled, so when you pitch away from vertical you are flying heads-up. The pitching of the vehicle is allowed only in one direction and to a maximum of -90 degrees (pointing straight down). SRB separation occurs at an altitude of about 25.8 miles and a speed of about Mach 4.8, which is similar to the space shuttle. The Rendezvous shuttle can handle the aerodynamic loads of a reasonable flight profile without throttling the main engines. The effect of the atmosphere has been realistically modeled in the launch phase, varying as a function of velocity, attitude, and altitude. Fly too fast and too low and you'll lose the ship. Since you can't throttle the main engines, you can't control the G-forces on the crew.

Hitting some kind of an orbit is not difficult with the Rendezvous launch simulation. After playing with various flight profiles for a while, it becomes rather easy. Hitting a parking orbit suitable for a transfer to the space station is something else, though.

### EARTH ORBITS

If you select the option of orbital rendezvous from the main menu, you are

## AT A GLANCE

prompted for a starting orbital altitude and a position relative to the space station. If you've successfully achieved some sort of an orbit in the launch phase, Rendezvous automatically switches to this option. In either case, the simulation presents a view of a nonrotating earth along the equatorial plane showing the western hemisphere. The orbital paths of both the Rendezvous vehicle and the space station are plotted, and both revolve around the planet in a counterclockwise direction. The bottom of the screen presents data about the current and projected vehicle orbits, such as energy remaining in the OMS engines and apogee/perigee altitudes. All flight-parameter input is through the keyboard.

Entering the orbital-rendezvous option through the mission menu puts you in a circular orbit at whatever altitude you choose. Selecting low-altitude orbits leaves the largest OMS fuel reserves for maneuvering. The maximum you can start with corresponds to changes in vehicle velocity of up to 2000 meters per second (m/s). At this point, one of the reasons for choosing such a high space-station altitude becomes apparent. A circle representing the earth is 7972 miles in diameter, and a low earth orbit of 250 miles produces a circle of 8222 miles in diameter. The high-resolution graphics mode is just barely able to differentiate the two circles.

Having 2000 m/s to play with and starting from a circular orbit, it's pretty easy to rendezvous with the space station. More interesting is trying it from the weird elliptical orbit you may have gotten into from the ground after burning most of your fuel. Many times, a partial orbit is achieved that intersects the atmosphere. These orbits have to be circularized or transferred from before you hit the atmosphere. Elliptical orbits can be circularized manually, but this is difficult. It's easier to set this up for the computer and let it do the worrying. Orbital maneuvering by the space shuttle is done exclusively through the on-board computers; manual control by the crew occurs only during approach

<b>Name</b>	Rendezvous	Saturn Navigator
<b>Type</b>	Space-flight simulator	Space-flight simulator
<b>Publisher</b>	Edu-Ware Services Inc. POB 22222 Agoura, CA 91301 (213) 706-0661	subLogic Communications Corp. 713 Edgebrook Dr. Champaign, IL 61820 (217) 359-8482
<b>Computer</b>	Apple II+ with 48K or Atari home computer with 48K and Atari BASIC; joystick optional	Apple II+ with 48K
<b>Documentation</b>	20-page operations manual	19-page user's guide
<b>Price</b>	\$39.95	\$34.95

and docking, with the rendezvous target visible.

Retrograde burns are available for orbit transfers from altitudes higher than the space station and for deorbit. At 250 miles, the space shuttle performs a deorbit burn that changes orbital velocity by 90 m/s (about 200 mph). Compare this to the 17,263-mph orbital velocity and you'll see that it doesn't take much to bring one of these things back down. The Rendezvous vehicle at this altitude will deorbit with 65 m/s or more, but the simulation doesn't provide for landings, so Huntress destroys you in the atmosphere.

You can rendezvous with the space station in many ways. But, as in the launch phase, you have to do it with enough fuel remaining for the approach and docking phases. A successful orbital rendezvous brings up the approach option automatically, or you can select it from the menu.

The display is a star field with a cross representing the Rendezvous vehicle. The data display presents velocity and range data relative to the space station and remaining maneuvering energy. You control the flight through the keyboard or joystick.

In an approach, you're in an almost identical orbit with the space station, either ahead of or behind it. There may also be some residual velocity along the approach vehicle's own internal *x*- and *y*-axes that needs to be reduced to some minimal value. Since you're still in an orbit around the

earth, firing an engine along the orbital path to approach the station from behind increases your altitude and actually slows you down. In the early 1960s, this effect caused some difficulty for the Gemini program and the Soviet space program when rendezvous techniques were being perfected. The solution is to successively raise apogee in a series of translational burns, each time coming closer to the target. Since Rendezvous does not model this situation, it uses a direct approach for the simulation.

For a successful approach, you have to get within 1.2 miles of the space station and reduce velocities along the three spatial axes to 20 m/s or less (with respect to the station). Accomplishing this takes you to the last part of the Rendezvous simulation: alignment and docking.

In the alignment and docking phase, the screen presents an animated, three-dimensional representation of the space station. Flight data available to you includes a graphical presentation of your vehicle position and the station position in case you lose sight of it on the screen; other data includes range, velocity, and vehicle rotation rates. In this part of the simulation you have control over rotation around the three vehicle axes: yaw, pitch, and roll. You manipulate this, along with translational motion, with the keyboard or joystick.

Translational and rotational maneuvering is required to position your-

(continued)

# Save big on the world's largest selection of computer printers

With 189 brands and 630 models, we make printers our only business!

- Printerland doesn't raise prices—only lowers them.
- By the time you read this, prices here have probably been lowered again!
- Unlike a mail order house, we provide service and helpful solutions. Call us with questions!

## PRINTERLAND WILL PAY THE SHIPPING

ABATI LQ-20 List Price \$479	Our Price	<b>\$391<sup>90</sup></b>
AMDEK 5055 List Price \$1995	Our Price	<b>\$1423<sup>10</sup></b>
ANADEK DP 6500 List Price \$2995	Our Price	<b>\$2487<sup>15</sup></b>
CITIZEN MSP10 List Price \$499	Our Price	<b>\$347<sup>10</sup></b>
C.ITOH 3500 List Price \$1995	Our Price	<b>\$1837<sup>15</sup></b>
CORONA LASER List Price \$3395	Our Price	<b>\$2995<sup>90</sup></b>
DATASOUTH DS220 List Price \$1695	Our Price	<b>\$1587<sup>95</sup></b>
FUJITSU SP830 List Price \$2950	Our Price	<b>\$2687<sup>75</sup></b>
GBT 6600 LASER List Price \$22500	Our Price	<b>\$19995<sup>00</sup></b>
EPSON RX-80 List Price \$299	Our Price	<b>\$208<sup>10</sup></b>
EPSON HOMEWRITER 10 INCLUDES COMMODORE INTERFACE List Price \$350	Our Price	<b>\$286<sup>10</sup></b>
OKIDATA 2410 List Price \$2395	Our Price	<b>\$1972<sup>10</sup></b>
QUANTEX 7065 List Price \$1995	Our Price	<b>\$1784<sup>25</sup></b>
QUME 11/90 List Price \$2695	Our Price	<b>\$2493<sup>85</sup></b>
SILVER REED 400 List Price \$399	Our Price	<b>\$229<sup>95</sup></b>
TEXAS INSTRUMENTS 865 List Price \$1299	Our Price	<b>\$1111<sup>10</sup></b>
TOSHIBA 1350 List Price \$1895	Our Price	<b>\$1045<sup>00</sup></b>

If for any reason you are dissatisfied with your new printer from Printerland, you may return it within one week for a full refund.

Printerland welcomes payments in cash or certified checks—no personal checks please. MasterCard and Visa purchases accepted with slight additional fee. Add 7% sales tax for orders in Illinois. Printerland will guarantee your shipment the day your order is received.

Prices subject to change without notice

TO ORDER NOW CALL TOLL FREE

**1-800-255-9888**

In Illinois call (312) 255-9888

**PRINTERLAND**<sup>®</sup>

5834 Dempster St., Morton Grove, IL 60053  
1740 Algonquin Rd., Arlington Heights, IL 60005

Inquiry 284

## REVIEW: SPACE FLIGHT

*The documentation does not describe the ship, but it probably has some kind of nuclear-fission propulsion system like the Discovery in 2001 and 2010.*

self in front of the space-station docking port. Arriving inside the port without hitting anything ends the simulation.

### SATURN NAVIGATOR

Saturn Navigator, also written by Wes Huntress, was originally sold as an add-on program requiring subLogic's A2-301 graphics package to run. It is now available as a stand-alone program running under Apple DOS. Saturn Navigator is a collection of simulations. The goal is to rendezvous with a space station in orbit around Saturn. The mission is divided into four flight phases: interplanetary transfer orbit, Saturn approach and orbit injection, orbital maneuvering, and rendezvous with the Saturn space station.

The program uses animated color graphics to display the flight; particularly effective is a three-dimensional wire model of Saturn and its rings during mid-course corrections and approach and orbit injection. You interact with the simulation through the keyboard.

Each flight phase is run in order; unlike Rendezvous, there is no provision for independent use of the individual programs. The documentation describes the options in the command menu for each flight phase as well as the general requirements for completing each part of the mission. Starting the simulation brings up a

nice graphic of Saturn and one of its moons. Next on the screen comes some explanatory text and a prompt for the velocity of the Saturn transfer orbit.

The documentation for Saturn Navigator does not describe the ship, but considering its performance capabilities, it probably has some kind of nuclear-fission propulsion system like the *Discovery* in 2001 and 2010. In setting up a transfer orbit to Saturn, you are presented with a plan view of the sun, Earth and its orbit, and Saturn and its orbit.

When you input a transfer velocity, the program calculates and plots a trajectory that intersects Saturn's orbit at that planet's location on the orbital path. It then provides the length of the flight in days, and you can request a view of the planet on approach for this trajectory or select a new transfer velocity.

Saturn Navigator lets you play with the relationship between travel time and fuel. The most economical way to go is the Hohmann transfer orbit, but this is also the slowest. (A Hohmann transfer orbit is an elliptical, heliocentric orbit that tangentially intersects the orbits of two planets. In terms of energy, it is the cheapest way to travel from one orbit to another.) Inputting the Hohmann transfer velocity to the program produces the correct transfer orbit, one that just intersects the orbits of Earth and Saturn; however, the calculated travel time is a bit off. A ship on a Hohmann transfer to Saturn would require 6 years for the flight; Saturn Navigator comes up with 5.8 years. The fastest transfer orbit you can select will get you there in 1.7 years, but you'll be left with precious little fuel for orbit injection and maneuvering.

Once you've committed the ship to a trajectory, another text screen comes up suggesting that you consult the documentation for a review of mid-course maneuvering. The screen also displays a countdown, which delays the start of the flight until Earth and Saturn are properly aligned for the transfer. I suppose this adds to the

(continued)

New from McGraw-Hill.

# X-VIEW 86™

Lets you observe the internal operations of DOS application software.

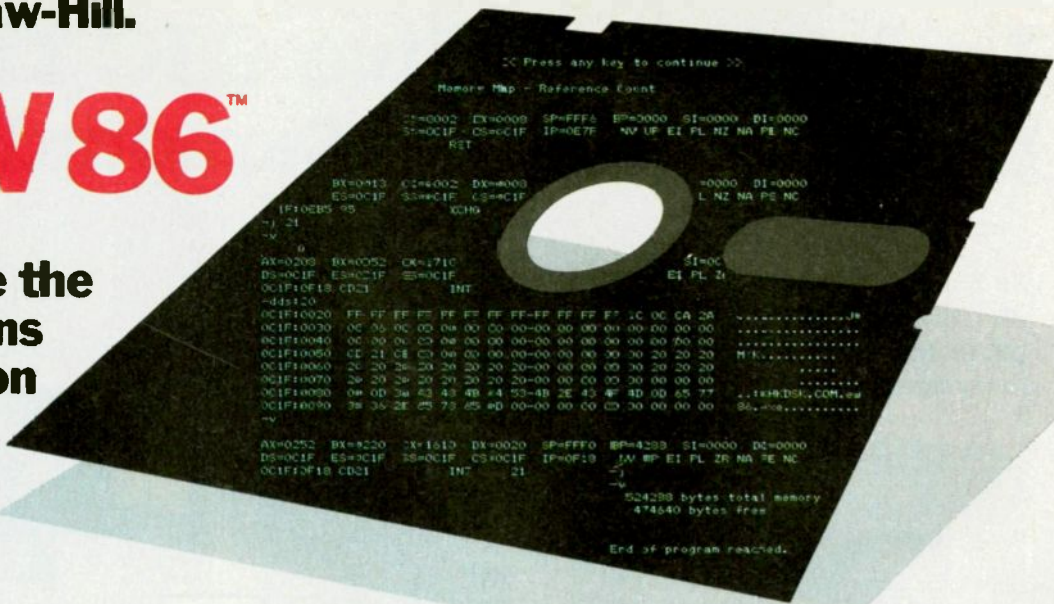

Maybe you've never put it into words. But you know the feeling. It's the frustration that gets you every time you analyze, debug, test, port, or convert DOS application software. To do the job right, you need something no one has invented. You've got to see what's going on inside the software, how it's acting and reacting. You need something that gives you x-ray vision. Now you've got it. X-VIEW 86™, new from McGraw-Hill, lets you observe the internal operations of DOS application software. Developed, tested, and refined in the highly respected technical labs of Future Computing, it helps you generate a thorough, reliable technical analysis. Far better than what you could produce on your own.

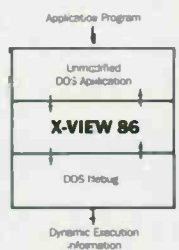

This powerful new tool — we call it a software analyzer — is an affordable \$59.95.

X-VIEW 86™ runs on any member of the IBM PC family — or any operationally compatible machine — with any memory configuration. You use it with PC-DOS Debug 2.0 or 2.1.

- Single-stroke commands allow you to interrupt the application program:
- on any processor I/O access
  - on any processor interrupt instruction
  - when its execution reaches a specified address
  - when it uses a specified memory location
- In addition, you can:
- automatically collect and analyze technical information on an application program
  - start program execution at a specified address
  - display the results of the analysis on screen
- X-VIEW 86™. A new kind of software. For developers and engineers with vision.



Inquiry 400

Future Computing Incorporated is a unit of McGraw-Hill Information Systems Company.

IBM is a registered trademark and PC-DOS is a trademark of International Business Machines Corporation.

**To order X-VIEW 86™ by credit card, call toll free 1-800-221-VIEW. In Texas call: 1-800-233-VIEW or send the coupon today.**

Customer Service  
McGraw-Hill Inc.  
8111 LBJ Freeway  
Dallas, Texas 75251

X-VIEW 86™ is \$59.95. All orders are subject to acceptance by McGraw-Hill Inc. Prices are subject to change without notice.  
 Check enclosed (Make check payable to McGraw-Hill Inc. Orders paid by check are subject to delay.)  
 A.E.  M.C.  VISA  D.C.

Please send me X-VIEW 86™.

Name \_\_\_\_\_

Title \_\_\_\_\_

Company \_\_\_\_\_

Address \_\_\_\_\_

City \_\_\_\_\_ State \_\_\_\_\_ Zip \_\_\_\_\_

Phone (\_\_\_\_) \_\_\_\_\_

Qty	Price	Total
_____	\$59.95	_____

Signature \_\_\_\_\_

Credit card no. \_\_\_\_\_

Expiration date \_\_\_\_\_

For IBM-PC Add-On Users

# In A Pinch? Give QIC The Inch Measure Us By The Standards We Set!

We Set The Standard On Price!

**QIC-01 Internal Hard Disk Subsystem**



10MB \$545  
20MB \$695

This low power Microscience subsystem comes complete with controller, cables, drive, easy instructions. Fits inside your floppy slot. Compatible with DOS 2.0, 2.1, and 3.0 without any patches. 33 MB half-height with controller, \$1,295 ... 20 MB Drive for the PC AT, \$895. Mounting hardware for Compaq is available. External 10 MB \$795, external 20 MB \$995.

We set The Standard In Quality!

**QIC-03 300/1200 Baud Modems**

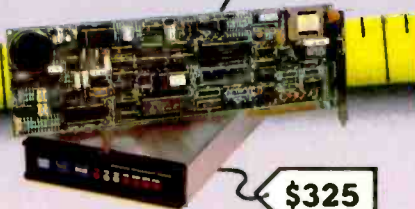

\$275

\$325

Our modems are fully Hayes compatible with features such as low heat dissipation, low power consumption, software volume control for the speaker, and large-scale-integration "Modem on a chip" for high reliability. It also comes with communications software which lets you emulate VT100 or IBM 3101. External \$325, Internal \$275.

We Set The Standard On Reliability!

**QIC-05 Five-Function Card**

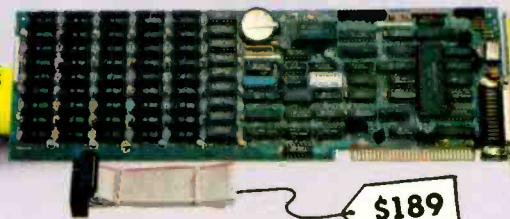

\$189

It gives you more than just added memory. It gives you reliable memory expansion (up to 384K), a serial port, a parallel port, a game port, and a battery back-up clock calendar. Includes RAM disk, print spooler, and clock utilities. (The 64K RAM set is only \$15.)

**QIC-2020 External Hard Disk with Tape Backup.**



\$1955

Here's a 20 MB hard disk with a 20 MB tape backup unit in a chassis with two extra I/O slots. Comes with cable and a half size host adapter card. 20 MB hard disk with 60 MB tape is only \$2450.

We Set The Standard On Performance!

**QIC-02 Floppy Tape Drive**



\$595

How's this for Performance? It backs up your 10 MB disk in only 20 minutes and performs both image and file-by-file back-up. This half-height drive will fit inside your floppy disk and connect to your floppy controller. (No need for an additional controller card.) ... \$595. External unit is only \$795.

## Graphics Boards

Hercules, Color .....	\$185
Hercules Compatible, Mono .....	\$245
Paradise Graphics .....	\$295
Everex Graphics Edge .....	\$295

## Back-up Tape Subsystems

45 MB Internal Streaming Tape for AT .....	\$895
45 MB Internal/External Streaming Tape for PC XT .....	\$950/\$1195
20 MB Internal/External Streaming Cassette .....	\$695/\$895
Expansion Chassis with I/O Slots .....	\$695
IBM PC, 256K, 2 Drives .....	CALL

## We Guarantee Satisfaction!

No Risk. All our products carry the manufacturer's warranty. And remember, if for any reason, you are not completely satisfied within 30 days, you can return it for a full refund.

**Call Us Today!**  
**(408) 942-8086**

Telex: 5101002379 QICRCH

**QIC RESEARCH**  
INCORPORATED

Inquiry 292  
QIC-403

489 Valley Way  
Milpitas, Ca 95035

realism, but I found it annoyingly long after the first few flights.

An animated display of the sun, Earth, Saturn, and the ship is presented after the transfer-orbit injection burn. Time into the mission in days and a plot of the ship's current position along the flight path are also displayed. At several points during the flight, you can make mid-course corrections of the flight path.

On a close approach to Saturn, that planet's gravity acts to "draw" you into a hyperbolic path around the planet. There is a point on this hyperbola where an appropriate engine burn causes the spacecraft to enter a closed orbit around the planet, a prograde orbit that doesn't hit the planet or the rings and leaves enough fuel for the orbital maneuvering required to rendezvous with the space station in an equatorial orbit around Saturn. You use mid-course maneuvering to target your approach so that you hit this point.

At each mid-course opportunity, Saturn Navigator puts up a three-dimensional view of the planet on approach along with a plot of the targeting point. Data about this point, such as the resulting orbital inclination and periapsis (of the trajectory), is also presented. You use this information to move the targeting point as required for the desired final approach. Once you've found and committed to a suitable target point, the computer initiates a burn to adjust the flight path to the new target point. The

display returns to a plot of spacecraft and planetary positions. Final approach occurs two days out from the planet and automatically moves you into the approach and orbit-injection routines in the simulation.

Using Saturn's gravity to help capture your spacecraft expends far less energy than would be needed to circularize an orbit at Saturn's "altitude" from the sun. On approach and orbit injection, the screen displays the effect of gravity on the flight path and an overhead or polar view of the planet and ring system. This part of the simulation also allows views from the equatorial plane and changes in approach velocity or the initiation of the orbit-injection maneuver. Once you commit to an orbit insertion, a nice animated view of the approach appears on the screen. This is particularly effective in high-inclination approaches.

When you reach the point of closest approach, the computer does the orbit-injection burn. You can either manually initiate orbital maneuvering or complete half of the orbit for automatic transition. Maneuver sequences are loaded to the computer to change the orbit shape and size for immediate execution from circular orbits or delayed execution from elliptical orbits. This delay is to time the engine burn for either apoapsis or periapsis in a Hohmann-type fuel-efficient orbit transfer. You can also change orbit inclination.

As soon as you have maneuvered

## *Personal computers can provide a feel for the problems of space flight.*

into some kind of an orbit inside the inner ring and have an inclination of 0 degrees, you are allowed to manually move into the final part of the simulation—the rendezvous with the Saturnian space station, which is in a circular orbit of 4125-mile altitude. The rest of the simulation is almost identical to Rendezvous except that you aren't required to handle approach and docking and you don't get a look at the station.

### CONCLUSION

Personal computers and simulations can provide a feel for the problems and techniques involved in space flight that is obtainable in no other way save direct experience (an option not yet open to most of us). Books and equations dealing with orbital mechanics and rocket flight are very important, but they just can't provide the interaction necessary for an intuitive grasp of space travel. Even the lucky few with flight opportunities spend an awful lot of time with computer-based flight and mission simulators. Until that day when the rest of us get to join in the fun, personal computers can serve as our space vehicles. ■

## THE \$2995 I<sup>2</sup> DEVELOPMENT SYSTEM

Turns any personal computer into a complete micro-computer DEVELOPMENT SYSTEM. Our integrated control/display program runs under MS-DOS, CP/M, ISIS, or Apple and controls the UDL via an RS-232 port.

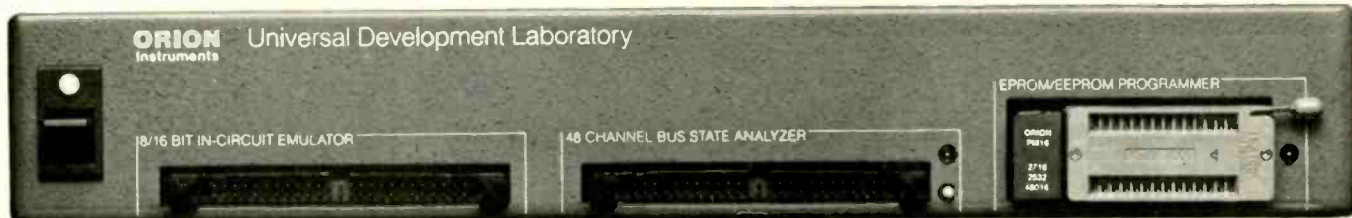

**32K bytes of EMULATION ROM (128K max)** allows you to make program patches instantly. Since the target ROM socket connects data and address lines to both the analyzer and the emulator, no expensive adaptors or personality modules are needed.

The powerful **BUS STATE ANALYZER** features four-step sequential triggering, selective trace, and pass and delay counters. Symbolic trace disassemblers and debuggers are available for Z-80, NSC-800, 8048, 6301, R65, 6500, 6800, 6801, 6802, 6805, 6809, 8051, 8085, Z-8, 1802, 8088/80188, 8085/80186, and 68000/8.

The **PROM GENERATOR** also doubles as a **STIMULUS GENERATOR**.

For further information, call or write:

**ORION** Instruments 702 Marshall Street, Suite 614, Redwood City, CA 94064 (415) 361-8883

# Mail-Order Electronics Worldwide Since 1974

## 12 MILLION P.C. IC CLEARANCE CALL FOR QUANTITY DISCOUNTS

Part No.	Price	7400	Part No.	Price
SN7400N	14.29	SN7414N	14.39	
SN7401N	14.29	SN7415N	14.45	
SN7402N	14.29	SN7416N	14.45	
SN7403N	14.29	SN7417N	14.45	
SN7404N	14.29	SN7418N	14.45	
SN7405N	14.29	SN7419N	14.45	
SN7406N	14.29	SN7420N	14.45	
SN7407N	14.29	SN7421N	14.45	
SN7408N	14.29	SN7422N	14.45	
SN7409N	14.29	SN7423N	14.45	
SN7410N	14.29	SN7424N	14.45	
SN7411N	14.29	SN7425N	14.45	
SN7412N	14.29	SN7426N	14.45	
SN7413N	14.29	SN7427N	14.45	
SN7414N	14.29	SN7428N	14.45	
SN7415N	14.29	SN7429N	14.45	
SN7416N	14.29	SN7430N	14.45	
SN7417N	14.29	SN7431N	14.45	
SN7418N	14.29	SN7432N	14.45	
SN7419N	14.29	SN7433N	14.45	
SN7420N	14.29	SN7434N	14.45	
SN7421N	14.29	SN7435N	14.45	
SN7422N	14.29	SN7436N	14.45	
SN7423N	14.29	SN7437N	14.45	
SN7424N	14.29	SN7438N	14.45	
SN7425N	14.29	SN7439N	14.45	
SN7426N	14.29	SN7440N	14.45	
SN7427N	14.29	SN7441N	14.45	
SN7428N	14.29	SN7442N	14.45	
SN7429N	14.29	SN7443N	14.45	
SN7430N	14.29	SN7444N	14.45	
SN7431N	14.29	SN7445N	14.45	
SN7432N	14.29	SN7446N	14.45	
SN7433N	14.29	SN7447N	14.45	
SN7434N	14.29	SN7448N	14.45	
SN7435N	14.29	SN7449N	14.45	
SN7436N	14.29	SN7450N	14.45	
SN7437N	14.29	SN7451N	14.45	
SN7438N	14.29	SN7452N	14.45	
SN7439N	14.29	SN7453N	14.45	
SN7440N	14.29	SN7454N	14.45	
SN7441N	14.29	SN7455N	14.45	
SN7442N	14.29	SN7456N	14.45	
SN7443N	14.29	SN7457N	14.45	
SN7444N	14.29	SN7458N	14.45	
SN7445N	14.29	SN7459N	14.45	
SN7446N	14.29	SN7460N	14.45	
SN7447N	14.29	SN7461N	14.45	
SN7448N	14.29	SN7462N	14.45	
SN7449N	14.29	SN7463N	14.45	
SN7450N	14.29	SN7464N	14.45	
SN7451N	14.29	SN7465N	14.45	
SN7452N	14.29	SN7466N	14.45	
SN7453N	14.29	SN7467N	14.45	
SN7454N	14.29	SN7468N	14.45	
SN7455N	14.29	SN7469N	14.45	
SN7456N	14.29	SN7470N	14.45	
SN7457N	14.29	SN7471N	14.45	
SN7458N	14.29	SN7472N	14.45	
SN7459N	14.29	SN7473N	14.45	
SN7460N	14.29	SN7474N	14.45	
SN7461N	14.29	SN7475N	14.45	
SN7462N	14.29	SN7476N	14.45	
SN7463N	14.29	SN7477N	14.45	
SN7464N	14.29	SN7478N	14.45	
SN7465N	14.29	SN7479N	14.45	
SN7466N	14.29	SN7480N	14.45	
SN7467N	14.29	SN7481N	14.45	
SN7468N	14.29	SN7482N	14.45	
SN7469N	14.29	SN7483N	14.45	
SN7470N	14.29	SN7484N	14.45	
SN7471N	14.29	SN7485N	14.45	
SN7472N	14.29	SN7486N	14.45	
SN7473N	14.29	SN7487N	14.45	
SN7474N	14.29	SN7488N	14.45	
SN7475N	14.29	SN7489N	14.45	
SN7476N	14.29	SN7490N	14.45	
SN7477N	14.29	SN7491N	14.45	
SN7478N	14.29	SN7492N	14.45	
SN7479N	14.29	SN7493N	14.45	
SN7480N	14.29	SN7494N	14.45	
SN7481N	14.29	SN7495N	14.45	
SN7482N	14.29	SN7496N	14.45	
SN7483N	14.29	SN7497N	14.45	
SN7484N	14.29	SN7498N	14.45	
SN7485N	14.29	SN7499N	14.45	
SN7486N	14.29	SN7500N	14.45	

## RED-HOT RAM & EPROM PRICES

Part No.	Description	Price	Part No.	Description	Price
21C14	(200ns) CMOS SRAM	9.99	6264P-15	(1500s) SRAM	12.49
27C16	(450ns) CMOS EPROM	9.95	6264LP-15	(1500s) LP SRAM	12.95
4164N-200	(DRAM)	2.25-9/19.95	27128-25	(2500s) EPROM	9.95
6116P-4	(200ns) SRAM	3.49	41256-200	(200ns) DRAM	8.95
6116LP-4	(200ns) LP SRAM	3.69	86764	(450ns) 21V EPROM	12.95
			EW-1	EPROM Window Covers	10/69

## NEW EEPROM

Part No.	Pins	Function	Price
2816	24	2048x8 16K E <sup>2</sup> PROM 350ns	12.95

Features: On-board Address/Data Latches - Auto-Timed Byte Write (no chip select) - 5V Erase/Write/Program - Auto Erase/Verify/Program (2V-2.2V) - Power Up/Down Write Protection - Auto Erase before Write  
The 2816 is an ideal nonvolatile memory providing in-system alterability with the same ease and with the same features as 2Kx8 Static RAMs.

## MICROPROCESSOR COMPONENTS

Part No.	Description	Price	Part No.	Description	Price
80C86	8086 Microprocessor	16.95	80C286	80286 Microprocessor	16.95
80C88	8088 Microprocessor	16.95	80C386	80386 Microprocessor	16.95
80C80	8080 Microprocessor	16.95	80C486	80486 Microprocessor	16.95
80C82	8082 Microprocessor	16.95	80C586	80586 Microprocessor	16.95
80C84	8084 Microprocessor	16.95	80C686	80686 Microprocessor	16.95
80C85	8085 Microprocessor	16.95	80C786	80786 Microprocessor	16.95
80C87	8087 Microprocessor	16.95	80C886	80886 Microprocessor	16.95
80C89	8089 Microprocessor	16.95	80C986	80986 Microprocessor	16.95
80C90	8090 Microprocessor	16.95	80C086	80086 Microprocessor	16.95
80C91	8091 Microprocessor	16.95	80C186	80186 Microprocessor	16.95
80C92	8092 Microprocessor	16.95	80C286	80286 Microprocessor	16.95
80C93	8093 Microprocessor	16.95	80C386	80386 Microprocessor	16.95
80C94	8094 Microprocessor	16.95	80C486	80486 Microprocessor	16.95
80C95	8095 Microprocessor	16.95	80C586	80586 Microprocessor	16.95
80C96	8096 Microprocessor	16.95	80C686	80686 Microprocessor	16.95
80C97	8097 Microprocessor	16.95	80C786	80786 Microprocessor	16.95
80C98	8098 Microprocessor	16.95	80C886	80886 Microprocessor	16.95
80C99	8099 Microprocessor	16.95	80C986	80986 Microprocessor	16.95

## 74LS

Part No.	Price	74LS1	Price
SN74LS00N	14.29	SN74LS01N	14.29
SN74LS01N	14.29	SN74LS02N	14.29
SN74LS02N	14.29	SN74LS03N	14.29
SN74LS03N	14.29	SN74LS04N	14.29
SN74LS04N	14.29	SN74LS05N	14.29
SN74LS05N	14.29	SN74LS06N	14.29
SN74LS06N	14.29	SN74LS07N	14.29
SN74LS07N	14.29	SN74LS08N	14.29
SN74LS08N	14.29	SN74LS09N	14.29
SN74LS09N	14.29	SN74LS10N	14.29
SN74LS10N	14.29	SN74LS11N	14.29
SN74LS11N	14.29	SN74LS12N	14.29
SN74LS12N	14.29	SN74LS13N	14.29
SN74LS13N	14.29	SN74LS14N	14.29
SN74LS14N	14.29	SN74LS15N	14.29
SN74LS15N	14.29	SN74LS16N	14.29
SN74LS16N	14.29	SN74LS17N	14.29
SN74LS17N	14.29	SN74LS18N	14.29
SN74LS18N	14.29	SN74LS19N	14.29
SN74LS19N	14.29	SN74LS20N	14.29
SN74LS20N	14.29	SN74LS21N	14.29
SN74LS21N	14.29	SN74LS22N	14.29
SN74LS22N	14.29	SN74LS23N	14.29
SN74LS23N	14.29	SN74LS24N	14.29
SN74LS24N	14.29	SN74LS25N	14.29
SN74LS25N	14.29	SN74LS26N	14.29
SN74LS26N	14.29	SN74LS27N	14.29
SN74LS27N	14.29	SN74LS28N	14.29
SN74LS28N	14.29	SN74LS29N	14.29
SN74LS29N	14.29	SN74LS30N	14.29
SN74LS30N	14.29	SN74LS31N	14.29
SN74LS31N	14.29	SN74LS32N	14.29
SN74LS32N	14.29	SN74LS33N	14.29
SN74LS33N	14.29	SN74LS34N	14.29
SN74LS34N	14.29	SN74LS35N	14.29
SN74LS35N	14.29	SN74LS36N	14.29
SN74LS36N	14.29	SN74LS37N	14.29
SN74LS37N	14.29	SN74LS38N	14.29
SN74LS38N	14.29	SN74LS39N	14.29
SN74LS39N	14.29	SN74LS40N	14.29
SN74LS40N	14.29	SN74LS41N	14.29
SN74LS41N	14.29	SN74LS42N	14.29
SN74LS42N	14.29	SN74LS43N	14.29
SN74LS43N	14.29	SN74LS44N	14.29
SN74LS44N	14.29	SN74LS45N	14.29
SN74LS45N	14.29	SN74LS46N	14.29
SN74LS46N	14.29	SN74LS47N	14.29
SN74LS47N	14.29	SN74LS48N	14.29
SN74LS48N	14.29	SN74LS49N	14.29
SN74LS49N	14.29	SN74LS50N	14.29
SN74LS50N	14.29	SN74LS51N	14.29
SN74LS51N	14.29	SN74LS52N	14.29
SN74LS52N	14.29	SN74LS53N	14.29
SN74LS53N	14.29	SN74LS54N	14.29
SN74LS54N	14.29	SN74LS55N	14.29
SN74LS55N	14.29	SN74LS56N	14.29
SN74LS56N	14.29	SN74LS57N	14.29
SN74LS57N	14.29	SN74LS58N	14.29
SN74LS58N	14.29	SN74LS59N	14.29
SN74LS59N	14.29	SN74LS60N	14.29
SN74LS60N	14.29	SN74LS61N	14.29
SN74LS61N	14.29	SN74LS62N	14.29
SN74LS62N	14.29	SN74LS63N	14.29
SN74LS63N	14.29	SN74LS64N	14.29
SN74LS64N	14.29	SN74LS65N	14.29
SN74LS65N	14.29	SN74LS66N	14.29
SN74LS66N	14.29	SN74LS67N	14.29
SN74LS67N	14.29	SN74LS68N	14.29
SN74LS68N	14.29	SN74LS69N	14.29
SN74LS69N	14.29	SN74LS70N	14.29
SN74LS70N	14.29	SN74LS71N	14.29
SN74LS71N	14.29	SN74LS72N	14.29
SN74LS72N	14.29	SN74LS73N	14.29
SN74LS73N	14.29	SN74LS74N	14.29
SN74LS74N	14.29	SN74LS75N	14.29
SN74LS75N	14.29	SN74LS76N	14.29
SN74LS76N	14.29	SN74LS77N	14.29
SN74LS77N	14.29	SN74LS78N	14.29
SN74LS78N	14.29	SN74LS79N	14.29
SN74LS79N	14.29	SN74LS80N	14.29
SN74LS80N	14.29	SN74LS81N	14.29
SN74LS81N	14.29	SN74LS82N	14.29
SN74LS82N	14.29	SN74LS83N	14.29
SN74LS83N	14.29	SN74LS84N	14.29
SN74LS84N	14.29	SN74LS85N	14.29
SN74LS85N	14.29	SN74LS86N	14.29
SN74LS86N	14.29	SN74LS87N	14.29
SN74LS87N	14.29	SN74LS88N	14.29
SN74LS88N	14.29	SN74LS89N	14.29
SN74LS89N	14.29	SN74LS90N	14.29
SN74LS90N	14.29	SN74LS91N	14.29
SN74LS91N	14.29	SN74LS92N	14.29
SN74LS92N	14.29	SN74LS93N	14.29
SN74LS93N	14.29	SN74LS94N	14.29
SN74LS94N	14.29	SN74LS95N	14.29
SN74LS95N	14.29	SN74LS96N	14.29
SN74LS96N	14.29	SN74LS97N	14.29
SN74LS97N	14.29	SN74LS98N	14.29
SN74LS98N	14.29	SN74LS99N	14.29
SN74LS99N	14.29	SN7500N	14.29

## 6501/68000 SERIES

Part No.	Description	Price
6502	6502 Microprocessor	16.95
6505	6505 Microprocessor	16.95
6506	6506 Microprocessor	16.95
6507	6507 Microprocessor	16.95
6508	6508 Microprocessor	16.95
6509	6509 Microprocessor	16.95
6510	6510 Microprocessor	16.95
6511	6511 Microprocessor	16.95
6512	6512 Microprocessor	16.95
6513	6513 Microprocessor	16.95
6514	6514 Microprocessor	16.95
6515	6515 Microprocessor	16.95
6516	6516 Microprocessor	16.95
6517	6517 Microprocessor	16.95
6518	6518 Microprocessor	16.95
6519	6519 Microprocessor	16.95
6520	6520 Microprocessor	16.95
6521	6521 Microprocessor	16.95



## Commodore® Accessories



**RS232 Adapter  
for VIC-20 and  
Commodore 64**

The JE232CM allows connection of standard serial RS232 printers, modems, etc. to your VIC-20 and C-64. A 4-pole switch allows the inversion of the 4 control lines. Complete installation and operation instructions included.

- Plugs Into User Port
- Provides Standard RS232 signal levels
- Uses 6 signals (Transmit, Receive, Clear to Send, Request to Send, Data Terminal Ready, Data Set Ready)

**JE232CM** . . . . . \$39.95

**VOICE SYNTHESIZER  
FOR COMMODORE VIC-20 AND C-64**  
*Plug-In — Talking in Minutes!*

**JE520CM** . . . . . \$99.95

## TRS-80 Accessories

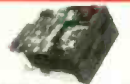

**MPI 5 1/4" DISK DRIVE**

- Use as a second disk drive
- Single-sided
- Single/double density
- Full-height drive
- 48 TPI
- Documentation included
- Weight: 3.7 lbs.

**MPI51S** . . . \$89.95 or 2 for \$159.95

## EXPAND TRS-80 MEMORY

### TRS-80 MODEL I, III

Each Kit comes complete with eight MMS290 (JPD4184) 16K Dynamic RAMs and documentation for conversion. Model I: 16K equipped with Expansion interface can be expanded to 48K with 2 Kits. Model III: Can be expanded from 16K to 48K using 2 Kits. Each kit will expand computer by 16K increments.

**TRS-16K3 200ns (Model III)** . . . . . \$6.29  
**TRS-16K4 250ns (Model I)** . . . . . \$5.49

### TRS-80 COLOR AND COLOR II

Easy to install Kit comes complete with 8 each 4164N-20 (200ns) 64K Dynamic RAMs and documentation for conversion. Converts TRS-80 Color Computers with D, E, ET, F and MC circuit boards to 32K. Also converts TRS-80 Color Computer II to 64K. Flex DOS or OS-9 required to utilize full 64K RAM on all computers.

**TRS-64K-2** . . . . . \$17.95

### TRS-80 MODEL IV & 4P

Easy to install Kit comes complete with 8 ea. 4164N-20 (200ns) 64K Dynamic RAMs and conversion documentation. Converts TRS-80 Model IV computers from 16K to 64K. Also expands Model 4P from 64K to 128K.

**TRS-64K-2** . . . . . \$17.95  
(Converts the Model IV from 16K to 64K or will expand the Model 4P from 64K to 128K)

**TRS-64K2PAL (Model IV only)** . . . . . \$38.95  
(8 - 4164N's with PAL Chip to expand from 64K to 128K)

### TRS-80 Model 100\* • NEC • Olivetti

\*ALSO COMPATIBLE WITH NEC PC-8201A AND OLIVETTI M10

Easy to install module plugs right into the sockets increasing memory in 8K increments. Complete with module and documentation for conversion.

**M1008K (TRS-80 Model 100 Expansion)** . . . . . \$49.95  
**NEC8KR (NEC PC-8201A & Olivetti M10) Please Specify** \$49.95

## PROMETHEUS MODEMS



**Intelligent 300/1200  
Baud Modem with Real  
Time Clock/Calendar**

The ProModem™ is a Bell 212A (300/1200 baud) intelligent stand-alone modem. Full featured expansion module. Standard features include: Auto Answer and Auto Dial, Help Commands, Programmable Intelligent Dialing, Touch Tone™ & Pulse Dialing and More. Hayes command set compatible plus an additional extended command set. Shown w/alphanumeric display option.

**PM1200 RS-232 Stand-Alone Unit** . . . . . \$319.95

### OPTIONS FOR ProModem 1200

**PM-COM** (ProCom Communication Software) . . . . . \$79.95  
Please specify Operating System.

**PM-OP** (Options Processor) . . . . . \$79.95

**PMO-15K** (Options Processor Memory — 15K) . . . . . \$ 4.50

**PMO-32K** (Options Processor Memory — 32K) . . . . . \$ 9.00

**PMO-64K** (Options Processor Memory — 64K) . . . . . \$18.00

**PM-ALP** (Alphanumeric Display) . . . . . \$79.95

(incl. Options-Processor  
64K Memory and  
Alphanumeric Display) . . . . . \$169.95

**PM-Special** . . . . . \$169.95

## SURGE PROTECTORS & BACK-UPS



**INDUSTRIES  
PROTECT YOURSELF...  
DATASHIELD®  
Surge Protector**

Eliminates voltage spikes and EMI-RFI noise before it can damage your equipment or cause data loss & month warranty. Power dissipation (100 microsecond) 2,000,000 watts

PART NO.	DESCRIPTION	PRICE
MODEL 75	4 Sockets, On/Off Switch	\$49.95
MODEL 100	6 Sockets, Super Filters, Low Voltage Alarm	\$69.95

### DATASHIELD® Back-Up Power Source

Protect your computer from back-outs, brown-outs, power surges and line noise. P77A PC200 is designed for PCs with floppy disk storage, the XT300 for hard disk storage and the AT800 for multi-user systems. A typical complete PC for each of these standbys will be supported for 15 to 25 minutes after power is lost (Weight: PC200, 27 lbs. — XT300, 43 lbs.) — (AT800 65 lbs.) — (AT800 83 lbs.)

PC200	(200 Watt Rating)	\$299.95
PC300	(300 Watt Rating)	\$399.95
AT500	(500 Watt Rating)	\$699.95
AT800	(800 Watt Rating)	\$799.95

## \*\*\*\*\* APPLE® Accessories \*\*\*\*\*



**APPLE\*  
Compatible  
CARDS**

### 16K RAM Card (Language Card)

The ARC-16K RAM Card allows the Apple® II and II+ computers to expand from 48K to 64K. Complete with instructions. Key: (a)

**ARC-16K** . . . . . \$39.95

### Z-80 CP/M Card

The AZ80-1 is Soft-card compatible. Used with CP/M related programs. Software not included. Key: (a,b)

**AZ80-1** . . . . . \$49.95

### EPROM Burner Card

The AEB-2 allows user to program and work with standard EPROMs (2716, 2732 & 2764). Easy to use, on-board firmware. Menu contains the following options: Write, Read, Copy, Compare, Blank-Check and Monitor. Complete with instructions. Key: (a,b)

**AEB-2** . . . . . \$69.95

### 80-Column Card w/Soft Switch

The A80-C is an 80-column card designed for the Apple® II and II+ computers. The card is equipped with a soft switch which allows easy hookup for any monitor. The A80-C also features inverse video capabilities. This card is similar to the Videx™ 80 column card. Complete with instructions. Key: (a)

**A80-C** . . . . . \$74.95

### Super Serial Card

The ASSC-P is a serial card with a printer mode. It generates standard RS-232C signals and is similar to the Apple® Super Serial Card. Complete with instructions. Key: (a,b)

**ASSC-P** . . . . . \$99.95

### Parallel Card w/64K Buffer

The APC-64K is a parallel card with a 64K buffer and graphic dump capabilities. Complete with instructions. Key: (a,b)

**APC-64K** . . . . . \$129.95

### 80-Column/64K RAM Card

Extended 80-Column/64K RAM Card expands memory by 64K to give 128K when used with programs like VisiCalc™. Complete with instructions. Key: (b)

**JE864** . . . . . \$79.95

\*APPLE, APPLE II, II+, IIc and Macintosh are registered trademarks of APPLE Computers. \*\*VisiCalc is a registered trademark of Visi Corp. Inc. \*\*\*Videx is a registered trademark of Videx Inc.

### APPLE™ Compatible 5 1/4" Half-Height Disk Drive



**Reduced Pricing!**

• Uses Chicon Pinch-type mechanics • 143K formatted storage • 35 tracks • Super quiet • Works with Apple Controllers or other compatibles (ACC-1) (soft) • Complete with connector — just plug into your controller. • Size: 5 1/4" W x 1 3/4" H x 8" D • Wt: 4 lbs. Key: (a,b)

**ADD-12** . . . . . \$159.95

### APPLE™ Compatible 5 1/4" Disk Drive & Controller Card



• Uses Shugart SA390 mechanics • 143K formatted storage • Color matches Apple Computer • Works with Apple Controller or other Apple-compatible controllers (ACC-1) • Complete with connector — just plug into your disk controller card • 35 tracks • Size: 5" W x 3 1/4" H x 8-9/16" D • Wt: 4 lbs. Key: (a,b)

**ADD-514 (Disk Drive)** . . . . . \$149.95  
**ACC-1 (Controller Card)** . . . . . \$ 49.95

\* Same specs as ADD-12 (soft) except no controller necessary.

**APPLE™ IIc Compatible  
5 1/4" Half-Height Disk Drive**  
• Same specs as ADD-12 (soft) except no controller necessary.

**ADD-IIc** . . . . . \$169.95

## Additional Apple\* Compatible Products

<b>APF-1</b>	Cooling Fan with surge protection • Key: (a,b)	\$ 39.95
<b>JE614</b>	Numeric/Aux. Keypad — 23 accessible functions • Key: (b)	\$ 49.95
<b>EAEC-1</b>	Expanded Apple Enclosure Case only • Key: (a)	\$ 59.95
<b>KHP4007</b>	Switching Power Supply • Key: (a)	\$ 59.95
<b>KB-A68</b>	68-Key Apple Keyboard only • Key: (a)	\$ 79.95
<b>MON-12G</b>	12" Green Monitor with swivel stand • Key: (a, b & i/c)	\$ 79.95
<b>JE520AP</b>	Voice Synthesizer — Plug-In, User Ready • Key: (a,b)	\$119.95
<b>KB-EA1</b>	Apple Keyboard and Case • Key: (a)	\$134.95
<b>PM1200A</b>	Prometheus Internal Modem — 2 cards • Key: (a,b)	\$299.95
<b>PM1200M</b>	Prometheus Macintosh Ext. Modem • Key: (Macintosh)	\$369.95

## General Application Power Supplies

**Power/Mate Corp. REGULATED POWER SUPPLY**

- Input: 105-125/210-250VAC @ 47-63Hz • Line regulation: ±0.05% • Three mounting surfaces • Overvoltage protection • UL recognized • CSA certified

Part No.	Output	Size	Weight	Price
<b>EMA5/6B</b>	5V@3A/6V@2.5A	4 1/2" x 4 1/4" x 2 1/2" H	2 lbs.	\$29.95
<b>EMA5/6C</b>	5V@6A/6V@5A	5 1/2" x 4 1/4" x 2 1/2" H	4 lbs.	\$39.95

**KEPCO/TDK 4-OUTPUT SWITCHING POWER SUPPLY**

- Ideal for disk drive needs of CRT terminals, microcomputers and video games • Input: 115/230VAC, 50/60Hz • Output: +5V @ 5A, +12V @ 1.8A, +12V @ 2A, -12V @ 0.5A • UL recognized • CSA certified • Size: 7 1/2" L x 6-3/16" W x 1 1/2" H • Weight: 2 lbs.

**MRM 174KF** . . . . . \$49.95

**4-CHANNEL SWITCHING POWER SUPPLY**

- Microprocessor, mini-computer, terminal, medical equipment and process control applications • Input: 90-130VAC, 47-40Hz • Output: +5VDC @ 5A, -5VDC @ 1A, +12VDC @ 1A, -12VDC @ 1A • Line regulation: ±0.2% • Ripple: 30mV p-p • Load regulation: ±1% • Overcurrent protection • Adj. 5V main output ±10% • Size: 6 1/2" L x 1 1/2" W x 4-1/16" H • Weight: 1 1/2 lbs.

**FCS-604A** . . . . . \$69.95

\$10 Minimum Order — U.S. Funds Only CA Residents: Add 6% Sales Tax Spec Sheets — 30¢ each Shipping: Add 5% plus \$1.50 Insurance Send \$1 Postage for FREE 1985 Jameco Catalog Prices Subject to Change Send stamped, un-addressed envelope to receive a Monthly Sales Flyer — FREE!



1355 SHOREWAY ROAD, BELMONT, CA 94002  
7185 PHONE ORDERS WELCOME — (415) 592-8097 — Telex: 176043

## IBM® Accessories



**8-Foot Parallel Printer Cable**  
**IBM-8PC** (DB25 Male to Centronics 36-pin Male) . . . . . \$19.95

**6-Foot Serial Printer/Modem Cable**  
**MMS-2206** (DB25 Male to DB25 Male) . . . . . \$14.95  
**MFS-2206** (DB25 Male to DB25 Female) . . . . . \$15.25

**5-Foot Keyboard Extension Cable for IBM-PC and XT Computers**  
**IBM-KEC** . . . . . \$9.95

## MEMORY EXPANSION KITS

### IBM PC, PC XT and Compatibles

The IBM64K Kit will increase memory in 64K byte increments. The Kit is simple to install — just insert the 9 - 64K RAM chips in the provided sockets and set the 2 groups of switches. Conversion documentation included.

**IBM64K (Nine 200ns 64K RAMs)** . . . . . \$19.95

### IBM PC AT

Each kit comes complete with nine 128K dynamic RAMs and documentation for conversion.

**IBM128K (Nine 250ns 128K RAMs)** . . . . . \$133.95



**IBM PCXT Equivalent  
130 Watt Power Supply**  
*UPGRADE YOUR PC!*

- Input: 110V @ 60Hz • Output: +5VDC @ 15A - 5VDC @ 0.5A +12VDC @ 4.2A -12VDC @ 0.5A • Plug compatible connectors • Fits into IBM PC • Weight: 6 lbs.

**IBM-PS** . . . . . \$159.95

## Prometheus Modems

The ProModem 1200B/BS is a 1200/300 baud modem card which plugs into IBM PC and XT. Provides a third serial port. Two versions available: 1200B (without software) and 1200BS (with software). The PM1200BS is supplied with powerful MITE communications software from Microfit Labs.

**PM1200B** (without Software) . . . . . \$239.95

**PM1200BS** (with MITE Software) . . . . . \$274.95

## IBM Compatible! DISK DRIVES



**Documentation Included**

<b>RFD480</b>	(Remex 5 1/4" DS full-ht.)	\$ 99.95
<b>FD55B</b>	(Iteac 5 1/4" DS half-ht.)	\$139.95
<b>SA455</b>	(Shugart 5 1/4" DS half-ht.)	\$139.95
<b>TM100-2</b>	(Tandon 5 1/4" DS full-ht.)	\$159.95

## 5 1/4" DISK DRIVE ENCLOSURES

Complete with power supply, switch, power cord, fuseholder and connectors

**DDE-1FH** (Houses 1 full-ht. 5 1/4" drive) . . . . . \$69.95

**DDE-2HH** (Houses 2 1/2-ht. 5 1/4" drives) . . . . . \$79.95

## General Application Keyboards

### Mitsumi 54-Key Unencoded All-Purpose Keyboard

• SPST keyswitches • 20 pin ribbon cable connection • Low profile keys • Features: cursor controls, control, caps (lock), function, enter and shift keys • Color (key-caps): grey • Weight: 1 lb. • Pinout incl. • Size: 13 1/2" L x 4 1/4" W x 1 1/4" H

**KB54** . . . . . \$14.95

### 74-Key ASCII Cherry Keyboard

• 7-bit parallel ASCII • Full Upper Case, Full Lower Case except I, m, n, o and p • Cursor keypad • SPST mechanical keyswitches • 26-pin header connector • Color: white • Size: 18 1/2" L x 6 1/2" W x 1 1/2" H • Spec included

**KB8201** . . . . . (1700 available) \$29.95

## UV-EPROM ERASER

**8 Chips - 21 Minutes**



**1 Chip - 15 Minutes**

Erases all EPROMs. Erases up to 8 chips within 21 minutes (1 chip in 15 minutes). Maintains constant exposure distance of one inch. Special conductive foam liner eliminates static build-up. Built-in safety lock to prevent UV exposure. Compact — only 9.00" x 3.70" x 2.60". Complete with holding tray for 8 chips.

**DE-4 UV-EPROM Eraser** . . . . . \$74.95  
**UVS-11EL Replacement Bulb** . . . . . \$16.95

# COMPUTER WAREHOUSE

CALL TOLL FREE **1-800-528-1054**

## PRINTERS

<b>Anadex</b>	Call
All Models	
<b>Brother</b>	
HR10 w/Tractors	\$239
Termwriter 5	\$810
HR-15XL	\$345
HR-25	\$599
HR-35	\$809
<b>Canon</b>	
LBP-8A1	Call
<b>C-Itch</b>	
A-10-30	\$469
F-10 Parallel or Serial	\$869
55 CPS Serial or Parallel	\$1035
8510 Parallel (Prowriter)	\$295
8510 SP	\$385
8510 SCP	\$485
8510 BPI	\$315
<b>Citizen</b>	
MSP-10	\$284
MSP-15	\$414
MSP-20	\$414
MSP-25	\$544
<b>Comrex</b>	
CR-2E	\$364
CR-4	Call
420	Call
<b>DaisyLaser</b>	
PR101	Call
<b>Datasouth</b>	
DS180	\$1089
DS220	\$1315
DS-PP-1	\$449
DS-PP-2	\$635
<b>Diablo</b>	
D-25	\$555
630 API	\$1484
630 ECS	\$1669
630 ECS/IBM	\$1669
Other Printer Models	Call
<b>Epson</b> All Printer Models	Call
<b>Infornner</b>	
Rileman w/Tractor	\$244
Rileman 15	\$499
Rileman Blue w/Tractor	\$299
<b>Juki</b>	
5500	Call
6000	\$199
6100	Call
6300	Call
<b>NEC</b>	
2010, 2015, 2030, 2050	\$629
3510, 3515, 3530, 3550	\$1009
8810, 8815, 8830, 8850	\$1399
P2, P3	Call
<b>Okidata</b> All Printer Models	Call
<b>Panasonic</b>	
1091	\$259
1092	\$349
1093	\$519
KXP3151	\$459
<b>Siemens</b>	
PT 88 InkJet	Call
PT 89 InkJet	Call
<b>Star Micronics</b> All Printer Models	Call
<b>Silver Reed</b>	
EXP400 Parallel	\$235
EXP500 Parallel or Serial	\$279
EXP550 Parallel or Serial	\$399
EXP770 Parallel or Serial	\$699
<b>Toshiba</b> P1340 Parallel or Serial	\$544
P351 Parallel or Serial	\$1155

## MONITORS

<b>Amdek</b> All Monitors	Call
<b>Princeton Graphic</b> HX-12	\$479
<b>Sanyo</b> CRT-36	\$149
<b>Taxan</b>	
121 Green	\$125
122 Amber	\$134
420 RGB	\$399
425 RGB/Green	\$410
440	\$549
<b>Zenith</b>	
ZVM-122 Amber	\$95
ZVM-123 Green	\$89
ZVM-124	\$129
ZVM-130	Call
ZVM-133 Color/RGB	\$410
ZVM-135 Color/RGB w/Audio	\$459
ZVM136	\$575

**FEDERAL EXPRESS**

**Puroator Courier**      **FREE**      **Air Express Shipping**

See Details Below

---

**SOFTWARE IBM PC and 100% Compatibles**

Crosstalk 16 .....	\$95
D Base III .....	\$335
Enable .....	\$329
Framework .....	\$335
Multimate 3.3 .....	\$239
Smart System .....	\$449
Super Calc 3 (ver. 2) . . .	\$159
Word Perfect 4.0 .....	\$209
Wordstar 2000 .....	\$239
Wordstar Professional . .	\$239

We do not guarantee computer compatibility.

**Canon**  
**PC**  
PERSONAL COPIERS



**Canon PC-10**  
Compact, Convenient. Personal. With the exclusive Canon cartridge copying system for easy maintenance. **\$519**



**Canon PC-20**  
Compact, yet efficient for any business. With the exclusive Canon cartridge copying system, Plus automatic paper feeding. Make 8 copies a minute. **\$749**



**Canon PC-25**  
Reduction and enlargement comes to Personal Cartridge copying. Make copies up to legal size from originals as big as 10" x 14" ! **\$979**

## MODEMS

<b>Anchor Automation</b>	
Anchor Express	\$269
Mark XII	\$239
<b>Hayes</b> Smartmodem 300 Baud	\$129
Smartmodem 1200 Baud	\$379
Smartmodem 1200B (IBM)	\$324
Smartmodem 2400 Baud	\$609
Micromodem IIE (Apple)	\$129
<b>Novation</b> Smart Cat Plus	\$315
Prometheus All Models	Call
<b>Racal-Vadic</b> All Models	Call
<b>US Robotics</b> Password 1200	\$209

## BOARDS

<b>AST</b> Six Pack Plus	\$259
<b>Hercules</b> Color Card	\$145
Graphic Card	\$295
<b>Paradise</b> Modular Graphic 06-1	\$259
Five Pak	\$159
<b>Quadram</b> Quadboard EX Ok	\$219
E-Ram 80	\$89
Quadlink	\$329
<b>Tec Mar</b>	
Graphics Master	\$449
126K Dynamic Memory	\$225
256K Dynamic Memory	\$299
Captain 128K	\$299
Captain 256K	\$399

## COMPUTERS

<b>NEC</b>	
PC-8201 Computer	\$315
PC-8401A	Call
8201 & 8401 Accessories	Call
<b>Sanyo</b> MBC-775 Portable	\$1859
MBC-555 Series	Call
MBC-885	Call
<b>Wyse</b>	
Wyse pc Dual	Call
Wyse pc 10 Meg	Call
<b>Zenith</b>	
Z-150 Single Drive	Save 25%
Z-150 Dual Drive	Save 25%
Z-150 W/10 Megabyte	Save 25%
Z-160 Single Drive	Save 25%
Z-160 Dual Drive	Save 25%

## KEYBOARDS

<b>Keytronics</b> 5151	\$179
5151 Jk.	\$179

## VIDEO TERMINALS

<b>Altos</b> Smart II	\$769
<b>Qume</b>	
QVT Green 101	\$294
QVT Amber 101	\$314
<b>Wyse</b> 50	\$429
75	\$565
Wyse 85	Call
<b>Zenith</b> Z-22	\$469
Z-29	\$599
Z-49	Call

## DISKETTES

<b>Maxell</b> MD-1 (Qty 100)	\$149
MD-2 (Qty 100)	\$189
<b>Nashua</b>	
S/S D/D (Qty 100)	\$125
D/S D/D (Qty 100)	\$135

## PLOTTERS

<b>Enter</b> Sweet-P600	\$780*
<b>Epson</b> H8-80	Call

## DISK DRIVES

<b>Alpha Omega</b> Turbo 10	\$689
Turbo 20	\$1019
Turbo 30	\$1379
<b>Haba</b> Habadisk for MacIntosh	\$329
<b>lomega</b> Bernoulli Box for IBM	
10 Megabyte	\$1799
20 Megabyte	\$2499
20 Megabyte Plus	\$2680
5 Megabyte for MacIntosh	\$1335
<b>Rana</b> Elite I	\$179
Elite II	\$339
Elite III	\$405
Elite 10M/Apple	\$1080
Controller (W/Drive Only)	\$69
1000 W/DOS for Atari	\$175
<b>Tallgrass</b> TG-3020	\$2289
TG-3135	\$3689
TG-4060	\$1469
Controller	\$119

# COMPUTER WAREHOUSE

Order Processing & Order Line: 1-800-528-1054  
Other Information: 602-954-6109

2222 E. Indian School Rd.  
Phoenix, Arizona 85016

Inquiry 101 for MS-DOS products. Inquiry 102 for all others.

Store Hours: Mon-Fri 10-5:30 Saturday 9-1  
Order Line Hours: Mon-Fri 8:30-5:30 Saturday 9-1

Prices reflect 3% to 5% cash discount. Product shipped in factory cartons with manufacturer's warranty. Please add \$9.00 per order for UPS ground shipping. Orders 10 lbs. and under you pay for ground service, receive air service at no extra charge. Available on orders 11-20 lbs. \$15 for air service. Orders 21-30 lbs. \$20 for air service. Prices & availability subject to change without notice. Send cashier's check or money order, all other checks will delay shipping two weeks.

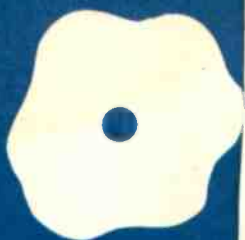

## An outline processor that has its own programming language

BY WILLIAM HERSHEY

the screen's bottom four lines. Your document occupies the rest of the screen. MaxThink encourages you to develop an outline as a hierarchy of lists. Each item in a list is called a "topic," and MaxThink numbers them sequentially for you. The screen displays a single "parent" topic at the top and an indented list of its direct descendants below. You use the up- and down-arrow keys to move a selection arrow from one topic to another. Highlighted or underlined topic numbers indicate the existence of deeper levels, as do ThinkTank's plus signs or Framework's triangular flags.

By pressing the right-arrow key you can zoom in on a selected topic with its subtopics. Conversely, the left-arrow key takes you to the outline's next higher level. Again a parent topic will appear at the top of the screen followed by an indented list of its topics. At the highest level, the "root" topic (i.e., the outline's title) appears.

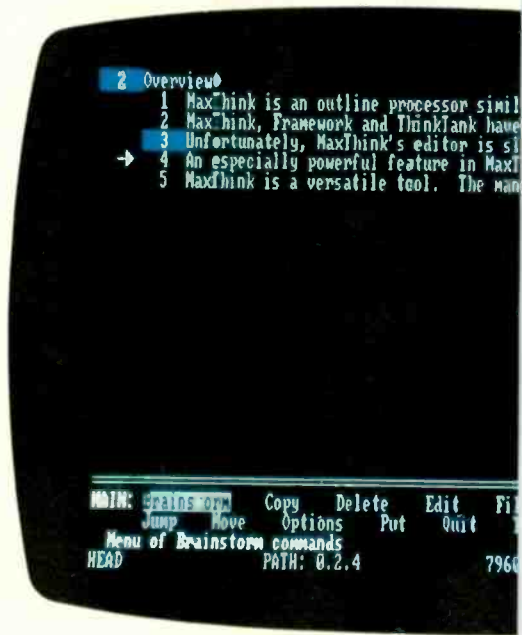

Photo 1: A sample list of topics in MaxThink. A topic number (e.g., 2.2, etc.) are the first lines of paragraphs. The word "HEAD" on the screen indicates that only the first lines of topics are displayed between this display and the one in photo 2 showing the full outline. The numbers indicate that subtopics exist. At the bottom of the screen is a menu. Other information at the bottom includes the filename, and the "path" designation for locating the file.

William Hershey is a computer engineer with a BS. in engineering from Princeton and an MS. in computer and communications sciences from the University of Michigan. He is also an instructor in computer literacy at the University of Maryland's University College. You can contact him at MITRE Corp., 182 Madison Blvd., McLean, VA 22104.

## REVIEW: MAXTHINK

MaxThink's display of a list hierarchy is slightly different from the methods used in ThinkTank and Framework. These programs maintain an outline view of your headings (topics) on the screen and let you expand any heading in the outline to any deeper level. Framework also offers a frame-based view of the document's hierarchy.) In MaxThink, the other programs let you view any outline level as a list of headings, but you might need several clicks to collapse or expand parts of an outline to show the desired list without subheadings. MaxThink maintains the list format automatically. An improved version of MaxThink, which the publisher says will be available by the time you read this, will use a function key to toggle between list and outline views of a document.

MaxThink offers you a great deal of flexibility in the ways you can use topics. A topic can be one word or several lines long. When you reach

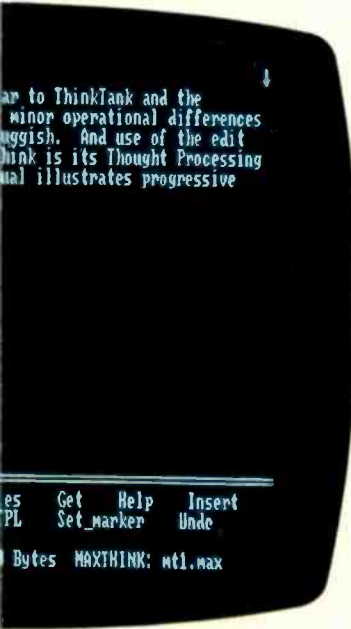

...ar to ThinkTank and the  
...minor operational differences  
...uggish. And use of the edit  
...ink is its Thought Processing  
...ual illustrates progressive

...es Get Help Insert  
...PL Set\_marker Unde  
...Bytes MAXTHINK: nt1.max

...pic can be a heading or the  
...on heading and its subtopics (2.1,  
...HEAD at the bottom left corner of  
...re displayed. The F2 key toggles  
...ull paragraphs. Highlighted topic  
...the screen is MaxThink's main  
...mount of memory remaining, the  
...topic targeted by the topic-selection

the end of a line, the text wraps to the next line as it would in most word processors. The second and succeeding lines become the "annotation."

You can thus format a topic either as a section heading or simply as the first line of a paragraph. I've found this flexibility especially helpful in the integration stage when I'm transforming an outline to a series of paragraphs. ThinkTank and Framework maintain outline headings and the paragraphs beneath them as independent entities. With these programs it is more awkward to retain some headings to serve as formal section headings and replace others with paragraphs.

The F2 function key toggles between two views of a given list of topics. You can look at the topics alone, each of which could be a section heading or the first line of a paragraph (see photo 1). The alternate view shows the annotations along with the topics, revealing all your paragraphs (see photo 2). This feature lets you move easily within your document and can be a handy editing tool. For example, in writing this review I replaced the first several topics in my initial outline with paragraphs and pressed F2 to get an overview. The topic-only view revealed that I had begun five out of the first six paragraphs with the name MaxThink. I quickly made some adjustments to add variety.

### BRAINSTORMING

The Move command is fundamental in word processing. Without it you might as well go back to scissors and tape. The ability to move the elements in a list or an outline is perhaps even more important than moving sentences or paragraphs in a text document. If you are really processing ideas, you have to be free to experiment with different ways of relating them to each other. Framework's Move command is easy to use. ThinkTank's is awkward except in the Macintosh version. MaxThink goes beyond conventional Move operations. In MaxThink you select the Brainstorm option in the main menu. This calls the "structure editor" into action.

The structure editor is merely a handy collection of commands for putting a list in a new order or for moving groups of topics from one level in your outline to another. These commands thus fall into two classes: ones that change the order of your topics in a list and ones that change the hierarchy.

The commands that change the order of topics include Prioritize, Randomize, and Sort. Prioritize inserts a separator line of pluses and the word PRIORITIZE at the top of your list. You then point to the topics with the cursor and press the Enter key to move them, one by one, from below the marker to above the marker. When you finish, the separator disappears. Randomize simply puts your list in a random order to give you a fresh perspective on the topics. The Sort command sorts the topics in your list in ascending or descending order, starting at the column you specify. Because you can specify the sort column and sort-string length, you could impose a tabular structure on a list of topics and sort on any column or field as though the list were a mini-database.

Commands that affect the hierarchy of topics include Binsort, Divide, Join, Fence, Categorize, and Levelize. Binsort is just a manual sort. It lets you group topics into higher-level bin topics. You simply enter a bin number for each of the topics to be moved (see photo 3).

The Divide command splits a topic into new topics for each word, line, sentence, or paragraph according to your instructions. The Join command combines multiple topics into single ones by lines or words.

The Fence command adds fences or boundaries to a list that is already in correct order. It provides an alternative to Binsort. After you insert horizontal fence separators into your list, each with a label, you can use the Categorize command to convert the fences to topics, with the other topics in the list subordinate to them. The Levelize command can reverse the effect of Binsort or Categorize by con-

(continued)

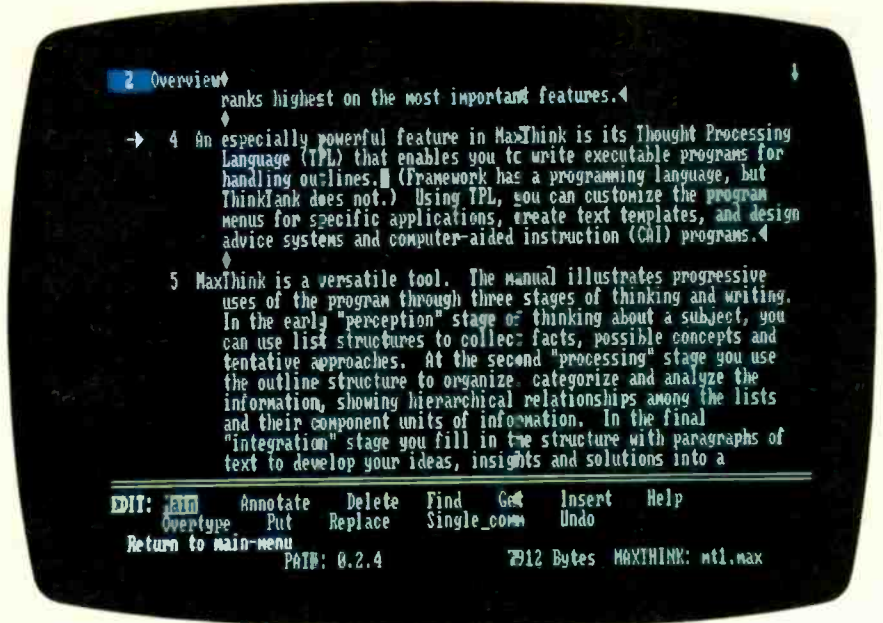

Photo 2: A view of MaxThink paragraphs. Each contains a topic, or first line, followed by an annotation, which in this case is the remainder of the paragraph. This display was obtained by pressing function key F2. Also note that the edit mode has been selected from the main menu. The edit menu appears at the bottom, and a cumbersome Insert command is necessary before you can enter text at the cursor position.

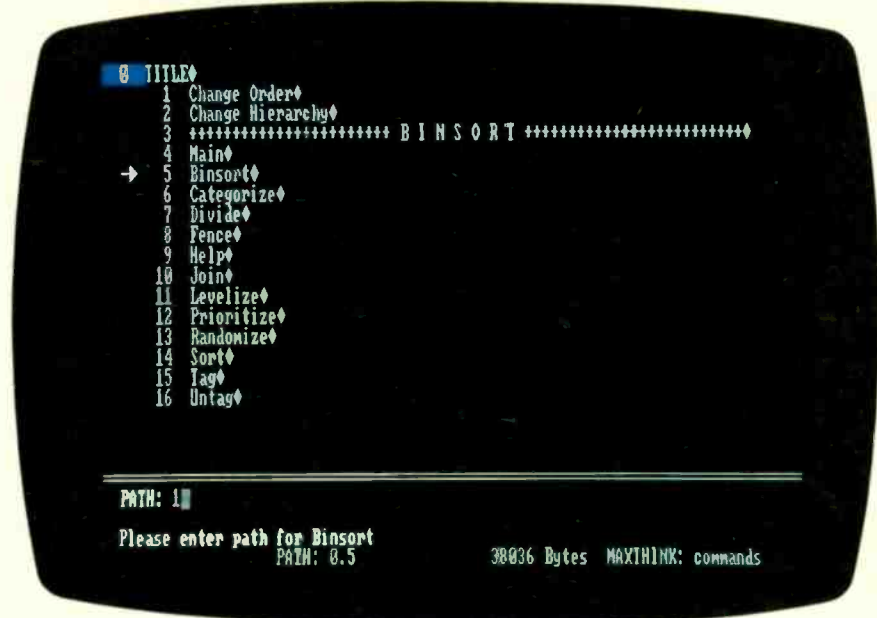

Photo 3: Binsort is one of the Brainstorm commands that make it easy to restructure MaxThink outlines. Binsorting is the manual process of assigning topics to groups or bins. You designate any number of bin topics (in this case two), and MaxThink inserts the Binsort separator line beneath them. You then point to each of the other topics and type the number of the bin where you want to put it as a subtopic. You could accomplish the same result with the Move command but not as quickly.

## AT A GLANCE

### Name

MaxThink

### Type

Outline processor

### Manufacturer

MaxThink Inc.  
230 Crocker Ave.  
Piedmont, CA 94610  
(800) 227-1590  
In California, (800) 642-2406

### Format

One 5¼-inch floppy disk

### Computer

IBM PC (or compatible) with 256K bytes, one drive, PC-DOS 2.0 (Macintosh and CP/M versions available soon)

### Features

Outlining, organizing, text editing, programming (Thought Processing Language), advice systems

### Documentation

Tutorial, reference guide, programming guide, thinking techniques, writing techniques

### Price

\$59.95

### Audience

Writers and others who need to plan and organize ideas

### Comments

The program has a cumbersome editor but is otherwise very well thought out with a good manual and a great price

verting subtopics into topics.

MaxThink also has the more conventional Move, Copy, and Delete commands, and even an Undo command. The Brainstorm commands, however, greatly simplify restructuring of lists and outlines.

### EDITING, FORMATTING, AND FILE HANDLING

The text editor is MaxThink's weakest component. It uses the cursor, Delete, and backspace keys conventionally and offers both insert and overtype modes. It executes several functions (like block copy and move) better than the ThinkTank editor but does not come close to the editor in Framework. The version I reviewed lacked niceties such as tabs and word deletion. Also, it is slow. I was not able to outtype the MaxThink editor, but autorepeated cursor movement with the arrow keys was very slow in long passages of text. I suppose the key is to keep your paragraphs small and to avoid putting too many of them beneath a topic. Neil Larson of MaxThink Inc. advises not to scroll through paragraphs but to jump from one to the next at the list level. He claims it is easier to keep track of your thoughts this way. Because of this slowness, you must also be careful when deleting characters; it is easy to go beyond the part you wish to delete. For deleting large blocks of text, use the Delete command in the edit menu.

If you are accustomed to WordStar or other word processors that put you directly into edit mode and expect control commands for most other operations, the MaxThink edit menu (at the bottom of photo 2) will seem backward to you. From the main menu, it takes two steps to begin editing: Edit, which invokes the menu, and Insert, which lets you type. You must return to the menu (with Esc) to perform block operations or Find/Replace commands. Deleted blocks go into a buffer, and you can copy them to other parts of your document. The Put command copies blocks from the buffer to the document. The Get command copies a

block into the buffer, as Delete does, but leaves the block intact in your document. The Put command will also work from the main menu.

The editor does not format your text on the screen as it will appear on paper, but the program does give you control over margin settings and other parameters. You can view your outline on the screen before printing if you wish.

The Format command offers 22 format settings for controlling the format of a printed document. Many of these, such as indentation settings, are specific to outlines. You can even set the multilevel numbering scheme for the topics in your outline to any combination of upper- and lowercase Roman numerals, Arabic numerals, and upper- and lowercase letters. One option lets you save a document in a format that WordStar can read.

In addition to standard commands for printing, loading, and saving outline files, MaxThink gives you access to five DOS-like commands for copying, erasing, and renaming files, and for setting the system date and time.

### THOUGHT PROCESSING LANGUAGE

Potentially the most interesting feature of MaxThink is its programmability via the Thought Processing Language. TPL programs can access the same commands that are in the MaxThink menus. When put into the format required for TPL, the commands are said to be in MaxMode format. A program of TPL commands is an outline, and you can switch easily between your program outline and your text outline while editing.

It is possible to specify any position within an outline by using what MaxThink calls a "path." For example, the path for the second subtopic of the third topic of an outline would be 0.3.2. Most spreadsheet programs give you the alternatives of pointing to a cell with the cursor or specifying that cell's row and column coordinates as a letter and a number. Similarly, MaxThink provides the path specification as an alternative to mov-

(continued)

# THE CLASSIC

# BYTE T-SHIRT



## "COMPUTER ENGINEERING" – July 1977 Byte Cover

One of the truly classic Byte covers —and boy, does it look great on a T-shirt! The vivid colors really jump out. But don't mistake this for one of those rubbery patches that crack and peel off after a few washings. This is true four-color process: the inks are silk-screened into the fabric of the shirt, resulting in a beautiful, full-color image that lasts.

You'll also appreciate the shirt itself: a real heavyweight made of 50% cotton, 50% polyester. You'll enjoy cotton comfort in a tough shirt that keeps its crisp, fresh look through many washings—with almost no shrinking! The price for each Byte Classic T-Shirt is only \$9.50 (\$8.50 each for 3 or more). Your order will be shipped within a week.

Please send me the following T-shirt(s) at \$9.50 each, or \$8.50 each for 3 or more. I have included \$2.00 for shipping and handling.

Qty.	Size	Amount
_____	Adult—Extra Large	\$ _____
_____	Adult—Large	\$ _____
_____	Adult—Medium	\$ _____
_____	Adult—Small	\$ _____
_____	Child—(sizes 10-12)	\$ _____
	Shipping and Handling (Overseas add \$3.00)	\$2.00
		\$ _____
	<b>TOTAL</b>	\$ _____

I have enclosed check or money order.  
 VISA     MasterCard     Send Dealer Info.  
 Card #: \_\_\_\_\_  
 Exp. Date: \_\_\_\_\_  
**Ship my T-Shirt(s) to:**  
 Name: \_\_\_\_\_  
 (Business): \_\_\_\_\_  
 Address: \_\_\_\_\_  
 City: \_\_\_\_\_  
 State: \_\_\_\_\_ Zip: \_\_\_\_\_

Mail this coupon to:

**Robert Tinney Graphics**  
 1864 North Pamela Dr.  
 Baton Rouge, Louisiana  
 70815

For VISA or MasterCard Orders  
 or for more information  
**Call 1-504-272-7266**

*In a comparison  
against two other  
popular outline  
processors, MaxThink  
ranks highest on the  
most important features.*

ing the selection arrow in an outline. TPL, like formulas in spreadsheets, uses the path to reference a given topic in an outline.

Each topic of a program outline can be a MaxThink command, a comment line, a blank line, data, or a TPL directive. Some directives affect the sequence of operations, the construction of menus, and statement branching. Others affect messages displayed, help screens, movement of data between the text and program outlines, and program execution. TPL has nearly 30 directives. The TPL menu that is accessible from MaxThink's main menu provides commands for creating, loading, running, and testing TPL programs.

I have written only a few simple TPL programs, so I can't claim to know how to take advantage of all of TPL's features. One thing is clear, however: it is a macro language, not a full programming language. The manual says that you can program MaxThink to provide advice, information, or customized help for applications that require listing and outlining capabili-

ties. MaxThink can be programmed to branch through an outline on the basis of user responses, so the manual claims you could use TPL to develop CAI (computer-aided instruction) applications and portions of expert systems. These claims are a bit overblown. TPL's menu-handling commands are nice, but the language has no arithmetic capabilities, and tests for conditional branching are limited to simple string and path matching. I wrote a program to give a multiple-choice test, but I could not use TPL to add up the number of correct responses.

**DOCUMENTATION AND SUPPORT**

The MaxThink manual is undergoing extensive revisions even as I type, so the version you see will almost certainly be different from the one I have been using. However, I can report that the manual I saw was well written and makes learning the program easy. Mine came in a loose-leaf binder with attractive artwork. The publisher says that the final format will be a paperback book.

The documentation includes thorough introductory, tutorial, and reference sections and a programming guide for TPL. The program also incorporates an on-line help feature that uses a 60K-byte help file. You might find the supplementary sections on writing and thinking most valuable of all. These provide some good techniques for collecting, organizing, and conveying information.

**CONCLUSION**

Table 1 ranks MaxThink against the two other popular outline processors.

The five summary features of the programs appear in order of their importance for idea processing, so MaxThink ranks highest on the most important features.

Along with the manual, the program itself is currently undergoing improvements. MaxThink keeps your entire outline in memory, and the current limit is about 38K bytes. The publisher is removing that limit to let your outline occupy as much memory as is available in your machine.

I had some anxious moments when MaxThink garbled the directory of the disk I was using to save this article. In fact, it also garbled my backup disk. The DOS CHKDSK utility saved me from retyping the whole article. The programmer at MaxThink said I had experienced a file-allocation problem related to the current limitation on memory. Another problem was that the program sometimes chopped off carriage returns at the ends of paragraphs during Load operations. A fix is in the works, but I advise you to be cautious with this program until its record is proven. Large files seem to cause the majority of problems right now.

MaxThink's copy-protection scheme has undergone several changes. The publisher plans to provide a version that can be transferred onto a hard disk and used directly, so it won't be necessary for you to have the master floppy disk handy.

Aside from the trauma of nearly losing this review, the limitations of the editor, and the minor inconvenience of the copy-protection scheme, I am enthusiastic about MaxThink. The publisher seems eager to provide a quality product and the support to go with it. The price of MaxThink is one indication of his sincerity; for \$59.95 you can't go wrong. ■

**REFERENCES**

1. Hershey, William R. "ThinkTank." BYTE, May 1984, page 189.
2. Hershey, William R. "Idea Processors." BYTE, June 1985, page 337.
3. Jadrnicek, Rik, John Markoff, and Ezra Shapiro. "Framework." BYTE, August 1984, page 121.

Table 1: Ratings of three outline processors and the convenience of their outline-processing commands. The highest rating is a 1; the lowest is a 3.

Summary Feature	MaxThink	Framework	ThinkTank
Restructuring	1	2	3
Viewing	1	2	3
Editing	3	1	2
Formatting	2	1	3
Manipulating files	2	1	3



# LycO Computer Marketing & Consultants



## SAVE ON THESE PRINTERS IN STOCK



**AXION**

GP 550 AT (Atari)	249
GP 550 CD (C-64)	249
GP 550 PC (IBM)	239
GP 550 AP (Apple)	279
GP 700 AT (Atari)	459
GP 700 AP (Apple)	459
Elite SCD (C-64)	329

**CARDCO**

LQ1	369
LQ3	279

**CITIZEN**

MSP-10	329
MSP-15	499
MSP-20	479
MSP-25	649

**EPSON**

RX-80	225
RX-80 FT	279
FX100	579
JX 80	529
LQ 1500 P	1089
LQ 1500 S	1149
HI-80 Color Plotter	399

**MANNESMANN TALLY**

Spirit 80	255
MTL-180L	549
MTL-180L	739

**NEC**

NEC 8025	\$699
NEC 8027	\$359

**PANASONIC**

1090	189
1091	259
1092	395
1093	589
3151	459

**BLUE CHIPS**

M12010	\$275
M12010 C-64	\$275

**COMREX**

CR-II-EC Comriter IIE Parallel	359
CR-II-ES Comriter II E Parallel	379
CR-IV-C Comriter IV Parallel	689
CR-IV-S Comriter IV Serial	689

**JUKI**

Juki 6100	379
RS 232 Serial Board	55
Tractor	119
Sheet Feeder	209
Juki 6300	769

**OKIDATA**

Okimate 10	179
82A	295
84	645
92	349
93	565
92 Imagewriter	425
92 IBM Version	349

**Smith Corona**

Fastax 80	189 00
D100	219 00
D200	399 00
D300	519 00
L1000	339 00

**C. ITOH**

Prowriter 8510 AP	279
8510 BC2	389
8510 BP1	319
8510 SP	379
8510 SR	429
8510 SCP	459
8510 SCR	479
7500 AP	205
7500 AP	245
1550 P	449
1550 BCD	489
A-10-20-P	459
F 10 40 PU or RDU	888
F10 SSPU or RDU	1069

**Corona**

LP300 Laser Printer	2699
200361 Toner Cartridge	89

**LEGEND**

880	219
1080	239
1200	249

**OLIVETTI**

DY 250 Parallel	739
DY 250 Serial	729
DY 450 Parallel	1099
DY 450 Serial	1079

**STARMICRONICS**

SG-10	219
SG-15	379
SD-10	339
SD-15	445
SR-10	489
SR-15	585
Powertype	309
Gemini 10X	CALL
Gemini 15X	CALL
SB-10	CALL

★ **PRINTER** ★  
**INTERFACING**  
Available

## MONITORS

<p><b>AMDEK</b></p> <table border="0"> <tr><td>300 Green</td><td>125</td></tr> <tr><td>300 Amber</td><td>139</td></tr> <tr><td>310 Amber IBM</td><td>155</td></tr> <tr><td>Color 300 Audio</td><td>245</td></tr> <tr><td>Color 500 Composite</td><td>369</td></tr> <tr><td>Color 600</td><td>429</td></tr> <tr><td>Color 700</td><td>495</td></tr> <tr><td>Color 710</td><td>569</td></tr> </table> <p><b>GORILLA</b></p> <table border="0"> <tr><td>12" Green</td><td>78</td></tr> <tr><td>2" Amber</td><td>84</td></tr> </table> <p><b>NEC</b></p> <table border="0"> <tr><td>JB-1260 Green</td><td>95</td></tr> <tr><td>JB-1201 Green</td><td>135</td></tr> <tr><td>JC 1215 Color</td><td>235</td></tr> <tr><td>JC 1216 RGB</td><td>375</td></tr> <tr><td>JC1460 Color</td><td>265</td></tr> <tr><td>JB-1205 Amber</td><td>139</td></tr> </table> <p><b>PANASONIC</b></p> <table border="0"> <tr><td>DT 1300 RG1 composite</td><td>329</td></tr> </table> <p><b>PRINCETON GRAPHICS</b></p> <table border="0"> <tr><td>MAX-12 Amber</td><td>189</td></tr> <tr><td>HX-12 RGB</td><td>475</td></tr> <tr><td>SR-12 RGB</td><td>599</td></tr> </table>	300 Green	125	300 Amber	139	310 Amber IBM	155	Color 300 Audio	245	Color 500 Composite	369	Color 600	429	Color 700	495	Color 710	569	12" Green	78	2" Amber	84	JB-1260 Green	95	JB-1201 Green	135	JC 1215 Color	235	JC 1216 RGB	375	JC1460 Color	265	JB-1205 Amber	139	DT 1300 RG1 composite	329	MAX-12 Amber	189	HX-12 RGB	475	SR-12 RGB	599	<p><b>SAKATA</b></p> <table border="0"> <tr><td>SC-100 Color</td><td>219</td></tr> <tr><td>STS1 Stand</td><td>29</td></tr> <tr><td>SG 1000 Green</td><td>99</td></tr> <tr><td>SA 1000 Amber</td><td>109</td></tr> </table> <p><b>TAXAN</b></p> <table border="0"> <tr><td>210 Color RGB</td><td>249</td></tr> <tr><td>115 Green</td><td>119</td></tr> <tr><td>116 Amber</td><td>125</td></tr> <tr><td>400 Color RGB</td><td>275</td></tr> <tr><td>410 Color RGB</td><td>339</td></tr> <tr><td>420 Color IBM</td><td>429</td></tr> <tr><td>121 Green IBM</td><td>139</td></tr> <tr><td>122 Amber IBM</td><td>145</td></tr> </table> <p><b>X-TRON</b></p> <table border="0"> <tr><td>Comcolor I Composite Green</td><td>199</td></tr> </table> <p><b>ZENITH</b></p> <table border="0"> <tr><td>ZVM 122A Amber</td><td>84</td></tr> <tr><td>ZVM 123G Green</td><td>75</td></tr> <tr><td>ZVM 124 Amber IBM</td><td>129</td></tr> <tr><td>ZVM 131 Color</td><td>275</td></tr> <tr><td>ZVM 133 RGB</td><td>389</td></tr> <tr><td>ZVM 135 Composite</td><td>449</td></tr> <tr><td>ZVM 136 Hi Res Color</td><td>589</td></tr> </table>	SC-100 Color	219	STS1 Stand	29	SG 1000 Green	99	SA 1000 Amber	109	210 Color RGB	249	115 Green	119	116 Amber	125	400 Color RGB	275	410 Color RGB	339	420 Color IBM	429	121 Green IBM	139	122 Amber IBM	145	Comcolor I Composite Green	199	ZVM 122A Amber	84	ZVM 123G Green	75	ZVM 124 Amber IBM	129	ZVM 131 Color	275	ZVM 133 RGB	389	ZVM 135 Composite	449	ZVM 136 Hi Res Color	589
300 Green	125																																																																																
300 Amber	139																																																																																
310 Amber IBM	155																																																																																
Color 300 Audio	245																																																																																
Color 500 Composite	369																																																																																
Color 600	429																																																																																
Color 700	495																																																																																
Color 710	569																																																																																
12" Green	78																																																																																
2" Amber	84																																																																																
JB-1260 Green	95																																																																																
JB-1201 Green	135																																																																																
JC 1215 Color	235																																																																																
JC 1216 RGB	375																																																																																
JC1460 Color	265																																																																																
JB-1205 Amber	139																																																																																
DT 1300 RG1 composite	329																																																																																
MAX-12 Amber	189																																																																																
HX-12 RGB	475																																																																																
SR-12 RGB	599																																																																																
SC-100 Color	219																																																																																
STS1 Stand	29																																																																																
SG 1000 Green	99																																																																																
SA 1000 Amber	109																																																																																
210 Color RGB	249																																																																																
115 Green	119																																																																																
116 Amber	125																																																																																
400 Color RGB	275																																																																																
410 Color RGB	339																																																																																
420 Color IBM	429																																																																																
121 Green IBM	139																																																																																
122 Amber IBM	145																																																																																
Comcolor I Composite Green	199																																																																																
ZVM 122A Amber	84																																																																																
ZVM 123G Green	75																																																																																
ZVM 124 Amber IBM	129																																																																																
ZVM 131 Color	275																																																																																
ZVM 133 RGB	389																																																																																
ZVM 135 Composite	449																																																																																
ZVM 136 Hi Res Color	589																																																																																



## MODEMS

<p><b>MICROBITS</b></p> <table border="0"> <tr><td>MPP 1000 E (Atari)</td><td>99.00</td></tr> <tr><td>MPP 1064 (C-64)</td><td>69.95</td></tr> </table> <p><b>HAYES</b></p> <table border="0"> <tr><td>Smartmodem 300</td><td>189</td></tr> <tr><td>Smartmodem 1200</td><td>459</td></tr> <tr><td>Smartmodem 1200B</td><td>389</td></tr> <tr><td>Micromodem IIE</td><td>249</td></tr> <tr><td>Micromodem 100</td><td>289</td></tr> <tr><td>Chronograph</td><td>179</td></tr> <tr><td>Smart Com II</td><td>75</td></tr> </table>	MPP 1000 E (Atari)	99.00	MPP 1064 (C-64)	69.95	Smartmodem 300	189	Smartmodem 1200	459	Smartmodem 1200B	389	Micromodem IIE	249	Micromodem 100	289	Chronograph	179	Smart Com II	75	<p><b>TELE LEARNING</b></p> <table border="0"> <tr><td>CM-250 (C-64)</td><td>65.00</td></tr> <tr><td>AP-250 (Apple)</td><td>109.95</td></tr> <tr><td>IB-250 (IBM)</td><td>109.95</td></tr> </table> <p><b>CARDCO MOD-1 (C-64)</b> CALL</p> <p><b>NESTRIDGE (C-64)</b> CALL</p> <p><b>MITEY MO (C-64)</b> CALL</p> <p><b>1660 AUTO MODEM (C-64)</b> 85</p>	CM-250 (C-64)	65.00	AP-250 (Apple)	109.95	IB-250 (IBM)	109.95
MPP 1000 E (Atari)	99.00																								
MPP 1064 (C-64)	69.95																								
Smartmodem 300	189																								
Smartmodem 1200	459																								
Smartmodem 1200B	389																								
Micromodem IIE	249																								
Micromodem 100	289																								
Chronograph	179																								
Smart Com II	75																								
CM-250 (C-64)	65.00																								
AP-250 (Apple)	109.95																								
IB-250 (IBM)	109.95																								

## DISK DRIVES

<p><b>INDUS</b></p> <table border="0"> <tr><td>GT Atari</td><td>\$219.00</td></tr> <tr><td>GT Commodore</td><td>\$249.00</td></tr> </table>	GT Atari	\$219.00	GT Commodore	\$249.00	<p><b>MSD</b></p> <table border="0"> <tr><td>SD1 Drive</td><td>\$229.00</td></tr> <tr><td>SD2 Drive</td><td>\$469.00</td></tr> </table>	SD1 Drive	\$229.00	SD2 Drive	\$469.00
GT Atari	\$219.00								
GT Commodore	\$249.00								
SD1 Drive	\$229.00								
SD2 Drive	\$469.00								

## DISKETTES

 <p><b>MAXELL</b></p> <table border="0"> <tr><td>5 1/4" MD-1</td><td>16.99</td></tr> <tr><td>5 1/4" MD-2</td><td>23.75</td></tr> <tr><td colspan="2" style="text-align: center;">(Box 10)</td></tr> </table>	5 1/4" MD-1	16.99	5 1/4" MD-2	23.75	(Box 10)		 <p><b>ELEPHANT</b></p> <table border="0"> <tr><td>5 1/4" SKC-SSSD</td><td>10.99</td></tr> <tr><td>5 1/4" SKC-SSDD</td><td>13.99</td></tr> <tr><td>5 1/4" SKC-SSDD</td><td>13.99</td></tr> <tr><td>5 1/4" SKC-DSDD</td><td>15.99</td></tr> <tr><td>5 1/4" SSSD</td><td>13.99</td></tr> <tr><td>5 1/4" SSDD</td><td>15.99</td></tr> <tr><td>5 1/4" DSDD</td><td>19.99</td></tr> </table>	5 1/4" SKC-SSSD	10.99	5 1/4" SKC-SSDD	13.99	5 1/4" SKC-SSDD	13.99	5 1/4" SKC-DSDD	15.99	5 1/4" SSSD	13.99	5 1/4" SSDD	15.99	5 1/4" DSDD	19.99
5 1/4" MD-1	16.99																				
5 1/4" MD-2	23.75																				
(Box 10)																					
5 1/4" SKC-SSSD	10.99																				
5 1/4" SKC-SSDD	13.99																				
5 1/4" SKC-SSDD	13.99																				
5 1/4" SKC-DSDD	15.99																				
5 1/4" SSSD	13.99																				
5 1/4" SSDD	15.99																				
5 1/4" DSDD	19.99																				

## IBM-PC COMPATABLE

<p><b>CORONA</b></p> <table border="0"> <tr><td>PPC 22A</td><td></td></tr> <tr><td>Portable 256K-Amber</td><td>1F99</td></tr> <tr><td>PPC 22G</td><td></td></tr> <tr><td>Portable 256-K-Green</td><td>1699</td></tr> <tr><td>PPCXTA</td><td></td></tr> <tr><td>Portable 256K-10Meg</td><td>2899</td></tr> <tr><td>CORi 28K 128K RAM</td><td>1599</td></tr> </table> <p><b>*LOTUS</b></p> <table border="0"> <tr><td>Lotus 1-2-3</td><td>309.00</td></tr> <tr><td>Symphony</td><td>439.00</td></tr> </table>	PPC 22A		Portable 256K-Amber	1F99	PPC 22G		Portable 256-K-Green	1699	PPCXTA		Portable 256K-10Meg	2899	CORi 28K 128K RAM	1599	Lotus 1-2-3	309.00	Symphony	439.00	<p><b>Zenith</b></p> <table border="0"> <tr><td>Z-150</td><td>Call</td></tr> </table> <p><b>Leading Edge</b></p> <table border="0"> <tr><td>PC Compatible</td><td>Call</td></tr> </table> <p><b>*PARADISE</b></p> <table border="0"> <tr><td>5-Pak Multifunction</td><td>179.00</td></tr> <tr><td>Modular Graphics</td><td>289.00</td></tr> <tr><td>Modular Graphics Card</td><td>315.00</td></tr> </table>	Z-150	Call	PC Compatible	Call	5-Pak Multifunction	179.00	Modular Graphics	289.00	Modular Graphics Card	315.00
PPC 22A																													
Portable 256K-Amber	1F99																												
PPC 22G																													
Portable 256-K-Green	1699																												
PPCXTA																													
Portable 256K-10Meg	2899																												
CORi 28K 128K RAM	1599																												
Lotus 1-2-3	309.00																												
Symphony	439.00																												
Z-150	Call																												
PC Compatible	Call																												
5-Pak Multifunction	179.00																												
Modular Graphics	289.00																												
Modular Graphics Card	315.00																												

# TOLL FREE 1-800-233-8760



TO ORDER

CALL TOLL FREE **800-233-8760** or send order to  
 LycO Computer  
 P O Box 5088  
 Customer Service 1-717-327-1825 Jersey Shore PA 17740

**RISK FREE POLICY**

In-stock item shipped within 24 hours of order. No deposit on C.O.D. orders. Free shipping on prepaid cash orders within the Continental U.S. PA residents add sales tax. APO, FPO, and International orders add \$5.00 plus 3% for priority mail service. Advertised prices show 4% discount for cash, add 4% for Master Card or Visa. Personal checks require 4 weeks clearance before shipping. All items subject to change without notice.

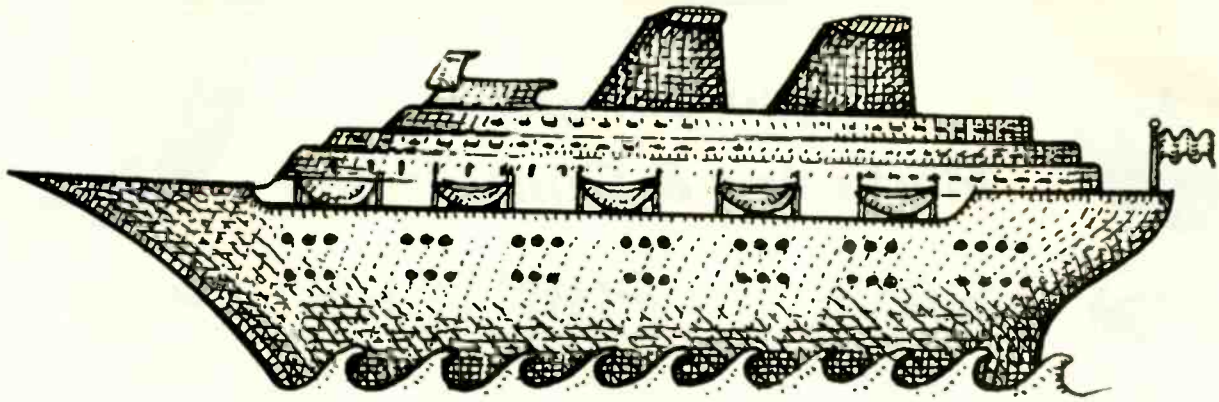
**For your protection, we check for stolen credit cards.**



## M2SDS

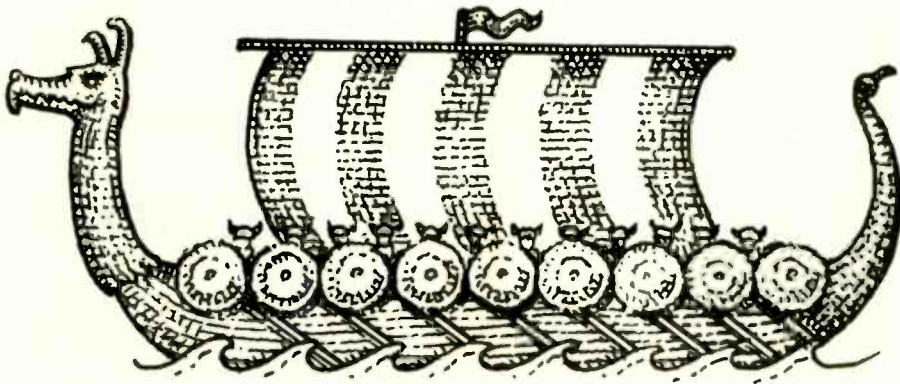

## TURBO PASCAL™

Now that there's the Modula-2 Software Development System (M2SDS), Turbo Pascal is all washed up. But you're not.

Because the Modula-2 language is based on Pascal. But it's better. And it's so easy to learn that Pascal programmers can launch into greater programming efficiency in virtually no time at all.

Modula-2 introduces the module concept that lets you create programs step-by-step. And M2SDS is a programming environment—complete with a linker—that lets you develop programs far beyond the 64K limit of Turbo Pascal. In fact, you can develop programs using your computer's full memory capacity.

M2SDS helps you pick up your programming speed, too. Unlike Turbo Pascal which has a basic word processing editor, M2SDS has an intelligent editor that saves up to 90% on typing time by letting you enter full statements with a single keystroke. It helps you avoid common syntax errors which

saves you hours of time debugging. And with a real-time compiler, you won't have to wait for your computer to do its job after you've done yours.

Best of all, the price of M2SDS is easy to swallow. Just \$80.88.

So join the new wave of programming efficiency. Order your M2SDS today.



### INTERFACE TECHNOLOGIES

3336 Richmond Ave., Suite 200 Houston, Texas 77098

1-800-922-9049 (In Texas, call 713/523-8422)

Checks, MasterCard, VISA, American Express accepted. Shipping & handling not included.  
In Texas add sales tax. International orders add \$30.

Turbo Pascal is a trademark of Borland International.



## The Anchor Automation Signalman Mark XII Modem

The Mark XII incorporates interesting features, yet lacks full Hayes compatibility

BY GEORGE V. KINAL

**I**f imitation is the sincerest form of flattery, Anchor Automation's Signalman Mark II modem is a compliment to the Hayes Smartmodem 1200. But, like many imitators, this product isn't entirely faithful to the original.

The Anchor Mark XII supports the 300-bps Bell 103 mode and the full-duplex 1200-bps Bell 212 mode. It operates in originate and answer modes. It can auto-answer an incoming telephone call and will auto-dial in either pulse or tone modes. The Mark XII has no switches except on/off; all programming is through the RS-232C interface. It adjusts its mode and data transmission rate to match that of an incoming caller (modem), or you can set the data rate desired on an outgoing (originated) call.

The modem has a gray plastic case, 6 by 9 by 1 inches. It uses an external power supply and a plug-in (RJ11) telephone cable. Unlike most other modems, which have a female DB-25 connector for the RS-232C connection, the Anchor has a 1-foot ribbon cable, on the end of which is a male DB-25 connector. You can plug this connector directly into the female DB-25 that most computers have, except the IBM PC. (You can purchase more recent versions of the Mark XII with either a male or a female connector.)

The Mark XII has a jack for your telephone so you don't need to buy a two-jack adapter if you want the modem and the phone on the same line. Thus, you might be able to save both the cost of an RS-232C cable and the adapter, which would be required with most other modems. The modem consumes less than 1 watt of electrical power and stays cool.

### COMPATIBILITY

The Mark XII is advertised as a Hayes Smartmodem 1200 work-alike. As I previously mentioned, it comes with the cables and two RJ11 telephone jacks, unlike the Hayes. The Anchor has a few extra features not available on the Hayes, but it also lacks

some of the Smartmodem's features.

The Mark XII recognizes all of its commands in upper- or lowercase; the Hayes must have the initial AT in uppercase. More significant, the Mark XII recognizes the dial tone and most busy signals and sends appropriate messages back to your computer. This is an advantage with certain communications software packages and so-called macros.

The disadvantages are that the Mark XII has fewer LEDs (light-emitting diodes) on the panel, and no DIP (dual in-line package) switches. The only one of the LEDs that I miss is OH (off hook). Both products have the HS (high speed) and CD (carrier detect) indicators. Where the Hayes has separate lights for send and receive data, the Mark XII uses one for both (SD/RD).

Hayes has 17 software-loadable registers, and Anchor has only the first 6. For example, in the Hayes you can change the duration and spacing of the touch tones. In the Mark XII, these parameters are preset to values like those to which the Hayes defaults.

The Mark XII will not produce dial tones for the \* or # buttons, which are not really necessary for public telephone networks. Anchor apparently has made design choices in deleting some of the Smartmodem's features, but most users will not notice the omissions.

One rather significant technical difference might make the Mark XII unsuitable for some users. The modem will not pass on the so-called Break signal in 1200-bps operation, only at 300. The Break is not an ASCII (American Standard Code for Information Interchange) character. Instead, it is a sustained (75 to 300 milliseconds) transmission of the Space signal. (When not sending specific ASCII characters, the interface and modem are sending the Mark signal.)

Many mainframe computers use the Break as an indication to interrupt whatever

(continued)

George V. Kinal (636 South Carolina Ave., Washington, DC 20003) is a communications systems engineer specializing in satellite data communications.

## AT A GLANCE

### Name

Anchor Automation Signalman Mark XII Modem

### Type

300/1200-bps modem for data communications (Bell 103 and 212 standard)

### Manufacturer

Anchor Automation Inc.  
6913 Valjean Ave.  
Van Nuys, CA 91406  
(818) 997-7758

### Size

6 by 9 by 1 inches

### Weight

13 ounces

### Power Requirements

12-volt DC, 60 mA, from 110-volt AC adapter supplied

### Necessary Hardware

Any computer or terminal with asynchronous serial (RS-232C) interface

### Necessary Software

Dumb terminal firmware or software sufficient, communications software with macros desirable

### Features

Auto-answer, auto-dial smart modem (all functions commanded via data interface); low power consumption, two-year warranty

### Documentation

29-page manual, 5 by 8½ inches

### Price

\$399

is going on. For example, you might temporarily halt transmission of a long file to save the already received portion to disk. Some computer systems have been modified to respond to XOFF (usually a Control-S). The remote database/network services all accept XOFF, as do almost all micro-computer bulletin boards.

The Mark XII will respond to commands of any parity but will not send back result codes with 8 bits and no parity (8NI). This has led some people to believe that the modem cannot handle 8-bit data, which is not the case.

Finally, the Hayes has a speaker so you can hear what is going on; the Mark XII does not. You can check on the results of a dial attempt by picking up the telephone handset (with pulse dialing, you must wait until the dialing sequence is finished).

### USER EXPERIENCES

I have tested the Mark XII on the Apple II and IIe with a wide variety of serial interface cards. I also substituted it for a Hayes Smartmodem 1200 on an IBM PC. Software used included ASCII Express-Professional, Transend II, MODEM7—a public-domain program, a homebrew program called COMTERM based on the TAFT program (see "TAFT: Terminal Apple with File Transfer" by Tom Gabriele, June 1982 BYTE, page 410), BLAST on the Apple and the PC, and PC-Talk. The modem performed satisfactorily and was functionally identical to the Hayes.

Surprisingly, 300-bps operation was less than perfect. When I called a local bulletin board, the Mark XII showed an occasional tendency to garble the received data. This was apparently caused by its inability to tolerate signals that were stronger than normal. If you take the telephone off the hook during the session, the garbling is almost completely eliminated. Other owners of the Mark XII reported the same problem when making a local call. The people at Anchor insist that a firmware change repairs this problem, but a replacement PROM (programmable read-only

memory) they sent failed to cure it.

A colleague tested the Mark XII using Hayes Smartcom II software on the IBM PC (certainly an acid test of the claim to Hayes compatibility). Again, 1200-bps operation was flawless. However, at 300 bps, in addition to the garble problem, the Anchor did not always reliably hang up upon completion of a session.

Another problem is that if the data carrier is suddenly dropped (the other end hangs up, for example), the modem won't respond to your commands. You can restore function only by turning the power off momentarily. This flaw makes the current version of the Mark XII unsuitable for auto-answer applications such as bulletin boards.

The biggest problem with the Mark XII seems to be the difficulty in getting it operating. The interface-card manual, the software manual, and the modem manual each give different connection instructions. The typical RS-232C interface does not expect to receive data until the carrier detect is high. But the modem manual says that when you send the AT command to the modem, you should see the response OK. Without carrier detect, you see nothing and assume that the new modem isn't working. Even worse, some interface cards for the Apple present a DCE instead of the DTE interface convention, so a cross-over cable or null modem is required. But the standard null modem does not strap the carrier detect high. These difficulties are not the fault of the modem design but can be frustrating.

### DOCUMENTATION

As for documentation, the Mark XII manual is no match for the thorough Hayes manual. It has barely enough information to install and use the product. However, producers of modems that might be used with many different computers, terminals, and interface cards are in a situation similar to that faced by printer manufacturers a few years ago. It is impossible to provide enough information in

(continued)



## Networking Raised to a Greater Power

Advanced Technology. With it, IBM tripled the speed of the PC and increased its memory capacity five-fold. Nowhere is this increase in computing power more important than in networking situations. If the AT's technological advances have prompted you to look into a multi-user network, you owe it to yourself to take a closer look at MultiLink Advanced™ . . . a unique multi-tasking, multi-user networking system that runs programs under PC-DOS 3.0.

**Eight Workstations for the Price of an AT.** MultiLink Advanced™ represents the next generation in networking systems for IBM microcomputers. The system enables terminals, connected to a single AT, to emulate IBM-PC's having up to 448K of RAM (The PC-Shadow™ terminal, shown above, even has a PC look-alike, as well as work-alike keyboard and display).

This means that instead of spending \$3,000 per workstation for a PC with a Kilobuck "Network Interface Board," you can use inexpensive terminals . . . eight of which cost less than an IBM AT. Even if you need only one workstation connected to your AT, you'll realize significant savings.

**MultiLink Advanced™ . . . Instant Access to All of Your Resources.** Central to most multi-user situations is the need to coordinate a variety of printers. With what's been described by *PC-Tech Journal* as ". . . by far, the best print spooler for the IBM PC," MultiLink Advanced™ gives users the option to print either at their workstations, or at a central location. In addition, programs and files can be shared by multiple users locally or through use of a modem. Just think of it . . . having remote access to an AT with a lightweight terminal/modem.

Although designed to take advantage of the AT, MultiLink Advanced™ runs on all versions of PC-DOS, except 1.0, and certain implementations of MS-DOS. A wide range of leading programs are supported which include WordStar, dBASE III, Multimate, and Lotus 1-2-3.

**Get the Advanced Story Today.** Call The Software Link Today for complete details and the dealer nearest you. MultiLink Advanced™ is immediately available at the suggested retail price of \$495 and comes with a money-back guarantee. VISA, MC, AMEX accepted.

# MultiLink<sup>™</sup> ADVANCED



THE SOFTWARE LINK, INC.

8601 Dunwoody Place, Suite 336, Atlanta, GA 30338 Telex 4996147 SWLINK  
CALL: 404/998-0700

Dealer Inquiries Invited

IBM, PC, AT, & PC-DOS are trademarks of IBM Corp. MS-DOS, WordStar, dBASE III, Lotus 1-2-3, and Multimate are trademarks of Microsoft Corp. MicroPro, Ashton-Tate, Lotus Development Corp. & Multimate International, respectively.

MultiLink Advanced™ & PC-Shadow™ are trademarks of The Software Link, Inc.

# One Board... One Family

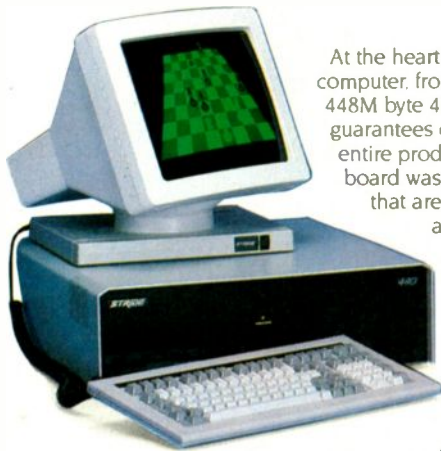

At the heart of every Stride 400 Series micro-computer, from the floppy-based 420 to the 448M byte 460, is an identical CPU board. This guarantees compatibility throughout the entire product family. And it means, our CPU board was designed with standard features that are either options or simply unavailable on other microcomputers:

- 68000 microprocessor (10 MHz with no wait states)
- VMEbus
- 256K bytes RAM
- 5¼" 640K byte floppy
- Battery-backed real time clock
- 4K CMOS RAM
- Four RS-232C serial ports (Stride multiuser BIOS)
- Centronics bi-directional parallel port
- Omninet Local Area Network (Liaison LAN software)

With this basic design, Stride is able to explore the full range of 68000 applications from an advanced multiuser, multi tasking BIOS to built-in local area networking. No other microcomputer offers the flexibility to run over a dozen different operating systems and more than 30 languages/compiler.

The basic design is backed by a rich option list:

- 12 MHz 68000 processor
- VMEbus (Eurocard) cage
- Low cost, high speed graphics
- NOD™ cursor control
- 12M bytes of RAM
- 448M bytes of hard disk storage
- 22 serial ports
- Floating point processor (NS16081)
- Cartridge streaming tape backup
- Memory Management Unit

**CBASIC COBOL**  
**Modula-2**  
**Pascal FORTRAN**  
**RM/COS Lisp**  
**UNIX System V**  
**Cp-System**  
**CP/M68K**

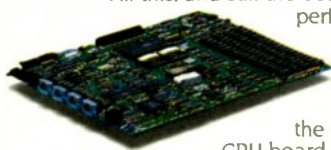

All this, and still the best price/performance ratios in the industry: from \$2900 to over \$60,000. But it begins with the powerful Stride CPU board, a standard feature of every 400 series system. It's what we call "Performance By Design"



Formerly Sage Computer

For more information on Stride or the location of the nearest Stride Dealer call or write us today. We'll also send you a free copy of our 32 page product catalog.

**Corporate Offices:**  
4905 Energy Way  
Reno, NV 89502  
(702) 322-6868

**Regional Offices:**  
Boston (617) 229-6868  
Dallas (214) 392-7070

## The Anchor's low power-consumption design contributes to long-term reliability.

a short manual to cover all the possibilities.

A key phrase appears in the manual: "Minimum to operate are pins 7, 2, and 3." In other words, the modem is perfectly happy with only these three wires of the RS-232C interface connected. But in most cases, the interface (computer) probably will not work. Most people are able to get the Hayes working, perhaps by trial and error, because of its Force DTR true and Force CD true switches. Anchor should do what Epson and Okidata did: print a separate booklet showing the interface requirements for all popular computers and interface cards.

### CONCLUSIONS

The Mark XII's operation is good at 1200 bps, except for the firmware's intermittent refusal to reset properly. A signal-level sensitivity problem occurs at 300 bps. Since the modem comes with a two-year warranty, perhaps these flaws will be corrected by the manufacturer in due course.

For about 90 percent of the potential applications, the Mark XII's lack of LEDs, DIP switches, and registers doesn't matter. The provision of two RJ11 jacks and the male DB-25 on 1 foot of cable can save the customer a few more dollars. Also, the Anchor's low power-consumption design should contribute to long-term reliability.

If you need RJ12/13 capability or the flexibility that the additional registers in the Hayes give you (for example, the ability to force the modem to transmit in the absence of received carrier), the Anchor is not for you. And before you consider the Mark XII, make sure that you can get along without the Break capability. ■

# "...it is impossible to lead in the development of new technology when your entire system design is dedicated to following."

[This is one of a series of design philosophy discussions with Rod Coleman, President of Stride Micro™ formerly Sage Computer]

**RC:** In the rush to gain instant marketshare, the concept of good microcomputer system design has been forgotten by many man-

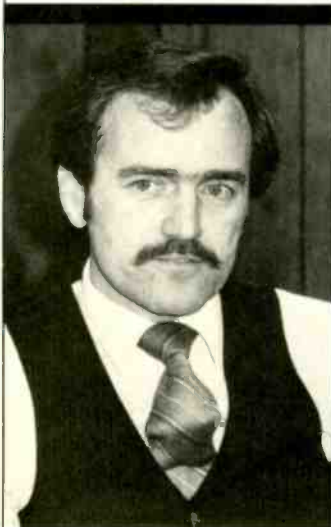

ufacturers. The worst abuses are among those who think that system design is deciding what color to paint your PC clone.

**Q:** So you're referring to the compatibles?

**RC:** They're the worst offenders, but lack of attention to system design is present at all levels. The IBM™ PC itself, as first designed and introduced in 1981, was a failure. They sold relatively few of their original cassette-based systems. It was the floppy diskette option

that made the product more reasonable and allowed the PC to dominate the market.

Likewise, the success of the hard disk model is more a credit to the innovators and second-source vendors who first provided Winchester disk add-ons. The XT is a tribute to independent ingenuity, not any system design work by IBM in Boca Raton.

Of course, the pure imitators are the worst. Some companies would have you believe that system design is determining which version of Apple or IBM to clone. The perversion here is that it is impossible to lead in the development of new technology when your entire system design is dedicated to following.

**Q:** How would you change that?

**RC:** Current practices aside, the correct way to approach design is to first define the problem or market need. Standards *should* be followed wherever possible. However, if technology is significantly advanced, the system design should never be unduly biased by fear of incompatibility.

Our work on the NOD™ cursor control device is a good example of this theory in practice. In looking at the mouse as a method of directing cursor movement, we recognized the problems of having to remove the hands from the keyboard and the requirement of having additional clear desk area.

This design began with the generalization of "what are we trying to do?" instead of looking for mouse re-designs or spinoffs like "foot mice."

"...system design should never be unduly biased by fear of incompatibility."



**Q:** Where did that lead?

**RC:** It allowed our engineers to be creative. We examined human factors such as what muscle groups have the finest control and the general aversion to having any wires attached to one's body. Then we matched those objectives against available technology, and our answer was something totally different: a cursor control system that tracks head movement using light rays. It's similar to the technology of a television remote

control device. Today we offer it as a development product to innovative software engineers. tomorrow its potential is unlimited.

The point here is that, whether it's the NOD individually or our system design in general, we seek the best solutions, whether they're standard or not. The goal is providing the best answer, not just the usual answer. Maybe the philosophy is best summarized in Stride's tagline: "Performance By Design™"



**STRIDE**  
MICRO

Formerly Sage Computer

For more information on Stride or the location of the nearest Stride Dealer call or write us today. We'll also send you a free copy of our 32 page product catalog.

**Corporate Offices:**

4905 Energy Way  
Reno, NV 89502  
(702) 322-6868

**Regional Offices:**

Boston: (617) 229-6868  
Dallas: (214) 392-7070

IBM PC and XT are trademarks of International Business Machines Corp. Stride, NOD, and "Performance By Design" are trademarks of Stride Micro.

# Got a minute?

The folks who make very modern personal computers would have you accept a very old fashioned idea. Namely that you should buy everything else from them, too. Including their printers.

But IBM owners everywhere are finding that while the IBM PC may be the right tool for their business, the ideal tool for putting their business on paper is the all new Microline 192 from Okidata. And it isn't taking them long to find out.

First there's speed. The Microline 192 is twice as fast as the IBM Graphics Printer. But IBM PC owners are finding some other very remarkable features about the Microline 192 that the Graphics Printer doesn't have.

PRINTER COMPARISON

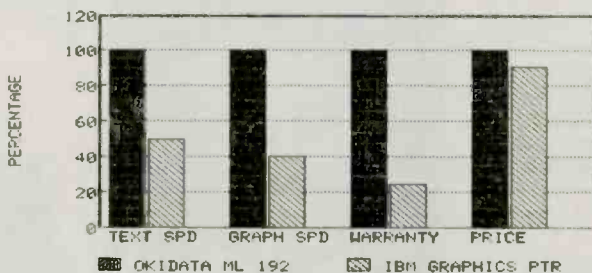

**FEATURE**

SPEED  
CORRESPONDENCE QUALITY  
FREE FONT SOFTWARE  
BIDIRECTIONAL GRAPHICS  
MENU SELECT MODE  
CUT SHEET FEEDER  
WIDE CARRIAGE MODEL

**OKIDATA**

160 CPS  
YES  
YES  
YES  
YES  
OPTIONAL  
YES (ML-193 \$699)

**IBM**

80 CPS  
NO  
NO  
NO  
NO  
NO  
NO

WARRANTY  
WEIGHT  
SUGGESTED LIST PRICE

1 FULL YEAR  
9 LBS  
\$499

90 DAYS  
13 LBS  
\$449

Oh, one other comparison worth repeating. In the minute and ten seconds it took the Microline 192 to print what you've just read, the IBM Graphics Printer wouldn't have told half the story.

OKIDATA, an OKI AMERICA company



# *That's about all it takes to discover why Okidata's new printer beats the IBM® Graphics Printer.*

The folks who make very modern personal computers would have you accept a very old fashioned idea. Namely that you should buy everything else from them, too. Including their printers.

But IBM owners everywhere are finding that while the IBM PC may be the right tool for their business, the ideal tool for putting their business on paper is the all new Microline 192 from Okidata. And it isn't taking them long to find out.

First there's speed. The Microline 192 is twice as fast as the IBM Graphics Printer. But IBM PC owners are finding some other very remarkable features about the Microline 192 that the Graphics Printer doesn't have.

PRINTER COMPARISON

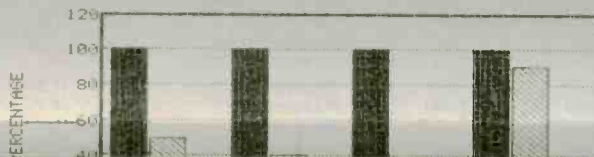

**IBM** Personal Computer  
Graphics Printer

**OKIDATA**  
an OKI AMERICA company  
Mt. Laurel, NJ 08054, 1-800-OKIDATA

Inquiry 261

# HOW TO BUY SOFTWARE WHEN ALL THE ADS LOOK THE SAME.

**W**e know it's hard to choose a software house. All the ads say the same thing—"Lowest prices," "fastest delivery," "best support," "biggest inventory."

Trouble is, although the claims are the same, the companies are very different. Which is why we want you to know some important facts about us:

**1.** 800-SOFTWARE is one of the oldest and most reputable firms in the industry. Our customers include Coca-Cola, GE, Hewlett-Packard, Xerox, AT&T, and thousands of other satisfied buyers.

**2.** Our National Accounts Program offers volume discounts and valuable services to large software users. We offer *incredibly* low prices on large bids!

**3.** We have a giant, \$1,000,000 inventory. Which means we can offer next-day delivery if needed.

**4.** With every product you get friendly, expert technical support. Have a question? You'll be glad you bought from 800-SOFTWARE!

**5.** We'll match our competitors' prices on most products. We *never* cut service.

**6.** We never charge extra for credit card purchases, nor do we process for payment until the product is shipped. (Our competitors don't make this claim!)

**7.** You'll automatically receive our Technical Support Newsletter—a great way to stay up-to-date.



**8.** We are members of the Better Business Bureau and the Direct Marketing Association.

**9.** We want your business. *And* your repeat business. Which is why we work so hard to keep you happy. Give us a call and let us *prove* it!

## CHECK OUT ALL OUR INCREDIBLE PRICES:

Wordstar 2000/2000 Plus CALL	PFS File/Graph/Write \$84	Okidata 92/93 \$399/\$649	Epson Printers CALL
RBase 4000 \$259	SuperCalc 2/3 \$159/\$195	Hercules Color/Graphic Card \$199/\$325	IUS Accounting \$299/mod.
<b>SOFTWARE</b> <b>BORLAND SOFTWARE™</b> Sidekick CALL Turbo Pascal/8087 \$49/\$75 <b>BOURBAKI™ 1Dir</b> \$ 79 <b>DECISION RESOURCES®</b> Chartmaster \$249 Signmaster \$189 <b>DIGITAL RESEARCH™</b> <b>FOX &amp; GELLER™</b> CALL <b>FUNK SOFTWARE™ Sideways</b> \$ 49 <b>HARVARD SOFTWARE™</b> Harvard Project Manager \$289 IMSI™ PC Paintbrush \$ 99 <b>LATTICE C-COMPILER™</b> \$359 <b>LIFETREE™ Volkswriter Deluxe</b> \$179 <b>MICROPRO®</b> WordStar \$209 WordStar 2000/2000 Plus CALL WordStar Pro Package/P.P. Plus \$259/\$359 InfoStar CALL All Other Products CALL	<b>MICRORIM™ RBase 4000</b> \$259 <b>MICROSOFT®</b> Multiplan \$125 Fortran \$269 All Other Products CALL <b>MICROSTUF™ Crosstalk</b> \$ 95 <b>MULTIMATE™</b> \$255 <b>ROSESOFT™ Pro Key</b> \$ 99 <b>SOFTWARE PUBLISHERS™</b> PFS File/Graph/Write \$ 84 PFS Report \$ 75 <b>SORCIMI/IUS™</b> SuperCalc 2/3 \$159/\$195 EasyWriter II System \$185 IUS Easy Business Accounting \$299/mod. Super Project \$209 All Other Products CALL	<b>HARDWARE, ETC</b> <b>AMDEK™ Monitors</b> CALL <b>AST™ Products</b> CALL <b>ATI™ &amp; CDEX™ TRAINING</b> CALL <b>CODE-A-PHONE Tel-A Modem</b> \$479 <b>EPSON™ PRINTERS</b> FX 80, FX 100 & LD 1500 CALL <b>HAYES™</b> Smartmodems 1200/1200B CALL <b>HERCULES™</b> Color Card \$199 Graphic Card \$325 <b>MAXELL™ &amp; MEMOREX™ DISKETTES</b> CALL <b>MEMORY CHIPS</b> CALL <b>OKIDATA™ PRINTERS</b> 92 IBM \$399 93 IBM \$649 <b>PRINCETON GRAPHICS™ MONITORS</b> CALL <b>QUADRAM™</b> CALL <b>WESTERN UNION EASY LINK®</b> FREE	

**WE ALSO CARRY HUNDREDS OF OTHER PRODUCTS FOR THE IBM-PC®  
AND COMPATIBLES, MACINTOSH®, APPLE II® AND CP/M®!**

 800-SOFTWARE, INC.  
940 Dwight Way  
Berkeley, CA 94710  
 Inquiry 8



To order call toll-free:

**800-227-4587 OR 415-644-3611**

- Dealer inquiries welcome.
- Quantity discounts available through our National Accounts Program.
- Purchase orders accepted. Please call us in advance.
- Call for shipping charges. Overnight delivery available.
- We do not add surcharge for credit card purchases.
- Prices may change. Above prices are for IBM-PC and compatibles.
- International orders welcome: TELEX #751743 800 SOFTWARE UD.
- All returnable products subject to a minor restocking charge.

## MODULA-2/86

We would like to clarify some important points regarding the review of Logitech's Modula-2/86 by Kevin Bowyer (February, page 311).

Three months prior to the review's publication, Logitech released a new version of Modula-2/86. Release 1.1 provides significant enhancements and modifications to 1.0.

Modula-2/86 1.1 no longer requires an 8087 numeric coprocessor chip. In addition to 8087 in-line code, the system now provides software emulation for real data-type operations and exception handling for real operations.

A utility program called LOD2EXE is now available as part of Modula-2/86's utilities package. This utility merges the run-time support (M2.EXE) with a .LOD file to produce one DOS-executable file (.EXE) so you can execute Modula-2/86 programs directly from PC-DOS. Modula-2/86 requires 256K bytes of RAM and is now compatible with MS-DOS 3.0.

The overall speed of compiling and linking has been improved by a factor of 10 to 40 percent.

A symbolic run-time debugger is available and sold as a separate package. The user interface of the new postmortem debugger, included in the base package, has been improved and made compatible with the optional symbolic run-time debugger. The run-time debugger is sold as a separate package.

The messages displayed during compilation have been changed to be more descriptive. And Modula-2/86 for MS-DOS is compatible with generic MS-DOS and therefore runs on a variety of machines other than the IBM PC.

CHRISTOPHER R. CALE  
Logitech  
Redwood City, CA

## EASYLINK AND MCI MAIL

We believe that Wayne Rash's review of EasyLink and MCI Mail (February, page 317) contained some misleading impressions. Also, several features added to EasyLink shortly before the issue was published make the service easy to use and inexpensive.

EasyLink's major new features are

prompting, two-hour express-document and overnight delivery of letter-quality documents, and session control. The prompting feature leads users step by step through creating and sending a message or retrieving information from the mailbox. To activate prompting, users type / Prompt and Enter. Once EasyLink users become familiar with the system, they can bypass prompting.

Two-hour express-document delivery is available for \$20 to most major U.S. metropolitan areas, with overnight delivery service available for \$7.75 to the entire country. Both services, which are provided by DHL Worldwide Courier Express, are less expensive than the MCI alternative.

The session-control feature lets EasyLink users move directly from EasyLink to another service (such as FYI) and back during the same phone call. Session control features menus to lead users through the switching process.

Your review states that from the information you had, the two software packages are functionally equivalent. But Instant Mail Manager from Western Union offers features superior to those in the package offered for MCI Mail, including a text editor, address-list maintenance, local-filing (message-management) capability, and easy communication with other hosts.

While your review employs a few comparisons that show EasyLink to be more expensive than MCI Mail, it can just as easily be shown that EasyLink is less expensive. Since the majority of business correspondence contains fewer characters than the MCI ounce, EasyLink would be less expensive in most cases.

MEL WEBSTER  
Miller Communications  
Boston, MA

## JANUS/ADA

The review of Janus/Ada by Mark J. Welch (February, page 295) was based on a version that was almost a year old. Mr. Welch had problems with several nonstandard features of Janus/Ada. The latest version, 1.5.1, contains a standard, full Ada grammar. Any program written in Ada will be accepted by Janus/Ada as syntactically correct (with some features marked as unim-

plemented). The "empty parentheses" problem does not exist in version 1.5.1; function calls have been updated to match the current Ada standard.

The new version also comes with an Ada-standard (subset) text\_io module. The get\_line routine is Ada-standard. No get\_line routine in Ada takes a single parameter, so Mr. Welch's program wouldn't have worked anyway. The Ada get for strings is the same as a loop that reads a fixed number of characters, so it is useless for interactive input.

The Janus/Ada code generator, particularly local-variable access, has been improved in version 1.5.1. The BYTE prime-number benchmark (as a subprogram, not a package) now runs in 18.44 seconds on an IBM PC XT. You can get a further improvement to 15.80 seconds by using the stand-alone optimizer provided in the tools. The optimizer was previously a separate product.

The prime-number benchmark is somewhat misleading since an Ada main program is a normal procedure. Unlike other languages, in Ada you can call a main program recursively. Thus the data contained in it must be allocated on the stack, rather than in memory. That makes Ada slower than most other languages in benchmarks, no matter how good the compiler.

Ada does not have an unsigned integer type, so I see no reason why the reviewer expected one. The Fibonacci benchmark, which expects 16-bit unsigned integers, is unfair to any language that does not have them (including Pascal).

Long\_integer is not a predefined type in Janus/Ada; it is an optional Ada type. We have been providing notes about the use of long\_integer for a long time; perhaps Mr. Welch did not get them. We have revised Janus/Ada's manual to eliminate problems like the erroneous mention of long\_integer as a predefined type. We also renumbered the sections to match the 1983 ANSI Ada standard. The new version of Janus/Ada has floating-point software and can use the 8087 chip. We generally recommend using the floating-point capabilities rather than the long\_integer routines.

The version 1.5.1 compiler completely  
(continued)



**This ad is for all those who ever wonder why your company runs a United Way campaign.**

When it comes right down to it, you're probably the best reason your company has for getting involved with the United Way.

You see, they know almost all of the money given to the United Way goes back out into the community to help people.

So if you, or the people you work with, should ever need any of our services, like day care, family counseling or health care, we'll be right there to help. In fact, there are tens of thousands of United Way-supported programs and services in cities and towns across the country. That means help is nearby wherever you are.

And your company knows that could mean the difference between keeping or losing a valuable employee.

That's why they give. And that's why they ask you to give. Because there may come a day when you need help yourself.



United Way

Thanks to you, it works, for ALL OF US.



A Public Service of This Magazine & The Advertising Council

implements exceptions and exception handlers, including those on blocks and packages.

Last, the prices mentioned in the article changed at the beginning of 1985. We no longer directly sell the CP/M version of Janus/Ada, but it is still available through Workman & Associates (112 Marion Ave., Suite 3B, Pasadena, CA 91106, (818) 796-4401). The C-Pak (the compiler, linker, and Ada-standard libraries), which is mainly intended for education, is available for \$99.95. The D-Pak, which includes the C-Pak, the tools, and the full set of libraries, is now priced at \$900. The S-Pak, which includes the D-Pak, our Pastran Pascal-to-Ada translator, and the source code to the libraries, is \$1500. The D- and S-Paks are intended for software development.

RANDALL L. BRUKARDT  
RR Software Inc.  
Madison, WI

*I am glad that RR Software has updated its compiler to handle Ada's current syntax. My impression as I finished the review was that the new version had not yet been released. I will be pleased to update the review when RR loans me the compiler's new version; they have promised to do so.*

*Mr. Brukardt is correct about get\_line. Ada does not have a single-parameter get\_line procedure (get\_line also returns a natural integer for the length of the string). My intent was to point out that get\_line had not been implemented as a procedure, something that has presumably been fixed in the new version.*

*Regarding BYTE benchmarks, I used the standard BYTE Sieve of Eratosthenes prime-number benchmark in Ada (January 1983, page 288); BYTE does not normally review the performance of optional optimizers or of rewritten benchmark programs, since these defeat the purpose of benchmarks. If the optimizer is now a standard component of Janus/Ada, an updated review should include its performance. Anyone who can suggest a better compiler benchmark that can be fairly translated across all languages should let me know.*

*I realize that Ada does not have an unsigned integer type. My point was that you cannot run the Fibonacci benchmark in Janus/Ada because the language cannot handle numbers that large without overflowing the stack or heap. I wasn't faulting the compiler or language as much as explaining why I couldn't pro-*

*vide a value for this standard benchmark. Since the maximum and minimum values for integer are not specified in the reference manual, other Ada compilers might be able to execute this benchmark.*

*I am happy to hear that the compiler's price is now \$99.95. If, as Mr. Brukardt reports, the compiler now matches standard Ada 1983 syntax, Janus/Ada is a bargain and a must for hobbyists trying to learn Ada.*

—MARK J. WELCH  
Staff Writer

**ALTOS 586**

I agree with Greg Corson's review of the Altos 586 with the XENIX Development System (March, page 247). However, we have managed to circumvent some of the problems he mentions.

We are using two Altos 986-40s with Altos Worknet, 10 terminals, two high-speed printers, two modems, and six local screen printers. The modem communication problem was solved by purchasing M-Link. This communication program lets us control communication protocol rather than rely on the standard Altos output.

The XENIX Development System is amazing; much like CP/M, you understand XENIX from other authors' articles and books, not from the original documentation. However, we are using programs written in COBOL, FORTRAN, C, and MS-BASIC interchangeably and without knowing which program is written in what language.

With the advent of XENIX 3.0 and Worknet 3.0, the documentation is now in 13 manuals covering 20 inches of shelf space. Both the hardware and the XENIX system are superior, but liaison between hardware and software becomes extremely confusing.

RICHARD C. LOFBERG  
Teaneck, NJ

**ATARI 800XL**

I was pleased to see Jon Edwards's review of the Atari 800XL (March, page 267). The 800XL is a superior machine for the money. For \$300, a computerist can get a disk drive and a 64K-byte 6502C machine.

Literally thousands of programs are available for the Atari, and two magazines devoted entirely to the machine do an outstanding job.

Also, the Action! compiler works faster than any I have seen, and it produces good, tight machine code. It is highly structured, complete with subroutines.

(continued)

\* ALL PC HARD DISKS  
LOW POWER

## THE WORLD OF PC UPGRADES

IS10	10 Mbyte Hard Disk with Controller	\$590
IS10R	10 Mbyte Removable Hard Disk/Controller	\$1295
IS20	20 Mbyte Hard Disk with Controller	\$790
IS30	30 Mbyte Hard Disk with Controller	\$1195
MT-10	10 Mbyte Micro Tape Backup "add it to your XT"	CALL
ISPS	Power Supply "Internal" (150 watts)	\$185
CC01	Floppy/Hard Disk Controller Card (1.6 Meg Floppy Compatible)	\$465
	when included in any of above Hard Disk Systems add	\$185

### "FOR YOUR AT"

AT20	20 Mbyte Hard Disk for IBM AT	\$795
AT33	33 Mbyte Hard Disk for IBM AT	\$995

NOTE: The above pricing is for internal units. External units are available.  
Micro Design International has been serving the Computer Industry for over 8 years.  
Our products carry a one year warranty with a 30-day money back guarantee.

**MAGNETIC MEMORY  
PRODUCTS FOR THE  
IBM AT, XT/PC AND  
COMPATIBLES...**

NOW  
FROM

**\$590**

**NEW  
LOW  
PRICES"**

**FREE**

WITH THE  
PURCHASE  
OF ANY  
HARD DISK

**COMMAND  
ASSIST** \$49.95  
(DOS manual on disk)  
...as reviewed in PC Week

**CACHE  
ASSIST** \$49.95  
(For faster disk access)

AND

TO ORDER CALL COLLECT  
(305) 677-8333

MasterCard/Visa/Check/or Money Order

Inquiry 234

**Micro Design International Inc.**

6566 University Boulevard, Winter Park, Florida 32792 (305) 677-8333 TELEX 332559 MDI:ORL JD





## You know that choosing the right software is serious business. So does WATCOM.

So before you make any decisions about your software needs, talk to WATCOM—the people major software users around the world have trusted for years. WATCOM has the products you need to get the job done right. Proven performers like WATFOR\*, WATFIV\*, WATBOL\*, and SCRIPT. Plus new leaders in software for PC workstations and micro-to-mainframe communications. Networks, language interpreters and compilers. Text preparation and data management. All WATCOM products are human engineered to provide the optimum in people efficiency and productivity. And they're designed to run compatibly on IBM mainframes and PC's, Digital main-

frames and micros, and Commodore micros.

Whatever you need is backed up by WATCOM's innovative maintenance and support services. You'll be kept up to date with the latest in product enhancements and information. And our publications and seminars will help you get the most out of your software investment. WATCOM. Quality products. Professional service. And a reputation built on more than 150,000 licensed mainframe and micro software programs throughout the world. So talk to us before you decide. After all, choosing the right software is serious business. For you. And for WATCOM.

### Make the right choice: JANET/2 NETWORK

Better resource management makes Janet/2 the right choice in software for IBM and PC Jr.\* networks.

Janet/2 shares hardware, software, and data. Libraries can be centrally secured for controlled access by a number of users. Run your favorite programs under standard DOS.

Janet/2 consists of a file server connected to a maximum of 16 workstations using IBM Cluster Adapters. The file server is usually an IBM XT\*. Janet/2 gives you faster logical diskettes

using a hard disk and workstation diskette drives are optional. Make the right choice. Call or write WATCOM today and we'll tell you all about Janet/2 or any of WATCOM'S other people-efficient products.

**WATCOM**  
The right choice in software.

Yes! I want to make the right choice in software. Send me more information on:

JANET/2 NETWORK  WATCOM Software Catalogue

Name: \_\_\_\_\_

Company: \_\_\_\_\_

Title: \_\_\_\_\_

Address: \_\_\_\_\_

City: \_\_\_\_\_ State: \_\_\_\_\_ Zip: \_\_\_\_\_

#### WATCOM PRODUCTS INC.

415 Phillip Street  
Waterloo, Ontario, Canada  
N2L 3X2

(519) 886-3700

Telex 06-955458  
BYF2

\*WATFOR, WATFIV and WATBOL are registered trademarks of the University of Waterloo.  
\*IBM PC and IBM XT are registered trademarks of International Business Machines Corporation.

## REVIEW FEEDBACK

global variables, local variables, and arguments. I wish someone would tell computer teachers in elementary schools how cheaply they could teach structured programming instead of BASIC.

J. RAY WOOD  
Benton, IL

### JUKI'S TRACTOR FEED

John J. Williams's letter in Review Feedback (March, page 303) found sympathetic readers: We experienced the same difficulty with the tractor feed. Since we have four Juki printers, we felt we had bought into a lemon factory until we hit on what appears to be an inexpensive solution.

The paper path from the underside of the tractor, around the platen, and back again through the top is too long and allows for paper slippage. This isn't too bad unless you need some form of double-printing. We finally found a method to take up the slack that gets rid of the wandering without causing gear-stripping friction.

The steel rod just below the paper-out bail is mounted to each end plate. We could remove only the left screw, but this was enough to access one side of the rod. We took polyethylene spiral wrap for harnessing cables and worked it on over the steel rod. The size we used was  $\frac{3}{8}$  inch outside diameter, but  $\frac{1}{2}$  inch would probably be easier to work with. A light touch of silicon lubricant helped it slide more easily, and any residue that made it to the outer surface of the wrap probably reduced the paper friction.

This slight addition to paper-path length worked wonders for us. The spiral wrap should be available locally, but several electronics mail-order catalogs carry it too.

JOHN J. NEVILLE  
Onamia, MN

### TECMAR'S JRCAPTAIN

In Glenn Hartwig's review of JrCaptain (March, page 299), he remarked about the cosmetics of the keyboard, the limitations of a single disk drive, and the need for more memory. In home use, I have found none of these problems insurmountable.

When you spend a lot of time with a PCjr, you find two less obvious problems, one major and one relatively minor. The minor one is the limited keyboard buffer. The serious problem is lack of direct-memory access (DMA): Everything stops when you read or write to disk. Almost every PCjr owner I meet has problems downloading files from remote host computers. There is a crying need for software that will support flow control for receiving

ASCII files, as well as XMODEM for binary files.

I assume that expansion units like Tecmar's do not provide DMA but do get around these problems by providing a virtual disk in RAM. Are reliable file transfers possible this way? Is that also possible without the memory expansion? In other words, is there a RAM-disk program that is compact and will fit 40K or 50K bytes of storage into the PCjr above the communications program?

P. M. MORETTI  
Stillwater, OK

*Perhaps other PCjr owners can offer suggestions.*

—GLENN HARTWIG  
Technical Editor, Reviews

Glenn Hartwig could not find the data sheet for an 8314 memory chip on Tecmar's JrCaptain because it does not exist. The number 8314 is a date code representing the 14th week of 1983 when the part was manufactured. Almost all semiconductors are branded by the manufacturer with its logo, a part number, and a date code for lot traceability. Off-brand or retested parts will have the manufacturer's logo obliterated or removed but will generally leave a generic part number such as 4164 and the date code.

DAVID W. THOMSON  
Highlands Ranch, CO

### MICROSOFT BASIC

Manly W. Mumford, commenting on Microsoft BASIC in Review Feedback (March, page 303), made the same observation my students do at first: It seems crude compared to BASICs on lap and home computers because it lacks a full-screen editor and a Clear Screen statement.

The problem is that MS-DOS and CP/M provide software with only a simple service to print ASCII characters to the screen. When Microsoft designed MBASIC to run, without changes, on any computer (that is, working strictly through the system), this limited cursor movements to the directions provided by ASCII or the system. Since ASCII was designed around Teletype terminals using paper, text display can proceed only to the right and down except for backspacing along the current line. This rules out the possibility of a full-screen editor.

For similar reasons, ASCII, MS-DOS, and CP/M do not provide for clearing the screen. To provide these services to soft-

(continued)

# DeSmet C

MACINTOSH™  
DEVELOPMENT  
PACKAGE

\$150  
Includes Shipping

### Runs on 128K and 512K Macintosh

- Produces FINDER/SHELL applications
- Dynamic OVERLAY support

### Full K&R C Compiler

- Native Code Compiler
- In-line asm directive
- IEEE S/W Floating Point

### Assembler, Linker, and Librarian

### Machine Code Debugger

### Source Code Editor

### "SHELL" Interface

- Environmental Variables
- Wild-Card Expansion
- Many Built-in Functions
- Command History
- Runs Any Application

### >120 Function STUDIO Library

### >450 Function Macintosh ROM Library

### 360 Page Manual

### RAM Disk

Macintosh is a trademark licensed to Apple Computer, Inc.

- Please Send Information.  
 Send Macintosh Development Package

Check # \_\_\_\_\_ Enclosed

SHIP TO:

ZIP \_\_\_\_\_

**CW A R E**  
CORPORATION

P.O. BOX C  
Sunnyvale, CA 94087  
(408) 720-9696

All orders shipped UPS surface. California residents add sales tax. Canada shipping add \$5, elsewhere add \$15. Checks must be on U.S. Bank and in U.S. Dollars. Call 9 a.m.-1 p.m. to CHARGE by VISA/MC/AMEX.

Street Address: 505 W. Olive, #767, Sunnyvale, CA 94086

# WAREHOUSE DATA PRODUCTS

Se habla Español

Call for programs not listed

**Technical & Other Information (602) 246-2222**  
**TOLL FREE ORDER LINE 1-(800)-421-3135**

Call for pricing on  
other Sperry Computers.

## SPERRY PC COMPUTERS

Authorized Sperry Dealer  
Dealer Inquiries Invited.

Mono Desktop 256K, 2 Drives, Serial Port, Par. Port,  
Clock, MSDOS 2.11, GWBasic plus Other Software ..... **\$1650**  
Portable Computer 256K 2 Drives Full IBM Compatibility ..... **\$1650**

### FREE! PRINTER SET SOFTWARE

Purchase an Okidata, Epson, Gemini or Toshiba printer and receive at no charge a menu driven program to set print characteristics or to make your computer function as a correcting typewriter. Retail value \$35. Available for most disk formats.

### --- PRINTERS ---

<b>CITIZEN</b>	
MSP-10 .....	\$299
MSP-15 .....	Call
MSP-20 .....	425
<b>C-ITOH</b>	
F-10-55 .....	1030
8510 Parallel (Pro-writer) .....	295
8510SEP .....	399
DAISYWRITER 2000 .....	795
<b>EPSON</b>	
FX 80+ .....	335
FX 100+ .....	469
LX 80 .....	255
LQ 1500 Parallel .....	906
Homewriter w/interface .....	360
<b>JUKI</b>	
Juki 6100 .....	385
Juki 6300 .....	685
Juki Tractors .....	129
<b>NEC</b>	
3550 .....	1190
8850 .....	1500
P2 Parallel .....	525
P3 Parallel .....	725
<b>OKIDATA</b>	
Okidata 192 Microline .....	369
Okidata 193 Microline .....	Call
Okimate 20 Color Printer .....	Call
Okidata 182 Microline .....	229
Okidata 84P .....	650
<b>SILVER REED</b>	
EXP 400P .....	235
EXP 500P .....	289
EXP 550P .....	399
EXP 770P .....	699
<b>STAR MICRONICS</b>	
SG-10 .....	235
SG-15 .....	369
Call for prices on other models	
<b>TOSHIBA</b>	
1340 .....	549
P351 .....	1164
AB PRINT SWITCH .....	85

--- MOUSE SYSTEMS ---  
PC Mouse w/Paint .....

\$135

--- TERMINALS ---  
Qume QVT-102 Green .....

448

WYSE 50 .....

450

--- MICROSOFT ---  
Bus. Mouse .....

129

Serial Mouse .....

129

--- MODEMS ---  
Hayes 1200 .....

395

Hayes 1200B .....

359

Hayes 2400 .....

595

Anchor Mark XII .....

239

Anchor Express .....

Call

Promodem 1200B .....

262

Promodem 1200 .....

309

--- RAM ---  
64K 150NS Chips (set of 9) .....

12

256K Ram Chips (set of 9) .....

69

--- BOARDS ---  
AST Six Pack Plus .....

249

AST Advantage .....

395

Hercules Color Card .....

149

Hercules Graphics Board .....

295

Paradise Graphics Board .....

259

Paradise Five Pak w/64K .....

175

Quadram Board w/p/s/g .....

225

Quadcolor I .....

185

Sigma Maximizer .....

239

Sigma 384K bd w/256K .....

220

STB Graphics II .....

245

STB Mono Board .....

155

--- DISK DRIVES ---  
CDC Disk Drives .....

139

Iomega Bernoulli 20 mg .....

2495

Iomega Bernoulli Plus 20 mg .....

2625

10 mg External Hard Drive .....

825

33 mg External Hard Drive .....

1625

Turbo 10 Internal Drive .....

685

Turbo 20 Internal Drive .....

1019

--- MONITORS ---  
AMDEK .....

Call for price

Taxan 425 .....

399

Taxan 121 Green .....

125

Taxan 122 amber .....

134

Princeton HX-12 .....

449

Princeton Max 12E .....

179

--- CP/M SOFTWARE ---  
Call us for pricing on CP/M Software!  
Programs like Multiplan, Wordstar  
Propack, Fortran, Move-It, Crosstalk and  
more!

**TERMS:** Prices include 3% cash discount. Add 3% for charge orders. Shipping on most items \$5.00. AZ orders +6% Sales Tax. Personal check, allow ten (10) days to clear. Prices subject to change.

**TOLL-FREE ORDER LINE 1-800-421-3135**

**WAREHOUSE DATA PRODUCTS**  
2701 West Glendale Ave., Suite 6  
Phoenix, AZ 85021



## REVIEW FEEDBACK

ware, terminals recognize escape sequences—sequences of two or more ASCII characters, often beginning with the Escape character—as special commands to move the cursor, erase lines, clear the screen, and so on. Unfortunately, each terminal maker uses different sequences. To clear my Osborne 1's screen, I print Ctrl-Z; on my employer's DEC Rainbow 100, I print seven characters: Esc | 2 | Esc | H.

Microsoft provided an Install program that lets the user adapt MBASIC to any terminal. You can solve your editing problem by saving your MBASIC program in ASCII form and using your favorite text editor. On my Osborne 1, I set up two function keys that transfer my work back and forth between MBASIC and the WordStar-like (but faster) public-domain editor VDO; the transfer takes only seconds in either direction. Mr. Mumford should be able to use MemoMaker on his HP 110 in this way.

Similarly, his terminal manual should describe a sequence that clears the screen. If such terminal-specific sequences are always written as subroutines or defined functions, MBASIC programs can be ported to other terminals by changing only those subroutines. I hope those moving up to MBASIC from home computers will notice the improvements, especially the ability to use up to 40 characters in truly descriptive variable names.

ALAN T. CHATTAWAY

Vancouver, British Columbia, Canada

### NEWWORD

In John Heilborn and Nanci Reel's review of NewWord (February, page 291), I was shocked to read: "The R command... is missing from NewWord, and NewStar Software has no plans to add it to NewWord's vocabulary." Our household has two Morrow MD3s that came bundled with NewWord 1.19 and NewWord 1.32; both include the R command, which I use frequently. In addition to formatting blank disks, running the program STATCOM allows maintenance of disk data.

Photo 1a in the review is clearly the introductory screen from a demonstration program, so perhaps the R function was deleted from the demo or perhaps the statement in the review pertains only to the MS-DOS/PC-DOS versions of NewWord (1.19 and 1.32 are CP/M versions).

ROBERT C. BROOKS  
Nashua, NH

### GENEVA PX-8

I have some comments on Rich Malloy's review of the Epson Geneva PX-8 lap com-

(continued)





# Better Waite

He's considered a heavy in the computer book market. Yet his writing style is light and informative. He's Mitch Waite.

Sams offers a wide variety of Waite books. We published Waite's first book in 1975. And we continue to add books to our Waite series every year.

From operating systems to programming, Sams Waite books make computing simple. They're easy-to-read and include various charts, diagrams, and command cards that guide you through each procedure step-by-step.

Better yet, Sams has four new Waite books covering today's most popular operating systems and printers. They're Waite's best books yet. And they'll help you learn the intricacies of computing better than ever!

There's never been a better time to buy Sams Waite books than now! Visit your local Sams dealer. Or call our toll-free number and ask for Operator 135.

*Modem Connections Bible*, No. 22446, \$24.95

*Inside Xenix™*, No. 22445, \$22.95

*UNIX™ System V Primer*, No. 22404, \$19.95

*Tricks of the UNIX Masters*, No. 22449, \$24.95

*CP/M® Primer (2nd Edition)*, No. 22170, \$16.95

*CP/M Bible: The Authoritative Reference Guide to CP/M*, No. 22015, \$19.95

*Soul of CP/M: How to use the Hidden Power of Your CP/M System*, No. 22030, \$19.95

*Al on the Mac*, No. 22447, \$21.95

*Advanced UNIX Assembly Programmers Guide*, No. 22403, \$18.95

*Using the IBM® PC LAN*, No. 22448, \$24.95



**800-428-SAMS**  
In Indiana, call 317-298-5566

**SAMS** Inquiry 312

Howard W. Sams & Co., Inc.  
4300 West 62nd Street  
Indianapolis, IN 46268

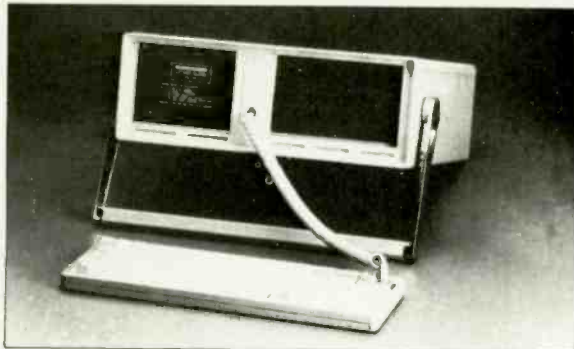

F3P APPLE II COMPATIBLE DESKTOP/PORTABLE COMPUTER  
 F3EP APPLE IIe COMPATIBLE DESKTOP/PORTABLE COMPUTER  
 F4P IBM XT COMPATIBLE DESKTOP/PORTABLE COMPUTER  
 F3P, F3EP, AND F4P MICROCOMPUTERS USE THE SAME DESK-  
 TOP/PORTABLE CASE AS SHOWN IN PICTURE

FOR MORE DETAILS OF ABOVE MICROCOMPUTERS AND OUR NEW  
 F8 APPLE/IBM KEYBOARD AND F9A HAYES 1200A COMPATIBLE  
 APPLE MODEM AND HAYES 1200B COMPATIBLE IBM PC/XT  
 MODEM PLEASE WRITE OR SEND TELEX

\* APPLE II APPLE IIe ARE REGISTERED TRADEMARKS OF APPLE COMPUTERS, INC.  
 \* IBM PC IBM XT ARE REGISTERED TRADEMARKS OF IBM CORP.  
 \* HAYES 1200A HAYES 1200B ARE REGISTERED TRADEMARKS OF HAYES  
 MICROCOMPUTER PRODUCTS, INC.

## DIGIFLEX COMPANY LTD.

BOX 4-4, NANKANG 4, TAIPEI, TAIWAN R.O.C. TELEX:14025  
 BELGIUM OFFICE TEL: (02) 428-5024 TELEX:65419

### HARD DISK DRIVE SETS AS LOW AS \$529!!! Other models available • Prices change rapidly • Please Call.



- 10 MB Set with Tandon Drive \$529
- 10 MB Set with Microscience Drive \$549
- 20 MB Set with Microscience Drive \$699

Includes top quality half height hard disk drive, Mitsuba hard disk drive controller, cables, full height cover plate, mounting screws, installation instructions. Full year warranty. You cannot beat the value & our low price.

#### Multifunction Board (OK) \$149

Includes one serial port, one parallel port, one game port, clock/calendar & 6 memory banks. Can add up to an additional 384 KB to your PC. Software included to perform set/get clock, RAM disk & printer spool.



130W Switching Power Supply \$109

Direct replacement for your IBM PC power supply. Fits inside your PC case. Four power plugs allow you to connect floppy & hard disk drives, tape backup systems, etc.

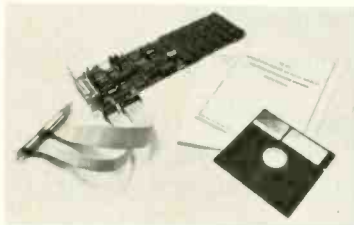

P.O. Box 571, Downers Grove, IL 60515

A Division of PACE Systems, Inc.

**Please call for FREE catalog and CURRENT LOW PRICES!**

1-800-548-8244 (Order Line) 312-810-0037 (Customer Service, Product Information & IL Orders)

Hours: Mon - Fri 8:30-5:30 Saturday 10-4

Check, moneyorder, Visa, MasterCard or American Express (include # & exp. date) \$2.50 shipping & handling in Continental U.S. (Alaska, Hawaii & foreign add 5%, min. \$5.00). Personal/company checks allow 2 weeks. Please add 2% for credit card use. Illinois residents add 6.25% sales tax. School & corporate P.O.'s welcome. Dealer inquiries invited. Prices subject to change.

## REVIEW FEEDBACK

puter (February, page 302).

The reviewer describes the connectors on the Epson as DIN connectors. However, the DIN connectors you can purchase in Radio Shack and from other sources are not compatible with these plugs. The usual DIN connectors are 1/2 inch in diameter; the Epson connector is something like 3/8 inch.

The review concludes that the PX-8 would make a good second computer. Most people with two computers want them to be able to talk to each other. The PX-8 comes with two programs, TERM and FILINK, for this purpose. TERM does not allow the transfer of binary files, only ASCII text files, and consequently isn't of much use; you can't transfer programs or WordStar text with TERM. Serious communication between your desktop computer and the PX-8 should be carried on through FILINK. If your first computer is an Epson QX-10, you have no problems since the QX-10 will talk to the Epson FILINK protocol. Everybody else is out of luck. In the vast documentation supplied with the PX-8, Epson neglected to describe the protocol used by FILINK. You can write or buy some other communications program, but this is counter-productive in a portable computer with extremely limited storage space.

The PX-8 comes with a version of WordStar. The review says: "The only features lacking are certain printing capabilities." The PX-8 WordStar will print only on an Epson or compatible printer. It's not a question of only being able to use fancy features with an Epson printer; the PX-8 WordStar appears to be deliberately configured to make its output impossible to use on any other printer.

Finally, the review commends the PX-8 documentation. In terms of user orientation, I agree. However, the PX-8 CP/M manual keeps referring to something called *PX-8 System Essentials* whenever a technical question arises. This document is not provided with the PX-8.

I cannot recommend the Geneva PX-8 to average users because, for the price, it has too many things wrong with it and not enough right.

GREGOR OWEN  
 Port Jefferson Station, NY

REVIEW FEEDBACK is a column of readers' letters. We welcome responses that support or challenge BYTE reviews. Send letters to Review Feedback, BYTE Publications, POB 372, Hancock, NH 03449. Name and address must be on all letters.

# Dac-easy accounting

# \$49.95

Introductory Price

*The software revolution of the year!*

*All 7 complete modules on 1 disk! Compare our features with other packages costing thousands more!*

## General

- Menu Driven •Fully Integrated
- MS-DOS & PC-DOS
- RUNS ON PCjr, PC, XT, AT, AND COMPATIBLES
- Password Protection In All Programs
- Slipcased Binder
- OVER 300 DIFFERENT REPORTS!!
- OVER 90 ROUTINES!!
- File Capacity Limited Only By Disk Space
- Service Contract Available
- ONLY \$49.95 FOR ALL 7 MODULES
- Money Back Guarantee

## General Ledger

- Double Entry •Unlimited # Of Accounts
- Multi-Level Accounting
- Unlimited Departments
- 3 Year Account History For CRT Inquiry
- Pencil & Pen Feature To Correct Mistakes Without Reverse Entries
- UNIQUE Budgeting Routine (See Forecasting)
- CRT Voucher Inquiry
- All Reports Compared to Last Year or Budget
- Unlimited Journals

## Accounts Receivable

- Open Item or Balance Forward
- 7 Customized Columns For Aging Report
- Unlimited # Of Customers
- Mailing Labels With 4 Different Sorts
- Automatic Finance Charges
- Supports Partial Payments •Directories
- 3 Year Customer History for # Of Invoices, Sales, Costs, And Profits
- Customized Text On Statements
- Cash Flow Analysis •Sales Analysis
- Automatic Sales Forecasting By Customer, Salesman, Or Customer Type

## Accounts Payable

- Check Printing •Automatic Allocation Of Available Cash To Payables
- Vendor Directories With Sorting By Vendor Code, Name, Or Territory
- Aging Reports With 7 Customized Columns
- Unlimited # Of Vendors
- Mailing Labels •3 Year Vendor History For CRT Inquiry And Printing
- Flexible Payment Calendar
- Automatic Forecasting of Purchases
- Unlimited Allocations Per Invoice
- Up To 10 Invoices Paid Per Check

## Inventory

- Supports Average, Last Purchase, And Standard Costing Methods •Physical Inventory
- Accepts Any Measure Units Per Case Like Fractions/Dozens/Gross/Etc
- Automatic Changing Of Costing Methods
- Time And Product Inventory
- 3 Year Product History In Units, Dollars, Cost, And Profits
- Automatic Forecast Of Product Sales
- Automatic Pricing Assignments
- Alert And Activity Reports With 11 Sorts
- CRT Shows On-Hand/On-Order/Committed/Sales/Cost/Profit/Turns/GROI

## Purchase Order

- Allows Up To 99 Lines Per Purchase Order
- Per Line Discount In %
- Purchase Order Accepts Generic Discounts/Freight/Taxes/Insurance
- Purchase Order Accepts Back Orders & Returns
- Purchase Journal
- Automatic Interfacing With General Ledger, Payables, And Inventory

## Billing

- Invoicing On Plain Or Pre-Printed Forms
- Prints Sales Journal
- Automatic Updating Of Committed Products In Inventory
- Ability To Customize Invoice For Remarks
- Allows Return Credit Memo

- Interfaces With Inventory, Accounts Receivable And General Ledger

## Forecasting

- Unique program that automatically forecasts using your 3 year history
- Forecast Revenue And Expense Accounts
- Forecast Vendor Purchases
- Forecast Customer Sales, Cost, And Profit By Customer Or Salesperson
- Forecast Inventory Item Usage By 4 Automatic Methods
- Forecast By Same As Last Year, Or % Base From Last Year, Or Trend, Or Least Square Trend Line Analysis Method

## NOT COPY-PROTECTED

### Minimum Hardware Requirements:

128K memory, one 5 1/4 DSDD floppy disk, 132 column printer in compressed mode, 80X24 CRT, MS-DOS, PC DOS 2.0 or later.

**Runs on your:** IBM (PCjr/PC/XT/AT), AT&T, EPSON, TANDY (1000/1200/2000), TI, COMPAQ, CORONA, SANYO, COLUMBIA, ETC. •

\* (Computer names are tradenames and/or trademarks of their respective manufacturers)

**To Order Call Toll Free:**

**1-800-431-0800**

**ASK FOR OPERATOR 17**

**For More Info Call:**

**(214)458-0038**

**30 Day Money-Back Guarantee:** Before you spend thousands of dollars on an accounting system, try dac-easy accounting, and if you are not fully satisfied, return it. For \$49.95 you owe it to yourself to find out that software doesn't have to be expensive to be the best.

**dac software, inc.** 5580 Peterson, Suite 130, Dallas, TX 75240

\$49.95 plus \$7.50 postage and handling Texas residents add 6 1/8 % sales tax (\$3.06) Credit card members can order by phone. Enclose check or money order with coupon. \$7.00 for C.O.D.

CHECK  MONEY ORDER  COD  VISA  MASTERCARD  AMEX

ACCOUNT NO. \_\_\_\_\_ EXPIRES \_\_\_\_\_

Name \_\_\_\_\_

Address \_\_\_\_\_

City \_\_\_\_\_ State \_\_\_\_\_ Zip \_\_\_\_\_

Phone \_\_\_\_\_ Signature \_\_\_\_\_ 17



# Get the best of both worlds: Price and Personalized Service!

## PC PROGRAMMERS CORNER

<b>Borland</b>	
Turbo Pascal.....	\$ 37
<b>CompuView</b>	
Vedit.....	\$130
Vedit+.....	179
<b>Digital Research</b>	
C Basic Camp (CB-86).....	\$339
CP/M-86.....	45
Concurrent CP/M w/ Windows.....	119
Concurrent DOS.....	179
Display Mgr.....	279
Fortran 77-DOS or CP/M.....	279
Personal Basic.....	99
<b>Emerging Technology</b>	
Edix (editor).....	\$139
<b>Heritage</b>	
Smartkey II+.....	\$ 75
<b>Microsoft</b>	
C Compiler.....	\$319
Pascal Comp.....	199
Basic Comp.....	249
<b>Morgan Computing</b>	
Prof Basic.....	\$ 79
Trace 86.....	99
<b>Peter Norton</b>	
Norton Util 3.0.....	\$ 59
<b>Supersoft</b>	
Fortran.....	\$209
<b>Lifeboat</b>	
Lattice Windows.....	\$209
Run-C.....	99
Dr Halo (Graphics).....	79
P Mate.....	159

## IBM/PC SOFTWARE

<b>Alpha Software</b>	
Data Base Mgr II.....	\$179
<b>Anderson Bell</b>	
Abstat.....	\$289
<b>Arrays, Inc.</b>	
Home Acct. +.....	\$ 90
<b>Ashton-Tate</b>	
dBase II.....	Call
dBase III (v. 1.1).....	Call
Framework (v. 1.1).....	Call
Friday.....	Call
<b>Central Point</b>	
Copy II PC.....	\$ 34
<b>CompuView</b>	
V-Print.....	\$ 99
V-Spell.....	99
<b>Connecticut Software</b>	
Printer Boss NEW v. 5 \$	99

<b>Dow Jones</b>	
Market Analyzer.....	\$229
Market Manager +.....	169
Spreadsheet Link.....	179
<b>Ecosoft, Inc.</b>	
Microstat.....	\$239
<b>Enertronics</b>	
Energraphics.....	\$219
w/ Plotter Option.....	279
<b>Fastware Thor.....</b>	\$245
<b>Financier, Inc.</b>	
Financier II.....	\$119
Tax Series.....	105
<b>Fox &amp; Geller</b>	
Grafox.....	\$159
dGraph.....	159
Quickcode (III or II).....	159
Quick Report.....	159
dUtil (III or II).....	58
<b>FYI</b>	
Superfile.....	\$139
FYI 3000.....	259
Sort Facility.....	99
<b>Harvard Software</b>	
Project Manager.....	\$249
Total Project Mgr.....	279
<b>Lifetree</b>	
Volkswriter Deluxe.....	\$155
Volkswriter Scientific.....	299
<b>Living Videotext</b>	
Think Tank (256K).....	\$119
<b>MDBS</b>	
Knowledge Man.....	\$275
<b>Menlo Corp.</b>	
In Search.....	\$319
<b>Micropro</b>	
Wordstar ProPak.....	\$255
Wordstar 2000.....	255
Wordstar 2000+.....	295
<b>Microrim</b>	
R-base 4000.....	\$265
R-base Clout (V 2.0).....	159
R-Writer.....	95
Prag Interface.....	259
<b>Microsoft</b>	
Flight Simulator.....	\$ 39
Project 1.01.....	169
Word 1.15.....	229
MuMath/MuSimp.....	179
<b>Microstuf</b>	
Crosstalk.....	\$ 99
<b>Multimate (V 3.3).....</b>	\$265
<b>Northwest Analytical</b>	
Statpak.....	\$329
<b>Open Systems</b>	
Acct'g Programs.....	\$379
<b>Peachtree</b>	
Acctg Modules.....	\$359
<b>Samna Corp.</b>	
Samna Word III.....	329
<b>Satellite Software</b>	
Word Perfect w/ Sp.....	\$229
<b>Sensible Designs</b>	
d Programmer.....	\$199
<b>Software Arts</b>	
TKI Solver.....	\$265

<b>Software Publishing</b>	
(PC Jr. Compatible)	
PFS: File, Graph	
Write, Plan.....	ea \$ 89
PFS: Report.....	79
PFS: Access, Proof.....	59
<b>Sorcim</b>	
Supercalc III.....	\$249
<b>Star Software Systems</b>	
Acct'g Partner.....	\$219
Acct'g Partner II.....	599
<b>Warner Software</b>	
(PC Jr. Compatible)	
Desk Organizer.....	\$129
<b>Westminster Software</b>	
Permaster.....	Call
... and many more!	

## MACINTOSH CORNER SOFTWARE

<b>Arrays, Inc.</b>	
Home Acct.....	\$ 69
<b>Creative Solutions</b>	
MacForth.....	\$ 99
MacForth II.....	169
<b>Human Edge Software</b>	
Sales, Mgmt	
Edge.....	ea \$159
Commun. Edge.....	139
<b>Infocom</b>	
Call	
<b>Living Videotext</b>	
Think Tank.....	\$ 89
<b>Microsoft</b>	
Basic Interp.....	\$ 99
Chart.....	79
File.....	139
Multiplan.....	139
Word.....	139
<b>Sierra On-Line</b>	
Frogger.....	\$ 32
<b>Software Publishing</b>	
PFS: File & Report Combo.....	\$119
<b>Telos Software</b>	
Television.....	\$109

## APPLE SOFTWARE

<b>Alpha Software</b>	
Apple-IBM Connection.....	\$169
<b>Arrays, Inc.</b>	
Home Acct.....	\$ 59
FCM.....	79
<b>Ashton-Tate</b>	
Call	

<b>Dow Jones</b>	
Market Analyzer.....	\$229
Market Manager.....	189
Spreadsheet Link.....	179
<b>Living Videotext</b>	
Think Tank.....	\$ 99
<b>Micropro</b>	
Pro Pak.....	\$349
<b>Microsoft</b>	
Call	
<b>Peachtree</b>	
Back to Basics.....	\$149
PeachPak Series 40 or 80.....	\$229
<b>Software Publishing</b>	
PFS: File, Graph, Report.....	ea \$ 79

## CP/M SOFTWARE

All prices below are for 8" standard.

<b>Ashton-Tate</b>	
dBase II.....	Call
<b>CompuView</b>	
Call	

<b>Digital Research</b>	
DR Assem & Tools 86.....	\$119
C Basic Camp (CB-80).....	289
SPP (86).....	149
Display Mgr 80.....	239
Display Mgr 86.....	279
Pascal MT+ 80.....	199
Pascal MT+ 86.....	349
PL/I 86.....	399
Access Mgr 86.....	239
Fortran 77 86.....	199
<b>Infocom</b>	
All Games.....	Call
<b>Micro Pro</b>	
WordStar.....	\$250
Pro-Pak (WS, MM, SI, SS).....	\$359
<b>Microsoft</b>	
Call	
<b>Microstuf</b>	
Crosstalk.....	\$ 99
<b>Northwest Analytical</b>	
Statpak.....	\$365
<b>Oasis</b>	
Word Plus.....	\$110
Punctuation & Style.....	99
<b>Supersoft</b>	
Disk Doctor.....	\$ 74

## PC SOFTWARE SPECIALS

<b>Enertronics — Energraphics</b>	
Interactive, 3-dimensional computer graphics tool.....	\$209
w/ Plotter option.....	269
<b>Microsoft — Fortran Compiler</b>	
Designed specifically for solving numerical problems. Widely used programming language for scientific and engineering applications.....	\$239
<b>MDBS — Knowledge Man</b>	
Integrated data mgmt, statistical analysis, spreadsheet, structured programming language pkg.....	\$269
Optional integrated components:	
K-Graph.....	135
K-Text.....	99
K-Point.....	59
K-Mouse.....	65
K-Report.....	135
<b>Spectrum Software — Micro-Cap</b>	
Microcomputer Circuit Analysis Program. A professional design tool created to enhance the productivity of electronics design by providing an interactive drawing and simulation system.....	\$359
Micro-Cap II.....	695
Micro Logic.....	345
Mathematics Series.....	45
<b>Wadsworth Professional Software — Statpro</b>	
Data Analysis Package. Enter, manipulate, transform, edit and graphically portray data and results.....	\$599
<b>Lifetree Software, Inc. — Volkswriter Scientific</b>	
Roman & Greek alphabets and all of the commonly used scientific and mathematical symbols and technical characters available for use. Multiple fonts and typesizes displayed on the screen exactly as they will print. Typeset oriented for excellent quality printing.....	\$279

Special prices in effect through July 31, 1985

## APPLE/ FRANKLIN BOARDS

ALS	
CP/M Card .....	\$269
Smarterm II.....	119
Z-Engine .....	139
CCS	
7711 Asynch Serial....	\$ 99
Microsoft	
Softcard +.....	\$449
Prem Softcard (IIE)....	295
Microtek	
Printer I/F.....	\$ 75
Dumpling-16K.....	169
Dumpling-GX.....	89
Orange Micro	
Grappler + .....	\$119
Prometheus	
Versocard.....	\$159
Videx	
Videoterm VT-602.....	\$249
Ulraterm .....	249

## DISPLAY CARDS

Fredericks/Plan-	
tronics Colorplus....	\$389
Hercules	
Graphics Board.....	\$339
Color Board.....	199
MA Systems	
PC Peacock	
Color Board.....	\$249
Paradise	
Modular/Display....	309
Quadram	
Quadcolor I.....	\$199
Quadcolor II.....	389
Tecmar	
Graphics Master....	\$479

## PLOTTERS

Amdtek	
DXY-100.....	\$599
Amplot II.....	899
Enter	
Sweet P Six Shooter... Call	
Houston Instruments Call	
Panasonic	
VP6801P Plotter.....	\$1375

## IBM/PC BOARDS

Memory Chips..... Call

AST Research	
Six Pak + 64K	
(exp 384K, S/P, Clk) ..	\$265
MegaPlus 64K, (Cl/Col,	
S Port, 512K cop	
w/ Megapak).....	\$269
Megapak 256K up-	
grade for Megapack. Call	
BYAD, Inc.....	Call
Maynard Electronics	
Floppy Drive Cntrlr....	\$119
w/ Par Port.....	169
w/ Ser Port.....	179
Sandstar .....	Call
Orange Micro	
Mr. Chips.....	Call
Orchid Technology	
"Orchid Blossom" .....	Call
Quadram	
Quadboard 64K, (exp	
384K, Clk/Col, S&P	
Ports, Software).....	\$269
Microfazer Stack Printer	
-P/P 8K (exp 512K) ....	\$139
-S/P 8K (exp 64K) .....	149
-S/S 8K (exp 64K) .....	149
Quadlink 64K Mem....	385
Other Products.....	Call
Tecmar	
Captain's Bd w/64K ...	\$299
1st Mate.....	259
2nd Mate.....	250
3rd Mate.....	379
Xedex/Microlog	
Baby Blue.....	\$325
Baby Blue II.....	525

## MONITORS

Amdtek	
300A Amber .....	\$149
310A .....	179
300 Clr .....	265
500 Clr RGB .....	385
600 Clr HR .....	455
700 Clr Ultra HR.....	535
NEC	
JB1260-12" Green ....	\$119
JC1216 RGB .....	429

PGS	
HX12 RGB Clr .....	\$489
MAX 12E .....	179
SR12 (690x480 Res) ...	639
Doubler Cord.....	175
Quadram	
Quadchrome .....	\$489
Quadchrome II.....	429
Amberchrome .....	175
Quadscreen HiRes.....	1449
Sanyo	
8112 12" HR Green....	\$169
Taxam	
440.....	\$679
420L.....	499
425 w/ audio .....	Call
Zenith	
135 (RGB or comp)....	\$499
136 .....	669
Others.....	Call

## MODEMS

Hayes	
Smartmodem 300.....	\$209
Smartmodem 1200 ....	429
Smartmodem 1200B... ..	369
Prometheus	
Promodem.....	\$399
Quadram	
Quadmodem .....	\$529
US Robotics	
Auto-Dial 300/1200 ...	\$459
S-100 Madem.....	349
Password.....	325
Zoom Telephonics	
Networker w/o SW ...	\$109

## DISK DRIVES

CDC 1800 .....	\$159
Corvus Hd.....	Call
Davong Hd .....	Call
I-Omega	
Bernoulli Box.....	Call

Maynard Electronics	
Maynstream: Port-	
able back-up for HD	
System 60 (incl	
1 cntrlr cd).....	\$1695

Mountain, Inc.	
FileSafe Combo	
Disk/Tape Pack for	
the IBM PC or XT.....	Call
Tall Grass	
For Wisconsin customers Call	
Tandon TM-100-2.....	Call

## PRINTERS

C. Itoh Electronics, Inc.	
Starwriter	
F10-40P (40cps) .....	\$999
A10-20S (20cps).....	529
Diablo	
630 ECS.....	Call
Epson .....	Call
NEC.....	Call
Okidata 82-93.....	Call
Quadram	
Quadjet.....	Call
Star Micronics.....	Call
Teletex T1014.....	\$399
...and much more.	

## DISKETTES

3M, Maxell, Verbatim	
Ultra Magnetics .....	Call

## MISC.

Alpha-Delta "MACC 8"	
Surge Protector .....	\$ 69

Computer Accessories	
Power Directors	
P2 Mtr Base .....	\$109
P12 IBM PC.....	145
P22 Stand Alone ..	75

Electronic	
Protection Devices	
Lemon / EC I.....	\$ 38
Lime / EC II .....	55
Orange / EC IV.....	75

Hauppauge	
8087 w/o software ....	\$149
8087 w/ software .....	255
80287 AT Chip w/o....	289
Other Products .....	Call
Kensington	
Masterpiece.....	\$109
Keytronic	
KB 5150.....	\$169
KB 5151.....	173
KB 5151 Dvorak.....	173
Mouse Systems	
PC Mouse.....	\$159
Touchtone Technology	
Touchtone II	
(PC Keypad).....	\$169
Versa Computing	
VersaWriter.....	\$239
WICO	
Joysticks (Ap).....	\$ 39

## PC Jr ACCESSORIES

Keytronic	
KB 5150 Jr.....	\$169
KB 5151 Jr.....	173
KB 5149 (Numeric	
Keypad).....	89
Legacy	
Legacy I .....	\$239
Legacy II.....	479
Quadram	
Quad Jr	
Exp Chassis .....	\$529
Quad Jr Exp Mem	
(for Chassis).....	\$219
Quadmem Jr 128K. Call	
Tecmar	
Jr. Captain	
(128K,C,P).....	\$319
Jr Wave (64K exp) .	259
Jr 2nd Mate	
(No Mem,C,P).....	129
Jr Cadet (64K exp	
for Jr Captain)....	169

For assistance in determining your needs use our technical line.\* We will be happy to provide full support.

This is only a sample of the nearly 10,000 products we carry. If you're interested in something not listed, PLEASE CALL!

### POLICY:

- ▶ Wisconsin residents add 5% for sales tax.
- ▶ Minimum \$4.00 for shipping, handling and insurance for orders to \$200.
- ▶ For orders over \$200, add 2 1/2% for shipping, handling and insurance.
- ▶ For cash prepayment of orders \$200 or more, add ONLY 2% for shipping, handling and insurance.
- ▶ Prices are subject to change without notice.
- ▶ All items subject to availability. BYAD 0785

### WE WELCOME:

- ▶ Visa, MasterCharge and American Express. (No charge for credit cards.)
- ▶ Corporate, government, educational or volume purchasers, please ask for special accounts desk for additional discount.
- ▶ COD (Add \$2.00 per box/parcel. Cash or certified check required.)
- ▶ Checks. (Allow 1-2 weeks for clearing.)

### INTERNATIONAL POLICY:

We welcome foreign orders. Shipping and handling charges per order are actual shipping costs plus \$50. international handling fee. Canadian orders — please call.

### WORKING HOURS:

Monday-Friday 8:30-6:00 • Saturday 10:00-2:00 • Central Time

Technical Support/Customer Service/Order Status: Call (715) 848-1374

Inquiry 267 for Hardware. Inquiry 268 for Software. Inquiry 269 for July Specials.

**ORYX SYSTEMS, INC.**  
CRAFTSMEN OF THE NEW TECHNOLOGY

**1 800 826-1589**

WITHIN WISCONSIN **1 800 472-3535**

INT'L TELEX: 260101 ORYX SYS WAU

425 First Street • P.O. Box 1961  
Wausau, Wisconsin 54401



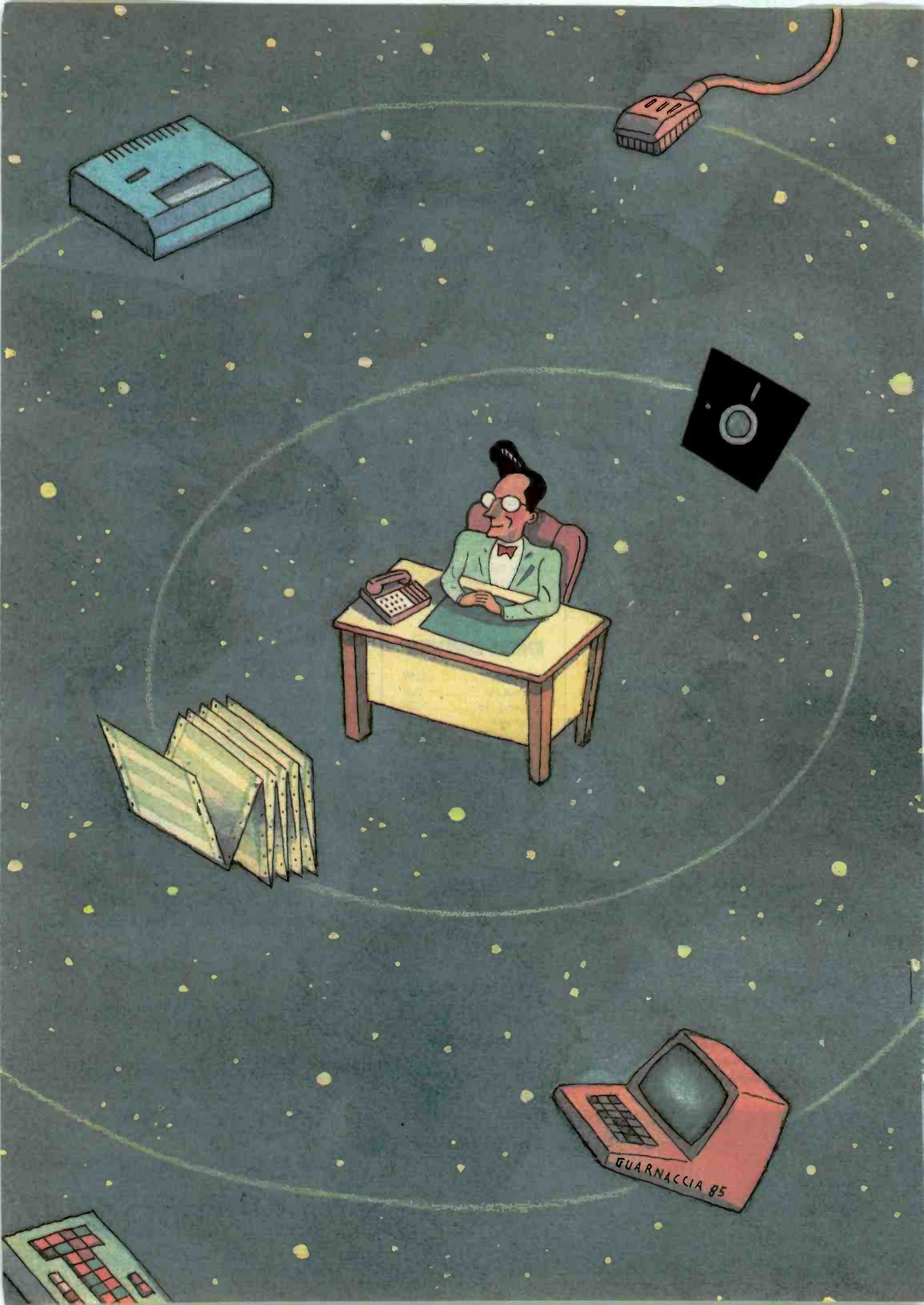

# Kernel

---

**COMPUTING AT CHAOS MANOR:  
COME TO THE FAIRE**  
*by Jerry Pournelle* ..... 309

**CHAOS MANOR MAIL**  
*conducted by Jerry Pournelle* ..... 338

**BYTE WEST COAST: SNOBOL AND ICON**  
*by Ezra Shapiro* ..... 341

**BYTE U. K.: STARLIT SPECTRUM**  
*by Dick Pountain* ..... 353

**BYTE JAPAN: PERIPHERALS,  
CHIPS, AND NEW COMPUTERS**  
*by William Raike* ..... 363

**ACCORDING TO WEBSTER: START-UP**  
*by Bruce Webster* ..... 367

**MATHEMATICAL RECREATIONS: PARSING  
AND SOLVING LINEAR EQUATIONS**  
*by Robert T. Kurosaka* ..... 385

**CIRCUIT CELLAR FEEDBACK**  
*conducted by Steve Ciarcia* ..... 391

**BYTE LINES**  
*conducted by Sol Libes* ..... 393

---

The renovation at Chaos Manor is nearing completion, but it was still chaotic enough for Jerry to spend much of his time on the road, making visits to the Stride Faire, Texas Instruments, and the MacFaire. At the Stride Faire he had a chance to meet Niklaus Wirth; at the MacFaire he discovered that the flood of software for the Macintosh has finally begun. In addition to his travels, he also spent some time answering readers' letters.

On the West Coast this month, Ezra Shapiro, BYTE's West Coast bureau chief, talked to Ralph Griswold about SNOBOL4 and his new language, Icon.

Dick Pountain reports from London on Andrew Hollis's Ormada Observatory in northern England and on the application of the Sinclair Spectrum microcomputer in measuring the brightness of celestial objects.

From Japan, Bill Raike reports on the Silver-Reed EB50, Fujitsu's new erasable optical-disc technology, the ongoing battle of memory chips in that country, and on two new personal computers.

This month sees the debut of a new column. According to Webster is another vehicle that will let us provide informed commentary on new products. This column, taken in conjunction with Computing at Chaos Manor, will help us better cover the many products that are appearing on the market. The author, Bruce Webster, knows the computer industry. His introductory column deals largely with Macintosh products.

In Mathematical Recreations, Bob Kurosaka presents a BASIC program that turns a system of equations into something a computer can deal with.

And finally, Steve Ciarcia provides a brief sampling, in Circuit Cellar Feedback, of the numerous letters he receives each month, and Sol Libes offers more news and speculation on the personal computing industry in BYTE LINES.

# THE PROGRAMMER'S SHOP™

helps save time, money and cut frustrations. Compare, evaluate, and find products.

## SERVICES

- Programmer's Referral List
- Compare Products
- Help find a Publisher
- Evaluation Literature free
- BULLETIN BOARD - 7 PM to 7 AM 617-826-4086
- Dealer's Inquire
- Newsletter
- Rush Order
- Over 700 products

## Free Literature - Compare Products

Evaluate products Compare competitors Learn about new alternatives One free call brings information on just about any programming need. Ask for any "Packet" or Addon Packet  ADA, Modula  AI  BASIC  C  COBOL  Editors  FORTH  FORTRAN  PASCAL  UNIX/PC or  Debuggers, Linkers, etc.

## RECENT DISCOVERIES

SMALL TALK for PC DOS - "Methods" has objects, windows, browser, inspector. PC DOS \$239

## ARTIFICIAL INTELLIGENCE

ExpertLISP - Interpreter: Common LISP syntax, lexical scoping, toolbox, graphics. Native code COMPILER. 512K MAC \$465

ExpertEASE - Expert system tool. Develop by describing examples of how you decide. PC DOS \$625

EXSYS - Expert System building tool. Full RAM, Probability, Why, serious, files PC DOS \$275

GC LISP - "COMMON LISP", Help, tutorial, co-routines, compiled functions, thorough. PC DOS Call

INSIGHT 1 - Expert Sys. Dev't, decent PC DOS \$ 95

M Prolog - full, rich, separate work spaces. MSDOS \$725

PROLOG-86 - Learn fast, Standard, tutorials, samples of Natural Language, Exp. Sys. MSDOS \$125

TLC LISP - "LISP-machine"-like, all RAM, classes, turtle graphics 8087. CP/M-86, MSDOS \$235

## EDITORS FOR PROGRAMMING

BRIEF Programmer's Editor - undo, windows, reconfigurable, macro programs, powerful. PC DOS \$195

VEDIT - well liked, macros, buffers, CPM-80-86, MSDOS, PC DOS \$119

## MACINTOSH

We evaluate, carry every available programmers product. Ask for a packet describing OVER 20 PRODUCTS

## C LANGUAGE

C Terp Interpreter by Gimbel, full K&R, .OBJ and ASM interface, 8087. MSDOS \$275

INSTANT C - Interactive development - Edit, Source Debug, run. Edit to Run - 3 Secs. MSDOS \$445

"INTRODUCING C" - Interactive C to learn fast. 500 page tutorial, examples, graphics. PC DOS \$ 95

MEGAMAX C - native Macintosh has fast compile, tight code, K&R, toolkit, .OBJ, DisASM MAC \$275

Wizard C - Lattice C compatible, full sys. III syntax, lint included, fast, lib. source. MSDOS \$450

## C ADDONS

APPLICATION TOOLKIT by Shaw - Complete: ISAM, Screen, Overlay mgmt, report gen, Strings, String-math. Source. CPM, MSDOS \$475

COMMUNICATIONS by Greenleaf (\$159) or Software horizons (\$139) includes Modem7, interrupts, etc. Source. Ask for Greenleaf demo.

C SHARP Realtime Toolkit - well supported, thorough, portable, objects, state sys. Source MANY \$600

C Index + - full B+Tree, variable length fields. Source, no royalties. MSDOS \$369

PC/LINT - Small, big model. Batch option. Lattice, C86 MSDOS \$ 95

## FORTRAN LANGUAGE

MacFORTRAN - full '77, '66 option, toolbox, debugger, 128K or 512K, ASM-out option MAC \$375

RM/Fortran - Full '77, BIG ARRAYS, 8087, optimize, back trace, debug. MSDOS \$525

Ask about Microsoft, Supersoft, others.

## OTHER LANGUAGES

ASSEMBLER - ask about FASM-86 (\$95), ED/ASM (\$95) - both are fast, compatible, or MASM (\$125), improvements.

BetterBASIC all RAM, modules, structure. BASICA-like PC DOS \$185

SNOBOL 4+ - great for strings, patterns. CPM86, MSDOS \$ 85

## SUPPORT PRODUCTS

BASIC DEVELOPMENT SYSTEM - (BDS) for BASICA; Adds Renum, crossref, compress. PC DOS \$115

CODESIFTER - Execution PRO-FILER. Spot bottlenecks. Symbolic, automatic. PC DOS \$109

FASTER C - Lattice users eliminate Link step. Normal 27 seconds. Faster C in 13 sec. MSDOS \$ 95

PLINK-86 for Overlays, most lang., segment control. MSDOS \$325

PS MAKE by Unipress - Interactive or batch. Full MAKE. MSDOS \$129

## "C" LANGUAGE

	OUR PRICE
MSDOS C86-8087, reliable	call
Instant C - Inter., fast, full	445
Lattice C - the standard	call
Microsoft C 3.0 - new	279
Williams - debugger, fast	call
Wizard C - full, fast	450
CPM80 - EcoPlus C - faster, SLR	275
BDS C - solid value	125
MACINTOSH: Hippo II	375
Megamax - optimizer, full	275
Consultair's MAC C, toolkit	395
Compare, evaluate, consider other Cs	

## BASIC

	RUNS DN
BASCOM-86 - MicroSoft	8086 279
CB-86 - DRI	CPM86 419
Data Manager-full source	MSDOS 325
CADSAM-Full Btree, source	MSDOS 150
InfoREPORTER-multitask	PC DOS 115
Prof. Basic-Inter., debug	PC DOS 89
SCREEN SCULPTOR	PC DOS 115
TRUE BASIC - ANSI	PC DOS 125

Ask about ISAM, other addons for BASIC

## SERVICE

ALL PRODUCTS - We carry 700 products for MSDOS, CP/M 86, CP/M 80. Macintosh and key products for other micros.

## EDITORS Programming

	OUR RUNS ON PRICE
BRIEF - Intuitive, flexible	PC DOS 195
C Screen with source	86/80 75
Epsilon - like EMACS	PC DOS 195
FINAL WORD-for manuals	86/80 215
PMATE - powerful	8086 185
VEDIT - full, liked	86/80 119
XTC - multitasking	PC DOS 95

## COBOL

Dig. Res-decent	MSDOS 525
Macintosh COBOL - Full	MAC 1850
MBP-Lev II, native, screen	MSDOS 885
Micro Focus Prof. - Full	PC DOS call
Microsoft - Lev II, no royal	MSDOS 500
Ryan McFarland - portable	MSDOS 695

Ask about program generators.

## LANGUAGE LIBRARIES

GRAPHICS: Halo for Turbo	PASCAL MSDOS 95
GRAPHMATIC - 3D, FTN, PAS	PC DOS 125
MultiHALO - fast, full-all lang.	PC DOS 220
File MGMT: BTree-all lang.	MSDOS 215
CIndex+ - source, no royal	86/80 369
CTree - source, no royal	ALL 369
DBC ISAM by Lattice	8086 229
dB VISTA - "Network" Structure	MSDOS 465
PHACT - up under UNIX, addons	MSDOS 225
OTHER: C Utilities by Essential	MSDOS 129
Greenleaf - 200+	MSDOS 159
SOFT Horizons - Blocks I	PC DOS 139
SCREEN: CURSES by Lattice	PC DOS 125
MetaWINDOW - icons, clip	PC DOS 139
PANEL - many lang. term	MSDOS 249
ProScreen - windows, source	PC DOS 415
Turbo V - Greenleaf C. fast	PC DOS 159
Windows for C	MSDOS 175

## FORTRAN

	OUR RUNS ON PRICE
MS FORTRAN-86 - Impr.	MSDOS 239
DR Fortran-86 - full '77	8086 249
PolyFORTRAN-XREF, Xtract	PC DOS 165

## OTHER PRODUCTS

Advanced Trace 86 - Symbolic	PC DOS 149
Assembler & Tools - DRI	8086 159
Atron Debugger for Lattice	PC DOS 395
C Helper: DIFF, xref, more	86/80 135
CODESMITH-86 - debug	PC DOS 129
MacASM - full, fast, tools	MAC 115
MBP Cobol-86 - fast	8086 885
MicroProlog - improved	MSDOS 185
Micro: SubMATH - FORTRAN full	86/80 250
Microsoft MASM-86	MSDOS 125
Multilink - Multitasking	PC DOS 265
PC FORTH - well liked	MSDOS 219
Profile by routine	MSDOS 345
PFIX-86 Debugger	MSDOS 169
PL1-86	8086 495
Polylibrarian - thorough	MSDOS 95
PolyMAKE	PC DOS 95
TRACE86 debugger ASM	MSDOS 115
ZAP Communications-VT100, TEK 4010, full xter	PC DOS 65

Note: All prices subject to change without notice. Mention this ad. Some prices are specials. Ask about COD and P.O.s. All formats available. UNIX is a trademark of Bell Labs.

Call for a catalog, literature, and solid value

# 800-421-8006

## THE PROGRAMMER'S SHOP™

128-B Rockland Street, Hanover, MA 02339  
 Visa Mass 800-442-8070 or 617-826-7531 MasterCard 8517



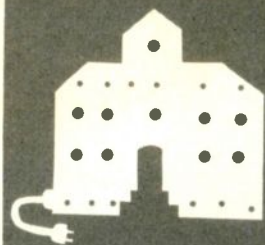

# C·O·M·P·U·T·I·N·G A·T C·H·A·O·S M·A·N·O·R

## Come to the Faire

The Stride Faire

Niklaus Wirth

Micro Modula-2

The Nod

ScenicWriter

Lilith CAD System

The MacFaire

MegaMac

Mac Software Galore

BY JERRY POURNELLE

I've just been upstairs to look at my new office suite. The floors are still bare plywood, the electricity isn't hooked up, and the windows haven't been installed; but the walls are up, the ceiling beams are in, and I can see what it's going to look like. It's magnificent. Of course, it's not done. Half the house is folded into the other half, I'm still crammed into the living room, and everything I own is in boxes. One more month. Sigh.

Fortunately, I was able to spend a good part of my time away from home. While the contractors drove our housekeeper, my staff, and my wife nearly out of their minds, I was able to get to the Stride Faire, visit Texas Instruments in both Dallas and Austin, and go to the MacFaire in San Francisco. Clever, no?

### STRIDE FAIRE

I still think of it as the Sage Faire, but they can call it anything they want to: it's one of my favorite computer shows, and this year there was a special treat. Thanks to Stride Micro I got to have lunch with Niklaus Wirth of the Swiss Federal Institute of Technology in Zurich, one of the genuine heroes of the computer revolution. I'm not usually at a loss for words, but when he told me he reads these columns I think I actually stammered a bit.

In my judgment, Stride Micro is still the leading outfit developing low-cost usable micro systems based on the Motorola 68000 chip family.

I now have a problem: longtime readers know what I mean by "chip family." Newer readers won't, and why should they? I'll take a moment to explain.

Chip family: the micro is built around the "computer on a chip." At the heart of any micro is a single chip called the central processing unit (CPU). There are four main families of microcomputer chips: the 8088, 8086, 80186, 80286 family from the Intel Corporation used in PClones and upgrades; the Motorola 6500, 68000, 68010, 68020

family used in Apple and Stride computers, etc.; National Semiconductor's 32016 and 32032 family which has yet to be adopted by a major manufacturer; and the Zilog Z80, which dominated the 8-bit market (I'm writing this on Zeke II, a CompuPro Z80) but whose upgrade, Z8000, has yet to catch on.

Now back to the 68000 family. Stride continues to stay on top of new developments in computer hardware. The new Stride machines are built around the VME bus and are designed with upgrades in mind; when superchips such as the 68020 and beyond become common, Stride will be right there.

Stride does have a rival, Pinnacle Systems. So far I haven't seen any Pinnacle equipment, but people I trust, including Carl Helmers, have been impressed. One day perhaps I'll do some comparisons; meanwhile, the 68000 machines get more useful and more powerful all the time. Now that 256K-byte chips are available in quantities, even the smallest Stride can have 2 megabytes of memory and can run at 12 megahertz. That's fast.

### QUO VADIMUS?

The mainstream of the micro community still looks as if it's flowing from Intel and the 8086 family. IBM certainly thinks that's the mainstream.

Then there's National Semiconductor with the 32016 (which used to be known as the 16032 and don't ask me why National changed the name); a lot of knowledgeable enthusiasts, including Dr. William Godbout, are highly impressed with its architecture.

A lot of top people ignore the Motorola 68000 family. Even so, it always happens: when I get among enthusiasts for the Motorola 68000 chip, and especially when I get around Stride Micro's president, Rod Coleman, I begin to wonder. Add Jack Brown, Motorola engineer and product manager, and the enthusiasm is catching.

According to Brown, the 68000 is the best thing in general use, while its follow-on

(continued)

*Jerry Pournelle holds a doctorate in psychology and is a science-fiction writer who also earns a comfortable living writing about computers present and future.*

ARC X turbo Board™  
40% Faster Than XT, 640K On Board

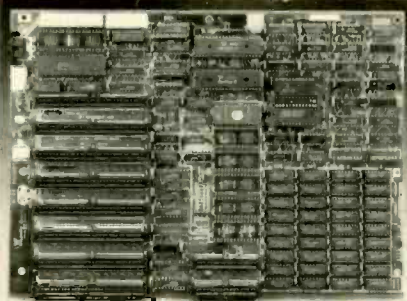

## CC&C Had it All !!

The Ultimate in Add-On's for  
your PC, Fully Comptible

- 7 Plus**            Multifunction Card, 2 Serial, 1 Parallel Port, 4 Floppy Drives, Clock/Calendar, Game Port
- 8 Plus**            Multifunction Card, (OK-384k)
- LDA-1440**        High Resolution Letter Quality Monochrome Adapter
- MGC-720i**        Monochrome Graphic Card Hercules Type, 1-2-3 Compatible
- CGC-640i**        Color Graphic Card
- MSC-I**            Computer Case Standard Size Heavy Duty Steel
- MSC-III**         Computer Case excellent for ARC X turbo Board, 2 L.E.D. Indicator
- IPS-135**         135 Watt Switching Power Supply
- IPS-200**         200 Watt Switching Power Supply
- PBC-064i**        Printer Buffer Card 64K No software required
- FDC-500i**        Floppy Disk Control Card, Up to 4 Drives
- Hard Disk**       10 MG Byte Microscience or 20 MG Byte Microscience With Control Card
- Keyboard**       5151 Compatible 5150 Compatible
- Panasonic Floppy Drive**    Half Height Floppy Disk Drive, \$105

Quality Enhancement to Rely On

### CALIFORNIA COMPUTER & COMPONENT, INC.

2001 W. CHESTNUT STREET  
ALHAMBRA, CA 91803

Dealer, OEM Inquires Welcome  
Call (818)-576-1621

X turbo Board is the trademark of ARC.  
IBM PC/XT are registered trademarks of IBM Corp.

## CHAOS MANOR

68020 is a better chip "than anything out there." In fact, the 68020 is faster than available memory, although that's changing rapidly. Machines using the 68020 can economically put the equivalent of a VAX at every workstation. Brown says Motorola will ship 75,000 of the 68020 chips this year.

Of course, the 68020 will become cheaper, just as all chips do. Brown put it this way: "If GM could do what we in the semiconductor industry can do, a Cadillac today would cost less than a thousand dollars. It would also be about a foot long . . ."

The 68020 is very much upward-compatible with the 68000, and all 68000 programs ought to run in 68020 machines without problems.

As I listened to different speakers tell of the virtues of the 68000 series, I kept wondering: Why isn't this the mainstream? Why hasn't the chip caught on better in the micro community?

### THERE'S THE RUB

I suppose the big problem with the 68000 family has been the operating system. The only popular one is the Lisa/Macintosh system developed by the folks at Apple, and not only are they not interested in standardization, they seem to fight it. Apple wants to sell Apple hardware. It's a policy that helps IBM more than Apple, but I don't expect the Apple strategists to understand that. More on the Macintosh when I get to the MacFaire.

There was also the Fortune-32 system using UNIX. That never caught on. Meanwhile, the Sage—introduced at the same West Coast Computer Faire as the Fortune-32—came out with SofTech's p-System as its major operating system. This tied Sage/Stride to a company whose marketing philosophy seemed to me a combination of the worst features from Apple and AT&T: arrogance, indifference to customer complaints, and total unwillingness to make any changes. SofTech's attitude seemed to be "We have this wonderful product, and if you're too stupid to realize just how wonderful it is, then you don't deserve to use it."

Understand, there was much to like about the p-System. It was too slow, but at first that wasn't much of a problem because the 68000 chip was so fast. Later, though, rival hardware got faster, but the p-System didn't. Indeed, as the rest of the micro world raced ahead, the p-System didn't. Meanwhile, Digital Research didn't do any better with CP/M-68000. I confess I had thought Digital would develop CP/M-68K into a new standard compatible with CP/M-86, after which CP/M would move forward to dominate the 16-bit world as thoroughly as CP/M-80 dominated the 8-bit micro universe. Boy, was I ever wrong.

There were a few other rather interesting operating systems, such as the British-developed Metacomco system, but none of them really caught on. Like it or not, the Sage's destiny was intertwined with the UCSD p-System.

Things may be different now. First, SofTech has reorganized, and the SofTech people assure me they've had a great change of heart. "We know we acted strangely," one of their reps told me at the Stride Faire. "It really is a good system, though, and we're working to make it better. We're working with the users groups, and we're open to suggestions from anyone." They've improved their relations with USUS, the p-System users group. Another visible sign of their change of attitude happened three days ago: an enormous box of SofTech products arrived at Chaos Manor. In the past, they not only wouldn't send review copies, they didn't even answer their mail.

Second, SofTech's p-System doesn't have to stand alone. Modula-2 has arrived.

### VIOLATIONS AND VOLITIONS

I first got interested in Modula-2 through the enthusiasm of Rod Coleman, and my first experiences with the language were on the Sage II. Naturally it ran under p-code. The Modula-2 implementation was developed by Volition Systems of San Diego. This was a typical start-up company with a small staff and little capi-

(continued)



# THE PERSONAL CHOICE OF ALL IBM COMPATIBLES

Facit 4509 has all the benefits of the standard IBM PC printer. And more.

*What benefits?*

Different fonts, bold, underline, pin graphics, etc. With a print quality that can either be medium resolution one-pass or higher resolution two-pass (vertical bold).

All the features provided by the IBM/Epson and Epson RX80 command sets. But with a higher throughput.

*How high?*

60 full 80-character lines per minute. With lasting print quality.

*For how long?*

The printhead lasts over 100,000,000 characters. This equals several years of

normal use. The ribbon life is also very long. It's good for over 4,000,000 characters. Part of our reliability plan.

*What reliability plan?*

Like all Facit printers, every 4509 is subjected to rigorous pre-delivery tests and quality control. Pound for pound, we use more metal in our designs than other makes. This is true for every PC printer in the Facit family.

*What Facit family?*

A family of PC printers that meets your requirements. Whatever they may be. At highly competitive prices.

*How competitive?*

Find out from your nearest Facit representative.

**Printer  
Perfect** 

**FACIT**

Inquiry 147

\*IBM is a trademark of International Business Machines Corporation.

Head Office: Facit AB, S-172 91 Sundbyberg, Sweden. Phone: (8) 764 30 00. USA: Facit Inc. P.O. Box 334, Merrimack, NH 03054. Phone: (603) 424-8000

AUSTRALIA: EAI Electronics Associates Pty Ltd., 427-3322. AUSTRIA: Ericsson Information Systems GmbH, 0222-613641. BELGIUM: Ericsson S.A., 02-2438211. CANADA: Facit Canada Inc., 416-821-9400. CYPRUS: LBM (Lillytos) Ltd 5164634. DENMARK: Facit A/S, 02-922400. FINLAND: OY Facit, 90-42021. FRANCE: Facit S.A., 1-7807117. GREAT BRITAIN: Facit, 0634-401721. GREECE: Computer Application Co., Ltd., 01-6719722. HONGKONG: Gilman & Co. Ltd., 5-7909555. ICELAND: Gisli J. Johnsen HF, 354-1731 11. INDIA: Forbes Forbes Campbell & Co. Ltd., 22-268081. IRELAND: Memory Ireland Computers Ltd., 1-989733. ITALY: Facit Data Products S.p.A., 039-636331. JAPAN: Electrolux (Japan) Ltd., 03-479-3411. THE NETHERLANDS: Ericsson Information Systems B.V., 03480-709 11. NEW ZEALAND: McLean Information Technology Ltd., 501-801, 501-219. NORWAY: Ericsson Information Systems A/S, 02-355820. PORTUGAL: Regisconta Sarl, 1-560091. SINGAPORE: Far East Office Eqpts Pte Ltd., 7458288. SPAIN: Facit, 91-45711 11. SWEDEN: Ericsson Information Systems Sverige AB, 08-282860. SWITZERLAND: Ericsson Information Systems AG, 01-39197 11. USA: Facit Inc., 603-424-8000. WEST GERMANY: Ericsson Information Systems GmbH, 0211-61090.

# Program Editing with

# BRIEF™

is More Productive and Less Frustrating because it will work YOUR way, and BRIEF elegantly integrates:

- A high-level, readable **Macro Programming Language** - allows full parsing or syntax analysis. . . . Complete, unlimited variables, etc.
- Edit **multiple** files of **unlimited size** (2 Meg is OK)
- Multiple **Windows** on screen with different or same file, fragments, etc.
- A bona-fide **UNDO** stack (up to 300) of **all operations**: deletions, reading files, search, translate, more
- Full "**regular expression search**" - wild cards, complex patterns
- A completely **reconfigurable keyboard**
- **Keystroke macros** - for common typing sequences
- Suspend BRIEF to execute, **exit to DOS** - run another program (like a compiler, dir, XREF, DIFF, or DEBUG) then resume BRIEF session
- **Compiler-specific** support like auto indent, syntax check, compile within BRIEF

AVAILABILITY: PC DOS, AT, & Compatibles ONLY \$195  
Full refund if not satisfied in 30 days

**Solution  
Systems™**

335-B Washington St., Norwell, MA 02061  
617-659-1571

CALL 800-821-2492

## CHAOS MANOR

tal; everyone worked in hopes of developing a best-selling product. It was likely that they'd do that. They were sharp troops, and many of Volition's people came from the University of California at San Diego and had thus worked on UCSD Pascal, from which grew the UCSD p-code that later became SofTech's p-code.

The best introduction to Modula-2 I've yet encountered was the Volition Modula-2 documentation. That was written by Richard Gleaves (generally called Glitch) and has since been published by Springer-Verlag. Alas, it isn't a beginner's book; it assumes you know something about programming in general and Pascal in particular. However, if you like Pascal, get Glitch's book; it will probably make a Modula-2 convert of you, and at the least it will show how easily Pascal programmers can learn Modula-2.

After Volition's people developed the p-System's Modula-2 compiler, they set to work on a native-code compiler for the 68000 chip. This was a product sorely needed, and the first company to bring out a reasonably bug-free compiler would get big sales. They might not do quite as well as Borland International did selling Turbo Pascal, but the potential market was large and growing.

Alas, Volition didn't focus its effort. Moreover, as often happens in small start-up companies, personality conflicts developed. Some of the original founders went away to work elsewhere. They retained ownership rights and promises that when Volition struck it rich they'd be paid for back salaries owed. Meanwhile, those who remained to work on the compiler were working for little to no pay.

This went on far too long. When the compiler was not quite finished, things came apart. Tensions had already developed between those who had left and those who stayed behind. Once the compiler was in sight, the tensions worsened. Reorganizations were announced. Proxy fights developed. The management team changed. Equipment was sold off. Volition went from healthy to

(continued)

# PROLOG-86™

## Become Familiar in One Evening

Thorough tutorials are designed to help learn the PROLOG language quickly. The interactive PROLOG-86 Interpreter gives immediate feedback. In a few hours you will begin to feel comfortable with it. In a few days you are likely to know enough to modify some of the more sophisticated sample programs.

### Sample Programs are Included like:

- an **EXPERT SYSTEM**
- a **NATURAL LANGUAGE INTERFACE**  
(it generates a dBASEII "DISPLAY" command)
- a **GAME** (It takes less than 1 page of PROLOG-86)

### PROTOTYPE Ideas and Applications QUICKLY

1 or 2 pages of PROLOG is often equivalent to 10 or 15 pages in "C" or PASCAL. It is a different way of thinking.

Describe the **FACTS** and **RULES** without concern for what the computer will have to do. Maybe you will rewrite in another programming language when you are done.

**Programming Experience is not required** but a logical mind is. PROLOG-86 supports the de facto **STANDARD** — in "Programming in Prolog" by Clocksin & Mellish.

**AVAILABILITY:** PROLOG-86 runs on MSDOS, PC DOS or CPM-86 machines. We provide most formats. The price of PROLOG-86 is **only \$125.**

**Only  
\$125.**

Full refund if not  
satisfied during  
first 30 days.

**Solution  
Systems™**

335-B Washington St.,  
Norwell, Mass. 02061  
617-659-1571  
800-821-2492

A man with glasses and a beard, wearing a white shirt and a red and white striped tie, is leaning over a light table. He is working on a large, complex printed circuit board (PCB) that is illuminated from below. Several other PCBs are scattered on the table. A soldering iron is visible in the background. The man has a name tag that says "Dennis BRUCE".

Telecommunications Engineers

# HAYES... Leading A Telecommunications Revolution From Atlanta and San Francisco.

We've built a powerful engineering and technical team here at Hayes. It's been our strength and the reason for our success from the very beginning. Our focus has been on recruiting and developing the talent it takes to do more than merely compete, but to lead. The result has been a success story few in the industry can equal.

For those of you who have searched far and wide for just such an environment, where talent is provided the freedom and encouragement to grow, then perhaps it's time to take a good, hard look at Hayes, with opportunities in both San Francisco and Atlanta. There's a future in it.

- VLSI/DSP DEVELOPMENT ENGINEERS
- HARDWARE/SOFTWARE DESIGN ENGINEERS
- SOFTWARE PROGRAMMERS & ANALYSTS
- MANUFACTURING/TEST ENGINEERS
- PRODUCT DEVELOPMENT ENGINEERS
- QUALITY/RELIABILITY ENGINEERS

Interested, qualified candidates should forward a confidential resume to: Hayes Microcomputer Products, Inc., Dept. 92-164, P.O. Box 105203, Atlanta, GA 30348 An Equal Opportunity Employer, M/F.

**Hayes**<sup>®</sup>  
Innovative products  
for enterprising people

# Who Knows What Evil Lurks In The Lines Of Power?

Saham Wilson

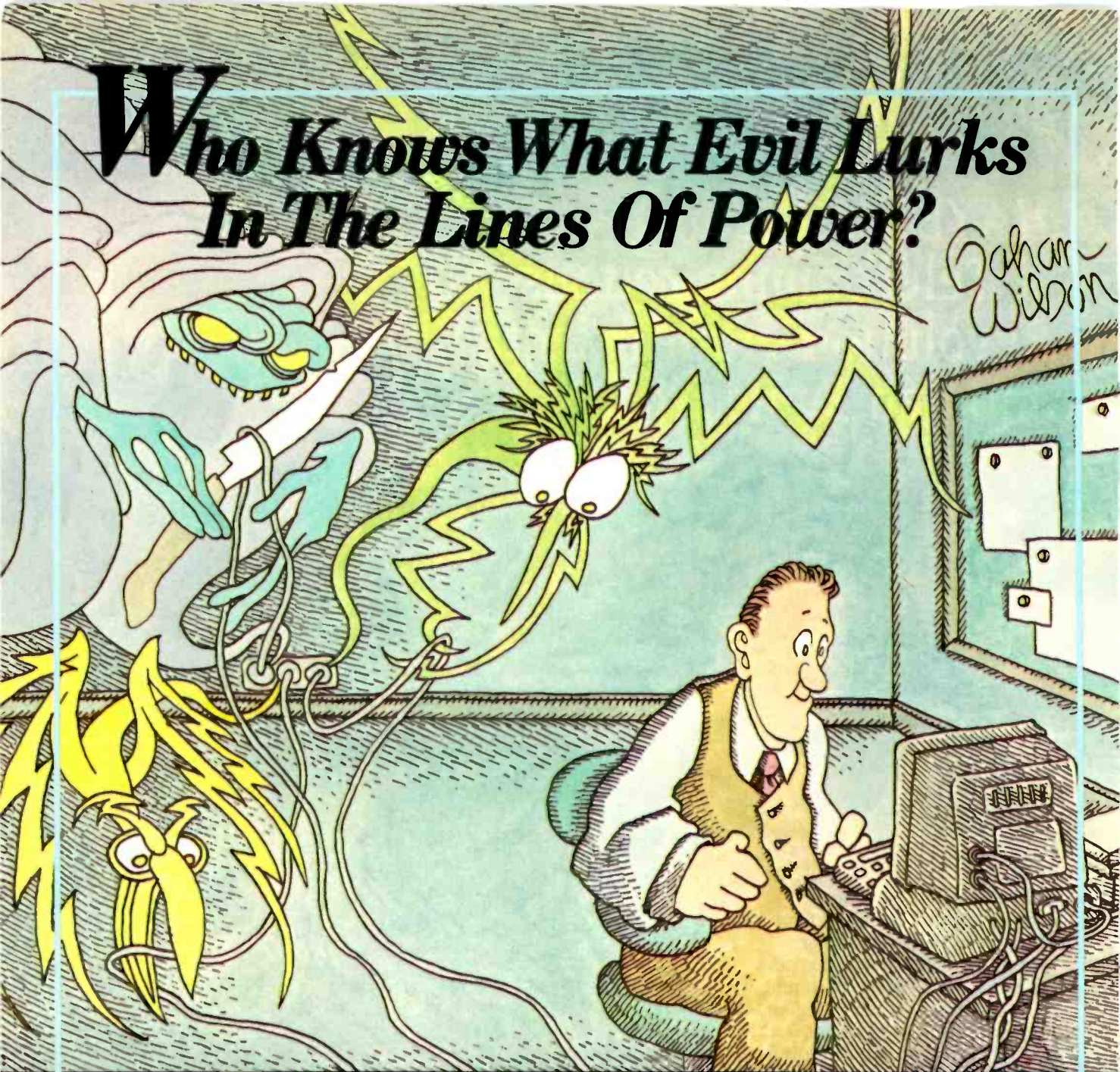

## **DynaTech Knows.**

This humorous illustration is no comfort to those who have experienced the frustration of losing hours of programming and data entry due to a power outage or surge. In addition to the inconvenience, such occurrences can mean lost programs and perhaps an expensive component destroyed.

DynaTech boasts 25 years of engineering experience in power and data line interference problems. We are one of the largest manufacturers of products solving these problems—and, without question, the engineering trendsetter in the industry.

The latest DynaTech trendsetter is our PowerHouse™ line of standby power supplies. Available in 300- and 500-watt models, PowerHouse protects your computer in two ways. First, should power fail, you instantaneously get clean, regulated power to your system, allowing for an orderly shutdown. Second, while on commercial power, our SurgeSentry™ circuitry protects your system from surges and other hazards.

To learn more about PowerHouse and other fine DynaTech products, call one of the dealers listed here or call us toll free for one near you: (800) 638-9098.



**DynaTech**  
Computer Power Inc.

4865 Scotts Valley Drive, Scotts Valley, CA 95066

# Dynatech Dealers

STATE	CITY	STORE NAME	PHONE
ALABAMA	DECATUR	SEQUENTIAL SYSTEMS/COMPUTER COTTAGE	205/355-4583
ALASKA	ANCHORAGE	ALASKA MICROSYSTEMS	907/562-3900
	NOME	GOLD RUSH BUSINESS & ELECTRONIC EQUIPT.	907/443-5111
ARIZONA	PHOENIX	STEWART TECHNOLOGIES	602/274-0124
	SCOTTSDALE	DAYZ SYSTEMS INC.	602/990-7276
ARKANSAS	LITTLE ROCK	ENTRE COMPUTER CENTER	501/224-7770
CALIFORNIA	CULVER CITY	ELECTRONIC TRADING POST	213/391-6763
	EL CAJON	COMPUTER KONTROL	619/448-9240
	HUNTINGTON BEACH	WEH COMPUTERS	714/969-2225
	LAWNDALE	STRICTLY SOFTWARE	213/970-1242
	MILL VALLEY	COMPUTERTIME	415/383-8800
	RIVERSIDE	COMPUTER KINGDOM	714/787-1142
	SAN DIEGO	ALLEN MICROCOMPUTER SERVICES	619/450-0810
	SAN FRANCISCO	COMPUTERTIME	415/397-6776
	SAN FRANCISCO	EXPRESS COMPUTER SUPPLIES	415/864-3026
	SAN RAFAEL	COMPUTERTIME	415/459-8080
	SCOTT'S VALLEY	PC LAND	408/438-5971
	VENTURA	ENTRE COMPUTER CENTER	805/658-0355
COLORADO	ENGLEWOOD	DATA SPECIALTIES	303/761-5763
FLORIDA	ORLANDO	G.M.I. DISTRIBUTORS	305/894-3354
GEORGIA	CLARKSTON	PEACHTREE MICROSYSTEMS	404/292-8050
HAWAII	AIEA	PEARL CITY COMPUTERS	808/486-4848
	HILO	THE COMPUTER STORE	808/969-1166
ILLINOIS	GRANITE CITY	METRO CONNECTION	618/797-6640
	PEKIN	ILLINOIS VALLEY COMPUTER	309/346-5181
	SCHAUMBURG	DIEHL OFFICE PRODUCTS	312/885-0008
INDIANA	FORT WAYNE	COMPUTER CORNER	219/493-6505
	INDIANAPOLIS	HEALTH CARE SYSTEMS INC.	317/844-5960
	SOUTH BEND	COMPUTER ASSOCIATES	219/232-7921
IOWA	DES MOINES	COMPUTER EMPORIUM	515/224-1992
	DES MOINES	THE COMPUTER SUPPLY STORE	515/288-6668
	WATERLOO	DHEIN'S TRUE VALUE	319/236-3861
KANSAS	ELLINWOOD	GENESYS SYSTEMS	316/564-3636
	LENEXA	MIDWEST COMPUTER ASSOCIATES	913/541-0001
KENTUCKY	BOWLING GREEN	COMPUTER MARKET	502/782-9466
	LOUISVILLE	COMPUTER EMPORIUM	502/589-1258
MAINE	PORTLAND	ENTRE COMPUTER CENTER	207/772-3622
MASSACHUSETTS	FITCHBURG	HYLAND/RICE SYSTEMS	617/342-9707
	NORTHBORO	MAIN STREET COMPUTERS	617/393-3151
MICHIGAN	FREMONT	POS ELECTRONIC BUSINESS SYSTEMS	616/924-0310
	GRAND BLANC	COMPUTER CONTACT	313/694-3740
	GRAND RAPIDS	ADVANCED INFORMATION SYSTEMS	616/243-1312
	WARREN	COMMAND COMPUTER SYSTEMS INC.	313/573-8130
MINNESOTA	MINNEAPOLIS	ON LINE INTERNATIONAL	612/888-4444
	MINNEAPOLIS	UNITED ELECTRIC	612/338-1915
MISSOURI	KANSAS CITY	TOTAL SOFTWARE INC.	816/891-6512
MONTANA	HELENA	MSD COMPUTER SUPPLY	800/752-3752
NEVADA	LAS VEGAS	AMERICAN OFFICE EQUIPMENT	702/737-1510
	LAS VEGAS	COYOTE PRODUCTS	702/870-4138
	RENO	HARRY'S BUSINESS MACHINES	702/322-4559
NEW JERSEY	ENGLISHTOWN	CMI (COMPUTER MADNESS)	201/467-9696
	HACKENSACK	MICROMED	201/487-0919
NEW MEXICO	ALBUQUERQUE	OMEGA BUSINESS PRODUCTS	505/883-4545
NORTH CAROLINA	ASHEVILLE	COMPUTER AID/MICRO MASTERS	704/658-2795
	WILMINGTON	COMPUTER E'S	919/799-0327
OHIO	CHILLICOTHE	THE CHILLICOTHE COMPUTER STORE	614/774-6565
	COLUMBUS	ON LINE COMPUTER CENTER	614/895-7747
	DAYTON	THE BLUE CHIP COMPUTER	513/299-4594
	GREENVILLE	HOWELL'S COMPUTER CENTER	513/548-3326
	LIMA	LIMA BUSINESS MACHINES	419/224-3746
	SANDUSKY	DATA DIMENSIONS INC.	419/625-2232
OKLAHOMA	ADA	ADA TYPEWRITER SUPPLY	405/332-5588
	KAW CITY	PROCESS INC.	405/269-2552
	MUSKOGEE	DIGITAL COMPUTER SYSTEMS	918/687-3161
	OKLAHOMA CITY	COMPUTER SOFTWARE CENTER	405/632-6007
	PIEDMONT	COMCON SYSTEMS INC.	405/373-3210
OREGON	CORVALLIS	OSU BOOKSTORE INC.	503/754-4323
PENNSYLVANIA	EBENSBURG	INFOCON CORPORATION	814/472-6066
	FT. WASHINGTON	SAFEGUARD BUSINESS SYSTEMS, INC.	800/528-7100
	FT. WASHINGTON	SAFEGUARD BUSINESS SYSTEMS, INC.	800/528-7300
	KULPSVILLE	COMPUTERS FOR THE PROFESSIONAL	215/362-1888
SOUTH DAKOTA	HOWARD	RESEARCH DATA SYSTEMS	605/772-5229
TENNESSEE	CHATTANOOGA	COMPUTER CONNECTION	615/892-3253
	MEMPHIS	MICROAGE COMPUTER STORE	901/722-8280
	NASHVILLE	COMPUTER SHOPPE	615/366-3810
TEXAS	DALLAS	MP SYSTEMS	214/385-8885
	DENTON	RADIO SHACK ASSOCIATES	817/383-2631
	DUMAS	THE UNLAUB COMPANY OF TEXAS	806/935-7492
	FT. WORTH	GEORGE DOWLING ASSOCIATES	817/654-5404
	HOUSTON	SOUTHWEST COMPUTER SUPPLIES	713/890-1025
	HOUSTON	TYNER AND ASSOCIATES	713/988-8560
	HURST	TAYLOR COMPUTER PRODUCTS	817/284-5251
	McALLEN	ADVANCED SYSTEM TECHNIQUES	512/682-2372
	MONCHACA	RESPONSE TECHNOLOGY INC.	512/280-1183
	ODESSA	THE COMPUTER DIVISION OF I.C.I.	915/563-1108
	PARIS	BUSINESS SYSTEMS	214/785-0041
	SAN ANGELO	DI SYSTEMS	915/949-9922
	SAN ANTONIO	COMPUTER & BUSINESS SUPPLIES	512/226-8188
	OREM	COM-TEL COMPUTER	801/224-8887
UTAH	MANCHESTER CENTER	COMPUTER SUPPLIES INTERNATIONAL	802/447-2186
VERMONT	RICHMOND	FIRST STEP COMPUTERS	804/320-6496
VIRGINIA	RICHLAND	ALPHA COMPUTER CENTER	509/943-5608
WASHINGTON	SPOKANE	NOVA SYSTEMS	509/922-6565
WISCONSIN	MILWAUKEE	APPLIED DATA SYSTEMS CORPORATION	414/276-5585

Dynatech Computer Power, Inc., was formed as the result of the acquisition and merger of RKS Industries, Inc., and Dymarc Industries by Dynatech International, Inc.

## CHAOS MANOR

struggling to near death.

Meanwhile, a few test versions of the compiler drifted about the micro community. One landed in the hands of Erik Smith of Scenic Computer Systems Corporation, a firm you'll hear more about shortly. Erik cleaned up most of the remaining bugs and worked on the documents. His improved version went to Stride Micro. The Stride people did some more work, with the result that they have, in house, a Modula-2 compiler that works splendidly with the Stride computers; works so well, in fact, that Stride wrote their 68000 assembly language in Modula-2.

The Volition Modula-2 compiler uses the p-System for the editor and file manager, and the compiler runs under the p-System; but once you have compiled the file, it is a true native-code program that has only minimal interface with the p-System. Volition Modula-2 programs don't have the 64K-byte limit on code size that p-System programs have; and they're very fast compared to p-code.

The new Stride Micro computer systems have *great* graphics capabilities. Stride now uses Wyse terminals, and they've done nearly incredible things. They can repaint a screen instantly, faster than Zeke II manages with memory-mapped video. The nice part is that Modula-2 is very nearly the perfect language for exploiting Stride's graphics. It is also a great language in which to develop a text editor. I've got a couple of colleagues working on doing just that. So, I suspect, does Stride.

Moreover, Modula-2 was explicitly designed as a language you can use to write an operating system. After Niklaus Wirth wrote Pascal, he spent a sabbatical year at the Xerox Palo Alto Research Center (PARC). Alan Kay was also at PARC. Much of the Macintosh operating system is no more than an implementation of Kay's ideas. Wirth left PARC with many of those ideas and went home to Zurich to write Modula-2. As a consequence, the Modula-2 operating system strongly resembles the Mac's. A

(continued)

Modula-2 operating system for the Stride could have most of the better features of the Macintosh without the limitations.

So far there's no Modula-2 operating system for the Sage, but that will change. Meanwhile, I did see demonstrations of Volition Modula-2 programs working within the p-System,

and they were *fast*. The Stride, unlike the Macintosh, can handle lots of memory, extra disk drives, tape backups, and the other peripherals one expects microcomputers routinely to make use of. I'd already thought that Modula-2 and the Sage, oops, Stride Micro machines were made for each other; seeing what they'd done using

the Volition compiler, I was absolutely sure of it.

#### ARBITRATION, ANYONE?

There was one big problem. The Volition compiler was all tied up in lawsuits and acrimony. There was no way any publisher could get an unclouded license to market it.

I'd heard bits and pieces of the Volition controversy before going to Reno for the Stride Faire. It had seemed unfortunate; but now that I'd seen the compiler working on a Stride, it was tragic. Stride was arranging to trade my Sage IV for a Stride 440—but they couldn't let me have the Modula-2 compiler.

Representatives from most of the major factions in the Volition dispute were present at the Faire. It wasn't hard to get each to give his version of the problem. When I'd heard them all, I wanted to cry. We had here a classic case of a failure to communicate, with serious complications caused by an awful lot of wounded pride.

Certain facts stood out. First: there were no villains here. Sure, each side could persuade itself that the others—or at least one of the others—was a villain, but objectively it just wasn't true.

More important, though, from what each told me he wanted, it was obvious they aren't even very far apart. It may well be that their lawyers have made needless claims—lawyers tend to do that—but from what the principals to the dispute told me, they'd *all* be better off if they *all* lost. That is: if in order to get the compiler on the market they agreed that each side would get no more than the other was willing to concede, and some random stranger, or the government, took all the rest, *all* of the factions would still be better off than they are now. The potential sales of the compiler—provided that it gets out there while it has a chance to grab some market share—are large, while the potential return from liquidating the company is small.

The image I get is a farm: the goose is dead, but there's one unhatched

(continued)

## TAKE ON TOMORROW TODAY

At General Dynamics' Convair Division, future technologies begin with the ingenuity of today's finest engineers and professionals. They work for a company that fully understands the two sides of the individual that need to be considered: the professional side and the personal side. One needs the other to satisfy the individual in mind and spirit, to satisfy the complete professional.

How do we do it? First, Convair offers tomorrow's most challenging assignments, today. Our team of creative specialists takes on major projects like ground-, air- and sea-launched missiles; related advanced missile systems, and major aircraft structure components.

Then we combine this stimulating atmosphere with the relaxing backdrop of San Diego's sunny beaches and rolling hills. A setting that perfectly complements the fast-paced high technology environment.

We also offer competitive salaries and a highly desirable benefits package designed to help employees realize their personal goals now and for years to come.

If you have the talent to take on tomorrow's advanced technology, and the dedication to see it through, take on this opportunity at Convair.

### SOFTWARE QUALITY ASSURANCE

You will define controls and provide methods for assuring software product quality and requirements compliance. You will also implement and report software quality assurance activities that verify quality aspects of software. Requires experience with DoD software in areas of development, tests or software quality assurance and knowledge of MIL-S-52779A and DOD-STD-1679A. B.S. degree in engineering or computer science preferred or equivalent combination of formal education and relevant experience.

Please send your resume to: Director-Quality Assurance,  
General Dynamics Convair Division, MZ 11-1342-1014,  
P.O. Box 85357, San Diego, CA 92138.

**GENERAL DYNAMICS**

*Convair Division*

Equal Opportunity Employer/U.S. Citizenship Required/Principals Only



# COMPUTER HUT

COMPARE  
OUR  
SERVICE & PRICE!

## SPECIAL OF THE MONTH

IBM-PC, XT & AT  
CALL FOR  
PRICE

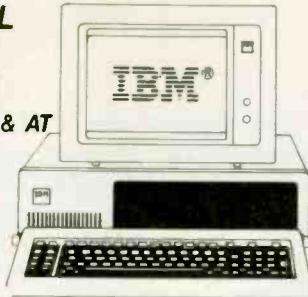

## MODEMS



Smartmodem 1200 ..... \$419  
Smartmodem 1200E ..... \$379  
Smartmodem 2400 ..... \$649

## NOVATION

SmartCat ..... \$349

## PRINTERS

### EPSON

FX-80+ .....		FX-100+ .....	
LX-80 .....	<b>BEST</b>	RX-100 .....	<b>BEST</b>
JX-80 .....	<b>DEAL</b>	LQ-1500 .....	<b>DEAL</b>
HI-80 plotter .....			<b>CALL</b>

### brother

HR-10 .....	\$299	HR-15 .....	\$389
HR-35 .....	\$795	2024L .....	<b>CALL</b>

### C-ITOH

PROWRITER .....	<b>CALL</b>
STARWRITER F-10P .....	<b>\$995</b>

### OKIDATA

182P .....		84P .....	
92P .....	<b>BEST</b>	192P .....	<b>BEST</b>
93P .....	<b>PRICES</b>	193P .....	<b>PRICES</b>
OKIMATE 20 .....			

### NEC

2050 .....	\$699	3550 .....	\$1149
8850 .....	\$1595		
Pinwriter P2 .....	\$589	P3 .....	\$795

### TOSHIBA

P351 .....	\$1295	P1340 .....	\$595
------------	--------	-------------	-------

### DAISYWRITER

2000 w/48K Buffer ..... \$849

## ACCESSORIES ..... CALL

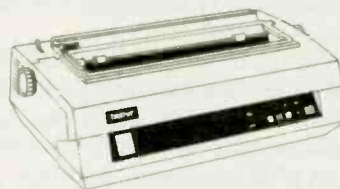

ASK ABOUT OUR  
TRAINING & REPAIR  
SERVICES.

## MONITORS

### AMDEK

Video 300G .....	\$135	300A .....	\$145
Video 310A .....			\$179

### CGS

Mono Monitor w/tilt & swivel ..... \$159

### PGS

HX12 Hi Res RGB monitor .....	\$489
MAX-12 Hi Res Mono .....	\$189
SR-12 Super Hi Res RGB .....	\$599



## SOFTWARE

### WORDPROCESSING

MS Word .....	\$239	Multimate .....	<b>CALL</b>
Volkswriter Deluxe .....			\$159
PFS: Write .....	\$89	PFS: Proof .....	\$69
WordPerfect .....	\$269		
WordStar 2000 .....			\$289

### DATABASE/INTEGRATED

dBase III .....	<b>CALL</b>	Quickcode III .....	\$179
RBase 4000 .....	\$279	Clout 2.0 .....	\$169
LOTUS 1-2-3 & Symphony .....			<b>CALL</b>
Framework .....			<b>CALL</b>

### UTILITIES/COMPILERS

Crosstalk .....	\$109	SmartcomII .....	\$109
Sideways .....	\$49	Norton Utilities .....	\$59
Sidekick .....	\$45	Turbo Pascal .....	\$55
LIFEBOAT Lattice C .....			\$299
MS Basic .....	\$259	MS Fortran .....	\$239

### BUSINESS

MICROSOFT Project .....	\$159	Chart .....	\$159
STAR Acct. Partner I & II .....			<b>CALL</b>
BPI SYSTEMS .....			<b>CALL</b>
PFS: File .....	\$89	PFS: Graph .....	\$89
PFS: Plan .....	\$89	Multiplan .....	\$129
Harvard Total Proj. ....			\$309

### OTHER

Mastertype .....	\$35	Typing TutorIII .....	\$39
Flight Simulator .....			\$39
Managing your money .....			\$129

## AND LOTS MORE

ANY PRODUCT NOT  
LISTED? CALL

## COMPAQ

CALL

## DISK DRIVES

Tandon TM100-2 DS/DD .....	\$159
MATSUSHITA JA 551 .....	\$139
TEAC FD-55B Slimline .....	\$139
IBM drives w/logo .....	\$169

## HARD DISKS/TAPE

### ME MAYNARD ELECTRONICS

WSO .....	\$695	WSI .....	\$795
20/30 Meg H.D. with Cont. ....			<b>CALL</b>
Mayn Stream Tape Backup .....			<b>CALL</b>

### IOMEGA

Bernoulli Box 20 Meg .....	\$2595
ALLOY .....	<b>CALL</b>

## ADD-ON BOARDS

### QUADRAM

Quadboard 64K exp. to 384K .....	\$269
Quad 512+ 64K .....	\$239

### AST RESEARCH

SixPak Plus 64K .....	\$269
I/OPlus II .....	\$129
Advantage 128K .....	\$409

### TECMAR

Graphics Master .....	\$489
MAESTRO .....	<b>CALL</b>

### HERCULES

Hi Res Mono Graphics .....	\$319
Color Graphics w/Par Port .....	\$185

### PARADISE

Modular Graphics .....	\$275
5-PACK OK .....	\$159

### PERSYST

Mono Card w/par port .....	\$195
Color Card .....	\$169

## EAST COAST

### COMPUTER HUT

OF NEW ENGLAND INC.

101 Elm St. Nashua, NH 03060

**(603) 889-0666**

For Orders Only — (800) 525 5012

## CANADA

### MICROCONTEXT

AUTHORIZED DEALER

4847 Ave Du Parc  
Montreal Que H2V4E7

**(514) 279-4595**

## MID-WEST

### COMPUTER HUT INC.

524 S. Hunter

Wichita, Kansas 67207

**(316) 681-2111**

For Orders Only — (800) 572 3333

All products usually in stock for immediate shipment and carry full manufacturers' warranty. Price subject to change — this ad prepared two months in advance. You get the lowest price. We honor personal checks — allow 10 days to clear. COD up to \$300 add 2%. Visa, MasterCard add 2%. For shipping & insurance add 2% or \$6.00 min. for small items and \$12. min. for monitors, printers, etc. We accept company checks and P.O.'s from Fortune 1000 Companies.

IBM is a trademark of IBM Corp.

Return authorization and order status call information line

Inquiry 96

75

*Many of the language's  
limits were imposed  
by the machinery  
Wirth had available,  
and they might  
be changed in  
later revisions.*

egg. All the heirs to the farm are standing in the nest fighting with sledgehammers.

It seemed a perfect situation for arbitration. I spent a good part of my time at the Stride Faire trying to persuade all parties of that. Now, it's a truism that the best way to make enemies is to stick your nose in other people's quarrels—but damn all, this isn't just their fight. Anyone interested in the future of the 68000 chip family has an interest in the outcome. As a result, I not only tried to persuade them to submit this mess to arbitration, but I even offered to get involved if that would help. So far no one has taken my offer; but I do understand there's a good chance they can come to sufficient agreement to get the compiler on the market.

Last-minute flash: it looks like they have. Stay tuned.

### MOSYS

It's almost an *embarras de richesses*. Until recently, there wasn't a good operating system for 68000-based computers. Now there are several based on Modula-2. One that I saw at the Stride Faire was MOSYS, which comes from the British firm Robinson Systems. I've known Brian Kirk, managing director (sort of like president) of Robinson for some time, and I'm always astonished at what his people can accomplish.

MOSYS is a full operating system and comes with an editor, document-processing program, and Modula-2

compiler. You also get quite a lot of source code. I saw it work on Stride systems, and I have the documents: a bit dry but thorough. I anticipate no problems with MOSYS. A copy will come with my Stride system; full report Real Soon Now.

### THE MASTER SPEAKS

I liked last year's Faire, but the big attraction for me this year was Dr. Niklaus Wirth, certainly one of the most influential leaders of the micro revolution. On my way to Reno I tried to imagine what Wirth would be like. I had a few clues: there's a famous story about his reply when asked how to pronounce his name.

"You can call me by name, or you can call me by value," he is supposed to have answered. "If you call me by name, it is 'VIRT'. If you call me by value, it is 'Worth.'"

I can't confirm that Wirth ever actually said anything like that. I think I do not know another pun that exploits three languages (German, English, and Pascal). Certainly the man I met would have been capable of it. He has a puckish sense of humor and speaks excellent English, as does his wife. Frau Wirth found Reno fascinating. During lunch she kept making one-dollar keno bets on numbers that mathematicians would find interesting; at last count she was about \$50 ahead.

After lunch Dr. Wirth gave a talk on Modula-2. He said too much for easy summarization; I expect I'll be cribbing pieces of it for a year. He managed, in a bit more than an hour, to say more interesting things about compiler design than I've learned in five years. I don't find Wirth a good writer; but he's a fascinating speaker.

Because I am a staunch Modula-2 enthusiast, a number of readers have asked me, more or less politely, to explain some of the curious aspects of the language. Why has Wirth done this? Why has he left that out? After hearing Wirth's lecture, I can make this generalization: when Wirth designs a compiler, there are no "accidents." There's a good reason for everything he does.

Wirth begins with a philosophy: keep it simple. "There should not be a compiler that takes 100,000 lines of source code and requires experts and armies of programmers to maintain. Such things should not exist." Compilers should be simple and consistent. There should be no surprises. When Wirth mentions Ada, he grows contemptuous. "They put in exception handling. They don't know how to program."

Of course, not all omissions and inclusions grow out of high philosophy. "If you are at a university and have only a few students to help you, you better don't do vast projects." At Wirth's university during 1975-76 he had only one machine, a PDP-11 with 56K bytes of storage. "This set definite limits to the size of programs, including compilers."

Of course, many people cannot distinguish between a language and their implementation of it. After Pascal's success showed the need for a follow-on language, Wirth developed Modula-2; but he had only a little time—part-time one summer—to write an implementation of it. The idea was to keep the compiler small and comprehensible and get it running. Once a Modula-2 compiler existed, it could be used to write a better compiler.

His first Modula-2 compiler took 25 minutes to compile itself. By working recursively, he was able to develop a version that would compile itself in 2 minutes. "As you see, you can gain not only by making fast hardware." The speed was not done at the sacrifice of comprehension.

Many of the language's limits were imposed by the machinery Wirth had available, and they might be changed in later revisions. On the other hand, Wirth is contemptuous of programmers who read through the language report and call for extensions before they have even tried to use the language. He has special scorn for those who insist that a language have exception handling.

"If you are deep inside nested structures, it can be good to raise your hand and shout 'Help!' But could not

(continued)

# TAPE IT EASY.

**B**oy, are you in for a surprise. You know you need mass storage. And you know you need some kind of backup.

But what you don't know is that making a backup from your hard disk can take the patience of a saint. And tax the memory of an elephant.

Unless, of course, you have a little TLC. The new TrimLine Combo from Corvus. You get mass storage (20 Mbytes). The incredible speed and efficiency of a hard disk. And an integral tape backup.

But there the similarity between a Corvus and anything else ends.

First of all, your TLC fits in beautifully. Between your IBM PC's monitor and base. No bulky boxes. And no clumsy cables and wires to trip over.

Next, you get the world's easiest tape

backup system. If you like using command lines, fine. The TLC will accommodate you. But if you're more interested in simplicity, just use one of the TLC's menus. And one of your fingers.

You can back up the entire disk. All your data for the day. A group of selected files. Or just one single file. As a matter of fact, you can back up whatever you want. Which will save you quite a bit of time and aggravation.

You'll also find backed up files in seconds with the TLC's Directory. No more searching an entire tape just to find one file.

Finally, you'll enjoy the backup speed of the TLC. There's no formatting of blank tapes (which can save you about two hours). And no worry about losing data to bad sectors the format has called good.

Scared? Don't be. Just tape it easy. Check out the TrimLine Combo from Corvus.

In addition to all the features, it's one of the lowest-priced tape backup systems you can find.

For more information and the name of your nearest Corvus TLC dealer, call (800-4-CORVUS).



IBM is a registered trademark of International Business Machines.  
© 1985 Corvus Systems, Inc.

**CORVUS**

PRINT NAME HERE

# I, \_\_\_\_\_, insist on calling the shots.

When I'm investing my hard-earned money, I don't want to rely entirely on other peoples' opinions.

Show me how my personal computer can help me become a better-informed investor. With stock quotes and research to give me a solid background. With ways to test a strategy before I actually plunge into the market. And, if I want it, the power to make my own trades through my computer, at a substantial discount.

Tell me about Investor Services from The Source and Spear Securities.

Now, my investment decisions will be based on the one opinion I respect most. My own.

**The Source**<sup>SM</sup>  
INFORMATION NETWORK  
**INVESTOR SERVICES**  
WITH SPEAR SECURITIES

For a free information kit, mail this ad to: The Source, 1616 Anderson Road, McLean, VA 22102. Or call toll-free.

Address \_\_\_\_\_

City \_\_\_\_\_

State \_\_\_\_\_

Zip \_\_\_\_\_

**800-336-3366** (In Virginia, call 703-821-6666)

All brokerage accounts and securities transactions are the responsibility of Spear Securities, Inc., and not of Source Telecomputing Corp. The Source is a service mark of Source Telecomputing Corp., a subsidiary of The Reader's Digest Assn., Inc. © 1985 Source Telecomputing Corp. 7825313

*'Industry needs standards much more than universities.*

*Even so, there is such a thing as too much standards.'*

that problem have been handled before? Rather than build exception structures—surprises—into the language, is it not better to raise flags and check them later?"

Wirth also commented on what he called the "urge to standardization. I appreciate the need of industry for standards. Industry needs standards much more than universities. Even so, there is such a thing as too much standards." Programmers must be clever enough *not* to explore the language and find "features" not described in the language report, or else they will later clamor that those "features" be in the language—yet there may be a very good reason why they should be left out. "A language report should not only be taken for what it says but for what it does not say."

Wirth finds one omission serious. "I will probably introduce forward definitions, but I do not like it. In general, you should not add complexities to handle a few pathological cases. If there were a trivial fix to the problem of forward declarations, I would have done it already."

There was a great deal more; enough that I'm still digesting his lecture while rethinking some of my objections. I'll admit it: I was one of those who clamored for certain extensions and changes to the language before I did much programming in it. On reflection, I find that a particularly silly form of hubris and a mistake I don't intend to continue. When we get Chaos Manor rebuilt and I have my machines set up again—at the mo-

(continued)

# Put your PC in Pictures<sup>SM</sup>

With PC-EYE™ your IBM PC can capture real-life pictures of people, products, drawings, text - anything a video camera can see. Add one or more of CHORUS' software packages and you can perform sophisticated graphic arts, data base management, security and long distance communications tasks.



Start with the PC-EYE™ video capture system. There are three models to choose from with up to 640 x 512 resolution — 16, 64, and 256 gray levels or color combinations. Then add one or more of the following software packages for your application.



## PhotoBase™ - Integrates pictures with your data base

Compatible with dBase II, R:Base 4000 and the IBM Filing Assistant and others, PhotoBase lets you use your data base system as you now do. BUT, now you can add a quarter screen picture captured by a video camera or VCR and display data, pictures, and signatures on the screen simultaneously. Applications include real estate, bank security and signature verification, medical record keeping, product cataloging and more.



## IMiGIT™ - Graphic Arts Capability

IMiGIT is icon driven and ideal for creating traditional or exotic illustrations using combinations of art, text and photos for slide presentations, video graphics, CAD, medical, advertising and publishing applications. IMiGIT PLUS delivers high quality true color graphics you can manipulate and edit with text, painting, air brushing, curve fitting, filled and unfilled circles, boxes and much more via mouse or digitizer pad.



## PhotoMail™ - Two-way Communications using pictures, text and voice.

Transmit pictures over ordinary telephone lines to remote computers. Pictures of people, diagrams, text, houses, construction sites - anything you can capture with standard video equipment you can display and transmit at resolutions up to 640 x 400 x 16 levels of gray or color. You can edit pictures with text and labels. Dual cursors permit simultaneous pointing to common pictures. PhotoMail supports alternate voice and image transmission, disk storage, and hardcopy printout. File conversion is included to support "electronic mail" systems.



## Great Value Added Opportunities

OEMs and software developers can incorporate high quality pictures into their products. Systems can be upgraded with PC-EYE digitizing expansion boards using an EIA RS-170 or RS-330 video source and PC-EYE imaging subroutines.

Call us about our other imaging products like Colorverter™, ScreenMaster™, and CompressIT™ to help meet your application needs. **1-800-OCHORUS** or **603-424-2900**. Or write for our "Seeing is Believing" comprehensive brochure.

TM: All are trademarks of CHORUS DATA SYSTEMS, INC.

\*dBase II is a trademark of Ashton-Tate; R-Base 4000 is a trademark of Microrim, Inc.; IBM Filing Assistant is a trademark of International Business Machines Corporation.

# CHORUS

Inquiry 76

ment there's only room for Zeke II, and he's crowded into the living room—I'll do some more exploration.

**HOW DO WE REALLY DO IT?**

After Wirth's lecture, there was a panel on the Modula-2 language. Alas, whether due to the hour or the speakers, I slept through much of it.

There were a few interesting points. Jon Bondy, former officer of USUS, talked about Modula-2's seeming simplicity. "At the end of a month I thought I knew all about the language, but then I feel this way every month." The real value of Modula-2 is that big projects can be broken up into meaningful parts for different people to work on—and it really works.

Tom DeMarco commented on programming philosophy and gave the opinion that Modula-2 is a major step toward developing a "standard software bus," which all of us, profes-

sionals and amateurs alike, can make use of.

One of the major advantages of Modula-2 is that it is truly possible to use teams of programmers to work on large projects. Modula's, er, *modular* structure allows projects to be broken apart and keeps the interfaces between pieces thin; according to the panelists, thinner than with any other language. Bondy told of some recent projects he'd worked on. "We wouldn't be finished without Modula-2."

All the panelists agreed that programmers think too little and begin writing code too early. "It's the APL-FORTH philosophy," Bondy said. "Don't think about the problem, just start hacking at it."

With Modula-2 you needn't do that. In fact, if you have a team of programmers, you can't do that. Instead, you must spend time breaking things apart and looking at logical divisions

of the work. In Modula-2 you can write code that describes what a program part does and what variables it uses without showing *how* that's to be accomplished. These "definition modules" can be passed back and forth, and once agreed on, they can be fixed even though the implementation modules that actually do the work are changed. This is the way to proceed.

I listened to all this and nodded agreement, but then I began to wonder. It all reminded me of how English teachers tell us we ought to write. Do outlines. Think of what you want to say. Get it all organized. Most people start writing too early. Don't. Wait until you know where you're going . . .

I don't know any professional writers who do that. Certainly I don't. If English teachers follow their own advice, it's no wonder that so few of them can support themselves by writing. It's perfectly true that badly organized material reads badly; but it's not necessarily true that the best way to do well-structured writing is to sit and think and outline forever. If I had to do that, I'd get so discouraged that I'd never write anything at all.

Most writers I know simply start hacking at the problem, writing whatever comes to mind. Get it down and written; then, later, when there's something to organize, you can work on the structure. That's what's so wonderful about writing with computers: it makes reorganization so easy. In the old days I had to use scissors and paste.

For me, at least, the big problem of writing is getting the thoughts down on paper. (Well, in my case, on disk.) The easiest thing I can find is a good reason why I should think about my essay or story rather than writing it. In fact, the best way I know of to get writer's block is to insist that first-draft stuff be presentable.

I find programming much the same. It's a lot easier to sit and think about structures than it is to hack out code. Now it may be that programming is a fundamentally different kind of

*(continued)*



**"INSIGHT is essentially the equivalent or better than any other tool available for the personal computer."**

*Paul Harmon, author of Expert Systems, Artificial Intelligence in Business*

Turn your PC into an expert.

**Give it Insight, or give it Insight 2.** Both let you create knowledge base systems using any PC-compatible text editor.

**Insight** not only simplifies access to lots of information, it analyzes and offers solutions. For entry-level operators it's a perfect procedural training package to help build and implement knowledge base software.

**Insight 2** is more than just an "expert." It's a knowledge base engineering tool with application capabilities. It can call up Pascal programs, read and write dBASE II® files, and its decision-making process can tie in directly to your existing databases. Run-only versions also can be developed and distributed.

**Two unique packages from the same expert idea.**

*Insight™ (\$95) and Insight 2™ (\$485) run on the IBM® PC, DEC® Rainbow, and Victor® 9000.*



**Level Five Research, Inc.**

4980 South A-1-A      Melbourne Beach, Florida 32951      (305) 729-9046

# Slash Programming Time in Half!

With **FirsTime**<sup>TM</sup>

- Fast program entry through single keystroke statement generators.
- Fast editing through syntax oriented cursor movements.
- Dramatically reduced debugging time through immediate syntax checking.
- Fast development through unique programmer oriented features.
- Automatic program formatter.

## FirsTime is a true syntax directed editor.

FirsTime ensures the integrity of your programs by performing all editing tasks like moves, inserts and deletes along the syntactic elements of a program. For example, when you move an IF statement, FirsTime will move the corresponding THEN and ELSE clauses with it.

Even FirsTime's cursor movements are by syntax elements instead of characters. The cursor automatically skips over blank spaces and required keywords and goes directly to the next editable position.

## FirsTime is a Syntax Checker

FirsTime checks the syntax of your program statements, and also:

- Semantics like undefined variables and mismatched statement types.
- The contents of include files and macro expansions.
- Statements for errors as they are entered and warns you immediately.

## FirsTime is a Program Formatter

FirsTime automatically indents statements as they are entered, saving you from having to track indentation levels and count spaces.

## FirsTime has Unique Features

No other editor offer these features:

The *Zoom command* gives you a top down view of your program logic.

The *View command* displays the contents of include files and macro expansions. This is valuable to sophisticated programmers writing complex code or to those updating unfamiliar programs.

FirsTime's *Transform command* lets you change a statement to another similar one with just two keystrokes. For example, you can instantly transform a FOR statement into a WHILE statement.

The *Move at Same Level command* moves the cursor up or down to the next statement at the same indentation level. This is very useful. For example, you can use it to locate the ELSE clause that corresponds to a given THEN clause or to traverse a program one procedure at a time.

## FirsTime is Unparalleled

FirsTime is the most advanced syntax directed editor available. It makes programming faster, easier and more fun.

**TO ORDER CALL (201) 741-8188**

or write:

# **Spruce Technology Corporation**

189 E. Bergen Place  
Red Bank, NJ 07701

Inquiry 401

In Germany, Austria and Switzerland contact:  
Markt & Technik Software Verlag  
Munchen, W. Germany  
(089) 4613-0

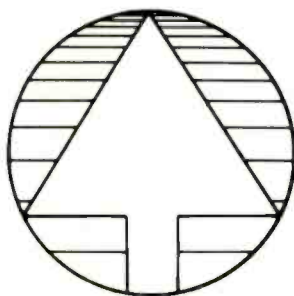

creative activity from writing and different rules ought to apply; but I don't believe it. I'm not a professional programmer, but I have written some pretty complicated programs, including the accounting system I use; and I find that the best way to get a program done is to treat it like an essay. Think about where you want to go; look at what must be done to get there; and start working on the parts that look the most interesting. It will all get reorganized later.

Most programmers I know work that way. Get something running; that's work, but it's also rewarding to see progress. When you're tired of writing code, stop and think again. It's a recursive process. Of course, programmers can, if not careful, get into a blind alley and be faced with throwing away a lot of work or hacking up some particularly horrible kludge; but that's also true for writers and only

goes to prove that courage is indispensable to programmers and writers alike.

Books written in collaboration need more organization than those written solo, of course; but once again, there's a strong motivation factor. Larry Niven and I have written five novels (the latest, *Footfall* from Ballantine Books, ought to be in your local bookstore right now) together; and the hardest part of it is when we have to work alone. When we get together and I see text I didn't write, or improvements in something I thought was pretty good to begin with, the result is a flurry of work. It's often necessary to sit at the conference table and work on an outline; but the real inspirations come when the words begin to flow.

Now, I am willing to concede the value of good organization and of thinking things out in advance; but just as good writing requires rewriting

and editing, so, I think, does good programming. It would be remarkable if my first cut at organizing an essay turned out to be optimum; and though I have less experience at programming, I suspect it's no different there. In fact, I'm tentatively putting it forth as one of Pournelle's laws: in any large programming effort, the outline will change when coding begins.

For all that, the panelists were agreed that Modula-2 makes it easier to do proper organization, as well as to compensate for organizational mistakes, whether you're working solo or as part of a team; and I believe that.

#### JUST TURN YOUR HEAD...

Some love them, some hate them, but many users have strong feelings about mice. Touch-typists find mice sometimes useful but are annoyed by machines that have no arrow keys and thus make you take your hands off the keyboard. In my own case, my desk is always covered with papers; not only is there no place to operate the mouse, but often I can't even find the silly thing.

Alternatives to mice include foot-controlled mice—sometimes called rats—joysticks, trackballs, thumb balls, and touchpads. Comes now the new Stride "spot" which they call The Nod. That is: Stride's engineers have mounted a small infrared source and detector on the screen. The operator takes a circle of silvered tape about the size of a quarter and mounts it on his head. You can stick it on your forehead, on your glasses, or on the end of a pencil to stick behind your ear. It doesn't matter. You can now control the cursor by moving your head.

This works. Naturally there are a number of control features. You can program in the slewing rate and that sort of thing, and there are various ways to enable/disable it. I don't know how I'll like it, because due to the construction here I don't have mine set up yet; but I had no trouble using the one on demonstration in Reno, and I rather like the idea. My new Stride

(continued)

When You Want The Best, Call...

**nbs** inc.

National Business Software and Supplies

**ORDER LINE 800-225-8800**

#### IBM PC SOFTWARE

VOLKSWRITER DELUXE	\$154	SUPERCALC III	\$215
LEADING EDGE W.P.	57	WORD PERFECT	229
NUTSHELL	60	ELECTRIC DESK	189
ABILITY	285	R BASE 5000	420
TURBO PASCAL	29	NORTON UTILITIES	59
WORDSTAR 2000 +	289	SMART SOFTWARE SYS	549
MULTIPLAN	118	SUPER KEY	39

#### PRINTERS

OKIDATA	CALL	NEC 2050	\$666
EPSON	CALL	TOSHIBA 1340	\$559

#### MISC.

AST 6 PAK	\$259	CHIPS 64 K SET	\$25
TEAC 55-B DRIVE	\$129	PRINTWHEELS &	
HAYES 1200 B	\$359	RIBBONS	CALL

#### TWO LOCATIONS:

500 W. Broadway, Suite 116  
Tempe, AZ 85282  
(602) 966-8005

P.O. Box 23,  
Painesville, OH 44077  
(216) 352-1262

Monday-Friday 8am-5pm

VISA & MasterCard Welcome

Shipping & handling add \$5 per order (printers \$10 per order). VISA & M/C add 3%. AZ residents add 6%. Allow two weeks for personal or company checks to clear. Returns subject to 15% restocking fee. All items are new with manufacturer's warranty. Machine compatibility not guaranteed. Prices subject to change, product subject to availability.

7/85



# To succeed in the future, you must learn to speak its language.

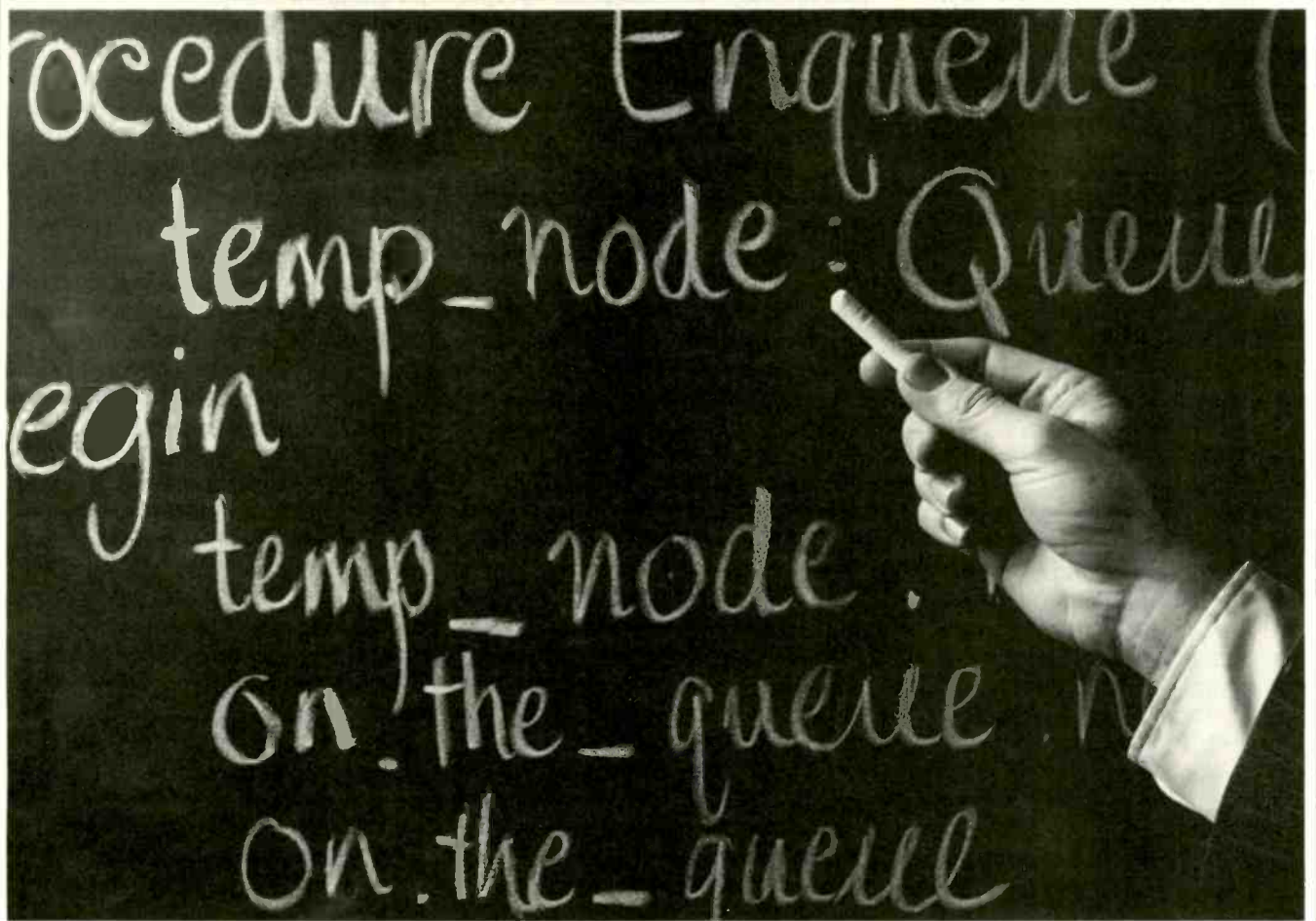

Martin Marietta Denver Aerospace is committed to a future of computer software excellence. Ada® is part of that future. But our commitment to becoming the software center of excellence requires exceptional people—people who don't wait for the future, but work to create it.

We are now looking for software and other aerospace professionals to move ahead with us, to step into the future and help lead the way. There are already many opportunities to work with Ada as we explore its many applications. We are continuing our intensive on-site software engineering education curriculum for our employees (a full-time, 13-week hands-on Ada program).

So, if you want to succeed in the future, come to where we already speak its language—Martin Marietta Denver Aerospace.

We have opportunities available for aerospace professionals with at least 3 years experience in:

- Systems • Electronics • Software • Test • Software Test
- Systems Safety • Logistics • Mechanical Engineering

- Quality Software, Electrical & Mechanical • Contracts
- Material Operations • Aerospace Program Planning
- Manufacturing • Finance Estimators

Other career opportunities exist at Martin Marietta Aerospace in Baltimore, Maryland; Orlando, Florida; & New Orleans, Louisiana.

**RECENT EXPERIENCE ON GOVERNMENT/DOD STATE-OF-THE-ART PROGRAMS A REAL PLUS.**

**SPECIAL BACKGROUND INVESTIGATION MAY BE REQUIRED.**

Please send your confidential resume to: Martin Marietta Denver Aerospace, P.O. Box 179, L1311, P909, Denver, Colorado 80201. No agencies please, we prefer talking to the individual.

**U.S. Citizenship Required.**

An Affirmative Action Employer Actively Seeking the Veteran and Handicapped.

**MARTIN MARIETTA**

*Lilith's CAD software is designed for use by technicians who know something about taping boards and don't want to become computer jocks.*

440 will be equipped with The Nod. More Real Soon Now.

**SCENIC**

If you're interested in computerized typesetting, you need to talk to the people at Scenic Computer Systems Corporation of Redmond, Washington. They've developed a number of typesetting/formatting programs, including the one used to set type for Glitch's Modula-2 book. Their original ScenicWriter programs were in various languages, including assembly languages, but now they're working seriously with Modula-2. ScenicWriter can do a lot, and once it's in Modula-2 it will be even easier to add special features. It will also be more portable.

Their system takes the output from a text editor—nearly any text editor—and formats it for a variety of printers, including the HP LaserJet and the new

Apple laser printer. I was fascinated by all the things they can do with the LaserJet making use of the various font cartridges available from HP. Erik Smith, their vice president for engineering whom I mentioned above, is impressively informed about both typesetting and computers. He tells me that the LaserJet is very nice. Those who do fancy printing may find Apple's LaserWriter is worth the extra money, but LaserJet is darn good.

This is a show report, not an evaluation: I'll have more on ScenicWriter when I get the Stride 440 set up in my new quarters. Meanwhile, I liked what I saw, and if you're in the fancy text-formatting business, look at ScenicWriter. You may like it a lot.

**SIGN OF THE TIMES**

A quick note: I now have review copies of three different commercial programs written in Logitech's Modula-2 for the IBM PC. They work. The language has come of age, and I expect to see many more Modula-2 programs in the coming year.

**SUPERPRACTICAL LILITH**

The Lilith computer is a wonderful Modula-2 programming environment, and I don't hesitate to recommend it for anyone seriously interested in writing big programs in that language. It's not likely to catch on as a mass-market machine, so I haven't in conscience been able to recommend it to anyone but Modula-2 programmers. That's all changed.

If your business involves laying out and taping circuit boards, you need to call Richard Ohran at Modula Corporation. He has turned the Lilith into a superbly practical engine for generating circuit-board templates.

The CAD (computer-aided design) software is designed for use by technicians who know something about taping boards and don't want to become computer jocks. The system can be learned in two days. The conversion is simple because Ohran's system is designed to be easy for computer neophytes to learn. After a couple of days' experience with the Lilith, board designers can take a complex multilayered board from circuit diagram to photo templates in a week or less.

Dr. Ohran had Lilith set up in his hotel room, and we went up after the Saturday dinner show—the MGM puts on the San Francisco Quake twice nightly, and it's still one of the best dinner shows I've ever seen—for a demonstration. I watched Ohran playing about with the system. He drew lines. Called in circuit components. Rerouted lines. Changed layouts. Marked chunks to be enlarged, worked on them, and changed their scale. "That's as good as I've seen on a Symbolics machine," I said.

Ohran didn't even chuckle. "Symbolics isn't as fast."

He was dead serious, and I'm sure he's right. I've seen *nothing* as fast for manipulating circuit elements. The

(continued)

**GRAPHS WITHOUT GRAPHICS?**

No need for color monitor or graphics board. Make graphs on dot matrix printers.

Easy to Use. No Programming. CP/M 2.2, 3, 80, or 86, MS-DOS or PC-DOS. Excellent Manual. Most disk formats.

**DataPlotter™**

Line Graphs & Scatterplots. . . . \$69

Bar Graphs & Pie Charts. . . . \$69

Both for \$99

(Prices include manual)

Add \$3 shipping.

\$8 outside US and Canada.

Specify type of Printer.

**Lark Software™**  
131 N. Leverett Rd.  
Leverett, MA 01054

(413) 773-8687 Visa, M/C

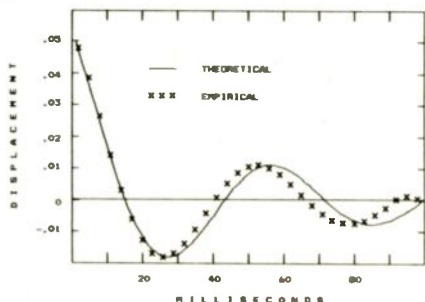
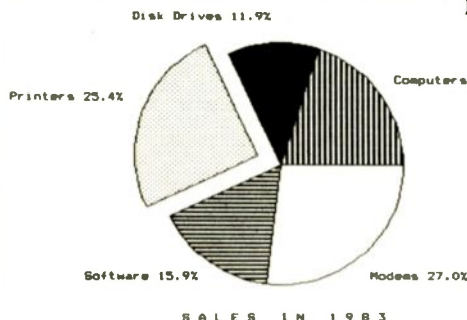

# New Generation Communications

Our new Crosstalk Mark 4 behaves just as reliably as the Crosstalk you've always trusted. But when you ask it for a bit extra, you're in for some surprises.

## Up To 15 Concurrent Sessions

Mark 4 supports the X.PC multiple-session protocol, so it's capable of up to 15 concurrent communications sessions, each with the end-to-end error-checking needed for tomorrow's higher speed modems.

With more than one session going on at once, you need some way to keep track of them all. Crosstalk Mark 4 has that, too.

## What You Get Is What You See

Mark 4 identifies each session with a "page" number. You can flick from one session to another with one keystroke. See each one full screen.

But if you'd like to keep an eye on more than one session at once, you can create windows — as many as you need in any size or shape — to display them all.

## Menu? Or Command?

No matter how expert you are, Mark 4 is just your speed. It operates on command, or with a menu, or any combination of the two.

Inquiry 247

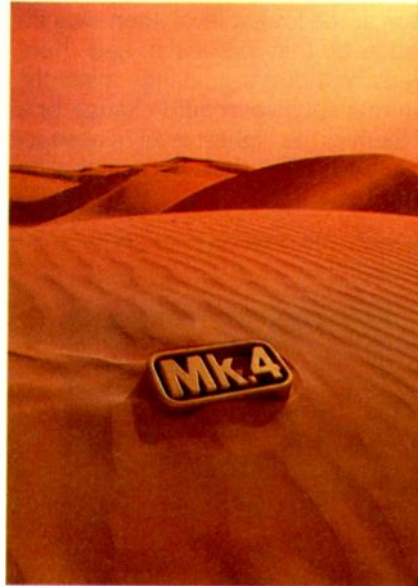

If you need help at any point in your command sequence, Mark 4 gives you suggestions that apply precisely to the task at hand.

## Why Repeat Yourself?

If you make the same calls often, as most people do, Mark 4 can save you a lot of dull repetition. It has built-in command programs to call up and log in to most of the major information utilities.

But Mark 4 goes one step further. It can "memorize" any command sequence you perform, then repeat it that way any time you ask it to. You can't make programming much easier than that.

## And Now, By Popular Request ...

— Mark 4 has a text-editor built in. You can create and edit files without having to leave Crosstalk.

— Mark 4 emulates the most popular terminals, including

IBM 3101, DEC VT-52, VT-100, and the TeleVideo 900 series. Most other programs emulate one or two.

— In addition to X.PC, Crosstalk Mark 4 supports Kermit, Xmodem, and of course our own Crosstalk protocol.

## How New Is New Generation Communication?

New enough for the advanced breed of modem that's already coming around the corner. New enough to give you the best high-speed, error-checked communication possible on noisy phone lines — or secure dedicated lines.

Finally, because Crosstalk is already the industry standard for small business computers, Mark 4 is at home in a broader universe than any other communications software.

It may be new and improved and revolutionary — but it's still Crosstalk.



**MICROSTUF**<sup>®</sup>

1000 Holcomb Woods Parkway / Roswell, Georgia 30076

JULY 1985 • BYTE 327

Lilith CAD system uses the mouse to draw circuit lines, chip-mount pads (the little wide spots that chips or chip sockets would be soldered to), and the other stuff that goes onto circuit boards. Elements, such as pads, can be built up into larger units, as large as you want. Since each is an element in the file, changes can be made at

any level. For example, if you change the design of one of the chip-mount pads at the lowest level, then *every* instance of that particular pad, hundreds of them, will change instantly. Alternatively, you could change one of them at the highest level of abstraction and only that particular one would change.

The system has a real mode and a quick mode. In quick mode the corners aren't exactly rounded, and there are other subtle shortcuts; but it's very fast, recalculating hundreds of images and redrawing them nearly instantaneously. Real mode is slower but shows on screen exactly what you'd get if you made printouts and templates. Real mode does size and shape and scale changes fast enough to work with; it's slow only in comparison to quick mode.

The Lilith will certainly raise productivity. One Santa Monica outfit has a Lilith CAD system with a slightly flaky hard disk. Dr. Ohran keeps urging them to ship the unit back to him for repair; but they say they can't spare the machine even for a couple of days. They'd rather keep lots of backups than be without the unit. "One of these days I'll have to ship them a loaner," Richard Ohran says.

The Lilith system is about \$21,000 with software, which is a bit beyond the price range I usually review. Still, I'm no great expert on CAD systems for making circuit-board templates, but I'd be much surprised if there's anything this effective at anything like its price. Anyone in that business should certainly find out about it.

**MACFAIRE**

The Macintosh Faire was held in San Francisco's Brooks Hall the 22nd and 23rd of February. I had a long-standing dinner engagement with Frank Herbert for the night of the 22nd, leaving nothing for it: I caught an airplane to San Francisco at 0700 Saturday the 23rd. This was unlikely to put me in a good mood for looking at MacProducts.

It didn't matter. Besides being in Brooks Hall, where the West Coast Computer Faire was held for so many years, the MacFaire had something else in common with the early West Coast Faires. There was an almost electric air of excitement. The MacFaire was full of people who *like* small computers. Whatever else I might think about the Macintosh, I give it full marks for bringing the fun back to the

(continued)



**Sweet deals on memory and logic programmers**

**Stand-alone, intelligent RS-232 units compatible with most computers or terminals; minimal or no interfacing**

**PROMPRO-8™**...Programs virtually all +5V EPROMs, single-chip micros, and emulates EPROMs. ONLY \$689.00 (128K RAM version)

**GANGPRO-8™**...Programs 8 EE/EPROMs at once (supports most EPROMs.) ONLY \$995.00

**UV ERASERS** ...Start at \$49.95, and \$97.50 for timer versions. Production model \$149.95 **AND MORE!** ...Call for more info on PALPRO, SHOOTER, PP7, XP, and required options. Detailed literature and spec sheets available. IBM PC, Apple and other popular PCs support.

PAL is a registered trademark of MMI.

**TOLL-FREE 1-800-EE1-PROM**

**It's only Logical.**

**LOGICAL DEVICES, INC.**

1321 N.W. 65th Place • Fort Lauderdale, FL 33309 • (305) 974-0967 • TELEX: 383142



# TIME & MONEY

SemiDisk is the disk emulator that saves you more of both.

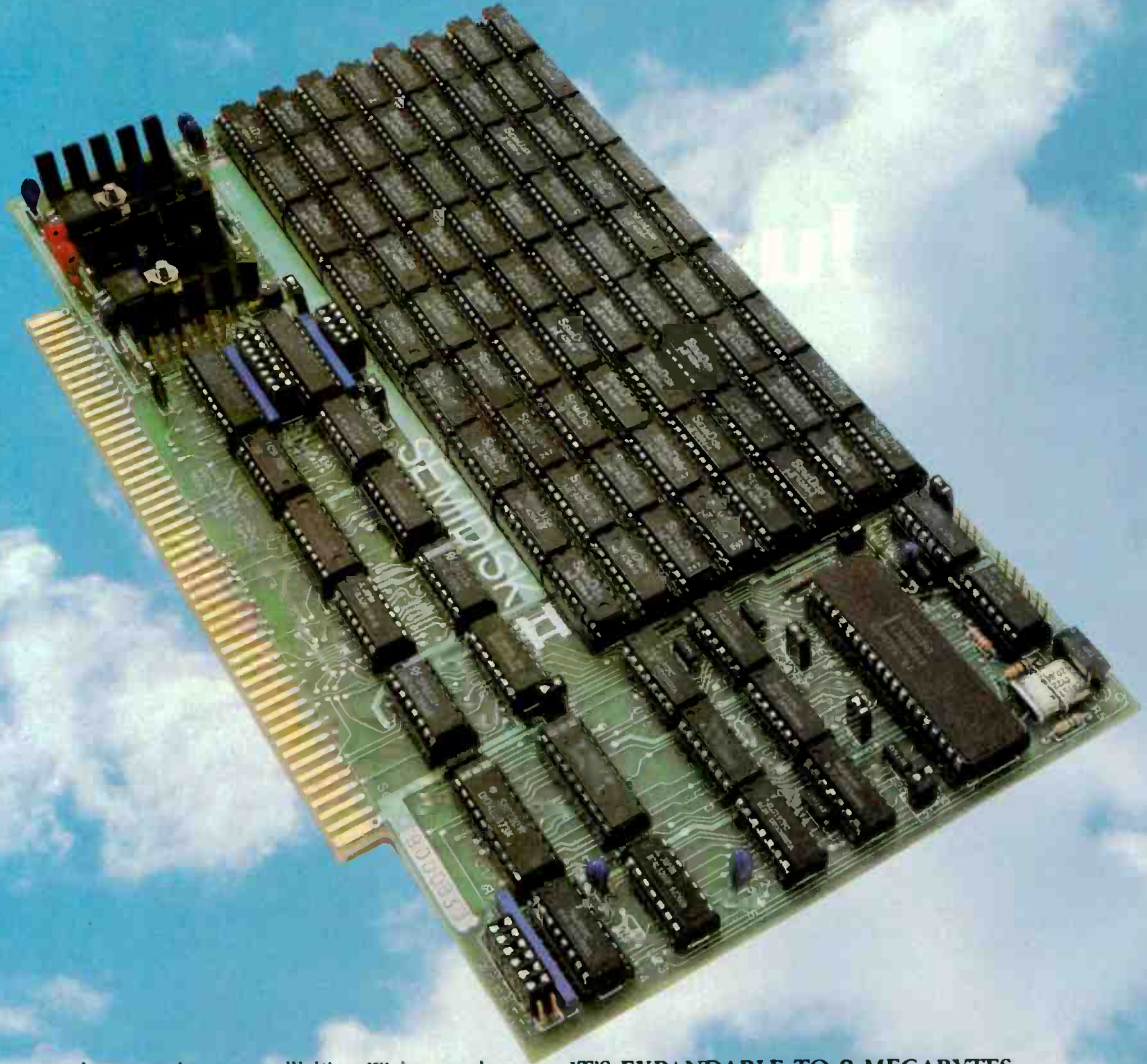

We've just done something we know you'll like. We've made the SemiDisk far more affordable than ever before. With price cuts over 25% for most of our product line. Even our new 2 megabyte units are included.

#### COMPARE WITH THE OTHERS.

SemiDisk Systems builds fast disk emulators for more microcomputers than anyone else. S-100, IBM-PC, Epson QX-10, TRS-80 Models II, 12, and 16. Up to 2 megabytes per board, standard. Up to 8 megabytes per computer, using only four bus slots, max! Software drivers are available for CP/M 80, MS-DOS, ZDOS, TurboDOS, VALDOCS 2, and Cromix. SemiDisk turns good computers into great computers.

#### GREAT NEWS FOR IBM PC AT USERS.

New MS-DOS 3.0 software drives take full advantage of the 80286's expanded instruction set, moving data four times faster than can be done on PC or XT.

#### BATTERY BACKUP, TOO.

At 0.7 amps per 2 megabytes, SemiDisk consumes far less power than the competition. And you don't have to worry if the lights go out. The battery backup option gives you 5-10 hours of data protection during a blackout. Nobody else has this important feature. Why risk valuable data?

#### IT'S EXPANDABLE TO 8 MEGABYTES.

You can start with as little as 512K bytes, and later upgrade to 2 megabytes per board. At your own pace, as your needs expand.

In an IBM PC, XT, and AT you can have multiple drives on a single system. And the SemiDisk gives you mainframe performance on the top of your desk.

#### AND THE BEST NEWS IS SAVED FOR LAST:

	512K	1Mbyte	2Mbyte
SemiDisk I, S-100	\$695	\$1395	
SemiDisk II, S-100	\$995		\$1995
IBM PC, XT, AT	\$695		\$1795
QX-10	\$595		\$1795
TRS-80 II, 12, 16	\$695		\$1795
Battery Backup Unit	\$150	\$150	\$150

## SEMIDISK

SemiDisk Systems, Inc.

P.O. Box GG, Beaverton, Oregon 97075

503-642-3100

Inquiry 317





# Just hatched



We just hatched a new line of automatic sheet feeders for the Epson FX-80+ and FX-100+.

They're called the Lettermate I/e's and they sell for chicken feed; starting at \$199.00.

Being LetterMates from BDT Products, they have all the features you'd expect: continuous feeding action, an adjustable bin for horizontal or landscape printing, and easy, super-fast installation by the user.

Your local BDT dealer would be proud as a peacock to show off the LetterMate I/e's. Give him a whistle.



**Nothing tops a printer like a LetterMate** 

For More Information, call or write: BDT Products Inc.

BDT Products Inc. 17152 Armstrong Ave. • Irvine, CA 92714 • (714) 660-1386 • Telex 681-334 • Telecopier (714) 474-0480  
In West Germany BDT GmbH • P.O. Box 80 • D-7210 Rottweil, W. Germany • Telephone (0741) 248-0 • Telex 762-876 (bdtr) d

Inquiry 49 for End-Users. Inquiry 50 for DEALERS ONLY.

small-computer game.

Moreover, there's no question about it: useful MacSoftware is beginning to appear. It's now possible to use the Macintosh as a serious business machine—and still have some fun while doing it.

Before a number of you write me triumphant letters saying "I told you so," let me hastily add that just about all that new software is for the 512K-byte Macintosh; the 128K-byte Mac still has severe limits. When the Mac first came out, I advised readers not

to get one. Those who took my advice saved a lot of money; now you can get a Fat Mac for less than you'd have paid for the thin one a year ago. During that year the 128K-byte Mac might have been a good companion for

(continued)

## ITEMS DISCUSSED

BARON (for Macintosh) . . . . .	\$59.95	MACINTOSH 128K bytes . . . . .	\$2195	NEC PC-8201 . . . . .	\$399
MILLIONAIRE (for Macintosh) . . . . .	\$59.95	512K bytes . . . . .	\$2795	NEC Home Electronics 1401 Estes Ave. Elk Grove Village, IL 60007 (312) 228-5900	
TYCOON (for Macintosh) . . . . .	\$59.95	Apple Computer 20525 Mariani Ave. Cupertino, CA 95014 (408) 973-2222		OMNIDRIVE (for Macintosh) 5.5 megabytes . . . . .	\$1495
Blue Chip Software 6740 Eton Ave. Canoga Park, CA 91303 (818) 346-0730		LILITH CAD SYSTEM . . . . .	\$21,000	11 megabytes . . . . .	\$1995
CONCERTWARE (for Macintosh) . . . . .	\$49.95	LILITH COMPUTER . . . . .	\$8000	21 megabytes . . . . .	\$2995
Great Wave Software POB 5847 Stanford, CA 94305 (415) 325-2202		MACMODULA-2 . . . . .	\$150	Corvus Systems Inc. 2100 Corvus Dr. San Jose, CA 95124 (408) 559-7000	
CP/M-68000 . . . . .	OEM product	Modula Corporation 950 North University Ave. Provo, UT 84604 (801) 377-3598		p-SYSTEM IV.2 (SoftTech's liaison) . . . . .	\$250
Digital Research 60 Garden Court Monterey, CA 93940 (408) 649-3896		MACNosy . . . . .	\$50	STRIDE 440 . . . . .	starts at \$5900
FAST FINDER . . . . .	\$100	Jasik Designs 343 Trenton Way Menlo Park, CA 94025 (415) 322-1386		THE NOD (available as a development tool) . . . . .	\$400 with cable
Tardis Software 2817 Sloat Rd. Pebble Beach, CA 93953 (408) 372-1722		MEGAMAC . . . . .	\$1395	Stride Micro 4905 Energy Way Reno, NV 89502 (702) 322-6868	
HP-110 . . . . .	\$2995	Micrographic Images 21040 Victory Blvd., Suite 210 Woodland Hills, CA 91367 (818) 368-3482		TECHFONTS (for Macintosh) . . . . .	Price unavailable
LASERJET . . . . .	\$3495	MODULA-2 (for IBM PC) . . . . .	\$495	Paragon Courseware 4954 Sun Valley Rd. Del Mar, CA 92014	
Hewlett-Packard 974 East Arques Ave., MS 72LP Sunnyvale, CA 94086 (800) 367-4772		Logitech Inc. 805 Veterans Blvd. Redwood City, CA 94063 (415) 365-9852		UNDERWARE COLORPENS . . . . .	\$14.95
HYPERDRIVE (for Macintosh) for 512K-byte Macintosh . . .	\$2195	MODULA-2 (for Stride) . . . . .	\$500	Diversions Inc. 1550 Winding Way Belmont, CA 94002 (415) 591-0660	
for 128K-byte Macintosh . . .	\$2795	SCENICWRITER . . . . .	\$995	WYSE WY-50 TERMINAL . . . . .	\$695
(includes \$600 upgrade to 512K-byte Macintosh)		Scenic Computer Systems Corporation 14852 Northeast 31st Circle Redmond, WA 98052 (206) 885-5500		Wyse Technology 3040 North First St. San Jose, CA 95134 (408) 946-3075 (inside California) (800) 421-1058 (outside California)	
General Computer Company 215 First St. Cambridge, MA 02142 (800) 422-0101		MOSYS OPERATING SYSTEM (for Stride) . . . . .	Price unavailable		
LASERWRITER . . . . .	\$6995	Robinson Systems Red Lion House St. Mary's St. Painswick GL6 6QR United Kingdom 0452-813699			

## *The Modula Corporation now has a working Modula-2 compiler for the Macintosh.*

those trying to grow a beard or making a study of wristwatch icons, but serious users would have gotten a lot more mileage out of something else.

The Mac is a better buy now. Of course, the documents still are inadequate in my judgment; even the \$150 "Inside Mac" package you can buy extra—do you know of any other company that sells you photocopied loose-leaf sheets in lieu of providing real technical documentation?—isn't very complete.

### **HACKING YOUR MAC**

The day I returned from the MacFaire I packed up my Macintosh and shipped it off to General Computer. Eight days later it returned with 512K bytes and the internal hard disk they call Hyperdrive. It's fast and works fine.

I also ordered another 128K-byte Mac. That one will go to Janek Kaliczak, president of Micrographic Images Corp., the outfit that did many of the House of Dracula special effects for the Universal Studio tours. Janek and his people demonstrated the MegaMac at the MacFaire. This is a package that can be installed by dealers in 20 minutes for less than \$1500; and it puts a full megabyte of memory at the MacUser's disposal. The Micrographic Images people did some clever work integrating the MegaMac into the Macintosh operating system, but even so the Macintosh can't make full use of more than 512K bytes of memory. However, the other 500K bytes in the MegaMac isn't wasted. It's used as a RAM (random-access read/write memory) disk. That lets the Mac swap screen images faster than I'd have believed. Every time I went past the MegaMac display, Janek was surrounded by huge

crowds fascinated by the Mac's newfound speed.

When it came time to integrate memory into the Mac, Janek used a VAX to disassemble the Macintosh ROMs (read-only memories) and operating system into source code. There's another way now. One of the programs demonstrated at the MacFaire was MacNosy, a disassembler that can be aimed at the Macintosh ROMs or any other Mac program. I haven't used it yet, but I have looked at the documentation. As you may suspect, you need to know something about 68000 assembly language and how disassemblers work. Given that and determination, though, you can find out a lot about what's happening in the Mac; more than Apple tells in its overpriced "developer's" documentation.

Anyway, my second Mac will become a MegaMac, after which the Corvus people will install their new hard disk, Omnidrive. I'll then be able to compare that system against the Fat Mac with Hyperdrive. It should prove interesting.

### **MACMODULA-2**

The Modula Corporation now has a working Modula-2 compiler for the Macintosh. The compiler was announced last summer, but it took a while to deliver. I don't recommend the 128K-byte Mac for any but the most patient users, but amazingly the compiler will even work with that. A story goes with that.

Richard Ohran got his Ph.D. from the Swiss Federal Institute of Technology in Zurich. Niklaus Wirth was his sponsor. Ohran believes he understands Modula-2. Moreover, the Modula Corporation has developed a perky little board for the Apple II that lets you write good Modula-2 programs and run them on that venerable machine. (The board speeds up the Apple II to be faster than a Macintosh. Apple owners ought to look into it.) Consequently, Dr. Ohran thought little of promising a Modula-2 compiler for the 128K-byte Mac even though he hadn't done much work on it.

"It almost ruined the company," Ohran told me. "They say it's a 128K-byte machine, but they use chunks of memory for everything. The screen, the operating system, clipboard, you name it. There's not more than 60K bytes of usable memory in the 128K-byte Mac."

"Agreed," I said. "But why didn't you just abandon the effort and wait for the 512K-byte Mac?"

"Because I'd promised to do the 128K-byte compiler."

There are still people who believe a promise made is a debt unpaid. Richard Ohran is one of them.

In the 128K-byte Mac, the compiler is still more curiosity than useful. Don't get me wrong. You can use Modula-2 to write useful programs for the small Mac; it will just take you a while because the compiler is slow. Of course, it takes a long time to write programs for the 128K-byte Mac in *any* language. Once compiled, Modula-2 programs run as fast as anything else. On the 128K-byte Mac that isn't very fast, but many find it adequate—or say they do.

However, MacModula-2 really shines in the 512K-byte Mac. The Fat Mac is no Lilith, nor yet even a Stride; but it's plenty good enough to learn Modula-2 with, and in the learning you can write some really powerful—and useful—programs.

Ohran's MacModula-2 is complete. It gives you access to the Mac Toolbox and QuickDraw. There's an editor, a linker, and a run-time system to execute programs.

There's also an excellent manual. This documentation is more than complete, comprising not merely a manual on how to use Modula-2 with the Macintosh but a darned good introduction to the Modula-2 language. The manual explicitly states that it does not contain enough information for you to learn the Modula-2 language without additional source materials, and I suppose that's true; but anyone at all familiar with Pascal will have little trouble writing programs in MacModula-2, especially if they have Glitch's *Modula-2 for the Pascal*

(continued)



# DATAEASE™

## The Corporate Database Standard.

### DATAEASE

#### #1 with Corporate users.

Thousands of businesses, both large and small, use DATAEASE to solve their needs. Because DATAEASE, with its ideal combination of power and ease-of-use, allows you to gather, link, calculate and report information key to decision making — all without programming skills.

*"We chose DATAEASE over dBASEII™ and Lotus 1-2-3™ because most of the programming was already done."*

**Joe Dane, Human Resources Director**  
MCI Telecommunications Corporation

*"Office staff members with little to no computer experience are actively using DATAEASE to improve productivity in handling large amounts of information."*

**Louis M. Brigando, Senior VP,**  
MetPath, Inc.

*"We switched from a \$250,000 mini system to a \$15,000 system of IBM PC's and DATAEASE. Now orders, inventory, sales... everything is easier. All without the help of a programmer."*

**J.A. Fulmer**  
Robinson  
Foundry, Inc.

### DATAEASE

#### #1 with Reviewers

*"I was very impressed with its overall performance and features."*

**Bill Jacobson**  
BYTE, October 1984

*"DATAEASE is a true winner."*

**Business Computer Systems**  
April 1984

*DATAEASE was rated good or excellent in performance, documentation, ease-of-use, error handling, support...in all areas.*

**InfoWorld**  
March 25, 1985

*"DATAEASE is perhaps the most effective blend of ease-of-use and performance available for PC users to date."*

**Data Decisions**  
January 1985

For information or the dealer nearest you call:

## 800-243-5123

### DATAEASE

#### #1 in Corporate sales.

According to several recent best seller lists, DATAEASE is now the industry standard for corporate users who want a database that doesn't require programming:

*DATAEASE tops dBASEII, R:BASE™ in Corporate Software sales.*

**Infosystems, March 1985**  
Corporate Best Seller List

*DATAEASE outsold all other database management systems — ahead of dBASEIII™, Symphony™, Framework™ and R:BASE 4000.*

**MIS, Inc., September 1984**  
A leading supplier to Corporate America

*DATAEASE ranked #3 on best sellers list; outselling Lotus 1-2-3™, R:BASE and Powerbase™*

**Software News, March 1985**  
Corporate Best Sellers List

Why settle for less? Contact Software Solutions, Inc. for more information on DATAEASE, the #1 choice of Corporate America.

**Software Solutions, Inc.**

305 Bic Drive, Milford, CT 06460

203-877-9268

Telex: 703972



© 1985 Software Solutions, Inc.

Scandinavia  
West Soft A/S, Alesund, Norway; (47) 71-41141

United Kingdom  
Sapphire Systems, Essex, 01-554-0582

South Africa  
Dataflex, Craighill; 11724-6353

West Germany, Austria  
M&T Software Verlag, Munich; 089-4613-0

Switzerland, France  
Softsource, S&A 1222 Vesenz, Switzerland; 022-5518-55

*Concertware is a  
music program  
that simulates  
different instruments  
and explains harmony.*

User at hand. There's plenty of information tucked into the MacModula-2 manual's 540+ pages. It also has an index and an analytical table of contents. I wish every software publisher would get a copy and study it; the MacModula-2 manual could serve as a standard for the rest of the industry to shoot for. Sure, I can find some things to gripe about, but there's not a lot out there this good at this price.

Modula Corporation's Mac-Modula-2 will do for the Macintosh what Borland's Turbo Pascal did for the IBM PC. If you're a Macintosh enthusiast, make haste to get a copy. You'll be glad you did.

**AND STILL MORE . . .**

There was a lot more excellent Macintosh software. Given that I'm running out of space, I think the best thing I can do is list some of what impressed me and promise full reviews for later.

Paragon Courseware has some wonderful technical fonts for the Mac. If you're into doing circuit diagrams, op amps, or complex math, look at what Paragon offers. It's great.

In previous columns I've mentioned Blue Chip Software's stock market simulation game Millionaire; now they have Tycoon, the commodity market game, and Baron, the real estate

game, for the Macintosh. The PC versions of these games are quite enjoyable, but the Mac versions are even nicer than that. These games will teach you a lot about real-world finances. They're also a lot of fun. Recommended.

Concertware from Great Wave Software is a music program that I'm still fooling around with. It simulates different instruments, explains harmony, and in general taught me more about music than I thought I'd ever learn. Highly recommended.

Diversion Inc. has added UnderWare Colorpens to their UnderWare line. UnderWare is a ribbon for the Mac Imagewriter that will put iron-on transfers on a sheet of normal bond paper. The idea is to use the Mac to create a T-shirt design; flip it to a mirror image; and print it on normal paper. You can now take the Under-

*(continued)*

<p>Come visit us in our Long Island Showroom 226 Sherwood Ave. Farmingdale, NY 11735</p>	<h1>Computer Channel</h1>	<p style="text-align: right;">Se Habla Español</p> <p style="text-align: right;">Cable: COMSYSTEC NEW YORK Telex: CSTNY 429418</p>																														
<p><b>OUR SPECIALTY: IBM COMPATIBLE PRODUCTS, GRAPHICS, DATABASE, 68000 UNIX, EXPORT</b></p>																																
<p><b>IBM PC &amp; COMPATIBLES</b> IBM PC/XT/AT, Compaq, Zenith, Sanyo, Leading Edge, Televideo <b>OTHER POPULAR COMPUTERS</b> Epson, Cromemco, NEC PC, Altos, North Star, Dual 68000, DEC PDP/VAX, APPLE — Mac We also have selected demonstration models for sale at special prices</p>	<p><b>AN AFFORDABLE CAD SYSTEM FOR ENGINEERS &amp; DESIGNERS</b></p> <p style="text-align: right;"><b>PKG. PRICE \$5800</b></p> <div style="text-align: center;"> </div>	<p><b>NEW UNDER \$4000 COMPLETE CASH REGISTER—COMPUTER—POINT OF SALE—COMBINATION SYSTEM—CALL!</b></p> <p>ALSO — SYSTEMS FOR MULTI-USER ACCOUNTING, LEGAL, MEDICAL, DENTAL, PHARMACY, CHIROPRACTIC, WHOLE-SALERS, RETAILERS, WAREHOUSES, BUSINESS, DATABASES, COMMUNICATION, NETWORKS</p>																														
<p><b>IBM PC II ADD-ONS</b> IBM AT BOARDS, DRIVES, ETC. AT COMPATIBLES BUSBOARDS—MULTIFUNCTIONS ALL IN ONE SLOT AS A to D, D to A, I/O, RAM, CLOCK, FLOPPY-HD, MONITOR, INTERFACES</p>	<p style="text-align: center;"><b>PLOTTERS/DIGITIZERS</b></p> <table border="0"> <tr> <td><b>GTCO</b></td> <td></td> <td></td> </tr> <tr> <td>MD7-0606P</td> <td>\$365</td> <td>DP5-1624T \$2199</td> </tr> <tr> <td>MD7-0606C</td> <td>424</td> <td>DP5-2436 3334</td> </tr> <tr> <td>MD7-1212P</td> <td>620</td> <td>DP5-3648 3900</td> </tr> <tr> <td>MD7-1212C</td> <td>676</td> <td>DP5-4260 4869</td> </tr> <tr> <td>DP5-1117</td> <td>1669</td> <td></td> </tr> </table>	<b>GTCO</b>			MD7-0606P	\$365	DP5-1624T \$2199	MD7-0606C	424	DP5-2436 3334	MD7-1212P	620	DP5-3648 3900	MD7-1212C	676	DP5-4260 4869	DP5-1117	1669		<p style="text-align: center;"><b>PRINTERS</b></p> <p><b>EPSON, OKIDATA</b> EPSON LQ1500 24 wire, excellent quality . . . \$1145 Hewlett Packard ThinkJet . . . 450 LaserJet . . . 3,300 Toshiba P1340 80 col., 160 cps . . . 799 Dataproduct 8010 180 cps . . . 545</p> <p style="text-align: center;">***Letter Quality***</p> <table border="0"> <tr> <td>Star Power Type</td> <td>18 cps parallel/serial . . . . . 375</td> </tr> <tr> <td>NEC 2050</td> <td>20 cps for IBM PC . . . . . 760</td> </tr> <tr> <td>3550</td> <td>35 cps for IBM PC . . . . . 1,520</td> </tr> <tr> <td>Clitoh F-10</td> <td>50 cps . . . . . 1,350</td> </tr> <tr> <td>Juki 6100</td> <td>18 cps . . . . . 459</td> </tr> <tr> <td>Qume 11/40</td> <td>w/IBM interface . . . . . 1,420</td> </tr> </table>	Star Power Type	18 cps parallel/serial . . . . . 375	NEC 2050	20 cps for IBM PC . . . . . 760	3550	35 cps for IBM PC . . . . . 1,520	Clitoh F-10	50 cps . . . . . 1,350	Juki 6100	18 cps . . . . . 459	Qume 11/40	w/IBM interface . . . . . 1,420
<b>GTCO</b>																																
MD7-0606P	\$365	DP5-1624T \$2199																														
MD7-0606C	424	DP5-2436 3334																														
MD7-1212P	620	DP5-3648 3900																														
MD7-1212C	676	DP5-4260 4869																														
DP5-1117	1669																															
Star Power Type	18 cps parallel/serial . . . . . 375																															
NEC 2050	20 cps for IBM PC . . . . . 760																															
3550	35 cps for IBM PC . . . . . 1,520																															
Clitoh F-10	50 cps . . . . . 1,350																															
Juki 6100	18 cps . . . . . 459																															
Qume 11/40	w/IBM interface . . . . . 1,420																															
<p><b>3COM NETWORKING PROGRAMS</b></p> <p>Prices subject to change. American Express, Visa/Mastercard add 3%. F.O.B. point of shipment. 20% restocking fee for returned merchandise. Personal checks take 3 weeks to clear. COD on certified check only. N.Y. residents add sales tax. Manufacturers' warranty only. International customers, please confirm price before order. Accept P.O. from Fortune 500, schools and gov't.</p> <p><b>Computer Channel</b> 226 Sherwood Ave. Farmingdale, NY 11735 For information CALL (516) 420-0142</p> <p style="text-align: right;"><b>TELEX: 429418 CSTNY</b></p>	<table border="0"> <tr> <td><b>Amdtek</b></td> <td>6-pen X-Y Plotter . . . . . \$895</td> </tr> <tr> <td><b>Houston Instrument</b></td> <td>DMP-29 8-pen X-Y Plotter . . . . . 1,795</td> </tr> <tr> <td></td> <td>DMP-40 1 pen plotter . . . . . 795</td> </tr> <tr> <td></td> <td>DMP-41, DMP-42 22 x 34", 24 x 36" 2450</td> </tr> <tr> <td></td> <td>DMP-51, DMP-52 22 x 34", 24 x 36" 3850</td> </tr> <tr> <td></td> <td>HIPAD DT-11AA Digitizer . . . . . 725</td> </tr> <tr> <td></td> <td>HIPAD DT114 4-button digitizer . . . . . 780</td> </tr> <tr> <td><b>Hewlett Packard</b></td> <td>7470A 2-pen plotter . . . . . 940</td> </tr> <tr> <td></td> <td>7475A 6-pen plotter . . . . . 1,640</td> </tr> <tr> <td><b>Calcomp M84</b></td> <td>8-pen plotter . . . . . 1,650</td> </tr> <tr> <td></td> <td>945A/PCI 24 x 48" . . . . . 13,800</td> </tr> <tr> <td></td> <td>955A/PCI 34 x 59" . . . . . 15,600</td> </tr> </table>	<b>Amdtek</b>	6-pen X-Y Plotter . . . . . \$895	<b>Houston Instrument</b>	DMP-29 8-pen X-Y Plotter . . . . . 1,795		DMP-40 1 pen plotter . . . . . 795		DMP-41, DMP-42 22 x 34", 24 x 36" 2450		DMP-51, DMP-52 22 x 34", 24 x 36" 3850		HIPAD DT-11AA Digitizer . . . . . 725		HIPAD DT114 4-button digitizer . . . . . 780	<b>Hewlett Packard</b>	7470A 2-pen plotter . . . . . 940		7475A 6-pen plotter . . . . . 1,640	<b>Calcomp M84</b>	8-pen plotter . . . . . 1,650		945A/PCI 24 x 48" . . . . . 13,800		955A/PCI 34 x 59" . . . . . 15,600	<p style="text-align: center;"><b>SYSTEM CONFIGURATION</b></p> <p>We assemble systems at special prices, including software, special operating systems, shells etc. Call us for business systems, CAD systems, networking, LANS, graphics, main-frame links, interfacing, application integration.</p> <p style="text-align: center;"><b>PLEASE ASK US FOR QUOTES! FORTUNE 1500 COMPANIES— LET US SOLVE YOUR SYSTEM NEEDS!</b></p>						
<b>Amdtek</b>	6-pen X-Y Plotter . . . . . \$895																															
<b>Houston Instrument</b>	DMP-29 8-pen X-Y Plotter . . . . . 1,795																															
	DMP-40 1 pen plotter . . . . . 795																															
	DMP-41, DMP-42 22 x 34", 24 x 36" 2450																															
	DMP-51, DMP-52 22 x 34", 24 x 36" 3850																															
	HIPAD DT-11AA Digitizer . . . . . 725																															
	HIPAD DT114 4-button digitizer . . . . . 780																															
<b>Hewlett Packard</b>	7470A 2-pen plotter . . . . . 940																															
	7475A 6-pen plotter . . . . . 1,640																															
<b>Calcomp M84</b>	8-pen plotter . . . . . 1,650																															
	945A/PCI 24 x 48" . . . . . 13,800																															
	955A/PCI 34 x 59" . . . . . 15,600																															

# Now! Tek quality and expert advice are just a free phone call away!

**The industry standard in CRT performance.** Crisp, easy-to-read, bright CRT; 14kV accelerating potential, provides high writing rate and small spot size. Full size 8x10 cm display for measurement accuracy.

**Display controls are flexible and easy to use.** Separate intensity controls reduce blooming in alternate sweep mode. Focus tracking minimizes control adjustment and BEAM FIND eliminates confusion.

**Vertical system provides measurement assurance.** Flat transient response and high accuracy ensures true reproduction of your signals. Fast risetime and high bandwidth is well suited for a variety of measurement.

**Perform delayed sweep measurements accurately and easily.** Both sweeps can be displayed alternately making differential measurements easy and accurate (1%). An interlocking SEC/DIV control simplifies set-up.

**Stable hands-off triggering.** P-P AUTO detects signal peaks, then sets the trigger level for you. Display asynchronous signals using VERT MODE triggering. Independent TV field and line selection.

**Front panel laid out by function for ease of use.** Color coding aids the user in operation. Functions and modes are placed logically. All nomenclature is clearly labeled, and protected behind a scratchless Lexan surface.



1-800-426-2200

**Our direct order line gets you the industry's leading price/performance portables... and fast answers from experts!**

The 60 MHz single time base delay 2213A, the 60 MHz dual time base 2215A and the 100 MHz dual time base 2235 offer unprecedented reliability and affordability, plus the industry's first 3-year warranty\* on labor and parts, CRT included.

**The cost: just \$1275 for the 2213A, \$1525 for the 2215A, \$1750 for the 2235.**† Even at these low prices, there's no scrimping on performance. You

have the bandwidth for digital and analog circuits. The sensitivity for low signal measurements. The sweep speeds for fast logic families. And delayed sweep for fast, accurate timing measurements. All scopes are UL Listed and CSA approved.

**You can order, or obtain literature, through the Tek National Marketing Center.** Technical personnel, expert in scope applications, will answer your questions and expedite delivery. Direct orders include comprehensive 3-year warranty\*, operator's

manual, two 10X probes, 15-day return policy and worldwide service backup.

**Order toll free: 1-800-426-2200, Ask for Rick.**

In Oregon, call collect: (503) 627-9000. Or write Tektronix, Inc. P.O. Box 1700 Beaverton, OR 97075

**Tektronix®**  
COMMITTED TO EXCELLENCE

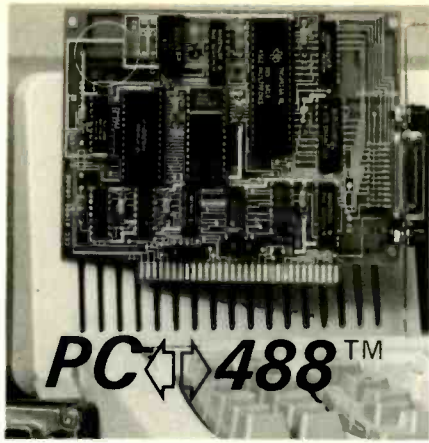

**An IEEE-488 interface for all IBM-PC's and COMPATIBLES**

**VERSATILE**

Easy-to-use commands for all IEEE-488 (GP-IB, HP-IB) functions.

Resident firmware supports **BASIC, Pascal, C, and FORTRAN.**

Emulates Hewlett-Packard controller functions and graphics language statements.

Supports Tektronix® Standard Codes and Formats.

Print listings, plot graphs, and use **Lotus 123™** with IEEE-488 peripherals.

**FAST**

Direct memory transfer rates to 800K bytes/second.

**PROFESSIONAL**

Clear and concise documentation includes a complete tutorial, programming examples, and application programs.

**\$395.00 complete.** There are no additional software charges.

Find out why **PC488** is the first choice of over 500 companies.



**CAPITAL EQUIPMENT CORP.**

10 Evergreen Avenue  
Burlington, MA. 01803  
(617) 273-1818

IBM is a trademark of International Business Machines Corp.  
Lotus 123 is a trademark of Lotus Development.  
Tektronix is a trademark of Tektronix, Inc.

**CHAOS MANOR**

Ware Colorpens and color in yellow, red, blue, green, and orange. This produces an iron-on that is colorfast unless you have a housekeeper who believes in using very hot water and Clorox.

If you're looking for something to put on your T-shirt, Miles Computing (Suite 212, 7136 Haskell Ave., Van Nuys, CA 91406, (818) 994-7901) has a treasury of clip art called Mac the Knife; this is a whole bunch of patterns, new fonts, and illustrations from *Star Trek* and *Star Wars* (R2D2 and the *Enterprise* are both here); Liberty Enlightening the World; fancy borders; international symbols; U.S. and world maps; the Illuminati Pyramid and Eye; and lots of other fun stuff. It's obviously useful for more than T-shirt design, but I intend to use it with UnderWare to produce something for the next science-fiction convention I go to. Recommended.

I also picked up the latest version of Mike Lehman's Fast Finder, a program I reviewed in the March issue. It's much faster than the standard Finder and highly recommended for anyone trying to do program development on the Mac. I am told by insiders that the new official Macintosh Finder—not released as I write this—corrects a lot of the original Finder's defects, so that Fast Finder is not quite as vital as it once was. On the other hand, I don't have the new Finder, so I can't compare. I do know that Fast Finder is fast, allows batch commands, works, and is in production.

There was a lot more Mac software. The flood has begun.

**WINDING DOWN**

I haven't even mentioned my trip to Texas Instruments in Dallas and Austin. TI has a corporate center for human factors where they're developing a keyboard that will knock your eyes out. I can hardly wait until they have an experimental model.

They're also doing fantastic things with artificial intelligence and natural-language interfaces. I've got some of their programs for Big Tex, our TI Professional; alas, given the construction I've been unable to do justice to what

TI has wrought. Next month for sure.

I've also got a huge pile of Hewlett-Packard software and hardware, including the HP 110 lapboard portable. I'm quite impressed with the 110. Like Percy, my NEC PC-8201 lapboard, you can't lose text by turning the machine off. Alas, although I find the HP 110's electronics, keyboard, and on-board programs (Lotus 1-2-3 and WordStar in ROM already) really nice, I cannot see the electronic-crystal display. I know such displays can be made visible, because I have no trouble adjusting Percy for almost any angle and light condition; but the 110 needs strong light and I have to hold my head right, else I find myself squinting at the display. It may just be me. I have no trouble recommending the HP 110—I've now taken it on three trips, and while it's a bit heavier than the NEC it's no more trouble—for those who've examined it and don't have visual problems; but for heaven's sake try it before you buy one!

I also have a pile of new fonts for the HP LaserJet; Tony Pietsch has yet another version of WRITE, my favorite text editor, with print drivers to use the LaserJet's true proportional spacing and other such goodies. My love affair with the printer continues unabated.

The book of the month is Ben Wattenberg's *The Good News Is the Bad News Is Wrong* (Simon and Schuster, 1984). It doesn't have much about computers, but it tells why we'll live to enjoy the computer revolution. There's no game of the month. What with the house construction and the annual school play, neither the boys nor I had time.

Next month we'll be upstairs in the new quarters, the Good Lord willing and the San Andreas don't let go. ■

*Jerry Pournelle welcomes readers' comments and opinions. Send a self-addressed, stamped envelope to Jerry Pournelle, c/o BYTE Publications, POB 372, Hancock, NH 03449. Please put your address on the letter as well as on the envelope. Due to the high volume of letters, Jerry cannot guarantee a personal reply.*

# THE MCGRAW-HILL ENCYCLOPEDIA OF ELECTRONICS AND COMPUTERS

## YOURS FOR ONLY \$2.95!

WHEN YOU JOIN THE LIBRARY OF  
COMPUTER AND INFORMATION SCIENCES.

You simply agree to buy 3 more books—at handsome discounts—within the next 12 months.

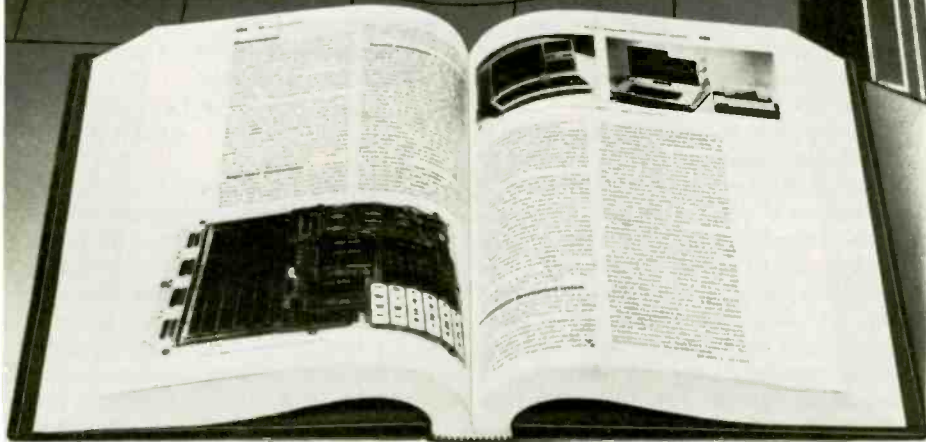

### 4 Good Reasons to Join

1. **The Finest Books.** Of the hundreds and hundreds of books submitted to us each year, only the very finest are selected and offered. Moreover, our books are always of equal quality to publishers' editions, *never* economy editions.

2. **Big Savings.** In addition to getting the McGRAW-HILL, ENCYCLOPEDIA OF ELECTRONICS AND COMPUTERS for \$2.95 when you join, you keep saving substantially—up to 30% and occasionally even more. (For example, your total savings as a trial member—including this introductory offer—can easily be over 50%. That's like getting every other book free!)

3. **Bonus Books.** Also, you will immediately become eligible to participate in our Bonus Book Plan, with savings up to 70% off the publishers' prices.

4. **Convenient Service.** At 3-4 week intervals (16 times per year) you will receive the Library of Computer and Information Sciences News, describing the Main Selection and Alternate Selections, together with a dated reply card. If you want the Main Selection do nothing and it will be sent to you automatically. If you prefer another selection, or no book at all, simply indicate your choice on the card, and return it by the date specified. You will have at least 10 days to decide. If, because of late mail delivery of the News, you should receive a book you do not want, we guarantee return postage.

Everything you want to know about computers is clearly, simply explained in the McGraw-Hill *Encyclopedia of Electronics and Computers*. With 964 double-columned pages, 477 articles by 272 contributors, and 1266 illustrations, tables, and graphs that clearly illustrate the how, the why, and the what.

Written by the most eminent authorities of the academic and industrial world, with substantial bibliographies for further study, the Encyclopedia covers such topics as: algorithms, analog computers, circuit theory, computer graphics, computer storage technology, data communications, disk recording, ferroelectronics, graph theory, information theory, lasers, optics, switching systems, and video disk recording. And that's just the beginning.

Join *The Library of Computer and Information Sciences* to keep up-to-date on the developments, theories, and applications important to your job.

*The Library of Computer and Information Sciences* offers an unmatched data bank for any computer professional. As the oldest, largest, and most respected club of its kind, it

brings you the finest publications from the most authoritative writers in the field. *All at significant savings!*

As a member, you won't have to spend time sorting through hundreds of books to find the ones worth reading. The Club's editors do it for you. Reviewing the hundreds of books submitted monthly, they select only those books that offer the critical, hands-on information you need. Books that give you an in-depth knowledge on a variety of exciting subjects—from systems design to applications, from software engineering to personal computing. You'll regularly be offered critically important books you might otherwise have missed.

Take advantage of our 10-day, no-risk examination period.

Join the Club risk-free, simply by sending for the McGraw-Hill *Encyclopedia of Electronics and Computers* now. When it arrives, examine it for 10 days. If you are not completely satisfied, return the book and owe nothing. Otherwise, we'll bill you just \$2.95.

Simply complete and mail the card attached.

If the reply card has been removed, please write to: The Library of Computer and Information Sciences, Dept. 7-CV2-61613, Riverside, N.J. 08075, to obtain membership information and an application.

Byte 7/85

## RAM DISKS AND CALENDAR/I

Dear Jerry,

In the February BYTE, you rightly condemn those authors and publishers who hurry to put out "junk" computer books and thereby reap quick and cynical profits; because, in your words, "newcomers to the computer field are desperate for books," making them ripe for rip-off. I agree, and I also agree with your implied argument: that if newcomers were greeted with real information and patient instruction, not with mysticism and condescension, they would become knowledgeable and able to pick out the good from the bad.

I was distressed to read on page 340: "A RAM (random-access read/write memory) disk, for those few who tuned in late (my emphasis), is . . ." If I said that from the pulpit, I would be condemned for putting down newcomers, to my church or to computers, and that condemnation would be just and justified. Later (page 352) you explain: "96-tpi (tracks per inch) . . ." If you need to explain "tpi" to your readers, why condescend to those who haven't learned what "RAM disk" means?

On another subject, I finally (after some anxious inquiry as to compatibility) bought Calendar/I from Clear Systems. You praised it highly; I can testify that your praise was not loud enough. For me, and I think for anyone who works with non-uniform schedules for several-to-many persons or groups, this thing is worth its weight in platinum. That's *not* what I want to tell you about Calendar/I, though.

What I want to tell you is that the folks at Clear Systems have one of the better license agreements I've seen. I think you will smile rather than frown at it. Parts read like this: "Clear Systems grants . . . license to use the software in *any computer belonging to the customer . . . the customer may modify or make copies of any part of the software*, provided . . . [that only 5 copies are made and that they are labeled with Clear Systems' trademark and copyright notices, and that they aren't sold or given away]" (all emphasis mine). And further, in an accompanying letter from Barbara Like (propitious name), product manager, I was told, "We're very nice about refunding money if the program isn't compatible

with a mysterious (to us) computer;" and there follow hints and encouragements about making Calendar/I run.

Run it does on Zaccheus my Z-100, to my delight; and delighted I am, also, to meet some nice, courteous, and (on the evidence) competent software people. Calendar/I and its folks are (famous phrase): Recommended.

JOHN CARL BOWERS  
Bronx, NY

*It's a real dilemma: although most of my readers have read one or more of my columns before, and many will have read quite a few of them, BYTE is a growing magazine, and thus inevitably there will be a fair number of readers who have never read my stuff at all.*

*I can't claim to have discovered RAM disks, but I was one of the earliest to write about them, and I've covered the subject in at least a dozen columns. I grow weary of explaining what a RAM disk is, but of course I must lest I lose someone just starting to read BYTE. Thus my "for those few who tuned in late," meaning (I thought) for those who just began reading my column. Since I hadn't explained tpi—or certainly hadn't as often as I'd explained RAM disk—I saw no need to think of a tag for that.*

*You're saying my tag was terminally cute. Perhaps you're right. It's still a problem: What do I say when I must, for the benefit of those who have just begun reading BYTE, explain something yet once more?*

*Glad you had pleasant experiences with Clear Systems. One of the satisfactions of writing this column is discovering small companies that my readers like.*  
Best.—Jerry

## TERMINAL RECOMMENDATION

Dear Jerry,

I saw the letter from Kaye Caldwell in the September Chaos Manor Mail (page 385) and wanted to add my praise of the Wyse WY-50. I have had mine for six months and couldn't be more pleased. Everything in that letter is true, especially about the feel of the keyboard and the location of the keys. Although it was not advertised, mine came with the function keys programmed

for WordStar, but that can be deselected and the functions programmed any way you want. The list price may be \$695, but it is available for much less (I got mine for less than \$500 from Computer Warehouse in Phoenix).

The only criticism I have is with the little user's manual that comes with it. It is sufficient to hook up and use the terminal, but there are no explanations or definition of terms, as if every buyer is an expert on terminals. The reference manual (\$25) and maintenance manual (\$50) are extra, but don't expect to get them fast. It took three letters to Wyse just to get a response saying how much they were.

Nevertheless, the WY-50 is quite a bit of terminal for the money.

CHARLES D. HAMILTON  
APO New York

*Stride Micro (Sage) has recently adopted the Wyse as its standard terminal. I saw a bunch of them at the Stride Faire and liked them. I was particularly impressed with the way they can communicate with the host computer at 38,400 bits per second; that's effectively as fast as my memory-mapped video!*

*However, two Wyse users told me that Wyse terminals have an intermittent keyboard-bounce problem. Shades of TRS-80 Model II! I gather it's not prohibitively severe, but it can be annoying. We're getting a Wyse; more when I know more. Thanks.—Jerry ■*

## USERS GROUP CORNER

COMPUTER WRITER'S ASSOCIATION  
POB 312  
Millford, OH 45150

Excellent market report and newsletter for writers publishing articles about computers. Dues \$15/year.

MICRO COMPUTER USERS  
OF FAIRBANKS  
c/o Smith Design  
POB 80582  
Fairbanks, AK 99708

Includes special groups for Osborne, Atari, Kaypro, and others. Meetings described as chaotically enjoyable.



# THE BETTER LETTER BOX

**Introducing EasyPlex™. The new, easy-to-use electronic mail system from CompuServe.**

Finally! Electronic Mail that's so easy to use you can start composing and sending messages the first time you get online.

Designed for various experience levels, EasyPlex has a menu mode with simple, easy-to-follow directions for beginners, and it lets experienced users save time by working in the prompt or command modes. With EasyPlex, you can compose, edit, send, file, and take advantage of sophisticated

options previously available only with more expensive services.

CompuServe's EasyPlex lets friends and relatives, associations and club members communicate any time of the day or night. And small business owners, real estate professionals, insurance agents, lawyers, writers, etc. can communicate quickly and simply—either interoffice or interstate. "It's Easy." "Just Plex it!"

Best of all, EasyPlex is available to all CompuServe subscribers. And along with EasyPlex, you get hundreds of valuable and entertaining computing options. Plus the assurance of belonging to the largest, fastest

growing computer information service in the world and the premier supplier of business information to FORTUNE 500 companies.

Start communicating! To buy a CompuServe Subscription Kit, see your nearest computer dealer. To receive our informative brochure or to order direct, call or write:

## CompuServe®

Information Services, P.O. Box 20212  
5000 Arlington Centre Blvd., Columbus, Ohio 43220

**800-848-8199**

In Ohio, call 614-457-0802

Inquiry 91

An H&R Block Company

# To get the world's most advanced 50 CPS daisywheel printer, you'll have to pay less.

The TeleVideo® 750 delivers 50 CPS performance using an incredible 40% fewer parts than any comparable printer. So it's no mere coincidence that the 750 sells for up to 40% less. With quality so good, you can produce camera ready copy directly.

Cost of ownership gets even better with time. Fewer parts equal more reliability: an average of 65,000 pages between failures. And with the works in a drawer, repairs — when necessary — are quick and easy.

Fewer parts also equal a low profile, small footprint, and light weight. The TeleVideo 750 printer is plug compatible with almost every computer system. And TeleVideo provides a complete selection of supplies and paper handling accessories.

You won't find a printer better suited than the TeleVideo 750 to an office environment. So if you're responsible for printer purchase decisions, the TeleVideo 750 should make your job significantly easier. Now there is a daisywheel printer that gives you high performance, low cost and excellent quality.

For information about TeleVideo Printer dealers in your area or a free demonstration, call 800-521-4897. In California 800-821-3774.

**Regional Sales Offices:** Schaumburg, IL (312) 397-5400, Norcross, GA (404) 447-1231, Waltham, MA (617) 890-3282, Syosset, NY (516) 496-4777, Irving, TX (214) 258-6776, Irvine, CA (714) 476-0244, San Jose, CA (408) 971-0255.

Inquiry 356

## Now \$1195



Printers  
© TeleVideo Systems, Inc.







## SNOBOL and Icon

Language  
designer  
Ralph  
Griswold  
looks at  
his language

BY EZRA SHAPIRO

**D**uring the course of 1984, three implementations of SNOBOL dialects appeared on the microcomputer language market (see page 350). SNOBOL, a convoluted acronym for "string-oriented symbolic language," emerged from Bell Laboratories in the mid-1960s and has been a staple of the mainframe and minicomputer environments ever since. It's a unique language with an unusual syntax, geared to text processing and string pattern matching. Because SNOBOL is unlike any other programming language, it is still taught in many computer science departments. It has also spawned a loyal community of users who find it the easiest way to solve programming problems involving nonnumeric data. However, because the language has never been sold commercially, it has remained something of an oddity . . . although it has refused to die. The most widespread version of the language, SNOBOL4, has changed little since its release to the public domain in 1968.

One of SNOBOL4's authors, Ralph E. Griswold, now teaching at the University of Arizona, has gone on to create a new language called Icon that combines many of SNOBOL's facilities for string analysis with more traditional control structures—although its philosophy and operation are anything but traditional. Icon is not yet available for personal microcomputers in any commercial form.

Early this year, Bruce Webster and I got a chance to chat with Griswold about SNOBOL, Icon, and computer languages in general. We found him to be charming, outspoken, and bemused by the sudden spurt of interest in SNOBOL.

**BYTE:** It's funny, when you look at the "hot new languages" and start looking back at SNOBOL4, you notice that a lot of the concepts—things like list processing, goal-directed programming, and object orientation—have always been a part of SNOBOL.

**Griswold:** Part of the reason for that is the philosophy we had at the time we developed SNOBOL4; we tried to find things that would make life easier for the programmer—not necessarily for the implementor. We kind of let ourselves freewheel with SNOBOL4. We didn't know a lot of computer science; we weren't constrained by knowledge. We were more concerned with

facility than efficiency at that time. We thought that human beings were more valuable than computers, which is something people forget.

I think a lot of things in SNOBOL4—list processing, so-called object-oriented processing, even a strong coherent system for string processing—have not been in later languages because of concerns about implementation.

I'll give you an example. In SNOBOL4 a string is a data type; it's not an array of characters. It's a type in its own right; a string is a data object. That's a concept that's still not generally accepted in programming languages. Even in C a string is essentially still an array of characters, and there's a difference, a substantial difference as far as the user is concerned.

But those ideas were going on back then. They're not really new ideas; they've just achieved a level of public acceptance that they didn't have then.

**BYTE:** Has the major interest in SNOBOL over the years been in the humanities community, for things like syntactic analysis?

**Griswold:** Well, that's a major component of it—people doing research in the humanities have always been SNOBOL fans. PL/I took over at some point as being the predominant language because many of these people were at IBM mainframe facilities, and SNOBOL4 is not officially supported by IBM. SNOBOL4 became the language of choice for computing in the humanities in Europe, more so than in this country, because they have so much textual material to process. There's always been a substantial user community there.

But people using SNOBOL4 cover every application imaginable except perhaps business applications. Systems programmers use it a lot when they have data-processing jobs to do—processing compilers, reformatting things. There's a lot of scientific programming; people working in molecular

(continued)

BYTE West Coast is prepared monthly by BYTE's editors and staff in San Francisco and Palo Alto. Correspondence should be addressed to BYTE West Coast, BYTE Magazine, 425 Battery St., San Francisco, CA 94111.

genetics or areas where the data is naturally nonnumeric do a lot of work with it. For a long time there was (and maybe still is) a fair amount of use of it in the federal government in classified departments—particularly for cryptography. The CIA and the NSA used it quite a bit for some time. The major use of the language has

been in academic institutions. It's a traditional part of the curriculum in courses in comparative programming languages at upper division levels and lower graduate levels, as a language that's sufficiently different to be interesting from an intellectual standpoint.

BYTE: *Availability is always a critical factor.*

Griswold: That's true. The success of SNOBOL4—to the extent that you would call it successful—is due to its availability, the fact that it's in the public domain, it's been supported for a great deal of time, it's essentially free in most of its implementations.

What usually makes a language available is when a computer manufacturer supports it officially. For very good reasons, computer manufacturers don't want to support a wide range of products, particularly those that are out in left field somewhere, because it's a very expensive process to support products like that—distribution, documentation, the maintenance burden. Something has to be really in demand before somebody will officially support it. If a company decides to make something available, then it comes into widespread use no matter how bad it is.

SNOBOL4 has never been officially supported by any organization. It's always been unofficial. Even at Bell Laboratories it was unofficial. There was never an official SNOBOL project there; it was done as a by-product of other work. It was never budgeted, it was never officially acknowledged. It was released but not marketed.

With the personal computer community and the computer networks, software is becoming more readily available, and that's going to change things. Sometimes it takes longer than one expects for the change to occur. In the case of SNOBOL4, the three PC implementations all came out within a few months of each other. After years and years and years of people talking about it and saying it couldn't be done, all of a sudden three of them came out. Until they did, I wasn't sure anybody would ever do it.

BYTE: *Is SNOBOL going to go through another round of evolution at this point?*  
Griswold: I've talked with the implementors and know the pressures they feel on both sides, the advantage of remaining compatible with existing programs versus the desire to take advantage of the nature of the computing equipment and facilities that

(continued)



# LATTICE<sup>®</sup> WORKS

## LATTICE TOPVIEW TOOLBASKET RELEASED

If you develop programs oriented to take advantage of IBM's TopView multi-tasking window environment, you need the Lattice TopView Toolbasket.

The Lattice TopView Toolbasket is a library of more than 70 C functions to control window, cursor, and pointer functions, along with printer controls, cut and paste functions, debugging, and general utilities. It also includes an assembler interface and master file and data definition headers.

This new Lattice product speeds your program development with its documented tips on handling I/O and dispatch routines, plus its sample programs with source code and batch files your programs can be patterned after.

The Lattice TopView Toolbasket runs on the IBM PC, XT, AT, and compatible systems with 256K (512K and TopView Toolkit from IBM recommended). The Lattice TopView Toolbasket is available for \$250. Binary and Source Code available for \$500. The Lattice TopView Toolbasket was developed for Lattice by Strawberry Software.

Speed your TopView program's release. Order the Lattice TopView Toolbasket today!

## UNICALC COMPONENT SPREADSHEET SOURCE KIT CHOSEN BY ORACLE

Lattice, Inc. and Oracle Corp. have jointly developed SQL-Calc, a unique product based on Lattice's UNICALC spreadsheet program and the ORACLE Database software.

SQL-Calc gives users the ability to extract and manipulate database information using spreadsheet features made popular by programs such as VisiCalc, SuperCalc, and Lotus 1-2-3. SQL-Calc is the first full-featured spreadsheet to be coupled so closely with a powerful relational database to give users the ability to treat SQL database access statements like normal spreadsheet formulas.

The UNICALC Source Kit, used to develop SQL-Calc, is a component electronic spreadsheet kit for UNIX, MS-DOS, PC-DOS, and other systems that support the C language, and is available to other program developers. It allows program developers to incorporate electronic spreadsheet features into new or existing software programs. UNICALC also gives users many display options and will generate printed reports in a variety of formats which may be saved for further manipulation by a word processing system.

The UNICALC Source Kit is available with a wide range of royalty and licensing arrangements at very competitive pricing. Call Lattice, Inc. at (312) 858-7950 to discuss your applications.

## LATTICE C COMPILERS CHOSEN BY MORE THAN 26,000 SOFTWARE DEVELOPERS!

The top-selling C compiler, Lattice C, is now published directly by Lattice, Inc.

When you purchase our edition, you get support directly from the people who wrote the C compiler. You also get free "bug fix" updates during the warranty period. When you register your purchase with us, you are notified of all updates, enhancements, and new C programming tools as they become available. And, as with all Lattice products, you are covered by a money-back guarantee.

When you are ready to purchase a C compiler, consider the source. Then call us: Lattice, Inc.

## ASK ABOUT OUR "TRADE UP TO LATTICE C POLICY"



Lattice, Inc.  
P.O. Box 3072  
Glen Ellyn, IL 60138  
(312) 858-7950  
TWX 910-291-2190

International Sales Offices  
Belgium: Softshop. Phone: (32) 53-664875  
England: Roundhill. Phone: (0672) 54675  
Japan: Lifeboat Japan. Phone: (03) 293-4711

# ARE YOU PLANNING TO UPGRADE YOUR PC AND DON'T KNOW HOW?

**DON'T WORRY! CALL US ON OUR HOTLINE AND WE'LL SAVE YOU THE HEADACHE AND HUNDREDS OF DOLLARS.**

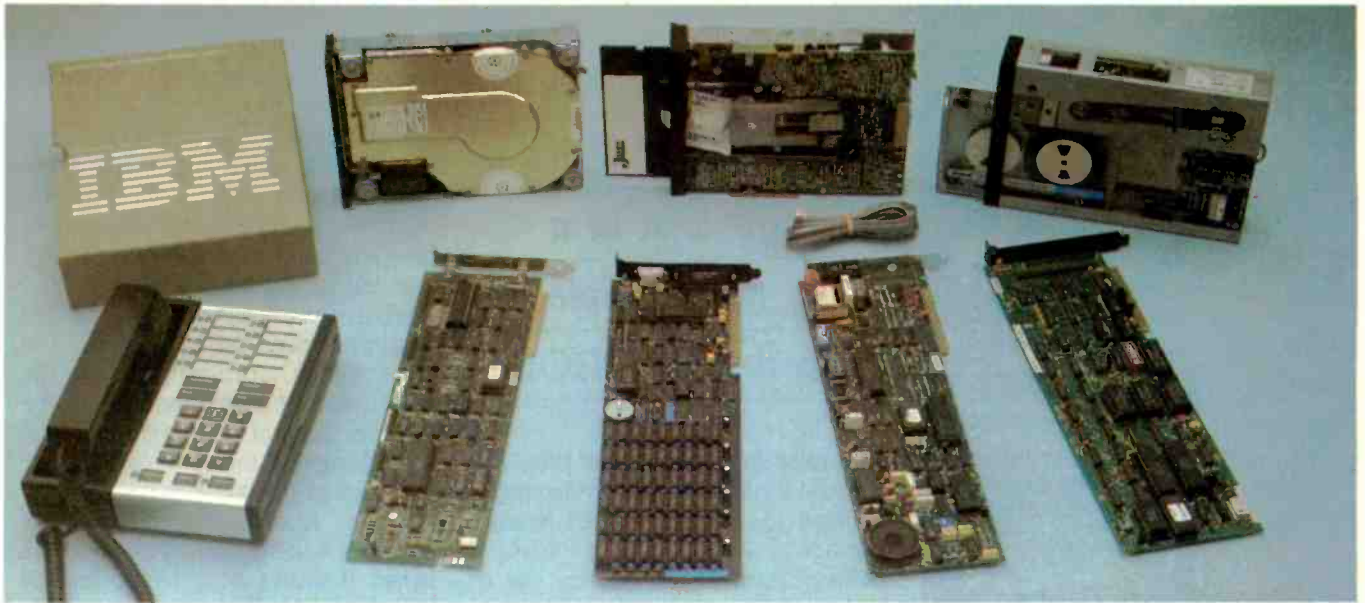

For years we have been selling our products through distributors hoping that they will provide better technical support and services to our customers. Lately, we find that most of them are not really technical and sensitive enough to satisfy our customer needs. In order to provide quality products and services at factory prices, we have decided to sell to you direct by passing distributors. Each of our product comes standard with an easy do-it-yourself installation guide. If you still have problems, our highly trained technical staff is only a phone call away to answer any of your questions.

To further back up our commitment for high quality and better services, our products offer a one year warranty and 30-day no question asked money back guarantee policy.

**10 MB Half-Height Hard Disk Subsystem** ..... ~~\$589.00!~~ *Too Low To Quote!*

Save \$500 on our 10 MB Microscience hard disk drive which is normally listed at \$1,095. Microscience drives are the leader in the half-height hard disk industry and have been selected by many major computer manufacturers e.g. COMPAQ.

**20 MB Half-Height Hard Disk Subsystem** ..... **\$775.00!**

Convert your PC into an AT. Save \$500 on our 20 MB Microscience hard disk drive which is normally listed at \$1,275. This drive is truly a breakthrough in technology. Its power requirement is actually lower than a 10 MB hard disk making it suitable to be installed into a PC.

**10-45 MB 1/4" Streaming Tape** ..... **\$865.00!**

No more worries in losing your valuable data. Save \$700 on this Wangtek streaming tape drive which is normally listed at \$1,595 and recently approved by IBM as their backup tape.

**20 MB Streaming Tape** ..... **\$725.00!**

Want to back up your valuable data and cannot afford the price? Consider this Memtec streaming tape drive which operates at the same speed as a quarter inch drive however at a much lower price. The limitation is capacity: 20 MB vs 45 MB. If you do not require high capacity back up, this is the ideal choice.

*Please don't hesitate to call us for a free catalog and we will save you hundreds of dollars and headaches.*

**Why would anyone pay more!!!**

**In Canada Call (416) 549-2303**

912 Barton Street, East  
Suite 26  
Hamilton, Ontario  
Canada L8L 3C2

**In USA Call 800-JEDEN US  
In California 800-JEDEN CA  
If busy please call 714-545-8108**

**300/1200 Modem** ..... **\$225.00!**

Want to dial into a bulletin board or NY Stock Exchange? Is price the only thing holding you back so far? Our modems are normally sold at \$425 through normal distribution. We think that is too much, therefore, we will sell to you direct for \$225. Our modem is 100% Hayes & Bell compatible with features like auto dial, auto log on and supports COM3 and COM4. With this card we also include a free communication software package.

**Memory Expansion Card** . **\$199.00 (with 64K)!**

Tired of running out of main memory? Why not expand your PC to the maximum memory of 64K and save \$50 to \$200. Can you imagine at a cost of \$199, we will ship you a memory expansion card capable of expanding 0-384K memory. We would even include a clock calendar with battery, parallel port, serial port, game adapter and 64K memory free. Furthermore, we will give you RAM Disk and Printer Spooler Utilities at absolutely no cost to you.

**Half-Height Floppy Drive** ..... **\$119.00!**

Add a half-height floppy to your PC, XT or AT or replace your full height monster with 2 of these half-height drives.

**Color-Mono Graphics Display Card** .. **\$280.00!**

Are you frustrated to find out that your system can only run graphics either in color or mono? Frustrate no more. Try our graphics controller which offers 640 x 200 resolution in color and 720 x 350 in monochrome graphics. Install it in 5 minutes and save yourself hundreds of dollars.

**New Product Line - Expansion Chassis**

**JEDEN**  
Computer  
Peripherals

1318 W. Sepulveda Blvd.  
Harbor City, California  
90710 USA

BUY  
**EPSON**  
DIRECT  
FROM

**MIDWEST  
COMPUTER  
AND  
VIDEO SUPPLY**

Why pay shipping from  
the East or West Coast?

We ship from St. Louis and  
most orders are shipped  
UPS same day!

CALL TOLL-FREE  
**1-800-527-5274**  
IN MISSOURI 314/423-8300

Best Prices! Fastest Delivery!  
No extra fee to use your  
Master or Visa . . . Call Us Last!

CALL FOR PRICES



Other Printers	Monitors
HOMEWRITER 10	CR-5650 A
RX-100	CR-5650 G
FX-100	CR-6600
JX-80	CR-6700
CR-420	

**Diskettes . . . Lowest Prices!**

TIRED OF SOME  
MAIL ORDER RUNAROUND?  
**WE DELIVER PRODUCT . . .  
NOT PROMISES!**  
Dealer Inquiries Invited

Exclusively **EPSON**  
AND COMREX

**Midwest  
Computer & Video  
Supply Company**

P.O. Box 28448  
St. Louis, Missouri 63146



**C.O.D.**

BYTE WEST COAST

*'Icon is competition  
for SNOBOL4; it's a  
successor to it in a  
sense. Most people  
prefer it to SNOBOL4.'*

are available at the present time. I've advised them to make compromises. Maintain the integrity of the language, but not at the expense of making it awkward and out of date or out of kilter with the computing context in which people are using it. That includes things like input and output, memory use, and so forth.

There's another point that inhibits them besides the desire to be compatible. They're working from existing implementations; they're not starting from scratch. They're taking generic implementations, the original SNOBOL4 implementation, called the SIL implementation, which was done in the 1960s, and Macro SPITBOL, which was done in the 1970s. Those are portable, generic systems, and all but one or two implementations of SNOBOL4 work from them.

I don't think anybody's going to do a language redesign for several reasons. It's not a language that most people will be able to implement starting from scratch. People learn in compiler courses how to write implementations of Pascal; there are a lot of tools for this—it's conventional knowledge. SNOBOL4 is complicated, difficult, sophisticated, the algorithms are not obvious, the implementation techniques are arcane. Very few people have attempted to implement it from scratch, and many of those have failed to implement the most important features of the language. It's a lot of work. I don't think there's enough motivation for anyone to undertake that; not that people don't exist that can do it, but it's not something an average programmer can sit down and do. A person who can write a C

compiler might not be able to implement SNOBOL4.

And I think there's enough wrong with the language that changing it represents a very substantial problem, not just in the implementation, but in deciding what to do with the things that are wrong with it.

What does happen is that people write preprocessors for SNOBOL4 to make it look more palatable to the user. I've done that myself with some success. But that's not quite the same as redesigning the language.

The other thing is that it's got competition. Icon is competition for SNOBOL4; it's a successor to it in a sense. It wasn't designed to replace it, but it's a product of the same work. Most people prefer it to SNOBOL4. So there's enough competition there that I think that someone would be reluctant to invest the person-years of effort it would take.

BYTE: Tell us about Icon. Where did it start?  
Griswold: It didn't start anywhere really; it sort of crept up behind us.

SNOBOL4 was developed at Bell Laboratories by a small group of people who needed a tool for doing something. We weren't language designers and we weren't computer scientists; we had some text to process (symbolic mathematics, in fact). So we just sat down and wrote something because we didn't have anything else. It was so successful we turned from solving the problem to becoming language designers.

FORTTRAN was a tremendous triumph in terms of language design, but the designers had available to them a repertoire of mathematical notation, operations, and syntax and semantics that people were used to. There was nothing like that for string processing; I mean, nobody processed strings seriously until computers came along—it's too much trouble. Short of algebraic operations, there wasn't any accumulated body of knowledge on which to base the linguistic facilities—and they're hard to implement, especially on conventional architectures that aren't de-

(continued)

# Meet The Princeton Graphic Systems Family.

**The right monitor at the right price.** Princeton Graphic Systems offers you a complete family of high performance personal computer monitors. Monitors that deliver the compatibility, resolution, and reliability you need for any application and any budget: from word processing to sophisticated business graphics.



**HX-12E.** High resolution RGB monitor 640x350 lines noninterlaced - .28 mm dot pitch -Compatible with IBM Enhanced Graphics Adapter -Nonglare screen -\$785



**MAX-12.** Amber monochrome -720 x 350 lines -Enhanced to interface with IBM color or monochrome adapter card -Nonglare screen -Can display 16 shades of amber -\$249

**HX-12.** High resolution RGB monitor -640 x 200 lines noninterlaced - .31 mm dot pitch tube-Nonglare screen -\$695



**HX-9/9E.** Nine inch, high resolution RGB monitor non-interlaced -.28mm dot pitch tube -9E compatible with IBM Enhanced Graphics Adapter -Nonglare screen -Green/amber switch -Apple/IBM colors - Etched dark glass screen -\$650/\$750 (9E)



**SR-12P.** PGS's top of the line RGB monitor 640x480 lines noninterlaced - .26 mm dot pitch - Analog input allows for the display of 4,096 possible colors -Compatible with IBM Professional Graphics Adapter -Nonglare screen -\$999



**SR-12.** Super-high resolution RGB monitor -640 x 400 lines noninterlaced -.31 mm dot pitch tube - Nonglare screen - Requires interface card -\$799

## Princeton Graphic Systems. The only real choice.

For office or home use, Princeton Graphic Systems has a monitor that's right for you. Inquire at your local computer store about our complete line of high resolution color and monochrome monitors; monitors that live up to the Princeton Graphic Systems' tradition of quality, performance, and value. **Princeton Graphic Systems.** 601 Ewing Street, Bldg. A, Princeton, N.J. 08540. (609) 683-1660 Telex: 821402PGSPRIN (800) 221-1490. Ext. 304.

**Princeton accessory product line.**  
Undergraduate tilt/swivel monitor base, ColorView card, Green/Amber switch, RGB-80 card and Scan Doubler card.

**PRINCETON**  
GRAPHIC SYSTEMS  
AN INTELLIGENT SYSTEMS COMPANY

IBM Enhanced Graphics Adapter, and IBM Professional Graphics Adapter are trademarks of International Business Machines, Inc. Compaq is a trademark of Compaq Computer Corp. Corona is a trademark of Corona Data Systems, Inc. Apple is a trademark of Apple Computer Corp. PC World is a trademark of CW Communications Inc. SR-12 screen courtesy of Mouse Systems, Inc.

*'With Icon, you can write an easy program that's quick and dirty—use it once and throw it away.'*

signed for this kind of thing. We became interested, from a research point of view, in linguistic facilities for string and list processing, and in implementational techniques.

I came here to the University of Arizona in 1971 from Bell Laboratories and got funding from the National Science Foundation, and it's been funded since then. That's 15 or 16 years of continuous funding in this

area. We've been working on developing programming languages for processing nonnumerical data and techniques for implementing them—the two going hand in hand.

This is a research project; it's not designed to produce another programming language—there are too many of them already—or a commercial product, but it's nice when your research can produce a by-product that's useful in the computing community. Every so often we've gotten to the point where the results of the research needed to be embodied in a working programming language; we've implemented it and made it available to the computing community.

There was a language called SL/5 following SNOBOL4. SL/5 stood for "SNOBOL Language 5"—I think we were kind of embarrassed by the name SNOBOL, which was originally

intended to be a joke and then caught up with us. At some point we realized that we had a conceptual breakthrough in the area of programming-language facilities and we set SL/5 aside and started working on a new linguistic context that became Icon.

Icon looks a lot like SNOBOL4 in some respects, but it looks very different in others. I use both of them indiscriminately, although I prefer Icon. I've taught both of them; I prefer to teach Icon because some of the things in SNOBOL4 date back to a time when our ideas about programming were very different from what they are now, and it's kind of embarrassing. Fun, but embarrassing.

In one sense Icon can be looked at as just what you were talking about, an attempt to keep the good features of SNOBOL4 and replace the bad ones with better ones. It's not an entirely accurate characterization, but it's one way of looking at it.

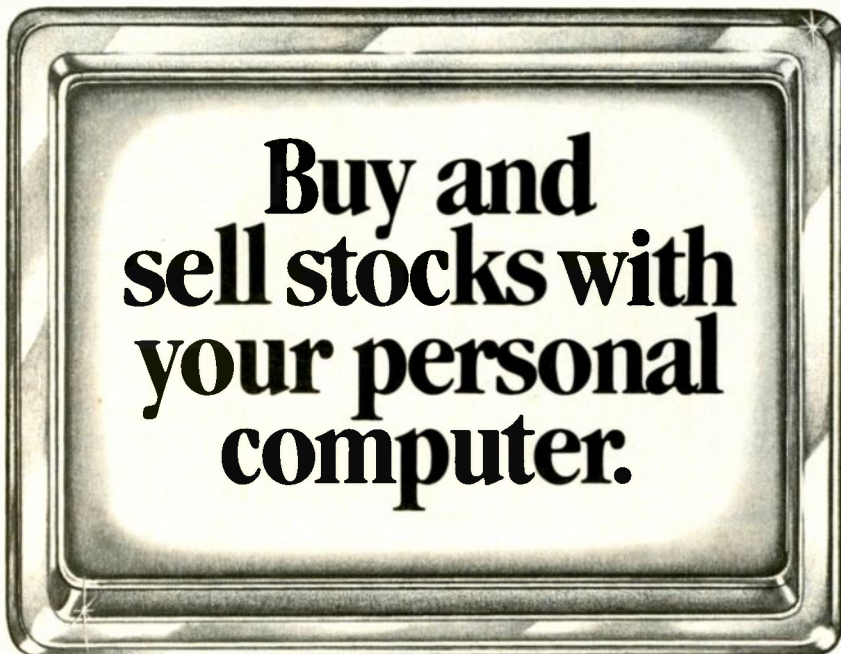

Now use your own personal computer to place stock and option orders 24 hours a day, seven days a week. Get quotes, review your portfolios and more. And save up to 75% on brokerage commissions.\* For more information, call toll free today:

**1-800-544-6666.**  
In Mass., call collect (617) 523-1919  
\*As compared with full-cost brokerage firms. Minimum commission is \$30.00. KQB060185

**FIDELITY**  
**INVESTORS PRESS**  
FIDELITY BROKERAGE SERVICES, INC.  
Member NYSE. SIPC.

BYTE: *What do you see as some of the special features of Icon?*

Griswold: In the first place, it carries some of the features of SNOBOL4 that were attractive to begin with—attractive for certain kinds of uses, for certain kinds of people. It tries to make programming easy, at the possible expense of efficiency. It tends to support the programmer. It's also good for one-shot programs. You can write an easy program that's quick and dirty—use it once and throw it away—very much like SNOBOL4.

The thing that's most intellectually interesting about it and most potentially significant in its influence on programming languages of the future is that expressions can have more than one value. This is a carryover from SNOBOL4 string pattern matching where patterns could first match one thing and then match another.

What motivated Icon really was the recognition that this didn't have to be limited to pattern matching; it could be a general feature of programming, not just string processing. Expressions in Icon are capable of producing a sequence of results. This works

(continued)

# ECCELL<sup>TM</sup> VS. ADVANTAGE!<sup>TM</sup>

Multifunction Board	Orchid ECCELL	Advantage!
Error Correction Code (ECC)	YES	NO
Switchless Installation	YES	NO
Maximum RAM Capacity 4 Mbytes	YES	NO
Free Productivity Software	YES	NO
2 Year Warranty	YES	NO
Supports Lotus/Intel Specification -Breaks the 640K DOS Barrier	YES	NO

Parity Version Available

Attention IBM AT<sup>TM</sup> owners. Your choice of multifunction boards is about to be simplified.

Because once you find out what ECCELL has to offer, you'll have only one choice: ECCELL by Orchid Technology.

ECCELL is the only multifunction board with ECC (Error Correction Code). ECC actually detects and corrects memory errors *before* they do any harm. So you can keep on working without worrying about the disastrous consequences

of losing your data. In fact, ECC is so critical, virtually no mainframe or minicomputer operates without it.

And ECCELL is the *only* multifunction board with switchless installation; the same advanced technology chosen by IBM when they built their AT. Technology so advanced we can back it with an unprecedented 2 year warranty.

Want more proof? Pick up a pen and prove it yourself.

Then pick up the phone and call Orchid Technology at 415-490-8586.

**Finally, advanced technology for the IBM AT.**



Inquiry 265

47790 Westinghouse Dr., Fremont, CA 94539, TXL: 709289

ECCELL is a trademark of Orchid Technology. Advantage! is a trademark of AST Research, Inc. IBM AT is a trademark of International Business Machines Corp.

'SNOBOL lets  
people write  
really simple, compact,  
natural code  
instead of crazy loops,  
nested things,  
and so forth.'

just as well in numerical domains and list processing as in string processing. It makes very simple and natural some kinds of formulations that are contorted and difficult in other languages.

Expressions may produce an infinite number of results. In that sense, Icon is a superset of ALGOL-like languages where you evaluate one expression and you get one result, period, no matter what. In Icon you may get zero results, which corresponds to failure in SNOBOL4; you may get one, which corresponds to normal computation; or you may get a lot of results if the surrounding context needs them to arrive at a solution. There's a flavor of logic programming in Icon; you can see logic programming as a subset of it. There's logical conjunction and disjunction. It all fits into a uniform theoretical

framework that the programmer may never have to see but which has the nice feature that you can see generalizations.

This is what turns people on; they can find new ways of expressing things they couldn't have before. You can iterate overall solutions. There are several programming languages that have iterators, going back to IPL-V, and more recently Alphard, CLU, and SETL, but they're all limited to specific kinds of structures or contexts over all the elements of a set. In Icon you can just have a lot of expressions that produce a lot of results and you can iterate the results overall. You can produce sequences; you can manipulate sequences. Those were all inherent in SNOBOL4 but they were limited to a very small context, and the programmer couldn't get his or her hands on them. Now it's been generalized, and that is what I think is going to appeal to people.

That, I think, is the most significant thing. In fact, it surprised us; we didn't expect that to be the result. That's what really excites people; they can write really simple, compact, natural code instead of all these crazy loops and nested things and so forth. It looks like it ought to look and it produces the results it ought to produce.

Icon produces interesting programs, and it's fun—which can't be knocked. Programmers are, after all, human beings.

BYTE: What Icon implementations are out

there right now?

Griswold: There are several versions. The one that is current, and maintained and supported, is version 5, which is the UNIX-based system. It's written mostly in C. It's available on PDP-11s, VAX-11s, Sun workstations, AT&T 3B20s, Onyx. . . . We have it running on PC/IX now—it's not ready for release, but the full language is running. And there's a VAX VMS implementation. There are 80 or 90 VMS systems out that we know of, most of those in educational environments.

There are probably two dozen implementations of Icon for various kinds of processors in progress, but what will become of them I don't know.

We've decided to go with C as an implementation language and UNIX as an environment. It's not easy to implement this in assembly language. Implementing Icon from the start is considered to be a research project. How you implement the expression-evaluation mechanism efficiently is not something that's obvious. It's incompatible with stack-based implementations of languages like ALGOL-68 or Pascal. So again, the implementations come from a generic one, and that limits its availability.

BYTE: Do you see a specific group of people using Icon?

Griswold: There is an academic group again. It's being taught in comparative

(continued)

# ATTENTION : OKIDATA OWNERS!

USE YOUR PRINTER TO ITS FULLEST WITH MARVEL PRINT™ I

- Allows you to backspace £ 5¢
- Includes a powerful Label Printing Program.
- Enables you to create graphics—even in the middle of the text.
- Proportional Spacing of letter quality text—(justifies right margins).

THIS (on the ML92-93)

Word Processor justification and micro-justification by MARVEL PRINT.

INSTEAD OF THIS:

Word Processor justification and micro-justification by MARVEL PRINT.

On the ML192-193 you can get TRUE proportional spacing with the right margin justified.

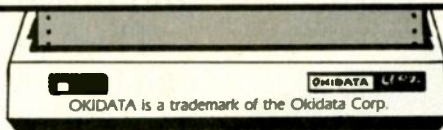

Access ALL features of the OKIDATA 92-93 192-193 Printers ANYWHERE in ANY (ASCII or WordStar) file:

MARVEL PRINT only	\$70
Character set—Clone package	\$25
DEMO disk (Refundable with purchase)	\$5
Proms for 92, 93 w/comp. MARVEL PRINT pkg.	\$145
OKIDATA 192 Printer w/comp. MARVEL PRINT pkg.	\$480
Shipping and handling \$5 (program), \$15 (printer)	

- Character Clone: Allows you to take characters from different sets & combine them for simultaneous use.

Character Sets: Use ours or create your own. Mix: Italics • Script • Science & Math Symbols • Hebrew • Russian • Arabic • Greek • Foreign Language Marks.

■ □ T 6 L 0 u u u  
n y n y n y u w m o a l t  
A B C D E F G H I J K L M N O P Q R S T U V W X Y Z  
[ \ ] ^ \_ ` a b c d e f g h i j k l m n o p q r s t u v w x y z  
{ | } ~ ¡ ¢ £ ¤ ¥ ¦ § ¨ © ª « ¬ ® ¯ ° ± ² ³ ´ µ ¶ · ¸ ¹ º » ¼ ½ ¾  
¿ À Á Â Ã Ä Å Æ Ç È É Ê Ë Ì Í Î Ï Ñ Ò Ó Ô Õ Ö × Ø Ù Ú Û Ü Ý Þ ß à á â ã

$$\int_a^b f(x) dx = \sum_{k=1}^n \frac{b-a}{n} f(x_k)$$

Call or write for more information. Dealers welcome. Works with Apple, CP/M-80, PC-DOS, MS-DOS State System. Visa, American Express, Mastercard welcome. Phone orders accepted or send check or M.O. to:

MARVEL SOFTWARE

1922 Ave. N, 8'th'yn, N.Y. 11230 • (718) 336-2323



# Clear advantage!

This board will expand to 4 Megabytes, 4 serial ports and starts at \$395. That's only part of the story . . .



**W**e love a good story. Better than that, we love a great product. After researching the expansion needs of AT users, we have concluded that the Basic Time AT4X4Plus provides the best array of standard features and upgradeability available. Compare the AT4X4Plus, feature by feature, to the AST Research Advantage!™ expansion board in terms of main board memory, total expansion memory, I/O capability, and price. You will then discover who has the clear advantage.

## You Can Never Have Enough Memory.

That is the oldest saying in computers. Two years ago, customers asked us what they could do with 256K on a PC. How times have changed . . . AT4X4Plus can hold up to 4 Megabytes of memory—2 Megabytes on the board itself and 2 on the 4X4RamPak. An important feature for future multi-user systems.

The 4X4's "double-split memory addressing" capability gives you the choice of using 64K or 256K RAM chips in the first bank of memory. A single row of 64K chips gives you 128K and is just right for the enhanced AT. Using 256K chips in the first row enables you to "max out" user memory to 640K on an unenhanced AT with a single row of chips. The remaining 128K will be available above the 1 MEG memory boundary. A first

row using 256K chips added to a enhanced AT will give you 640K user memory and 384K above the 1 MEG boundary. The memory above 1 MEG can be used by DOS 3.X for VDISK, a virtual ram disk. We think that a 512K board (a first row of 256K chips) is your best buy.

## Want Real I/O Power?

Multifunction boards only start with memory. The AT4X4Plus comes standard with a parallel printer port and an asynchronous serial (RS-232C) communications port. Have more than one serial device? No problem, 3 more are optional, 1 on the AT4X4Plus itself and 2 more on the 4X4DualSerialPak piggy-back board. Need a game port for a joystick or mouse? It's also available as an option.

## Your Satisfaction Is Guaranteed.

With apologies to AST Research's advertising, we think at least 4 out of 5 AT expansion board buyers want more capability at lower cost. The AT4X4Plus is the clear choice and we guarantee it. If you are not completely satisfied with your AT4X4Plus within 30 days of purchase you may return it for a full refund, including the freight to return it. And if you should ever have a problem during the twelve month warranty period, we will fix or replace your board within 48 hours of receipt.

## AT4X4Plus Prices:

AT4X4-128 1 parallel, 1 serial, 128K	\$395
AT4X4-512 1 parallel, 1 serial, 512K	495
AT4X4-1MB 1 parallel, 1 serial, 1 MEG	695
AT4X4-2MB 1 parallel, 1 serial, 2 MEG	1095

## AT4X4Plus Option Prices:

AT4X4-2S second serial port on 4X4 board	\$50
AT4X4-RAM 2 MEG 4X4RamPak	995
AT4X4-SER 2 serial port 4X4DualSerialPak	295
AT4X4-GAME game port	35
AT4X4-PCP preferred customer plan (24-month warranty, 24-hour repairs)	75

All prices include UPS surface charges. For fast delivery, send cashier's check, money order, or order by Mastercard/Visa. Personal checks, allow 18 days to clear. In a hurry? UPS Blue Label is just \$5.00. Company purchase orders accepted, call for prior authorization. California residents, add 6% sales tax.

Hours: M-F 8 am - 5 pm PTZ  
Sat. 9 am - 1 pm PTZ

London (01) 871-2855  
Paris (01) 321-5316  
Sydney (02) 579-3322  
Canada (403) 438-0994



Outside California

**1-800-821-4479**

Inside California

**1-805-987-9741**

4809 Calle Alto  
Camarillo, California 93010

# QUBIE'

Order Today,  
Shipped Tomorrow!™

© 1985, Qubie'. Advantage! is a registered trademark of AST Research Inc.

programming languages as a replacement for SNOBOL4 here at the University of Arizona, and at Carnegie-Mellon, Illinois Institute of Technology, Duke, and a few other places. That's probably because Icon is more cosmetic from a computer science point of view, even if you think of it as SNOBOL4 embedded in Pascal, which it isn't, but even if you think of it that way.

People in industry are using Icon for VLSI [very large scale integration] layout. They're using it for utility programming; we have quite a few utilities written in it here. It's good for all kinds of things, from producing nicely centered labels for mailing lists to random-sentence generators, linguistic analysis, all those unusual things that other languages don't do well. It fits into the humanities very nicely; we're getting a lot of people really looking at Icon in the humanities now. Icon tends to be a catchall like SNOBOL4 for all those applications that other languages are not designed for.

It's still fairly young; SNOBOL started in 1962 and SNOBOL4 came out in 1968. Icon wasn't available to anybody outside the University of Arizona until about 1978 or 1979, and the current version, the UNIX version, is quite a bit more recent than that.

I don't think Icon will develop an

identifiable user community. I think it will be a tool that some people use by preference or other people use for special purposes.

BYTE: *Why the name "Icon"?*

Griswold: No reason. You need a name when you want to talk about something.

One of my colleagues was into one-character names at the time, C being the current attraction, but there were languages called A and B before C. He wanted to call the language S, because it's short. Well, that doesn't look very good when you're writing—it looks like you've made a typo. C is bad enough and S is worse.

So we sat around for a long time trying to think up names. I personally am not very enthusiastic about acronyms or naming languages after famous or infamous people, but you need a name.

I'm responsible for the name. You can find some thread, in the sense that the language development of which it's a by-product has been rather iconoclastic. But that's not why we picked the name; it's just an excuse I can give you for it.

In hindsight, I think the unfortunate thing is that it's caused some confusion because of the use of the word "icon" to mean a symbol in programming systems—the Lisa and so forth—

which came after Icon was developed and published. Every so often we get a request for Icon because somebody thinks he's going to get some kind of screen-manipulation package. But we couldn't have anticipated that. I don't suppose.

We chose not to call it SNOBOL6 because that sounds like it's just another revision, and it's so substantially different. It's as different as PL/I is from FORTRAN.

It's a problem, picking names. You pick a name and later on you wish you hadn't.

BYTE: *Where do you think microcomputers are taking us?*

Griswold: I've been in computing for about 25 years. When I first got into it I thought, "Gee, wouldn't it be great if I could have my own computer! But what happens when I retire because the machine is an IBM 360/50 and costs a million dollars and it's as big as this room?" One of my colleagues said that was his ambition—to have a 360 in his basement. Now, of course, I run UNIX on an IBM PC XT and have at my fingertips essentially the kind of computation that used to be too expensive for even a whole organization to own, at a price I can afford. And I don't think we fully understand what the impact of that is going to be.

BYTE: *In the next few years, we'll be seeing microprocessors that can address gigabytes of memory. There are very few languages or programming concepts out there now that can't be done in that kind of space.*

Griswold: Someone will invent one. Someone *always* invents one. Given that amount of space, they'll find a reason. ■

FOR FURTHER INFORMATION

Griswold, R. E., J. F. Poage, and I. P. Polonsky. *The SNOBOL4 Programming Language*. 2nd ed. Englewood Cliffs, NJ: Prentice-Hall, 1971.

Griswold, M. T., and R. E. Griswold. *The Icon Programming Language*. Englewood Cliffs, NJ: Prentice-Hall, 1983.

For information on Icon, contact the Icon Project, Department of Computer Science, University of Arizona, Tucson, AZ 85721.

## LANGUAGE IMPLEMENTATIONS:

SNOBOL4+ .....	\$95	The Minnesota	
Catspaw Inc.		SNOBOL4 Language .....	\$45
POB 1123		Source code .....	\$500
Salida, CO 81201		Berstis International	
(303) 539-3884		POB 441	
(MS-DOS, CP/M-86)		Millwood, NY 10546	
		(914) 271-5855	
SNOBOL4+ .....	\$95	(MS-DOS)	
Prentice-Hall Inc.		IBM/PC Macro SPITBOL .....	\$195
Micro Service Dept.		Robert B. K. Dewar	
200 Old Tappan Rd.		73 Fifth Ave.	
Old Tappan, NJ 07675		New York, NY 10003	
(800) 624-0023		(212) 460-7470	
(800) 624-0024, in NJ		(MS-DOS)	
(MS-DOS)			

# TAXAN

## We Make Your Apple Shine

Being #1 is an education. Picking the right Monitor for your Apple takes an educated guess, too!

At TAXAN we keep it simple. Our Apple line of Monitors combines many of the great features of our IBM line. Super High-Res and High-Res capabilities allow for the

finest in business graphics. Video games look better, too! And your children will love you for choosing TAXAN instead of Brand X.



**MODEL 420** 12 inch Super High-Res RGB Color Monitor. Fully compatible with Apple, IBM and most other personal computers. 640x262 line resolution. Unlimited colors available through analog video circuit. Black face, non-glare tube.



**MODEL 410** 12 inch High-Res RGB Color Monitor. Fully compatible with Apple, IBM and most other personal computers. 510x262 line resolution. Unlimited colors available through analog video circuit.



**MODEL 210** 12 inch Medium-Res RGB and Composite monitor with audio. Composite Mode: Standard NTSC Signal. Compatible with Apple and most personal and home computers. Removable screen filter, Built-in Audio and VCR input. RGB Mode: Compatible with Apple II+ and IIe computers with interface card (Option). 380x262 line resolution.



**MODEL 116** 12 inch High-Res Amber Monitor. Long Persistence Phosphor with non-glare screen. Fully compatible with Apple, IBM and most other personal computers. 1000 line resolution. More than 20 MHz bandwidth. 2000 character display. Optional Tilt/Swivel Base available Model 110-12. Green Phosphor available (Model 115).



**410-08** RGB interface card for the Apple II, II+, IIe and Franklin Ace 1,000 and I 200 Rev. A only.

**410-15** RGB Module for Apple IIc.

**410-80** 80 Column and RGB interface card Compatible with Apple IIe. Third color cursor for text editing.

**410-8064** Same as 410-80 with additional 64K Ram memory and 6 color double High-Res graphics. Text is color changeable.

### MODEL 500 PRINTER BUFFER

Centronics compatible parallel interface with 64K memory expandable to 256K. Four function modes include: Manual, Double, Free and Command. Compatible with most printers.

### OPTIONS—

**Model 599-01** 64K Extra Memory Add-on

**Model 599-02** Extra parallel Cable



# TAXAN

So, get an education. See TAXAN today!  
**The Smart Choice.**

18005 Cortney Ct. City of Industry, CA 91748 (818) 810-1291

© 1985 TAXAN Corporation

Inquiry 352

\*Apple is a registered trademark of Apple Computer, Inc.

\*IBM is a registered trademark of International Business Machines, Inc.

# DATASOUTH WHEELS OUT YOUR NEW CORPORATE IMAGE

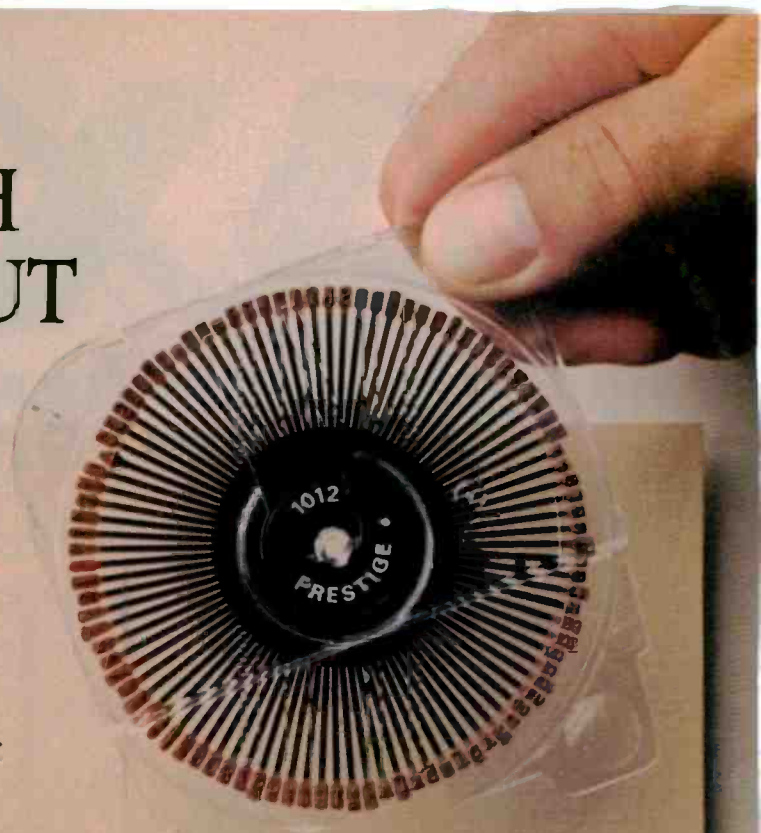

Dear Businessperson:

A good daisywheel printer should work like a pin-stripe suit for your letterhead.

That's why you need a new DaisyWheel 36 from Datasouth. It is, literally, a very impressive machine.

The DaisyWheel 36 is quick, with a top speed of 36 cps. It's more capable than any other daisywheel in its class, with superscripts, subscripts, boldfacing, underlining, text reprinting, red & black color printing and proportional spacing, among other impressive features. And with its Diablo 630 compatibility, your DaisyWheel 36 will get along with just about any computer in your office.

Your secretary will get along with your DaisyWheel 36 too--thanks to its sheet and tractor feed options, cartridge ribbon, and a whole garden of distinctive daisywheel type faces, each with its own protective cassette.

Best of all, the DaisyWheel 36 comes from a company with a most impressive name: Datasouth--the name that means high performance.

So wheel over to your Datasouth Dealer and run some of your best letterhead through a new DaisyWheel 36, the high performance daisywheel from Datasouth.

By the way, the DaisyWheel 36 lists for just \$995

Which is a pretty good price for the best image around.

Eventually yours,

*DaisyWheel 36*



**datasouth**

H I G H P E R F O R M A N C E P R I N T E R S

Datasouth Computer Corporation  
Box 240947 · Charlotte, NC 28224  
704/523-8500 · Telex 6843018 DASOU UW

Inquiry 119

CALL TOLL FREE:  
**1-800-222-4528**

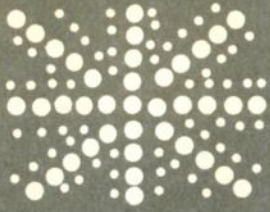

## Starlit Spectrum

Using the  
Sinclair  
Spectrum to  
collect and  
process  
astronomical  
data

BY DICK POUNTAIN

**T**he subject of this month's column is the prominent U.K. amateur astronomer Andrew J. Hollis. He uses a low-cost Sinclair Spectrum microcomputer to perform data capture and processing on observations obtained by photoelectronic photometry (the electronic measurement of the brightness of celestial objects).

Mr. Hollis, who is a chartered engineer by profession, runs the Ormada Observatory from the garden of his house in the northern England country village of Cuddington in Cheshire.

He became interested in astronomy in 1957 when his parents showed him the comet Arend-Roland through a pair of opera glasses; from this beginning he went on to join the British Astronomical Association (B.A.A.) and build his own 8-inch reflecting telescope in the late 1960s. Though his interest in astronomy is broad, he is particularly interested in variable stars and in the asteroids (more properly called the *minor planets*) and is now director of the minor planets section of the B.A.A.

No science (with the possible exception of ornithology) is as open to contributions by "amateurs" as astronomy. Indeed, the term "amateur," which has acquired faintly derogatory overtones in this century, seems barely adequate to describe their efforts. There is certainly nothing "amateurish" about the activities at Ormada Observatory. Therefore, I shall intend the term in its original sense of one who works for love of the subject. The results obtained by Mr. Hollis and his coamateurs are often significant enough to be published in the B.A.A. and other astronomical journals.

The advantage of a large telescope is that it collects more light, hence it can measure fainter objects that smaller telescopes can't detect. Since the giant telescopes are almost always dedicated to the inspection of the most remote objects beyond our galaxy, it's not uncommon for professional astronomers to actively solicit the participation of serious amateurs when an event of

interest like an eclipse occurs in this solar system. The combined small telescopes of amateur observers around the world add up to a formidable instrument.

Time on the large telescopes at major observatories must be booked many months in advance and is tightly rationed. An observer whose allocated slot comes up is then at the mercy of the weather; if conditions are bad, the whole session may be fruitless. Consequently, a professional observer who wishes to study a particular variable star or minor planet may get only 16 or so hours of observation a year. Hollis reckons that he can get in at least 50 hours per year because he is in a position to observe from his garden observatory any time the weather is fit.

### PHOTOELECTRONIC PHOTOMETRY

The study of both variable stars and asteroids depends in part upon measuring their brightness. In the case of a variable star, the aim is to chart the changes in brightness over time. The shape of the light curve so produced can help to answer several questions about the star system that produced the stars: Is it a binary or ternary system of stars orbiting each other? What are their relative sizes? Do they have extensive atmospheres? Are they exchanging matter?

Andrew Hollis spends much time measuring such light curves to derive the times of minima (those points in a star's cycle when the brightness is at its lowest level). He acquires further information by taking accurate measurements of the period of variable stars, i.e., the time between minima. If this is done to sufficient precision, long-term fluctuations can be distinguished, as some stars appear to slow down or speed up over years or decades. Mr. Hollis also measures the brightness of asteroids and plots this against their progress in orbit around the sun. These measurements yield details about their shape and orientation.

(continued)

Dick Pountain is a technical author and software consultant living in London, England. He can be contacted c/o BYTE, POB 372, Hancock, NH 03449.

Before the advent of electronics, brightness was estimated visually using the magnitude system. Certain important groups of stars were classified into groups of similar brightness, and these groups were then ranked in magnitudes—first magnitude being brightest and so on in order of decreasing brightness down to the limits of visual discrimination at the sixth magnitude.

To estimate the brightness of an object visually, you use a star map to identify a nearby star of known magnitude, compare the object with it, and decide whether the object is more or less bright in the telescope than the nearby star. Choose another known star and repeat. By making numerous comparisons of this sort you can assign a magnitude to the object, interpolating if necessary between the two nearest known values. Though it may sound rough, skilled observers can in fact produce remarkably accurate estimates this way. However, it lacks the degree of precision necessary to follow fine variations in variable stars.

Photoelectronic photometry re-

places this visual ranking method with a direct measurement of the light entering the telescope from the object. (To accommodate this, the magnitude system has been refined into a more quantitative logarithmic scale that permits fractional magnitudes extending down to the 20th magnitude and below.)

Some kind of photoelectric detector is placed at the prime focus of a telescope so that the image of the star falls on it. The current or voltage produced by the detector must be in some way proportional to the amount of light falling on it. The telescope is not used to magnify the image of stars, as we do with terrestrial images, but merely as a light collector.

The telescope collects light from a more or less large region of sky (determined by its aperture), not merely from the desired star. To narrow this field to the object of interest, a diaphragm plate with a tiny hole in it is placed at the focus and the star image is positioned (by eye) over this hole, thus excluding surrounding stars. A further refinement is to take a second light reading with the telescope

focused on a region of empty space. This reading can be subtracted from the first to eliminate the residual effect of background light and the spurious dark current produced by most detectors.

Photodetectors typically respond to a broad band of wavelengths in the starlight. Astronomers are interested in certain wavebands and so will usually interpose filters between telescope and detector, allowing only certain bands to pass. Hollis works in three widely studied bands known as the UBV, for ultraviolet, blue, visual.

Readings taken straight from the photodetector bear a most indirect relation to the magnitude of the star, and it is here that a computer can be used to make the necessary conversions.

#### THE HOLLIS SYSTEM

At the time of my visit to Ormada in February, Andrew Hollis's own 300-millimeter telescope was away being rebuilt, and his photometry system was mounted on a borrowed 135-millimeter telescope (it sits on a German equatorial mounting, powered by a synchronous electric motor from a home-built power supply).

At the heart of the system is a side-window photomultiplier tube (RCA 1P21) that does the actual detecting—it looks like those vacuum tubes used in old radios. Photo 1 shows the detector mounted in its enclosure on the telescope—the eyepiece and flip-up mirror allow visual positioning of the star image onto the diaphragm plate.

Inside the evacuated glass envelope of the photomultiplier tube are nine metal anode chambers. At one side is a window through which light passes and falls onto a photocathode, dislodging a few electrons.

A DC voltage of around 1000 volts accelerates these electrons to the first anode. On striking the anode, each electron dislodges more electrons, which accelerate to the second anode, etc. This snowballing effect results in a huge amplification, with around 1 million electrons arriving at

(continued)

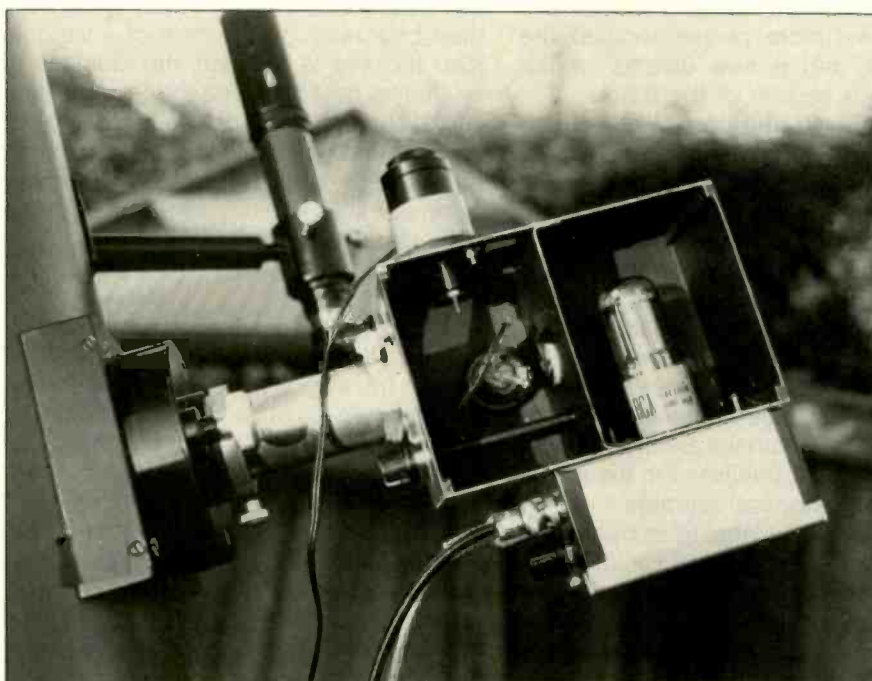
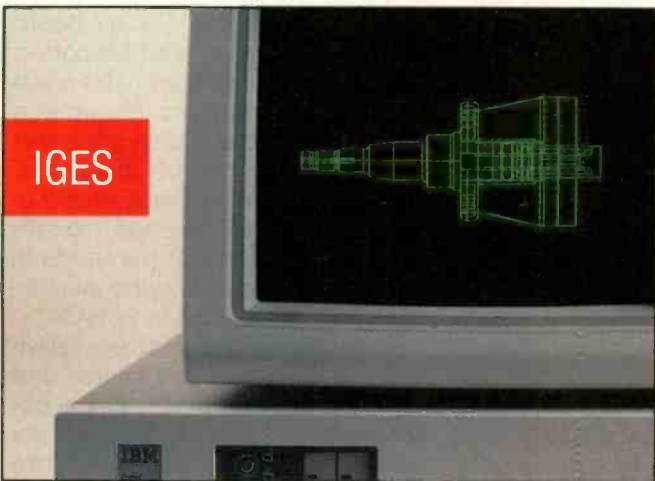

Photo 1: The photodetector subsystem attached to the telescope has a flip-up mirror in the left-hand compartment that directs light to the eyepiece on top.

# See what EnerConnect can do with mainframe graphics on your PC.



*EnerConnect® is the first software package that puts mainframe graphics capability into the hands of anyone with an IBM PC/XT/AT or 3270 PC.*

*Now a PC user can have desktop access to business and technical graphics applications generated by GDDM, ISSCO's Tell-A-Graf® and DISSPLA®, SAS/GRAPH® and IGES datafiles.*

*Once they're displayed, EnerConnect lets you manipulate them in a variety of ways. You can rotate, enlarge, reduce, cut-and-paste with other elements from different mainframe files, add text and even direct output on low-cost PC*

*printers and plotters. All without using expensive mainframe connect and processing time.*

*You can also use our PC-based graphics program, EnerGraphics, to interface with spreadsheet data from LOTUS 1-2-3, VISICALC and other packages, turn the data into easy-to-understand bar charts and then combine them with mainframe graphics.*

*EnerConnect. Your Mainframe-to-PC software link. Developed by the specialists in graphics applications software.*

*Call or write for our free brochure and see what EnerConnect can do for you.*

**ENERTRONICS** SEEING IS BELIEVING

*The interface program is written to use interactive printer output, much like the old days of the Teletype.*

the final anode for every electron initially dislodged by a photon.

The end result is a tiny burst of current, measured in nanoamps or even picoamps, proportional to the original amount of light. To increase efficiency, the star image is actually defocused by a lens after passing through the diaphragm aperture, so that it covers more of the photocathode; only the total amount of light is important, not the image itself.

The processing of this tiny signal begins immediately when it is passed to a high-gain current-to-voltage amplifier. (Hollis uses an Intersil ICL7650 chopper stabilized op-amp on a single chip.) The output is now a DC voltage in the range of 0-10 volts. However, it varies during each observation, and reading it directly would involve messy averaging calculations. Consequently, Hollis passes this signal to another chip, a Teledyne 9400C voltage-to-frequency converter, which outputs either a stream of pulses or a continuous square wave whose frequency is proportional to the input voltage.

This can now be sent to a pulse counter and the count read off from a calculator-style visual display. By recording for a fixed period of time, the number of pulses counted will be a measure of the light received integrated over that period.

Hollis finished his basic system in 1983 and began recording observations manually from the pulse-counter display. Each observation requires at least three readings: two from the star (which are averaged) and one from the background sky (to be subtracted). Sometimes readings must be

repeated because some stray event lights up the sky and causes a bad reading.

To obtain standard star magnitudes, these readings must be performed on both the object of interest and a comparison star of known magnitude. Then these two readings need to be reduced using various mathematical formulas to convert them from instrumental magnitude to the Standard UBV Magnitude. One formula calculates the differential air mass (i.e., the distance the light had to travel through the earth's atmosphere) according to the stars' heights above the horizon, another corrects for instrumental scale factors, while others convert from geocentric to heliocentric time.

Finally, subtracting these results yields the differential magnitude of the object of interest; a long, timed series of such differential magnitudes is required to show the variation in brightness, and thence the time of minimum.

**COMPUTERIZED DATA ACQUISITION**

It quickly occurred to Hollis that this whole rigmarole, including the initial capture of data from the instrument, could be performed by a microcomputer with considerable savings of effort and increase of reliability. He selected the Sinclair Spectrum because of its low cost, availability, and its large volume of add-on circuitry published in the electronics hobby press.

The Spectrum, Britain's largest selling computer, was sold for some time in the U.S. (in a slightly modified form as the Timex 2000). For those who are not familiar with it, it's a Z80-based machine with 48K bytes of RAM (random-access read/write memory) and a highly individual BASIC in ROM (read-only memory). It is supplied with no standard I/O (input/output) ports (e.g., RS-232C or Centronics) but has a parallel expansion socket, using a proprietary bus, and cassette port. Internally it is a low chip-count design, with all the peripheral activities controlled by a single ULA (uncommitted

logic array, or gate array as it is commonly called in the U.S.).

Hollis built his own interface box to fit onto the bus-expansion connector. This contains the high-gain amp and voltage-to-frequency converter chips and a Z80A-PIO (parallel I/O) chip.

Instead of taking the pulse output from the voltage-to-frequency converter to a counter, the alternative square-wave output is taken to the first data pin of the PIO. The PIO is configured in mode 3, or control mode, with no handshaking. The net effect is that the central processing unit sees the first bit of an 8-bit port toggling on and off at the frequency of the square-wave signal.

Hollis realized that Sinclair BASIC would be too slow to read this port—a sampling rate of at least 6500 reads per second is required. He wrote a short machine-code subroutine that counts the number of changes of state of the single bit that is input over a variable integration period, typically 10 seconds, and returns the answer in the Z80's BC register to the main interface program, written in BASIC.

Hollis doesn't like to take a television set out into the confined and often damp environment of the observatory, and so the interface program is written to use interactive printer output, much like the old days of the Teletype. Data can be inspected immediately on the Sinclair printer, a tiny low-cost device that prints electrostatically on rolls of 4-inch metalized paper and takes its power from the Spectrum. Any reading that is clearly wrong can be deleted and taken again. Satisfactory readings can then be stored on cassette tape for further processing by other programs.

To further simplify the business of gathering data, Hollis has built a remote-control unit to operate the Spectrum. This is made from an off-the-shelf 5-key cursor keypad mounted in an alloy box and connected by a long lead to another interface box on the bus-expansion port. It allows Hollis to take readings without leaving the telescope.

After an observing session the

*(continued)*



# CHECK-OUT ENERGRAPHICS™

## YOUR TOTAL GRAPHICS SOFTWARE

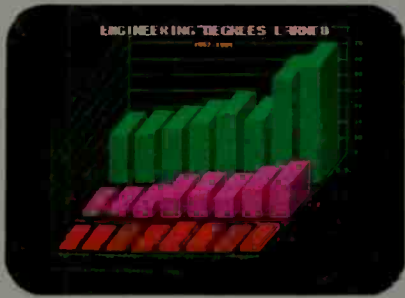

**Presentation Business Graphics**  
EnerGraphics delivers pie charts, flowcharts, bar charts, line graphs and more with easy interface to Lotus 1-2-3, MultiPlan and other spreadsheet. You'll learn it quickly because we're menu-driven.

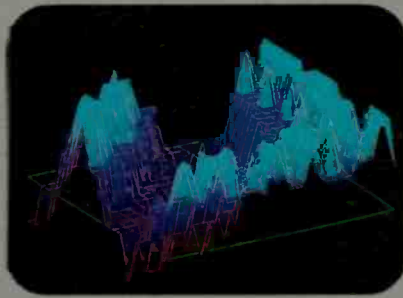

**Drawing Capability With EnerGraphics**, simple keystroke commands enable you to create text, flow, gantt, PERT and organization charts with the capability to enlarge, reduce, rotate, draw, modify, duplicate and overlay.

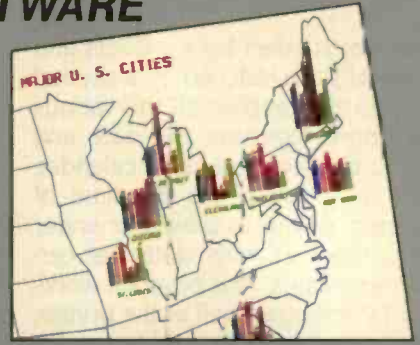

**3-D Object & Surface Drawings**  
EnerGraphics gives you entry-level 3-D CAD features such as zoom, rotate and hidden line removal.

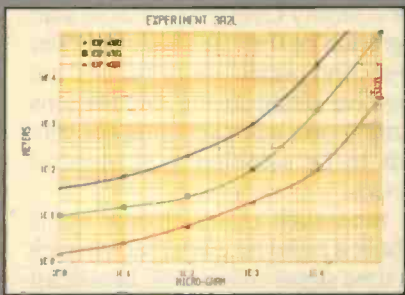

**Statistics** EnerGraphics enables you to analyze data using linear and log scales to do linear and polynomial regression. Statistical information can be represented in scatter graphs.

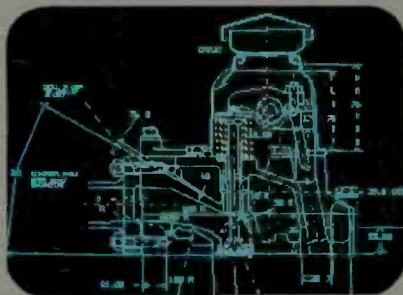

**Mainframe Link** Our new EnerConnect program allows you to combine PC-based graphics with mainframe graphics such as GDDM, ISSCO'S Tel-A-Graf®, Disspla® and IGES data files.



**PC Compatibility** EnerGraphics can give you an unlimited number of graphics applications on Wang, TI, IBM PC/XT/AT, 3270/PC and compatibles.



**Slide Show** Any of our attractive graphics can be converted into color or b&w slides, or overhead or on-screen presentations using the Polaroid Palette.

# FORTUNE 500

**Corporate Use** You'll find EnerGraphics is the graphics software choice of over 100 leading corporations with more being added all of the time.



**Price** At a retail price of just \$350 (\$450 with plotter) EnerGraphics actually costs less than many packages that offer only a few of these features.

EnerGraphics. Brought to you by the specialists in graphics application software.

Find out why users rate us at the top among stand alone business graphic packages. Just check with your local EnerGraphics dealer today.

# ENERTRONICS

## SEEING IS BELIEVING

Enertronics Research, Inc. • 150 N. Meramec St. Louis, MO 63105 • (314) 725-5566 • Toll Free 800-325-0174

Spectrum is taken back indoors and the results are reduced by a second program that applies all the various corrections, converts the date and time to the required Julian calendar, and finally prints out the time of minimum of the variable star under study, together with statistical certainty estimates. This program works on a TV screen as well as the printer.

A third program is used to predict the time of minima. This contains a database of the periods of 67 selected variable stars, gleaned from the *General Catalog of Variable Stars*. It calculates and prints out a list of the times of all the minima for a given night, allowing Hollis to plan his evening viewing efficiently.

A home-brewed graphing program for the diminutive Sinclair printer produces neat and highly presentable scatter graphs of light curves. Figure 1 shows a typical light curve for the asteroid VW Cephei.

**TIMING MATTERS**

The Spectrum has proved itself highly competent and cost-effective for the sort of work that Hollis requires. Its main limitations are the lack of double-precision floating-point arithmetic and a real-time clock. The relatively slow BASIC and cassette

storage are no problem and are only noticeable in the Minima Prediction program.

Precision is not too serious a matter as the 10 significant figures of the Spectrum's BASIC are well beyond the inherent accuracy of the photometer readings. The only problem involves the representation of Julian dates, in which the time and date are combined to give the time in fractional days since noon on January 1 of the year 4713 B.C. These numbers have seven figures before the point and up to six places after it, if you're measuring to fractions of a second (I'm writing this word at approximately 2446123.57540). Hollis gets around this by dropping the initial 24 in internal calculations, which is unlikely to cause any problems for a century or two.

Timing is a more serious problem. The Spectrum uses interrupts for its I/O, causing the software clock to stop during printing and cassette operations. At first, Hollis tried timing the printing operations and adding a correction factor, but he was soon looking for a proper real-time clock.

He found a suitable design published in an electronics magazine and built it. It has battery backup and is based on an MM 58174 clock chip

with its own 2K-byte static RAM into which the Spectrum can write key parameters such as the latitude and longitude of the observatory and the year (which the chip's designers inexplicably left out). This clock card stacks onto the bus-expansion connector at the back of the Spectrum, making quite a pile of hardware.

There is a scheme afoot, however, to provide even more precise timing. Hollis intends to move into new areas of observation, including studying the orbits of Jupiter's moons and the occultation (i.e., hiding) of stars by asteroids. This requires high-speed photometry using the highest possible sampling rate.

For a slowly changing variable star, integration of the light received over a 10-second period is satisfactory, but to resolve detail in the occultations occurring over a few seconds, the light needs to be sampled at subsecond intervals.

To time such observations, Hollis has built a radio receiver that can pick up a time signal called MSF, broadcast on 60 Hz from Rugby in the Midlands. Fortunately, there's no need to synchronize the readings with the transmitter (which would be a major programming problem); it is sufficient to merely record the time "pips" alongside the data like the time base on an oscilloscope.

**LIGHT DETECTORS**

There is now a small community of astronomers like Andrew Hollis using the comparatively cheap side-window photomultiplier tube as a light detector. By experimenting and exchanging their findings they have extended the limits of its performance in quite unexpected ways.

One drawback of the device is its comparatively large and variable dark current (i.e., the signal produced even when no light is falling on it). Hollis and confederates have discovered that this dark current can be drastically reduced and made more constant, not by cooling as is often done with photodetectors, but by drying the environment in which it operates.

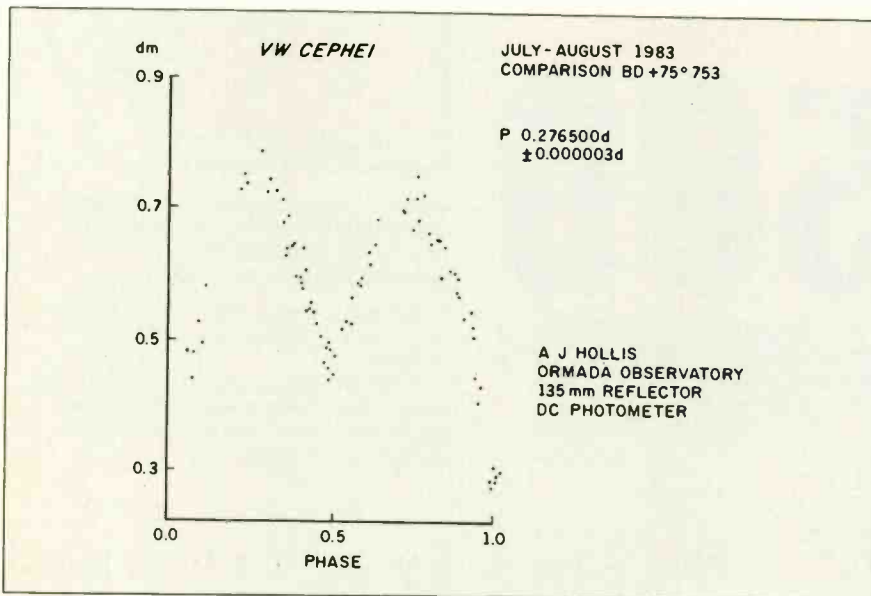
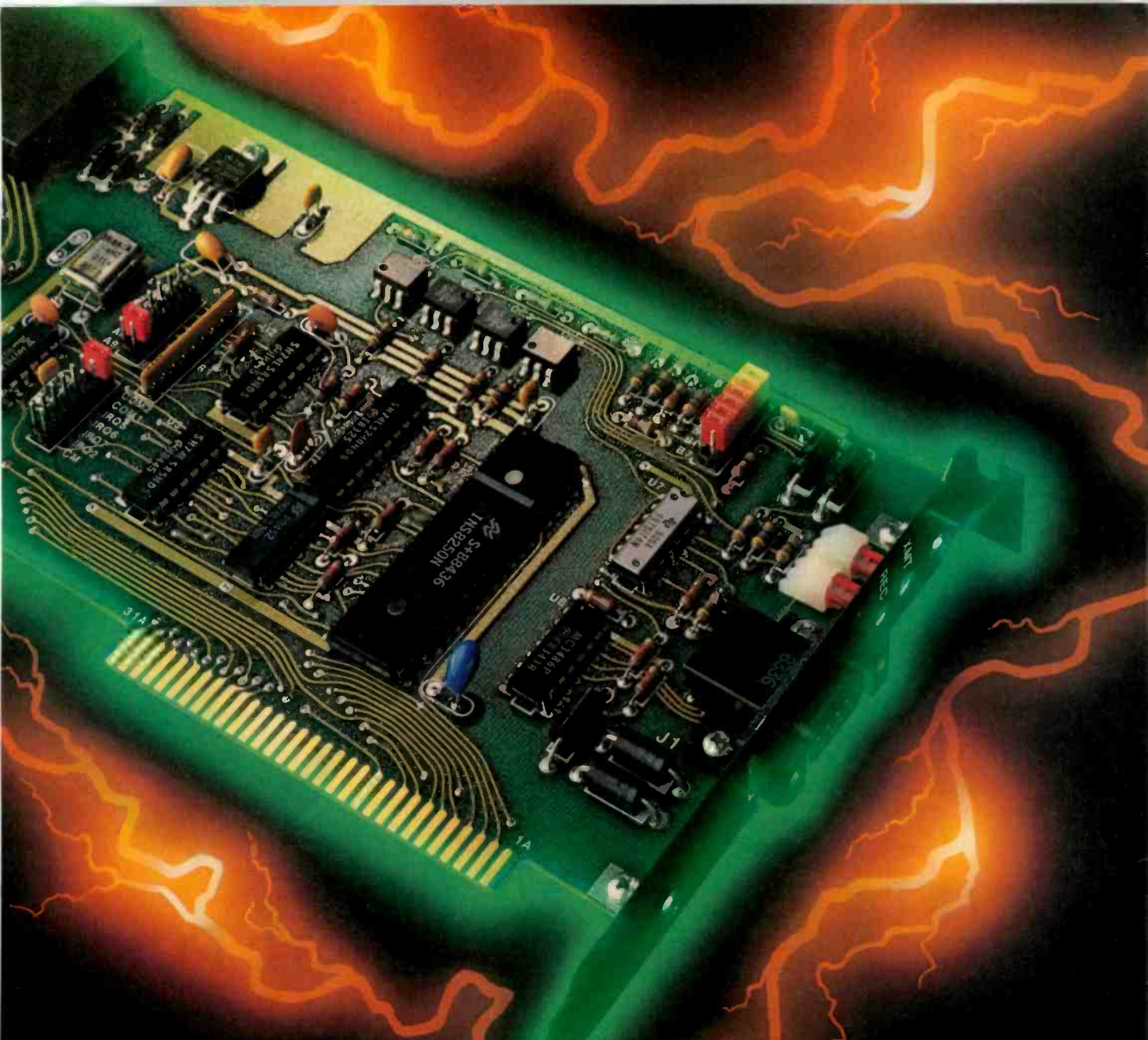

Figure 1: A typical light curve for the asteroid VW Cephei.

(continued)



## **RS422 Card Isolated from your IBM PC by 4000 volts**

With Opto 22's new IBM PC plug in card you can run a 4000V optically isolated RS422 Link throughout your factory and know your computer is safe from destructive voltage transients.

An on board 4000 volt isolated supply completes the protection to your computer.

Additional features include Receive and Transmit LEDs, hand-

shake control lines (flow control), and RS422 transmitter enable.

Complete compatibility with IBM PC, XT, AT and 5531. And, best of all, this NEW card is standard equipment on our erg 2™ industrial computer.

As usual shipment is from stock. (Order Part Number AC24) Call us for information on our complete line of computer adapter cards.

**opto 22**

15431 Springdale Street  
Huntington Beach, California 92649  
Telephone (714) 891-5861

Inquiry 263 for End-Users.  
Inquiry 264 for DEALERS ONLY.



# BYTE inside the IBM® PCs.

## IBM is under our surveillance

Once again, the crack team of **BYTE** editors is examining the full story of the **IBM PCs** and compatibles. In this 1985 additional issue, "Inside the **IBM PCs**", **BYTE** will offer the results of their in-depth investigation to your customers—the **BYTE** reader.

Want to collaborate? The code word is **IBM**. For information on rates and space

reservations, look for your **BYTE** rep—the one with a red rose in the lapel—or call Peter Huestis, Advertising Sales Manager, at (603) 924-9281. He'll give you conclusive evidence on how **BYTE** wrapped up sales leads from last year's "Guide to the **IBM PCs**".

**CLOSING DATE: September 6, 1985**  
**ON-SALE DATE: Mid-October, 1985**



IBM is a registered trademark of IBM Corporation.

# BYTE

THE SMALL SYSTEMS JOURNAL  
 70 Main Street  
 Peterborough, NH 03458  
 (603) 924-9281

## Placing silica gel in the chamber dries the environment.

This is accomplished by placing silica gel in the chamber that houses it.

No one knows for certain why it works, but Hollis's theory is that adsorbed moisture on the insulating base of the tube creates variable resistive paths between the high-tension pins (up to 1000 volts). Drying the moisture raises the resistance of such paths.

Hollis is also trying out other types of photodetectors. When I visited, he showed me an experimental setup that uses a photodiode, though so far the results from it have been unsatisfactory.

### CONCLUSION

I was impressed by the simplicity and effectiveness of the system Andrew Hollis developed. Excluding the telescope, the hardware costs less than £600 (about \$760 at the current exchange rate) and yet can produce results with a certainty of  $\pm 0.01$  magnitude, or around 1 percent error. It's also gratifying to see one of the humblest of home microcomputers serving science in such a competent fashion.

Interestingly, Hollis denies that he is in any way a computer buff; he has learned only enough about computers to get the job done, with astronomy always being most important. It's rather sobering to think that the amount of computing he had to learn would probably qualify him as a computer design engineer; we are still living very much in the frontier days.

During my visit to Ormada, a fond hope that I once entertained was revived: that the spread of personal computers might do for computer science what cheaper telescopes have done for astronomy and encourage amateurs to make significant contributions. ■

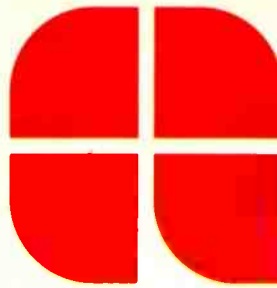

# GenTech

### COMPUTERS

#### IBM SYSTEM SPECIALS

256K, 2 Drives	\$Call
256K, 1 Drive & 10 MB Hard	\$Call
COLUMBIA MPC 4220	\$1899
CDRONA 400 Series	\$Call
FUJITSU Micro 16s (8086/Z80A)	\$1995



KAYPRO All Models	\$Call
LEADING EDGE PC	\$Call
MORROW DESIGNS All Models	\$Call
NCR All Models	\$Call
NEC APC-III PACKAGES	
w/2 Dr, Wordstar Pro Pk, 2050	\$2299
w/plotter, digitizer & AutoCAD	\$Call
SEEQUA Chameleon/Plus	\$Call
WANG	
PC w/256K, 2 Dr.	\$Call
Office Assistant w/printer	\$Call
ZENITH	
ZF-151-52 w/Zenith Monitor	\$Call
ZF-151-21 w/10 MB Hard Disk	\$Call
ZF-161-52 (Portable, 2 Dr)	\$Call

### FOR IBM PC/AT/JR & COMPAQ

BLUE LYNX 3278	\$Call
DCA Irma/IrmaLine/IrmaKey	\$Call
IDEAcomm 3278	\$Call
ANCHOR Mark XII	\$239
HAYES	
Smartmodem 1200/2400	\$385/\$Call
1200B w/Smartcom II	\$355
NOVATION SmartCat Plus	\$329
PRENTICE POPCOM	
C100X100	\$255/\$270
VEN-TEL 300/1200 Half Card	\$409



AST RESEARCH INC.	
ADVANTAGE I (for AT)	\$Call
SIX PACK PLUS w/64K	\$Call
jrCOMBO (exp. to 512K)	\$Call
HERCULES Graphics Card	\$299
Color Card (RGB/Comp/Par)	\$155
INTEL 8087/80287	\$Call
ORCHID PCTurbo 186 w/28K	\$655
PARADISE SYSTEMS Multi-Display	\$280
Modular Graphics Card	\$269
Module A/B	\$75/\$179
PROMETHEUS Promodem Ext	\$315

QUADRAM	
EXPANDED QUADBOARD w/64K	\$239
QUAD 512+ w/384K	\$309
SIGMA DESIGNS Color 400	
/Mouse	\$519/\$575
STB SYSTEMS Graphix Plus II	\$269
Super Rio w/64K	\$279
TALL TREE JRAM-2	\$Call
TANDON TM 100-2 (DSDD)	\$149
TEAC FD-55B (Thinline DSDD)	\$125
TECMAR Graphics Master	\$485
Captain w/DK	\$179
jrCaptain w/128K	\$309

### HARD DISK

AMPEX 20 MB w/25 MB Tape	\$Call
CORVUS	
11.1 MB Omnidrive Starter Kit	\$1649
45 MB Omnidrive	\$4149



INTERDYNE Tape Back Up	\$Call
IRWIN Internal Tape Back Up	\$549
IOMEGA Bernoulli 20 MB	\$2499
MICROSCIENCE/SEAGATE	\$Call
MAYNARD ELECTRONICS	\$Call
SYSGEN Image/Quick-File/XL	\$Call
TALLGRASS	
TC-5025 (25 MB w/60 MB Tape)	\$2759
TC-6180 (80 MB w/60 MB Tape)	\$Call

### DOT MATRIX PRINTERS

C-ITON All Models	\$Call
CITIZEN	
MSP-10	\$329
MSP-15	\$489
MSP-20	\$Call
MSP-25	\$Call



EPSON JX-80 Color	\$489
LQ-1500	\$899
LK-80	\$229
FX-80+	\$345
FX-100+	\$485
NEC P2/P3 Pinwriters	\$525/\$735
OKI/OKATA	
192	\$359
ML 84P	\$Call
Dkimate 20	\$Call
Pacemark	\$Call
PANASONIC KX-P1091/1093	\$Call
STAR MICRONICS	
Gemini 15X	\$345
SG-10	\$229
SD-1015	\$Call
SR-15	\$619
TOSHIBA	
P1340	\$559
P351	\$Call

### LETTER QUALITY

BROTHER/DYNAX	
HR-15 XL (20 CPS)	\$359
HR-25/HR-35	\$495/\$729
HEWLETT-PACKARD Laser Jet	\$Call
DIABLO 630 ECS/IBM	\$1799
JUKI 6100/6300	\$409/\$730
NEC	
ELF 360	\$415
2050	\$669
3550	\$1069
8850	\$1499
QUME Sprint 1140/1155/1190	\$Call
SILVER REED EXP 500/590	\$250/\$449
STAR MICRONICS Power Type	\$339

### PLOTTERS & DIGITIZERS

POLAROID PALETTE	\$1175
ENTER COMPUTER Six Shooter	\$779



HOUSTON INSTRUMENTS	
PC-695	\$549
DMP-41/42	\$2349
DMP-29	\$1799
DMP-51/52	\$3529
DT-11 Digitizer	\$679
ROLAND DXY-800/880	\$699/\$920
SUMMAGRAPHICS SummaSketch	\$Call

### MONITORS & TERMINALS

AMDEK	
Video 300/300A/310A	\$125/\$130/\$155
Color 500/710	\$359/\$579
PRINCETON GRAPHICS Max-12E	\$175
HX-12/SR-12	\$469/\$599
QUME All Models	\$Call
ROLAND	
MB-122G	\$155
MB-14D	\$Call
CB-141	\$269
CC-141	\$559
TAXAN	
115	\$115
116	\$125
42D/L	\$Call
44D	\$559
TELEVIDEO All Models	\$Call
WYSE	
WY-50	\$459
WY-350	\$Call
ZENITH	
ZVM-123A	\$79
ZVM-124	\$Call
ZVM-135	\$439
ZVM-136	\$Call
Z-29A	\$Call
Z-49	\$Call

### FOR APPLE II/IIe

ALS Smarterm II (80 Col. Card)	\$129
AST RESEARCH INC. Multi I/O	\$Call
DIGITAL RESEARCH CP/M Gold Card	\$269
FOURTH DIMENSION 16K RAM Card	\$55
80 Column Card (IIe)	\$55
HAYES	
Micromodem IIe w/Smartcom I	\$149
MICROSOFT Softcard II	\$339
MICROTEK Dumping GX	\$69
NOVATION Apple Cat II	\$209
212 Apple Cat II (1200)	\$389
ORANGE MICRO Grappler +	\$179
Buffered Grappler +	\$145
PCPI Applicard 6 MHz	\$Call
MACINTOSH DRIVE I	CALL FOR \$\$

### MISCELLANEOUS

RAM CHIPS	
64K SET	\$14
256K SET	\$Call
	call for quantity pricing
DOUBLE-SIDED DISKETTES	
3M	\$27
Dysan	\$30
Maxell	\$25
Wabash	\$19
PRINT BUFFERS	
QUADRAM Microfazer	
Parallel/Parallel 16K	\$139
64K	\$185
128K	\$239
Serial/Serial, Ser/Par, Par/Ser	
BK	\$139
64K	\$159
INTER. STRUCT. Shuffle-Buffer 32K	\$269
SURGE PROTECTORS	
EPD/CURTIS All models	\$Call
NETWORKX Wire Tree/Plus	\$39/\$55
ULTIMA SF-600	\$39
EMERGENCY POWER SYSTEMS	
SOLA Mini UPS	\$Call
TrippLite BC-425-FC (425 Watts)	\$375
SWITCHBOXES	
CABLECD 3 Way Serial/Parallel	\$Call
COMPUTER ACCESSORIES	
Data Directors (All Models)	\$Call

### CUSTOMER SERVICE

**401-781-0020**

### ORDERS ONLY

**800-843-4302**

150 Broadway, Suite 2212, NY, NY 10038

HOURS 9-8 EST. MONDAY-SATURDAY  
Personal Ck (2 Weeks To Clear), Cashier's Ck, Money Order  
APO Orders Add 6% (minimum \$7). Add 3% For Net Terms. All Returned Non-Defective Merchandise Are Subject To A 20% Restocking Charge. GenTech Reserves The Right to Change Advertised Prices.



# The fastest micro in the world



No micro in its right mind would want a showdown with Pinnacle.

Its awesome fire power is provided by the superb Motorola 68000 charging along at 12MHz with no wait states (giving about 3MIPS).

And Pinnacle's ammo belt is just bristling with high powered options to give rapid fire to all seven users.

P-System, Unix,™ CP/M-68K,™ Mosys, BOS, Mirage, Tripos all obey instantly – along with their armies of applications.

Up to 8 Megabytes of directly addressable RAM and 110 Megabytes of Winchester storage dance when Pinnacle barks its sharp orders.

And that's just for starters. There's also the Pinnacle IX with TWO 68000's, DMA, and Memory Management hardware. Ideal for disk intensive operating systems like Unix™ and Pick.

And a Pinnacle LX expansion chassis allowing nine 68000 processors to network 56 users. A micro's gotta do what a micro's gotta do.

And starting at under \$4000 Pinnacle's just the fastest there is.

## PINNACLE

The accessible peak of performance

US DISTRIBUTORS **Pinnacle Systems Inc.** 10410 Markinson Road, Dallas, Texas 75238. Tel. (214) 340-4941. Telex 88-8442

ELECTRONIC MANUFACTURING/SERVICE **Lamtech Electronics Corporation**, 620 Easy Street, Garland, Texas. Tel. (214) 272-3504

INTERNATIONAL SYSTEMS GROUP **ISG Pinnacle**, Dallas, Texas. Tel. (214) 340-4941. (Distributor enquiries invited).

VERTICAL MARKET SYSTEMS **VMS Pinnacle**, Dallas, Texas. Tel (214) 340-4941.

EUROPEAN DISTRIBUTORS **TDI Pinnacle Ltd**, 29 Alma Vale Road, Bristol BS8 2HL, England. Tel. (0272) 742796. Telex 444653.

UNIX is a Registered Trade Mark of Bell Labs. CP/M-68K is a Registered Trade Mark of Digital Research.

## Peripherals, Chips, and New Computers

### Erasable optical-disc coating from Fujitsu and more new Japanese products

BY WILLIAM M. RAIKE

**I**n the past month at least two new personal computers have appeared on the market here; the battle of the memory chips continues with the major contenders evidently undaunted by the slump in the chip market (both Toshiba and Hitachi have introduced new large-scale memory chips); Fujitsu announced a new erasable optical-disc technology; there are glimmers of hope that the dismal situation in the Japanese software industry may be headed for improvement; and I discovered the Silver-Reed EB50, a battery-powered lap-size portable four-color printer/plotter/typewriter/thingamajig that's just plain neat.

#### TAKE YOUR GRAPHICS ALONG

It's hard to know just what to call the Silver-Reed EB50. It looks like a briefcase-size portable electronic typewriter, but there's no print element. Instead there are four ball-point pens (black, red, blue, and green) mounted in a little drum that draws the characters you enter from the keyboard (alphanumeric or katakana) in any of three sizes, in either Courier or italic type, either vertically or horizontally. You can also draw four-color graphs in any of 12 styles, including various kinds of pie charts, bar graphs, and broken-line graphs, complete with labels and axes. A 15-character liquid-crystal display helps you orchestrate all this from the keyboard.

The EB50 has a built-in serial interface, so it only needs paper and an RS-232C cable to turn it into a four-color plotter. A hard carrying case with a handle is standard, and the total weight, including batteries, comes to 5½ pounds. I still don't believe the list price; it's only about \$200. However, I don't have any idea whether the company is planning to export the EB50.

#### NEW FUJITSU OPTICAL-DISC MATERIAL

Optical discs, like videodiscs and compact digital audiodiscs, store large amounts of data; you read the data by scanning the

discs with a laser beam. But you can write data on the newer types of optical discs with a computer, something you cannot do to videodiscs and compact discs. The two main types of optical discs are DRAW (direct read after write), on which you can only write once, and erasable, on which you can write, erase, and rewrite a number of times.

Fujitsu has just developed a new coating material for optical discs that allows data to be written by creating holes in the coating with a laser beam. Then this material can be partially melted by a lower-power laser beam that effectively erases the data. It also overcomes one of the main drawbacks of earlier materials: it is thermally stable, which makes long-term data storage practical. The new material, a thin crystal layer of selenium, indium, and antimony, also resists corrosion and oxidation better than the exotic tellurium used in other optical-recording materials.

To record data, you shine a 5-milliwatt laser beam on the surface for 100 nanoseconds; the surface reflectivity of the resulting hole ends up being about 30 percent higher than the surrounding area. When a half-power laser beam heats up the same spot for several microseconds, the hole is smoothed out, reducing reflectivity by about 20 percent and effectively erasing the data.

Existing optical-disc units store about 1 gigabyte per 20-centimeter disc, but according to BYTE's Japanese sister publication, *Nikkei BYTE*, which featured optical discs in a recent issue, 5¼-inch units are on the way and promise to open up new applications. We should start to see commercial products within the next two years.

#### LET THE CHIPS FALL . . .

Just about all the Japanese electronics giants got into the chip act in recent weeks. First, there was NEC's announcement of a new superfast Josephson-junction inte-

(continued)

William M. Raiké, who has a Ph.D. in applied mathematics from Northwestern University, has taught operations research and computer science in Austin, Texas, and Monterey, California. He holds a patent on a voice scrambler and was formerly an officer of Cryptext Corporation in the United States. In 1980, he went to Japan looking for 64K-bit RAMs. He has been there ever since working as a technical translator and a software developer. He can be contacted c/o BYTE, POB 372, Hancock, NH 03449.

grated circuit (IC). In the U.S., IBM abandoned Josephson-junction research and development as impractical about two years ago; NEC obviously thinks it's not that impractical. Josephson-junction devices use superconductors cooled to -269 degrees Celsius and are capable of the fastest operations currently known. Logic gates based on Josephson-junction technology can operate in times as short as 5 picoseconds, and speed will be a crucial factor in future supercomputer projects. NEC's latest IC, an experimental device, was a multiplier circuit; it could multiply a pair of 4-bit numbers in only 280 picoseconds, several times faster than previously possible. The whole circuit is on a chip only 2.7 millimeters square, and it contains 862 Josephson junctions arranged to form 249 logic gates.

Meanwhile, Toshiba claims to have

developed the fastest 1-megabit dynamic RAM (random-access read/write memory) chip. It has an access time of only 60 nanoseconds. Like many new ultralarge-scale ICs, it's based on CMOS (complementary metal-oxide semiconductor) technology, which means low power consumption; the new 1-megabit memory requires only three-quarters of the power of the 256K-bit dynamic RAM chips being sold now.

Speaking of 256K-bit dynamic RAM chips, I spotted some Hitachi 150-nanosecond memory chips on sale in the electronics bazaar in the Akihabara district of Tokyo just a few days ago. The cost is now down to about \$4.60 per chip; last year the first units were selling for over 10 times that amount.

Recently Hitachi also made a tantalizing announcement: It has developed a "multilevel slant-cell

dynamic RAM." According to the company, with this new technique you can store four times as much information with no change in the dynamic RAM structure; instead of holding 1 bit of data, each cell holds 4 bits (represented by a 16-level staircase-voltage signal). The speed of this new type of memory, 1 to 2 microseconds, is slow compared with conventional dynamic RAM chips, presumably because of some type of analog-to-digital conversion. Nevertheless, it's not hard to think of applications where the speed penalty wouldn't be important. There was no word from Hitachi on when it might be possible to buy a multilevel slant-cell dynamic RAM, or what the cost for such a chip might be.

#### JAPAN MOVES TO IMPROVE SOFTWARE QUALITY

Japanese computer manufacturers and software houses are aware of the low productivity and questionable quality of much software-development activity in Japan; one software company here, Reed Corporation, is dealing with the problem by commissioning over a dozen U.S. software firms to develop custom software, linking minicomputers in Tokyo with the U.S. companies via a satellite hookup.

The Japanese government, through MITI (the Ministry of International Trade and Industry) and its subagency, the Information Technology Promotion Agency (IPA), is concerned about the software problem, which is projected to get worse with time because of the increasing shortage of software specialists. MITI started the Sigma Project this past April in cooperation with domestic and foreign software firms. Combined government and private spending on the project will be almost \$12 million the first year and \$100 million over the next five years; the objective is a fourfold improvement in software productivity and a dramatic improvement in reliability and modularity, particularly in the area of business software.

As hardware costs decrease and computing power increases, software

# To get a lot out of your printer, you need a lot of programs, right?

**Wrong.**

Sure, you could buy one package to change type sizes, another to create fonts, and still another to print sideways.

Or you could get one simple program to do it all!

**Printworks.™**  
It's loaded.



**SoftStyle™**

SoftStyle, Inc. 7192 Kalaniana'ole Hwy. Suite 205  
Honolulu, Hawaii 96825 Phone (800) 367-5600

\$69.95 Enhances over 30 dot matrix printers, including  
Epson and Okidata. IBM PC or compatible



for personal computers and low-priced office computers is certain to be a major factor in the success, and even the survival, of computer manufacturers. Part of the dramatic success of the NEC personal computers stems from the company's efforts to encourage and attract independent software houses to develop and sell software products specifically designed for NEC machines. Some other Japanese manufacturers are providing monetary incentives to software developers to encourage them to design and develop software that runs only on their hardware. This could help counter the reluctance of many software firms to invest heavily in the development of general-purpose software for wide distribution; those firms currently rely on orders for high-priced custom software.

**THE NEW IBM 5540 AND THE OKI IF800/60**

Last year IBM Japan Ltd. announced its JX personal computer; it was too little too late—basically an IBM PCjr-compatible at IBM PC prices. It was greeted with thundering silence at the cash registers. On the other hand, IBM's 5550 workstation achieved a limited popularity as an office computer, despite its \$4000-plus price tag and extreme sluggishness in recognizing Japanese-language kanji input.

Now IBM has introduced the 5540. In a nutshell, the 5540 is yet another computer based on the 8086 microprocessor, but not much else. Even the kanji ROM (read-only memory) isn't standard; you have to buy it as an option. You get either one or two 5¼-inch 720K-byte floppy-disk drives—not particularly impressive when you consider the 1-megabyte drives in the Fujitsu FM-11BS and FM-16β, or in the newest version of NEC's market-dominating personal computer, the PC-9801M2. (See the May BYTE Japan, page 355, for more information.) Standard memory is 256K bytes, expandable to 640K bytes. The IBM 5540 has no color-display capability; other than that, it can run all the 5550 software, which amounts to a tiny fraction of the soft-

ware available (for example, for NEC's PC-9801 machines). This lackluster bundle costs about \$1450 for the single-drive version and \$1700 for the two-drive version—about the same as for either the Fujitsu or NEC machine, but it has far fewer capabilities and a much narrower choice of software.

The newest machine from Oki Electric, the if800 model 60, is far more likely to win the hearts and minds of the computer-buying public than the IBM 5540. Despite having very little software written specifically for it, the if800/60 comes with Japanese-language MS-DOS 2.11, so owners have access to the mass of generic MS-DOS software on the market. Interestingly, Oki has developed its own windowing software, called SuperView, which runs hand in hand with MS-DOS on the new machine. SuperView also has standard 720- by 512-dot color-graphics capability supported by 512K bytes of graphics video RAM in addition to the 512K bytes of standard main RAM. That's more than double the memory of the NEC PC-9801M2 and better graphics capability than the new Fujitsu FM-16β. Like the NEC machine, the new Oki if800/60 runs an 8-MHz 8086-2 microprocessor; the Fujitsu FM-16β uses the faster 80186 processor and a video coprocessor. All three of these machines include two 1-megabyte 5¼-inch floppy-disk drives; on the Oki you can fit an optional 10-megabyte hard disk into the main unit along with the two floppy disks. The list price for the if800/60 is about \$1750; unlike most other Japanese computers, the Oki's price includes a high-resolution monochrome display, so it actually ends up costing a few hundred dollars less than either the NEC or the Fujitsu machine, and discounts of at least 20 percent are inevitable in this highly competitive market.

**COMING UP**

In next month's column I'll report on the first-ever COMDEX in Japan and on several of the products on display there, including a Fujitsu lap-size portable, the NEC PC-8401A, and more. ■

**If they can make it here, they'll make it anywhere.**

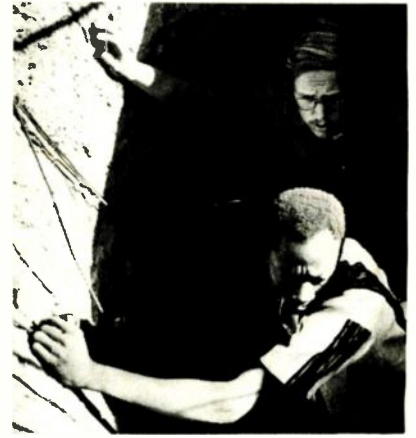

When's the last time you saw "digging a well" on someone's résumé? Working in the Peace Corps is not your average everyday job.

Whatever it takes to be Peace Corps volunteers, it's a way of working that develops a resourcefulness and a degree of self-reliance that volunteers use long after they've come home. Anyplace they work. On any job they're given.

Hire a former Peace Corps volunteer, and put that experience to work on your "toughest job." Call Peace Corps toll-free, 800-424-8580 (ext. 76) to tell them about job possibilities for returned volunteers. Or if you know of those who might like to volunteer, use the same phone number (ext. 93) to put their experience to work where it can do a world of good.

**Peace Corps**  
The toughest job you'll ever love.

**Ad Council**  
A Public Service of This Publication

# EVEREX EVER FOR EXCELLENCE



## The Everex Hard Disk/Backup Systems Are Your Expansion Systems too... with little additional cost.

### More Room To Expand, Not More Money

Think about Off-loading expansion boards from your PC or XT to an External Hard Disk/Backup System. Everex provides a complete line to choose from ...

- Full-size system with eight expansion slots and room to add up to four hard disk/backup systems.
- Half-size system with four expansion slots and space for two hard disk/backup systems.
- Slimline system, only 2½ inches high with three full-size, one half-size expansion slots and room for two hard disk/backup systems.
- All Expansion systems are available with any combination of Everex hard disk drives and backup systems.

### Unique Features

- One shielded round cable (as IBM) instead of flat ribbon cables.

Replace the clumsy flat ribbon cable with Everex's shielded, round cable.

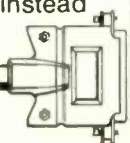

- Advanced design eliminates "wait states" for faster data transmission.
- Compatible with more controllers than other systems.

Visit your local Everex dealer today and ask to see Everex Hard Disk/Backup Systems in action. For the name of your nearest Everex dealer, please call (415) 498-1111, 47777 Warm Springs Blvd., Fremont, CA 94539. Dealer Hotline (800) 821-0806. In CA (800) 821-0807

Imaging Engineering Ultimo, Australia TLX: 74349 IMAGIN AA  
Microage Distribution Ltd. London, England TLX: 881 3241  
WONGS G

Feeder Paris, France TLX: 4413241 FEEDER  
Automated Office Systems Hout Bay, South Africa 2721-70-8091  
Survex, 1027 Speers Road, Oakville, Ontario Canada L6L-2X5,  
416-842-6093  
Pride Computers, 102-8167 Main Street, Vancouver,  
British Columbia, V5X 3L2, 604-321-5690

IBM, PC, XT and AT are registered trademarks of International Business Machines Corporation.

**EVEREX**  
EVER for Excellence



## Start-up

Fat Mac  
MacWorld Exposition  
XL/Serve  
MacAide  
MacNosy  
Airborne  
QC-10  
Mac Bernoulli Box  
ChipWits  
Macintosh p-System  
MacAdvantage  
Mind Prober  
Videx  
GEM Seminar

BY BRUCE WEBSTER

**A**s you probably know, the period of time after a product is released until a review shows up in *BYTE* can be pretty long. Our editorial staff is all too aware of that delay. According to Webster is an attempt to close that gap a little. Its goal is to look at what's new in software and hardware and to comment on the industry itself. We can't bring you the latest news; our three- to four-month editorial lag time just won't permit it. But we can—and, we hope, will—bring you reasoned, informed commentary.

### A WORD ABOUT THE AUTHOR

You're probably wondering who I am and why I am writing this. I'm a semiretired professional software engineer who has decided to pursue writing full-time for a while. My educational background includes a B.S. in computer science (BYU, 1978) and some graduate work at the University of Houston. My professional background includes work at General Dynamics, the Lunar and Planetary Institute, and Monitor Labs. Perhaps more significant is that I spent two years working for a microcomputer software house. While there, I helped bring two products to market. I wrote about 5 percent of the first one and 95 percent of the second. Both received many glowing reviews, both have been commercially successful, and both are still on the market—so I'll refrain from identifying them or the firm I worked for.

I don't bring this up to pat myself on the back; I just want to point out that I don't fall into the second category of "those that can, do; those that can't, teach/review/critique/etc." I know firsthand all the headaches and difficulties in developing a product, putting it on the shelves, and supporting it. On the other hand, I know the shortcuts, the excuses, the temptations to cheat, and the song-and-dance routines that the customers get. Of course, this doesn't mean that I used them . . . at least, not very much. It does mean that I know the difference between

problems inherent in the application and problems caused by sloppiness or corner-cutting.

While I am no longer developing commercial software, I still spend most of my time in front of computers. I currently own three, all paid for out of my own pocket. The first is a Compaq, which I use mostly for word processing and telecommunication. When I'm not using it, I run a bulletin board on it. The second is a Macintosh, which is used for word and outline processing, software development, and other tasks. The third is an Apple IIe, which right now isn't used for much of anything. And, of course, I have various chunks of hardware and software floating by from time to time.

Which brings us back to this column and why I am writing it. Some of you are probably asking yourselves, "If he's such a hot-shot programmer, how come he's writing this?" The truth is, I burned myself out finishing an updated version of product #2. I had been writing articles part-time for several years, so I decided to try it full-time. *BYTE* graciously offered me the chance to write this column, and the rest, as they say, is history. I still do software development; in fact, I spend more time writing code than prose. The difference is, I'm doing it for my own pleasure and entertainment, nobody else's.

Enough about me. As mentioned above, the idea is to cover the latest in software and hardware. Unfortunately, I've got several months' accumulation of "the latest," so it's going to take a column or two to clear things out. Not only that, but most of it is for the Macintosh. Those of you who aren't Mac fans can skip to the section entitled "And Now for Something Completely Different." The rest of you can read on.

### MACINTOSH REDUX

In my review of the Mac (August 1984, page 238), I stated that the 128K-byte one-drive Mac was "an amazing machine but not

(continued)

*Bruce Webster is a consulting editor for BYTE and a charter member of the PMS Commandos. He can be reached at BYTE, 425 Battery St., San Francisco, CA 94111.*

really a powerful one" and that a 512K-byte Mac with two drives "is both amazing and powerful." This, of course, was conjecture on my part, since the 512K-byte Mac wasn't available when I wrote that. As you all know, that changed last September. A few months ago, Apple lent me a Fat Mac so that I could test the truth of

my statement. It's true: a 512K-byte Mac with two drives is both amazing and powerful. A 512K-byte Mac with a hard disk is even better. You shouldn't even consider buying a 128K-byte machine; it just isn't worth the aggravation.

More significant has been the dramatic drop in prices. At the time

of the review, a 512K-byte Mac with two drives and an Imagewriter printer would have cost \$4500, which doesn't compare very well with the \$3000 I paid for my Compaq (512K bytes, two 360K-byte drives, Epson RX-80 printer). This week I saw two computer stores advertising that exact Fat Mac system for \$2795. Since \$2795 is the current official list price for a Fat Mac, those stores are effectively throwing in the printer and extra disk drive for "free." By contrast, my Compaq system has barely dropped in price; it would cost me about \$2800 today. Coincidentally, \$2800 is almost exactly what I spent on my 128K-byte single-drive Mac (with Imagewriter) a year ago. It shows what a difference a year can make, but most of you already knew that.

Though it's old hat as I write this, I have to comment on Apple's 512K-byte upgrade policy. The initial \$1000 cost (it dropped to \$700 in January) was in my opinion atrocious and inexcusable, especially since other firms are now offering \$300-\$400 Mac upgrades. Apple's price was designed to make money, which I'm sure it did. Unfortunately, Apple squandered a far more precious resource: the goodwill and loyalty of tens of thousands of Mac users who were patiently putting up with a crippled machine while waiting for the upgrade to come out. Almost every Mac user I know expressed disgust or disappointment at finding that upgrade priced pretty much out of his or her reach. Apple users are known for their zeal and fervor; in many Mac users, that's been replaced with caution and cynicism. And I don't even know if Apple people realize what they've lost.

#### MACWORLD EXPOSITION

I spent two days at the MacWorld Exposition in San Francisco in February. The show wasn't overly large; it didn't quite fill up all of Brooks Hall, the underground portion of the Civic Center. On the other hand, as Guy Kawasaki of Apple noted in a talk, had the show been held a year earlier, only three exhibitors would have been

(continued)



### Screen Displays. Fast and Easy!

Blaise Computing presents **VIEW MANAGER™**—a screen programming system for the IBM personal computer and hardware compatibles. **VIEW MANAGER™** speeds the creation, documentation, and incorporation of screens into programs developed in high level languages. Versions for C (Lattice, Microsoft, or Computer Innovations) and Pascal (IBM or Microsoft) are now available.

**VIEW MANAGER™** lets you create input/output screens by providing an integrated system of programs carefully constructed to make your screen development easy and fast. It features:

- ◆ Quick creation of new screens and editing of existing ones using an interactive painter efficiently storing screens in a screen database;
- ◆ Extensive control over the format of data written to and read from data capture fields;

- ◆ Ability to create on-line help files as part of the screen system;
- ◆ Automatic generation of screen documentation files, including details of formats for data entry fields, screen images, and names and sizes of all existing screens;
- ◆ A comprehensive library of routines to include in your programs allowing full manipulation of screens and the data that they display or capture;
- ◆ Royalty-free distribution of your commercial or in-house applications developed using **VIEW MANAGER™**.

All this adds up to a productivity tool no system developer in the C and Pascal environment should be without.

**\$275** (Source code available for routine library—an additional \$150)

**VIEW MANAGER™** is part of the Blaise Computing Productivity Series. Other products to speed your development projects in C and Pascal include:

**TOOLS™**—A library of routines for advanced string handling, forms utilities, screen handling or more \$125

**TOOLS 2™**—A library of routines for access to operating services of DOS 2.0+ from within your program—includes memory allocation, program chaining, file and buffer handling \$100

**EXEC™**—A program chaining dispatcher for all DOS-executable files supporting a common data area \$95

#### BLAISE COMPUTING INC.

2034 Blake Street Berkeley, CA 94704  
(415) 540-5441

# PROFESSIONAL DISK DRIVE MANUFACTURER —UNITRON

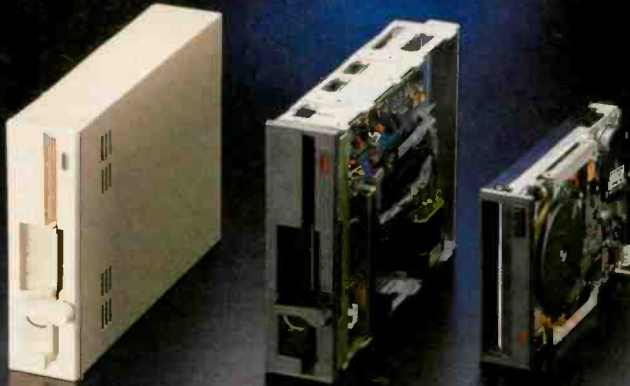

5 1/4" Floppy Disk  
Drive Series

3 1/2" Floppy Disk  
Drive Series

**FULL SERIES FOR APPLE, IBM, BBC  
AND CEMMODORE COMPUTERS.**

**\*OEM & DISTRIBUTORS WANTED**

—A LEADING MANUFACTURER OF FLOPPY DISK DRIVES IN TAIWAN.  
—A TOP SUPPLIER OF VERSATILE PERSONAL COMPUTERS, EXPANSION CARDS  
AND ACCESSORIES



Manufacturer & Exporter

5F, NO. 3, LANE 521, CHUNG CHENG RD.,  
HSIN TIEN, TAIPEI-HSIEN, TAIWAN, R.O.C.  
TEL: (02) 8171881-5 TELEX: 32445 UNITRONS

## BEST QUALITY IS OUR GUARANTEE!

1. SPS FOR IBM PC-XT 135W, PC-AT 200W
2. SPS FOR APPLE II, APPLE II+, APPLE IIe
3. IBM PC & APPLE II Case
4. Personal Computer & Peripherals

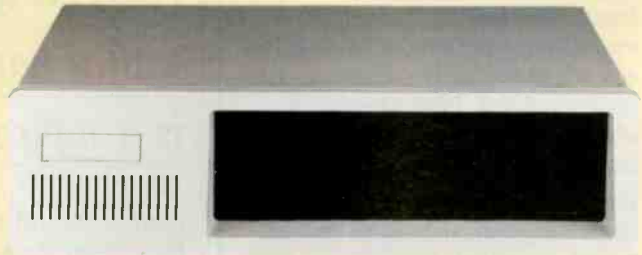

MODEL: S4135AI



MODEL: S4135AG



Taiwan Manufacture/  
**CHUNG YU ELECTRONICS CO., LTD. (B)**

P.O. BOX 30-535 TAIPEI, TAIWAN, R.O.C.  
TEL: (02) 3918100 • 3414596  
TLX/24451 CYELEC

## ASIA TECHNOLOGY SERVICES INC.

YOUR SOURCING SPECIALIST IN ASIA & TAIWAN COMPUTER HARDWARE,  
ELECTRONIC COMPONENTS, MECHANICAL/PLATIC PARTS.

### COMPLETE INDEPENDENT SOURCING SERVICES

PRINCIPLE INQUIRIES INVITED

DETAILED INFO AVAILABLE UPON REQUEST

OUR PROCUREMENT SERVICES GIVE YOU ACCESS  
TO THE FASTEST AND LOWEST-COST OVERSEAS  
VENDORIZATION PROGRAM

- OEM PRODUCTS OFFSHORE TRAFER
- IN-PROCESS QUALITY MONITORING
- VENDORS SURVEY AND QUALIFICATION
- OUT-GOING QUALITY INSPECTION
- COST ANALYSIS AND ENGINEERING SAMPLES APPROVAL



## ASIA TECHNOLOGY SERVICES INC.

3F, NO. 45, SEC. 2, FU-HSING S. RD., TAIPEI, TAIWAN, R.O.C.  
TEL: (02) 7068764 7048607 TELEX: 11774 DIOATS FAX: 02-7003490



APPLE IBM ANY SW POWER SUPPLY  
FERRITE TRANSFORMER DESIGN MANUFACTURER



UPS FOR COM: UTER



SW POWER SUPPLY TESTER & ELECT. LOAD



TRANSISTOR SCR  
RECTIFIER ETC.  
VOLTAGE & LIFE  
TESTER MAY  
BEFOREHAND  
JUDGE BUG DATE

## TECHNICS DESIGN CO.

NO. 16, LANE 50, WU-FONG RD.,  
PANCHIAO, TAIPEI, TAIWAN, R.O.C.  
TEL: 02-2510022 TELEX: 34295 TDES

# EXCELLENT STORAGE

MANUFACTURER  
EXPORTER



DJ-560

DJ-510

DJ-310



## HEH JEOU ENTERPRISE CO., LTD.

NO. 9, ALLEY 15, LANE 188, CHUNG SHAN RD.  
SEC. 1, YUNG HO, TAIPEI, TAIWAN, R.O.C.  
P. O. BOX 18-368 TAIPEI  
CABLE "HEHJEJU" TAIPEI  
TELEX: 10649 MAGIPRO, TAIPEI ATTN: HEHJEJU

\* APPLE II is a registered trademark of APPLE Computers, INC. \* IBM is a registered trademark of International Business Machines Corp.

## The Best Source Debugger for C

**Interactive testing:** enter any C expression, statement, or function call, and it is immediately executed and the result displayed. **Direct execution** allows fast and thorough testing, makes learning C a snap.

**Run-time checking:** execution stops upon exception, and source code displayed. Exceptions include array reference bounds, stack overflow arithmetic or floating point error, etc. Pointers are checked for null or out of range values.

**Breakpoints:** any number of breakpoints can be set *anywhere* in your program; breakpoints are set with screen editor, not by line numbers. Breakpoints may be conditional. Single-step by statement. Interrupt execution from keyboard. Breakpoint, exception, or interruption is always shown with source code. Examine and modify data, look at stack history. Even change your program and then resume execution!

**Lint-like Compile-time checking:** argument number and sizes are checked for consistency. Never mismatch source and object code.

The best feature of all: the *fastest* C interpreter is right there when you're debugging. Make changes in seconds with the integrated screen editor. Test the changes immediately, running your program at compiled speed. Save source code for your favorite compiler, or make stand-alone executable programs. Nothing else is needed. **Instant-C is the fastest way to get working, fully debugged C programs available today.**

"We sincerely feel that *Instant-C* can have a major positive impact on programmer productivity." *Computer Language*, Feb. 85, pp. 82-83.

**Instant-C** is only \$495. Money back for any reason in first 31 days.

**Rational**  
Systems, Inc.

(617) 653-6194  
P.O. Box 480  
Natick, MA 07160

## ACCORDING TO WEBSTER

### A 512K-byte Mac with a hard disk is a nifty system.

there . . . and two of those would have been showing carrying cases.

There were a lot of start-up companies, firms that were banking their whole future on the success of the Macintosh. Indeed, the Mac appears to be attracting companies who believe that the IBM market is overcrowded and tends to be dominated by a few major companies. They see the Macintosh as a chance to get in on a ground floor that the IBM market passed three years ago. Others, most notably software developers, follow the Mac because they find it a more interesting and challenging machine than the IBM PC. Yet others, such as Hayden, see the Mac as a chance to get back into an industry that they've been slowly squeezed out of. And, of course, we must remember that all these firms must (and want to) make money. Most are still waiting to see if the Mac helps them to do just that.

There wasn't much new at the show, unless you knew where to look. Several hard disks were announced, although most won't be ready to ship for a while. Infosphere showed two products that didn't appear all that flashy, but they could be very important to increased acceptance of the Macintosh. XL/Serve is a program that turns a Mac XL (aka Lisa) into an AppleTalk file server. This means that AppleTalk is an immediate reality. What's more, it runs in "background" mode, so that the Mac XL can still be used for other tasks, although performance is degraded. MacAide is a Z80-based board (designed mostly for OEMs) that serves as a bridge from AppleTalk to just about anything else: SASI, serial, IEEE-959 bus, even another AppleTalk network. The Infosphere people had an \$800 Xybec hard disk (10 megabytes) talking to a Mac through a MacAide card. Keep an eye on this product.

Other interesting products were shown. For die-hard hackers, Steve Jasik was selling MacNosy, a disassembler that lets you rip the Toolbox ROM (read-only memory) and other programs apart. (Incidentally, Jasik, who has looked at all the ROM routines, had harsh things to say about the quality of some of the code therein.) Professional Data Systems showed an external video adapter for the Mac, along with a large (23 inches) high-resolution monochrome monitor and a high-resolution video-projection system. Large crowds gathered to look at the Hyperdrive, a 10-megabyte hard disk that mounts inside the Mac. Everyone wants one, but they're leery about letting someone mess with the innards of their Macs. Large crowds also flocked to the Odessa booth, where they were displaying Helix (which is finally shipping). And the Apple booth itself attracted many people.

The award for "Most Original Boot-up Sequence" goes to Silicon Beach Software, which was previewing its arcade game Airborne. If you boot Airborne on a 512K-byte Mac, it plays 20 seconds of Wagner's "Ride of the Valkyries." We're not talking about the four-voice chamber music found in MusicWorks—this is a full orchestral rendition. Turns out the folks at SBS took the excerpt from an actual symphonic recording, digitized it using a VAX, and then downloaded it to the Mac. The file takes up 138K bytes, which is why it plays only on the Fat Mac. The game itself isn't terribly original—a cross between Sabotage and Choplifter—but the sound effects are nice.

The show was enjoyable and manageable. It will be interesting to contrast it with the West Coast Computer Faire. Look for comments here in a few months.

#### MASS STORAGE

As mentioned above, a 512K-byte Mac with a hard disk is a pretty nifty system. The extra storage and faster response time do much to overcome the limitations of the basic Mac sys-

(continued)



DON BANKARD, PROCESSING SECTION SUPERVISOR, PG&E

# “ZIP+4 codes will save Pacific Gas & Electric Company \$200,000 this year.”

MAIL THIS COUPON TO SEE HOW YOUR COMPANY CAN SAVE, TOO.

PG&E was one of the first companies to convert to ZIP+4 codes—the Postal Service’s 9-digit system for First-Class Mail®. Now its once-a-month mailing to 4 million customers is made at considerable savings. “About \$18,000 a month,” Mr. Bankard explained, “is purely ZIP+4 savings. That’s on top of our Presort savings.”

As for the conversion, “we contracted it out. And got it done for less than expected. All the conversion costs will be paid back in only 3 months.”

Find out how the ZIP+4 program can work for you. Complete this coupon. For immediate assistance or the number of a local postal customer service representative, call 1 800 842-9000, ext. 423.

Please check your line of business:

- Insurance,  Banking,  Manufacturing,
- Securities,  Utilities,  Education,
- Retail,  Government,  Publishing,
- Service Company,  Other. And check your yearly First-Class Mail volume:
- Up to 10,000,  10,001-50,000,  50,001-100,000,  100,001-1,000,000,  1,000,000+

U.S. Postal Service, Regular Mail Services  
P.O. Box 2999  
Washington, D.C. 20013-2999

Name \_\_\_\_\_

Title \_\_\_\_\_ Company \_\_\_\_\_

Address \_\_\_\_\_

City \_\_\_\_\_

State \_\_\_\_\_ ZIP \_\_\_\_\_



7K41

ADDRESSING TOMORROW TODAY.

© USPS 1984



## PROGRAMMER'S UTILITIES

especially for Turbo Pascal on  
IBM PC/XT/AT and compatibles

### MORE POWERFUL THAN UNIX UTILITIES!!!

Whether you are a

-- Student -- Hobbyist -- Professional Software Developer --

THESE UTILITIES WILL IMPROVE YOUR  
PROGRAMMING PRODUCTIVITY!!!

These Powerful, Ready-to-Use programs fully support Turbo Pascal versions 2.0 and 3.0, and MSDOS 2.X and 3.0. Here's what you get:

#### Pretty Printer

Standardize capitalization, indentation, and spacing of source code. Don't waste your own time! Several adjustable parameters to suit your tastes (works with any standard Pascal source).

#### Program Structure Analyzer

Find subtle problems the compiler doesn't: uninitialized and unused variables, modified value parameters, "sneaky" variable modification, redefined standard identifiers. Also generates a complete variable cross reference and a program hierarchy diagram. Interactive or write to file (works with any standard Pascal source).

#### Execution Timer

Obtain a summary of time spent in each procedure and function of your program, accurate to within 200 microseconds. Also counts number of calls to each subprogram. Fully automatic.

#### Execution Profiler

Obtain a graphic profile of where your program spends its time. Interactive, easy-to-use. Identify weak code at the instruction level. (Profiler and Timer for Turbo Pascal Source code only.)

#### Command Repeater

Go beyond MSDOS batch files to combine a powerful text parser with general-purpose command execution capability. Use to copy, print or delete across subdirectories, "make" programs and more.

#### Pattern Replacer

Find and REPLACE versatile regular expression patterns in any text file. Supports nesting, alternation, tagged words and more. Over a dozen programmer's applications included.

#### Difference Finder

Find differences between two text files, and optionally create an EDLIN script which rebuilds one from the other. Disregard white space, case, arbitrary characters and Pascal comments if desired.

#### Super Directory

Replace PCDOS DIR command with extended pattern matching, sort capability, hidden file display, date filtering, and more.

#### File Finder

Locate files anywhere in the subdirectory tree and access them with a single keystroke. Display the subdirectory tree graphically.

### AVAILABLE IN SOURCE AND EXECUTABLE FORMAT

**Executable: \$55 COMPLETE** including tax and shipping. Compiled and ready to run, includes user manual, reference card and one 5 1/4" DSDD disk. Ideal for programmers not using Turbo.

**Source: \$95 COMPLETE** including tax and shipping. Includes all of the above, and two additional DSDD disks. Disks include complete Turbo Pascal source code, detailed programmer's manual (on disk) and several bonus utilities. Requires Turbo Pascal 2.0 or 3.0.

Requirements: MSDOS 2.X or 3.0, 192K RAM -- programs run in less RAM with reduced capacity, two drives or hard disk recommended.

#### TO ORDER:

VISA/MasterCard orders, call 7 days toll-free 1-800-538-8157 x830. In California, call 1-800-672-3470 x830 any day. Or mail check/money order to:

TurboPower Software  
478 W. Hamilton Ave., Suite 196  
Campbell, CA 95008

## ACCORDING TO WEBSTER

tem. For the last month or so, I've had the pleasure of working with two mass-storage devices for the Mac: the QC-10 from Quark and the Mac Bernoulli Box from IOmega.

The QC-10 is a nice piece of hardware with good software support. It's a 10-megabyte hard disk that can be used with the Macintosh, the Apple II, and the Apple III. What's more, you can use one disk with all three systems. The QC-10 Volume Manager software lets you allocate chunks of the disk for the Mac, DOS, ProDOS, and SOS. (Software to support Apple Pascal is under development.) For example, the unit I had on loan (and have since, regretfully, returned) had a 2-megabyte SOS volume, a 2-megabyte ProDOS volume, and four Mac volumes, two of 1 megabyte and two of 2 megabytes. Each Mac volume acts like a floppy disk, with its own volume name and directory. Using the Volume Manager, each volume can be mounted or dismounted, and each can be selected for automatic mounting on boot. Yes, you do have to boot off a disk.

As many hard disks do, the QC-10 makes chirping noises during read/write operations, but they are by no means annoying. Most important, during a month of heavy use, I never had a single problem with the QC-10: no crashes, no lost files, nothing. Note, though, that all my QC-10 use was with a 512K-byte Mac. A friend who has been using the QC-10 with a 128K-byte Mac has reported some problems. I can't verify that since I no longer have the QC-10 here, but be warned.

The QC-10 plugs into the Mac's external drive port. It has a matching port on back, but you can't plug an extra Mac drive in there (yet). However, if you're using it with an Apple IIc or a IIe with a DuoDisk, you can indeed plug your drives into that port. For example, to hook the QC-10 up to my IIe, I would plug it into the DuoDisk controller, then plug the DuoDisk unit into the QC-10. A special cable is provided to connect it to a regular Disk II controller. You use two rocker switches to tell the QC-10 just what it's

talking to. All the cables needed are provided, along with a tiny screwdriver (very thoughtful), and, of course, Mac, DOS/ProDOS, and SOS versions of the Volume Manager software.

The speedup on the Mac was nice, although it was not as great as I would like. However, the same appears to be true of most hard disks and is largely due to the Mac system software. Apple knows this and is apparently taking steps to correct it. A press release handed out at the Apple shareholders' meeting in January stated that "... during 1985 we will enhance the Macintosh user interface and file system to significantly improve Macintosh performance, particularly with hard disks." I hope so.

If you're considering getting a hard disk for your Mac (or Apple II or Apple III), you should take a good look at the QC-10. If you have two or more of those models, you should look very closely.

Question: What looks like a hard disk, acts like a hard disk, but isn't a hard disk? Answer: a Bernoulli Box. Built by IOmega Corporation, the Bernoulli Box has been around for some time as a mass-storage device for the IBM PC. Instead of using rigid platters, it uses a flexible disk inside a removable plastic case. In other words, it's like a very fat floppy-disk drive. How fat? From 5 to 10 megabytes per disk. I've been intrigued with the Bernoulli Box ever since it came out, so I was pleasantly surprised to spot a Macintosh version at COMDEX last November. It holds "only" 5 megabytes per disk, but since you can buy disks at \$60 a pop, your total storage is limited only by your wallet.

I received a loaner unit in December, about a month sooner than expected. It was one of the first ones off the assembly line and, as might have been expected, was D.O.A. Actually, it would power up and everything; it just wouldn't format any disks. A few weeks later, an IOmega representative visited me and replaced a ROM, fixing the problem.

The Box plugs into the modem port

(continued)



# Remote Control.



When you're on the road, don't leave your office to manage itself. Give them a call on AT&T Long Distance from a public phone. And make sure everything's under control. Wherever you are.

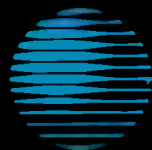

**AT&T**

The right choice.

*I can recommend  
both the QC-10 and  
the Bernoulli Box if  
you are adding mass  
storage to your Mac.*

and looks like a single disk drive to the Mac. Unfortunately, the Mac Finder has problems supporting more than 128 files on a single drive; if you create too many files on the drive, the system crashes. Since a 5-megabyte drive can easily hold two or three times that many files, it's hard to make full use of the disk space. IOmega has just released software to let you make the drive look like several disks; look for a follow-up next month.

The Bernoulli Box is noticeably faster than the QC-10; at least, I noticed the difference when I returned the QC-10 and went back to using the Box. It's also much quieter. The disk-drive emulation is consistent and thorough. You can "eject" the current disk; the drive door actually does pop up, and you can remove the disk and insert another one. You can swap disks, transfer files, and generally treat the Box like another disk drive.

The real advantage of the Box is that you can set up different mass-storage environments. For example, I have two disks: Development and Write/Paint. The Development disk has MacAdvantage (UCSD Pascal), MacASM (68000 assembly language), Microsoft BASIC, MacFORTH, Copy II Mac/MacTools, IconEdit, Resource-Editor, other utilities, and numerous program source files. The Write/Paint disk has Microsoft Word, Think-Tank-512, MacWrite, MacPaint, Multiplan, Dollars and Sense, and Hayden: Speller, along with numerous documents. And I have plenty of room on both disks for more. In other words, I've replaced a few dozen disks with just two. When I want to program, I plug in the Development disk and

everything I need is right there. If I need to write or paint, I eject the Development disk, plug in the Write/Paint disk, and go to work.

An ideal use for a Bernoulli Box would be on a Mac shared by two or more people. Each person would have his or her own 5-megabyte disk with all the programs and data files that he or she needs. No problems with security, no need to worry about accidental (or deliberate) alteration or deletion of files, and no fighting for space.

Aside from the initial ROM problem and the limit on number of files, the Bernoulli Box has been almost as solid as the QC-10. I say "almost" because at one point some of my development software started acting flaky, and I wasn't entirely sure if the problem was with the Box or with the 512K-byte Mac (which has had a few hardware problems of its own). I copied all my program files off, reformatted the disk, put everything I needed back on it, and it's been solid ever since. Since the Mac is on 12-18 hours each day, the Box, like the QC-10, has gotten plenty of work. Also, I have worked with the Bernoulli Box hooked to a 128K-byte Mac, and I have run into a situation where I can't eject the Box's disk via the regular method, forcing me to reboot before ejecting. Recommendation: If possible, upgrade to a 512K-byte machine before (or soon after) getting the Box.

Besides the partitioning software, IOmega is also planning to release a slave drive (also 5 megabytes) for the Box. It would be smaller and cheaper and would plug into the pass-through RS-422 port in the back of the Box. Among other things, this would let you do quick backups, doing a complete disk-to-disk transfer. I have no idea when this will be available or how much it will cost.

I can recommend both the QC-10 (\$1995) and the Bernoulli Box (\$1895) for anyone adding mass storage to their Mac. Each has its own strengths and weaknesses; you need to consider how each might (or might not) meet your needs. And again: If you

are considering getting any hard disk for your Mac, you should first upgrade your Mac to 512K bytes. Heck, you should upgrade to 512K bytes even if you aren't considering getting a hard disk, but that's already been discussed.

**PRODUCT OF THE MONTH:  
CHIPWITS**

When I first saw the Macintosh, I thought about how it would be to develop a graphical programming language for it, i.e., a language that used graphical images instead of text. At the Consumer Electronics Show, I was startled and pleased to see that someone had taken a stab at it. Doug Sharp and Mike Johnson (of Discourse Inc.) have come up with a delightful game called ChipWits. The game resembles a cross between two classic Apple II programs: Robot Wars and Rocky's Boots. Your goal is to design a robot to get through a given environment, i.e., a collection of rooms connected by doors. The robot must avoid obstacles; refuel by finding and picking up coffee and pie; avoid (or destroy) dangers such as electrocrabs, bouncers, and bombs; and gain points by collecting "good items" like oil cans and disks. Eight different environments are included, each with its own mix of objects and overall goal.

If that were all there was to ChipWits, the game would be merely nice. What makes it remarkable is the icon-based programming language, IBOL, that Doug and Mike have implemented. To program your robot, you position and connect icons on a grid (6 by 10) of rectangles. Program flow starts in the upper left corner of the grid (which always has a "green light" icon). Each icon points to the next one to be executed. A number of icons make tests and have TRUE and FALSE arrows that show which way to go based on the test. A "return to start" icon always takes you back to the green light, as does an empty rectangle. And it has subroutines: seven additional grids that you can call from the main grid. Like the main grid, each subgrid starts with a green light icon

*(continued)*

# If you don't have a Hercules Graphics Card, you could end up looking like this:

"I know, because one day it happened to me . . .

"I was running some routine tests on a non-Hercules monochrome graphics card when I was struck by a severe case of *low resolutionitis*. I'm the president of Hercules and that's me exhibiting the symptoms of the disease in its advanced stages. Not a pretty sight, is it?

"What causes *low resolutionitis*? Experts point to ordinary monochrome graphics cards with coarse, hard-to-read graphics. A bad case of eyestrain may develop if action is not taken immediately.

"Fortunately for me, a Hercules Graphics Card was nearby. A quick change brought soothing 720 x 348 graphics. That's twice the resolution of ordinary 640 x 200 graphics cards.

"Which means better graphics for Lotus™ 1-2-3™, Symphony™, Framework™, pfs:Graph™, Microsoft® Chart and Word, SuperCalc3™, AutoCad™, and dozens of other programs.

"Including Microsoft Flight Simulator, now Hercules compatible!

"Oh, and don't forget that a parallel printer port is standard on the Hercules Graphics Card, not an extra cost option.

"Now, if you're worried about buying a new product that hasn't had all the bugs

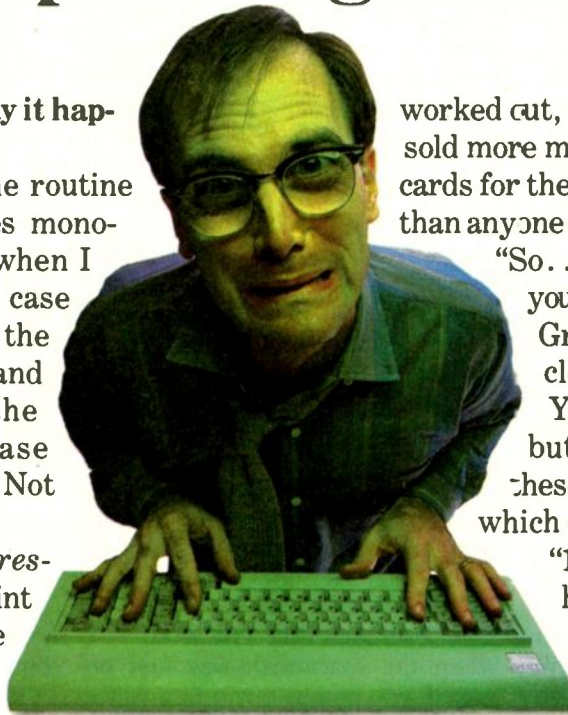

worked out, relax. Hercules has sold more monochrome graphics cards for the IBM® PC, XT™ and AT™ than anyone else in the world.

"So . . . you're convinced that you should buy a Hercules Graphics Card. Now, steer clear of cheap imitations. You may save a few bucks, but you won't get all of these five essential features which only Hercules has:

"1) A safety switch that helps prevent damage to your monitor, 2) the ability to keep a Hercules

Color Card in your system, 3) the ability to use the PC's BASIC to do graphics, 4) a Hercules designed chip that eliminates 30% of the parts that can go wrong, and 5) a two year warranty, because we think reliability is something you should deliver and not just talk about."

"Call 1-800-532-0600 Ext 408 for the name of the Hercules dealer nearest you and we'll rush you our free info kit.

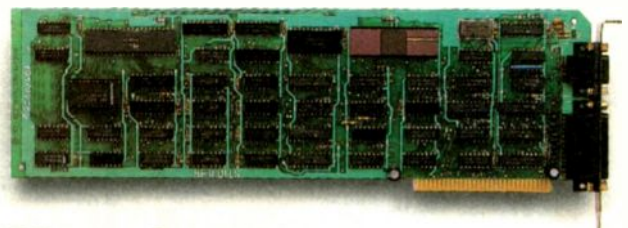

## Hercules. We're strong on graphics.

in the upper left; a special "boomerang" icon returns you to the main grid. What's more, you have three different stacks to use (values, objects, and directions), which lets you do things like set up loops or pass parameters to subroutines. On top of that are single-stepping and trace functions that let you observe the icons, the stacks, and other variables while watching the robot run around. Figure 1 shows one of my creations.

This may all sound complicated; it isn't. I sat down my 8-year-old daughter (who has never programmed) in front of it. Within 10 minutes, and with only a little help from me, she had built a pretty good beginning robot. More than that, she knew why it was doing what it was doing—she understood the program that she had written. One of the advantages of IBOL is that it is impossible to write a program with a syntax error in it. All programs run and run in predictable ways. This makes it an ideal language to introduce programming to nonprogrammers, because *anything they write will run*. The robot may not do very much—indeed, it may even hasten its own destruction—

but the program will at least run.

The only real weakness in ChipWits is the documentation (which wasn't written by Doug and Mike, though it probably should have been). I had a very hard time finding the information I wanted, either because it was stuck in some obscure location or because it just wasn't in there. On the other hand, the IBOL quick-reference card tells you most of what you really need to know. I did find one or two minor bugs in the program itself, but they were truly minor; I passed them on to Doug and Mike, and I'm sure they'll have been corrected by the time you read this.

Even with the poor documentation (did I mention the ugly packaging, also?), ChipWits is a program that every Mac owner should have. It really shows the strength of the visually oriented approach that the Mac promotes. Plus it's a lot of fun. Get it.

**TWO PASCALS FOR THE MAC**

When the Macintosh was first released, you had to buy a Lisa (since renamed the Macintosh XL) to develop software for it. This, understandably, was a sore point with many de-

velopers, since the Lisa 2/10 cost two to three times as much as a Macintosh. In the last year, the situation has changed dramatically. A growing assortment of development systems that run on the Mac itself have appeared, aided by the release of the 512K-byte Mac and various hard disks.

Two Pascal development systems for the Mac are available. Both are from SofTech Microsystems, and both use a p-code interpreter. The first to come out was the Macintosh p-System, a full-fledged port of the p-System onto the Macintosh. Instead of using the Mac interface (mouse, desktop, pull-down menus), it uses the standard p-System menu and utilities (filer, editor, etc.). If you've done any p-System development on another computer, as I have, you'll feel right at home here. However, if you want to bring up a Mac-like application, you're pretty much out of luck. A small graphics library supports sections of QuickDraw and the Event Manager, but that's about it.

The basic Pascal Development System costs \$195 and includes the operating system, compiler, editor, filer, and some other odds and ends. It also includes a few manuals, which are general to the p-System, and a supplement specifically for the Macintosh. If you're going to do any serious programming, you'll also want to get the Advanced Development Tool Kit (\$150), which has a 68000 assembler, a native-code generator, some other advanced utilities, the source code (both Pascal and 68000) for the graphics library given in the basic package, and a few more manuals.

I have mixed feelings about this Pascal implementation. My big software project was done with a version of the p-System, and since it had its own user interface, I think I could have converted it to the Mac in a relatively short time using this package. But that's something of a rare case. Most people who want to write software for the Mac want to make some use of the Mac interface; this package doesn't let you do that. On top of that comes the problem of SofTech's li-

(continued)

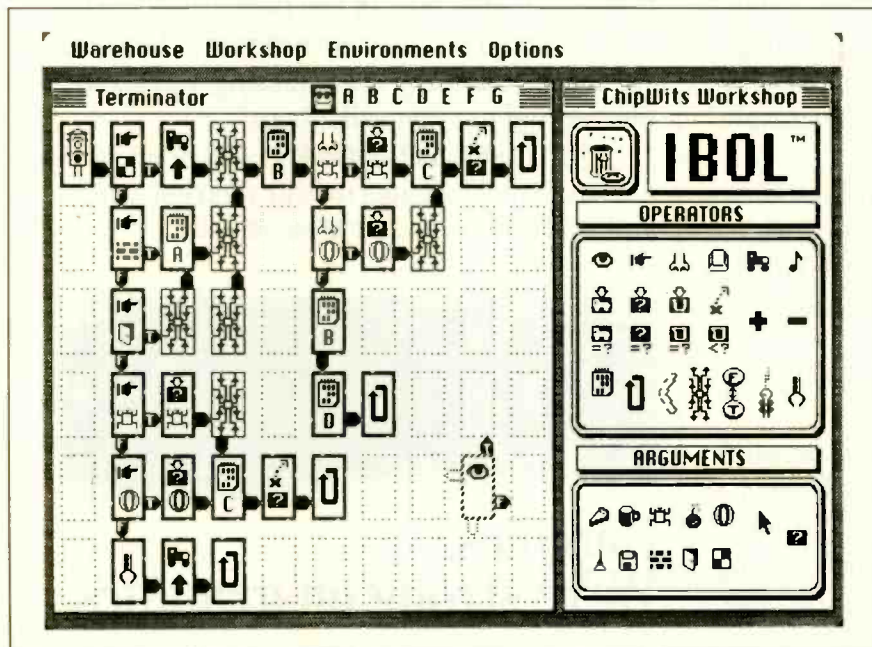
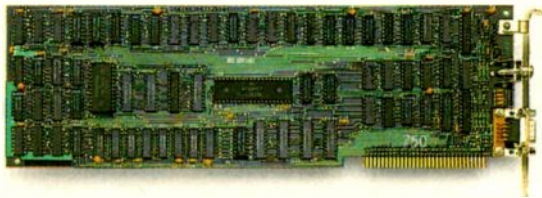

Figure 1: A portion of one of the author's IBOL robot-control programs in the game ChipWits for the Macintosh.

# Compare the Hercules™ Color Card to IBM's.

Five reasons why the Hercules Color Card is better.



**IBM Color Adapter \$244**



**Hercules Color Card \$245**

**1. Compatibility**

Runs hundreds of graphics programs.

Runs the same hundreds of graphics programs. "The Hercules Color Card is so nearly identical to the IBM Color/ Graphics Card that it's almost uncanny." PC Mag.

**2. Printer port.**

None.

Standard. Our parallel port allows you to hook up to any IBM compatible printer.

**3. Size.**

13.25 inches. Limited to long slots.

5.25 inches. Fits in a long or short slot in a PC, XT, AT or *Portable*.

**4. Flexibility.**

Can't always work with a Hercules Graphics Card.

Always works with a Hercules Graphics Card by means of a software switch.

**5. Warranty.**

90 days.

Two years.

Any one of these five features is enough reason to buy a Hercules Color Card. But perhaps the most convincing reason of all is just how easy the Hercules Color Card is to use: "Right out of the box, the Hercules Color Card goes into an empty expansion slot, ready for you to plug in . . . and go to work—no jumpers, no software. For most applications, it's just that easy." PC Magazine.

Call 1-800-532-0600 Ext. 421 for the name of the Hercules dealer nearest you and we'll rush you our free info kit.

**Hercules.**

**We're strong on graphics.**

Inquiry 169

*Mind Prober has  
a personal flavor.  
Its purpose is to  
help you find out  
what makes people  
tick—why they do  
what they do.*

censing fees, which involve a per-copy fee, some of which (\$2000–\$6000) has to be paid in advance. This actually represents a dramatic improvement over the fees that SofTech used to charge (which required as much as \$50,000 up front), but it puts this product at the very high end of Mac licensing fees. Unless you have a product that's closely tied to the p-System, and unless you don't want to use the Mac interface, you really shouldn't consider this package for software development.

SofTech's second package has the unwieldy name of MacAdvantage: UCSD Pascal. That's the only unwieldy thing about it. MacAdvantage is a UCSD Pascal development system that runs under the Mac operating system, i.e., the Finder. With this system, you can point, click, and drag, just as with other Mac applications. More important, you have access to more than 95 percent of the Toolbox routines, which means that you can create Mac-style applications that also let you point, click, and drag.

The editor, developed by Bill Duvall of Consulair Corporation, is a nice MacWrite-like program editor. It is disk-based, so your programs don't have to fit into memory all at once. You can open up to four files at the same time, which makes it easy to move chunks of code between programs. You can even open the same file more than once, which lets you look at one part of the program (such

as global declarations) while editing another part. It has an auto-indent option for easy formatting of your Pascal programs.

Another feature of MacAdvantage is a little (4K bytes) program called Executive. When you run it, it clears the desktop and changes the menu bar to reflect the development environment (editor, compilers, utilities, run, etc.). This is helpful because it takes only a second or two to go from, say, the editor back to Executive, while it takes 10 to 15 seconds to go from the editor back to the Finder. You can move quickly through the development cycle (edit, compile, run), avoiding the constant, agonizing redrawing of the desktop.

Yet another asset of MacAdvantage is the resource compiler, RMAKER. With it, you can set up your resources (menus, windows, icons, cursors, and so on) in a separate text file and compile them into a resource file. When you compile your Pascal program, these resources are copied into the resulting code file.

The Pascal compiler does produce p-code, but you never have to be aware of this. When you double-click a code file, it automatically loads in the interpreter and run-time library, then runs the program. Only two real disadvantages arise when you have p-code files. First, they execute more slowly than machine-code files (those produced by Lisa Pascal and the various C compilers). Second, you can't produce a stand-alone program to distribute; the interpreter and the run-time library have to go with it. You used to have to pay an annual licensing fee, but no more. As of 1 July, SofTech dropped that fee. SofTech also dropped the price of MacAdvantage from \$295 to \$119.

The abolition of the licensing fee represents a growing trend in development software. Creative Solutions Inc., maker of MacFORTH, has lowered the price of its Level III development system from \$2500 to \$499 and has dropped the per-copy fee altogether. Likewise, Modula Corporation has eliminated all licensing fees connected with its MacModula-2 product.

Most notable are the various C compilers, which produce fast stand-alone code and have never had any fees. Because of that, C is becoming the standard Mac development language. This is ironic since Apple wanted to make Pascal the standard; however, Apple's inability (or unwillingness) to come out with a true compiled Pascal for the Mac has dimmed the chances of that happening. SofTech's efforts help but may be a case of too little too late.

**MIND PROBER**

Human Edge Software Corporation specializes in "mind-reading" software, products to give some sort of edge in dealing with others. Most of these are business-oriented (sales, negotiations, etc.); however, Mind Prober has more of a personal flavor. Its purpose is to help you find out what makes someone else tick—why they do what they do.

Mind Prober works by asking you to give a little information on the subject (male/female, over 18/18 and under) and then asking you to choose AGREE or DISAGREE for a long list of attributes (CHARITABLE, PRECISE, SELF-BLAMING, SPONTANEOUS). When you've finished, you can then ask for a report on that person, to be sent either to the screen or to the printer. The report attempts to describe the subject, talking about his or her feelings and actions with regards to work, sex (or, if he/she is under 18, school), relationships, stress, personal interests, and so on. The reports discuss both reactions to situations and underlying motivations. You are then supposed to use this information somehow.

My wife and I separately ran the program on each of us. It was interesting to see how accurate many portions of the report were, while noting the different ways we view ourselves as opposed to how we viewed each other. We then tried a "committee" run on myself. In other words, we both sat and together answered the questions, with some discussion (and arguing). The result was not accurate at all.

*(continued)*

# Cure development headaches with our \$105\* Controller



\* BCC11 100 quantity or  
qualified buyers' price.

At \$105, Micromint's System Controller is a dirt cheap development tool without equal.

It'll turn your IBM PC into a design laboratory that saves your company thousands of dollars and months of evaluation. You'll save headaches, too. When you tell your boss the first phase of your pet project is only going to cost \$105, watch the relief begin.

Micromint's Z8 System Controller, the tiny computer on a board, is the cornerstone of an entire family of integrated, intelligent products from AC/IO to smart terminals. Able to speak three languages (BASIC, FORTH and Assembly), this tiny 4" x 4 1/2" computer supports 6K bytes of EPROM or 4K bytes of RAM, two parallel ports and an RS-232 serial port.

If learning a new language isn't in your future, no problem. **WRITE YOUR PROGRAMS IN BASIC AND TRANSLATE THEM INTO FORTH WITH A SINGLE KEY STROKE.** Our specially masked chip will let you know in an instant whether your program is operational. You'll be building before the competition is de-bugging.

For OEM Orders and Customer Assistance Call Our Toll Free Line

## 1-800-635-3355



Call or write for a complete product line brochure. Or order our complete set of 12 fully detailed owners' and technical reference manuals for only \$29.95. This set includes all of the following manuals:

- Z8 FORTH System Controller
- Z8 BASIC System Controller
- BASIC/Debug Software Reference
- Z8 Microcomputer Assembly Language/Hardware Technical Reference
- Memory and I/O Expansion
- EPROM Programmer
- Analog to Digital Converter
- 16K Memory Expansion
- Serial I/O Expansion
- RS-232/20mA Converter
- Smart Video Terminal
- AC/DC Power I/O

ORDER PRODUCT CODE BCC99.

## Micromint, Inc.

Dept. 14, 25 Terrace Drive, Vernon, CT 06066

Attempts to fine-tune the report by changing answers didn't help much. Our conclusion was that the program worked best if you didn't think too hard or long about the answers.

A psychologist, Dr. Irene Brennan, then took the program and our Mac for a week. She ran Mind Prober on her family and some of her clients.

Her conclusion: Mind Prober does indeed help to reveal information about us. She also thought it was fun.

We did encounter several limitations with the program. First, after doing a number of reports, the same sentences start to appear over and over again, which makes the program lose some of its "oracle" aura. Second,

when the report didn't match exactly, we tended to tweak the answers to get a more accurate report. This implies that the program is always right and that we had just answered the questions wrong. This, of course, is not necessarily the case. Third, we wondered how useful the program would be if we didn't know the subject that well. Changing just a few answers often had a dramatic effect on the report; if we were forced to guess about that many answers, the possible reports that could come out would diverge wildly.

Keeping these limitations in mind, Mind Prober is an interesting and entertaining program. In fact, I've seen it used at a few parties as sort of the modern version of Mad Libs. Just be sure not to take the report too seriously.

**SOFTWARE FROM VIDEX**

Videx has released a number of software packages for the Macintosh: a desk accessory and several games. The desk accessory, MacCalendar, isn't really worth getting. Some public-domain calendar desk accessories function almost as well; and if you need something more powerful than those, you should probably look at Front Desk (from Layered).

**AND NOW FOR SOMETHING COMPLETELY DIFFERENT**

Well, not quite. If imitation is the sincerest form of flattery, the folks at Apple can feel honored indeed. I spent two days this month at the GEM seminar put on in Monterey by Digital Research Inc. GEM is a Mac-like environment that DRI hopes to support on a number of machines, most notably the IBM PC (and clones) and the Atari ST (Jackintosh) series. The similarities to the Mac are striking: textured desktop; windows that you can drag, size, scroll, and make go away; icons that you can click (or double-click); mouse-oriented system; drop-down menus (not to be confused with pull-down menus, for various legal reasons); alert and dialog boxes; and so on. Much of the terminology is un-

(continued)

# You're in Good Company When You Program in BetterBASIC



All of these companies rely on BetterBASIC to write their software programs. They have found that BetterBASIC combines the features they need from BASIC, Pascal, C and Fort in one familiar environment. Some of these features include the following.

**640K** Now you can use the full memory of your PC to develop large programs.

**STRUCTURED** Create well organized programs using procedures and functions that are easily identified and understood and completely reusable in future programs.

**MODULAR** Use procedures and functions grouped together to form "library modules."

**INTERACTIVE** BetterBASIC acts like an interpreter, responding to the users' commands in an immediate mode. However, each statement is actually compiled as it is entered.

**EXTENSIBLE** Create your own BetterBASIC modules which contain BetterBASIC extensions (ideal for OEMs).

**COMPILED** Each line of the program is compiled as it is entered



into the computer's memory rather than interpreted at runtime. The optional Runtime System generates EXE files.

**BetterBASIC** Runs on IBM PC, IBM PC/XT and compatibles.

**CALL 1-800-225-5800** (In Canada: 416-469-5244) Order BetterBASIC now, or write Summit Software Technology, Inc.™, P.O. Box 99, Babson Park, Wellesley, MA 02157. Prices are listed below.

BetterBASIC: \$199 Runtime System: \$250  
8087 Math Module: \$99

Order the BetterBASIC sample disk which includes a demo, a tutorial, compatibility issues and more. Only \$10.

MasterCard, VISA, P.O. Checks, Money Order, C.O.D. accepted.

BetterBASIC is a registered trademark of Summit Software Technology, Inc.

IBM PC and IBM PC/XT are registered trademarks of International Business Machines Corp. Tandy is a registered trademark of Tandy Corp. Illustrated above are registered trademarks of the following companies: Mobil Oil Corp., A T & T, General Electric Co., Westinghouse Electric Corp., TRW, Inc.

ALSO AVAILABLE FOR THE TANDY 2000, 1200 AND 1000





AHH. IT'S LONELY AT THE TOP.

TWA's FIRST CLASS SLEEPER-SEAT<sup>SM</sup> TO EUROPE AND THE AMERICAN EXPRESS<sup>®</sup> CARD PUT YOU COMFORTABLY AHEAD OF THE CROWD.

Success has its rewards. And TWA's First Class and the American Express Card are two rather impressive examples.

In TWA's First Class you can select from a menu that includes caviar and champagne. Entrees like chateaubriand. And vintage wines like Puligny-Montrachet.

Then stretch out comfortably in a Sleeper-Seat, and sleep the flight away.

And as a First Class passenger, you'll be treated accordingly from the moment you first reach the airport. With a separate check-in desk for your convenience. And a special invitation to relax in TWA's Ambassadors Club<sup>®</sup> lounge before your flight.

And when you take the American Express Card along, you have an ideal travelling companion. Because it's known and welcomed all over the world.

So you can use it to pay for your TWA tickets, your hotel, rental car, meals — or just about anything else that strikes your fancy along the way.

And of course, when you carry the American Express Card, you carry all the cachet that comes with it. Don't leave home without it.<sup>®</sup>

And do take TWA's First Class on your next trip to Europe. It's in a class by itself.



LEADING THE WAY. <sup>SM</sup>TWA.

abashedly borrowed from *Inside Macintosh*, and, for that matter, why not? It would have been annoying and confusing for DRI to have come up with brand-new names for everything. There is also a desktop program to replace the MS-DOS interface with a Mac-like display.

GEM actually has some striking improvements over the Mac operating system. First, of course, is that the IBM PC version supports several graphics cards (three from IBM, the Hercules card, etc.), so you can have a Mac-like environment with glorious color. The response time on the IBM PC AT was

very quick, and it didn't seem all that much slower on the PC XT. An ingenious object definition allows everything to be linked together in a tree-based structure. This can make for some sophisticated graphics manipulation on the screen. Best of all is the amazing Resource Construction Set, which lets you graphically lay out menus, dialog boxes, windows, etc., and which then generates the necessary resource code for that item. This last tool had a lot of Mac developers in the audience drooling, and I wouldn't be surprised to see some Mac versions of that appear in the near future.

As impressive as GEM looks, anyone who has done Mac development starts to see gaps and barriers. A number of arbitrary limits crop up: only eight windows open at one time, and only four of those can belong to the application; a maximum of six desk accessories (and that limit can be further constrained by RAM). Text-editing and memory-management routines are primitive. And so on. The result: GEM requires more work to get generally less effect.

The most serious limit announced at the seminar nearly caused a riot among the software developers (300 or so). In the last session, the DRI marketing people announced that the MS-DOS version of GEM would run only on IBM equipment and not on any of the compatibles . . . at least, not until each manufacturer of a compatible machine had paid an OEM fee to DRI. The developers immediately saw the headache of having to either maintain a separate version of their product for each compatible (bundling GEM in) or else release the product without GEM bundled and hope that the end users would buy GEM so that they (the end users) could run the product. In the session, in the lobby, in the taxis and limos, at the crowded Monterey airport, and on the planes, the single topic of discussion was this deliberate crippling of GEM. And the consensus was nearly universal: DRI was making a big mistake.

Digital Research got the message.

## ITEMS DISCUSSED

AIRBORNE . . . . . \$34.95 Silicon Beach Software 11212 Dalby Place, Suite 201 San Diego, CA 92126 (619) 695-6956	MACINTOSH (512K bytes) . . . . . \$2795 and falling Apple Computer Inc. 20525 Mariani Ave. Cupertino, CA 95104 (408) 996-1010
BIG MAC MONITOR SYSTEM . . . . \$1995 PROJECT-A-MAC SYSTEM . . . . . \$4495 Professional Data Systems 20 Sunnyside Ave. Mill Valley, CA 94941 (415) 383-5537	MACINTOSH p-SYSTEM . . . . . \$195 MACADVANTAGE: UCSD PASCAL . . \$119 SoftTech Microsystems Inc. 16885 West Bernardo Dr. San Diego, CA 92127 (619) 451-1230
CHIPWITS . . . . . \$39.95 Brainpower 24009 Ventura Blvd., Suite 250 Calabasas, CA 91302 (818) 884-6911	MACNOSY . . . . . \$50 Jasik Designs 343 Trenton Way Menlo Park, CA 94025 (415) 322-1386
GEM DEVELOPMENT SYSTEM . . . . \$500 Digital Research Inc. 60 Garden Court POB DRI Monterey, CA 93942 (408) 649-3896	MIND PROBER . . . . . \$49.95 Human Edge Software Inc. 2445 Faber Place Palo Alto, CA 94303 (415) 493-1593
MAC BERNOULLI BOX . . . . . \$1995 IOmega 1821 West 4000 South Roy, UT 84067 (801) 776-7330	QC-10 HARD DISK . . . . . \$1995 Quark Peripherals Inc. 2525 West Evans, Suite 220 Denver, CO 80219-5554 (800) 543-7711
MACCALENDAR . . . . . \$89 Videx Inc. 1105 Northeast Circle Blvd. Corvallis, OR 97330 (503) 758-0521	XL SERVE . . . . . \$195 MACAIDE . . . . . OEM pricing Infosphere 4730 Southwest Macadam Ave. Portland, OR 97201 (503) 226-3620
MACFORTH Level I . . . . . \$149 Level II . . . . . \$249 Level III . . . . . \$499 Creative Solutions Inc. 4801 Randolph Rd. Rockville, MD 20852 (301) 984-0262	



# GoldStar



## Another Futuristic Leap from Goldstar's Long Line of Electronics—5.25" Floppy Disks

Goldstar is determined to keep pace with the new frontiers in this electronic age. So, we introduce a new development in this surge of technology—GOLDSTAR 5 $\frac{1}{4}$ " FLOPPY DISKS.

All of Goldstar's pioneering experience, research and demand for excellence has been channelled into this product. Therefore, you can be sure of our reliability, as Korea's electronic history-maker.

Our self-imposed demands match yours exactly — nothing less than perfection, and we're even trying to improve that, as new scientific developments are created. So, we incorporate only the most advanced technology in our disks.

All Goldstar disks are individually certified 100% error-free at all levels, equal to, or above ANSO, DIN, ECMA, ISO, and JIS standards. Goldstar Floppy Disks are engineered to the highest possible quality precision, for the maximum in long archival life,

accuracy, data integrity and matchless reliability.

Goldstar Floppy Disks have a premium magnetic oxide base material burnished to a mirror-smooth surface for maximum disk life and minimal head wear. It is housed in a superior jacket design which insures perfect operation.

*So, for superiority and reliability,  
CHOOSE GOLDSTAR 5 $\frac{1}{4}$ " FLOPPY DISKS!*



### LINE-UP

Type	Tracks/inch	Bits/inch	Capacity
M-1S	48	2768	80 KB
M-1D	48	5536	160 KB
M-2D	48	5876	320 KB
M-2DD	96	5922	640 KB

*(Soft sectored)*



## LUCKY-GOLDSTAR INTERNATIONAL CORP.

Magnetech Group C.P.O. Box 1899 Seoul, Korea Tel.: 756-9090, Tlx.: LGINTL K29579

Inquiry 393

 LUCKY-GOLDSTAR

New York Office: 2nd Floor 1050 Wall Street West, Lyndhurst, New Jersey 07071, U.S.A. Tel.: (201)460-8010 Tlx.: LGI UR 219108 Fax.: 201-935-5686  
Los Angeles Office: 13013 East 166th Street, Cerritos, Calif. 90701, U.S.A. Tel.: (213)404-2626/9 Tlx.: LGI LA 910-583-5719 Fax.: 213-926-0849



# M·A·T·H·E·M·A·T·I·C·A·L R·E·C·R·E·A·T·I·O·N·S

## Parsing and Solving Linear Equations

Set up  
and solve  
simultaneous  
linear  
equations

BY ROBERT T. KUROSACA

**M**ary has \$1.10 in nickels and dimes. She has a total of 12 coins. How many of each coin does she have?

John is 5 years younger than Bob. Next year, John will be two-thirds of Bob's age now. Find their present ages.

$$\begin{aligned}x + y &= 5 \\x + \frac{1}{2}y &= 2x + 1\end{aligned}$$

Look familiar? Of course they do. You've been required to solve systems of linear equations ever since your first course in high school algebra. This month's column is about teaching computers to solve them.

With computers, as with students, the hard part is teaching them how to set up the equations. Solving the system is easy. I wouldn't know how to write a program to set up the two story problems I began with, but I have written a BASIC program to turn the system of equations into something the computer can deal with (that is, to *parse* the expressions). That doesn't seem as if it should be difficult to do. When we write BASIC programs, we commonly write code that looks a lot like algebra already— $x=y-7$  or  $x=x+1$  (oops!). So the first thing I want to do is clarify the difference between what BASIC means by  $x$  and what algebra means by  $x$ . The key is in that funny BASIC statement  $x=x+1$ .

In an algebraic expression like  $1/6x + 1/12x + 5 = x$ ,  $x$  has some numerical value or set of values. The function of algebra is to determine what those values are. In a BASIC expression like  $x=x+1$ , on the other hand,  $x$  is the name of a memory location. The function of BASIC is to modify the contents of that memory location in the way specified by the expression. Put differently, algebraic expressions state facts; BASIC expressions specify operations. The value of  $x$  in BASIC is always known (at least by the computer), while the value of  $x$  is the object of our inquiry in algebra. How then do we solve a system of linear equations?

We have a variety of methods for solving

systems of linear equations: matrix methods (by normalization of the matrix or by inverse matrices), by determinants (Cramer's rule), and many more. I will use the normalization method. Two considerations make this an attractive choice. First, consider the situation where we have four equations for two unknowns, and three of the equations are equivalent. The system is soluble, and we want our method to handle it in a straightforward manner. Second, consider an incomplete or inconsistent system. In that case, the system will be insoluble. We want our program to tell us that without the program hanging because of something like a divide-by-zero exception.

I will use the equations in table 1 to illustrate the way this program will solve systems of linear equations. The equations in table 1a create the matrix shown in table 1b, with the constant terms occupying the zeroth (leftmost) column in the matrix and the other columns filled by the coefficients of the alphabetically ordered variables. In equations that do not include a given variable, a 0 coefficient is entered. That is, each column corresponds to one—and only one—variable. Two row operations are needed for as much normalization as is necessary to solve the system. They are (1) multiply or divide a row by any nonzero constant, and (2) add or subtract a nonzero multiple of a row to another row.

To begin our procedure, we locate the first nonzero coefficient, or *pivot*, in the matrix. In our example, the first pivot is the "2" at the (1,2) position. Set the pivot term equal to 1 by dividing the entire row by the pivot value (table 1c). (R1)/2 means divide each element of row 1 by the number 2.

Use that pivot to create zeros elsewhere in its column. That is, eliminate the "1" and "2" below the pivot. The "1" is removed by subtracting row 1 from row 3 [(R3)-(R1)], and the "2" is removed by subtracting twice row 1 from row 4 [(R4)-2(R1)]. Of course, we need not do anything to row 2. The

(continued)

Robert T. Kurosaka teaches mathematics in the Massachusetts State College system. He invites your correspondence to BYTE, POB 372, Hancock, NH 03449.

# 6 Reasons Why **ReadiWriter**<sup>TM</sup> is the **Only Choice** For Formatting **Large Documents**

- Reformats & Renumbers After Changes
- Automatic Table of Contents
- Indexing - Rebuilt Automatically
- Footnotes: Bottom of Page; End of Chapter; Automatic Numbering; Auto Flow to Next Page
- Precision Control over Document Layout
- Rich Set of Features: Lists, Figures, Macros, Fonts, Proportional Spacing,...

ReadiWriter is a word processor utilizing imbedded "Tags". It comes with a full screen editor and 3 indexed manuals.

IBM/PC & Compatibles, 256K  
 2 drives, DOS 2.x **\$ 395**

ReadiWriter & Manuals	\$395
Mailing Labels and Forms letter Option	\$ 50
Shipping & Handling	\$ 3

MI and CT Residents Add Sales Tax  
**At Your Computer Store**  
 Or direct, Call 616-327-9172  
 or send your order now to:  
**ReadiWare Systems, Inc.**  
 Box 515, Portage, MI 49081

## PARSING EQUATIONS

Table 1: Steps in solving simultaneous linear equations.

$2y - z = 1$	$x \ y \ z$	$x \ y \ z$	$x \ y \ z$
$2x + z = 3$	1   0 2 -1	0.5   0 1 -0.5	0.5   0 1 -0.5
$x + y = 2$	3   2 0 1	3   2 0 1	3   2 0 1
$2x + 2y + 3z = 1$	2   1 1 0	2   1 1 0	1.5   1 0 0.5
	1   2 2 3	1   2 2 3	0   2 0 4
a: the system of equations	b: the matrix from (a)	c: (R1)/2	d: (R3)-(R1), (R4)-2(R1)
	$x \ y \ z$	$x \ y \ z$	$x \ y \ z$
	0.5   0 1 -0.5	0.5   0 1 -0.5	0   0 1 0
	1.5   1 0 0.5	1.5   1 0 0.5	2   1 0 0
	1.5   1 0 0.5	0   0 0 0	0   0 0 0
	0   2 0 4	-3   0 0 3	-1   0 0 1
e: (R2)/2	f: (R3)-(R2), (R4)-2(R2)	g: (R4)/3	h: (R1)-0.5(R4), (R2)-0.5(R4)

```
ENTER EQUATION 1 ? 2y-z=1
ENTER EQUATION 2 ? 2x+z=3
ENTER EQUATION 3 ? x+y=2
```

THE STANDARD FORMS OF THE EQUATIONS ARE

```
y - 0.5z = 0.5
x + 0.5z = 1.5
x + y = 2
```

TOO FEW INDEPENDENT EQUATIONS

Figure 1: Screen dump of the program's response to an underdetermined system. Notice that adding the standard forms of equations 1 and 2 gives equation 3.

### THIS PROGRAM'S LIMITATIONS INCLUDE

- (1) IT WILL HANDLE ONLY "LINEAR EQUATIONS". THAT IS, INEQUALITIES AND VARIABLES MULTIPLIED OR DIVIDED BY VARIABLES WILL CAUSE ERRORS.
- (2) 2y IS WRITTEN AS SHOWN, NOT AS 2\*y OR 2xy. SPACING IS OPTIONAL.
- (3) YOU MAY NOT USE THE LETTERS d OR e AS VARIABLE NAMES.
- (4) YOU MAY USE ONLY ONE EQUAL SIGN IN AN EQUATION, I.E., x=y=z IS NOT ALLOWED.
- (5) PARENTHESES CAN BE USED ONLY IN VARIABLE NAMES, I.E., -(-2x) IS NOT A VALID TERM, BUT --2x(1) IS.
- (6) MIXED FRACTIONS (E.G., 1 1/2 x), TRAILING COEFFICIENTS (E.G., x/2), AND SCIENTIFIC NOTATION (1 e-2 x, 1x10-2 x) WILL CAUSE ERRORS.
- (7) IF THE SYSTEM OF EQUATIONS CONTAINS MORE THAN 10 VARIABLES, IT WILL CAUSE A SUBSCRIPT OUT OF RANGE ERROR.

ENTER THE NUMBER OF EQUATIONS IN THE SYSTEM (MAX. 10)?

Figure 2: Screen dump of the program's limitations.

## PARSING EQUATIONS

result is table 1d. In table 1e our second pivot (2,1) has been set equal to  $1/((R2)/2)$ . Note that row 3 has gone to 0 in table 1f. If equations 1 through 3 were the only ones in our system, the set would be underdetermined, i.e., insoluble (figure 1). If all of row 3 except for the constant (zeroth term) went to 0, the system of equations would be inconsistent.

Since row 3 is all zeros, we skip over it and find the last pivot in row 4. In table 1g we have set the pivot term equal to 1 by  $(R4)/3$ . We then eliminate the z-term from rows 1 and 2 by  $(R1)-0.5(R4)$  and  $(R2)-0.5(R4)$ . The final result is table 1h. The solution set for our system is thus  $y=0$ ,  $x=2$ , and  $z=-1$ .

As I mentioned earlier, the hard part is not solving the system of equations but getting from table 1a to table 1b. How do we do that? Consider the expression  $3x-x+1=x+2$ . We want to begin by collecting terms. In a linear equation, a term is separated from the next term by "+", "-", or "=".

Let's limit our attention to the left-hand side of the equation for now. Clearly, we want to combine the "3x" term and the "-x" term. We add the coefficients, 3 and -1, to get 2x. The third term, "1," is on the "wrong side" of the equation. So we want to change its sign to minus and save it as a constant. Now we can deal with the right-hand side. We see that "x" is on the wrong side. We must change the sign of its coefficient and add it to the other "x" term, giving a total of 1x. The 2 should be added to the constant term, leaving 1. Thus, our collected expression is  $x=1$ .

If that looks like a lot of work, you don't know the half of it. Consider the expression  $x-y=0$ . This is entered in BASIC as a string expression. I use the VAL operator to identify the coefficient. In our example, the VAL operator will return 0 for the value of each term. What we want returned are 1, -1, and 0, respectively. Again,  $1x=1/2y$  will return 1 for the coefficient of each term. Clearly, the program needs to do a lot of bookkeeping.

Figure 2 is a screen dump of the first screen of the program I have provided

### *Parsing string data in BASIC requires a lot of bookkeeping.*

for downloading on BYTEnet Listings at (617) 861-9774. As you can see, I left many potential problems unaddressed in the program. I invite you to alter the program to cover whatever limitations you think need to be eliminated. What I want to do here is just discuss what the limitations tell you about the program.

Limitation number 2 is rather typical. If you enter  $2*y=1$  instead of  $2y=1$ , the parser will interpret the variable name as \*y. If another equation is in the system, say  $y-z=5$ , the program will not treat the two ys as the same variable. The same is true for using 2xy. It would be a small addition to the program to make the parser throw away all occurrences of "\*" and the first problem would be overcome. The case of indicating multiplication by x is more problematic. There is no reasonable way to distinguish between an x used as a multiplication sign and an x used as a variable name or the first letter of a variable name.

Limitation 3 is kind of interesting. Consider the expression  $2e+3f=4$ . The VAL operator will return 2000 as the numerical part of the string because  $2e+3$  is a valid BASIC way of saying 2000. If you change the e to a d, you just have a double-precision way of saying 2000. I eliminated the ambiguity by disallowing both e as a variable name and  $2e+3$  as a coefficient (limitation 6). You could avoid limitation 3 by separating the "2" from the rest of the string before taking its VAL. As for scientific notation, it seems to me that such notation has too many different ways of writing numbers to be worth the effort of using.

In limitation 4 the variable on the right-hand side would be  $y=z$  according to the parser. In limitation 5 the

(continued)

IBM PC Programmers:

## Super Tools™ for Turbo Pascal™

Tested source code routines  
for rapid program development

### Window Management \$45

Manage many windows easily and in full color. Overlap and recall any window with a procedure call. Make your programs "user friendly" with pop-up menus and help windows. Use window librarian to create windows on disk for later display in your program. Beat the 64K barrier by separating window text from your code.

### System and File Information \$30

Include these routines and get a handle on your disk I/O and system configuration. Determine runtime equipment (e.g. number and type of drives). Get directory information, available disk space. Access system status and file attributes (e.g. date and time). Don't let your programs be ignorant!

### Math Expression Evaluator \$35

Provides a single function which accepts a mathematical expression in the form of a string and evaluates it to produce a real result. Supports 22 functions. Allows nested parentheses and a relaxed syntax. Traps overflow or division by zero. Reports position and type of syntactic errors.

Order only the package you  
need, or get the whole  
Super Tools™ Library for  
only \$75.

### Announcing DiskOrder™

Is your hard disk a mess! Get your files organized with DiskOrder™, the easy to use file transfer and update utility. Simplifies mass copies between subdirectories. Checks file dates and only copies most recent versions. Locates files, returning paths. \$25

### In the Works: Scientist's Tools

Including arbitrary precision and complex arithmetic, equation solver, least squares fit, and much more!

Visa and MasterCard accepted.  
California residents include 6% tax.  
Shipping included.

**Paragon Courseware**  
4954 Sun Valley Road  
Del Mar, CA 92014  
(619) 481-1477

Super Tools and DiskOrder are trademarks of Paragon Courseware.  
Turbo Pascal is a trademark of Borland International.

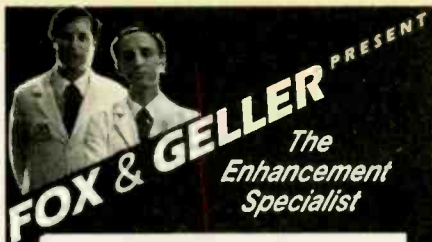

# dBASE

# III

POWER TOOLS

## QUICKREPORT™

dBASE Report Writer

- Prints *any kind* of report or form
- Up to **6 databases** per report!!
- Use bold, italics, etc.
- Incredibly easy to use
- No programming required

## QUICKCODE III™

dBASE Program Generator

- Create PRG files *automatically*
- Data entry screens
- Data input error checking
- Computed fields & totals
- Link up to 8 databases!

Why write programs yourself?  
Let QUICKCODE III do it!

## dGRAPH III™

dBASE Graphics System

- Pie, line, bar charts
- Printer, plotter, or CRT
- Many automatic features

## dUTIL III™

dBASE Program Utility

- Finds program errors
- Improves code
- Saves time

## NEW QUICKINDEX™

- Index dBase files up to **10 times** faster than dBASE

—Versions available for dBASE II—

INFORMATION  
HOTLINE

800-221-0156

FOX & GELLER

Fox & Geller, Inc. 604 Market St., Elmwood Park, N.J. 07407

dBASE II and dBASE III are trademarks of Ashton-Tate.  
QUICKCODE and QUICKINDEX III are trademarks of Fox & Geller, Inc.

## PARSING EQUATIONS

```

ENTER EQUATION 1 ? 0.05 NICKELS + 0.10 DIMES = 1.10
ENTER EQUATION 2 ? NICKELS + DIMES = 12

THE STANDARD FORMS OF THE EQUATIONS ARE

DIMES + 0.5 NICKELS = 11
DIMES + NICKELS = 12

THE SOLUTION SET FOR THE SYSTEM OF EQUATIONS IS

DIMES = 10
NICKELS = 2
    
```

Figure 3a: Screen dump of the program's handling of the coin problem.

```

ENTER EQUATION 1 ? JOHN'S.AGE = BOB'S.AGE - 5
ENTER EQUATION 2 ? JOHN'S.AGE + 1 = 2/3 BOB'S.AGE

THE STANDARD FORMS OF THE EQUATIONS ARE

BOB'S.AGE - JOHN'S.AGE = 5
BOB'S.AGE - 1.5 JOHN'S.AGE = 1.5

THE SOLUTION SET FOR THE SYSTEM OF EQUATIONS IS

BOB'S.AGE = 12
JOHN'S.AGE = 7
    
```

Figure 3b: Screen dump of the age-problem solution. The period is used in the variable names for readability because the program removes all spaces.

coefficient would be  $-1$  and the variable name  $(-2x)$ . Both of these are avoidable without much trouble. The second one seems more interesting to me because you will commonly use linear expressions of the form  $3(x+1) = 4$ . It would be useful for the parser to multiply through the parentheses rather than leave everything in parentheses uninterpreted. If you do this, be careful. You don't want to multiply through the parentheses on an expression like  $3x(1)$ ; an expression like  $3(x+1)$  should be multiplied through; and an expression like  $x(x+1)$  should generate an error.

We've already discussed one aspect of limitation 6. The problem with  $1/2x$  is that the parser removes all blanks from a string. Otherwise, "x" and " x" will be two different variable names. Therefore,  $1/2x$  actually looks like  $1/2x$ , as does eleven-halves  $x$ . A different approach to parsing will avoid this if you want to. In  $x/2$  the parser will treat the coefficient as 1 and the variable name as  $x/2$ . Avoiding this problem would be more work than it

looks like and probably more work than it's worth.

Limitation 7 is simply a matter of having left all of the arrays undimensioned.

At least one more interesting situation can arise in the program. I'm not sure I want to call it a limitation. Consider the equation  $x+y=x+3$ . If you enter this equation by itself in the program, you will be told that it has too many variables for the system to be soluble, even though the program will also print out the standard form of the equation as  $y=3$ . Most of us would take  $y=3$  as the answer. However,  $x$  is clearly underdetermined. If you want the parser to handle this kind of situation, the variable name  $x$  must be removed from the list of variable names in the expression when the coefficient of  $x$  goes to 0.

In closing, I have provided a screen dump of the program solving the two story problems at the beginning (figure 3). I hope you get a chance to download the program and that you enjoy playing with it. ■



# \$299

## MODEM CARD

### FOR APPLE® IIe - 1200 BPS

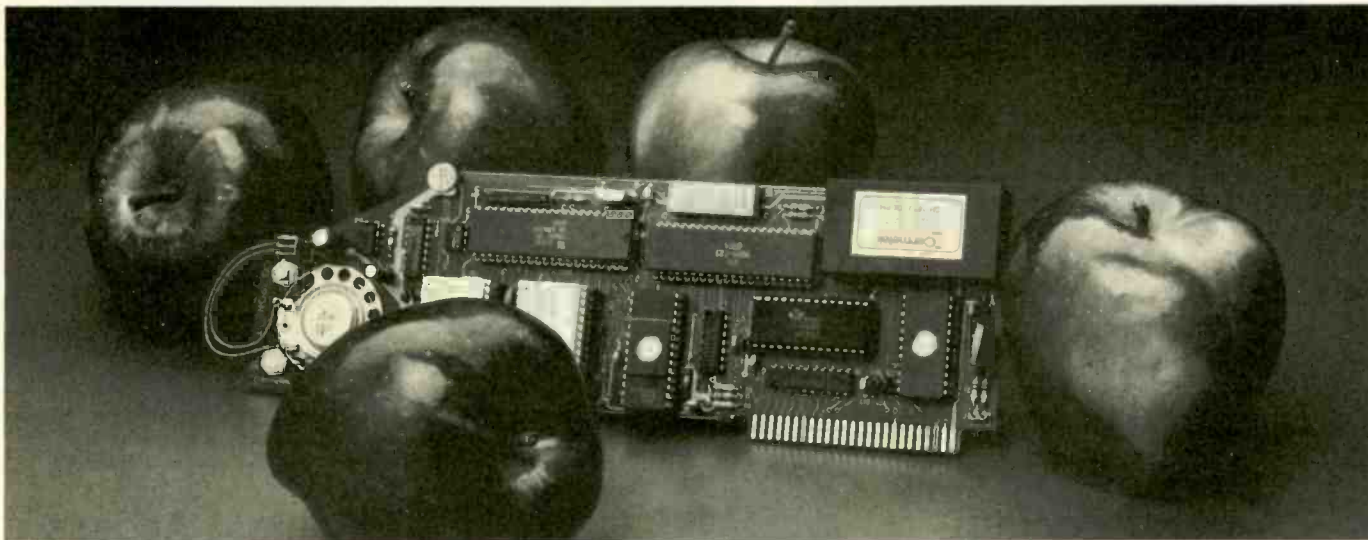

#### TAKE A BITE OUT OF DATA COMMUNICATIONS COSTS!

At \$299 the APPLE-MATE 1200 offers you high modem performance at very low cost. It additionally reduces your software cost by storing Apple IIe Communications software in ROM. Right on the card! The modem can also be used with most disk-based software since it is completely Hayes® compatible.

#### APPLE-MATE MODEM FEATURES

- HAYES "AT" COMMAND COMPATIBLE
- 1200/300/110 bits per second
- Bell 212A and 103 compatible
- Built-in communications software
- Auto-dial, auto-answer
- Auto-speed, auto-parity
- Built-in speaker
- Volume control
- One year limited warranty

Apple is a registered trademark of Apple Computer, Inc.  
Hayes is a registered trademark of Hayes Microcomputer Products, Inc.

DEALER INQUIRIES INVITED.

**SHIP TO:**

NAME \_\_\_\_\_

ADDRESS \_\_\_\_\_

DAY PHONE \_\_\_\_\_

CHECK ENCLOSED

VISA

MASTERCARD

ACCT. NO. \_\_\_\_\_

EXP. DATE \_\_\_\_\_

SIGNATURE \_\_\_\_\_

California residents add 6½% sales tax. All USA orders add \$4 per modem card for shipping and handling. (Canadian orders add \$10 per modem, international orders extra.) No C.O.D.s or purchase orders accepted. Limited quantity available.  
(800) 862-6274 (California (408) 752-5095)

MAIL TO:

SUNNYVALE COMMUNICATIONS COMPANY  
1308 BORREGAS AVENUE  
SUNNYVALE, CA 94088-3565

**APPLE-MATE  
1200 MODEM**

# SAVE YOUR MEMORY

## EDC IS FOR EVERYBODY!

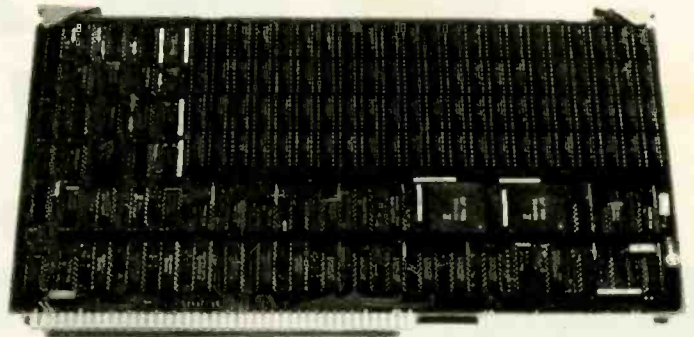
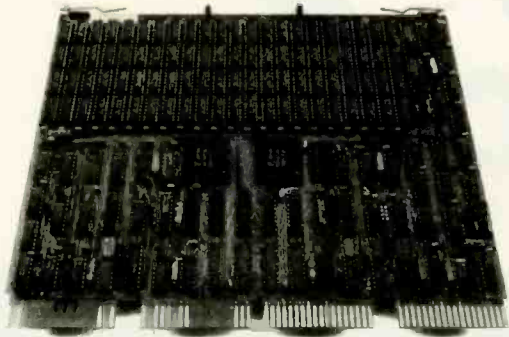

### ERROR DETECTION AND CORRECTION MEMORY FOR QBUS and MULTIBUS 2MB ONLY \$1500

- Lowest Pricing
- Fastest Delivery



- Fastest Access
- 24 Hour Repair

Chrislin knows that faulty memory for a computer serving business or science is unacceptable. That is why, **ERROR DETECTION AND CORRECTION (EDC) ON A MEMORY IS NECESSARY.** EDC provides a computer system with unbeatable performance and reliability. Without EDC implemented, an error could occur in a matter of days. But with EDC implemented, the likelihood of an error would be a matter of years. And that's not all! Each board has a 5 year warranty, 24 hour repair, and each QBUS memory comes with a software support program for onsite repair or service. Add reliability to your computer memory and take a step forward by placing your order today.

Also try our QBUS compatible Systems and Subsystems.

*"OFFERING QUALITY WITH AFFORDABLE PRICING"*



## **Chrislin Industries, Inc.**

31352 Via Colinas • Westlake Village, CA 91362

Telephone (818) 991-2254 • TWX 910-494-1253 CHRISLIN WKVG

AUTHORIZED DISTRIBUTORS: Mississauga, Canada—Transduction Ltd (416) 625-1907;

France—SNGA/Auctel (1)736.87.00, Peru—General Trading Corporation (51)-14-222506.

QBUS is a trademark of Digital Equipment Corporation

MULTIBUS is a trademark of Intel Corporation

Conducted by Steve Ciarcia

## OFFER EXTENDED

Dear Circuit Cellar Project Builders,

In my November 1984 article on the Lis'ner 1000 voice-recognition board, I offered the software separately to Circuit Cellar project builders for \$17 through March 1, 1985. Requests have poured in throughout the offering period, but the majority of foreign mail has just started to arrive. To give everyone time to properly evaluate the project and respond, I am extending the availability of the software through August 1, 1985. Thanks for your support.—Steve

## TRUMP CARD AND NEC

Dear Steve,

In rereading some older issues of BYTE recently, I came across your Trump Card project (May and June 1984). Though I find it very intriguing, it raises several questions regarding its adaptation and use with my PC look-alike, the NEC APC III. I feel that I can overcome the minor problems with physical board-size differences but want to know what possible problems there would be with using the software mentioned under MS-DOS 2.11. Another issue is that of using 256K-byte RAMs rather than 64K-byte RAMs. I don't feel that the project would warrant consideration if the software mentioned could not be modified to run on the system.

My computer is currently configured with 256K bytes, dual 360K-byte disk drives, serial and parallel ports, graphics card (192K bytes), 102-key keyboard, and 640- by 400-pixel resolution color monitor. It is an 8-MHz 8086-based processor. I thought this additional information might be helpful in determining whether or not this project is feasible.

I would be interested in your thoughts on the design and adaptation of a RAM-disk board using 1-megabit bubble-memory modules instead of either 64K- or 256K-byte dynamic RAM chips.

OTTO BARTSCH  
Plano, TX

*The Trump Card was tested on several different systems running under MS-DOS 2.0 and operated without problems on these systems. Since the Trump Card project was presented, the software has*

*been updated by Sweet Micro Systems. Any specific questions about the software interaction with a particular system should be addressed to Sweet Micro Systems Inc., 50 Freeway Dr., Cranston, RI 02920, (401) 461-0530.*

*If you change the memory chips in the Trump Card to 256K-byte chips, you should use chips with 150-nanosecond access times. You will also have to change the address decoding to accommodate the added address lines on the 256K-byte chips.*

*Bubble memory is still relatively high priced compared to other types of storage, especially with the prices of hard disks coming down as fast as they are. However, bubble memory still has a place in systems where the environment is not suited for hard disks and where the price is not a factor. If you are interested in building a bubble-memory system, you should read the two-part article by Louis Wheeler in the January and February 1984 issues of BYTE called "Bubbles on the S-100 Bus."—Steve*

## 8749 PROGRAMMER

Dear Steve,

For some time now, I have wanted to experiment with the Intel 8749 single-chip microcomputer. On reading your November 1983 article ("Build the H-Com Handicapped Communicator"), I learned that you have used the Intel 8748, which is very similar to the 8749.

The only real problem I have is burning the code into the 8749. Can you please refer me to any articles that describe an 8749 programmer? Perhaps it can be connected to a few I/O ports of a personal computer.

NICHOLAS T. VASIL  
Bridgeport, CT

*Several companies advertising in BYTE offer EPROM programmers that are capable of programming the EPROM on the 8749 microprocessor. These programmers can be interfaced to any computer through an RS-232C serial port. For example, GTEK Inc. sells the Model 7128 EPROM programmer that will program 19 different types of EPROMs, 5 different EEPROMs, and 7 different microproces-*

*sors with on-board EPROMs. Contact GTEK Inc., POB 289, Waveland, MS 39576, (601) 467-8048.*

*If you intend to build a dedicated programmer for the 8749, you can obtain the programming voltage specifications and the programming timing sequence from the Intel Component Data Catalog. You can obtain this catalog from Intel Corporation, Literature Department SV3-3, 3065 Bowers Ave., Santa Clara, CA 95051.*

*For information on how to connect an EPROM programmer to an RS-232C serial port, see my article on page 104 of the February BYTE ("Build a Serial EPROM Programmer").—Steve*

## SPEECH AND THE VIC-20

Dear Steve,

While perusing some back issues of BYTE, I noticed that you have published several articles on speech synthesizers. I purchased a speech chip from Radio Shack to connect to my VIC-20, but I am unable to figure out how to interface it to my computer. Can you give me any help?

GARY W. TIDWELL  
Killen, AL

*The chip set that you got at Radio Shack was probably the General Instrument SP0256-AL2 Allophone Speech Processor with a special ROM chip containing encoded words for use as a talking clock. See "Build a Talking Clock Speech Synthesizer" by Ernest H. Piette (May BYTE, page 143) for details on interfacing the SP0256-AL2 to a variety of microcomputers, including the VIC-20.—Steve ■*

*Over the years I have presented many different projects in BYTE. I know many of you have built them and are making use of them in many ways.*

*I am interested in hearing from any of you telling me what you've done with these projects or how you may have been influenced by the basic ideas. Write me at Circuit Cellar Feed-back, POB 582, Glastonbury, CT 06033, and fill me in on your applications. All letters and photographs become the property of Steve Ciarcia and cannot be returned.*

Lotus, dBase, WordStar and MultiMate Users

# Smarten Up

FOR ONLY \$495

To help introduce the newest, fastest, and most powerful Smart Software System (version 2.0), we're repeating an outstanding offer.

For a limited time, you can upgrade to the complete Smart Software System and save \$400 off suggested retail price. Or upgrade to individual Smart modules at comparable savings.

And, whichever way you choose to Smarten up, you'll get the bonus of Smart Communications, Smart Programming Language, and Smart Time Management with every purchase.

IF YOU OWN:	UPGRADE TO:	SUGGESTED RETAIL:	FOR ONLY!
Lotus 1-2-3, Symphony, dBase II, dBase III, MultiMate, WordStar	The Smart Software System	\$895*	\$495
dBase II dBase III	The Smart Data Manager	\$495*	\$195
Lotus 1-2-3	The Smart Spreadsheet with Graphics	\$395*	\$195
MultiMate WordStar	The Smart Word Processor	\$295*	\$195

\*Suggested retail prices effective with version 2.0.

#### JOIN THE RANKS OF SMART USERS.

No matter how you decide to get Smart, you can count on full-featured, fully-integrated performance.

The Smart Spreadsheet is the largest and fastest you'll find. It reads and writes Lotus files. And its Graphics will draw unmatched attention to your data.

The fully-relational Smart Data Manager handles up to 1,000,000 records. Yet for its size and capabilities, it's uncommonly easy to master.

And for memo writing to the most complex documents, nothing beats the versatility of The Smart Word Processor.

#### UPGRADE OFFER EXPIRES JULY 31, 1985.

If you decide to play it Smart, you must act fast. Just stop by the nearest Smart dealer for an Upgrade Order Form. Mail it, along with your check (or charge card authorization) and qualifying proof of purchase.

#### GET SMART TODAY.

For the name of your nearest Smart dealer, call us toll free at 800-GET-SMART. (In Kansas call 913-383-1089.)

**Smart Software**  
from Innovative Software

Inquiry 186

© 1985 Innovative Software, Inc.

Lotus 1-2-3 and Symphony are registered trademarks of Lotus Development Corporation. dBase II and dBase III are trademarks of Ashton-Tate. WordStar and MultiMate are trademarks of Micro Pro International Corporation and MultiMate International respectively.

## Conducted by Sol Libes

Congratulations to Altos for being the first company to introduce a system using the Motorola 68020 microprocessor, a true 32-bitter. The Altos 3068 runs UNIX System V and will handle up to 30 users.

At the January Consumer Electronics Show, Atari's Jack Tramiel (chairman of the board) promised the company would ship 5 million of its new ST-series machines this year. In March, Atari's president, Sam Tramiel (Jack's son), cut the prediction to just over a million units. Rumors now are that Atari will not start shipping the ST in earnest until this month, which would make it difficult to achieve the revised goal. Meanwhile, Leonard Tramiel (another son) revealed that Atari plans an OEM version of the 68000-based machine as well as a local-area network for the system. It is expected that the LAN will use the ST's MIDI (musical instrument digital interface) port and operate at 31.25 kbps. This would make it slower than the AppleTalk net but faster than LANs using RS-232C interfaces.

Digital Research is expected to add an MS-DOS emulation feature to the GEM operating system running on the new Atari 68000-based computer, meaning that users may be able to run many of the programs written for the IBM PC.

Manufacturers of clones are moving from the IBM PC to the PC AT marketplace. Expect Tandy, Hewlett-Packard, Wang, Honeywell, Philips, Siemens, Ericsson, and AT&T (plus several Japanese, Korean, and Taiwanese companies) to introduce AT-compatible machines before the end of the year. Compaq, Xerox, NCR, Texas Instruments, Zenith, and Kaypro already have AT clones out. There are even rumors that Apple is seriously considering producing one. Most are expected to run faster than the AT and have display circuitry compatible with IBM's Enhanced Graphics Adapter (EGA). Chips and Technologies, a custom IC maker in San Jose, CA, is reportedly attempting to reduce the EGA from 150 to 23 ICs.

Also, rumors are going around that General Electric and AT&T have attempted to acquire Apple Computer.

### IBM RUMORS AND SPECULATIONS

The long-rumored PC II is expected to be officially announced by IBM next month,

with shipments to users starting in the fall. . . . Industry pundits expect that this fall IBM will bring out a more powerful and faster version of the AT running UNIX System V and handling up to 16 users. . . . Rumors say that IBM may put TopView into ROM on future PC products along with a new operating system being developed in-house. . . . Expect IBM to introduce a laser printer with much better dot density than current Apple and HP printers.

Future Computing of Dallas predicts that IBM will sell 350,000 ATs this year worth \$1.6 billion. The people there estimate that in 1984 IBM shipped 90,000 ATs worth \$500 million.

Expect IBM to shortly switch to 3½-inch floppies. IBM has ordered 1.5 million 1-megabyte disks from Toshiba, Alps, and Matsushita.

It is estimated that IBM, at the time the company announced it was ceasing production of the PCjr, had around 350,000 units in its warehouses. There are reports that IBM, in an attempt to move large quantities of the units, offered them to liquidation brokers for \$80 each but did not get any takers. There are also reports that IBM, this spring, had as many as 600,000 XT's in stock. In an effort to move them out of warehouses, IBM reduced the XT price by 12 percent, included several software packages, and also began selling PCs with XT motherboards. The feeling is that the introduction of the AT last summer severely undercut sales of the XT. Further, IBM raised the price of the PC to discourage dealers from upgrading PCs to XT's using non-IBM components. In any event, IBM's overstocked warehouses appear to be the cause of the delay in the introduction of the PC II.

Some reports say that IBM is putting the squeeze on independent suppliers of software packages that it distributes. Currently, these companies give IBM 40 to 60 percent discounts. It is reported that IBM is now asking for 70 percent discounts.

### APPLE BYTES AND PITS

First there was the Macintosh with 128K bytes of RAM, quickly followed by the Fat Mac with 512K bytes. Now, industry watchers expect Apple to soon introduce a 1-megabyte Mac. Apple already offers

a 1-megabyte plug-in RAM card for the Mac XL (née Lisa 2).

The 1-megabyte Mac should improve performance, particularly for memory-hungry spreadsheets and font-generating programs. It would also encourage a RAM-disk operation to compensate for the Mac's slow disk access.

Several companies already offer do-it-yourself Mac memory add-ons of up to 2 megabytes, and we can expect these independents, when 1-megabit chips become available, to offer 4-megabyte RAM upgrades (the maximum addressing limit of the Mac). These upgrades require opening the Mac and soldering to the main processor board, a violation of Apple's warranty, and is not recommended for the inexperienced. Levco Enterprises (11568 Sorrento Valley Rd. #14, San Diego, CA 92121) and Beck-Tech (41 Tunnel Rd., Berkeley, CA 94705) offer such kits. Levco also offers a motorless, piezoelectric fan to cool the 2 megabytes of RAM.

I also hear rumors that Apple may introduce a new version of the Mac with a bus-expansion slot, a feature being asked for by value-added retailers. Also expected is a doubling of the ROM from 64K bytes to 128K bytes to improve and expand the operating system. The likelihood is that Apple will offer a new dealer-installed enhanced processor board for the 350,000 Macs already sold. However, Apple will have to figure out how to make this upgrade more popular than its \$995 upgrade from 128K bytes to 512K bytes, which created a great deal of resentment among Mac owners, many of whom did not take Apple up on the offer.

Finally, Apple is expected to introduce an Apple II with the Western Design

*(continued)*

BYTELINES, news and speculation about personal computing, is conducted by Sol Libes, the author of numerous books and articles on computers. He is the founder of the Amateur Computer Group of New Jersey and a coorganizer of the Trenton Computer Festival. He edits and publishes Micro/Systems Journal, a bimonthly publication for system programmers and integrators. He can be contacted c/o BYTE, POB 372, Hancock, NH 03449.

Center 8-/16-bit 65816 microprocessor. Look for it to be introduced at Apple's January stockholders' meeting. There is some question as to whether Apple will provide an upgrade kit for the current 2.5 million Apple II users. If Apple doesn't do it, you can bet somebody else will!

**MICROSOFT TO INTRODUCE MS-DOS 4.0**

Late this year, Microsoft is expected to release version 4.0 of MS-DOS, the primary operating system for the IBM PC/XT/AT family of computers and compatibles. Version 4.0 should add multitasking and a virtual memory space in excess of 640K bytes. Multitasking is expected to improve the operating speed of Microsoft's Windows environment. Currently, the only way to get PC software-compatible multitasking on PC-compatible machines is with Digital Research's Concurrent DOS. The latest version of Concurrent DOS (4.1) also includes the GEM user interface.

Also, version 5.0 of MS-DOS is reportedly in development, designed specifically for the 80286 processor. It should execute programs in the 80286 protected virtual-address mode.

**INTEL UNWRAPS 386**

Intel is expected to shortly make a formal announcement of its new 80386 32-bit microprocessor. For the first time, Intel finds itself running behind National Semiconductor (already shipping production quantities of the 32032), Motorola (sampling for close to a year and ready to start 68020 production), and AT&T (selling its 32-bitter to OEMs). Production of the 80386 is not expected until next year. This means that the first computers using the device may be introduced by late 1986.

The 80386 is expected to be upward-compatible with the 80286 (used in the IBM PC AT), contain more than twice the number of devices, and be two to three times faster. It should have on-chip memory management, with a protection feature, to work with up to 4 gigabytes of physical memory and 64 terabytes of virtual memory.

**MEMORY SIZES INCREASING**

In Japan, large-volume pricing of 256K-bit RAM chips is already less than \$4 each, with 64K-bit chips less than \$1. Toshiba, NEC, Hitachi, and Fujitsu are expected to start sampling 1-megabit chips by year's end. Such chips should start appearing in equipment in 1987, earlier than previously expected, making the life of 256K-bit chips

shorter than the 64K-bit and 16K-bit chips. The base RAM memory size in 1987 is expected to be 1 megabyte, compared to the current 256K-byte and previous 64K-byte standards.

ROM size is also growing. Several companies are sampling 1-megabit ROM chips organized as 128K 8-bit words or 64K 16-bit words. This means that the entire operating system for most personal computers can now be in ROM, allowing faster operation and freeing up valuable disk space. HP already has a UNIX portable machine with the operating-system kernel in 256K bytes of ROM. Further, plug-in application-software ROM cartridges will contain larger programs.

**MICRO MARKET IN SLUMP**

A definite slowdown in personal computer demand developed in the late spring of 1984, just as many manufacturers, carried away with the euphoria of the early 1980s, brought increased production facilities on line. This resulted in an inventory buildup for most manufacturers. (IBM reportedly had \$1.8 billion of finished goods plus \$300 million of parts in inventory.) Many companies attempted to cope with the situation with special promotions during the fall and Christmas seasons. IBM cut the price of the PCjr and included a color monitor and software, which brought the list price of a complete system down to less than \$1000 (with a street price of substantially less than \$900). Apple, Commodore, and Atari also offered special prices to move inventory out of warehouses. This policy proved effective in moving out a lot of systems, particularly during the Christmas selling season.

However, since the first of the year, manufacturer inventories have soared as demand fell off again. Some manufacturers have restored higher prices. For example, IBM raised the price of the PCjr to more than \$1400 and saw demand for the unit shrivel to virtually nil.

Apple had such a buildup of inventory that it closed all its plants for a week in March and forced employees to take a vacation. Also, it offered dealer rebates of as much as \$300 in an attempt to get Apple IIs and Macs moving again.

**SINCLAIR GOING WSI**

Sinclair Research, the British company that startled the industry with its inexpensive ZX80/81 microcomputer just a few years ago, is rumored to be planning a new breakthrough. It is expected to introduce late next year a portable system (tentatively called Proteus) using wafer-scale integra-

tion (WSI) and the flat-screen display currently being used in its pocket TV. WSI is expected to allow several megabytes of memory to be built on one wafer. Sinclair is now in the initial stages of constructing a factory to build an estimated 300,000 units a year.

**A PC CLONE FOR LESS THAN \$900**

I just came back from attending the Trenton Computer Festival. This event held every April has the largest personal computer flea market in the country. With components I purchased at TCF, mostly from Taiwan, I was able to put together a very close copy of the IBM PC for less than \$900. If you are looking for the best prices on microcomputer equipment, I suggest you check out computer flea markets held in your area. At TCF I also was able to buy supplies at incredibly low cost (e.g., DS/DD floppies for 70 cents each). If you want specific information on how I built my clone, send me a stamped self-addressed business-size envelope. Send it to POB 1192, Mountainside, NJ 07092.

**ZILOG DELAYS Z80000 AND Z800**

Zilog has again pushed back introduction of its Z80000 32-bit and Z800 super 8-/16-bit (Z80-compatible) microprocessors to the spring of 1986. If Zilog does manage to ship samples when promised, it will be a full six years since announcing it was developing the units.

Zilog, owned by Exxon, has shown a profit only one year in its 11-year life and recently cut 400 people from its payroll. Although a pioneer in microprocessor development, with its Z80 and Z8000 8- and 16-bit microprocessors, it has suffered from a reliance on microprocessor manufacturing, while competitors like Intel, Motorola, and National Semiconductor have used microprocessors as loss leaders to sell memory and other types of ICs.

**RANDOM BITS**

Novix, Cupertino, CA, has introduced a 16-bit microprocessor that directly executes the FORTH language. . . . A catalog issued by Markline Co., Belmont, MA, features a \$39.95 electronic toaster using a microchip to assure uniform toasting. . . . For the first time, it appears that there will not be a waiting list for booth space at this month's National Computer Conference. . . . Hewlett-Packard, long a pioneer in the computer business (first to introduce the touchscreen, the 3½-inch disk, a UNIX portable, etc.), is expected to be the first company out with a computer optical-disc unit. ■

# B.O.O.K.S R.E.C.E.I.V.E.D

- ADVANCED LEVEL I DBASE: CONCEPTS FOR FIRST-TIME USERS.** Alan Freedman. Englewood Cliffs, NJ: Prentice-Hall, 1985; 71 pages, spiral-bound, ISBN 0-13-011420-0, \$6.95.
- ADVANCED PROGRAMMING: A PRACTICAL COURSE.** D. W. Barron and J. M. Bishop. New York: John Wiley & Sons, 1984; 300 pages, hardcover, ISBN 0-471-90319-1, \$24.95.
- THE ANALYSIS OF ALGORITHMS.** Paul Walton Purdom Jr. and Cynthia A. Brown. New York: Holt, Rinehart & Winston, 1985; 560 pages, hardcover, ISBN 0-03-072044-3, \$39.95.
- ANIMATION MAGIC WITH YOUR IBM PC AND PCjr.** Ron Person. Berkeley, CA: Osborne/McGraw-Hill, 1985; 256 pages, softcover, ISBN 0-88134-145-2, \$15.95.
- APPLE COMPUTER DIRECTORY: HARDWARE, SOFTWARE, AND PERIPHERALS—APPLE II/II+, APPLE IIE, MACINTOSH, LISA, APPLE III, APPLE IIC.** Kelly-Grimes. New York: John Wiley & Sons, 1985; 496 pages, softcover, ISBN 0-471-87818-9, \$26.95.
- APPLICATION DEBUGGING.** Robert Binder. Englewood Cliffs, NJ: Prentice-Hall, 1985; 382 pages, hardcover, ISBN 0-13-039348-7, \$29.95.
- ASSEMBLY LANGUAGE PROGRAMMING FOR THE VAX-11.** Michael H. Pressman. Palo Alto, CA: Mayfield Publishing Co., 1985; 400 pages, hardcover, ISBN 0-87484-599-8, \$28.95.
- BASIC.** Bijan Mashaw. Palo Alto, CA: Mayfield Publishing Co., 1985; 560 pages, softcover, ISBN 0-87484-692-7, \$23.95. Includes instructor's manual (ISBN 0-87484-737-0).
- THE BASIC ADAM: A SELF-TEACHING GUIDE.** William Abikoff and Gary Cornell. New York: John Wiley & Sons, 1984; 536 pages, softcover, ISBN 0-471-80807-5, \$14.95.
- BASIC PROGRAMS FOR THE ATARI 600XL & 800XL.** Timothy Orr Knight. Blue Ridge Summit, PA: Tab Books, 1984; 128 pages, softcover, ISBN 0-8306-1726-4, \$8.95.
- BEST MICROCOMPUTER HARDWARE.** Chung I. Park, ed. Morton Grove, IL: Ad Digest, 1985; 64 pages, softcover, ISBN 0-939670-03-8, \$3.95.
- BEST MICROCOMPUTER SOFTWARE.** Chung I. Park, ed. Morton Grove, IL: Ad Digest, 1985; 64 pages, softcover, ISBN 0-939670-04-6, \$3.95.
- C LANGUAGE FOR PROGRAMMERS.** Kenneth Pugh. Glenview, IL: Scott, Foresman and Co., 1984; 206 pages, softcover, ISBN 0-673-18034-4, \$17.95.
- THE C PROGRAMMER'S HANDBOOK.** M. I. Bolsky. Englewood Cliffs, NJ: Prentice-Hall, 1985; 88 pages, spiral-bound, ISBN 0-13-110073-4, \$14.95.
- CHARGED BODIES: PEOPLE, POWER, AND PARADOX IN SILICON VALLEY.** Thomas Mahon. New York: New American Books, 1985; 352 pages, hardcover, ISBN 0-453-00487-3, \$15.95.
- THE CHIP: HOW TWO AMERICANS INVENTED THE MICROCHIP & LAUNCHED A REVOLUTION.** T. R. Reid. New York: Simon & Schuster, 1985; 246 pages, hardcover, ISBN 0-671-45393-9, \$17.95.
- COMMODORE 64 BASIC MADE EASY.** David A. Gardner and Marianne L. Gardner. Englewood Cliffs, NJ: Prentice-Hall, 1985; 256 pages, hardcover, ISBN 0-13-152067-9, \$19.95.
- COMMODORE 64 BASICS: A SELF-TEACHING GUIDE.** Ann Harris. New York: John Wiley & Sons, 1985; 456 pages, softcover, ISBN 0-471-88008-6, \$15.95.
- COMMODORE 64 LOGO: A LEARNING AND TEACHING GUIDE.** Peter Goodyear. New York: John Wiley & Sons, 1984; 204 pages, softcover, ISBN 0-471-81964-6, \$14.95.
- THE COMPLETE PFS: BOOK.** Ralph Mylius. Plano, TX: Wordware Publishing, 1985; 200 pages, softcover, ISBN 0-915381-70-2, \$19.95.
- COMPUTER GENEALOGY: A GUIDE TO RESEARCH THROUGH HIGH TECHNOLOGY.** Paul A. Andereck and Richard A. Pence. Salt Lake City, UT: Ancestry Inc., 1985; 304 pages, softcover, ISBN 0-916489-02-7, \$12.95.
- COMPUTER USABILITY TESTING AND EVALUATION.** Richard H. Spencer. Englewood Cliffs, NJ: Prentice-Hall, 1985; 240 pages, hardcover, ISBN 0-13-164088-7, \$27.50.
- COMPUTERS AND APPLICATION SOFTWARE: AN INTRODUCTION.** Wilson T. Price. New York: Holt, Rinehart and Winston, 1985; 582 pages, softcover, ISBN 0-03-000349-0, \$26.95.
- DBASE II: TECHNIQUES AND REFERENCE MANUAL.** Jack E. Lohman. Milwaukee, WI: dTECHNIQUE, 1984; 146 pages, softcover, ISBN 0-9614034-0-3, \$19.95.
- THE DBASE DOZEN FOR DBASE II.** Alan Freedman. Englewood Cliffs, NJ: Prentice-Hall, 1985; 71 pages, spiral-bound, ISBN 0-13-195967-0, \$6.95.
- THE DBASE DOZEN FOR DBASE III.** Alan Freedman. Englewood Cliffs, NJ: Prentice-Hall, 1985; 71 pages, spiral-bound, ISBN 0-13-196288-4, \$6.95.
- THE DBASE QUERY LANGUAGE.** Alan Freedman. Englewood Cliffs, NJ: Prentice-Hall, 1985; 72 pages, softcover, ISBN 0-13-196171-3, \$6.95.
- DEBUGGING BASIC PROGRAMS.** David R. Cecil. Blue Ridge Summit, PA: Tab Books, 1984; 178 pages, softcover, ISBN 0-8306-1813-9, \$9.95.
- DEC MICROCOMPUTER DIRECTORY: HARDWARE, SOFTWARE, AND PERIPHERALS—RAINBOW, RAINBOW PLUS, DECMATE II, PROFESSIONAL SERIES.** Kelly-Grimes. New York: John Wiley & Sons, 1985; 366 pages, softcover, ISBN 0-471-87822-7, \$26.95.
- DEFECT CORRECTION METHODS: THEORY AND APPLICATIONS.** K. Böhmer and H. J. Stetter, eds. New York: Springer-Verlag, 1984; 256 pages, softcover, ISBN 0-387-81832-4, \$20.
- DICTIONARY OF MICROELECTRONICS AND MICROCOMPUTER TECHNOLOGY (German-English/English-German).** Yvonne Hélène Attiyate and Raymond Shah. Philadelphia, PA: Heyden & Son, 1984; 460 pages, hardcover, ISBN 3-18-400652-2, \$31.
- DO YOU REALLY NEED A HOME COMPUTER?** Derek Rowntree. New York: Charles Scribner's Sons, 1985; 160 pages, softcover, ISBN 0-684-18182-7, \$6.95.
- 8086/8088 ASSEMBLY LANGUAGE PROGRAMMING.** Bik Chung Yeung. New York: John Wiley & Sons, 1984; 280 pages, softcover, ISBN 0-471-90463-5, \$19.95.
- THE ELECTRONIC LINK: USING THE IBM PC TO COMMUNICATE.** Lawrence J. Magid and John Boesch. New York: John Wiley & Sons, 1985; 280 pages, soft-

*THIS IS A LIST of books received at BYTE Publications. It is not meant to be exhaustive; its purpose is to acquaint BYTE readers with recently published titles in computer science and related fields. We regret that we cannot review all the books we receive; instead, this list is meant to be a monthly acknowledgment of these books and the publishers who sent them.*

(continued)

# IBM PC KEYBOARD IMPROVEMENT!

Plug in a better keyboard for your IBM PC or PC-XT. Our new keyboards feature conductive elastomer technology with "Maxi-Touch" tactile response. Low-profile design, three versions:

- Standard IBM layout
- Enhanced layout (improved Return, Enter, Left Shift and Slash positioning)
- Dvorak high-efficiency layout

Keyboard enclosure matches IBM, has comfortable palm rest. With coiled cord, connector. Only \$168.00 plus shipping. Available from stock.

Maxi is a leading OEM keyboard supplier.



IBM PC AND PC-XT are trademarks of International Business Machines.

THE **Maxi-SWITCH CO.**

9997 EAST RIVER ROAD • MINNEAPOLIS, MINNESOTA 55433  
 Subsidiary of EECO Incorporated. (612) 755-7660  
 TWX 910-576-2690



No More WAITING with . . .

# FASTBREAK™

8087 SPEED for LOTUS 1-2-3™

FASTBREAK speeds up 1-2-3 recalculations by up to 36 to 1 on a 4.77 MHz PC and by 79 to 1 on a NUMBER SMASHER equipped PC. It extends DOS functionality to include the 8087 and comes with a daughterboard which fits into the 8087 socket, an 8087, a break button and the necessary software. A number of additional features are invoked through its novel break button. These enable the user to lock out the keyboard, exchange information with programs written in BASIC, FORTRAN or C that are running concurrently, spool LOTUS output to a printer and install a single protected copy of 1-2-3 and FASTBREAK on your hard disk. An optional LOCK BOX makes it possible to RESET your PC and remove the break button from the computer . . . \$339 LOCK BOX . . . \$60

See our full page ads elsewhere in this issue for other MicroWay products including:

8087 5MHz	\$109
64K RAM Set	\$9
256K HMOS RAM Set	\$49
256K CMOS RAM Set	\$135

Contact MicroWay, Inc. or your local MicroWay® Installation Center to order.

Lotus and 1-2-3 are trademarks of Lotus Development Corp. MicroWay, FASTBREAK and NUMBER SMASHER are trademarks of MicroWay, Inc.

**MicroWay**

P.O. Box 79  
 Kingston, Mass.  
 02364 USA  
 (617) 746-7341

**The World Leader  
 in 8087 Support!**

## BOOKS RECEIVED

cover. ISBN 0-471-88382-4. \$15.95.

ESSENTIAL PROGRAMS FOR SMALL BUSINESS PLANNING OF THE APPLE II/IIe/IIc. Michael Kilpatrick. New York: John Wiley & Sons, 1985; 272 pages, softcover. ISBN 0-471-80602-1. \$46.90. Includes floppy disk.

EVERYTHING YOU NEED TO DO YOUR TAXES WITH LOTUS 1-2-3. Michael Kwatinetz, Joel Pitt, and Leonard Kwatinetz. New York: Sterling Publishing Co., 1984; 320 pages, softcover. ISBN 0-8069-7928-3. \$14.95.

EVERYTHING YOU NEED TO DO YOUR TAXES WITH SUPERCALC. Michael Kwatinetz, Joel Pitt, and Leonard Kwatinetz. New York: Sterling Publishing Co., 1984; 264 pages, softcover. ISBN 0-8069-7932-1. \$12.95.

FIRST BOOK ON UNIX FOR EXECUTIVES. Yukari Shirota and Toshiyasu L. Kunii. New York: Springer-Verlag, 1984; 170 pages, softcover. ISBN 0-387-70003-X. \$16.

FORTH. W. P. Salman, O. Tisserand, and B. Toulout. New York: Springer-Verlag, 1984; 176 pages, softcover. ISBN 0-387-91256-8. \$14.

FOUNDATIONS OF COMPUTER MUSIC. Curtis Roads and John Strawn, eds. Cambridge, MA: MIT Press, 1985; 736 pages, hardcover. ISBN 0-262-18114-2. \$50.

GOING FROM BASIC TO C. Robert J. Traister. Englewood Cliffs, NJ: Prentice-Hall, 1985; 176 pages, softcover. ISBN 0-13-357799-6. \$17.95.

GUIDE TO TELECOMMUNICATIONS WITH YOUR IBM PC. Greg Kearsley, Beverly Hunter, and Hal Hunter. Glenview, IL: Scott, Foresman and Co., 1985; 176 pages, softcover. ISBN 0-673-15944-2. \$39.95. Includes floppy disk.

HOW TO REPAIR AND MAINTAIN YOUR IBM PC. Gene B. Williams. Radnor, PA: Chilton Book Co., 1984; 224 pages, softcover. ISBN 0-8019-7537-9. \$12.95.

IBM PC COMPATIBLE COMPUTER DIRECTORY: HARDWARE, SOFT-

WARE, AND PERIPHERALS—COMPAQ, EAGLE, COLUMBIA, HYPERION, TI PROFESSIONAL, . . . AND MORE. Kelly-Grimes. New York: John Wiley & Sons, 1985; 608 pages, softcover. ISBN 0-471-87819-7. \$26.95.

IBM PC COMPUTER DIRECTORY: HARDWARE, SOFTWARE, AND PERIPHERALS—IBM PC, PCjr, CS 9000, IBM PC/XT. Kelly-Grimes. New York: John Wiley & Sons, 1985; 590 pages, softcover. ISBN 0-471-87821-9. \$26.95.

IBM PC 8088 MACRO ASSEMBLER PROGRAMMING. Dan Rollins. New York: Macmillan Publishing, 1985; 464 pages, softcover. ISBN 0-02-403210-7. \$18.

THE IBM PC/XT: MAKING THE RIGHT CONNECTIONS. Martin D. Seyer. Englewood Cliffs, NJ: Prentice-Hall, 1985; 320 pages, hardcover. ISBN 0-13-449026-6. \$24.95.

IBM PORTABLE PERSONAL COMPUTER USER'S HANDBOOK, staff of Weber Systems, Cleveland, OH: Weber Systems Inc., 1984; 316 pages, softcover. ISBN 0-938862-17-0. \$15.95.

THE ILLUSTRATED LOTUS 1-2-3 BOOK. Thomas H. Berliner and David T. Reeves. Dallas, TX: Wordware Publishing, 1985; 304 pages, softcover. ISBN 0-915381-52-4. \$17.95.

IMPROVING CAI IN BASIC. Sharon Burrowes and Ted Burrowes. Eugene, OR: The International Council for Computers in Education, 1985; 88 pages, softcover. ISBN 0-924667-08-7. \$6.

INFORMATION MANAGEMENT WITH BASIC FOR THE IBM PC/XT. Tom Shoemaker. Reston, VA: Reston Publishing, 1985; 192 pages, softcover. ISBN 0-8359-3076-9. \$14.95.

INTELLIGENT SYSTEMS: THE UNPRECEDENTED OPPORTUNITY. J. E. Hayes and D. Michie, eds. New York: John Wiley & Sons, 1984; 224 pages, softcover. ISBN 0-470-20139-8. \$19.95.

INTRODUCTION TO ADA, 2nd ed. S. J. Young. New York: John Wiley & Sons, 1984; 404 pages, softcover. ISBN 0-470-20112-6. \$29.95.



BOOKS RECEIVED

INTRODUCTION TO NON-LINEAR OPTIMIZATION. L. E. Scales. New York: Springer-Verlag, 1985; 256 pages. softcover. ISBN 0-387-91252-5. \$19.80.

INTRODUCTION TO NUMERICAL METHODS FOR PARALLEL COMPUTERS. U. Schendel. New York: John Wiley & Sons, 1984; 152 pages. hardcover. ISBN 0-470-20091-X. \$21.95.

LEARNING ASSEMBLY LANGUAGE. Hugo T. Jackson and A. M. Fischer. New York: Harper & Row, 1985; 318 pages. softcover. ISBN 0-06-043247-0. \$19.95.

LEARNING FORTH. Margaret A. Armstrong. New York: John Wiley & Sons, 1985; 226 pages. softcover. ISBN 0-471-88245-3. \$16.95.

LEARNING MS-BASIC ON THE TI PROFESSIONAL COMPUTER. Donald W. Drury. Blue Ridge Summit, PA: Tab Books, 1984; 240 pages. softcover. ISBN 0-8306-1815-5. \$15.95.

LEARNING WITH COMMODORE Logo. Daniel Watt. New York: McGraw-Hill, 1985; 332 pages. spiral-bound. ISBN 0-07-068581-9. \$19.95.

LOGICS FOR ARTIFICIAL INTELLIGENCE. Raymond Turner. New York: John Wiley & Sons, 1984; 128 pages. hardcover. ISBN 0-470-20123-1. \$29.95.

MACGUIDE: THE COMPLETE HANDBOOK TO THE MACINTOSH. Leslie S. Smith. New York: New American Library, 1985; 288 pages. softcover. ISBN 0-452-25569-4. \$14.95.

MACTELECOMMUNICATIONS. Jonathan Erickson and William D. Cramer. Berkeley, CA: Osborne/McGraw-Hill, 1985; 224 pages. softcover. ISBN 0-88134-155-X. \$16.95.

MANAGING MICROCOMPUTERS IN LARGE ORGANIZATIONS. National Research Council. Washington, DC: National Academy Press, 1985; 160 pages. softcover. ISBN 0-309-03492-2. \$13.95.

MASTERING YOUR COMMODORE 64 THROUGH EIGHT BASIC PROJECTS. Robert M. Tripp, ed. Englewood Cliffs, NJ: Prentice-Hall, 1984; 192 pages. softcover.

ISBN 0-13-559543-6. \$19.95. Includes floppy disk.

MICROCOMPUTERS AND MICRO-PROCESSORS: THE 8080, 8085, AND Z-80—PROGRAMMING, INTER-FACING, AND TROUBLESHOOTING. John Uffenbeck. Englewood Cliffs, NJ: Prentice-Hall, 1985; 688 pages. hardcover. ISBN 0-13-580309-8. \$31.95.

MULTIPLAN MADE EASY. MACINTOSH EDITION. Walter A. Ettl. Berkeley, CA: Osborne/McGraw-Hill, 1985; 288 pages. softcover. ISBN 0-88134-153-3. \$14.95.

OKIDATA PRINTER USER'S HANDBOOK. staff of Weber Systems. Cleveland, OH: Weber Systems Inc., 1984; 304 pages. softcover. ISBN 0-938862-19-7. \$15.95.

OR ON THE MICRO. David Whitaker. New York: John Wiley & Sons, 1984; 208 pages. hardcover. ISBN 0-471-90083-4. \$19.95.

THE PC SOFTWARE AND SYSTEMS DIRECTORY FOR COMPUTER-AIDED ENGINEERING, the editors of CAD/CIM Alert and CAE Workstation Alert. Brookline, MA: Management Roundtable Inc., 1985; 86 pages. spiral-bound. #002PC. \$79.

THE PERSONAL COMPUTER INVESTMENT HANDBOOK. Jon Zonderman. Blue Ridge Summit, PA: Tab Books, 1984; 160 pages. softcover. ISBN 0-8306-1807-4. \$11.95.

THE PLAIN ENGLISH MAINTENANCE AND REPAIR GUIDE FOR IBM PERSONAL COMPUTERS: IBM PC, PC XT, PCjr. AND COMPATIBLES. Henry F. Beechhold. New York: Simon & Schuster, 1985; 272 pages. softcover. ISBN 0-671-52864-5. \$14.95.

THE PRINCIPLES AND PRACTICE OF COST/SCHEDULE CONTROL SYSTEMS. Chuck M. Slemaker. Princeton, NJ: Petrocelli Books, 1985; 440 pages. hardcover. ISBN 0-89433-227-9. \$39.95.

PROGRAMMER'S GUIDE TO VIDEO DISPLAY TERMINALS. David Stephens. Dallas, TX: Atlantis Publishing, 1985; 336 pages. softcover. ISBN 0-936158-01-8. \$30.

(continued)

# DISKETTES

CALL TOLL FREE → West of Rockies 1-800-621-6221  
Central & East 1-800-654-4058

<b>Dysan</b> 5 1/4" Disks S-SIDE 1695 D-DEN 2195 S-SIDE 96TPI 2895 D-SIDE 96TPI 3895 HIGH DEN. 5195 8" Disks S-SIDE 2195 S-DEN 2395 D-DEN 2795	<b>maxell</b> 5 1/4" Disks S-SIDE 1395 D-DEN 1995 D-SIDE 1995 S-SIDE 96TPI 2495 D-SIDE 96TPI 3095 HIGH DEN. 3995 3 1/2" Disks S-SIDE 2895 D-SIDE 4295 8" Disks S-SIDE 2595 D-DEN 2895	<b>BONUS</b> Disks-10 pk \$9.95 per box Verbatim Kits 495 Refills 895 Media Mate 895 ea *2% Shipping 100 Disk Bulk Pack 85.00 SS DD 97.00 DS DD	<b>3M</b> 5 1/4" Disks S-SIDE 1495 D-DEN 1995 D-SIDE 1995 S-SIDE 96TPI 2495 D-SIDE 96TPI 3095 3 1/2" Disks S-SIDE 2895 D-SIDE 2895	<b>Verbatim Datalife</b> 5 1/4" Datalife S-SIDE 1495 D-DEN 1995 D-SIDE 1995 S-SIDE 96TPI 2495 D-SIDE 96TPI 3095 3 1/2" Datalife S-SIDE 2795 D-SIDE 2795 8" Datalife S-SIDE 1995 S-DEN 1995 D-DEN 2295 D-SIDE 2695
--	--	--	---	---

**the Diskette Connection**  1-800-621-6221 P.O. Box 1213 Boulder City, NV, 89006  
1-800-654-4058 P.O. Box 1674 Bethany, OK, 73008

**TERMS:** Minimum 20 disks or \$35.00 — VISA or MasterCard accepted. C.O.D. orders add 2% for special handling. **SHIPPING:** 3 1/2" & 5 1/4" Diskettes: Add 3% for every 100 Diskettes or any fraction thereof. 8" Diskettes: Add 4% for every 100 Diskettes or any fraction thereof. We ship UPS; orders requiring other delivery methods add shipping, plus 2% of total order.



## data systems

THE QUALITY GOES IN BEFORE THE NAME GOES ON

**PROFIT FROM ZENITH DATA SYSTEMS Z-150 PC DESKTOP OR Z-160 PC PORTABLE IBM COMPATIBLES!**

**OWN TOTAL PERFORMANCE . . . . . BETTER THAN AN XT!**



**ZENITH DATA SYSTEMS Z-150 PC DESKTOP SYSTEM**  
2 DRIVES, 320K RAM, GAME, SERIAL & 2 PARALLEL PORTS, CLOCK-CALENDAR WITH BATTERY BACK-UP, FREE SOFTWARE TO INCLUDE MS-DOS, RAM-DISK, PRINT SPOILER, MS-WORD\*, MS-MULTIPLAN\* \$1,899  
640K RAM OPTION \$99  
2 FLOPPY & 10Mb DRIVES \$2,399  
2 FLOPPY & 20Mb DRIVES \$2,599  
1/2 HT 10Mb TAPE \$675  
\*WHILE SPECIAL OFFER LASTS!



**ZENITH DATA SYSTEMS Z-160 PC PORTABLE SYSTEM**  
SAME AS Z150PC W/ 2 DRVS. 320K RAM, S, P, MS-DOS, WORD\* AND MULTI-PLAN\* SOFTWARE \$2,239  
W/ 2 FLOPPY & 10Mb DRIVES \$2,849  
\*WHILE SPECIAL OFFER LASTS!



**(800) 528-3138**

**SEE PAGE 431 FOR MONITORS**

DYNAMIC RAMS				STATIC RAMS			
41256	256K x 1	120 ns	\$ 4.95	6264LP	8K x 8	120 ns	\$ 8.50
		150 ns	\$ 4.25			150 ns	\$ 7.25
4164	64K x 1	120 ns	\$ 1.50	6116P	2K x 8	120 ns	\$ 2.60
		150 ns	\$ 1.10			150 ns	\$ 2.35
		200 ns	\$ 1.15			200 ns	\$ 4.95
				5514	1K x 4	300 ns	\$ 4.45
E. PROMS							
27256	32K x 8	250 ns	\$12.00	8000's			
27128	16K x 8	250 ns	\$ 4.95	7201	\$ 7.25	8253-5	\$ 3.75
27C64	8K x 8	200 ns	\$ 7.75	765A	\$ 7.25	8255A-5	\$ 3.75
		200 ns	\$ 4.10	8085A	\$ 3.95	8748	\$12.25
		250 ns	\$ 3.40	8088	\$ 8.75	8749HD	\$15.50
2764	8K x 8	450 ns	\$ 3.20	8155	\$ 3.25	8755A	\$16.75
		200 ns	\$ 3.95	8251A	\$ 3.50	*For more parts not listed here. Please call	
		250 ns	\$ 3.75	SPECIAL ITEMS			
2732A	4K x 8	450 ns	\$ 3.25	8087-2			\$130.00
2732	4K x 8	450 ns	\$ 3.25	8087-3			\$105.00
2532	4K x 8	450 ns	\$ 4.95	80287-3			\$225.00
2716	2K x 8	450 ns	\$ 2.65				

**PRINTERS AND KEYBOARDS**

\*Made in Japan, high quality product with one year warrantee.

SX-100 cps	PRINTER	\$189.00
SX-130 cps	PRINTER (IBM Compatible)	\$199.00
SFK-201B	KEYBOARD (IBM Compatible • Capacity Type)	\$119.00

# I.C. EXPRESS

15358 Valley Boulevard, City of Industry, CA 91746  
Phone: 818-369-2688 (Mon-Fri • 8-5)

**ORDER TOLL FREE**  
**800-892-8889 • 800-882-8181**

EXCEPT FROM CALIFORNIA CALIFORNIA RESIDENTS ONLY  
Call for current prices & volume discounts. Prices are subject to change.  
TERMS: Minimum order \$10.00. California residents must add 6.5% sales tax.  
Shipping & Handling: UPS Ground \$3.00. UPS Air \$5.00 (under 1 lb.)  
ALL MERCHANDISE IS 100% GUARANTEED.

## New 64K SBC



Only  
**\$375.**  
4" x 6"

- Requires no terminal. Includes Video Controller and CP/M® 2.2
- Runs any size floppy drive
- Substantial OEM Discounts Available

Other models include Hard Disk Controller, CP/M® 3.0, 128K or 256K RAM, Time of Day Clock, E<sup>2</sup>PROM, Peripheral Expansion & RGB Color Video Display

- |                          |   |
|--------------------------|---|
| <b>64K SBC Includes:</b> | • I/O Expansion   |
| • 6 MHz Z808®            | • Source Code and Drivers included  |
| • Video Controller       | • CP/M® 2.2   |
| • 2 Serial Ports         | <small>CP/M is a registered trademark of Digital Research Inc. Z808 is a registered trademark of Zilog Inc.</small> |
| • 4 Parallel Ports       |   |

Megatel Computer Technologies  
Head Office and Technical Support Center  
150 Turbine Drive, Weston, Ontario M9L 2S2  
Telephone: (416) 745-7214 Telex: 065-27453 MEGATEL TOR.  
U.S. Sales and Service Office  
2311 South Anthony, Fort Wayne IN 46805  
Telephone: (219) 745-0310

# megatel

## BOOKS RECEIVED

PROGRAMMING IN IBM PC DOS PASCAL, David M. Chess. Englewood Cliffs, NJ: Prentice-Hall, 1985; 240 pages, softcover. ISBN 0-13-730292-4, \$14.95.

PROGRAMMING TIPS FOR THE COMMODORE 64, David Highmore and Liz Page. New York: John Wiley & Sons, 1985; 112 pages, softcover. ISBN 0-471-81553-5, \$14.95.

RECURSION VIA PASCAL, J. S. Rohl. New York: Cambridge University Press, 1984; 206 pages, hardcover. ISBN 0-521-26329-8, \$34.40.

RESEARCH AND DEVELOPMENT IN INFORMATION RETRIEVAL, C. J. van Rigsbergen, ed. New York: Cambridge University Press, 1985; 450 pages, hardcover. ISBN 0-521-26865-6, \$49.50.

SANYO MBC USER'S HANDBOOK, staff of Weber Systems. Cleveland, OH: Weber Systems, Inc., 1984; 340 pages, softcover. ISBN 0-938862-24-3, \$17.95.

SERIOUS PROGRAMMING FOR THE COMMODORE 64, Henry Simpson. Blue Ridge Summit, PA: Tab Books, 1984; 208 pages, softcover. ISBN 0-8306-1821-X, \$9.95.

6502 MACHINE AND ASSEMBLY LANGUAGE PROGRAMMING, Mike Smith. Blue Ridge Summit, PA: Tab Books, 1984; 322 pages, softcover. ISBN 0-8306-1750-7, \$12.95.

SOFTWARE FOR AMATEUR RADIO, Joe Kasser, G3ZCZ. Blue Ridge Summit, PA: Tab Books, 1984; 304 pages, softcover. ISBN 0-8306-0260-7, \$15.95.

STAR POWER: MASTERING WORDSTAR, MAILMERGE, SPELLSTAR, DATASTAR, SUPERSORT, CALCSTAR, INFOSTAR, STARINDEX, CORRECTSTAR, STARBURST, REPORTSTAR, & PLANSTAR, Paul Garrison. Blue Ridge Summit, PA: Tab Books, 1985; 320 pages, softcover. ISBN 0-8306-1742-6, \$16.95.

STOCK SELECTION: MODERN PORTFOLIO MANAGEMENT, IBM PC VERSION, Robert J. Bibbero. New York: John Wiley & Sons, 1984; 110 pages, 3-ring binder.

ISBN 0-471-80550-5, \$125. Includes floppy disk.

SYSTEMS ANALYSIS, DESIGN, AND DEVELOPMENT WITH STRUCTURED CONCEPTS, Perry Edwards. New York: Holt, Rinehart and Winston, 1985; 526 pages, hardcover. ISBN 0-03-000142-0, \$27.95.

TEXT PROCESSING, A. Colin Day. New York: Cambridge University Press, 1984; 160 pages, hardcover. ISBN 0-521-24432-3, \$29.95.

A USER GUIDE TO THE UNIX SYSTEM, 2nd ed., Rebecca Thomas, Ph.D., and Jean Yates. Berkeley, CA: Osborne/McGraw-Hill, 1985; 736 pages, softcover. ISBN 0-88134-109-6, \$18.95.

WORD PROCESSING COOKBOOK, Glenn B. Stuart. Englewood Cliffs, NJ: Prentice-Hall, 1985; 304 pages, softcover. ISBN 0-13-963380-4, \$18.95.

WORD PROCESSING FOR THE IBM PC & PCjr AND COMPATIBLE COMPUTERS, Carole Boggs Matthews and Martin S. Matthews. New York: McGraw-Hill, 1985; 248 pages, softcover. ISBN 0-07-040952-8, \$18.95.

WORD PROCESSING SOFTWARE FOR THE IBM PC, Ronni T. Marshak. New York: McGraw-Hill, 1985; 208 pages, softcover. ISBN 0-07-056322-5, \$15.95.

WORDSTAR IN 3 DAYS, Miranda Morse. Huntington, NY: Maple Hill Press, 1984; 216 pages, spiral-bound. ISBN 0-930545-02-8, \$14.95.

WORDSTAR WITHOUT TEARS: A SELF-TEACHING GUIDE, Ruth Ashley, Judl N. Fernandez, and Robert Sansom. New York: John Wiley & Sons, 1985; 220 pages, softcover. ISBN 0-471-80540-8, \$14.95.

WORKING FROM HOME, Paul and Sarah Edwards. Los Angeles, CA: Jeremy P. Tarcher Inc., 1985; 432 pages, softcover. ISBN 0-87477-240-0, \$11.95.

THE ZX PROGRAMMERS' COMPANION, John and Catherine Grant. New York: Cambridge University Press, 1984; 256 pages, softcover. ISBN 0-521-27044-8, \$11.95. ■

Your #1 first-stop source of information  
on all high-level  
programming languages

McGraw-Hill

## PERSONAL COMPUTER PROGRAMMING ENCYCLOPEDIA

Languages and Operating Systems

William J. Birnes, Editor in Chief • 700 pages, illustrated



When you need functional or operating definitions of any statements, commands, or source codes in any high-level microcomputer programming language, your best first move is to turn at once to McGraw-Hill's big, new **PERSONAL COMPUTER PROGRAMMING ENCYCLOPEDIA**.

Designed for fast access and easy use, it covers all 19 high-level programming languages — as well as 8-, 16-, and 32-bit assembly languages and machine codes. With it, you'll be able to:

- ✓ design and write programs more easily
- ✓ readily translate programs between different machine dialects of the same language and transfer programs from one machine to another
- ✓ systematically compare the operations, architecture, and syntax of different languages
- ✓ select the most suitable language for specific applications

The Encyclopedia's entries define function, statement, source code, and commands in all 19 of the high-level microcomputing languages available to personal computer users. Exemplary routines show how each code word operates.

Plus, the book provides a comprehensive translation index between languages and language dialects . . . special overview sections that point out the strengths and weaknesses of each language . . . cross references to help you quickly compare operations . . . an equivalency table relating machine languages to high-level languages . . . and more.

Whether you're an experienced professional programmer or a novice, you'll find this practical Encyclopedia will serve as your #1 central source of information for all kinds of problems and questions on microcomputer languages and programming.

### Special Features

- Nonmathematical easy-access approach
- Illustrated with diagrams, logic and circuit maps, schematics, and flow charts
- Helpful overviews of all 19 languages and of hardware systems from a programming perspective
- Useful glossaries of all languages provide clear, precise definitions
- Cross references make systematic operations comparisons easy
- Outsized 8½ x 11" format

*"Comprehensive, exceptionally well done . . . more extensive coverage than is now available within any one volume."*

— Dr. Carl Hammer, Consultant  
Director of Computer Sciences (ret),  
Sperry Univac



Among the top people in the field that have contributed their experience and expertise . . .

Jonathan Amsterdam  
Henry F. Beechhold  
David Dameo  
Michael Iannone  
R. Claude Kagan  
Guy Kelly  
David Lewis  
Len Lindsay  
Kenneth Madell  
Lawrence Mahon

Gary Markman  
Ross Overbeek  
Mark J. Robillard  
Al Rubottom  
Max Schindler  
Stephen Seadler  
Ernest R. Tello  
Linda Welsner  
Robert Wharton  
William Woodall

At your computer store or bookstore. Or use this handy coupon for a 15-day free examination.

#### McGraw-Hill Book Company

P.O. Box 400, Hightstown, NJ 08520

#### Free Examination!

Please send me Birnes: **PERSONAL COMPUTER PROGRAMMING ENCYCLOPEDIA** (005389-8) at \$80, plus postage, handling, and local tax. I will either pay for the book within 15 days or return it postpaid.

#### Save money!

Enclose payment, plus local tax, with your order and McGraw-Hill pays postage and handling costs on the books which you order.

#### MasterCard and VISA holders call toll-free!

1-800-628-0004 (in New York call 212-512-5999) to order your books by phone.

Your order instructions, please.

My check (including local tax) is enclosed.

Bill me  Bill my company

Charge my  VISA  MasterCard Exp. date \_\_\_\_\_

Card # \_\_\_\_\_

Signature \_\_\_\_\_

Name \_\_\_\_\_

Address \_\_\_\_\_

City \_\_\_\_\_

(No P.O. box, please)

State \_\_\_\_\_

Zip \_\_\_\_\_

(Order subject to acceptance by McGraw-Hill)

In Canada, available from McGraw-Hill Ryerson Ltd., 330 Progress Avenue,  
Scarborough, Ontario M1P 2Z5. Prices slightly higher outside of US

50-E102-4001-3

# A COMPUTER PROGRAM THAT SPEAKS YOUR LANGUAGE



**The Computer Chronicles**, a half-hour weekly television series brings you news and information from Silicon Valley and around the world. Correspondent Stewart Cheifet and Gary Kildall, creator of CP/M cover today's headlines and the stories behind them. Find out what is, what was and what will be, with the only computer program you're ever going to need. **The Computer Chronicles**, every week on a public television station near you. (Check local listings for time and channel.)



Produced by KCSM, San Mateo, CA and WITF, Harrisburg, PA with funding from McGraw-Hill's **BYTE** and **POPULAR COMPUTING** magazines.

(continued from page 32)

where the values of  $x_8$  and  $x_9$  are arbitrarily selected.

For example, if a magic number of 9 is desired and if  $x_8$  and  $x_9$  are arbitrarily selected to be 31 and 15 respectively, the values for the remaining boxes are

$$\begin{aligned}x_1 &= -15 + 6 = -9 \\x_2 &= -31 + 6 = -25 \\x_3 &= 31 + 15 - 3 = 43 \\x_4 &= 31 + 30 - 6 = 55 \\x_5 &= 3 \\x_6 &= -31 - 30 + 12 = -49 \\x_7 &= -31 - 15 + 9 = -37\end{aligned}$$

The derivation of this general solution is extensive. Solutions for larger squares (higher order of  $n$ ) can also be obtained using this technique.

Listing 1 is a short BASIC program (written for the unheard-of IM-1 computer manufactured by the "late" APF Industries) that will calculate a magic-square solution using the equations described above. Except for the second line of code (which is directed to turning the audio off and clearing the screen), this program should work on virtually any computer that runs some version of BASIC.

ALFRED A. FRESSOLA  
Fairfield, CT

### MODEM MISMATCH

Since I am in charge of a laboratory computer system I needed a modem link to my home to save me trips into town to fix small problems that could have easily been handled over the phone. Our system already had a Racal-Vadic Model VA3455 modem (300/1200 bps) installed on it for remote diagnostics by our software vendor so I figured that I would use it. I bought an Anchor Automation Mark XII 300/1200-bps modem and hooked it up to my Model 4P at home. I thought I was all set.

What I discovered was that the two modems would not lock into each other. After a couple of phone calls I was told by Anchor Automation that its modem first checks at 1200 bps and then at 300 bps if it hasn't detected a carrier and that Racal-Vadic performs just the opposite. The two units were both switching data rates so that they would never lock in!

It appears to me that there is some degree of nonstandardization in the modem industry that should be made known to others. Since modems are becoming cheaper, smarter, and more prolific, I am sure that others will also run into this problem. The problem would not exist

Listing 1: A program to calculate magic-square solutions.

```

5 DIM A$(1)
10 POKE 24578,38: CALL 17046
20 INPUT "ENTER MAGIC-SQUARE NUMBER",MAGIC
22 IF INT (MAGIC/3) < > MAGIC/3 THEN GOSUB 300
30 MAGIC = - ABS ( INT (MAGIC))
40 PRINT "MAGIC-SQUARE NUMBER IS ", -MAGIC
50 PRINT : PRINT "CHOOSE LOWER MIDDLE BOX VALUE": INPUT X8
60 X8 = ABS ( INT (X8))
65 PRINT : PRINT "LOWER MIDDLE BOX = ";X8
70 PRINT : PRINT "CHOOSE LOWER RIGHT-HAND BOX": INPUT "VALUE ",X9
75 PRINT : PRINT "LOWER RIGHT-HAND BOX = ";X9
90 X9 = ABS ( INT X9))
110 X1 = -X9 - 2*MAGIC/3
120 X2 = -X8 - 2*MAGIC/3
130 X3 = X8 + X9 + MAGIC/3
140 X4 = X8 + 2*X9 + 2*MAGIC/3
150 X5 = -MAGIC/3
160 X6 = -X8 - 2*X9 - 4*MAGIC/3
170 X7 = -X8 - X9 - MAGIC
200 PRINT : PRINT : PRINT "MAGIC-SQUARE BOX VALUES FOR A": PRINT
    "MAGIC- SQUARE VALUE OF "; -MAGIC;" ARE"
205 PRINT : PRINT
210 PRINT X1,X2,X3
220 PRINT X4,X5,X6
230 PRINT X7,X8,X9
250 END
300 PRINT : PRINT : PRINT "FOR A WHOLE NUMBER IN EACH BOX"
310 PRINT "YOU MUST ENTER A MAGIC VALUE"
320 PRINT "THAT IS EVENLY DIVISIBLE BY 3."
330 PRINT : PRINT "KEEP THE PRESENT VALUE ?"
340 INPUT A$
350 IF A$ = "Y" THEN RETURN
360 GOTO 330

```

if the remote were a single-speed unit, but the problem seems to arise when two automatic two-speed units trying to establish a link continuously shift gears in opposite directions.

I would be interested if others have had this same problem and whether something can be done to remedy the situation.

T. TED SCHWANINGER

### SUPER HYPER

Thank you for publishing Richard B. Leining's "Factoring with Hyper" (March, page 396). The enclosed program (listing 2) was derived entirely from his equation (11) and considers right triangles instead of rectangular hyperbolas. Loop 1 factors quickly and exactly those numbers that can be factored directly without overflow, and loop 2 shrinks the remaining number to trigonometric ratios (between 0 and 1) that can be manipulated without overflow and then enlarged. The program requires the same number of iterations (always fewer

than  $n/12$ ) but factors 94,815,109 three times as fast and factors numbers with almost twice as many digits. My program (I call it BIGFAC) can factor 99,876,225,023 on my 12-digit computer in the blink of an eye, but it takes more than half an hour to determine that 999,983 is prime. When I get a multitasking computer (perhaps the Hewlett-Packard Integral) I can run BIGFAC simultaneously with a program that can factor any 12-digit number in half an hour (see Jim Horn's "Fast Factoring on the HP-75C," *Computer Journal of PPC*, November/December 1982).

To convert this HP BASIC program to Microsoft BASIC, you need to know that HMS\$ converts elapsed seconds into hours, minutes and seconds. ! equals REM, @ equals :, and DISP is similar to PRINT. On a 16-digit computer one would want to lengthen L to 16 digits in line 80 and L9 to 15 digits in line 90.

GORDON D. KIRCHEVEL  
Chicago, IL

(continued)

Richard Leining replies:

Bravo! You've reaffirmed the progress begotten by publication. You've beaten the size of the numbers being juggled from  $N^2/4$  in Hyper to  $N$  in BIGFAC. That triangular simplification was really slick. It wouldn't have occurred to me in a long time. My efforts to fit right triangles to

the origin, foci, and differences of a hyperbola, in search of some kind of Pythagorean triple, led nowhere. I was still glued to that hyperbola, while you were free of it.

The use of upper or lower numbers was neat: I'm just learning them. I looked for some  $w,r$  analogy to the key numbers

used to find Pythagorean triples and primitive hypotenuses, without finding any. After all, one side of your triangle is irrational, whereas Fermat and Euler were obsessed with integers.

Your scaling down of the problem is a clever way to get the most out of limited-precision software. In the long run, there is more growth potential in working with arrays of integers. Their running times are an incentive to eliminate trial values of  $\phi$  (or  $w$ ) with a minimum of arithmetic.

#### Listing 2: The BIGFAC factoring program.

```

10 ! BIGFAC: factoring program
20 ! derived from
30 ! Richard B. Leining's HYPER
40 ! BYTE, March 1985, p. 396
50 ! written in Hewlett-Packard enhanced BASIC
60 ! for the HP-85A computer
70 ! with Advanced Programming ROM.
80 ! LET L = 999999999999 ! Largest integer (on 12-digit computer)
90 ! LET L9 = 999999999999 ! Largest N to integerize r accurately
100 DISP "Number to be factored";
110 INPUT N @ T = TIME ! T is the starting time.
120 IF N < 4 THEN BEEP @ DISP "Number too small." @ GOTO 100
130 IF L9 < N THEN BEEP @ DISP "Number too large." @ GOTO 100
140 IF N \ 2 * 2 = N THEN DISP 2; N/2 @ GOTO 360 ! N \ 2 = INT(N/2).
150 LET S = SQR(N)
160 LET W = IP(S) ! (IP(S) = INT(S))
170 IF N MODE 4 = 1 AND W MOD 2 = 0 THEN LET W = W - 1
180 IF N MOD 4 = 3 AND W MOD 2 = 1 THEN LET W = W - 1
190 IF W < S THEN LET W = W + 2
200 LET W9 = (N \ 3 + 3) \ 2 @ LET W5 = MIN(SQR(L), W9)
210 ! Loop 1
220 IF W > W5 THEN 260
230 R = SQR(W * W - N)
240 IF FP(R) = 0 THEN DISP W + R; W - R @ W = L ! FP(R) = R - INT(R).
250 W = W + 2 @ GOTO 210
260 ! Exit loop 1
270 LET I = 10 * LEN(VAL$(N)) - 1 ! I is an "integerizer" as long as N. VAL$ = STR$.
280 ! Loop 2
290 IF W > W9 THEN 340
300 C = S/W ! Cosine of a right triangle whose sides are w (hypotenuse), r, and square root to N

```

(continued)

#### IBM-INTERFERENCE SOLUTION

There I was, typing away on my IBM PC and churning out copies of the world's greatest program on my Epson FX-80, when I received a phone call from my landlady.

She called to ask if I was using a computer. When I told her I was, she replied that a television repairman was at her place to fix her TV, which was suffering from terrible reception. Seems she had been throwing away one "bad" TV after another, until she finally called the repairman, who told her there was nothing wrong with the sets, there was just some jerk in the area who was operating a personal computer.

At first, I didn't believe I was the jerk. I turned off my computer. "Hey, my TV is working OK now," came the startled cry from my landlady over the phone. I turned the computer back on. "Ack. It just went bad again," she said.

I was the jerk.

I confessed to the crime, turned off my computer, and sank into a deep depression. Visions of being drummed out of the neighborhood by the FCC danced through my head. Human nature being what it is, I began experimenting.

(continued)

Q. Business Systems Consulting?  
A. Masterbyte.

MASTERBYTE COMPUTERS OF NEW YORK, INC.  
Ste. 815, 19 W. 34 St., NY, NY 10001 • (212) 760-0341  
SERVING BUSINESSES SINCE 1984

# MICROWAY'S 8087 RUNS 1-2-3™!

MicroWay is the world's leading retailer of 8087s and high performance PC upgrades. We stock a complete selection of 8087s that run at 5 and 8mhz. All of our coprocessors are shipped with a diagnostic disk and the best warranty in the business - 180 days! We also offer daughterboards for socketless computers such as the NEC PC and PCjr, and a board which increases the clock speed of the 80287 in the PC AT. Our new NUMBER SMASHER™ includes 512K ram. It will run the IBM PC at clock speeds up to 9.5mhz and achieves a throughput of .1 megaflops

with 87BASIC/INLINE, Intel Fortran, or Microsoft Fortran. Software reviewers consistently cite MicroWay software as the best in the industry! Our customers frequently write to thank us for recommending the correct software and hardware to meet their specific needs. They also thank us for our same day shipping! In addition to our own products which support the 8087 and 80287, we stock the largest supply of specialized software available anywhere. For information call us at

**617-746-7341**

## FASTBREAK™

MicroWay's daughterboard turns on your 8087 during 1-2-3™ execution and extends DOS functionality. Recalculations run up to 36 times faster. Includes an 8087 chip. When used with the NUMBER SMASHER™ it can provide a total increase in 1-2-3™ execution speed of up to 79 to 1.

FASTBREAK™ 5mhz.....	\$339
FASTBREAK™ 8mhz.....	\$479
FASTBREAK™ without 8087.....	\$249
FASTBREAK™ LOCK BOX.....	\$60

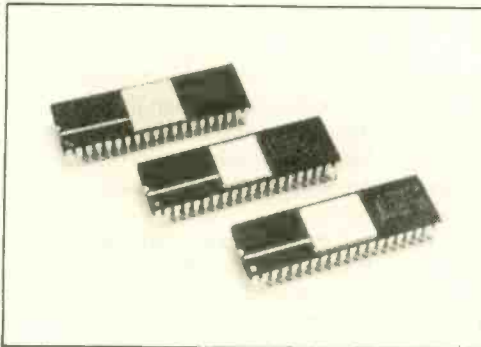

# MicroWay® 8087 Support

For the IBM PC, PC XT, PC AT and Compatibles.

**87FFT™** Written in assembly language, performs Forward and Inverse FFTs on real and complex arrays which occupy up to 512K bytes of RAM. Also does convolutions, auto correlations, hamming, complex vector multiplication, and complex to radial conversions. Callable from MS Fortran, 87MACRO or 87BASIC/INLINE..... \$150

**87FFT-2™** performs two-dimensional FFTs. Ideal for image processing. Requires 87FFT.....\$75

**MATRIXPAK™** manages a MEGABYTE! Written in assembly language, our runtime package accurately manipulates large matrices at very fast speeds. Includes matrix inversion and the solution of simultaneous linear equations. Callable from MS Fortran 3.2, 87MACRO, and 87BASIC/INLINE..... each \$150

### GRAPHICS PACKAGES

Grafmatic for MS Fortran or Pascal..... \$125  
Plotmatic for Grafmatic..... \$125  
MultiHalo (one language)..... \$189

### DFixer™

A disk utility which thoroughly checks PC or AT hard disks for bad sectors and updates the MS DOS file allocation table accordingly..... \$149

**87DEBUG™** - a professional debugger with 8087 support, a sophisticated screen-oriented macro command processor, and trace features which include the ability to skip tracing through branches to calls and software and hardware interrupts. Breakpoints can be set in code or on guarded addresses in RAM..... \$150

**HARDSCOPE™** includes a version of 87DEBUG which interfaces a Breaker Box which makes it possible to reset your PC and break program execution independent of DOS..... \$249

**AST Advantage™**..... \$439

**JRAM-2™ (ØK)**..... \$199

**JRAM™ AT (ØK)**..... \$229

**MAYNSTREAM™** 60 meg..... \$1695

**87BASIC/INLINE™** converts the output of the IBM Basic Compiler into optimized 8087 inline code which executes up to seven times faster than 87BASIC. Supports separately compiled inline subroutines which are located in their own segments and can contain up to 64K bytes of code. This allows programs greater than 128K! Requires the IBM Basic Compiler and Macro Assembler. Includes 87BASIC..... \$200

**87BASIC™** includes patches to the IBM Basic Compiler and both runtime libraries for USER TRANSPARENT 8087 support. Provides super fast performance for all numeric operations including trigonometrics, transcendental, addition, subtraction, multiplication, and division..... \$150

**87MACRO™** - our complete 8087 software development package. It contains a "Pre-processor," source code for a set of 8087 macros, and an object library of numeric functions including transcendental, trigonometrics, hyperbolics, encoding, decoding and conversions. For the IBM Macro Assembler, Version 1.0 or 2.0..... \$150

**OBJ→ASM™** - a multipass object module translator and disassembler. Produces assembly language listings which include public symbols, external symbols, and labels commented with cross references. Ideal for understanding and patching object modules and libraries for which source is not available..... \$200

### RTOS - REAL TIME OPERATING SYSTEM

RTOS is a multi-user, multi-tasking real time operating system. It includes a configured version of Intel's iRMX-86, LINK-86, LOC-86, LIB-86, OH-86, and MicroWay's 87DEBUG. Runs on the IBM-PC, XT, PC-AT and COMPAQ..... \$400

### INTEL COMPILERS¹

FORTRAN-86.....	\$750
PASCAL-86.....	\$750
PL/M-86.....	\$500
87C (LATTICE/MICROWAY).....	\$750
ASM-86.....	\$200

¹Requires RTOS or iRMX-86. All Intel compiler names and iRMX-86 TM Intel Corp.

**8087 5mhz..... \$109**

Including DIAGNOSTICS and one-year warranty For IBM PC and compatibles.

**8087-2 8mhz..... \$195**

For Wang, AT&T, DeskPro, NEC, Leading Edge

**80287-3 5mhz..... \$250**

For the IBM PC AT

**64K RAM Set..... \$9**

**256K RAM Set..... \$49**

**256K CMOS RAM Set..... \$135**

**128K RAM Set PC AT..... \$169**

**NUMBER SMASHER™..... 1590**

9.54mhz 8087 coprocessor board with 512K

### FORTRAN and UTILITIES

Microsoft Fortran 3.2.....	229
IBM Professional Fortran.....	545
Intel Fortran-86¹.....	750
FORLIB+.....	65
STRINGS and THINGS.....	65

### C and UTILITIES

Lattice C.....	299
Microsoft C Version 3.0.....	299
C86.....	299
FLOAT87.....	150

### BASIC and UTILITIES

IBM Basic Compiler.....	270
87BASIC.....	150
87BASIC/INLINE.....	200
Summit BetterBASIC™.....	175
Summit 8087 Module.....	87

### MACRO ASSEMBLERS

IBM Assembler with Librarian.....	155
87MACRO.....	150
Microsoft Assembler V 3.0.....	125

### PASCAL

Microsoft Pascal 3.2.....	199
Borland Turbo with 8087 and BCD.....	85

### APL

STSC APL★PLUS/PC.....	450
Pocket APL.....	85

COSMOS Revelation.....	750
SPSS/PC.....	595

FASTBREAK and NUMBER SMASHER are trademarks of MicroWay, Inc. Lotus and 1-2-3 are trademarks of Lotus Development Corp.

# MicroWay

P.O. Box 79  
Kingston, Mass.  
02364 USA  
(617) 746-7341

**The World Leader  
in 8087 Support!**

## LETTERS

```

310 R = SQR(1 - C * C) * W + I - I ! Converts cos to sin, solves for r and integerizes
      near-integer r's.
320 IF FP(R) = 0 THEN GOSUB 390
330 W = W + 2 @ GOTO 280
340 ! Exit loop 2
350 IF W < L + 2 THEN DISP N; "is prime."
360 T2 = TIME @ BEEP @ DISP HMS$(T2 - T + 86400) MOD 86400 @ DISP !
      Displays elapsed time.
370 STOP
380 ! Subroutine: Test product
390 BEEP @ P = W + R @ Q = W - R @ IF P * Q = N THEN DISP Q; P @ W = L
400 RETURN
410 END
    
```

It turned out that whenever I had the parallel printer cable connected to my computer, the interference was emitted. It didn't matter if the cable was connected to the printer, or if the printer was on. I was using an AST SixPak card as a parallel printer adapter, but I don't know if that had anything to do with the problem.

I called my dealer. He was out of town. His technical-support manager didn't know what to do but suggested I write to

Washington for "a bulletin that gives hints." IBM told me to call my dealer. My friends told me to wrap the cable in several layers of aluminum foil (kept me off the streets for a night, but it didn't do a thing for the interference). I borrowed a shielded cable from work and tried it on my errant system. It didn't make an ohm of difference.

Then I saw a catalog from Moore Computer Supplies (Box 20, Wheeling, IL 60090), and there on page 31 was a pic-

ture of a cable that was like none other: "full tinned copper braid sleeve for highest degree of transmission shielding," a metal casing extending from the cable and onto the connectors "for total EMI/RFI protection," and a grounding lug!

Moore had a toll-free number for technical support, and it had Business Centers that stocked its equipment all over the country. There was one in San Diego, from which I ordered the cable. The cable that was sent had no grounding lug and didn't offer much improvement. I explained the problem to manager Gary Tuck, whom I found to be very helpful and courteous. He contacted the manufacturer, who said the cable was specially made for the IBM because of the very problem I was experiencing. Two days later, I had a new cable.

The cable made a remarkable difference. It cut out about 90 percent of the interference, and I trust the distance from my apartment to my neighbors' will take care of the rest.

BILL PARKER  
Los Angeles, CA ■

### NOVA PC/XT



### THE TOP OF THE LINE IBM COMPATIBLE SUMMER SPECIALS

#### FEATURES:

- Affordably priced PC/XT Computer
- Runs PC, MS-DOS, CPM/86
- Of course, this versatile computer runs Flight Simulator, Lotus 1-2-3, Symphony, Framework, Peachtree, D base II & III, PC Paint, Auto C.A.D., and tones of software.
- We have a Demo system available for your testing.
- OEM, Dealer Inquiry welcome.
- Free installation

#### COMPUTER SYSTEMS:

**NOVA PC Bare Bone** ..... \$695

Includes: 64K mother board, case, 130W power supply, keyboard, floppy controller card.

**NOVA PC 356K system** ..... \$1295

Includes: keyboard, 130W power supply, 2 1/4 in. dr., 6 pack compatible multifunction board, color graphic card, 4-drive controller card.

**NOVA XT 256K** ..... \$1935

Includes: keyboard, 130W power supply, 2 1/4 in. dr., 6 pack compatible multifunction card, color graphic card, 4-drive controller, 10MB hard disk, DTC hard disk controller

#### 1UP GRADE KIT for PC to XT or XT PLUS 22MB

Internal, Miniscribe 10MB H.D. + DTC controller ..... \$625

Internal, Miniscribe 20MB H.D. + DTC controller ..... \$795

Internal, Irwin 10MB Tape back up with cartridge and cable ..... \$625

High quality XT 130W power supply ..... \$139

NOVA external, 10MB hard disk drive ..... \$875

NOVA external, 10MB hard disk with 10MB Tape back up system ..... \$1650

NOVA external, 20MB hard disk drive ..... \$995

NOVA external, 10MB Tape back up system ..... \$850

NOVA external, 45 MB Tape back up ..... \$1450

#### NEW PRODUCTS:

IBM/AT compatible CASE ..... \$175

195W switching power supply for AT ..... \$225

Serial parallel card for AT (2 serial, 1 parallel) ..... \$150

Multi I/O card for PC/XT (2 serial, 1 parallel, clock) ..... \$145

#### NOVA SERIES ADD ON BOARD:

Nova mother board with installation manual ..... \$75

Nova 6-function board with 64K (AST 6 pack compatible) ..... \$185

Mono-graphic board (hercules compatible) ..... \$170

Color-graphic board with printer port, game port ..... \$150

Floppy controller w/cable ..... \$90

#### DESK DRIVE and MONITOR and ACCESSORIES:

Teac 55B 1/4 in. 360K floppy dr. ..... \$110

Microscience 10MB, 20MB (lowest price) ..... \$620

MINISCRIBE or TEAC 10MB 1/4 in. hard disk ..... \$420

MINISCRIBE 20MB 1/4 in. H.D. ..... \$620

KEYTRONIC compatible #5151 keyboard ..... \$130

High Tec keyboard ..... \$130

AMDEX 310A (Amber monitor) ..... \$147

AMDEX 600 RGB (640x200) ..... \$285

**DEALER INQUIRIES WELCOME - NOVA PC/XT KITS AVAILABLE  
COMPUTRADE COMPANY (in Koll Commercial Center)**

780 Trimble Road, Suite 605, San Jose, CA 95131

Tel. (408) 946-2442, Telex: 171605

Hours: Mon-Fri 9:00 a.m.-6:00 p.m.

## a message to our subscribers

From time to time we make the BYTE subscriber list available to other companies who wish to send our subscribers material about their products. We take great care to screen these companies, choosing only those who are reputable, and whose products, services, or information we feel would be of interest to you. Direct mail is an efficient medium for presenting the latest personal computer goods and services to our subscribers.

Many BYTE subscribers appreciate this controlled use of our mailing list, and look forward to finding information of interest to them in the mail. Used are our subscribers' names and addresses only (no other information we may have is ever given).

While we believe the distribution of this information is of benefit to our subscribers, we firmly respect the wishes of any subscriber who does not want to receive such promotional literature. Should you wish to restrict the use of your name, simply send your request to the following address.

BYTE Publications Inc.

Attn: Circulation Department,  
70 Main St., Peterborough, NH 03458



# A growth market.

The kids of today are the real growth market of tomorrow. They are the doctors and nurses, the engineers and scientists, the teachers and journalists, the leaders who will create tomorrow's prosperity.

It will take your company's help to assure these children a first-rate college education because today colleges are having a hard time coping with the high costs of learning.

Invest in the future of America by giving to the college of your choice.

You'll be making an investment in the leading growth market of America. And you couldn't ask for a better investment than that.

Send for our free booklet: "Guidelines—How to Develop an Effective Program of Corporate Support for Higher Education." Write CFAE, 680 Fifth Avenue, New York, NY 10019.



**Invest in the future of America.  
Give to the college of your choice.**

## NEW SYSTEMS

**Talking Computer**

**C**omputer Aids Corporation's Small Talk is a five-pound, battery-powered, talking computer. Small Talk is based on the Epson HX-20 notebook computer. The manufacturer uses the SSI-263 speech chip and a specially developed text-to-speech program to produce speech.

Small Talk contains a built-in dot-matrix printer and cassette storage. It has a speaker, a headphone jack, and two RS-232C serial ports for connecting external printers, modems, or braille devices.

A version of Computer Aids Corporation's WordTalk word processor is built into Small Talk's firmware. WordTalk vocalizes each key as it is pressed in a synthetic voice, and it provides spoken review of characters, words, lines, or entire documents.

Also in Small Talk's firmware are a scientific calculator and a clock/calendar. An optional terminal program is scheduled for release in the fall. Small Talk is completely programmable so the user can write her or his own BASIC programs.

With its carrying case and battery charger, Small Talk sells for under \$2000. Contact Computer Aids Corp., 124 West Washington, Lower Arcade, Fort Wayne, IN 46802. (219) 422-2424. Inquiry **620**.



*The Olivetti M24 IBM PC-compatible.*

**Olivetti M24  
IBM PC-Compatible**

**O**livetti's M24 is an IBM PC-compatible personal computer that uses an 8-MHz 8086-2 processor and MS-DOS 2.11. Its standard features include 128K bytes of RAM (expandable to 640K bytes) on dual-disk models or 256K bytes of RAM (also expandable to 640K bytes) on hard-disk models, a 12-inch monitor with 640- by 400-pixel resolution, serial and parallel ports, a clock/calen-

dar, a graphics card, and seven expansion slots.

You can choose your disk-drive configuration: two 360K-byte slim-line floppy-disk drives or one 360K-byte floppy disk and one 10-megabyte slim-line hard-disk drive. The 83-key keyboard has LED indicators and is detachable.

In its 128K-byte configuration with dual floppy-disk drives and monochrome monitor, the Olivetti M24 is priced at \$2745. The same system with a color monitor is \$3395. Contact Docutel/Olivetti Corp., 5615 Highpoint Dr., Irving, TX 75062. (214) 258-5400. Inquiry **621**.

**IBM PC  
AT-Compatible  
Transportable**

**C**orona Data Systems' Corona AT Transportable (ATP) computer is an MS-DOS machine that uses Intel's 80286 processor. It has a built-in color/monochrome video graphics card and can operate as a stand-alone system or a workstation for the IBM PC AT.

The Corona ATP runs at 6 MHz and supports the 80287 numeric coprocessor. It includes parallel printer and RS-232C serial ports and a built-in floppy-disk controller. The green-phosphor, 9-inch display has 640- by 400-pixel resolution. Three of the system's five expansion slots are AT-compatible; the remaining two are XT-compatible. The AT-style detachable keyboard features an IBM PC XT interface.

You can choose the ATP-6-QD or ATP-6-Q20 model of the Corona ATP. The ATP-6-QD has a 1.2-megabyte floppy-disk drive, a 360K-byte floppy-disk drive, and 512K bytes of RAM. The ATP-6-Q20 has a 20-megabyte Winchester drive, a 1.2-megabyte floppy drive, 512K bytes of RAM, and an AT-compatible hard-disk controller.

Suggested retail price for the ATP-6-QD is under \$4500; the ATP-6-Q20 is priced under \$5500. For more information, contact Corona Data Systems Inc., 275 East Hillcrest Dr., Thousand Oaks, CA 91360. (805) 495-5800. Inquiry **622**.

## ADD-INS

**Instrument Modules for IBMs**

**P**CI-20000 from Burr-Brown consists of a family of instrument modules and a bus-compatible carrier board for the IBM PC, PC XT, PC AT, or Compaq computer. The carrier board provides the computer interface, power supply, and intermodule communications, as well as inputs for three modules. An optional carrier configuration gives you 32 points of buffered, TTL-compatible, digital I/O.

The carrier bus is designed for data acquisition and measurement. It performs standard computer-bus functions and allows for chaining analog signals among the plug-in instruments. The bus lets sync and trigger signals pass among the modules.

Among the instrument modules available are a 16-channel, 12-bit accuracy, data-acquisition module; a data-acquisition expansion module; two types of analog-output modules; a digital-I/O module; and a counter/timer/pulse-generator module. Three different termination panels connect field signals to the PCI-20000 instrument modules.

Prices for the PCI-20000 system start at \$295 each for carrier boards and \$199 for each instrument module. Contact Burr-Brown Corp., POB 11400, Tucson, AZ 85734, (602) 746-1111. Inquiry **623**.

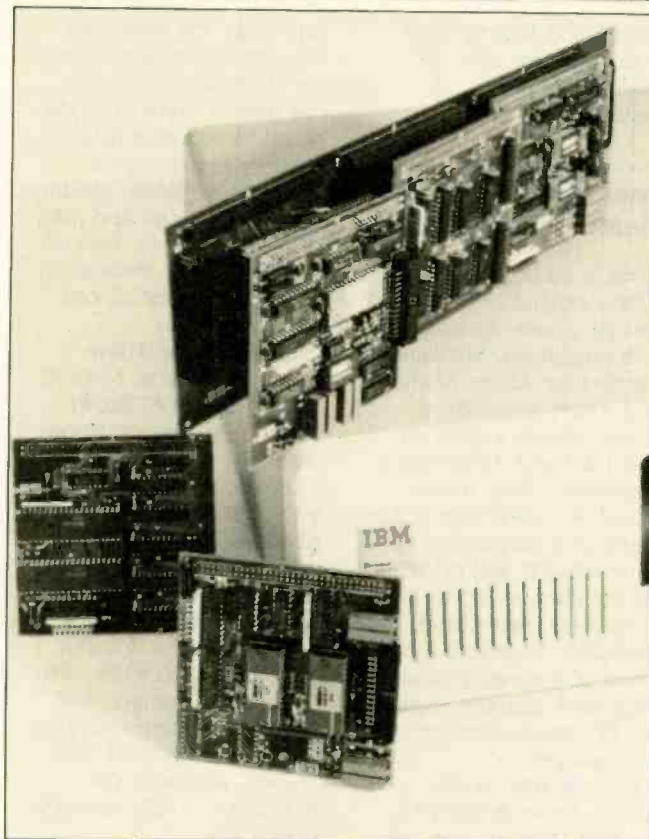

The PCI-20000 instrument modules for IBM-compatibles.

**IBM PC AT Debugger**

**A**tron's AT Probe is a hardware/software combination for the IBM PC AT that provides hardware-assisted debugging. The AT Probe intercepts signals to and from the processor and can trap and trace all occurrences in the system.

A 1-megabyte on-line symbol table, independent of PC AT memory, lets you debug large applications and facilitates source-level debugging. The AT Probe supports source-level (symbolic) debugging for the standard assembler and for high-level languages such as C, Pascal, and FORTRAN. Real-time trace lets you capture and store program ex-

ecution to create a rolling window of the last 2048 memory cycles. Also, you can set breakpoints on reading or writing memory, on doing I/O, at instruction execution, or upon interrupts.

The AT Probe's performance and timing-analysis software lets you create a histogram to display where the program spends its time. You can profile execution of individual procedures and display a procedure-duration measurement or do program event-count analysis and display an event-count measurement.

The AT Probe lists for \$2495. Contact Atron.

20665 Fourth St., Saratoga, CA 95070, (408) 741-5900. Inquiry **624**.

**TanPak Expansion Board**

**T**he TanPak multifunction board is specifically designed to fit the Tandy 1000's 11-inch expansion slots. It contains DMA circuitry, a serial port, and a clock, as well as software to support its features.

The TanPak comes in 128K-, 256K-, and 512K-byte versions. You can also get 256K-byte upgrade kits for those versions with less than 512K bytes of memory.

The 128K-byte TanPak board costs \$399. Contact Hard Drive Specialist, 16208 Hickory Knoll, Houston, TX 77059, (800) 231-6671; in Texas, (713) 480-6000. Inquiry **625**.

**Apple IIe Multifunction Card**

**S**treet Electronics says it has combined the most common Apple IIe interfacing needs on its BusinessCard. It includes two serial interfaces, a clock/calendar with battery backup, and built-in high-resolution graphics and text-screen printing capabilities using pull-down menus.

By adding three buffer chips, you can give the BusinessCard a 16K- or 64K-byte print buffer. The 64K-byte version allows storage of up to 20 pages of text.

The BusinessCard has more than 60 commands for printing graphics and text. Graphics printing commands include windowing, zoom, rotate, and inverse. Among available text-formatting

(continued)

## ADD-INS

features are setting margins, line and page length, page titles, and page numbers.

The BusinessCard is also available in a version for parallel printers. It sells for less than \$200. Contact Street Electronics Corp., 1140 Mark Ave., Carpinteria, CA 93013, (805) 684-4593. Inquiry **626**.

### Quadsprint

**Q**uadram's Quadsprint board, which comes with a plug-in cable that connects to the 8088 socket on the IBM PC's system board, doubles the PC's processing speed.

Quadsprint has a 10-MHz 8086 microprocessor with 4K bytes of high-speed cache memory. Its installation does not affect existing system memory.

Retail price for Quadsprint is \$645. Contact Quadram

Corp., 4355 International Blvd., Norcross, GA 30093, (404) 923-6666. Inquiry **627**.

### Intel IBM PC Memory Products

**I**ntel's add-in boards let you expand IBM PC, XT, and AT system memory up to 8 megabytes. Software support for Above Board/PC and Above Board/AT includes Lotus's Symphony and 1-2-3 and Ashton-Tate's Framework. Four Above Board/PCs, each with a maximum of 2 megabytes, expand IBM PC and PC XT system memory up to 8 megabytes. Two Above Board/ATs, each with a maximum of 4 megabytes using piggyback memory, expand PC AT system memory up to 8 megabytes.

An operating system driver, Above Board's Expanded Memory Manager

supervises the expanded memory and supports multiple applications. You can mix memory types on one board to accommodate memory requirements.

The Above Board products include RAM-disk and print-buffer capabilities. They offer menu-driven installation, memory diagnostics, and fault isolation.

Intel is selling Above Board products in conjunction with its 8087/80287 Math Coprocessors. Above Board/PC retails for \$395 with 64K bytes and \$595 with 256K bytes of memory. Above Board/AT is \$595 with 128K bytes and \$995 with 512K bytes. Above Board/AT with piggyback memory costs \$295 with 128K bytes and \$795 with 512K bytes. Contact Intel Corp., 5200 Northeast Elam Young Parkway, Mail Stop TOC-03, Hillsboro, OR 97124-6497, (503) 629-7354. Inquiry **628**.

### MacMegabytes and RAMDISC

**B**eck-Tech's MacMegabytes memory-expansion board lets you have more than a megabyte of internal memory in your 128K- or 512K-byte Macintosh.

With the MacMegabytes hardware, Beck-Tech provides the RAMDISC software package, which includes slide-show utilities and access to an electronic disk for faster program and data access.

MacMegabytes conversions are priced at \$849 for your 128K-byte Macintosh and \$549 for a 512K-byte machine. You can purchase MacMegabytes as a kit for \$699 if you have a 128K-byte Mac and \$399 if you have 512K bytes. The RAMDISC software alone is \$39.95. Contact Beck-Tech Co., 41 Tunnel Rd., Berkeley, CA 94705, (415) 548-4054. Inquiry **629**.

## PERIPHERALS

### Programmable Backup Subsystems

**S**ysgen's Smart Image and Smart QIC-File tape-backup systems can be programmed to automatically back up your hard-disk drive or selected files at predetermined times. You program these drives using a menu-driven utility program that lets you preselect the files to be backed up. Files specified may include sub-directories or only those files that have changed

since the last backup. Files may be backed up twice daily.

Your computer will beep if in use when a backup is scheduled. Then you can either approve the action or put the backup on hold until you exit to the operating system. Utility programs verify that the proper files have been backed up. The same file can be stored in different tape sets, and data can be restored to different hard disks than were originally backed up.

The cassette-based Smart Image subsystem is \$995. The Smart QIC-File, which uses the QIC-format cartridge, costs \$1395 (internal) and \$1495 (external). Con-

tact Sysgen Inc., 47853 Warm Springs Blvd., Fremont, CA 94539, (415) 490-6770. Inquiry **630**.

### Memory-Card System

**D**ataser-Station encodes and reads pocket-size storage cards that are less sensitive to harsh environments than floppy disks. The station is compatible with any microprocessor that has a standard RS-232C interface.

The Datalok Memory Cards are configured in either 2K by 8 bits or 8K by 8 bits. The cards are hermetically sealed to exclude hydrocarbon solvents, dust, smoke, and chemical vapors. Electromagnetic field and electrostatic discharge do not affect the cards.

The Dataser-Station is \$599.75. The 2K- by 8-bit card costs \$85.95, while the 8K- by 8-bit card costs \$226.80. The interface module lists for \$376.25. Dataser-Station is manufactured by BI ELEC SA of Switzerland; information is available from the U.S. representative, Survivors Ltd., 4654 20th St. N. Arlington, VA 22207, (703) 528-1498. Inquiry **631**.

PERIPHERALS

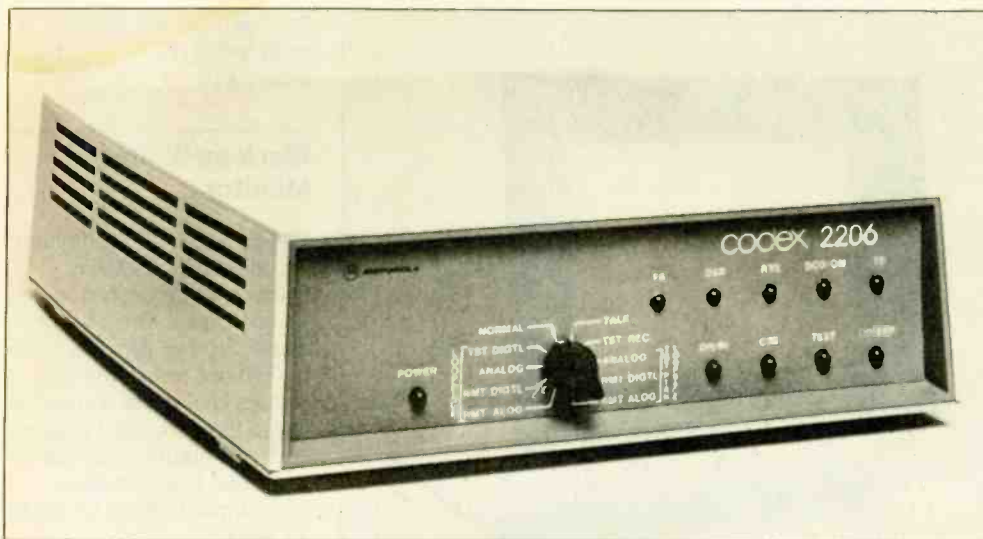

The Codex 2206 modem transmits data at 4800, 7200, or 9600 bps.

**9600-bps Modem**

The Codex 2206 modem can transmit data at 9600 bps over dial or leased lines or at optional rates of 7200 or 4800 bps. It can operate in either two-wire half-duplex or four-wire full-duplex modes.

This microprocessor-based device uses a double-sided band, eight-phase, quadrature amplitude modulation (QAM) scheme. The QAM scheme's 1200-Hz digital adaptive equalizer with multiple settings improves output.

Currently available, the 2206 modem lists for \$1995. Contact Codex Corp., 20 Cabot Blvd., Mansfield, MA 02048, (617) 364-2000. Inquiry 632.

**Digital Copiers for IBM PCs**

Two digital photocopiers from LaserFAX scan photographs, artwork, and

text and digitize the captured image for use on an IBM PC XT, PC AT, or PC-compatible. The stored images can then be manipulated using graphics-editing software that is supplied with the copiers.

Scanning 200 lines per inch, the SpectraSCAN 200 copies 8½- by 14-inch color pages, while the DS-200 digitizes black-and-white images. Peripheral equipment ranging from dot-matrix to laser devices can print the digitized images.

The scanners are software-driven; you control operations through icon screens pulled down by a mouse. This screen looks like a standard photocopier control panel.

The machines contain vacant IBM slots for future applications. Current optional cards include the LaserFAXimile card for communications with facsimile machines and the TEXreader for direct scan-to-processing text reading.

The SpectraSCAN 200 costs \$3995, and the DS-200 scanner lists for \$2995. The LaserFAXimile card is \$995.

while the TEXreader costs \$1200. Contact LaserFAX Inc., 2000 Palm St. S, Naples, FL 33962, (813) 775-2737.

Inquiry 633.

**Hard-Disk/Tape-Backup Subsystem**

The PC Megastore 227 by Ampex Corporation gives you 20 megabytes of hard-disk storage and 25 megabytes of tape backup. This subsystem can be used with the IBM PC, XT, and compatibles and with the Apple II and IIe. Cards for the Macintosh, TRS-80, S-100 bus systems, and other systems will soon be available.

The tape backup has its own 64K-byte buffered memory, is directly addressable, and can function as the primary storage unit.

The PC Megastore 227 costs \$3400; an adapter

card is priced at \$175. Available separately, 10- and 20-megabyte hard disks cost \$1995 and \$2395, respectively, and a 25-megabyte tape backup lists for \$1995. Contact Ampex Corp., 10435 North Tantau Ave., Cupertino, CA 95014, (800) 421-6863; in California, (213) 640-0150. Inquiry 634.

**19-inch Color Graphics Terminal**

Amtron's CD1920 color monitor offers 150-MHz bandwidth, automatic vertical synchronization up to 180 MHz, and 0.31-mm dot pitch resolution resulting in a 1280- by 1024-pixel display. The terminal is said to work well with Artist and BMW graphics engines, but it must be adjusted to interface with the various boards' timing signals. The 19-inch screen is nested in a chassis of dimensions common for a 15-inch monitor. The terminal weighs 47 pounds.

The price for a single CD1920 ranges from \$3800 to \$4100, depending on options and on the host graphics system.

Contact Amtron Corp., 2260 De La Cruz Blvd., Santa Clara, CA 95050, (408) 748-8500. Inquiry 635.

**Portable Disk Drive for Tandy Model 100**

The Chipmunk portable disk drive allows Tandy Model 100 and 200 owners to store data on 3½-inch disks. Weighing in at 3½ pounds, the Chipmunk emulates the 100's "main menu" concept and appears

(continued)

PERIPHERALS

to the user as an extension of the computer's memory. The disk drive fits into the computer's 40-pin main bus and is controlled by CDOS—the Chipmunk Disk Operating System, which requires 5K bytes of the 100's RAM.

The drive lists for \$599 and comes bundled with a telecommunications program and five other business programs. Contact Holmes Engineering/PCSG, 11035 Harry Hines Blvd. #207, Dallas, TX 75229, (214) 351-0564. Inquiry 636.

**Dot Matrix for IBM**

**F**ujitsu America's DotMax Model 241 is a 24-wire dot-matrix printer that's compatible with IBM computers. The Model 241 emulates an IBM graphics printer for word processing and graphics, yet it can accept commands for the Epson FX-80 printer.

This printer features bit-mapped graphics, block character sets, and two

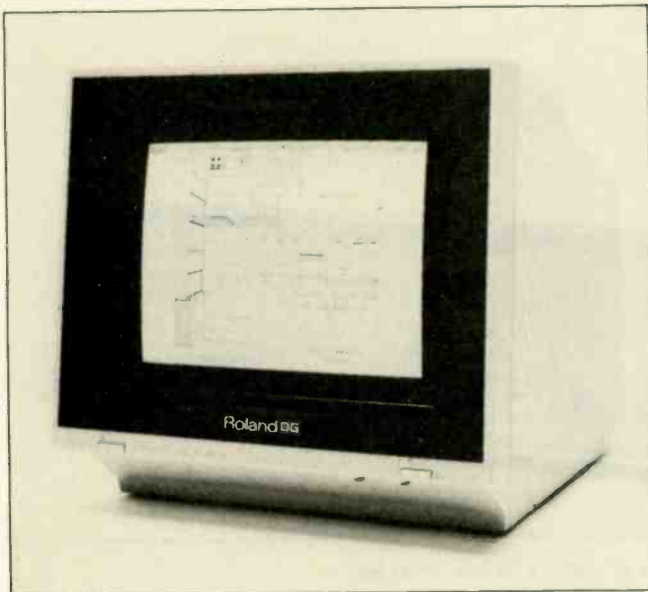

The MB-142 TTL black-and-white monitor.

graphics modes: an 8-bit image mode with 200- by 160-dot-per-inch resolution and a 24-bit image mode with 360 by 180 dpi. The DotMax 241 includes downloadable character fonts, cutsheet feeder commands, and such print op-

tions as underline and boldface.

The \$1995 printer reaches speeds of 80 cps (letter quality) and 240 cps (draft quality). Dual serial and parallel interfaces are standard. Contact Fujitsu America Inc., 3055 Orchard

Dr., San Jose, CA 95134, (408) 946-8777. Inquiry 637.

**Black-on-White Monitor**

**T**he MB-142 TTL monitor displays characters black-on-white or vice versa on command. The 14-inch display screen provides 720- by 350-dot resolution and creates characters somewhat larger than standard display. Text and graphics can be displayed simultaneously. The format is 80 columns by 25 lines.

The monitor plugs directly into the monochrome board of IBM and IBM-compatible computers. Text boards, including Persyst, STB, Paradise, Hercules, and AST, can be used. The MB-142 has a 25-MHz bandwidth.

The MB-142 is priced at \$375. Contact Roland DG Corp., 7200 Dominion Circle, Los Angeles, CA 90040, (213) 685-5141. Inquiry 638.

SOFTWARE • IBM PC

**Matrix Laboratory**

**A**n integrated analysis program that specializes in matrix computations. PC-MATLAB combines graphics and data-manipulation capabilities to turn an IBM PC into a scientific and engineering workstation. It's suitable for such applications as numeric analysis, matrix theory, statistics, control theory, signal processing, geophysics, and other disciplines that employ matrix computation and linear algebra as tools.

The program accepts commands in standard mathematical notation for matrix operations. Eigenvalues and eigenvectors, fast Fourier transforms, digital filtering, linear-equation solution, singular-value decomposition, and matrix inversion are among its analytical capabilities. Graphics commands include linear, semilog, polar, and three-dimensional mesh surface plots.

Written in C, this program runs under MS-DOS 2.0 and higher on the PC, XT, AT, and compatibles with 256K bytes of memory and an 8087 coprocessor; an IBM

color/graphics board is necessary if you want to use the graphics capabilities. PC-MATLAB costs \$695. Contact The MathWorks Inc., 124 Foxwood Rd., Portola Valley, CA 94025, (415) 851-7217. Inquiry 639.

**Electronic-Design Package**

**T**he CT2000 CAE Design System, a program for designers of integrated circuits and printed-circuit boards, reportedly provides the functionality of a CAE

(computer-aided engineering) workstation. Case Technology says its package should not be confused with schematic-entry and electronic CAD programs; the system includes a version of the SCALD tools developed in a mainframe environment at Lawrence Livermore National Laboratories.

CT2000 incorporates a structured graphics editor for schematic entry and design capture, a SCALD hardware compiler, a netlist postprocessor, a hardcopy postprocessor, a cross-reference generator, a firmware compiler, and component libraries.

According to Case, you

can easily create a hierarchical design database with the graphics editor. As you manipulate your design, the system automatically keeps track of all changes and maintains the database describing the state of the electrical circuit. You can create a schematic using your own guidelines and then use that same diagram as input to advanced design-analysis programs, such as a timing verifier and a logic simulator (both of which the vendor sells for \$3500 each).

CT2000 runs on an IBM PC, XT, and AT. It costs \$5200. Contact Case Technology Inc., Suite 250, 633 Menlo Ave., Menlo Park, CA 94025, (415) 322-4057.

**Inquiry 640.**

## Analytical Chemistry Software

Sim-Soft and Lab-Stat from Scientific Computing are software packages for use in analytical chemistry labs. Both programs run on an IBM PC or PC XT with at least 128K bytes of RAM.

Sim-Soft provides database management for lab samples and handles data storage, maintenance of data files, and status reports of samples. The package costs \$895. (The company said versions for Apple and Hewlett-Packard computers will be available this summer.)

Lab-Stat is a statistical-analysis program that calculates standard deviation, relative standard deviation, percent error, average percent recovery, correlation coefficient, mean variance, and standard error of mean.

It can be used as a stand-alone program or as a module of Sim-Soft. Lab-Stat is priced at \$215, but if you buy Sim-Soft by September 15, Lab-Stat comes for free.

For more information, contact Scientific Computing Inc., 249 Jericho Rd., Essex Junction, VT 05452, (802) 899-2147.

**Inquiry 641.**

## APL Without an 8087

Running APL on a PC normally requires an 8087 (or 80287) math coprocessor, but the 8087 Eliminator from Fort's Software lets you run IBM's APL without the coprocessor by emulating its functions.

Two versions are available. The standard Eliminator works with the PCjr, PC, and PC XT and costs \$49. The 8087 Eliminator/AT supports the PC AT and costs \$75. Both programs have a 30-day money-back guarantee and are not copy-protected. Minimum requirements are IBM APL version 1.0, PC-DOS 2.0 or higher, and 128K bytes of RAM (although the vendor recommends 192K for all configurations except a PC with PC-DOS 2.x).

For more information, contact Fort's Software.

Inquiries, POB 396, Manhattan, KS 66502.

**Inquiry 642.**

## PC XT Serial Communications

ISAC (Integrated Serial Asynchronous Communications) is a multilayered communications system written specifically for the PC XT and compatibles. The two top layers provide the commonly used functions of

terminal emulation. ISAC can operate in its own smart mode or, with an option, emulate a DEC VT-100. It maintains a 10-page memory buffer to record data from the external host. You can selectively display the full contents of the buffer or write portions of it to disk without disturbing the serial link. ISAC can insert variable-length intercharacter and interline time delays and wait for a prompt from the host before transmitting each line.

The lower layers form what the vendor calls the SPM (Serial Port Manager), an assembly-language program that becomes an extension of DOS when you load it into memory. SPM provides an RS-232C/CCITT-style link between the PC and the outside world that's capable of running at up to 9600 bps. It's interrupt-driven, automatically buffers all data, and operates on either IBM serial port.

ISAC is priced at \$140; the VT-100 emulator costs an extra \$30; BASIC, FORTRAN, C, and Pascal interfaces to ISAC cost \$25 each. Contact Akron Software Research and Development, 53 Hillside Ave., Toronto, Ontario M8V 1S7, Canada, (416) 251-1866.

**Inquiry 643.**

## Bulletin-Board Program

A bulletin-board program from Micro-Systems Software supports electronic mail and program- or data-file exchanges on PCs and compatibles. BBS-PC provides 16 separate sections, or sub-boards, four file-

transfer protocols, and a terminal-mode feature that supports a second modem, COM port, and phone line to let you answer one modem and dial out on another.

BBS-PC, which can handle 1200 or 2400 bps, supports MODEM, XMODEM, MODEM7, and other protocols of the MODEM family, plus standard ASCII line- or block-transmission modes. A system can be partitioned into four sections: default drive or directory, with the system program, its master data file, and a user-log data file; message base; member files; and upload/download.

Other features include true message formatting, permanent user records, private messages, chat mode, and automatic reclamation of space when messages are deleted. The sysop has complete control over all sections and can implement 256 security levels.

BBS-PC runs on the PC, XT, and PCjr with 256K bytes of memory. Suggested retail price is \$249. The vendor also offers applications software, including a word processor (\$79.95), a smart-terminal communications package (\$79.95), and a full-screen editor (\$199). Contact Micro-Systems Software Inc., 4301-18 Oak Circle, Boca Raton, FL 33431, (305) 391-5077.

**Inquiry 644.**

## Plotting with the IBM and HP's Plotters

A graphics package developed for the IBM PC and Hewlett-Packard's HP 7470A and HP 7475A plotters, GRA-FIT is intended

(continued)

## SOFTWARE • IBM PC

primarily for engineers and scientists. The program gives you control over the graph layout: pen selection, axis dimensions and labeling, titles, etc.

GRA-FIT is driven from a sequential command file that you create using EDLIN or another text editor. You can plot multiple curves on one graph and multiple graphs on one sheet of paper in horizontal or vertical format.

The package offers several methods for plotting. Data points can be plotted, points can be connected with straight lines or joined with a cubic spline, and data can be smoothed with piecewise polynomials prior to plotting. You can combine any number of these interpolation techniques on one graph or on one set of data.

GRA-FIT costs \$95, is not copy-protected, and requires at least 128K bytes of memory, one disk drive, MS-DOS 1.1 or later, and an HP plotter. Contact Jayar Systems, POB 2885, Station A, Sudbury, Ontario P3A 5J3, Canada. Inquiry 645.

### Images and Text Over Ordinary Phone Lines

You can capture images with a video camera and transmit them to a remote IBM PC over ordinary telephone lines with PhotoMail, an icon-driven communications kit from Chorus Data Systems. Still-frame pictures of people, diagrams, and text can be sent at a resolution of up to 640 by 400 in 16 colors or levels of gray. Once an image is transmitted, you

can save it on a disk or print it.

In addition to video images, the system can handle IBM 320 by 200 four-color graphic displays and screen displays generated by some applications programs. The communications icon supports the Hayes Smart-modem and compatibles as well as some 2400-bps units. Besides PC-to-PC communication with pictures, PhotoMail can format images to be used with electronic-mail services.

The complete PhotoMail kit is priced at \$2495, which gets you a video digitizer, graphics display card, mouse, and software; the software by itself costs \$795. PhotoMail runs on the PC, XT, AT, and compatibles. Contact Chorus Data Systems, 6 Continental Blvd., POB 370, Merrimack, NH 03054, (603) 424-2900. Inquiry 646.

### Speak Your Commands

With Pronounce, you can give instructions to your computer and enter data by speaking into a microphone. This speech-input system accepts vocabulary files of 128 words or short phrases. Each word or phrase can be associated with up to 255 keystrokes, thus letting you form a macro to fit your needs or standardize nonrelated programs under natural voice control.

When you say "memorize," Pronounce starts remembering the keystrokes you type. You then give these keystrokes a natural-language name and store them. Speaking the name into the microphone invokes them. At any time you can exit

your application program, enter Pronounce, and add, modify, or retrain vocabulary words.

Pronounce costs \$895 and consists of a circuit card, microphone, manual, and software. You'll need a PC, XT, AT, or true compatible with at least 256K bytes of memory. The vendor claims it works with most PC-DOS or MS-DOS applications. Contact MicroPhonics Technology Corp., Suite B, 234 Southwest 43rd St., Renton, WA 98057, (206) 251-9009. Inquiry 647.

### Package for Turbo Pascal Programmers

TurboPower Software has released a set of nine utilities for Turbo Pascal programmers. The package is designed to provide utilities usually found in a main-frame environment.

TurboPower Utilities includes a structure analyzer, execution timer, execution profiler, prettyprinter, command repeater, pattern replacer, difference finder, file finder, and directory. When practical, the utilities use MS-DOS path names and standard I/O facilities, the company said.

The package supports Turbo Pascal 2.0 and 3.0 and runs on the PC, XT, AT, and compatibles. An executable version that includes a manual costs \$55; with full source code and a detailed programmer's manual, the price is \$95. Contact TurboPower Software, Suite 196, 478 West Hamilton Ave., Campbell, CA 95008, (408) 378-3672. Inquiry 648.

### MIDI Sequencer/Editor

Octave Plateau's Sequencer Plus is designed to turn a PC into a 64-track MIDI recording and editing facility. The software records the control information from MIDI instruments (notes on and off, keystroke velocities, pitch bends, etc.) and stores them in memory. You can then use your PC to edit them and play them back through the instruments.

Among the program's features are full editing of all tracks (including independent per-track control of the MIDI channel); capacity to add to, copy, delete, and name individual tracks; automatic record of each track's bar length; full visual editing of all notes; recording and manipulation of MIDI program changes, both within a music track or as a separate control track; and playback quantizing that ranges from quarter notes down to 64th-note triplets.

You can control the time signature of each track, from  $\frac{1}{2}$  to  $\frac{3}{16}$ , and mix time signatures within a track (or create polyrhythms between tracks). You can set the playback tempo from 16 to 255 beats per minute. With a 256K-byte system, you can store approximately 12,000 notes; a 640K-byte system can handle up to 60,000 notes. The program has 10 memory buffers.

Hardware requirements include a PC or compatible, Roland Corporation's MPU-401 MIDI processing unit and interface cables, and MIDI-equipped instruments. Sequencer Plus retails for \$495. Contact Octave Plateau, 51 Main St., Yonkers, NY 10701, (914) 964-0225. Inquiry 649.



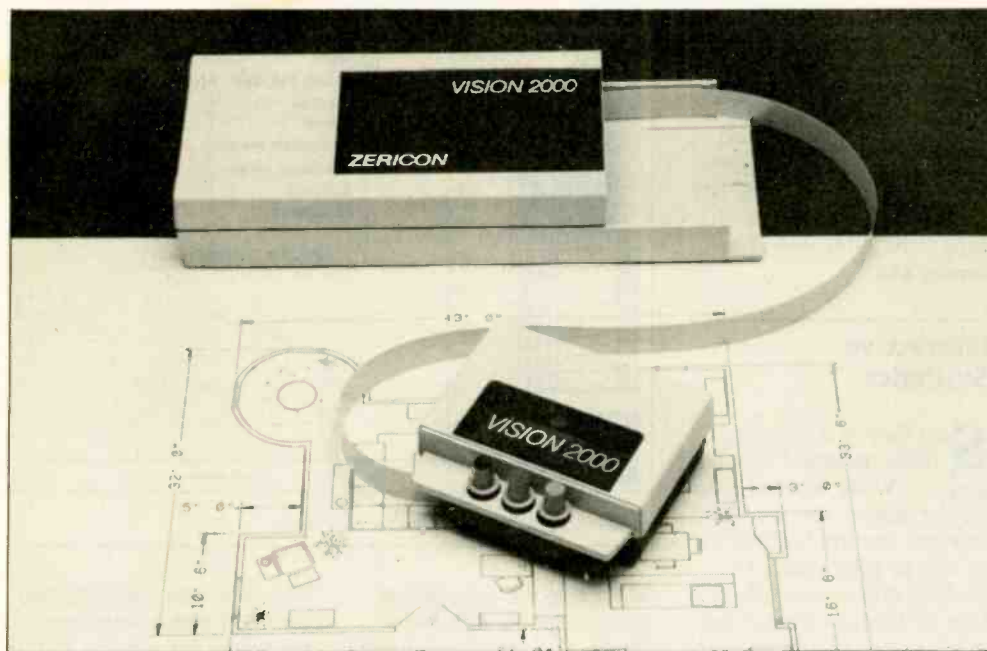

Zericon's two-dimensional drafting system, Vision 2000, works with Apple and IBM computers.

## FORTH for the Macintosh

**M**asterForth 1.0, an implementation of FORTH for Apple's Macintosh, provides a 68000 macroassembler and supports the mouse, finder, menus, and graphics toolbox. With relocatable utilities and transient definitions, you can run substantial software packages even on a 128K Mac, the vendor said. The string package and resident debugger are regular features.

MasterForth 1.0 matches the FORTH-83 standard as described in *Mastering FORTH* by Anita Anderson and Martin Tracy (Bowie, MD: Brady Communications Co., 1984), a copy of which is included with the software.

MasterForth 1.0 is also available for the Apple II series, the IBM PC, the Commodore 64, and CP/M machines. You can write software on one system and run it on all the others.

The price of MasterForth 1.0 is \$125. Optional extensions are available. Contact MicroMotion, 12077 Wilshire Blvd. #506, Los Angeles, CA 90025, (213) 821-4340. Inquiry 650.

## Spectrum Analyzer

**Z**entech Systems' Data Analyzer is a hardware/software combination that converts your Macintosh into a spectrum analyzer. This package comprises a waveform digitizer that plugs into the Mac's modem port and control and analysis software.

Waveforms are displayed on the screen and can be manipulated, stored on disk,

and subsequently transformed for analysis. Software control panels contain text, push buttons, and sliders to display and configure the parameters of the digitizer and to make such adjustments to the size, scaling, and viewing area of waveform windows. Waveforms can be transformed through functions such as FFT, IFFT, and convolution.

Suggested retail price of the Data Analyzer is \$1499. Contact Zentech Systems Corp., 2226 West 12th Ave., Vancouver, British Columbia V6K 2N5, Canada, (604) 736-9764. Inquiry 651.

## Tool for Drawing Circuit Boards

**M**cCad is a package for drawing circuit boards on a Macintosh with either a mouse or a graphics tablet. The system supports six layers and comes with utility functions. You can design printed-circuit boards up to 30 by 30 inches.

The program outputs each layer individually in addition to a composite check-print. For output, you can use an Apple Imagewriter, Apple Laser Printer, or an ink plotter.

McCad runs on a Mac or Lisa. It costs \$395. Contact VAMP Inc., POB 411, Los Angeles, CA 90028, (213) 466-5533.

Inquiry 652.

## CAD Drafting Package

**A** two-dimensional drafting system for Apple and IBM computers, Vision 2000 consists of a graphics touch-tablet and CAD software with automatic dimensioning capabilities for \$495. An optional robotic pen plotter, which works with paper sizes up to 24 by 36 inches, is an additional \$395.

Vision 2000 can be used to produce just about any kind of drawing, the vendor said, such as architectural, mechanical, and technical. Other applications include electrical schematics, circuit-board layouts, flowcharts, and interior designs.

With the tablet, you select screen commands and position the drawing cursor. You can create graphics to 14 decimal places of accuracy

(continued)

## SOFTWARE • APPLE

on the PC and 6 decimal places on the Apple II. Commands are menu-selectable and a pop-up keypad handles numeric input.

Among its other features are multiple metric and English database units in fractions or decimals, 256 registered overlays, floating-point database structure, and relative and local coordinate systems. The system incorporates a device-independent software module that supports most popular pen plotters and graphics-input devices. Contact Zericon, Suite 416, 655 John Muir Dr., San Francisco, CA 94132, (415) 585-9329. Inquiry **653**.

### Electrical Engineering with Mac

**M**acEngineer—Electric Engineering for the Macintosh contains formulas for the most frequently used calculations in such areas as lighting, motors, transformers, and direct current. You select a formula in one of these categories, enter the variables, and the software calculates and displays the result. Using the Mac's graphics capabilities, the program also prepares  $x,y$  and line graphs.

Formulas for lighting include room ratio, ceiling cavity ratio, and number of lamps needed. Some of the motor formulas are motor horsepower, full-load torque, and energy required for inertia. Among the formulas for transformers are number of turns/secondary winder, rated primary current, and secondary winding current.

Direct-current formulas cover condenser capacitance and condenser requirements.

The price is \$99.95. For more information, contact Superex Business Software, 151 Ludlow St., Yonkers, NY 10705, (800) 862-8800; in New York, (914) 964-5200. Inquiry **654**.

### Interactive Statistics

**S**tatView is a technical utility designed for data analysis. While keeping data on the screen, the package lets you use the Macintosh mouse to select data for analysis and choose the type of analysis from a pull-down menu. Results appear in another window, which changes as modifications are made to the data. In a window next to the data screen you can have tables, charts, scattergrams, or other graphic representations.

The types of evaluation possible with StatView include descriptive statistics, comparative statistics, and nonparametric tests. The program's descriptive capability encompasses harmonic and geometric mean, standard deviation and error, variance, median, and frequency distribution. All calculations are done with 80-bit precision using IEEE floating-point mathematics.

StatView is for use on all

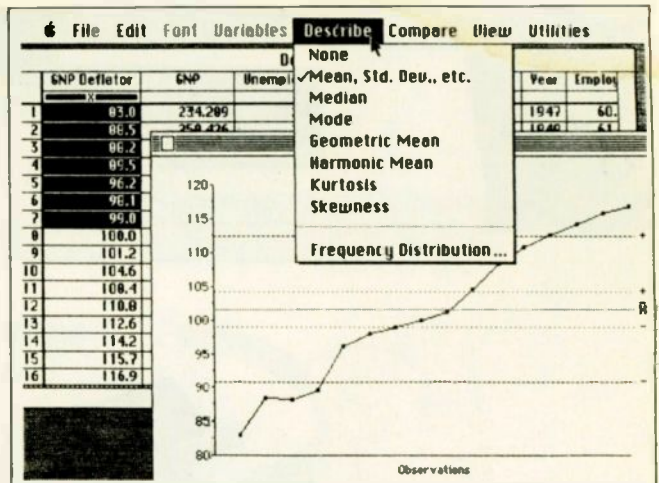

A screen dump of Brainpower's StatView.

Macs and the 1-megabyte Lisa equipped with MacWorks. Suggested retail price is \$199.95. Contact Brainpower Inc., 24009 Ventura Blvd., Calabasas, CA 91302, (818) 884-6911. Inquiry **655**.

### Electronic Music Applications

**C**omputers and Music has released several products for making music with Apples and synthesizers.

The Analyzer/Interpolator is a software/hardware system for the IIe that can digitally record a sound, analyze its harmonic content, plot the sound's amplitude envelope, and show the sampled sound-wave cycles on the screen. In addition, it lets you create a wave from a sampled sound that's compatible with systems from SynTauri, Passport Designs, and Mountain Music. It costs \$100 and requires the Decillionix DX-1 Apple sampling board.

The MIDI Librarian software offloads either individual presets or banks of presets from the synthesizer

into computer memory. You can then name, save, and retransmit the presets to the synthesizer. Also, you can reassign individual sounds from one bank to another. The MIDI Librarian is also available for the IBM PC. Both versions are \$49.95. It supports the Yamaha DX-7, Roland Juno 106, Oberheim OB-8, and Casio CZ 101 and 1000.

The Apple IIe MIDI Development System contains one MIDI board (compatible with Passport, Yamaha, and Korg) and documented source code for sending and receiving MIDI bytes. Appropriate addresses are indicated, and a short program that displays MIDI bytes from any device that sends MIDI data is included. Board and software cost \$125; software alone is \$25.

For more information, contact Computers and Music, 1989 Junipero Serra Blvd., Daly City, CA 94014, (415) 994-2909. Inquiry **656**.

## Window Controller for TRS

The PRO-NTO window-controller and applications-manager package runs on the TRS-80 Models 4/4P, II/12/16, or the Lobo MAX-80.

PRO-NTO's Window function supports four nested overlay windows that can be used directly from BASIC, C, FORTRAN, Pascal, and other languages by simple file I/O statements. Window sizes range from 1 by 1 to an 80 by 24 format screen. Other functions are character PEEK/POKE, cursor positioning, image transfer, and import/export between windows.

The application manager includes address mailing label and rotating index file, appointment scheduler, calculator, card filer and notepad, telephone list, and auto-dialer.

PRO-NTO lists for \$49.95. Contact MISOSYS Inc., POB 239, Sterling, VA 22170, (703) 450-4181. Inquiry 657.

## Local-Area Network for Tandy Computers

ViaNet software and ARCnet hardware link Tandy computers running MS-DOS into a local-area network (LAN). ViaNet is an off-the-shelf LAN software system with a distributed architecture and thus does not require a dedicated file server.

Each computer on the network receives a board but also must have 128K bytes of its RAM dedicated to the network. Transparent to the user, ViaNet is logically structured and possesses a set of 11 simple commands.

The hardware/software package for each computer costs \$499.95. Contact Tandy Corp./Radio Shack, 1800 One Tandy Center, Fort Worth, TX 76102, (817) 390-2728. Inquiry 658.

## Modula-2 Language for Z80 CP/M

Hochstrasser Computing's Modula-2 System for Z80 CP/M-based computers consists of a compiler, a linker, utility programs, and a library of utility modules. The resulting Z80 code, which can be embedded in ROM, is said to be fast, small, and reentrant. Chaining and shared data between several programs are supported.

The entire system costs approximately \$150, which covers any royalty fees for programs developed by using this system. Contact Hochstrasser Computing AG, Leonhardshalde 21, CH-8001 Zürich, Switzerland; tel: 01/47 55 48. Inquiry 659.

## Expert System and C Compiler

XPER and Super C systems from Abacus Software are said to offer advanced programming capabilities for the Commodore 64 and 128 computers.

XPER is an expert system that lets you build databases according to your own decision framework. Later, the system guides you through a series of searching techniques.

The Super C Language Compiler is a development system that supports the Kernighan & Ritchie C-language standard. The editor handles source-code files up to 41K bytes in length. The compiler produces 6510 machine code.

XPER costs \$80, while the Super C compiler lists for \$60. Contact Abacus Software Inc., POB 7211, Grand Rapids, MI 49510, (616) 241-5510. Inquiry 660.

## Pocket References for UNIX and C

Four versions of the *UNIX Command Summary* booklet are available from Specialized Systems Consultants: the 32-page System III booklet, the 48-page BSD version, the 48-page System V reference, and the 32-page XENIX edition.

Other resources include the *V1 Reference*, a comprehensive guide to Berkeley's visual editor on an 8-sided card; a 16-page *C Library Reference* that includes all library functions; a *C Reference Card* for programmers without access to

library functions; and the *Fortran 77 Reference* on a 10-sided card.

Prices range from \$2.50 for individual cards to \$4 for the booklets in 100-piece quantities. Contact Specialized Systems Consultants, POB 7, Northgate Station, Seattle, WA 98125, (206) 367-8649. Inquiry 661.

## LISP on UNIX

UniLISP is fully compatible with Common LISP and is suitable for developing expert systems. Its kernel requires 32K bytes of memory on most UNIX machines, so you can use it for building interpretive filters, knowledge networks, and natural-language front ends.

UniLISP offers a segmented object list called OBLIST and optional math, statistical, and graphic add-on object lists for expert-system development. It also features standard UNIX I/O support, support for UNIX operating systems calls, physical memory access, and such editing features as vi. UniLISP has arithmetic primitives, the ability to link and unlink files or pipes, and concurrent communications.

UniLISP runs on the DEC Pro 300 series and IBM PC AT machines. Ports to other computers are in the works. Pricing was not available at press time, but a company spokesperson estimated that the end-user price will be less than \$1000 when UniLISP ships at the end of August. A demonstration disk is \$30. Contact r/i group, 7623 Leviston St., El Cerrito, CA 94530, (415) 527-1438. Inquiry 662.

### WHERE DO NEW PRODUCT ITEMS COME FROM?

*The new products listed in this section of BYTE are chosen from the thousands of press releases, letters, and telephone calls we receive each month from manufacturers, distributors, designers, and readers. The basic criteria for selection for publication are: (a) does a product match our readers' interests? and (b) is it new or is it simply a reintroduction of an old item? Because of the volume of submissions we must sort through every month, the items we publish are based on vendors' statements and are not individually verified. If you want your product to be considered for publication (at no charge), send full information about it, including its price and an address and telephone number where a reader can get further information, to New Products Editor, BYTE, POB 372, Hancock, NH 03449.*

# CCT-4 SYSTEM SERIES

The latest CCT implementation of the new generation Intel 16-Bit Processor technology. This means extreme speed, unequalled power, and the ultimate in reliability, and of course, the innovators at CCT behind it.

This series in the CCT line exploits the speed and power of the Intel 80286 and Zilog Z-80H (8MHz), on the 286Z CPU board. This combination, along with CompuPro DMA controllers and I/O boards, yields a dramatic improvement in system throughput speeds, from basic CP/M operation, up to large powerful multi-user/multi-tasking machines. The CCT-4 represents the most advanced hardware presently available in a microcomputer to run the thousands of CP/M type software programs on the market, and with CONCURRENT DOS 8-16 and the CompuPro PC Graphics board (when available), all software written for the IBM PC machines. This series is for the serious business/scientific user.

- CCT-4A** State-of-the-art power in it's basic form. Consists of CCT-286Z CPU board and CCT-M256 (256K), along with CompuPro: Enclosure 2 Desk (21 slot MF), Disk 1A, System Support 1, Interfacer 4, the CCT-2.4 floppy drive system, and CP/M 80 and CP/M 86, and with SF-200 surge suppressor system. **\$5,495.00**
- CCT-4B** Single-user/hard disk power. As the 4A, except priced without the CCT-2.4, to add in your choice of CCT hard/floppy combination drive subsystem, at the published pricing. **\$4,375.00**  
*(Example: CCT-4B Mainframe with CCT-10/1 = \$6,548.00)* Plus cost of selected drive subsystem
- CCT-4C** Multi-user/hard disk power. As the 4B, with the CCT-M512 (512K static RAM board) instead of M256; Interfacer 3 instead of Interfacer 4; SF-400 instead of SF-200, plus Concur. DOS 8-16 O.S. (6 user system) **\$6,075.00**  
*(Example: CCT-4C Mainframe with CCT-40/1 = \$9,248.00)* Plus cost of selected drive subsystem

**NEW RAM BOARD**

**Limited Time Offer - FREE Supercalc 86 with any CCT-4**

The above systems include all necessary cabling, assembly, testing, minimum 20 hour burn-in, and the CCT unconditional 12 month direct warranty.

- CCT-M512** CCT introduces it's 512K static RAM board. IEEE Standard 12MHz. 512K in one slot! **Introductory Price: \$1,799**
- CCT-M256** 256K version of M512 upgradeable to full 512K. Perfect 256K RAM board for any CompuPro system **\$949**

**CUSTOM COMPUTER TECHNOLOGY / BOX 4160 / SEDONA, ARIZONA 86340**  
**TOLL FREE ORDERING: 800-222-8686 / For technical support / service: 602-282-6299**



## SUNTRONICS CO., INC.

12603 Crenshaw Blvd., Hawthorne, CA 90250

1-800-421-5775 (Order Only)  
 (213) 644-1140 (CA Order & Info)  
**STORE HOURS**  
 Mon-Fri 9 a.m. to 6 p.m.  
 Sat 10 a.m. to 5 p.m.

**TERMS:** VISA MASTERCARD C.O.D. (Cash or Certified Check Required) Check (Allow 2-3 Weeks for Clearing) Shipping & H.C \$3.00 for 3 Lbs. plus 50c for each add'l. Lb. Calif. residents add Calif. Sales Tax \$10.00 Minimum Order IBM and Apple are registered trademarks of IBM & Apple

### SUN-XT COMPUTER SYSTEM



- 2 DSDD DISK DRIVES
- 256 K RAM
- MONOCHROME GRAPHICS CARD
- 135 W POWER SUPPLY
- MONOCHROME MONITOR (TTL)
- PARALLEL PRINTER PORT
- **IBM-XT COMPATIBLE \$995.00**

#### SUN-XT CPU BOARD

- 8088 MPU
- 8 EXPANSION SLOTS
- RAM EXPANDABLE TO 1 MEG BYTE
- FULLY IBM COMPATIBLE
- DIMENSION SAME AS IBM PC/XT
- NO RAM

**\$195.00**

#### MULTI-FUNCTION BOARD

- EXPANDABLE TO 384K
- SERIAL/PARALLEL PORT
- CLOCK CALENDAR w/BATTERY BACK UP
- GAME PORT
- SPOOL & RAM DISK
- NO RAM

**\$159.00**

#### MONOCHROME GRAPHICS CARD

- HIGH-RES MONOCHROME CHARACTER
- 720(H) x 348(V)
- 80 x 25 TEXT MODE
- RUN LOTUS 1-2-3 ETC.
- WITH PARALLEL PRINTER PORT

**\$149.00**

#### COLOR GRAPHICS CARD

- RGB & COMPOSITE VIDEO
- 640 x 200 HI-RES
- 320 x 200 LO-RES
- 80 x 25 TEXT MODE
- WITH LIGHT PEN INTERFACE

**\$105.00**

#### FLOPPY DISK CONTROLLER

- STANDARD DOUBLE SIDE/DOUBLE DENSITY
- RUN 2 INTERNAL & 2 EXTERNAL WITH CABLE

**\$59.00**

#### IBM STYLE CABINET

- 8 SLOT BACK PANEL
- COMES WITH MOUNTING BRACKET & HARDWARE
- FITS IBM POWER SUPPLY

**\$59.00**

- 135 WATT POWER SUPPLY ..... **\$ 97.00**
- 150 WATT POWER SUPPLY ..... **\$119.00**
- FULL-FUNCTION KEYBOARD ..... **\$ 79.00**
- MULTI I/O CARD (FDC, CLOCK CALENDAR, SERIAL PARALLEL) ... **\$189.00**
- HARD DISK CONTROLLER W/CABLE (10MB & 20MB) ..... **\$219.00**
- PARALLEL PRINTER PORT ..... **\$ 39.00**
- ASYNC RS 232 CARD ..... **\$ 59.00**
- APPARAT EPROM BLASTER (28 PIN, 24 PIN) ..... **\$129.00**
- TEAC 55B DISK DRIVE (360K) ..... **\$ 89.00**
- IBM UP GRADE KIT (4164 150NS) ..... **\$9.50/Kit**
- IBM UP GRADE KIT (41256 150NS) ..... **\$49.00/Kit**
- MICROLOG Z80B CO-PROCESSOR (MULTI-FUNCTION) NO RAM ..... **\$450.00**

**DEALER & OEM INQUIRIES INVITED!!!**

**APPLE COMPATIBLE & GENERAL PRODUCTS**

- SUN Z80 CARD (W/O SOFTWARE APPLE II & II+ ONLY) ..... **\$ 39.00**
- SUN 80 COLUMN CARD (APPLE II & II+ ONLY) ..... **\$ 69.00**
- POWER SUPPLY (5AMP) ..... **\$ 52.00**
- COOLING FAN ..... **\$ 36.00**
- FLOPPY DISK CONTROLLER ..... **\$ 33.00**
- 16K RAM CARD ..... **\$ 39.00**
- PARALLEL PRINTER CARD W/CABLE ..... **\$ 39.00**
- APPLE COMPATIBLE DISK DRIVE ..... **\$139.00**
- APPARAT EPROM BLASTER ..... **\$119.00**
- SAM SUNG TTL MONITOR (AMBER OR GREEN) FOR IBM ..... **\$105.00**
- 12" SAM WOO MONITOR (HIGH-RES. COMPOSITE) ..... **\$ 85.00**
- 14" SUPER COLOR MONITOR (R&B 654 x 490) ..... **\$385.00**

**TOLL-FREE  
ORDERING:  
800-222-8686**

# CCT<sup>®</sup> CUSTOM COMPUTER TECHNOLOGY

**FOR TECHNICAL SUPPORT/  
SERVICE / IN ARIZONA:  
602-282-6299**

**1 CCT PLAZA — P.O. BOX 4160 — SEDONA, ARIZONA 86340**

Purchase your Hardware and Software directly from an OEM / Systems Integrator. Take advantage of our buying power! We stock a full line of Board Level Components, Software and Peripherals. Call for your needs. We'll give you the Lowest Prices, and the Technical Support and Know-How we are quickly becoming well-known for. Satisfied Customers Nationwide. The Nation's Custom Systems House for Business, Education and Science. Call for a system quote. CCT implements tomorrow's technology today!

**• FOREMOST QUALITY • ADVANCED SUPPORT • REASONABLE COST •**



### 80286 NOW!

□ **CCT-286Z** is our model designation for the **MI-286** dual processor board from **Macrotech**. It features the super high speed combination of **Z-80H** and **80286**, with provision for the **80287** math chip. Directly replaces **8085/88** and **8086** CPUs running **CP/M**, **MP/M** Concurrent **DOS**, and **MS-DOS**, at throughput increases of **3X to 5X!**

**SPECIAL PRICE-\$895**  
**80287 Option - Installed - \$250**

**SEE THE CCT-4 SERIES  
USING THIS BOARD  
DETAILED ON THE FACING PAGE**

### NEW—TRUE IBM PC INTERFACE ULTRA HI-RES GRAPHICS!

**CCT S-100/PC** is a break-through for the **Science/Business** user. Mini-enclosure accepts **PC & compatible** boards and directly connects to your **S-100** system, running **PC-DOS** or **Concurrent DOS**. **Hercules™** Graphics System—Coming this May!

**!! THE BEST OF BOTH WORLDS !!**

### LIBERTY TERMINALS

• Superior Reliability •

**110-14" GREEN-80/132 Column** . . . \$499  
**110-14" AMBER** . . . \$519  
**200-14" GREEN-80/132 Super Deluxe** \$569  
**200-14" AMBER** . . . \$589

### OKIDATA PRINTERS - Top Quality

**82 - 80 Col. .CALL 83 - 132 Col. .CALL**  
**92 - 80 Col. .CALL 93 - 132 Col. .CALL**  
**84 - 132 Col/200cps—Top of the line. .CALL**  
**For Serial Interfaces—Add. . . . .CALL**

**TOSHIBA P351 - 288 CPS/24 PIN - \$1499**

### DIABLO — Letter Quality Series

**Model 620 . \$969 Model 630 . \$1799**

**WE HAVE ALL SOFTWARE—CALL**

## \$ ACROSS THE BOARD PRICE REDUCTIONS \$

INDUSTRIAL GRADE  
SUPERIOR QUALITY

## CCT DISK DRIVE SYSTEMS

ROLLS ROYCES OF  
THE INDUSTRY

### S-100 HARD DISK SUBSYSTEMS

Professionally engineered **ST-506** type systems for the business market **S-100** Computer user. Includes industry top quality drives, **CompuPro** Disk 3 DMA controller, all cabling, **A&T**, formatted, burned-in. Provisions for up to two hard disks in each system. We include operating system update. **CP/M 80**, **CP/M 86**, **CP/M 8-16**, **MP/M 8-16**, **CP/M 68K**. (1 Systems are CCT innovated hard/floppy combinations, with **Mitsubishi DSDD 8"** drive.) 12 month warranty.

CCT-10 (11 + MEG)	\$1499	CCT-10/1	\$2049
CCT-20 (22 + MEG)	\$2019	CCT-20/1	\$2569
CCT-40 (36 + MEG)	\$2499	CCT-40/1	\$3049
CCT-60 (58 + MEG) (New)	\$3699	CCT-60/1	\$4249
CCT-90 (87 + MEG) (New)	\$4909	CCT-90/1	\$5459
CCT-125 (123 + MEG) (New)	\$6099	CCT-125/1	\$6649

## NEW 10 MEG REMOVABLE CARTRIDGE DRIVE SYSTEM

for hard disk back-up — DMA using Disk 3 controller.  
Super fast/Ultra reliable — Available April

### FLOPPY SYSTEMS

**CCT-2.4 • Dual 8" DSDD**  
Mitsubishi 2.4 Megabyte in Extra Heavy horizontal enclosure, removeable filter air system, all cabling, **A&T**, Burned in. The fastest system available: . . . . . \$1229

**CCT-5 • 5 1/4" DSDD**  
IBM Compatible Tandon 320K. Extra Heavy Cabinet accommodates two drives, hard or floppy. All cabling, **A&T**, Burned-in. Perfect for our **PC-DOS** Package . . . . . \$399

### CCT-8/5 • FULL IBM COMPATIBILITY

One Mitsubishi 8" DSDD (1.2 Meg)/One 5-1/4" DSDD (360K) IBM Drive  
Both 3ms step rate — For Concurrent DOS and PC DOS . . . . . \$1029

## ★ SUPER PRICES ★ COMPUPRO COMPONENTS ★ IN STOCK ★

**CPU-Z - \$229 • Disk 1A - \$399 • Disk 1A w/CP/M - \$499 • CPU 8086/10 - \$359 • SPU-Z - ?**  
**CPU 8085/88 - \$229 • CPU 286 - \$849 • CPU 68K - 10Mhz - \$359**  
**PC Graphics - \$399 • Disk 3 - \$459 • RAM 22 (256K) - \$1179 • RAM 23/64K - \$279/128K - \$469**

**NEW → M-Drive/H - 512K - \$469 / 2 Meg - \$1989**

**Enclosure 2 Desk - \$699/Rack - \$749 • Interfacer 3 - \$409 • Interfacer 4 - \$289 • System Support 1 - \$299**  
**Concurrent DOS 8-16 (CCTCMX) - \$309 • CP/M 80 (CCTHMX) - \$125 • CP/M 86 (CCTTMX) - \$175**  
**CP/M 8-16 (CCTTMX) - \$199 • CP/M 68K (CCTCX) - \$279 • Operating System Updates/Remakes - \$30**

**16 Bit Upgrade Kit: CP/M 86, RAM 23, System Support 1, Cable \$729 □ CP/M 8-16 - Kit - \$753**

### CCT-1 — ENTRY LEVEL S-100 BUSINESS SYSTEM

- Enclosure 2-Desk-21 Slot Mainframe •
- CPU 8085/88 - 6Mhz 8085/8Mhz 8088 •
- Disk 1A - DMA Floppy Disk Controller •
- RAM 23 - 64K Static RAM - 12Mhz •
- Interfacer 4 - 3 Serial/2 Parallel I/O •
- CCT-2.4-Dual 8" Mitsubishi DSDD Drive System - 2.4 Megabytes •
- CP/M 80 - 2.2 HMX - CCT Modified •
- All Cabling, Complete CCT Assembly, Testing, and Minimum 20 Hour Burn-in •

**SPECIAL PRICE  
\$3,375**

**RUNS ALL STANDARD 8" CP/M SOFTWARE - INCLUDES OUR EXCLUSIVE 12 MONTH DIRECT WARRANTY**

Prices & availability subject to change. All products new, and carry full manufacturer's warranties. Call for catalog. Free technical help to anyone. All products we sell are CCT Individually tested and set up for your system - Plug-In & Go! Arizona residents add sales tax. **CCT<sup>®</sup>** Trademark — Custom Computer Technology; **MS-DOS<sup>®</sup>** Trademark — Microsoft; **IBM<sup>®</sup>** Trademark — International Business Machines; **CompuPro<sup>®</sup>** Trademark — W.J. Godbout; **CP/M<sup>®</sup>** **MP/M<sup>®</sup>** Trademarks — Digital Research; **HERCULES<sup>™</sup>** Trademark — Hercules Computer Technology

Contact us for other low prices on hardware and software.

Next Day Air Extra

# FREE SHIPPING. NO SURCHARGE FOR OR .

Call for latest prices.

## 10, 20, 33 AND 44 MEG INTERNAL AND EXTERNAL HARD DISK SYSTEMS

	10 MEG	20 MEG	33 MEG	44 MEG
<b>Internal</b>	<b>\$495</b>	<b>\$619</b>	<b>\$995</b>	<b>\$1195</b>
<b>External</b>	<b>\$645</b>	<b>\$769</b>	<b>\$1095</b>	<b>\$1295</b>



Externals mounted with independent power supply and fan. Fully DOS 2.X or 3.X compatible. Both Internals and Externals boot from Hard Disk. 33 and 44 Meg Internal Disks include extender power supply. The system comes complete and ready to install with the Hard Disk, Controller, Cables, Manual, Software, and Mounting Hardware. One Year Warranty.

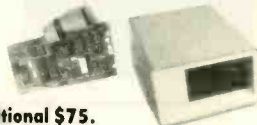

10, 20, and 33 Meg Hard Disks are available with combined Floppy/Hard Disk Controller Card for additional \$75.

**COMPAQ®**

**\$2549**

256K, 1/360K drive,  
10 Meg Internal

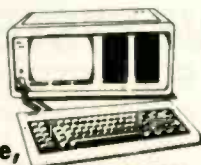

Functional equivalent to a Compaq Plus™

Now using 3½" shock-mounted Winchester drives. The same as used in the Compaq Plus™. Also available with 2 half-height drives and 10 MEG HD. **\$2749**

Or upgrade your Compaq to a Compaq Plus™ equivalent with our 3½" shock-mounted Winchester disk kit. Includes Hard Disk, Controller, Cables, Manual, software, and Mounting Hardware. One year warranty. **\$549**

**COMPAQ®**

It simply works better. **DESKPRO™**

640K, One 360K Drive,  
One 10 Meg Internal Hard Drive  
Tape Backup Unit.

**\$3495**

Includes Monitor



With 20 Meg Internal Hard Drive--\$3619  
With 33 Meg Internal Hard Drive--\$3995  
With 44 Meg Internal Hard Drive--\$4195

Compaq is a registered trademark and Compaq Plus and Compaq Deskpro are trademarks of Compaq Computer Corporation.

**IBM AT™  
CALL**



**IBM PC™  
CALL**

IBM is a trademark of IBM Corp.

Call us for competitive prices on larger quantities of RAM chips.

**64K RAM**  
Set of 9 chips, 200 or 150 Nanoseconds

**\$10**

**256K RAM**  
Set of 9 chips

**\$39**

**AST SixPak Plus™**



w/64K \$249  
w/384K \$299

One Year Warranty

- Upgradeable to 58k
- Clock/Calendar
- Software included

**PC'S LIMITED  
Six Function Card**



w/0K \$149  
w/384K \$209

Two Year Warranty

- Parallel Port
- Serial Port
- Optional Game Port, \$25



**DISK DRIVES**

**TEAC**  
55-B, Half-Height, DS/DD  
**\$95**

**INTEL 8087  
Math Co-processor**



**CALL**

8087-2—CALL 80287—CALL

**SOLVE YOUR POWER PROBLEM.  
XT™ POWER 135W**



**\$95**

Fully XT™ compatible.  
One Year Warranty.

Directly Replaces Power Supply in PC™

10 or more **\$85** 150W **\$119**

**IBM PC AT™  
PRODUCTS**



128K RAM **\$59**  
20 MEG Internal Hard Disk **\$649**  
32 MEG Internal Hard Disk **\$995**

Fully compatible w/IBM PC AT™ Disk Controller, DOS 3.0 or 3.1

These are high-performance disk drives,  
well-suited for the AT™.

IBM is a trademark of IBM Corp.

**Irwin Tape  
Backup System**

**\$595**



- Uses Floppy Controller Card
- 10 3 1/2 Meg Formatted Capacity
- Used in Compaq Deskpro.
- Half Height
- Low Power

Terms: Due to our low prices and assurance that all merchandise is new, we do not accept returns. Call included support for return authorization number on all warranty requests. Any unauthorized returns subject to a 10% restocking fee. Payment methods: money orders, VISA, MasterCard, American Express, or approved company purchase orders are accepted. No surcharge for VISA or MasterCard. 5% surcharge for American Express.

Compaq, TEAC, IBM, Irwin, and Intel are trademarks of their respective companies. All brand names are registered trademarks. We are an independent sales organization.

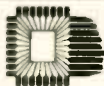

**PC'S LIMITED®**

**OUTSIDE TEXAS, ORDERS ONLY, CALL 1-800-IBM-5150**

**7801 N. Lamar, #E-200, Austin, Texas 78752**

All calls for technical support and inside Texas,  
call (512) 452-0323.

Telex No. 9103808386 PC LTD



Ad number 407

# What the world really needs is a 99 cent Double Sided, Double Density Diskette with a LIFETIME WARRANTY!

## And DISK WORLD! has it.

### Introducing Super Star Diskettes: the high quality diskette with the lowest price and the best LIFETIME WARRANTY!

In the course of selling more than a million diskettes every month, we've learned something: higher prices don't necessarily mean higher quality.

In fact, we've found that a good diskette manufacturer simply manufactures a good diskette...no matter what they charge for it. (By way of example, consider that none of the brands that we carry has a return rate of greater than 1/1,000th of 1 percent!)

In other words, when people buy a more expensive diskette, they aren't necessarily buying higher quality.

The extra money might be going toward flashier advertising, snazzier packaging or simply higher profits.

But the extra money in a higher price isn't buying better quality.

All of the good manufacturers put out a good diskette. Period.

#### How to cut diskette prices... without cutting quality.

Now this discovery posed a dilemma: how to cut the price of diskettes without lowering the quality.

There are about 85 companies claiming to be "diskette" manufacturers.

Trouble is, most of them aren't manufacturers.

Rather they are fabricators or marketers, taking other company's components, possibly doing one or more steps of the processing themselves and pasting their labels on the finished product.

The new Eastman Kodak diskettes, for example, are one of these. So are IBM 5 1/4" diskettes. Same for DYSAN, Polaroid and many, many other familiar diskette brand names. Each of these diskettes is manufactured in whole or in part by another company!

So, we decided to act just like the big guys. That's how we would cut diskette prices...without lowering the quality.

We would go out and find smaller companies to manufacture a diskette to our specifications...specifications which are higher than most...and simply create our own "name brand" diskette.

Name brand diskettes that offered high quality at low prices.



Super Star diskettes are sold in multiples of 50 only. Diskettes are shipped with white Tyvec sleeves, reinforced hubs, user ID labels and write-protect tabs.

#### Boy, did we get lucky. Our Super Star Diskettes are the same ones you've been using for years...without knowing it.

In our search for the low priced, high quality diskette of our dreams, we found something even more interesting.

We found that there are several manufacturers who don't give a hoot about the consumer market for their diskettes. They don't spend millions of dollars in advertising trying to get you, the computer user, to use their diskettes.

Instead, they concentrate their efforts on turning out the highest quality diskettes they can...because they sell them to the software publishers, computer manufacturers and other folks who (in turn) put their name on them...and sell them for much higher prices to you!

After all, when a software publisher or computer manufacturer or diskette marketer puts their name on a diskette, they want it to work fine after time, everytime. (Especially software publishers who have the nasty habit of copy-protecting their originals!)

#### Super Star Diskettes. You already know how good they are. Now you can buy them...cheap.

Well, that's the story. Super Star diskettes don't roll off the boat from Pago-Pago or emerge from a basement plant just east of Nowhere.

Super Star diskettes have been around for years...and you've used them for years as copy-protected software originals, unprotected originals. Sometimes, depending on which computer you own, the system master may have been on a Super Star diskette. And maybe more than once, you've bought a box or two or more of Super Star diskettes without knowing it. They just had some "big" company's name on them.

Super Star Diskettes are good. So good that a lot of major software publishers, computer manufacturers and other diskette marketers buy them in the tens or hundreds of thousands.

We buy them in the millions.  
And then we sell them to you.  
Cheap.

#### When every little bit counts, it's Super Star Diskettes.

You've used them a hundred times...under different names.

Now, you can buy the real McCoy, the same diskette that major software publishers, computer manufacturers and diskette marketers buy...and call their own.

We simply charge less.

#### Super Special!

Order 50 Super Star Diskettes and we'll be happy to sell you an Amaray Media-Mate 50 for only \$8.75, shipping included...a lot less than the suggested retail price of \$15.95.



Regular DISK WORLD! price: \$10.95 ea.  
+ \$2.00 Shpng.

#### DISKETTE STORAGE CASES

##### PERFECTDATA DIAL 'N FILE

Terrific! Holds 10 5 1/4" diskettes. Just flip the lever and they all slide up for easy access and identification. Grey with smoked plastic front.

\$2.75 Ea. + .35 Shpng.

##### DISK CADDIES

The original flip-up holder for 10 5 1/4" diskettes. Beige or Grey only.

\$1.65 ea. + .20 Shpng.

##### DISKETTE 70 STORAGE

Dust-free storage for 70 5 1/4" diskettes. Six dividers included. An excellent value.

\$11.95 ea. + \$3.00 Shpng.



#### HOW TO ORDER:

ORDERS ONLY:  
1-800-621-6827  
(In Illinois: 1-312-944-2788)

INQUIRIES:  
1-312-944-2788

FOR FASTEST SERVICE, USE NO-COST MCI MAIL: Our address is DISK WORLD! It's a FREE MCI MAIL letter. No charge to you. (Situation permitting, we'll ship these orders in 24 hours or less.)

SHIPPING: 5 1/4" & 3 1/2" DISKETTES—Add \$3.00 per each 100 or fewer diskettes. OTHER ITEMS: Add shipping charges as shown in addition to other shipping charges. PAYMENT: VISA, MASTERCARD and Prepaid orders accepted. COD ORDERS: Add additional \$3.00 special handling charge. APO, FPO, AK, HI & PR ORDERS: Include shipping charges as shown and additional 5% of total order amount to cover PAL and insurance. We ship only to United States addresses, except for those listed above. TAXES: Illinois residents, add 8% sales tax.

MINIMUM ORDER: \$35.00 or 20 diskettes.

#### The Super Star LIFETIME WARRANTY!

Super Star Diskettes are unconditionally warranted against defects in original material and workmanship so long as owned by the original purchaser. Returns are simple: just send the defective diskettes with proof of purchase, postage-paid by you with a short explanation of the problem, and we'll send you the replacements. (Incidentally, coffee stained diskettes and diskettes with staples driven through them don't qualify as "defective".)

WE WILL MEET OR BEAT ANY NATIONALLY  
ADVERTISED PRICE  
ON THE SAME PRODUCTS AND QUANTITIES  
SUBJECT TO THE SAME TERMS AND CONDITIONS.

HOURS:  
Human: 8AM-6PM Central Time, Monday through Friday  
Answering Machine: 6PM-8AM, All Times  
MCI MAIL: 24 hours a day.

# DISK WORLD!, Inc.

Suite 4806  
30 East Huron Street  
Chicago, Illinois 60611

**AMERICA  
WORKS  
BEST**

**WHEN  
AMERICANS  
WORK  
TOGETHER**



Teamwork is making a comeback in America.

Cooperation on the production line helped America win World War II. We're in another kind of battle today — a fight for economic survival in an increasingly competitive world market. Cooperation in the workplace is helping us meet this challenge too.

In plants and offices throughout the country, management is asking employees for their ideas on how to increase productivity and improve the

work environment. And workers and their unions are responding with a wealth of practical suggestions and a renewed spirit of cooperation.

For information about how others are working better by working together, contact:

Cooperative Labor-Management Programs  
U.S. Department of Labor  
Washington, D.C. 20216  
202—523-6098

U.S. Department of Labor



# BYTE back issues for sale

	1977	1978	1979	1980	1981	1982	1983	1984	1985
Jan.			\$2.75	\$3.25	\$3.25		\$3.70	\$4.25	\$4.25
Feb.		\$2.75	\$2.75	\$3.25	\$3.25	\$3.70	\$3.70	\$4.25	\$4.25
March		\$2.75		\$3.25		\$3.70	\$3.70	\$4.25	\$4.25
April		\$2.75	\$2.75	\$3.25	\$3.25	\$3.70	\$3.70	\$4.25	\$4.25
May	\$2.00	\$2.75	\$2.75	\$3.25		\$3.70	\$3.70	\$4.25	\$4.25
June	\$2.00	\$2.75	\$2.75	\$3.25		\$3.70	\$3.70	\$4.25	\$4.25
July	\$2.00	\$2.75	\$2.75	\$3.25		\$3.70	\$4.25	\$4.25	
Aug.	\$2.00	\$2.75	\$2.75			\$3.70	\$4.25	\$4.25	
Sept.	\$2.75	\$2.75	\$2.75	\$3.25		\$3.70	\$4.25	\$4.25	
Oct.		\$2.75	\$2.75	\$3.25	\$3.25	\$3.70	\$4.25	\$4.25	
Nov.			\$3.25		\$3.25	\$3.70	\$4.25	\$4.25	
Dec.	\$2.75	\$2.75	\$3.25	\$3.25	\$3.25	\$3.70	\$4.25	\$4.25	

Special BYTE Guide to IBM PC's — \$4.75

Circle and send requests with payments to:  
**BYTE Back Issues**  
**P.O. Box 328**  
**Hancock, NH 03449**

Prices include postage in the US. Please add \$.50 per copy for Canada and Mexico; and \$2.00 per copy for foreign countries (surface delivery).

Check enclosed

Payments from foreign countries must be made in US funds payable at a US bank.

VISA

MasterCard

Card # \_\_\_\_\_

Exp. \_\_\_\_\_

Signature \_\_\_\_\_

Please allow 4 weeks for domestic delivery and 12 weeks for foreign delivery.

**NAME** \_\_\_\_\_

**ADDRESS** \_\_\_\_\_

**CITY** \_\_\_\_\_

**STATE** \_\_\_\_\_ **ZIP** \_\_\_\_\_



# 100% GUARANTEED ICs - MONEY BACK!

## 1-800-245-2235

### SPECIAL\*

#### 64K DRAM .65

FULLY FUNCTIONAL  
WITH SLIGHTLY  
SHORTER LEADS  
200ns or FASTER

That's right! . . . 100% money-back guaranteed ICs at prices never before possible! Krueger Technology's unique patented IC removal process is the key to our ability to sell so low. The fact is, it costs less to retrieve and refurbish an IC from an obsolete PC board than manufacture a new one. Since we maintain an inventory in excess of six million ICs and process over 100,000 ICs per day (over thirty million in the past ten years) we can supply you with most, if not all of your IC needs.

Until this year our vast inventory of ICs was available to only manufacturers and distributors. The phenomenal growth of the catalog market has allowed us to open our inventory to you. You can now buy direct and cut out all middlemen.

Call today and discover what seven of the ten largest computer manufacturers already know . . . "The Krueger Alternative". Don't forget, you get an additional 30% discount on orders over \$500!

### SPECIALS\*

74LS322	.50
8080A	.75
Z80ASIO/0	3.75
TMS9900	2.00
27128-450ns	5.00
FDC1793	5.00

#### MICROPROCESSORS

TMS9900	2.00*	8087-3	99.00
Z8001	7.50	8088	7.50
8031	5.00	68000-8	18.00
8035	2.00	68000-10	24.00
8039	2.00	68008-E	18.00
8080A	.75*	87XX	10.00
8085	2.00	8X300	6.00
8086	4.00		

#### LINEAR

XR22XX	1.00
CA3XXX	.50
3470	1.50

#### CONTROLLERS/UARTS

1691	5.25	2661	4.00
1771	6.50	5027	5.00
1791	10.00	5037	5.00
1793	5.00*	7201	4.50
1795	10.00	765	4.00
1797	10.00	CQM8F16	5.00
2651	4.00	8250	4.00

#### SOUND CHIPS

76477	2.00
76489	3.50
AY3-8910	2.00
AY3-8912	2.00

#### 82XX PERIPHERALS

8202	14.00	8259	2.00
8212	1.00	8272	4.00
8216	1.00	8273	10.00
8224	3.00	8274	9.00
8228	3.00	8275	9.00
8237	3.00	8276	15.00
8238	2.50	8279	3.50
8243	1.50	8281	7.50
8251	2.00	8283	5.50
8253	2.00	8284	2.00
8254	4.00	8288	4.00
8255	2.00	8291	20.00
8257	2.00	8292	21.00

#### INTERFACE

0026	1.50	75XX*	.50
1488	.50	3232	1.00
1489	.50	3242	4.00
88XX	.50	8303	3.00
8TXX	.50	8304	1.75

#### DYNAMIC RAMS\*

41256-150ns	7.50
4164-150ns	1.25
4164-200ns	1.10
4164-250ns	.75
4416-150ns	1.50
4116-150ns	.75
4116-200ns	.35
4116-250ns	.25

#### STATIC RAMS\*

6264-150ns	6.00
6116-150ns	2.00
6116-200ns	1.75
6116-250ns	1.25
1420-55ns	2.00
2147, 2148, 2149	2.00
2114-450ns	.50
2114-FASTER	.80

#### 74 SERIES

74XX	.25	74SXX	.35
741XX	.35	74S1XX	.45
742XX	.50	74S2XX	.60
743XX	.50	74S3XX	.60
74LSXX	.25	74ALSXX	.35
74LS1XX	.35	74ALS1XX	.45
74LS2XX	.50	74ALS2XX	.60
74LS3XX	.50	74ALS3XX	.60
74FXX	.35	74HCXX	.35
74F1XX	.45	74HC1XX	.45
74F2XX	.60	74HC2XX	.60
74F3XX	.60	74HC3XX	.60

#### 74HCTXX

74HCTXX	.35
74HCT1XX	.45
74HCT2XX	.60
74HCT3XX	.60

#### CMOS

ANY 4000 SERIES	.25
ANY 4500 SERIES	.50

#### 6500/6800 SERIES

ANY 65XX	2.00
ANY 65XXA	2.50
ANY 65XXB	3.00
ANY 68XX	2.00
ANY 68AXX	2.50
ANY 68BXX	3.00
6810	.75

#### OUR POLICY

Delivery: Orders normally shipped within 2 business days. Add \$3 for UPS ground-5# & under. Add \$4 for UPS blue (air), 2# & under. For each additional air pound add \$1. Arizona residents add 6% sales tax. Payment: Visa, MC, cashiers check, certified check, money order, personal check accepted (Allow 10 days for personal checks to clear.) No surcharge on credit card orders. CODs welcome with cash, certified check, cashiers check or money order. Add \$3 COD handling charge.

Pricing: Minimum order \$20. 30% discount on orders over \$500. Prices subject to change without notice. All items limited to stock on hand.

\*We reserve the right to limit quantities.

# 30% DISCOUNT ON \$500 ORDERS

#### EPROMS

27128-250ns	7.00*
27128-300ns	6.00*
27128-450ns	5.00*
2764-250ns	3.50
2764-300ns	3.00
2764-450ns	2.50
2764-650ns	2.00
2732-250ns	3.50
2732-300ns	3.00
2732-450ns	2.50
2716-350ns	2.25
2716-450ns	2.00
2716-650ns	1.35
2708	2.00
68766, 68764	6.00
68708	4.00

CMOS version at double the above prices

25 Series EPROMS are the same price as 27 Series EPROMS

#### DIGITAL

MC4024	2.00	8136	4.00
MC4044	2.00	9602	.75
8131	2.25	96L502	1.50

#### ECL

ANY 10K LOGIC	1.00
ANY ECL RAM	3.00*
ANY 100K LOGIC	5.00

#### Z80 SERIES

2.5 MHZ	
CPU, CTC, PIO	1.00
DMA, DART, SIO	3.00
4.0 MHZ (A)	
CPU, CTC, PIO	2.00
DMA, DART, SIO	4.50
6.0 MHZ (B)	
CPU, CTC, PIO	3.00
DMA, DART, SIO	9.00

#### TMS 9900 SERIES

3901	1.50
3918	20.00
3980	10.00

ALL OTHER 99XX SERIES  
3.00

#### ADC/DAC

ADC08XX	3.50
DAC08XX	1.50
DAC80	8.00

\* 30% discount does not apply to RAMS or at-risked specials

# KRUEGER Technology, Inc.

2219 South 48th Street • Tempe, AZ 85282

## 800-245-2235

In Arizona 602-438-1570

HOURS: 7a.m.-5:30p.m.  
(MOUNTAIN TIME)  
Monday Thru Friday



# ICs PROMPT DELIVERY!!!

SAME DAY SHIPPING (USUALLY)

OUTSIDE OKLAHOMA NO SALES TAX

ADD 640 Kbytes TO PC/XT & SLOT MOTHERBOARD CONSUME NO EXPANSION SLOTS: \$100.00

8087-3	MATH	\$110.00
8087-2	COPROCESSORS	150.00
<b>DYNAMIC RAM</b>		
256K	256Kx1 120 ns	\$ 5.65
256K	256Kx1 150 ns	4.45
64K	64Kx1 150 ns	1.10
<b>EPROM</b>		
27C256	32Kx8 250 ns	\$19.99
27256	32Kx8 250 ns	10.99
27128	16Kx8 250 ns	4.48
27C64	8Kx8 200 ns	7.85
2764	8Kx8 250 ns	2.95
2732A	4Kx8 250 ns	2.95
<b>STATIC RAM</b>		
6264LP-15	8Kx8 150 ns	\$6.25
6116LP-3	2Kx8 150 ns	2.24

QUANTITY ONE PRICES SHOWN

OPEN 6 1/2 DAYS: WE CAN SHIP VIA FED-EX ON SAT.

NO EXTRA COST ON 8-12 SAT DELIVERY

MasterCard VISA or UPS CASH COD  
**Factory New, Prime Parts**   
**MICROPROCESSORS UNLIMITED**  
 24,000 S. Peoria Ave. (918) 267-4961  
 BEGGS, OK 74421

Prices shown above are for May 28, 1985  
 \*Please call for current prices. Prices subject to change. Please expect higher or lower prices on some parts due to supply & demand and our changing costs. Shipping & insurance extra. Cash discount prices shown. Orders received by 6 PM CST can usually be delivered to you by the next morning, via Federal Express Standard Air @ \$8.00, or Priority One @ \$12.00

Inquiry 242

## Universal Machine Independent Assembler

MOPI:

A unique software development system.

The only assembler capable of generating machine code for any 8- or 16-bit micro using a universal set of instructions, including procedural, the manufacturer's or user defined instructions.

The first assembler to implement a proposed AL Standard, applicable to any computer; simplifies learning AL, reduces development time, offers limited portability.

Simple enough for a beginning programmer, sophisticated enough for experienced computer professionals.

For CP/M or PC-DOC - \$195



**VOCS**

P.O. Box 3705  
 Mpls., MN 55403

Inquiry 375

## Commodore 64 One Megabyte Disk Drive

# \$179<sup>00</sup>

5 1/2 times the capacity of the 1541 on double sided disks. This IEEE drive works with PET, B128, 8032, and C 64 w/ Interloc. Perfect as a second drive. List \$899. **Sale \$179.**

(Add \$17.50 Shipping)

# PROTECTO

22292 N. Pepper Rd., Barrington, IL 60010

**312/382-5244**

*We Love Our Customers*

Inquiry 289

## Call For DEALER'S ADVANTAGE

### Add-on Products for IBM PC®

10 Mb Hard Disk Kit (with controller)	\$500.
20 Mb Hard Disk Kit (with controller)	\$650.
Floppy Controller Card	\$50.
Color Graphics Card (RGB and NTSC Comp.)	\$95.
Monochrome Graphics Card	\$100.
Memory Card with 256K	\$150.

### MINIMUM OF TEN BOARDS

100 Bulk Diskettes OS/DD	\$95.
--------------------------	-------

\* IBM is a registered trademark of International Business Machines, Inc.

## CRANE Associates, Inc

3928 S. Sepulveda Blvd., Ste. 12  
 Culver City, CA 90230  
 (213) 390-9840

Inquiry 111

## PC EXPANSIONS

AST SixPakPlus (64k)	\$259
SixPakPlus (384k)	\$339
MegaPlus (64k)	\$269
Advantage (128k)	\$419
I/O Plus	\$129
PCnet - starter kit	\$809
Quadboard (64k)	\$245
Quadboard (384k)	\$319
Quadmeg-AT (128k)	\$319
Quadport-AT	\$105
HERCULES graphics board	\$319
Color Card with PP	\$159
HAYES Modems: 2400	\$call
Smartmodem 1200	\$409
Smartmodem 1200B.	\$379
Set of 9 chips (64k)	\$15
256k chips (each)	\$6
8087 chip	\$119
Maynard Disk Controller	\$100
Sandstar Series	\$call
Internal Hard Disks from	\$679
MaynStream tape backup from.	\$979
Qume 142A	\$129
Teac FD55B	\$129
Tandon TM100-2	\$129
CDC 9409	\$129
Verbatim Datalite disks (10)	\$25

### VLM Computer Electronics

10 Park Place • Morristown, NJ 07960  
 (201) 267-3268 VISA, MC, Check or COD

Inquiry 374

## 1st PLACE

COMPUTER SYSTEMS  
 13422 N. CAVECREEK RD.  
 PHOENIX, AZ. 85022

CALL FREE 1-800-841-2748



Hi - I'm Joan,  
 We are still doing business as usual, same low prices, fast and courteous service. We've gone small for the summer to keep our prices low. Call me for current pricing. I'll be waiting for your call.

Thanks again and God Bless  
 -Joan

WYSE - JUKI - CITOH

ALTOs - LEADING EDGE - SANYO

HAYES - PRO MATHSUS - NEC

Inquiry 405

## PERCON® E-Z-READER™ BAR CODE READERS

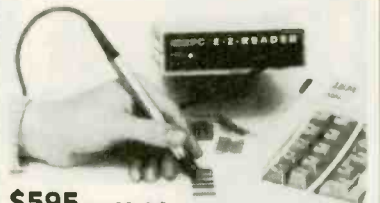

**\$595** QUANTITY ONE

**QUALITY, PERFORMANCE, PRICE**

IBM® PC, XT, AT KEYBOARD COMPATIBLE VERSION Works with most compatibles; hooks up in seconds without changing software

RS 232C SERIAL VERSION

READS UPC A/E, CODE 39, CODABAR, ABC, 12 OF 5  
 DECODES BOTH DOT MATRIX & HIGH DENSITY PRINTED LABELS ACCURATELY

MS/PC DOS Bar Code Printing Software \$99

 503/344-1189  
 2190 W. 11th St.  
 Eugene, OR 97402  
 1 Year Limited Warranty In Stock VISA, M/C or COD

Inquiry 279

## Verbatim®

Data Life Diskettes

Lifetime Warranty

	Catalog #	Box of 10
5 1/4" SSDD	18158	\$15.50
5 1/4" DSDD	18188	\$19.95
5 1/4" DSQD	18239	\$28.50

minimum quantity 100

Disk Drives

5 1/4" 1/2 heights

TEAC 55B	\$119
Panasonic/Shugart	\$109
3 1/2" SS Shugart SA 300	\$110

limited quantity

## Kimtron KT-7® Terminal

Compatible to Televideo® 925 \$545

Also carry complete line of computer products

**MICROSCRIBE, INC.**

3350 Scott Blvd. Bldg. 15 Santa Clara, CA 95054  
 Call M-F 8:00 - 5:00 (408) 748-1333

Inquiry 388

NEW!



**SafeSkin™**  
 KEYBOARD PROTECTOR

Remains in place during keyboard use. Prevents damage from liquid spills, dust, ashes, etc. Fits like a second skin, excellent feel. Available for: IBM-PC, AT, Apple (all), Compaq, Model 100, NEC 8201, C64, Zenith 150, DEC, Kaypro and many others. Send \$29.95, check, M.O., Visa & MC include exp. date. Specify computer type. Dealer inquiries invited. Free brochure avail.

Merritt Computer Products, Inc.  
 2925 LBJ Fwy. #180 / Dallas, Texas 75234  
 (214) 942-1142

Inquiry 229

**Micro Products International**  
714/898-0840

# Independence Specials

**We Cater to IBM™ Dealers**  
★ Hardware ★ Software  
★ Training Tapes ★ Dealers  
**Call for our Catalog now!**

## New Hayes SmartModem Compatible!

Finally a price breakthrough on a Hayes compatible, external 300/1200 baud modem. This low price is without driver software, but if you need it add \$25.00. Call for a 26 page catalog of our special deals. Look in this spot every month for Hot, New Items sure to catch your interest.



- Runs the popular Hayes communications software
- FCC approved direct RJ-11 connection
- Phone Cable & power supply one low price. MOD-8100-00

**\$229.00**

## IBM PC-XT SELECTRIC KEYBOARDS

Our volume purchase of these excellent Selectric type keyboards will bring the features you have been wanting down to a price you can't resist. So many features you'll love it!

- Single key reset
- Separate numeric keypad
- Separate "Arrow" keypad
- Dimple marked "5", F, & J keys



KEY-1051-00 Selectric **\$129.00**  
KEY-1050-00 Standard **89.00**

## ADD-ON POWER SUPPLIES

Two new, thoroughly tested IBM PC/XT power supplies for your system upgrade. Best price in Byte with ONE YEAR warranty!!



POW-1040-00 135 watt ..... **\$ 99.00**  
POW-1044-00 150 watt ..... **\$115.00**

## XPC TURBO MOTHERBOARD

Micro Products announces a powerful new IBM XT type motherboard. 4 layers for superior reliability & speed. Turbo mode allows 75% higher thru-put by increasing system clock to 7 MHz under software control. Designed to use new 256K RAM chips or 64K chips. 640K memory expansion does not require use of valuable card slots. Many outstanding features combined with our new 7 PAK Multifunction board make previously expensive options standard features at a LOW LOW Cost. BOA-6078-00 Supplied with OK ..... **\$349.00**

## SUPER 12 PAK MULTI-FUNCTION

This one is really loaded! Features: One Parallel Port, One RS232-C Serial Port, One Game Port, Real-Time Clock / Calendar with Battery Back-up, Expandable to 384K of Parity-checked Memory, Supplied OK Memory, all cables, PrintSpooler and RAM Disk Software.

BOA-6335-00 ..... **\$149.95**  
Additional (9) 64K Memory Chips  
KIT-8000-00 ..... **\$ 10.00**

Terms: We accept Visa, M/C, Pre-Pay by Check or Money Order. COD's are accepted by Telephone & Mail. COD Terms are Cashier's Check for first time orders over \$100.00  
Fax: 714/897-3363 Tlx: 887841 XORDATA HTB

## Do it Yourself!

Three ways to begin - an Empty cabinet - a "Basic" system Full system - all that you assemble yourself!

**CABINET ONLY**  
Slot CAB-3068-00 ..... **\$75.00**

**"BASIC"**  
Cabinet, Keyboard, Power Supply, Motherboard w/OK /S-8000-00 ..... **\$525.00**

**XPC KIT**  
Cabinet, Keyboard, Power Supply, Motherboard, Floppy Controller, Mono Video, TTL Monitor, 2 ves, no software - 1 1/2 hrs. Assembly.  
T-9500-00 ..... **\$1195.00**

## \$1395.00 WOW! Complete System! XPC TURBO

**NEW 17,000 in Service!**

- Features!**
- RAM Disk
  - Game Port
  - 640K cpcy
  - PrintSpooler
  - Turbo mode!
- 4.77MHz to 7MHz!
- Ser, Par
  - Clock



**10 Meg H.D.**  
Complete System!  
**\$1995.00**

**20 Meg Color**  
Complete System!  
**\$2550.00**

**40 Meg w/Tape**  
Complete System!  
**\$3035.00**

- Software**
- XWORD
  - XBASIC
  - XBASE
  - XCALC
  - XCOM

### Check These Standard Features:

- Full-Size, FeatherTouch, Capacitance Keyboard, 10 Function Keys, Calculator-Type Numeric Keypad
- Parallel & Serial I/O • Real Time Clock • Game Port • 2-Silimite 5 1/4" DS/DD 48 TPI 360K Drives
- IBM expansion slots • RAM Disk • Print Spooler • 4 DMA & 3 Timer channels
- Full 640K capacity on-board • 8088 16-bit CPU • Monochrome Video Card
- Up to 32K of EPROM (full 8K supplied) • Supports PC-DOS • MS-DOS • CP/M-86
- Power Supply Hard-Disk-Ready, no need to add-on additional power
- High resolution 12" Monitor, Green Screen, 22 MHz bandwidth

## Add-On H.D. & Tape



10 or 20 Megabyte on the top, your choice of Hard Disk on the bottom. Super appearance! Requires one slot in your PC for SASI interface and an extension connector on the floppy card. Everything else is supplied by us.

10 Meg	\$1295	40 Meg	\$1995
20 Meg	\$1395	105 Meg	\$4395
26 Meg	\$1595	140 Meg	\$4995

**Add-On Hard Disk**

Two ways to go. The Internal system is cheaper because it does not need a PIS & Chassis. The same PIS & Chassis can be used for a 10 Meg Tape Back-up on your XT!

10 Megabyte	\$1195 int/\$1295 ext	40 Megabyte	\$1195 int/\$1295 ext
20 Megabyte	\$1795 int/\$1795 ext	105 Megabyte	\$3795 int/\$3995 ext
26 Megabyte	\$1895 int/\$1895 ext	140 Megabyte	\$4395 int/\$4695 ext

## Add-On 20 Meg Tape



Sub-8300-00 ..... **\$595.00**

If your IBM-AT needs a little help in the Back-up category, you won't be able to beat this price! Cables, software and everything!

# Not enough room here - Call for Catalog

### PROM LASER

This is the One! Our PROM Burner allows reading, storing-to-disk, recalling, and burning. Hi-speed algorithms burns 2764 in 45 seconds! Also handles 2716, 2732, 27128, 27256. Features: Zero insertion force sockets; On-board Voltage Generator; No interference with normal computer operations.  
BOA-8640-00 ..... **\$199.00**

### We want your DRIVE business!

Shugart 360K TEAC 360K NEC 10meg Tulin 26meg Memtek 26

\$85.00	\$95.00	\$345.00	\$695.00	\$495.00
---------	---------	----------	----------	----------

### Now XPC-XT in a Kit! Completely XT Compatible

**\$1195.00**



Why didn't anybody think of it before? If you have a phillips screwdriver and 1 - 2 hours available, SAVE yourself a bundle of MONEY! No where will you beat this deal on a complete 8 slot ready-to-assemble and run XT compatible.

- Cabinet
- 135 watt Power Supply
- Keyboard
- 8 Slot Motherboard
- 256K RAM
- 2-360K Shugart Drives
- Floppy Controller & Cable
- Mono Video Card
- TTL Amber Monitor

### MISCELLANEOUS \$\$\$ SAVERS

7 PAK Multifunction Floppy, RTC, 2 Serial, 1 Parallel, Game, RAM Disk BOA-6250-00 ..... **\$189.00**  
64K Memory Chips (9) NEC for IBM KIT-8000-00 ..... **\$ 10.00**  
256K DRAM Memory Chips (9) = 256K KIT-9000-00 ..... **\$ 45.00**  
Add-On Memory, (up to 512K) supplied OK BOA-6350-00 ..... **\$ 99.00**  
Floppy Controller, Controls up to four drives. 5 1/4" 48/96 TPI BOA-6100-00 ..... **\$ 95.00**  
Monochrome Graphics Card, (Hercules type) (1-2-3 compatible) 720h x 348v BOA-6375-00 ..... **\$175.00**  
Color Graphics Card, 320 x 200 Res. Color, 640 x 200 Monochrome BOA-6200-00 ..... **\$145.00**  
Clock Calendar Board, fits in "short slot" w/battery Back-up BOA-6375-00 ..... **\$ 55.00**  
Hard Disk Controller, standard ST-506 interface for DOS 1.1 & 2.0 BOA-8060-00 ..... **\$185.00**  
300 / 1200 Baud Modem Internal w/PC Talk III Communications Software BOA-8725-00 ..... **\$239.00**  
Monochrome Monitor, 22MHz bandwidth, composite input or TTL MON-1725-00 Green/Comp ..... **99.00** MON-1700-00 Amber/Comp ..... **104.00**  
MON-1775-00 Green/TTL ..... **104.00** MON-1750-00 Amber/TTL ..... **109.00**

### INTERNATIONAL ORDERS

Micro Products is ready to serve your needs in several countries. Each Office has Sales Literature, Local Pricing, Inventory and Technical Service available to support your needs. There are no problems with U.S. Export Forms.

**USA OFFICE**  
Darryl R. Green  
15392 Assembly Lane, Unit A  
Huntington Beach, CA 92649  
Tel: 714 / 898-0840  
Tlx: 887841 XORDATA HTB

**AMSTERDAM OFFICE**  
Cynthia Clark  
Building 70, 4th Floor  
1117 ZH Schiphol-East  
Amsterdam, The Netherlands  
Tel: (020) 45 26 50 - Tlx: 18306

**AUSTRALIAN OFFICE**  
8 Irwin Street, Bellevue  
W. Australia 6056  
Tel: 274-3701

**MARACAIBO OFFICE**  
Jim Stevens  
Av. 3F Esq. Calle 81  
Centro Com. Maella - Local #5  
Maracaibo, Venezuela 4001-A  
Tel: 061-913328 - Tlx: 62344 PEMIN

**BOMBAY OFFICE**  
Dhiraj House  
311 Sindhli Lane  
Nanubhai Desai Rd.  
Bombay 400-004 India  
Tel: 357172 - Tlx: 011-2868

**CANADA OFFICE**  
Andre Desrochers  
264 Principale, St. Blaise  
Quebec, Canada J0J1W0  
Tel: 514/291-3118

# IBM PC/VT100

EM100 for IBM PC, XT, AT, JR.

- VT102 emulation
- File Transfer
- 132 Column modes
- Color Support

## EM100-4010

- Tektronix 4010 emulation
- VT102 emulation
- Picture files
- High resolution hardcopy
- Supports IBM, IBM Enhanced.
- Hercules and Temnar graphics cards.

Multicopy discounts



**Diversified Computer Systems, Inc.**

100 Arapahoe, Boulder, CO 80302  
(303) 447-9251

Trademarks: VT100 — Digital Equipment; IBM PC, XT — IBM Corp.  
Hercules — Hercules Computer Technology

Inquiry 129

"KING OF THE ELECTRONICS JUNGLE"



LEO ELECTRONICS, INC.  
P.O. Box 11307  
Torrance, CA 90510-1307  
Tel: 213/212-8133 800/421-9565  
TLX: 291 985 LEO UR  
FAX: 213/212-6106

## MEMORY EXPANSION CHIPS

RANDOM ACCESS MEMORY			
	PRICE EACH	SET OF 8	SET OF 9
4164-150ns) 64K	1.90	\$14.40	\$ 18.20
4164-200ns)	1.80	\$15.20	\$ 17.10
4128-150ns) (8M/AT)	13.65	—	\$122.85
41256-150ns) 256K	7.50	\$60.00	\$ 67.50
HM6116P-3	3.50	\$28.00	—

EPROMS	PRICE
2716	\$ 2.80
2732	\$ 3.50
2764	\$ 4.50
27128	\$ 7.00
27256	\$15.00

## WE NOW CARRY:

Disk drives, Power supplies,  
384K Multifunction boards,  
Color/graphic boards, and  
more...  
CALL FOR BROCHURE

We accept checks Visa, MasterCard. Purchase Orders from qualified firms and institutions U.S. funds only. Call for C.O.D. California residents add 6% tax. Shipping is UPS. Add \$2.00 for ground and \$5.00 for air. All major manufacturers. All parts 100% guaranteed. Pricing subject to change without notice. Call for volume pricing.

Inquiry 211

MARYMAC INDUSTRIES INC.

800-231-3680

## Radio Shack TRS-80's Epson Printers

People you Trust to give you the very best!



• Lowest  
Discount  
Prices

• Reliable  
Service

• Quality  
Products



"World's largest independent authorized Tandy dealer."

22511 Katy Fwy., Katy (Houston) Texas 77450  
(713) 392-0747 Telex 774132

Inquiry 223

# The Statistician

CPM IBM-PC  
TRS-DOS XENIX

- Multiple Regression
- Stepwise Ridge
- All Subsets
- Backward Elimination
- Time Series Analysis
- Descriptive Statistics
- Transformations
- Survey Research
- Nonparametrics
- XY Plots
- ANOVA
- Random Samples
- Data Base
- Search & sort
- Hypothesis tests

Please call TOLL FREE  
1-800-334-0854 (Ext. 814)



for more information  
or write:  
Quant Systems  
Box 628  
Charleston, SC 29402  
VISA/MC Accepted

Inquiry 296



wabash  
**DATA TECH**  
DISKETTES

Lifetime Warranty—100% Certified  
**\*FREE DELIVERY\***

5 1/4" \$105 each SINGLE 5.25" DISKETTES 48 TRK 160KB BING Packaged 10 per Soft Pack QTY 30	BULK SSD 89¢ each 5.25" 5.25" SINGLE DISKETTES 48 TRK 160KB BING Packaged 10 per Soft Pack QTY 30
5 1/4" \$125 each SINGLE 5.25" DISKETTES 48 TRK 160KB BING Packaged 10 per Soft Pack QTY 30	BULK SSD \$107 each 5.25" 5.25" SINGLE DISKETTES 48 TRK 160KB BING Packaged 10 per Soft Pack QTY 30
5 1/4" \$165 each DOUBLE 5.25" DISKETTES 48 TRK 160KB BING Packaged 10 per Soft Pack QTY 30	BULK DSD \$142 each 5.25" 5.25" DOUBLE DISKETTES 48 TRK 160KB BING Packaged 10 per Soft Pack QTY 30

24 Hour Order Desk



TOLL FREE NAT'L 1-800-634-2248

Visa, MasterCard, Cert. chk., M.O., C.O.D. cash  
Get immediate shipment. Schools & govt. on P.O. #.  
Personal or company checks held 14 days  
APO, FPO, Can. and other non-UPS delivered, add \$5.

\*Frag delivers on minimum orders of \$50 or more. Others add \$2 for S & H

## Software Services™

1323 23rd Street South Suite C Fargo, ND 58103 1-701-280-0121

Inquiry 328

## PRINTER RIBBONS

	PRICE	PER RIBBON	PER DOZEN
ANADIX 9500	10.50	109.80	
APPLE DMP	5.50	58.80	
BROTHER HR-15/25 MS	5.95	68.40	
C. ITOH PROWRITER	5.50	58.80	
COMMODORE MPS-801	8.00	90.00	
EPSON MX-FX 70/80	5.00	48.00	
EPSON MX-FX 100	6.95	75.00	
EPSON LQ-1500	9.75	111.00	
GEMINI 10-10X-15-15X	2.50	23.40	
IBM/IDS 4-COLOR	15.75	180.00	
IDS MICROPRISM-480	5.75	58.80	
NEC - 3500 M/S Non Flip	6.25	69.00	
NEC - 3500 NYLON	9.00	96.00	
NEC - 8023A	5.50	58.80	
OKIDATA 80/82/83/92	2.50	23.40	
RADIO SHACK DMP-2100	7.50	87.00	
RADIO SHACK LP VI & VIII	5.75	58.80	
RITEMAN	8.50	96.00	
SILVER REED EX 550 M/S	8.50	90.00	
SILVER REED EX 550 NYLON	6.95	75.00	
TALLY SPIRIT - 80 M/S	7.50	84.00	
TALLY - MT-160	8.00	90.00	
TALLY - MT-180	8.50	96.00	
TOSHIBA - 1350/1351	7.50	87.00	

Add \$3.00 Ship. & Hand. — To Order Call  
Toll Free 1-800-742-1122

In MI (313) 569-3218 or Write for our Catalog  
**DWIGHT COMPANY, INC.**  
15565 Northland Drive - West Tower  
Southfield, Michigan 48075-6496

Inquiry 134

## DATA ACQUISITION and control for ANY computer

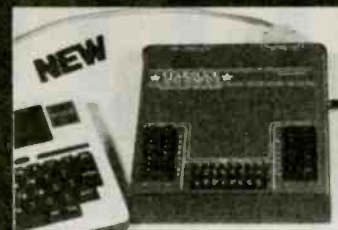

The Model 1232 communicates via RS-232, and has 8 analog inputs ( $\pm 4$  VDC; 12 bits), 8 digital inputs and outputs, and a 2000 point buffer. Suitable for field data logging or lab use, the 1232 costs only \$690. The 8-bit system (0-5 VDC) is \$490. Detailed manual, \$6. Phone our applications engineer at 617-899-8629 or write:

★ ★ STARBUCK DATA COMPANY ★ ★

225 Crescent St., Waltham, MA 02154

Inquiry 340

**A WESOME TECHNOLOGY, INC.**

## Poor Man's TopView™

"MULTIPLE CHOICE" Provides:

- Screen switching under DOS
- Up to 8 programs in memory
- Efficient memory use - run 123 with WordStar in 256K
- Data transfer screen snapshot
- ✓ All of the above available NOW

Multiple Choice is only \$64 and runs on IBM PC/XT/AT/clones

For Information, Call (408) 646-1384

**A WESOME TECHNOLOGY, INC.**

177 Webster St. Ste. A-416  
Monterey, CA 93940

Order Toll Free (VISA/MC)

Outside CA (800) 548-2255 Ext 803

Inside CA (800) 624-2644 Ext 803

TopView is a trademark of IBM Corporation

Inquiry 45

# IBM PC SPECIALS!

IBM PC, 256K, One Half Height 320K Disk Drive DS/DD, Persyst Color Card With Printer Port, Taxan Green Monitor, DOS 2.1, PLUS a 10MB Hard Disk Sub System All For:

**\$2599.**



IBM PC, 256K, Two Half Height Drives DS/DD, Persyst Color Card With Printer Port, Taxan Green Monitor, DOS 2.1, 130 Watt Power Supply, 20MB Hard Disk Sub System All For:

**\$3299.**

IBM PC, 256K, Two Half Height Drives DS/DD, Persyst Color Card With Printer Port, Taxan Green Monitor, DOS 2.1, 130 Watt Power Supply, 10MB Hard Disk Sub System, PLUS 10MB Tape Back Up System All For:

**\$3499.**

IBM PC, 256K, Two Half Height Drives DS/DD, Persyst Color Card With Printer Port, Taxan Green Monitor, DOS 2.1, 130 Watt Power Supply PLUS a 10MB Hard Disk Sub System All For:

**\$2899.**

IBM PC, 256K, Two Half Height Drives DS/DD, Persyst Color Card With Printer Port, Taxan Green Monitor, DOS 2.1, 130 Watt Power Supply, 20MB Hard Disk Sub System, PLUS 10MB Tape Back Up System All For:

**\$3899.**

## MONITORS

AMDEK 300 Green	\$135.00
AMDEK 300 Amber	\$149.00
AMDEK 310 Amber W/TTL Plug	\$165.00
PGS HX-12	\$465.00
PGS MAX-12	\$185.00
PGS SR-12	\$625.00
TAXAN #115 Green Composit	\$125.00
TAXAN #116 Amber Composit	\$135.00
TAXAN #121 Green W/TTL Plug	\$149.00
TAXAN #122 Amber W/TTL Plug	\$159.00
TAXAN #425 COLOR MONITOR	\$449.00
TAXAN #440 COLOR MONITOR	\$569.00
IBM MONOCHROME DISPLAY	\$260.00
IBM COLOR DISPLAY	\$590.00

## PRINTERS

OKIDATA 182	\$235.00
OKIDATA 192	\$385.00
OKIDATA 193	\$599.00
OKIDATA 83A	\$555.00
OKIDATA 92P	\$385.00
OKIDATA 93P	\$599.00
OKIDATA 84P	\$725.00
OKIDATA 2350P	\$1925.00
OKIDATA 2410P	\$1899.00
NEC 3550	\$1550.00
NEC PINWRITER 80 Col.	\$699.00
NEC PINWRITER 130 Col.	\$899.00
EPSON LX 80	\$249.00
EPSON FX 80	\$399.00
EPSON FX 100	\$525.00
EPSON RX 100	\$399.00
EPSON JX 80	\$525.00
EPSON LQ 1500	\$925.00
COMREX CR 420	\$1895.00
TOSHIBA 351	\$1275.00
STAR MICRONICS SG 10	\$259.00
STAR MICRONICS SG 15	\$395.00
CITIZEN PRINTER MSP-10	\$375.00
CITIZEN PRINTER MSP-15	\$585.00
CITIZEN PRINTER MSP-20	\$545.00
CITIZEN PRINTER MSP-25	\$740.00
JUKI LQ 6100	\$425.00
JUKI LQ 6300	\$745.00
BROTHER HR-25	\$665.00
BROTHER HR-35	\$895.00
DYNAX DX 15XL	\$389.00

## MODEMS

HAYES SMART MODEM 1200	\$459.00
HAYES SMART MODEM 300	\$209.00
HAYES 1200B PLUG IN CARD	\$399.00
HAYES 2400 BAUD MODEM	\$714.00
POP COM 1200 EXTERNAL	\$375.00
AST REACH MODEM	\$389.00
QIC MODEM INTERNAL	\$275.00

## DRIVES

TANDON TM-100-2 DS/DD	\$155.00
TOSHIBA SLIMLINE DS/DD	\$139.00
TEAC SLIMLINE DS/DD	\$139.00

## HARD DISKS

10MB SUB SYSTEM INTERNAL	\$750.00
EXTERNAL	\$925.00
20MB SUB SYSTEM INTERNAL	\$975.00
EXTERNAL	\$1150.00
40MB SUB SYSTEM INTERNAL	\$1295.00
EXTERNAL	\$1475.00

## HARD DISKS & TAPE BACK-UP UNITS (EXTERNAL)

10MB HARD DISK	
W/10MB TAPE BACK UP	\$1250.00
20MB HARD DISK	
W/10MB TAPE BACK UP	\$1475.00
40MB HARD DISK	
W/10MB TAPE BACK UP	\$1795.00

## MULTIFUNCTION BOARDS

AST I/O MINI CARD, 1-SER.	\$150.00
AST SIX PACK 64K, 1-SER., 1-PAR.	\$265.00
AST PREVIEW	\$309.00
AST ADVANTAGE CARD	
128K FOR AT	\$495.00
ALR CHALLENGER CARD	
128K FOR AT	\$395.00
PERSYST COLOR	
PRINTER ADAPTER	\$179.00
PERSYST MONOCHROME	
PRINTER ADAPTER	\$199.00
PERSYST BOB CARD	\$395.00
HERCULES COLOR	
PRINTER ADAPTER	\$179.00
HERCULES GRAPHIC	
PRINTER ADAPTER	\$325.00
STB GRAPHIC PLUS II	\$325.00
IBM COLOR GRAPHIC ADAPTER	\$225.00
IBM MONO PRINTER ADAPTER	\$230.00
GENOA SPECTRUM GRAPHIC CARD	\$349.00
ORCHID TURBO-186, 128K	\$975.00
ORCHID DAUGHTER	
TURBO-186, 128K	\$219.00

## GENERAL

MAXELL DISKETTES MD2	\$35.00/box
MAXELL MD2-HDM FOR AT	\$65.00/box
CONTROL DATA DISKETTES	\$30.00/box
KEYTRONIC KEYBOARD KB 5151	\$189.00

Many other products available, Please call for Low, Low Prices!

*Microshop*  
COMPUTER PRODUCTS

**(714) 838-7530**

2640 Walnut Avenue, Unit K, Tustin, California 92680

Prices & availability subject to change without notice - IBM is a registered trademark of IBM Corporation

**LOW COST UNIVERSAL  
(R) PROM PROGRAMMER**

- SUPPORTS: (EPROMS) 2516 THRU 64, 2716 THRU 512, 27C16 THRU 128, 64732 THRU 66 (EEPROMS) 52B13 THRU 33, 2816A THRU 64A (MICROS) 8741 THRU 49H
- NO PERSONALITY MODULES, ONBOARD POWER SUPPLY
- NS232C INTERFACE, XON-XOFF, RTS, CTS, DTR
- ACCEPTS KEYBOARD ENTRY WITH LINE EDITING
- ACCEPTS ASCII, INTEL, AND MOTOROLA FORMATS
- USER FRIENDLY MONITOR FOR I/O DEBUGGING
- FAST PROGRAMMING SUPPORTED: 2764 UNDER 3 MIN.
- LOW/HIGH BYTE PROGRAMMING FOR 16 BIT DATA PATH
- BYTE, BLOCK, OR CHIP ERASE (EEPROMS ONLY)
- LIST IN INTEL OR MOTOROLA HEX FORMAT
- VERIFY PROGRAM AND VERIFY BLANK COMMANDS

- 1409-01: 4K FIRMWARE, PCB, XFORMER, DOC \$90.00
- 1409-02: 1409-01 + FULL SET OF PARTS \$200.00
- 1409-03: ASSEMBLED AND TESTED UNIT \$300.00
- 1409-11: 8K FIRMWARE, PCB, XFORMER, DOC \$125.00
- 1409-12: 1409-11 + FULL SET OF PARTS \$250.00
- 1409-13: ASSEMBLED AND TESTED UNIT \$350.00
- COMMUNICATION DRIVERS FOR MOST PCs \$35.00

**H&C MICROSYSTEMS**  
6322 MOJAVE DR., SAN JOSE, CA 95120  
Tel. (408)997-7685, TWX 4995363



**Sure  
it's insured?**

SAFEWARE® Insurance provides full replacement of hardware, media and purchased software. As little as \$39/yr. covers:

- Fire • Theft • Power Surges
- Earthquake • Water Damage • Auto Accident

For information or immediate coverage call:  
**1-800-848-3469**

In Ohio call 1-614-262-0559



SAFEWARE, The Insurance Agency Inc.

Inquiry 311

**A New Text Editor**

for the DEC® Rainbow®  
and IBM® PC

- Edit many files at once
- Memory mapped video display
- Buffered input
- Context sensitive help
- Undo deletions
- Create, edit & save scratch buffers
- Powerful buffer operations
- Keystroke macros
- Easily reconfigurable
- Fast, Small for its power (38K)
- Utilizes all memory available
- Not copy protected
- Much more

Also included: A speller with a 25000+ word expandable dictionary, and a text formatter redefinable to familiar commands.

DEC: Both MS-DOS® & CP/M®, manual  
IBM & compatibles: MS-DOS version, manual  
**\$49.95 M/C, Visa accepted**

Plus \$3 shipping. IA res add 4% sales tax.

Orders: 1 800-227-2400 ext 975

1-800-772-2666 ext 975 (within CA)  
College Software • 911 Clark Avenue  
Ames, IA 50010 • (515)233-4023

Inquiry 83

**64K & 256K  
DRAMS**

**8087-3  
8087-2**

BITTNER  
**BE**  
ELECTRONICS

1287 CLIFF DRIVE  
SUITE ONE  
LAGUNA BEACH, CA 92651  
(714) 497-4910

Inquiry 53

NOW INCLUDES  
TINY BASIC  
FORTH AVAILABLE

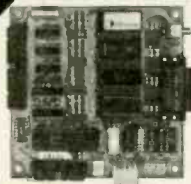

**SIBEC 51**

8051/52 DEVELOPMENT BOARD

8051-Based Single-Board Computer with  
Monitor/Debugger

- 4 28-pin byte-wide sockets; monitor will program EEPROMS.
- Perfect for System Development and Educational Applications

**\$335**

Binary Technology

PO BOX 87 • MERIDEN, NH 03770 • 603/469-3232

Inquiry 52

**BIG DISCOUNTS  
ON LITTLE BOARDS™  
& ACCESSORIES**

- AMPRO LITTLE BOARD™—64K, Z80a CPU, CTC, DART, 1 parallel port, 5 1/4 controller supports four 48tpi and/or 96tpi drives w/CP/M 2.2 and ZCPR3 (A & T) \$329
- SYSTEM SUPPORT PKG—Manuals, source code schematics, connectors & cables \$99
- SCSI PLUS—DMA Hard disk interface \$99
- TEAC 55B DSDD 48tpi 1/2 ht drive \$159
- TEAC 55F DSDD 96tpi 1/2 ht drive \$189
- INTEGRAND Custom two drive cabinet with 5 amp power supply & power cables \$179
- TERM-MATE—Cabinet for 2 1/2 ht + LITTLE BOARD w/all cables & supply \$229
- AMPRO SERIES 100 complete systems SCALL

VISA & MASTER CHARGE Personal Checks.  
Please allow 2 weeks. Shipped via UPS.  
Prices F.O.B. Prairie View, IL  
For additional information write or call:  
DISKS PLUS • 15945 West Pope Blvd • Prairie View, IL  
60609 • (312)537-7888

**DISKS PLUS**  
DIVISION OF SOLARONICS INC.

Inquiry 125

**IBM AT 3Mb  
COMBO CARD  
WITH LIFETIME WARRANTY\***



The AT Multifunction Card that can give you up to  
3Mb of added memory plus added I/O features.

Expandable from 128K to 3Mb. Add memory as you need it. • IBM AT Compatible • Parallel Port • Serial Port • Spooler • Supports IBM VDISK • User Upgradable • Parity Checking Standard • Split Memory Addressing.

Complete with 128K RAM, Serial and Parallel Port **\$449**  
AT RAM Expansion Card (8K) **\$129**

Additional RAM available at our low prices. **OTHER ADD ONS \$84K**  
RAM/ Clock, 512K RAM Card, Spoolers, RAM Cards for PPGs and more.

**Apparat, Inc.**  
ADD ON AND ON AND ON AND ON AND ON

4401 So Tamarac Parkway / Denver, CO 80237 / 303/741-1778

ORDERING AND DEALER INFORMATION  
800/525-7674

Stores in Denver & Chicago / \*On all cards sold after June 1, 1984

Inquiry 35

**NEC PRINTERS**

- 2050 ..... \$ 625
- 3550 ..... \$ 990
- 8850 ..... \$1400

- 2010/15/30 ..... \$ 625
- 3510/15/30 ..... \$ 990
- 8810/15/30 ..... \$1400

Elf 360 ..... \$ 399

Pinwriter P-2 ..... \$ 490  
(w/Interface & Tractor)

Pinwriter P-3 ..... \$ 690  
(w/Interface & Tractor)

Terms: PREPAID — FREE FREIGHT!!

QUALITY PRINTERS  
8415 Cement City Rd.  
Brooklyn, Michigan 49230  
Phone: 517-592-3749

Inquiry 295

**DOS UTILITIES**

- Attrib\* - set/reset file attributes
- Crypt - file encryption
- DSort - sort directory files
- Find\* - find strings in files
- Log - log computer usage for IRS
- Move\* - rename across directories
- Tree - disk/file usage statistics
- \* supports DOS wildcards

SEE - Full screen editor:  
supports optional microsoft mouse;  
block pick, put, cut, paste; search  
1000 wps; single & global replace;  
multiple windows & files; center,  
justify; spell check, correct 300 wps  
from supplied + user dictionary;  
32000 lines/file, 32000 chars/line;  
Instruction course included.

**\$49 for all 8 programs**

\$79 unprotected  
Visa/MC - CA add 6% sales tax

California Scientific Software  
25642 Hazelnut, El Toro, CA 92630  
(714) 581-7654

Inquiry 70

# PRIORITY **1** ELECTRONICS

ONE

## Paradise 5 PACK

MULTIFUNCTION  
CARD FOR IBM PC™

With 384K!

- One Serial Port
- Clock Calendar with battery backup
- RAM disk software
- Print Spooler software

BSPAR5PACK384

Memory shipped  
uninstalled



Sh. Wt. 2lbs

**\$249**

## SURGE SUPPRESSORS

*Don't let power spikes pull you  
down! Protect your equipment  
from All angles*

AC Power line  
With 6 outlets  
BSWBDRG115S  
Sh. Wt. 2lbs

RS232  
Serial  
BSPRISP25MF  
Sh. Wt. 1lb.

Telephone/  
Modem  
BSPRITELSSW  
Sh. Wt. 1lb

**YOUR  
CHOICE**

**\$29.95**

each

## 150VA & 300VA Line Conditioners

*Better Than A Surge Suppressor!*  
Provides both surge and noise suppression  
along with brownout protection as well!

**150VA**  
Great for Your PC!

**\$99**

BSSHP150  
Sh. Wt. 15lbs.

**300VA**  
Great for Your XT!

**\$139**

BSSHP300  
Sh. Wt. 30lbs

## 20Mbyte Add-On Hard Disk For Your IBM PC™ and Compatibles

Comes Complete With Half High  
Disk Drive, Controller, and Cables

**INTERNAL      EXTERNAL**  
**\$899            \$1099**

BSPRIPCSUB20I

BSPRIPCSUB20X

Include \$5.00 (Internal), \$9.00 (External) for Shipping

*Speed Computer Operations  
By As Much As 3500%!!!*

## VIASYN/CompuPro M-Drive®/H™ 512K

S-100 Disk Emulation Card

List Price:

\$895.00

BSGTA072

Sh. Wt. 2lbs.

**\$549. ea**

2 or More

**\$499.**

## Memory Expansion

*150ns  
or Better!* Chip Sets

**64K**

Set of 9 = 64K

**\$14.95**

BSPDB18MEM9

Set of 36 = 256K

**\$59.**

BSPDB18MEM36

**256K**

Set of 9 = 256K

**\$69.**

BSPDB256MEM9

Set of 36 = 1Meg

**\$269.**

BSPDB256MEM36

CALL for QUANTITY PRICING

## Disk Drive Cabinets from JMR Electronics

Part Number	Description	Price
BSJMR1C5	5¼" Sgl Floppy 5lbs.	\$ 59.
BSJMR2C5	5¼" Dbl Floppy 9lbs.	\$ 89.
BSJMR2C5C	JMR2C5 with data cable	\$ 99.
BSJMR2S5	Dual 5¼" ½Hi Flipy 7lbs.	\$ 65.
BSJMR2C8	Dual 8" Floppy 35lbs.	\$229.
BSJMRDTC8	Dual 8" ½Hi Floppy 12lbs	\$179.
BSJMRHDC51	Sgl 5¼" Hard Disk 16lbs.	\$199.
BSJMRHDC51HH	Sgl 5¼" ½ HI Hard 16lbs.	\$199.
BSJMRHDC52	Dual 5¼" Hrd Dsk 20lbs.	\$299.

## B & K Precision 1580 Dual Trace 100MHz Scope



BSBK1580

List Price

\$1595.00

Sh. Wt. 25lbs.

**\$895**

**You Save \$700.00!!!**

## 5¼" Double Sided Double Density Diskettes

**\$1.20    \$1.00    95¢**

Each In Packs  
of 50

\$1.20 x 50 =  
\$60.00/pack

Each In Packs  
of 250

\$1.00 x 250 =  
\$250.00/pack

Each In Packs  
of 1000

95¢ x 1000 =  
\$950.00/pack

BS50S50 2lbs.

BS50S250 8lbs.

BS50S1000 30lbs.

## Shugart SA604 5Mbyte Hard Disk ST506 Compatible!

BSSHU604

Sh. Wt. 9lbs.

BSSHU604M Manual

**\$99**

\$15.00

Inquiry 285



**PRIORITY **1** ELECTRONICS**

9161 Deering Ave., Chatsworth, CA 91311-5887



**ORDER TOLL FREE (800) 423-5922, Local: (818) 709-5111**

MINIMUM PREPAID ORDER \$25.00. Terms U.S. VISA, MC, BAC, Check, Money Order, U.S. Funds ONLY. CA residents add 6%, 6 1/4%, or 7% Sales Tax, depending on your local rates. Include MINIMUM SHIPPING & HANDLING of \$3.00 for the first 3 lbs., plus 40¢ for each additional pound (20¢ if within California) Plus 25¢ per \$100.00 value of your order for Insurance. Orders over 70 lbs. sent freight collect. Just in case, include your phone number. Prices subject to change without notice. We will do our best to maintain prices through July 1985. Credit card orders will be charged appropriate freight. We are not responsible for typographical errors.

**ORDER TOLL FREE (800) 423-5922 - CA, AK, HI CALL (818) 709-5111**



A word for this Punch/Reader Combo is

**Speed!** Model 510 punches paper tape at 110cps, reads at 150cps. This rugged machine is computer compatible offering RS232C, current loop, parallel inputs. The ASCII-to-Baudot code conversion permits direct keyboard entry for Telex/TWX transmission. Plus: 256 character storage, 75-9600 baud rate, 5-8 level tape, stock ADDMASTER CORP 416 Junipero Serra Dr., San Gabriel, CA 91776 ★ 818/285-1121.

Inquiry 15

## ZENITH/ Heath Users

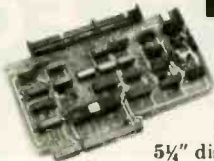

**Double Your  
5 1/4" disk storage  
capacity without adding a drive.**

Get twice as much from your H88 or H89 microcomputer. Our FDC-880H floppy disk controller, in conjunction with your 5 1/4" drives, for example, expands memory capacity from 256 bytes to 512 bytes per sector.

And it handles single and double-sided, single and double-density, 8" and 5 1/4" drives — simultaneously.



C.D.R. Systems Inc.

Controlled Data Recording Systems Inc.  
7210 Clairmont Mesa Blvd., San Diego, CA 92111  
(619) 560-1272

Inquiry 75

## PC/XT USERS!

- COGTREE Utilities by  
Cogitate ..... \$129.95
- LYNC by Norton-Lamber ..... \$199.95
- DATAFLEX by Data Access... *Varies*
- RM/COBOL by Ryan/  
McFarland ..... *Varies*
- Universe by Omnitrend ..... \$ 98.50
- Blue MacI by Cogitate ..... \$599.00
- CadPower+ by Trillex ..... \$995.00
- Softext Teaching Aids ..... \$ 95.00
- PrintSet by Cogitate ..... \$ 79.95
- CogiTAPE by Cogitate ..... CALLII
- Anti-Static Products ..... *Varies*
- Uninterruptible Power  
Backups ..... *Varies*
- TeleVideo Software ..... CALLII

**COGITATE**

"A Higher Form of Software"  
24000 Telegraph Road  
Southfield, MI 48034  
(313) 352-2345/Telex 386581

VISA/MASTERCARD ACCEPTED  
Dealer Inquiries Welcomed

Inquiry 81

## DATA ACQUISITION TO GO INTERFACE FOR ANY COMPUTER



Connects via RS-232. Built-in BASIC. Stand alone capability. Expandable. Battery Option. Basic system: 16 ch. 12 bit A/D, 2 ch. D/A, 32 bit Digital I/O. Expansion boards available. Direct Bus units for many computers.

SPECIALISTS IN PORTABLE APPLICATIONS  
(201) 299-1615

P.O. Box 246, Morris Plains, NJ 07950

**ELEXOR**

Inquiry 137

## Dysan CORPORATION

Solve your disc problems, buy 100% surface tested Dysan diskettes. All orders shipped from stock, within 24 hours. Call toll FREE (800) 235-4137 for prices and information. Visa and Master Card accepted.



**PACIFIC  
EXCHANGES**

100 Foothill Blvd.  
San Luis Obispo, CA  
93401 (In Cal. call  
(805) 543-1037)

Inquiry 272

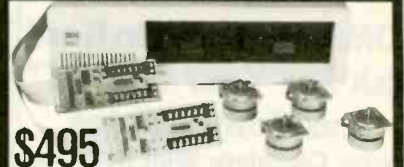

**\$495**

## PCMOTION™ Control Board

IBM PC/XT compatible stepper motor control plug-in board

- 4 Axis stepper motor controller interface
- 32 digital I/O with (5) interrupts
- 4 channels encoder pulse inputs
- Includes real time interrupt-driven easy to use software

Smart board for Industrial and Robotic motion control that uses only a small percentage of cpu time. System needs only simple BASIC commands from application software.

— 100's of satisfied customers  
use our products —  
\*\*\*30-day money back guarantee\*\*\*

**ROGERS LABS** Tel. (714) 751-0442  
Telex 681393  
2727 Crodody Way #E, Santa Ana, CA 92704

Inquiry 304

## Electronic Circuit Analysis

- New release
- Transient, AC, DC analysis
- Full nonlinear
- Over 200 nodes
- Full editing
- Macro circuits
- Worst case, Monte-Carlo
- Temperature effects
- Frequency dependent parts
- Time dependent parts

For MS-DOS. 128k minimum.  
\$395.00

**Tatum Labs**  
P.O. Box 698  
Sandy Hook, CT 06482  
(203) 426-2184

Inquiry 349

## Erases Most Eproms in 3 Minutes



ONLY  
\$34.95

Solid State 2-8 Min.  
Timer Version ..... \$54.95

For all 24 or 28 pin devices—2 at a time  
90 DAY WARRANTY SHIPPING & HANDLING  
DEALERS WELCOME \$2.50  
AZ RESIDENTS  
ADD 6% TAX

**WALLING CO.**

4401 S. JUNIPER • TEMPE, AZ 85282 • (602) 838-1277

Inquiry 376

## SUPERCOPY FOR IBM PC

Powerful utility copier, it allows making of backups of any diskette for IBM PC and compatibles.

Very compact, it replaces the Diskcopy without virtually losing any space. Its menu offers easy access to functions such as protection against copies from a diskette; analysis diagnosis; parameter modification and erasing of the target diskette.

Available in English, French and Spanish with instructions included in the diskette.

Frequently updated, its price is \$30 each or \$15 for orders of ten or more. This product is provided for the purpose of enabling you to make archival copies only.

N.Y. residents add sales tax.  
Send check or money order to:

**Yetiware**  
P.O. Box 1368  
New York, NY 10025  
212-222-6682

IBM PC is a trademark of IBM Corporation.

**WE WANT DEALERS.**

Inquiry 384



# LOWEST PRICES OF THE SUMMER

**COMPUTER CONNECTION**  
TOLL FREE ORDER LINE

## PRINTERS

<b>OKIDATA</b>	
ML182P 120 cps	229
ML182 IBM Graphics Comp	229
ML182S 10" Carriage	279
ML83A, 15" Para. & Ser.	545
ML192P, 160 cps	359
ML192 IBM Graphics Comp	359
ML192S, 160 cps	465
ML193P, 160 cps	579
ML193 IBM Graphics Comp	579
ML193S, 160 cps	599
ML84P, 200 cps	669
ML84 IBM	669
ML84S, 200 cps	769

<b>STAR MICRONICS</b>	
SG-10, 120 cps, 2K buffer	\$ 239
SG-15, 120 cps, 2K buffer	389
RX-100, 160 cps, 10" carriage	369
SD-15, 160 cps, Corr. Qual.	479
SB-10 Draft & NLQ 24 wire printhead	799

<b>EPSON</b>	
LX80, 100 cps, 10" carriage	Call
FX80 +, 160 cps, 10" carriage	Us
RX100, 100 cps, 15" carriage	First
FX100 +, 160 cps, 15" carriage	For
LQ1500 Draft NLQ	Lowest
SQ2000, All New	Prices

<b>C. ITOH</b>	
Prowriter 8510 AP +, 120 cps	\$ 329
Prowriter 8510 SP, 180 cps	399
Prowriter II 1550 P, 15" 120 cps	435
Prowriter II 1550BCD, 15" 120 cps	499
1550 SP, 180 cps	525
Starwriter F10-40PU, 40 cps	949
Printmaster F10-55PU, 55 cps	1029

<b>DYNAX</b>	
DX15XL, 20 cps By Brother	\$ 379

<b>JUKI</b>	
6100, L.Q. 18 cps w/proportional spc.	\$ 379
6300	689

<b>TOSHIBA</b>	
P1340 P	\$ 595
P1340 S	595
P351 P, Faster than 1351	1275
P351 P/S, Faster and More Versatile	1325

<b>PANASONIC</b>	
1091 w/Tractor, 120 cps, 1 yr. war.	\$ 279
1092	439
1093	669

<b>HARD DISK DRIVES</b>	
<b>RODIME</b>	
10 Meg w/Cont., 1 yr. warr.	\$ 650

<b>SEAGATE</b>	
10 Meg w/Cont., 1 yr. warr.	\$ 679

<b>ALPHA OMEGA</b>	
10 Meg w/Controller Card	\$ 699
20 Meg w/Controller Card	1099
33 Meg w/Controller Card	1395

<b>DISK DRIVES</b>	
<b>TANDON</b>	
TM100-2 for IBM PC	\$ 95

<b>QUME</b>	
1/2 Ht. ds/dd 360K, 100% IBM Comp.	\$ 85

<b>TEAC</b>	
55B Double Sided 360K	\$ 99
Quad Density	159

<b>Drives For Apple &amp; Franklin</b>	
<b>MICRO-SCI</b>	
A-2	\$ 169
A.5C for IIc w/cable	179
A.5 1/2 height for IIE	189
Controller Add	55

## PRINTER ACCESSORIES

<b>ORANGE MICRO</b>	
Grappier +	\$ 85
Buffered Grappier +, 16K exp. 64K	155

<b>TOSHIBA</b>	
Bi-Directional Trac. 1351/351	\$ 149/155
Font Disk for Down loading P1351	50

<b>MICROTEK</b>	
Dumpling GX (same as Grappier +)	\$ 69
Dumpling GX w/16K buffer	135
Dumpling GX w/32K buffer	147
Additional Buffering 16K	12

<b>FOURTH DIMENSION</b>	
Par. Card & Cable for Apple	\$ 47

<b>OKIDATA</b>	
Plug and Play for IBM	\$ 49
Tractor for 82A & 92	49

<b>JUKI</b>	
Bi-Direc. Tractor for 6100/6300	\$ 125/135
Serial Interface	65

## DISPLAY MONITORS

<b>QUADRAM</b>	
Amber chrome IBM compatible	\$ 165

<b>AMDEK</b>	
V300G	\$ 125
V300A	135
V310A for IBM PC	159
Color 500 Color Composite	339
Color 600 RGB Hi-Res	429
Color 710 Super Hi-Res	545

<b>TAXAN</b>	
IBM Green Monochrome #121	\$ 129
IBM Amber Monochrome #122	139
RGB IBM w/Cable RGB Comp.	429
RGB Super Hi-Res. #415	499
RGB Super Hi-Res. #440 Best Buy	499
RGB/Comp. Med. Res. #210	259

<b>PRINCETON GRAPHICS</b>	
HX-12 for use with IBM PC	\$ 445
Max 12E Amber for IBM	179
SR 12 Super Hi-Res	565
Scan Doubler	185

<b>X-TRON</b>	
AG-12, 1000 x 450 Hi-Res w/tlt. swvl.	\$ 130
AA-12, 1000 x 450 Hi-Res w/IL swvl.	135

## FIRECRACKER SPECIALS!!

<b>IBM PC</b>	<b>COMPAQ DESK TOP</b>
• 256K of Memory	• One Drive
• Two 1/2 Height Drives	• 256K of Memory w/Par. Port
• Color Graphics Card	• 10 Meg Hard Disk
• Taxan Green Monitor	• Taxan Green or Amber
<b>\$1750</b>	<b>\$2450</b>

<b>IBM PC XT</b>	<b>COMPAQ DESK TOP</b>
• 256K of Memory	• 640K of Memory
• One IBM Floppy	• Two Disk Drives
• 10 Meg. Hard Disk	• 10 Meg Hard Disk
• Color Card	• Taxan Green or Amber
• Taxan #425 RGB Hi-Res & Comp. Gt.	• Epson LX80 w/Cable
<b>\$3190</b>	<b>\$2995</b>

**"THE COMPANY THAT DELIVERS"**

## IBM PC ACCESSORIES

<b>IBM</b>	
IBM Dos 3.0	\$ 69
Tech Ref. for Dos 2.1 or 3.0	69

<b>PARADISE</b>	
Modular Graphics Card	\$ 269
Module A	79
Module B	120
S-Pak	165

<b>64K MEMORY UPGRADE</b>	
64K (8 chips) 200ns	\$ 14

<b>PERSYST BOARD</b>	
Bob Hi-Res Display Adaptor.	\$ 389

<b>QUADRAM</b>	
Quad Color 1 Board	\$ 199
Exp. Quadboard w/64K & Game Port	239
QuadLink 3000 Run Apple sft on IBM	349

## APPLE & FRANKLIN ACCESSORIES

<b>ACCESSORIES</b>	
Kensington System Saver	\$ 69
Fan for Apple II & IIE w/surge	37

<b>MICROTEK</b>	
Serial Interface	\$ 75

<b>MICROMAX</b>	
Viewmax 128K extended 80 col. card for Apple IIE w/64K	\$ 124
80 col. card for Apple II & II +	139

<b>ADVANCED LOGIC SYSTEMS</b>	
Z Engine 2.2	\$ 119

<b>APPLE</b>	
Super Serial Card	\$ 135

<b>ASTAR</b>	
RF Modulator	\$ 17

<b>MICRO-SCI</b>	
64K, 80 Col. Card	\$ 85

## We Stock What We Sell!!

IF YOU SEE IT ADVERTISED FOR LESS, CALL COMPUTER CONNECTION FIRST FOR LOWEST QUOTE!

**MAIL ORDER:**  
17121 S. Central Avenue, Unit L  
Carson, California 90746



NO SURCHARGE FOR CREDIT CARDS

We accept VISA, MasterCard, COO (w/Deposit), Certified Checks or Wire Transfers. Minimum Shipping Charge \$4.00. Some items subject to back order. California Res. add 8 1/2% Sales Tax. All returns are subject to a 15% restocking charge and must be authorized by store manager within 10 days. Prices subject to change without notice. This Ad supersedes all others.

## PERSONAL SYSTEMS

<b>APPLE</b>	
Professional Sys. incl: Apple IIE w/128K & 80 col., tilt mon., duo disk w/con't kit	\$1345
Apple IIc Lightweight Portable	Call

<b>IBM</b>	
IBM PC Bare w/cont. & keyboard	\$1345
IBM PC 64K, 1 Drive	1475
IBM PC, 2 Drives w/256K	1599
IBM XT, 10 Meg., 360K Dr. w/256	2795
IBM XT Bare w/256K & IBM Floppy	2095

<b>Call About All "AT" Systems</b>	
<b>SANYO</b>	
MBC 550-2 w/1 320K Drive & sftwr.	\$ 750
MBC 555-2 w/2 320K Drives & more software	990
Portable	Call
Serial Port for Sanyo	79

<b>COMPAQ</b>	
256K, w/2- 320K Drives	\$1975
Desk Top Model 1	1725
Desk Top Model 2	2150
Desk Top Model 3	3795
Desk Top Model 4	4495

<b>WYSE</b>	
1100-1 Incl. 256K w/two 360K Drives, 1 par & 2 ser. ports	\$1399
1100-2 Incl. 10 meg, 1 floppy, 256K, 1 par. & 2 ser. ports	2599

<b>SOFTWARE</b>	
<b>LOTUS DEVELOPMENT CORP.</b>	
Lotus 1-2-3	\$ 295
Symphony	437

<b>ASHTON TATE</b>	
D Base II	\$ 329
D Base III	419

<b>PRINTER SWITCH BOX</b>	
<b>EXPONENT</b>	
Centronics Two Switch	\$ 84
Centronics Four Switch	110
Serial Two Switch	75

<b>MODEMS</b>	
<b>ANCHOR</b>	
Mark XII	\$ 219
Volkmodem XII	185
Anchor Express	Call

<b>HAYES MICRO</b>	
300 Baud Smart Modem	\$ 189
1200 Baud Smart Modem	389
1200 B for IBM PC w/SM II	379
2400 Baud Modem	645
Micro Modem IIE	259
Chronograph	189
300 For Apple IIc w/Sftwr	Call

<b>DISKETTES</b>	
<b>PC DISKETTES</b>	
Sgl./Dbl. (Box of 10)	\$ 16
Dbl./Dbl. (Box of 10)	18

<b>COMPUTER CONNECTION</b>	
Dbl./Dbl. (Box of 10)	\$ 16
Sgl./Dbl. w/Disk Container (10)	20
Dbl./Dbl. w/Disk Container	20
Bulk 50 & Up - Dbl./Dbl.	1.35 ea.
5 yr. warranty	

## ORDER LINE (800) 732-0304

(Outside California) [213] 635-2809

(Inside California) Mon.-Fri. 7 a.m. to 6 p.m. Saturday 11 a.m. to 3 p.m.

**CUSTOMER SERVICE:**  
[213] 635-5065  
Mon.-Fri. 9 a.m. to 3 p.m.

**COMPUTER CONNECTION**



## Computer Systems

Please call w/ your System Requirements so that we may quote the configuration that best fits your needs.

**CROMEMCO 10MHz 68000 UNIX-5 Systems**  
CS-100H50X20E 2Mb ECC RAM 50Mb H.D. \$13,849

**INTERCONTINENTAL MICRO SYSTEMS 12 User Hi-Speed 16 Bit System.** Includes 1Mb Automatic Cache Buffer, Dual 8" Floppies, 25Mb Fixed and 25Mb Removable Hard Disk (Complete Back-Up in 5-Min.) 256K Ram Per User, Turbosdos 1.41, NewWord Word Processor, w/Spelling Checker & Merge Print \$18,995

**MORROW MD3, MD770 & HR15-XL Printer** \$1,595  
**MORROW MD5, MD770 & HR15-XL Printer** \$2,125  
**MORROW MD11, MD770 & HR15-XL Printer** \$2,295  
**MORROW PIVOT I & II 11.5 LB** Portable W/4 HR Battery IBM Compatibility, Expansion Capability, S/W & More  
**Call For Our Dual Drive Lumicon Screen Special!**

**MOTOROLA 16 User MEGAFRAME** with Parallel Processing, UNIX System 5 & VAX 750 PWR. CALL  
**PC-100 S-100's PC COMPAT.** with Dual 5 1/4" DRVS., P.S. & G Ports, Clock-Cal/Batt. 8 Slots, Mono. Video CTRL, 256K RAM, MS-DOS 2.1 & NewWord Word Proc. Merge-Print & Spell Check \$1,299 W/10Mb H.D. \$1,749  
**VIASYN 816/C-H40 w/ 5 1/4"x8" FLPY'S** \$6,795  
**VIASYN 816/10-H40 w/ Two 5 1/4" FLPY'S** \$5,395  
**CALL FOR OTHER SYSTEM CONFIGURATIONS**  
**ZENITH 150-PC COMPATIBLE SEE PAGE** 397

## S-100 Bus Boards

If you purchased before calling us, you probably paid too much! We stock ACKERMAN DIGITAL, ADVANCED DIGITAL, CCS, COMPUPRO/VIASYN, CROMEMCO, ELECTROLOGICS, HUDSON, INTERCONTINENTAL MICRO SYSTEM, KONAN, MORROW, MULLEN COMPUTER, NORTH STAR, PICKLES & TROUT, SYNTech DATA, TARBELL, TECMAR, TRANSEND  
A Few Of This Month's SPECIALS Are:

**COMPUPRO/VIASYN RAM 22, 256K STATIC** \$779  
**COMPUPRO/VIASYN RAM 23, 128K STATIC** \$415  
**DUAL NEW BOARD SPECIALS** CALL  
**MACROTECH 256-ST STATIC RAM** \$850  
**MACROTECH 512-ST STATIC RAM** \$1,650  
**MACROTECH ADIT-4** From 4 to 16 INTELLIGENT SERIAL I/O Board FROM \$699  
**MACROTECH MI-286 80286/280H DUAL PROC.** \$799  
**MACROTECH MSR-II 1Mb DYNAMIC RAM** \$1,165  
**SYNTech DATA SYS - 40% OFF PRESENT STOCK**

## PC-Slave Boards

**ADVANCED DIGITAL PC-SLAVE W/256K, 8 MHz 8088 CPU, 2 S Ports, RTNX S/W-For Multi-User PC** \$595  
**ALLOY PC-SLAVE/16 256K to 768K RAM** CALL

## PC-Multifunction Boards

We Have a Good Selection of Multifunction and Memory Boards for PC, XT, AT, JR, AT & T, and PC Portables

**STB BIG BYTE 384K** \$210  
**STB GRANDE BYTE/PC-AT 2.5Mb** \$789  
**STB RIO GRANDE/PC-AT 1.5Mb, 2 S, P, & G** \$659  
**STB RIO PLUS II/PC & XT 384K** \$299  
**TECMAR CAPTAIN 384K w/Treasure Chest** \$220  
**TECMAR JR. CAPTAIN 128K w/Treasure Chest** \$289  
**TECMAR EXPANSION CHASSIS With 8 Slots** \$675  
**TECMAR MAESTRO 2.5Mb** \$695  
**TECMAR WAVE 256K Fits XT Short Slot** \$209

## PC-Video/Graphics Boards

**STB GRAPHICS PLUS II W/ Paral. PRT Port** \$240  
**STB MONO PLUS II w/ Paral. PRT. Port** \$155  
**STB SUPER RES 400 16 Color Hi-Res** \$359  
**TECMAR GRAPHICS MASTER 16 Color Hi-Res** \$439  
**TECMAR GRAPHICS TENDER RGB/PRT. PORT** \$189

## PC-Scientific/Industrial Boards

**TECMAR BASE BOARD 96 Digital I/O Lines** \$219  
**TECMAR DADIO D to A Up to 24 Devices** \$249  
**TECMAR E+EPPROM PROGRAMMER/READER** \$319  
**TECMAR E+EPPROM EXPANSION 192K Ext.** \$379  
**TECMAR E+EPPROM SOFTWARE** \$65  
**TECMAR IEEE-488 Board** \$249  
**TECMAR LABMASTER w/ TM40 PGL Option** \$865  
**TECMAR VIDEO VAN GOGH with Software to Digitize TV Images** \$275

## PC-Data Security

**WESTERN DIGITAL WD200 w/ Incrypt-Decrypt S/W - Absolute Security For Stored or Transmitted Files.** Can Be User Transparent & Automatic. \$139

## Floppy Disk Drives

**MITSUBISHI 2894 STD. HT. 8" DSDD** \$395  
**MITSUBISHI 2895 HALF HT. 8" DSDD** \$369  
**MITSUBISHI 4853 HALF HT. 5 1/4" 96TPI DSDD** 139  
**TANDON 100-2A IBM-PC Compatible** \$115  
**TEAC FD55B & MITSUBISHI 4851 5 1/4" 1/2HT.** \$95

## Hard Disk Subsystems

**ALLOY, ACMODYNE, MAXTOR, MICROPOLIS, MITSUBISHI, QUANTUM, RODIME, TANDON and TEAC Drives.** SEE PAGE 86

## Modems

**HAYES SMART MODEM 2400, RS-232** \$449  
**HAYES SMART MODEM 2400, Universal** \$669  
**PRENTICE POPCOM w/ PFS Access C150/X150** \$315  
**PROMETHEUS PROMODEM 1200 Hayes Compatible w/ Built-in PWR Supply-RS232 Stand Alone Unit** \$289

**OPTIONS FOR PROMODEM 1200 ARE:**  
**OPTION: PROCESSOR** \$75  
**OPTION: 64K MEMORY** \$35  
**OPTION: ALPHANUMERIC DISPLAY** \$79  
**PROMETHEUS 1200A Apple II, II+, IIe Card w/Terminal Software In ROM** \$295  
**PROMETHEUS 1200 B/PC w/ PROCOM S/W** \$265  
**PROMETHEUS 1200M MAC-PAC w/ Software** \$329  
**U.S. ROBOTICS PASSWORD 1200** CALL  
**U.S. ROBOTICS AUTO DIAL 212A** CALL  
**U.S. ROBOTICS S-100 BOARD 300/1200** \$295  
**U.S. ROBOTICS PC MODEM w/Telpac Software** \$249  
**U.S. ROBOTICS PC-MODEM With Clock-Cal./Battery, Printer Port, 256K & Telpac** \$459

## Monitors & Terminals

**TATUNG CM-1322 640X200 RGB-SATISFACTION GUAR.** It Puts Competition to Shame! \$395  
**TATUNG CM-1360 640X200 RGB W/GRN & AMB Switch PLEASE ASK ABOUT OUR "HOT SPARES"**  
**LOANER POLICY** \$419  
**TATUNG CM-1370 720X480 RGB w/GRN Switch Long Persist Phos. Works w/ STB's SUPER RES 400** \$499  
**TATUNG MM-1222G/A Hi-Res 12" TTL (IBM)** \$119/125  
**TATUNG DM-12VLG/A Hi-Res 12" Compos.** \$119/125

**TAXAN MONITORS** Call for Low Prices  
**TECMAR 640X480 RGB, GRN Switch Long Phos** \$519  
**ZENITH ZVM123A (GRN) 122A (AMB)** \$85/\$89  
**ZENITH ZVM135 HI-RES RGB w/ Green Switch** \$449  
**KIMTRON KT-7/PC Emulating Terminal** CALL  
**LIBERTY TERMINALS w/Variable Scrolling, Green, Amber, 14", DEC Compatibility Extra Pages of Memory, and Graphics Options In Stock at Unbeatable Prices.**

**LINK 125 WYSE50 Compat. 14" GRN or AMB** CALL  
**LINK 125/PC w/PC Emulating Video & Keyboard** CALL  
**WYSE 50/75 TERMINALS In Stock** \$469/\$639  
**ZENITH Z29/Z49 TERMINALS** \$619/\$849

## Printers & Plotters

**BROTHER HR-10 12CPS Daisy w/ TRAC., S&P** \$299  
**BROTHER HR-15-XL 17CPS Daisywheel S or P** \$359  
**BROTHER HR-35 36 CPS Daisywheel S or P** \$699  
**BROTHER M1009 50CPS Dot Matrix 8.6 Lbs.** \$195  
**CITIZEN MSP-25 200/50 CPS 15" ULTRA QUIET** \$599  
**COMREX 425 420 CPS DATA to 107CPS NLO** CALL  
**EPSON LX80, RX100+, FX80+, FX100+, LQ1500** CALL  
**HOUSTON INST. PLOTTERS & DIGITIZERS** CALL  
**NEC DATASOUTH DIABLO** Available Upon Request  
**OKIDATA New 182 Quiet 120 CPS & 60 CPS** CALL  
**We Also Stock OKIDATA 92, 93 & Accessories** CALL  
**TEXAS INSTRUMENTS 800 SERIES** CALL

## Printer Buffers

**JOHNATHON FREEMAN UPB 64K FORMERLY TTX In and/or Out Serial and/or Parallel** \$169  
**PRACTICAL PERIPH. MICROBUFFER 64K** CALL

## Testing Devices & Software

**DATACOM TRI-STATE RS232 V.24 Breakout** \$175  
**DYSAN Floppy Analyzers** CALL  
**FLUKE 77 DVMM w/ Holster** \$119  
**RID-DYMEK FLPY DRV DIAGNOSTIC DISKETTE** \$25

## Diskettes & Cartridges

**3M TAPE CARTRIDGES 300XL & 600A In Stock** \$29.95  
**DYSAN DISKETTES** Low Prices From \$19.50  
**DYSAN Hard Disk Cartridges 5 1/4" & 8"** \$99/\$150  
**FUJI FILM FLOPPY DISKS** Low Prices From \$16.50

## Networking & Switch Boxes

**GILTRONIX MANUAL AND AUTOMATIC SWITCHING UNITS** to Fit all of Your SHARED Printer, Terminal, Modem, and Other Peripheral Needs. From \$79  
**INTERCONT. MICRO SYS. LAN-PC w/o RAM** \$469  
**INTERCONT. MICRO SYSTEMS LANS-100** \$359

## Software

We Have Access to all Well Known Brands - ORDER CORRECTLY -- SOFTWARE IS NOT RETURNABLE!

## Accounting

**CORE SOFTWARE'S FASTRAK: A DATA FLEX Application** for All Your Accounting Needs Supporting All Popular Networks & Operating Systems CALL

## Spreadsheets & Integrated Pkgs.

**ASHTON-TATE Framework** CALL  
**LOTUS 1-2-3/SYMPHONY** \$299/\$429  
**MOBS KnowledgeMan** \$319  
**MICROSOFT Multiplan** \$129  
**PFS Plan** CALL  
**SORCIM Supercalc-3 Better Than 1-2-3!!!** \$209

## Operating Systems & Utilities

**BORLAND SideKick Windows & Calculator** CALL  
**COMPUPRO/VIASYN CPM** at Affordable Prices  
**CROMEMCO COMPLETE LINE** at GOOD ECONOMIES  
**DIGITAL RESEARCH** Complete Line up to 35% Off

## Language And Tools

**BD SOFTWARE "C" Compiler 8" SS SD 8 BIT** \$95  
**COMPUTER INNOVATIONS C-86 "C" Compiler** \$299  
**COMPUVIEW Vedit-86/Vedit-MSDOS** \$150/\$120  
**DIGITAL RESEARCH Most Products in Stock** CALL  
**LATTICE "C" Compiler (Ask About Options)** \$299  
**MICROSOFT Complete Line** CALL

## Data Base Managers

**ASHTON-TATE dBase II & III** \$275/\$375  
**DATA ACCESS Dataflex Multi-User** BEST PRICE  
**PFS File/Report** CALL

## Graphics And CAD

**DIGITAL RESEARCH DR. GRAPH AND DRAW** \$189  
**MICROPRO CHARTSTAR** CALL  
**PFS Graph** CALL  
**VECTRIX Graphics Systems Utilize 9 Bit Planes and have 384K RAM to Operate Independently of Host Video Controller and RAM Memory**

**VECTRIX VX/PCA 512 Colors/Palette of 4,096** \$1,995  
**VECTRIX VX384A Stand Alone RS232 Co-proc.** \$3,395  
**VECTRIX VX1301 13" RGB Analog Monitor** \$1,295  
**VECTRIX VX1901 19" RGB Analog Monitor** CALL  
**VECTRIX VX/PCB 512 Col./Pall. of 16,800,000** \$2,595  
**VECTRIX VXTB 11"x11" Graphics Tablet** \$895

## Communications

**MYCROFT LABS MITE AND MITE Plus** From \$79  
**MICROSTUF CROSS TALK XV** \$98  
**PFS Access** CALL

## Word Processors

**MICROPRO WORDSTAR, Etc.** CALL  
**NEWSTAR NEWWORD w/ Money Back Guar.** \$129  
**OASIS THE WORD PLUS Spell Check, CP/M86** \$89  
**PFS WRITE/PROOF** CALL/CALL

## Power Solutions

**SAFT SPS1000VA/SINE 1mSec Switch** CALL  
**SOLA MINI UPS 750 Watt Sine Wave HIGH INRUSH (4500 Watt) 100% Batt. Op. w/o Switch-Over** CALL  
**TRIPPLITE BC-425-FC 425 Watts 15-20 Minutes** \$449  
**TRIPPLITE ISOBAR Line Suppressor-Filters from 40**  
**TRIPPLITE SB-1000 Watt w/80 Amp/Hr. Battery** \$695

## Mainframe & Drive Enclosures

**INTEGRAND 1100 7 Slots and 2 X 8" Drives** \$475  
**JMR 1HS 5 1/4" H.D. Cabinet** \$189  
**MESA POWER SYSTEMS 5401 5 1/4" Hard Disk** \$209  
**MICROWARE 511001 Dual Hor. 1/2 Ht 5 1/4" FLPY** \$75  
**PARA DYNAMICS 3820S PRONTO** \$1,150

## Chips

We Have Some of the LOWEST PRICES in the Nation!!  
**64K, 256K, 8087 & 80287** CALL

**FULL DEALER SUPPORT**  
**VISIT OUR SHOWROOM**  
**HRS. 8:30 AM - 5:00 PM M-F**

All merchandise new. Advertised prices are cash prepaid only. MC, Visa & P.O.'s from qualified firms - add 3%. Wires, COD's (\$5 min. fee) with Cashiers Check/M.O. & APO's accepted. Shipping minimum \$4 first 3 lbs. Tax: AZ RES ONLY add 6% sales tax. All returns subject to 20% restocking fee. Retail prices slightly higher.



**5 Year Warranty**  
**SAVE 50% ON**  
**Verbatim Datalife**  
**Diskettes**

**SPECIAL DISKETTE OFFER**  
 Verbatim Datalife Disks have 6 data-shielding improvements for greater disk durability and longer data life.

**PLUS!** If you call, write, or utilize reader service in response to this ad—we'll send you our full-range catalog of computer supplies with Special Offers good for further savings on Verbatim diskettes and many other quality products.

Call or write for our discount catalog.  
**LYBEN COMPUTER SYSTEMS**  
 1250-E Rankin Dr., Troy, MI 48083  
 Phone: (313) 589-3440

**DATALIFE • THE NAME IS THE PROMISE**  
**THE WARRANTY IS THE PROOF**

Inquiry 217

**DATAMASTER™**  
**One-of-A-kind Data Management Program**  
**Developed Especially**  
**for You.**  
**\$175.00**



STOP thinking about any other programs  
 STOP worrying about custom programming  
 START saving time and money  
 START being your own MASTER

California (800) 423-0320  
 Outside (800) 482-DATA

**C.D.A. INTERNATIONAL SOFTWARE CORP.**  
 (818) 986-3233 Telex: 215666

Inquiry 74

**Macintosh™**



**512K**  
**\$1995**

Macintosh is a trademark licensed to Apple Computer, Inc.

Call for prices on other Macintosh products.

**PC'S LIMITED**  
 OUTSIDE TEXAS, ORDERS ONLY, CALL 1-800-426-5150.  
 7801 N. Lamar, #E-200, Austin, Texas 78753  
 All calls for technical support and inside Texas, call (512) 452-0723.  
 Ad number 407 A

Call technical support for return authorized number on all warranty repairs. Any unauthorized repairs subject to a 10% restocking fee. No surcharge for VISA or MasterCard. 5% surcharge for American Express.

Inquiry 278

**I.B.M. Compatible**

Case \$ 65.00  
 Motherboard (256K RAM space, RAM not included) 280.00  
 Color Graphic Adapter 150.00  
 Floppy Disk Driver Controller Card 75.00  
 Plotter (4 colors) 495.00  
 Computer (2 DD Drivers, Color Graphic Adapter, 256K RAM Case, Keyboard and 135 W Power Supply) 1,500.00  
 Keyboard 100.00

**APPLE Compatible**

Z 80 Card 40.00  
 80 Column Card 50.00  
 I.C. Tester 125.00  
 Pal Writer Card 299.00  
 Graphic Pad Card (includes graphic program) 220.00  
 Prom 8200 Programmer (Fast Universal Type Eeprom & Prom Programmer)  
 For Eeprom: 2716-27512; 2516-25512; (No Adapter Needed)  
 For Prom: 63xx, 745xx, 145xx, 185xx, 245xx, 285xx, 825xx, 875xx,  
 Include RS232 Interface IC's Available

CALL NOW (312) 280-7610  
 Telex 280208 HFFMM INT CGO  
 DIST. WANTED  
**HOFFMAN INT'L**  
 600 N McClurg Ct. Ste. 309A  
 Chicago, Illinois 60611

Inquiry 170

**DATA BROKERS**  
**1-800-833-2600**  
 in Ohio (513) 561-0099  
**FREE SHIPPING**  
**NO EXTRA CHARGES!**

Hayes Compatible  
**MODEMS**

HAYES 1200 \$399  
 HAYES 1200B \$379  
 VOLKSMODEM 1200 \$189  
 ANCHOR MARK XII \$225  
 MARK X 300 \$ 99  
 PASSWORD 1200 \$229  
 COURIER 2400 \$479  
 CERMETEK 1200 \$439  
 CERMETEK 1200PC \$349  
 CERMETEK 2400 \$489  
 CERMETEK SECURITY \$599

3535 Roundbottom Rd. Cinti., OH 45244

Inquiry 118

**Osborne**

As available only! Very limited quantity.

Important: Always call to check availability before ordering.	To fix yourself, or for parts. Complete, but known not working.	Guaranteed for 30 days. May be new or rebuilt, depending on availability. Exch./Repair	Outright
Main Board OS-1	\$49	\$79	\$159
Main Board Exec.	\$159	\$139	\$299
Battery Pack, 40 Watt	—	—	\$49
Double Density Kit **	—	—	\$79
** Includes board, cable, documentation & disk.			
5" CRT (Grn/White)	\$9.95	\$19	\$29
7" CRT (Amber)	\$19	\$49	\$99
15" CRT, no case	—	—	\$85
Drive Analog Card	\$9.95	\$29	\$59
Drive Mechanism	—	\$25	\$59
Power Supply	\$4.95	\$24	\$29
Keyboard (No enclos.)	\$19	—	\$99

Shipping charged on all orders  
 Computer Parts Mart 415-493-5930  
 3200 Park Blvd \* Palo Alto \* CA 94306

Inquiry 403

Serial ← ■■■■■■■■ → Parallel

**NEW!**



**Convert What You Have To What You Want!**

- \* RS232 Serial
- \* 8 Baud Rates
- \* Latched Outputs
- \* Centronics Parallel
- \* Handshake Signals
- \* Compact 3 1/2 x 4 1/2 x 1 1/2

No longer will your peripheral choices be limited by the type of port you have available! Our new High Performance 700 Series Converters provide the missing link. Based on the latest in CMOS technology, these units feature full baud rate selection to 19.2K, with handshake signals to maximize transfer efficiency. Detailed documentation allows simplified installation. Order the Model 770 (Ser/Par) or Model 775 (Par/Ser) Today!

only \$89.95  
 Connector Option \$10.00  
 CA Residents 6% Tax  
 UPS Shipping \$3.00

Buffer Products Coming Soon

**Tigertronics**  
 2734-C Johnson Dr.  
 Post Office Box 3717  
 Ventura, California 93006

CALL (805) 658-7466 or 658-7467  
 For FAST Delivery

Inquiry 140

**DATAFLEX™**

- Multi-user Database!
- Powerful!
- Multiple Operating System Compatibility!
- Attractive Dealer Pricing!
- Full Dealer Support!

Dataflex is a trademark of Data Access  
 Dealer Inquiries Invited

**COGITATE**

24000 Telegraph Road  
 Southfield, Michigan 48034 USA  
 (313) 352-2345

Inquiry 82

**PAL, EPROM PROGRAMMERS & UV ERASERS**  
**FROM \$49.95**

**LOGICAL DEVICES INC.**

Where Reliability and Customer Support is of utmost Importance

SEE OUR AD ON PAGE 328

**LOGICAL**

ORDER TOLL FREE  
**1-800-EEL-PROM**  
 (1-800-331-7766)

Inquiry 215

# Announcing 4 New Collector Edition

# BYTE COVERS

The 4 Byte covers shown below are the newest additions to the Collector Edition Byte Cover series. Each full color print is 11" x 14", including a 1/2" border, and is part of an edition strictly limited to 1,000 prints. Each print is a faithful reproduction of the original Byte painting, printed on museum quality acid free paper, and is personally inspected, signed and numbered by the artist, Robert Tinney. A Certificate of Authenticity accompanies each print.

Collector Edition Prints are carefully packaged flat to avoid bending, and are shipped first class within one week of receipt of order. The price of each print is \$30. All 4 prints are available for only \$100.

Other Collector Edition Byte Covers are also available from Robert Tinney Graphics. For a color brochure, or to order one or more of the prints shown, please check the appropriate box in the coupon below.



#25 Computers and the Handicapped \$30

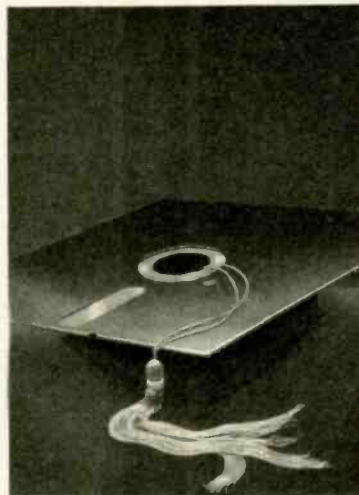

#26 Graduation Memories \$30



#27 The Keys to Education \$30

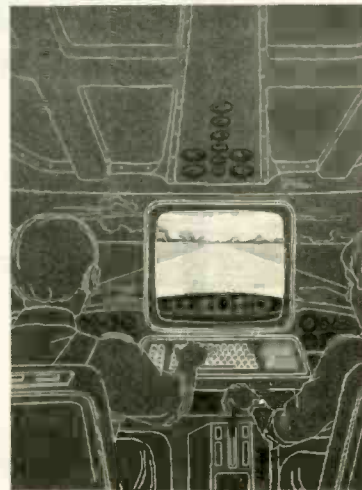

#28 Simulation \$30

Please send me the following Prints (\$30). All 4 only \$100.

QTY.	TITLE & PRINT NO.	AMOUNT
_____	_____	\$ _____
_____	_____	\$ _____
_____	_____	\$ _____
postage & handling \$3.00 (Overseas \$8.00)		\$ _____
<b>TOTAL \$</b>		_____

Please send me your color brochure.

I have enclosed check or money order.

Visa  MasterCard

Card No. \_\_\_\_\_

Exp. Date: \_\_\_\_\_

SHIP MY PRINTS (OR BROCHURE) TO:

Name: \_\_\_\_\_

Address: \_\_\_\_\_

City: \_\_\_\_\_

State: \_\_\_\_\_ Zip: \_\_\_\_\_

Mail this coupon to:

**robert tinney graphics**

1864 N. Pamela Drive

Baton Rouge, LA

70815

**FOR VISA OR MASTERCARD ORDERS**  
or for more information  
**CALL 1-504-272-7266**  
Daytime or Evenings

# DoKay

COMPUTER  
PRODUCTS,  
Inc.

ORDER TOLL FREE

(800)  
538-8800

(CALIFORNIA RESIDENTS)

(800)  
848-8008



### STATIC RAMS

2101	256 x 4	450ns	1.90
2102	1K x 1	450ns	.79
2102L-4	1K x 1	450ns	.89
2102L-2	1K x 1	250ns	1.29
2111	256 x 4	450ns	2.29
2112	256 x 4	450ns	2.29
2114	1K x 4	450ns	.99
2114-25	1K x 4	250ns	1.10
2114L-4	1K x 4	450ns	1.20
2114L-3	1K x 4	300ns	1.30
2114L-2	1K x 4	200ns	1.40
2147	4K x 1	55ns	3.95
5101	256 x 4	450ns	3.90
TMS4044-4	4K x 1	450ns	2.95
TMS4044-3	4K x 1	300ns	3.45
TMS4044-2	4K x 1	200ns	3.95
NK4118	1K x 8	250ns	8.95
TMM2016-20	2K x 8	200ns	2.49
TMM2016-15	2K x 8	150ns	2.99
TMM2016-10	2K x 8	100ns	4.49
HM5118-4	2K x 8	200ns	CMOS 2.49
HM5118-3	2K x 8	150ns	CMOS 2.99
HM5118-2	2K x 8	120ns	CMOS 5.49
HM5118LP-4	2K x 8	200ns	CMOS 2.99
HM5118LP-3	2K x 8	150ns	CMOS 3.49
HM5118LP-2	2K x 8	120ns	CMOS 6.49
Z-8132	4K x 8	300ns	CMOS 29.95
HM6284P-15	8K x 8	150ns	CMOS 7.95
HM6284LP-15	8K x 8	150ns	CMOS 8.95
HM6284LP-12	8K x 8	120ns	CMOS 10.95

### DYNAMIC RAMS

TMS4027	4K x 1	250ns	1.45
UP0411	4K x 1	300ns	1.95
HM5280	4K x 1	300ns	1.95
NK4108	8K x 1	200ns	1.49
HM5298	8K x 1	250ns	.49
4118-20	16K x 1	200ns	.79
4118-15	16K x 1	150ns	.99
4118-12	16K x 1	120ns	1.49
2118	18K x 1	150ns	5v 3.95
4164-25	64K x 1	250ns	5v 1.50
4184-20	64K x 1	200ns	5v 1.75
4164-15	64K x 1	150ns	5v 2.00
41256-20	256 x 1	200ns	7.95
41256-15	256 x 1	150ns	8.95

### EPROMS

1702	256 x 8	1 wa	3.95
2708	1K x 8	450ns	2.49
2758	1K x 8	450ns	5.90
2716	2K x 8	450ns	5v 2.95
2718-1	2K x 8	350ns	3.95
TMS2716	2K x 8	450ns	5v 3.95
TMS2716	2K x 8	450ns	8.95
TMS2732	4K x 8	450ns	5v 3.95
2732	4K x 8	450ns	5v 3.95
2732 A-4	4K x 8	450ns	21v 3.95
2732 A-35	4K x 8	350ns	21v 3.95
2732 A	4K x 8	250ns	21v 5.95
2732 A-2	4K x 8	200ns	21v 8.95
2784	8K x 8	450ns	5v 4.25
2784-25	8K x 8	250ns	5v 4.95
2784-20	8K x 1	200ns	5v 7.95
TMS2564	8K x 8	450ns	5v 9.95
MC68764	8K x 8	450ns	5v 17.95
MC68766	8K x 8	350ns	5v 10.95
27128-45	16K x 8	250ns	5v 8.95
27128-30	16K x 8	300ns	5v 9.95
27128-25	16K x 8	250ns	5v 10.95
27256-25	32K x 8	250ns	14v 24.95

### 74LS00

74LS00	.23	74LS125	.48	74LS260	.58
74LS01	.24	74LS128	.48	74LS268	.54
74LS02	.24	74LS132	.58	74LS273	1.45
74LS03	.24	74LS133	.58	74LS275	3.30
74LS04	.23	74LS138	.38	74LS279	.48
74LS05	.24	74LS137	.98	74LS280	1.95
74LS08	.27	74LS138	.54	74LS283	.68
74LS09	.28	74LS139	.54	74LS290	.88
74LS10	.24	74LS145	1.15	74LS293	.88
74LS11	.34	74LS147	2.45	74LS295	.98
74LS12	.34	74LS148	1.30	74LS298	.88
74LS13	.44	74LS151	.54	74LS299	1.70
74LS14	.58	74LS153	.54	74LS323	3.45
74LS15	.34	74LS154	1.85	74LS324	1.70
74LS20	.24	74LS155	.88	74LS352	1.25
74LS21	.28	74LS156	.88	74LS353	1.25
74LS22	.24	74LS157	.64	74LS363	1.30
74LS26	.28	74LS158	.58	74LS364	1.90
74LS27	.28	74LS160	.88	74LS365	.48
74LS28	.34	74LS161	.84	74LS366	.48
74LS30	.24	74LS162	.88	74LS367	.44
74LS32	.28	74LS163	.84	74LS368	.44
74LS33	.54	74LS164	.88	74LS373	1.35
74LS37	.34	74LS165	.94	74LS374	1.35
74LS38	.34	74LS166	1.90	74LS377	1.35
74LS40	.24	74LS168	1.70	74LS378	1.15
74LS42	.48	74LS169	1.70	74LS378	1.30
74LS47	.74	74LS170	1.45	74LS385	1.85
74LS48	.74	74LS173	.88	74LS386	.44
74LS49	.74	74LS174	.54	74LS390	1.15
74LS51	.24	74LS175	.54	74LS393	1.15
74LS54	.28	74LS181	2.10	74LS395	1.15
74LS55	.28	74LS189	8.90	74LS399	1.45
74LS63	1.20	74LS190	.88	74LS424	2.90
74LS73	.38	74LS191	.88	74LS447	.38
74LS74	.34	74LS192	.78	74LS490	1.80
74LS75	.38	74LS193	.78	74LS624	3.95
74LS76	.38	74LS194	.88	74LS640	2.15
74LS78	.48	74LS195	.88	74LS645	2.15
74LS83	.58	74LS196	.78	74LS668	1.65
74LS85	.88	74LS197	.78	74LS669	1.85
74LS86	.38	74LS221	.88	74LS670	1.45
74LS90	.54	74LS240	.94	74LS674	9.80
74LS91	.88	74LS241	.98	74LS682	3.15
74LS92	.54	74LS242	.98	74LS683	3.15
74LS93	.54	74LS243	.98	74LS684	3.15
74LS95	.74	74LS244	1.25	74LS685	3.15
74LS96	.88	74LS245	1.45	74LS688	2.35
74LS107	.38	74LS247	.74	74LS689	3.15
74LS109	.38	74LS248	.98	74LS783	23.95
74LS112	.38	74LS249	.98	81LS95	1.45
74LS113	.38	74LS251	.58	81LS96	1.45
74LS114	.38	74LS253	.58	81LS97	1.45
74LS122	.44	74LS257	.58	81LS98	1.45
74LS123	.78	74LS258	.58	25LS2521	2.75
74LS124	2.85	74LS259	2.70	25LS2569	4.20

We will try to **BEAT**  
All Competitor's Prices  
**CALL for Quote!**

### DISC CONTROLLERS

1691	.....	6.90	2795	.....	38.90
1771	.....	14.90	2797	.....	38.90
1791	.....	22.90	8843	.....	33.90
1793	.....	22.90	8272	.....	19.90
1795	.....	22.90	M88876	.....	22.90
1797	.....	22.90	M88877	.....	22.90
2143	.....	6.90	MC3470	.....	4.90
2791	.....	38.90	UP0765	.....	19.90
2793	.....	38.90			

### CRT CONTROLLERS

6845	.....	11.90	CRT5027	.....	18.90
6847	.....	10.90	CRT5037	.....	28.90
68047	.....	23.90	OP8350	.....	38.90
68845	.....	18.90	HD46505	.....	11.90
7220	.....	38.90	MC1372	.....	6.90
8275	.....	28.90	TMS9918A	.....	38.90

## UV ERASERS

**QUV-T8/1 \$49.95**  
ECONOMY Model



- Erases 15 EPROMS in 20 minutes
- Plastic Enclosure

### 6500 6500 A

6502	4.90	6502A	5.90
6504	6.90	6520A	5.90
6505	8.90	6522A	9.90
6507	9.90	6532A	10.90
6520	4.30	6545A	12.90
6522	4.80	6551A	10.90
6532	9.90		
6545	9.90		
6551	9.90	6502B	7.90

### 6E00 68B00 2 MHz

6800	2.90	68800	9.90
6802	7.90	68802	11.90
6803	17.90	68803	11.90
6808	12.90	68809	11.90
6809E	8.90	68809E	11.90
6809	8.90	68810	5.90
6810	2.90	68821	5.90
6820	4.30	68840	18.90
6821	2.90	68845	18.90
6828	13.90	68850	5.90
6840	11.90		
6843	33.90		
6844	24.90		
6845	11.90		
6847	10.90	68800-8	34.90
6850	2.90	68047	23.90
6852	5.90	68488	18.90
6860	7.90	68652	14.90
6862	10.90	68661	8.90
6875	6.90	38786	17.95
6880	1.90		
6883	21.90		

### 80C0 80C00

8031	14.90	8253	6.90
8035	5.90	8253-5	7.90
8039	5.90	8255	4.45
IMS-8060	16.90	8255-5	4.90
1MS-8073	29.90	8257	7.90
8080A	3.90	8257-5	8.90
8085	4.90	8259	5.90
8085A-2	11.90	8259-5	6.90
8086	24.90	8271	69.90
8087-3 (5 MHz)	124.95	8272	19.90
8087-2 (8MHz)	199.95	8274	28.90
8088	19.90	8275	28.90
8089	59.90	8279	6.90

### 8100 8200 8300

8131	2.90	8343	2.90
8155	6.90	8344	1.90
8155-2	7.90	8367	2.90
8156	6.90	8388	2.90
8185	28.90	8310	3.90
8185-2	38.90	8311	3.90
		8216	1.75
		8224	2.20
		8226	1.75
		8228	3.45
		8237	12.90
		8237-5	14.90
		8238	4.45
		8243	4.45
		8250	9.90
		8251	3.90
		8251A	4.45

### 8200 8300

8202	23.90	8343	2.90
8203	38.90	8344	1.90
8205	2.90	8367	2.90
8212	1.75	8388	2.90
8214	3.75	8310	3.90
8216	1.75	8311	3.90
8224	2.20		
8226	1.75	8741	28.90
8228	3.45	8748	18.90
8237	12.90	8749	29.90
8237-5	14.90	8755	23.90
8238	4.45		
8243	4.45		
8250	9.90		
8251	3.90	80116-6	89.90
8251A	4.45	80188	89.90

### 8200 8300

8202	23.90	8343	2.90
8203	38.90	8344	1.90
8205	2.90	8367	2.90
8212	1.75	8388	2.90
8214	3.75	8310	3.90
8216	1.75	8311	3.90
8224	2.20		
8226	1.75	8741	28.90
8228	3.45	8748	18.90
8237	12.90	8749	29.90
8237-5			



# FORTRON CORPORATION

3797 YALE WAY, FREMONT, CA 94538

Power Supply Professional

INFORMATION & CALIF. RES. [415] 490-8171

FOR YOUR IBM PC, XT, AT OR COMPATIBLES

ORDER TOLL FREE:

[800] 821-9771



## POWER SUPPLIES

For PC/AT



PRICE:  
please call

### #FC 5192, 200 WATTS

- +5V/19.8A, +12V/7.3A -5V/1A, -12V/1A
- 110/230 VAC Switchable
- Come with 4 Drives Connector
- Pending
- ONE YEAR WARRANTY

**#FC-130 40**  
130 Watt power supply for PC/XT



159.00

- Good for Faraday, DTC Megaboard, and other PC/XT compatibles
- Back side on-off switch
- Use cabinet FC 630
- 110/230 VAC convertible

140 W.(MAX)  
**POWER SWITCHER**  
#FC 135-40



only  
175.00

[Assembled & Fully Tested in USA]

## KEYBOARD

**#FC-427** 109.00



- IBM PC/XT compatible
- 20 million Time Life Cycle
- Light on NUM and Caps Lock Keys

#FC 630 A-T



Splice call

- IBM® PC/AT identical dimension
- Heavy duty metal frame & front plastic panel
- Completed hardware and accessories
- Use our power supply FC-5192

## COMPUTER CHASSIS

#FC-630 A-2



99.00

- IBM® PC/XT identical dimension
- Righthand side on-off switch position
- Hardwares included
- 7 & 8 slot rear panels. Good for 0.75" or 1" apart slot connectors

#FC-630



99.00

- Rear side on-off switch position
- Good for Faraday, DTC megaboard and other compatibles
- 6 or 8 slot on rear panel
- Use FC-130-40 power supply

## IBM PC, XT ADD-ON CARDS LOW COST

### FC 230 Floppy Disk Controller

- Drives 4 x 5 1/4" FDD
- IBM fully compatible
- w/cable



89.00

### FC 330 Hard Disk Controller

- Up to 2 Hard Disk Drives
- Fully Buffered I/O Bus
- Built-in ECC



219.00

### FC 530 Monochrome Controller w/Printer port

- 8 x 25 Screen
- 9 x 14 Character Box
- 7 x 9 Character
- TTL level of output



129.00

### FC 730 Multifunction Card

- Exp. to 384K bytes
- Serial port
- Printer port
- Clock/calendar



159.00

### Monochrome/Graphic with Printer Port, CT-6040

- 80 x 25 Text mode
- 720 x 348 Graphic mode
- Can run Lotus 1-2-3
- 64K Graphic Display memory
- Monitor & printer interface



199.00

### FC 830 512K Memory Exp. Card

- Exp. to 512K
- Addressable on any 64K boundary



119.00  
(64K on Board)

### FC 930 RS232C/Printer Controller

- Programmable to 9600 baud
- Fully Centronics compatible



99.00

### FC 940 RS232C/REAL TIME CLOCK

- To 9600 Baud
- Battery Back-up



99.00

Please Call For Catalogue

### Color/Graphic with Printer Port CT-6020

- RGB color port
- Printer port
- Light pen interface
- 320 x 200 Line Graphic mode
- 80 x 25 Text mode



179.00

## MONITORS

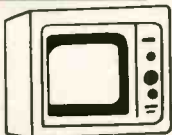

Monochrome: 109.00

- 12" non-glare
- TTL level
- Hi-resolution 1000 lines, center 800 lines, corner
- 2000 characters (5 x 7 dots, 80 x 25)

Color: 439.00

- 14" Hi-contrast CRT
- 0.39" mm dot pitch
- RGB TTL level
- 2000 character (5 x 7 dots, 80 x 25)
- Resolution 640 dots

## CABLES



- 9 pin D type to 25 pin D type for PC AT ..... 29.00
- Floppy Drive Cable ..... 7.90
- Printer cable 25 pin D type to Centronics ..... 19.00
- RS232 to RS232 Cable ..... 21.00

## I.C.

4164 (64K D RAM). 1300/9 pcs. 8237 A-5 ..... 650/ea.  
100 pcs & up ..... 100/ea. 8284A ..... 290/ea.  
41256 (256 D RAMS) ..... 585/ea. 8284C ..... 100/ea.  
2764 EPROM ..... 485/ea. 74LS245 ..... 085/ea.

### TERMS:

1. Shipping & handling charge \$6.00 minimum. Check with us for actual charge
2. CA add 6.5% tax
3. Restocking charge 15%
4. RMA # is required for return goods
5. Prices subject to change

## American Semiconductor

Computers, Components, Hardware and Software

4164	HIT   MOT DKI   NAT	79¢
128K	FOR AT	4.90
41256	MDS   ORI NAT   HIT	4.44

**COC DRIVES**

80287 FOR AT	89
8087 Math Coprocessor	175
AT TURBO KITS	99
10 mb 1/2 Winchester	399
AT-20 mb Hi Speed	475
EPSON Fx-100	499
COLOR CARDS	180
HAYES 1200B	395
AT 360K 1/2 Height	135

**800-237-5758**  
SALES EXT. 501

Vendor Line  
813-949-3193

Call 3%

Inquiry 29

## Save on top quality 3M Diskettes



5 1/4"	SINGLE SIDE DOUBLE DENSITY SOFT SECTOR	\$177
5 1/4"	DOUBLE SIDE DOUBLE DENSITY SOFT SECTOR	\$239

SOLD IN BOXES OF TEN ONLY

3 1/2" 3M diskettes are also available

tremendous selection of software books, accessories and supplies

UP TO 50% OFF!

Software for IBM PC

dBase III	349	Multimate	269
Framework	349	Symphony	429
Home Acc'l Plus	85	Wordstar 2000	299
w/Ultralle	169	Wordstar ProPac	259

ABOVE SOFTWARE AVAILABLE IN OTHER FORMATS. CALL FOR AVAILABILITY AND PRICE.  
Minimum shipping and handling \$2.00. California residents add 6% sales tax.  
Prices subject to change without notice. Write for our free catalog.

**ABC data products**

P. O. BOX 16720, SAN DIEGO, CALIFORNIA 92116

619-283-5488 800-854-1555

Inquiry 13

## Mini-Tester Monitors

7 Most Important RS-232 Lines



Only \$34.95

2 1/4 x 2 1/4 x 3/4  
Model 232MTT

2 color LED's clearly display status of TD, RD, RTS, CTS, DSR, CD and DTR. Pocket size, 1 male & 1 female connector, requires no power. May be left in permanently. Satisfaction guaranteed. **ORDER NOW!** New low price of \$34.95. All cash orders postpaid (IL res. add 6% sales tax). FREE: Newly revised illustrated catalog of RS-232 interface and testing equipment. Phone: 815-434-0846.

**B&B electronics**  
MANUFACTURING COMPANY  
P.O. Box 1008B, OTTAWA, IL 61350

Inquiry 46

## SUMMER SALE

FREE LQP PRINTER  
VIVITAR TRANSTAR 120  
RETAILS FOR \$599.00



MSDOS/CPM86

### EAGLE PC-2 FEATURES:

- 128Kb RAM expandable to 512Kb
- (2) 320Kb Floppy Disks
- Monochrome Monitor
- Eagle Writer, Eaglecalc
- MS-DOS, CP/M-86
- One Year Warranty

List: \$3,495.00 **SALE \$1488.00+**

800-624-2001  
716-325-5530

**EXSEL**  
OFFICE EQUIPMENT BROKERS  
215 ALEXANDER STREET  
ROCHESTER, NEW YORK 14607

Inquiry 146

## REMINDER (follow-up system)

- Professionals and managers, insure that no important commitment or action date will be overlooked. Map out future work flow for yourself and staff.
- REMINDER prints out your daily to-do list. What you didn't do today carries over into tomorrow's list. Repetitive to-dos are automatically rescheduled. You never have to rewrite the text of message.
- Enter items in up to 30 custom categories and as far ahead as 1999. No limit on entries.
- Toll-free number answers user questions. Runs on all IBM PCs or compatibles.
- Price \$99. 30-day money back guarantee.



CAMPBELL SERVICES, INC.  
21700 Northwestern Hwy., Suite 1070  
Southfield, MI 48075  
(313) 559-5955 Toll-free: (800) 521-9314

Inquiry 71

## AMX

8086  
8088  
Now  
68000

### Real-Time Multitasking Executive

- No royalties
- Source code included
- Fault free operation
- Ideal for process control
- Timing control provided
- Low interrupt overhead
- Inter-task messages

- Language Interfaces  
C Pascal  
PL/M Fortran
- DOS File Access:  
CP/M-80  
IBM PC DOS

Options:

- Resource Manager
- Buffer Manager
- Integer Math Library

AMX is THE #1 KADAK Product! Ltd.  
CP/M-80 is THE #1 Digital Executive™ Comp.  
IBM PC DOS is THE #1 IBM Comp.

AMX for 8080	\$ 800 US
8086	950
68009	950
68000	1600

Manual (specify processor) 75

**KADAK Products Ltd.** (604) 734-2796  
206-1847 W Broadway, Vancouver, B.C., Canada V6J 1Y5  
Telex: 04-55670

Inquiry 202

## 15 1/2" Printer

### Tractor/Friction

## 150-170 CPS

# \$249<sup>00</sup>

This Heavy Duty Business Printer includes downloadable characters. Bit image graphics, near letter quality, 136-250 columns plus multiple pin tractor for smooth error free paper feed. List \$899. **Sale \$249.** (Add \$17.50 Shipping)

## PROTECTO

22292 N. Pepper Rd., Barrington, IL 60010

### 312/382-5244

We Love Our Customers

Inquiry 290

## NEW LOCKIT II

- Password Protected Subdirectories
- Hides files-makes files Read-Only
- Runs on any PC or compatible with Hard Disk under DOS 2.0 or Higher—
- Easy to use - only \$79.95

## LOCKIT I

- Password Enabled Boot-up
- For IBM PC or PC/XT
- Optional Hard-Disk-Only Boot.
- Invulnerable! \$129.95

## PC RESET/QUICKON

- Reset without turning off power
- Eliminate turn-on & Reboot wait
- Saves time, frustration & damage to PC & PC/XT \$89.95

Specify PC or XT, MC/VISA

SECURITY	16 Flagg Place
MICROSYSTEMS	Suite 102B
CONSULTANTS	S.I., NY 10304

(718) 667-1019

Inquiry 316

## NEW I/O BUS

### FOR DATA ACQUISITION & CONTROL

Now available for IBM PC, XT, AT & Apple II.



The Local Applications Bus, LAB 40, is a versatile computer to peripheral interface and a product development system. It is optimized for connecting directly to micro-processor compatible I.C.s & hybrids. **Applications:** data acquisition, robotics, instrumentation, control, conventional peripherals. **Capabilities:** access up to 64 sixteen bit ports, 8 interrupts, DMA speeds, more. Presently available Applications modules include 8 & 12 bit high speed A/D w/programmable gain. Prices for the LAB 40 developers kit (circuit, software & manual) start at \$200.

**Computer Continuum**

75 Southgate Ave., Suite 6  
Oakley City, CA 94015 (415) 755-1978



# Compu\$ave

Call Toll Free: 1-800-624-8949

ARIZONA RESIDENTS CALL (602) 967-3532

## PRINTERS

C. ITOH	
8510	294
1550	435
A10-30	466
All Other Models	CALL

<b>EPSON</b>	
All Models	CALL

<b>JUKI</b>	
6100	385
All Other Models	CALL

<b>NEC</b>	
3550	1067
8850	1505
All Other Models	CALL

<b>OKIDATA</b>	
All Models	CALL

<b>PANASONIC</b>	
1090	186
1091	262
1092	348
All Other Models	CALL

<b>SILVER-REED</b>	
EXP 400	234
EXP 500	278
All Other Models	CALL

<b>STAR MICRONICS</b>	
All Models	CALL

<b>TOSHIBA</b>	
P1340	548
P351	1172
All Other Models	CALL

TRACTORS, SHEET FEEDERS,  
AND PRINTER SUPPLIES  
AVAILABLE FOR MOST ALL  
PRINTERS

## MODEMS

<b>ANCHOR</b>	
Volsmodem/External	48
Volsmodem 12/External	184

<b>NOVATION</b>	
Novation Cat/External	142
Apple Cat II/External	192
Smartcat/External	384
Smartcat +/Macintosh	307
Smartcat +/PC Internal	309
Smartcat +/PC External	318
All Other Models	CALL

<b>QUBIE</b>	
PC212AS/IBM Internal	252
212A/IBM External	272

## SUPER SPECIAL

### HAYES SMARTMODEM 1200

- Auto Dial
- 1200 Baud
- Auto Answer
- External



**HAYES SMARTMODEM 1200B/IBM-INTERNAL \$334**

For All Other Models And Modem Software... Call

## BOARDS

<b>AST</b>	
Six Pac Plus	255
Mega Plus II	255
All Other Types	CALL

<b>HERCULES</b>	
Color Card	144
All Other Types	CALL

<b>MICROTEK</b>	
All Types	CALL

<b>ORANGE MICRO</b>	
Grappler +	71
Buffered Grappler +	137
All Other Types	CALL

<b>PARADISE</b>	
Multi Display Card	285
Modular Graphics Card	258
All Other Types	CALL

<b>QUADRAM</b>	
Quadboard W/64K	260
Quad 512+ W/64K	225
All Other Types	CALL

<b>STB</b>	
All Types	CALL

## TERMINALS

<b>ADDS</b>	
All Models	CALL

<b>ALTOS</b>	
Al II	758
Al III	534

<b>AMPEX</b>	
210G	373
230G	451

<b>HAZELTINE</b>	
All Models	CALL

<b>QUME</b>	
QVT 101G	305
QVT 102G	428
All Other Models	CALL

<b>TELEVIDEO</b>	
All Models	CALL

<b>VISUAL</b>	
Viewpoint 60	439
All Other Models	CALL

<b>WYSE</b>	
WY 50	458
WY 75	561
All Other Models	CALL

## ACCESSORIES

<b>CHIPS</b>	
4164 Ram Chips 64K	17
8087 Coprocessor Chip	139

<b>DISKETTES</b>	
Maxell MD1 (Qty 50)	74
Maxell MD2 (Qty 50)	94
Verbatim SS/DD (Qty 50)	80
Verbatim DS/DD (Qty 50)	109
Bulk, IBM-AT, Macintosh	CALL

## CALL

- External Printer Buffers
- Power Surge Protectors
- Holston And Other Plotters
- Kurta And Other Digitizers
- 2 And 4 Position Switch Boxes
- Key Tronic And Other Keyboards
- All Types of Standard Cables
- Disk Drive Cleaning Kits
- Printer And Other Stands

## COMPUTERS

<b>ALTOS</b>	
586-20 Multiuser	5332
All Other Models	CALL

<b>APPLE</b>	
Ile W/64K/1 Drive	858
Ile Professional	1430
Ile And Macintosh	CALL

<b>IBM</b>	
PC W/256K/2 Drives	1772
XT And AT	CALL

<b>ZENITH</b>	
All Models	CALL

## DISK DRIVES

FLOPPY AND HARD DRIVES  
FOR ALL APPLE, IBM AND  
COMPATIBLES

- Alpha Omega
- Apple
- Cogita
- Gamma
- Hitachi
- IBM
- Mitsubishi
- IOMEGA
- Micro Sci
- Rodine
- Seagate
- Tandon
- Teac
- Matsushita

LOW PRICES... CALL

## MONITORS

<b>AMDEK</b>	
310A-Amber	142
Color 300	208
Color 500	303
All Other Models	CALL

<b>PRINCETON</b>	
MAX 12-Amber	169
HX 12-Color	469
All Other Models	CALL

<b>QUADRAM</b>	
Amberchrome-Amber	158
All Other Models	CALL

<b>TAXAN</b>	
420-Color	395
440-Color	545
All Other Models	CALL

<b>ZENITH</b>	
ZVM 122-Amber	85
ZVM 123-Green	85
All Other Models	CALL

**ORDER LINE HOURS: MONDAY - FRIDAY  
8AM-6PM / SATURDAY 9AM-2PM**

Send Orders & Payments to: CompuSave, 3010 S. 48th St., Suite 8, Phoenix, AZ 85040  
For Customer Service & Other Information Call Mon-Fri: (602) 967-3533

Prices reflect a cash discount of 3% to 5%. Prices and availability are subject to change without notice. Merchandise is shipped in factory cartons with manufacturer's warranty. Minimum shipping charge is \$4.00. Pay by wire, cashier's check, money order, or charge. Business or personal checks delay shipment 2 weeks. CompuSave is a Division of Adlanko Corporation. (85-7)

**PURCHASE ORDERS  
& BID REQUESTS  
WELCOME**  
Inquiry 90

**WE ACCEPT MAJOR  
CHARGE CARDS**



# MEGA-BOARD™-XT

**#1 CHOICE OF MAJOR OEM MANUFACTURERS, UNIVERSITIES, RESEARCH LABS ETC.** A THOROUGHLY FIELD PROVEN DESIGN. HIGH VOLUME PRODUCTION ENGINEERED.

- FULL IBM PC-XT\* COMPATIBILITY!
- FULL MEGA-BYTE RAM CAPACITY ON MOTHERBOARD!

**THOUSANDS SOLD WORLD WIDE!**

**DEALERS AND OEM MANUFACTURERS QUANTITY DISCOUNTS AVAILABLE**

**Standard Key-board Interface**  
(Full PC compatible)

**Hardware Reset**  
(Overcomes reset flaw in PC)

**Eight Compatible I/O Interface Connectors**  
(Full PC compatible)  
(compatible with all IBM-PC\* plug-in cards)

**Power Connector**  
(Full IBM\* pinout compatible)

**Special J1 Interface**  
(Allows horizontal mounting of compatible expansion cards for easy bus expansion and custom configuring) (Board has 62 pin gold plated compatible connector)

**8088 Processor**  
(Same as PC)

**8087 Numeric Processor**  
(Same as PC)

**Peripheral Support Circuits**  
(Same as PC)

**Extended ROM Capability**  
(Runs all compatible PC ROMS) (Jumper programmable to accommodate all popular 8K, 16K, 32K and 64K ROM chips and NEW EE ROMS! VPP power pin available for EP ROM burning!) (External VPP voltage required)

**Configuration Switches**  
(Same as PC)

**Speaker/Audio Port**  
(Same as PC)

**Wire Wrap Area**  
To facilitate special custom applications!

**Full Mega-Byte Ram Capacity! On board!**  
(With parity)  
 256K Bytes using 64K chips  
 1 Mega Bytes using 256K chips

**ONLY! \$499.95**

Mega-Board™ Triple-tested, fully socketed and assembled with IC's.

Includes highest quality PC board with gold plating, silk screen, solder mask

**Board Size** 10.5 inch X 13.5 inch

- MEGA-BOARD™ — XT
  - BARE BOARD KIT ..... \$ 99.95
  - ASSEMBLED AND TESTED SOCKET KIT (LESS IC'S) (FULLY SOCKETED) ..... \$199.95
  - ASSEMBLED AND TESTED — COMPLETE (INCLUDES USERS MANUAL AND MEGA-BIOS ROM) ..... \$499.95
  - USERS MANUAL WITH THEORY OF OPERATION, SCHEMATICS, BLOCK DIAGRAM, APPLICATION NOTES ..... \$ 19.95
  - MEGA-BIOS™ ROM (2764) FULLY XT COMPATIBLE, MS-DOS, PC DOS ..... \$ 29.95
  - HARD TO GET PARTS ..... CALL

**FREE OFFER**

**FREE! Displaytel™ Exclusive.**  
Our Commitment to Microcomputer Education!

**FREE Intel 8088 Data Book** with each Mega-Board™ Order!

**ORDER NOW!!!** Fast, friendly service

**CALL 214-991-1644**



**Immediate shipment!**  
Most instock items shipped same or next day!

10 Day money back guarantee if not completely satisfied!

**DTC™ DISPLAY TELECOMMUNICATIONS CORPORATION**

4100 SPRING VALLEY ROAD  
SUITE 400  
DALLAS, TX 75234  
(214) 991-1644

**TERMS:** We accept cash, checks, money orders, or purchase orders from qualified firms and institutions. Prices and availability subject to change without notice. Shipping and handling charges extra.

Now, the lowest prices ever on

# 3M Scotch® DISKETTES

LIFETIME WARRANTY!

**\$149** ea. 5 1/4" SSDD Qty. 50      **\$199** ea. 5 1/4" DSDD Qty. 50

5 1/4" SSDD-96TPI → \$2.29 ea. 5 1/4" DSDD-96TPI → \$2.85 ea.  
**SOFT SECTOR ONLY! MINIMUM ORDER: 20 DISKETTES**  
 ADD 3% FOR ORDERS UNDER 50! **FREE!** FLIP 'N FILE 15 w/10 DISKETTES. (Etl. Thru 5/30/85)

These are factory-fresh 3M diskettes packed in boxes of 10 with Tyvek sleeves, reinforced hubs, identification labels and write-protect tabs.  
**3.5" MICRO-DISKETTES—SS-135 TPI → \$2.89 ea.**  
**LIFETIME WARRANTY ON ALL 3M SCOTCH DISKETTES!**  
 HOURS: 8AM-5PM Central Time, Monday-Friday  
**WE WILL BEAT ANY NATIONALLY ADVERTISED PRICE ON THE SAME PRODUCTS AND QUANTITIES!**

**DISK WORLD!, Inc.**  
 Suite 4806 • 30 East Huron Street • Chicago, Illinois 60611

**DISK WORLD!** Authorized Distributor Information Processing Products **3M**

## FANTASTIC LOW PRICES ON BASF QUALIMETRIC DISKETTES!

LIFETIME WARRANTY!

**\$129** ea. 5 1/4" SSDD Qty. 20      **\$149** ea. 5 1/4" DSDD Qty. 20

5 1/4" SSDD-96TPI → \$1.46 ea. 5 1/4" DSDD-96TPI → \$1.75 ea.  
**PACKED IN CARDBOARD CASES!**  
 BASF QUALIMETRIC DISKETTES have a LIFETIME WARRANTY with Tyvek sleeves, reinforced hubs, user identification labels and write-protect tabs.

**SOFT SECTOR ONLY! MINIMUM ORDER: 20 DISKETTES**  
 BASF 3.5" MICRO-FLOPPIES      BASF 5 1/4" HIGH DENSITY FOR IBM PC-AT  
 SSDD-135 TPI → \$2.50 ea.      DSDD-HD → \$4.91 ea.  
**FOR ORDERS ONLY: 1-800-621-6827**      **INFORMATION & INQUIRIES: 1-312-944-2788**  
 (In Illinois: 1-312-944-2788)      HOURS: 8AM-5PM Central Time, Monday-Friday  
**WE WILL BEAT ANY NATIONALLY ADVERTISED PRICE ON THE SAME PRODUCTS AND QUANTITIES!**

**DISK WORLD!** Authorized Reseller Information Processing Media **BASF**

## Incredible value! Nashua™ Diskettes

LIFETIME WARRANTY!

**\$105** ea. 5 1/4" SSDD Qty. 50      **\$115** ea. 5 1/4" DSDD Qty. 50

These are poly-bagged diskettes packaged with Tyvek sleeves, reinforced hubs, user identification labels and write-protect tabs. NASHUA Corporation is a half-billion dollar corporation and a recognized leader in magnetic media.

**SOFT SECTOR ONLY! Sold in multiples of 50 only!**  
**FOR ORDERS ONLY: 1-800-621-6827**      **INFORMATION & INQUIRIES: 1-312-944-2788**  
 (In Illinois: 1-312-944-2788)      HOURS: 8AM-5PM Central Time, Monday-Friday  
**WE WILL BEAT ANY NATIONALLY ADVERTISED PRICE ON THE SAME PRODUCTS AND QUANTITIES!**

**DISK WORLD!, Inc.**  
 Suite 4806 • 30 East Huron Street • Chicago, Illinois 60611

**DISK WORLD!** Authorized Distributor **NASHUA MAGNETIC MEDIA**

### BETTER MODEMS AT LOWER PRICES!

...and get 24-hour shipping on your DISK WORLD! orders

1200/300 Baud Avatex Modem **\$189.95 ea.**      300 Baud Avatex Modem **\$59.95 ea.**

Avatex Modems have everything. They're inexpensive, Hayes-compatible, Auto Dial, Auto Answer and high quality (backed by a one-year warranty). Best of all, our combination includes a One-Year FREE subscription to MCI MAIL and special communications software for placing TOLL-FREE orders with DISK WORLD!

Orders received via MCI MAIL are shipped within 24-hours (subject to product availability). (Cables are not included.)  
**FOR ORDERS ONLY: 1-800-621-6827**      **INFORMATION & INQUIRIES: 1-312-944-2788**  
 (In Illinois: 1-312-944-2788)      HOURS: 8AM-5PM Central Time, Monday-Friday  
**WE WILL BEAT ANY NATIONALLY ADVERTISED PRICE ON THE SAME PRODUCTS AND QUANTITIES!**  
**DISK WORLD!, Inc.**  
 Suite 4806 • 30 East Huron Street • Chicago, Illinois 60611

**DISK WORLD!** Authorized Distributor **AVATEX MODEMS**

## DISK WORLD! Ordering & Shipping Instructions

Shipping: 5 1/4" & 3.5" DISKETTES—Add \$3.00 per each 100 or fewer diskettes. Other Items: Add shipping charges as shown in addition to other shipping charges. Payment: VISA and MASTER-CARD accepted. COD Orders: Add additional \$3.00 Special Handling charge. APO, FPO, AK, HI & PR Orders: Include shipping charges as shown and additional 5% of total order amount to cover PAL and insurance. Taxes: Illinois residents only, add 8% sales tax.  
 Prices subject to change without notice. This ad supercedes all other ads. Not responsible for typographical errors. MINIMUM TOTAL ORDER: \$35.00

**FOR ORDERS ONLY: 1-800-621-6827**      **INFORMATION & INQUIRIES: 1-312-944-2788**  
 (In Illinois: 1-312-944-2788)      HOURS: 8AM-5PM Central Time, Monday-Friday  
**WE WILL BEAT ANY NATIONALLY ADVERTISED PRICE ON THE SAME PRODUCTS AND QUANTITIES!**  
**DISK WORLD!, Inc.**  
 Suite 4806 • 30 East Huron Street • Chicago, Illinois 60611

**DISK WORLD!**

## ATHANA DISKETTES

The great unknown!

**99¢** ea. 5 1/4" SSDD Qty. 50      **\$109** ea. 5 1/4" DSDD Qty. 50

You've used these diskettes hundreds of times...as copy-protected originals on some of the most popular software packages. They're packed in poly-bags of 25 with Tyvek sleeves, reinforced hubs, user identification labels and write-protect tabs.

**LIFETIME WARRANTY!**  
**SOFT SECTOR ONLY! Sold in multiples of 50 only.**  
**FOR ORDERS ONLY: 1-800-621-6827**      **INFORMATION & INQUIRIES: 1-312-944-2788**  
 (In Illinois: 1-312-944-2788)      HOURS: 8AM-5PM Central Time, Monday-Friday  
**WE WILL BEAT ANY NATIONALLY ADVERTISED PRICE ON THE SAME PRODUCTS AND QUANTITIES!**  
**DISK WORLD!, Inc.**  
 Suite 4806 • 30 East Huron Street • Chicago, Illinois 60611

**DISK WORLD!** Authorized Distributor **ATHANA MAGNETIC MEDIA**

## DISKETTE STORAGE CASES

**AMARAY MEDIA-MATE 50: A REVOLUTION IN DISKETTE STORAGE**  
 Every once in a while, someone takes the simple and makes it elegant! This unit holds 50 5 1/4" diskettes, has grooves for easy stacking, inside nipples to keep diskettes from slipping and several other features. We like it!  
**\$10.95** ea. Shpg. + \$2.00

**DISKETTE 70 STORAGE: STILL A GREAT BUY.**  
 Dust-free storage for 70 5 1/4" diskettes. Six dividers included. An excellent value.  
**\$11.95** ea. Shpg. + \$3.00

**DISK CADDIES**  
 The original flip-up holder for 10 5 1/4" diskettes. Beige or grey only.  
**\$1.65** ea. + 20¢ Shpg.

**FOR ORDERS ONLY: 1-800-621-6827**      **INFORMATION & INQUIRIES: 1-312-944-2788**  
 (In Illinois: 1-312-944-2788)      HOURS: 8AM-5PM Central Time, Monday-Friday  
**WE WILL BEAT ANY NATIONALLY ADVERTISED PRICE ON THE SAME PRODUCTS AND QUANTITIES!**  
**DISK WORLD!, Inc.**  
 Suite 4806 • 30 East Huron Street • Chicago, Illinois 60611

**DISK WORLD!** The value leader in Computer supplies And accessories.

## PRINTER RIBBONS:

at extraordinary prices!

Brand new ribbons, manufactured to Original Equipment Manufacturer's specifications, in housings. (Not re-linked or spools only.)

**LIFETIME WARRANTY!**  
 Epson MX-70/80 . . . \$3.58 ea. + 25¢ Shpg.  
 Epson MX-100 . . . \$4.95 ea. + 25¢ Shpg.  
 Okidata Micro83 . . . \$1.48 ea. + 25¢ Shpg.  
 Okidata Micro84 . . . \$3.66 ea. + 25¢ Shpg.

**FOR ORDERS ONLY: 1-800-621-6827**      **INFORMATION & INQUIRIES: 1-312-944-2788**  
 (In Illinois: 1-312-944-2788)      HOURS: 8AM-5PM Central Time, Monday-Friday  
**WE WILL BEAT ANY NATIONALLY ADVERTISED PRICE ON THE SAME PRODUCTS AND QUANTITIES!**  
**DISK WORLD!, Inc.**  
 Suite 4806 • 30 East Huron Street • Chicago, Illinois 60611

**DISK WORLD!**

## Nail down great prices on MEMOREX diskettes!

LIFETIME WARRANTY!

**\$128** ea. 5 1/4" SSDD Qty. 20      **\$170** ea. 5 1/4" DSDD Qty. 20

MEMOREX DISKETTES come with heavy, lintless paper sleeves, reinforced hubs, write-protect tabs and user ID labels.

**3.5" MICRO-FLOPPIES**      **SOFT SECTOR ONLY!**      **5 1/4" DSDD-HD**  
 SSDD-135TPI      **MINIMUM ORDER: 20 DISKETTES**      **FOR IBM PC-AT**  
 \$2.44 ea.      **INFORMATION & INQUIRIES: 1-312-944-2788**      \$3.89 ea.

**FOR ORDERS ONLY: 1-800-621-6827**      **INFORMATION & INQUIRIES: 1-312-944-2788**  
 (In Illinois: 1-312-944-2788)      HOURS: 8AM-5PM Central Time, Monday-Friday  
**WE WILL BEAT ANY NATIONALLY ADVERTISED PRICE ON THE SAME PRODUCTS AND QUANTITIES!**  
**DISK WORLD!, Inc.**  
 Suite 4806 • 30 East Huron Street • Chicago, Illinois 60611

**DISK WORLD!**

# DISK DRIVES



**FREE Disk Tub With Every Order Over \$20 — Holds 60 5 1/4" Disks**

## Hard Disk

- ★ 10 Meg Hard Disk
- ★ w/IBM Controller

**\$499**

## Apple Compatible Drives

### Micro Sci

A-2 or A-20 Full HT ..... \$ 159  
Controller ..... 60

### CCU

FD525A Slimline for IIE ..... \$ 129  
FD525C for IIC ..... 139  
FD555A Fully Compatible Full HT ..... \$ 139

**Hard Disk**  
10 Meg w/cont. & pwr supply ..... \$ 995

## 5 1/4" Disk Drives

**Teac**  
FD55A, 160K ..... \$ 99  
FD55B, 360K ..... 95  
FD55F, Quad Density ..... 129  
All Teac's are Half Heights

### Tandon

TM100-2, 360K ..... \$ 99  
TM101-4, Quad Density ..... 269

### Mitsubishi

4851, 360K 1/2 Height ..... \$ 129  
4853, Quad Den. 1/2 Height ..... 139

### Hard Disk

10 Meg w/IBM Controller ..... \$ 499

## 8" Disk Drives

### Siemens

FDD-100-8 Sgl Side ..... \$ 129  
FDD-200-8 Dbl Side ..... 189

## Shugart

801R, Sgl Side ..... \$ 349  
851R, Dbl Side ..... 499

## Tandon

848-1E, Sgl Side, 1/2 Ht. .... \$ 279  
848-2E, Dbl Side, 1/2 Ht. .... 379

## Mitsubishi

M2894-63, Dbl./Dbl. .... \$ 399  
M2896-63, Dbl./Dbl. 1/2 Ht. .... 399

## 5 1/4" & 8"

## Power Supply & Cabinets

### JMR 5 1/4"

Single Cabinet w/ pwr ..... \$ 79  
Dual Thinline Cab w/ pwr ..... 89  
Dual Cabinet & Power ..... 89

All have 6 month Warranty

### JMR 8"

Sgl. Cabinet w/ pwr & fan ..... \$ 229  
Dual w/ pwr for 2 thinlines ..... 239  
Dual w/ pwr & fan ..... 279

# PRINTERS



## Epson FX-100

- ★ 160cps
- ★ 15" Carriage

**\$479**

## Brother Dist. by Dynax

HR15XL, 12 cps ..... \$ 359  
HR25, 25 cps ..... 625  
HR35, 36 cps ..... 835

## Epson

LX-80  
RX-80 (120 cps)  
RX-80FT  
RX-100 +  
FX-80 +  
FX-100 +  
LQ1500  
JX-80

We will  
Beat ALL Pricing

We are an Authorized Dealer

## Okidata

OKI 182 ..... \$ 229  
OKI 83A ..... 535  
OKI 84P ..... 669  
OKI 84S ..... 749  
OKI 192 ..... 349  
OKI 193 ..... 585  
OKI MATE20 Color Printer ..... 129

Call for other Models

## A B SWITCHBOX

Par. or Ser. .... \$ 69

## PRINTER INTERFACES

### Fourth Dimension

Card & Cable (For Apple) ..... \$ 45

### Microtek

Dumpling GX (Grappler Compatible) \$ 75  
Dumpling GX exp to 64K ..... 145  
Dumpling GX 16K w/ 16K exp to 64K ..... 160

### Okidata Options

Tractor for 82 & 92 ..... \$ 55  
Serial Interface ..... 85

### Orange Micro

Grappler + ..... \$ 84  
Grappler + w/16K ..... 174

### Epson Accessories

Epson Serial Interface ..... \$ 99  
Letter Writer NCO Kit ..... 59  
LX-80 or FX-80 Tractor ..... 39

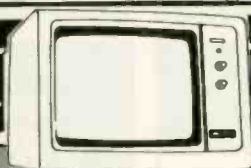

# MONITORS

## Taxan

- ★ 440 Ultra Hi-Res

**\$519**

## Amdek

300G, Hi-Res Green ..... \$ 125  
300A, Hi-Res Amber ..... 134  
310A, Monochrome Amber ..... 158  
300 Hi-Res Color Comp. .... 275  
500 RGB Composite ..... 399  
DVM Board for Apple RGB ..... 119

## Taxan

425 Color RGB ..... \$ 399  
440 Ultra Hi-Res ..... 539

## Stand

Tilt & Turn Stand ..... \$ 19

## Princeton Graphics

MAX12, Monochrome Amber ..... \$ 169  
HX12, RGB Color ..... 449  
SR-12 w/ Doubler Board ..... 775

## IBM

Monochrome Green ..... \$ 239  
Color Hi-Res ..... 559

## Zenith

ZVM122 ..... \$ 95  
ZVM123 ..... 95

## BMC

12AUW Hi-Res Green ..... \$ 79

**Computer Components Unlimited**  
A California Corporation

Inquiry 87



No Surcharge for Credit Cards

All Prices Reflect a Cash,  
Pre-Paid Discount

This Ad Supersedes All Others

**Customer Service & Technical**

**(213) 618-0487**

**Sales Desk**

**(800) 847-1718**

Outside California

**(213) 618-0477**

Inside California

# SYSTEMS

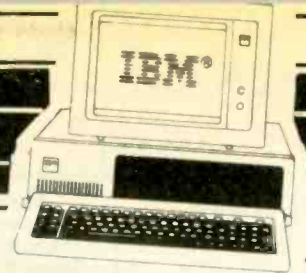

## IBM PC

- ★ 256K ★ Two 360K Tandons
- ★ Hercules Color Graphics w/parallel port
- ★ Hi-Res Green Monitor
- ★ 10 Meg Hard Disk

**\$2199**

## IBM AT

- ★ Enhanced
- \$4950**

### Apple

IIE cpu	\$ 790
Macintosh	1895
Iic Portable	899

### Compaq

Portable (PC Compatible) 2, 360K Drives	\$1845
256K of Memory	3300
Compaq + w/10 Meg	1640
Deskpro 1	2250
Deskpro 2	3900
Deskpro 3	Call
Deskpro 4	Call

### IBM

PC 256K, 2 Drives	\$1499
XT w/10 Meg, 256K	2895
Additional Memory 64K	9
AT Standard Config.	Call
AT w/20 meg	Call
Add \$50 for Configurations & Testing	

# MODEMS

## Hayes Modem

- ★ Hayes 2400 Baud
- \$599**

### Hayes

Micro Modem IIE	\$ 169
300 Baud	169
1200B IBM Internal	359
1200	389
2400 Baud	629

### Anchor Automation

Mark For TI	\$ 59
Mark VI 300 Baud IBM	79
Mark XII, 1200 Baud	219
Mark X, 300 Baud Stand alone	149
Express 1200 Baud	269

### Prometheus

Promodem	\$ 289
Pro 1200A Apple Int w/sw	329
Pro 1200B IBM Int w/sw	299
Pro Mac w/ cable & sw	279
No. C Cable	12
Alpha Disp.	89
Options Proc.	89

### U.S. Robotics

Password	\$ 219
----------	--------

# IBM & APPLE ACCY'S

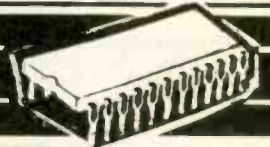

## 64K Upgrades

- ★ Nine 4164, 200ns
- ★ 1 Year Warranty
- ★ Nine to a Set

**\$9**

### APPLE EXTRAS

<b>ALS</b>	
Z Engine	\$ 119
CPM 3.0 Card	240
<b>CCU</b>	
RF Modulator	\$ 9
Fan w/ Surge	34
16K Mem. Card 1 yr war	\$ 45
<b>Micro Max</b>	
Viewmax 80, 80 col. card	\$ 135
Viewmax 80E (F for IIE) 64K	120
<b>Micro Soft</b>	
Premium Soft Card IIE	\$ 369
Soft Card (Z80) w/ 64K	279
<b>Micro Tek</b>	
Serial Interface	\$ 89

### IBM EXTRAS

<b>Ast Research</b>	
Six Pack + w/384K	\$ 299
<b>Hercules</b>	
Color Card	\$ 149
Graphics Card	304
<b>Hard Disk</b>	
10 Meg. External w/ power supply	\$999
<b>IBM</b>	
Monochrome Adapter	\$ 219
Color Card	225
<b>Paradise Systems</b>	
Multi-display Card	\$ 329
New Modular Card	260
5 Pack Multifunction	160
<b>Quadram</b>	
Quad Color Card	\$ 199
Quadlink	349
<b>64K Upgrade</b>	
64K of Mem.	\$9
<b>AT Upgrade</b>	
200 ns.	\$89
<b>Ports</b>	
Parallel	\$ 79
Serial	79
<b>CCU</b>	
Color Graphics Card	\$ 119
<b>Everex</b>	
Graphics Edge	\$ 329

### CCU Multifunction Card

Par. & Ser. Ports w/64K exp 384K	
Clock, Calendar, Sftwr & Manuals	\$ 160
w/384K	220
<b>8087's</b>	
8087-2	\$ 149
8087-3	104
8087-6	95

### 5 1/4" DISKETTES

<b>CCU</b>	
Sgl/DbI reinforced hub	\$11 100 for 100
DbI/DbI reinforced hub	13 100 for 110
Not Bulk Packed	
<b>Dysan</b>	
Sgl/DbI	\$33 100 for 300
DbI/DbI	39 100 for 370
<b>Verbatim</b>	
Sgl/DbI	\$26 100 for 240
DbI/DbI	36 100 for 340

### 8" Diskettes Available — Call

### DISK ACCESSORIES

<b>Verbatim</b>	
8" or 5 1/4" Head Cleaning Kit	\$ 9
<b>Flip Tub</b>	
5 1/4" Holds 60 disks, plexiglass	\$ 9

Inquiry 87

### RETAIL STORES:

11976 Aviation Blvd.  
Inglewood, CA 90304

16129 Hawthorne Blvd., Suite E  
Lawndale, CA 9026C

### MAIL ORDER:

P.O. Box 1936  
Hawthorne, CA 90250

### Retail Hours:

10 a.m. - 6 p.m. Mon.-Fri.

10 a.m. - 3 p.m. Sat.

All merchandise new. We accept MC, Visa, Wire Transfer, COD Call, Certified Check, P.O.'s from qualified firms, APO accepted. Shipping: Minimum \$4.50 First 5 pounds. Tax: California Res. Only add 6 1/2% sales tax. All returns subject to 15% restocking charge. Advertised prices for Mail Order only. Retail prices slightly higher.  
Prices Subject to Change.

### Customer Service Hours:

10 a.m. - 4 p.m. Mon.-Fri.

John Aurentz

(213) 618-0487

### Mail Order Hours:

8 a.m. - 6 p.m. Mon.-Fri.

10 a.m. - 3 p.m. Sat.

(800)847-1718 (213)618-0477  
(Outside California) (Inside California)

# Computers to . . . . .

## COMPUTER SYSTEMS

IBM PC, XT, AT (Several Configurations Available)	.....\$Call
IBM PC with 10 Mb Hard Disk, 256K, 360K Disk Drive	.....2169
IBM PC with 256K, 2-360K Disk Drives	.....1589

## AST RESEARCH

All AST Boards come with 1 year warranty

SixPakPlus w/64K Upgradeable to 384K, Now includes a FREE! copy of Borland's SIDEKICK (copiable) S. P. C	.....245
SixPakPlus w/384K fully populated	.....369
I/O Plus II with Serial and Clock Calendar (parallel, game or second serial port optional)	.....127
I/O Mini w/Ser. and Clk Calendar (Short card XT size)	.....135
Par./Game/Ser. Port for any AST Board (specify board)	.....35
Reach Modem w/Crosstalk XVI on short XT card	.....415
AST Preview Graphics card with parallel port, Hi-Res	.....299
Advantage w/128K (Up to 3Mb) S, P, for AT	.....399
Advantage w/3Mb	.....1675
AST-5251-11 Connect PC to IBM Sys 34/36/38	.....699
AST-5251-12	.....519
AST-3780	.....579
Colossus 67Mb Hard Disk with 60Mb Tape Back-up (Specify if for PC or AT)	.....5695

## INTEL

All Intel Boards come with 5 year warranty. Intel Boards are compatible with Lotus/Symphony Bank switching Std.

Above Board PC w/64K Upgradeable to 512K	.....320
Above Board AT w/128K Upgradeable to 1.6Mb	.....469
8087 Math Coprocessor up to 5MHz	.....109
8087-2 Up to 8MHz	.....129
80287 Up to 6MHz	.....289

## HAYES

Smartmodem 1200 (External)	.....\$Call
Smartmodem 2400 (External)	.....629
Smartmodem 1200B (Internal with Smartcom II)	.....365

## HERCULES

Graphics Card with Parallel port	.....305
Color Card with Parallel port	.....164

## EPSON

ACP has the best prices on the new Epson Plus series with the NLQ option. All Epson printers have graphics capability. We stock the RX-100, FX-80+, FX-100+, JX-80 Color, LQ-1500, Spectrum LX-80 (Includes NLQ option) \$Call

Esprint 100cps Dot-Matrix Printer (Ser. or Par.)	.....199
--	----------

## KEYTRONICS

KB5151 Deluxe Keyboard	.....\$Call
KB5150 PC Keyboard	.....155
ACP 5150 Ccompatible to the KB5150	.....99

## QUADRAM

Quadboard w/64K Upgradeable to 384K	.....239
Quadlink The Apple IBM Link	.....449
Quadchrome II 14" HI-Res Color Monitor	.....445

## TECMAR

Graphics Master High end color graphics w/PC Paint	.....499
Expansion Chassis Complete expansion chassis	.....729

## PRINCETON GRAPHICS

MAX-12 Amber Monitor	.....175
HX-12E 690x240 Color Monitor	.....539
HX-12 690x240 Color Monitor	.....449
SR-12 720x480 Color Monitor	.....619
San Doubler	.....196

## TAXAN

Taxan 440 Ultra Hi-Res 720x400 (req. Bob Board)	.....579
Special Offer Taxan 440 plus Bob Board	.....995
Taxan 121 or 122 Green/Amber Monitor	.....159
Taxan 415 (640x260 Acorn lable but a steal while supply lasts!) This monitor was sold for 699. Req cable to IBM (\$18)	.....299

## FLOPPY DISK DRIVES

Shugart SA450 DS/DD	.....79
Shugart SA350 3 1/2"	.....250
IBM PC Compatible 1/2 High or Full SS/DD Drive	.....49
	Qty
	1 2-5
Teac 55B IBM PC type DS/DD (48tpi)	.....95 92
Tandon TM-100-2 Std. Height IBM Style DS/DD	.....99 97

## FLOPPY DISK DRIVES - Cont.

Shugart SA455 IBM Style DS/DD	.....99 97
Shugart 801R 8" SS/DD Supply Limited	.....249 239
Shugart 851R 8" DS/DD Supply Limited	.....449 435
Tandon TM-848-1E 8" SS/DD Thinline	.....269 259
Tandon TM-848-2E 8" DS/DD Thinline	.....359 349

Call us for your volume disk drive requirements. We are direct importers on several name brands.

ACP maintains full testing and alignment capability. If you are having problems with your drives, give us a call.

## APPLE FLOPPY COMPATIBLE DRIVES

Apple II, II+, IIe Compatible Drive (1/2 Hight only)	.....\$115
Apple IIc Compatible Drive (1/2 Hight only)	.....125
Macintosh Compatible Drive (1/2 Hight only)	.....299

## HARD DISK DRIVES

Shugart SA604 5Mb Seagate ST506 Compatible	.....99
Shugart SA712 10Mb 1/2 Ht. Low Power. (Supply Limited)	.....249
Miniscribe 3012 10Mb 1/2 Hight	.....275
CMI Call for 10, 22, 33Mb Drives	.....\$Call
Seagate ST212 10Mb	.....299
Quantum 42Mb	.....1375
Winchester Controller Same hard disk controller as used by IBM. Please specify your drive and we will supply with proper firmware. Firmware currently in stock for over 25 different drives. Comes with 1 year warranty	.....195

## HARD DISK EXPANSION

5Mb Internal w/controller. (for PC req. added power)	.....299
5Mb External w/controller. PS, IBM style chassis & fan	.....419
10Mb Internal w/controller (1/2 Ht) w/full bezel	.....449
10Mb External w/cont., IBM style case w/PS and fan	.....649
20, 33Mb & up drives, please call for current prices	.....\$Call

## TAPE CARTRIDGE BACK-UP

Excell 4500 PC Internal with 45Mb. This is the top selling tape back-up for the PC. It uses the Wangtek Tape Cartridge with controller. We are always back-ordered on this popular product

Excell 4500 External (for XT add \$100)	.....1199
Excell 4500 XT	.....1099

## IBM PC HARDWARE KEY VALUES

ACP Multifunction 384K w/OK plus all the same function and features as the SixPakPlus	.....160
ACP Color Card 139	.....139
ACP Monocard	.....99
ACP Floppy Card	.....99
PC Style Chassis (IBM Style chassis)	.....99
PC 130 Watt Power Supply (Drops right in)	.....119
IBM Style Monitor (Green w/TTL input) priced right	.....119
IBM PC 256K RAM Card w/64K	.....69.95 w/256K 99.95

## APPLE HARDWARE KEY VALUES

Grappler + (Most popular Printer Interface at new price)	.....88
Buffered Grappler from Orange Micro	.....165
Serial Grappler (Works great w/Immagewriter)	.....119
ACP 16K Buffered Serial Card	.....95
ACP 80 Column Card (Super In Apple II, II+)	.....69
Kennsinton System Saver (Preferred Apple Cooler)	.....69
ACP System Cooling Fan (Similar to sys saver)	.....30
Apple IIe Keyboard (Replacement keyboard for IIe)	.....30
Apple II/IIe Power Supply (Compatible to Apple)	.....60
Apple II, II+, IIe Disk Controller (Compatible)	.....40
ACP Parallel Interface (w/Cable II, II+, IIe)	.....40
Crickett IIc (Speech board for IIc by Street Electronics)	.....129
ECHO II Speech Synthesizer (Best for II, II+, IIe)	.....99
Titan Ramcard	.....199
Titan Accelerator Card	.....299
ACP Extended 80 Column w/64K (for Apple IIe)	.....99

## APPLE & IBM SOFTWARE VALUES

We stock a complete line of Apple and IBM Software titles all at discount prices. Call our sales desk for the current low price for your software needs.

Flashcalc (Super spreadsheet formerly Visicalc APII)	.....79
Wordstar (for IBM)	.....229
Supercalc I (Closeout on original IBM version)	.....20



## 10 Mb \$449.00 HARD DISK

w/Controller for IBM PC and Compatibles.

At This Price, Supply Is Limited.

External Enclosure Add \$195.00

## PC UPGRADE SPECIAL

\$ 10<sup>00</sup>

SET OF (9) 64K RAMS

\$ 45<sup>00</sup>

SET OF (9) 256K RAMS

PIGGYBACKS FOR AT 128K RAMS \$5.95



## 5 Mb EXTERNAL

Sharp IBM Look-a-like w/controller for IBM PC.

Sub-System Price: \$429.00

Internal w/controller

Sub-System Price: \$299.00

## DELUXE JOYSTICK

\$11.95



Compatible w/Atari 2600, 400, 800, VIC-20/64 and Apple. Requires optional cable adapter. Add \$1.50

## APPLE DISK DRIVE

\$115.00



High quality 1/2 high drive for Apple II, II+, IIe or IIc. Apple IIc requires optional cable adapter. Add \$10.00

# ★ Advanced Computer

# Parts

**TOLL FREE**  
**800-854-8230**  
Calif. Residents  
**714-558-8815**

**OUR POLICY** Inquiry 17

- No surcharge for VISA or Mastercard.
- No sales tax. • All shipments insured.
- Your card is NOT charged until we ship.
- Same day FEDEX shipment is available.
- Volume purchasing agreements available.
- Government agencies, corporate and Institutional PO's accepted.
- Orders subject to availability.
- All items have manufacturer warranty. Some warranties up to 5 years.
- Pricing subject to change w/o notice.
- Returns or cancellations may be subject to restocking fee.
- ACP Retail Store pricing may vary.
- We are NOT responsible for typos.

### UPS POWER SUPPLY

Back Up Power for your IBM, Apple or Compatible

UPS-PC 200 Watts \$277.00  
UPS-KT 425 Watts 453.00  
UPS-AT 3000 Watts 975.00

### A-B PRINTER SWITCH

An AB Switch allows use of two printers with your computer system. We stock over 15 different configurations.

AB Switch (Centronics) \$59.00  
AB Switch (DB25) 59.00

### COLOR VIDEO CARDS

Panasonic Color Plus \$375.00  
IBM Color Card 227.00  
IBM Mono Color w/adapter 219.00  
STB Graphics Plus 369.00  
Pantech Multifunction Card 345.00  
Everset Graphics Edge 349.00

### DRIVE CABINETS

IBM Style Hard disk w/ power supply and fan \$195.00  
Dual Hard Disk w/ power sup. & fan 295.00  
Dual 5 1/4" Full height vertical mount 65.00  
Dual 5 1/4" Full height horizontal mount 99.00  
Dual 5 1/4" Thinline w/ power sup. & fan 60.00  
Single 5 1/4" Full height w/ power sup. & fan 60.00  
Single 5 1/4" Thinline w/ power sup. & fan 60.00

### PERISTY CARDS

Perisyst Mono Combo - NEW! \$339.00  
Perisyst Color Combo - NEW! 339.00  
Perisyst Shortport Color Cab 445.00  
Perisyst Mini Mono Cab 445.00  
Perisyst Mini Time Spectrum w/Kit 179.95  
Perisyst 192K Rainbow DEC Card 149.95

### SPECIAL BUY

Budget BA 4064 16" 28MB Hard Disk \$499.00

### MODEM SPECIAL

Nayes Smartmodem Compatible 1200 Baud. External. Sold for 399.00 \$219.00

### INTERISL STD-BUS BOARDS

IBM310 Z80 CPU 181.00  
IBM311 Z80 Linc. CPU 200.00  
IBM310 8085 CPU 200.00  
IBM311 16M CMOS RAM 610.00  
IBM311 16M Static RAM 200.00  
IBM320 16M CMOS RAM 710.00  
IBM320 Z80 PIO (D. mating) 250.00  
IBM330 Z80 PIO (D. mating) 250.00  
IBM331 Universal PIO 210.00  
IBM330 Opto. Pkwa. Input 300.00  
IBM340 Floppy Controller 215.00  
IBM340 SASI (DMA) W/Int. Inter. 255.00  
IBM350 Trac. 270.00  
IBM3510 Opto-Input 270.00  
IBM3600 SPT Relay 150.00  
IBM3610 DPT Relay 150.00  
IBM3600 Arithmetic 375.00  
IBM3610 EPROM Programmer 260.00  
IBM3700 Sync/Async 245.00  
IBM3711 Linc. Sync/Async 245.00  
IBM3720 REMOADS 315.00  
IBM3830 12 Bit AD 270.00

### TRANSISTORS/DIODES

2.5MHz "A" 4.0MHz "B" 6.0MHz

Z80-CPU 2.25 2.75 6.95  
Z80-CTC 2.50 3.75 9.25  
Z80-DART 7.80 8.50 17.95  
Z80-DMA 8.00 8.95 17.95  
Z80-DIO 2.00 3.50 9.50  
Z80-DIOA 8.50 9.90 22.95  
Z80-DIO-1 8.50 9.90 --  
Z80-SHO-2 8.50 9.90 22.95  
Z80-SHO-2 8.50 9.90 --

### DISK CONTROLLERS

UDP705 \$249.95 1797 821.95 6643 829.95  
1777 17.95 2793 32.95 1691 8.95  
1791 21.50 2793 32.95 1691 8.95  
1793 21.50 2793 32.95 1691 8.95  
1795 21.50 2793 32.95 1691 8.95

### CRT CONTROLLERS

6845 \$11.95 6275 \$28.50 TMS9918 \$38.50  
1777 17.95 7220 24.95 8500 38.95  
6847 18.00 5027 17.95 6945 14.95  
4605 16.75 5037 21.95 8232 10.95  
6847 18.50 URT2720 Graphics 34.95

### UARTS/USARTS

1602B 3.95 2350 5.95 M4643 8.75  
1013A 3.95 952 10.50 TMS5501 14.95  
1015A 9.75 B4494Z 7.75 2651 8.95

### EPROMS

1702 (1M5) 8.35 2732A-4 (4505) 8.45  
2732 (4505) 8.35 2732A (2505) 8.45  
2754 (5V) 5.50 2754-2 (2005) 5.95  
2718 (4505) 3.75 2754 (4505) 4.50  
2718 (3505) 3.50 2754 (2505) 6.50  
2754 (5V) 5.50 2754-2 (2005) 5.95  
TMS2716 7.60 TMS2564 (4505) 9.95  
TMS2532 7.60 MCM4678A (4505) 19.95  
2732 (4505) 8.00 MCM4678B (2505) 21.95  
2732 (2005) 8.00 2712B (2505) 15.95  
2732 (2005) 8.00 2712B (2505) 15.95

### STATIC RAMS

2101 (4505) \$1.89 MK4118 \$4.95  
2102 (4505) .99 TMM201B-15 (1505) 3.10  
2103 (4505) .77 TMM201B-15 (1505) 3.10  
2102B (2505) 1.39 TMM201B-15 (2005) 3.10  
2111 (4505) 2.75 HMM181P4 (2505) 4.78  
2112 (4505) 2.75 HMM181P3 (2505) 4.78  
2114 (4505) 1.45 68650 HMM181P3-1 (2505) 5.75  
2114-4 (3000) 1.69 81250 HMM11P3-1 (LP) 3.80  
2114-3 (2000) 1.79 81330 HMM11P3-1 (LP) 3.80  
2114-2 (2000) 1.89 81330 HMM11P3-1 (LP) 3.80  
2114 (2505) 4.90 2712B (2505) 32.95  
4044A (4505) 3.25 HMM20P4-16 (150) 14.95  
4044-3 (3000) 3.75 HMM20P4-16 (LP) 14.95  
4044-2 (2000) 3.75 HMM20P4-16 (LP) 14.95  
4044-1 (2000) 3.75 93415 (1505) 3.85  
5101 (CMOS) 3.80 93425 (1505) 3.95

### DYNAMIC RAMS

4027 (2505) \$1.29 TMS4406 (2005) \$6.75  
1103 (3005) 7.99 TMS4416 (1505) 87.95  
4118M-2 (1505) 1.20 81 695 4126M-150 (1505) 8.95  
4118M-3 (2005) 1.19 81 625 4126M-200 (2005) 7.95  
4118M-4 (2505) 89 81 590 TMS4050 (1505) 1.85  
4164M-150 (1505) 1.59 81120 TMS4400 (2005) 1.85  
4164M-200 (2005) 1.49 81010 HMM290 (2005) 1.85  
4164M-120 (1505) 6.25 UPD411 (3005) 1.85  
TMS4164 (1505) 5.95 MMS290 (2005) 1.85

### CAPACITORS

01uF DISC BYPASS CAPACITOR 10005.50  
1 uF DISC BYPASS CAPACITOR 10005.50  
1uF MONOLITHIC CAPACITOR 10011.25  
1 uF MONOLITHIC CAPACITOR 10014.25

### CORCOM EMI FILTER

STD CORCOM 3 Conductor Filter \$4.50  
Line Cord for above - 8 foot 1.49  
Line Cord 2 Conductor - 8 foot 3.00  
Line Cord 3 Conductor - 8 foot 3.00

### SPECIAL VALUES!

MCM4670S EPROM \$9.95  
61162016-1505M \$10.95  
61162016-1505M \$10.95  
2732-4505M \$10.95  
2732-4505M \$10.95

### MUFFIN FANS

Over 10,000 in Stock

Torn 3" TA-300 Fan NEW! \$9.95  
Torn 4" Muffin Fan NEW! 12.95  
12VDC Fan NEW! 19.95  
Finger Guards added  
Power Cords Added 1.49

### IC SOCKETS

SOLDERTAIL 1.99 160  
8 Pin STAP \$1.13 10  
14 Pin STAP \$1.15 11  
18 Pin STAP \$1.17 12  
18 Pin STAP \$1.17 12  
20 Pin STAP \$1.20 26  
20 Pin STAP \$1.20 26  
24 Pin STAP \$1.29 27  
24 Pin STAP \$1.29 27  
28 Pin STAP \$1.39 33  
38 Pin STAP \$1.58 38  
40 Pin STAP \$1.69 42  
64 Pin STAP \$3.95 42

### WIRESHAP (GOLD)

18 Pin WW/3L \$4.99 40  
14 Pin WW/3L \$2.49 40  
18 Pin WW/3L \$2.49 40  
18 Pin WW/3L \$2.49 40  
18 Pin WW/3L \$2.49 40  
20 Pin WW/3L \$2.99 40  
22 Pin WW/3L \$2.99 40  
24 Pin WW/3L \$2.99 40  
40 Pin WW/3L \$1.99 1.15

### TEXTOOZIF ZERO INSERTION

16 Pin \$4.75 24 Pin \$7.85 28 Pin \$8.95  
(We Stock All Types of Sockets)

### EDGE CONNECTORS

S-100 ST \$3.95 \$3.25  
S-100 WW \$4.75 \$4.10  
44 Pin ST 2.75 2.60  
44 Pin WW 4.75 4.25  
72 Pin ST 6.50 6.10  
72 Pin WW 7.25 6.95

### D-SUBMINIATURE

DB25S (Female) \$3.10 \$2.90  
DB25P (Male) 2.40 2.20  
Hood \$1.25  
DE37S (Female) \$5.95 \$5.75  
DE37P (Male) 8.25 8.10  
Hood \$1.75  
DD50S (Female) \$8.95 \$8.45  
DD50P (Male) 8.00 8.75  
Hood \$3.25 Mfg HW \$ 9.90

### CENTRONICS

IOC 38 Pin Male \$8.95  
IOC 38 Pin Female \$8.49  
Solder 38 Pin Male 17.49  
Solder 38 Pin Female 9.95  
ICALL TOLL FREE FOR IOC's

### IC CONNECTORS

IDC TYPE	ACP NO.	NUMBER OF CONTACTS					
		10	20	26	30	40	
Solder Header	IDHxS	79	1.20	1.65	2.10	2.40	3.00
Rt Angle Solder Header	IDHxSR	79	1.20	1.65	2.10	2.40	3.00
Ribbon Header Socket	IDXxx	75	95	1.35	1.50	1.85	2.10
Ribbon Header	IDMxx	-	5.25	5.95	6.75	7.25	8.25
Ribbon Edgecard	IDExx	1.70	2.15	2.50	2.80	3.70	3.95
Wirewrap Header	IDHxW	1.80	2.90	3.75	4.25	4.95	6.50
Rt Angle WW Header	IDHxWR	1.99	3.10	4.10	4.20	4.80	7.15

NOTE: To order insert number of contacts in place of xx in ACP part number.  
ORDER QUANTITY OF 50pcs (mixed) AND TAKE AN ADDITIONAL 10% OFF.

### DISK SPECIAL (IBM PC DSD)

\$1.00 EACH DSDC WOW! Supply Limited

PACKAGE Major Corp. Type/Color Mfg.

### OKIDATA PRINTERS

Okidata 20 Color Printer \$179.00  
Plug N Print for Okidata 20 69.00  
Okidata 162 (100cps, Graphics) 259.00  
Okidata 192 (180cps, Graphics) 349.00  
Okidata 193 (180cps, 15" Paper) 549.00  
Okidata 92 (180cps, Graphics) 349.00  
Okidata 93 (160cps, 15" Paper) 599.00  
Extra Ribbon 5.00

Okidata 84 (200cps, Parallel) \$799.00  
Okidata 84 (200cps, Serial) \$949.00  
Tractor for Okidata 192 44.00  
Tractor for Okidata 92 54.00  
28 Serial Board for Okidata 192/193 69.00  
28 Serial Board for Okidata 92/93 99.00  
Extra Ribbon 5.00

### DISK SPECIAL (IBM PC DSD)

\$1.00 EACH DSDC WOW! Supply Limited

PACKAGE Major Corp. Type/Color Mfg.

### DISKETTES

5 1/4" DISKETTES  
VERBATIM 5-1/4" SS/D 822.95 118.95  
VERBATIM 5-1/4" DSDC (IBM) 24.95 24.95  
MAXELL MD-2 DSDC (IBM) 27.95 27.95  
MAXELL MD-2 DSDC (IBM) 27.95 27.95  
MAXELL DS-As for AT (80ps) 46.95 43.95  
DYSAN 10412 DSDC (IBM) 27.95 27.95  
DYSAN 10420 DSDC (IBM) 27.95 27.95  
ACP DSDC (IBM) 14.95 12.95  
ACP DSDC (IBM) 17.95 15.95

### 3 1/2" DISKETTES

VERBATIM 3 1/2" MF350 (MAC) 30.00 29.00  
MAXELL 3 1/2" MICRODISC (MAC) 33.00 31.00

### 5 1/4" DISKETTES

VERBATIM 5 1/4" DSDC 28.95 26.95  
VERBATIM 5 1/4" DSDC 32.95 30.95  
DYSAN 8" DSDC 18.95 49.95  
DYSAN 8" DSDC 18.95 49.95

### 5 1/4" DISK

80.95

### 3 1/2" DISK

14.95

### HEAD CLEANING

18.95

### CMOS

4000 5 20 4028 5 45 4050 87 90 4505 8.95  
22 4029 75 4060 85 4508 11.10  
4062 22 4030 38 4066 30 4507 1.10  
4066 22 4041 3 4078 29 4512 1.80  
22 4032 2.15 4070 35 4510 7.79  
4048 95 4034 1.81 4071 28 4511 7.79  
4090 9 4035 78 4072 29 4512 1.80  
4010 30 4037 1.95 4073 28 4514 1.18  
4011 24 4040 75 4075 28 4515 1.79  
4022 79 4031 3 4078 29 4516 1.19  
4013 38 4042 85 4077 35 4518 8.85  
404 75 4043 85 4078 35 4520 7.75  
4015 39 4044 69 4081 29 4555 9.95  
4037 39 4049 35 4093 45 80C97 4.8  
4017 85 4047 89 4085 95 4586 1.35  
4018 79 4048 39 4086 95 80C96 1.80  
4039 39 4049 35 4093 45 80C97 4.8  
4021 69 4051 75 4098 1.90 1M1409 12.95  
4022 69 4052 75 4099 1.85 1M1410 12.95  
4023 25 4053 75 4501 1M1411 11.95  
4024 59 4055 3.95 4502 95 1M1412 9.95  
4425 28 4056 2.95 4503 49 1M1419 4.95  
4227 .45 CALL FOR PRICE

### 74C00

74C00 20 74C74 8 95 74C161 61.15 74C373 82.35  
74C02 20 74C86 1.9 74C175 1.15 74C374 2.35  
74C04 29 74C00 1.15 74C240 1.89 74C801 5.9  
74C05 3 74C06 1.15 74C240 1.89 74C801 5.9  
74C10 35 MORE 74C IN STOCK - ALSO IN CATALOG

### LINEAR

LM1084H \$3.95 NE590 82.45 LM3900 98  
LM3009 99 NE592 2.70 LM3914 2.95  
LM3044 1.89 LM700H 1.80 LM3915 82.95  
LM3049 95 LM710 8.95 MC4024 3.75  
LM3050 95 LM711 7.95 MC4028 2.75  
LM3074 40 LM718 3.95 MC4131 1.25  
LM3083 65 LM723A 3.85 MC4136 1.19  
LM3084 1.85 LM723B 3.15 MC4151 3.75  
LM3124 1.78 LM747 1.95 MC4308 1.25  
LM3128 1.45 LM747CN 3.30 CR4048 1.25  
LM3130 1.55 LM747A 1.85 MC4309 2.85  
LM3139 1.19 LM747D 29 CA3080 2.60  
LM3200 (see VDR) LM747F 65 CA3081 1.10  
LM3201 1.55 LM747H 1.85 MC4310 1.25  
LM3389 95 LM1014 1.15 CA3081 1.60  
LM3400 (see VDR) LM1303 1.90 CO3082 1.80  
LM3489 1.95 LM1310 1.45 CA3083 1.55  
LM3539 85 LM1318 1.85 CA3089 2.85  
LM3539 85 LM1318 1.85 CA3089 2.85  
LM3600 2.95 MC1350 1.15 CA3098 3.45  
LM3600 2.95 MC1350 1.15 CA3098 3.45  
LM3789 3.75 LM1411 1.5 CA3146 1.70  
LM3790 2.90 LM1558H 2.99 CA3150 1.49  
LM3800 1.85 LM1800 2.90 CA3160 1.25  
LM3800 1.85 LM1812 3.10 LM1870 1.45  
LM3818 1.59 LM1818 3.40 LM19300 1.45  
LM3829 1.35 LM1871 6.55 LM2000 8.85  
LM3834 95 LM1972 4.45 L361 50  
LM3849 1.78 LM1977 3.20 L553 90  
LM3854 75 LP2211 3.75 L362 50  
LM3879 1.29 LM1996 1.70 L368 110  
LM3894 1.15 LM2001 1.95 L577 139  
LM3929 89 LM2203 1.48 L7071CP 79  
LM3939 48 LM2204 1.95 L7072CP 79  
LM3955 35 RP2211 3.75 L7074CN 1.90  
NE531 2.85 RP2206 4.00 L7081CP 59  
NE535 75 RP2211 3.75 L7082H 79  
NE555 5.5 LM2877P 2.00 L4984 4.10  
NE555A 1.49 LM2878P 2.25 L496 1.85  
NE555B 2.15 LM2879 1.85 L496 1.85  
NE564 2.85 LM3001 1.69 MC3423 2.90  
LM595 95 LM3003 49 MC3453 1.95  
LM598 1.45 LM3007 2.45 MC3456 1.29  
LM598 1.45 LM3007 2.45 MC3456 1.29  
NE570 3.85 LM3900 5.5 MC3469 5.25  
NE571 2.00 LM3905 1.15 MC3470 7.95

### VOLTAGE REGULATORS

7805 45 7805AL 60  
8.12, 24V .69 12.18, 24V 1.39  
7805, 12, 15V .85 7806, 12, 15V .75  
7806, 12, 15V .85 7806, 12, 15V .75  
7806/7806G 1.40 LM379H 1.25/6.85  
7806+AC 8.75 LM332K 4.85  
7806K 4.95 LM332K 4.85  
12, 15, 24V 1.29 LM337K 3.75  
7806 4.95 LM337K 3.75  
8.12, 15, 24V 79 LM350K 4.78

### SPECIAL PURPOSE CHIPS

MC14411 \$11.50 58174 \$11.25 HW97 \$ 9.25  
BR1941 11.50 5832 3.75 HW97 3.78  
34702 12.50 AY3278 11.80 6488 3.79  
5816 14.50 AY3900 11.50 6489 3.75  
8116 10.50 2513-011U 9.80 AY3910 1.29  
5307 10.50 2513-002L 9.50 AY3912 1.95  
MC4024 3.75 LPD7071 2.75 BS-263 3.95  
8038 3.75 3341 4.50 M6849 3.75  
9369 3.50 11C90 13.25 Diplexer 3.45  
98187 12.25 MC15908 2.95 LM13000N 1.95  
SP1000 Speech 59.95 TR1865 SW UART 84.25

### DATA ACQUISITION

ADC0800 34.95 ADC0817 38.78 1408.6 81.95  
ADC0804 8.45 DAC0800 4.75 1408.8 2.85  
ADC0808 1.90 DAC0806 2.85 DAC100 7.95  
ADC0816 14.25 DAC1022 5.85 DAC01 6.95  
AD7523JUN 197 L353N 1.90 LFY3201N 1.99  
LM3900 98  
LM3909 99  
LM3914 2.95  
LM3915 82.95  
LM3916 2.95  
LM3917 82.95  
LM3918 2.95  
LM3919 82.95  
LM3920 2.95  
LM3921 82.95  
LM3922 2.95  
LM3923 82.95  
LM3924 2.95  
LM3925 82.95  
LM3926 2.95  
LM3927 82.95  
LM3928 2.95  
LM3929 2.95  
LM3930 2.95  
LM3931 82.95  
LM3932 2.95  
LM3933 82.95  
LM3934 2.95  
LM3935 82.95  
LM3936 2.95  
LM3937 82.95  
LM3938 2.95  
LM3939 82.95  
LM3940 2.95  
LM3941 82.95  
LM3942 2.95  
LM3943 82.95  
LM3944 2.95  
LM3945 82.95  
LM3946 2.95  
LM3947 82.95  
LM3948 2.95  
LM3949 82.95  
LM3950 2.95  
LM3951 82.95  
LM3952 2.95  
LM3953 82.95  
LM3954 2.95  
LM3955 82.95  
LM3956 2.95  
LM3957 82.95  
LM3958 2.95  
LM3959 82.95  
LM3960 2.95  
LM3961 82.95  
LM3962 2.95  
LM3963 82.95  
LM3964 2.95  
LM3965 82.95  
LM3966 2.95  
LM3967 82.95  
LM3968 2.95  
LM3969 82.95  
LM3970 2.95  
LM3971 82.95  
LM3972 2.95  
LM3973 82.95  
LM3974 2.95  
LM3975 82.95  
LM3976 2.95  
LM3977 82.95  
LM3978 2.95  
LM3979 82.95  
LM3980 2.95  
LM3981 82.95  
LM3982 2.95  
LM3983 82.95  
LM3984 2.95  
LM3985 82.95  
LM3986 2.95  
LM3987 82.95  
LM3988 2.95  
LM3989 82.95  
LM3990 2.95  
LM3991 82.95  
LM3992 2.95  
LM3993 82.95  
LM3994 2.95  
LM3995 82.95  
LM3996 2.95  
LM3997 82.95  
LM3998 2.95  
LM3999 82.95

### 7400

7400 18 7448 5.88 74123 8.45 74176 8.99  
7401 18 7447 6.85 74125 42 74177 6.95  
7402 18 7446 6.88 74126 44 74179 1.34  
7403 18 7445 6.88 74127 48 74180 2.25  
7404 18 7451 10.74 74132 45 74181 1.75  
7405 23 7453 19.74 74136 47 74182 1.15  
7406 48 7458 18.74 74138 49 74183 1.85  
7407 7459 25.74 74142 29 74185 2.25  
7408 24 7460 37.74 74143 30 74187 8.77  
7409 18 7470 26.74 74144 25 74189 8.77  
7410 18 7472 33.74 74147 1.49 74191 8.77  
7411 24 7473 33.74 74148 1.19 74194 8.77  
7412 38 7474 34.74 74148 1.19 74194 8.77  
7413 34 7475 34.74 74149 1.19 74194 8.77  
7414 49 7476 34.74 74151 55 74196 7.75  
7415 40 7478 4.60 74152 87 74197 8.6  
7416 40 7480 6.95 74153 88 74198 1.15  
7417 48 7482 5.74 74159 1.19 74207 1.85  
7418 7485 45.74 74165 49 74221 1.19  
7419 7486 55.74 74166 59 74221 7.75  
7420 7487 19.74 74168 65 74228 2.80  
7421 35 7488 45.74 74169 69 74230 1.95  
7422 45 7489 55.74 74170 69 74230 1.95  
7423 29 7490 19.74 74171 69 74230 1.95  
7424 29 7491 19.74 74172 69 74230 1.95  
7425 29 7492 19.

# California Digital

17700 Figueroa Street • Carson, California 90248

## F10 DAISY WHEEL PRINTER

# \$499

## LETTER QUALITY



The TEC F-10 Daisy Wheel printer is the perfect answer to a reasonably priced 40 character word processing printer. While this printer is "extremely" similar to C.Itoh's F-10/40 Starwriter printer. Legal counsel for the C.Itoh Company have advised us that we should refrain from referring to the TEC printer as a Starwriter.

This 40 character per second printer auto installs with Wordstar and Perfect Writer. Features extensive built-in word processing functions that allow easy adaptability and reduced software complexity. Industry standard Centronics interface provides instant compatibil-

ity with all computers equipped with a parallel printer port. The TEC F-10 accepts paper up to 15 inches in width.

These printers were originally priced to sell at over \$1400. Through a special arrangement California Digital has purchased these units from a major computer manufacturer and is offering these printers at a fraction of their original cost.

Options available include tractor feed, buffered memory and an assortment of printer cables for a variety of computers.

## 10 MEGABYTE WINCHESTER SPECIAL

California Digital has recently purchased several thousand 10 Megabyte Winchester disk drives. The manufacturer has asked us not to advertise their name. Please telephone for details

# \$319

## Shugart 604 WINCHESTER



# \$99

These 6.7 Megabyte drives are new units recently released by the Shugart division of Xerox. The Shugart 604 is fully 506 industry compatible. Each drive is tested before shipment and is supplied with a 90 day warranty. SHU-604

### Five Inch Winchester Hard Disk Drives

FUJITSU M2235AS 27 Meg.	899	859
RODIME RO-208 53 Meg.	1589	1493
MAXTOR XT10140 140 Meg.	3895	3785
SHUGART 712 13 Meg. 1/2 Ht	495	465
SHUGART 604 6.7 Meg.	99	89
TANDON 502 10 Meg.	419	395
TANDON 503 19 Meg.	695	675
SEAGATE 225 25 Meg.	695	625



# \$119

Your Choice

## TEAC 55B 55F 48TPI-96TP

One Two Ten

### Five Inch Double Sided Drives

TEAC FD55B half height	119	115	109
TEAC FD55F 96 TPI, half ht.	119	115	109
CONTROL DATA 9409 PC	169	159	155
SHUGART SA455 Half Height	119	115	109
SHUGART SA465 1/2 Ht. 96TPI	119	115	109
TANDON 100-2 full height	149	145	139
TANDON 101-4 96TPI full ht.	299	289	279
MITSUBISHI 4851 half height	139	135	129
MITSUBISHI 4853 96/TPI 1/2 Ht.	155	149	139
MITSUBISHI 4854 8" elec.	295	285	275
QUME 142 half height	219	205	199

### Eight Inch Single Sided Drives

SHUGART 801R			
SIEMENS FDD 100-8	119	115	109
TANDON 848E-1 Half Height	369	359	349

### Eight Inch Double Sided Drives

SHUGART SA851R	495	485	475
QUME 842 "QUME TRACK 8"	319	319	313
TANDON 848E-2 Half Height	459	447	435
REMEX RFD-4000	219	219	209
MITSUBISHI M2896-63 1/2 Ht.	459	449	409

## MEMORY

4164 DYNAMIC MEMORY 150ns



Quantity 100

# \$1.35

### DYNAMIC MEMORY

4164 150ns. 64K 128 refresh	ICM-4164150	1.31	32 +	100 +
41256 150ns. 256K	ICM-41256150	2.29	1.99	1.35
4116 150ns. 16K	ICM-4116150	0.95	0.50	0.25
4116 200ns 16K	ICM-4116200	1.75	1.65	1.45
4128 for IBM/AT	ICM-4128150	0.95	0.75	0.35
DP8409 dynamic controller	ICT-8409	39.00	35.00	29.00

### STATIC MEMORY

21102 200ns. 1K static	ICM-21102200	1.49	1.29	1.15
21102 450ns. 1K static	ICM-21102450	1.29	1.15	.99
2112 450ns. 2K static	ICM-2112450	2.99	2.85	2.75
2114 300ns. 1K x 4	ICM-2114300	1.95	1.85	1.75
4044TMS 450ns. 4K x 1	ICM-4044450	3.49	3.25	2.99
5257 300ns. 4K x 1	ICM-5257300	2.50	2.25	1.99
6116 P4 200ns. 2K x 8	ICM-6116200	3.95	3.85	3.70
6116 P3 150ns. 2K x 8	ICM-6116150	4.55	4.35	4.15

### EPROMS

2708 450ns. 1K x 8	ICE-2708	4.95	4.75	4.55
2716 450ns. 2K x 8	ICE-2716	4.50	4.25	3.97
2716TMS 450ns. Tri-voltage	ICE-2716TMS	7.95	7.65	7.25
2732 450ns. 4K x 8	ICE-2732	4.50	3.75	3.55
2764 350ns. 8K x 8	ICE-2764	5.95	5.75	6.25
27128 350ns. 16K x 8	ICE-27128	7.95	7.35	6.95

Shipping: First five pounds \$3.00, each additional pound \$5.00. Foreign orders: 10% shipping, excess will be refunded. California residents add 6 1/2% sales tax. • COD's discouraged. Open accounts extended to state supported educational institutions and companies with a strong "Dun & Bradstreet" rating.





# California Digital

77700 Figueroa Street • Carson, California 90248

## NEC RGB COLOR MONITOR \$239



The NEC JC-1401D is a 13" medium/high resolution RGB monitor suitable for use with the Sanyo MBC-550/555 or the IBM/PC. The monitor features a resolution of 400 dots by 240 lines. Colors available are Red, Green, Blue, Yellow, Cyan, Magenta, Black and White. These monitors are currently being used in applications far more critical than microcomputers. The NEC monitor carries the Litton-Monroe label and was originally scheduled for use in their "Office of the Future" equipment. A change in Monroe's marketing strategy has made these units excess inventory which we are selling to California Digital. We are offering these prime "new" RGB monitors at a fraction of their original cost. Sanyo compatible NEC-1401/S; IBM/PC Computer compatible NEC-1401/PC

## COMPUTER PLOTTER

\$249

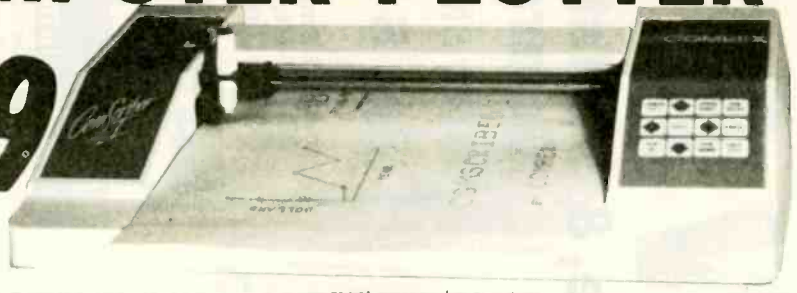

The Comrex Comscriber I is the ideal solution to make short work of translating financial and numeric data into a graphic presentation. Many ready to run programs such as Lotus 1-2-3, Visi-on and Apple business graphics already support this plotter. The Comscriber I features programmable paper sizes up to 8 1/2 by 120 inches, 6 inch per second plot speed and 0.004" step size. Easy to implement Centronics interface allows the Comscriber I immediate use with the printer port of

most personal computers. The Comscriber I is manufactured for Comrex by the Enter Computer Corporation. The plotter is marketed by Heath Kit and also sold under Enters own "Sweet P" Label. This is your opportunity to purchase a graphic plotter which was originally priced at \$795 for only \$219. Also available is a support package which includes demonstration software, interface cable, amulticolor pen assortment and a variety of paper and transparency material.

## MONITORS

IMC 12A green phosphor 15 kHz. composite video.	BMC 12A	78.95
IMC 12 high resolution 20MHz.	BMC 12EN	119.00
IMC 3002 12" green phosphor	AMK 300G	128.95
IMC 300A 12" amber phosphor	AMK 300A	138.95
IMC 310A designed for IBM/PC, amber	AMK 310A	158.95
Zenith ZVM122 Amber Phosphor 12" 40:80 column switch.	ZTH 122	89.95
Zenith ZVM125 green phosphor 12" 40:80 column switch	ZTH Z125	478.00
NEC JB1201 green phosphor 18 1/2" 40:80 composite video	NEC JB1201	159.00
NEC JB1260 commercial grade composite.	NEC JB1260	119.00
Comarc B open frame requires horiz. sync. & 12v. supply.	COM-BW9	59.00

## MODEMS

\$519



## 2400 BAUD

An exciting new modem from the telecommunication experts at Fujitsu. Reliable 2400 BPS communication over public phone lines. Automatically selects 2400 or 1200 baud depending incoming terminal speed. Integral speaker allows monitoring call progress. Will work in full and half duplex as well as simplex modes, both Synchronous and Asynchronous communication protocols are available. Switch selectable test modes available for digital loopback, analog loopback, and Asynchronous. Four microprocessor design assures reliable operation over noisy phone lines at both 1200 and 2400 baud. Switch selectable Bell 212A or CCITT V.22 compatible. Sleep mode can be enabled through the use of the DTR line.

## TELETYPE MODEL 40

\$239

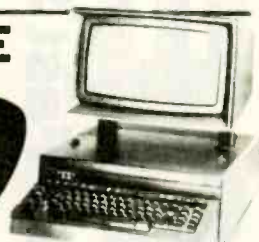

The Teletype Model 40 CRT terminal is continuous heavy duty communication equipment that have recently come off lease from a Cado Computer customer. It is seldom that California Digital becomes involved in the marketing of USED products but we felt that this peripheral represented such an exceptional value that we had to offer this equipment to our customers. Our engineering staff has fully tested every Model 40 terminal before shipment.

## PRINTERS

### MATRIX PRINTERS

Star Gemini 108 120 char/sec.	STR-G10X	249.00
Star Gemini 15X 100 char/sec. 15" paper	STR-G15X	365.00
Star Gemini Delta 10, 160 Char/sec	STR-D10	359.00
Toshiba P1351, 192 char/sec. letter quality	TOS P1351	1495.00
Datatac 82A serial & parallel 9" paper	OKI-82A	299.00
Datatac 92A parallel interface 160 char/sec.	OKI-92A	379.00
Datatac 83A & parallel 15" paper	OKI-83A	549.00
Datatac 84A & parallel 18" paper	OKI-84A	529.00
Epson LX 80 120 Char/sec	EPS-LX80	239.00
Epson FX 80FT, 10" 160 char./sec. with graphics	EPS-FX80	399.00
Epson FX 100FT 15" 160 char./sec. with graphics	EPS-FX100	599.00
Epson LX 1500, 15" correspondence quality	EPS-LX1500	1079.00
Epson JX 80 Color printer	EPS-JX80	579.00
Prowriter 85 10 parallel 8 1/2" paper	PRO-8510P	599.00
Prowriter II, parallel 15" paper, graphics	PRO-2P	599.00
Dataproducts B-600-3, band printer 800 LPM	DPS-8600	6995.00
Printpro P300 ultra high speed printer 300 lines per minute.	PTX-P300	3995.00
Printpro P600 ultra high speed 600 lines per minute	PTX-P600	5795.00

\$229



The Team 212A offers all the features of the Hayes Smart Modem 1200 for a fraction of the price. Now is your opportunity to purchase a 1200 baud modem at the price of a 300 baud modem. California Digital is so confident of your complete satisfaction that we will allow the return the Team 212A and apply the full credit towards the purchase of any other modem.

### ANCHOR AUTOMATION

\$69



The Anchor Automation Mark VI is a 300 baud direct connect modem that plugs into any slot of your IBM/PC. This modem supports auto answer and auto dial capabilities. Other features include telephone number storage, send/receive text files, single key-stroke dialing along with many other functions provided on disk. The Mark VI was originally priced at over \$300.

## DUAL TEAC SUBSYSTEM

\$289

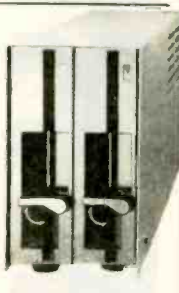

The dual Teac subsystem features your choice of two FD55B (48 tpi) or two FD55F (96tpi) 5 1/4" double sided disk drives. Also supplied within the subsystem is 50 watt power supply and a four foot shielded signal cable.

## WORD PROCESSING PRINTERS

Star Gemini F10 parallel 40 char/sec.	PHD-F10P	499.00
EC8810 55 char/second, serial interface	NEC 8810	1659.00
EC8830 55 char/sec. par1 interface	NEC 8830	1659.00
EC3550 popular printer designed for the IBM/PC	NEC-3550	1599.00
EC2950 designed for IBM/PC 20 char/sec. par1	NEC-2950	689.00
Silver Reed EXP500, 14 char/sec. par1 interface	SRD-EXP500	319.00
Silver Reed EXP550 17 Char/sec. par1 interface	SRD-EXP550	429.00
Labio 630 40 char./sec. serial	DLB 633	1469.00
Labio 620, proportional spacing, horiz. & vert. tab. 20 cps	DLB 620	768.00
Uki 6100, 18 char./sec	JUK-6100	399.00
Uki 6300, 40 char./sec	JUK-6300	699.00
Zemlin G12, 5-buff., proportional spacing, par1	CRK-G12P	395.00

## TERMINALS

Freedom 100, split screen, detachable keyboard	LIB-F100	495.00
June 102 green phosphor terminal	QJM-102	535.00
Amplex Dialogue 125 green screen.	APX-D125G	675.00
Amplex Dialogue 175 amber screen, two page, func. keys	APX-D175A	719.00
Nyse 50, 14" green phosphor	WYS-50	395.00
Nyse 300, Eight color display, split screen	WYS-300	1159.00
Termin 29 terminal, VT32 compatible, detach. kb keyboard.	ZTH-229	765.00
Televideo 910 Plus, black mode	TVI-910P	575.00
Televideo 925, detachable keyboard, 22 function keys	TVI-925	769.00
Televideo 950, graphic char., split screen, 22 func.	TVI-950	950.00
Televideo 970, 14" green, 132 column, European	TVI-970	1095.00

Fujitsu 2400/1200 baud auto everything.	FLL-1935D	519.00
Team 1200 Hayes Compatible	TEM-SM1200	229.00
CTS 212AH 1200 baud auto dial	CTS-212AH	299.00
Terminal software for CTS 212AH	CTS-212SF	35.00
Prometheus 1200 super features	PRM-P1200	319.00
Prometheus 1200B internal PC	PRM-P1200B	279.00
Signalman Mark 12, 1200 baud, Hayes compatible.	SGL-MK12	239.00
Signalman Mark VI, 300 baud internal PC	SGL-MK6	69.00
Signalman Mark 1, direct connect with terminal cable	SGL-MK1	75.00
Hayes Smart Modem 1200 baud, auto answer, auto dial	HYS-212AD	429.00
Hayes 1200B for use with the IBM/PC, 1200 baud	HYS-1200B	399.00
Hayes Smartmodem, 300 baud only, auto answer, auto dial	HYS-103AD	229.00
Hayes Micromodem II, 103 Aupac direct connect	HYS-MMK2	279.00
Hayes Chronograph, time & date	HYS-CHR232	199.00
Pennil 300/1200 industrial quality	PRM-12AD	495.00
Universal Data 103LP, line power, answer & originate	UDS-103LP	169.00
Universal Data 202, 1200 baud, full duplex only	UDS-202P	219.00
Universal Data 212P, full 1200 baud duplex, line power	UDS-212P	359.00

## Return of a Smash Hit Sellout DRAGON \$99



Compatible with most Radio Shack Color Computer software, The world famous Dragon computer is now available in the United States. Manufactured by the Tano Corp. under license of the Binish Broadcasting Company. The Dragon comes complete with 64K Byte of memory, serial modem port along with a Centronics printer interface. This unique micro-computer features Motorola's advanced 6809C microprocessor and comes standard with Microsoft Color Basic, data base manager, and a complete word processing package. The computer outputs color composite video along with R.F. video that allows the unit to be used in conjunction with any color television. This is the ideal low cost computer to be used with any data up information system such as the Source, Western Union's EasyLink or any other time share service.

TOLL FREE ORDER LINE (800) 421-5041

TECHNICAL & CALIFORNIA (213) 217-0500

# PRICE WARR!

## Name Brands, Fast Service, & Satisfaction Guaranteed

TALL TREE JRAM-2  
**2 MEGABYTE**  
 Multi-Function Board for your  
 IBM, PC, XT, AT

WITHOUT MEMORY  
**\$199<sup>95</sup>**

- Up to 2 megabytes of RAM
- Optional Parallel, Serial & Clock
- Free Jet Driver/J Spool Software
- Uses only 1 slot
- No loose cables!

	LIST	JADE
J RAM-2 without memory	\$219	\$199 <sup>95</sup>
J RAM-2 with 1 megabyte	\$519	\$499 <sup>95</sup>
J RAM-2 with 2 megabytes	\$819	\$699 <sup>95</sup>
Serial/Parallel/Clock module	\$180	\$149 <sup>95</sup>
Serial/Serial/Clock module	\$269	\$229 <sup>95</sup>
J RAM-AT without memory	\$569	\$479 <sup>95</sup>
J RAM-AT with 1 megabyte	\$869	\$749 <sup>95</sup>
J RAM-2 with 2 megabytes	\$1130	\$1199 <sup>95</sup>
AT Serial/Parallel module	\$130	\$119 <sup>95</sup>
Jet Driver/J Spool Software	\$120	\$99 <sup>95</sup>

**JADE ExpandoRam**  
**Multifunction Card \$169<sup>95</sup>**  
**For Your IBM PC**

Up to 384K, parallel printer port, RS-232 serial port, game port, clock/calendar, RAM disk/printer buffer and diagnostic software package.

	LIST	JADE
0K JADE Expando RAM	\$299	\$169 <sup>95</sup>
64K JADE Expando RAM	\$449	\$194 <sup>95</sup>
256K JADE Expando RAM	\$549	\$259 <sup>95</sup>
384K JADE Expando RAM	\$649	\$279 <sup>95</sup>

**AST for IBM PC**

**135 WATT**  
 Drop-in replacement  
**POWER SUPPLY**  
 For your IBM PC  
 List Price \$199 **\$119<sup>95</sup>**

**IBM PC-XT**  
 10 Megabyte, 256K, Serial Port

**\$2895**

**IBM PC-AT**  
 Enhanced With 20 Megabyte

**\$4995**

**10 MEGABYTE**  
**Hard Disk System**



FOR YOUR  
**IBM PC**

**\$499<sup>95</sup>**

Complete with controller card, data cable, and mounting hardware, totally PC/XT compatible. External model includes cabinet & power supply.

**Expansion Boards**  
**for Your IBM-AT**

	LIST	JADE
128K AST Advantage-AT	\$595	\$449 <sup>95</sup>
512K AST Advantage-AT	\$1395	\$999 <sup>95</sup>
1.5 MB AST Advantage-AT	\$2195	\$1599 <sup>95</sup>
3.0 MB AST Advantage-AT	\$4145	\$2999 <sup>95</sup>
JADE AT-Expando Plus	\$495	\$395 <sup>95</sup>
STB Rio Grande 128K to 1.5M	\$495	\$359 <sup>95</sup>
STB Grande Byte 128K to 2.5M	\$395	\$299 <sup>95</sup>
Quadport-AT 1S, 1P	\$154	\$139 <sup>95</sup>
4 Serial Port Option For Above	\$195	\$179 <sup>95</sup>
128K Upgrade Kit	\$395	\$129 <sup>95</sup>
20 Megabyte Hard Disk	\$1790	\$895 <sup>95</sup>
360K Disk Drive for AT	\$395	\$119 <sup>95</sup>

**IBM Video Boards**

	LIST	JADE
Hercules Color	\$245	\$189 <sup>95</sup>
Hercules Graphic	\$499	\$339 <sup>95</sup>
Plantronics Color Plus	\$549	\$379 <sup>95</sup>
AST Preview	\$399	\$309 <sup>95</sup>
AST Monograph Plus	\$449 <sup>95</sup>	\$499 <sup>95</sup>
Tecmar Graphics Master	\$699	\$499 <sup>95</sup>
Quadcolor I	\$295	\$209 <sup>95</sup>
Quadcolor II	\$275	\$209 <sup>95</sup>
PC Peacock	\$299	\$239 <sup>95</sup>
Paradise Graphics Card	\$395	\$319 <sup>95</sup>
Sigma Color 400	\$795	\$599 <sup>95</sup>
JADE RGB w/ Parallel & Serial	\$299	\$199 <sup>95</sup>
Everex Graphics Edge	\$599	\$349 <sup>95</sup>

**HAYES SMARTMODEM**  
 YOUR CHOICE **\$169<sup>95</sup>**  
 HAYES Smartmodem 300  
 HAYES Micromodem IIc  
 HAYES Smartmodem IIc

**SAVE UP TO \$200!**

**HAYES Smartmodems**

Sophisticated direct-connect auto-answer/auto dial modem, touch tone or pulse dialing RS232 interface programmable

	LIST	JADE
HAYES Smartmodem 2400	\$899	\$629 <sup>95</sup>
HAYES Smartmodem 1200	\$699	\$389 <sup>95</sup>
HAYES 1200B w/o Smartcom II	\$539	\$339 <sup>95</sup>
HAYES 1200B for IBM PC	\$599	\$359 <sup>95</sup>
HAYES Smartmodem 300	\$289	\$169 <sup>95</sup>
HAYES Chronograph	\$249	\$199 <sup>95</sup>
HAYES Micromodem IIc	\$299	\$169 <sup>95</sup>
HAYES Smartmodem IIc	\$399	\$169 <sup>95</sup>
HAYES Transet 1000	\$399	\$299 <sup>95</sup>
HAYES Smartcom II	\$149	\$99 <sup>95</sup>
Modem Cable	\$35	\$24 <sup>95</sup>

**PROMODEMS**  
**AS LOW AS \$149<sup>95</sup>**

	LIST	JADE
ProModem 300c for Apple IIc	\$199	\$149 <sup>95</sup>
ProModem 1200B for IBM PC	\$399	\$289 <sup>95</sup>
ProModem 1200 RS-232	\$495	\$299 <sup>95</sup>
ProModem 1200A for Apple	\$449	\$349 <sup>95</sup>
ProModem 1200 for Macintosh	\$99	\$79 <sup>95</sup>
Alpha/num Display Option	\$495	\$349 <sup>95</sup>
Options Processor	\$99	\$79 <sup>95</sup>
64K Mem Expansion for Above	\$99	\$19 <sup>95</sup>
Modem Cable	\$35	\$24 <sup>95</sup>

**Expand Your PC jr**

	LIST	JADE
External 360K Disk Drive	\$499	\$369 <sup>95</sup>
AST 512K jr Combo w/ 128K	\$395	\$299 <sup>95</sup>
Tecmar Captain jr w/ 128K	\$489	\$349 <sup>95</sup>
Parallel Printer Port	\$120	\$94 <sup>95</sup>

**JADE 1200 BAUD MODEM**

	LIST	JADE
Hayes Smartmodem compatible, 1200 BAUD modem at a fraction of the price. FCC approved.		
JADE 1200 BAUD Modem	\$399	\$229 <sup>95</sup>
JADE 1200B for IBM	\$399	\$239 <sup>95</sup>
JADE 2400 BAUD Modem	\$699	\$449 <sup>95</sup>

## Mouse by MOUSE SYSTEMS

	LIST	JADE
PC MOUSE with Pop-ups	195	\$139.95
PC MOUSE with Paint	220	\$159.95
FIELD MOUSE (male or female)	175	\$129.95
PC PAINT Software	99	\$69.95
MOUSE WINDOW Software	150	\$109.95
POP UP MENU Software	99	\$39.95

## 64K RAM Upgrade Kits for Your IBM PC \$1795

High speed RAM upgrade kit with FREE! parity (error detection) and one year warranty. We ship thousands of these kits to satisfied customers every week.

	LIST	JADE
128K RAM Chip Kit for AT	359	\$129.95
256K RAM Chip Kit	495	\$178.95

## QUADRAM for IBM PC

	LIST	JADE
Quadboard No RAM	269	\$234.95
Quadboard 64K	395	\$275.95
Quadboard 128K	495	\$319.95
Quadboard 256K	595	\$399.95
Quadboard 384K	795	\$489.95
Quadlink	680	\$349.95

## TEAC 55B 360K Disk Drive for IBM PC \$9995

	LIST	JADE
Double-sided, double density	299	\$119.95
TANDON 100-2	249	\$99.95
TEAC 55B		

## The LITTLE BOARD with FREE! CP/M 2.2

Miniature single board CP/M computer designed to mount directly on top of a 5 1/4" floppy disk drive (7.75" x 5.75")

	LIST	JADE
Little Board with CP/M	400	\$329.95
Support Package	59	\$48.95
Serial Cable	13	\$11.95
Diskless Monitor Eptom	30	\$24.95
SCSI/Plus I/O Adapter	99	\$89.95

## MICROSOFT for IBM PC

	LIST	JADE
Microsoft Word	495	\$319.95
Microsoft Mouse, RS-232 Serial	199	\$129.95
Microsoft Mouse, IBM Buss	199	\$129.95

## HIGH RESOLUTION TAXAN MONITOR RGB COLOR \$29995

640 x 260, .38 Dot Pitch  
LIST PRICE \$699  
For cable add \$19.00



## High Resolution Video Monitors

	LIST	JADE
Amdtek 300G	179	\$139.95
Amdtek 300A	199	\$149.95
Amdtek 310A	230	\$179.95
Amdtek Color 300	349	\$269.95
Amdtek Color 500	525	\$399.95
Amdtek Color 600	650	\$449.95
Amdtek Color 710	799	\$589.95
PGS MAX-12	269	\$179.95
PGS HX-12 640x240	699	\$449.95
PGS SR-12 720x480	799	\$629.95
PGS Scan-Doubler	299	\$199.95
14 inch Quadchrome II	599	\$499.95
Taxan 440 Ultra Hi-res RGB	799	\$599.95
Taxan 210 RGB/Composite	349	\$289.95
Taxan TV Tuner for RGB Monitor	99	\$89.95

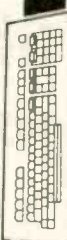

## KEYTRONICS

	LIST	JADE
5150 Improved IBM Keyboard	209	\$159.95
5151 Deluxe IBM Keyboard	299	\$199.95

## High Speed 8087 APU

LIST PRICE \$293 ..... SALE PRICE \$119.95

## ISO-BAR



These industrial quality ISO-BARS look like a standard multi-outlet power strip but contain surge suppression circuitry and built-in noise filters plus a 15 amp circuit breaker.

	LIST	JADE
4 Receptacle Iso-Bar	89	\$59.95
8 Receptacle Iso-Bar	99	\$69.95

**UNINTERRUPTIBLE POWER SUPPLY**  
Emergency back-up power to save your computer system and your valuable data. A must for every computer system

	LIST	JADE
200 Watt UPS	359	\$279.95
425 Watt UPS	539	\$459.95
1000 Watt UPS	1179	\$995.95

## Disk Drive for Your Apple IIc \$12995



	LIST	JADE
Disk Drive for Apple IIc	249	\$129.95
Full Height Disk Drive	299	\$139.95
Half Height Disk Drive	249	\$129.95
ALS Z Engine	299	\$145.95
16K RAM Card	99	\$39.95
64K 80 Column Card for IIc	219	\$119.95
Best 80 Column Card II/II+	219	\$139.95
Printer Card & Cable	109	\$49.95
Fan with Surge Protection	99	\$59.95
Grapppler Plus	175	\$99.95
64K Buffered Grapppler+ w/16K	275	\$149.95

## JADE XPC

- ▶ 256K of RAM Expands to 640K on Main Board
- ▶ 140 Watt Power Supply
- ▶ 4.77 or 7 MHz Clock
- ▶ 8 Expansion Slots
- ▶ Deluxe Keyboard
- ▶ 90 Day Warranty



## 256K of RAM, Two 360K Disk Drives, & Disk Controller \$1295

## OPTION #1 \$1995

- 256K of RAM
- 10 Megabyte Hard Disk
- One 360K Drive
- 130 Watts of Power
- Multifunction Card
- Hercules Card
- Amdtek 300

## OPTION #2

- 256K of RAM
- Two 360K Drives
- Parallel & Serial Ports
- Taxan RGB Monitor

## IBM PC \$1995

## JADE XPC \$1595

## IBM PC \$2995

## JADE XPC \$2495

## IBM PC \$2395

## JADE XPC \$1995

Place Orders Toll Free!

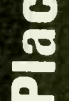

Continental U.S.A. Inside California Los Angeles Area  
(800) 421-5500 (800) 262-1710 (213) 973-7707

# JADE

## Computer Products

4901 West Rosecrans Ave. Hawthorne, CA 90250

## NEW! EPSON LX-80

EPSON LX-80 100 cps, NLQ  
 EPSON RX-100F/T+ 100 cps  
 EPSON JX-80+ 160 cps, Color  
 EPSON FX-80FT + 160 cps  
 EPSON FX-100F/T+ 160 cps  
 EPSON LQ-1500 200 cps, NLO  
 EPSON HI-80 4 Pen Plotter  
 EPSON/COMREX 420 cps  
 2K Serial Board for RX/FX  
 NLO Board for RX/FX  
 LetterWriter NLQ Kit for FX  
 LX-80 Tractor  
 FX-80 Tractor  
 LQ-1500 Tractor  
 LQ-1500 Sheet Feeder

\$2,495 \$1,749.95  
 \$149 \$99.95  
 \$219 \$179.95  
 \$75 \$59.95  
 \$59 \$29.95  
 \$59 \$39.95  
 \$89 \$49.95  
 \$499 \$399.95

## NEW! OKIDATA PRINTER

MICROLINE **\$349.95**

**192**  
 160 CPS, Near Letter Quality, & Graphics  
 Call For Price

	LIST	JADE
OKIMATE 20 Color printer	\$150	\$139.95
PLUG-N-PRINT for OKI 20	75	69.95
OKI 182 120 cps, graphics	\$299	\$259.95
OKI 192 160 cps, graphics	\$499	\$449.95
OKI 193 160 cps, 15" paper	\$699	\$649.95
OKI 192 160 cps, graphics	\$599	\$549.95
OKI 93 160 cps, 15" paper	\$995	\$949.95
OKI 84 200 cps, parallel	\$1399	\$1299.95
OKI 84 200 cps, serial	\$1499	\$1399.95
Tractor for OKI 192	50	44.95
Tractor for OKI 92	89	54.95
2K Serial Board for 192/193	99	69.95
2K serial Board for 92/93	\$120	\$99.95
Extra Ribbon	9	14.95

**Double-sided Double-density Diskettes**  
 In bulk packages of 125 pcs. **99¢** Each

	LIST	JADE
Single-sided, double-density	\$34	\$16.50
Double-sided, double-density	\$42	\$19.50
Double-sided, 1.2 MB for AT	\$69	\$49.50
3 1/2" Single-sided for Mac	\$69	\$39.50
3 1/2" Double-sided for DG/1	\$89	\$49.50
Bulk Diskettes as low as		90¢

Continental U.S.  
**800-421-5500**  
 Inside California  
**800-262-1710**

For Technical Inquiries  
 or Customer Service call:  
**213-973-7707**

## CITIZEN Printers

Best Near-Letter-Quality printers for under \$1000!!!

	LIST	JADE
CITIZEN MSP-10 FT 160 cps	\$499	\$329.95
CITIZEN MSP-15 FT 160 cps	749	\$479.95
CITIZEN MSP-20 FT 200 cps	\$699	\$479.95
CITIZEN MSP-25 FT 200 cps	\$949	\$629.95
CITIZEN Serial Option	60	\$49.95

## Printer Accessories

	LIST	JADE
IBM PC style cable	54	\$19.95
Standard parallel cable	40	\$19.95
Dual Printer Switch Box	149	\$89.95
Apple Card & cable	109	\$49.95
RS-232C serial cable	30	\$24.95
Ribbons	as low as	\$4.99
Apple IIc cable	39	\$19.95

**SHUGART 851R**  
 Double-sided, Double-density  
**8" DISK DRIVE**  
 LIST PRICE **\$249.95**  
 \$605

	LIST	JADE
Dual 851 Sub-System Kit	\$1445	\$999.95
Dual 851 Sub-System A&T	\$1645	\$799.95
Complete dual 851 disk drive sub-system with two Shugart SA-851R, cabinet, power supply, fan, etc.		

We accept cash, checks, credit cards, or purchase orders from qualified firms and institutions. Minimum prepaid order \$15.00 California residents add 6 1/2% tax. Export customers outside the US or Canada please add 10% to all prices. Prices and availability subject to change without notice. Shipping and handling charges via UPS Ground 50¢/lb. UPS Air \$1.00/lb. Minimum charge \$3.00

WHY PAY \$1149 FOR A C. ITOH

# STARWRITER™ F-10

When Our 40 CPS Letter-Quality Daisywheel  
 From The Same Manufacturer

IS **\$499.95**  
 ONLY

For 2K Buffer Option Add \$299.95

StarWriter is a Trademark of C. Itoh Digital Products, Inc.



## A-B Printer Switch

Fully bi-directional switch allows your computer to run either of two printers, or allows two computers to share one printer. standard parallel switch box

	LIST	JADE
Printer Switch	\$149	\$69.95
Extra Cable	40	\$29.95

## Data Switches

	LIST	JADE
SERIAL A-B Switch	\$129	\$79.95
PARALLEL A-B Switch	\$129	\$79.95
SERIAL A-B-C-D Switch	\$175	\$89.95
PARALLEL A-B-C-D Switch	\$175	\$89.95

## QUADRAM MICROFAZER Buffers

Expandable to 64K (parallel model expands to 512K)

	LIST	JADE
8K Parallel in/Parallel out	\$169	\$139.95
64K Parallel in/Parallel out	\$225	\$164.95
128K Parallel in/Parallel out	\$445	\$269.95
8K Serial in/Parallel out	\$199	\$169.95
64K Serial in/Parallel out	\$260	\$199.95
8K Parallel in/Serial out	\$199	\$169.95
64K Parallel in/Serial out	\$260	\$199.95
8K Serial in/Serial out	\$199	\$169.95
64K Serial in/Serial out	\$260	\$199.95

## PRACTICAL PERIPHERAL MICROBUFFERS

Stand alone Microbuffers for Printers & Modems

	LIST	JADE
32K Parallel in/Parallel out	\$299	\$229.95
64K Parallel in/Parallel out	\$349	\$249.95
32K Serial in/Serial out	\$299	\$229.95
64K Serial in/Serial out	\$349	\$249.95
64K Add-on Board	\$179	\$149.95

## Letter Quality Printers On Sale!

	LIST	JADE
JUKI 6100 18 CPS	\$599	\$399.95
JUKI 6300 40 CPS	995	\$849.95
COMREX CR-11e 20 CPS	\$599	\$399.95
NEC 3550 33 CPS	\$2250	\$1399.95
DIABLO 630 40 CPS	\$2340	\$1569.95
TOSHIBA P1340 180 CPS	995	\$599.95
TOSHIBA P1351 180 CPS	\$1895	\$1249.95
TOSHIBA P351 208 CPS	\$1850	\$1299.95
T.I. 855 150 CPS	\$935	\$689.95
T.I. 865 150 CPS	\$1299	\$949.95

## STAR Printers

	LIST	JADE
SG-10 120 CPS	\$299	\$239.95
SG-15 120 CPS	\$499	\$399.95
POWERTYPE 18 CPS	\$499	\$359.95

# JADE

Computer Products

NEW

### Monitor Mover Gives Back the Desk



\$159.95

- Models to fit most CRT's
- Rotates 360° on base
- Adjustable height
- Support tray swivels and tilts
- Holds up to 50 lbs
- Clamp, screw and wall mountings

Lintek

P.O. Box 8056  
Grand Rapids, MI 49508  
(616) 241-4040

Inquiry 213

### EPROM PROGRAMMER



APROTEK 1000  
ONLY  
**\$265.00**

COMPLETE WITH  
PERSONALITY  
MODULE

117 AC POWER-RS232  
-6 BAUD RATES- HANDSHAKE TO HOST  
-ALLOWS READ, WRITE, VERIFY & COPY

Comes complete with CPM, IBM and Apple BASIC Driver Program Listings. Driver Programs on Disk only \$20.00.

Programs the following 5 Volt 24 or 28 pin devices: 2716 series through 27256, 25xx series, 68764 plus others. Please Specify Personality Module desired with order. Additional Personality Modules only \$15.00 ea. Full 1 year warranty.

TO ORDER: CALL 1-800/962-580C OR WRITE

APROTEK  
1071-A AVENIDA ACASO Add  
CAMARILLO, CA 93010 \$4.00 Shipping USA  
Info: (805) 987-2454 VISA or MC Add 3%

Inquiry 38

300/1200 (Hayes Compatible) **MODEM \$179**  
**COMPLETE KIT \$120**



Add 5% Shipping • 10 DAYS MONEY BACK GUARANTEE

(Allow 3 Weeks Delivery)

**IBM-XT or APPLE IIe \$210 EA.**  
(98% compatible, new or replacement)

### MOTHERBOARD

(64K, no Rom. Tested. 30 days guarantee)

- FOR IBM: \*Control Card ..... \$70
- \*Printer or Game Card ..... \$35
- \*Color Graphic Card ..... \$120

**BEST PRICES FOR APPLE/IBM CARDS**  
Write for Price List — Dealer Welcome

CONCORD Technology Inc. Ph.: (604) 879-3555  
47 W. Broadway, Van., B.C. Canada V5Y 1P1

Inquiry 105

### Your I.C. Connection (213) 516-7018

DYNAMIC RAMS	
4164-150NS	1.59
41256-150NS	5.69
STATIC RAMS	
6264LP-150NS	9.99
6116P-3 (150NS)	2.27
6116LP-3 (150NS)	2.59
EPROMS	
2716-450NS	2.79
2532-450NS	3.59
2764-250NS	3.89

MANY OTHERS IN STOCK  
CALL FOR SPECIAL PRICES

- Low, low prices
- Top Quality Parts
- Wide Selection
- Fast Delivery

**EXIM INTERNATIONAL (U.S.A.)**  
A DIVISION OF HAN YANG TRADING COMPANY, INC.

13760 Grammercy Place  
Gardena, CA 90249

TLX: 664747 HYEXIM FAX: (213) 217-0363

Inquiry 144

### Computer System Sale

Lowest Price Computer System in the U.S.A.

**\$449.00**

Includes Atari 800XL 88K Computer, 127K Disk Drive, 20 CPS Letter Quality Printer, Beginners Basic Book, and more. List \$852.90.

All for only \$449.00

152K System \$499.00

**312/ 382-5050**

- Over 1000 programs available
- free catalog

### COMPUTER DIRECT

22292 N. Pepper Rd., Barrington, IL 60010

We Love Our Customers

Inquiry 291

### MetalCE-31



Powerful Real Time 8031 Emulator That Runs on your IBM PC

The MetalCE series of emulators provide full speed, real time, transparent in-circuit emulation capability for either the 8031, 8032 or 8344. Many unique features are provided including over 16,000 hardware breakpoints. MetalCE emulators simply connect to your IBM PC or compatible through an RS232C interface. Each MetalCE emulator includes an advanced menu driven host interface. Prices start at under \$1,500.00. A Demonstration Package is available for \$35.00. Call toll free for more information: 1-800-METAICE.

MetaLink Corp.  
33 W. Boxelder Place  
Chandler, AZ 85224  
1-800-METAICE In AZ (602) 926-0797

Inquiry 230

### POWERFUL MICROCONTROLLER SYSTEM w/BASIC MONITOR



#### 4015 Board System Featuring:

- Intel's Powerful 8052-BASIC Microcontroller
- Up to 32K EPROM Programmability (2764/128)
- Up to 24K RAM (8K RAM provided)
- 2/8255, 1/8155 I/O chips, & 8741 option
- Auto Baud/RS232C/10MHz crystal
- 5 1/2" x 11 1/2" PCB
- \$389 assbl'd/tested 4015 board + \$10 P&H

For further info on 4015 & other micro's Contact:

**Tech Star Laboratory**  
1701 N. Greenville Ave; Suite 709  
Richardson, TX 75081  
(214) 680-2304

Inquiry 353

### AMBER CRTs

- Eliminates strobe, flicker, and eye fatigue
- Made with Lead/Strontium impregnated glass that stops X-ray emission
- Available in slow decay green or medium decay "European Amber" (the standard in Europe)
- High-contrast double dark face glass that also cuts U.V. radiation
- Tube face is etched to stop glare
- Ideal for word processing and programming, yet fast enough for games and graphics
- Warranted for one full year against manufacturing defects or tube failure
- Comes with a 30-day money back guarantee
- Easily installed (comes with premounted hardware)

Now, you can easily upgrade your monitor to exceed European standards for persistence and color with the installation of a Langley-St. Clair Soft-View™ CRT! Available for the TRS-80,™ TeleVideo™ Kaypro™ Heath™ DEC™ Zenith™ IBM PC™ Apple III™ and a wide variety of other monitors

Call now to order your Soft-View™ CRT from Langley-St. Clair — \$99.95 Plus \$7 for packing and UPS Shipping (\$17 for Overseas, Parcel Post or UPS Blue Label). Add sales tax where applicable. Visa/MasterCard orders welcomed.

TO ORDER:  
CALL 800  
221-7070

Langley-St. Clair  
Instrumentation Systems, Inc.  
132 W. 24th St.  
New York, NY 10011  
In New York call 212 989-6876

### RAM Memory Expansion Kit 4264/4164 Compatible Fits Major PC Brands

Free Shipping!



FACTORY DIRECT HIGHEST QUALITY!

MICRON DRAMs	LIST	OUR PRICE!
9 64K DRAMs	\$ 25.	\$ 20.
9 128K DRAMs	\$359.	\$125.
9 256K DRAMs	\$369.	\$149.

150 ns Access Time

**MICRON TECHNOLOGY, INC.** Marketing Department  
2805 E. Columbia Rd.  
Boise, Idaho 83706

(208) 386-3900 TWX 901-970-5973

IMMEDIATE SHIPPING!

VISA, MasterCard, Certified Check,  
COD & Money Orders

Inquiry 241

# COASTLINE COMPUTERS

# 800-228-4615

Please call collect if 800 number not in service.

## 213-329-4828

1956 W. 153 St., Gardena, CA 90247

**COASTLINE OFFERING A 2% DISCOUNT WHEN PREPAYING WITH CASHIERS CHECK OR MONEY ORDER – WE JUST LEFT THE COMPETITION BEHIND!**

### IBM PC

- 2 MPI Full High Drives
- 256K Memory

**\$1549**

### IBM PC

- 2 Drives, 256K Memory
- Color Card and HX12

**\$2100**

### IBM XT

- 1 Drive, 10Mb Hard Disk
- 128K Memory, 100% IBM

**\$2695**



### IBM PC

- 2 ½ High Teac 55B's
- 256K Memory
- Color Graphics Board
- Green 12" Monitor

**\$1699**

### IBM PC

- 2 Teac 55B ½ High Drives
- 256K Memory
- 8087-2 Math Chip
- OKI 192 Printer
- All Cables Included

**\$2195**

**WE WILL NOT BE UNDERSOLD BY ANYONE – CALL US TODAY!!!**

<b>COMPAQ Portable</b> 2 Drives & 256K <b>\$1959.00</b>	<b>COMPAQ Desk Pro 2</b> 2 Drives, 256K, Grn Monitor <b>\$2299.00</b>	<b>COMPAQ Plus</b> Portable with Hard Disk <b>\$3395.00</b>
<b>INTEL Math Coprocessor</b> 8087-3 for PC & Compatibles <b>\$109.00</b>	<b>AST SIXPAC +</b> Comes with 384K, Clock Calendar, Par/Ser Port, Plus Software <b>\$299.00</b>	<b>PRINCETON GRAPHICS</b> HX-12 Color Monitor <b>\$439.00</b>
<b>IBM CABLE</b> Computer to Par Printer 6 Foot Long <b>\$12.50</b>	<b>BMC</b> 13" Amber Monitor <b>\$89.00</b>	<b>IBM DOS 2.1 or 3.1</b> IBM PC & XT Operating System <b>\$54.99</b> DOS 3.1 Latest Version - Call
<b>QUANTITY ORDERS</b> Call for Bigger Discounts Corporate & School Accts Call for Information Dealer Programs Avail - P.O.s Expedited	<b>Star Micronics</b> <b>GEMINI</b> SG-10 Printer <b>Lowest Price - Call</b>	<b>CAL DEK 10 Meg</b> <b>INTERNAL HARD DISK</b> For PC or Compatible Comes w/Drive Controller <b>\$644.00</b> (120 day warranty)
<b>DRIVE CONTROLLER</b> PC Compatible Card <b>\$69.00</b>	<b>OKIDATA 192P</b> 160 cps for IBM PC <b>\$369.00</b>	<b>KEYTRONICS</b> 5151 Keyboard <b>\$179.00</b>

Mail Orders To: 1956 W. 153 St., Gardena, CA 90247. Terms: Visa, Mastercard, COD:s and Wire Transfers. No surcharge for credit cards. UPS, Federal and Emery shipping available. Calif. residents add 6½% sales tax. Prices subject to change without notice. Not responsible for typos.

ORDER TOLL FREE **800-228-4615** FOR SPECIALS YOU WONT BELIEVE

<b>HAYES MODEM</b> 1200 Baud Internal Modem w/SmartCom 1 Software <b>\$339.00</b> 2400 Baud \$639.00	<b>ANCHOR MODEM</b> Mark 12 External 1200 Baud Modem <b>\$219.00</b>	<b>ANCHOR MODEM</b> Volksmodem 12 300 - 1200 Baud Modem <b>\$189.00</b>
<b>AMDEK MONITOR</b> Color 710 Superior RGB Resolution <b>\$559.00</b>	<b>AMDEK MONITOR</b> 310A Monochrome <b>\$159.00</b>	<b>PRINCETON GRAPHICS</b> HX-12 (Hi Res Color) \$439.00 MAX-12 (Monochrome) \$169.00 SR-12 & Scandouble      Call
<b>BMC MONITOR</b> Color Monitor <b>\$189.00</b>	<b>TAXAN MONITOR</b> Model 122 <b>\$139.00</b>	<b>GORILLA MONITOR</b> Green Monitor <b>\$89.00</b>
<b>DRIVES (IBM Compatible)</b> TEAC 55B      \$95.00 MPI B-52      \$75.00 TANDON 100-2      \$119.00	<b>DISKETTES</b> DYSAN DS/DD      \$29.95 COASTLINE DS/DD \$19.95	<b>DISK CLEANERS</b> <b>HEAD CLEANERS</b> <b>CALL</b>
<b>OKIDATA PRINTER</b> 192P (160cps) Streamline, Near Letter Quality <b>\$369.00</b>	<b>GEMINI PRINTER</b> SG 15 (100cps) <b>\$389.00</b>	<b>JUKI PRINTER</b> 6100 (18cps)      \$389.00 6300      Call Juki Tractor      \$129.00
<b>MEMORY UPGRADES</b> 64K      \$9.25 128K      \$18.00	<b>DEALERS NOTE</b> 1000 pcs 4164      \$ .80 ea. 5000 pcs 4164      \$ .75 ea.	<b>HERCULES</b> Color Card w/Par. Port      \$169.00 Monocard      \$309.00
<b>INTERFACE</b> Techmar Graphics Master \$449.00 Quadram Color I      \$199.00	<b>AST SIXPAC</b> Par./Ser. Port Exp to 384K <b>\$239.00</b>	<b>QUADBOARD</b> with Game and 64K <b>\$249.00</b>
<b>MATH COPROCESSOR</b> Intel 8087-2 <b>\$95.00</b>	<b>VOLT GUARD</b> Surge Protector <b>\$39.00</b>	<b>Paradise Graphics Card</b> \$259 <b>Persyst BOB Card</b> \$359 <b>Taxan Monitors</b> Call
<b>IBM PC's</b> Quantity Orders Welcome <b>CALL</b>	<b>IBM PC's</b> Barebone Available <b>CALL</b>	<b>CALL FOR LATEST</b> <b>PRICE CHANGES</b>

The Only Friend You need When Buying a New PC  
 Is Coastline Computers. Call Today!

**COASTLINE COMPUTERS**



**800-228-4615**

Please call collect if 800 number not in service.

**213-329-0825**

1956 W. 153 St., Gardena, CA 90247

# I\*U\*CO™ is the best thing to happen to personal computing since the invention of the personal computer!

**I\*U\*CO is an idea whose time has come.**

**I\*U\*CO is the International Union of Computer Owners, an organization designed to protect the interests of personal computer owners and users against those who would take their money...and then deliver less than they promised.**

**Here's an overview of some of the vital services I\*U\*CO provides:**

1. Access to the lowest priced, reputable vendor for nearly every computer related need; and,
2. Protection from the rip-off artists, vaporware specialists, false advertisers and other creepy, crawly creatures who have been attracted to the computer industry by the scent of your money; and,
3. Constantly updated information on software, hardware and peripheral releases, upgrades, bug reports, bug fixes, reviews, letters to the editor and other data individually tailored to your needs through the exclusive I\*U\*CO COMPUTER REGISTRY™; and,
4. Finally, a chance to get even with those characters out there who promised a lot, took your money...and then delivered less than they promised.

**I\*U\*CO™:  
a lynch mob  
with a purpose.**

Every computer owner has been ripped off at least once.

Or maybe a dozen times or more might be a more appropriate number.

In any event, we've all been victimized by the computer industry.

### **And it wasn't accidental.**

Today's computer industry is filled with hysteresis, rip-off artists, vaporware specialists and others whose sole function in life is to part you from your money by delivering a little less than you bargained for...or by charging you more than you would otherwise have to pay.

The rip-off might have been a computer that wasn't quite as "compatible" as advertised. Or it could have been a well-known computer that was to be delivered at the same time that "hundreds" of programs would be available with it...if you consider the same time to be a year-and-a-half later.

Or the rip-off might be in the form of measures taken by certain manufacturers and software publishers to limit sales of their products through "authorized" dealers only.

This is, of course, designed (they say) to get you better service.

But it's also a neat way to keep prices

artificially high by restricting competitive forces in the market place.

The number of ways you're being ripped off grow everyday, as greed becomes the major motivating factor in the computer marketplace.

Possibly, you've been had by a software manufacturer who continuously upgrades their software...charging you a pretty penny for the elimination of bugs which shouldn't have been there in the first place!

In a few cases, it's nothing more complex than a vendor who takes your money and simply takes their time in delivering.

If they ever get around to delivering at all.

In any event, the computer industry just isn't the friendly place it used to be, when everyone was trying to help each other learn about their machines.

Today's computer market has been an invitation to be ripped off.

**Until now, that is .  
I\*U\*CO**

**means protection.**

I\*U\*CO™ subscribes to some very ancient wisdom: there's strength in numbers.

Labor unions learned the lesson a long time ago.

The individual worker had no clout.

But when the workers organized, they got a lot of power.

Even automobile owners learned the lesson a long time ago. Back when the early driver got tired of dirt roads, they organized the American Automobile Association...and that's part of the reason the United States is laced with an incomparable highway and street system today.

Needless to say, the computer industry knows the value of organization as well.

Computer manufacturers, software publishers and others eager to get as much as they can from you have formed various associations to achieve such lofty goals as making sure that they can't be held responsible when their products don't work to prevent you from copying the software you "licensed" from them...so they can sell you a back-up disk.

In short, everyone seems to have learned the benefits of getting organized and gaining power.

Except the personal computer owner and user.

And that's why there has to be an I\*U\*CO™



I\*U\*CO™ is designed to be what very collective organization is: a means to protect the special interests of its own members!

And, in this case, the members are the victims...the people who own and use personal computers.

The people who until now have been  
o w e r l e s s .

**First of all,  
I\*U\*CO™**

**means low prices.**

The first benefit an I\*U\*CO™ member gets is an opportunity to save money. Lots of it.

While certain manufacturers of software, peripherals and hardware are trying hard to rack down on what they call the "grey market" (thus keeping prices higher than they should be), I\*U\*CO™ will maintain a database of every mail-order advertisement that appears in the major national computer magazines. A similar database will also be kept for selected major retail markets, so you can take advantage of special sales and

h e l p l i k e .  
When you want the lowest price on something, just (electronically) mail your shopping list to I\*U\*CO™.

Within a day, you'll get the three lowest and most recently quoted prices...and, quite possibly, special prices that haven't been advertised anywhere!

**I\*U\*CO™ protects you.**

Of course, buying by mail or from a supplier you don't know can get you more than low prices.

It can get you problems in delivery, service and general dissatisfaction with the product you bought.

So, along with the low price quotations, you also get I\*U\*CO™ member evaluations of the product and the vendor and a bibliography of reviews, letters to the editor, articles and other information that just might convince you not to spend the money in the first place.

(Remember, most sellers are pretty strict about returns, particularly software returns.)

So, as an I\*U\*CO™ member, you get:

1. The lowest possible prices.
2. An assessment of both the product and the vendor.
3. Information on the actual use value of the product. (An awful lot of products sound better in their advertising than they are in reality. That's why so few companies offer a money-back guaranty.)

**Continuing protection  
from I\*U\*CO™:**

**the Computer Registry™.**

As an I\*U\*CO™ member, you can also become part of our exclusive Computer Registry™.

You simply register the appropriate information about all the hardware, software and peripherals you own with I\*U\*CO™.

Then, as updates are announced, bugs discovered or fixed and so on, you automatically get this information as part of a customized and individualized monthly bulletin.

No more finding out a year after the fact that you're still using Version 1.00 and everyone else has Version 9.4! Or, you might find out that the problem you thought was yours alone is actually widespread.

(As a personal note, you'll find that this I\*U\*CO™ service is invaluable.

In the past few weeks, I found out that a) the ROMS in my Anadex printer have been upgraded, b) there's at least one undocumented bug in running MacPaint with the 512K upgrade, c) the ROMS in my IOMEGA Bernoulli Box were upgraded, and d) [best of all] MicroPro knew of a bug in Infostar 1.6 which they didn't tell anyone about for 18 months!)

In none of these instances did the manufacturer tell the consumer.

As an I\*U\*CO™ member, you could get this information on a customized and individualized basis, each and every month for every piece of hardware, software and peripheral equipment you own or acquire.

**I\*U\*CO™:  
the iron fist.**

The best part of I\*U\*CO™ has been saved for last.

Yes, I\*U\*CO™ will help you get the lowest prices on everything you want to buy for your computer.

And I\*U\*CO™ will give you solid information on the integrity of products and vendors.

Finally, if you choose to become a part of I\*U\*CO™s™ exclusive Computer Registry™, you can also stay current with the products you own or acquire.

**But with I\*U\*CO™,  
you also get power!**

But, more importantly, your membership in I\*U\*CO™ gives you the power of belonging to a community...a community of personal computer owners and users who need to protect their rights.

For instance, a group of software publishers managed to get the Louisiana legislature to pass a law "legalizing" the non-warranties they provide with their software. (You know, "this software is sold without any guaranty that it will work." Just pay your money and take your chances.)

**I\*U\*CO™  
will fight for you!**

I\*U\*CO™ will fight that kind of nonsense by lobbying against it, organizing PAC's and, in general, by doing what every other special interest group does: fight for its own special needs and interests.

As one person, there is little you can do when you're ripped off by a vendor. The powers that be...such as the FTC...don't pay much attention to one person.

But when a special group like I\*U\*CO™ has a lot of members which can be translated into publicity and political pressure, you'd be surprised what can be done.

There's a lot more to the I\*U\*CO™ story.

More than we can afford to tell here.

Complete information costs only \$ 1.00.

So, fill in the coupon below.

## Free! A guide to your legal rights as a personal computer owner!

Send a dollar for more information on I\*U\*CO™ membership and we'll include FREE a guide to your legal rights (and obligations) as a personal computer owner.

This synopsis, written by an attorney who also happens to be an electrical engineer will give you helpful information on questions such as using copy programs for making your own backup copies, how to complain effectively and other issues which affect you as a personal computer owner.

It's a slim volume, to be sure, because unless you're both rich and tough, you're going to learn that you haven't got all that many rights.

International Union of Computer Owners, Inc.  
30 East Huron Street  
Chicago, Illinois 60611

YES, I'm tired of being ripped off. Enclosed is \$ 1.00. Please send information on I\*U\*CO™. I understand that I am under no obligation to enroll as a member.

Please print all information!

Name \_\_\_\_\_  
Company \_\_\_\_\_  
Address \_\_\_\_\_  
City \_\_\_\_\_ State \_\_\_\_\_ ZIP \_\_\_\_\_  
Make of computer: \_\_\_\_\_

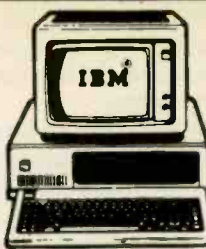
<b>IBM PC</b> 256k, 2 floppies (360k)	<b>IBM PC 10 MB</b> 256k, 1 or 2 floppies (360k) 10 MB Hard Disk (auto boot)	<b>EXCLUSIVELY FOR IBM PC</b> 	<b>IBM XT</b> 256k, 2 floppies (360k)	<b>IBM XT 10 MB</b> 256k, 1 or 2 floppies (360k) 10 MB Hard Disk
<b>IBM PC 20 MB</b> 256k, 1 or 2 floppies (360k) 20 MB Hard Disk (auto boot)	<b>IBM PC 30 MB</b> 256k, 1 or 2 floppies (360k) 30 MB Hard Disk (auto boot)		<b>IBM XT 20 MB</b> 256k, 1 or 2 floppies (360k) 20 MB Hard Disk	<b>IBM PC 30 MB</b> 256k, 1 or 2 floppies (360k) 30 MB Hard Disk
<b>IBM PC 10 + 10</b> 256k, 1 or 2 floppies (360k) 10 MB HD & 10 MB Tape Backup	<b>IBM PC 20 + 20</b> 256k, 1 or 2 floppies (360k) 10 MB HD & 10 MB Tape Backup		<b>IBM XT 10 + 10</b> 256k, 1 or 2 floppies (360k) 10 MB HD & 10 MB Tape Backup	<b>IBM XT 20 + 20</b> 256k, 1 or 2 floppies (360k) 20 MB HD & 10 MB Tape Backup
<b>IBM AT 20 MB</b> 512k, 1 or 2 floppies (360k/1.2 MB), 20 MB HD	<b>IBM AT 40 MB</b> 512k, 1 or 2 floppies (360k/1.2 MB), 40 MB HD		Call for the latest prices for your custom configuration. All systems are configured and tested at no extra cost and come only with CompuMail's 90 day warranty.	<b>IBM AT 80 MB</b> 512k, 1 or 2 floppies (360k/1.2 MB), 80 MB HD

★ **PRICE WAR** ★ **CALL US LAST** WITH YOUR BEST QUOTES ★

**PRINTERS      FLOPPY/HARD DISKS      MULTI-FUNCTION CARDS      MODEMS**

**EPSON** FX-80+ \$339 FX-100+ \$459  
 LX-80/H180/JX-80 \$219/\$359/\$469  
 LQ-1500 Par/Ser \$939/\$989  
 Tractor FX-80/LX-80/LQ1500 \$50/\$60/\$70  
 LQ Sht Fdr Single Bin/Dual Bin \$450/\$750  
 LX-90 w/IBM Interface Cartridge \$279  
 SO-2000 CALL

**OKIDATA** OKIMATE 20-IBM Plug & Print \$199  
 182-P/182-IBM \$219 192-P/192-IBM \$329  
 193-P/193-IBM \$479 84-P/84-IBM \$629  
 192 Tractor \$70 84 Sheet Feeder \$390

**TOSHIBA** 1340P (80 column) \$529  
 TOSHIBA 351P (132 column) \$1099  
 351 Tractor/Sheet Feeder \$170/\$790

**JUKI** 6100 (18 cps), 13" wide \$349  
 JUKI 6300 (40 cps), 16" wide \$679  
 6100/6300 Tractor/Sht Fdr \$140/\$240  
 5510P (160cps), \$369 5510 Color Kit \$140

**BROTHER** HR-15 XL (20 cps) Too low to Quote  
 HR-15 Tractor/Keyboard/Sheet Feeder \$110/\$160/\$190  
 HR-25 (23 cps) \$449 HR-35 (36 cps) \$649  
 Tractor/Sheet Fdr for HR-25/35 \$120/\$200  
 HR-10 (12 cps) w/Tractor Too low to Quote  
 TWINRITER 5 Dot Matrix & Daisy Wheel, 140/36 cps CALL  
 TWINRITER 5 Tractor/Sheet Feeder CALL  
 2024L LQ/Graphics-24 pin, 160/80 cps \$899  
 2024L Cutsheet Feeders-Narrow \$220  
 Wide \$290

**C. ITOH** 8510-BPI \$289 8510-SEP \$359  
 8510-SCP \$439 8510-SCPE \$419  
 1550-EP \$419 1550-SEP \$499  
 1550-SCP \$579 1550-SCPE \$559  
 Y10-20-P \$399 A10-30-P \$449  
 F-10-40-P \$849 F-10-55-P \$999  
 F10/A10 Tractor/Sheet Feeder \$180/\$490  
 ALL NEW MODELS CALL

**QUME** LetterPro 20P (20 cps) \$399  
 20P Tractor/Sheet Feeder \$140/\$380  
 SPRINT 1140 + \$1299  
 SPRINT 1155 + \$1419  
 SPRINT Interface Module: IBM Par \$80  
 SPRINT Tractor/Sheet Feeder \$210/\$690

**PANASONIC** KX-P3151 LQ 22 cps \$479  
 KX-P1090/91/92/93 \$189/\$269/\$359/\$529

**TEAC** Half HI FD 558-DSDD 'REDUCED' \$995  
 TANOOON 100-2 Full HI DSDD 'CALL' \$999

**HARD DISKS for IBM PC/XT**  
 10 MB Int 'CALL' \$489 10 MB Ext 'CALL' \$729  
 20 MB Int 'CALL' \$675 20 MB Ext 'CALL' \$875  
 33 MB Int 'CALL' \$4096 33 MB Ext 'CALL' \$4196  
 44 MB Int 'CALL' \$1495 44 MB Ext 'CALL' \$1595  
 70 MB Int 'CALL' 70 MB Ext 'CALL'  
 140 MB Int 'CALL' 140 MB Ext 'CALL'

**BACKUP for IBM PC/XT**  
 10 MB Int 'CALL' \$499 10 MB Ext 'CALL' \$669  
 20 MB Int 'CALL' \$599 20 MB Ext 'CALL' \$749  
 40 MB/60 MB Int/Ext 'CALL'

**HARO DISKS FOR IBM PC AT**  
 20 MB Int 'CALL' \$649 40 MB Int 'CALL' \$1399  
 80 MB Int 'CALL' 140 MB Int 'CALL'

**TALL GRASS NEW PC/T FORMAT DRIVES/BACKUP**  
 25 MB w/60 MB \$2599 35 MB w/60 MB \$3399  
 50 MB w/60 MB \$4299 80 MB w/60 MB \$5499  
 Controller \$140 Cartridge (60 MB) \$40

**EVEREX** 10 MB/20 MB Int. 'REDUCED' \$699/\$749  
**IRWIN MAGNETICS TAPE BACKUP**  
 10 MB Int. 'CALL' \$649 10 MB Ext. 'CALL' \$689  
 20 MB Int. 'CALL' \$629 20 MB Ext. 'CALL' \$799  
**PWR SUPPLY** 130/150 Watts \$99/\$129

**AST SIXPAK O-K** \$239 384K \$299  
**ORCHID Blossom Q-K** \$179 384K \$239  
**PARADISE 5-Pack O-K** \$159 384K \$219  
**TECMAR Captain O-K** \$179 384K \$239  
**BT6 Plus w/64k** \$199 384k \$249  
**IDS B-512 O-K** \$199 512k \$279  
 P/S/G Ports, Clock/Cal & disk emulation

**QUADBOARD O-K** \$219 \$384K \$279  
 Silver Quadboard: O-K to 640k CALL  
 Gold Quadboard: Multifunction & Color CALL

**PERSYST** Multifunction & Color or Mono. from \$329  
 RAM installation (1-8 sets) & test board \$20

**EasyData** 12B 300/1200 Bd Int w/software \$199

**HAYES** 1200 B w/SmartCom II \$339  
**HAYES** 1200 Ext. w/o Software \$359  
 Smartcom II \$90 NEW 2400 Baud Ext. CALL

**POPCOM** C-100/X-100 \$269/\$289

**AST Reach!** 1200 Bd short card w/Crosstalk \$379

**PROMETHEUS** PROMODEM 1200 Ext \$279  
 For 1200 Ext: Alphanum Display/Comm Buffer CALL  
 PROMODEM 1200 B Int w/MITE software \$249

**QUADMODEM** II shortcard w/Crosstalk XVI CALL  
**2400** Bd Upgrade Kit for Quadmodem II CALL

**Van-Tel** Half Card w/Crosstalk XVI \$369  
 1200 Plus Ext w/o software \$339

**ANCHOR** Volksmodem 12 \$179  
 Signalman MK XII \$229  
 Signalman Express \$259

**BIZCOMP** Intellimodem ST/XL/XT \$289/\$319/\$359

**CALL FOR CURRENT PRICES  
 QUANTITY DISCOUNTS AVAILABLE  
 OEM • WHOLESALE • RETAIL**

**DISPLAY CARDS**

**EVEREX** Graphics Edge Best Price Ever  
**AST** Monograph Plus w/clock, Par & Ser Ports \$399  
**AST** Preview for Mono Graphics CALL

**PERSYST** Bob Brd \$349 w/TAXAN 440 \$849  
 Short-Port Color \$159 Mini-Mono \$289  
 Color Combo: Multifunction & Color from \$329  
 Mono Combo: Multifunction & Mono from \$329

**QUADRAM** Quadcolor I or II \$209 Both \$398  
 Gold Quadboard: Multifunction & Color CALL

**STB's** Chaffeur CALL

**PARADISE** Modular Brd \$259 Modules CALL

**IDS** B-450 Mono, Color & Printer Port \$249

**TECMAR** Graphics Master \$439  
 w/Amdek 710 \$919

**HERCULES** MonoGraphics \$289 Color \$149

**GENOA** Spectrum BEST PRICE

**MYLEX** Chairman \$399

**SIGMA** COLOR 400 \$479 w/PGS SR-12 \$999

**MONITORS**

**PGS** MAX-12E/HX-12/HX-12E \$169/\$419/CALL  
 SR-12 \$549 SR-12 w/Sigma 400 \$999

**TAXAN** COMPOSIT 115 Green/116 Amber \$129  
**MONO** 121 Green/122 Amber (1000x360) \$139  
 COLOR 411 (510x260) \$349 425 (640x262) \$449  
 COLOR 440 (720x400) \$519  
 W/Persyst Bob Brd \$849

**AMDEK** 300G/300A/310A (M) \$139/\$149/CALL  
 COLOR 300/500/600 \$239/\$349/\$419  
 710 \$499 With Tecmar Graphics Master \$919

**QUADRAM** AMBERCHROME (720x350) \$169  
**ROLAND** MB-142 14" Mono B/W \$299  
**TECMAR** Color \$529 w/Graphics Master \$949

**TILT/SWIVEL** Monitor Pedestal  
 W/Purchase of any Monitor \$25

**CALL FOR OUR WEEKLY  
 UNADVERTISED SPECIALS**

★ **SUPER SPECIALS** ★

**\$1000 + SINGLE ORDER ENTITLES YOU TO THESE SPECIAL PRICES**

**JUKI** 6100/6300 \$339/\$659  
**OKIDATA** 192/193/84 P or IBM \$319/\$469/\$599  
**BROTHER** HR-15/25/35 CALL/\$435/\$629  
**TOSHIBA** 1340 P \$499  
**PGS** MAX-12E \$159 HX-12 \$399  
**ROLAND** MB-142 14" Mono B/W & Reverse \$279  
 EasyData 12B 300/1200 Bd Int w/Crosstalk \$185  
**HAYES** 1200B w/sft \$319 1200 Ext \$339  
 Signalman MK XII/Signalman Express \$189/\$249  
**BIZCOMP** Intellimodem ST/XL/XT \$279/\$309/\$349

**MYLEX** Chairman \$379  
**IDS** B-450 Mono, Color & Printer Port \$229  
**PARADISE** 5-Pack + 384K RAM \$199  
**BT 6 PLUS** + 384K RAM \$229  
**IDS** B-512 + 384k/512k \$235/\$255  
**ORCHID** Pctorbo w/640k \$769  
 Floppy Drive Controller for IBM PC/XT \$99  
**KEYTRONIC** Deluxe Keyboard KB5151 \$155  
**POWER DIRECTOR** P2/P12 \$79/\$119  
**PWR SUPPLY** 130/150 Watts \$89/\$119

**COMPANY POLICY:** Min. order \$100. Prices & availability subject to change. We ship UPS only. Shipping/handling charges vary. Prices reflect cash discount on prepaid orders. Add 1% for COD orders, 3% for MC/VISA & 5% for AMEX. COD requires cashiers check. All merchandise sold is new and all warranties are final. Refused shipments subject to 20% charge (Min \$50). Products shipped in factory cartons come with manufacturer warranty. For others, including IBM systems, call tech support for return auth. # for warranty repairs. Non-defective items returned as defective subject to 10% service charge (Min \$50). Not responsible for hardware or software compatibility of any product. No open acct PO's or foreign orders. No showroom, demonstrations or walk-in sales. Personal or company checks take 3 weeks to clear. FOR ADVANCE PAYMENTS or PICKUP, PLEASE CALL FIRST FOR WORKORDER #.

**COMPUTER ACCESSORIES** P2(5) \$89  
**POWER DIRECTOR** P12(6) \$129 P1-2-3 \$299

**KENSINGTON** Master Piece (5 outlets) \$89  
 PC Keyboard Storage Drawer \$89

**STANDBY PWR SUPPLY** w/surge protection  
 200/300/800 Watts \$269/\$359/\$699

**KOALAPAD** w/PC Design \$89  
**KENSINGTON** Universal Printer Stand \$20  
**TILT/SWIVEL** Monitor Pedestal \$30  
**PWR SUPPLY** 130/150 Watts \$99/\$129

**CREDIT CARDS**





**COMPU**  **805-987-7015**

406-C CONSTITUTION AVE., CAMARILLO, CA 93010      WHEN ORDERING PLEASE REFER TO AD #B800

# NOW C HERE! CROSS SOFTWARE for the NS32000

Also Available for IBM PC

## INCLUDES:

- \* Cross Assembler \*
- \* Cross Linker \*
- \* Debugger \*
- \* N.S. ISE Support \*
- \* Librarian \*
- \* Pascal Cross Compiler \*
- \* C Cross Compiler \*

U.S. prices start at \$500

## SOLUTIONWARE

1283 Mt. View-Alviso Rd.  
Suite B  
Sunnyvale, Calif. 94069  
408/745-7818 • TLX 4994264

Inquiry 334



### ONLY PUBLIC DOMAIN SOFTWARE

is uncopyrighted, so no license fees to pay to anyone! Thousands of useful database, spreadsheet, word processors, games, utilities and business programs you can copy yourself from our User Group rental libraries. Join hundreds of companies and users enjoying a wealth of inexpensive software!

**RENTAL LIBRARIES FOR CP/M**

SIG/M UG (New Jersey Area Computer Club)	\$125.00
216 Disk Sides	
CP/M UG (New York Area Computer Club)	\$45.00
92 Disk Sides	
<b>PICONET (Bay Area User Group)</b>	
34 Disk Sides	\$25.00
<b>WUG (Charlottesville Kaypro User Group)</b>	
39 Disk Sides	\$45.00
<b>NATIONAL EPSON UG</b>	
34 Disk Sides	\$40.00
<b>PD DIRECTORY CATALOG DISK</b>	
SPECIAL SALE—includes CP/M, SIG/M UG & PNET \$5.00 pp	
<b>RENTAL LIBRARIES FOR IBM PC DOS</b>	
<b>PC-BLUE (NYACC)</b>	
110 Disk Sides	\$135.00
<b>IBM-PC SIG (Santa Clara Group, others)</b>	
300 Disk Sides	\$325.00
<b>RENTAL LIBRARIES FOR COMMODORE 64</b>	
28 Disk Sides	\$25.00
<b>PD DIRECTORY DISK</b>	
Rental is for 7 days after receipt 3 more days grace for return. Use your credit card — NO DISK DEPOSIT! Most formats available—even Apple! Specify. Software also available for sale, \$6.00 per disk full.	
24 hr. 3 minute info. recording	
(619) 727-1015	
<b>NATIONAL PUBLIC DOMAIN RENTAL CENTER</b>	
1533 Avophill Dr. Vista, CA 92083	
(619) 941-0925 Orders	

Inquiry 258

## DISK DRIVES

Half Height  
IBM Compatible

### ONE YEAR WARRANTY

40 tr. DS/DD	.....	\$89.00
80 tr. DS/DD	.....	\$99.00
1.2 meg. floppy	.....	CALL

Enclosures and mounting kits  
Special bracketed pair pricing

IN STOCK \* 2 DAY SHIP



### ALLIED MICRO DEVICES

2809 Boardwalk, Ann Arbor, MI 48104  
(313) 996-1282: TX 2907707 AMEL  
\*Manufactured by SANYO

Inquiry 23



## ASTRONOMY

COME TO US FOR YOUR  
ASTRONOMICAL COMPUTING NEEDS

FORTH, the programming language created by astronomers.

**Fast - Compact - Quick debugging**  
Now available for most micros and DEC minis

- \* Our GENERAL ASTRONOMY UTILITY does sidereal time, coordinate conversions, precession, etc
- \* The EPHEMERIDE PROGRAM will let you locate Comet Haley quickly!
- \* We have CATALOGS too, the YBS (9000 naked-eye stars), the RRGC (galaxies), the GVCS (variable stars), and the SAO (260,000 stars) in popular disk formats
- \* And we customize programs for photometry, spectral analysis and image processing

Write today for our free catalog. All software has a 30 day money-back guarantee!

**UNIFIED SOFTWARE SYSTEMS**  
P.O. Box 2644, New Carrollton, MD 20784  
(301) 552-9590

Inquiry 363

**Hello, Gemini Printer Users:**

You do not need to buy a new printer to obtain N.L.Q. (near letter quality) printing capabilities.

We are offering to you an easy-to-install kit for your Printer:

**PRICE \$57.50**

To Order: Call or Write  
**ESP CORPORATION**  
7900 N. Tamiami Trail  
Sarasota, FL 34243  
(813) 355-6797

When ordering we need the Model # and Serial # of your printer.

Personal Check and COD's  
accepted — No Credit Cards  
4-6 weeks delivery

Inquiry 142

The world's fastest, most powerful  
8080 relocating macro assembler

## SLRMAC™ ONLY \$4995

"... In two words, I'd say speed & flexibility".  
Edward Joyce, Nov. 84, Microcomputing

This is what they said about Z80ASM, our Z80 assembler. Now the same features and performance are available in our Intel Mnemonic product. SLRMAC is compatible with M80 in .8080 mode with many extensions. Too many features to list.

To order or find out more about our complete family of development tools, call or write:

## SLR Systems

1622 N. Main St. Butler, PA 16001  
(800) 833-3061 • (412) 282-0864  
Telex 559215 SLR SYS

Inquiry 406



## ROSE DATA SWITCHES

SHARE computers, printers, any parallel or serial device  
**ELIMINATE** cable swapping  
**INEXPENSIVE** way to network  
**COMPATIBLE** with all computers.  
Businesses, Schools, Homes

**WE ALSO OFFER:**  
Data Buffers, Line Drivers, Modems, Protocol Converters, Parallel - Serial Converters, Cables, Computers, Printers, Disk Drives, and more.

**AUTOMATIC - CARETAKER** is ideal for a business or school to share a printer or modem among many computers. Operation is fully automatic with no software required. Parallel or Serial 4 channels - \$295 8 channels - \$395

**MANUAL - HARD SWITCH** is operated with the flip of a switch. 2:2 and 2:4 models allow simultaneous communication.  
Serial 1:2 - \$59 1:4 - \$ 99 2:2 - \$109 2:4 - \$169  
Parallel 1:2 - \$99 1:4 - \$159 2:2 - \$189 2:4 - \$279  
LED and spike protection on serial models add \$20.

**CODE ACTIVATED - PORTER** connects one computer to multiple peripherals. A software code selects the peripheral. Parallel or Serial 4 channels - \$295 8 channels - \$395  
Buffer option 64K - \$100 256K - \$250

**REMOTE - TELEPATH** connects multiple computers to multiple peripherals. A selector at each computer or terminal chooses up to 4 peripherals and displays busy status.  
4:4 - \$495 4:8 - \$795 selector - \$39

*Give a Rose to your computer*

**ROSE ELECTRONICS (713) 240-7673**  
P.O. BOX 742571 MC & VISA Accepted  
HOUSTON, TX 77274 Dealer Inquiries Invited  
**CALL US FOR ALL YOUR INTERFACE NEEDS**

Inquiry 407

## FoxBASE™

### Interpreter/Compiler

- dBASE II® source compatible
- Runs 3-20 times faster than dBASE II
- 8087 coprocessor support
- 14 digit precision
- Up to 48 fields per record
- Full type-ahead capabilities
- Provides compact object code and program security
- Twice as many memory variables as dBASE II

**FOX SOFTWARE INC.**  
13330 Bishop Road, P.O. Box 269  
Bowling Green, OH 43402  
419-354-3981



Inquiry 154

## OK-WRITER™

### LETTER QUALITY



Enhancement for  
Okidata ML82A/83A  
Dot Matrix Printers

- Easy to install
- Plug-in module
- Letter Quality: 30 cps
- Draft Quality: 120 cps
- 10, 12, 17 cpi
- Full dot addressable graphics
- Front panel access to all features
- Proportional spacing, bold, double width, underlining, self-test, etc.
- Serial and parallel interfaces retained
- HELP mode; Diagnostic HEX dump
- And many other features



### RAINBOW TECHNOLOGIES, INC.

17971-E Skypark Circle, Irvine, CA 92714  
(714) 261-0228 Telex 386078  
UK Distributor: X-DATA (0753) 72331

Inquiry 300

# 4164 64K DYNAMIC 200ns 9/10.50

# 41256 256K DYNAMIC 200ns 5.25

## STATIC RAMS

2101	256x4 (450ns)	1.95
5101	256x4 (450ns)(cmos)	3.95
2102-1	1024x4 (450ns)	8.99
2102L-4	1024x1 (450ns)(LP)	9.99
2102L-2	1024x1 (250ns)(LP)	1.45
2125	1024x1 (45ns)	2.95
2111	256x4 (450ns)	2.49
2111L	256x4 (450ns)(LP)	2.95
2112	256x4 (450ns)	2.99
2114	1024x4 (450ns)	8 9.95
2114-25	1024x4 (250ns)	8 10.95
2114L-4	1024x4 (450ns)(LP)	8 12.95
2114L-3	1024x4 (300ns)(LP)	8 13.45
2114L-2	1024x4 (200ns)(LP)	8 13.95
2114L-15	1024x4 (150ns)(LP)	8 19.95
TC5514	1024x4 (650ns)(cmos)	4.95
2141	4096x1 (200ns)	2.95
2147	4096x1 (55ns)	4.95
2148	1024x4 (70ns)	4.95
TMS4044-4	4096x1 (450ns)	3.49
TMS4044-3	4096x1 (300ns)	3.99
TMS4044-2	4096x1 (200ns)	4.49
TMS4044-1	4096x1 (200ns)(LP)	4.95
UPD410	4096x1 (100ns)	3.95
MK4118	1024x8 (250ns)	9.95
TMM2016-200	2048x8 (200ns)	3.25
TMM2016-150	2048x8 (150ns)	3.75
TMM2016-100	2048x8 (100ns)	4.75
HM6116-4	2048x8 (200ns)(cmos)	3.69
HM6116-3	2048x8 (150ns)(cmos)	3.95
HM6116-2	2048x8 (120ns)(cmos)	6.95
HM6116LP-4	2048x8 (200ns)(cmos)(LP)	3.95
HM6116LP-3	2048x8 (150ns)(cmos)(LP)	4.25
HM6116LP-2	2048x8 (120ns)(cmos)(LP)	6.95
TC5516	2048x8 (250ns)(cmos)	9.95
TMS4016	2048x8 (200ns)	6.95
Z 6132	4096x8 (300ns)(Qstat)	34.95
HM6264P-15	8192x8 (150ns)(cmos)	9.75
HM6264LP-15	8192x8 (150ns)(cmos)(LP)	9.95
HM6264LP-12	8192x8 (120ns)(cmos)(LP)	10.95

LP - Low power Qstat - Quasi-Static

## DYNAMIC RAMS

TMS4027	4096x1 (250ns)	1.99
2107	4096x1 (200ns)	1.95
MM5280	4096x1 (300ns)	1.95
TMS4050	4096x1 (300ns)	1.95
UPD411	4096x1 (300ns)	1.95
TMS4060	4096x1 (300ns)	1.95
MK4108	8192x1 (200ns)	4.9
MM5298	8192x1 (250ns)	4.9
4116-300	16384x1 (300ns)	8 8.95
4116-250	16384x1 (250ns)	8 9.95
4116-200	16384x1 (200ns)	8 8.95
4116-150	16384x1 (150ns)	8 10.95
4116-120	16384x1 (120ns)	8 12.95
2118	16384x1 (150ns)(5v)	4.95
MK4332	32768x1 (200ns)	9.95
4164-200	65536x1 (200ns)(5v)	9 10.50
4164-150	65536x1 (150ns)(5v)	9 12.00
4164-120	65536x1 (120ns)(5v)	3.95
MCM6665	65536x1 (200ns)(5v)	4.95
TMS4164-20	65536x1 (200ns)(5v)	4.25
TMS4164-15	65536x1 (150ns)(5v)	4.95
4164-REFRESH	65536x1 (150ns)(5v)(REFRESH)	8.95
TMS4416-20	16384x4 (200ns)(5v)	8.95
TMS4416-15	16384x4 (150ns)(5v)	9.95
41128-150	131072x1 (150ns)(5v)	13.95
41256-200	262144x1 (200ns)(5v)	5.25
41256-150	262144x1 (150ns)(5v)	5.50

5v - Single 5 Volt Supply REFRESH - Pin 1 Refresh

## EPROMS

1702	256x8 (1us)	4.50
2708	1024x8 (450ns)	3.95
2716	2048x8 (450ns)(5V)	2.95
2716-6	2048x8 (450ns)(5V)	2.95
2716	2048x8 (450ns)(5V)	3.50
2716-1	2048x8 (350ns)(5V)	4.95
TMS2516	2048x8 (450ns)(5V)	4.95
TMS2532	2048x8 (450ns)(5V)	4.95
2732	4096x8 (450ns)(5V)	4.95
2732A-4	4096x8 (450ns)(5V)(21V PGM)	4.95
2732A-35	4096x8 (350ns)(5V)(21V PGM)	4.95
2732A	4096x8 (250ns)(5V)(21V PGM)	6.95
2732A-2	4096x8 (200ns)(5V)(21V PGM)	10.95
2764	8192x8 (450ns)(5V)	4.25
2764-250	8192x8 (250ns)(5V)	4.95
2764-200	8192x8 (200ns)(5V)	6.95
TMS2564	8192x8 (450ns)(5V)	10.95
MCM68764	8192x8 (450ns)(5V)(24 pin)	24.95
MCM68766	8192x8 (350ns)(5V)(24 pin)	42.95
27128-45	16384x8 (450ns)(5V)	7.50
27128-30	16384x8 (300ns)(5V)	7.75
27128	16384x8 (250ns)(5V)	7.95
27256	32768x8 (250ns)(5V)	12.95

5V - Single 5 Volt Supply 21V PGM - Program at 21 Volts

## CRYSTALS

32.768 KHz	1.95
1.0 MHz	3.95
1.8432	3.95
2.0	2.95
2.097152	2.95
2.4576	2.95
3.2768	2.95
3.579545	2.95
4.0	2.95
4.032	2.95
5.0	2.95
5.0688	2.95
5.185	2.95
5.7143	2.95
6.0	2.95
6.144	2.95
6.5536	2.95
8.0	2.95
10.0	2.95
10.738635	2.95
14.31818	2.95
15.0	2.95
16.0	2.95
17.430	2.95
18.0	2.95
18.432	2.95
20.0	2.95
22.1184	2.95
24.0	2.95
32.0	2.95

## CRYSTAL OSCILLATORS

1.0MHz	7.95	8.0	7.95
1.8432	7.95	10.0	7.95
2.0	7.95	12.0	7.95
2.4576	7.95	15.0	7.95
2.5	7.95	16.0	7.95
4.0	7.95	18.432	7.95
5.0688	7.95	20.0	7.95
6.0	7.95	24.0	7.95
6.144	7.95		

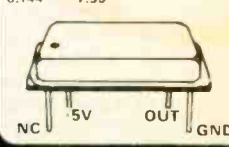

## 74LS00

74LS00	24	74LS189	8.95
74LS01	25	74LS190	8.9
74LS02	25	74LS191	8.9
74LS03	25	74LS192	7.9
74LS04	24	74LS193	7.9
74LS05	25	74LS194	6.9
74LS08	28	74LS195	5.9
74LS09	29	74LS196	7.9
74LS10	25	74LS197	7.9
74LS11	35	74LS221	8.9
74LS12	35	74LS240	9.5
74LS13	45	74LS241	9.9
4701	12.95	74LS242	9.5
COM5016	16.95	74LS25	7.95
COM8116	10.95	74LS244	1.29
MM5307	10.95	74LS245	1.49
		74LS247	7.5
		74LS248	9.9
		74LS249	9.9
		74LS251	5.9
		74LS252	5.9
		74LS253	5.9
		74LS254	5.9
		74LS255	5.9
		74LS256	5.9
		74LS257	5.9
		74LS258	5.9
		74LS259	2.75
		74LS260	5.9
		74LS261	2.25
		74LS262	5.5
		74LS263	6.9
		74LS264	8.9
		74LS265	8.9
		74LS266	8.9
		74LS267	8.9
		74LS268	8.9
		74LS269	8.9
		74LS270	8.9
		74LS271	8.9
		74LS272	8.9
		74LS273	1.49
		74LS274	1.49
		74LS275	3.35
		74LS276	3.35
		74LS277	4.9
		74LS278	4.9
		74LS279	4.9
		74LS280	1.98
		74LS281	1.98
		74LS282	1.98
		74LS283	6.9
		74LS284	6.9
		74LS285	6.9
		74LS286	6.9
		74LS287	6.9
		74LS288	6.9
		74LS289	6.9
		74LS290	6.9
		74LS291	6.9
		74LS292	6.9
		74LS293	6.9
		74LS294	6.9
		74LS295	6.9
		74LS296	6.9
		74LS297	6.9
		74LS298	6.9
		74LS299	6.9
		74LS300	6.9
		74LS301	6.9
		74LS302	6.9
		74LS303	6.9
		74LS304	6.9
		74LS305	6.9
		74LS306	6.9
		74LS307	6.9
		74LS308	6.9
		74LS309	6.9
		74LS310	6.9
		74LS311	6.9
		74LS312	6.9
		74LS313	6.9
		74LS314	6.9
		74LS315	6.9
		74LS316	6.9
		74LS317	6.9
		74LS318	6.9
		74LS319	6.9
		74LS320	6.9
		74LS321	6.9
		74LS322	6.9
		74LS323	6.9
		74LS324	6.9
		74LS325	6.9
		74LS326	6.9
		74LS327	6.9
		74LS328	6.9
		74LS329	6.9
		74LS330	6.9
		74LS331	6.9
		74LS332	6.9
		74LS333	6.9
		74LS334	6.9
		74LS335	6.9
		74LS336	6.9
		74LS337	6.9
		74LS338	6.9
		74LS339	6.9
		74LS340	6.9
		74LS341	6.9
		74LS342	6.9
		74LS343	6.9
		74LS344	6.9
		74LS345	6.9
		74LS346	6.9
		74LS347	6.9
		74LS348	6.9
		74LS349	6.9
		74LS350	6.9
		74LS351	6.9
		74LS352	6.9
		74LS353	6.9
		74LS354	6.9
		74LS355	6.9
		74LS356	6.9
		74LS357	6.9
		74LS358	6.9
		74LS359	6.9
		74LS360	6.9
		74LS361	6.9
		74LS362	6.9
		74LS363	6.9
		74LS364	6.9
		74LS365	6.9
		74LS366	6.9
		74LS367	6.9
		74LS368	6.9
		74LS369	6.9
		74LS370	6.9
		74LS371	6.9
		74LS372	6.9
		74LS373	6.9
		74LS374	6.9
		74LS375	6.9
		74LS376	6.9
		74LS377	6.9
		74LS378	6.9
		74LS379	6.9
		74LS380	6.9
		74LS381	6.9
		74LS382	6.9
		74LS383	6.9
		74LS384	6.9
		74LS385	6.9
		74LS386	6.9
		74LS387	6.9
		74LS388	6.9
		74LS389	6.9
		74LS390	6.9
		74LS391	6.9
		74LS392	6.9
		74LS393	6.9
		74LS394	6.9
		74LS395	6.9
		74LS396	6.9
		74LS397	6.9
		74LS398	6.9
		74LS399	6.9
		74LS400	6.9

★★★★ HIGH-TECH ★★★★★  
**27256 \$12.95**  
 ★ 32K x 8 EPROM  
 ★ SINGLE 5 VOLT SUPPLY  
 ★ SINGLE LOCATION & HIGH SPEED PROGRAMMING  
 ★ 250ns ACCESS TIME

★★★★ SPOTLIGHT ★★★★★

**ORDER TOLL FREE**  
**800-538-5000**  
**800-662-6279**  
 (CALIFORNIA RESIDENTS)

## GENERATORS BIT RATE

MC14411	11.95
BR1941	11.95
4701	12.95
COM5016	16.95
COM8116	10.95
MM5307	10.95

## FUNCTION

MC4024	3.95
LM556	1.49
KR2206	3.75
8038	3.95

## CRT CONTROLLERS

6845	12.95
68845	19.95
6847	11.95
68047	24.95
HD46505SP	15.95
MC1372	6.95

# HM6264P-15 8Kx8 STATIC 150ns 9.75 SSI263 SPEECH SYNTHESIZER 39.95

## 74S00

74S00	.32	74S135	.89	74S244	2.20
74S02	.35	74S138	.85	74S251	.95
74S03	.35	74S139	.95	74S253	.95
74S04	.35	74S140	.85	74S257	.95
74S05	.35	74S151	.95	74S258	.95
74S08	.35	74S153	.95	74S260	.79
74S09	.40	74S157	.95	74S273	2.45
74S10	.35	74S158	.95	74S274	19.95
74S11	.35	74S161	1.95	74S275	19.95
74S15	.35	74S162	1.95	74S280	1.95
74S20	.35	74S163	1.95	74S283	3.29
74S22	.35	74S168	3.95	74S287	1.90
74S30	.35	74S169	3.95	74S288	1.90
74S32	.40	74S174	.95	74S289	6.98
74S37	.88	74S175	.95	74S299	7.35
74S38	.85	74S180	11.95	74S301	6.95
74S40	.35	74S181	3.95	74S373	8.45
74S51	.35	74S182	2.95	74S374	2.45
74S64	.40	74S185	16.95	74S381	7.95
74S65	.40	74S188	1.95	74S387	1.95
74S74	.50	74S189	6.95	74S399	2.95
74S85	1.99	74S194	1.49	74S412	2.98
74S86	.50	74S195	1.49	74S470	6.95
74S112	.50	74S196	1.49	74S471	6.95
74S113	.50	74S197	1.49	74S472	4.95
74S114	.55	74S201	6.95	74S474	4.95
74S124	2.75	74S225	7.95	74S570	2.95
74S132	1.24	74S226	3.99	74S571	2.95
74S133	.45	74S240	2.20	74S573	9.95
74S134	.50	74S241	2.20	87S181	16.25
				87S185	16.95

## CMOS

4000	.29	4521	.95
4001	.25	4522	1.95
4002	.25	4528	1.95
4006	.85	4529	1.95
4007	.29	45-1	2.64
4008	.95	4543	1.19
4009	.39	4553	5.79
4010	.45	4555	.95
4011	.25	4556	.95
4012	.25	4558	2.45
4013	.38	45514	4.25
4014	.79	4559	3.49
4015	.39	4581	1.95
4016	.39	4582	1.95
4017	.69	4584	.75
4018	.79	4585	.75
4019	.39	45151	12.95
4020	.75	45102	12.95
4021	.79	45124	1.50
4022	.79	74C00	.35
4023	.29	74C02	.35
4024	.65	74C04	.35
4025	.29	74C08	.35
4026	1.65	74C10	.35
4027	.65	74C14	.55
4028	.69	74C20	.35
4029	.79	74C30	.35
4030	.39	74C32	.39
4034	1.95	74C42	1.29
4035	.85	74C48	1.99
4040	.75	74C73	.65
4041	.75	74C74	.65
4042	.65	74C76	.65
4043	.85	74C83	1.95
4044	.79	74C85	1.95
4046	.85	74C86	.39
4047	.95	74C89	4.50
4048	.69	74C90	1.19
4049	.35	74C93	1.75
4050	.39	74C95	.95
4051	.79	74C150	5.75
4052	1.99	74C151	2.25
4053	.79	74C154	3.25
4056	.89	74C157	1.75
4060	.39	74C160	1.19
4062	.39	74C161	1.19
4069	.29	74C162	1.19
4070	.35	74C163	1.19
4071	.29	74C164	1.39
4072	.29	74C165	2.00
4073	.29	74C173	.79
4075	.29	74C174	1.19
4076	.79	74C175	1.19
4077	.59	74C192	1.49
4078	.29	74C193	1.49
4081	.29	74C195	1.39
4082	.29	74C200	5.75
4085	.95	74C221	1.75
4086	.95	74C224	2.25
4087	.49	74C373	2.45
4094	2.99	74C374	2.45
4098	2.49	74C901	.39
4099	1.95	74C902	.85
14009	12.95	74C903	.85
14410	12.95	74C905	10.95
14411	11.95	74C906	.95
14412	1.95	74C907	1.00
14413	7.95	74C908	2.00
14433	14.95	74C909	2.75
14490	4.95	74C910	9.95
4502	.95	74C911	8.95
4503	.65	74C912	8.95
4507	1.25	74C914	.95
4508	1.95	74C915	1.19
4510	.85	74C918	2.75
4511	.85	74C920	17.95
4512	.85	74C921	15.95
4514	1.25	74C922	4.49
4515	1.79	74C923	4.95
4516	1.55	74C925	5.95
4518	.95	74C926	7.95
4519	.39	74C927	7.95
4520	.79	74C928	7.95
4521	4.99	74C929	19.95
4522	1.25	74C930	4.95
4526	1.25	80C95	.85
4527	1.95	80C96	.95
4528	1.19	80C97	.95
4529	2.95	80C98	1.20

## HIGH SPEED CMOS

A new family of high speed CMOS logic featuring the speed of low power Schottky (8ns typical gate propagation delay), combined with the advantages of CMOS: very low power consumption, superior noise immunity, and improved output drive.

### 74HC00

Operate at CMOS logic levels and are ideal for use with all CMOS designs.

74HC00	.59	74HC175	.99
74HC02	.59	74HC193	1.25
74HC04	.59	74HC194	1.04
74HC08	.59	74HC195	1.09
74HC10	.59	74HC238	1.35
74HC11	.59	74HC240	1.89
74HC14	.79	74HC241	1.89
74HC20	.59	74HC242	1.89
74HC27	.59	74HC243	1.89
74HC30	.59	74HC244	1.89
74HC32	.69	74HC245	1.89
74HC51	.59	74HC251	.89
74HC74	.75	74HC257	.85
74HC75	.85	74HC259	1.39
74HC85	1.39	74HC273	1.89
74HC86	.69	74HC283	1.29
74HC93	1.19	74HC367	.99
74HC125	1.19	74HC373	2.29
74HC132	1.19	74HC374	2.29
74HC138	.99	74HC393	1.39
74HC139	.99	74HC4017	1.99
74HC151	.89	74HC4020	1.39
74HC153	.89	74HC4024	1.59
74HC154	2.49	74HC4040	.89
74HC157	.89	74HC4049	.89
74HC161	1.15	74HC4050	.89
74HC164	1.25	74HC406C	1.29
74HC166	2.95	74HC4511	2.39
74HC174	.99	74HC453E	2.29

### 74HC700

Direct, drop-in replacements for 74LS TTL and can be intermixed with 74LS in the same circuit.

74HC700	.69	74HC717	1.69
74HC702	.69	74HC719	1.39
74HC704	.69	74HC7194	1.19
74HC705	.69	74HC723	1.29
74HC710	.69	74HC723A	1.49
74HC711	.69	74HC724	2.19
74HC713	.89	74HC724I	2.19
74HC723	.69	74HC724I	2.19
74HC727	.69	74HC724J	2.19
74HC730	.69	74HC724K	2.19
74HC732	.79	74HC725	2.19
74HC751	.69	74HC725I	1.09
74HC754	.85	74HC727	1.99
74HC755	1.49	74HC729	1.59
74HC756	.79	74HC729	5.25
74HC793	1.29	74HC7357	1.09
74HC795	1.29	74HC735	1.29
74HC732	1.29	74HC734	2.49
74HC738	1.15	74HC737	1.59
74HC7139	1.15	74HC74017	2.19
74HC7151	1.05	74HC74020	1.59
74HC7153	1.05	74HC74024	1.79
74HC7154	2.95	74HC74040	1.59
74HC7157	.99	74HC74049	.99
74HC7161	1.29	74HC74050	.99
74HC7164	1.39	74HC74060	1.49
74HC7166	3.05	74HC74511	2.69
74HC7174	1.09	74HC7453E	2.59

## VOLTAGE REGULATORS TO-20 CASE PACKAGE

7805T	.75	7905T	.85
7808T	.75	7908T	.85
7812T	.75	7912T	.85
7815T	.75	7915T	.85
7824T	.75	7924T	.85

## TO-3 CASE PACKAGE

7805K	1.39	7905K	1.49
7812K	1.39	7912K	1.49
7815K	1.39	7915K	1.49
7824K	1.39	7924K	1.49

## TO-92 CASE PACKAGE

78L05	.69	79L05	.79
78L12	.69	79L12	.79
78L15	.69	79L15	.79

## OTHER VOLTAGE REGS

78M05C	5volt	1amp	TO-220	.35
LM323K	5volt	3amp	TO-3	4.95
LM338K	Adj.	Shmp	TO-3	3.95
78H05K	5volt	5amp	BT	3.95
78M12K	12volt	5amp	TO-3	9.95
78P05K	5volt	10amp	TO-3	14.95
UA78S40	FAIRCHILD	DIP		1.95

## LINEAR

LM301	.34	NE570	3.95
LM301H	.79	NE571	2.95
LM307	.45	NE590	2.50
LM308	.69	NE592	.98
LM308H	1.15	LM709	5.9
LM309H	1.95	LM710	7.5
LM309K	1.25	LM711	7.9
LM310	1.75	LM723	4.9
LM311	.64	LM723H	5.9
LM311H	.89	LM733	.98
LM312H	.75	LM741	.35
LM317K	3.95	LM741N-14	35
LM317T	1.19	LM741	4.0
LM318	1.49	LM747	6.9
LM318H	1.59	LM748	.59
LM319H	1.90	LM7014	1.19
LM319	1.25	LM1303	1.95
LM320	see 7900	LM1310	1.49
LM322	1.65	MC1330	1.69
LM323K	4.95	MC1349	5.89
LM324	.59	MC1350	1.19
LM329	.65	MC1358	1.69
LM331	3.95	MC1372	6.95
LM334	1.19	LM1414	1.59
LM335	1.40	LM1458	.59
LM336	1.75	LM1488	.69
LM337	1.95	LM1489	.69
LM337K	3.95	LM1496	.85
LM338K	3.95	LM1558H	3.10
LM339	.99	LM1800	2.37
LM340	see 7800	LM1812	8.25
LM348	.99	LM1830	3.50
LM350K	4.95	LM1871	5.49
LM350T	4.60	LM1872	5.49
LM358	.69	LM1877	3.52
LM359	1.79	LM1889	1.95
LM376	3.75	LM1896	1.75
LM377	1.95	ULN2003	1.29
LM378	2.50	XR2206	3.75
LM379	4.50	LM2877	2.05
LM380	.89	LM2878	2.25
LM380N-8	1.10	LM2900	.85
LM381	1.60	LM2901	1.00
LM382	1.60	MPQ2907	1.95
LM383	1.95	LM2917	2.95
LM384	1.95	MC3487	2.95
LM385	.89	MC3489	3.59
LM387	1.40	LM3905	1.25
LM389	1.35	LM3909	.98
LM390	1.95	LM3911	2.25
LM392	.69	LM3914	3.95
LM393	1.29	LM3915	3.95
LM393H	4.60	LM3916	3.95
LM394H	5.90	MC4004	3.59
NE531	2.95	MC4044	5.00
NE555	.34	RC1336	1.25
NE556	.65	RC4151	3.95
NE558	1.50	LM4250	1.75
NE564	2.95	LM4250	3.25
LM565	.99	RC4558	.69
LM566	1.49	LM1360	

**DB25S** RS232 FEMALE SOLDER CUP

**2.25**

**DB25P** RS232 MALE SOLDER CUP

**1.90**

**BARGAIN HUNTERS CORNER**

**DYNAMIC RAMS**

**4164** 200ns **\$.99** ea.  
100 PIECE MINIMUM

**41256** 150ns  
**\$5.50** ea.

**SPECIALS END 7/31/85**

**RF MODULATOR**

(ASTEUM1082)  
QUANTITIES LIMITED

- PRESET TO CHANNEL 3
- USE TO BUILD TV COMPUTER INTERFACE
- 5 VOLT OPERATION

**\$6.95**

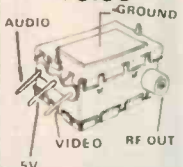

**EMI FILTER**

- MAJOR MANUFACTURER
- LOW COST
- FITS LC-HP BELOW

**\$4.95**

**LINE CORDS**

- LC-2 2 CONDUCTOR 6 ft. 39
- LC-3 3 CONDUCTOR 6 ft. 99
- LC-HP 3 CONDUCTOR WITH STANDARD FEMALE SOCKET 6 ft. 1.49
- LC-CIR CIGARETTE LIGHTER PLUG WITH 6 FOOT CORD 2.95

**MUFFIN FANS**

- 4.68" SQUARE 14.95
- 3" SQUARE 14.95

**RESISTORS**

- 1/4 WATT 5% CARBON FILM ALL STANDARD VALUES FROM 1 OHM TO 10 MEG OHM
- 50 PIECES SAME VALUE 025
- 100 PIECES SAME VALUE 02
- 1000 PIECES SAME VALUE 015

**BYPASS CAPS**

- 01/4 DISC 100 \$6.00
- 01/4 MONOLITHIC 100 \$12.00
- 1/4 DISC 100 \$8.00
- 1/4 MONOLITHIC 100 \$15.00

**DIODES**

- 1N751 5.1 VOLT ZENER .25
- 1N759 12.0 VOLT ZENER .25
- 1N4148 (1N914) SWITCHING 25 1.00
- 1N4001 50PIV 1A 12 1.00
- 1N4004 400PIV RECTIFIER 10 1.00
- 1N5402 200PIV 3A 25
- KBPO2 200PIV 1.5A BRIDGE 45
- KBPO4 400PIV 1.5A BRIDGE 55
- MDA801 50PIV 12A BRIDGE 1.39
- MDA980 50PIV 12A BRIDGE 1.99
- MDA980-2 100PIV 12A BRIDGE 2.25
- VM48 BRIDGE 35

**HEAT SINKS**

- TO-220 SCREW ON .35
- TO-220 CLIP ON .35
- TO-3 SCREW ON .95
- TO-220 INSULATOP 10 1.00
- TO-3 INSULATOP 10 1.00

**SWITCHES**

- SPDT MINI-TOGGLE ON-ON 1.25
- DPDT MINI-TOGGLE ON-ON 1.50
- DPDT MINI-TOGGLE ON-OFF ON 1.75
- SPST MINI-PUSHBUTTON N.O. .39
- SPST MINI-PUSHBUTTON N.C. .39
- BCD OUT 10 POSITION 6 P IN DIP 1.95

**CAPACITORS**

TANTALUM					
10µf	15V	40	47µf	35V	50
6.8	15V	70	1.0	35V	45
10	15V	80	2.2	35V	65
22	15V	1.35	4.7	35V	85
.22	35V	40	10	35V	1.00

**DISC**

10µf	50V	05	560	50V	05
22	50V	05	680	50V	05
25	50V	05	820	50V	05
27	50V	05	.001µf	50V	05
33	50V	05	.0015	50V	05
47	50V	05	.0025	50V	05
56	50V	05	.005	50V	05
68	50V	05	.01	50V	07
82	50V	05	.02	50V	07
100	50V	05	.05	50V	07
220	50V	05	.1	12V	10

**MONOLITHIC**

01µf	50V	.14	1µf	50V	18
.047µf	50V	.15	.47µf	50V	.25

**ELECTROLYTIC**

RADIAL		AXIAL			
1µf	25V	.14	1µf	50V	14
2.2	35V	.15	4.7	16V	14
4.7	50V	.15	10	16V	14
10	50V	.15	10	50V	16
47	35V	.18	22	16V	14
100	16V	.18	47	50V	20
220	35V	.20	100	15V	20
470	25V	.30	100	35V	25
2200	16V	.60	220	25V	30

**COMPUTER GRADE**

44,000µf	30V	3.95	6000	16V	85
			2200	16V	70
			6000	16V	85

**LED DISPLAYS**

HP5082-7760	CC	.43	1.29
MAN-72	CA	3"	.99
MAN-74	CC	3"	.99
FND-357(359)	CC	.375"	1.25
FND-500(503)	CC	5"	1.49
FND-507(510)	CA	5"	1.49
TIL 311 4x7 HEX W	LOGIC	270"	9.95

**DIFFUSED LEDS**

JUMBO RED	T1 1/2	1.99	100µp
JUMBO GREEN	T1 1/2	10	.09
JUMBO YELLOW	T1 1/2	18	.15
MOUNTING HDW	T1 1/2	10	.09
MINI RED	T1	10	.09
MINI GREEN	T1	18	.15
MINI YELLOW	T1	18	.15
RECT RED	2x5mm	25	.22
RECT GREEN	2x5mm	.30	.27
RECT YELLOW	2x5mm	30	.27

**HARD TO FIND "SNAPABLE" HEADERS**

Can easily be snapped apart to make any size header, all with 1" centers

- 1x40 STRAIGHT LEAD .99
- 1x40 RIGHT ANGLE 1.49
- 2x40 STRAIGHT LEAD 2.49
- 2x40 RIGHT ANGLE 2.99

**SHORTING BLOCKS**

SPACED AT 1" CENTERS IDEAL FOR DISK DRIVES OR ANY 1" HEADER

**5/1.00**

**DIP SWITCHES**

- 4 POSITION .85
- 5 POSITION .90
- 6 POSITION .90
- 7 POSITION .95
- 8 POSITION .95
- 10 POSITION 1.29

**36 PIN CENTRONICS**

- IDCEN36 RIBBON CABLE MALE 8.95
- IDCEN36 F RIBBON CABLE FEMALE 8.95
- CEN36 SOLDER CUP MALE 7.95

**DIP CONNECTORS**

DESCRIPTION	ORDER BY	CONTACTS								
		8	14	16	18	20	22	24	28	40
HIGH RELIABILITY TOOLED ST IC SOCKETS	AUGATxxST	99	99	99	1.69	1.89	1.89	1.99	2.49	2.99
HIGH RELIABILITY TOOLED WW IC SOCKETS	AUGATxxWW	1.30	1.80	2.10	2.40	2.50	2.90	3.15	3.70	5.40
COMPONENT CARRIES (DIP HEADERS)	ICCxx	49	59	69	99	99	99	99	1.09	1.49
RIBBON CABLE DIP PLUGS (IDC)	IDPxx		95	95				1.75		2.95

FOR ORDERING INSTRUCTIONS SEE IDC CONNECTORS BELOW

**D-SUBMINIATURE**

DESCRIPTION	ORDER BY	CONTACTS				
		9	15	25	37	50
SOLDER CUP	MALE DBxxP	1.19	1.59	1.90	2.85	4.25
	FEMALE DBxxS	1.50	1.85	2.25	3.90	5.25
RIGHT ANGLE	MALE DBxxPR	1.65	2.20	3.00	4.83	
	FEMALE DBxxSR	2.18	3.03	3.00	6.19	
WIRE WRAP	MALE DBxxPWW	1.69	2.56	3.89	5.60	
	FEMALE DBxxSww	2.76	4.27	6.84	9.95	
IDC RIBBON CABLE	MALE IDBxxP	2.95	3.90	4.75	8.95	
	FEMALE IDBxxS	3.25	4.29	5.25	7.95	
HOODS	BLACK HOOD-B				99	
	GREY HOODxx	89	99	99	1.09	1.19

**MOUNTING HARDWARE-\$1.00**

FOR ORDERING INSTRUCTIONS SEE IDC CONNECTORS BELOW



DB37S



DB37S



DB25SR

**TEXTOL ZERO INSERTION FORCE SOCKETS AND RECEPTACLES**



TYPE	CONTACTS				
	14	16	24	28	40
ECONO ZIF		4.95	6.75	7.75	9.95
ZIF SOCKET	4.95	4.95	5.95	6.95	9.95
ZIF RECEPTACLE	8.25	8.75	9.75	10.50	12.75

**IDC CONNECTORS**

DESCRIPTION	ORDER BY	CONTACTS					
		10	20	26	34	40	50
SOLDER HEADER	IDHxxS	82	1.29	1.68	2.20	2.58	3.24
RIGHT ANGLE SOLDER HEADER	IDHxxSR	85	1.35	1.76	2.31	2.72	3.39
WW HEADER	IDHxxW	1.86	2.98	3.84	4.50	5.28	6.63
RIGHT ANGLE WW HEADER	IDHxxWR	2.05	3.28	4.22	4.45	4.80	7.30
RIBBON HEADER SOCKET	IDSxx	79	99	1.39	1.59	1.99	2.25
RIBBON HEADER	IOMxx		5.50	6.25	7.00	7.50	8.50
RIBBON EDGE CARD	IDExx	1.75	2.25	2.65	2.75	3.80	3.95



IDC20W



IDE50

**RIBBON CABLE**

CONTACTS	SINGLE COLOR		COLOR CODED	
	1'	10'	1'	10'
10	18	1.60	83	7.30
16	28	2.50	1.00	8.80
20	36	3.20	1.25	11.00
25	45	4.00	1.32	11.60
26	46	4.10	1.32	11.60
34	61	5.40	1.65	14.50
40	72	6.40	1.92	16.80
50	89	7.50	2.50	22.00

**RETAIL STORE - 1256 S. BASCOM AVENUE**  
**HOURS: M-W-F, 9-5 TU-TH, 9-9 SAT, 10-3**

PLEASE USE YOUR CUSTOMER NUMBER WHEN ORDERING

TERMS: Minimum order \$10.00. For shipping and handling include \$2.50 for UPS Ground and \$3.50 for UPS Air. Orders over 1 lb. and foreign orders may require additional shipping charges - please contact our sales department for the amount. CA. residents must include 6% sales tax. Bay Area and LA residents include 6 1/2%. All merchandise is warranted for 90 days unless otherwise stated. Prices are subject to change without notice. We are not responsible for typographical errors. We reserve the right to limit quantities and to substitute manufacturer. All merchandise subject to prior sale.

**JDR Microdevices**  
1224 S. Bascom Avenue, San Jose, CA 95128  
800-538-5000 • 800-662-6279 (CA) • (408) 995-5430  
FAX (408) 275-8415 • Telex 171-110

# IBM PC PROTOTYPE CARD WITH DECODING LAYOUT \$29.95

## WIRE WRAP PROTOTYPE CARDS

FR-4 EPOXY GLASS LAMINATE WITH GOLD-PLATED EDGE-CARD FINGERS



**IBM**  
BOTH CARDS HAVE SILK SCREENED LEGENDS AND INCLUDES MOUNTING BRACKET

IBM-PR1 WITH -5V AND GROUND PLANE \$27.95  
IBM-PR2 AS ABOVE WITH DECODING LAYOUT \$29.95

**S-100**

P100-1 BARE - NO FOIL PADS \$15.15  
P100-2 HORIZONTAL BUS \$21.80  
P100-3 VERTICAL BUS \$21.80  
P100-4 SINGLE FOIL PADS PER HOLE \$22.75

**APPLE**

P500-1 BARE - NO FOIL PADS \$15.15  
P500-3 HORIZONTAL BUS \$22.75  
P500-4 SINGLE FOIL PADS PER HOLE \$21.80  
7050-45 FOR APPLE II<sub>+</sub> AUX SLOT \$30.00

## GENERAL PURPOSE

22/44 PIN EDGE-CARD (.156" SPACING)

P441-1 BARE - NO FOIL PADS 4.5" x 6.0" \$9.45  
P441-3 VERTICAL BUS 4.5" x 6.0" \$13.95  
P441-4 SINGLE FOIL PADS 4.5" x 6.0" \$14.20  
P442-1 BARE - NO FOIL PADS 4.5" x 9.0" \$10.40  
P442-3 VERTICAL BUS 4.5" x 9.0" \$14.20  
P442-4 SINGLE FOIL PADS 4.5" x 9.0" \$13.50

36/72 PIN EDGE-CARD (.1" SPACING)

P721-1 BARE - NO FOIL PADS 4.5" x 6.0" \$9.45  
P721-3 VERTICAL BUS 4.5" x 6.0" \$13.25  
P721-4 SINGLE FOIL PADS 4.5" x 6.0" \$14.20  
P722-1 BARE - NO FOIL PADS 4.5" x 9.0" \$10.40  
P722-3 VERTICAL BUS 4.5" x 9.0" \$14.20  
P722-4 SINGLE FOIL PADS 4.5" x 9.0" \$15.15

**BARE GLASS BOARDS** NO EDGE-CARD FINGERS OR FOIL

P25x45 2.5" x 4.5" \$2.40  
P45x65 4.5" x 6.5" \$4.70  
P45x85 4.5" x 8.5" \$6.20  
P45x170 4.5" x 17.0" \$11.35  
P85x170 8.5" x 17.0" \$18.95

**EXTENDER CARDS**

IBM \$45.00  
APPLE \$45.00  
MULTIBUS \$86.00

## WIRE WRAP WIRE PRECUT AND STRIPPED

Note: 1 inch of insulation is stripped on each end. A 3.5" wire has only 1.5" of insulation.

LENGTH (INCHES)	100	500	1000
2.5	1.60	4.70	8.20
3	1.60	4.70	8.20
3.5	1.65	5.00	8.90
4	1.75	5.40	9.60
4.5	1.80	5.75	10.30
5	1.85	6.10	11.00
5.5	1.90	6.50	11.75
6	2.00	6.85	12.50
6.5	2.30	7.80	14.30
7	2.40	8.20	15.05
7.5	2.50	8.55	15.85
8	2.60	8.95	16.60
8.5	2.65	9.30	17.40
9	2.70	9.80	18.15
9.5	2.80	10.00	18.95
10	2.90	10.50	19.70

## PRECUT ASSORTMENT IN ASSORTED COLORS \$27.50

100ea: 5.5", 6", 6.5", 7"  
250ea: 2.5", 4.5", 5"  
500ea: 3", 3.5", 4"

**SPOOLS**

100 feet \$4.30 250 feet \$7.25  
500 feet \$13.25 1000 feet \$21.95

Please specify color: Blue, Black, Yellow or Red

## GE NICKEL-CADMIUM RECHARGABLE BATTERIES NI-CAD CHARGER PACKAGE

PRICE INCLUDES CHARGER (WALL PLUG), BATTERIES, & MODULAR BATTERY HOLDER

AAA CELLS QTY. 2 \$11.71  
AA CELLS QTY. 2 \$11.71  
C CELLS QTY. 2 \$13.21  
D CELLS QTY. 2 \$13.21  
9 VOLT QTY. 1 \$13.21

**BATTERIES ONLY**

AAA CELLS PKG. 2 \$6.07 pr.  
AA CELLS PKG. 1 \$3.03 ea.  
C CELLS PKG. 1 \$3.78 ea.  
D CELLS PKG. 1 \$3.78 ea.  
9 VOLT PKG. 1 \$7.57 ea.

## DISK DRIVES TANDON

TM 100-1 5 1/4" (FOR IBM) SS DD \$119.95  
TM 100-2 5 1/4" (FOR IBM) DS DD \$99.95

**MPI**

MPI-B52 5 1/4" (FOR IBM) DS DD \$89.95

**TEAC**

FD-55B 5/8" HEIGHT DS DD \$89.95  
FD-55F 5/8" HEIGHT DS QUAD \$99.55

**SHUGART**

SA 400L 5 1/4" (40 TRACK) SS DD \$199.95  
SA 460 5 1/4" (80 TRACK) DS QUAD \$199.95

**8" DISK DRIVES**

FD100-8 BY SIEMENS. SHUGART 801 EQUIV. SS DD \$129.90  
FD200-8 BY SIEMENS. SHUGART 851 EQUIV. DS DD \$180.90

**JFORMAT-2 \$49.95**  
SUPPORT FOR QUAD DENSITY DRIVES FROM "ALL TREE SYSTEMS"

TANDON TM100-2

PLEASE INCLUDE SUFFICIENT AMOUNT FOR SHIPPING ON ABOVE ITEMS



## DISK DRIVE CABINETS

**CABINET #1 \$29.95**  
- Fits one full height 5 1/4" disk drive  
- Color matches Apple

**CABINET #2 \$79.00**  
- Fits one full height 5 1/4" disk drive  
- Complete with power supply, switch, line cord, fuse and standard power connector  
- Please specify Grey or Tan

**CABINET #3 \$89.95**  
- Fits two half height 5 1/4" disk drives  
- Complete with power supply, switch, line cord, fuse and standard power connectors

**8" DISK DRIVE CABINETS ALSO AVAILABLE-PLEASE CALL**  
PLEASE INCLUDE SUFFICIENT AMOUNT FOR SHIPPING ON ABOVE ITEMS

## SWITCHING POWER SUPPLIES

**PS-IBM \$99.95**

- FOR IBM PC-XT COMPATIBLE
- 130 WATTS
- 5V @ 15A, -12V @ 4.2A
- 5V @ .5A, -12V @ .5A
- ONE YEAR WARRANTY

**PS-A \$49.95**

- USE TO POWER APPLE TYPE SYSTEMS
- 5V @ 4A, -12V @ 2.5A
- 5V @ .5A, -12V @ .5A
- APPLE POWER CONNECTOR

**PS-3 \$39.95**

- AS USED IN APPLE III
- 5V @ 4A, -12V @ 2.5A
- 5V @ .5A, -12V @ 30A
- 15.5" x 4.5" x 2", 884 LBS.

**PS-ASTEC \$19.95**

- CAN POWER TWO 5 1/4" FD DS
- 5V @ 2.5A, -12V @ 2A
- 12V @ .1A
- 5V @ 5A IF -12V IS NOT USED
- 6.3" x 4.0" x 1.9"



## OK INDUSTRIES

**EX-1 IC EXTRACTION TOOL**

- ONE PIECE METAL CONSTRUCTION
- EASILY EXTRACTS 8-24 PIN DEVICES
- LOW COST \$2.19

**EX-2 IC EXTRACTION TOOL**

- EXTRACTS 24-40 PIN DEVICES
- HEAVY DUTY METAL CONSTRUCTION
- GROUND LUGS FOR MOS EXTRACTIONS
- EASY ONE HANDED OPERATION \$12.74

**IC INSERTION TOOLS**

INS-1416 for 14-16 pin IC's \$5.15  
MOS-1416 for 14-16 pin IC's \$10.92  
MOS-2428 for 24-28 pin IC's \$10.92  
MOS-40 for 40 pin IC's \$12.43  
MOS series insertion tools have metal construction and include grounding lug for CMOS applications.

**BW-630 WIRE WRAP GUN**

- BATTERY POWERED-USES 2 NI-CAD C CELLS (NOT INCLUDED)
- POSITIVE INDEXING
- ANTI-OVERWRAP DEVICE \$41.55

**WSU-30 WIRE WRAP TOOLS**

- WRAPS, STRIPS, AND UNWRAPS
- WSU-30M WRAPS AN EXTRA TURN OF INSULATION
- WSU-30 \$8.84 / WSU-30M \$10.14

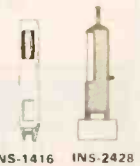

**WIRE WRAP TERMINALS**

WWT-1 SLOTTED 25/27.06  
WWT-2 SINGLE SIDED 25/24.25  
WWT-3 IC SOCKET 25/27.06  
WWT-4 DOUBLE SIDED 25/2.80  
INS-1 IC INSERTION TOOL \$5.64

**WIRE DISPENSER**

- WITH 50' ROLL OF WIRE
- BUILT IN PLUNGER CUTS WIRE
- BUILT IN STRIPPER STRIPES 1"
- REFILLABLE

**WD-30 \$6.50 WD-30TRI \$9.50**  
Specify Blue white. With 50' of each: Yellow or Red Red, Blue and White

**SOCKET-WRAP I.D.™**

- SLIPS OVER WIRE WRAP PINS
- IDENTIFIES PIN NUMBERS ON WRAP SIDE OF BOARD
- CAN WRITE ON PLASTIC, SUCH AS IC #

PINS	PART#	PCK. OF	PRICE
8	IDWRAP 08	10	1.95
14	IDWRAP 14	10	1.95
16	IDWRAP 16	10	1.95
18	IDWRAP 18	5	1.95
20	IDWRAP 20	5	1.95
22	IDWRAP 22	5	1.95
24	IDWRAP 24	5	1.95
28	IDWRAP 28	5	1.95
40	IDWRAP 40	5	1.95

PLEASE ORDER BY NUMBER OF PACKAGES (PCK. OF)

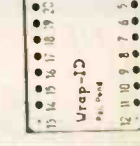
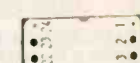

## TRANSFORMERS FRAME STYLE

12.6V AC	2 AMP	4.95
12.6V AC CT	2 AMP	5.35
12.6V AC CT	4 AMP	7.35
12.6V AC CT	8 AMP	10.35
25.2V AC CT	2 AMP	7.95

**PLUG CASE STYLE**

12V AC	250ma	3.95
12V AC	500ma	4.95
12V AC	1 AMP	5.95
12V AC	2 AMP	6.95

**DC ADAPTER**

6, 9, 12V DC SELECTABLE WITH UNIVERSAL ADAPTER 8.95

## MICROCOMPUTER HARDWARE HANDBOOK

FROM ELCOM \$14.95

Over 800 pages of manufacturer's data sheets on the most commonly used IC's

- TTL - 74, 74LS & 74F
- CMOS
- Voltage regulators
- Memory - RAM, ROM, EPROM
- CPU's - 6800, 6500, Z80, 8080, 8085 & 8036/8
- MPU Support & Interface, 6800, 6500, Z80, 8200, etc.

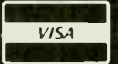

**ORDER TOLL FREE**  
**800-538-5000**  
**800-662-6279**  
(CALIFORNIA RESIDENTS)

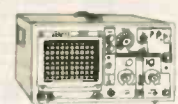

## 20 MHz DUAL TRACE OSCILLOSCOPE

UNSURPASSED QUALITY AT AN UNBEATABLE PRICE

- BAND WIDTH: DC TO 20MHz (-3db)
- AC: 10Hz TO 20MHz (-3db)
- SWEEP TIME: 2 μSEC TO 3 SEC / DIV ON 20 RANGES
- VERT. HORZ. DEFLECTIO V: 5mV TO 20V / DIV ON 20 RANGES
- COMPLETE MANUAL AND HIGH QUALITY
- HOOK-ON PROBES INCLD DEG
- INPUT IMPEDANCE: 1 MEG OHM
- TV VIDEO SYNC FILTER
- X, Y AND Z AXIS OPERATION
- 110-220 VOLT 50/60Hz OPERATION
- COMPONENT TESTER
- LP CONSUMPTION - 19 WATTS
- BUILT IN CALIBRATOR
- AUTOMATIC OR TRIGGERED TIMEBASE

**\$399.95**  
WITH PROBES  
**FULL ONE YEAR WARRANTY**

## MULTIMETER PEN



**AUTO RANGING, POLARITY & DECIMAL!**

- LARGE 3 1/2 DIGIT DISPLAY
- DATA HOLD SWITCH FREEZES READING
- FAST, AUDIBLE CONTINUITY TEST
- LOW BATTERY INDICATOR
- OVERLOAD PROTECTION
- ONLY 1 1/2" x 5 1/2" x 3/4"
- DC VOLTS: 1mV-500V
- AC VOLTS: 1mV-500V
- 1 OHM-20 MEG OHMS
- WEIGHS ONLY 2.3 OUNCES
- LOW PARTS COUNT-CUSTOM 80 PIN LSI INSURES RELIABILITY
- INCLUDES MANUAL, BATTERIES, SOFT CASE, 2 PROBE TIPS, AND ALIGATOR CLIP

**ONLY \$49.95**

**TEAC-FD55B** DS/DD 1/2 HT. **\$89.95** **MPI-B52** DS/DD FULL HT. **\$89.95**  
 FOR IBM PC FOR IBM PC

**EPROM PROGRAMMER**  
 FOR APPLE COMPUTERS



RP525  
**\$79.95**

- DUPLICATE OR BURN ANY STANDARD 27xx SERIES EPROM
- EASY TO USE MENU-DRIVEN SOFTWARE INCLUDED
- MENU SELECTION FOR 2716, 2732, 2732A, 2764 & 27128
- HIGH SPEED WRITE ALGORITHM
- LED INDICATORS FOR ACTIVITY
- NO EXTERNAL POWER SUPPLY REQUIRED

**DISK DRIVES FOR IBM**

**TEAC**  
 FD55B  
**\$89.95**

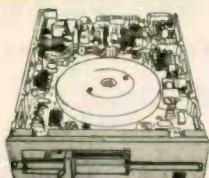

**TANDON**  
 TM100-2  
**\$99.95**

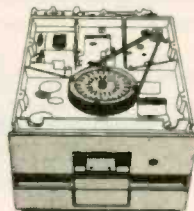

**MPI**  
 MODEL B52  
**\$89.95**

**IBM ACCESSORIES**

- MAXIMIZER** SIGMA MULTIFUNCTION CARD \$259.95
- HAYES SMARTMODEM** 1200B FOR IBM \$419.95
- PRINTER CABLE** PARALLEL 6' SHIELDED CABLE \$19.95
- KRAFT JOYSTICK** \$39.95

**DISKETTE FILE**

**\$8.95** IF PURCHASED WITH 50 DISKETTES OR MORE

\$9.95 IF PURCHASED ALONE

HOLDS 70 5 1/4" DISKETTES, WITH ROOM TO SPARE

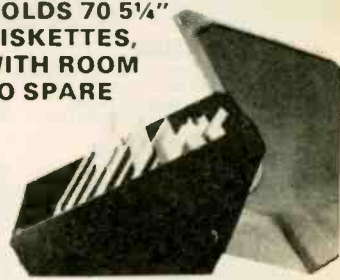

**DISK DRIVES**

FOR APPLE COMPUTERS



**BAL-525**  
**\$119.95**

- 1/2 HEIGHT-ALPS MECHANISM
- 100% APPLE COMPATIBLE
- FULL 1 YEAR WARRANTY

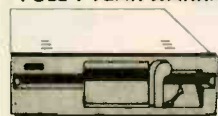

**BAL-500**  
**\$139.95**

- TEAC MECHANISM- DIRECT DRIVE
- 100% APPLE COMPATIBLE
- FULL 1 YEAR WARRANTY



**MITAC**  
 AD-1  
**\$129.95**

- FULL HT. SHUGART MECHANISM
- DIRECT REPLACEMENT FOR APPLE DISK II
- SIX MONTH WARRANTY

**DISK DRIVE ACCESSORIES**

- DISK CONTROLLER CARD** \$49.95
- APPLE IIc ADAPTOR CABLE** \$19.95

**BMC MONITOR STAND**  
 MODEL PA-900

TILTS AND SWIVELS TO PROVIDE OPTIMUM VIEWING ANGLE, REDUCES OPERATOR FATIGUE



**FACTORY SPECIAL \$14.95**

**ORDER TOLL FREE**  
**800-538-5000**  
**800-662-6279 (CA)**

**16K RAM CARD \$39.95**

- BARE PC CARD AND INSTRUCTIONS \$9.95
- 2 YEAR WARRANTY
- EXPAND YOUR 48K APPLE TO 64K
- USE IN PLACE OF APPLE LANGUAGE CARD

**APPLE ACCESSORIES**

- VIEWMAX-80** \$159.95
- VIEWMAX-80e** \$129.95
- GRAPHMAX** \$129.95
- THUNDERCLOCK** \$129.95
- KRAFT JOYSTICK** \$39.95
- POWER SUPPLY** \$49.95

**NASHUA DISKETTES**

5 1/4" SOFT SECTOR DS/DD WITH HUB RINGS

BULK PACKAGED IN FACTORY SEALED BAGS OF 50. INCLUDES DISKETTE SLEEVES AND WRITE PROTECT TABS. IDEAL FOR SCHOOLS, CLUBS, AND USERS GROUPS. THIS IS A SPECIAL PURCHASE, SO QUANTITIES ARE LIMITED. THERE IS A 5 YEAR WARRANTY.

**\$.89ea.** QTY 250 **\$.95ea.** QTY 100 **\$.99ea.** QTY 50

NASHUA DISKETTES WERE JUDGED TO HAVE THE HIGHEST POLISH AND RECORDED AMPLITUDE OF ANY DISKETTES TESTED. (SEE "COMPARING FLOPPY DISKS", BYTE 9/84)

**VERBATIM DATALIFE DISKETTES**

- SS/DD SOFT SECTOR \$29.95
- SS/DD 10 SECTOR HARD \$29.95
- DS/DD SOFT SECTOR \$34.95

**IBM COMPATIBLE POWER SUPPLIES**

**130 WATT \$99.95**

XT COMPATIBLE

- +5V @ 15A, +12 @ 4.2A, -5 @ .5A, -12 @ .5A
- UPGRADE YOUR PC, POWERS HARD DISK
- POWER CABLES FOR 4 FDDs
- ONE YEAR WARRANTY
- SWITCH ON SIDE (FITS IBM CASE)



**100 WATT \$89.95**

- SWITCH ON REAR
- FOR USE IN OTHER IBM TYPE MACHINES
- AVAILABLE IN 100W OR 130W VERSIONS
- 90 DAY WARRANTY



**130 WATT MODEL \$99.95**

**JDR Microdevices**

1224 S. Bascom Avenue, San Jose, CA 95128

800-538-5000 • 800-662-6279 (CA) • (408) 995-5430

FAX (408) 275-8415 • Telex 171-110

RETAIL STORE - 1256 S. BASCOM AVENUE  
 HOURS: M-W-F, 9-5 TU-TH, 9-9 SAT, 10-3

PLEASE USE YOUR CUSTOMER NUMBER WHEN ORDERING

TERMS: Mirimum order \$10.00. For shipping and handling include \$2.50 for UPS Ground and \$3.50 for UPS Air. Orders over 1 lb. and foreign orders may require additional shipping charges - please contact our sales department for the amount. CA. residents must include 6% sales tax, Bay Area and LA residents include 6 1/2%. All merchandise is warranted for 90 days unless otherwise stated. Prices are subject to change without notice. We are not responsible for typographical errors. We reserve the right to limit quantities and to substitute manufacturer. All merchandise subject to prior sale.



# U·N·C·L·A·S·S·I·F·I·E·D A·D·S

**NEEDED:** Computer (Apple, IBM, compatible), printer, and monitor to help nonprofit adoption organization find good homes for orphaned hard-to-place children. Will provide certified tax-deductible receipt. Children's World, 9311 Farralone Ave., Chatsworth, CA 91311, (818) 709-4737.

**WANTED:** Nonprofit educational organization seeks tax-deductible donation of IBM System/34 and peripherals. John B. Ellison, International Correspondence Institute, c/o Division of Foreign Missions, 1445 Boonville Ave., Springfield, MO 65802.

**WANTED:** Nonprofit organization serving southeastern Kentucky area seeks tax-deductible donation of IBM computers, hardware, and public-domain software for youth rehabilitation program. Kentucky Youth, c/o Bob Rains, 520 Beach St., POB 173, Benham, KY 40807.

**WANTED:** Eastside Mental Health (a nonprofit organization) seeks tax-deductible donation of IBM PC or Macintosh, peripherals, printer, monitor, terminals, public-domain software, etc., for applied research with the chronically disturbed. Will pay shipping. Debbie Bertram, Eastside Mental Health, 1605 116th Ave. NE, Bellevue, WA 98004, (206) 455-4357.

**NEEDED:** Nonprofit Costa Rican educational foundation seeks donation of disk-based microcomputers (Heath H-89 or similar) to teach programming to poor students. Will pay shipping. FILEC, POB 2911, San Jose 1000, Costa Rica.

**WANTED:** Nonprofit environmental education center seeks tax-deductible donation of a computer (preferably IBM-compatible) and printer for use with school groups and in our office. Montclair State College, New Jersey School of Conservation, RD #2, Box 272, Branchville, NJ 07826, (201) 948-4646.

**WANTED:** Information on operating microcomputer equipment in the marine environment. Can a computer survive fog, dampness, humidity, and salt air if kept dry and at a moderate temperature? Alan Born, POB 272, Tiburon, CA 94920, (415) 924-6352.

**WANTED:** Nonprofit community organization needs tax-deductible donation of computers, printers, terminals, and public-domain software to assist in ADM and training. R. Hankins, PCT Inc., 160 Millagra Dr., Pacifica, CA 94044, (415) 355-8000.

**WANTED:** Tax-deductible donation of peripherals, printers, monitors, disk drives, memory expansion, etc., for the TRS-80 Model I. Certified receipts furnished; will pay reasonable shipping. Pirchei Agudath Israel of Kew Gardens Hills, 144-19 70th Rd., Flushing, NY 11367.

**WANTED:** Christian academy seeks tax-deductible donations of Apple IIe computers with minimum 64K, disk drives, 80-column card, and monitor for high school math and science classes. Cheswick Christian Academy, 1407 Pittsburgh St., Cheswick, PA 15024, (412) 274-4846.

**WANTED:** Nonprofit organization seeks tax-deductible donation of IBM PC, 256K to 512K RAM, two 360K disk drives or 5- or 10-megabyte hard-disk drive, and monochrome monitor for running high school track meets. Massachusetts State Track Coaches Association, c/o Edmund N. Delgado, 28 Warbler Lane, West Yarmouth, MA 02673, (617) 394-7571.

**WANTED:** Information and equipment for an old Ohio Scientific Challenger IIP 8K microcomputer used in school. We need manuals, ideas for use, and public-domain software. Jeffrey Branzburg, Castle Hill JHS, 1560 Purdy St., Bronx, NY 10462.

**WANTED:** Casio PB-700 user in Australia wishes to correspond with users in America or anywhere about starting a users group. Terry Gill, 35A Kent St., Regents Park, New South Wales 2143, Australia.

**NEEDED:** My Access-Actrix monitor is missing dots. Need schematic or other service assistance. L. Rogers, 313 South Ravinia, Dallas, TX 75211, (214) 339-7007.

**NEEDED:** Manuals, schematics, etc., for Seattle Computer Products 8086 CPU and CPU Support Board (SCP-200 and SCP-300). Also information on 8087 accessory board. Willing to pay. Stephen Hathaway, 86 Parsons St., Northampton, MA 01060, (413) 586-4341, evenings.

**NEEDED:** User-written scientific applications software in Applesoft and Apple Pascal. Statistics, plotting, data logging, modeling, etc. Peter Petokas, POB 16,

Little York, NY 13087.

**FOR SALE:** Davong 5-megabyte hard disk with controller for IBM PC. \$325. Colby PC-1 portable with power supply, amber monochrome display, and keyboard; install your own PC board, drives, and display adapter to create portable machine; brand new. \$650. Buyer pays shipping and COD charges. Tom Guyton, 12 Harned Ct., Odessa, TX 79762.

**FOR SALE:** Microvox text-to-speech voice synthesizer expertly assembled from Micromint kit; will connect to any computer with RS-232C (with RTS input) or Centronics-compatible parallel I/O. \$200. Includes Realistic Wedge speaker. Hans Raillard, 6400 Lone Pine Rd., Sebastopol, CA 95472.

**FOR SALE:** Various S-100 components and disk drives including CPU boards, memory boards, floppy-disk controllers, and Tandon 848-I disk drives. Richard Whiteman, 635 Holman Ave., Athens, GA 30606, (404) 546-8814.

**FOR SALE:** TI 99/4A peripheral-expansion system, disk-controller card, disk drive, memory-expansion card (32K RAM). \$400. All items are new. Dave Watters, 3901 Torrington Ave., Parma, OH 44134, (216) 845-9669.

**FOR SALE:** Atari 850 interface. Bit 3 80-column card, and more. \$300. Sonam Gyato, (201) 868-9695.

**WANTED:** TI 99/4As, KIM-1s, Altair 8800A/Bs, and similar machines for community project. Nothing elaborate or expensive. Also need *The First Book of KIM and Machine Language Programming for the 8008*. Dr. J.R. Johnston, Edon Institute, POB 2258, Saginaw, MI 48605.

**TRADE:** Physics student with TI 99/4A computer seeks working or nonworking stand-alone disk drive and compatible dot-matrix printer with interface in exchange for public-domain BASIC/Extended software. Will pay postage. Dennis Hothem, 1218 10th Ave., Belle Fourche, SD 57717, (605) 892-3752.

**FOR SALE:** Vlewmax-80 for Apple II. new. Best offer. John Chen, Rt. 8, Box 483, Caldwell, ID 83605.

**FOR SALE:** BYTE, November 1977 through May 1980. \$2 per issue. Digital Group 4-port parallel I/O board. \$20. Digital Group keyboard. \$60. Buyer pays shipping. Harold Frye, 1551 5th Ave. SW, Rochester, MN 55902, (507) 289-0247.

**FOR SALE:** Tecmar 1st Mate for IBM PC XT or compatible. 64K, clock/calendar, serial port, parallel port. Brand new. \$275. N. D. Diamantides, 2517 14th St., Cuyahoga Falls, OH 44223.

**WANTED:** Public-domain or non-copyrighted CBIOS to interface CPM 2.2 to a North Star single-density micro-disk system running on a SOL terminal computer. Most interested in the source code for the deblocking and disk-access routines. David J. Mankoff, 3 Skyvue Ct., South Setauket, NY 11720, (516) 736-3631.

**FOR SALE:** "Tubeless Terminal" Synertek KT3-3/40 with 24 by 40 display, RS-232C-compatible output, and optional Micro-Verter MVX-500 that transmits UHF signal on UHF 14-17. Best offer. Al Safer, 77 LaBelle Circle, Chicopee, MA 01020.

**FOR SALE:** HP 86A with 512K, HP 82913A monitor; two HP 9130A 5¼-inch drives, HP 82905 printer. Also HP 98165 with 768K, HP 9121D dual 3½-inch drives, large keyboard, HP 82905B printer, and more. Make offer. John Blair, POB 164, Swan Lake, MT 59911, (406) 886-2370.

**WANTED:** If you own an Atari or Apple computer and want to join the National Software Consortium, con-

tact National Software Consortium, c/o S. Mikutel, 95-18 Ashbourn Dr., Burke, VA 22015.

**WANTED:** Correspondence about Japanese computing scene. Keiko Orata, Nishi-tsutsuji 1-24-1, Chofu City, Tokyo 182, Japan, 0424-85-0860.

**FOR SALE:** DECwriter IV (LA34), lightweight desktop terminal. 1 year old, original carton with documentation, extra ribbons, 45 cps, 7 by 9 dot matrix, variable pitch, plain paper or preprinted forms, RS-232C interface, used less than 20 hours. \$895 or best offer. Mike Kwiatkowski, 136 Lyndale Ave., Baltimore, MD 21236, (301) 665-6261.

**WANTED:** New or used tractor feed for a Brother HR-1 printer. J. Fears, 665 Sapphire Lane, Stevensville, MT 59870.

**FOR SALE:** Sanyo 1000 8-inch disk-controller board, cable, and card guide. Data General "Dasher" print head, new. Motors for same. John Johnson, 707 Edge Hill Rd., New Bern, NC 28560, (919) 638-6976.

**FOR SALE:** BYTE, 1979 (volume 4) to present. \$2 per copy. David Moore, 2031 Maine, Quincy, IL 62301, (217) 228-1792, evenings.

**FOR SALE:** BYTE, October 1975, March 1976, July 1976 through December 1984 (except August 1980). Kilobaud, January 1977 through March 1978; *Creative Computing*, March/April 1975 through September/October 1978; *Interface Age*, July 1976 through May 1978. Other publications available. Make offer. Steve Baylus, 12212 Old Creedwood Rd., Raleigh, NC 27612, (919) 781-0605 or 848-3018.

**FOR SALE:** Two Tektronix 4054 graphics computers with 19-inch screens and ¼-inch tape drives. \$3000 each or best offer. Tektronix 4631 hard-copy unit. \$700. Tim Zeisloff, 2161 Shattuck Ave., #210, Berkeley, CA 94704, (415) 849-0629.

**FOR SALE:** GIMIX #39 mainframe, two 8-inch floppy drives, one 5-inch floppy, 5-megabyte hard disk, 340K static RAM, intelligent I/O processor, other I/O boards, Privac hi-res graphics, Meta-Labs Z80 CP/M board, Windrush PROM burner, Z19 terminal 9511, and more. Asking \$7500. Will sell separately. Dick Bartholomew, 4849 Bethlehem Pike, Telford, PA 18969, (215) 257-3992.

**FOR SALE:** Two TeleVideo 925 terminals. \$500 each. Two S-100 systems with Advanced Digital Super Six SBC (6-MHz Z80, 128K RAM, 4K ROM), dual 8-inch Mitsubishi DS/DD floppy drives, Integrand 7 slot, wood-grain cabinet, all manuals: \$1750 each. Phil Erwin Jr., 2101A Mona Ct., Lexington, KY 40503, (606) 299-4096.

**FOR SALE:** 8K RAM for Radio Shack PC-2 or the Sharp PC-1500 pocket computer. Asking \$50. Also seek 16K RAM with battery backup for same machines. Interested in starting a users group for pocket computers. Robert Lerner, 23 Mayer Dr., Suffern, NY 10901.

**FOR SALE:** BYTE, number 1 through September 1980: all in excellent condition (missing numbers 6 and 8, 1977, numbers 4 and 5, 1978; and number 7, 1980). \$300. Negotiable. Jack Molinelli, 499 Harding Rd., Fair Haven, NJ 07701, (201) 842-7036.

**FOR SALE OR TRADE:** Heathkit H-14 printer with many features. \$300. Donald Mayes, Apt. #3, 8515 Greenwood Ave., Takoma Park, MD 20912, (301) 589-4190 or (202) 282-0585.

**FOR SALE:** Mindset computer with expansion unit purchased new September 1984. Includes parallel card, mouse, Quadchrome HX-12 color monitor. All original manuals. Will guarantee operation. \$2750 or best offer. S. Adams, (212) 675-6707.

**WANTED:** Anyone wanting to sell a Sinclair ZX80 or ZX81 in working condition. I'm interested in parallel processing for music applications. Chris Schaefer, 2140 Harvard St., Palo Alto, CA 94306.

**FOR SALE:** TI 99/4A with original packing. Good condition. Seller will pay postage \$110. Mike Busing, 1129 Harter Blvd., Anderson, IN 46011, (317) 642-9063.

**FOR SALE:** Heath H-89 computer, 64K, three disk drives, three SIO ports, CDR DD controller, Cleveland Codonics graphics board, and more. \$1800 for the works. Tom Dorsett, East 2726 Golden Rd., Spokane, WA 99208, (509) 466-0585.

**FOR SALE:** TRS-80 Model 12, Daisy Wheel Printer II, excellent condition; asking \$4000. Charles Denison, 14 Landover Dr., Coatesville, PA 19320, (215) 384-1869, after 6 p.m.

UNCLASSIFIED ADS MUST be noncommercial, from readers who have computer equipment to buy, sell, or trade on a one-time basis. All requests for donated computer equipment must be from nonprofit organizations. Programs to be exchanged must be written by the individual or be in the public domain. Ads must be typed double-spaced, contain 50 words or less, and include full name and address. This is a free service; ads are printed as space permits. BYTE reserves the right to reject any unclassified ad that does not meet these criteria. When you submit your ad (BYTE, Unclassified Ads, POB 372, Hancock, NH 03449), allow at least four months for it to appear.

## BYTE'S ONGOING MONITOR BOX

ARTICLE#	PAGE	ARTICLE	AUTHOR(S)	ARTICLE#	PAGE	ARTICLE	AUTHOR(S)
1	9	Microbytes	staff	16	239	Astronomical Computing w/lt Micros	Bochonko, Peters
2	39, 406	What's New	staff	17	252	Texas Instruments' Pro-Lite Professional Computer	Grehan, White
3	48	Ask BYTE	Ciarcla	18	258	NCR Personal Computer Model 4	Holden
4	65	Book Reviews	Wilke, Cass. Rogers, Cox. Avila	19	265	Monitoring Halley's Comet	Mosley
5	106	Programming Project: New Perspective on Nearby Stars	Webster	20	269	Space-Flight Simulators	Bernar
6	119	Liquid-Crystal Displays for Portables	Adler	21	279	MaxThink	Hershey
7	129	Product Description: The GRIDCase	Malloy	22	287	The Anchor Automation Signalman Mark XII Modem	Kinal
8	141	Ciarcla's Circuit Cellar: Living in a Sensible Environment	Ciarcla	23	309	Computing at Chaos Manor: Come to the Faire	Pournelle
9	163	Programming Insight: Travesty Revisited	Lesser	24	341	BYTE West Coast: SNOBOL and Icon	Shapiro
10	171	Programming Insight: Real-Number Formatting on Your Apple	Davidduck	25	353	BYTE U.K.: Starlt Spectrum	Pountain
11	179	Updating the Oldest Science	Genet	26	363	BYTE Japan: Peripherals. Chips, and New Computers	Raike
12	192	Microcomputers in NASA's SIR-B	Wilton	27	367	According to Webster: Start-up	Webster
13	203	Comet Lines in FORTRAN	Dixon	28	385	Mathematical Recreations: Parsing and Solving Linear Equations	Kurosaka
14	215	Tracking Earth Satellites	Weiss	29	393	BYTELINES	Libes
15	227	Automating a Telescope	Boyd				

## July BOMB Results

### HOME RUN WON

The first in the series from Ciarcla's Circuit Cellar on how to "Build the Home Run Control System" placed first in April. It introduced a project for energy management, convenience, and security for the home or factory. Jerry Pournelle's "Over the Moat" captured second place. His battles with the flu, construction, and computer-type issues continue in the saga of Computing at Chaos Manor. And whether it's new or not,

"What's Not" did win third. In fourth, and the winner of the \$100 prize, is John K. Stevens's theme article on a model of circuitry entitled "Reverse Engineering the Brain." And in fifth place is "The Quest to Understand Thinking." Roger Schank and Larry Hunter will half the \$50 bonus. Congratulations to all.

### BYTE ADVERTISING SALES STAFF:

**J. Peter Huestis, Advertising Sales Manager, 70 Main Street, Peterborough, NH 03458, tel. (603) 924-9281**

#### NEW ENGLAND

ME, NH, VT, MA, RI  
Paul McPherson Jr. (617) 262-1160  
McGraw-Hill Publications  
575 Boylston Street  
Boston, MA 02116

#### ATLANTIC

NY, NYC, CT, NJ (NORTH)  
Leah Goldman (212) 512-2096  
McGraw-Hill Publications  
1221 Avenue of the Americas—  
39th Floor  
New York, NY 10020

Dick McGurk (203) 968-7111  
McGraw-Hill Publications  
Building A—3rd Floor  
777 Long Ridge Road  
Stamford, CT 06902

#### EAST

PA (EAST), NJ (SOUTH),  
MD, VA, W VA, DE, D.C.  
Daniel Ferro (215) 496-3833  
McGraw-Hill Publications  
Three Parkway  
Philadelphia, PA 19102

#### SOUTHEAST

NC, SC, GA, FL, AL, TN  
Maggie M. Dorvee (404) 252-0626  
McGraw-Hill Publications  
4170 Ashford-Dunwoody Road—  
Suite 420  
Atlanta, GA 30319

#### MIDWEST

IL, MO, KS, IA, ND, SD, MN, WI, NB, IN  
Bob Denmead (312) 751-3740  
McGraw-Hill Publications  
Blair Building  
645 North Michigan Ave.  
Chicago, IL 60611

#### GREAT LAKES, OHIO REGION

MI, OH, PA (ALLEGHENY), KY,  
EASTERN CANADA  
Mike Kisseberth (313) 352-9760  
McGraw-Hill Publications  
4000 Town Center—Suite 770  
Southfield, MI 48075

#### SOUTH PACIFIC

SOUTHERN CA, AZ, NM, LAS VEGAS  
Jack Anderson (714) 557-6292  
McGraw-Hill Publications  
3001 Red Hill Ave.  
Building #1—Suite 222  
Costa Mesa, CA 92626

Karen Niles (213) 480-5243, 487-1160  
McGraw-Hill Publications  
3333 Wilshire Boulevard #407  
Los Angeles, CA 90010

#### NORTH PACIFIC

HI, WA, OR, ID, MT, NORTHERN CA,  
NV (except LAS VEGAS), W. CANADA  
David Iern (415) 362-4600  
McGraw-Hill Publications  
425 Battery Street  
San Francisco, CA 94111  
Bill McAfee (415) 964-0624  
McGraw-Hill Publications  
1000 Elwell Court—Suite 225  
Palo Alto, CA 94303

#### SOUTHWEST, ROCKY MOUNTAIN

UT, CO, WY, OK, TX, AR, MS, LA  
Dennis Riley (214) 458-2400  
McGraw-Hill Publications  
Prestonwood Tower—Suite 907  
5151 Beltline  
Dallas, TX 75240

#### WEST COAST SURPLUS AND RETAIL ACCOUNTS

Tom Harvey (805) 964-8577  
3463 State Street—Suite 256  
Santa Barbara, CA 93105

#### The Buyer's Mart

Karen Burgess (603) 924-9281  
BYTE Publications  
70 Main Street  
Peterborough, NH 03458

#### Post Card Mailings

**National**  
Bradley Browne (603) 924-6166  
BYTE Publications  
70 Main Street  
Peterborough, NH 03458

### International Advertising Sales Representatives:

Mr. Hans Csokor  
Publimedia  
Reisnerstrasse 61  
A-1037 Vienna, Austria  
222 75 76 84

Mrs. Gurit Gepner  
McGraw-Hill Publishing Co.  
PO Box 2156  
Bat Yam, 59121 Israel  
3 866 561 321 39

Mr. Fritz Krusebecker  
McGraw-Hill Publishing Co.  
Liebigstrasse 19  
D-6000 Frankfurt/Main 1  
West Germany  
69 72 01 81

Mrs. Maria Sarmiento  
Pedro Teixeira 8, Off. 320  
Iberia Mart I  
Madrid 4, Spain  
I 45 52 891

Mr. Andrew Karnig  
Andrew Karnig & Associates  
Finnbodavagen  
S-131 31 Nacka, Sweden  
8-44 0005

Mr. Jean Christian Acis  
McGraw-Hill Publishing Co.  
17 rue Georges Bizet  
F 75116 Paris  
France  
I 720 33 42

Mr. Arthur Scheffer  
McGraw-Hill Publishing Co.  
34 Dover St.  
London W1X 3RA  
England 01 493 1451

Mr. Savio Pesavento  
McGraw-Hill Publishing Co.  
Via Flavio Baracchini 1  
20123 Milan, Italy  
011 86 90 656

Seavex Ltd.  
400 Orchard Road, #10-01  
Singapore 0923  
Republic of Singapore  
Tel: 734-9790  
Telex: R53539 SEAVEX

Seavex Ltd.  
503 Wilson House  
19-27 Wyndham St.  
Central, Hong Kong  
Tel: 5-260149  
Telex: 60904 SEVEX HX

Hiro Morita  
McGraw-Hill Publishing Co.  
Overseas Corp.  
Room 1528  
Kasumigaseki Bldg.  
3-2-5 Kasumigaseki,  
Chiyoda-Ku  
Tokyo 100, Japan  
3 581 9811

# R·E·A·D·E·R S·E·R·V·I·C·E

Inquiry No.	Page No.	Inquiry No.	Page No.	Inquiry No.	Page No.	Inquiry No.	Page No.	
405	1ST PLACE SYSTEMS	422	83	COLLEGE SOFTWARE	426	148	FIDELITY-FIE	346
2	3-M COMMERCIAL OFFICE	217	85	COMMODORE BUSN. MACHINES	12, 13	149	FLAGSTAFF ENGINEERING	202
8	800 SOFTWARE	294	87	COMP. COMPNTS UNLTD	440, 441	150	FLAGSTAFF ENGINEERING	202
9	A.S.T. RESEARCH	19	*	COMPAQ COMPUTER	INSERT 32 A-L	151	FORTRON, INC.	435
10	A.S.T. RESEARCH	19	88	COMPETITIVE EDGE	96	152	FORTRON, INC.	435
11	AB COMPUTERS	164	*	COMPUMAIL	454	153	FOX AND GELLER	388
12	AB COMPUTERS	165	90	COMPUSAVE	437	154	FOX SOFTWARE INC.	455
13	ABC DATA PRODUCTS	436	91	COMPUSERVE	339	400	FUTURE COMPUTING	273
14	ACS INT'L, INC.	61	92	COMPUTER AFFAIRS INC.	198	155	GENERAL DYNAMICS	316
15	ADDMASTER CORP.	428	93	COMPUTER CHANNEL	334	156	GENERAL SOFTWARE	78
16	ADTEK	55	*	COMPUTER CHRONICLES	400	157	GENERAL TECHNOLOGY	361
17	ADVANCED COMP. PROD.	442, 443	94	COMPUTER CONNECTION	429	158	GENEST TECH	78
19	ADVANCED LOGIC RESEARCH	60	*	COMPUTER CONTINUUM	436	159	GENEST TECH	78
20	ADVANCED LOGIC RESEARCH	60	291	COMPUTER DIRECT	449	160	GIFFORD COMP. SYS.	5
22	ALF PRODUCTS, INC.	82	96	COMPUTER HUT OF N.E.	317	161	GOLD HILL COMPUTERS	178
23	ALLIED MICRO DEVICES	455	98	COMPUTER MAIL ORDER	236, 237	162	GOLDEN BOW SYSTEMS	82
*	AMBER SYSTEMS	224, 225	99	COMPUTER MART	219	163	GTEK INC.	92
29	AMERICAN SEMICONDUCTOR	436	403	COMPUTER PARTS MART	432	164	H&E COMPUTRONICS	123
30	AMPERE INC	30	101	COMPUTER WAREHOUSE	278	165	HANZON DATA INC.	18
31	AMPEX CORP.	62, 63	102	COMPUTER WAREHOUSE	278	166	HARMONY VIDEO & COMP.	68
32	AMPRO COMPUTERS INC.	173	103	COMPUTERBANQ	74	167	HAYES MICROCOMP. PROD.	313
33	ANCHOR AUTOMATION	233	104	COMPUTRADE	404	5	HEH JEJU ENTERPRISE	369
34	ANCHOR AUTOMATION	233	105	CONCORD TECHNOLOGY INC.	449	168	HERCULES COMPUTER TECH.	375
35	APPARAT INC.	426	106	CONROY-LAPOINTE	116, 117	169	HERCULES COMPUTER TECH.	377
*	APPLE COMPUTER INC.	CII, 1	107	CONROY-LAPOINTE	116, 117	170	HOFFMAN INT'L	432
36	APPLIED I.	430	108	CONROY-LAPOINTE	116, 117	171	HOLMES & COMPANY	128
37	APPLIED SOFTWARE TECH.	93	109	CORVUS SYS. INC.	319	172	HOOLEON COMPANY	97
*	APROTEK	159	110	COSMOS	185	173	HOOLEON COMPANY	97
38	APROTEK	449	111	CRANE ASSOCIATES	422	174	HOUSTON INSTR./BAUSCH&LOMB	209
39	ARK ELECTRONICS PRODUCTS	135	112	CUESTA SYSTEMS	188	175	IBM-(ISG) SERVICES	125
40	ARTIFICIAL INT'L. RESRCH.GRP.	430	113	CUSTOM COMP. TECH.	416	176	IBM CORP.	28, 29
41	ASHTON-TATE	94, 95	114	CUSTOM COMP. TECH.	417	177	IBM CORP.	174, 175
3	ASIA TECH. SERVICES INC.	369	115	DAC SOFTWARE INC.	303	386	IBS CORP.	97
*	AT&T COMMUNICATIONS	373	395	DATA SPEC	86	387	IBS CORP.	97
*	AT&T INFORMATION SYS.	64	396	DATA SPEC	86	180	IC EXPRESS	398
42	ATKINS ASSOCIATES	270	397	DATA SPEC	96	181	ILAR SYSTEMS INC.	52
43	AVOCET	138, 139	398	DATA SPEC	96	182	ILAR SYSTEMS INC.	52
45	AWESOME TECHNOLOGY, INC.	424	118	DATABROKERS	432	183	IMSI	190, 191
46	B&B ELECTRONICS	436	119	DATASOUTH COMP. CORP.	352	185	INFOCOM	160, 161
*	B&C MICROSYSTEMS	426	120	DAYNA COMM.	102, 103	184	INFOSCRIBE	182
47	BA5F SYSTEMS	118	*	DICK SMITH ELECTRONICS	383	187	INTERNATIONAL UNION OF COMPUTER OWNERS INC.	452, 453
48	BAY TECHNICAL ASSOC.	23	121	DIGIFLEX COMPANY	302	188	INTEGRAND	232
49	BDT PRODUCTS	330	122	DIGITAL RESEARCH	223	189	INTERCONTN. MICRO SYS.	115
50	BDT PRODUCTS	330	*	DIGITAL RESEARCH	INSERT 128 A-L	190	INTERCONTN. MICRO SYS.	115
51	BELLSOFT INC.	267	123	DIGITAL RESEARCH COMPUTERS	71	191	INTERFACE INC.	199
52	BINARY TECHNOLOGY	426	*	DISCOUNT COMPUTER CENTERS	186	192	INTERFACE INC.	199
53	BITTNER ELECTRONICS	426	124	DISKETTE CONNECTION	397	194	INTERFACE TECH CORP.	286
54	BLAISE COMPUTING INC.	368	125	DISKS PLUS	426	194	IOMEGA	51
55	BORLAND INT'L.	41	126	DISKWORL'D! INC.	419	195	JADE COMP. PROD.	446, 447, 448
56	BORLAND INT'L.	41	127	DISKWORL'D! INC.	439	196	JAMECO ELECTRONICS	276, 277
57	BORLAND INT'L.	43	128	DISPLAY TELECOMMNTNS	438	197	IDR MICRODEVICES INC.	456, 457
58	BORLAND INT'L.	43	129	DIVERSIFIED COMPUTER SYS.	424	198	IDR MICRODEVICES INC.	458, 459
59	BORLAND INT'L.	45	130	DOKAY COMP. PROD. INC.	434	199	IDR MICRODEVICES INC.	460
60	BORLAND INT'L.	45	131	DOW JONES NEWS RETRIEVAL	140	200	IJEDEN	343
61	BORLAND INT'L.	47	*	DOW JONES SOFTWARE	238	201	IUKI INDUSTRY OF AMERICA	264
62	BORLAND INT'L.	47	133	DUAL SYSTEMS CORP.	213	202	KADAK PRODUCTS	436
63	BUSINESS TOOLS INC.	221	134	DWIGHT CO. INC.	424	385	KEA SYSTEMS LTD.	430
*	BYTE BACK ISSUES	420	*	DYNATECH	314, 315	203	KIMTRON CORP.	197
*	BYTE IBM GUIDE	360	135	DYNAX, INC.	137	204	KRUEGER TECHNOLOGY INC.	421
*	BYTE SUBSCRIPTION MESSAGE	404	136	ECOSOFT	16	205	KRUEGER TECHNOLOGY INC.	421
*	BYTE SUBSCRIPTION SERVICE	212	137	ELEXOR INC.	428	207	LABORATORY MICROSYS.	16
*	C WARE/DESMET C.	299	*	ELLIS COMPUTING INC.	69	*	LANGLEY-ST. CLAIR	449
65	C. ITOH DIGITAL PRODUCTS	38	138	ENERTRONICS	355	209	LARK SOFTWARE	326
66	C. ITOH DIGITAL PRODUCTS	38	139	ENERTRONICS	357	210	LATTICE, INC.	342
67	CALIF. COMPUTER COMPONENT	310	142	ESP CORPORATION	455	211	LEO ELECTRONICS	424
68	CALIF. COMPUTER COMPONENT	310	143	EVEREX SYSTEMS	366	212	LEVEL 5 RESEARCH	322
*	CALIF. DIGITAL	444, 445	144	EXIM INTERNATIONAL	449	213	LINTEK INC.	449
69	CALIF. MICRO HOUSE	122	145	EXPRESS BUSINESS SOFTWARE	243	214	LOGICAL DEVICES	328
70	CALIF. SCIENTIFIC SFTW.	426	399	EXPRESS SYSTEMS	200, 201	215	LOGICAL DEVICES	432
71	CAMPBELL SERVICES	436	146	EXSEL INC.	436	*	LOGICSOFT	INSERT 96 A-B
72	CAPITAL EQUIPMENT CORP.	336	147	FACIT AB	311			
74	C.D.A. INT'L. SOFTWARE	432						
75	CDR SYSTEMS	428						
76	CHORUS DATA SYSTEMS	321						
77	CHRISLIN INDUSTRIES, INC.	390						
4	CHUNG YU ELECT.	369						
78	CMA MICRO COMP. DIV.	100						
79	COASTLINE COMPUTER	450, 451						
*	CODEX CORPORATION	167						
81	COGITATE	428						
82	COGITATE	432						

TO GET FURTHER information on the products advertised in BYTE, either pick up your touch-tone telephone and use TIPS (if you are a subscriber), or fill out the reader service card. Either way full instructions are provided following this reader service index which is provided as an additional service by the publisher, who assumes no liability for errors or omissions. \*Correspond directly with company.



# INTRODUCING SPINWRITER E·L·F!

## IT'S A SMALL PRICE TO PAY FOR LETTER QUALITY PRINTING.

Many popular personal computer applications demand letter quality printing. But until now, a good letter quality printer came with a big price tag. Until the Spinwriter elf™



You can control many functions with the touch of a finger.

The Spinwriter elf is a compact and durable letter quality printer. And it's the lowest priced Spinwriter® ever. But don't let the price fool you, it's still a Spinwriter.

**Spinwriter printers are most preferred.**

Spinwriter is the #1 name in letter quality printers for PC's. In fact, *Popular Computing*, *Creative Computing* and *Datamation* all

ranked Spinwriter as the #1 letter quality printers for business.

The reasons?

One is print quality. Spinwriter print quality is unsurpassed.

Another reason is Spinwriter's legendary reliability. Many Spinwriter printers go years without needing service.

And there's versatility. Spinwriter printers offer you over 70 different type styles. And more forms handlers than anyone else.

**Find out how clever an e·l·f can be.**

See your dealer for a Spinwriter elf demonstration. You'll find the elf can print an average letter in less than a minute. You'll find it comes standard with a sheet guide.



Makes popular software look even better.

And you'll find a control panel that lets you change type pitch and form length at the touch of a finger.

So see your dealer about the Spinwriter elf today. And you'll know you've found the right printer. For more information call 1-800-343-4418. (In MA call 617-264-8635). And see why so many PC users are saying, "NEC and me."



Not only is the print quality attractive, so is the price—\$545, for plug-compatible IBM PCjr. model; \$595, for model compatible with all other PC's.

**\$595.**

# NEC AND ME

NEC Information Systems, Inc.  
Department 1610  
1414 Mass. Ave.  
Boxborough,  
MA 01719

Inquiry 260



**IT'S  
ONLY  
4½ LBS.**

**The Tandy 200 is the  
one portable for all.**

Meet the new generation of portable computing—more built-in software, a flip-up 40 x 16 screen and larger memory. Our exclusive 40-column LCD means bigger, clearer text and less eyestrain. All this in a system that's 2¼ x 11¾ x 8½" and is battery powered.

**Comes with Six  
Programs Built-In—  
Including Multiplan**

For complex spreadsheet analysis and calculations, we put popular Multiplan software into Tandy 200's permanent memory. Now it's easier than ever to do budgeting, P&L projections, sales forecasts, pricing, engineering calculations and more. Five other "instant-on" programs let you use the Tandy 200 for word processing,



**AND  
RARING  
TO GO!**

as a personal appointment calendar, address and phone directory and telephone auto-dialer. You can even write your own programs in the BASIC language, too.

**Adopt One Today!**

Step up to the powerful software and impressive capabilities of the Tandy 200 portable computer for just \$999

(26-3860). Best of all, the

Tandy 200 represents the state of the art in performance, quality and price. Stop by your local Radio Shack Computer Center, or participating Radio Shack store or dealer and "size it up" today!

**Radio Shack®  
The Technology Store™**

A DIVISION OF TANDY CORPORATION

Inquiry 299