



Register your
new device on
MyBosch now and
get free benefits:
**[bosch-home.com/
welcome](https://bosch-home.com/welcome)**



Cooker hood

DWKA98G60I / DWKF68G60I

DWKA68G60I / DWKA68H60I

[en] Instruction manual

Cooker hood







Preface

- Thanks for your choosing Bosch cooking appliances. Please read this instruction carefully before you use the product and keep it properly for future reference. If you have any question, please contact local service centre or dealer.



BSH Household Appliances Manufacturing Pvt. Ltd.reserves the final interpretation rights for the Operation and Installation Instruction. Any change of it will not be further notified.

Table of contents

	Important Safety Information	3
	Safety precautions	3
	Packaging of new appliance	3
	Disposal of old cooking appliances	3
	Before using the new appliance	3
	Your New Appliance	4
	View of new appliance	4
	Control panel	4
	Operation Instruction	4
	Turn on / off the fan	4
	Fan speed control	4
	Self clean function	4
	Lamp control	4
	Care and Cleaning	5
	Matters need attention	5
	Clean the glass panel	5
	Clean the grill filter	5
	Clean oil collector	5
	Maintenance and Service	6
	Faults analysis and troubleshooting	6
	Lamp information	6
	Tips with good intention	6
	Installation Instruction	7
	Safety precautions	7
	Installation position and height	7
	The installation diagram of hood	7
	Caution	7
	Installing Mouting Plate	8
	Installing pipe socket	8
	Fixing cooker hood	8
	Connecting exhaust pipe	8
	Installing duct cover	8
	Installing oil collector	8
	Test run	8
	anti-somke valve installation instructions	9
	Package List	9

Important Safety Information

Please read this manual "Important Safety Information" and the relevant contents of the cooker instructions you have purchased.

Safety precautions

Warning – Risk of Carbon Monoxide Intoxication!

The room must be well ventilated when the hood is used in conjunction with a stove burning gas or other fuel. This is because the gas cooker at work requires a lot of air to help burn, so please open the door and window to keep air ventilation to avoid suffocation.

Warning – Burn Risk!

Do not touch the lamp shade that has been turned on or off for a long time.

Warning – Fire Risk!

Prohibit the fire directly bake the hood. Do not barbecue under the range hood. DO NOT leave the kitchen when cooking fried and other oil consumption of more food, to avoid causing fire due to dry fried oil for a long time. The air deflector can only be opened when the hood is cleaned manually. Do not open the air deflector of hood during the whole working process, to avoid the danger. Regularly clean the cavity, air deflector and oil cups. Due to excessive oil accumulation will have fire hazards, three meals a day cooking case recommended weekly cleaning.

Caution:

Accessible parts may become hot when used with cooking appliances.

The range hood is only intended to be installed over a hob with no more than four hob elements.

Before first use:

- Make sure the filter frame and oil collector of the cooker hood are already correctly installed.

In use:

- This appliance is not intended for use by persons (including children) with reduced physical, sensory or mental capabilities, or lack of experience and knowledge, unless they have been given supervision or instruction concerning use of the appliance by a person responsible for their safety. Children should be supervised to ensure that they do not play with the appliance.
- DO NOT drag the wire to remove the electric plug.
- NEVER insert or remove an electric plug with wet hands.
- Cleaning and user maintenance shall not be made by children without supervision.
- "CAUTION: Accessible parts may become hot when used with cooking appliances".

After use:

- If the cooker hood is put aside for a long time, please remove the electric plug.

Packaging of new appliance

- All the packing materials are environmental friendly and recyclable. When you are disposing of these materials, please do so in such a way that protects the environment and minimizes waste.

 **Warning** – Do not allow children to play with the thin film or packing case to avoid suffocation or accidents!

Disposal of old cooking appliances

- Discard the used cooker hood which cannot be used any longer. Remove the power line plug and cut off the power line.
- The used cooker hood contains recyclable materials. Dispose or recycle the returnable materials correctly to protect our environment.

Before using the new appliance

- This unit is approved for use with domestic appliances for general domestic kitchen ventilating use only. DO NOT use the unit for other purposes.
- Discharging type of this cooker hood is external discharge.
- If there is any obvious damage to the cooker hood, DO NOT connect the cooker hood to the power supply. Please call up service hot line or dealer.

Your New Appliance

View of new appliance

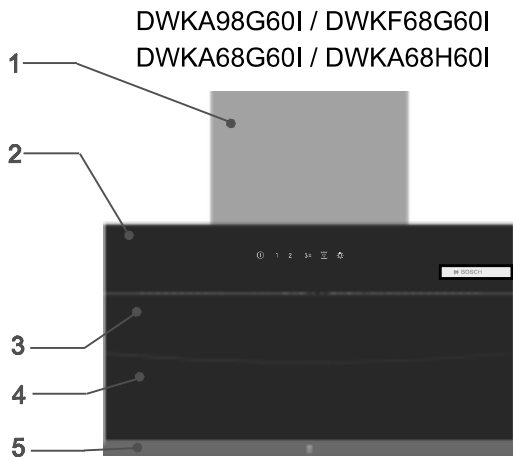

- 1. Duct cover
- 2. Control panel
- 3. Moveable glass
- 4. Bottom glass
- 5. Oil Collector

Control panel

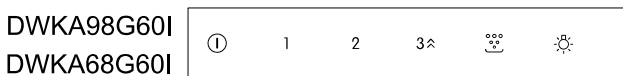
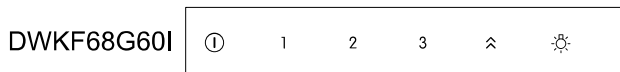

Symbol	Description
	Fan on/off
1 2 3	Fan Speed
1 2 3^	
1 2 3 ^	
	Self-cleaning mode
	Light The lamp is controlled individually and is not affected by any other buttons.

Operation Instruction

Turn on / off the fan

- Press the button first time, the fan runs at the speed 1, The button indicator lighting and the button 1 indicator is on.
- Press the button again, fan will be off.
- Press the button for 3 seconds to enter Delay Off state for 10 minutes, the button indicator will be blink and fan will runs at the speed 1.

Fan speed control

- When the fan is working, press the button 1, 2, 3 or 3^ and the fan work at speed 1, 2 and 3 respectively, and the speed button indicator is on.
- Press the button 3^ for 3 seconds to enter the boost and the button indicator will be blink. Boost will continue 10 minutes. After 10 minutes, it will be go back previous speed.
- If the control panel printed with ^, press the button ^ to enter the boost. Boost will continue 10 minutes. After 10 minutes, it will be go back previous speed.

Self clean function

- After a period of use, the button indicator will blink to remind user that it's time to activate self clean mode. In that case, the other functions must be stopped (except for lamp) and then activate self clean by pressing the button 3 seconds.
- Press the button to cancel the reminder when the indicator is blinking.
- If the button indicator does not blink, the other functions of the hood are also closed (except for lamp), at this time, press the button for 3 seconds, the button indicator is on, and activate self clean mode.
- The cycle for self clean mode is 9 minutes. When cycle time is expired, self clean mode will be deactivated automatically.
- During self clean, long press 3 seconds to stop self clean mode.

Note: Before the self clean, please empty your oil collector to prevent oil from overflowing and remove the visible sticky oil/grease from the hood. When the self clean is running, do not leave your cooker hood alone to avoid accidents.

Lamp control

- Press the button to turn on/off the lamp.

Gesture control

- If the control panel printed with , the machine has gesture control.
- Wave from left to right . Turn on the machine and change the fan speed from 1-2-3-boost. when enter the boost, it will continue 10 minutes. After 10 minutes, it will be go back speed 3.
- Wave from right to left . Change the fan speed from boost-3-2-1. and continue wave from right to left to enter delay off mode (Automatic shutdown after 10 minutes).
- When is blink (delay off mode), wave from right to left , turn the fan and lamp off.



Care and Cleaning

Matters need attention

- Pull off the electric plug before caring and cleaning the cooker hood.
- Wear protection gloves when cleaning or maintaining the cooker hood, to prevent your fingers being hurt in cleaning.
- DO NOT flush the cooker hood directly with water.
- The cooker hood should be cleaned regularly depending on the use frequency and surrounding environment to keep a good exhausting effect and have a longer service life.

Warning – There is a fire risk if cleaning is not carried out in accordance with the instructions.

Clean the glass panel

- Clean the glass panel every week with a soft cloth.

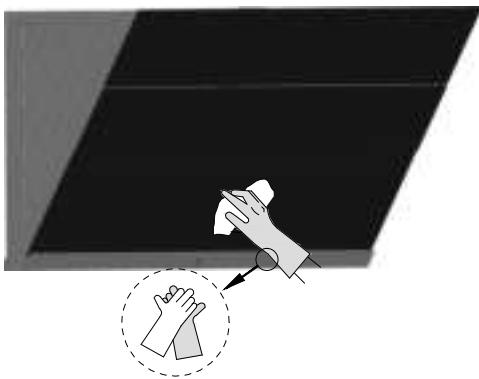

Warning – Cooking just finished, the temperature of the lower part of the oil collector which close to the hearth will be relatively high, do not touch at this time, waiting for the temperature down then start cleaning, to avoid burns!

Clean the grill filter

- Open method:
 1. Press the button ① to open the moveable glass;
 2. Unplug the power plug;
 3. Clean the grill filter;
 4. Plug in.

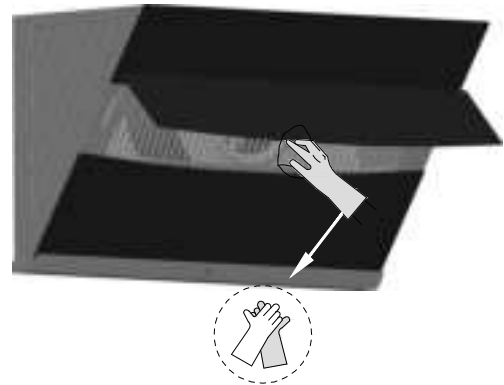

Note: The moveable glass is in the process of open, be careful hand clamping.

Clean oil collector

- When the oil takes up two thirds of the oil collector, the oil collector should be cleaned in time in case that the oil spills over. Detach the oil collector according to the figure.

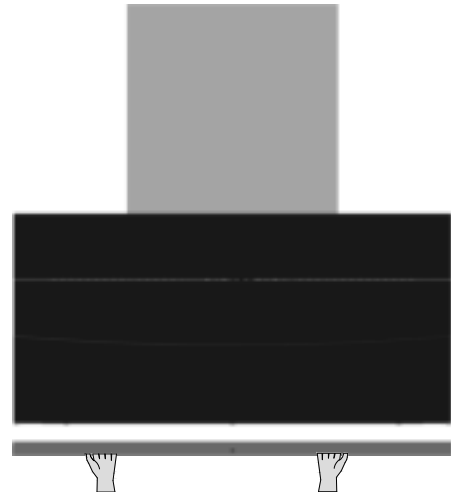

Maintenance and Service

Faults analysis and troubleshooting

Abnormal Phenomenon	Possible Explanations	Troubleshooting
Cooker hood does not work	External electromagnetic interference; Public flue wind pressure, fumes flooded	Unplug the power plug, wait 1 minute after the plug and try again. If the fault persists, please call the Service Hotline.
Motor does not work and lamp cannot be turned on	The plug is not or improperly inserted or no power supply	Make sure plug is inserted properly; ask an electrician to repair
Motor works and lamp cannot be turned on	Lamp is damaged	Contact service to replace the lamp
Suction force is not strong	Not the maximum fan speed; Air convection is strong	Turn on the fan speed to maximum; Close the window at one side;

Lamp information

	Max Power	Voltage	Picture
LED module	3Wx1	DC 12V	 Square : 23 x 171mm

Tips with good intention

 **Warning** – Only the specially trained and qualified installation personnel are allowed to repair the cooker hood. Anyone other than such personnel must not disassemble the machine for repair without authority in case serious consequences are incurred!

- Tempered glass on the products has strict quality control, but there is a minimal probability below phenomenon because of the production process and its characteristics.
- When cleaning things around the cooker hood (such as ceiling, cabinet) which maybe touch the hoods, please wear protection glove or take other protection methods to prevent being injured.

- If you have a problem with your appliance, please refer to "Faults Analysis and Troubleshooting" before calling service.
 - Please make sure you have the following information to hand, as this will help us deal with your query more quickly and efficiently, and save your unnecessary expenses:
 - exact address and telephone number
 - detailed description of the fault
 - date of receipt or invoice
 - product number(E-Nr)
 - production date(FD)
- Before the service engineer visiting, please prepare the proof of receipt or invoice in advance.

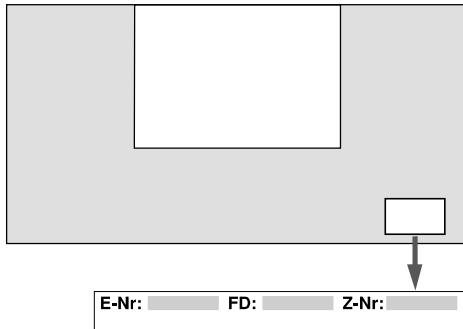

- The cooker hood must be grounded. A three pin plug is provided, and this plug must be inserted in a truly grounded receptacle. In case of current leakage, a current loop is formed by the grounding to avoid an electric shock.

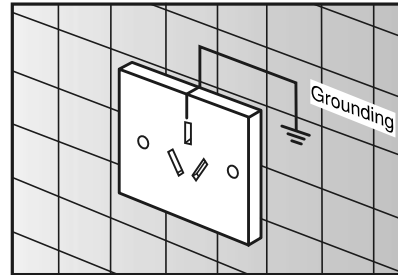

Installation position and height

- Install the cooker hood in a dry place and avoid direct sunlight.
- Ambient temperature of cooker hood less than 40 °C.
- The cooker hood must be installed right above the gas stove and in the same centerline of the gas stove.
- The distance of stove cooking appliances supporting surface and the lowest part of the range hood should be at least 650mm. Such as the gas stove installation instructions specify a larger installation distance, which should be considered.

Installation Instruction

Safety precautions

- Only the specially trained and qualified installation personnel are allowed to install and commission the cooker hood. Anyone other than such personnel must not disassemble the machine for repair without authority in case serious consequences are incurred.
- If the power line of your cooker hood is damaged, please contact service to change it.
- If your kitchen is under decoration, please DO NOT expose the cooker hood outside.
- When moving and installing hood, don't take glass parts, avoiding break and loose.
- The wall must have sufficient strength to bear the weight of the cooker hood and an even surface. Thus, the cooker hood can be installed steadily without shaking.
- The wall which install the cooker hood must be non-combustible.
- DO NOT install the cooker hood above a cooker using solid fuel.
- DO NOT let the cooker hood and other gas equipment (e.g. gas water heater) share the same duct cover.
- Make sure the power supply system (current, voltage and connecting wires) in your house can bear the normal load of the cooker hood.
- Take care of the wires embedded in the wall when drilling holes in the wall to avoid the risk of electric shock.

The installation diagram of hood

- Machine installation size map

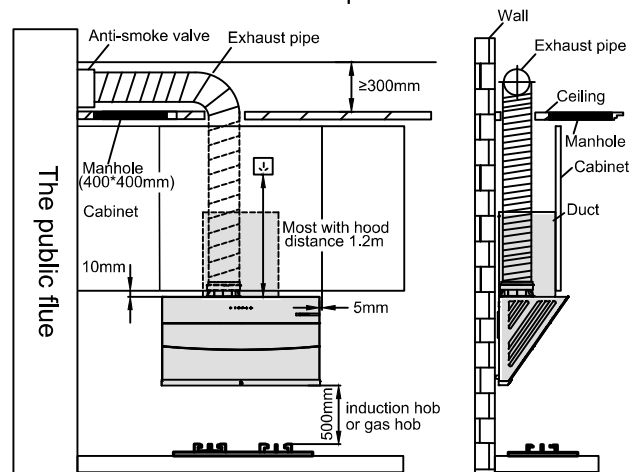

Caution!

- If the exhaust pipe to the public flue, recommended installation diameter not less than 170mm of the Anti-smoke valve(customer service consulting,purchase) can effectively prevent the smoke and odour, and ensure that the smoke exhaust effect. Do not put the exhaust pipe into the public flue too deep, in order to avoid smoke resistance increases.
- If the exhaust pipe is directly connected to the wall, make sure the exhaust pipe extends out of the outer wall of 30mm.
- A smoke straight, short tube can make the exhaust hood more smoothly.

- Try to avoid the use of long exhaust pipe, as far as possible to reduce the number of exhaust pipe bending angle, which will affect the smoke exhaust effect.
- The exhaust pipe can not be installed in the following manner, so as not to affect the exhaust effect.

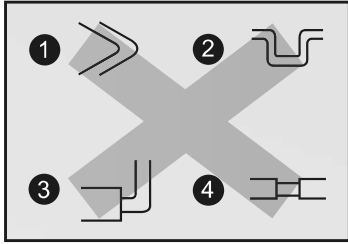

- The hole is too small will affect the exhaust effect, on the premise of ensuring safety, recommended wall hole diameter 180mm.
- Ceiling space to facilitate the pipe installation, and there can be no obstacle affecting the smoke tube arrangement, not less than 300mm.
- Manhole is to exhaust system failure can facilitate the maintenance and design, so be placed in check valve near. In order to facilitate the operation of maintenance personnel, as far as the size of 400mm*400mm, avoid any obstructions above. In order to ensure the use of manhole, manhole please avoid cabinets.

The ceiling exhaust pipe hole and the detailed installation size diagram to see the installation leaflet.

Installing Mounting Plate

- According to the diagram, drill 4 holes with $\Phi 8\text{mm}$ and depth of 50-60mm in the corresponding position of the wall, press the wall plug into the hole, and use 4 pieces of screws M5x50 randomly equipped to reliably fix the Mounting Plate.

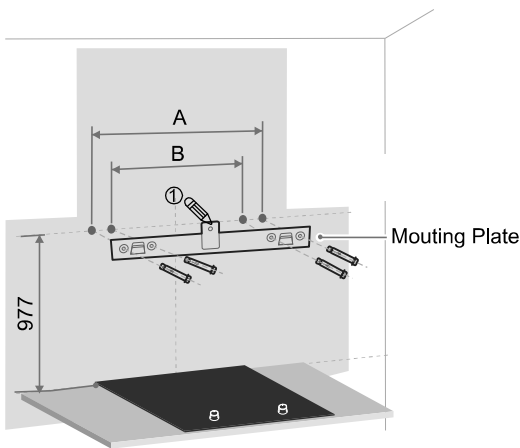

VIB	A(mm)	B(mm)
DWKA98G60I	580	420
DWKF68G60I	324	180
DWKA68G60I		
DWKA68H60I		

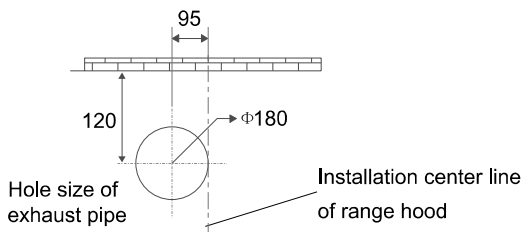

Installing pipe socket

- Fix the pipe socket and sealing gasket onto the blower system with 4 pieces of screw ST4.2x16.

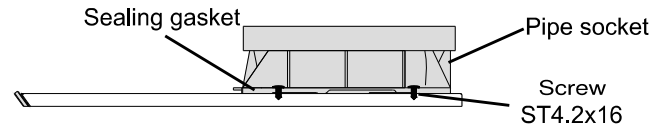

Fixing cooker hood

- Hang the cooker hood on the mounting rail on the wall to make sure the cooker hood does not shake or hook off. Keep the cooker hood horizontal.
- Install the accessory fixing screw M5x16 in the hole position on ① in installation leaflet to prevent to cooker hood hooking off from the mounting arm.

Connecting exhaust pipe

- Fix the exhaust pipe to the pipe socket of the cooker hood to ensure the exhaust pipe and the pipe socket fixed tightly.

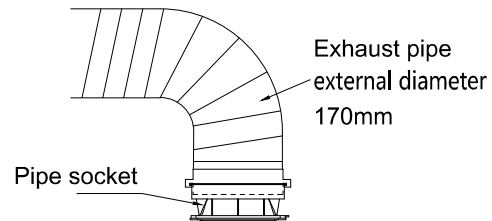

Installing duct cover

- Fix the three ST4.2x16 screws to the corresponding holes on the top of the outer shell, cover the holes on the bottom edge of the duct cover with the corresponding three screws, and then push the duct cover back to the fixed position. Finally, buckle the fixing plate into the hole in the upper back of the duct cover.

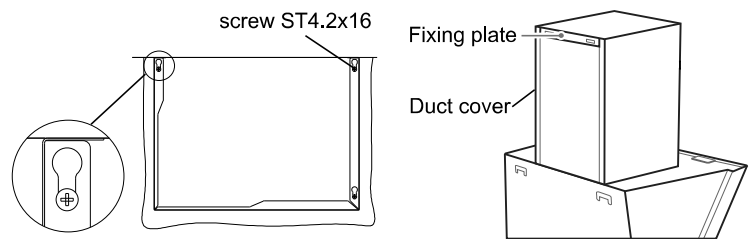

Installing oil collector

- Install the oil collector under the bottom glass.

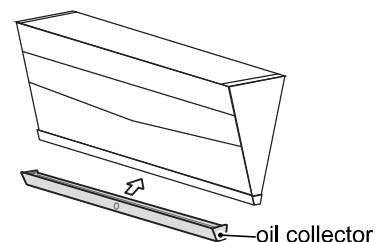

Test run

- After installation, test run according to the operation instruction, then clean and maintain the surface of the cooker hood.

Anti-somke valve Installation instructions

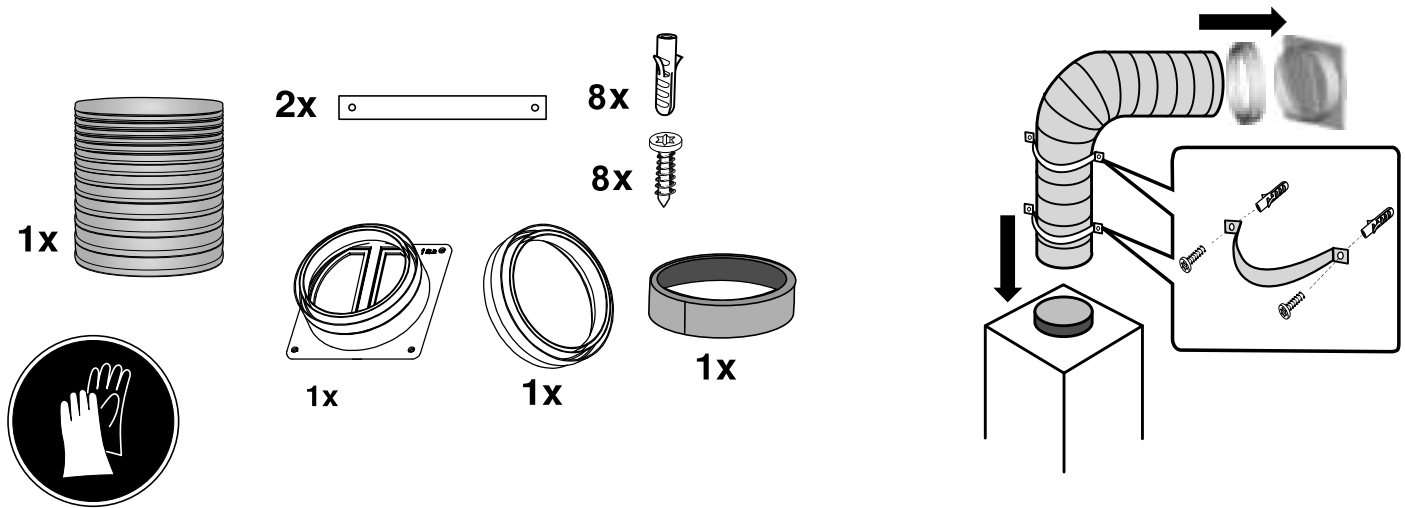

Instruction method:

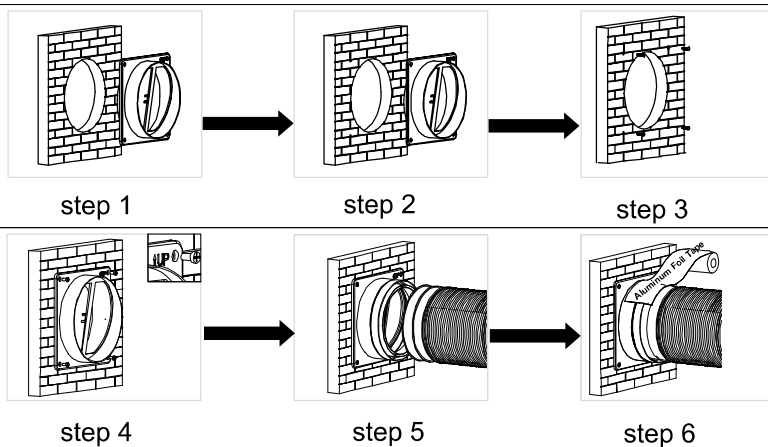

step 1: Align the valve body with the smoke hole on the wall.

step 2: Drill holes in the wall according to the hole of valve seat.

step 3: Press the expansion plastic plug into the wall.

step 4: Fix the valve seat with screws.

step 5: Put the multi-path joint on the valve seat, put the exhaust pipe in the appropriate slot.

step 6: Fix the pipe with aluminum foil tape.

Package List

Number	Parts name	QTY	Unit
1	Cooker hood	1	PC
2	User manual	1	PC
3	Mouting Plate	1	PC
4	Anti-smoke valve	1	PC
5	Exhaust pipe	1	PC
6	Screw M5x16	1	PC
7	Wall plug $\phi 10 \times 43$	5	PC
8	Screw M5x50	4	PC
9	Screw ST4.2x16	8	PC
10	Oil collector	1	PC
11	Screw M5x45	1	PC
12	Duct cover	1	PC
13	Fixing plate	1	PC
14	Pipe socket	1	PC
15	Sealing gasket	1	PC
16	Screw ST2.9x9.5	2	PC



Thank you for buying a Bosch Home Appliance!

Register your new device on MyBosch now and profit directly from:

- Expert tips & tricks for your appliance
- Warranty extension options
- Discounts for accessories & spare-parts
- Digital manual and all appliance data at hand
- Easy access to Bosch Home Appliances Service

Free and easy registration – also on mobile phones:
www.bosch-home.com/welcome

BOSCH
HOME APPLIANCES
SERVICE

Looking for help? You'll find it here.

Expert advice for your Bosch home appliances, need help with problems
or a repair from Bosch experts.

Find out everything about the many ways Bosch can support you:

www.bosch-home.com/service

Contact data of all countries are listed in the attached service directory.

BSH Household Appliances Manufacturing Pvt. Ltd.

Arena house, 2nd Floor Main Building,
Plot No. 103, Road no. 12, MIDC, Andheri (E),
Mumbai 400093

8001214157
20210511