



User Manual

FERREX[®] PRO

10093

224CC, 4 STROKE, ELECTRIC START, SELF
PROPELLED, PETROL LAWN MOWER
WITH SIDE DISCHARGE
& MULCH FUNCTION



Product
Info



+ VIDEO

<https://help.tools>



Read all safety warnings and all instructions thoroughly before operating this product.

Ensure you keep your manual in a safe place for future reference.

QR codes take you where you want to go quickly and easily

Whether you require product information, spare parts or accessories, details on warranties or aftersales service, or if you want to watch a product demonstration video, our QR codes will take you there in no time at all.

What is a QR code?

A QR-code (QR=Quick Response) is a type of matrix that can be read with a smartphone camera and that contains a link to a website or contact details, for example.

Advantage: You are not required to manually enter a website address or contact details.

How it works

To scan the QR code, all you need is a smartphone with QR codes reader software and an Internet connection*. This type of software can be downloaded for free from your smartphone's app store.

Try it out now

Just scan the QR code with your smartphone and find out more about the Aldi product you have purchased*.



* Depending on your tariff you may be charged for the connection.

Contents

| | |
|---|-----------|
| Pack Contents /Parts | 2 |
| Description of Symbols | 3 |
| General Safety Warnings | 4 |
| Safety Rules for Petrol Lawn Mowers | 6 |
| Operation Safety Instructions | 10 |
| Safety Rules for Charger & Batteries | 12 |
| Intended use of the 224cc Petrol Lawn Mower | 14 |
| Parts List | 16 |
| Assembly | 19 |
| Assembling the Lower Handle and Adjusting the Handle Height | 19 |
| Attaching the Upper Handle Bar to the Lower Handle | 21 |
| Assembly of the Hard Catcher | 22 |
| Attaching the Hard Catcher | 22 |
| Assembly of the Side Discharge Chute | 23 |
| Recoil Starter Handle Holder | 24 |
| Battery Charging | 24 |
| Preparing for Operation | 25 |
| Mulch and Mowing | 25 |
| Adding and Checking the oil | 26 |
| Fuelling | 27 |
| Adjusting the Cutting Height | 28 |
| Operation | 29 |
| Starting the Engine (Electric / Key Start) | 29 |
| Starting the Engine (Manual Recoil Start) | 30 |
| Stopping the Engine | 30 |
| Emergency Stopping | 30 |
| Mowing Advice/Engine tipping | 31 |
| Poor Engine Performance | 32 |
| Operating Functions of the Lawn Mower | 32 |
| Maintenance | 33 |
| Replacing the Blades | 33 |
| Removing Oil | 34 |
| Air cleaner Maintenance | 35 |
| Spark Plug | 36 |
| Deck Wash | 37 |
| Storage and Transporting | 39 |
| Transporting | 39 |
| Storage | 39 |
| Warranty | 41 |
| Warranty | 41 |
| Environmental Protection | 41 |
| What your 5 year Warranty Means | 41 |
| Accessories and After Sales Parts | 42 |
| Troubleshooting | 43 |
| Service Support | 43 |
| Technical Specifications | 44 |

Pack Contents /Parts

Congratulations on the purchase of your FERREX® PRO 224cc 4 Stroke Petrol Lawn Mower. When you open your packaging, first remove all items and check there are no parts damaged or missing. If you find anything wrong, do not operate the product until the parts have been replaced or the fault has been rectified. Failure to do so could result in serious personal injury.

Intended use of the 224cc Petrol LawnMower

NOTE: This product is for private domestic DIY use only.

It is not suitable for commercial, industrial or trade use.

This product is suitable for private home use i.e for use in home and gardening environments, for the application of mowing.

IMPORTANT INFORMATION.

NOTE: This is a 4 stroke Lawn Mower.

The engine **MUST** be filled with 500ml of SAE 10W/30 BEFORE starting.

Fresh unleaded fuel must be used in this unit.

DO NOT use Ethanol based fuels. Do NOT mix oil with fuel.

NOTE: First time users or inexperienced operators pay particular attention to the operation of the Lawn Mower, including details of starting and stopping the mower on pages 27-29 and correct use of the Lawn Mower on pages 29-31.

Contents of carton

| | |
|--|--------------------------------|
| 1 x Lawn Mower | 1 x Charger Adaptor |
| 1 x Hard Catcher (not fitted) | 1 x Key Set (2) |
| 1 x Side Discharge Chute (not fitted) | 1 x Mulching Block (fitted) |
| 1 x Spark Plug Wrench | 4 x Cable Holder Clip (fitted) |
| 1 x Standard Hose Fitting (not fitted) | 1 x Instruction Manual |
| 1 x 20V Xfinity Li-Ion Battery | 1 x Warranty Card & details |
| 1 x Plug Pack Charger | 1 x Quick Start Guide |
| 2 x Drink Holder Cups | |
| 2 x Upper Handle Locking Levers with 2 x round washers + 2 x curved washers + 2 x locking knobs (not fitted) | |

Description of Symbols

The rating plate on your product may show symbols. These represent important information about the product or instructions on its use.



Conforms to relevant standards for electrical safety and electromagnetic compatibility.



Wear hearing protection. Wear eye protection. Wear breathing protection.



Wear safety footwear.



Wear safety gloves.



Warning.



Do not crush, disassemble, short terminals or dispose in fire; there is a risk of burns, explosion or fire.



Do not put in water.



Do not charge the battery pack if the ambient temperature is less than 0°C or greater than 40°C.



Indoor use.



Double Insulation. There are two independent barriers of insulation to protect you from the possibility of electrical shock.

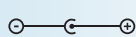

Polarity.



Read these instructions for use carefully.



Use at a distance of at least 15m from other people.



Thrown objects can cause severe injury.



Explosive material.



Extremely hot surface. Do not touch a hot muffler, gear box or cylinder, you may get burned. These parts get extremely hot from operation and remain hot for a short time after the unit is turned off.



Before carrying out any operation stop the engine and disconnect the spark plug.



Risk of hand and feet injuries.



Waste electrical products should not be disposed of with household waste.



Noise label rating 98dbBA (taken at 4 metres). You must wear ear protection at all times.



The box is recyclable at the kerbside.



The inserts are recyclable at the kerbside.



60 Months Warranty



12 Months Warranty



Check the oil level!

General Safety Warnings

Safety instructions



WARNING Read and understand all instructions. Failure to follow all instructions listed below may result in electric shock, fire and/or serious injury. The term “power tool” in all of the warnings below refers to your mains-operated (corded) power tool, garden power tool, battery-operated (cordless) power tool or your petrol operated garden tool.

Save these instructions

Work area

- Ensure the area to be mowed is clear and free of debris, rocks, gravel, garden furniture etc.
- Keep work area clean and well lit. Cluttered and dark areas invite accidents.
- Do not operate power tools in explosive atmospheres, such as in the presence of flammable liquids, gases, or dust. Power tools create sparks which may ignite the dust or fumes.
- Ensure all animals, children and bystanders are at least 15m away while operating this lawn mower. Distractions can cause you to lose control.

Personal safety

- Stay alert, watch what you are doing and use common sense when operating a power tool. Do not use a power tool while you are tired or under the influence of drugs, alcohol, or medication. A moment of inattention while operating power tools may result in serious personal injury.
- Use safety equipment. Always wear eye protection. Safety equipment such as a dust mask, non-skid safety shoes, hard hat, or hearing protection used for appropriate conditions will reduce personal injuries.
- Remove any adjusting key or wrench before turning the tool on. A wrench or a key that is left attached to a rotating part of the power tool may result in personal injury.
- Do not overreach. Keep proper footing and balance at all times.

This enables better control of the power tool in unexpected situations.

- Dress properly. Do not wear loose clothing or jewellery. Keep your hair, clothing and gloves away from moving parts. Loose clothes, jewellery or long hair can be caught in moving parts.
- If devices are provided for the connection of dust extraction and collection facilities ensure that these are connected and properly used. Use of these devices can reduce dust-related hazards.

Power tool use and care

- Do not force the power tool. Use the correct power tool for your application. The correct power tool will do the job better and safer at the rate for which it was designed.
- Do not use the power tool if the switch does not turn it on and off. Any power tool that cannot be controlled with the switch is dangerous and must be repaired.
- Turn tool off completely before making any adjustments, changing accessories, or storing power tools. Such preventive safety measures reduce the risk of starting the power tool accidentally.
- When not in use, store power tools out of the reach of children and do not allow persons unfamiliar with the power tool or these instructions to operate the power tool. Power tools are dangerous in the hands of untrained users.
- Maintain power tools. Check for misalignment or binding of moving parts, breakage of parts and any other condition that may affect the power tool's operation. If damaged, have the power tool repaired before use. Many accidents are caused by poorly maintained power tools.
- Keep cutting tools sharp and clean. Properly maintained cutting tools with sharp cutting edges are less likely to bind and are easier to control.
- Use the power tool, accessories and tool bits etc., in accordance with these instructions and in the manner intended for the particular type of power tool, taking into account the working conditions and the work to be performed. Use of the power tool for operations different from intended could result in a hazardous situation.

Service

- Have your power tool serviced by a qualified repair personnel using only identical replacement parts. This will ensure that the safety of the power tool is maintained.

General Safety Warnings

Safety rules for Petrol Lawn Mowers

Training

- Read the instructions carefully. Get familiar with the controls and proper use of the equipment.
- Only use the lawn mower for the purpose for which it was designed, i.e. for cutting and collecting grass. Any other use can be hazardous, causing damage to the machine.
- Never allow children or people unfamiliar with these instructions to use the lawn mower. Local regulations may restrict the age of the operator.
- Never use the lawn mower:
- When people, especially children, or pets are nearby.
- If the operator has taken medicine or substances that can affect his ability to react and concentrate.
- Remember that the operator or user is responsible for accidents or hazards occurring to other people or their property.

Preparation

- While mowing, always wear sturdy footwear and long trousers. Do not operate the equipment when barefoot or wearing open sandals.
- Thoroughly inspect the area where the equipment is to be used and remove all objects which may be thrown by the machine or damage the cutter assembly and the engine (stones, sticks, metal wire, bones, etc.)



WARNING: DANGER!

Engine fuel is highly flammable.

- Store fuel in containers specifically designed for this purpose.
- Refuel using a funnel and outdoors only.
- Do not smoke while refuelling or whenever handling the fuel.
- Never refuel near an open flame.

- Add fuel before starting the engine. Never remove the cap of the fuel tank or add fuel while the engine is running or when the engine is hot.
- If fuel is spilled, do not attempt to start the engine but move the machine away from the area of spillage and avoid creating any source of ignition until the fuel has evaporated and the vapour dispersed.
- Replace all fuel tanks and containers caps securely.
- Substitute faulty silencers.
- Before use, always inspect the machine, especially the condition of the blades, and check that the screws and cutting assembly are not worn or damaged. Replace worn or damaged blades and screws in sets to preserve balance.
- Discharge openings must be guarded at all times. Do not remove the discharge guard or hold it up while mowing.
- It is advisable to wear suitable eye protection when operating the mower.

Operation

- Do not operate the engine in a confined space where dangerous carbon monoxide fumes can collect.
- Mow only in daylight or good artificial light.
- If possible, avoid operating the equipment in wet grass.
- Always be sure of your footing on slopes.
- Walk, never run and do not allow yourself to be pulled along by the lawn mower.
- Mow across the face of slopes, never up and down.
- Exercise extreme caution when changing direction on slopes.
- Do not mow on slopes of more than 20°.
- Exercise extreme caution when pulling the lawn mower towards you.
- Stop the blade if the lawn mower has to be tilted for transportation when crossing surfaces other than grass, and when transporting the lawn mower to and from the area to be mowed.
- Never operate the lawn mower with defective guards, or without safety devices, such as the stoneguard and/or grass-catcher, in place. Replace if damaged.
- Do not change the engine governor settings or over speed the engine.

- On power-driven models, disengage the drive clutch before starting the engine.
- Start the engine carefully, following the instructions and keeping feet well away from the blade.
- Do not tilt the lawn mower when starting the engine.
Start the engine on a flat surface that is free of obstacles and tall grass.
- Do not put hands or feet near or under rotating parts. Keep clear of the discharge opening at all times.
- Never pick up or carry a lawn mower while the engine is running.
- Stop the engine and disconnect the spark plug wire:
 - Before carrying out any work underneath the cutting deck or before unclogging the chute;
 - Before checking, cleaning or working on lawn mower;
 - After striking a foreign object. Inspect the lawn mower for damage and make repairs before restarting and operating the lawn mower;
 - If the lawn mower starts to vibrate abnormally (find and remove the cause of the vibration immediately).
- Stop the engine:
 - Whenever you leave the lawn mower unattended.
 - Before refuelling.
 - Every time you remove or replace the grass-catcher.
- When mowing, always keep to a safe distance from the rotating blade. This distance is the length of the handle.
- Never cut grass while walking backwards.
- Stop the engine before pushing mower across gravel drives, walks or roads.
- This machine is to be used exclusively for cutting natural grass. Never use the mower for other purposes. Any other utilization can involve danger for your safety and can involve damage to the mower.
- The user is responsible for the safety of other people, animals and objects in the working area. Keep children and domestic animals at a safe distance while the mower is in use.

Maintenance and Storage

- Keep all nuts, bolts and screws tight to be sure the equipment is in safe working condition. Regular maintenance is essential for safety and performance.
- Never store the equipment with fuel in the tank inside a building where vapour may reach a flame or a spark or a source of extreme heat.
- Allow the engine to cool before storing in an enclosed space.
- To reduce the fire hazard, keep the engine, exhaust silencer, battery compartment and fuel storage area free of grass, leaves, or excessive grease. Do not leave containers with grass cuttings in rooms.
- Check the stone-guard and grass-catcher frequently for wear and deterioration and replace if damaged.
- If the fuel tank has to be drained, this should be done outdoors and when the engine is cool.
- Wear strong work gloves when removing and reassembling the blade.
- Check the blade's balance after sharpening.
- For reasons of safety, do not use the equipment with worn or damaged parts. Parts are to be replaced and not repaired. Parts that are not of the same quality can damage the equipment and be dangerous for your safety.
- Whenever the machine is to be handled, transported or tilted you must:
 - Wear strong working gloves;
 - Grasp the machine at the points that offer a safe grip, taking account of the weight and its distribution.
- Damaged blades and worn bolts are major hazards.
- Fuel goes off in about 3 - 4 months. If you find your mower does not start, try changing the fuel in the tank with newly purchased fresh unleaded fuel. **Do not use ethanol based fuels.**

Operation Safety Instructions



WARNING: Stop the engine and unplug the spark plug before any repairs or maintenance operations.

- Check that all nuts, bolts and screws are well tightened before every use.
- Before mowing ensure that the blade and the blade fixing screw are securely fastened. When the blade edges require re-sharpening, this must be done evenly on both sides to prevent any imbalance. If the blades are damaged, it must be replaced.
- When mowing always wear long trousers and strong, covered footwear.
- Do not run the engine in an enclosed and/or poorly ventilated area. The gas of the engine contains carbon monoxide, which is dangerous to your health.
- Work only when there is sufficient light.
- Do not use the lawn mower when it is raining or when the grass is wet.
- Caution must be taken while mowing on slopes. Mow across the face of slopes, never down or up.
- Turn off the engine if you must leave the lawn mower unattended.
- Never lift the rear of the mower while starting the engine and never place your hands and feet underneath the deck while the engine is running.
- If working on high grass, adjust the mowing height to reduce the friction and prevent over loading. The optimal mowing height should be 1/3 the height of the grass. It would affect the work efficiency of lawn mower if too much higher or lower.
- Never change the rated speed of the engine in any way .
- Never lift or carry the mower while the engine is running.
- Stop the engine and remove the spark plug cover in these cases:
 - Before any operation under the deck.
 - Before any maintenance, repairing or checking operations.
 - Before carrying, lifting or removing the mower.
 - If you leave the mower unattended or change the cutting height.
 - After hitting a foreign object, stop the engine and check thoroughly the mower in order to see if it is damaged. Take the mower to an authorised service centre to carry out any repairs if necessary.

- If the mower vibrates in an abnormal way, take the mower to an authorised service centre.
- Check the bolts and nuts regularly. Bolts and nuts may vibrate loose over time.



WARNING:
Fuel is highly flammable.

- Keep fuel in a jerry can specially made for this purpose.
- Fill the fuel tank with a funnel and outside. Do not smoke or use a mobile phone during this process.
- Fill with fuel and oil before starting the engine. Never open the cap of the fuel tank to add petrol while the engine is running or still hot.
- Do not start the engine if there is spilt fuel on the mower or in the area surrounding. Take the mower away from the zone where fuel has been spilt and avoid any contact from a hot source as long as the spilt petrol is completely evaporated.
- Tighten the fuel tank cap and jerry can cap tightly.

Residual risk

Even if you use the petrol lawn mower properly and follow all safety notes, there

are always residual risks. The following risks may occur:

- Lung injury if a suitable dust mask is not worn when dry mower.
- Hearing loss if suitable ear protection is not worn.
- Injury to health attributed to hand-arm vibrations if the petrol lawn mower is used for a prolonged period of time.
- Risk of injury if long hair, loose-fitting clothing or jewellery get caught by rotating parts.

Reduce residual risks by using the petrol lawn mower with care and following all safety notes as well as other instructions.

Safety Rules for Charger & Batteries

- a) **Use only the charger and batteries supplied in this pack.**
- b) **Protect the charger and battery pack against moisture including rain and high humidity.**
- c) **Always check that the power cord is correctly connected before using the charger.**
- d) **When you are not using the charger, remove the plug from the mains socket.** Do not pull the plug out by the power cord.
- e) **Handle the battery pack carefully.** Do not let it fall or be subject to impact.
- f) **Always remove the plug from the power socket before you clean or maintain the charger or battery pack.**
- g) **Do not charge the battery pack if the ambient temperature is less than 0°C or greater than 40°C.**
- h) **Do not short circuit the battery pack.** A short circuit gives rise to a heavy current causing overheating and the possibility of fire or explosion.
- i) **Do not connect a cable to the battery pack terminals.**
- j) **Make sure that no metal objects such as a nail, paper clip or coin finds its way into the charging socket.**
- k) **A damaged battery pack or one which no longer holds its charge must be disposed of in a special way and not placed for normal household rubbish collection.**
- l) **Never throw a battery pack into a fire or into water.**
- m) **Keep handles dry, clean and free from oil and grease.**
Slippery handles do not allow for safe handling and control of the tool in unexpected situations.

n) This product should only be started by using Aldi Xfinity Plus batteries only. Other Battery models will be available from time to time but use only models marked as Xfinity Plus 20V.

NOTE: This unit may not be used by people (including children) with reduced physical, sensory or mental capacities, with a lack of experience and without the appropriate knowledge, unless they are supervised by someone who is responsible for their safety or have been instructed by such a person with regard to how the unit is to be operated.

Children should be supervised to ensure that they do not play with the device.

Intended use of the 224cc Petrol Lawn Mower

NOTE: This product is for private domestic DIY use only.

It is not suitable for commercial, industrial or trade use.

This product is suitable for private home use i.e for use in home and gardening environments, for the application of mowing and mulching grass.

This lawn mower offers various functions to accommodate different lawn mowing requirements.

- A. **Catcher Mowing** – standard lawn mowing with hard catcher attached.
- B. **Side Discharge Mow** - Using the side discharge chute, grass clippings are ejected from the mower on the right hand side of the deck. The rear hard catcher should not be used when the side discharge is used.
- C. **Mulch and Mow** - Using the mower without the hard catcher attached; the lawn mower will mulch as it cuts and the fine grass clippings are distributed back onto the grass surface without leaving piles of grass clippings.
- D. **Self Propelled** - Using the self propel function for effortless mowing which can be used with any of the mowing functions listed above.
- E. **Deck Wash** - The deck wash feature allows you to wash/clean the underside of the lawn mower deck using a standard garden hose fitting or the supplied garden hose fitting.
- F. **Electric Start** - The electric start feature operates with an ALDI Xfinity 20V Lithium-Ion battery to provide effortless starting.



* No Catcher

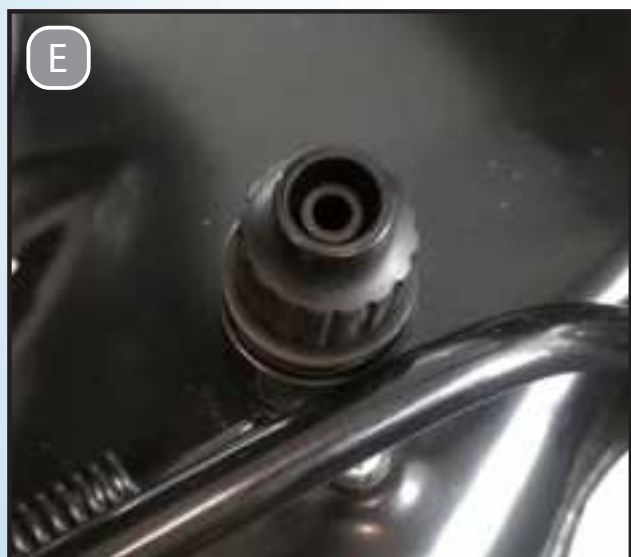

* Hose not included



Parts List

1. Upper handle bar
2. Self Propel engage/disengage bar
3. Tool and refreshment holder
(2 x drink holders)
4. Cable holder clip/s
5. Upper handle locking lever (x2)
6. Upper handle locking knob (x2)
7. Self Propel engagement cable
8. Lower handle
9. Cutting height adjustment lever
10. Recoil starter
11. Engine
12. Air filter cover
13. Spark plug cover
14. Carry handle
15. Front wheels
16. Side ejector cover
17. Muffler
18. Oil drain plug
19. Oil filler cap/dipstick
20. Rear wheels
21. Rotating quick adjustment
knobs (x2)
22. Rear discharge guard
23. Hard catcher
24. Key start battery system
charging cable
25. Recoil Starter handle holder
26. Key Set (x2)
27. Fuel tank cap
28. Fuel tank
29. Lower handle mounting plate
(with 3 height position)
30. Side discharge chute
31. Catcher attachment hook (x2)
32. Catcher attachment bracket (x2)
33. Deck wash nozzle
34. Mulching block
35. Air filter
36. 4 x Blades
37. Blade bolt
38. Outer Flange + washer
39. Spark Plug wrench
40. Blade mounting plate
41. Standard hose fitting
42. Battery compartment
43. Battery charger adaptor
44. Plug Pack Charger
45. Battery release button
46. 20V Xfinity Li-ion Battery
47. Spark Plug

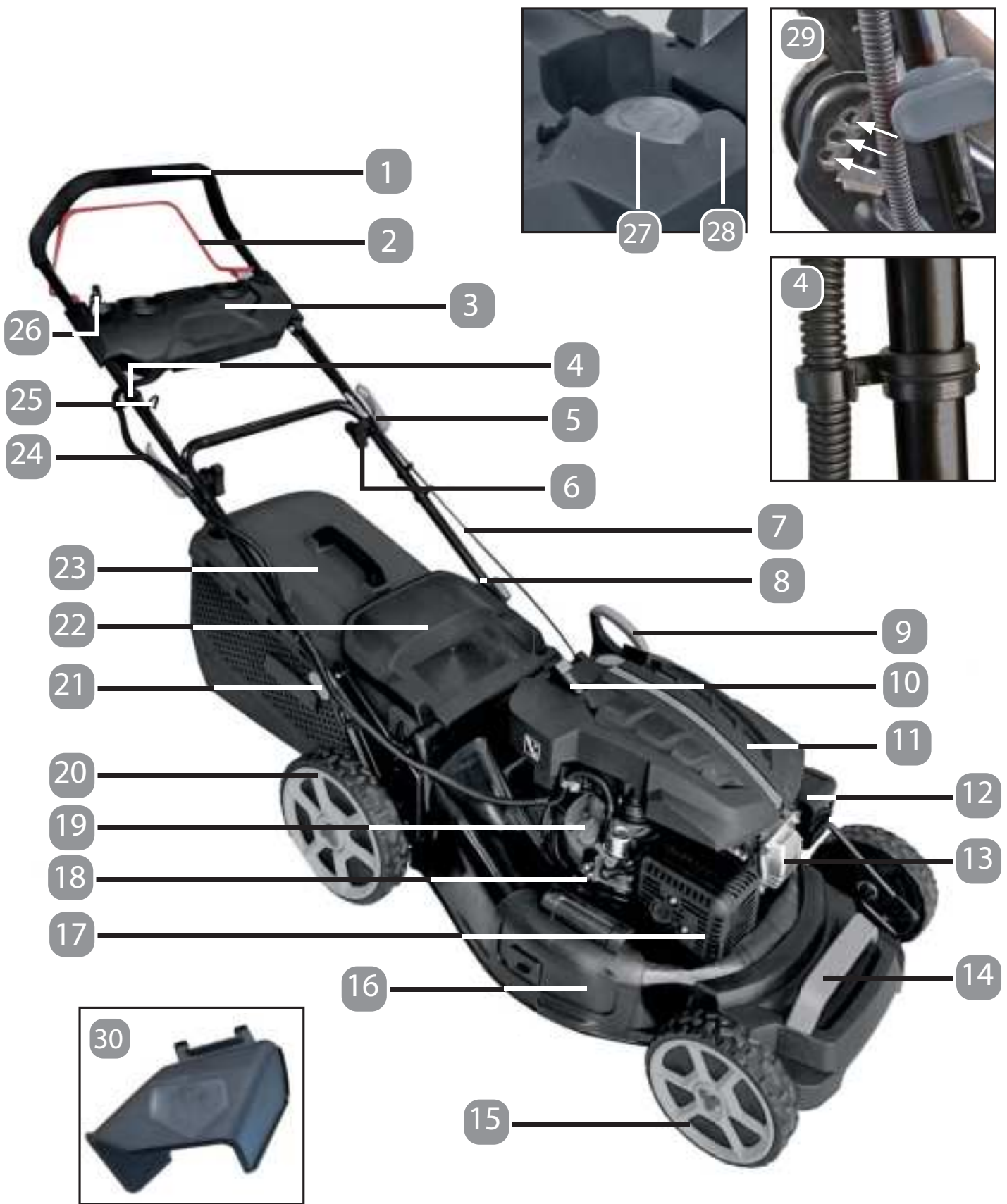

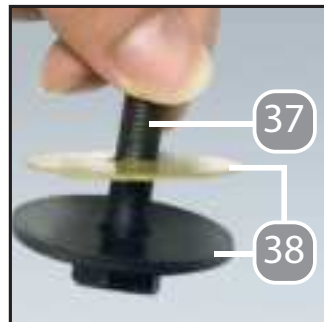
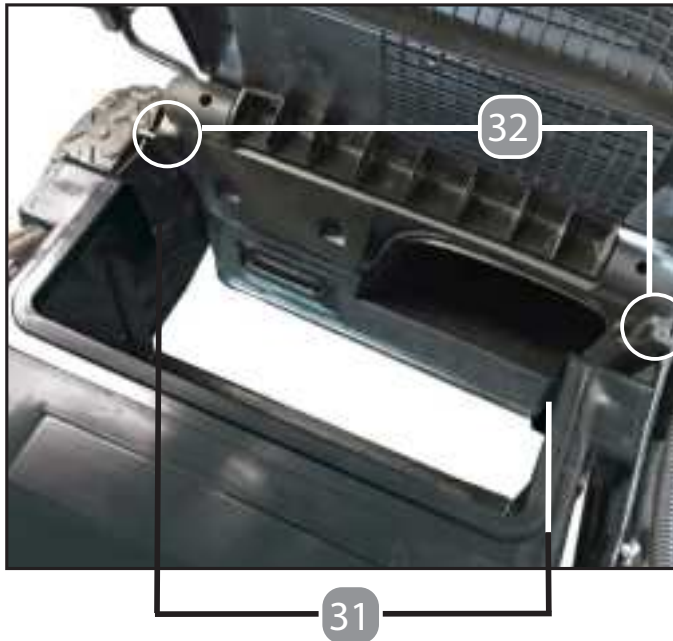

Assembly

 **WARNING: Stop the engine and unplug the spark plug (47) before any repairs or maintenance operations.**

 **WARNING: DO NOT attempt to start this mower without first adding 500ml of SAE 10W/30 engine oil to the Engine.**

 **WARNING: Do Not attempt to start this mower without the mower first being FULLY assembled.**

It is necessary to unfold the lower handle (8), fit the upper handle bar (1), and hard catcher (23).

Assembling the Lower Handle and Adjusting the Handle Height

NOTE: When preparing, first lift and remove the upper handle bar (1) / Tool and refreshment holder (3) and the lawnmower with lower handle (8) fitted, from the packaging box, ensuring the cables do not become tangled or crossed over. Damage to the cables can affect performance of the engine. After removing from the packaging box, lay the lawn mower out as shown in Fig A1. The self propel engagement cable (7) should be aligned down the left hand side of the handles. The key start battery system charging cable (24) should be aligned down the right hand side of the mower. Ensure during assembly all the cables are laid above the handles not on the underside of the handles.

NOTE: The key start battery system charging cable (24) and self propel engagement cable (7) are already held in position to the upper handle bar with 4 cable clips, as indicated by the arrow.

NOTE: The upper and lower handles are already fitted to the lawn mower. After removing from the box, unfold the handle outwards.



1. Pull the 2 rotating quick adjustment knobs (21) located on the external side of the lower handles (8) outwards a little. (Fig. A2)
 2. Turn the rotating quick adjustment knobs (21) to about 90° position, and the location pin of the rotating quick adjustment knobs (21) will draw back into the lower handle (8). Unfold the lower handle (8) to an open position from transportation position. (Fig. A3)
 3. There are 3 optional height positions on the lower handle mounting plate (29) as shown in Fig. A4. Select an appropriate position, align the hole on the lower handle (8) and the selected hole on the handle mounting plate (29). (Fig. A5)
- NOTE:** It is suggested to select the middle location to start with. You can then raise or lower the adjustment after you have seen the overall height when the assembly is complete.
5. Turn the rotating quick adjustment knobs (21) 90° back to the original position. The location pins for the rotating quick adjustment knobs (21) will stretch out and insert into the selected hole while the forward rotating quick adjustment knob (21) is rotating. (Fig. A6)
 6. Repeat the steps above for the other side of the lower handle (8). Check the lower handle (8) is securely locked in place. (Fig. A7)
 7. To adjust the handle height, pull the 2 rotating quick adjustment knobs (21) outwards and turn 90°. Select another suitable position and align the two holes on the lower handle (8) and the mounting plate (29). Turn the rotating quick adjustment knob (21) 90° back to the original position. Repeat for the other side to lock the handle into position.

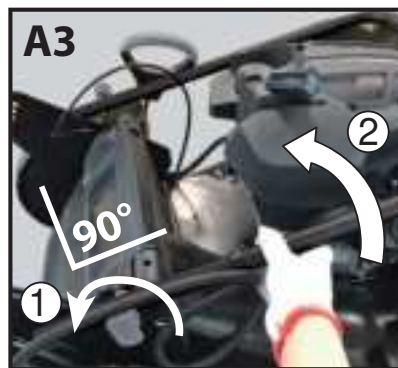

Attaching the Upper Handle Bar to the Lower Handle

With the lower handle (8) in position, the upper handle bar (1) can now be secured in position.

 **IMPORTANT: Again ensure the cables are not tangled or crossing over before applying the upper handle bar (1).**

1. Take out the 2 x upper handle locking levers (5) with washers & 2 x curved washers & 2 x locking knobs (6) from your accessory bag. (Fig. B1)
 2. Align and insert the ends of the upper handle bar (1) on the external side of the lower handle (8) such that the holes in the ends of the upper handle bar (1) align with the holes in the top of the lower handle (8). (Fig. B2)
 3. Insert the upper handle locking lever (5) bolt through the upper handle bar (1), then through the lower handle (8). When in position repeat on the opposite side to keep the upper handle bar (1) sturdy in position. (Fig. B3)
 4. Apply the curved washer and locking knob (6) on the internal side of the lower handles (8), push the locking lever down towards the handle bar (1), then tighten the locking knob (6) until secure. (Fig. B4)
- NOTE:** Tension on the upper handle locking lever/s (5) can be adjusted by rotating the lever (5).
5. The cable holder clips (4) already fitted on the lower handle (8) ensure the key start battery system charging cable (24) and self propel engagement cable (7) are secure in position above the handle bar and not tangled. (Fig. B5)

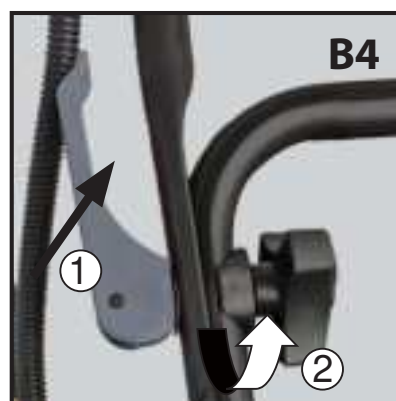
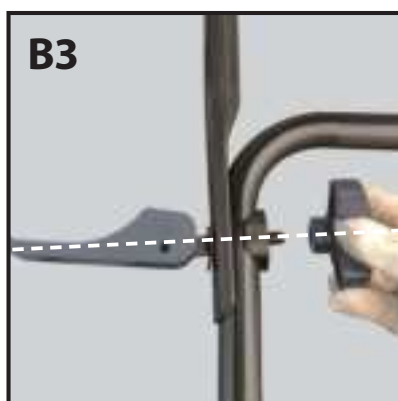
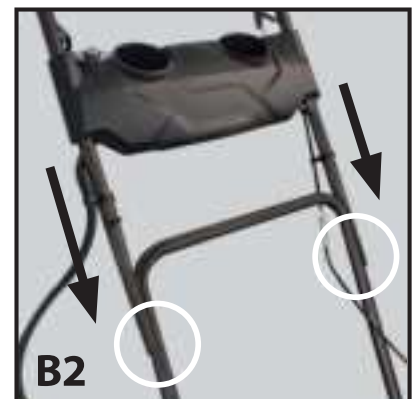

Assembly of the Hard Catcher

The hard catcher (23) is supplied in 2 sections. Locate the top half of the catcher on top of the bottom half and interlock them together by aligning the clips on the top half of the catcher into the raised ridge around the bottom half of the catcher, then push the halves together until they click into place. (Fig. C)



Attaching the Hard Catcher

1. Lift the rear discharge guard (22) and hold it up in order to position the assembled hard catcher (23). Remove the mulching block (34) if it is in the rear chute. (Fig. D1)

NOTE: Do NOT ever start the lawn mower if the rear discharge guard (22) does not fully return to the close position if the catcher (23) is not fitted.

2. Pick up the hard catcher (23) by the handle, attach the hard catcher (23) by aligning the catcher attachment hooks (31) located on both sides of the catcher over the catcher attachment brackets (32) so the catcher (23) is sitting evenly. (Fig. D2 & D3)
3. Release the rear discharge guard (22) to secure the hard catcher (23) into place. (Fig D4)

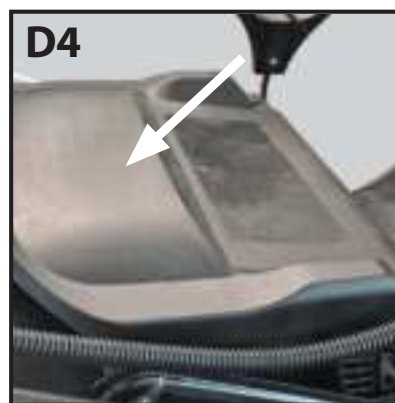
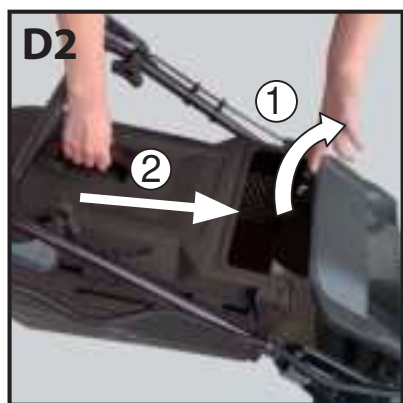

Assembly of the Side Discharge Chute

 **WARNING:** Ensure the engine is **NOT** operating when fitting the side discharge chute (30).

Do not operate or have the engine running when the side ejector cover (16) is opened and the discharge chute (30) is not fitted.

NOTE: The side discharge chute (30) is used to distribute grass clippings from the side of the mower while the mower is in use. To use this function, the hard catcher (23) is **NOT** required to be assembled on the lawn mower.

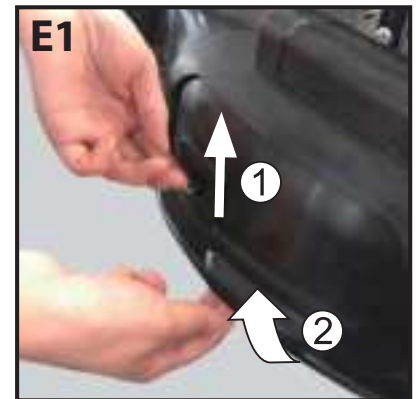

1. This side ejector has a lock to ensure it is secured when not in use. Push the lock tab in an upwards direction to disengage the lock, then using your other hand, lift up the side ejector cover (16) to be able to position the side discharge chute (30) onto the side of the deck of the lawn mower. (Fig. E1)
2. Place the side discharge chute (30) into position on the side of the deck, by aligning the 2 top tabs on the side discharge chute (30) with the bars on each side at the top of the side ejector cover (16), and then place the 2 top tabs underneath the bars to secure. (Fig. E2 & E3) Release the side ejector cover (16). (Fig. E4)
3. To remove the side discharge chute (30), raise the side ejector cover (16), and remove the side discharge chute (30). Lower / release the side ejector cover (16).

NOTE: Ensure the locking tab on the side ejector cover (16) has engaged on the deck to ensure there is no chance of it opening during operation. This should not occur anyway as the cover (16) is spring loaded, however, it is recommended to ensure the lock tab is engaged also.

NOTE: For the best performance in "side discharge chute" mode, insert the mulching block (34).

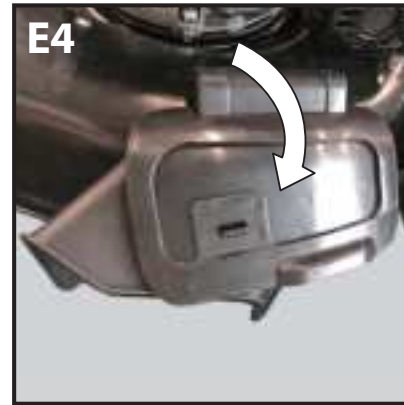
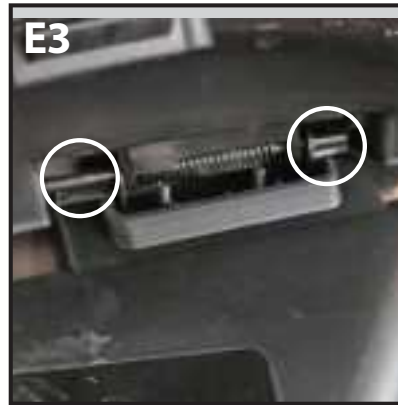

Recoil Starter Handle holder

When not using the recoil starter (10), it can be pulled up to the recoil starter handle holder (25). By looping the pull cord through the holder, the recoil handle can sit securely in the recoil starter handle holder (25) for when not in use.

Battery Charging

This lawnmower is equipped with electric start and uses ALDI Xfinity 20V powered batteries to start the product.

The charger provided with this product is a standard charger.

⚠ IMPORTANT. Before attempting to charge the battery, check the battery charger adaptor (43), plug pack charger (44), and the battery (46) to ensure the charging equipment matches the battery supplied. The components are all labelled with component numbers.

NOTE: The 20V Xfinity Li-ion battery (46) needs to be removed from the lawn mower for charging.

⚠ CAUTION! The 20V Xfinity Li-ion battery (46) may require charging at first use. A full charge will require approximately 4-6 hours.

⚠ CAUTION! The working temperature of the charging operation is 0°C to 40°C.



1. Connect the battery charger adaptor (43) into the plug pack charger (44). (Fig. F1)
2. Connect the plug pack charger (44) into the 240V mains power outlet. A "green" light indicates power. (Fig. F2)
3. Slide the battery charger adaptor (43) onto the 20V Xfinity Li-ion battery (46) by aligning the guiding rails. A click indicates the battery (46) is fitted. (Fig. F3)
4. The plug pack charger (44) light will change to "red". The 20V Xfinity Li-ion battery (46) is now in the charging process. (Fig. F2)
When the light returns to "green", the 20V Xfinity Li-ion battery (46) is fully charged.



NOTE: The power to the charger should be turned off when unattended, with or without a battery inserted.

Preparing for Operation

Mulch and Mowing

Using the mower without the hard catcher (23) attached, the lawn mower will mulch as it cuts and the fine grass clippings are distributed back onto the grass surface without leaving piles of grass clippings.

 **WARNING: Ensure the engine is NOT operating when undertaking this task.**

1. Remove the hard catcher (23) by lifting the rear discharge guard (22) and releasing the hard catcher (23). (Fig. G1)
2. Lift the rear discharge guard (22), insert the mulching block (34) into position, then release and close the rear discharge guard (22). (The mulching block (34) is correctly in place when the circle tabs on the block click into place at

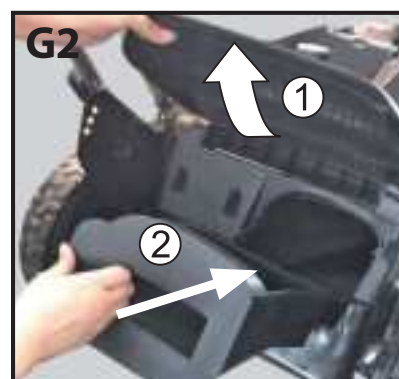

the bottom of the rear discharge chute. (Fig. G2)

3. Ensure the side ejector cover (16) is in the closed position. (Fig. G3)

Do NOT use the side discharge chute (30) when mulch and mowing.

Adding and Checking the oil

⚠ IMPORTANT: The engine of this lawn mower is packed with NO OIL in the engine. Prior to starting the engine, Oil MUST be added to the sump of the engine.

Failure to add sufficient oil will result in damage to the engine which is NOT covered under the warranty of the lawn mower.

On a new lawn mower, the engine needs to be filled with 500ml of SAE 10W/30 engine oil. We recommend FERREX® PRO Full Synthetic 4 Stroke Oil.

Each time the lawn mower is used, the oil level should be checked and if low, add sufficient oil to ensure the oil level is to the full mark on the dipstick.

1. Position the lawn mower on a flat and level surface. Clean the area directly around the oil filler cap/dipstick (19).
2. Remove the oil filler cap/dipstick (19) by turning approximately a quarter turn in an anti clockwise direction and lift the cap (19) outwards. (Fig. H1 & H2)
3. Clean the oil filler cap/dipstick (19) with a clean cloth, cleaning away any visual oil.
4. FOR A NEW LAWN MOWER, add 500ml of 4 stroke SAE 10W/30 engine oil.
5. Insert the oil dipstick (19) back and secure the oil filler cap/dipstick (19) by turning approximately a quarter turn in a clockwise direction.

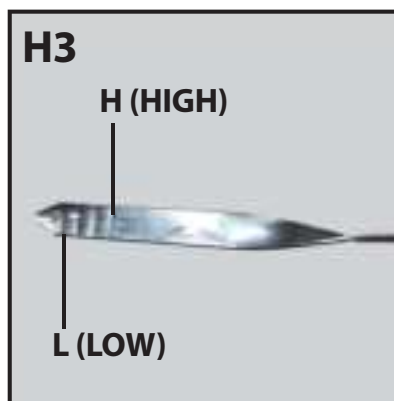
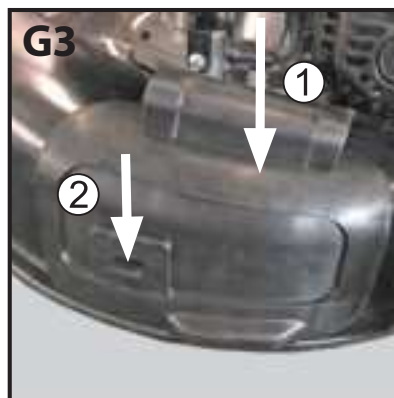

6. Again remove the oil filler cap/dipstick (19) and check the oil level. It should be at the top of the full (H marking) indicator on the dipstick (19). (Fig. H3)
 7. If low, add oil slowly into the engine oil fill. Do not overfill. After adding oil, wait one minute and then recheck the oil level.
 8. Re-position and tighten the oil filler cap/dipstick (19). Always ensure the oil filler cap/dipstick (19) is firmly locked in place before the engine is started.
- NOTE:** Do not allow engine to run low on oil as it will reduce the life of the engine.
- NOTE:** Do not over fill with oil above the full indicator mark.

Fuelling

 **IMPORTANT: Fuel goes off after about 3-4 months. If you find your lawn mower does not start, first change the fuel in the tank (28) with newly purchased fresh unleaded fuel. Do not use ethanol based fuels.**

 **WARNING. Do not refill fuel tank (28) while engine is running or is hot.**

- **Be careful not to admit dust, dirt, water or other foreign objects into the fuel.**
 - **Wipe off spilt fuel thoroughly before starting engine.**
 - **Ensure you DO NOT fuel the lawn mower in close proximity to any open flames, lit cigarettes, or hot objects.**
1. Unscrew the fuel tank cap (27) and pour fresh unleaded fuel into the tank (28) with the aid of a funnel. (Fig. I1-I3)
 2. Fill the tank (28) to approximately 2.5 cm below the lowest portion of the neck to allow for fuel expansion. Be careful not to over fill or spill any fuel. If this happens, wipe the spill with a clean rag.
 3. Start the engine at least 3 metres away from the area where the fuel tank (28) has been filled in order to avoid the risk of fire.



Adjusting the Cutting Height

The mower has a cutting height adjustment lever (9) to easily adjust the cutting height. There are 7 height settings.

NOTE: Always try to adjust the cutting height of the lawn mower while positioned on the area of grass you plan to mow.

It is recommended to start on a higher setting and mow a trial area of lawn before deciding on the final cutting height position. Then re-adjust if necessary.

1. To increase the cutting height, first pull the cutting height adjustment lever (9) outward a little towards the wheel, and move it up a notch, towards the rear of the lawn mower. (Fig. J1 & Fig. J2)
2. To decrease the cutting height, pull the cutting height adjustment lever (9) outward a little towards the wheel (20), and move it down a notch, towards the engine (11). (Fig. J1 & Fig. J3)
3. After adjustment, ensure the lever (9) is fully located in the selected notch.

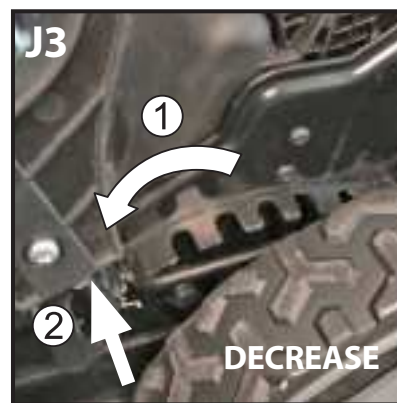
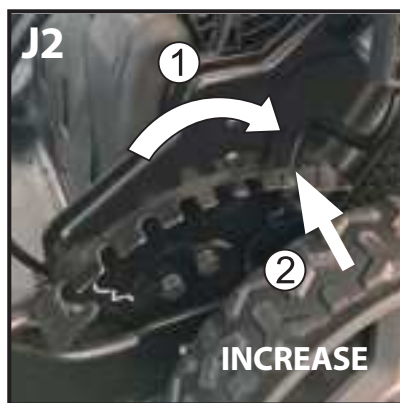

Operation

Starting the Engine (Electric / Key Start)

NOTE: Before starting the mower check the oil and fuel levels. The engine **MUST** be filled with 500ml of SAE 10W/30 engine oil **BEFORE** starting. Fresh unleaded fuel must be used in this unit.



WARNING: DO NOT use Ethanol based fuels. Do NOT mix oil with fuel.

Warranty will be void if the engine becomes faulty due to insufficient oil and fuel levels.

For starting, ensure the mower is set to the highest height setting so the blades are not resting deep into the grass.

NOTE: The engine of this lawn mower has an automatic choke start and operation feature, and no priming bulb, hence no priming or choke adjustment is required before starting the engine.

1. Ensure the 20V Xfinity Li-ion battery (46) is charged. If not, refer to the "Battery Charging" section of the manual.
2. Insert the 20V Xfinity Li-ion battery (46) into the battery compartment (42) at the rear of the tool and refreshment holder (3). A click will be heard when the battery has engaged. (Fig. K1)
3. Turn the key (26) to the right to the "START" position to start the lawn mower engine. The engine should start. (Fig. K2) Release the key (26) as soon as the engine starts. The key (26) will automatically move back to the "ON" position.



WARNING: Do not wash your lawnmower with the battery inserted. Please store your battery in a dry safe place. Always store your battery in a safe location and never leave outside.

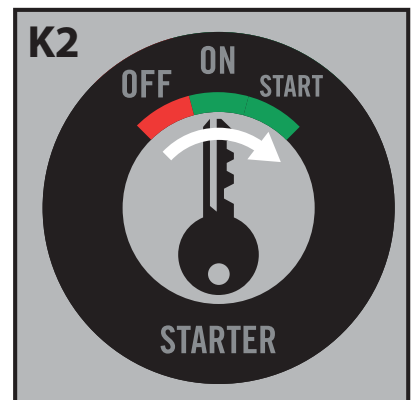

Starting the Engine (Manual Recoil Start)

1. Turn the key (26) to the right to the "ON" position.
2. Firmly hold the recoil starter (10) & pull slowly until resistance is felt, then pull rapidly. (Fig. L)

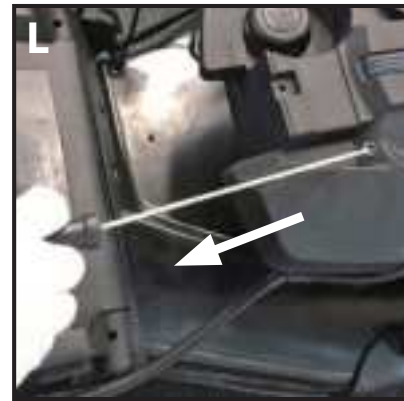

Stopping the Engine

1. To stop the engine (11), move the key (26) to the left to the "OFF" position. (Fig. M)

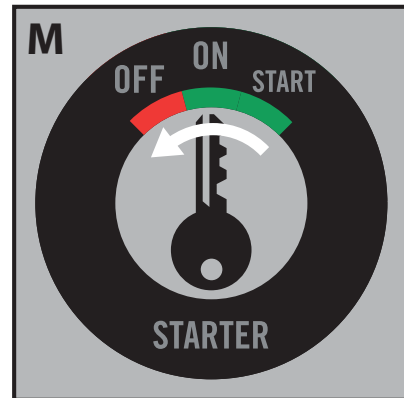

Emergency Stopping

If you have turned the key (26) and the lawnmower fails to stop, **DO NOT PANIC** - there are two other safe stopping methods available for you to try. Do not put fingers or hands anywhere near the cutting deck.

The safest method is to wheel the lawn mower to a safe area and allow the lawn mower to continue to run until the fuel has been all used up.

An alternative to this where the user is confident, is to remove the spark plug cover (13) by pulling it from the spark plug (47). (Fig. N) This removes the engines ability to fire and run.

However it is recommended to wear a rubber glove when grasping the spark plug cover (13) as a small electric shock is possible when pulling the cover (13) off.

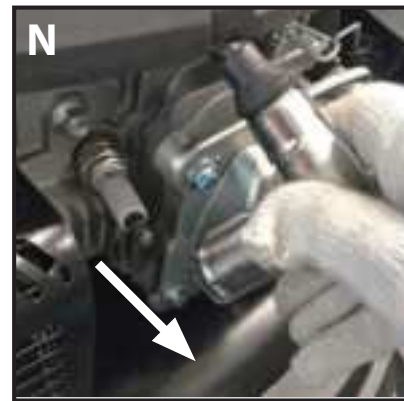

Ensure you feel confident to do this . If not, simply allow the lawnmower to run out of fuel.

CAUTION: The spark plug (47) may be hot.
Persons with heart conditions or any medical condition which can be affected by electric shock should not attempt the spark plug removal method.

Do not attempt to restart the lawnmower and contact your local service agent and book a repair of the product.

Do NOT lift the lawn mower. Do NOT tilt the lawn mower.

Do NOT leave the running lawn mower unattended.

Do NOT put hands under the running lawn mower under any circumstances.

Mowing advice

1. Before mowing always check and clear the grassed area for all foreign objects, especially solid ones semi concealed in the ground such as rocks, stumps and garden stakes.
2. Sharp blades cut cleanly and efficiently, if the blades are dull it will tear the grass. This will result in the ends turning brown. When the blades no longer cut cleanly either sharpen them or replace them.
3. To safely operate the mower ensure all four wheels are on the ground and be careful not to lose your footing or control of the mower. Be very careful when mowing uneven or rough ground. Keep a firm grip on the handle bar at all times, always walk, never run with the lawn mower.
4. For healthy growth, grass should not be cut too short. The grass will remain healthier, greener and require less watering.
5. Vary your cutting pattern from week to week, this will help to prevent matting and graining of the grass.
6. If using the mulching function, and grass is piling up behind the lawn mower during the cutting action, lift the lawn mower to the next cutting height using the cutting height adjustment lever (9).

Engine tipping

NOTE: Always ensure the engine (11) is switched off and the spark plug cover (13) is removed before undertaking this task.

When cleaning, or performing any maintenance such as replacing the blades, it is very important that the lawn mower is **ONLY** tipped backwards. (Fig. O) Failing to do so will result in the engine damage. Should this occur, the mower should be taken to a lawn mower repair shop which is not covered under warranty.

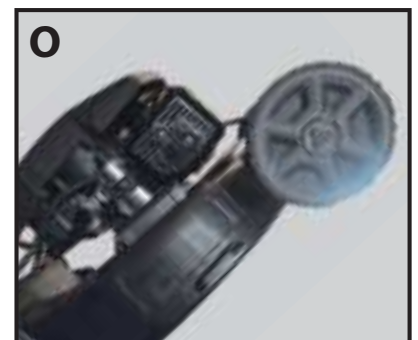

Poor engine performance

Should the engine (11) idle or run rough at full speed with excessive blue/black smoke emanating from the muffler, it is possible that either the engine was slightly tipped incorrectly (refer above). If the mower had previously been tipped, allow the engine to run for a few minutes and the excess oil will burn out.

If the engine is not running at full speed, check the fuel is fresh, check the oil level, and also inspect under the deck to ensure there is no build up of grass. Check the spark plug (47). If the mower continues to underperform, take the mower to your nearest an authorised Service Agent.

Operating Functions of the Lawn Mower

Self propelled or manual operation of the lawn mower:

This lawn mower has the option to be manually pushed or engine driven self propelled when the engine is operating.

1. Manual Operation:

The lawn mower is manually maneuvered under the user's own power when the mower is operating. i.e the user is pushing the lawn mower to power its movement forwards or backwards.

To operate this way manually, simply leave the self propel engage/disengage bar (2) in its standard position. i.e DO NOT LIFT the self propel engage/disengage bar (2) towards the upper handle bar (1). (Fig. P1)

2. Self Propelled Operation:

The self propelled operation will only operate when the engine of the lawn mower is operating, and the self propel engage / disengage bar (2) has been activated by lifting it up to the handle bar and holding in position, (Fig. P2) hence the mower will move forward itself with the operator steering and directing from the handlebars.

The self propelled operation is ONLY in the forward direction and is at a set single speed.

To stop the self propelled function, release the self propel engage/disengage bar (2) and the mower will cease forward movement. (Fig. P3)

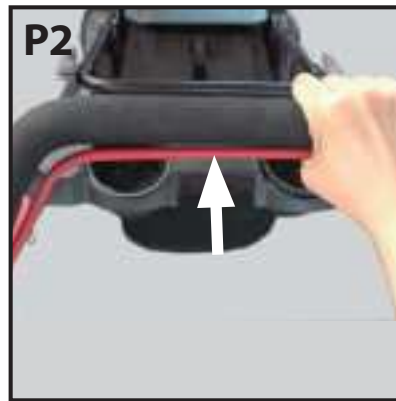
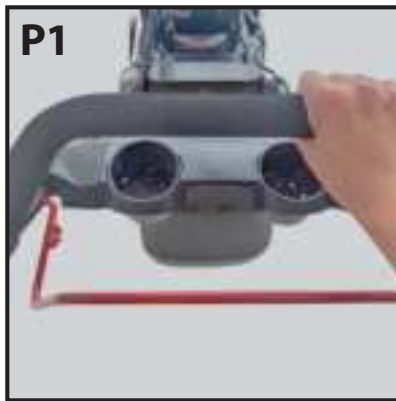

Maintenance

Replacing the Blades

NOTE: Before making any adjustment or maintenance procedures to the lawn mower ensure it is turned off and the spark plug lead is removed.

NOTE: Wear heavy gloves to protect your hands.

1. With the engine switched off, remove the hard catcher (23) and lift the front of the lawn mower upwards so the upper handle bar (1) sits on the ground and the spark plug (47) faces upwards.
2. Remove the blade bolt (37) using a 17mm spanner (not supplied) by turning in an anti-clockwise direction (Fig. Q1), then remove the outer flange and washer (38). (Fig. Q2) This allows you to be able to remove the blade mounting plate (40) from the lawn mower.
3. To remove a single blade from the blade mounting plate (40), again use a 17mm spanner (not supplied) to loosen and remove the nut, screw and washers. (Fig. Q3 & Q4)



NOTE: There is 1 washer located under the screw on the outer side of the blade mounting plate (40), and one on the underside of the blade mounting plate in between the blade and blade mounting plate (40). Be careful not to lose these. (Fig. Q5)



* Please note gloves should be worn for this maintenance task. Non gloved images are shown for instructional purposes only.

4. Repeat the process to remove the other 3 blades.
5. Clean the dirt and grass from around the blade mounting area.
6. Replace all 4 blades to ensure a smooth even cut and re-fit them on the mower in the reverse direction they were removed.
7. Lastly, secure the nuts firmly, (20-25Nm) repeating this for the other 3 blades.
8. Replace the blade mounting plate (40) with new blades attached, then the outer flange (38), followed by the blade bolt (37). Retighten the blade bolt tightly (50 – 59Nm).

NOTE: Use a wooden block to stop the blade from turning. The 4 blades should be tightened fully but check to ensure they can still swing back if they were to hit a solid object. Where required tighten the bolts with a torque wrench, the centre disc blade bolt torque: 50 – 59Nm and the four blades torque: 20-25Nm. If you do not have a torque wrench ask a mower service dealer to tighten the blade bolts before you use the mower.

Blades should be replaced when they become worn and no longer cut the grass cleanly. The performance of grass catching can also reduce if the blades become worn. Replacement blade sets are available for purchase from <https://help.tools/> or by calling 1300 889 028.

Removing Oil



IMPORTANT: Drain the oil while the engine is still warm to ensure rapid and complete draining.

1. With the engine off but still warm, disconnect the spark plug cover (13) and make sure it is kept away from the spark plug (47).

- Remove the oil drain plug (18) bolt, (Fig. R1) using a 10mm spanner (not supplied) in an anti-clockwise direction to loosen. (Fig. R2)



WARNING: Oil may be hot.

- Drain the oil into a suitable / approved container for the disposal of oils and the like.
- After the oil has drained, install and tighten the oil drain plug (18) bolt. Wipe up any spilt oil.
- To refill the oil tank, follow the process on page 26.

NOTE: Please dispose of used engine oil in a manner that is compatible with the environment. We suggest you take it in a sealed container to your local service station for reclamation. Do not throw it in the trash, pour it into the earth, or pour down drains.



Air Cleaner Maintenance

The air cleaner system uses a pleated filter.



IMPORTANT A dirty air filter (35) will restrict air flow to the carburettor.

To prevent carburettor malfunction, service the air filter (35) regularly.

Check that the air filter (35) is clean and dry of dirt.

Filters thick with debris will not allow the engine to breathe and result in difficult starting and poor engine performance.

The air filter (35) should be checked after approximately 25 hours of use, or annually.

- Refer to Adjusting the Cutting Height section in Preparing for Operation part on Page 28 to set the height to the highest level, in order to avoid interference between the air filter cover (12) and the bar (a) above the deck. (Fig. S1)
- Open the air filter cover (12) by pushing in the rear tab (right hand side) to release the clip, and then



- pushing the cover back and away to release the 2 front clips. (Fig. S1)
- Open the air filter cover (12) and remove the air filter (35). (Fig. S2)
 - To loosen debris, gently tap the air filter (35) on a hard surface. If the filter is excessively dirty, replace with a new filter.
 - Wash the filter in liquid detergent and water. Then allow it to thoroughly air dry. Do not oil the filter.
 - Re-install the air filter (35). Close the air filter cover (12) and secure the fastener.



CAUTION: Never use fuel or low burning paint solvents to clean the filter (35). A fire or explosion could result.



CAUTION: Clean the filter (35) in a solution of household detergent and warm water. Ensure the filter (35) is dry before re fitting.

Replacement air filters are available for purchase from <https://help.tools/>, or by calling 1300 889 028.

Spark plug

To ensure the engine is operating correctly, the spark plug (47) must be properly gapped and free of carbon deposits. Always check the spark plug cable is firmly fitted to the top of the spark plug (47). The spark plug (47) should be changed after approximately 25 hours of use, or annually.



CAUTION: If the engine (11) has been running, the muffler (17) will be very hot. Be careful not to touch the muffler (17).

- Remove the spark plug cover (13). (Fig. T1)
- Take out the hexagonal socket + axle (39). Insert the axle into the hole at the end of the socket to assemble a spark plug spanner. (Fig. T2)
- Using the assembled spark plug spanner to remove the spark plug (47) (Fig. T3 & T4), and clean any deposits from the spark plug (47) with a rag or damp cloth.
- Visually inspect the spark plug (47). Discard the spark plug (47) if there is apparent wear, or if the insulator is cracked or chipped.

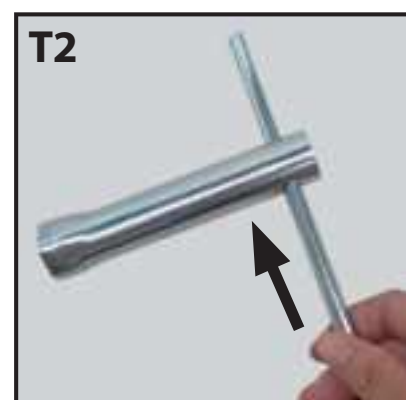

5. Check that the end of the spark plug (47) is not blackened by carbon build up. Clean with a soft wire brush if necessary.
 6. Measure the plug gap with a feeler gauge. Correct as necessary by bending the side electrode. The gap should be 0.7- 0.8mm. (Fig. T5)
 7. Thread the spark plug (47) in by hand to prevent cross-threading.
 8. Once the spark plug (47) is seated, tighten with the assembled spark plug spanner to compress the washer.
- NOTE:** When installing a new spark plug, tighten 1/2 turn after the spark plug seats to compress the washer.
9. Re-position the spark plug cover (13). ENSURE the cable to the cover is in the TOP position and is clear of the carburettor rod.

 **CAUTION: The spark plug (47) must be securely tightened. An improperly tightened spark plug (47) can become very hot and may damage the engine.**

Replacement spark plugs are available for purchase from <https://help.tools/> or from lawn mower or small engine repair shops.

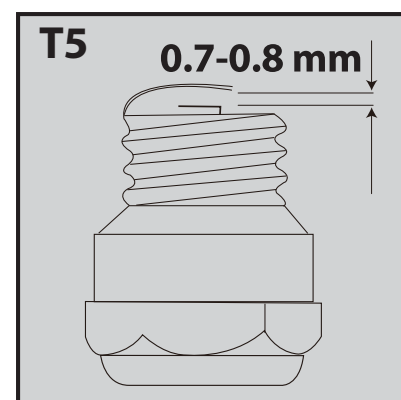
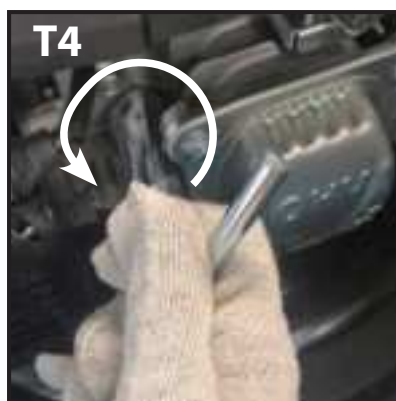

Deck Wash

The deck wash feature allows you to wash/clean the underside of the lawn mower deck using a standard garden hose fitting or the supplied standard hose fitting (41). (Fig. U1)

 **WARNING: Stop the engine and unplug the spark plug (47) before undertaking any repairs or maintenance operations.**

 **WARNING. Do not wash your lawnmower with the battery inserted. Please store your battery in a dry safe place. Always store your battery in a safe location and never leave outside.**

WARNING: It is recommended to wear gloves during this process so as to not risk any personal injury from the blades when cleaning the underside of the deck.

1. Position mower on a flat and level section of grass, which will not cause problems if the grass and surrounding area will get wet.
NOTE: It is NOT recommended to perform this operation on a concrete surface as the concrete may be stained.
2. Remove the hard catcher (23) and ensure the rear discharge guard (22) is closed.
3. Attach a standard quick connect garden hose fitting to the deck wash nozzle (33). (Fig. U2)
- NOTE:** If you do not have a standard garden hose fitting, use the supplied standard hose fitting (41) to connect to your garden hose. (Fig. U3)
4. Raise the deck height to approximately mid height using the cutting height adjustment lever (9).
5. Start the lawn mower.
6. Turn on the water at the tap, so as to distribute the water under the entire deck.
7. Run the process with the water running for approx 5 min or shorter if no more grass is washing out from under the deck and then turn off the water. Continue to run the lawn mower for a few minutes to assist in drying out the under deck.
8. Turn off the lawn mower and remove the standard hose fitting (41) from the deck wash nozzle (33).

NOTE: For general cleaning and maintenance of the mower, including the housing, catcher, handles, levers and knobs, these can be cleaned using a rag or damp cloth. Do not use chemicals or solvents.



Storage and Transporting

Transporting



WARNING: Ensure the engine (11) is not running and has cooled before transporting.



WARNING: If the engine (11) must be tipped to transport equipment or to inspect or remove grass, keep the spark plug (47) upwards.

Transporting or tipping the engine spark plug (47) down may cause:

- Smoking
- Difficulty starting
- Spark plug fouling
- Oil saturation of the air filter

Ensure the storage area is free from excessive humidity and dust.

Drain the fuel tank (28) and carburettor.



WARNING: Fuel is extremely flammable and explosive under certain conditions. Do not smoke or allow flames or sparks in the area.

NOTE: Be aware to not hit or cut the fuel tank while you are transporting.

Storage

- Remove the battery pack, and pull out the key.
- Store the mower far away from children.
- When you finish working, clean the engine completely, making sure there is no grass or dirt on the engine.
- Store the engine away from direct sunlight.
- At the end of the season, give the engine an overall cleaning and a thorough check.
- Whenever the machine is not used for a long period of time, proceed as follows:
 - Empty the fuel tank completely.
 - Empty the Carburettor bowl of all fuel by starting the lawn mower and letting it stop when the fuel is all used in the bowl.
 - Protect all metal engine parts from corrosion by coating them with oil.
 - Completely empty the engine oil.
 - Coat areas that may rust with a light film of oil. Cover the engine and store it on a level surface in a dry, dust free area.

Maintenance

Periodic Maintenance

| Periodic maintenance | | | | | | |
|--|---|-----------------------------|--------------------------|------------------------|-------------------------|--------------------------|
| Item | Remarks | Pre-operation check (daily) | Initial 1 months or 20Hr | Every 3 months or 50Hr | Every 6 months or 100Hr | Every 12 months or 300Hr |
| Spark plug | Check condition, adjust gap and clean. Replace if necessary. | | | ✓ | | |
| Engine oil* | Check oil level. | ✓ | | | | |
| | Replace (Fuel goes off after about 3-4 months) | | | ✓ | | |
| Air filter | Clean. Replace if necessary. | | | ✓ | | |
| Fuel* | Check fuel level. | ✓ | | | | |
| Blade/s | Replace when they become worn and no longer cut the grass cleanly. (dependent upon regularity of use) | | | ← ✓ | ✓ → | ✓ |
| Deck Wash | Check for residue grass clippings on the blades and around underside of the deck. | ✓ | | | | |
| Upper and Lower handle locking knobs / levers | Check before using the lawn mower. | ✓ | | | | |
| Catcher | Empty clippings when the catcher is 3/4's full. | ✓ | | | | |
| Battery Starting system | Ensure battery is charged for operation. | ✓ | | | | |
| Fittings, fasteners, screws, bolts, mulching block, side discharge chute, side ejector cover | Ensure secure and in good condition. | ✓ | | | | |

Regular maintenance is most important for the best performance and safe operation. Failure to periodically maintain the condition of your lawn mower which results in malfunction of the lawn mower will void warranty.

* Dispose of used engine oil / fuel in a manner that is compatible with the environment. We suggest you take it in a sealed container to your local service station for reclamation. Do not throw it in the trash or pour it into the earth.

Warranty

Warranty

Your new FERREX® PRO 224cc 4 Stroke Petrol Lawn Mower will more than satisfy your expectations. It has been manufactured under stringent FERREX® PRO Quality Standards to meet superior performance criteria.

You will find your new 224cc 4 Stroke Petrol Lawn Mower easy and safe to operate, and, with proper care, it will give you many years of dependable service.

CAUTION. Carefully read through this entire instruction manual before using your new FERREX® PRO 224cc 4 Stroke Petrol Lawn Mower.

Take special care to heed the Cautions and Warnings.

Your FERREX® PRO 224cc 4 Stroke Petrol Lawn Mower has many features that will make your job faster and easier. Safety, performance, and dependability have been given top priority in the development of this 224cc 4 Stroke Petrol Lawn Mower, making it easy to maintain and operate.

Use only FERREX® PRO replacement parts for your product. Non-conforming parts or modifications made to parts will void your warranty.

Environmental protection



Recycle unwanted materials instead of disposing of them as waste.

All tools, hoses and packaging should be sorted, taken to the local recycling centre and disposed of in an environmentally safe way.

Dispose of used engine oil in a manner that is compatible with the environment.

We suggest you take it in a sealed container to your local service station for reclamation. Do not throw it in the trash or pour it into the earth.

What your 5 year warranty means

Great care has gone into the manufacture of this product and it should therefore provide you with years of good service when used properly.

In the event of product failure within its intended use over the course of the first 5 years* after the date of purchase, we will remedy the problem as quickly as possible once it has been brought to our attention. In the unlikely event of such an occurrence, or if you require any information about the product please contact us via our after sales support services, details of which can be found in this manual and on the product itself. After Sales Support TEL: 1300 889 028 or email: info.aldi@positecgroup.com

* 5 year warranty applies for the lawn mower.

1 year warranty applies for the 20V Lithium-Ion Battery and Battery charger.

Accessories and After Sales parts

Should you find the following accessories are worn or past their user life, replacements can be purchased online via our website <https://help.tools/>



* blade mounting plate not included

1. 4 x swing blades (10093-BL)



2. Side discharge Chute (10093-SDC)



3. Standard hose fitting (10093-SHF)



4. Recoil Starter (10093-RS)



5. Mulching Block (10093-MB)



6. Spark Plug (LG F7RTC)



7. Air Filter (10093-AF)



8. 20V Li-Ion Battery



9. Charger base + Plug pack charger

If you have any queries regarding these accessories, please call us on our Customer Support Line: 1300 889 028.

* Note also all ALDI Xfinity Plus 20V Batteries and chargers are compatible with this lawn mower.

Troubleshooting

| Problem | Possible Cause | Solution |
|--|---|--|
| Engine does not start. | Fuel tank (28) is empty. Oil tank is empty. Spark plug (47). Blades hitting the grass to be cut. 20V Xfinity Li-ion battery (46) is flat. | Check the fuel tank (28), and refuel if required. Check the level of the oil filler cap/dipstick (19), and if low or empty, add oil. Clean or replace if dirty or worn. Increase the cutting height of the mower so the blades do not make contact with the grass on start up. Charge the 20V Xfinity Li-ion battery (46). |
| Cutting / Engine performance decreases. | Cutting height. 4 x blades (36) are dull or blunt. When using side discharge chute (30). Hard catcher (23) is full. | Increase the cutting height using the cutting height adjustment lever (9). Replace the blades with new / sharp blades. Clean around the side ejector chute. NOTE: Always ensure the engine is turned off before undertaking this task. Empty hard catcher (23). |
| Hard catcher is not filling up to optimum level. | Cutting height too low. When Mulching, piles of grass are left behind the mower. Grass is wet. 4 x swing blades (36) are dull or blunt Rear discharge chute is blocked. | Increase the cutting height using the cutting height adjustment lever (9). Lift the height of the cutting depth by one notch using the cutting height adjustment lever (9). Allow the grass to dry before mowing. Sharpen or replace the 4 x blades (36). Stop mower and clear the rear discharge chute. |
| Mower cannot be pulled backward. | Gearbox is engaged. | Release the self propel engage/disengage bar (2). |
| Self propel does not operate. | Gear box not engaged. Engine not operating. | Fully lift self propel engage/disengage bar (2) against the upper handle bar (1). Start motor and retry. |
| Engine does not stop | Key failure | The safest method is to wheel the lawn mower to a safe area and allow the lawn mower to continue to run until the fuel has been all used up. Refer to the Emergency stopping section on page 30 for more detail. |

Service Support

If you have any issues with the operation of your product, please take it with a copy of your receipt to one of our National Service Agents for repair. A listing of our Service Agents is included with your product, however, you can also find our most updated listing by visiting <https://help.tools/> and clicking on the Service Agent link. Alternately call us on our Customer Support line, 1300 889 028, for advice or support.

Technical Specifications

Lawn Mower Specifications

| | |
|------------------------------------|--|
| Engine: | 224cc Four Stroke |
| Engine Capacity: | 224cc |
| No load Speed: | 2800 min ⁻¹ +/- 15% |
| Fuel Type: | Unleaded petrol |
| Oil Type: | 4 Stroke Engine Oil SAE 10W/30 |
| Fuel Tank Capacity: | 1.2 L +/- 0.15 L |
| Oil Tank Capacity: | 500 ml +/- 60 ml |
| Width of cut: | 530 mm (21") |
| Blades: | 4 x swing back blades |
| Height adjustment: | 7 Levels |
| Front wheel diameter: | 8" (20.3 cm) |
| Rear wheel diameter: | 11" (27.9 cm) |
| Spark Plug Type: | LG F7RTC |
| Equivalent Replacement Spark Plug: | NGK BPR6ES |
| Catcher Capacity: | 65 L |
| Weight (NW): | 40 kg |
| Noise label rating: | 98 dBA (taken at 4 metres) You must wear ear protection at all times. |
| Product Dimensions: | 1700 x 625 x 1100 mm +/- 10% (L x W x H) |

Battery and Charger Specifications

| | |
|-----------------------------|---|
| Battery: | 20 V  Max. 1.5 Ah/Li-Ion |
| Battery Model Number #: | ABP1815MA |
| Other Compatible Batteries: | Any ALDI Xfinity Plus branded 20V 2A or 4A batteries available in store. |
| Charger Adaptor Model #: | Z10 |
| Plug Pack Charger Model #: | WJA-Y082200360WZ |
| Charging time: | Ready for use in 3-5 Hours |

NOTE: Any other ALDI Xfinity Plus branded 20V Chargers are compatible with this product.

224cc 4 Stroke Petrol Lawn Mower

| | |
|-----------------------------|---|
| This product complies with: | Safety: EN ISO 5395-1 EN ISO 5395-2 |
| Charger: | EMC: EN ISO 14982 Safety: IEC60335-1 IEC60335-2-29 AS/NZS60335.1 AS/NZS60335.2.29 |
| Battery: | EMC: EN 55014-1 EN 55014-2 EN 61000-3-2 EN 61000-3-3 Safety: IEC62133-2:2017 |



ALDI guarantees that our exclusive brand products are developed to our stringent quality specifications. If you are not entirely satisfied with this product, please return it to your nearest ALDI store, within 60 days from the date of purchase, for a full refund or replacement, or take advantage of our after sales support by calling the supplier's Customer Service Hotline.



Made in China

FERREX® PRO is a registered trademark of ALDI Stores

DISTRIBUTED BY:

ALDI STORES

1 SARGENTS ROAD

MINCHINBURY NSW 2770

www.aldi.com.au

AFTER SALES SUPPORT



 ^{AU} 1300 889 028 (toll free)

e-mail: info.aldi@positecgroup.com

MODEL: SLM531 • 09/2021 • 10093

5

YEAR WARRANTY