

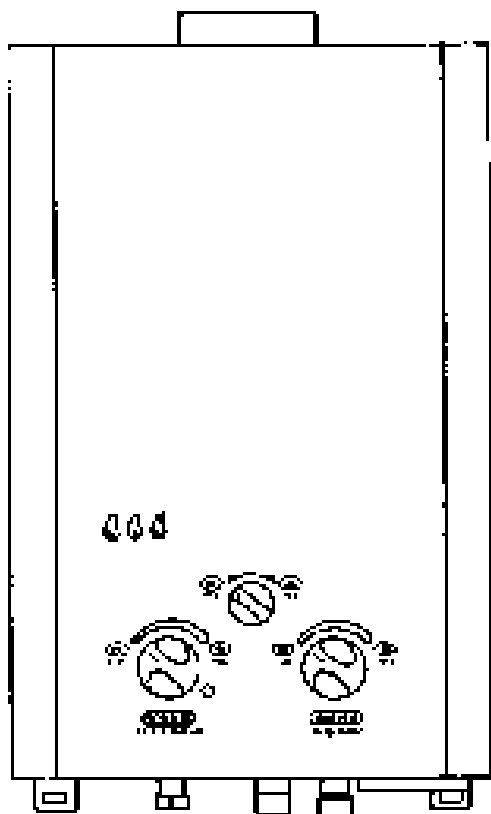

Fully-automatic Gas tankless Water Heater

**USER'S MANUAL
FOR MODEL EZ-101**



ISO9001 certified

Thank you for purchasing our fully-automatic gas-fired tankless water heater.
Please completely read this Manual before installing and operating your heater.

Keep this manual for future reference.

Contents

- Features & Benefits.....
- Specification.....
- Parts Name.....
- Dimensions.....
- Installation.....
- Operation Method.....
- Cautions for Safety.....
- Maintenance.....
- Freeze information & combustion air requirements..
- Trouble Shooting.....

Features & Benefits

1. Automatic operation, convenient to use.

- Fully-automatic operation, just turn on the water tap, faucet or shower and hot water will be produced on demand. After the tap is turned off, the flame will automatically extinguish and the heater will return to stand-by mode.
- Independent control of water flow and gas flow makes it easy to regulate water temperature.

2. Innovative design

- Ultra-thin design, attractive shape and convenient to install.
- Advanced energy-saving combustion technology greatly promotes burning efficiency.
- No standing pilot for more energy-savings.
- Low water pressure (2.9 Psi) ignition.
- With a three position winter-summer switch to regulate the burner making temperature regulation easier.

3. Complete safety

- Sensitive ion flame sensor will cut gas supply if flame goes out unexpectedly.
- Insufficient water pressure protection. In case of inadequate water supply, the gas valve will automatically turn off
- With a 20-minute timer, helps to prevent accidental carbon monoxide poisoning due to inadvertent or accidental long period use.

Specifications

Item	Instant Gas Water Heater						
Model			EZ-101				
Rated heat input			12				
Rated hot water supply (temp. rise 25°C) (77F)			1.6 GPM				
packing dimension (a*b*c) (INCHES)	17.5x11.8x4.7						
Rated gas pressure (Psi)	LPG (0.46) (11" WC)						
	NG (0.29) (7" WC)						
Control method	Outlet control						
Exhaust method	Flue						
Ignition method	Water-operated Automatic Ignition						
Power	2 D Cells (Not Included)						
Safety Devices	Flame-out Protection A 20-minute timer, etc.						
Suitable Water Pressure	(8 to 100 Psi)						
Connector specification	Gas inlet: G1/2 inch USA Pipe thread						
	Cold water inlet: G1/2 inch USA Pipe thread						
	Hot water outlet: G1/2 inch USA pipe thread						

(Notice: please see the label for the actual rated gas pressure and suitable water pressures)

PARTS NAME

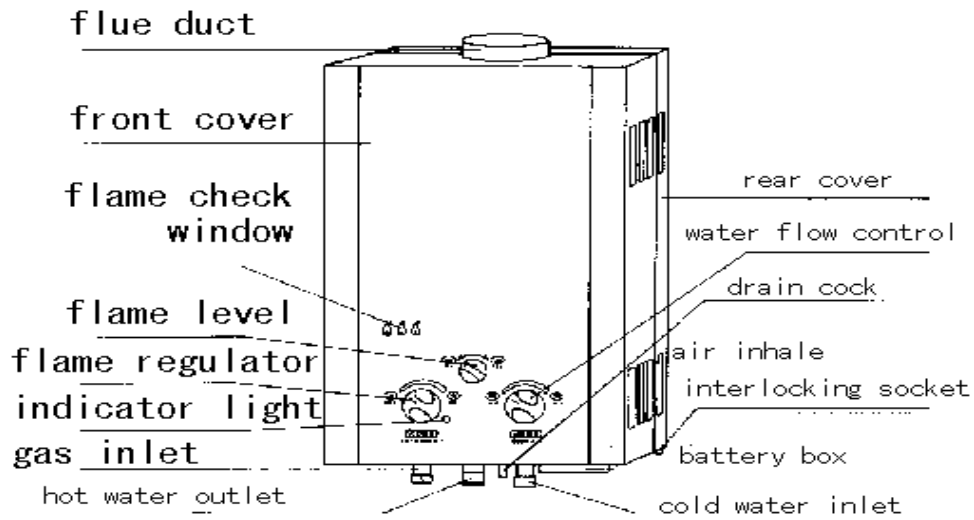

Fig. 1

Dimension

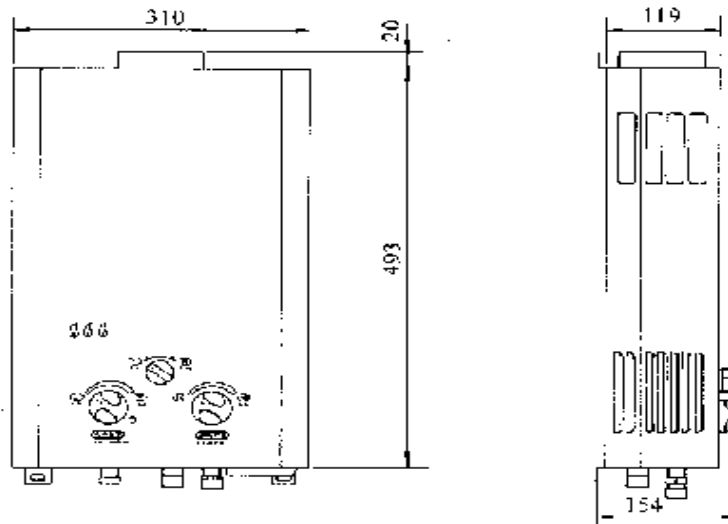

Fig. 2

Dimensions

Width 12.2 inches – Height 19.4 inches – Depth 4.7 inches

BEFORE INSTALLATION

Before installation, contact your local gas dealer or gas management department, directly or indirectly, for a qualified engineer's opinion, because improper installation is dangerous to safety, or may even endanger your life.

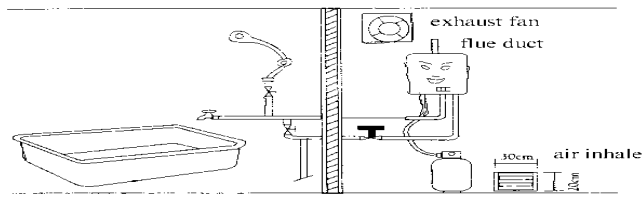

FIG 3

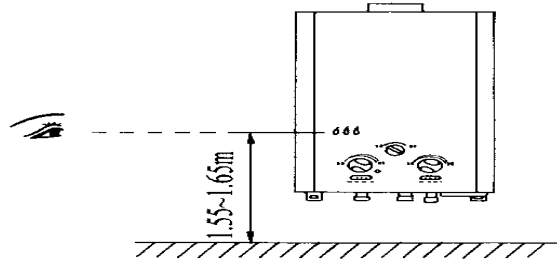

FIG 4

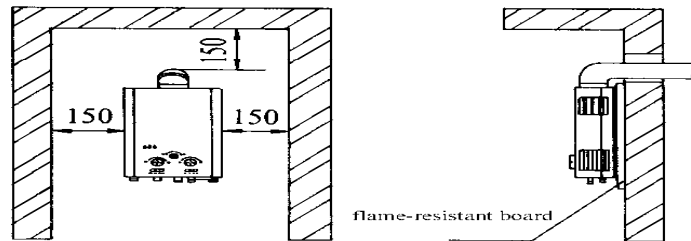

FIG 5

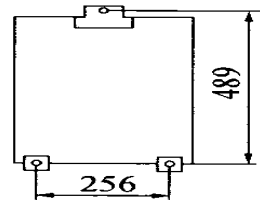

FIG 6

Installation requirements

- Do not install the water heater in a bedroom, basement, bathroom, or any room with poor ventilation. In order to keep the room for installation ventilated well, an air-intake hole should be made in the lower area of the room, and the hole areas should not be less than 100cm^2 – (15 square inches) (**See combustion air requirements below**)
- The flame display window of the water heater should be located in a position where the flame window can be easily viewed at eye level (approximately five feet above the floor)
- No wires or electric equipment shall be put above the water heater. The heater should be kept at least 15 inches away from electronics horizontally. The heater should be kept well away from any flammable substance or liquid.
- Do not install the water heater where adverse winds may blow, causing flame-out or incomplete combustion.

Installation

Installation mounting

Mount the water heater vertically on the upper bolt without any inclination and tighten lower holes with expansion bolts.

Piping, plumbing, and exhaust venting

- LPG users are required to use a standard regulator that will supply 44,000 btu.
- Gas Inlet
 - (1) For LPG users, connect the gas inlet and the gas pressure-regulator to the gas cylinder.
 - (2) For NG users, contact the gas dealer to connect with a suitable pipe.
 - (3) After connecting the gas pipes, check the connections with soap suds for gas leakage.
- Water Inlet connection.

It's best to use proper tubing, flex-hose, or rigid pipe to connect the water inlet. A water shut-off valve should be installed before the water inlet fitting. (Fig.7). (Note: There is a screen type filter inside the water inlet nipple, do not lose it during installation).
- Hot Water Outlet connection.

If connecting the hot water outlet directly to a shower, you can use tubing, hose or rigid pipe. When installing a control valve or tap to the hot water outlet, or installing the shower with a control tap, do not use pipes made of materials not pressure or temperature-tolerant.

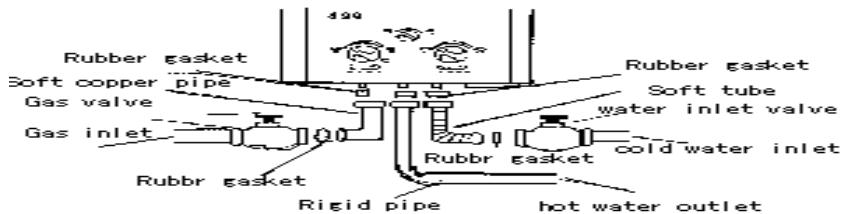

Fig 7

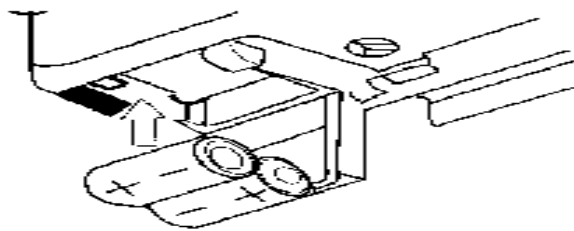

Fig 8

4. Battery Cell Installation

Do not confuse the positive and negative ends of the D cells. (Fig.8)

5. Flue Installation

As this water heater is flue type, the waste gas exhaust pipe must be installed. (Unless you are using this heater outdoors in the open) (Fig. 9) Basic requirements:

- The inner diameter of the flue: $\phi 90\text{mm}$. (3.54 inches)
- The main body of the flue must be made of stainless steel material.
- The horizontal part of the flue shall have a minimum of 1% down inclination, and there shall be a $\frac{1}{2}$ inch hole at the bottom of the vertical part of the flue outside the room for the purpose of draining water condensation or rain droplets.
- The outlet of the flue must have a windproof cap, which should not be clogged.

Installation method:

- Drill proper holes in the wall according to the dimensions of the heater and install a certified wall thimble of class-III stainless steel. Contact your inspector or plumber for code requirements in your area.
- Insulate the gaps or openings with high temperature tolerant non-flammable materials.

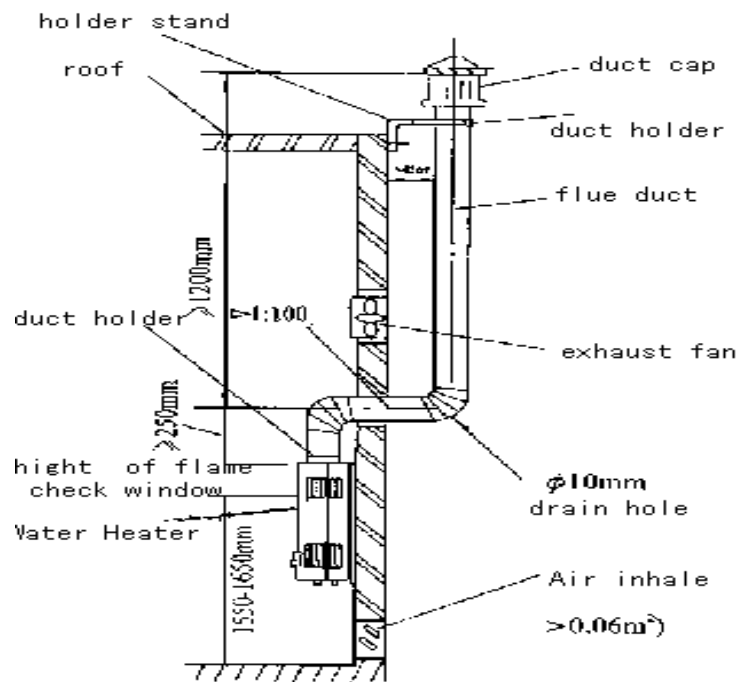

Fig 9

Operation

1. Preparation before Ignition

- Make sure the type of gas used complies with that stipulated on the label of this heater.
- If mounted inside a building or structure, comply with combustion air requirements. (See below.)
- Turn on the gas valve.

Turn on the water valve, faucet or tap (making sure there is water flowing out), there will be a "clicking" ignition sound. The burner will ignite and hot water flows out almost instantly. If the water pressure is low, or the batteries are weak or not installed correctly, the water heater will not operate.

- After initial installation or a change of the gas cylinder, air may remain in the gas pipes and it may require several ignition attempts to bleed the air out of the pipes before the gas can be ignited. If a problem arises after normal operation, turn off the water immediately. Wait 10-20 seconds for potential gasses to dissipate to avoid the possibility of an explosion.
- Water Temperature Control
 - (1) Turn the temperature regulator knob to control the water flow and its temperature. In addition, you may turn the flame regulator to control the flame of the burner thus controlling the hot water temperature.
- When you turn off the water flow, the water heater will automatically shut off.
- Test water temperature before use to avoid scalding. (Fig.10)
- For the utmost safety, turn off the gas valve when not in use. (Fig.11)
- In cold weather or in times when not using the heater for a long period, the heater should be drained as follows:

- 1) Turn off the water valve.
- 2) Turn off the power switch.
- 3) Remove the water line(s) and allow the water to drain from the heater. You may also blow a slight flow of compressed air to clear the internal components of water.

2. Flame level Control

- In hot weather and higher ground water temperatures, you may wish to turn the flame level switch (winter-summer switch) to the position of "warm", and only one burner will ignite.
- In cold weather, and colder ground water temperatures turn the flame level switch (winter-summer switch) to the position of "hot", allowing all three burners to ignite so as to insure the required hot water.

Cautions for Safety

■ Gas Leak Prevention

- It's best to install a gas leakage-warning device and of course a common carbon monoxide detector.
- Check whether the flame is extinguished after each use and do not forget to turn off the gas valve (Fig. 11).
- Always check all the gas pipe connections with soap suds to see whether it has gas leakage. In case of gas leakage, shut off the gas supply and open the windows immediately. Under such condition, switching on/off the electric power supply is strictly prohibited to avoid a possible spark, explosion and fire. (Fig.12)
- Only use the required type of gas for your type of heater, never mix them.
- Check the gas hose regularly as it may age and crack after long periods of use. Replace if a cracked hose is found. Under normal operation, the gas hose should be replaced yearly.
- For LPG users, if the flame of the heater is not stable, it may be caused by the breakdown of the pressure regulator connected to the outlet of the gas tank. In that case, stop using the heater immediately and contact a service technician.
- For NG users, if the flame of the heater is not stable, it may be caused by the instability of the gas pressure. In that case, stop using the heater; otherwise it may be damaged or even

cause an accident.

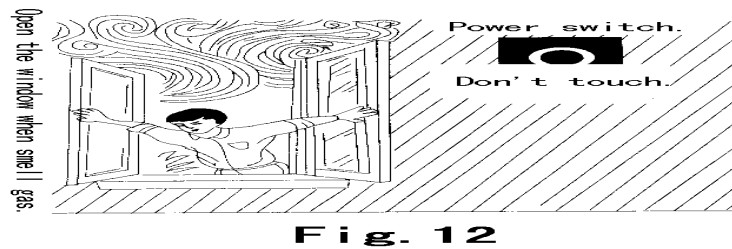
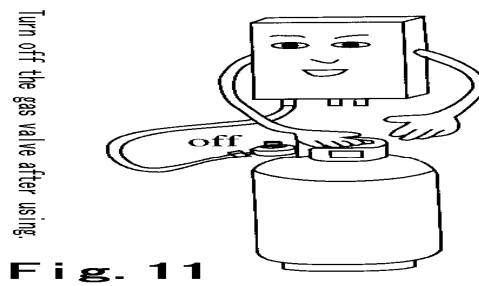
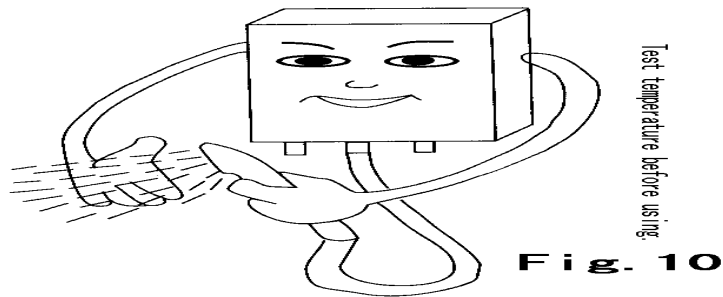

■ Accidental Fire Prevention

- Make sure that the flame of the heater has extinguished before leaving the room or going to sleep.
- Turn off the main gas valve and the water valve in case of water leakage.
- Do not pile inflammables, explosives or volatile materials anywhere near the heater. (Fig.13)
- Do not place inflammables like towels or clothing onto the waste gas exhaust outlet or the air inlet. (Fig.14)
- For LPG users, NEVER tilt or invert the tank, otherwise the liquid in the gas cylinder may flow into the heater, and cause an accidental fire or explosion.

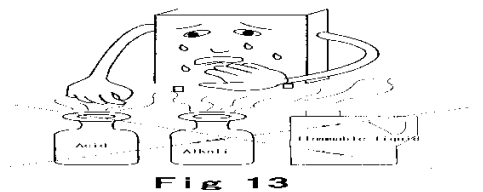

■ Carbon Monoxide Poisoning Prevention

Excessively high winds may cause the exhaust to back-flow. During high wind conditions, please stop using the heater or it may lead to a dangerous situation.

- In confined spaces the burning of gas consumes large amounts of air and produces gases which contain certain amounts of carbon monoxide. Thus, the heater must be fixed in a ventilated location. (See combustion air requirements below)
- As this water heater is a flue type, if mounted inside a structure, a flue must be installed to drain the waste gas out of the room. (See combustion air requirements below)
- NG users must pay attention to the back-fire phenomenon when the gas pressure is insufficient. This causes carbon deposits in the burner to increase and affects the normal use of the heater. In such case, should the flame turn from blue to yellow, the amount of carbon monoxide would increase. Stop using the heater and contact the gas company or the service center.
- The heater must always be installed vertically.

■ Prevent Eye injury.

- Keep eyes away from the flame check window at a minimum safety distance of 12 inches during ignition. If the first attempt of ignition fails, wait 10-20 seconds before the next attempt for the gasses to clear.

■ Prevent no-water “dry Burning” of the Heater

After each shower, make sure that the flame is extinguished when the valve is closed. If the flame still exists after the water valve is closed, something must be wrong with the heater. Switch off the gas valve immediately and contact the service center. Otherwise the heater may be damaged by overheating and then may cause an accidental fire.

■ Freeze Prevention

- Under low temperature situations, drain the water remaining in the heater after each use completely. Otherwise the water may freeze and expand which may internally damage the heater. (See freeze warning below)

■ Reduce the Chance of Encrustation (mineral and sediment deposits)

We recommend a pre-filtration device be installed on the incoming water supply line to keep the interior of the heater clean.

■ Dealing with Abnormal Conditions

- Stop the heater when there is strong adverse wind blowing which may cause the heater to become inoperable.
- In case of abnormal burning (e.g. fire back, fire off, yellow flame or black smoke, etc.), unusual smell, noise or other abnormal matters, keep calm and turn off the gas valve and the heater switch. Then contact the service center or the gas dealer.

REMARKS: Since the heater has multiple safety protection functions it may turn off when a problem is encountered, please refer to the "trouble shooting" table to solve the problem before using again.

■ Replacing the D cells

- After the batteries are used a period of time (about 6 months under normal use), the heater wont ignite. Simply replace these batteries.
- To replace the batteries please see above "cell installation" (fig. 8)

■ Preventing Overheating - Scalding

- After shower, or when the water temperature control is still at “high” position, be careful of the temperature of the water at the beginning and ending of shower, as it may remain high and scald your skin.
- During or right after use, do not touch any part of the heater other than the control knobs, especially the parts around the flame indicator window and exhaust components. These parts are hot.

■ The following Situations Are Normal

- When the water pressure is lower than 8 Psi, the heater cannot be ignited.
- The drain valve is dripping. When the water pressure is too high, the check-valve will release the water so as to reduce the pressure to protect the heater.
- When the heater is supplying hot water to several points at the same time, the hot water flow will be reduced, or even no hot water will come out. In this case, the GPM capabilities of the heater are being exceeded. This heater is not designed for whole home use. It will run one hot water source at one time.
- During use, if the heater is operated for more than 20 minutes, the flame will automatically turn off due to the 20-minute timer protection of the heater. (To restart, simply turn off and back on the faucet.)
- When the voltage of the D cells drops below 2.1V, the heater will not ignite, Please replace the batteries.

■ Maintenance

- Check the gas hose/pipe regularly for any defects. Contact service center for any doubt.
- Clean the water filter screen regularly.
- Check for water leakage regularly.
- When the flame turns from blue to yellow with black smoke, stop using and contact the service center immediately for help.
- Every 6 months contact qualified professionals to check whether the heat exchanger and burner are clogged. Every 6 months, it may be necessary to flush the heater internally.
- Always keep the cover of the heater clean.

FREEZE WARNING

This water heater holds cold water in its heat exchanger and water valves when not in use. Because of this, any cold air that comes down through the unit's vent pipe is capable of freezing these components. We simply cannot control how this unit is mounted, atmospheric conditions of the location of installation, or type of use (indoor or outdoor, heated or unheated building), and improper precautions taken by the user and therefore, simple common sense tells us that we cannot be held responsible for reverse-draft caused or any other type of resulting internal freeze damage.

When all requirements are followed, this unit will operate properly and safely. However, there may still be a risk of freezing due to negative draft if all the combustion appliances in the area are not being supplied with a sufficient amount of make-up combustion air. A wood stove or furnace can draw its makeup air backwards into the vent pipe if this heater. This cold infiltrating air is capable of rapidly freezing the cold water held inside this heater's heat exchanger.

More make up air is the solution for preventing a freeze-up.

Supplying more combustion air for all combustion appliances is the solution.

A HVAC specialist should be used to design solutions for providing more make-up air if necessary. Observe the following instructions concerning combustion air.

Combustion air requirements

Appliances located in unconfined spaces:

a) An unconfined space is one whose volume is greater than 50 cubic feet per 1000 Btu per hour of the combined rating of all appliances installed in the space.

b) Installations in structures that have been tightly constructed (air infiltration rate of 0.40 ACH or less) must be provided for combustion air per the National Fuel Gas Code. Consult a HVAC specialist if your air infiltration rate is questionable.

Basic rules for Appliances located in confined spaces:

The confined space must be provided with two permanent openings, one commencing within 12 inches of the top and one commencing within 12 inches of the bottom of the enclosure. Each opening must have a minimum free area of one square inch per:

. 1000 Btu/hr if all air is taken from inside the building.

. 2000 Btu/hr if all air is taken from the outside by horizontal ducts.

. 4000 Btu/hr if all air is taken from the outside by direct openings or vertical ducts. Or the confined space must be provided with one permanent opening or duct that is within 12 inches of the ceiling of the enclosure. This opening must have a minimum free area of one square inch per: 3000 Btu/hr if all air is taken from the outside by a direct opening or vertical duct.

Louvers, grills and screens have a blocking effect. If the effective free area is not known, increase the sizes of your openings by 400% if your louvers are wood and by 135% if your louvers are metal. Refer to the National Fuel Gas Code for complete information. In buildings of tight construction all air should be taken from outside.

Trouble Shooting

Symptoms												Solutions	
Reasons		The flame goes out	No ignition after opening water valve	Bumpy noise in	Yellow flame	Abnormal smell	Abnormal ignition sound	Low temperature of water at "high" position	High temperature of water at "low" position	Flame out at "low" position	Burning after closing the water valve		Indicator lights flash
Gas valve not open		●	●	●								●	Turn on main valve or replace the gas
Gas valve half open								●				●	Turn on the main valve
Air in the gas pipe												●	Repeat opening the water valve until ignition
Unsuitable Pressure Gas	High Low	●		●					●			●	Contact the repairer to check the gas pressure valve
Cold water valve closed													Turn on the water supply main valve
Freezing										●			Use after de-frosting
Inadequate water supply		●	●										Repairer to check water pressure, then clean the filter
Wrong temperature adjustment method								●					Turn the temperature and flame regulator properly
Insufficient fresh air		●			●							●	Open the ventilation hole to let enough fresh air in
Power shortage			●									●	Replace the D cells
Burner clogged							●						Contact the service center
Heat exchanger clogged		●					●						ib.
Water control device failure		●	●									●	ib.
Unsuitable ignition needle position		●	●	●									ib.
Continuous 20 minutes operation		●											Re-ignite for use if the ventilation is good

Accessories

Item Names	QUANTITY
Water Heater	1
Shower(with hose)	1
Incoming Water Hose	2
Mounting Screws	4
Manual	1
Gas Inlet Connection (with rubber seal ring)	1
Expansion Bolts (M6)	1