



HP ProBook 6360b Notebook PC

Maintenance and Service Guide

© Copyright 2011 Hewlett-Packard
Development Company, L.P.

Bluetooth is a trademark owned by its proprietor and used by Hewlett-Packard Company under license. Intel and Core are trademarks or registered trademarks of Intel Corporation in the United States and other countries. Microsoft, Windows, and Windows Vista are either trademarks or registered trademarks of Microsoft Corporation in the United States and/or other countries. SD Logo is a trademark of its proprietor.

The information contained herein is subject to change without notice. The only warranties for HP products and services are set forth in the express warranty statements accompanying such products and services. Nothing herein should be construed as constituting an additional warranty. HP shall not be liable for technical or editorial errors or omissions contained herein.

Second Edition: September 2011

First Edition: March 2011

Document Part Number: 644145-002

Safety warning notice

 **WARNING!** To reduce the possibility of heat-related injuries or of overheating the computer, do not place the computer directly on your lap or obstruct the computer air vents. Use the computer only on a hard, flat surface. Do not allow another hard surface, such as an adjoining optional printer, or a soft surface, such as pillows or rugs or clothing, to block airflow. Also, do not allow the AC adapter to contact the skin or a soft surface, such as pillows or rugs or clothing, during operation. The computer and the AC adapter comply with the user-accessible surface temperature limits defined by the International Standard for Safety of Information Technology Equipment (IEC 60950).

Table of contents

1 Product description	1
2 External component identification	8
Display	8
Top components	10
Pointing devices (select models only)	10
Lights	11
Buttons, switches, and fingerprint reader	12
Keys	14
Front components	15
Left-side components	16
Rear components	17
Right-side components	17
Bottom components	18
Wireless antennas (select models only)	19
3 Illustrated parts catalog	20
Service tag	20
Computer major components	21
Display components	28
Plastics Kit	29
Cable Kit	30
Hinge Kit	31
Mass storage devices	32
Miscellaneous parts	33
Sequential part number listing	35
4 Removal and replacement procedures	42
Preliminary replacement requirements	42
Tools required	42
Service considerations	42

Plastic parts	42
Cables and connectors	43
Drive handling	43
Grounding guidelines	44
Electrostatic discharge damage	44
Packaging and transporting guidelines	45
Workstation guidelines	45
Equipment guidelines	46
Component replacement procedures	47
Service tag	47
Computer feet	48
Battery	49
SIM	50
Bottom cover	51
WLAN module	52
Optical drive	56
Upgrade bay	58
Hard drive	60
Bluetooth module	62
Expansion memory modules	63
Keyboard	65
WWAN module	68
Modem module	70
Primary memory module	72
Fan	74
Heat sink	75
Processor	77
Base enclosure	79
Speaker assembly	82
Display assembly	84
System board	91
RTC battery	94
Power button board	95
Wireless/web/mute function board	96
Fingerprint reader board	98
ExpressCard assembly	99
RJ-11 connector cable	100
Power connector cable	102
5 Computer Setup	104
Starting Computer Setup	104

Using Computer Setup	104
Navigating and selecting in Computer Setup	104
Restoring factory settings in Computer Setup	105
Computer Setup menus	106
File menu	106
Security menu	107
System Configuration menu	108
6 Specifications	112
Computer specifications	112
33.8-cm (13.3-in) HD display specifications	113
Hard drive specifications	114
DVD±RW SuperMulti DL LightScribe Drive specifications	115
Blu-ray ROM DVD±RW SuperMulti DL LightScribe Drive	116
DVD-ROM Drive specifications	117
Specification information in Device Manager	118
7 Backup and recovery	119
Windows 7	119
Backing up your information	119
Performing a recovery	121
Using the Windows recovery tools	121
Using f11	122
Using a Windows 7 operating system DVD (purchased separately)	122
Windows Vista	123
Backing up your information	123
Performing a recovery	124
Using the Windows recovery tools	124
Using f11	125
Using a Windows Vista operating system DVD (purchased separately)	126
Windows XP	126
Backing up your information	127
Performing a recovery	127
Recovering your information	128
Recovering the operating system and programs	128
8 Power cord set requirements	129
Requirements for all countries and regions	129
Requirements for specific countries and regions	130

9 Recycling	131
Battery	131
Display	131
Index	137

1 Product description

Category	Description
Product Name	HP ProBook 6360b Notebook PC
Processors	Intel® Core™ i7 processor, Dual Core 2nd Generation Intel Core i7-2620M, 2.70GHz (Turbo up to 3.40GHz) 4MB L3 Cache, 4 threads
	Intel Core i5 processors, Dual Core 2nd Generation Intel Core i5-2540M, 2.60-GHz (Turbo up to 3.30) processor 3-MB L3 cache, 4 threads
	2nd Generation Intel Core i5-2520M, 2.50-GHz (Turbo up to 3.20) processor 3-MB L3 cache, 4 threads
	2nd Generation Intel Core i5-2410M, 2.30-GHz (Turbo up to 2.90) processor 3-MB L3 cache, 4 threads
	Intel Core i3 processors, Dual Core Intel Core i3-2330M, 2.20-GHz processor 3-MB L3 cache, 4 threads
	Intel Core i3-2310M, 2.10-GHz processor 3-MB L3 cache, 4 threads
	Intel Celeron processor Celeron B810, 1.60GHz, 2MB L3 Cache, 2 threads
Chipset	vPro: Mobile Intel QM67 chipset Non-vPro: Mobile Intel HM65 chipset
Graphics	UMA: Intel HD Graphics 3000 UMA/Celeron: Intel HD Graphics
Panel	All display assemblies include 2 wireless local area network (WLAN) antennas. All WWAN display assemblies include 2 wireless wide area network (WWAN) antennas as well. 33.8-cm (13.3-in) HD AntiGlare LED SVA (1366x768) 33.8-cm (13.3-in) HD AntiGlare LED SVA (1366x768) WWAN 33.8-cm (13.3-in) HD AntiGlare LED SVA (1366x768) with webcam 33.8-cm (13.3-in) HD AntiGlare LED SVA (1366x768) WWAN with webcam Support privacy filter

Category	Description
Memory	Two customer-accessible/upgradeable memory module slots supporting up to 16 GB of RAM
	Supports dual-channel memory
	PC3-10600, 1333-MHz, DDR3
	Supports the following configurations:
	<ul style="list-style-type: none"> • 16384 (8192 × 2) — Qual Only • 8192 (4096 × 2) • 8192 (8192 × 1) • 6144 (4096 × 1) + (2048 × 1) • 4096 (2048 × 2) • 4096 (4096 × 1) • 3072 (2048 × 1) + (1024 × 1) • 2048 (2048 × 1)
Hard drives	Supports 7mm or 9.5mm, 6.35cm (2.5") SATA hard drives
	Supports 2.5" solid-state drives (SSDs)
	Customer-accessible
	Supports the following drives:
	<ul style="list-style-type: none"> • 750-GB, 7200-rpm • 500-GB, 7200-rpm • 320-GB, 7200-rpm • 320-GB, 7200-rpm Self Encrypting Drive (SED) • 250-GB, 7200-rpm
	Supports the following solid-state drives:
<ul style="list-style-type: none"> • 160-GB • 128-GB 	
	HP Mobile Data Protection System 3D
Upgrade bay	Fixed (removal of 1 screw required)
	Customer-accessible
	Serial ATA
	12.7-mm tray load
	Supports "No Drive" option (weight saver)

Category	Description
	<p>Supports the following 12.7-mm SATA optical drives:</p> <ul style="list-style-type: none"> • DVD±RW SuperMulti DL LightScribe Drive • Blu-ray ROM DVD±RW SuperMulti DL LightScribe Drive • DVD-ROM Drive <p>Supports the following 9.5-mm SATA hard drive:</p> <ul style="list-style-type: none"> • 320-GB, 7200-rpm
Microphone	<p>Webcam: Integrated dual-array microphone</p> <p>Non-Webcam: Integrated mono microphone</p>
Audio	<p>HD audio</p> <p>Stereo speakers. Produce SRS Premium Sound.</p>
Webcam	Integrated 720p HD webcam
Modem	<p>56K V.92 MDC data/fax modem</p> <p>Modem cable not included</p> <p>Supports "No Modem" option</p>
Ethernet	<p>vPro: Intel 82579LM GbE LAN 10/100/1000 network interface card (NIC) with iAMT</p> <p>Non-vPro: Intel 82579V GbE LAN 10/100/1000 network interface card (NIC)</p> <p>S3/S4/S5 wake on LAN</p> <p>NIC power down technology</p> <p>Ethernet cable not included</p>
Wireless	<p>Integrated WLAN options by way of wireless module:</p> <p>Two WLAN antennas built into display assembly</p> <p>Supports "no WLAN" option</p> <p>Supports the following WLAN formats:</p> <ul style="list-style-type: none"> • Intel Wi-Fi Link 6205, 802.11a/b/g/n, 2 × 2 • Intel Wi-Fi Link 1000, 802.11b/g/n 1 × 2 • Broadcom 4322 802.11a/b/g/n, 2 × 2 • Broadcom 4313 802.11b/g/n 1 × 1 <p>Integrated WWAN options by way of wireless module:</p> <p>Two WWAN antennas built into display assembly</p> <p>GPS support</p> <p>Subscriber identity module (SIM) security (customer-accessible in battery bay)</p> <p>Supports "no WWAN" option</p>

Category	Description
	Supports the following WWAN modules: <ul style="list-style-type: none"> • Qualcomm Gobi 3000 HSPA/CDMA with GPS • Ericsson 5521 HSPA+ with GPS
	Integrated personal area network (PAN) options by way of Bluetooth® module:
	Supports “no PAN” option
	Broadcom Bluetooth
External media card	ExpressCard (54mm) slot <p>NOTE: This slot can be configured with either an ExpressCard or Smart Card reader.</p>
	Integrated Media Card Reader with SD and MMC support
Ports	Audio-in (stereo microphone)
	Audio-out (stereo headphone)
	DisplayPort
	RJ-11 (modem)
	RJ-45 (Ethernet, includes link and activity lights)
	USB 2.0 (3)
	eSATA/USB 2.0 Combo
	VGA (Dsub 15-pin) supporting 1600 × 1200 external resolution at 75-GHz (hot plug with auto-detect)
	1394a
	3-pin AC power
	Docking connector
Docking	HP 90W Docking Station
	HP 120W Advanced Docking Station
Keyboard/pointing devices	Full-size keyboard
	Supports TouchPad only or dual point (pointing stick and TouchPad)
	Spill-resistant design, HP DuraKeys
	Three launch buttons (QuickWeb, WLAN on/off, and Mute)
Power requirements	AC adapter (65-W) with localized cable plug support (3-wire plug with ground pin, supports 3-pin DC connector)
	9-cell, 3.00-Ah (100-Wh) Li-ion battery
	6-cell HP Long Life, 2.8-Ah (55-Wh) Li-ion battery
	6-cell, 2.55-Ah (55-Wh) Li-ion battery
	3-cell, 2.80-Ah (31-Wh) Li-ion battery
	Supports ST09 Extended Life Notebook Battery

Category	Description
	Supports BB09 Ultra Extended Life Notebook Battery
	Support for 6-cell, 2.80-Ah (62-Wh) battery
	HP Fast Charge Technology (does NOT support 9-cell, 3.00-Ah (100-Wh) Li-ion battery)
Security	Integrated fingerprint reader
	Integrated Smart Card reader slot
	NOTE: This slot can be configured with either an ExpressCard or Smart Card reader (optional).
	Security cable slot
	Trusted platform module (TPM) V.1.2
	Full volume encryption
	Preboot authentication (password, Smart Card)
Operating system	Preinstalled:
	Windows 7 Professional 64 with MS Basics
	Windows 7 Professional 32 with MS Basics
	Windows 7 Home Premium 64 with MS Basics
	Windows 7 Home Premium 32 with MS Basics
	Windows Vista Basic 32 with MS Basics
	Novell™: SuSE Linux™ Enterprise Desktop
	FreeDOS
	Preinstalled with Microsoft® Office:
	Windows 7 Professional 64 with Microsoft Office 2010 Professional
	Windows 7 Professional 64 with Microsoft Office 2010 Home & Business
	Windows 7 Professional 64 with Microsoft Office 2010 Personal
	Windows 7 Professional 64 with Microsoft Office 2010 pre-loaded (purchase of a Product Key required to activate a full Office 2010 suite)
	Windows 7 Professional 32 with Microsoft Office 2010 Professional
	Windows 7 Professional 32 with Microsoft Office 2010 Home & Business
	Windows 7 Professional 32 with Microsoft Office 2010 Personal
	Windows 7 Professional 32 with Microsoft Office 2010 pre-loaded (purchase of a Product Key required to activate a full Office 2010 suite)
	Windows 7 Home Premium 64 with Microsoft Office 2010 Professional
	Windows 7 Home Premium 64 with Microsoft Office 2010 Home & Business
	Windows 7 Home Premium 64 with Microsoft Office 2010 Personal
	Windows 7 Home Premium 64 with Microsoft Office 2010 pre-loaded (purchase of a Product Key required to activate a full Office 2010 suite)

Category	Description
	Windows 7 Home Premium 32 with Microsoft Office 2010 Professional
	Windows 7 Home Premium 32 with Microsoft Office 2010 Home & Business
	Windows 7 Home Premium 32 with Microsoft Office 2010 Personal
	Windows 7 Home Premium 32 with Microsoft Office 2010 pre-loaded (purchase of a Product Key required to activate a full Office 2010 suite)
	Windows 7 Home Basic 32 with Microsoft Office 2010 pre-loaded (purchase of a Product Key required to activate a full Office 2010 suite)
	Windows 7 Starter 32 with Microsoft Office 2010 pre-loaded (purchase of a Product Key required to activate a full Office 2010 suite)
	Windows Vista Home Basic with Microsoft Office 2010 Professional
	Windows Vista Home Basic with Microsoft Office 2010 Home & Business
	Windows Vista Home Basic with Microsoft Office 2010 Personal
	Windows Vista Home Basic with Microsoft Office 2010 pre-loaded (purchase of a Product Key required to activate a full Office 2010 suite)
	Restore Media:
	Windows 7 Starter
	Windows 7 Home Basic 32
	Windows 7 Home Premium 32
	Windows 7 Home Premium 64
	Windows 7 Professional 32
	Windows 7 Professional 64
	Windows 7 DRDVD with WinDVD (Available with Windows 7 Home Basic and Windows 7 Starter)
	Windows 7 DRDVD without WinDVD (Available with Windows 7 Home Premium and Windows 7 Professional)
	Web-only support:
	Windows XP Professional 32
	Windows Vista 32/64 Enterprise
	Windows Vista 32/64 Business
	Windows 7 Enterprise 32/64 (SP1)
	Windows 7 Ultimate 32/64 (SP1)
	Certified:
	Novell™: SuSE Linux™ Enterprise Desktop
Serviceability	Customer service replaceable parts:
	AC adapter
	Battery (system)

Category	Description
	Hard drive/SSD
	Memory module
	Optical drive
	Mini-PCI components (WLAN, WWAN, Bluetooth, Flashcache, SIM)

2 External component identification

Display

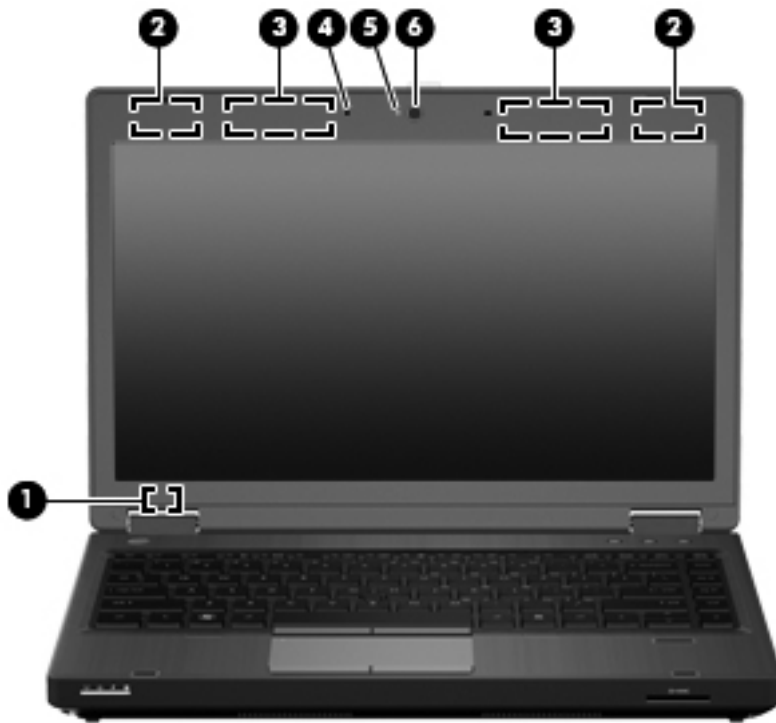

Component	Description
(1) Internal display switch	Turns off the display or initiates Sleep if the display is closed while the power is on. NOTE: The display switch is not visible from the outside of the computer.
(2) WLAN antennas (2)*	Send and receive wireless signals to communicate with wireless local area networks (WLAN).
(3) WWAN antennas (2)* (select models only)	Send and receive wireless signals to communicate with wireless wide-area networks (WWAN).
(4) Internal microphone(s) (1 or 2 depending on model)	Record sound. NOTE: Single microphone provided for non-webcam models and dual microphones provided for webcam models.

Component	Description
(5) Webcam light (select models only)	On: The webcam is in use.
(6) Webcam (select models only)	Records video and captures still photographs. To use the webcam, select Start > All Programs > HP > HP Webcam .

*The antennas are not visible from the outside of the computer. For optimal transmission, keep the areas immediately around the antennas free from obstructions. To see wireless regulatory notices, refer to the section of the *Regulatory, Safety and Environmental Notices* that applies to your country or region. These notices are located in Help and Support.

Top components

Pointing devices (select models only)



Component	Description
(1) Pointing stick	Moves the pointer and selects or activates items on the screen.
(2) Left pointing stick button	Can be used with the pointing stick and functions like the left button on an external mouse.
(3) TouchPad on/off button	Turns the TouchPad on and off.
(4) TouchPad	Moves the pointer and selects or activates items on the screen. NOTE: Vertical scrolling is supported on the right edge of the TouchPad.
(5) Left TouchPad button	Functions like the left button on an external mouse.
(6) Right pointing stick button	Can be used with the pointing stick and functions like the right button on an external mouse.
(7) Right TouchPad button	Functions like the right button on an external mouse.

*This table describes factory settings. To view or change pointing device preferences, select **Start > Control Panel > Hardware and Sound > Mouse**.

Lights

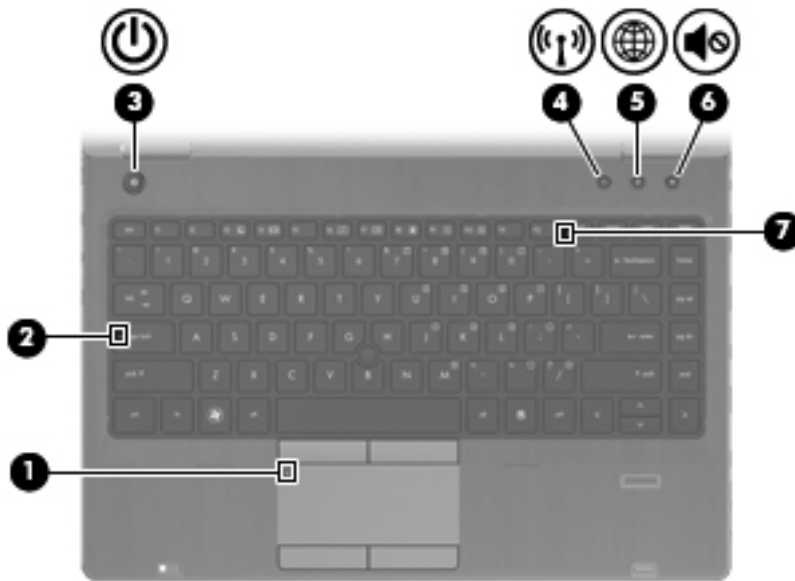

Component	Description
(1) TouchPad on/off light	<ul style="list-style-type: none"> • Amber: The TouchPad is off. • Off: The TouchPad is on.
(2) Caps lock light	On: Caps lock is on.
(3) Power light*	<ul style="list-style-type: none"> • On: The computer is on. • Blinking: The computer is in the Sleep state. • Off: The computer is off or in Hibernation.
(4) Wireless light†	<ul style="list-style-type: none"> • White: An integrated wireless device, such as a wireless local area network (WLAN) device and/or a Bluetooth® device, is on. • Amber: All wireless devices are off.
(5) QuickWeb light	<ul style="list-style-type: none"> • On: The computer is on. • Off: The computer is off or in Hibernation. <p>NOTE: For more information, refer to “HP QuickWeb” in this guide and to the HP Quickweb software Help</p>
(6) Mute light	<ul style="list-style-type: none"> • Amber: Computer sound is off. • Off: Computer sound is on.
(7) Num lock light	On: Num lock is on.

*The light on the power button is visible only when the computer is open. The power light on the front of the computer is visible whether the computer is open or closed.

†The light on the wireless button is visible only when the computer is open. The wireless light on the front of the computer is visible whether the computer is open or closed.

Buttons, switches, and fingerprint reader



Component	Description
(1) TouchPad on/off button	Turns the TouchPad on and off.
(2) Power button	<ul style="list-style-type: none"> When the computer is off, press the button to turn on the computer. When the computer is on, press the button briefly to initiate Sleep. When the computer is in the Sleep state, press the button briefly to exit Sleep. When the computer is in Hibernation, press the button briefly to exit Hibernation. <p>If the computer has stopped responding and Windows® shutdown procedures are ineffective, press and hold the power button for at least 5 seconds to turn off the computer.</p> <p>To learn more about your power settings:</p> <ul style="list-style-type: none"> Windows 7—Select Start > Control Panel > System and Security > Power Options. Windows Vista—Select Start > Control Panel > System and Maintenance > Power Options Or refer to the <i>HP Notebook Reference Guide</i>.
(3) Wireless button	Turns the wireless feature on or off but does not establish a wireless connection.

Component	Description
(4) QuickWeb button	<ul style="list-style-type: none"> • When the computer is off or in Hibernation, press the button to open HP QuickWeb. • When the computer is in Microsoft Windows, press the button to open the default Web browser. • When the computer is in HP QuickWeb, press the button to open the default Web browser. <p>NOTE: For more information, refer to “HP QuickWeb” in this guide and to the HP QuickWeb software Help. If your computer does not have HP QuickWeb software, the button does not perform any action or function.</p>
(5) Volume mute button	Mutes and restores speaker sound.
(6) Fingerprint reader (select models only)	Allows a fingerprint logon to Windows, instead of a password logon.

Keys

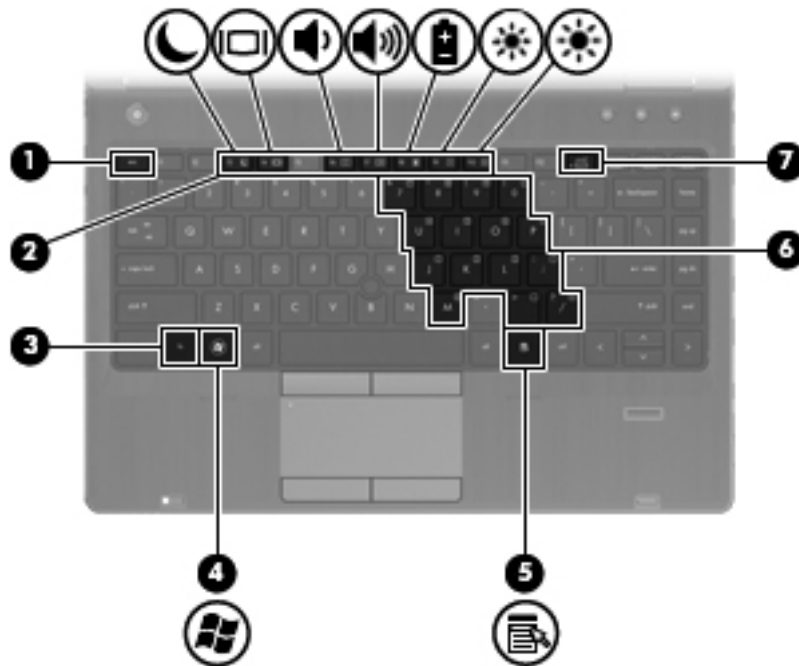

Component	Description
(1) <code>esc</code> key	Displays system information when pressed in combination with the <code>fn</code> key.
(2) Function keys	Execute frequently used system functions when pressed in combination with the <code>fn</code> key.
(3) <code>fn</code> key	Turns the embedded numeric keypad on and off when pressed in combination with the <code>num lk</code> key.
(4) Windows logo key	Displays the Windows Start menu.
(5) Windows applications key	Displays a shortcut menu for items beneath the pointer.
(6) Integrated numeric keypad keys	Can be used like the keys on an external numeric keypad.
(7) <code>num lk</code> key	Turns the embedded numeric keypad on and off when pressed in combination with the <code>fn</code> key.

Front components

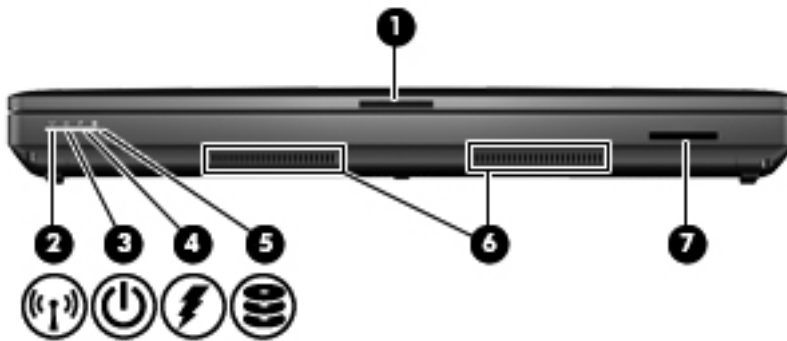

Component	Description
(1) Display release latch	Opens the computer.
(2) Wireless light	<ul style="list-style-type: none"> An integrated wireless device, such as a WLAN device, the HP Mobile Broadband Module (select models only), and/or a Bluetooth device, is on. Amber: All wireless devices are off.
(3) Power light	<ul style="list-style-type: none"> On: The computer is on. Blinking: The computer is in the Sleep state. Off: The computer is off or in Hibernation.
(4) Battery light	<ul style="list-style-type: none"> Amber: A battery is charging. Turquoise: A battery is close to full charge capacity. Blinking amber: A battery that is the only available power source has reached a low battery level. When the battery reaches a critical battery level, the battery light begins blinking rapidly. Off: If the computer is plugged into an external power source, the light turns off when all batteries in the computer are fully charged. If the computer is not plugged into an external power source, the light stays off until the battery reaches a low battery level.
(5) Drive light	<ul style="list-style-type: none"> Blinking turquoise: The hard drive or optical drive is being accessed. Amber: HP 3D DriveGuard has temporarily parked the hard drive.
(6) Speakers (2)	Produce SRS Premium Sound. NOTE: To use the SRS Premium Sound software, select Start > All Programs > SRS Premium Sound .
(7) Media Card Reader	Supports the following optional digital card formats: <ul style="list-style-type: none"> MultiMediaCard Secure Digital (SD) Memory Card

Left-side components

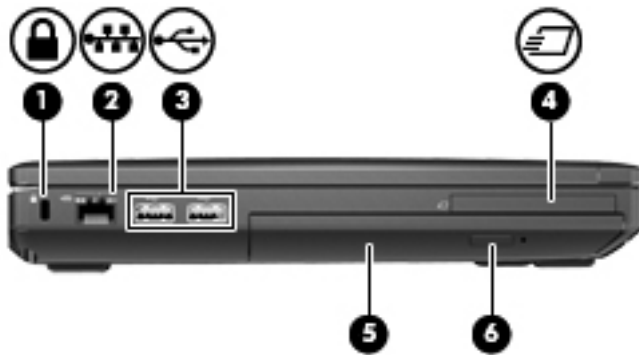

Component	Description
(1) Security cable slot	Attaches an optional security cable to the computer. NOTE: The security cable is designed to act as a deterrent, but it may not prevent the computer from being mishandled or stolen.
(2) RJ-45 (network) jack	Connects a network cable.
(3) USB ports (2)	Connect optional USB devices.
(4) ExpressCard slot	Supports optional ExpressCards. NOTE: This slot can be configured with either an ExpressCard or Smart Card reader.
(5) Upgrade bay	Supports an optical drive, secondary hard drive, or “No Drive” option (weight saver).
(6) Optical drive eject button (select models only)	Ejects the optical drive.

Rear components



The vent enables airflow to cool internal components.

NOTE: The computer fan starts up automatically to cool internal components and prevent overheating. It is normal for the internal fan to cycle on and off during routine operation.

Component	Description
Vent	Enables airflow to cool internal components.

NOTE: The computer fan starts up automatically to cool internal components and prevent overheating. It is normal for the internal fan to cycle on and off during routine operation.

Right-side components

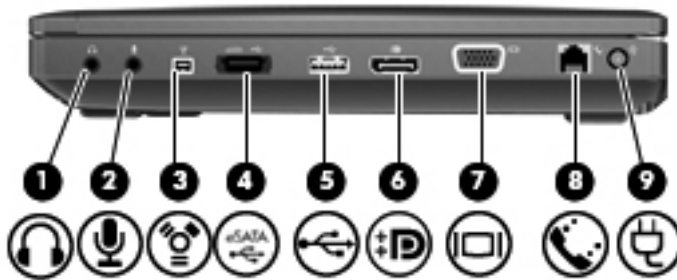

Component	Description
(1) Audio-out (headphone) jack	Produces sound when connected to optional powered stereo speakers, headphones, ear buds, a headset, or television audio. NOTE: When a device is connected to the headphone jack, the computer speakers are disabled.
(2) Audio-in (microphone) jack	Connects an optional computer headset microphone, stereo array microphone, or monaural microphone.
(3) 1394 port	Connects an optional IEEE 1394 or 1394a device, such as a camcorder.
(4) eSATA/USB port	Connects high-performance eSATA components, such as an eSATA external hard drive or connects an optional USB device.
(5) USB port	Connect optional USB devices.
(6) DisplayPort	Connects an optional digital display device, such as a high-performance monitor or projector.
(7) External monitor port	Connects an external VGA monitor or projector.
(8) RJ-11 (modem) jack	Connects a modem cable.
(9) Power connector	Connects an AC adapter.

Bottom components

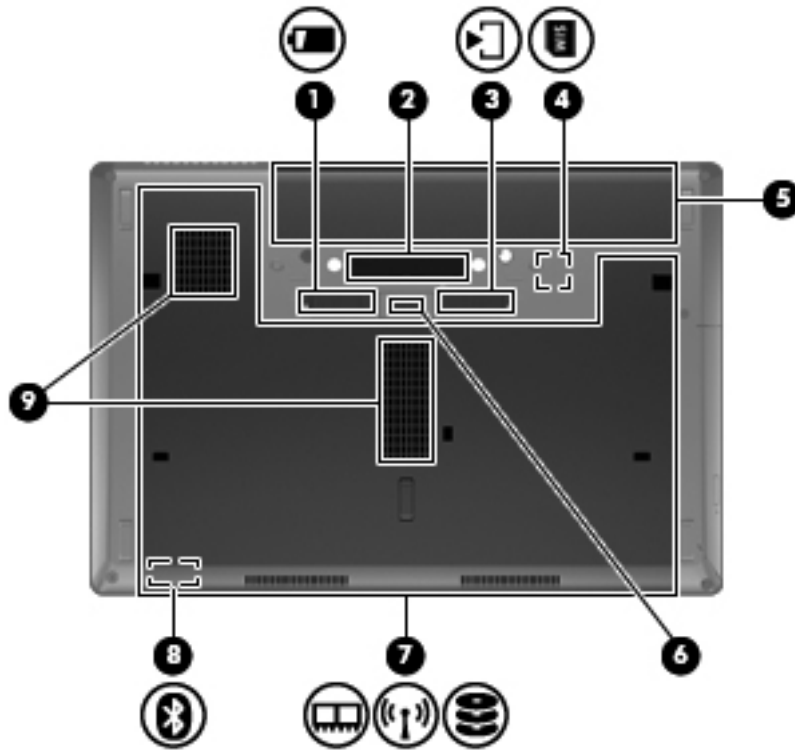

Component	Description
(1) Battery release latch	Releases the battery from the battery bay.
(2) Docking connector	Connects an optional docking device.
(3) Bottom cover release latch	Releases or locks the bottom cover.
(4) SIM slot	Contains a wireless subscriber identity module (SIM) (select models only). The SIM slot is located inside the battery bay.
(5) Battery bay	Holds the battery.
(6) Accessory battery connector	Connects an optional accessory battery.
(7) Wireless and memory module compartments and hard drive bay	Hold an HP Mobile Broadband Module, the memory modules, and the hard drive. NOTE: To prevent an unresponsive system, replace the wireless module only with a wireless module authorized for use in the computer by the governmental agency that regulates wireless devices in your country or region. If you replace the module and then receive a warning message, remove the module to restore computer functionality, and then contact technical support through Help and Support.
(8) Bluetooth compartment	Contains a Bluetooth device.
(9) Vents (2)	Enable airflow to cool internal components. NOTE: The computer fan starts up automatically to cool internal components and prevent overheating. It is normal for the internal fan to cycle on and off during routine operation.

Wireless antennas (select models only)

The antennas send and receive signals from one or more wireless devices. These antennas are not visible from the outside of the computer.



Component	Description
(1) WLAN antennas (2)*	Send and receive wireless signals to communicate with wireless local area networks (WLANs).
(2) WWAN antennas (2)*	Send and receive wireless signals to communicate with wireless wide area networks (WWANs).

*The antennas are not visible from the outside of the computer. For optimal transmission, keep the areas immediately around the antennas free from obstructions.

To see wireless regulatory notices, refer to the section of the *Regulatory, Safety and Environmental Notices* that applies to your country or region. These notices are located in Help and Support.

3 Illustrated parts catalog

Service tag

When ordering parts or requesting information, provide the computer serial number and model description provided on the service tag.

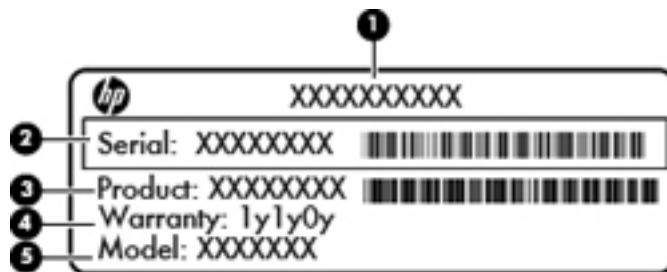

- Product name **(1)**. This is the product name affixed to the front of the computer.
- Serial number (s/n) **(2)**. This is an alphanumeric identifier that is unique to each product.
- Part number/Product number (p/n) **(3)**. This number provides specific information about the product's hardware components. The part number helps a service technician to determine what components and parts are needed.
- Warranty period **(4)**. This number describes the duration (in years) of the warranty period for the computer.
- Model description **(5)**. This is the alphanumeric identifier used to locate documents, drivers, and support for the computer.

Computer major components

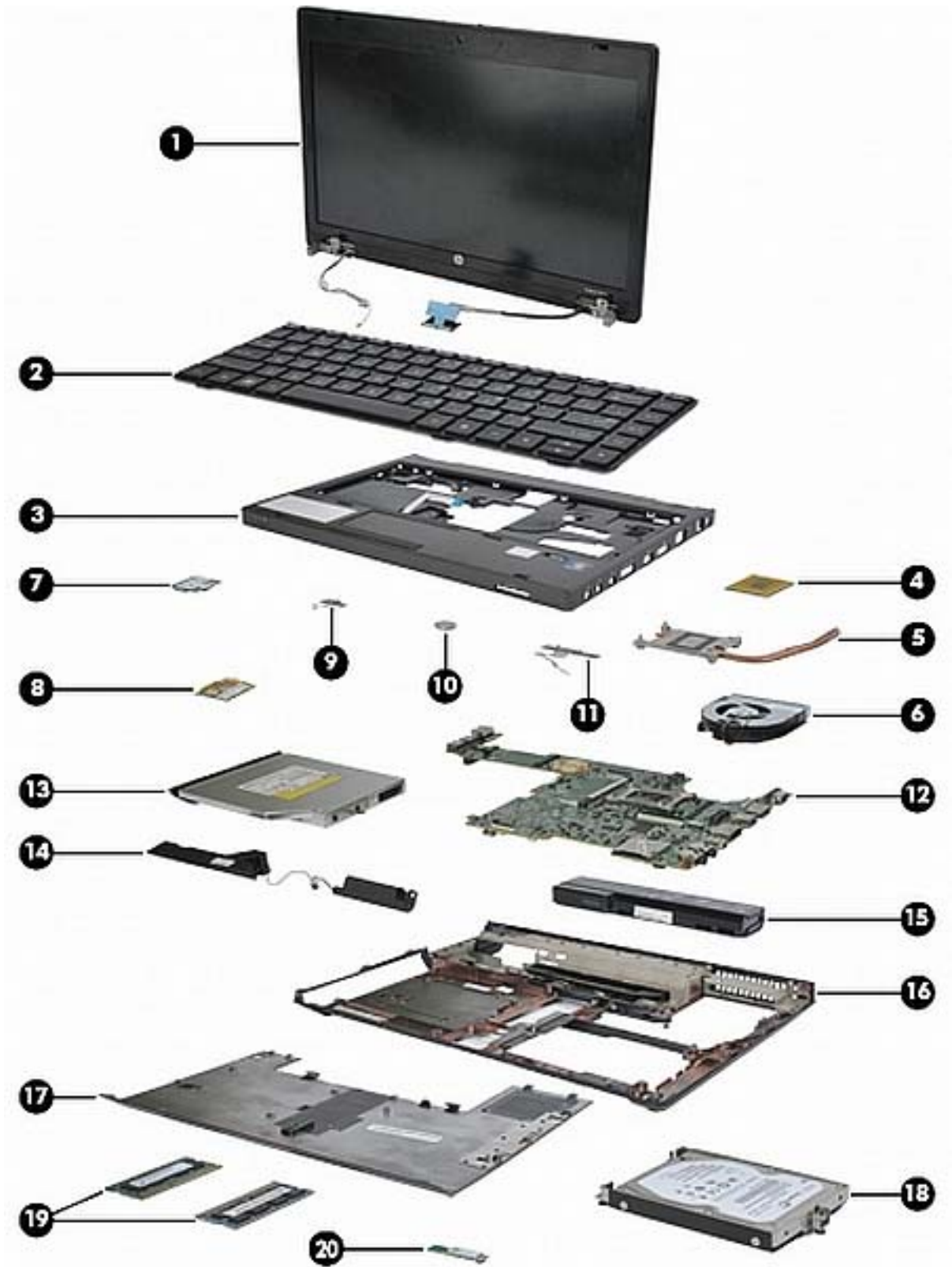

Item	Description	Spare part number
(1)	Display assembly (includes 2 WLAN antenna transceivers and cables and 2 WWAN antenna transceivers and cables (select models only))	
(2)	Keyboard	
	Keyboard without pointing stick (2 button TouchPad)	
	For use in Belgium	639477-A41
	For use in Brazil	639477-201
	For use in Bulgaria	639477-261
	For use in the Czech Republic and Slovakia	639477-A81
	For use in Denmark	639477-081
	For use in France	639477-051
	For use in French Canada	639477-121
	For use in Germany	639477-041
	For use in Greece	639477-DJ1
	For use in Hungary	639477-211
	For use in Iceland	639477-DD1
	For use in Israel	639477-BB1
	For use in Italy	639477-061
	For use in Japan	639477-291
	For use in Latin America	639477-161
	For use in the Netherlands	639477-B31
	For use in Norway	639477-091
	For use in Portugal	639477-131
	For use in Russia	639477-251
	For use in Saudi Arabia	639477-171
	For use in Slovenia	639477-BA1
	For use in South Korea	639477-AD1
	For use in Spain	639477-071
	For use in Sweden	639477-B71
	For use in Switzerland	639477-BG1
	For use in Taiwan	639477-AB1
	For use in Thailand	639477-281
	For use in Turkey	639477-141
	For use in the United Kingdom	639477-031
	For use in the United States	639477-001

Item	Description	Spare part number
	Keyboard with pointing stick (includes pointing stick and pointing stick cable)	
	For use in Belgium	639478-A41
	For use in Brazil	639478-201
	For use in Bulgaria	639478-261
	For use in the Czech Republic and Slovakia	639478-A81
	For use in Denmark	639478-081
	For use in France	639478-051
	For use in French Canada	639478-121
	For use in Germany	639478-041
	For use in Greece	639478-DJ1
	For use in Hungary	639478-211
	For use in Iceland	639478-DD1
	For use in Israel	639478-BB1
	For use in Italy	639478-061
	For use in Japan	639478-291
	For use in Latin America	639478-161
	For use in the Netherlands	639478-B31
	For use in Norway	639478-091
	For use in Portugal	639478-131
	For use in Russia	639478-251
	For use in Saudi Arabia	639478-171
	For use in Slovenia	639478-BA1
	For use in South Korea	639478-AD1
	For use in Spain	639478-071
	For use in Sweden	639478-B71
	For use in Switzerland	639478-BG1
	For use in Taiwan	639478-AB1
	For use in Thailand	639478-281
	For use in Turkey	639478-141
	For use in the United Kingdom	639478-031
	For use in the United States	639478-001
(3)	Top cover (includes TouchPad button and bracket)	
	Top cover includes fingerprint reader and TouchPad (2 button)	639485-001
	Top cover includes TouchPad (2 button)	639486-001

Item	Description	Spare part number
	Top cover includes fingerprint reader and TouchPad (4 button)	641736-001
	Top cover includes TouchPad (4 button)	641737-001
(4)	Processor	
	Intel Core i7 processor, Dual Core	
	2nd Generation Intel Core i7-2620M, 2.70GHz (Turbo up to 3.40GHz) 4MB L3 Cache, 4 threads	631252-001
	Intel Core i5 processors, Dual Core	
	2nd Generation Intel Core i5-2540M, 2.60-GHz (Turbo up to 3.30) processor 3-MB L3 cache, 4 threads	631255-001
	2nd Generation Intel Core i5-2520M, 2.50-GHz (Turbo up to 3.20) processor 3-MB L3 cache, 4 threads	631253-001
	2nd Generation Intel Core i5-2410M, 2.30-GHz (Turbo up to 2.90) processor 3-MB L3 cache, 4 threads	638039-001
	Intel Core i3 processors, Dual Core	
	Intel Core i3-2330M, 2.20-GHz processor 3-MB L3 cache, 4 threads	653339-001
	Intel Core i3-2310M, 2.10-GHz processor 3-MB L3 cache, 4 threads	638037-001
	Intel Celeron processor	
	Celeron B810, 1.60GHz, 2MB L3 Cache, 2 threads	646760-001
(5)	Heat sink (includes replacement thermal material)	639475-001 or
	NOTE: If 639475-001 is not available, use 661525-001.	661525-001
(6)	Fan	639474-001
(7)	Modem module	628824-001
	NOTE: The modem module spare part kit does not include a modem module cable. The modem module cable is included in the Cable Kit, spare part number 639473-001. See Cable Kit on page 30 for more Cable Kit spare part number information.	
(8)	WLAN module	
	Intel Wi-Fi Link 6205, 802.11a/b/g/n for use in Andorra, Antigua and Barbuda, Argentina, Aruba, Australia, Austria, Azerbaijan, Bahamas, Bahrain, Barbados, Belgium, Bermuda, Bolivia, Bosnia and Herzegovina, Brazil, Brunei, Bulgaria, Canada, Cayman Islands, Chile, the People's Republic of China, Colombia, Costa Rica, Croatia, Cyprus, Czech Republic, Denmark, Dominican Republic, Ecuador, Egypt, El Salvador, Estonia, Finland, France, French Guiana, Georgia, Germany, Ghana, Greece, Guadeloupe, Guam, Guatemala, Haiti, Honduras, Hong Kong, Hungary, Iceland, India, Indonesia, Ireland, Israel, Italy, Ivory Coast, Jamaica, Japan, Jordan, Kenya, Kuwait, Kyrgyzstan, Latvia, Lebanon, Martinique, Liechtenstein, Lithuania, Luxembourg, Malawi, Malaysia, Malta, Mauritius, Mexico, Monaco, Montenegro, Morocco, the Nether Antilles, the Netherlands, New Zealand, Nicaragua, Nigeria, Norway, Oman, Pakistan, Panama, Paraguay, Peru, Philippines, Poland, Portugal, Puerto Rico, Qatar, Romania, San Marino, Saudi Arabia, Senegal, Singapore, Slovakia, Slovenia, South Africa, South Korea, Spain, Sri Lanka, Sweden, Switzerland, Taiwan, Tanzania, Thailand, Trinidad and Tobago, Tunisia, Turkey, the United Arab Emirates, the United Kingdom, the United States, Uruguay, the U.S. Virgin Islands, Venezuela, Vietnam, Yemen, Zambia, and Zimbabwe	631954-001

Item	Description	Spare part number
	Intel Wi-Fi Link 1000, 802.11b/g/n for use in Andorra, Antigua and Barbuda, Argentina, Aruba, Australia, Austria, Azerbaijan, Bahamas, Bahrain, Barbados, Belgium, Bermuda, Bolivia, Bosnia and Herzegovina, Brazil, Brunei, Bulgaria, Canada, Cayman Islands, Chile, the People's Republic of China, Colombia, Costa Rica, Croatia, Cyprus, Czech Republic, Denmark, Dominican Republic, Ecuador, Egypt, El Salvador, Estonia, Finland, France, French Guiana, Georgia, Germany, Ghana, Greece, Guadeloupe, Guam, Guatemala, Haiti, Honduras, Hong Kong, Hungary, Iceland, India, Indonesia, Ireland, Israel, Italy, Ivory Coast, Jamaica, Japan, Jordan, Kenya, Kuwait, Kyrgyzstan, Latvia, Lebanon, Martinique, Liechtenstein, Lithuania, Luxembourg, Malawi, Malaysia, Malta, Mauritius, Mexico, Monaco, Montenegro, Morocco, the Nether Antilles, the Netherlands, New Zealand, Nicaragua, Nigeria, Norway, Oman, Pakistan, Panama, Paraguay, Peru, Philippines, Poland, Portugal, Puerto Rico, Qatar, Romania, San Marino, Saudi Arabia, Senegal, Singapore, Slovakia, Slovenia, South Africa, South Korea, Spain, Sri Lanka, Sweden, Switzerland, Taiwan, Tanzania, Thailand, Trinidad and Tobago, Tunisia, Turkey, the United Arab Emirates, the United Kingdom, the United States, Uruguay, the U.S. Virgin Islands, Venezuela, Vietnam, Yemen, Zambia, and Zimbabwe	572520-001
	Broadcom 4322 AGN 802.11a/b/g/n WLAN module for use in Antigua and Barbuda, Barbados, Belize, Canada, the Cayman Islands, Guam, Puerto Rico, Trinidad and Tobago, the U.S. Virgin Islands, and the United States	582564-001
	Broadcom 4322 AGN 802.11a/b/g/n WLAN module for use in Afghanistan, Albania, Algeria, Andorra, Angola, Antigua and Barbuda, Argentina, Armenia, Aruba, Australia, Austria, Azerbaijan, the Bahamas, Bahrain, Bangladesh, Barbados, Belarus, Belgium, Belize, Benin, Bermuda, Bhutan, Bolivia, Bosnia and Herzegovina, Botswana, Brazil, the British Virgin Islands, Brunei, Bulgaria, Burkina Faso, Burundi, Cameroon, Cape Verde, the Central African Republic, Chad, Chile, the People's Republic of China, Colombia, Comoros, the Congo, Costa Rica, Croatia, Cyprus, the Czech Republic, Denmark, Djibouti, Dominica, the Dominican Republic, East Timor, Ecuador, Egypt, El Salvador, Equatorial Guinea, Eritrea, Estonia, Ethiopia, Fiji, Finland, France, French Guiana, Gabon, Gambia, Georgia, Germany, Ghana, Gibraltar, Greece, Grenada, Guadeloupe, Guatemala, Guinea, Guinea-Bissau, Guyana, Haiti, Honduras, Hong Kong, Hungary, Iceland, India, Ireland, Israel, Italy, the Ivory Coast, Jamaica, Jordan, Kazakhstan, Kenya, Kiribati, Kyrgyzstan, Laos, Latvia, Lebanon, Lesotho, Liberia, Liechtenstein, Lithuania, Luxembourg, Macedonia, Madagascar, Malawi, Malaysia, the Maldives, Mali, Malta, the Marshall Islands, Martinique, Mauritania, Mauritius, Mexico, Micronesia, Monaco, Mongolia, Montenegro, Morocco, Mozambique, Namibia, Nauru, Nepal, the Nether Antilles, the Netherlands, New Zealand, Nicaragua, Niger, Nigeria, Norway, Oman, Pakistan, Palau, Panama, Papua New Guinea, Paraguay, Peru, the Philippines, Poland, Portugal, the Republic of Moldova, Romania, Russia, Rwanda, Samoa, San Marino, Sao Tome and Principe, Saudi Arabia, Senegal, Serbia, the Seychelles, Sierra Leone, Singapore, Slovakia, Slovenia, the Solomon Islands, Somalia, South Africa, South Korea, Spain, Sri Lanka, St. Kitts and Nevis, St. Lucia, St. Vincent and the Grenadines, Suriname, Swaziland, Sweden, Switzerland, Taiwan, Tajikistan, Tanzania, Togo, Tonga, Trinidad and Tobago, Tunisia, Turkey, Turkmenistan, Tuvalu, Uganda, Ukraine, the United Arab Emirates, the United Kingdom, Uruguay, Uzbekistan, Vanuatu, Venezuela, Vietnam, Yemen, Zaire, Zambia, and Zimbabwe	582564-002
	Broadcom 4313 BGN 802.11b/g/n WLAN module for use in Antigua and Barbuda, Barbados, Belize, Canada, the Cayman Islands, Guam, Puerto Rico, Trinidad and Tobago, the U.S. Virgin Islands, and the United States	593836-001

Item	Description	Spare part number
	Broadcom 4313 BGN 802.11b/g/n WLAN module for use in Afghanistan, Albania, Algeria, Andorra, Angola, Antigua and Barbuda, Argentina, Armenia, Aruba, Australia, Austria, Azerbaijan, the Bahamas, Bahrain, Bangladesh, Barbados, Belarus, Belgium, Belize, Benin, Bermuda, Bhutan, Bolivia, Bosnia and Herzegovina, Botswana, Brazil, the British Virgin Islands, Brunei, Bulgaria, Burkina Faso, Burundi, Cameroon, Cape Verde, the Central African Republic, Chad, Chile, the People's Republic of China, Colombia, Comoros, the Congo, Costa Rica, Croatia, Cyprus, the Czech Republic, Denmark, Djibouti, Dominica, the Dominican Republic, East Timor, Ecuador, Egypt, El Salvador, Equatorial Guinea, Eritrea, Estonia, Ethiopia, Fiji, Finland, France, French Guiana, Gabon, Gambia, Georgia, Germany, Ghana, Gibraltar, Greece, Grenada, Guadeloupe, Guatemala, Guinea, Guinea-Bissau, Guyana, Haiti, Honduras, Hong Kong, Hungary, Iceland, India, Ireland, Israel, Italy, the Ivory Coast, Jamaica, Jordan, Kazakhstan, Kenya, Kiribati, Kyrgyzstan, Laos, Latvia, Lebanon, Lesotho, Liberia, Liechtenstein, Lithuania, Luxembourg, Macedonia, Madagascar, Malawi, Malaysia, the Maldives, Mali, Malta, the Marshall Islands, Martinique, Mauritania, Mauritius, Mexico, Micronesia, Monaco, Mongolia, Montenegro, Morocco, Mozambique, Namibia, Nauru, Nepal, the Nether Antilles, the Netherlands, New Zealand, Nicaragua, Niger, Nigeria, Norway, Oman, Pakistan, Palau, Panama, Papua New Guinea, Paraguay, Peru, the Philippines, Poland, Portugal, the Republic of Moldova, Romania, Russia, Rwanda, Samoa, San Marino, Sao Tome and Principe, Saudi Arabia, Senegal, Serbia, the Seychelles, Sierra Leone, Singapore, Slovakia, Slovenia, the Solomon Islands, Somalia, South Africa, South Korea, Spain, Sri Lanka, St. Kitts and Nevis, St. Lucia, St. Vincent and the Grenadines, Suriname, Swaziland, Sweden, Switzerland, Taiwan, Tajikistan, Tanzania, Togo, Tonga, Trinidad and Tobago, Tunisia, Turkey, Turkmenistan, Tuvalu, Uganda, Ukraine, the United Arab Emirates, the United Kingdom, Uruguay, Uzbekistan, Vanuatu, Venezuela, Vietnam, Yemen, Zaire, Zambia, and Zimbabwe	593836-002
(9)	Wireless/web/mute function board (includes cable)	639480-001
(10)	RTC battery	651038-001
(11)	Power button board (includes cable)	639481-001
(12)	System board (includes replacement thermal material)	
	System board (HM65 includes WWAN and RTC battery) for use in all countries and regions except for Russia and China	641733-001
	System board (HM65 includes WWAN and RTC battery) for use in Russia and China	650161-001
	System board (HM65 includes RTC battery) for use in all countries and regions except for Russia and China	643216-001
	System board (HM65 includes RTC battery) for use in Russia and China	650163-001
	System board (QM67 includes RTC battery) for use in all countries and regions except for Russia and China	641734-001
	System board (QM67 includes RTC battery) for use in Russia and China	650162-001
(13)	Optical drive (includes bracket, bezel, and screws)	
	DVD±RW SuperMulti DL LightScribe Drive	647673-001
	DVD-ROM Drive	647672-001
	Blu-ray ROM DVD±RW SuperMulti DL LightScribe Drive	647674-001
(14)	Speaker assembly	639484-001
(15)	Battery	
	9-cell Li-ion battery	
	100-Wh battery	631243-001

Item	Description	Spare part number
	73-Wh battery	634089-001
	6-cell Li-ion battery	
	62-Wh battery	628668-001
	55-Wh HP Long Life battery	628670-001
	55-Wh battery	628666-001
	3-cell Li-ion battery	
	31-Wh battery	628664-001
(16)	Base enclosure (includes rubber feet)	639468-001
(17)	Bottom cover	646077-001
(18)	Hard drive (includes hard drive bracket and screws)	
	750-GB, 7200-rpm	633252-001
	500-GB, 7200-rpm	634926-001
	320-GB, 7200-rpm	641672-001
	320-GB, 7200-rpm, Self-Encrypting Drive (SED)	626978-001
	250-GB, 7200-rpm	635225-001
	160-GB solid-state drive	649657-001
	128-GB solid-state drive	649658-001
(19)	Memory modules (PC3-10600, 1333-MHz, DDR3)	
	8-GB	634091-001
	4-GB	621569-001
	2-GB	621565-001
(20)	Bluetooth module (does not include Bluetooth module cable)	537921-001
	NOTE: The Bluetooth module spare part kit does not include a Bluetooth module cable. The Bluetooth module cable is included in the Cable Kit, spare part number 639473-001. See Cable Kit on page 30 for more Cable Kit spare part number information.	
	WWAN modules (not illustrated)	
	HP F5521 Broadband	632155-001
	HP un2430 EV-DO/HSPA Mobile Broadband Module	634400-001
	Fingerprint reader board (not illustrated; includes fingerprint reader board cable)	651913-001
	Cable Kit (not illustrated; see Cable Kit on page 30 for more Cable Kit spare part number information)	639473-001

Display components

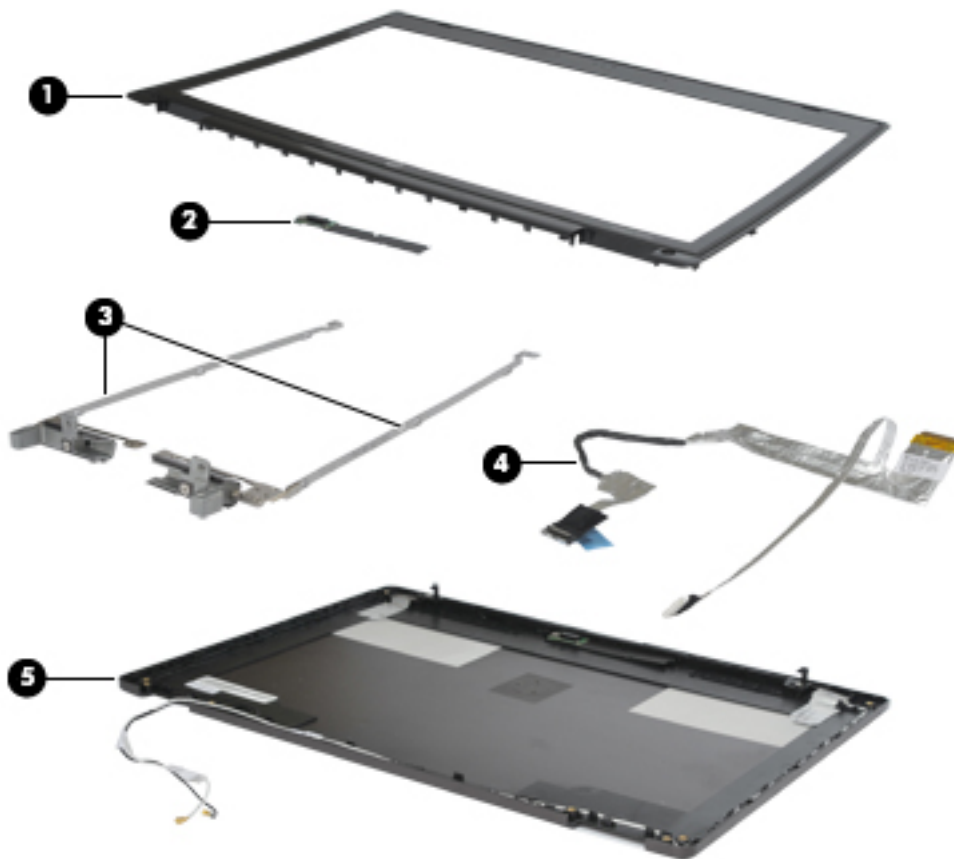

Item	Description	Spare part number
(1)	Display bezel	
	For use with computer models with a webcam	639469-001
	For use with computer models without a webcam	639470-001
(2)	Webcam module	641735-001
(3)	Display hinges (Hinge kit includes left and right hinges, brackets, and covers)	639476-001
(4)	Display cable kit includes LCD cable, LCD cable (system board to color mapping board), LCD cable (color mapping board to panel)	
	For use with computer models with a webcam	639471-001
	For use with computer models without a webcam	639472-001
(5)	Display enclosure (LCD back cover assembly)	639467-001

Item	Description	Spare part number
	Display panel (not illustrated)	647671-001
	Display Panel Support Kit (not illustrated), includes:	657833-001
	<ul style="list-style-type: none"> • WLAN antennas • WWAN antennas • Camera cable • Display panel rear cover 	

Plastics Kit



Item	Description	Spare part number
	Plastics Kit:	639482-001
(1)	Base enclosure	
(2)	Bottom cover	
	ExpressCard slot protective insert (not illustrated)	
	LCD hinge covers (left and right; not illustrated)	

Cable Kit

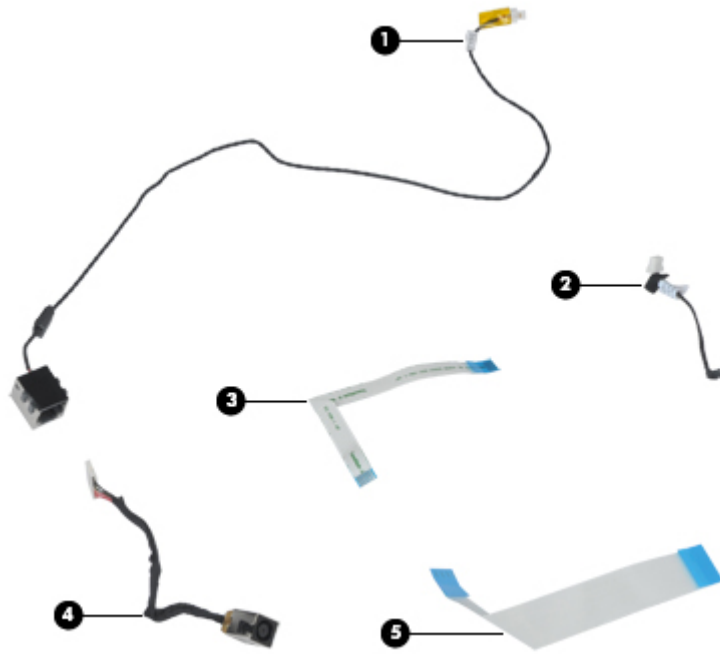

Item	Description	Spare part number
	Cable Kit:	639473-001
(1)	RJ-11 connector cable	
(2)	Bluetooth module cable	
(3)	TouchPad cable	
(4)	Power connector cable	
(5)	ExpressCard cable	

Hinge Kit

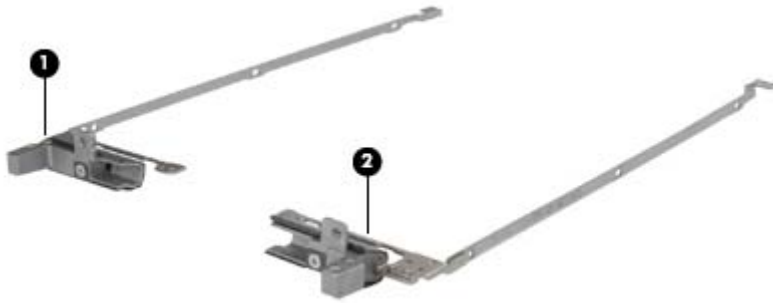

Item	Description	Spare part number
	Hinge Kit:	639476-001
(1)	Left hinge assembly	
(2)	Right hinge assembly	
	LCD hinge covers (left and right; not illustrated)	

Mass storage devices



Item	Description	Spare part number
(1)	Optical drive	
	DVD±RW SuperMulti DL LightScribe Drive	647673-001
	Blu-ray ROM DVD±RW SuperMulti DL LightScribe Drive	647674-001
	DVD-ROM Drive	647672-001
(2)	Hard drive (includes bracket and screws)	
	750-GB, 7200-rpm	633252-001
	500-GB, 7200-rpm	634926-001
	320-GB, 7200-rpm	641672-001
	320-GB, 7200-rpm, Self-Encrypting Drive (SED)	626978-001
	250-GB, 7200-rpm	635225-001
	256-GB solid-state drive (SSD)	649658-001
	160-GB solid-state drive (SSD)	649657-001

Miscellaneous parts

Description	Spare part number
AC adapter	
65-W AC adapter	609939-001
90-W AC adapter	609940-001
90-W AC adapter for use in India	609947-001
65-W AC adapter for use in India	609948-001
Power cords:	
For use in Argentina	490371-D01
For use in Australia	490371-011
For use in Brazil	490371-202
For use in Denmark	490371-081
For use in Europe, the Middle East, and Africa	490371-021
For use in India	490371-D01
For use in Israel	490371-BB1
For use in Italy	490371-061
For use in Japan	490371-291
For use in the People's Republic of China	490371-AA1
For use in South Africa	490371-AR1
For use in South Korea	490371-AD1
For use in Switzerland	490371-111
Power cord for use in Taiwan	490371-AB1
Power cord for use in Thailand	490371-201
For use in the United Kingdom	490371-031
For use in the United States	490371-001
Rubber Kit (includes rubber feet and rubber screw covers)	639483-001

Description	Spare part number
Screw Kit	647676-001
<ul style="list-style-type: none"> • Phillips PM2.0×5.0 captive screw • Black Phillips PM2.5×12.0 captive screw • Silver Phillips PM2.5×12.0 captive screw • Phillips PM2.0×7.0 captive screw • Phillips PM2.0×4.0 screw • Phillips PM3.0×3.0 screw • Phillips PM2.5×5.0 screw • Phillips PM2.5×3.0 screw • Phillips PM2.0×3.0 screw • Black Phillips PM2.5×6.0 screw • Black Phillips PM2.0×5.0 screw • Torx T8M2.5×7.0 screw • Torx T8M2.5×8.0 screw • Torx T8M2.0×8.0 screw • Torx T8M2.5×6.0 screw 	
Cases	
HP Basic Carrying Case	455084-001
Professional slim case, top load	592923-001
Essential Nylon Case	612757-001
HP Docking Station	581597-001
Upgrade bay insert	666230-001
Combination lock	591699-001
Mice	
Optical, USB	390632-001
Travel, USB	434594-001

Sequential part number listing

Spare part number	Description
390632-001	Mouse, optical, USB
434594-001	Mouse, travel, USB
455084-001	HP Basic Carrying Case
490371-001	Power cord for use in North America
490371-011	Power cord for use in Australia
490371-021	Power cord for use in Europe, the Middle East, and Africa
490371-031	Power cord for use in the United Kingdom
490371-061	Power cord for use in Italy
490371-081	Power cord for use in Denmark
490371-111	Power cord for use in Switzerland
490371-201	Power cord for use in Thailand
490371-202	Power cord for use in Brazil
490371-291	Power cord for use in Japan
490371-AA1	Power cord for use in the People's Republic of China
490371-AB1	Power cord for use in Taiwan
490371-AD1	Power cord for use in South Korea
490371-AR1	Power cord for use in South Africa
490371-BB1	Power cord for use in Israel
490371-D01	Power cord for use in Argentina
490371-D61	Power cord for use in India
537921-001	Bluetooth module
572520-001	Intel Wi-Fi Link 1000, 802.11b/g/n WLAN module for use in Andorra, Antigua and Barbuda, Argentina, Aruba, Australia, Austria, Azerbaijan, Bahamas, Bahrain, Barbados, Belgium, Bermuda, Bolivia, Bosnia and Herzegovina, Brazil, Brunei, Bulgaria, Canada, Cayman Islands, Chile, the People's Republic of China, Colombia, Costa Rica, Croatia, Cyprus, Czech Republic, Denmark, Dominican Republic, Ecuador, Egypt, El Salvador, Estonia, Finland, France, French Guiana, Georgia, Germany, Ghana, Greece, Guadeloupe, Guam, Guatemala, Haiti, Honduras, Hong Kong, Hungary, Iceland, India, Indonesia, Ireland, Israel, Italy, Ivory Coast, Jamaica, Japan, Jordan, Kenya, South Korea, Kuwait, Kyrgyzstan, Latvia, Lebanon, Martinique, US Virgin Islands, Puerto Rico, Nether Antilles, Liechtenstein, Lithuania, Luxembourg, Malawi, Malaysia, Malta, Mauritius, Mexico, Monaco, Montenegro, Morocco, the Netherlands, New Zealand, Nicaragua, Nigeria, Norway, Oman, Pakistan, Panama, Paraguay, Peru, Philippines, Poland, Portugal, Qatar, Romania, San Marino, Saudi Arabia, Senegal, Singapore, Slovakia, Slovenia, South Africa, Spain, Sri Lanka, Sweden, Switzerland, Taiwan, Tanzania, Thailand, Trinidad and Tobago, Turkey, the United Arab Emirates, the United Kingdom, the United States, Uruguay, Venezuela, Vietnam, Yemen, Zambia, and Zimbabwe
581597-001	HP Docking Station
582564-001	Broadcom 4322 AGN 802.11a/b/g/n WLAN module for use in Antigua and Barbuda, Barbados, Belize, Canada, the Cayman Islands, Guam, Puerto Rico, Trinidad and Tobago, the U.S. Virgin Islands, and the United States

Spare part number	Description
582564-002	Broadcom 4322 AGN 802.11a/b/g/n WLAN module for use in Afghanistan, Albania, Algeria, Andorra, Angola, Antigua and Barbuda, Argentina, Armenia, Aruba, Australia, Austria, Azerbaijan, the Bahamas, Bahrain, Bangladesh, Barbados, Belarus, Belgium, Belize, Benin, Bermuda, Bhutan, Bolivia, Bosnia and Herzegovina, Botswana, Brazil, the British Virgin Islands, Brunei, Bulgaria, Burkina Faso, Burundi, Cameroon, Cape Verde, the Central African Republic, Chad, Chile, the People's Republic of China, Colombia, Comoros, the Congo, Costa Rica, Croatia, Cyprus, the Czech Republic, Denmark, Djibouti, Dominica, the Dominican Republic, East Timor, Ecuador, Egypt, El Salvador, Equatorial Guinea, Eritrea, Estonia, Ethiopia, Fiji, Finland, France, French Guiana, Gabon, Gambia, Georgia, Germany, Ghana, Gibraltar, Greece, Grenada, Guadeloupe, Guatemala, Guinea, Guinea-Bissau, Guyana, Haiti, Honduras, Hong Kong, Hungary, Iceland, India, Ireland, Israel, Italy, the Ivory Coast, Jamaica, Jordan, Kazakhstan, Kenya, Kiribati, Kyrgyzstan, Laos, Latvia, Lebanon, Lesotho, Liberia, Liechtenstein, Lithuania, Luxembourg, Macedonia, Madagascar, Malawi, Malaysia, the Maldives, Mali, Malta, the Marshall Islands, Martinique, Mauritania, Mauritius, Mexico, Micronesia, Monaco, Mongolia, Montenegro, Morocco, Mozambique, Namibia, Nauru, Nepal, the Nether Antilles, the Netherlands, New Zealand, Nicaragua, Niger, Nigeria, Norway, Oman, Pakistan, Palau, Panama, Papua New Guinea, Paraguay, Peru, the Philippines, Poland, Portugal, the Republic of Moldova, Romania, Russia, Rwanda, Samoa, San Marino, Sao Tome and Principe, Saudi Arabia, Senegal, Serbia, the Seychelles, Sierra Leone, Singapore, Slovakia, Slovenia, the Solomon Islands, Somalia, South Africa, South Korea, Spain, Sri Lanka, St. Kitts and Nevis, St. Lucia, St. Vincent and the Grenadines, Suriname, Swaziland, Sweden, Switzerland, Taiwan, Tajikistan, Tanzania, Togo, Tonga, Trinidad and Tobago, Tunisia, Turkey, Turkmenistan, Tuvalu, Uganda, Ukraine, the United Arab Emirates, the United Kingdom, Uruguay, Uzbekistan, Vanuatu, Venezuela, Vietnam, Yemen, Zaire, Zambia, and Zimbabwe
591699-001	Combination lock
592923-001	Professional slim case, top load
593836-001	Broadcom 4313 BGN 802.11b/g/n WLAN module for use in Antigua and Barbuda, Barbados, Belize, Canada, the Cayman Islands, Guam, Puerto Rico, Trinidad and Tobago, the U.S. Virgin Islands, and the United States
593836-002	Broadcom 4313 BGN 802.11b/g/n WLAN module for use in Afghanistan, Albania, Algeria, Andorra, Angola, Antigua and Barbuda, Argentina, Armenia, Aruba, Australia, Austria, Azerbaijan, the Bahamas, Bahrain, Bangladesh, Barbados, Belarus, Belgium, Belize, Benin, Bermuda, Bhutan, Bolivia, Bosnia and Herzegovina, Botswana, Brazil, the British Virgin Islands, Brunei, Bulgaria, Burkina Faso, Burundi, Cameroon, Cape Verde, the Central African Republic, Chad, Chile, the People's Republic of China, Colombia, Comoros, the Congo, Costa Rica, Croatia, Cyprus, the Czech Republic, Denmark, Djibouti, Dominica, the Dominican Republic, East Timor, Ecuador, Egypt, El Salvador, Equatorial Guinea, Eritrea, Estonia, Ethiopia, Fiji, Finland, France, French Guiana, Gabon, Gambia, Georgia, Germany, Ghana, Gibraltar, Greece, Grenada, Guadeloupe, Guatemala, Guinea, Guinea-Bissau, Guyana, Haiti, Honduras, Hong Kong, Hungary, Iceland, India, Ireland, Israel, Italy, the Ivory Coast, Jamaica, Jordan, Kazakhstan, Kenya, Kiribati, Kyrgyzstan, Laos, Latvia, Lebanon, Lesotho, Liberia, Liechtenstein, Lithuania, Luxembourg, Macedonia, Madagascar, Malawi, Malaysia, the Maldives, Mali, Malta, the Marshall Islands, Martinique, Mauritania, Mauritius, Mexico, Micronesia, Monaco, Mongolia, Montenegro, Morocco, Mozambique, Namibia, Nauru, Nepal, the Nether Antilles, the Netherlands, New Zealand, Nicaragua, Niger, Nigeria, Norway, Oman, Pakistan, Palau, Panama, Papua New Guinea, Paraguay, Peru, the Philippines, Poland, Portugal, the Republic of Moldova, Romania, Russia, Rwanda, Samoa, San Marino, Sao Tome and Principe, Saudi Arabia, Senegal, Serbia, the Seychelles, Sierra Leone, Singapore, Slovakia, Slovenia, the Solomon Islands, Somalia, South Africa, South Korea, Spain, Sri Lanka, St. Kitts and Nevis, St. Lucia, St. Vincent and the Grenadines, Suriname, Swaziland, Sweden, Switzerland, Taiwan, Tajikistan, Tanzania, Togo, Tonga, Trinidad and Tobago, Tunisia, Turkey, Turkmenistan, Tuvalu, Uganda, Ukraine, the United Arab Emirates, the United Kingdom, Uruguay, Uzbekistan, Vanuatu, Venezuela, Vietnam, Yemen, Zaire, Zambia, and Zimbabwe
609939-001	65-W AC adapter
609940-001	90-W AC adapter
609947-001	90-W AC adapter for use in India
609948-001	65-W AC adapter for use in India
612757-001	Essential Nylon Case

Spare part number	Description
621565-001	2-GB memory module (PC3-10600, 1333-MHz, DDR3)
621569-001	4-GB memory module (PC3-10600, 1333-MHz, DDR3)
626978-001	320-GB, 7200-rpm, Self-Encrypting Drive (SED)
628664-001	3-cell, 31-Wh Li-ion battery
628666-001	6-cell, 55-Wh Li-ion battery
628668-001	6-cell, 62-Wh Li-ion battery
628670-001	6-cell, 55-Wh HP Long Life Li-ion battery
628824-001	Modem module for use in all countries and regions NOTE: The modem module spare part kit does not include a modem module cable. The modem module cable is included in the Cable Kit, spare part number 639473-001. See Cable Kit on page 30 for more Cable Kit spare part number information.
631243-001	9-cell, 100-Wh Li-ion battery
631252-001	2nd Generation Intel Core i7-2620M, 2.70GHz (Turbo up to 3.40GHz) 4MB L3 Cache, 4 threads
631253-001	2nd Generation Intel Core i5-2520M, 2.50-GHz (Turbo up to 3.20) processor 3-MB L3 cache, 4 threads
631255-001	2nd Generation Intel Core i5-2540M, 2.60-GHz (Turbo up to 3.30) processor 3-MB L3 cache, 4 threads
631954-001	Intel Wi-Fi Link 6205, 802.11a/b/g/n WLAN module for use in Andorra, Antigua and Barbuda, Argentina, Aruba, Australia, Austria, Azerbaijan, Bahamas, Bahrain, Barbados, Belgium, Bermuda, Bolivia, Bosnia and Herzegovina, Brazil, Brunei, Bulgaria, Canada, Cayman Islands, Chile, the People's Republic of China, Colombia, Costa Rica, Croatia, Cyprus, Czech Republic, Denmark, Dominican Republic, Ecuador, Egypt, El Salvador, Estonia, Finland, France, French Guiana, Georgia, Germany, Ghana, Greece, Guadeloupe, Guam, Guatemala, Haiti, Honduras, Hong Kong, Hungary, Iceland, India, Indonesia, Ireland, Israel, Italy, Ivory Coast, Jamaica, Japan, Jordan, Kenya, Kuwait, Kyrgyzstan, Latvia, Lebanon, Martinique, Liechtenstein, Lithuania, Luxembourg, Malawi, Malaysia, Malta, Mauritius, Mexico, Monaco, Montenegro, Morocco, the Nether Antilles, the Netherlands, New Zealand, Nicaragua, Nigeria, Norway, Oman, Pakistan, Panama, Paraguay, Peru, Philippines, Poland, Portugal, Puerto Rico, Qatar, Romania, San Marino, Saudi Arabia, Senegal, Singapore, Slovakia, Slovenia, South Africa, South Korea, Spain, Sri Lanka, Sweden, Switzerland, Taiwan, Tanzania, Thailand, Trinidad and Tobago, Tunisia, Turkey, the United Arab Emirates, the United Kingdom, the United States, Uruguay, the U.S. Virgin Islands, Venezuela, Vietnam, Yemen, Zambia, and Zimbabwe
632155-001	HP F5521 Broadband Module (WWAN)
633252-001	750-GB, 7200-rpm hard drive (includes hard drive bracket and screws)
634089-001	9-cell, 73-Wh Li-ion battery
634091-001	8-GB memory module (PC3-10600, 1333-MHz, DDR3)
634400-001	HP un2430 EV-DO/HSPA Mobile Broadband Module
634926-001	500-GB, 7200-rpm hard drive (includes hard drive bracket and screws)
635225-001	250-GB, 7200-rpm hard drive (includes hard drive bracket and screws)
638037-001	Intel Core i3-2310M, 2.10-GHz processor 3-MB L3 cache, 4 threads
638039-001	2nd Generation Intel Core i5-2410M, 2.30-GHz (Turbo up to 2.90) processor 3-MB L3 cache, 4 threads
639467-001	Display enclosure (LCD back cover assembly)
639468-001	Base enclosure

Spare part number	Description
639469-001	Display bezel for use with computer models with a webcam
639470-001	Display bezel for use with computer models without a webcam
639471-001	Display cable kit, includes LCD cable, LCD cable (system board to color mapping board), LCD cable (color mapping board to panel). For use with computer models with a webcam.
639472-001	Display cable kit, includes LCD cable, LCD cable (system board to color mapping board), LCD cable (color mapping board to panel). For use with computer models without a webcam.
639473-001	Cable Kit (see Cable Kit on page 30 for more Cable Kit spare part information)
639474-001	Fan
639475-001	Heat sink (does not include fan)
	NOTE: If 639475-001 is not available, use 661525-001.
639476-001	Display hinge kit (includes left and right hinges, brackets, and covers)
639477-001	Keyboard without pointing stick for use in the United States
639477-121	Keyboard without pointing stick for use in French Canada
639477-201	Keyboard without pointing stick for use in Brazil
639477-161	Keyboard without pointing stick for use in Latin America
639477-BA1	Keyboard without pointing stick for use in Slovenia
639477-171	Keyboard without pointing stick for use in Saudi Arabia
639477-A41	Keyboard without pointing stick for use in Belgium
639477-261	Keyboard without pointing stick for use in Bulgaria
639477-A81	Keyboard without pointing stick for use in the Czech Republic and Slovakia
639477-081	Keyboard without pointing stick for use in Denmark
639477-B31	Keyboard without pointing stick for use in the Netherlands and Europe
639477-051	Keyboard without pointing stick for use in France
639477-041	Keyboard without pointing stick for use in Germany
639477-DJ1	Keyboard without pointing stick for use in Greece
639477-DD1	Keyboard without pointing stick for use in Iceland
639477-211	Keyboard without pointing stick for use in Hungary
639477-BB1	Keyboard without pointing stick for use in Israel
639477-061	Keyboard without pointing stick for use in Italy
639477-091	Keyboard without pointing stick for use in Norway
639477-131	Keyboard without pointing stick for use in Portugal
639477-251	Keyboard without pointing stick for use in Russia
639477-071	Keyboard without pointing stick for use in Spain
639477-B71	Keyboard without pointing stick for use in Sweden

Spare part number	Description
639477-BG1	Keyboard without pointing stick for use in Switzerland
639477-141	Keyboard without pointing stick for use in Turkey
639477-031	Keyboard without pointing stick for use in the United Kingdom
639477-291	Keyboard without pointing stick for use in Japan
639477-AD1	Keyboard without pointing stick for use in South Korea
639477-AB1	Keyboard without pointing stick for use in Taiwan
639477-281	Keyboard without pointing stick for use in Thailand
639478-001	Keyboard with pointing stick for use in the United States (includes keyboard and pointing stick cables)
639478-121	Keyboard with pointing stick for use in French Canada (includes keyboard and pointing stick cables)
639478-201	Keyboard with pointing stick for use in Brazil (includes keyboard and pointing stick cables)
639478-161	Keyboard with pointing stick for use in Latin America (includes keyboard and pointing stick cables)
639478-BA1	Keyboard with pointing stick for use in Slovenia (includes keyboard and pointing stick cables)
639478-171	Keyboard with pointing stick for use in Saudi Arabia (includes keyboard and pointing stick cables)
639478-A41	Keyboard with pointing stick for use in Belgium (includes keyboard and pointing stick cables)
639478-261	Keyboard with pointing stick for use in Bulgaria (includes keyboard and pointing stick cables)
639478-A81	Keyboard with pointing stick for use in the Czech Republic and Slovakia (includes keyboard and pointing stick cables)
639478-081	Keyboard with pointing stick for use in Denmark (includes keyboard and pointing stick cables)
639478-B31	Keyboard with pointing stick for use in the Netherlands and Europe (includes keyboard and pointing stick cables)
639478-051	Keyboard with pointing stick for use in France (includes keyboard and pointing stick cables)
639478-041	Keyboard with pointing stick for use in Germany (includes keyboard and pointing stick cables)
639478-DJ1	Keyboard with pointing stick for use in Greece (includes keyboard and pointing stick cables)
639478-DD1	Keyboard with pointing stick for use in Iceland (includes keyboard and pointing stick cables)
639478-211	Keyboard with pointing stick for use in Hungary (includes keyboard and pointing stick cables)
639478-BB1	Keyboard with pointing stick for use in Israel (includes keyboard and pointing stick cables)
639478-061	Keyboard with pointing stick for use in Italy (includes keyboard and pointing stick cables)
639478-091	Keyboard with pointing stick for use in Norway (includes keyboard and pointing stick cables)
639478-131	Keyboard with pointing stick for use in Portugal (includes keyboard and pointing stick cables)
639478-251	Keyboard with pointing stick for use in Russia (includes keyboard and pointing stick cables)
639478-071	Keyboard with pointing stick for use in Spain (includes keyboard and pointing stick cables)
639478-B71	Keyboard with pointing stick for use in Sweden (includes keyboard and pointing stick cables)
639478-BG1	Keyboard with pointing stick for use in Switzerland (includes keyboard and pointing stick cables)
639478-141	Keyboard with pointing stick for use in Turkey (includes keyboard and pointing stick cables)

Spare part number	Description
639478-031	Keyboard with pointing stick for use in the United Kingdom (includes keyboard and pointing stick cables)
639478-291	Keyboard with pointing stick for use in Japan (includes keyboard and pointing stick cables)
639478-AD1	Keyboard with pointing stick for use in South Korea (includes keyboard and pointing stick cables)
639478-AB1	Keyboard with pointing stick for use in Taiwan (includes keyboard and pointing stick cables)
639478-281	Keyboard with pointing stick for use in Thailand (includes keyboard and pointing stick cables)
639479-001	ExpressCard assembly
639480-001	Wireless/web/mute function board (includes cable)
639481-001	Power button board
639482-001	Plastics Kit (see Plastics Kit on page 29 for more Plastics Kit spare part information)
639483-001	Rubber Kit (includes rubber feet and rubber screw covers)
639484-001	Speaker assembly
639485-001	Top cover (includes finger print reader, Touchpad (2 button) and bracket))
639486-001	Top cover (includes Touchpad (2 button) and bracket))
641672-001	320-GB, 7200-rpm hard drive (includes hard drive bracket and screws)
641733-001	System board (HM65 includes WWAN and RTC battery) for use in all countries and regions except for Russia and China
641734-001	System board (QM67 includes RTC battery) for use in all countries and regions except for Russia and China
641735-001	Webcam module
641736-001	Top cover (includes finger print reader, Touchpad (4 button) and bracket))
641737-001	Top cover (includes Touchpad (4 button) and bracket))
643216-001	System board (HM65 includes RTC battery) for use in all countries and regions except for Russia and China
646760-001	Intel Celeron B810, 1.60GHz, 2MB L3 Cache, 2 threads
647671-001	Display panel
647672-001	DVD-ROM drive
647673-001	DVD±RW SuperMulti DL LightScribe Drive
647674-001	Blu-ray ROM DVD±RW SuperMulti DL LightScribe Drive
647675-001	Microphone board (includes microphone, and microphone mylar)
647676-001	Screw Kit
649657-001	160-GB solid-state drive (SSD) (includes hard drive bracket and screws)
649658-001	128-GB solid-state drive (SSD) (includes hard drive bracket and screws)
650161-001	System board (HM65 includes WWAN and RTC battery) for use in Russia and China
650162-001	System board (QM67 includes RTC battery) for use in Russia and China
650163-001	System board (HM65 includes RTC battery) for use in Russia and China

Spare part number	Description
651038-001	RTC battery
651649-001	HDD Hardware Kit
651656-001	Smart Card reader
651913-001	Fingerprint reader board (includes fingerprint reader board cable)
653339-001	Intel Core i3-2330M, 2.20-GHz processor 3-MB L3 cache, 4 threads
657833-001	Display Panel Support Kit
661525-001	Heat sink
666230-001	Upgrade bay insert

4 Removal and replacement procedures

Preliminary replacement requirements

Tools required

You will need the following tools to complete the removal and replacement procedures:

- Flat-bladed screwdriver
- Phillips P0 and P1 screwdrivers
- Torx T8 screwdriver

Service considerations

The following sections include some of the considerations that you must keep in mind during disassembly and assembly procedures.



NOTE: As you remove each subassembly from the computer, place the subassembly (and all accompanying screws) away from the work area to prevent damage.

Plastic parts



CAUTION: Using excessive force during disassembly and reassembly can damage plastic parts. Use care when handling the plastic parts. Apply pressure only at the points designated in the maintenance instructions.

Cables and connectors

⚠ CAUTION: When servicing the computer, be sure that cables are placed in their proper locations during the reassembly process. Improper cable placement can damage the computer.

Cables must be handled with extreme care to avoid damage. Apply only the tension required to unseat or seat the cables during removal and insertion. Handle cables by the connector whenever possible. In all cases, avoid bending, twisting, or tearing cables. Be sure that cables are routed in such a way that they cannot be caught or snagged by parts being removed or replaced. Handle flex cables with extreme care; these cables tear easily.

Drive handling

⚠ CAUTION: Drives are fragile components that must be handled with care. To prevent damage to the computer, damage to a drive, or loss of information, observe these precautions:

Before removing or inserting a hard drive, shut down the computer. If you are unsure whether the computer is off or in Hibernation, turn the computer on, and then shut it down through the operating system.

Before handling a drive, be sure that you are discharged of static electricity. While handling a drive, avoid touching the connector.

Before removing an optical drive, be sure that the disc is not in the drive and be sure that the optical drive tray is closed.

Handle drives on surfaces covered with at least 2.5 cm (one inch) of shock-proof foam.

Avoid dropping drives from any height onto any surface.

After removing a hard drive or an optical drive, place it in a static-proof bag.

Avoid exposing a hard drive to products that have magnetic fields, such as monitors or speakers.

Avoid exposing a drive to temperature extremes or liquids.

If a drive must be mailed, place the drive in a bubble pack mailer or other suitable form of protective packaging and label the package "FRAGILE."

Grounding guidelines

Electrostatic discharge damage

Electronic components are sensitive to electrostatic discharge (ESD). Circuitry design and structure determine the degree of sensitivity. Networks built into many integrated circuits provide some protection, but in many cases, ESD contains enough power to alter device parameters or melt silicon junctions.

A discharge of static electricity from a finger or other conductor can destroy static-sensitive devices or microcircuitry. Even if the spark is neither felt nor heard, damage may have occurred.

An electronic device exposed to ESD may not be affected at all and can work perfectly throughout a normal cycle. Or the device may function normally for a while, and then degrade in the internal layers, reducing its life expectancy.

CAUTION: To prevent damage to the computer when you are removing or installing internal components, observe these precautions:

Keep components in their electrostatic-safe containers until you are ready to install them.

Use nonmagnetic tools.

Before touching an electronic component, discharge static electricity by using the guidelines described in this section.

Avoid touching pins, leads, and circuitry. Handle electronic components as little as possible.

If you remove a component, place it in an electrostatic-safe container.

The following table shows how humidity affects the electrostatic voltage levels generated by different activities.

CAUTION: A product can be degraded by as little as 700 V.

Typical electrostatic voltage levels			
Event	Relative humidity		
	10%	40%	55%
Walking across carpet	35,000 V	15,000 V	7,500 V
Walking across vinyl floor	12,000 V	5,000 V	3,000 V
Motions of bench worker	6,000 V	800 V	400 V
Removing DIPS from plastic tube	2,000 V	700 V	400 V
Removing DIPS from vinyl tray	11,500 V	4,000 V	2,000 V
Removing DIPS from Styrofoam	14,500 V	5,000 V	3,500 V
Removing bubble pack from PCB	26,500 V	20,000 V	7,000 V
Packing PCBs in foam-lined box	21,000 V	11,000 V	5,000 V

Packaging and transporting guidelines

Follow these grounding guidelines when packaging and transporting equipment:

- To avoid hand contact, transport products in static-safe tubes, bags, or boxes.
- Protect ESD-sensitive parts and assemblies with conductive or approved containers or packaging.
- Keep ESD-sensitive parts in their containers until the parts arrive at static-free workstations.
- Place items on a grounded surface before removing items from their containers.
- Always be properly grounded when touching a component or assembly.
- Store reusable ESD-sensitive parts from assemblies in protective packaging or nonconductive foam.
- Use transporters and conveyors made of antistatic belts and roller bushings. Be sure that mechanized equipment used for moving materials is wired to ground and that proper materials are selected to avoid static charging. When grounding is not possible, use an ionizer to dissipate electric charges.

Workstation guidelines

Follow these grounding workstation guidelines:

- Cover the workstation with approved static-shielding material.
- Use a wrist strap connected to a properly grounded work surface and use properly grounded tools and equipment.
- Use conductive field service tools, such as cutters, screwdrivers, and vacuums.
- When fixtures must directly contact dissipative surfaces, use fixtures made only of static-safe materials.
- Keep the work area free of nonconductive materials, such as ordinary plastic assembly aids and Styrofoam.
- Handle ESD-sensitive components, parts, and assemblies by the case or PCM laminate. Handle these items only at static-free workstations.
- Avoid contact with pins, leads, or circuitry.
- Turn off power and input signals before inserting or removing connectors or test equipment.

Equipment guidelines

Grounding equipment must include either a wrist strap or a foot strap at a grounded workstation.

- When seated, wear a wrist strap connected to a grounded system. Wrist straps are flexible straps with a minimum of one megohm $\pm 10\%$ resistance in the ground cords. To provide proper ground, wear a strap snugly against the skin at all times. On grounded mats with banana-plug connectors, use alligator clips to connect a wrist strap.
- When standing, use foot straps and a grounded floor mat. Foot straps (heel, toe, or boot straps) can be used at standing workstations and are compatible with most types of shoes or boots. On conductive floors or dissipative floor mats, use foot straps on both feet with a minimum of one megohm resistance between the operator and ground. To be effective, the conductive strips must be worn in contact with the skin.

The following grounding equipment is recommended to prevent electrostatic damage:

- Antistatic tape
- Antistatic smocks, aprons, and sleeve protectors
- Conductive bins and other assembly or soldering aids
- Nonconductive foam
- Conductive tabletop workstations with ground cords of one megohm resistance
- Static-dissipative tables or floor mats with hard ties to the ground
- Field service kits
- Static awareness labels
- Material-handling packages
- Nonconductive plastic bags, tubes, or boxes
- Metal tote boxes
- Electrostatic voltage levels and protective materials

The following table lists the shielding protection provided by antistatic bags and floor mats.

Material	Use	Voltage protection level
Antistatic plastic	Bags	1,500 V
Carbon-loaded plastic	Floor mats	7,500 V
Metallized laminate	Floor mats	5,000 V

Component replacement procedures

This chapter provides removal and replacement procedures.

There are as many as 95 screws and screw locks, in 15 different sizes, that must be removed, replaced, or loosened when servicing the computer. Make special note of each screw and screw lock size and location during removal and replacement.

Service tag

When ordering parts or requesting information, provide the computer serial number and model description provided on the service tag.

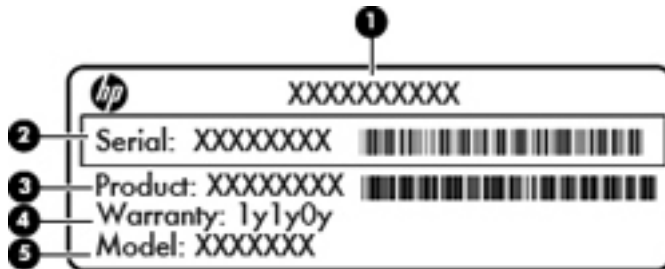

- Product name **(1)**. This is the product name affixed to the front of the computer.
- Serial number (s/n) **(2)**. This is an alphanumeric identifier that is unique to each product.
- Part number/Product number (p/n) **(3)**. This number provides specific information about the product's hardware components. The part number helps a service technician to determine what components and parts are needed.
- Warranty period **(4)**. This number describes the duration (in years) of the warranty period for the computer.
- Model description **(5)**. This is the alphanumeric identifier used to locate documents, drivers, and support for the computer.

Computer feet

The computer feet are adhesive-backed rubber pads. The feet are included in the Rubber Kit, spare part number 639483-001. There are 5 rubber feet that attach to the base enclosure/bottom cover in the locations illustrated below.

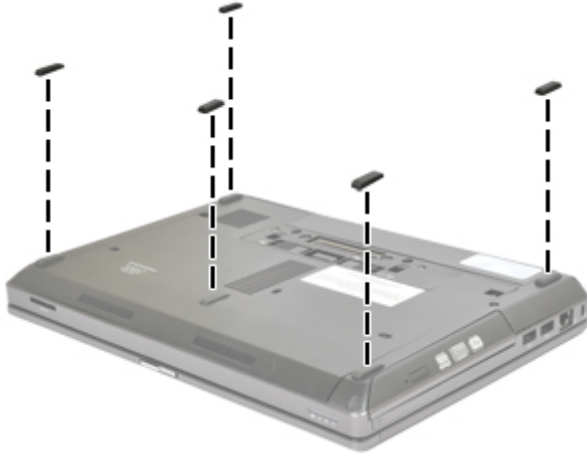

Battery

Description	Spare part number
9-cell, 100-Wh Li-ion battery	631243-001
9-cell, 73-Wh Li-ion battery	634089-001
6-cell, 62-Wh Li-ion battery	628668-001
6-cell, 55-Wh Li-ion battery	628666-001
6-cell, 55-Wh HP Long Life Li-ion battery	628670-001
3-cell, 31-Wh Li-ion battery	628664-001

Before disassembling the computer, follow these steps:

1. Shut down the computer. If you are unsure whether the computer is off or in Hibernation, turn the computer on, and then shut it down through the operating system.
2. Disconnect all external devices connected to the computer.
3. Disconnect the power from the computer by first unplugging the power cord from the AC outlet, and then unplugging the AC adapter from the computer.

Remove the battery:

1. Turn the computer upside-down on a flat surface, with the battery bay toward you.
2. Slide the battery release latch **(1)** to release the battery.
3. Remove the battery **(2)** from the computer.

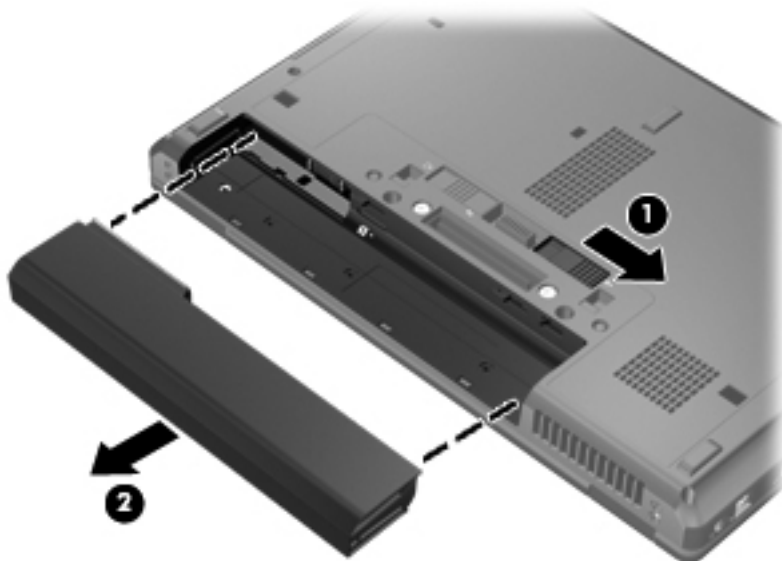

Install the battery by inserting it into the battery bay until you hear a click.

SIM

 **NOTE:** This section applies only to computer models with WWAN capability.

 **NOTE:** If there is a SIM inserted in the SIM slot, it must be removed before disassembling the computer. Be sure that the SIM is reinserted in the SIM slot after reassembling the computer.

Before removing the SIM, follow these steps:

1. Shut down the computer. If you are unsure whether the computer is off or in Hibernation, turn the computer on, and then shut it down through the operating system.
2. Disconnect all external devices connected to the computer.
3. Disconnect the power from the computer by first unplugging the power cord from the AC outlet, and then unplugging the AC adapter from the computer.
4. Remove the battery (see [Battery on page 49](#)).

Remove the SIM:

1. Press in on the SIM **(1)**. (The module is partially ejected from the SIM slot.)
2. Remove the SIM **(2)** from the SIM slot.

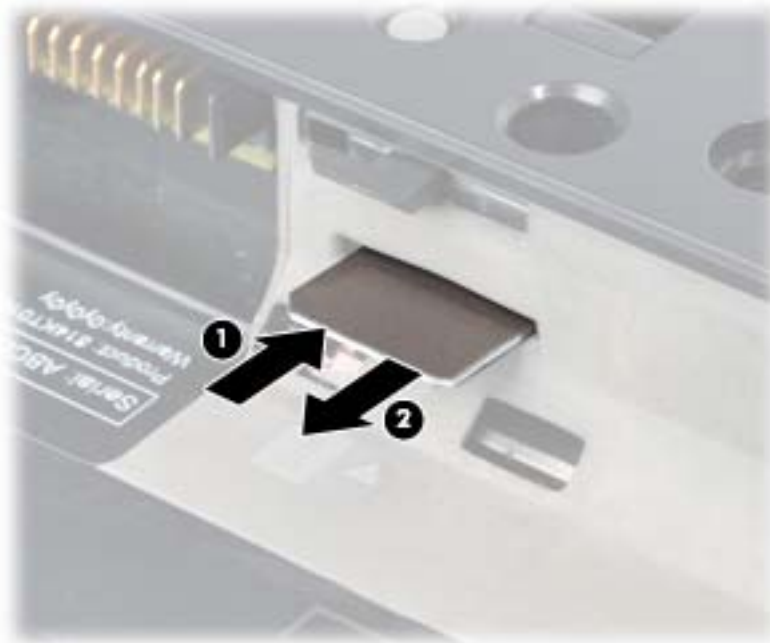

Reverse this procedure to install the SIM.

Bottom cover

 **NOTE:** The optional screw is located on the inside of the bottom cover.

Description	Spare part number
Bottom cover	646077-001

Before removing the bottom cover, follow these steps:

1. Shut down the computer. If you are unsure whether the computer is off or in Hibernation, turn the computer on, and then shut it down through the operating system.
2. Disconnect all external devices connected to the computer.
3. Disconnect the power from the computer by first unplugging the power cord from the AC outlet, and then unplugging the AC adapter from the computer.
4. Remove the battery (see [Battery on page 49](#)).

Remove the bottom cover:

1. Turn the computer upside-down on a flat surface, with the battery bay toward you.
2. Slide the bottom cover release latch **(1)** to the left, remove the screw (if the optional screw is being used) **(2)**.
3. Slide the release latch again **(3)** to release the bottom cover.
4. Slide the bottom cover towards the front of the computer **(4)** and lift **(5)** to remove the cover.

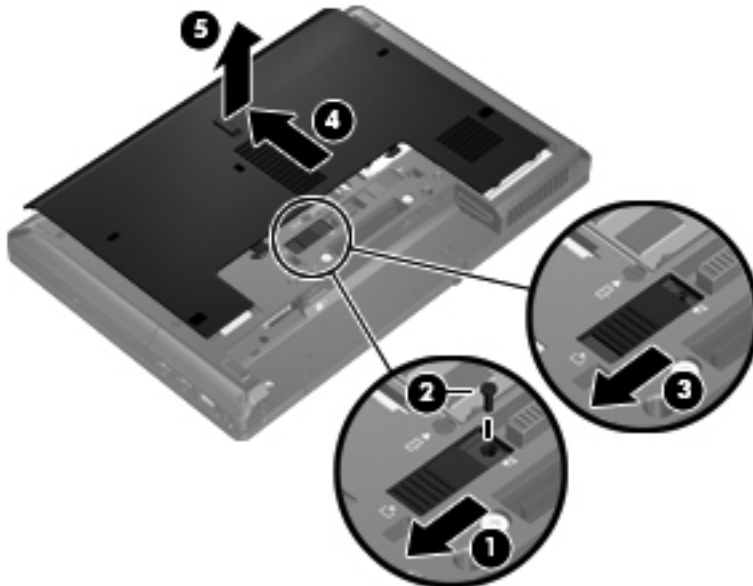

WLAN module

 **CAUTION:** The WLAN module and the WWAN module are not interchangeable.

Description	Spare part number
Intel Wi-Fi Link 1000, 802.11b/g/n WLAN module for use in Andorra, Antigua and Barbuda, Argentina, Aruba, Australia, Austria, Azerbaijan, Bahamas, Bahrain, Barbados, Belgium, Bermuda, Bolivia, Bosnia and Herzegovina, Brazil, Brunei, Bulgaria, Canada, Cayman Islands, Chile, the People's Republic of China, Colombia, Costa Rica, Croatia, Cyprus, Czech Republic, Denmark, Dominican Republic, Ecuador, Egypt, El Salvador, Estonia, Finland, France, French Guiana, Georgia, Germany, Ghana, Greece, Guadeloupe, Guam, Guatemala, Haiti, Honduras, Hong Kong, Hungary, Iceland, India, Indonesia, Ireland, Israel, Italy, Ivory Coast, Jamaica, Japan, Jordan, Kenya, South Korea, Kuwait, Kyrgyzstan, Latvia, Lebanon, Martinique, US Virgin Islands, Puerto Rico, Nether Antilles, Liechtenstein, Lithuania, Luxembourg, Malawi, Malaysia, Malta, Mauritius, Mexico, Monaco, Montenegro, Morocco, the Netherlands, New Zealand, Nicaragua, Nigeria, Norway, Oman, Pakistan, Panama, Paraguay, Peru, Philippines, Poland, Portugal, Qatar, Romania, San Marino, Saudi Arabia, Senegal, Singapore, Slovakia, Slovenia, South Africa, Spain, Sri Lanka, Sweden, Switzerland, Taiwan, Tanzania, Thailand, Trinidad and Tobago, Turkey, the United Arab Emirates, the United Kingdom, the United States, Uruguay, Venezuela, Vietnam, Yemen, Zambia, and Zimbabwe	572520-001
Intel Wi-Fi Link 6205, 802.11a/b/g/n WLAN module for use in Andorra, Antigua and Barbuda, Argentina, Aruba, Australia, Austria, Azerbaijan, Bahamas, Bahrain, Barbados, Belgium, Bermuda, Bolivia, Bosnia and Herzegovina, Brazil, Brunei, Bulgaria, Canada, Cayman Islands, Chile, the People's Republic of China, Colombia, Costa Rica, Croatia, Cyprus, Czech Republic, Denmark, Dominican Republic, Ecuador, Egypt, El Salvador, Estonia, Finland, France, French Guiana, Georgia, Germany, Ghana, Greece, Guadeloupe, Guam, Guatemala, Haiti, Honduras, Hong Kong, Hungary, Iceland, India, Indonesia, Ireland, Israel, Italy, Ivory Coast, Jamaica, Japan, Jordan, Kenya, Kuwait, Kyrgyzstan, Latvia, Lebanon, Martinique, Liechtenstein, Lithuania, Luxembourg, Malawi, Malaysia, Malta, Mauritius, Mexico, Monaco, Montenegro, Morocco, the Nether Antilles, the Netherlands, New Zealand, Nicaragua, Nigeria, Norway, Oman, Pakistan, Panama, Paraguay, Peru, Philippines, Poland, Portugal, Puerto Rico, Qatar, Romania, San Marino, Saudi Arabia, Senegal, Singapore, Slovakia, Slovenia, South Africa, South Korea, Spain, Sri Lanka, Sweden, Switzerland, Taiwan, Tanzania, Thailand, Trinidad and Tobago, Tunisia, Turkey, the United Arab Emirates, the United Kingdom, the United States, Uruguay, the U.S. Virgin Islands, Venezuela, Vietnam, Yemen, Zambia, and Zimbabwe	631954-001
Broadcom 4322 AGN 802.11a/b/g/n WLAN module for use in Antigua and Barbuda, Barbados, Belize, Canada, the Cayman Islands, Guam, Puerto Rico, Trinidad and Tobago, the U.S. Virgin Islands, and the United States	582564-001

Description	Spare part number
Broadcom 4322 AGN 802.11a/b/g/n WLAN module for use in Afghanistan, Albania, Algeria, Andorra, Angola, Antigua and Barbuda, Argentina, Armenia, Aruba, Australia, Austria, Azerbaijan, the Bahamas, Bahrain, Bangladesh, Barbados, Belarus, Belgium, Belize, Benin, Bermuda, Bhutan, Bolivia, Bosnia and Herzegovina, Botswana, Brazil, the British Virgin Islands, Brunei, Bulgaria, Burkina Faso, Burundi, Cameroon, Cape Verde, the Central African Republic, Chad, Chile, the People's Republic of China, Colombia, Comoros, the Congo, Costa Rica, Croatia, Cyprus, the Czech Republic, Denmark, Djibouti, Dominica, the Dominican Republic, East Timor, Ecuador, Egypt, El Salvador, Equatorial Guinea, Eritrea, Estonia, Ethiopia, Fiji, Finland, France, French Guiana, Gabon, Gambia, Georgia, Germany, Ghana, Gibraltar, Greece, Grenada, Guadeloupe, Guatemala, Guinea, Guinea-Bissau, Guyana, Haiti, Honduras, Hong Kong, Hungary, Iceland, India, Ireland, Israel, Italy, the Ivory Coast, Jamaica, Jordan, Kazakhstan, Kenya, Kiribati, Kyrgyzstan, Laos, Latvia, Lebanon, Lesotho, Liberia, Liechtenstein, Lithuania, Luxembourg, Macedonia, Madagascar, Malawi, Malaysia, the Maldives, Mali, Malta, the Marshall Islands, Martinique, Mauritania, Mauritius, Mexico, Micronesia, Monaco, Mongolia, Montenegro, Morocco, Mozambique, Namibia, Nauru, Nepal, the Nether Antilles, the Netherlands, New Zealand, Nicaragua, Niger, Nigeria, Norway, Oman, Pakistan, Palau, Panama, Papua New Guinea, Paraguay, Peru, the Philippines, Poland, Portugal, the Republic of Moldova, Romania, Russia, Rwanda, Samoa, San Marino, Sao Tome and Principe, Saudi Arabia, Senegal, Serbia, the Seychelles, Sierra Leone, Singapore, Slovakia, Slovenia, the Solomon Islands, Somalia, South Africa, South Korea, Spain, Sri Lanka, St. Kitts and Nevis, St. Lucia, St. Vincent and the Grenadines, Suriname, Swaziland, Sweden, Switzerland, Taiwan, Tajikistan, Tanzania, Togo, Tonga, Trinidad and Tobago, Tunisia, Turkey, Turkmenistan, Tuvalu, Uganda, Ukraine, the United Arab Emirates, the United Kingdom, Uruguay, Uzbekistan, Vanuatu, Venezuela, Vietnam, Yemen, Zaire, Zambia, and Zimbabwe	582564-002
Broadcom 4313 BGN 802.11b/g/n WLAN module for use in Antigua and Barbuda, Barbados, Belize, Canada, the Cayman Islands, Guam, Puerto Rico, Trinidad and Tobago, the U.S. Virgin Islands, and the United States	593836-001
Broadcom 4313 BGN 802.11b/g/n WLAN module for use in Afghanistan, Albania, Algeria, Andorra, Angola, Antigua and Barbuda, Argentina, Armenia, Aruba, Australia, Austria, Azerbaijan, the Bahamas, Bahrain, Bangladesh, Barbados, Belarus, Belgium, Belize, Benin, Bermuda, Bhutan, Bolivia, Bosnia and Herzegovina, Botswana, Brazil, the British Virgin Islands, Brunei, Bulgaria, Burkina Faso, Burundi, Cameroon, Cape Verde, the Central African Republic, Chad, Chile, the People's Republic of China, Colombia, Comoros, the Congo, Costa Rica, Croatia, Cyprus, the Czech Republic, Denmark, Djibouti, Dominica, the Dominican Republic, East Timor, Ecuador, Egypt, El Salvador, Equatorial Guinea, Eritrea, Estonia, Ethiopia, Fiji, Finland, France, French Guiana, Gabon, Gambia, Georgia, Germany, Ghana, Gibraltar, Greece, Grenada, Guadeloupe, Guatemala, Guinea, Guinea-Bissau, Guyana, Haiti, Honduras, Hong Kong, Hungary, Iceland, India, Ireland, Israel, Italy, the Ivory Coast, Jamaica, Jordan, Kazakhstan, Kenya, Kiribati, Kyrgyzstan, Laos, Latvia, Lebanon, Lesotho, Liberia, Liechtenstein, Lithuania, Luxembourg, Macedonia, Madagascar, Malawi, Malaysia, the Maldives, Mali, Malta, the Marshall Islands, Martinique, Mauritania, Mauritius, Mexico, Micronesia, Monaco, Mongolia, Montenegro, Morocco, Mozambique, Namibia, Nauru, Nepal, the Nether Antilles, the Netherlands, New Zealand, Nicaragua, Niger, Nigeria, Norway, Oman, Pakistan, Palau, Panama, Papua New Guinea, Paraguay, Peru, the Philippines, Poland, Portugal, the Republic of Moldova, Romania, Russia, Rwanda, Samoa, San Marino, Sao Tome and Principe, Saudi Arabia, Senegal, Serbia, the Seychelles, Sierra Leone, Singapore, Slovakia, Slovenia, the Solomon Islands, Somalia, South Africa, South Korea, Spain, Sri Lanka, St. Kitts and Nevis, St. Lucia, St. Vincent and the Grenadines, Suriname, Swaziland, Sweden, Switzerland, Taiwan, Tajikistan, Tanzania, Togo, Tonga, Trinidad and Tobago, Tunisia, Turkey, Turkmenistan, Tuvalu, Uganda, Ukraine, the United Arab Emirates, the United Kingdom, Uruguay, Uzbekistan, Vanuatu, Venezuela, Vietnam, Yemen, Zaire, Zambia, and Zimbabwe	593836-002

Before removing the WLAN module, follow these steps:

1. Shut down the computer. If you are unsure whether the computer is off or in Hibernation, turn the computer on, and then shut it down through the operating system.
2. Disconnect all external devices connected to the computer.

3. Disconnect the power from the computer by first unplugging the power cord from the AC outlet, and then unplugging the AC adapter from the computer.
4. Remove the battery (see [Battery on page 49](#)).
5. Remove the bottom cover (see [Bottom cover on page 51](#)).

Remove the WLAN module:

1. Turn the computer upside-down, with the front toward you.
2. Disconnect the WLAN antenna cables (1) from the terminals on the WLAN module.

 **NOTE:** The WLAN antenna cable (“Black” tag labelled (1)) is connected to the WLAN module “Main” terminal. The WLAN antenna cable (“White” tag labelled (2)) is connected to the WLAN module “Aux” terminal.

3. Remove the two Phillips PM2.0×3.0 screws (2) that secure the WLAN module to the computer. (The edge of the module opposite the slot rises away from the computer.)
4. Remove the WLAN module (3) by pulling the module away from the slot at an angle.

 **NOTE:** WLAN modules are designed with a notch (4) to prevent incorrect insertion.

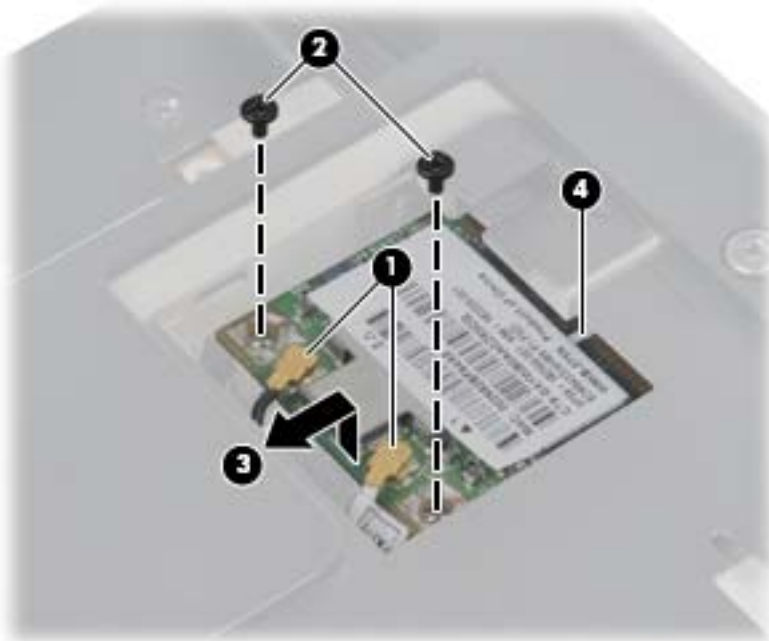

 **NOTE:** If the WLAN antennas are not connected to the terminals on the WLAN module, the protective sleeves must be installed on the antenna connectors, as shown in the following illustration.

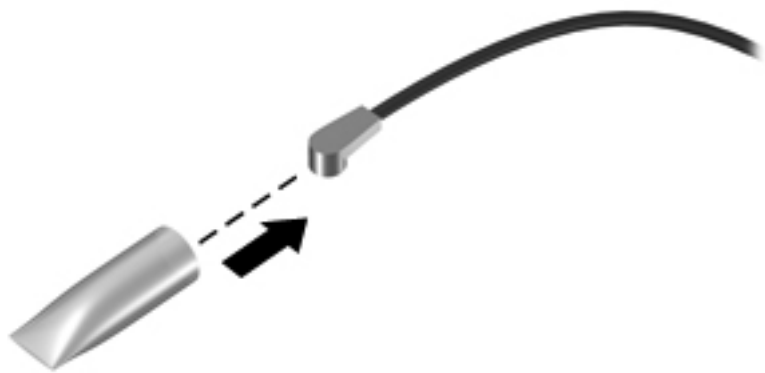

Reverse this procedure to install the WLAN module.

Optical drive



NOTE: All optical drive spare part kits include an optical drive bezel.

Description	Spare part number
DVD±RW SuperMulti DL LightScribe Drive	647673-001
Blu-ray ROM DVD±RW SuperMulti DL LightScribe Drive	647674-001
DVD-ROM Drive	647672-001

Before removing the optical drive, follow these steps:

1. Shut down the computer. If you are unsure whether the computer is off or in Hibernation, turn the computer on, and then shut it down through the operating system.
2. Disconnect all external devices connected to the computer.
3. Disconnect the power from the computer by first unplugging the power cord from the AC outlet, and then unplugging the AC adapter from the computer.
4. Remove the battery (see [Battery on page 49](#)).
5. Remove the bottom cover (see [Bottom cover on page 51](#)).

Remove the optical drive:

1. Position the computer upside-down with the right side toward you.
2. Remove the Phillips PM2.5×12.0 captive screw **(1)** that secures the optical drive to the computer.
3. Push the optical drive tab **(2)** to release the optical drive from the computer.

4. Remove the optical drive **(3)** from the computer.



5. If it is necessary to replace the optical drive bracket, position the optical drive with the rear toward you.
6. Remove the two Phillips PM2.0×3.0 screws **(1)** that secure the optical drive bracket to the optical drive.
7. Remove the optical drive bracket **(2)**.



Reverse this procedure to install an optical drive.

Upgrade bay

Description	Spare part number
320-GB, 7200-rpm, Self-Encrypting Drive (SED)	626978-001
Upgrade bay insert	666230-001

Before removing a drive from the upgrade bay, follow these steps:

1. Shut down the computer. If you are unsure whether the computer is off or in Hibernation, turn the computer on, and then shut it down through the operating system.
2. Disconnect all external devices connected to the computer.
3. Disconnect the power from the computer by first unplugging the power cord from the AC outlet, and then unplugging the AC adapter from the computer.
4. Remove the battery (see [Battery on page 49](#)).
5. Remove the bottom cover (see [Bottom cover on page 51](#)).

Remove the drive from the upgrade bay:

1. Position the computer upside-down, with the front toward you.
2. Remove the four Phillips PM2.0×4.0 screws that secure the hard drive assembly into the upgrade bay.

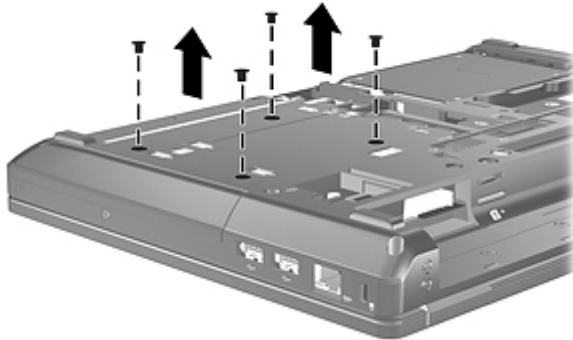

3. Remove the Phillips PM2.5×12.0 captive screw **(1)** that secures the optical drive to the computer.
4. Push the optical drive tab **(2)** to release the drive from the computer.

5. Remove the optical drive **(3)** from the computer.

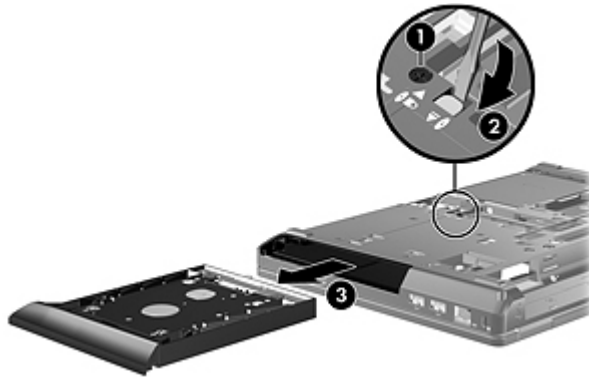

6. Remove the assembly from the base enclosure.

Reverse this procedure to install the hard drive into the upgrade bay.

Hard drive



NOTE: All hard drive spare part kits include a hard drive bracket and screws.

Description	Spare part number
750-GB, 7200-rpm hard drive	633252-001
500-GB, 7200-rpm hard drive	634926-001
320-GB, 7200-rpm hard drive	641672-001
250-GB, 7200-rpm hard drive	635225-001
160-GB solid-state drive (SSD)	649657-001
128-GB solid-state drive (SSD)	649658-001

Before disassembling the computer, follow these steps:

1. Shut down the computer. If you are unsure whether the computer is off or in Hibernation, turn the computer on, and then shut it down through the operating system.
2. Disconnect all external devices connected to the computer.
3. Disconnect the power from the computer by first unplugging the power cord from the AC outlet, and then unplugging the AC adapter from the computer.
4. Remove the battery (see [Battery on page 49](#)).
5. Remove the bottom cover (see [Bottom cover on page 51](#)).

Remove the hard drive:

1. Position the computer upside-down, with the battery bay toward you.
2. Loosen the three Phillips PM2.5×12.0 captive screws **(1)** that secures the hard drive to the computer.
3. Grasp the Mylar tab **(2)** on the hard drive and slide the hard drive to the left to disconnect it from the system board.

4. Use the plastic tab to lift the connector side of the hard drive up at an angle (3) and remove the drive (4) from the hard drive bay.

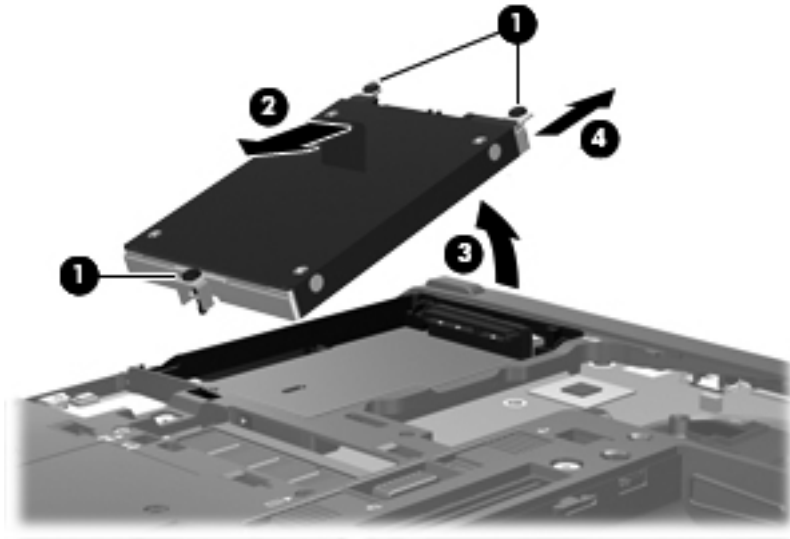

5. If it is necessary to replace the hard drive bracket, remove the four Phillips PM3.0×5.0 hard drive bracket screws (1) from each side of the hard drive.
6. Lift the bracket (2) straight up to remove it from the hard drive.

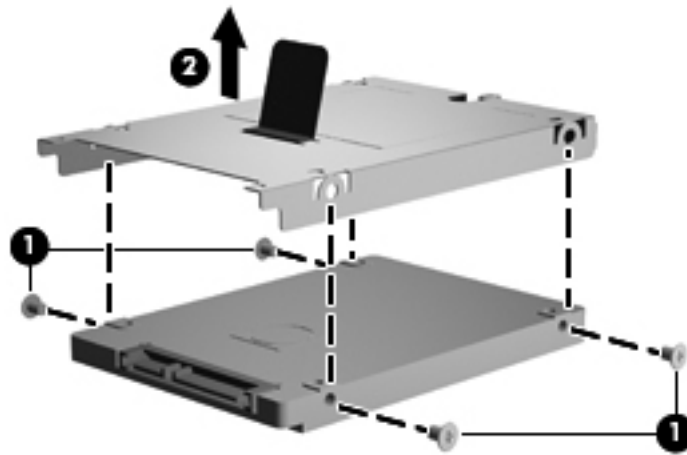

Reverse this procedure to reassemble and install the hard drive.

Bluetooth module

 **NOTE:** The Bluetooth module spare part kit does not include a Bluetooth module cable. The Bluetooth module cable is included in the Cable Kit, spare part number 639473-001. See [Cable Kit on page 30](#) for more Cable Kit spare part number information.

Description	Spare part number
Bluetooth module	537921-001

Before removing the Bluetooth module, follow these steps:

1. Shut down the computer. If you are unsure whether the computer is off or in Hibernation, turn the computer on, and then shut it down through the operating system.
2. Disconnect all external devices connected to the computer.
3. Disconnect the power from the computer by first unplugging the power cord from the AC outlet, and then unplugging the AC adapter from the computer.
4. Remove the battery (see [Battery on page 49](#)).
5. Remove the bottom cover (see [Bottom cover on page 51](#)).

Remove the Bluetooth module:

1. Position the computer upside-down, with the front toward you.
2. Remove the Bluetooth module by lifting it straight up and out of the compartment **(1)** as far as the cable allows.
3. Disconnect the Bluetooth module cable **(2)** from the Bluetooth module.

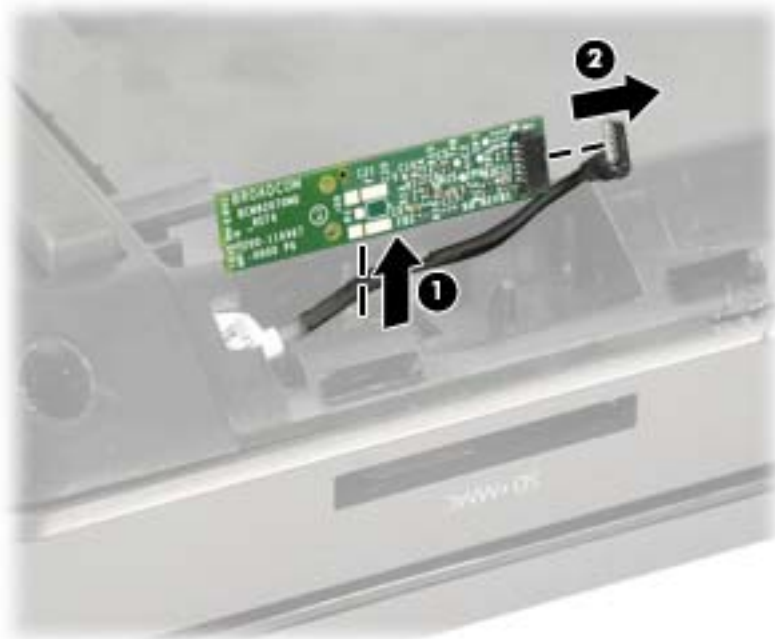

Reverse this procedure to install the Bluetooth module.

Expansion memory modules

 **NOTE:** There are two memory slots. Expansion memory is installed in a compartment containing a single slot (slot 2) on the bottom of the computer and the primary memory is installed in a compartment containing a single slot (slot 1) under the keyboard.

Slot 2 cannot be populated if slot 1 is not populated.

Description	Spare part number
2-GB (PC3-10600, 1333-MHz, DDR3)	621565-001
4-GB (PC3-10600, 1333-MHz, DDR3)	621569-001
8-GB (PC3-10600, 1333-MHz, DDR3)	634091-001

Update BIOS before adding memory modules

Before adding new memory, make sure you update the computer to the latest BIOS.

 **CAUTION:** Failure to update the computer to the latest BIOS prior to installing new memory may result in various system problems.

To update BIOS:

1. Navigate to www.hp.com.
2. Click **Support & Drivers** > click **Drivers & Software**.
3. In the **Enter a product name/number** box, type the computer model information, and then click **Search**.
4. Click the link for the computer model.
5. Select the operating system, and then click **Next**.
6. Under **Step 2: Select a Download**, click the **BIOS** link.
7. Click the link for the most recent BIOS.
8. Click the **Download** button, and then follow the on-screen instructions.

Before removing the memory module, follow these steps:

1. Shut down the computer. If you are unsure whether the computer is off or in Hibernation, turn the computer on, and then shut it down through the operating system.
2. Disconnect all external devices connected to the computer.
3. Disconnect the power from the computer by first unplugging the power cord from the AC outlet, and then unplugging the AC adapter from the computer.
4. Remove the battery (see [Battery on page 49](#)).
5. Remove the bottom cover (see [Bottom cover on page 51](#)).

Remove the expansion memory module:

1. Position the computer upside-down, with the front toward you.
2. Spread the retaining tabs **(1)** on each side of the expansion memory module slot to release the memory module. (The edge of the module opposite the slot rises away from the computer.)
3. Remove the expansion memory module **(2)** by pulling the module away from the slot at an angle.

 **NOTE:** Memory modules are designed with a notch **(3)** to prevent incorrect insertion into the memory module slot.

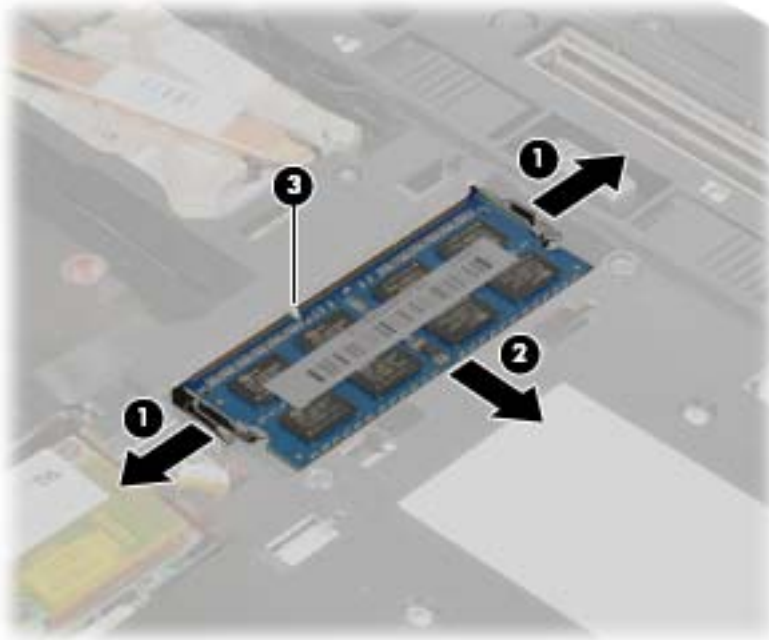

Reverse this procedure to install an expansion memory module.

Keyboard

For use in:	Spare part number	For use in:	Spare part number
Keyboards with pointing stick (includes pointing stick cable):			
Belgium	639478-A41	Latin America	639478-161
Brazil	639478-201	The Netherlands and Europe	639478-B31
Bulgaria	639478-261	Norway	639478-091
Czech Republic and Slovakia	639478-A81	Portugal	639478-131
Denmark	639478-081	Russia	639478-251
France	639478-051	Saudi Arabia	639478-171
French Canada	639478-121	Slovenia	639478-BA1
Germany	639478-041	Spain	639478-071
Greece	639478-DJ1	Sweden and Finland	639478-B71
Hungary	639478-211	Switzerland	639478-BG1
Iceland	639478-DD1	Taiwan	639478-AB1
Israel	639478-BB1	Thailand	639478-281
Italy	639478-061	Turkey	639478-141
Japan	639478-291	The United Kingdom	639478-031
South Korea	639478-AD1	The United States	639478-001

Before removing the keyboard, follow these steps:

1. Shut down the computer. If you are unsure whether the computer is off or in Hibernation, turn the computer on, and then shut it down through the operating system.
2. Disconnect all external devices connected to the computer.
3. Disconnect the power from the computer by first unplugging the power cord from the AC outlet, and then unplugging the AC adapter from the computer.
4. Remove the battery (see [Battery on page 49](#)).

Remove the keyboard:

1. Turn the computer upside-down, with the rear toward you.
2. Loosen the three Phillips PM2.5×12.0 captive screws **(1)** that secure the keyboard to the computer.

3. Release the keyboard by pressing down on the keyboard release cut-out **(2)**.

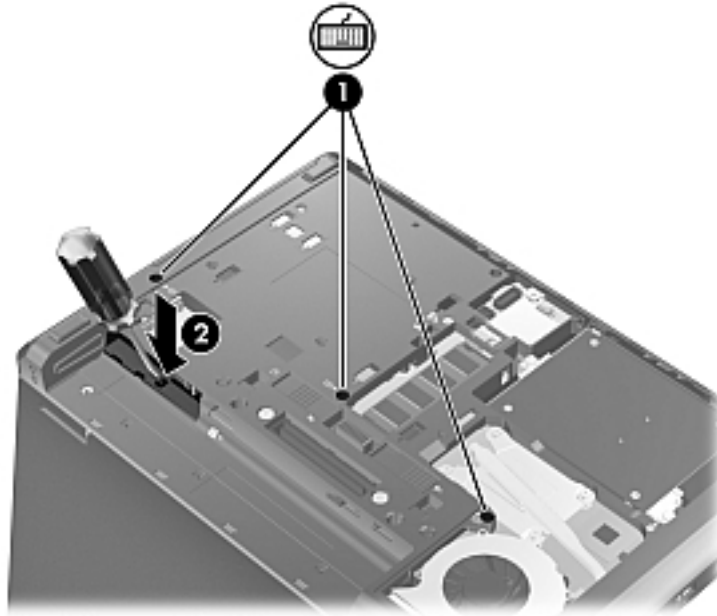

4. Turn the computer right-side up, with the front toward you.
5. Open the computer as far as possible.
6. Lift the top edge of the keyboard, and then rotate the keyboard forward until it rests upside-down on top of the TouchPad.



7. Release the zero insertion force (ZIF) connector to which the keyboard cable **(1)** is attached, and then disconnect the keyboard cable from the system board.

8. Release the ZIF connector to which the pointing stick cable (2) is attached, and then disconnect the pointing stick cable from the system board.

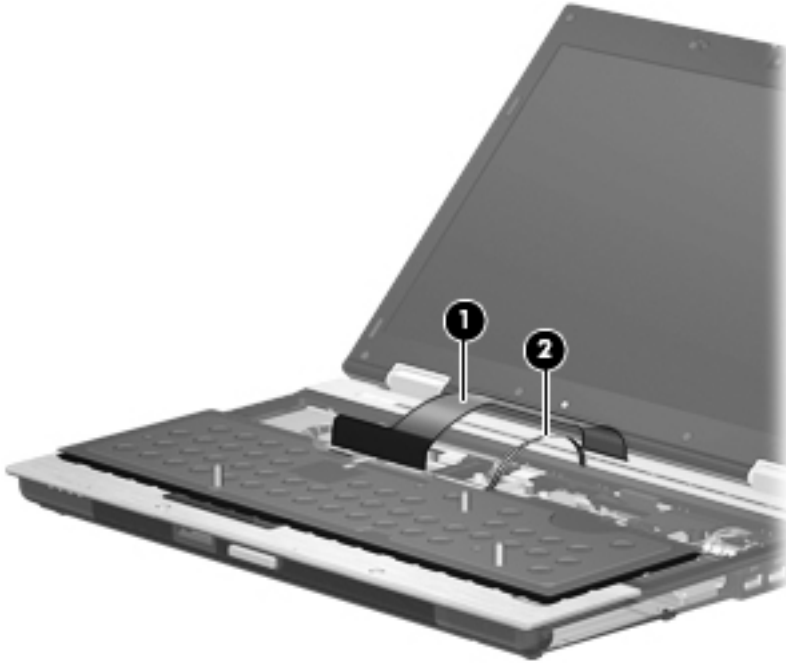

9. Remove the keyboard.

Reverse this procedure to install the keyboard.

WWAN module

 **CAUTION:** The WWAN module and the WLAN module are not interchangeable.

 **NOTE:** Ericsson modules are only available in EMEA on certain computers.

Description	Spare part number
HP F5521 Broadband Module (WWAN)	632155-001
HP un2430 EV-DO/HSPA Mobile Broadband Module	634400-001

Before removing the WWAN module, follow these steps:

1. Shut down the computer. If you are unsure whether the computer is off or in Hibernation, turn the computer on, and then shut it down through the operating system.
2. Disconnect all external devices connected to the computer.
3. Disconnect the power from the computer by first unplugging the power cord from the AC outlet, and then unplugging the AC adapter from the computer.
4. Remove the battery (see [Battery on page 49](#)).
5. Remove the SIM (see [SIM on page 50](#)).
6. Remove the keyboard (see [Keyboard on page 65](#)).

Remove the WWAN module:

1. Disconnect the WWAN antenna cables **(1)** from the terminals on the WWAN module.

 **NOTE:** The WWAN antenna cable (“Red” tag labelled **(5)**) is connected to the WWAN module “Main” terminal. The WWAN antenna cable (“Blue” tag labelled **(6)**) is connected to the WWAN module “Aux” terminal.

There are two different WWAN modules available, and each module has the antenna connectors reversed.

2. Remove the two Phillips PM2.5×3.0 screws **(2)** that secure the WWAN module to the computer. (The edge of the module opposite the slot rises away from the computer.)

3. Remove the WWAN module (3) by pulling the module away from the slot at an angle.

 **NOTE:** WWAN modules are designed with a notch (4) to prevent incorrect insertion.

Figure 4-1 Ericsson module antenna locations

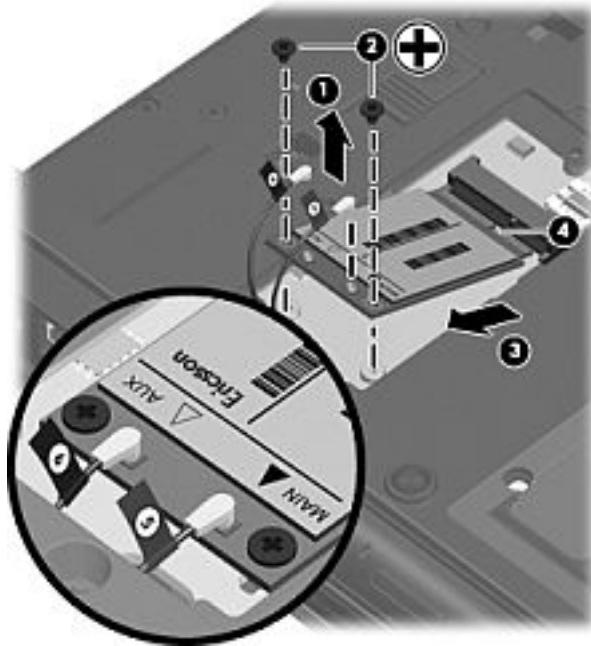
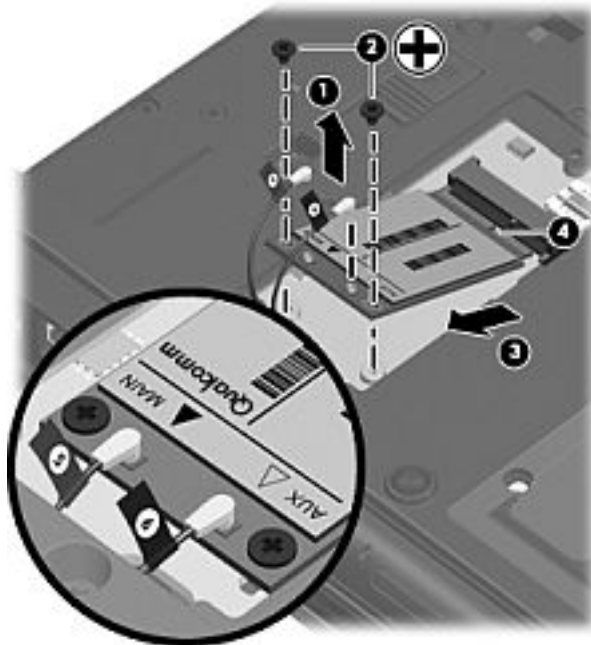

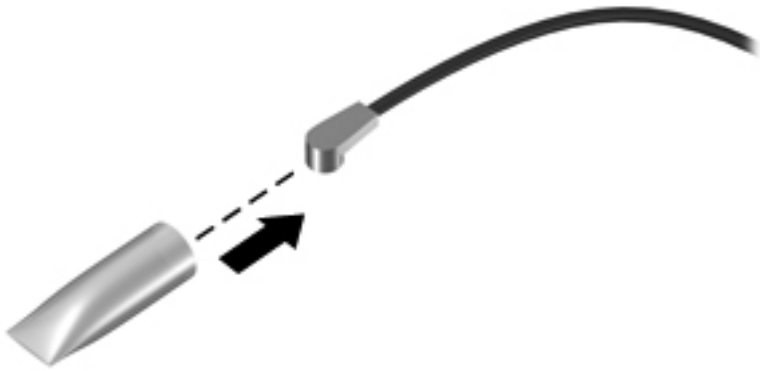

Figure 4-2 Qualcomm module antenna locations



 **NOTE:** If the WWAN antennas are not connected to the terminals on the WWAN module, the protective sleeves must be installed on the antenna connectors, as shown in the following illustration.



Reverse this procedure to install the WWAN module.

Modem module

 **NOTE:** The modem module spare part kit does not include a modem module cable. The modem module cable is included in the Cable Kit, spare part number 639473-001. See [Cable Kit on page 30](#) for more Cable Kit spare part number information.

Description	Spare part number
Modem module for use in all countries and regions	628824-001

Before removing the modem module, follow these steps:

1. Shut down the computer. If you are unsure whether the computer is off or in Hibernation, turn the computer on, and then shut it down through the operating system.
2. Disconnect all external devices connected to the computer.
3. Disconnect the power from the computer by first unplugging the power cord from the AC outlet, and then unplugging the AC adapter from the computer.
4. Remove the battery (see [Battery on page 49](#)).
5. Remove the bottom cover (see [Bottom cover on page 51](#)).

Remove the modem module:

1. Position the computer upside-down, with the front toward you.
2. Remove the Phillips PM2.0×3.0 screws **(1)** that secure the modem module to the system board.
3. Disconnect the modem module **(2)** from the system board by lifting it straight up.

4. Disconnect the modem module cable (3) from the modem module.

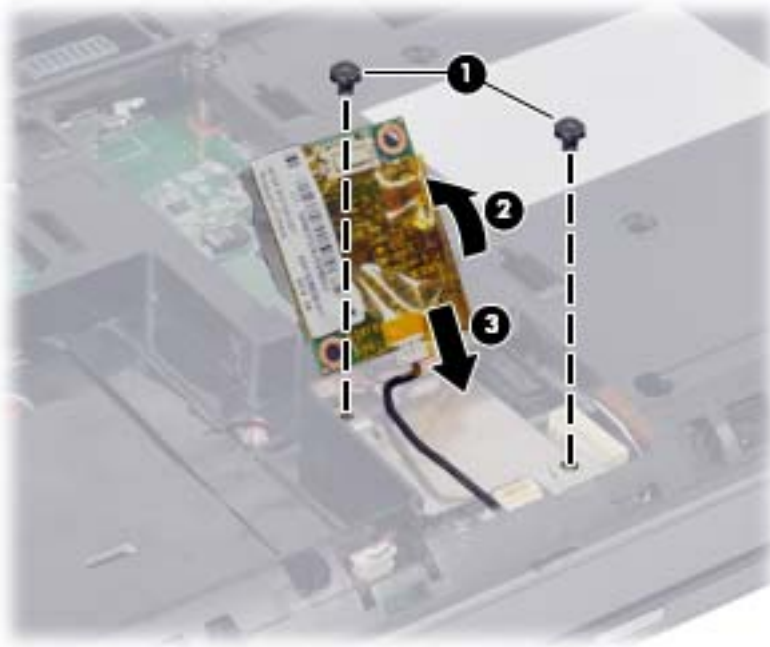

Reverse this procedure to install the modem module.

Primary memory module

 **NOTE:** There are two memory slots. Expansion memory is installed in a compartment containing a single slot (slot 2) on the bottom of the computer and the primary memory is installed in a compartment containing a single slot (slot 1) under the keyboard.

Slot 2 cannot be populated if slot 1 is not populated.

Description	Spare part number
2-GB (PC3-10600, 1333-MHz, DDR3)	621565-001
4-GB (PC3-10600, 1333-MHz, DDR3)	621569-001
8-GB (PC3-10600, 1333-MHz, DDR3)	634091-001

Update BIOS before adding memory modules

Before adding new memory, make sure you update the computer to the latest BIOS.

 **CAUTION:** Failure to update the computer to the latest BIOS prior to installing new memory may result in various system problems.

To update BIOS:

1. Navigate to www.hp.com.
2. Click **Support & Drivers** > click **Drivers & Software**.
3. In the **Enter a product name/number** box, type the computer model information, and then click **Search**.
4. Click the link for the computer model.
5. Select the operating system, and then click **Next**.
6. Under **Step 2: Select a Download**, click the **BIOS** link.
7. Click the link for the most recent BIOS.
8. Click the **Download** button, and then follow the on-screen instructions.

Before removing the primary memory module, follow these steps:

1. Shut down the computer. If you are unsure whether the computer is off or in Hibernation, turn the computer on, and then shut it down through the operating system.
2. Disconnect all external devices connected to the computer.
3. Disconnect the power from the computer by first unplugging the power cord from the AC outlet, and then unplugging the AC adapter from the computer.
4. Remove the battery (see [Battery on page 49](#)).
5. Remove the keyboard (see [Keyboard on page 65](#)).

Remove the primary memory module:

1. Spread the retaining tabs **(1)** on each side of the primary memory module slot to release the memory module. (The edge of the module opposite the slot rises away from the computer.)
2. Remove the primary memory module **(2)** by pulling the module away from the slot at an angle.

 **NOTE:** Memory modules are designed with a notch **(3)** to prevent incorrect insertion into the memory module slot.

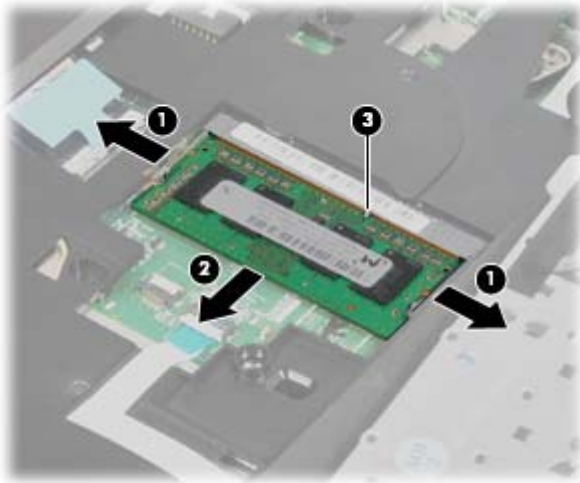

Reverse this procedure to install a primary memory module.

Fan

Description	Spare part number
Fan	639474-001

Before removing the fan, follow these steps:

1. Shut down the computer. If you are unsure whether the computer is off or in Hibernation, turn the computer on, and then shut it down through the operating system.
2. Disconnect all external devices connected to the computer.
3. Disconnect the power from the computer by first unplugging the power cord from the AC outlet, and then unplugging the AC adapter from the computer.
4. Remove the battery (see [Battery on page 49](#)).
5. Remove the bottom cover (see [Bottom cover on page 51](#)).

Remove the fan:

1. Turn the computer upside-down, with the front toward you.
2. Disconnect the fan cable (1) from the system board.
3. Remove the two Phillips PM 2.5x5.0 screws (2) that secure the fan to the base enclosure.
4. Lift the fan (3) from the base enclosure.

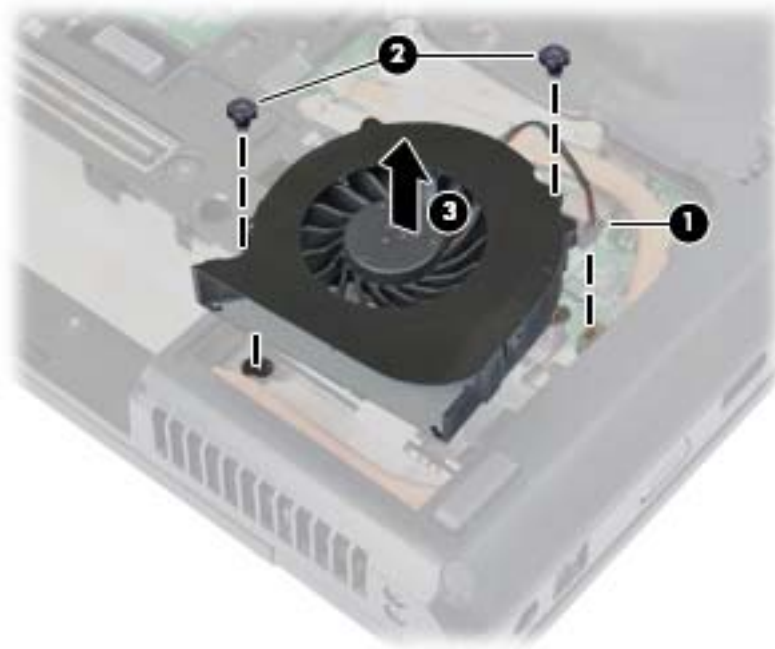

Reverse this procedure to install the fan.

 **NOTE:** To properly ventilate the computer, allow at least a 7.6-cm (3-in) clearance on the left side of the computer.

The computer uses an electric fan for ventilation. The fan is controlled by a temperature sensor and is designed to turn on automatically when high temperature conditions exist. These conditions are affected by high external temperatures, system power consumption, power management/battery conservation configurations, battery fast charging, and software requirements. Exhaust air is displaced through the ventilation grill located on the left side of the computer.

Heat sink

All heat sink spare part kits include replacement thermal material.

Description	Spare part number
Heat sink (does not include fan)	639475-001 or
NOTE: If 639475-001 is not available, use 661525-001.	661525-001

Before removing the heat sink, follow these steps:

1. Shut down the computer. If you are unsure whether the computer is off or in Hibernation, turn the computer on, and then shut it down through the operating system.
2. Disconnect all external devices connected to the computer.
3. Disconnect the power from the computer by first unplugging the power cord from the AC outlet, and then unplugging the AC adapter from the computer.
4. Remove the battery (see [Battery on page 49](#)).
5. Remove the following components:
 - a. Remove the bottom cover (see [Bottom cover on page 51](#)).
 - b. Fan (see [Fan on page 74](#)).

Remove the heat sink:

1. Turn the computer upside-down, with the front toward you.

2. Remove the four Torx T8M2.0x8.0 screws (1) that secure the heat sink to the base enclosure.



3. Lift the right side of the heat sink (1) to disengage it from the system board.
4. Rotate and lift the heat sink counter-clockwise (2) to clear the base enclosure, and then remove it from the computer.

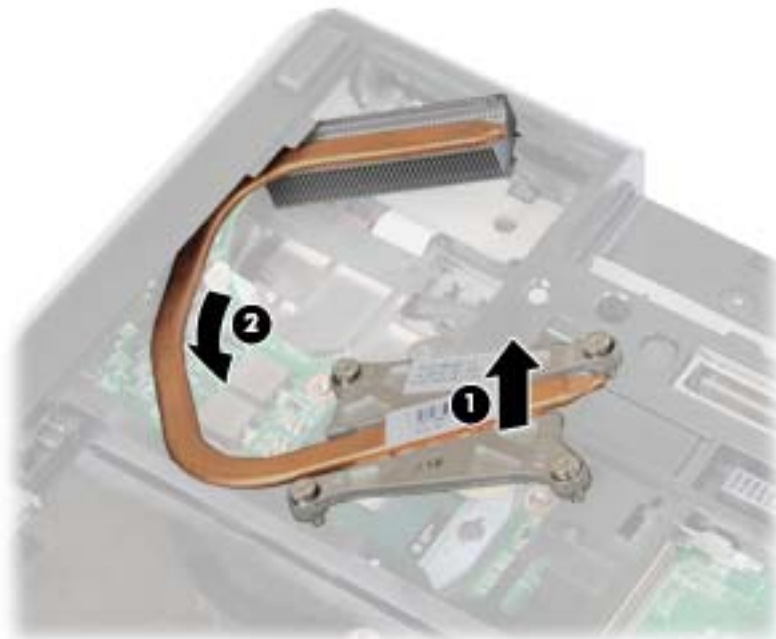

 **NOTE:** The thermal material must be thoroughly cleaned from the surfaces of the heat sink (1) each time the heat sink is removed. Thermal material is included with all heat sink and processor spare part kits.

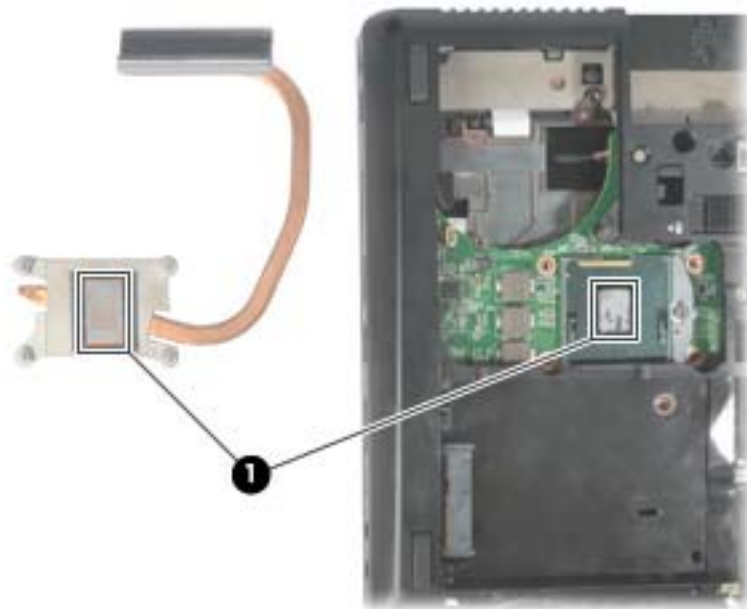

Reverse this procedure to install the heat sink.

Processor

 **NOTE:** All processor spare part kits include replacement thermal material.

Description	Spare part number
Intel Core i7 processor, Dual Core	
2nd Generation Intel Core i7-2620M, 2.70GHz (Turbo up to 3.40GHz) 4MB L3 Cache, 4 threads	631252-001
Intel Core i5 processors, Dual Core	
2nd Generation Intel Core i5-2540M, 2.60-GHz (Turbo up to 3.30) processor 3-MB L3 cache, 4 threads	631255-001
2nd Generation Intel Core i5-2520M, 2.50-GHz (Turbo up to 3.20) processor 3-MB L3 cache, 4 threads	631253-001
2nd Generation Intel Core i5-2410M, 2.30-GHz (Turbo up to 2.90) processor 3-MB L3 cache, 4 threads	638039-001
Intel Core i3 processors, Dual Core	
Intel Core i3-2330M, 2.20-GHz processor 3-MB L3 cache, 4 threads	653339-001
Intel Core i3-2310M, 2.10-GHz processor 3-MB L3 cache, 4 threads	638037-001
Intel Celeron processor	
Celeron B810, 1.60GHz, 2MB L3 Cache, 2 threads	646760-001

Before removing the processor, follow these steps:

1. Shut down the computer. If you are unsure whether the computer is off or in Hibernation, turn the computer on, and then shut it down through the operating system.
2. Disconnect all external devices connected to the computer.
3. Disconnect the power from the computer by first unplugging the power cord from the AC outlet, and then unplugging the AC adapter from the computer.
4. Remove the battery (see [Battery on page 49](#)).
5. Remove the following components:
 - a. Keyboard (see [Keyboard on page 65](#))
 - b. Remove the bottom cover (see [Bottom cover on page 51](#)).
 - c. Fan (see [Fan on page 74](#)).
 - d. Heat sink (see [Heat sink on page 75](#)).

Remove the processor:

1. Turn the computer upside-down, with the front toward you.
2. Use a flat-bladed screwdriver to turn the processor locking screw **(1)** one-half turn counterclockwise until you hear a click.
3. Lift the processor **(2)** straight up and remove it.

 **NOTE:** The gold triangle **(3)** on the processor must be aligned with the triangle **(4)** embossed on the processor slot when you install the processor.

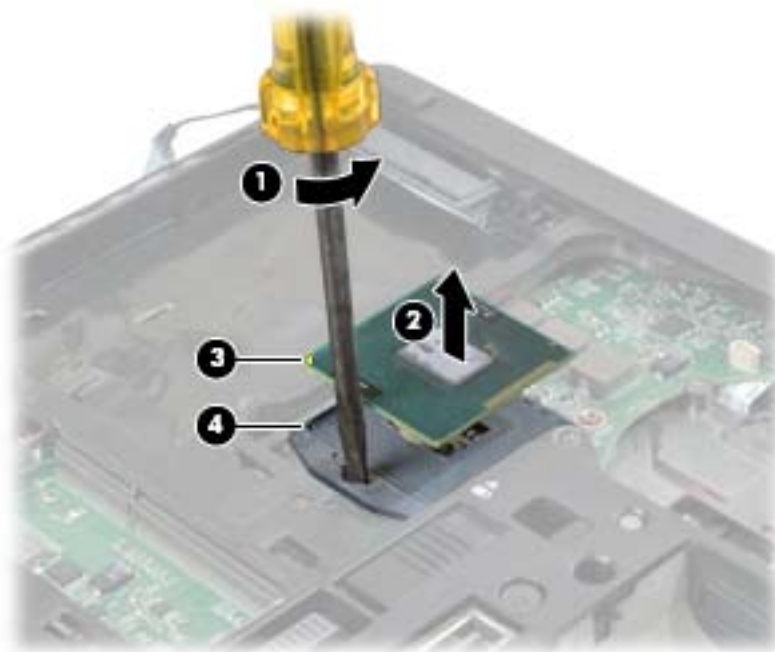

Reverse this procedure to install the processor.

Base enclosure

Description	Spare part number
Base enclosure	639468-001

Before removing the base enclosure, follow these steps:

1. Shut down the computer. If you are unsure whether the computer is off or in Hibernation, turn the computer on, and then shut it down through the operating system.
2. Disconnect all external devices connected to the computer.
3. Disconnect the power from the computer by first unplugging the power cord from the AC outlet, and then unplugging the AC adapter from the computer.
4. Remove the battery (see [Battery on page 49](#)).
5. Disconnect the wireless antenna cables from the WLAN module (see [WLAN module on page 52](#)) and the WWAN module (see [WWAN module on page 68](#)).
6. Remove the keyboard (see [Keyboard on page 65](#)).
7. Remove the fan (see [Fan on page 74](#)).
8. Remove the heat sink (see [Heat sink on page 75](#)).

Remove the base enclosure:

1. Position the computer right-side up, with the front toward you.
2. Remove the Two Torx T8M2.5×7.0 screws from under the keyboard.

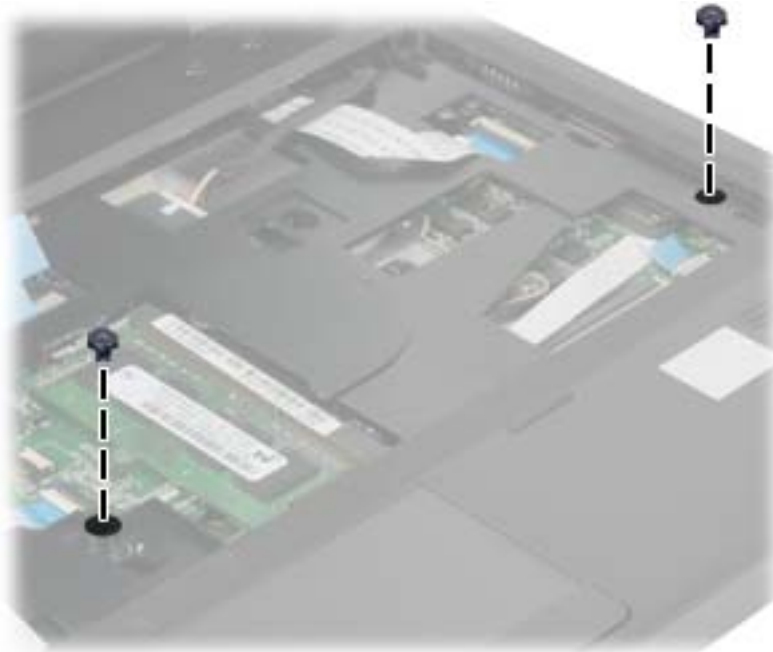

3. Position the computer right-side up, with the rear toward you.

4. Remove the Four Torx T8M2.5×7.0 screws from the back of the unit that secure the display assembly to the computer.



5. Position the computer upside-down, with the front toward you.
6. Remove the following covers and Torx screws:
 - (1) Four rubber screw covers
 - (2) Eight Torx T8M2.5×7.0 screws

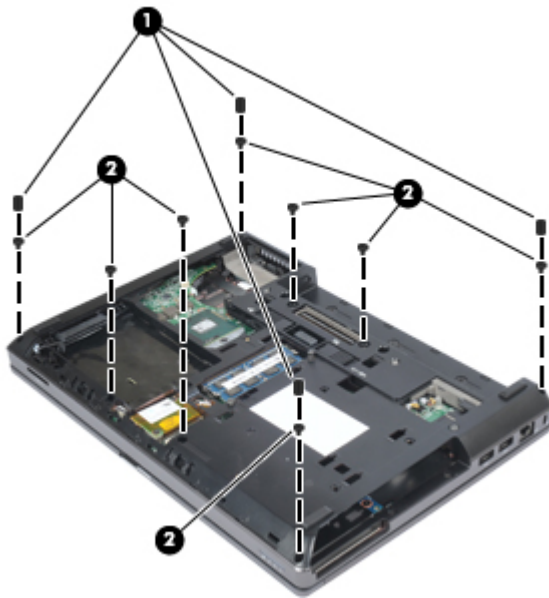

7. Remove the following Phillips screws:
 - (1) Three Phillips PM2.0×3.0bh screws in the battery bay
 - (2) Two Phillips PM2.0×3.0 screws in the ODD drive bay

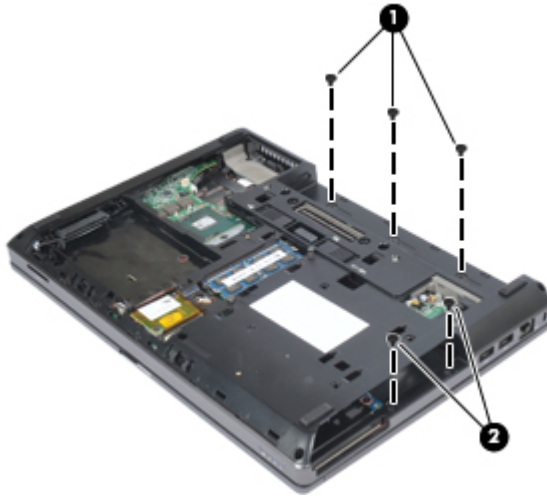

8. Lift the base enclosure (1) up and forward.
9. Disconnect the speaker cable (2).
10. Remove the base enclosure.

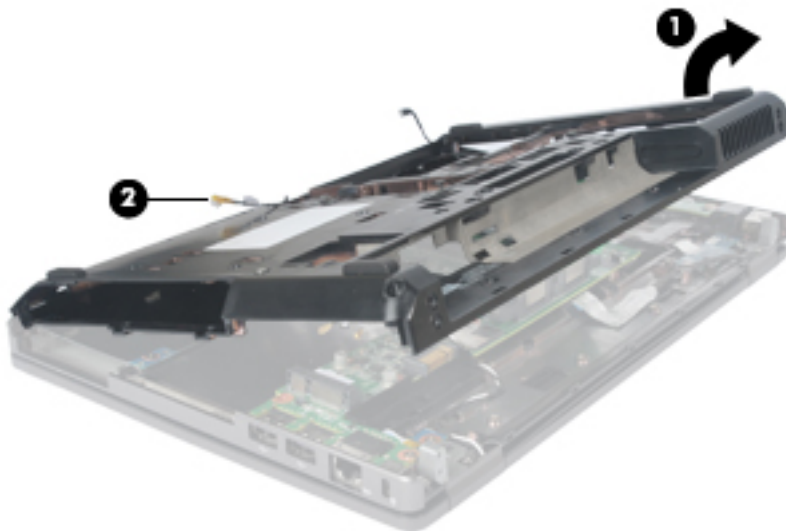

⚠ CAUTION: When installing the base enclosure, be sure that the wireless antenna cables routed out of the display assembly are routed and arranged properly.

Failure to follow these routing instructions can result in degradation of the computer's WLAN and WWAN performance.

Reverse this procedure to reassemble and install the base enclosure.

Speaker assembly

Description	Spare part number
Speaker assembly (kit)	639484-001

Before removing the speaker assembly, follow these steps:

1. Shut down the computer. If you are unsure whether the computer is off or in Hibernation, turn the computer on, and then shut it down through the operating system.
2. Disconnect all external devices connected to the computer.
3. Disconnect the power from the computer by first unplugging the power cord from the AC outlet, and then unplugging the AC adapter from the computer.
4. Remove the battery (see [Battery on page 49](#)).
5. Remove the following components:
 - a. Hard drive (see [Hard drive on page 60](#))
 - b. Optical drive (see [Optical drive on page 56](#))
 - c. Keyboard (see [Keyboard on page 65](#))
 - d. Fan (see [Fan on page 74](#))
 - e. Heat sink (see [Heat sink on page 75](#))
 - f. Base enclosure (see [Base enclosure on page 79](#)).

Remove the speaker assembly:

1. Position the base enclosure upside-down, with the front toward you.

2. Remove the Bluetooth cable (1) by unplugging it from the system board (2).

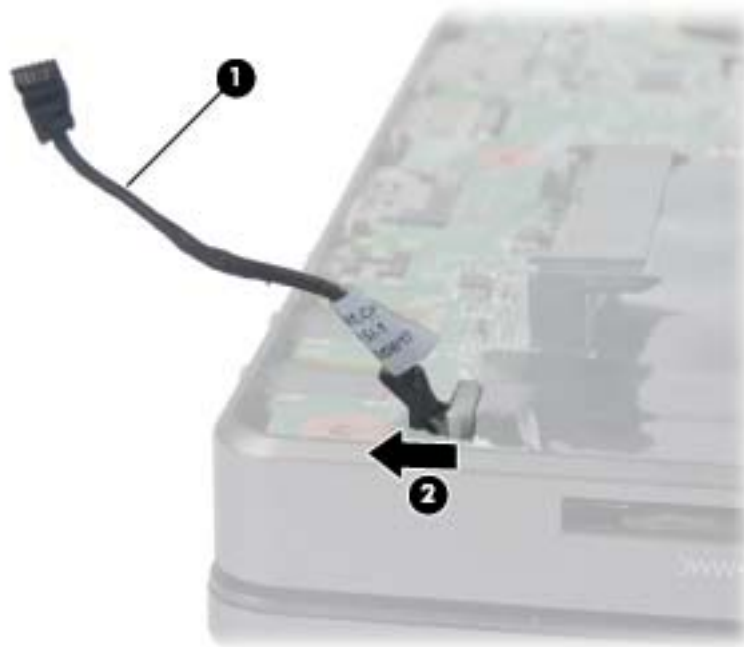

3. Remove the two Phillips PM2.5×5.0 screws (1) that secure the speaker assembly to the base enclosure.
4. Remove the tape (2) from the speaker cable.
5. Slide the large speaker to the left (3) until the cutout in the speaker lines-up with the metal clip.
6. Remove the speaker assembly (4) from the base enclosure.

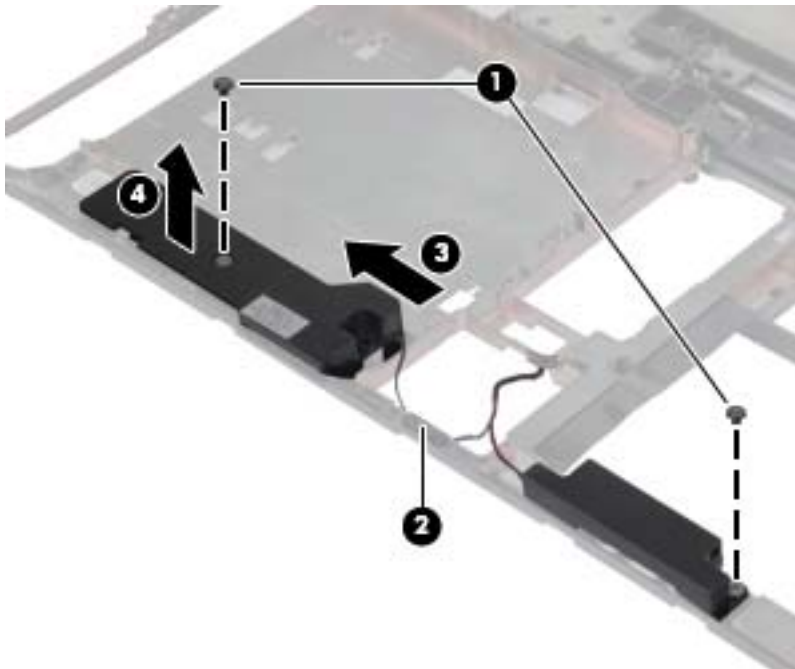

Reverse this procedure to install the speaker assembly.

Display assembly

All display assemblies include 2 WLAN antenna transceivers and cables, and 2 WWAN antenna transceivers and cables (select models only).

A Display Panel Support Kit is available using spare part number 657833-001. The kit includes:

- WLAN antennas
- WWAN antennas
- Camera cable
- Display panel rear cover

Before removing the display assembly, follow these steps:

1. Shut down the computer. If you are unsure whether the computer is off or in Hibernation, turn the computer on, and then shut it down through the operating system.
2. Disconnect all external devices connected to the computer.
3. Disconnect the power from the computer by first unplugging the power cord from the AC outlet, and then unplugging the AC adapter from the computer.
4. Remove the battery (see [Battery on page 49](#)).
5. Disconnect the wireless antenna cables from the WLAN module (see [WLAN module on page 52](#)) and the WWAN module (see [WWAN module on page 68](#)).
6. Remove the keyboard (see [Keyboard on page 65](#)).
7. Remove the base enclosure (see [Base enclosure on page 79](#)).

Remove the display assembly:

1. Position the computer right-side up, with the front toward you.
2. Disconnect the display panel cable **(1)** from the system board **(2)**.

3. Push the display panel cable through the pass-thru cutout in the base enclosure (3).

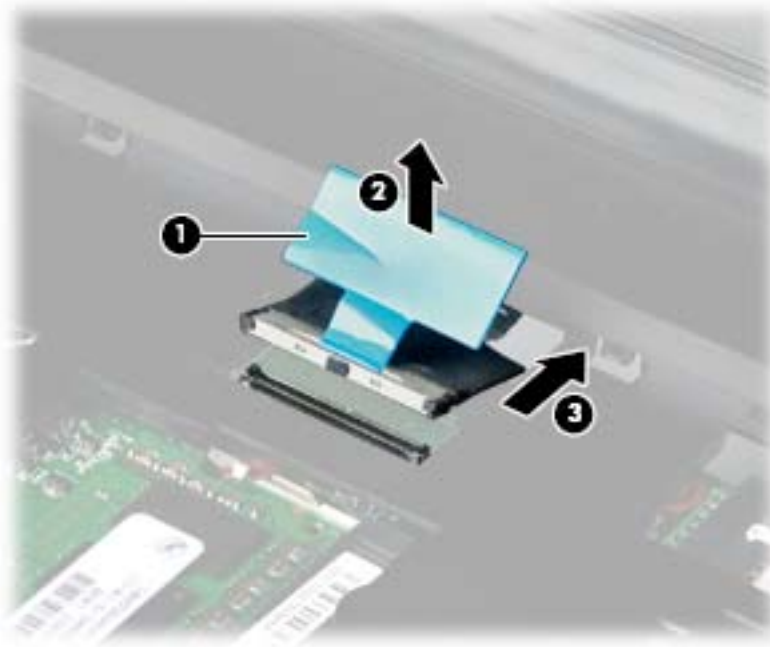

4. Position the computer upside-down, with the front toward you.

5. Remove the following:

(1) Display panel cable and tape from top cover

(2) Display panel cable from clips in top cover

(3) Two WLAN cables from routing out of hole in top cover and clips in upper right side of top cover

(4) Two WLAN cables and tape from top cover

(5) Two WLAN cables from clips in top cover

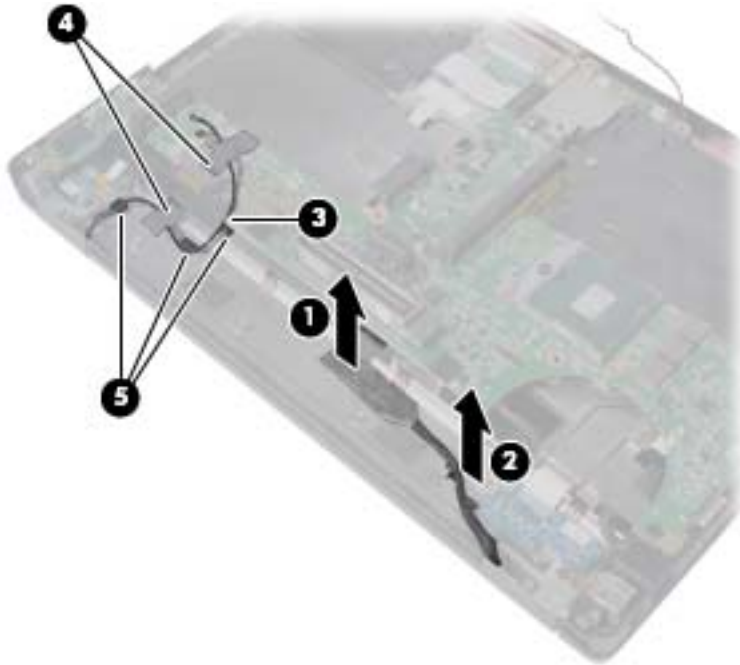

6. Turn the computer right-side up, with the front toward you.

7. Pull the display assembly out away from the base enclosure and lift the display assembly **(1)** straight up and remove it.



⚠ CAUTION: When installing the display assembly, be sure that the wireless antenna cables routed out of the display right hinge are routed and arranged properly.

Failure to follow these routing instructions can result in degradation of the computer's WLAN and WWAN performance.

8. If it is necessary to replace the display bezel or display hinges, remove the following:
 - (1) Two rubber screw covers on the display bezel bottom edge
 - (2) Two Phillips PM2.5×5.0 screws on the display bezel bottom edge



9. Flex the top of the bezel, the inside edges of the left and right sides **(1)**, and then the top and bottom **(2)** of the bezel until it disengages from the display enclosure.

10. Remove the display bezel (3). The display bezel is available using spare part numbers 639469-001 (for use with computer models with a webcam), and 639470-001 (for use with computer models equipped without a webcam).



11. If it is necessary to replace the webcam module from the display enclosure, disconnect the webcam cable from the module (1), gently pull the webcam module away from the double-sided tape on the display enclosure (2), and then remove the webcam (3). The webcam module is available using spare part number 641735-001.

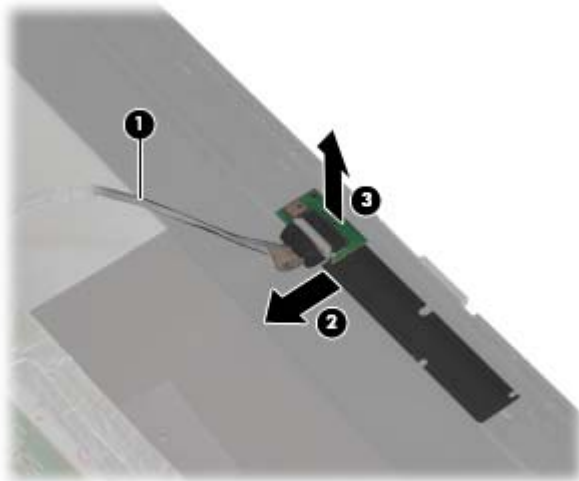

12. If it is necessary to replace the display panel, remove the six Phillips PM2.5×5.0 screws (1) that secure the display panel to the display enclosure, four screws on the bottom and two screws on the top.
13. Remove the display panel (2) from the display panel back cover.
14. Disconnect the webcam/microphone cable (3) from the display assembly.

15. Remove the display panel (4). The display panel is available using spare part number 647671-001.

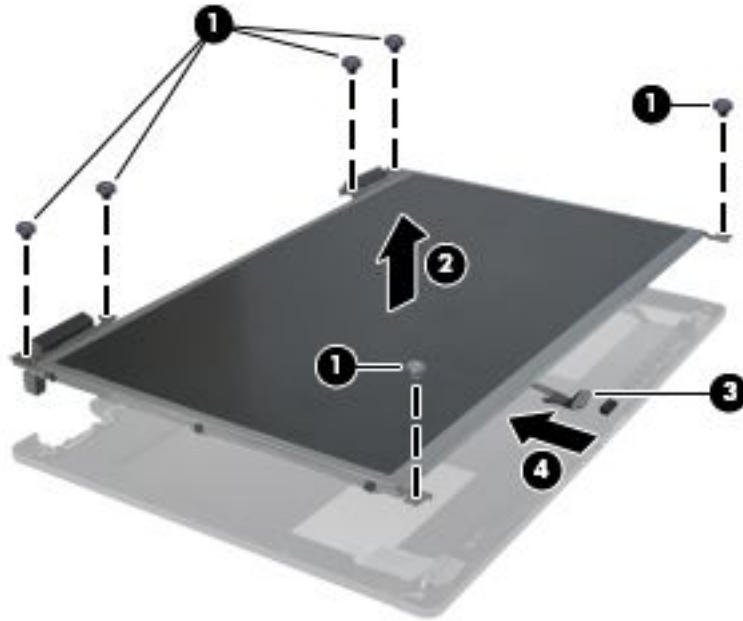

16. If it is necessary to remove the display panel cable, remove the tape (1) covering the display panel cable along with the cable from the back of the display. Disconnect the video board cable (2). Also, it is necessary to disconnect the webcam/microphone cable and tape that secures this cable to the display, and then lift the cable and tape away from the display panel (3). The display panel cable is in the Display Panel Cable Kit, spare part number 639471-001 (with webcam) or 639472-001 (without webcam).

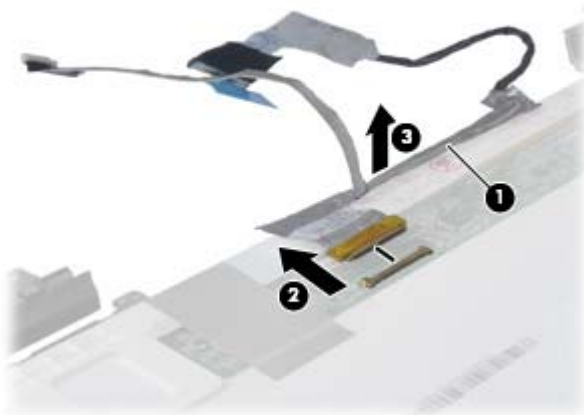

17. If it is necessary to replace the display hinges, remove the six Phillips PM2.5×3.0 screws (1) that secure each display hinge to the display panel.

18. If it is necessary to remove the WWAN antenna transceivers (1) and cables, remove them from the display enclosure back cover by lifting them (2) from the clips in the display enclosure back cover.

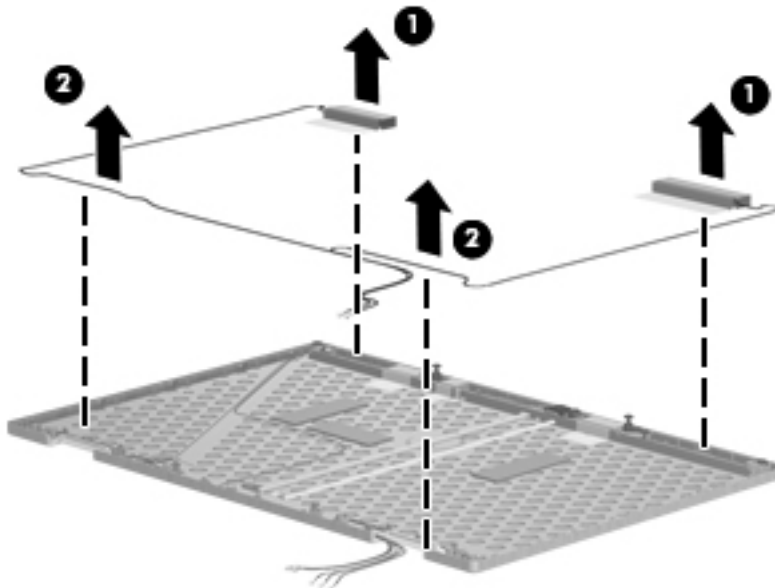

19. If it is necessary to remove the WLAN antenna transceivers (1) and cables, remove them from the display enclosure back cover by lifting them (2) from the clips in the display enclosure back cover.

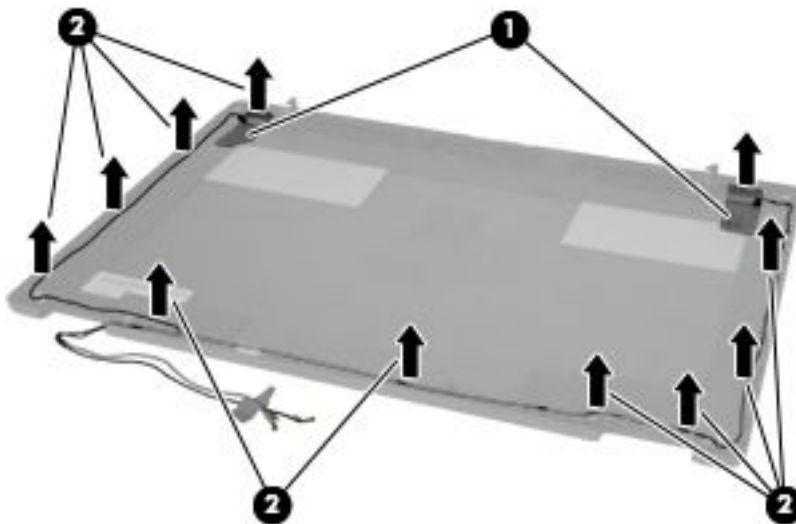

20. If it is necessary to replace the display panel hinges, remove the six Phillips PM2.0×3.0 screws (1) that secure the display panel hinges to the display panel, three screws on the left and three screws on the right.

21. Remove the display hinges (2). The left and right display hinges are available using spare part number 639476-001.



Reverse this procedure to reassemble and install the display assembly.

System board

 **NOTE:** All system board spare part kits include replacement thermal material.

Description	Spare part number
System board (HM65 includes WWAN and RTC battery) for use in all countries and regions except for Russia and China	641733-001
System board (HM65 includes WWAN and RTC battery) for use in Russia and China	650161-001
System board (HM65 includes RTC battery) for use in all countries and regions except for Russia and China	643216-001
System board (HM65 includes RTC battery) for use in Russia and China	650163-001
System board (QM67 includes RTC battery) for use in all countries and regions except for Russia and China	641734-001
System board (QM67 includes RTC battery) for use in Russia and China	650162-001

Before removing the system board, follow these steps:

1. Shut down the computer. If you are unsure whether the computer is off or in Hibernation, turn the computer on, and then shut it down through the operating system.
2. Disconnect all external devices connected to the computer.
3. Disconnect the power from the computer by first unplugging the power cord from the AC outlet, and then unplugging the AC adapter from the computer.

4. Remove the battery (see [Battery on page 49](#)).
5. Remove the following components:
 - a. Hard drive (see [Hard drive on page 60](#))
 - b. Optical drive (see [Optical drive on page 56](#))
 - c. Keyboard (see [Keyboard on page 65](#))
 - d. Modem module (see [Modem module on page 70](#))
 - e. Fan (see [Fan on page 74](#))
 - f. Heat sink (see [Heat sink on page 75](#))
 - g. Base enclosure (see [Base enclosure on page 79](#))
 - h. Display assembly (see [Display assembly on page 84](#))

When replacing the system board, be sure that the following components are removed from the defective system board and installed on the replacement system board:

- SIM (see [SIM on page 50](#))
- Primary memory module (see [Primary memory module on page 72](#))
- Expansion memory module (see [Expansion memory modules on page 63](#))
- WLAN module (see [WLAN module on page 52](#))
- WWAN module (see [WWAN module on page 68](#))
- Processor (see [Processor on page 77](#))

Remove the system board:

1. Position the top cover right-side up, with the front toward you.
2. Disconnect the power button cable **(1)** swinging ZIF connector from the system board **(2)**.
3. Disconnect the TouchPad cable **(3)** swinging ZIF connector from the system board **(4)**.
4. Disconnect the wireless/web/mute function board cable **(5)** swinging ZIF connector from the system board **(6)**.
5. Disconnect the fingerprint reader cable **(7)** swinging ZIF connector from the system board **(8)**.

6. Disconnect the power connector cable (9) from the system board (10).

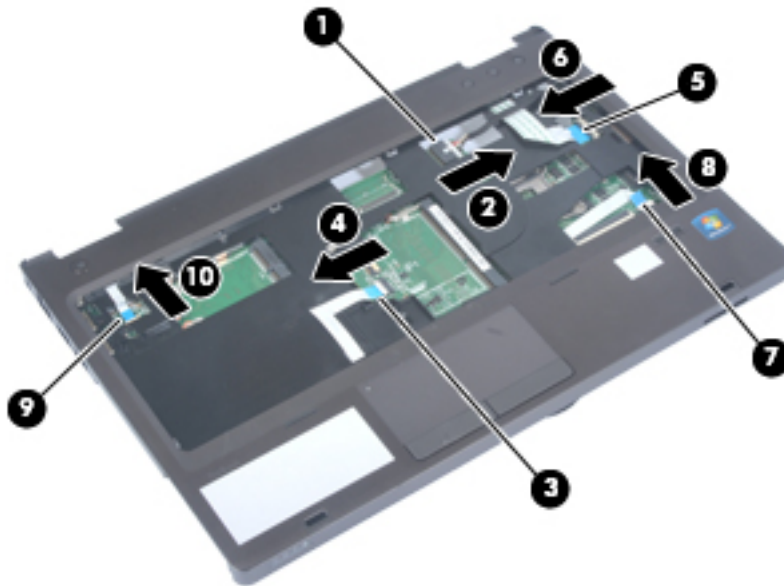

7. Position the system board upside-down (top cover upside-down)
8. Remove the two Phillips PM2.5x5.0 screws (1) that secure the system board to the top cover.
9. Lift up the front edge (2) of the system board.
10. Disconnect the ExpressCard cable (3) swinging ZIF connector from the system board (4).
11. Remove the system board from the chassis (5).

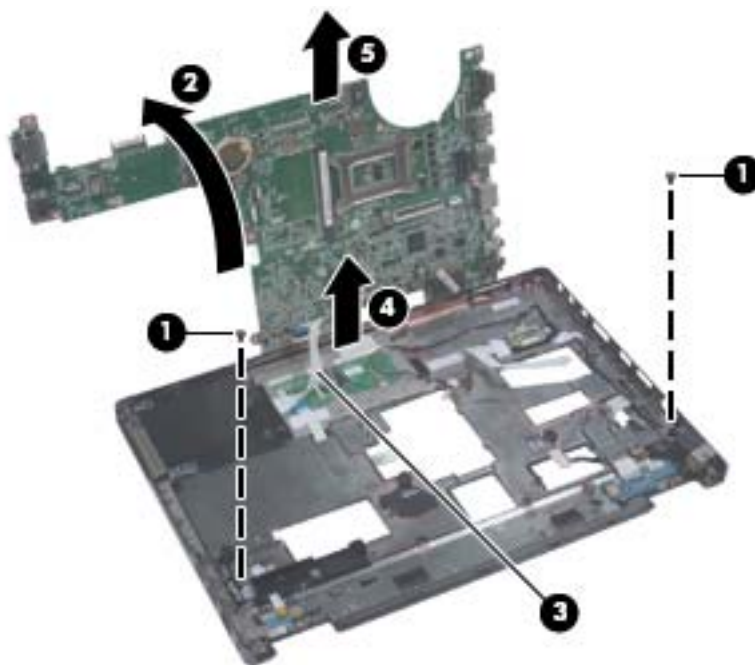

Reverse the preceding procedure to install the system board.

RTC battery

Description	Spare part number
RTC battery	651038-001

Before removing the RTC battery, follow these steps:

1. Shut down the computer. If you are unsure whether the computer is off or in Hibernation, turn the computer on, and then shut it down through the operating system.
2. Disconnect all external devices connected to the computer.
3. Disconnect the power from the computer by first unplugging the power cord from the AC outlet, and then unplugging the AC adapter from the computer.
4. Remove the battery (see [Battery on page 49](#)).
5. Remove the following components:
 - a. Hard drive (see [Hard drive on page 60](#))
 - b. Optical drive (see [Optical drive on page 56](#))
 - c. Keyboard (see [Keyboard on page 65](#))
 - d. Modem module (see [Modem module on page 70](#))
 - e. Fan (see [Fan on page 74](#))
 - f. Heat sink (see [Heat sink on page 75](#))
 - g. Base enclosure (see [Base enclosure on page 79](#))
 - h. Display assembly (see [Display assembly on page 84](#))
 - i. System board (see [System board on page 91](#))

Remove the RTC battery:

1. Position the system board right-side up, with the front toward you.

2. Pull the battery out of the socket and remove it from the system board.

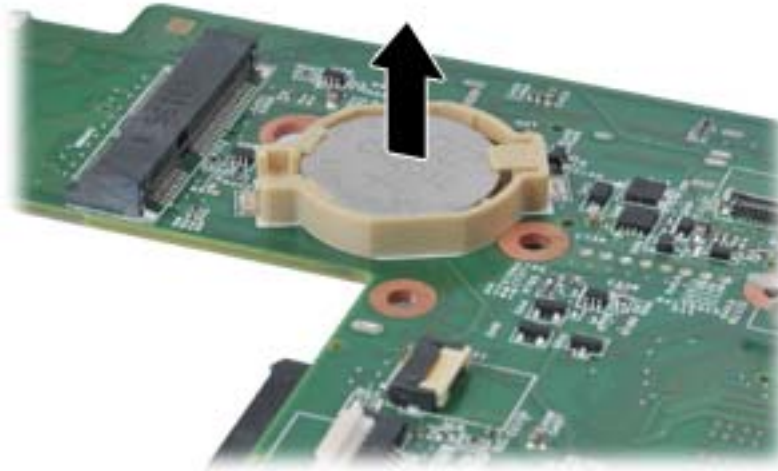

Reverse this procedure to install the RTC battery.

Power button board

 **NOTE:** The power button board assembly spare includes the power button cable.

Description	Spare part number
Power button board assembly	639481-001

Before removing the Power button board assembly, follow these steps:

1. Shut down the computer. If you are unsure whether the computer is off or in Hibernation, turn the computer on, and then shut it down through the operating system.
2. Disconnect all external devices connected to the computer.
3. Disconnect the power from the computer by first unplugging the power cord from the AC outlet, and then unplugging the AC adapter from the computer.
4. Remove the battery (see [Battery on page 49](#)).
5. Remove the following components:
 - a. Hard drive (see [Hard drive on page 60](#))
 - b. Optical drive (see [Optical drive on page 56](#))
 - c. Keyboard (see [Keyboard on page 65](#))
 - d. Modem module (see [Modem module on page 70](#))

- e. Fan (see [Fan on page 74](#))
- f. Heat sink (see [Heat sink on page 75](#))
- g. Base enclosure (see [Base enclosure on page 79](#))
- h. Display assembly (see [Display assembly on page 84](#))
- i. System board (see [System board on page 91](#))

Remove the Power button board assembly:

1. Position the top cover upside-down, with the front toward you.
2. Remove the single Phillips PM2.5×3.0 screw (1) that secures the assembly to the top cover.
3. Remove the Power button board and cable (2) from the top cover.

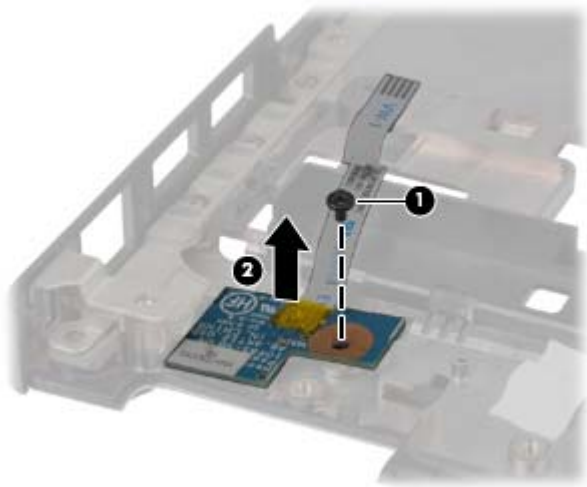

Reverse this procedure to install the Power button board assembly.

Wireless/web/mute function board

 **NOTE:** The Wireless/web/mute function board assembly spare includes the power button cable.

Description	Spare part number
Wireless/web/mute function board assembly	639480-001

Before removing the Wireless/web/mute function board assembly, follow these steps:

1. Shut down the computer. If you are unsure whether the computer is off or in Hibernation, turn the computer on, and then shut it down through the operating system.
2. Disconnect all external devices connected to the computer.
3. Disconnect the power from the computer by first unplugging the power cord from the AC outlet, and then unplugging the AC adapter from the computer.

4. Remove the battery (see [Battery on page 49](#)).
5. Remove the following components:
 - a. Hard drive (see [Hard drive on page 60](#))
 - b. Optical drive (see [Optical drive on page 56](#))
 - c. Keyboard (see [Keyboard on page 65](#))
 - d. Modem module (see [Modem module on page 70](#))
 - e. Fan (see [Fan on page 74](#))
 - f. Heat sink (see [Heat sink on page 75](#))
 - g. Base enclosure (see [Base enclosure on page 79](#))
 - h. Display assembly (see [Display assembly on page 84](#))
 - i. System board (see [System board on page 91](#))

Remove the Wireless/web/mute function board assembly:

1. Position the top cover upside-down, with the front toward you.
2. Remove the single Phillips PM2.5×3.0 screw (1) that secures the assembly to the top cover.
3. Remove the Wireless/web/mute function board and cable (2) from the top cover.

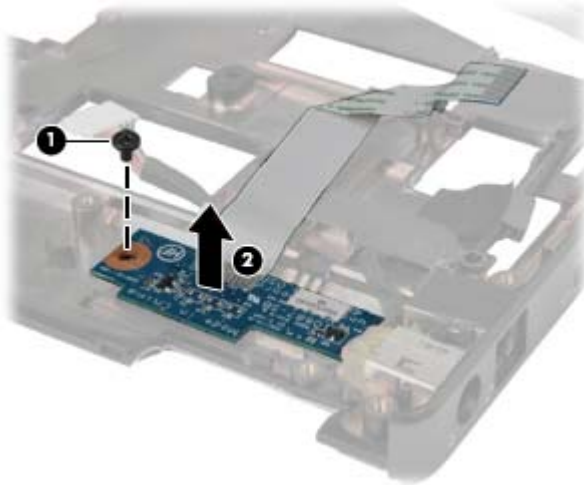

Reverse this procedure to install the Wireless/web/mute function board assembly.

Fingerprint reader board



NOTE: The Fingerprint reader board assembly spare includes the fingerprint reader cable.

Description	Spare part number
Fingerprint reader board assembly	651913-001

Before removing the Fingerprint reader board assembly, follow these steps:

1. Shut down the computer. If you are unsure whether the computer is off or in Hibernation, turn the computer on, and then shut it down through the operating system.
2. Disconnect all external devices connected to the computer.
3. Disconnect the power from the computer by first unplugging the power cord from the AC outlet, and then unplugging the AC adapter from the computer.
4. Remove the battery (see [Battery on page 49](#))
5. Remove the following components:
 - a. Hard drive (see [Hard drive on page 60](#))
 - b. Optical drive (see [Optical drive on page 56](#))
 - c. Keyboard (see [Keyboard on page 65](#))
 - d. Modem module (see [Modem module on page 70](#))
 - e. Fan (see [Fan on page 74](#))
 - f. Heat sink (see [Heat sink on page 75](#))
 - g. Base enclosure (see [Base enclosure on page 79](#))
 - h. Display assembly (see [Display assembly on page 84](#))
 - i. System board (see [System board on page 91](#))

Remove the Fingerprint reader board assembly:

1. Position the top cover upside-down, with the front toward you.
2. Remove the single Phillips PM2.5×3.0 screw **(1)** that secures the assembly to the top cover.
3. Slide the bracket **(2)** to remove the clips in top cover and lift off unit.

4. Remove the Fingerprint reader board and cable (3) from the top cover.

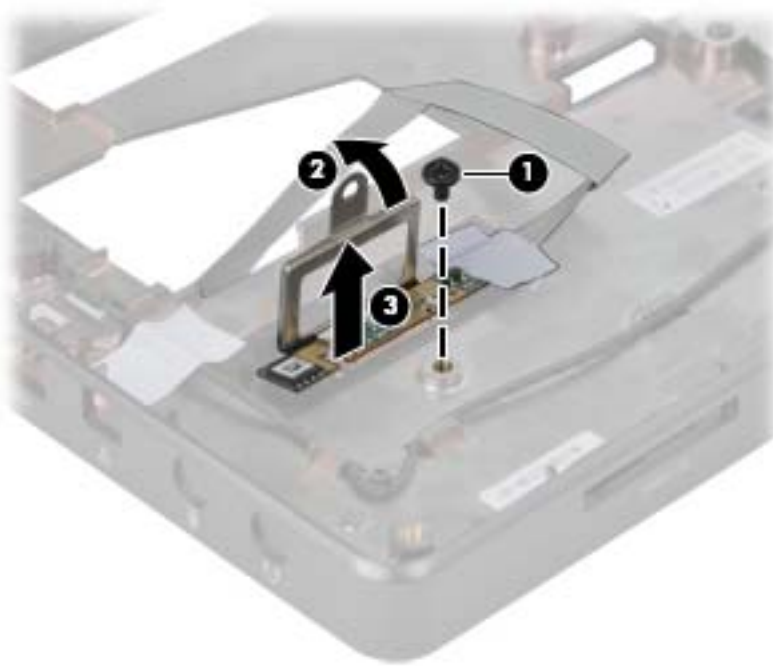

Reverse this procedure to install the Fingerprint reader board assembly.

ExpressCard assembly

Description	Spare part number
ExpressCard assembly	639479-001

Before removing the ExpressCard assembly, follow these steps:

1. Shut down the computer. If you are unsure whether the computer is off or in Hibernation, turn the computer on, and then shut it down through the operating system.
2. Disconnect all external devices connected to the computer.
3. Disconnect the power from the computer by first unplugging the power cord from the AC outlet, and then unplugging the AC adapter from the computer.
4. Remove the battery (see [Battery on page 49](#)).
5. Remove the following components:
 - a. Hard drive (see [Hard drive on page 60](#))
 - b. Optical drive (see [Optical drive on page 56](#))
 - c. Keyboard (see [Keyboard on page 65](#))
 - d. Modem module (see [Modem module on page 70](#))
 - e. Fan (see [Fan on page 74](#))

- f. Heat sink (see [Heat sink on page 75](#))
- g. Base enclosure (see [Base enclosure on page 79](#))
- h. Display assembly (see [Display assembly on page 84](#))
- i. System board (see [System board on page 91](#))

Remove the ExpressCard assembly:

1. Position the top cover upside-down, with the front toward you.
2. Remove the three Phillips PM2.5×5.0 screws (1) that secure the assembly to the top cover.
3. Lift the tab of the assembly (2) until it disengages from the opening in the top cover.
4. Remove the ExpressCard board and cable (3) from the top cover.

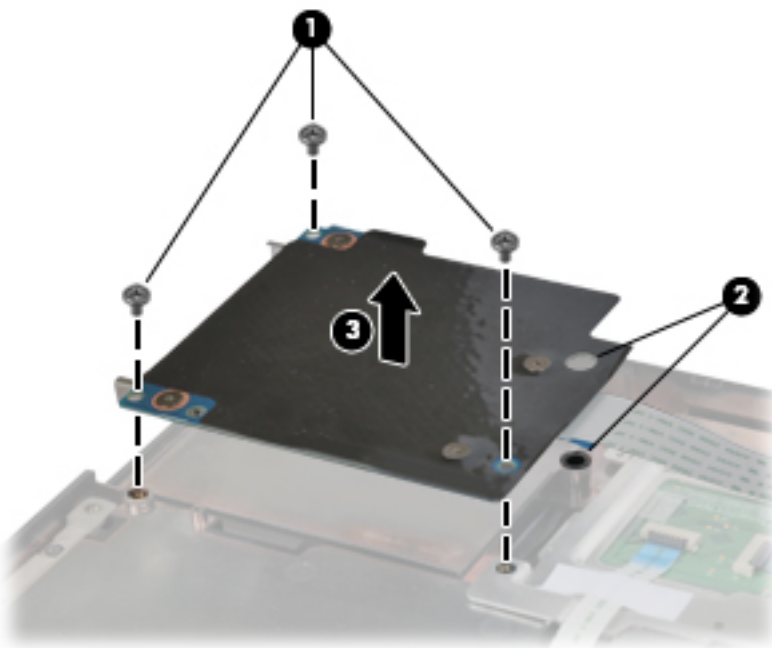

Reverse this procedure to install the ExpressCard assembly.

RJ-11 connector cable

 **NOTE:** The RJ-11 connector cable is included in the Cable Kit, spare part number 639473-001.

Before removing the RJ-11 connector cable, follow these steps:

1. Shut down the computer. If you are unsure whether the computer is off or in Hibernation, turn the computer on, and then shut it down through the operating system.
2. Disconnect all external devices connected to the computer.
3. Disconnect the power from the computer by first unplugging the power cord from the AC outlet, and then unplugging the AC adapter from the computer.

4. Remove the battery (see [Battery on page 49](#)).
5. Remove the following components:
 - a. Hard drive (see [Hard drive on page 60](#))
 - b. Optical drive (see [Optical drive on page 56](#))
 - c. Keyboard (see [Keyboard on page 65](#))
 - d. Modem module (see [Modem module on page 70](#))
 - e. Fan (see [Fan on page 74](#))
 - f. Heat sink (see [Heat sink on page 75](#))
 - g. Base enclosure (see [Base enclosure on page 79](#))
 - h. Display assembly (see [Display assembly on page 84](#))
 - i. System board (see [System board on page 91](#))

Remove the RJ-11 connector cable:

1. Position the top cover upside-down, with the front toward you.
2. Remove the RJ-11 connector (1) from the clip built into the top cover.
3. Remove the RJ-11 connector cable from the clips and routing channel (2) built into the top cover.

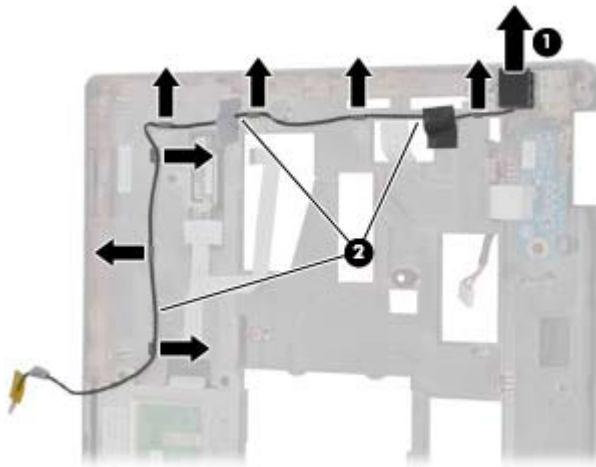

4. Remove the RJ-11 connector cable from the top cover.

Reverse this procedure to install the RJ-11 connector cable.

Power connector cable



NOTE: The power connector cable is included in the Cable Kit, spare part number 639473-001.

Before removing the power connector cable, follow these steps:

1. Shut down the computer. If you are unsure whether the computer is off or in Hibernation, turn the computer on, and then shut it down through the operating system.
2. Disconnect all external devices connected to the computer.
3. Disconnect the power from the computer by first unplugging the power cord from the AC outlet, and then unplugging the AC adapter from the computer.
4. Remove the battery (see [Battery on page 49](#)).
5. Remove the following components:
 - a. Hard drive (see [Hard drive on page 60](#))
 - b. Optical drive (see [Optical drive on page 56](#))
 - c. Keyboard (see [Keyboard on page 65](#))
 - d. Modem module (see [Modem module on page 70](#))
 - e. Fan (see [Fan on page 74](#))
 - f. Heat sink (see [Heat sink on page 75](#))
 - g. Base enclosure (see [Base enclosure on page 79](#))
 - h. Display assembly (see [Display assembly on page 84](#))
 - i. System board (see [System board on page 91](#))

Remove the power connector cable:

1. Position the top cover upside-down, with the front toward you.
2. Lift the power connector up from the clips in the rear of the base enclosure.

3. Remove the power connector cable from the enclosure.

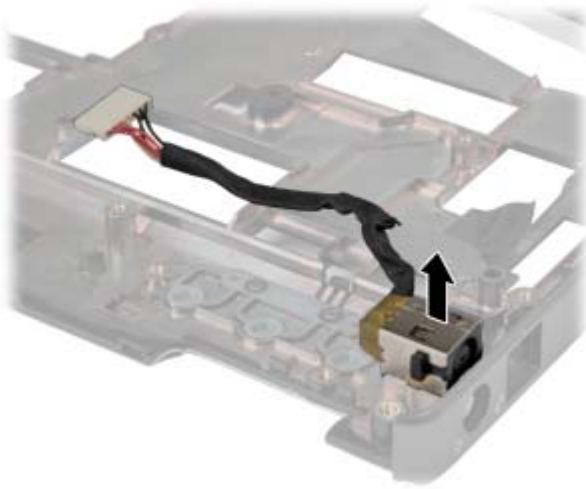



Reverse this procedure to install the power connector cable.

5 Computer Setup

Starting Computer Setup

Computer Setup is a preinstalled, ROM-based utility that can be used even when the operating system is not working or will not load.

 **NOTE:** Some of the Computer Setup menu items listed in this guide may not be supported by your computer.

 **NOTE:** An external keyboard or mouse connected to a USB port can be used with Computer Setup only if USB legacy support is enabled.

To start Computer Setup, follow these steps:

1. Turn on or restart the computer, and then press **esc** while the “Press the ESC key for Startup Menu” message is displayed at the bottom of the screen.
2. Press **f10** to enter BIOS Setup.

Using Computer Setup

Navigating and selecting in Computer Setup

The information and settings in Computer Setup are accessed from the File, Security, Diagnostics, and System Configuration menus.

To navigate and select in Computer Setup, follow these steps:

1. Turn on or restart the computer, and then press **esc** while the “Press the ESC key for Startup Menu” message is displayed at the bottom of the screen.
 - To select a menu or a menu item, use the tab key and the keyboard arrow keys, and then press **enter**, or use a pointing device to click the item.
 - To scroll up and down, click the up arrow or the down arrow in the upper-right corner of the screen, or use the up arrow key or the down arrow key.
 - To close open dialog boxes and return to the main Computer Setup screen, press **esc**, and then follow the on-screen instructions.

 **NOTE:** You can use either a pointing device (TouchPad, pointing stick, or USB mouse) or the keyboard to navigate and make selections in Computer Setup.

2. Press **f10** to enter BIOS Setup.
3. Select the **File, Security, Diagnostics,** or **System Configuration** menu.

To exit Computer Setup menus, choose one of the following methods:

- To exit Computer Setup menus without saving your changes, click the **Exit** icon in the lower-left corner of the screen, and then follow the on-screen instructions.

– or –

Use the tab key and the arrow keys to select **File > Ignore changes and exit**, and then press **enter**.

– or –

- To save your changes and exit Computer Setup menus, click the **Save** icon in the lower-left corner of the screen, and then follow the on-screen instructions.

– or –

Use the tab key and the arrow keys to select **File > Save changes and exit**, and then press **enter**.

Your changes go into effect when the computer restarts.

Restoring factory settings in Computer Setup

 **NOTE:** Restoring defaults will not change the hard drive mode.

To return all settings in Computer Setup to the values that were set at the factory, follow these steps:

1. Turn on or restart the computer, and then press **esc** while the “Press the ESC key for Startup Menu” message is displayed at the bottom of the screen.
2. Press **f10** to enter BIOS Setup.
3. Use a pointing device or the arrow keys to select **File > Restore defaults**.
4. Follow the on-screen instructions.
5. To save your changes and exit, click the **Save** icon in the lower-left corner of the screen, and then follow the on-screen instructions.

– or –

Use the arrow keys to select **File > Save changes and exit**, and then press **enter**.

Your changes go into effect when the computer restarts.

 **NOTE:** Your password settings and security settings are not changed when you restore the factory settings.

Computer Setup menus

The menu tables in this section provide an overview of Computer Setup options.

 **NOTE:** Some of the Computer Setup menu items listed in this chapter may not be supported by your computer.

File menu

Select	To do this
System Information	<ul style="list-style-type: none">• View identification information for the computer and the batteries in the system.• View specification information for the processor, cache and memory size, system ROM, video revision, and keyboard controller version.
Set System Date and Time	Set or change the date and time on the computer.
System Diagnostics	Displays the following information: <ul style="list-style-type: none">• System Information<ul style="list-style-type: none">◦ Identification information for the computer and the batteries in the system.◦ Specification information for the processor, cache and memory size, system ROM, video revision, and keyboard controller version.• Start-up Test—Verifies the system components needed for starting the computer.• Run-In Test—Runs a comprehensive check on system memory.• Hard Disk Test—Runs a comprehensive self-test on any hard drive in the system.• Memory Test—Runs a comprehensive test on any memory installed in the computer.• Battery Test—Runs a comprehensive test on any batteries installed in the computer.• Error Log—Displays a log file if any errors have occurred.
Restore defaults	Replace the configuration settings in Computer Setup with the original factory settings. (Hard drive mode, password settings, and security settings are not changed when you restore the factory settings.)
Reset BIOS security to factory default	Restore the BIOS security settings to the factory default.
Ignore changes and exit	Cancel any changes entered during the current session. Then, exit and restart the computer.
Save changes and exit	Save any changes entered during the current session. Then, exit and restart the computer. Your changes go into effect when the computer restarts.

Security menu



NOTE: Some of the menu items listed in this section may not be supported by your computer.

Select	To do this
Administrator Tools	
Setup BIOS Administrator Password	Set up a BIOS administrator password.
User Management (requires a BIOS administrator password)	
Create New BIOS User Account	<ul style="list-style-type: none"> Select from a list of BIOS users. Select from a list of ProtectTools users.
Password Policy (requires a BIOS administrator password)	Revise password policy criteria.
HP SpareKey	Enable/disable HP SpareKey (enabled by default).
Always Prompt for HP SpareKey Enrollment	Enable/disable HP SpareKey enrollment (enabled by default).
Fingerprint Reset on Reboot (if present)	Reset/clear the fingerprint reader ownership (select models only; disabled by default).
User Tools	
Change Password	Enter, change, or delete a BIOS administrator password.
HP SpareKey Enrollment	Enroll or reset HP SpareKey, which is a set of security questions and answers used if you forget your password.
Anti Theft	
AT-p	Enable/disable Anti-Theft Protection.
DriveLock Passwords	<ul style="list-style-type: none"> Enable/disable DriveLock on any computer hard drive (enabled by default). Change a DriveLock user password or master password. <p>NOTE: DriveLock settings are accessible only when you enter Computer Setup by turning on (not restarting) the computer.</p>
Automatic DriveLock	Enable/disable Automatic DriveLock support.
TPM Embedded Security	<p>Enable/disable support for Trusted Platform Module (TPM) Embedded Security, which protects the computer from unauthorized access to owner functions available in Embedded Security for ProtectTools. For more information, refer to the ProtectTools software Help.</p> <p>NOTE: You must have a setup password to change this setting.</p>
Disk Sanitizer	<p>Run Disk Sanitizer to destroy all existing data on the primary hard drive or the drive in the upgrade bay.</p> <p>CAUTION: If you run Disk Sanitizer, the data on the selected drive is destroyed permanently.</p>
System IDs	Enter a user-defined computer asset tracking number and ownership tag.

System Configuration menu



NOTE: Some of the listed System Configuration options may not be supported by your computer.

Select	To do this
Language	Change the Computer Setup language.
Boot Options	<ul style="list-style-type: none">• Set a Startup Menu delay (in seconds).• Set the Multiboot Express Boot Popup delay (in seconds).• Enable/disable Custom Logo (disabled by default).• Enable/disable Display Diagnostic URL (enabled by default).• Enable/disable CD-ROM boot (disabled by default).• Enable/disable SD Card boot (enabled by default).• Enable/disable floppy boot (enabled by default).• Enable/disable PXE Internal NIC boot (enabled by default).• Enable/Disable Unified Extensible Firmware Interface (UEFI) Boot Mode (disabled by default).• Set the Legacy Boot Order.
Device Configurations	<ul style="list-style-type: none">• Enable/disable USB legacy support (enabled by default). When enabled, USB legacy support allows the following:<ul style="list-style-type: none">◦ Use of a USB keyboard in Computer Setup even when a Windows operating system is not running.◦ Startup from bootable USB devices, including a hard drive or optical drive connected by a USB port to the computer.• Select a parallel port mode: ECP (Enhanced Capabilities Port), standard, bidirectional, or EPP (Enhanced Parallel Port).• Enable/disable fan always on while connected to an AC outlet (enabled by default).• Enable/disable Data Execution Prevention (select models only). When enabled, the processor can disable some virus code execution, which helps to improve computer security (disabled by default).• SATA (Serial Advanced Technology Attachment) device mode. The following options are available:<ul style="list-style-type: none">◦ AHCI (Advanced Host Controller Interface)◦ IDE (Integrated Drive Electronics)

Select	To do this
	<p>NOTE: Availability of these options varies by computer model.</p> <ul style="list-style-type: none">• Enable/disable secondary battery fast charge (enabled by default).• Enable/disable HP QuickLook (enabled by default).• Enable/disable Preboot Authentication on HP QuickLook Boot (enabled by default).• Enable/disable HP QuickWeb (enabled by default).• Enable/disable HP QuickWeb: Write Protect (disabled by default).• Enable/disable Virtualization Technology (select models only; disabled by default).• Enable/disable TXT (Intel Trusted Execution Technology) (select models only; disabled by default).• Multi Core CPU (enabled by default).• Intel HT Technology (enabled by default).• Enable/disable Wake on USB (enabled by default).• Enable/disable Num lock state at boot (disabled by default).

Select	To do this
Built-In Device Options	<ul style="list-style-type: none">• Enable/disable the wireless button state (enabled by default).• Enable/disable embedded WLAN device radio (select models only; enabled by default).• Enable/disable the embedded Bluetooth device radio (enabled by default).• Enable/disable the Network Interface Controller (NIC) (enabled by default).• Enable/disable LAN/WLAN switching (disabled by default).• Set the wake on LAN state. Options include the following:<ul style="list-style-type: none">◦ Disabled◦ Boot to Network◦ Follow Boot Order• Enable/disable the Ambient Light Sensor.• Enable/disable the Notebook Upgrade Bay device (enabled by default).• Enable/disable the fingerprint device (enabled by default).• Enable/disable the integrated camera (enabled by default).• Enable/disable the Power Monitor Circuit (enabled by default).• Enable/disable the audio device (enabled by default).• Enable/disable a modem device (enabled by default).• Enable/disable the microphone (enabled by default).• Enable/disable the internal speakers (enabled by default).

Select	To do this
Port Options	<p>NOTE: All port options are enabled by default.</p> <ul style="list-style-type: none"> • Enable/disable the serial port. • Enable/disable the parallel port. • Enable/disable the flash media reader. • Enable/disable the USB port. <p>CAUTION: Disabling the USB port also disables MultiBay devices and ExpressCard devices on the advanced port replicator.</p> <ul style="list-style-type: none"> • Enable/disable the 1394 port. • Enable/disable the ExpressCard slot. • Enable/disable the Smart Card reader slot. • Enable/disable the eSATA port.
AMT Options	<ul style="list-style-type: none"> • Enable/disable Firmware Verbosity. • Enable/disable AMT Setup Prompt (Ctrl+P). • Enable/disable USB Key Provisioning Support. • Enable/disable Unconfigure AMT on next boot. • Select Terminal Emulation Mode. <ul style="list-style-type: none"> ◦ ANSI ◦ VT100 • Enable/disable Firmware Progress Event Support. • Enable/disable Initiate Intel CIRA.
Set Security Level	Change, view, or hide security levels for all BIOS menu items.
Restore Security Defaults	Restore the default security settings.

6 Specifications

Computer specifications

	Metric	U.S.
Dimensions		
Length	22.0 cm	8.7 in
Width	32.2 cm	12.7 in
Height (front to rear)	3.4 to 3.6 cm	1.32 to 1.41 in
Weight (equipped with 33.8-cm (13.3-in) HD display, DVD drive, 1-GB DIMM, 250-GB hard drive, 3-cell battery)	1.95kg	4.30 lbs
Input power		
Operating voltage	18.5 V dc @ 3.5 A – 65 W	
Operating current	3.5 A	
Temperature		
Operating (not writing to optical disc)	0°C to 35°C	32°F to 95°F
Operating (writing to optical disc)	5°C to 35°C	41°F to 95°F
Nonoperating	-20°C to 60°C	-4°F to 140°F
Relative humidity		
Operating	10% to 90%	
Nonoperating	5% to 95%	
Maximum altitude (unpressurized)		
Operating (14.7 to 10.1 psia)	-15 m to 3,048 m	50 ft to 10,000 ft
Nonoperating (14.7 to 4.4 psia)	-15 m to 12,192 m	-50 ft to 40,000 ft
Shock		
Operating	125 g, 2 ms, half-sine	
Nonoperating	200 g, 2 ms, half-sine	
Random vibration		
Operating	0.75 g zero-to-peak, 10 Hz to 500 Hz, 0.25 oct/min sweep rate	

	Metric	U.S.
Nonoperating	1.50 g zero-to-peak, 10 Hz to 500 Hz, 0.5 oct/min sweep rate	

NOTE: Applicable product safety standards specify thermal limits for plastic surfaces. The computer operates well within this range of temperatures.

33.8-cm (13.3-in) HD display specifications

	Metric	U.S.
Dimensions		
Height	21.0 cm	8.25 in
Width	35.9 cm	14.15 in
Diagonal	33.8 cm	13.3 in
Surface treatment	Anti-glare	
Contrast ratio	300:1 (typical)	
Refresh rate	60 Hz	
Brightness	200 nits (typical)	
Pixel resolution		
Pitch	0.252 mm	
Format	1366 × 768	
Configuration	RGB stripe	
Backlight	LED	
PPI	101 ppi	
Viewing angle	+/-30 horizontal (minimum), +/-10° vertical (minimum) 30/30/20/10 (Left/Right/Down/Up) (minimum) or 45/45/35/25 (Left/Right/Down/Up) (typical)	

Hard drive specifications

	750-GB*	500-GB*	320-GB*	250-GB*
Dimensions				
Height	9.5 mm	9.5 mm	9.5 mm	9.5 mm
Width	70 mm	70 mm	70 mm	70 mm
Weight	101 g	101 g	101 g	101 g
Interface type	SATA	SATA	SATA	SATA
Transfer rate	100 MB/sec	100 MB/sec	100 MB/sec	100 MB/sec
Security	ATA security	ATA security	ATA security	ATA security
Seek times (typical read, including setting)				
Single track	3 ms	3 ms	3 ms	3 ms
Average	13 ms	13 ms	13 ms	13 ms
Maximum	24 ms	24 ms	24 ms	24 ms
Logical blocks	1,572,864,000	1,048,576,000	625,141,400	488,397,168
Disc rotational speed	7200 rpm	7200 rpm	7200 rpm	7200 rpm
Operating temperature	5°C to 55°C (41°F to 131°F)			
*1 GB = 1 billion bytes when referring to hard drive storage capacity. Actual accessible capacity is less. Actual drive specifications may differ slightly.				
NOTE: Certain restrictions and exclusions apply. Contact technical support for details.				

DVD±RW SuperMulti DL LightScribe Drive specifications

Applicable disc	Read: CD-DA, CD+(E)G, CD-MIDI, CD-TEXT, CD-ROM, CD-ROM XA, MIXED MODE CD, CD-I, CD-I Bridge (Photo-CD, Video CD), Multisession CD (Photo-CD, CD-EXTRA, Portfolio, CD-R, CD-RW), CD-R, CD-RW, DVD-ROM (DVD-5, DVD-9, DVD-10, DVD-18), DVD-R, DVD-RW, DVD+R, DVD+RW, DVD-RAM	Write: CD-R and CD-RW DVD+R, DVD+RW, DVD-R, DVD-RW, DVD-RAM
Center hole diameter	1.5 cm (0.59 in)	
Disc diameter		
Standard disc	12 cm (4.72 in)	
Mini disc	8 cm (3.15 in)	
Disc thickness	1.2 mm (0.047 in)	
Track pitch	0.74 µm	
Access time	CD	DVD
Random	< 175 ms	< 230 ms
Full stroke	< 285 ms	< 335 ms
Audio output level	Line-out, 0.7 Vrms	
Cache buffer	2 MB	
Data transfer rate		
24X CD-ROM	3,600 KB/sec	
8X DVD-ROM	10,800 KB/sec	
24X CD-R	3,600 KB/sec	
16X CD-RW	2,400 KB/sec	
8X DVD+R	10,800 KB/sec	
4X DVD+RW	5,400 KB/sec	
8X DVD-R	10,800 KB/sec	
4X DVD-RW	5,400 KB/sec	
2.4X DVD+R(9)	2,700 KB/sec	
5X DVD-RAM	6,750 KB/sec	
Transfer mode	Multiword DMA Mode	
Startup time	< 15 seconds	
Stop time	< 6 seconds	

Blu-ray ROM DVD±RW SuperMulti DL LightScribe Drive

Applicable disc	Read:	Write:		
	CD-DA, CD+(E)G, CD-MIDI, CDTEXT, CD-ROM, CD-ROM XA, MIXED MODE CD, CD-I, CD-I Bridge (Photo-CD, Video CD), Multisession CD (Photo-CD, CD-EXTRA, Portfolio, CD-R, CD-RW), CD-R, CD-RW, DVDROM (DVD-5, DVD-9, DVD-10, DVD-18), DVD-R, DVD-RW, DVD+R, DVD+RW, DVD-RAM, HD-ROM (Single Layer), HD-ROM (Dual Layer), HD DVD-R, HD DVD-R for Dual Layer, HD DVD-RW	CD-R and CD-RW DVD+R, DVD+R(9), DVD+RW, DVD-R, DVD-R(9),DVD-RW, DVD-RAM		
Access time	CD	DVD	HD	
Random	170 ms	170 ms	230 ms	
Cache buffer	8 MB			
Data transfer rate				
24X CD-ROM	3,600 KB/sec			
8X DVD	10,800 KB/sec			
24X CD-R	3,600 KB/sec			
16X CD-RW	2,400 KB/sec			
8X DVD+R	10,800 KB/sec			
4X DVD+RW	5,400 KB/sec			
8X DVD-R	10,800 KB/sec			
4X DVD-RW	5,400 KB/sec			
2.4X DVD+R(9)	2,700 KB/sec			
5X DVD-RAM	6,750 KB/sec			
1X BD-ROM	4,500 KB/sec			
1X BD-R read	4,500 KB/sec			
1X BD-RE read	4,500 KB/sec			
Transfer mode	Multiword DMA Mode			

DVD-ROM Drive specifications

Applicable disc	DVD-ROM (DVD-5, DVD-9, DVD-10, DVD-18, CD-ROM (Mode 1 and 2), CD Digital Audio, CD-XA ready (Mode 2, Form 1 and Form 2), CD-I (Mode 2, Form 1 and Form 2), CD-R, CD-RW, Photo CD (single and multisession), CD-Bridge	
Center hole diameter	1.5 cm (0.59 in)	
Disc diameter		
Standard disc	12 cm (4.72 in)	
Mini disc	8 cm (3.15 in)	
Disc thickness	1.2 mm (0.047 in)	
Track pitch	0.74 μ m	
Access time	CD	DVD
Random	< 100 ms	< 125 ms
Full stroke	< 175 ms	< 225 ms
Audio output level	Line-out, 0.7 Vrms	
Cache buffer	512 KB	
Data transfer rate		
CD-R (24X)	3600 KB/s (150 KB/s at 1X CD rate)	
CD-RW (10X)	1500 KB/s (150 KB/s at 1X CD rate)	
CD-ROM (24X)	3600 KB/s (150 KB/s at 1X CD rate)	
DVD (8X)	10,800 KB/s (1,352 KB/s at 1X DVD rate)	
Multiword DMA mode 2	16.6 MB/s	
Startup time	< 10 seconds	
Stop time	< 3 seconds	

Specification information in Device Manager

Device Manager allows you to view and control the hardware attached to the computer, as well as provides hardware specification information.

You can also add hardware or modify device configurations using Device Manager.



NOTE: Windows 7 and Windows Vista include the User Account Control feature to improve the security of your computer. You may be prompted for your permission or password for tasks such as installing software, running utilities, or changing Windows settings. Refer to Windows Help and Support for more information.

After you open Device Manager, drill-down to a device and double-click it to access its properties.

To access Device Manager in Windows 7:

1. Select **Start > Computer > System properties**.
2. In the left pane, click **Device Manager**.

To access Device Manager in Windows Vista:

1. Select **Start > Computer > System properties**.
2. In the left pane, click **Device Manager**.

To access Device Manager in Windows XP:

1. Select **Start > My Computer**.
2. In the left pane of the System Tasks window, select **View system information**.
3. Select **Hardware tab > Device Manager**.

7 Backup and recovery

Windows 7

To protect your information, use Windows Backup and Restore to back up individual files and folders, back up your entire hard drive (select models only), create system repair discs (select models only), or create system restore points. In case of system failure, you can use the backup files to restore the contents of your computer.

Windows Backup and Restore provides the following options:

- Creating a system repair disc (select models only)
- Backing up individual files and folders
- Creating a system image (select models only)
- Scheduling automatic backups (select models only)
- Creating system restore points
- Recovering individual files
- Restoring the computer to a previous state
- Recovering information using recovery tools

 **NOTE:** For detailed instructions, perform a search for these topics in Help and Support.

 **NOTE:** In case of system instability, HP recommends that you print the recovery procedures and save them for later use.

Backing up your information

Recovery after a system failure is as complete as your most current backup. You should create system repair discs (select models only) and your initial backup immediately after software setup. As you add new software and data files, you should continue to back up your system on a regular basis to maintain a reasonably current backup. The system repair discs (select models only) are used to start up (boot) the computer and repair the operating system in case of system instability or failure. Your initial and subsequent backups allow you to restore your data and settings if a failure occurs.

You can back up your information to an optional external hard drive, a network drive, or discs.

Note the following when backing up:

- Store personal files in the Documents library, and back it up regularly.
- Back up templates that are stored in their associated programs.
- Save customized settings that appear in a window, toolbar, or menu bar by taking a screen shot of your settings. The screen shot can be a time-saver if you have to reset your preferences.

To create a screen shot:

1. Display the screen you want to save.
2. Copy the screen image:

To copy only the active window, press **alt+fn+prt sc**.

To copy the entire screen, press **fn+prt sc**.

3. Open a word-processing document, and then select **Edit > Paste**.

The screen image is added to the document.

4. Save the document.

- When backing up to discs, use any of the following types of discs (purchased separately): CD-R, CD-RW, DVD+R, DVD+R DL, DVD-R, DVD-R DL, or DVD±RW. The discs you use will depend on the type of optical drive installed in your computer.

 **NOTE:** DVDs and DVDs with double-layer (DL) support store more information than CDs, so using them for backup reduces the number of recovery discs required.

- When backing up to discs, number each disc before inserting it into the optical drive of the computer.

To create a backup using Backup and Restore, follow these steps:

 **NOTE:** Be sure that the computer is connected to AC power before you start the backup process.

 **NOTE:** The backup process may take over an hour, depending on file size and the speed of the computer.

1. Select **Start > All Programs > Maintenance > Backup and Restore**.
2. Follow the on-screen instructions to set up your backup, create a system image (select models only), or create a system repair disc (select models only).

 **NOTE:** Windows includes the User Account Control feature to improve the security of your computer. You may be prompted for your permission or password for tasks such as installing software, running utilities, or changing Windows settings. Refer to Windows Help and Support for more information.

Performing a recovery

In case of system failure or instability, the computer provides the following tools to recover your files:

- Windows recovery tools: You can use Windows Backup and Restore to recover information you have previously backed up. You can also use Windows Startup Repair to fix problems that might prevent Windows from starting correctly.
- f11 recovery tools: You can use the f11 recovery tools to recover your original hard drive image. The image includes the Windows operating system and software programs installed at the factory.

 **NOTE:** If you are unable to boot (start up) your computer and you cannot use the system repair discs you previously created (select models only), you must purchase a Windows 7 operating system DVD to reboot the computer and repair the operating system. For additional information, refer to the “Using a Windows 7 operating system DVD (purchased separately)” section in this guide.

Using the Windows recovery tools

To recover information you previously backed up, follow these steps:

1. Select **Start > All Programs > Maintenance > Backup and Restore**.
2. Follow the on-screen instructions to recover your system settings, your computer (select models only), or your files.

 **NOTE:** Windows includes the User Account Control feature to improve the security of your computer. You may be prompted for your permission or password for tasks such as installing software, running utilities, or changing Windows settings. Refer to Windows Help and Support for more information.

To recover your information using Startup Repair, follow these steps:

 **CAUTION:** Using Startup Repair completely erases hard drive contents and reformats the hard drive. All files you have created and any software installed on the computer are permanently removed. When reformatting is complete, the recovery process restores the operating system, as well as the drivers, software, and utilities from the backup used for recovery.

1. If possible, back up all personal files.
2. If possible, check for the presence of the Windows partition and the HP Recovery partition.

To check for the Windows partition, select **Start > Computer**.

To check for the HP Recovery partition, select **Start**, right-click **Computer**, click **Manage**, and then click **Disk Management**.

 **NOTE:** If the Windows partition and the HP Recovery partition are not listed, you must recover your operating system and programs using the Windows 7 operating system DVD and the *Driver Recovery* disc (both purchased separately). For additional information, refer to the “Using a Windows 7 operating system DVD (purchased separately)” section in this guide.

3. If the Windows partition and the HP Recovery partition are listed, restart the computer, and then press f8 before the Windows operating system loads.
4. Select **Startup Repair**.
5. Follow the on-screen instructions.



NOTE: For additional information on recovering information using the Windows tools, perform a search for these topics in Help and Support.

Using f11



CAUTION: Using **f11** completely erases hard drive contents and reformats the hard drive. All files you have created and any software installed on the computer are permanently removed. The **f11** recovery tool reinstalls the operating system and HP programs and drivers that were installed at the factory. Software not installed at the factory must be reinstalled.

To recover the original hard drive image using **f11**, follow these steps:

1. If possible, back up all personal files.
2. If possible, check for the presence of the HP Recovery partition: select **Start**, right-click **Computer**, click **Manage**, and then click **Disk Management**.



NOTE: If the HP Recovery partition is not listed, you must recover your operating system and programs using the Windows 7 operating system DVD and the *Driver Recovery* disc (both purchased separately). For additional information, refer to the “Using a Windows 7 operating system DVD (purchased separately)” section in this guide.

3. If the HP Recovery partition is listed, restart the computer, and then press **esc** while the “Press the ESC key for Startup Menu” message is displayed at the bottom of the screen.
4. Press **f11** while the “Press <F11> for recovery” message is displayed on the screen.
5. Follow the on-screen instructions.

Using a Windows 7 operating system DVD (purchased separately)

If you are unable to boot (start up) your computer and you cannot use the system repair discs you previously created (select models only), you must purchase a Windows 7 operating system DVD to reboot the computer and repair the operating system. Make sure that your most recent backup (stored on discs or on an external drive) is easily accessible. To order a Windows 7 operating system DVD, go to <http://www.hp.com/support>, select your country or region, and then follow the on-screen instructions. You can also order the DVD by calling technical support. For contact information, refer to the *Worldwide Telephone Numbers* booklet included with the computer.



CAUTION: Using a Windows 7 operating system DVD completely erases hard drive contents and reformats the hard drive. All files you have created and any software installed on the computer are permanently removed. When reformatting is complete, the recovery process helps you restore the operating system, as well as drivers, software, and utilities.

To initiate recovery using a Windows 7 operating system DVD, follow these steps:



NOTE: This process takes several minutes.

1. If possible, back up all personal files.
2. Restart the computer, and then insert the Windows 7 operating system DVD into the optical drive before the Windows operating system loads.
3. When prompted, press any keyboard key.
4. Follow the on-screen instructions.
5. Click **Next**.

6. Select **Repair your computer**.
7. Follow the on-screen instructions.

Windows Vista

To protect your information, use the Backup and Restore Center to back up individual files and folders, back up your entire hard drive (select models only), or create system restore points. In case of system failure, you can use the backup files to restore the contents of your computer.

The Backup and Restore Center provides the following options:

- Backing up individual files and folders
- Backing up the entire hard drive (select models only)
- Scheduling automatic backups (select models only)
- Creating system restore points
- Recovering individual files
- Restoring the computer to a previous state
- Recovering information using recovery tools

 **NOTE:** For detailed instructions, perform a search for these topics in Help and Support.

 **NOTE:** In case of system instability, HP recommends that you print the recovery procedures and save them for later use.

Backing up your information

Recovery after a system failure is as complete as your most current backup. You should create your initial backup immediately after software setup. As you add new software and data files, you should continue to back up your system on a regular basis to maintain a reasonably current backup.

You can back up your information to an optional external hard drive, a network drive, or discs.

Note the following when backing up:

- Store personal files in the Documents folder, and back it up regularly.
- Back up templates that are stored in their associated programs.
- Save customized settings that appear in a window, toolbar, or menu bar by taking a screen shot of your settings. The screen shot can be a time-saver if you have to reset your preferences.

To create a screen shot:

1. Display the screen you want to save.
2. Copy the screen image:
To copy only the active window, press **alt+fn+prt sc**.
To copy the entire screen, press **fn+prt sc**.
3. Open a word-processing document, and then select **Edit > Paste**.

The screen image is added to the document.

4. Save the document.

- When backing up to discs, use any of the following types of discs (purchased separately): CD-R, CD-RW, DVD+R, DVD+R DL, DVD-R, DVD-R DL, or DVD±RW. The discs you use will depend on the type of optical drive installed in your computer.

 **NOTE:** DVDs and DVDs with double-layer (DL) support store more information than CDs, so using them for backup reduces the number of recovery discs required.

- When backing up to discs, number each disc before inserting it into the optical drive of the computer.

To create a backup using Backup and Restore Center, follow these steps:

 **NOTE:** Be sure that the computer is connected to AC power before you start the backup process.

 **NOTE:** The backup process may take over an hour, depending on file size and the speed of the computer.

1. Select **Start > All Programs > Maintenance > Backup and Restore Center**.
2. Follow the on-screen instructions to back up your entire computer (select models only) or your files.

 **NOTE:** Windows includes the User Account Control feature to improve the security of your computer. You may be prompted for your permission or password for tasks such as installing software, running utilities, or changing Windows settings. Refer to Windows Help and Support for more information.

Performing a recovery

In case of system failure or instability, the computer provides the following tools to recover your files:

- Windows recovery tools: You can use the Backup and Restore Center to recover information you have previously backed up. You can also use Windows Startup Repair to fix problems that might prevent Windows from starting correctly.
- **f11** recovery tools: You can use the **f11** recovery tools to recover your original hard drive image. The image includes the Windows operating system and software programs installed at the factory.

 **NOTE:** If you are unable to boot (start up) your computer, you must purchase a Windows Vista® operating system DVD to reboot the computer and repair the operating system. For additional information, refer to the “Using a Windows Vista operating system DVD (purchased separately)” section in this guide.

Using the Windows recovery tools

To recover information you previously backed up, follow these steps:

1. Select **Start > All Programs > Maintenance > Backup and Restore Center**.
2. Follow the on-screen instructions to recover your entire computer (select models only) or your files.

 **NOTE:** Windows includes the User Account Control feature to improve the security of your computer. You may be prompted for your permission or password for tasks such as installing software, running utilities, or changing Windows settings. Refer to Windows Help and Support for more information.

To recover your information using Startup Repair, follow these steps:

 **CAUTION:** Using Startup Repair completely erases hard drive contents and reformats the hard drive. All files you have created and any software installed on the computer are permanently removed. When reformatting is complete, the recovery process restores the operating system, as well as the drivers, software, and utilities from the backup used for recovery.

1. If possible, back up all personal files.
2. If possible, check for the presence of the Windows partition and the HP Recovery partition. To find the partitions, select **Start > Computer**.

 **NOTE:** If the Windows partition and the HP Recovery partition have been deleted, you must recover your operating system and programs using the Windows Vista operating system DVD and the *Driver Recovery* disc (both purchased separately). For additional information, refer to the “Using a Windows Vista operating system DVD (purchased separately)” section in this guide.

3. Restart the computer, and then press **f8** before the Windows operating system loads.
4. Select **Repair your computer**.
5. Follow the on-screen instructions.

 **NOTE:** For additional information on recovering information using the Windows tools, perform a search for these topics in Help and Support.

Using f11

 **CAUTION:** Using **f11** completely erases hard drive contents and reformats the hard drive. All files you have created and any software installed on the computer are permanently removed. The **f11** recovery tool reinstalls the operating system and HP programs and drivers that were installed at the factory. Software not installed at the factory must be reinstalled.

To recover the original hard drive image using **f11**, follow these steps:

1. If possible, back up all personal files.
2. If possible, check for the presence of the HP Recovery partition. To find the partition, select **Start > Computer**.

 **NOTE:** If the HP Recovery partition has been deleted, you must recover your operating system and programs using the Windows Vista operating system DVD and the *Driver Recovery* disc (both purchased separately). For additional information, refer to the “Using a Windows Vista operating system DVD (purchased separately)” section in this guide.

3. Turn on or restart the computer, and then press **esc** while the “Press the ESC key for Startup Menu” message is displayed at the bottom of the screen.
4. Press **f11** while the “Press <F11> for recovery” message is displayed on the screen.
5. Follow the on-screen instructions.

Using a Windows Vista operating system DVD (purchased separately)

If you are unable to boot (start up) your computer, you must purchase a Windows Vista operating system DVD to reboot the computer and repair the operating system. Make sure that your most recent backup (stored on discs or on an external drive) is easily accessible. To order a Windows Vista operating system DVD, go to <http://www.hp.com/support>, select your country or region, and then follow the on-screen instructions. You can also order the DVD by calling technical support. For contact information, refer to the *Worldwide Telephone Numbers* booklet included with the computer.

 **CAUTION:** Using a Windows Vista operating system DVD completely erases hard drive contents and reformats the hard drive. All files you have created and any software installed on the computer are permanently removed. When reformatting is complete, the recovery process helps you restore the operating system, as well as drivers, software, and utilities.

To initiate recovery using a Windows Vista operating system DVD, follow these steps:

 **NOTE:** This process takes several minutes.

1. If possible, back up all personal files.
2. Restart the computer, and then insert the Windows Vista operating system DVD into the optical drive before the Windows operating system loads.
3. When prompted, press any keyboard key.
4. Follow the on-screen instructions.
5. Click **Next**.
6. Select **Repair your computer**.
7. Follow the on-screen instructions.

Windows XP

To protect your information, use the Windows Backup utility (select models only) to back up files and folders or create recovery points. In case of system failure, you can use the backup files to restore your computer.

Windows provides the following options:

- Backing up individual files and folders
- Backing up all files and folders
- Scheduling automatic backups
- Creating recovery points
- Recovering information

 **NOTE:** For detailed instructions, perform a search for these topics in Help and Support.

 **NOTE:** In case of system instability, HP recommends that you print the recovery procedures and save them for later use.

Backing up your information

Recovery after a system failure is as complete as your most current backup. You should create your initial backup immediately after software setup. As you add new software and data files, you should continue to back up your system on a regular basis to maintain a reasonably current backup.

You can back up individual files or folders to an optional external hard drive or to a network drive.

Note the following when backing up:

- Store personal files in the My Documents folder, and back it up periodically.
- Back up templates stored in their associated programs.
- Save customized settings that appear in a window, toolbar, or menu bar by taking a screen shot of your settings. The screen shot can be a time saver if you have to reset your preferences.

To copy the screen and paste it into a word-processing document:

- a. Display the screen you want to save.
- b. Copy the screen image:
To copy only the active window, press **alt+fn+prt sc**.
To copy the entire screen, press **fn+prt sc**.
- c. Open a word-processing document, click **Edit > Paste**.
The screen image is added to the document.
- d. Save the document.

To create a backup using the Windows Backup utility (select models only), follow these steps:

 **NOTE:** Be sure that the computer is connected to AC power before you start the backup process.

 **NOTE:** The backup process may take over an hour, depending on file size and the speed of the computer.

1. Select **Start > All Programs > Accessories > System Tools > Backup**.
2. Follow the on-screen instructions.

Performing a recovery

In case of system failure or instability, the computer provides the following tools to recover your files:

- Windows recovery tools (select models only): You can use the Windows Backup utility to recover information you have previously backed up.
- *Operating System* and *Driver Recovery* discs (included with your computer): You can use the discs to recover your operating system and programs installed at the factory.

Recovering your information

To recover information you previously backed up, follow these steps:

1. If possible, back up all personal files.
2. Select **Start > All Programs > Accessories > System Tools > Backup**.
The Backup or Restore Wizard opens.
3. Click **Restore files and settings**, and then click **Next**.
4. Follow the on-screen instructions.



NOTE: For additional information on initiating a recovery in Windows, perform a search for this topic in Help and Support.

Recovering the operating system and programs



CAUTION: The recovery process reformats and completely erases the hard drive. All files you have created and any software installed on the computer are permanently removed. The recovery process reinstalls the original operating system, software, and drivers. Software, drivers, and updates not installed by HP must be manually reinstalled.

To recover your operating system and programs, follow these steps:

1. If possible, back up all personal files.
2. Insert the *Operating System* disc into the optical drive.
3. Shut down the computer.
4. Turn on the computer.
5. Follow the on-screen instructions to install the operating system.
6. After the operating system is installed, remove the *Operating System* disc and insert the *Driver Recovery* disc.
7. Follow the on-screen instructions to install the drivers and programs.

8 Power cord set requirements

The wide range input feature of the computer permits it to operate from any line voltage from 100 to 120 volts AC, or from 220 to 240 volts AC.

The 3-conductor power cord set included with the computer meets the requirements for use in the country or region where the equipment is purchased.

Power cord sets for use in other countries and regions must meet the requirements of the country or region where the computer is used.

Requirements for all countries and regions

The requirements listed below are applicable to all countries and regions:

- The length of the power cord set must be at least 1.5 m (5.0 ft) and no more than 2.0 m (6.5 ft).
- All power cord sets must be approved by an acceptable accredited agency responsible for evaluation in the country or region where the power cord set will be used.
- The power cord sets must have a minimum current capacity of 10 amps and a nominal voltage rating of 125 or 250 V AC, as required by the power system of each country or region.
- The appliance coupler must meet the mechanical configuration of an EN 60 320/IEC 320 Standard Sheet C13 connector for mating with the appliance inlet on the back of the computer.

Requirements for specific countries and regions

Country/region	Accredited agency	Applicable note number
Australia	EANSW	1
Austria	OVE	1
Belgium	CEBC	1
Canada	CSA	2
Denmark	DEMKO	1
Finland	FIMKO	1
France	UTE	1
Germany	VDE	1
Italy	IMQ	1
Japan	METI	3
The Netherlands	KEMA	1
Norway	NEMKO	1
The People's Republic of China	CCC	5
South Korea	EK	4
Sweden	SEMKO	1
Switzerland	SEV	1
Taiwan	BSMI	4
The United Kingdom	BSI	1
The United States	UL	2

1. The flexible cord must be Type HO5VV-F, 3-conductor, 1.0-mm² conductor size. Power cord set fittings (appliance coupler and wall plug) must bear the certification mark of the agency responsible for evaluation in the country or region where it will be used.
2. The flexible cord must be Type SPT-3 or equivalent, No. 18 AWG, 3-conductor. The wall plug must be a two-pole grounding type with a NEMA 5-15P (15 A, 125 V) or NEMA 6-15P (15 A, 250 V) configuration.
3. The appliance coupler, flexible cord, and wall plug must bear a "T" mark and registration number in accordance with the Japanese Dentori Law. The flexible cord must be Type VCT or VCTF, 3-conductor, 1.00-mm² conductor size. The wall plug must be a two-pole grounding type with a Japanese Industrial Standard C8303 (7 A, 125 V) configuration.
4. The flexible cord must be Type RVV, 3-conductor, 0.75-mm² conductor size. Power cord set fittings (appliance coupler and wall plug) must bear the certification mark of the agency responsible for evaluation in the country or region where it will be used.
5. The flexible cord must be Type VCTF, 3-conductor, 0.75-mm² conductor size. Power cord set fittings (appliance coupler and wall plug) must bear the certification mark of the agency responsible for evaluation in the country or region where it will be used.

9 Recycling

Battery

When a battery has reached the end of its useful life, do not dispose of the battery in general household waste. Follow the local laws and regulations in your area for computer battery disposal.

Display

⚠ WARNING! The backlight contains mercury. Exercise caution when removing and handling the backlight to avoid damaging this component and causing exposure to the mercury.

⚠ CAUTION: The procedures in this chapter can result in damage to display components. The only components intended for recycling purposes are the LCD panel and the backlight. When you remove these components, handle them carefully.

📝 NOTE: Materials Disposal. This HP product contains mercury in the backlight in the display assembly that might require special handling at end-of-life. Disposal of mercury may be regulated because of environmental considerations. For disposal or recycling information, contact your local authorities, or see the Electronic Industries Alliance (EIA) Web site at <http://www.eiae.org>.

This section provides disassembly instructions for the display assembly. The display assembly must be disassembled to gain access to the backlight **(1)** and the liquid crystal display (LCD) panel **(2)**.



📝 NOTE: The procedures provided in this chapter are general disassembly instructions. Specific details, such as screw sizes, quantities, and locations, and component shapes and sizes, can vary from one computer model to another.

Perform the following steps to disassemble the display assembly:

1. Remove all screw covers (1) and screws (2) that secure the display bezel to the display assembly.

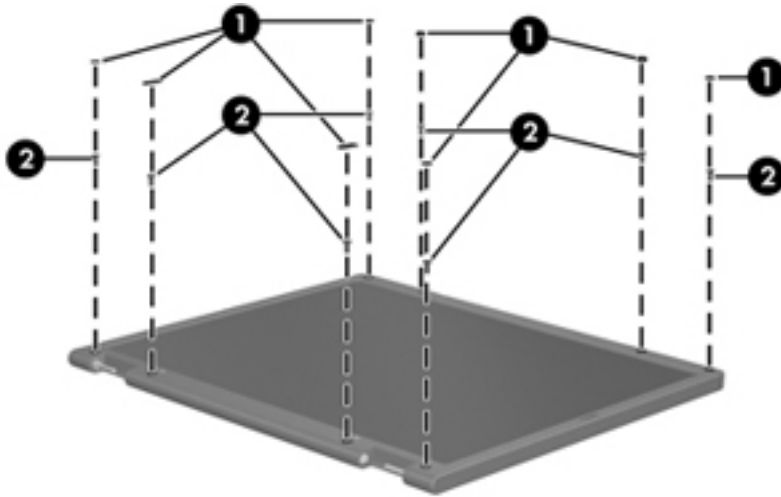

2. Lift up and out on the left and right inside edges (1) and the top and bottom inside edges (2) of the display bezel until the bezel disengages from the display assembly.
3. Remove the display bezel (3).

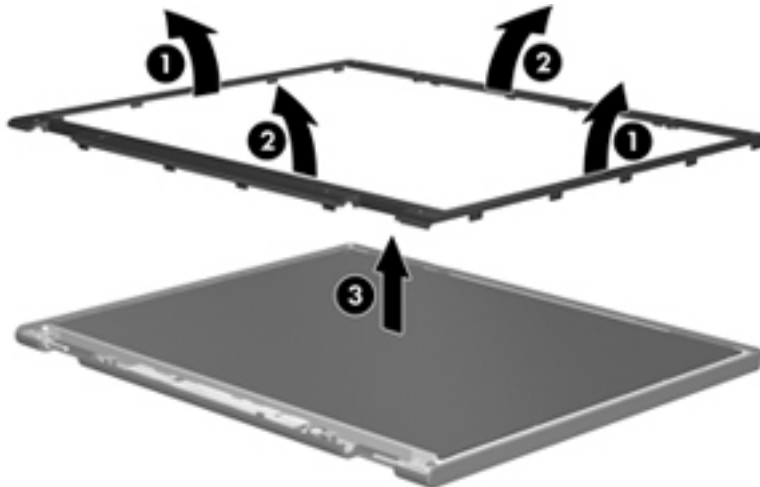

4. Disconnect all display panel cables (1) from the display inverter and remove the inverter (2).

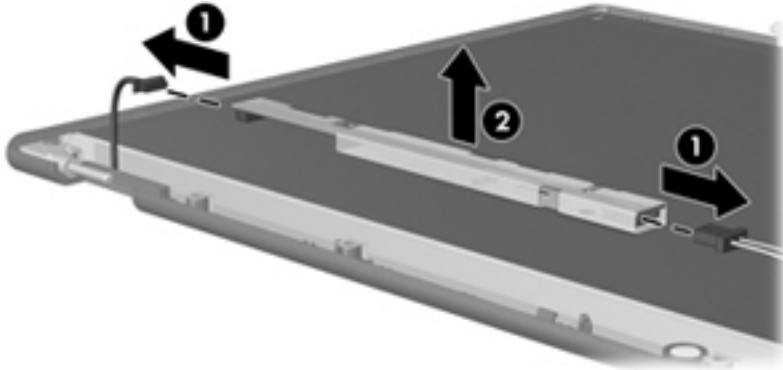

5. Remove all screws (1) that secure the display panel assembly to the display enclosure.
6. Remove the display panel assembly (2) from the display enclosure.

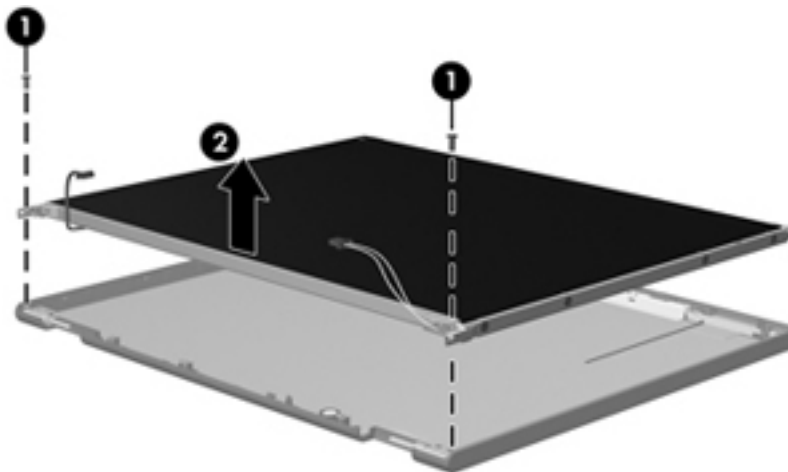

7. Turn the display panel assembly upside-down.
8. Remove all screws that secure the display panel frame to the display panel.

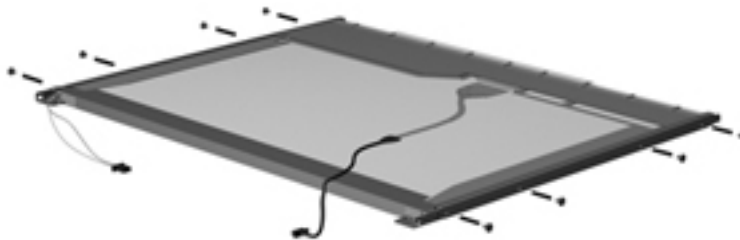

9. Use a sharp-edged tool to cut the tape (1) that secures the sides of the display panel to the display panel frame.

10. Remove the display panel frame (2) from the display panel.

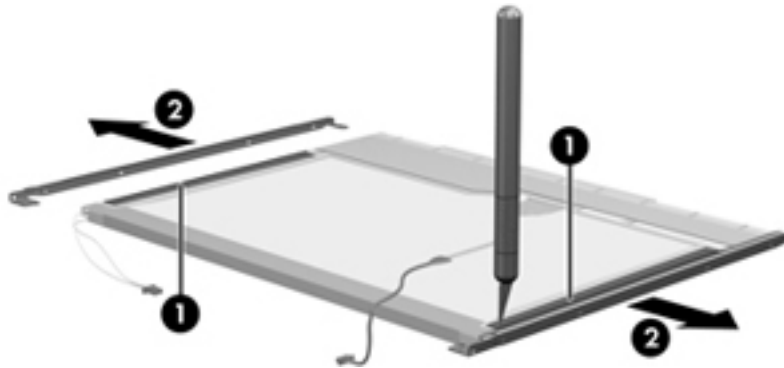

11. Remove the screws (1) that secure the backlight cover to the display panel.
12. Lift the top edge of the backlight cover (2) and swing it outward.

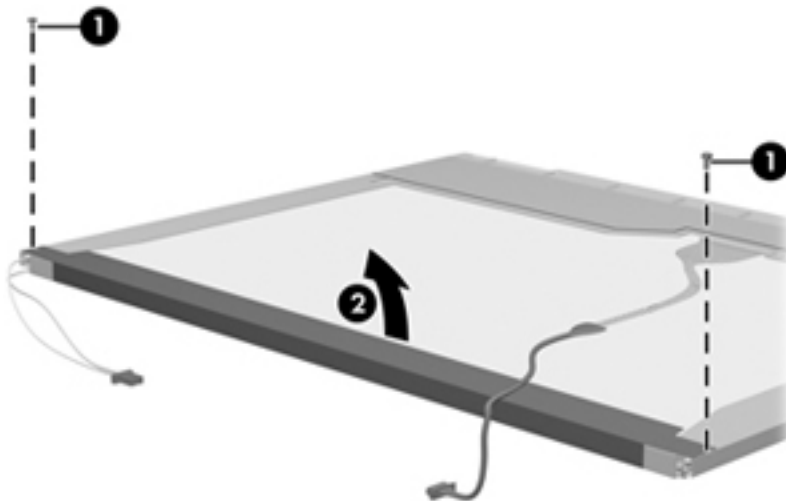

13. Remove the backlight cover.
14. Turn the display panel right-side up.

15. Remove the backlight cables (1) from the clip (2) in the display panel.

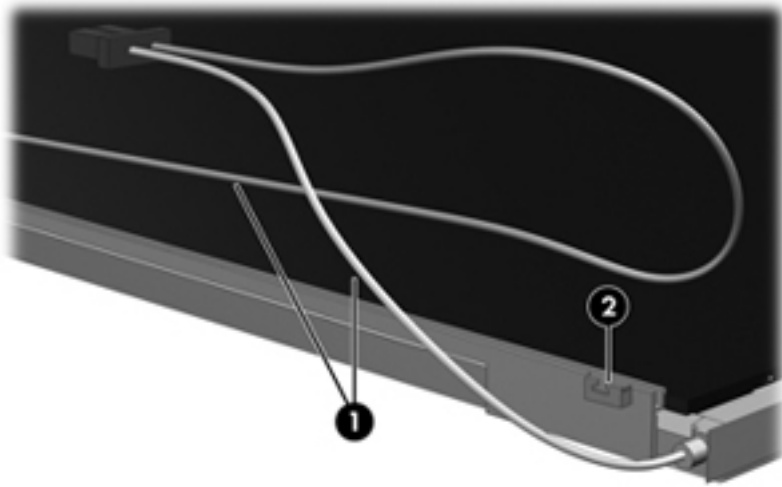

16. Turn the display panel upside-down.

⚠ WARNING! The backlight contains mercury. Exercise caution when removing and handling the backlight to avoid damaging this component and causing exposure to the mercury.

17. Remove the backlight frame from the display panel.

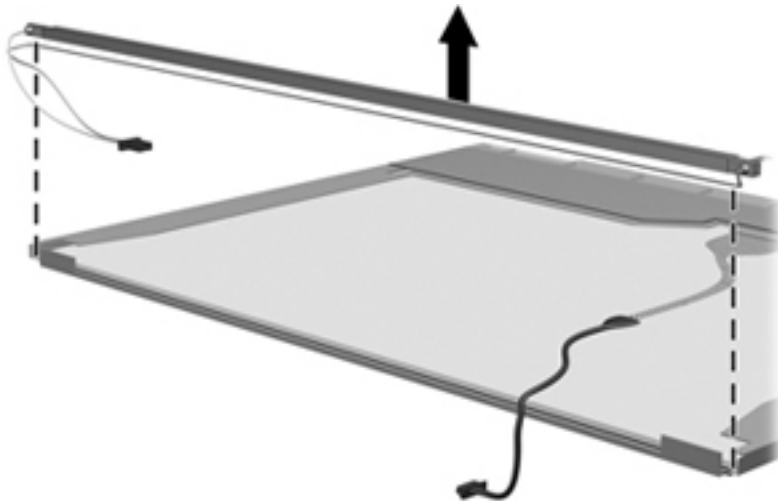

18. Remove the backlight from the backlight frame.

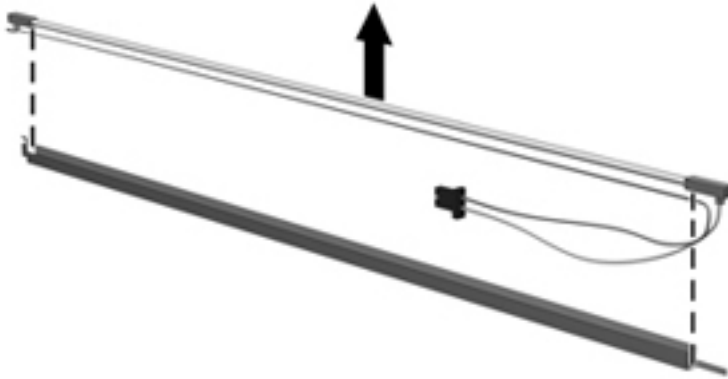

19. Disconnect the display panel cable (1) from the LCD panel.
20. Remove the screws (2) that secure the LCD panel to the display rear panel.
21. Release the LCD panel (3) from the display rear panel.
22. Release the tape (4) that secures the LCD panel to the display rear panel.

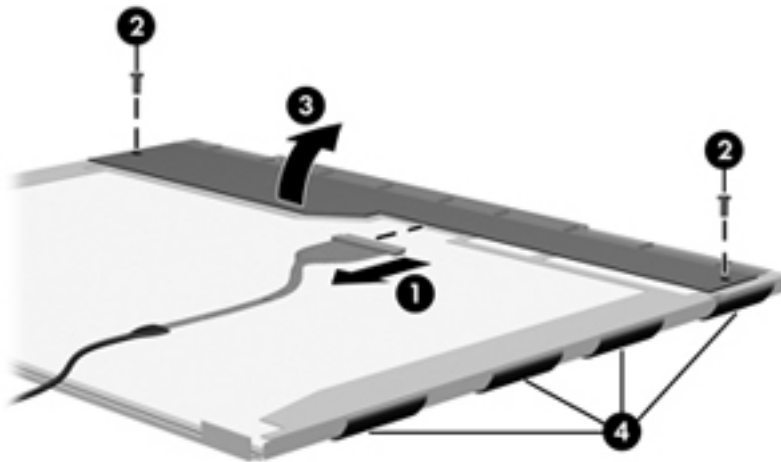

23. Remove the LCD panel.

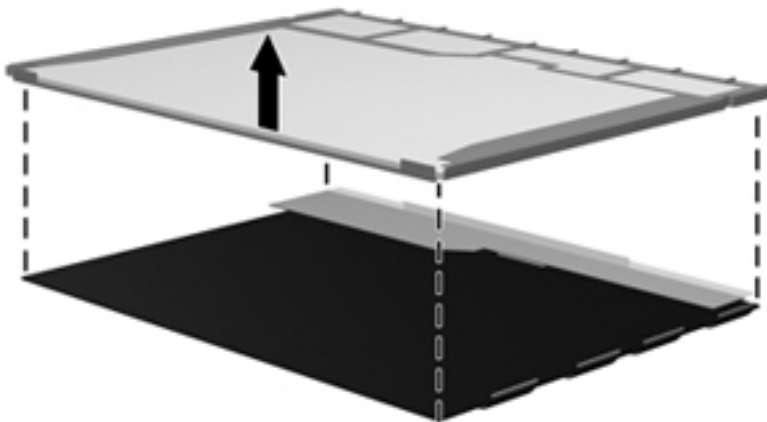

24. Recycle the LCD panel and backlight.

Index

Symbols/Numerics

1394 port, identifying 17

A

AC adapter, spare part numbers
33, 36

AMT options 111

AMT Setup Prompt (Ctrl-P)
111

Firmware Progress Event
Support 111

Firmware Verbosity 111

Initiate Intel CIRA 111

Terminal Emulation Mode 111

Unconfigure AMT on next
boot 111

USB Key Provisioning
Support 111

antennas 19

disconnecting 54, 68

WLAN 19

WWAN 19

Anti Theft 107

applications key, Windows 14

audio, product description 3

audio-in (microphone) jack
identifying 17

audio-out (headphone) jack
identifying 17

B

backing up files 119

Backup and Restore 119, 120

Backup and Restore Center 123,
124

base enclosure

illustrated 29

removal 79

spare part number 27, 37, 79

battery

removal 49

spare part number 26, 49

battery bay 18

battery light 15

battery release latch 18

BIOS administrator password
107

Blu-ray ROM DVD±RW SuperMulti
DL LightScribe Drive
removal 56
spare part number 26, 32, 40,
56

Bluetooth cable, illustrated 30

Bluetooth module

removal 62

spare part number 27, 35, 62

boot options 108

boot order 108

Bottom cover

illustrated 29

removal 51

spare part number 27, 51

Bottom cover release latch 18

built-in device

Ambient Light Sensor 110

audio device 110

Bluetooth device radio 110

fingerprint reader 110

integrated camera 110

internal speakers 110

LAN/WLAN switching 110

microphone 110

modem 110

Network Interface Controller
(LAN) 110

Notebook Upgrade Bay 110

Power Monitor Circuit 110

Wake on LAN 110

wireless button 110

WLAN device radio 110

built-in device options 110

buttons

left pointing stick button 10

left TouchPad 10

power 12

QuickWeb 13

right pointing stick button 10

right TouchPad 10

TouchPad 12

TouchPad on/off 10

volume mute 13

wireless 12

C

Cable Kit

contents 30

spare part number 27, 30, 38

cables, service considerations 43

caps lock light, identifying 11

chipset, product description 1

components

bottom 18

display 8

front 15

left-side 16

rear 17

right-side 17

top 10

computer feet

locations 48

spare part number 48

Computer Setup

File menu 106

navigating and selecting 104

restoring factory settings 105

- Security menu 107
- System Configuration menu 108
- computer specifications 112
- connector, power 17
- connectors, service considerations 43
- creating a backup 119

D

- device configurations 108
- discs
 - Driver Recovery 127
 - Operating System 127, 128
- disk sanitizer 107
- display assembly
 - removal 84
 - spare part numbers 22, 84
- display bezel
 - removal 87
 - spare part numbers 28, 38, 88
- display component recycling 131
- display components, spare part numbers 28
- display hinge
 - removal 89
 - spare part number 28, 91
- display hinge kit
 - spare part number 38
- display panel
 - product description 1
 - removal 89
- Display Panel Support Kit, spare part number 29, 41
- display panel, spare part number 29, 40
- display release latch, identifying 15
- display specifications 113
- DisplayPort, identifying 17
- docking support, product description 4
- drive light 15
- DriveLock
 - automatic 107
 - password 107
- Driver Recovery disc 127
- drives
 - boot order 108
 - preventing damage 43

- DVD-ROM Drive
 - precautions 43
 - removal 56
 - spare part number 26, 32, 40, 56
 - specifications 117
- DVD±RW SuperMulti DL LightScribe Drive
 - precautions 43
 - removal 56
 - spare part number 26, 32, 40, 56

E

- eject button
 - optical drive 16
- electrostatic discharge 44
- eSATA port, identifying 17
- esc key, identifying 14
- Ethernet, product description 3
- Execution Disable 108
- expansion memory module
 - removal 63
 - spare part numbers 63
- ExpressCard assembly
 - removal 99
 - spare part number 40, 99
- ExpressCard cable, illustrated 30
- ExpressCard slot, identifying 16
- external media cards, product description 4
- external monitor port
 - identifying 17

F

- f11 recovery 122, 125
- fan
 - removal 74
 - spare part number 24, 38, 74
- feet
 - locations 48
 - spare part number 48
- File menu 106
- Fingerprint reader board
 - removal 98
 - spare part number 27, 41, 98
- fingerprint reader, identifying 13
- fn key, identifying 14
- function keys, identifying 14

G

- graphics, product description 1
- grounding equipment and methods 46

H

- hard drive
 - precautions 43
 - product description 2
 - removal 60
 - spare part number 40
 - spare part numbers 27, 32, 37, 60
 - specifications 114
- hard drive bracket, removal 61
- hard drive recovery 122, 125
- HDD Hardware Kit
 - spare part number 41
- headphone (audio-out) jack
 - identifying 17
- heat sink
 - removal 75
 - spare part number 24, 41, 75
- hinge
 - removal 89
 - spare part number 28, 38, 91
- Hinge Kit
 - contents 31
 - spare part number 31
- HP QuickLook 109
- HP QuickWeb light 11
- HP SpareKey enrollment 107

I

- IEEE 1394 port, identifying 17
- integrated webcam light, identifying 9
- Intel HT Technology 109
- internal display switch 8
- internal microphones, identifying 8

J

- jacks
 - audio-in (microphone) 17
 - audio-out (headphone) 17
 - RJ-11 (modem) 17
 - RJ-45 (network) 16

K

keyboard
 product description 4
 removal 65
 spare part numbers 22, 38,
 39, 65
keypad keys, identifying 14
keys
 esc 14
 fn 14
 function 14
 keypad 14
 num lk 14
 Windows applications 14
 Windows logo 14

L

language, changing in Computer
 Setup 108
latch
 display release 15
latch, battery release 18
latch, Bottom cover release 18
Left hinge assembly, illustrated
 31
legacy support, USB 104, 108
lights
 battery 15
 caps lock 11
 drive 15
 HP QuickWeb 11
 local area network (LAN) 15
 mute 11
 num lock 11
 power 11, 15
 webcam 9
 wireless 11, 15

M

mass storage devices, spare part
 numbers 32
Media Card Reader, identifying
 15
memory module
 product description 2
 removal 63, 72
 spare part number 72
 spare part numbers 27, 63

microphone (audio-in) jack
 identifying 17
 product description 3
microphone board
 spare part numbers 40
model name 1
modem module
 product description 3
 removal 70
 spare part number 24, 37, 70
monitor port
 external 17
Multi Core CPU 109
mute light, identifying 11

N

num lk key, identifying 14
num lock light 11

O

Operating System disc 127, 128
operating system, product
 description 5
optical drive
 precautions 43
 product description 2
 removal 56
 spare part numbers 26, 32, 56
 specifications 115, 116, 117
optical drive eject button
 identifying 16

P

packing guidelines 45
parallel port mode 108
passwords 107
plastic parts 42
Plastics Kit
 contents 29
 spare part number 29, 40
pointing device, product
 description 4
pointing stick 10
port options 111
 1394 port 111
 eSATA port 111
 ExpressCard slot 111
 flash media reader 111
 parallel port 111
 serial port 111

Smart Card reader slot 111
USB port 111
ports
 1394 17
 DisplayPort 17
 eSATA 17
 external monitor 17
 product description 4
 USB 16, 17
Power button board
 removal 95
 spare part number 26, 40, 95
power button, identifying 12
power connector cable
 illustrated 30
 removal 102
 spare part numbers 102
power connector, identifying 17
power cord
 set requirements 129
 spare part numbers 33, 35
power light 11
power lights, identifying 15
power requirements, product
 description 4
primary memory module
 removal 72
 spare part number 72
processor
 product description 1
 removal 77
 spare part numbers 24, 77
product description
 audio 3
 chipset 1
 display panel 1
 docking support 4
 Ethernet 3
 external media cards 4
 graphics 1
 hard drives 2
 keyboard 4
 memory module 2
 microphone 3
 modem module 3
 operating system 5
 optical drives 2
 pointing devices 4
 ports 4
 power requirements 4

- processors 1
- product name 1
- security 5
- serviceability 6
- webcam 3
- wireless 3
- product name 1

Q

- QuickWeb button, identifying 13

R

- recovery partition 122, 125
- release latch, battery 18
- release latch, Bottom cover 18
- removal/replacement
 - preliminaries 42
 - procedures 47
- restore security defaults 111
- restore the factory settings 106
- restoring
 - hard drive 122, 125
- Right hinge, illustrated 31
- RJ-11 (modem) jack
 - identifying 17
- RJ-11 connector cable
 - illustrated 30
 - removal 100
- RJ-45 (network) jack
 - identifying 16
- RTC battery
 - removal 94
 - spare part number 26, 41, 94
- Rubber Kit, spare part number 40

S

- SATA (Serial Advanced Technology Attachment) devices 108
 - AHCI (Advanced Host Controller Interface) 108
 - IDE (Integrated Drive Electronics) 108
- Screw Kit, spare part number 34, 40
- Secondary Battery Fast Charge 109
- security cable slot, identifying 16
- Security menu 107
 - always prompt for HP SpareKey enrollment 107

- Automatic DriveLock 107
 - change password 107
- Disk Sanitizer 107
- DriveLock 107
- fingerprint reader reset 107
- HP Sparekey 107
- HP Sparekey enrollment 107
- password policy 107
- set up BIOS administrator
 - password 107
 - System IDs 107
- security, product description 5
- service considerations 42
- service tag 20, 47
- serviceability, product description 6
- set security level 111
- setup utility
 - File menu 106
 - navigating and selecting 104
 - restoring factory settings 105
 - Security menu 107
 - System Configuration menu 108
- SIM, removal 50
- slots
 - ExpressCard 16
 - security cable 16
- Smart Card reader
 - spare part number 41
- solid-state drive, spare part numbers 27, 32, 40, 60
- speaker assembly
 - identifying 15
 - removal 82
 - spare part number 26, 40, 82
- speaker kit
 - spare part number 82
- specifications
 - Blu-ray ROM DVD±RW SuperMulti DL LightScribe Drive 116
 - computer 112
 - display 113
 - DVD-ROM Drive 117
 - DVD±RW SuperMulti DL LightScribe Drive 115
 - hard drive 114
 - optical drive 115, 116, 117
- static-shielding materials 46

- system board
 - removal 91
 - spare part number 26
 - spare part numbers 40, 91
- System Configuration menu 108
- system date and time 106
- system diagnostics 106
- system fan 108
- system IDs 107
- system information 106

T

- thermal material, replacement 76
- tools required 42
- top cover
 - spare part number 23
 - spare part numbers 40
- TouchPad
 - buttons 10
- TouchPad cable, illustrated 30
- TouchPad on/off button
 - buttons 10
 - identifying 12
- TouchPad, identifying 10
- TPM Embedded Security 107
- transporting guidelines 45
- TXT (Intel Trusted Execution Technology) 109

U

- Unified Extensible Firmware Interface (UEFI) mode 108
- upgrade bay
 - identifying 16
 - removal 58
 - spare part number 58
- Upgrade Bay, spare part number 41
- USB legacy support 104, 108
- USB ports, identifying 16, 17
- User management 107

V

- vents, identifying 17, 18
- Virtualization Technology 109
- volume mute button, identifying 13

W

- webcam 9
 - product description 3
 - spare part number 40
- webcam light, identifying 9
- webcam, identifying 9
- Windows 7 operating system
 - DVD 122
- Windows applications key,
 - identifying 14
- Windows Backup utility 126, 127
- Windows logo key, identifying 14
- Windows recovery 128
- Windows Vista operating system
 - DVD 126
- wireless antennas
 - disconnecting 54, 68
 - location 19
- wireless antennas, identifying 8
- wireless button, identifying 12
- wireless light, identifying 15
- wireless lights 11
- wireless, product description 3
- Wireless/web/mute function board
 - removal 96
 - spare part number 26, 96
 - spare part numbers 40
- WLAN antennas, identifying 8,
19
- WLAN module
 - removal 52
 - spare part number 35, 37, 52
 - spare part numbers 24
- workstation guidelines 45
- WWAN antennas, identifying 8,
19
- WWAN module
 - removal 68
 - spare part number 27, 37, 68

