





OM-270 404A

2015-01

Processes

 MIG (GMAW) Welding
Flux Cored (FCAW) Welding

 Stick (SMAW) Welding

 TIG (GTAW) Welding

 Air Carbon Arc (CAC-A)
Cutting and Gouging

Description



Engine Driven Welder/Generator

Big Blue[®] 500 PRO

Perkins

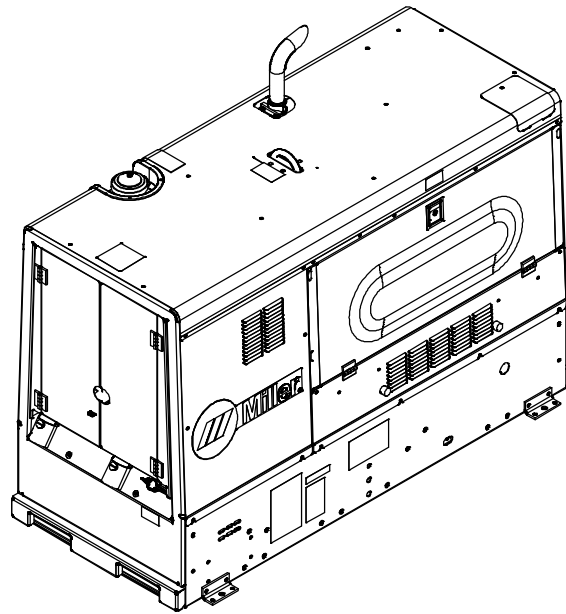

OWNER'S MANUAL

File: Engine Drive 



Visit our website at
www.MillerWelds.com

From Miller to You

Thank you and congratulations on choosing Miller. Now you can get the job done and get it done right. We know you don't have time to do it any other way.

That's why when Niels Miller first started building arc welders in 1929, he made sure his products offered long-lasting value and superior quality. Like you, his customers couldn't afford anything less. Miller products had to be more than the best they could be. They had to be the best you could buy.

Today, the people that build and sell Miller products continue the tradition. They're just as committed to providing equipment and service that meets the high standards of quality and value established in 1929.

This Owner's Manual is designed to help you get the most out of your Miller products. Please take time to read the Safety precautions. They will help you protect yourself against potential hazards on the worksite.

We've made installation and operation quick and easy. With Miller you can count on years of reliable service with proper maintenance. And if for some reason the unit needs repair, there's a Troubleshooting section that will help you figure out what the problem is. The parts list will then help you to decide the exact part you may need to fix the problem. Warranty and service information for your particular model are also provided.



Miller is the first welding equipment manufacturer in the U.S.A. to be registered to the ISO 9001 Quality System Standard.

Miller Electric manufactures a full line of welders and welding related equipment. For information on other quality Miller products, contact your local Miller distributor to receive the latest full line catalog or individual specification sheets. **To locate your nearest distributor or service agency call 1-800-4-A-Miller, or visit us at www.MillerWelds.com on the web.**



Working as hard as you do – every power source from Miller is backed by the most hassle-free warranty in the business.



TABLE OF CONTENTS

SECTION 1 – SAFETY PRECAUTIONS – READ BEFORE USING	1
1-1. Symbol Usage	1
1-2. Arc Welding Hazards	1
1-3. Engine Hazards	3
1-4. Compressed Air Hazards	3
1-5. Additional Symbols For Installation, Operation, And Maintenance	4
1-6. California Proposition 65 Warnings	6
1-7. Principal Safety Standards	6
1-8. EMF Information	6
SECTION 2 – CONSIGNES DE SÉCURITÉ – LIRE AVANT UTILISATION	7
2-1. Signification des symboles	7
2-2. Dangers relatifs au soudage à l'arc	7
2-3. Dangers existant en relation avec le moteur	9
2-4. Dangers liés à l'air comprimé	10
2-5. Dangers supplémentaires en relation avec l'installation, le fonctionnement et la maintenance	11
2-6. Proposition californienne 65 Avertissements	13
2-7. Principales normes de sécurité	13
2-8. Informations relatives aux CEM	13
SECTION 3 – DEFINITIONS	14
3-1. Additional Safety Symbols And Definitions	14
3-2. Miscellaneous Symbols And Definitions	17
SECTION 4 – SPECIFICATIONS	18
4-1. Serial Number And Rating Label Locations	18
4-2. Weld, Power, And Engine Specifications	18
4-3. Dimensions, Weights, And Operating Angles	18
4-4. Environmental Specifications	18
4-5. Duty Cycle And Overheating	19
4-6. Fuel Consumption	19
4-7. Volt-Ampere Curves	20
4-8. Generator Power Curves	21
SECTION 5 – INSTALLATION	22
5-1. Installing Welder/Generator	22
5-2. Grounding Generator To Truck Or Trailer Frame	23
5-3. Installing Exhaust Pipe	23
5-4. Connecting The Battery	24
5-5. Engine Prestart Checks	25
5-6. Weld Output Terminals	26
5-7. Connecting To Weld Output Terminals	26
5-8. Weld Output Terminals And Selecting Cable Sizes*	27
5-9. Connecting To Remote 14 Receptacle	27

TABLE OF CONTENTS

SECTION 6 – OPERATING WELDER / GENERATOR	28
6-1. Front Panel Controls (See Section 6-2)	28
6-2. Description Of Front Panel Controls (See Section 6-1)	29
6-3. Process/Contactor Switch	30
6-4. Arc Control	31
6-5. Low Open-Circuit Voltage (VRD) Switch Mode	32
6-6. Stick Start Procedure – Scratch Start Technique	32
6-7. Lift-Arc™ TIG With Auto-Stop™	33
6-8. Remote Voltage/Amperage Control	34
6-9. Fuel/Hour Gauge Descriptions	35
6-10. Oil Pan Heater Operation	36
SECTION 7 – OPERATING AUXILIARY EQUIPMENT	37
7-1. North American Auxiliary Power Receptacles	37
7-2. Export Auxiliary Power Receptacles	38
7-3. GFCI Receptacle Information, Resetting And Testing	39
SECTION 8 – MAINTENANCE	40
8-1. Maintenance Label	40
8-2. Routine Maintenance	41
8-3. Servicing Air Cleaner	42
8-4. Engine Speed Adjustment	43
8-5. Checking Generator Brushes	44
8-6. Battery Replacement	44
8-7. Battery Maintenance	44
8-8. Servicing Fuel And Lubrication Systems	45
8-9. Engine/Generator Overload Protection	46
8-10. Voltmeter/Ammeter Help Displays	47
SECTION 9 – TROUBLESHOOTING	48
9-1. Troubleshooting	48
SECTION 10 – PARTS LIST	51
10-1. Recommended Spare Parts	51
SECTION 11 – ELECTRICAL DIAGRAMS	52
SECTION 12 – RUN-IN PROCEDURE	54
12-1. Wetstacking	54
12-2. Run-In Procedure Using Load Bank Or Resistance Grid	55
SECTION 13 – GENERATOR POWER GUIDELINES	56
COMPLETE PARTS LIST – Available at www.MillerWelds.com	
WARRANTY	

SECTION 1 – SAFETY PRECAUTIONS – READ BEFORE USING

rom_2013-09

⚠ Protect yourself and others from injury — read, follow, and save these important safety precautions and operating instructions.

1-1. Symbol Usage



DANGER! – Indicates a hazardous situation which, if not avoided, will result in death or serious injury. The possible hazards are shown in the adjoining symbols or explained in the text.



Indicates a hazardous situation which, if not avoided, could result in death or serious injury. The possible hazards are shown in the adjoining symbols or explained in the text.

NOTICE – Indicates statements not related to personal injury.

 Indicates special instructions.



This group of symbols means Warning! Watch Out! ELECTRIC SHOCK, MOVING PARTS, and HOT PARTS hazards. Consult symbols and related instructions below for necessary actions to avoid the hazards.

1-2. Arc Welding Hazards



The symbols shown below are used throughout this manual to call attention to and identify possible hazards. When you see the symbol, watch out, and follow the related instructions to avoid the hazard. The safety information given below is only a summary of the more complete safety information found in the Safety Standards listed in Section 1-7. Read and follow all Safety Standards.



Only qualified persons should install, operate, maintain, and repair this unit.



During operation, keep everybody, especially children, away.

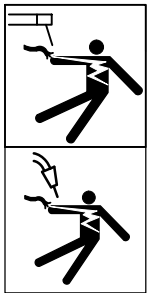

ELECTRIC SHOCK can kill.

Touching live electrical parts can cause fatal shocks or severe burns. The electrode and work circuit is electrically live whenever the output is on. The input power circuit and machine internal circuits are also live when power is on. In semiautomatic or automatic wire welding, the wire, wire reel, drive roll housing, and all metal parts touching the welding wire are electrically live. Incorrectly installed or improperly grounded equipment is a hazard.

- Do not touch live electrical parts.
- Wear dry, hole-free insulating gloves and body protection.
- Insulate yourself from work and ground using dry insulating mats or covers big enough to prevent any physical contact with the work or ground.
- Do not use AC output in damp areas, if movement is confined, or if there is a danger of falling.
- Use AC output ONLY if required for the welding process.
- If AC output is required, use remote output control if present on unit.
- Additional safety precautions are required when any of the following electrically hazardous conditions are present: in damp locations or while wearing wet clothing; on metal structures such as floors, gratings, or scaffolds; when in cramped positions such as sitting, kneeling, or lying; or when there is a high risk of unavoidable or accidental contact with the workpiece or ground. For these conditions, use the following equipment in order presented: 1) a semiautomatic DC constant voltage (wire) welder, 2) a DC manual (stick) welder, or 3) an AC welder with reduced open-circuit voltage. In most situations, use of a DC, constant voltage wire welder is recommended. And, do not work alone!
- Disconnect input power or stop engine before installing or servicing this equipment. Lockout/tagout input power according to OSHA 29 CFR 1910.147 (see Safety Standards).
- Properly install, ground, and operate this equipment according to its Owner's Manual and national, state, and local codes.

- Always verify the supply ground — check and be sure that input power cord ground wire is properly connected to ground terminal in disconnect box or that cord plug is connected to a properly grounded receptacle outlet.
- When making input connections, attach proper grounding conductor first – double-check connections.
- Keep cords dry, free of oil and grease, and protected from hot metal and sparks.
- Frequently inspect input power cord and ground conductor for damage or bare wiring – replace immediately if damaged – bare wiring can kill.
- Turn off all equipment when not in use.
- Do not use worn, damaged, undersized, or repaired cables.
- Do not drape cables over your body.
- If earth grounding of the workpiece is required, ground it directly with a separate cable.
- Do not touch electrode if you are in contact with the work, ground, or another electrode from a different machine.
- Use only well-maintained equipment. Repair or replace damaged parts at once. Maintain unit according to manual.
- Do not touch electrode holders connected to two welding machines at the same time since double open-circuit voltage will be present.
- Wear a safety harness if working above floor level.
- Keep all panels and covers securely in place.
- Clamp work cable with good metal-to-metal contact to workpiece or worktable as near the weld as practical.
- Insulate work clamp when not connected to workpiece to prevent contact with any metal object.
- Do not connect more than one electrode or work cable to any single weld output terminal. Disconnect cable for process not in use.
- Use GFCI protection when operating auxiliary equipment. Do not test or reset GFCI receptacles at idle speed/low voltage or the GFCI will be damaged and not provide protection from electric shock caused by a ground fault.

SIGNIFICANT DC VOLTAGE exists in inverter power sources AFTER stopping engine.

- Stop engine on inverter and discharge input capacitors according to instructions in Maintenance Section before touching any parts.



HOT PARTS can burn.

- Do not touch hot parts bare handed.
- Allow cooling period before working on equipment.
- To handle hot parts, use proper tools and/or wear heavy, insulated welding gloves and clothing to prevent burns.

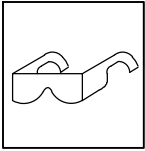

FLYING METAL or DIRT can injure eyes.

- Welding, chipping, wire brushing, and grinding cause sparks and flying metal. As welds cool, they can throw off slag.
- Wear approved safety glasses with side shields even under your welding helmet.



FUMES AND GASES can be hazardous.

Welding produces fumes and gases. Breathing these fumes and gases can be hazardous to your health.

- Keep your head out of the fumes. Do not breathe the fumes.
- If inside, ventilate the area and/or use local forced ventilation at the arc to remove welding fumes and gases. The recommended way to determine adequate ventilation is to sample for the composition and quantity of fumes and gases to which personnel are exposed.
- If ventilation is poor, wear an approved air-supplied respirator.
- Read and understand the Safety Data Sheets (SDSs) and the manufacturer's instructions for adhesives, coatings, cleaners, consumables, coolants, degreasers, fluxes, and metals.
- Work in a confined space only if it is well ventilated, or while wearing an air-supplied respirator. Always have a trained watch-person nearby. Welding fumes and gases can displace air and lower the oxygen level causing injury or death. Be sure the breathing air is safe.
- Do not weld in locations near degreasing, cleaning, or spraying operations. The heat and rays of the arc can react with vapors to form highly toxic and irritating gases.
- Do not weld on coated metals, such as galvanized, lead, or cadmium plated steel, unless the coating is removed from the weld area, the area is well ventilated, and while wearing an air-supplied respirator. The coatings and any metals containing these elements can give off toxic fumes if welded.



BUILDUP OF GAS can injure or kill.

- Shut off compressed gas supply when not in use.
- Always ventilate confined spaces or use approved air-supplied respirator.



ARC RAYS can burn eyes and skin.

Arc rays from the welding process produce intense visible and invisible (ultraviolet and infrared) rays that can burn eyes and skin. Sparks fly off from the weld.

- Wear an approved welding helmet fitted with a proper shade of filter lenses to protect your face and eyes from arc rays and sparks when welding or watching (see ANSI Z49.1 and Z87.1 listed in Safety Standards).
- Wear approved safety glasses with side shields under your helmet.
- Use protective screens or barriers to protect others from flash, glare, and sparks; warn others not to watch the arc.
- Wear body protection made from durable, flame-resistant material (leather, heavy cotton, wool). Body protection includes oil-free clothing such as leather gloves, heavy shirt, cuffless trousers, high shoes, and a cap.

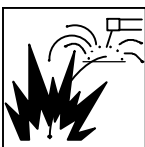

WELDING can cause fire or explosion.

Welding on closed containers, such as tanks, drums, or pipes, can cause them to blow up. Sparks can fly off from the welding arc. The flying sparks, hot workpiece, and hot equipment can cause fires and burns. Accidental contact of electrode to metal objects can cause sparks, explosion, overheating, or fire. Check and be sure the area is safe before doing any welding.

- Remove all flammables within 35 ft (10.7 m) of the welding arc. If this is not possible, tightly cover them with approved covers.
- Do not weld where flying sparks can strike flammable material.
- Protect yourself and others from flying sparks and hot metal.

- Be alert that welding sparks and hot materials from welding can easily go through small cracks and openings to adjacent areas.
- Watch for fire, and keep a fire extinguisher nearby.
- Be aware that welding on a ceiling, floor, bulkhead, or partition can cause fire on the hidden side.
- Do not weld on containers that have held combustibles, or on closed containers such as tanks, drums, or pipes unless they are properly prepared according to AWS F4.1 and AWS A6.0 (see Safety Standards).
- Do not weld where the atmosphere may contain flammable dust, gas, or liquid vapors (such as gasoline).
- Connect work cable to the work as close to the welding area as practical to prevent welding current from traveling long, possibly unknown paths and causing electric shock, sparks, and fire hazards.
- Do not use welder to thaw frozen pipes.
- Remove stick electrode from holder or cut off welding wire at contact tip when not in use.
- Wear body protection made from durable, flame-resistant material (leather, heavy cotton, wool). Body protection includes oil-free clothing such as leather gloves, heavy shirt, cuffless trousers, high shoes, and a cap.
- Remove any combustibles, such as a butane lighter or matches, from your person before doing any welding.
- After completion of work, inspect area to ensure it is free of sparks, glowing embers, and flames.
- Use only correct fuses or circuit breakers. Do not oversize or bypass them.
- Follow requirements in OSHA 1910.252 (a) (2) (iv) and NFPA 51B for hot work and have a fire watcher and extinguisher nearby.
- Read and understand the Safety Data Sheets (SDSs) and the manufacturer's instructions for adhesives, coatings, cleaners, consumables, coolants, degreasers, fluxes, and metals.

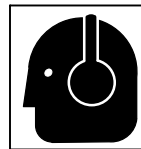

NOISE can damage hearing.

Noise from some processes or equipment can damage hearing.

- Wear approved ear protection if noise level is high.

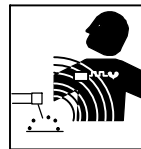

ELECTRIC AND MAGNETIC FIELDS (EMF) can affect Implanted Medical Devices.

- Wearers of Pacemakers and other Implanted Medical Devices should keep away.
- Implanted Medical Device wearers should consult their doctor and the device manufacturer before going near arc welding, spot welding, gouging, plasma arc cutting, or induction heating operations.

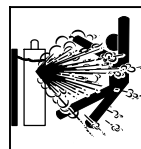

CYLINDERS can explode if damaged.

Compressed gas cylinders contain gas under high pressure. If damaged, a cylinder can explode. Since gas cylinders are normally part of the welding process, be sure to treat them carefully.

- Protect compressed gas cylinders from excessive heat, mechanical shocks, physical damage, slag, open flames, sparks, and arcs.
- Install cylinders in an upright position by securing to a stationary support or cylinder rack to prevent falling or tipping.
- Keep cylinders away from any welding or other electrical circuits.
- Never drape a welding torch over a gas cylinder.
- Never allow a welding electrode to touch any cylinder.
- Never weld on a pressurized cylinder — explosion will result.
- Use only correct compressed gas cylinders, regulators, hoses, and fittings designed for the specific application; maintain them and associated parts in good condition.
- Turn face away from valve outlet when opening cylinder valve. Do not stand in front of or behind the regulator when opening the valve.
- Keep protective cap in place over valve except when cylinder is in use or connected for use.
- Use the right equipment, correct procedures, and sufficient number of persons to lift and move cylinders.
- Read and follow instructions on compressed gas cylinders, associated equipment, and Compressed Gas Association (CGA) publication P-1 listed in Safety Standards.

1-3. Engine Hazards

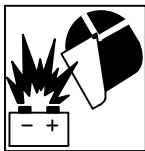

BATTERY EXPLOSION can injure.

- Always wear a face shield, rubber gloves, and protective clothing when working on a battery.
- Stop engine before disconnecting or connecting battery cables, battery charging cables (if applicable), or servicing battery.
- Do not allow tools to cause sparks when working on a battery.
- Do not use welder to charge batteries or jump start vehicles unless the unit has a battery charging feature designed for this purpose.
- Observe correct polarity (+ and -) on batteries.
- Disconnect negative (-) cable first and connect it last.
- Keep sparks, flames, cigarettes, and other ignition sources away from batteries. Batteries produce explosive gases during normal operation and when being charged.
- Follow battery manufacturer's instructions when working on or near a battery.



FUEL can cause fire or explosion.

- Stop engine and let it cool off before checking or adding fuel.
- Do not add fuel while smoking or if unit is near any sparks or open flames.
- Do not overfill tank — allow room for fuel to expand.
- Do not spill fuel. If fuel is spilled, clean up before starting engine.
- Dispose of rags in a fireproof container.
- Always keep nozzle in contact with tank when fueling.



MOVING PARTS can injure.

- Keep away from moving parts such as fans, belts, and rotors.
- Keep all doors, panels, covers, and guards closed and securely in place.
- Stop engine before installing or connecting unit.
- Have only qualified persons remove doors, panels, covers, or guards for maintenance and troubleshooting as necessary.
- To prevent accidental starting during servicing, disconnect negative (-) battery cable from battery.
- Keep hands, hair, loose clothing, and tools away from moving parts.
- Reinstall doors, panels, covers, or guards when servicing is finished and before starting engine.
- Before working on generator, remove spark plugs or injectors to keep engine from kicking back or starting.
- Block flywheel so that it will not turn while working on generator components.



EXHAUST SPARKS can cause fire.

- Do not let engine exhaust sparks cause fire.
- Use approved engine exhaust spark arrestor in required areas — see applicable codes.



HOT PARTS can burn.

- Do not touch hot parts bare handed.
- Allow cooling period before working on equipment.
- To handle hot parts, use proper tools and/or wear heavy, insulated welding gloves and clothing to prevent burns.



STEAM AND HOT COOLANT can burn.

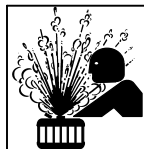

- If possible, check coolant level when engine is cold to avoid scalding.
- Always check coolant level at overflow tank, if present on unit, instead of radiator (unless told otherwise in maintenance section or engine manual).
- If the engine is warm, checking is needed, and there is no overflow tank, follow the next two statements.
- Wear safety glasses and gloves and put a rag over radiator cap.
- Turn cap slightly and let pressure escape slowly before completely removing cap.

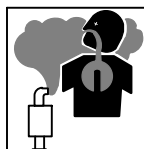

Using a generator indoors CAN KILL YOU IN MINUTES.

- Generator exhaust contains carbon monoxide. This is a poison you cannot see or smell.
- NEVER use inside a home or garage, EVEN IF doors and windows are open.
- Only use OUTSIDE and far away from windows, doors, and vents.

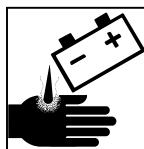

BATTERY ACID can BURN SKIN and EYES.

- Do not tip battery.
- Replace damaged battery.
- Flush eyes and skin immediately with water.



ENGINE HEAT can cause fire.

- Do not locate unit on, over, or near combustible surfaces or flammables.
- Keep exhaust and exhaust pipes way from flammables.

1-4. Compressed Air Hazards



COMPRESSED AIR EQUIPMENT can injure or kill.

- Incorrect installation or operation of this unit could result in equipment failure and personal injury. Only qualified persons should install, operate, and service this unit according to its Owner's Manual, industry standards, and national, state, and local codes.
- Do not exceed the rated output or capacity of the compressor or any equipment in the compressed air system. Design compressed air system so failure of any component will not put people or property at risk.
- Before working on compressed air system, turn off and lockout/tagout unit, release pressure, and be sure air pressure cannot be accidentally applied.
- Do not work on compressed air system with unit running unless you are a qualified person and following the manufacturer's instructions.
- Do not modify or alter compressor or manufacturer-supplied equipment. Do not disconnect, disable, or override any safety equipment in the compressed air system.
- Use only components and accessories approved by the manufacturer.
- Keep away from potential pinch points or crush points created by equipment connected to the compressed air system.
- Do not work under or around any equipment that is supported only by air pressure. Properly support equipment by mechanical means.



HOT METAL from air arc cutting and gouging can cause fire or explosion.

- Do not cut or gouge near flammables.
- Watch for fire; keep extinguisher nearby.



COMPRESSED AIR can injure or kill.

- Before working on compressed air system, turn off and lockout/tagout unit, release pressure, and be sure air pressure cannot be accidentally applied.
- Relieve pressure before disconnecting or connecting air lines.
- Check compressed air system components and all connections and hoses for damage, leaks, and wear before operating unit.

- Do not direct air stream toward self or others.
- Wear protective equipment such as safety glasses, hearing protection, leather gloves, heavy shirt and trousers, high shoes, and a cap when working on compressed air system.
- Use soapy water or an ultrasonic detector to search for leaks—never use bare hands. Do not use equipment if leaks are found.
- Reinstall doors, panels, covers, or guards when servicing is finished and before starting unit.
- If ANY air is injected into the skin or body seek medical help immediately.



BREATHING COMPRESSED AIR can injure or kill.

- Do not use compressed air for breathing.
- Use only for cutting, gouging, and tools.



TRAPPED AIR PRESSURE AND WHIPPING HOSES can injure.

- Release air pressure from tools and system before servicing, adding or changing attachments, or opening compressor oil drain or oil fill cap.



MOVING PARTS can injure.

- Keep away from moving parts such as fans, belts and rotors.
- Keep all doors, panels, covers, and guards closed and securely in place.
- Keep hands, hair, loose clothing, and tools away from moving parts.
- Before working on compressed air system, turn off and lockout/tagout unit, release pressure, and be sure air pressure cannot be accidentally applied.
- Have only qualified people remove guards or covers for maintenance and troubleshooting as necessary.
- Reinstall doors, panels, covers, or guards when servicing is finished and before starting engine.



HOT PARTS can burn.

- Do not touch hot compressor or air system parts.
- Allow cooling period before working on equipment.
- To handle hot parts, use proper tools and/or wear heavy, insulated welding gloves and clothing to prevent burns.

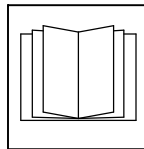

READ INSTRUCTIONS.

- Read and follow all labels and the Owner's Manual carefully before installing, operating, or servicing unit. Read the safety information at the beginning of the manual and in each section.
- Use only genuine replacement parts from the manufacturer.
- Perform maintenance and service according to the Owner's Manuals, industry standards, and national, state, and local codes.

1-5. Additional Symbols For Installation, Operation, And Maintenance



FIRE OR EXPLOSION hazard.

- Do not install or place unit on, over, or near combustible surfaces.
- Do not install unit near flammables.
- Do not overload building wiring – be sure power supply system is properly sized, rated, and protected to handle this unit.



FALLING EQUIPMENT can injure.

- Use lifting eye to lift unit and properly installed accessories only, NOT gas cylinders. Do not exceed maximum lift eye weight rating (see Specifications).
- Use equipment of adequate capacity to lift and support unit.
- If using lift forks to move unit, be sure forks are long enough to extend beyond opposite side of unit.
- Keep equipment (cables and cords) away from moving vehicles when working from an aerial location.
- Follow the guidelines in the Applications Manual for the Revised NIOSH Lifting Equation (Publication No. 94-110) when manually lifting heavy parts or equipment.

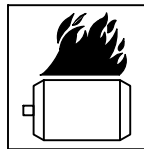

OVERHEATING can damage motors.

- Turn off or unplug equipment before starting or stopping engine.
- Do not let low voltage and frequency caused by low engine speed damage electric motors.
- Do not connect 50 or 60 Hertz motors to the 100 Hertz receptacle where applicable.

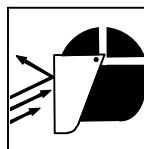

FLYING SPARKS can injure.

- Wear a face shield to protect eyes and face.
- Shape tungsten electrode only on grinder with proper guards in a safe location wearing proper face, hand, and body protection.
- Sparks can cause fires — keep flammables away.

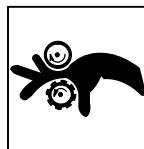

MOVING PARTS can injure.

- Keep away from moving parts.
- Keep away from pinch points such as drive rolls.



BATTERY CHARGING OUTPUT and BATTERY EXPLOSION can injure.

Battery charging not present on all models.

- Always wear a face shield, rubber gloves, and protective clothing when working on a battery.
- Stop engine before disconnecting or connecting battery cables, battery charging cables (if applicable), or servicing battery.
- Do not allow tools to cause sparks when working on a battery.
- Do not use welder to charge batteries or jump start vehicles unless it has a battery charging feature designed for this purpose.
- Observe correct polarity (+ and -) on batteries.
- Disconnect negative (-) cable first and connect it last.
- Keep sparks, flames, cigarettes, and other ignition sources away from batteries. Batteries produce explosive gases during normal operation and when being charged.
- Follow battery manufacturer's instructions when working on or near a battery.
- Have only qualified persons do battery charging work.
- If battery is being removed from a vehicle for charging, disconnect negative (-) cable first and connect it last. To prevent an arc, make sure all accessories are off.
- Charge lead-acid batteries only. Do not use battery charger to supply power to an extra-low-voltage electrical system or to charge dry cell batteries.
- Do not charge a frozen battery.
- Do not use damaged charging cables.
- Do not charge batteries in a closed area or where ventilation is restricted.
- Do not charge a battery that has loose terminals or one showing damage such as a cracked case or cover.
- Before charging battery, select correct charger voltage to match battery voltage.
- Set battery charging controls to the Off position before connecting to battery. Do not allow battery charging clips to touch each other.
- Keep charging cables away from vehicle hood, door, or moving parts.



WELDING WIRE can injure.

- Do not press gun trigger until instructed to do so.
- Do not point gun toward any part of the body, other people, or any metal when threading welding wire.

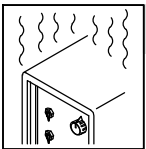

OVERUSE can cause OVERHEATING.

- Allow cooling period; follow rated duty cycle.
- Reduce current or reduce duty cycle before starting to weld again.
- Do not block or filter airflow to unit.

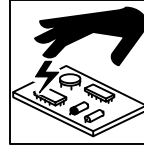

STATIC (ESD) can damage PC boards.

- Put on grounded wrist strap BEFORE handling boards or parts.
- Use proper static-proof bags and boxes to store, move, or ship PC boards.

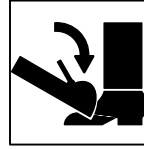

TILTING OF TRAILER can injure.

- Use tongue jack or blocks to support weight.
- Properly install welding generator onto trailer according to instructions supplied with trailer.

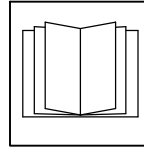

READ INSTRUCTIONS.

- Read and follow all labels and the Owner's Manual carefully before installing, operating, or servicing unit. Read the safety information at the beginning of the manual and in each section.
- Use only genuine replacement parts from the manufacturer.
- Perform maintenance and service according to the Owner's Manuals, industry standards, and national, state, and local codes.

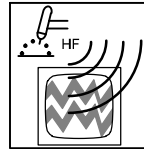

H.F. RADIATION can cause interference.

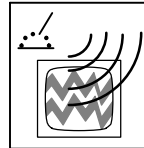

- High-frequency (H.F.) can interfere with radio navigation, safety services, computers, and communications equipment.
- Have only qualified persons familiar with electronic equipment perform this installation.
- The user is responsible for having a qualified electrician promptly correct any interference problem resulting from the installation.
- If notified by the FCC about interference, stop using the equipment at once.
- Have the installation regularly checked and maintained.
- Keep high-frequency source doors and panels tightly shut, keep spark gaps at correct setting, and use grounding and shielding to minimize the possibility of interference.



ARC WELDING can cause interference.

- Electromagnetic energy can interfere with sensitive electronic equipment such as micro-processors, computers, and computer-driven equipment such as robots.
- Be sure all equipment in the welding area is electromagnetically compatible.
- To reduce possible interference, keep weld cables as short as possible, close together, and down low, such as on the floor.
- Locate welding operation 100 meters from any sensitive electronic equipment.
- Be sure this welding machine is installed and grounded according to this manual.
- If interference still occurs, the user must take extra measures such as moving the welding machine, using shielded cables, using line filters, or shielding the work area.

1-6. California Proposition 65 Warnings

-  **Welding or cutting equipment produces fumes or gases which contain chemicals known to the State of California to cause birth defects and, in some cases, cancer. (California Health & Safety Code Section 25249.5 et seq.)**
-  **Battery posts, terminals and related accessories contain lead and lead compounds, chemicals known to the State of California to cause cancer and birth defects or other reproductive harm. *Wash hands after handling.***
-  **This product contains chemicals, including lead, known to the state of California to cause cancer, birth defects, or other reproductive harm. *Wash hands after use.***

For Gasoline Engines:

-  **Engine exhaust contains chemicals known to the State of California to cause cancer, birth defects, or other reproductive harm.**

For Diesel Engines:

-  **Diesel engine exhaust and some of its constituents are known to the State of California to cause cancer, birth defects, and other reproductive harm.**

1-7. Principal Safety Standards

Safety in Welding, Cutting, and Allied Processes, ANSI Standard Z49.1, is available as a free download from the American Welding Society at <http://www.aws.org> or purchased from Global Engineering Documents (phone: 1-877-413-5184, website: www.global.ihs.com).

Safe Practices for the Preparation of Containers and Piping for Welding and Cutting, American Welding Society Standard AWS F4.1, from Global Engineering Documents (phone: 1-877-413-5184, website: www.global.ihs.com).

Safe Practices for Welding and Cutting Containers that have Held Combustibles, American Welding Society Standard AWS A6.0, from Global Engineering Documents (phone: 1-877-413-5184, website: www.global.ihs.com).

National Electrical Code, NFPA Standard 70, from National Fire Protection Association, Quincy, MA 02269 (phone: 1-800-344-3555, website: www.nfpa.org and www.sparky.org).

Safe Handling of Compressed Gases in Cylinders, CGA Pamphlet P-1, from Compressed Gas Association, 14501 George Carter Way, Suite 103, Chantilly, VA 20151 (phone: 703-788-2700, website: www.cganet.com).

Safety in Welding, Cutting, and Allied Processes, CSA Standard W117.2, from Canadian Standards Association, Standards Sales, 5060 Spectrum Way, Suite 100, Ontario, Canada L4W 5NS (phone: 800-463-6727, website: www.csa-international.org).

Battery Chargers, CSA Standard C22.2 NO 107.2-01, from Canadian Standards Association, Standards Sales, 5060 Spectrum Way, Suite

100, Ontario, Canada L4W 5NS (phone: 800-463-6727, website: www.csa-international.org).

Safe Practice For Occupational And Educational Eye And Face Protection, ANSI Standard Z87.1, from American National Standards Institute, 25 West 43rd Street, New York, NY 10036 (phone: 212-642-4900, website: www.ansi.org).

Standard for Fire Prevention During Welding, Cutting, and Other Hot Work, NFPA Standard 51B, from National Fire Protection Association, Quincy, MA 02269 (phone: 1-800-344-3555, website: www.nfpa.org).

OSHA, Occupational Safety and Health Standards for General Industry, Title 29, Code of Federal Regulations (CFR), Part 1910, Subpart Q, and Part 1926, Subpart J, from U.S. Government Printing Office, Superintendent of Documents, P.O. Box 371954, Pittsburgh, PA 15250-7954 (phone: 1-866-512-1800) (there are 10 OSHA Regional Offices—phone for Region 5, Chicago, is 312-353-2220, website: www.osha.gov).

Portable Generators Safety Alert, U.S. Consumer Product Safety Commission (CPSC), 4330 East West Highway, Bethesda, MD 20814 (phone: 301-504-7923, website: www.cpsc.gov/cpsc/pub/pubs/portgen.pdf).

Applications Manual for the Revised NIOSH Lifting Equation, The National Institute for Occupational Safety and Health (NIOSH), 1600 Clifton Rd, Atlanta, GA 30333 (phone: 1-800-232-4636, website: www.cdc.gov/NIOSH).

1-8. EMF Information

Electric current flowing through any conductor causes localized electric and magnetic fields (EMF). The current from arc welding (and allied processes including spot welding, gouging, plasma arc cutting, and induction heating operations) creates an EMF field around the welding circuit. EMF fields may interfere with some medical implants, e.g. pacemakers. Protective measures for persons wearing medical implants have to be taken. For example, restrict access for passers-by or conduct individual risk assessment for welders. All welders should use the following procedures in order to minimize exposure to EMF fields from the welding circuit:

1. Keep cables close together by twisting or taping them, or using a cable cover.
2. Do not place your body between welding cables. Arrange cables to one side and away from the operator.
3. Do not coil or drape cables around your body.

4. Keep head and trunk as far away from the equipment in the welding circuit as possible.
5. Connect work clamp to workpiece as close to the weld as possible.
6. Do not work next to, sit or lean on the welding power source.
7. Do not weld whilst carrying the welding power source or wire feeder.

About Implanted Medical Devices:

Implanted Medical Device wearers should consult their doctor and the device manufacturer before performing or going near arc welding, spot welding, gouging, plasma arc cutting, or induction heating operations. If cleared by your doctor, then following the above procedures is recommended.

SECTION 2 – CONSIGNES DE SÉCURITÉ – LIRE AVANT UTILISATION

fre_rom_2013-09

! Pour écarter les risques de blessure pour vous-même et pour autrui — lire, appliquer et ranger en lieu sûr ces consignes relatives aux précautions de sécurité et au mode opératoire.

2-1. Signification des symboles



DANGER! – Indique une situation dangereuse qui si on l'évite pas peut donner la mort ou des blessures graves. Les dangers possibles sont montrés par les symboles joints ou sont expliqués dans le texte.



Indique une situation dangereuse qui si on l'évite pas peut donner la mort ou des blessures graves. Les dangers possibles sont montrés par les symboles joints ou sont expliqués dans le texte.

NOTE – Indique des déclarations pas en relation avec des blessures personnelles.

Indique des instructions spécifiques.



Ce groupe de symboles veut dire Avertissement! Attention! DANGER DE CHOC ELECTRIQUE, PIECES EN MOUVEMENT, et PIECES CHAUDES. Consulter les symboles et les instructions ci-dessous y afférant pour les actions nécessaires afin d'éviter le danger.

2-2. Dangers relatifs au soudage à l'arc



Les symboles présentés ci-après sont utilisés tout au long du présent manuel pour attirer votre attention et identifier les risques de danger. Lorsque vous voyez un symbole, soyez vigilant et suivez les directives mentionnées afin d'éviter tout danger. Les consignes de sécurité présentées ci-après ne font que résumer l'information contenue dans les normes de sécurité énumérées à la section 2-7. Veuillez lire et respecter toutes ces normes de sécurité.



L'installation, l'utilisation, l'entretien et les réparations ne doivent être confiés qu'à des personnes qualifiées.



Au cours de l'utilisation, tenir toute personne à l'écart et plus particulièrement les enfants.



UN CHOC ÉLECTRIQUE peut tuer.

Un simple contact avec des pièces électriques peut provoquer une électrocution ou des blessures graves. L'électrode et le circuit de soudage sont sous tension dès que l'appareil est sur ON. Le circuit d'entrée et les circuits internes de l'appareil sont également sous tension à ce moment-là. En soudage semi-automatique ou automatique, le fil, le dévidoir, le logement des galets d'entraînement et les pièces métalliques en contact avec le fil de soudage sont sous tension. Des matériels mal installés ou mal mis à la terre présentent un danger.

- Ne jamais toucher les pièces électriques sous tension.
- Porter des gants et des vêtements de protection secs ne comportant pas de trous.
- S'isoler de la pièce et de la terre au moyen de tapis ou d'autres moyens isolants suffisamment grands pour empêcher le contact physique éventuel avec la pièce ou la terre.
- Ne pas se servir de source électrique à courant électrique dans les zones humides, dans les endroits confinés ou là où on risque de tomber.
- Se servir d'une source électrique à courant électrique UNIQUEMENT si le procédé de soudage le demande.
- Si l'utilisation d'une source électrique à courant électrique s'avère nécessaire, se servir de la fonction de télécommande si l'appareil en est équipé.
- Des précautions de sécurité supplémentaires sont requises dans des environnements à risque comme: les endroits humides ou lorsque l'on porte des vêtements mouillés; sur des structures métalliques au sol, grillages et échafaudages; dans des positions assises, à genoux et allongées; ou quand il y a un risque important de contact accidentel avec la pièce ou le sol. Dans ces cas utiliser les appareils suivants dans l'ordre de préférence: 1) un poste à souder DC semi-automatique de type CV (MIG/MAG), 2) un poste à souder manuel (électrode enrobée) DC, 3) un poste à souder manuel AC avec tension à vide réduite. Dans la plupart des cas, un poste courant continu de type CV est recommandé. Et, ne pas travailler seul!
- Couper l'alimentation ou arrêter le moteur avant de procéder à l'installation, à la réparation ou à l'entretien de l'appareil. Déverrouiller l'alimentation selon la norme OSHA 29 CFR 1910.147 (voir normes de sécurité).
- Installez, mettez à la terre et utilisez correctement cet équipement conformément à son Manuel d'Utilisation et aux réglementations nationales, gouvernementales et locales.
- Installer et mettre à la terre correctement cet appareil conformément à son manuel d'utilisation et aux codes nationaux, provinciaux et municipaux.
- Toujours vérifier la terre du cordon d'alimentation – Vérifier et s'assurer que le fil de terre du cordon d'alimentation est bien raccordé à la borne de terre du sectionneur ou que la fiche du cordon est raccordée à une prise correctement mise à la terre.
- En effectuant les raccordements d'entrée fixer d'abord le conducteur de mise à la terre approprié et contre-vérifier les connexions.
- Les câbles doivent être exempts d'humidité, d'huile et de graisse; protégez-les contre les étincelles et les pièces métalliques chaudes.
- Vérifier fréquemment le cordon d'alimentation et le conducteur de mise à la terre afin de s'assurer qu'il n'est pas altéré ou dénudé –, le remplacer immédiatement s'il l'est –. Un fil dénudé peut entraîner la mort.
- Mettre l'appareil hors tension quand on ne l'utilise pas.
- Ne pas utiliser des câbles usés, endommagés, sous dimensionnés ou réparés.
- Ne pas enrouler les câbles autour du corps.
- Si la pièce soudée doit être mise à la terre, le faire directement avec un câble distinct – ne pas utiliser le connecteur de pièce ou le câble de retour.
- Ne pas toucher l'électrode quand on est en contact avec la pièce, la terre ou une électrode provenant d'une autre machine.
- Ne pas toucher des porte électrodes connectés à deux machines en même temps à cause de la présence d'une tension à vide doublée.
- N'utiliser qu'un matériel en bon état. Réparer ou remplacer sur-le-champ les pièces endommagées. Entretenir l'appareil conformément à ce manuel.
- Porter un harnais de sécurité quand on travaille en hauteur.
- Maintenir solidement en place tous les panneaux et capots.
- Fixer le câble de retour de façon à obtenir un bon contact métal-métal avec la pièce à souder ou la table de travail, le plus près possible de la soudure.
- Isoler la pince de masse quand pas mis à la pièce pour éviter le contact avec tout objet métallique.
- Ne pas raccorder plus d'une électrode ou plus d'un câble de masse à une même borne de sortie de soudage. Débrancher le câble pour le procédé non utilisé.

- Utiliser une protection différentielle lors de l'utilisation d'un équipement auxiliaire. Ne pas tester ni réarmer les prises femelles avec différentiel au régime de ralenti/en basse tension: cela endommagerait le disjoncteur différentiel, qui ne remplirait plus son rôle de protection contre une électrocution causée par un défaut de masse.

Il reste une TENSION DC NON NÉGLIGEABLE dans les sources de soudage onduleur UNE FOIS le moteur coupé.

- Couper l'alimentation du poste et décharger les condensateurs d'entrée comme indiqué dans la Section Maintenance avant de toucher des composants.



LES PIÈCES CHAUDES peuvent provoquer des brûlures.

- Ne pas toucher à mains nues les parties chaudes.
- Prévoit une période de refroidissement avant de travailler à l'équipement.
- Ne pas toucher aux pièces chaudes, utiliser les outils recommandés et porter des gants de soudage et des vêtements épais pour éviter les brûlures.

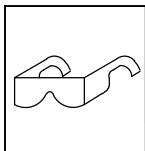

DES PIÈCES DE METAL ou DES SALETES peuvent provoquer des blessures dans les yeux.

- Le soudage, l'écaillage, le passage de la pièce à la brosse en fil de fer, et le meulage génèrent des étincelles et des particules métalliques volantes. Pendant la période de refroidissement des soudures, elles risquent de projeter du laitier.
- Porter des lunettes de sécurité avec écrans latéraux ou un écran facial.



LES FUMÉES ET LES GAZ peuvent être dangereux.

Le soudage génère des fumées et des gaz. Leur inhalation peut être dangereux pour votre santé.

- Eloigner votre tête des fumées. Ne pas respirer les fumées.
- À l'intérieur, ventiler la zone et/ou utiliser une ventilation forcée au niveau de l'arc pour l'évacuation des fumées et des gaz de soudage. Pour déterminer la bonne ventilation, il est recommandé de procéder à un prélèvement pour la composition et la quantité de fumées et de gaz auxquels est exposé le personnel.
- Si la ventilation est médiocre, porter un respirateur anti-vapeurs approuvé.
- Lire et comprendre les fiches de données de sécurité et les instructions du fabricant concernant les adhésifs, les revêtements, les nettoyants, les consommables, les produits de refroidissement, les dégraissages, les flux et les métaux.
- Travailler dans un espace fermé seulement s'il est bien ventilé ou en portant un respirateur à alimentation d'air. Demander toujours à un surveillant dûment formé de se tenir à proximité. Des fumées et des gaz de soudage peuvent déplacer l'air et abaisser le niveau d'oxygène provoquant des blessures ou des accidents mortels. S'assurer que l'air de respiration ne présente aucun danger.
- Ne pas souder dans des endroits situés à proximité d'opérations de dégraissage, de nettoyage ou de pulvérisation. La chaleur et les rayons de l'arc peuvent réagir en présence de vapeurs et former des gaz hautement toxiques et irritants.
- Ne pas souder des métaux munis d'un revêtement, tels que l'acier galvanisé, plaqué en plomb ou au cadmium à moins que le revêtement n'ait été enlevé dans la zone de soudure, que l'endroit soit bien ventilé, et en portant un respirateur à alimentation d'air. Les revêtements et tous les métaux renfermant ces éléments peuvent dégager des fumées toxiques en cas de soudage.



LES ACCUMULATIONS DE GAZ risquent de provoquer des blessures ou même la mort.

- Fermer l'alimentation du gaz comprimé en cas de non utilisation.
- Veiller toujours à bien aérer les espaces confinés ou se servir d'un respirateur d'adduction d'air homologué.

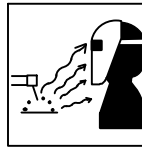

LES RAYONS DE L'ARC peuvent provoquer des brûlures dans les yeux et sur la peau.

Le rayonnement de l'arc du procédé de soudage génère des rayons visibles et invisibles intenses (ultraviolets et infrarouges) susceptibles de provoquer des brûlures dans les yeux et sur la peau. Des étincelles sont projetées pendant le soudage.

- Porter un casque de soudage approuvé muni de verres filtrants appropriés pour protéger visage et yeux pour protéger votre visage et vos yeux pendant le soudage ou pour regarder (voir ANSI Z49.1 et Z87.1 énuméré dans les normes de sécurité).
- Porter des lunettes de sécurité avec écrans latéraux même sous votre casque.
- Avoir recours à des écrans protecteurs ou à des rideaux pour protéger les autres contre les rayonnements les éblouissements et les étincelles ; prévenir toute personne sur les lieux de ne pas regarder l'arc.
- Porter un équipement de protection pour le corps fait d'un matériau résistant et ignifuge (cuir, coton robuste, laine). La protection du corps comporte des vêtements sans huile comme par ex. des gants de cuir, une chemise solide, des pantalons sans revers, des chaussures hautes et une casquette.

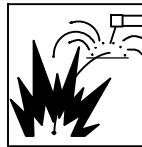

LE SOUDAGE peut provoquer un incendie ou une explosion.

Le soudage effectué sur des conteneurs fermés tels que des réservoirs, tambours ou des conduites peut provoquer leur éclatement. Des étincelles peuvent être projetées de l'arc de soudure. La projection d'étincelles, des pièces chaudes et des équipements chauds peut provoquer des incendies et des brûlures. Le contact accidentel de l'électrode avec des objets métalliques peut provoquer des étincelles, une explosion, un surchauffement ou un incendie. Avant de commencer le soudage, vérifier et s'assurer que l'endroit ne présente pas de danger.

- Déplacer toutes les substances inflammables à une distance de 10,7 m de l'arc de soudage. En cas d'impossibilité les recouvrir soigneusement avec des protections homologués.
- Ne pas souder dans un endroit où des étincelles peuvent tomber sur des substances inflammables.
- Se protéger et d'autres personnes de la projection d'étincelles et de métal chaud.
- Des étincelles et des matériaux chauds du soudage peuvent facilement passer dans d'autres zones en traversant de petites fissures et des ouvertures.
- Surveiller tout déclenchement d'incendie et tenir un extincteur à proximité.
- Le soudage effectué sur un plafond, plancher, paroi ou séparation peut déclencher un incendie de l'autre côté.
- Ne pas effectuer le soudage sur des conteneurs fermés tels que des réservoirs, tambours, ou conduites, à moins qu'ils n'aient été préparés correctement conformément à AWS F4.1 et AWS A6.0 (voir les Normes de Sécurité).
- Ne soudez pas si l'air ambiant est chargé de particules, gaz, ou vapeurs inflammables (vapeur d'essence, par exemple).
- Brancher le câble de masse sur la pièce la plus près possible de la zone de soudage pour éviter le transport du courant sur une longue distance par des chemins inconnus éventuels en provoquant des risques d'électrocution, d'étincelles et d'incendie.
- Ne pas utiliser le poste de soudage pour dégeler des conduites gelées.
- En cas de non utilisation, enlever la baguette d'électrode du porte-électrode ou couper le fil à la pointe de contact.

- Porter un équipement de protection pour le corps fait d'un matériau résistant et ignifuge (cuir, coton robuste, laine). La protection du corps comporte des vêtements sans huile comme par ex. des gants de cuir, une chemise solide, des pantalons sans revers, des chaussures hautes et une casquette.
- Avant de souder, retirer toute substance combustible de vos poches telles qu'un allumeur au butane ou des allumettes.
- Une fois le travail achevé, assurez-vous qu'il ne reste aucune trace d'étincelles incandescentes ni de flammes.
- Utiliser exclusivement des fusibles ou coupe-circuits appropriés. Ne pas augmenter leur puissance; ne pas les ponter.
- Suivre les recommandations dans OSHA 1910.252(a)(2)(iv) et NFPA 51B pour les travaux à chaud et avoir de la surveillance et un extincteur à proximité.



LE BRUIT peut affecter l'ouïe.

Le bruit des processus et des équipements peut affecter l'ouïe.

- Porter des protections approuvés pour les oreilles si le niveau sonore est trop élevé.



Les CHAMPS ÉLECTROMAGNÉTIQUES (CEM) peuvent affecter les implants médicaux.

- Les porteurs de stimulateurs cardiaques et autres implants médicaux doivent rester à distance.
- Les porteurs d'implants médicaux doivent consulter leur médecin et le fabricant du dispositif avant de s'approcher de la zone où se déroule du soudage à l'arc, du soudage par points, du gougeage, de la découpe plasma ou une opération de chauffage par induction.

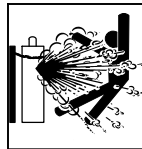

Si des BOUTEILLES sont endommagées, elles pourront exploser.

Des bouteilles de gaz comprimé protecteur contiennent du gaz sous haute pression. Si une bouteille est endommagée, elle peut exploser. Du fait que les

bouteilles de gaz font normalement partie du procédé de soudage, les manipuler avec précaution.

- Protéger les bouteilles de gaz comprimé d'une chaleur excessive, des chocs mécaniques, des dommages physiques, du laitier, des flammes ouvertes, des étincelles et des arcs.
- Placer les bouteilles debout en les fixant dans un support stationnaire ou dans un porte-bouteilles pour les empêcher de tomber ou de se renverser.
- Tenir les bouteilles éloignées des circuits de soudage ou autres circuits électriques.
- Ne jamais placer une torche de soudage sur une bouteille à gaz.
- Une électrode de soudage ne doit jamais entrer en contact avec une bouteille.
- Ne jamais souder une bouteille pressurisée – risque d'explosion.
- Utiliser seulement des bouteilles de gaz comprimé, régulateurs, tuyaux et raccords convenables pour cette application spécifique; les maintenir ainsi que les éléments associés en bon état.
- Tourner le dos à la sortie de vanne lors de l'ouverture de la vanne de la bouteille. Ne pas se tenir devant ou derrière le régulateur lors de l'ouverture de la vanne.
- Maintenir le chapeau de protection sur la soupape, sauf en cas d'utilisation ou de branchement de la bouteille.
- Utiliser les équipements corrects, les bonnes procédures et suffisamment de personnes pour soulever et déplacer les bouteilles.
- Lire et suivre les instructions sur les bouteilles de gaz comprimé, l'équipement connexe et le dépliant P-1 de la CGA (Compressed Gas Association) mentionné dans les principales normes de sécurité.

2-3. Dangers existant en relation avec le moteur

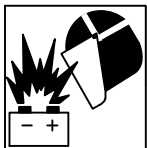

L'EXPLOSION DE LA BATTERIE peut provoquer des blessures.

- Toujours porter une protection faciale, des gants en caoutchouc et vêtements de protection lors d'une intervention sur la batterie.
- Arrêter le moteur avant de débrancher ou de brancher des câbles de batterie, des câbles de chargeur de batterie (le cas échéant) ou de batterie d'entretien.
- Éviter de provoquer des étincelles avec les outils en travaillant sur la batterie.
- Ne pas utiliser l'appareil de soudage pour charger des batteries ou faire démarrer des véhicules à l'aide de câbles de démarrage, sauf si l'appareil dispose d'une fonctionnalité de charge de batterie destinée à cet usage.
- Observer la polarité correcte (+ et -) sur les batteries.
- Débrancher le câble négatif (-) en premier lieu. Le rebrancher en dernier lieu.
- Les sources d'étincelles, flammes nues, cigarettes et autres sources d'inflammation doivent être maintenues à l'écart des batteries. Ces dernières produisent des gaz explosifs en fonctionnement normal et en cours de charge.
- Respecter les consignes du fabricant de la batterie pour travailler sur une batterie ou à proximité.



LE CARBURANT MOTEUR peut provoquer un incendie ou une explosion.

- Arrêter le moteur avant de vérifier le niveau de carburant ou de faire le plein.
- Ne pas faire le plein en fumant ou proche d'une source d'étincelles ou d'une flamme nue.
- Ne pas faire le plein de carburant à ras bord; prévoir de l'espace pour son expansion.
- Faire attention de ne pas renverser de carburant. Nettoyer tout carburant renversé avant de faire démarrer le moteur.
- Jeter les chiffons dans un récipient ignifuge.
- Toujours garder le pistolet en contact avec le réservoir lors du remplissage.



Les PIÈCES MOBILES peuvent causer des blessures.

- S'abstenir de toucher des parties mobiles telles que des ventilateurs, courroies et rotors.
- Maintenir fermés et verrouillés les portes, panneaux, recouvrements et dispositifs de protection.
- Arrêter le moteur avant d'installer ou brancher l'appareil.
- Lorsque cela est nécessaire pour des travaux d'entretien et de dépannage, faire retirer les portes, panneaux, recouvrements ou dispositifs de protection uniquement par du personnel qualifié.

- Pour empêcher tout démarrage accidentel pendant les travaux d'entretien, débrancher le câble négatif (-) de batterie de la borne.
- Ne pas approcher les mains, cheveux, vêtements lâches et outils des organes mobiles.
- Remettre en place les portes, panneaux, recouvrements ou dispositifs de protection à la fin des travaux d'entretien et avant de mettre le moteur en marche.
- Avant d'intervenir, déposer les bougies ou injecteurs pour éviter la mise en route accidentelle du moteur.
- Bloquer le volant moteur pour éviter sa rotation lors d'une intervention sur le générateur.



LES ÉTINCELLES À L'ÉCHAPPEMENT peuvent provoquer un incendie.

- Empêcher les étincelles d'échappement du moteur de provoquer un incendie.
- Utiliser uniquement un pare-étincelles approuvé – voir codes en vigueur.



LES PIÈCES CHAUDES peuvent provoquer des brûlures.

- Ne pas toucher des parties chaudes à mains nues.
- Prévoir une période de refroidissement avant de travailler à l'équipement.
- Ne pas toucher aux pièces chaudes, utiliser les outils recommandés et porter des gants de soudage et des vêtements épais pour éviter les brûlures.



LA VAPEUR ET LE LIQUIDE DE REFROIDISSEMENT CHAUD peuvent provoquer des brûlures.

- Il est préférable de vérifier le liquide de refroidissement une fois le moteur refroidi pour éviter de se brûler.



- Toujours vérifier le niveau de liquide de refroidissement dans le vase d'expansion (si présent), et non dans le radiateur (sauf si précisé autrement dans la section maintenance du manuel du moteur).
- Si le moteur est chaud et que le liquide doit être vérifié, opérer comme suivant.
- Mettre des lunettes de sécurité et des gants, placer un torchon sur le bouchon du radiateur.
- Dévisser le bouchon légèrement et laisser la vapeur s'échapper avant d'enlever le bouchon.

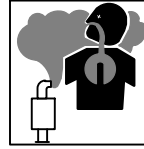

L'utilisation d'un groupe autonome à l'intérieur PEUT VOUS TUER EN QUELQUES MINUTES.

- Les fumées d'un groupe autonome contiennent du monoxyde de carbone. C'est un poison invisible et inodore.
- JAMAIS utiliser dans une maison ou garage, même avec les portes et fenêtres ouvertes.
- Uniquement utiliser à l'EXTÉRIEUR, loin des portes, fenêtres et bouches aération.

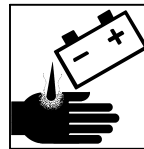

L'ACIDE DE LA BATTERIE peut provoquer des brûlures dans les YEUX et sur la PEAU.

- Ne pas renverser la batterie.
- Remplacer une batterie endommagée.
- Rincer immédiatement les yeux et la peau à l'eau.



LA CHALEUR DU MOTEUR peut provoquer un incendie.

- Ne pas placer l'appareil sur, au-dessus ou à proximité de surfaces inflammables.
- Tenir à distance les produits inflammables de l'échappement.

2-4. Dangers liés à l'air comprimé



Un ÉQUIPEMENT PNEUMATIQUE risque de provoquer des blessures ou même la mort.

- Une installation ou une utilisation incorrecte de cet appareil pourrait conduire à des dégâts matériels ou corporels. Seul un personnel qualifié est autorisé à installer, utiliser et entretenir cet appareil conformément à son manuel d'utilisation, aux normes industrielles et aux codes nationaux, d'état ou locaux.
- Ne pas dépasser le débit nominal ou la capacité du compresseur ou de tout équipement du circuit d'air comprimé. Concevoir le circuit d'air comprimé de telle sorte que la défaillance d'un composant ne risque pas de provoquer un accident matériel ou corporel.
- Avant d'intervenir sur le circuit d'air comprimé, couper l'alimentation électrique, verrouiller et étiqueter l'appareil, détendre la pression et s'assurer que le circuit d'air ne peut être mis sous pression par inadvertance.
- Ne pas intervenir sur le circuit d'air comprimé lorsque l'appareil fonctionne. Seul un personnel qualifié est autorisé, et appliquant les consignes du fabricant.
- Ne pas modifier ou altérer le compresseur ou les équipements fournis par le fabricant. Ne pas débrancher, désactiver ou neutraliser les équipements de sécurité du circuit d'air comprimé.
- Utiliser uniquement des composants et accessoires homologués par le fabricant.
- Se tenir à l'écart de tout point présentant un danger de pincement ou d'écrasement créé par l'équipement raccordé au circuit d'air comprimé.



MÉTAL CHAUD provenant du découpage ou du gougeage à l'arc risque de provoquer un incendie ou une explosion.

- Ne pas découper ou gouger à proximité de produits inflammables.
- Attention aux risques d'incendie: tenir un extincteur à proximité.

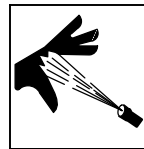

L'AIR COMPRIMÉ risque de provoquer des blessures ou même la mort.

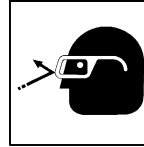

- Avant d'intervenir sur le circuit d'air comprimé, couper l'alimentation électrique, verrouiller et étiqueter l'appareil, détendre la pression et s'assurer que le circuit d'air ne peut être mis sous pression par inadvertance.
- Détendre la pression avant de débrancher ou de brancher des canalisations d'air.
- Avant d'utiliser l'appareil, contrôler les composants du circuit d'air comprimé, les branchements et les flexibles en recherchant tout signe de détérioration, de fuite et d'usure.
- Ne pas diriger un jet d'air vers soi-même ou vers autrui.
- Pour intervenir sur un circuit d'air comprimé, porter un équipement de protection tel que des lunettes de sécurité, des gants de cuir, une chemise et un pantalon en tissu résistant, des chaussures montantes et une coiffe.

- Pour rechercher des fuites, utiliser de l'eau savonneuse ou un détecteur à ultrasons, jamais les mains nues. En cas de détection de fuite, ne pas utiliser l'équipement.
- Remettre les portes, panneaux, recouvrements ou dispositifs de protection quand l'entretien est terminé et avant de mettre en marche l'appareil.
- En cas d'injection d'air dans la peau ou le corps, demander immédiatement une assistance médicale.



L'INHALATION D'AIR COMPRIMÉ risque de provoquer des blessures ou même la mort.

- Ne pas inhaler d'air comprimé.
- Utiliser l'air comprimé uniquement pour découper ou gouger ainsi que pour l'outillage pneumatique.

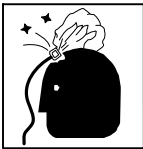

Une PRESSION D'AIR RÉSIDUELLE ET DES FLEXIBLES QUI FOUETTENT risquent de provoquer des blessures.

- Détendre la pression pneumatique des outils et circuits avant d'entretenir, ajouter ou changer des accessoires et avant d'ouvrir le bouchon de vidange ou de remplissage d'huile du compresseur.



Les PIÈCES MOBILES peuvent causer des blessures.

- S'abstenir de toucher des parties mobiles telles que des ventilateurs, courroies et rotors.
- Maintenir fermés et verrouillés les portes, panneaux, recouvrements et dispositifs de protection.

- Ne pas approcher les mains, cheveux, vêtements lâches et outils des organes mobiles.
- Avant d'intervenir sur le circuit d'air comprimé, couper l'alimentation électrique, verrouiller et étiqueter l'appareil, détendre la pression et s'assurer que le circuit d'air ne peut être mis sous pression par inadvertance.
- Demander seulement à un personnel qualifié d'enlever les dispositifs de sécurité ou les recouvrements pour effectuer, s'il y a lieu, des travaux d'entretien et de dépannage.
- Remettre en place les portes, panneaux, recouvrements ou dispositifs de protection à la fin des travaux d'entretien et avant de mettre le moteur en marche.



DES PIÈCES CHAUDES peuvent provoquer des brûlures graves.

- Ne pas toucher de pièces chaudes du compresseur ou du circuit d'air.
- Prévoir une période de refroidissement avant d'intervenir sur l'équipement.
- Ne pas toucher aux pièces chaudes, utiliser les outils recommandés et porter des gants de soudage et des vêtements épais pour éviter les brûlures.

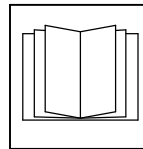

LIRE LES INSTRUCTIONS.

- Lire et appliquer les instructions sur les étiquettes et le Mode d'emploi avant l'installation, l'utilisation ou l'entretien de l'appareil. Lire les informations de sécurité au début du manuel et dans chaque section.
- N'utiliser que les pièces de rechange recommandées par le constructeur.
- Effectuer l'entretien en respectant les manuels d'utilisation, les normes industrielles et les codes nationaux, d'état et locaux.

2-5. Dangers supplémentaires en relation avec l'installation, le fonctionnement et la maintenance



Risque D'INCENDIE OU D'EXPLOSION.

- Ne pas placer l'appareil sur, au-dessus ou à proximité de surfaces inflammables.
- Ne pas installer l'appareil à proximité de produits inflammables.
- Ne pas surcharger l'installation électrique – s'assurer que l'alimentation est correctement dimensionnée et protégée avant de mettre l'appareil en service.

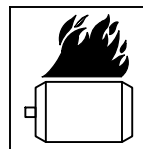

LE SURCHAUFFEMENT peut endommager le moteur électrique.

- Arrêter ou déconnecter l'équipement avant de démarrer ou d'arrêter le moteur.
- Ne pas laisser tourner le moteur trop lentement sous risque d'endommager le moteur électrique à cause d'une tension et d'une fréquence trop faibles.
- Ne pas brancher de moteur de 50 ou de 60 Hz à la prise de 100 Hz, s'il y a lieu.



LA CHUTE DE L'ÉQUIPEMENT peut provoquer des blessures.

- Utiliser l'anneau de levage pour lever l'appareil et les accessoires correctement installés seuls, PAS les bouteilles de gaz. Ne pas dépasser le poids nominal maximal de l'œilleton (voir les spécifications).
- Utiliser un équipement de levage de capacité suffisante pour lever l'appareil.
- En utilisant des fourches de levage pour déplacer l'unité, s'assurer que les fourches sont suffisamment longues pour dépasser du côté opposé de l'appareil.
- Tenir l'équipement (câbles et cordons) à distance des véhicules mobiles lors de toute opération en hauteur.
- Suivre les consignes du Manuel des applications pour l'équation de levage NIOSH révisée (Publication N°94-110) lors du levage manuel de pièces ou équipements lourds.

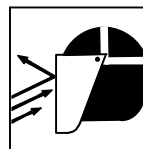

LES ÉTINCELLES PROJETÉES peuvent provoquer des blessures.

- Porter un écran facial pour protéger le visage et les yeux.
- Affûter l'électrode au tungstène uniquement à la meuleuse dotée de protecteurs. Cette manœuvre est à exécuter dans un endroit sûr lorsque l'on porte l'équipement homologué de protection du visage, des mains et du corps.
- Les étincelles risquent de causer un incendie – éloigner toute substance inflammable.

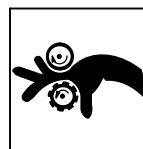

Les PIÈCES MOBILES peuvent causer des blessures.

- Ne pas s'approcher des organes mobiles.
- Ne pas s'approcher des points de coincement tels que des rouleaux de commande.



LA SORTIE DE RECHARGE et L'EXPLOSION DE LA BATTERIE peuvent provoquer des blessures.

La recharge de batterie n'existe pas sur tous les modèles.

- Toujours porter une protection faciale, des gants en caoutchouc et vêtements de protection lors d'une intervention sur la batterie.
- Arrêter le moteur avant de débrancher ou de brancher des câbles de batterie, des câbles de chargeur de batterie (le cas échéant) ou de batterie d'entretien.
- Eviter de provoquer des étincelles avec les outils en travaillant sur la batterie.
- Ne pas utiliser l'appareil de soudage pour charger des batteries ou faire démarrer des véhicules à l'aide de câbles de démarrage, sauf si l'appareil dispose d'une fonctionnalité de charge de batterie destinée à cet usage.
- Observer la polarité correcte (+ et -) sur les batteries.
- Débrancher le câble négatif (-) en premier lieu. Le rebrancher en dernier lieu.
- Les sources d'étincelles, flammes nues, cigarettes et autres sources d'inflammation doivent être maintenues à l'écart des batteries. Ces dernières produisent des gaz explosifs en fonctionnement normal et en cours de charge.
- Respecter les consignes du fabricant de la batterie pour travailler sur une batterie ou à proximité.
- Les opérations de charge de batterie ne doivent être effectuées que par des personnes qualifiées.
- Pour enlever la batterie d'un véhicule pour la recharge, débrancher tout d'abord le câble négatif (-) et le rebrancher en dernier lieu. Pour éviter un arc, s'assurer que tous les accessoires sont débranchés.
- Ne charger que des batteries plomb-acide. Ne pas utiliser le chargeur de batterie pour alimenter un autre circuit électrique basse tension ou pour charger des batteries sèches.
- Ne pas charger une batterie gelée.
- Ne pas utiliser de câbles de charge endommagés.
- Ne pas charger des batteries dans un espace fermé ou en l'absence d'une ventilation.
- Ne pas charger une batterie dont les bornes sont desserrées ou présentant une détérioration comme par exemple un boîtier ou un couvercle fissuré.
- Avant de charger une batterie, sélectionner la tension de charge correspondant à la tension de la batterie.
- Régler les commandes de charge de batterie sur la position d'arrêt avant de brancher la batterie. Veiller à ce que les pinces de charge ne se touchent pas.
- Ranger les câbles de charge à distance du capot, des portes et des pièces mobiles du véhicule.



LES FILS DE SOUDAGE peuvent provoquer des blessures.

- Ne pas appuyer sur la gâchette avant d'en avoir reçu l'instruction.
- Ne pas diriger le pistolet vers soi, d'autres personnes ou toute pièce mécanique en engageant le fil de soudage.

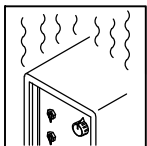

L'EMPLOI EXCESSIF peut SURCHAUFFER L'ÉQUIPEMENT.

- Laisser l'équipement refroidir ; respecter le facteur de marche nominal.
- Réduire le courant ou le facteur de marche avant de poursuivre le soudage.
- Ne pas obstruer les passages d'air du poste.

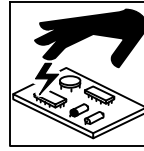

LES CHARGES ÉLECTROSTATIQUES peuvent endommager les circuits imprimés.

- Établir la connexion avec la barrette de terre avant de manipuler des cartes ou des pièces.
- Utiliser des pochettes et des boîtes antistatiques pour stocker, déplacer ou expédier des cartes de circuits imprimés.

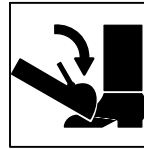

UNE REMORQUE QUI BASCULE peut provoquer des blessures.

- Utiliser les supports de la remorque ou des blocs pour soutenir le poids.
- Installer convenablement le poste sur la remorque comme indiqué dans le manuel s'y rapportant.

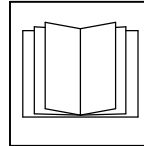

LIRE LES INSTRUCTIONS.

- Lire et appliquer les instructions sur les étiquettes et le Mode d'emploi avant l'installation, l'utilisation ou l'entretien de l'appareil. Lire les informations de sécurité au début du manuel et dans chaque section.
- N'utiliser que les pièces de rechange recommandées par le constructeur.
- Effectuer l'entretien en respectant les manuels d'utilisation, les normes industrielles et les codes nationaux, d'état et locaux.

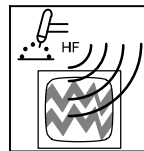

LE RAYONNEMENT HAUTE FRÉQUENCE (H.F.) risque de provoquer des interférences.

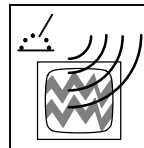

- Le rayonnement haute fréquence (H.F.) peut provoquer des interférences avec les équipements de radio-navigation et de communication, les services de sécurité et les ordinateurs.
- Demander seulement à des personnes qualifiées familiarisées avec des équipements électroniques de faire fonctionner l'installation.
- L'utilisateur est tenu de faire corriger rapidement par un électricien qualifié les interférences résultant de l'installation.
- Si le FCC signale des interférences, arrêter immédiatement l'appareil.
- Effectuer régulièrement le contrôle et l'entretien de l'installation.
- Maintenir soigneusement fermés les portes et les panneaux des sources de haute fréquence, maintenir les éclateurs à une distance correcte et utiliser une terre et un blindage pour réduire les interférences éventuelles.



LE SOUDAGE À L'ARC risque de provoquer des interférences.

- L'énergie électromagnétique risque de provoquer des interférences pour l'équipement électronique sensible tel que les ordinateurs et l'équipement commandé par ordinateur tel que les robots.
- Veiller à ce que tout l'équipement de la zone de soudage soit compatible électromagnétiquement.
- Pour réduire la possibilité d'interférence, maintenir les câbles de soudage aussi courts que possible, les grouper, et les poser aussi bas que possible (ex. par terre).
- Veiller à souder à une distance de 100 mètres de tout équipement électronique sensible.
- Veiller à ce que ce poste de soudage soit posé et mis à la terre conformément à ce mode d'emploi.
- En cas d'interférences après avoir pris les mesures précédentes, il incombe à l'utilisateur de prendre des mesures supplémentaires telles que le déplacement du poste, l'utilisation de câbles blindés, l'utilisation de filtres de ligne ou la pose de protecteurs dans la zone de travail.

2-6. Proposition californienne 65 Avertissements

-  **Les équipements de soudage et de coupage produisent des fumées et des gaz qui contiennent des produits chimiques dont l'État de Californie reconnaît qu'ils provoquent des malformations congénitales et, dans certains cas, des cancers. (Code de santé et de sécurité de Californie, chapitre 25249.5 et suivants)**
-  **Les batteries, les bornes et autres accessoires contiennent du plomb et des composés à base de plomb, produits chimiques dont l'État de Californie reconnaît qu'ils provoquent des cancers et des malformations congénitales ou autres problèmes de procréation. *Se laver les mains après manipulation.***
-  **Ce produit contient des produits chimiques, notamment du plomb, dont l'État de Californie reconnaît qu'ils provoquent des cancers, des malformations congénitales ou d'autres problèmes de procréation. *Se laver les mains après utilisation.***

Pour les moteurs à essence :

-  **Les gaz d'échappement des moteurs contiennent des produits chimiques dont l'État de Californie reconnaît qu'ils provoquent des cancers et des malformations congénitales ou autres problèmes de procréation.**

Pour les moteurs diesel :

-  **Les gaz d'échappement des moteurs diesel et certains de leurs composants sont reconnus par l'État de Californie comme provoquant des cancers et des malformations congénitales ou autres problèmes de procréation.**

2-7. Principales normes de sécurité

Safety in Welding, Cutting, and Allied Processes, ANSI Standard Z49.1, is available as a free download from the American Welding Society at <http://www.aws.org> or purchased from Global Engineering Documents (phone: 1-877-413-5184, website: www.global.ihs.com).

Safe Practices for the Preparation of Containers and Piping for Welding and Cutting, American Welding Society Standard AWS F4.1, from Global Engineering Documents (phone: 1-877-413-5184, website: www.global.ihs.com).

Safe Practices for Welding and Cutting Containers that have Held Com-bustibles, American Welding Society Standard AWS A6.0, from Global Engineering Documents (phone: 1-877-413-5184, website: www.global.ihs.com).

National Electrical Code, NFPA Standard 70, from National Fire Protection Association, Quincy, MA 02269 (phone: 1-800-344-3555, website: www.nfpa.org and www.sparky.org).

Safe Handling of Compressed Gases in Cylinders, CGA Pamphlet P-1, from Compressed Gas Association, 14501 George Carter Way, Suite 103, Chantilly, VA 20151 (phone: 703-788-2700, website: www.cganet.com).

Safety in Welding, Cutting, and Allied Processes, CSA Standard W117.2, from Canadian Standards Association, Standards Sales, 5060 Spectrum Way, Suite 100, Ontario, Canada L4W 5NS (phone: 800-463-6727, website: www.csa-international.org).

Battery Chargers, CSA Standard C22.2 NO 107.2-01, from Canadian Standards Association, Standards Sales, 5060 Spectrum Way, Suite

100, Ontario, Canada L4W 5NS (phone: 800-463-6727, website: www.csa-international.org).

Safe Practice For Occupational And Educational Eye And Face Protection, ANSI Standard Z87.1, from American National Standards Institute, 25 West 43rd Street, New York, NY 10036 (phone: 212-642-4900, website: www.ansi.org).

Standard for Fire Prevention During Welding, Cutting, and Other Hot Work, NFPA Standard 51B, from National Fire Protection Association, Quincy, MA 02269 (phone: 1-800-344-3555, website: www.nfpa.org).

OSHA, Occupational Safety and Health Standards for General Industry, Title 29, Code of Federal Regulations (CFR), Part 1910, Subpart Q, and Part 1926, Subpart J, from U.S. Government Printing Office, Superintendent of Documents, P.O. Box 371954, Pittsburgh, PA 15250-7954 (phone: 1-866-512-1800) (there are 10 OSHA Regional Offices—phone for Region 5, Chicago, is 312-353-2220, website: www.osha.gov).

Portable Generators Safety Alert, U.S. Consumer Product Safety Commission (CPSC), 4330 East West Highway, Bethesda, MD 20814 (phone: 301-504-7923, website: www.cpsc.gov/cpsc/pub/pubs/portgen.pdf).

Applications Manual for the Revised NIOSH Lifting Equation, The National Institute for Occupational Safety and Health (NIOSH), 1600 Clifton Rd, Atlanta, GA 30333 (phone: 1-800-232-4636, website: www.cdc.gov/NIOSH).

2-8. Informations relatives aux CEM

Le courant électrique qui traverse tout conducteur génère des champs électromagnétiques (CEM) à certains endroits. Le courant issu d'un soudage à l'arc (et de procédés connexes, y compris le soudage par points, le gougeage, le découpage plasma et les opérations de chauffage par induction) crée un champ électromagnétique (CEM) autour du circuit de soudage. Des mesures de protection pour les porteurs d'implants médicaux doivent être prises: par exemple, des restrictions d'accès pour les passants ou une évaluation individuelle des risques pour les soudeurs. Tous les soudeurs doivent appliquer les procédures suivantes pour minimiser l'exposition aux CEM provenant du circuit de soudage:

1. Rassembler les câbles en les torsadant ou en les attachant avec du ruban adhésif ou avec une housse.
2. Ne pas se tenir au milieu des câbles de soudage. Disposer les câbles d'un côté et à distance de l'opérateur.

3. Ne pas courber et ne pas entourer les câbles autour de votre corps.
4. Maintenir la tête et le torse aussi loin que possible du matériel du circuit de soudage.
5. Connecter la pince sur la pièce aussi près que possible de la soudure.
6. Ne pas travailler à proximité d'une source de soudage, ni s'asseoir ou se pencher dessus.
7. Ne pas souder tout en portant la source de soudage ou le dévidoir.





En ce qui concerne les implants médicaux :





Les porteurs d'implants doivent d'abord consulter leur médecin avant de s'approcher des opérations de soudage à l'arc, de soudage par points, de gougeage, du découpage plasma ou de chauffage par induction. Si le médecin approuve, il est recommandé de suivre les procédures précédentes.

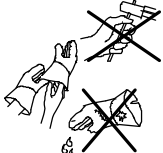
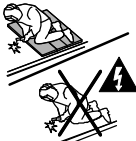
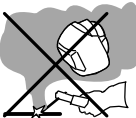
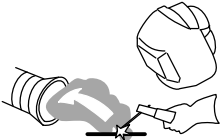
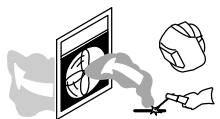
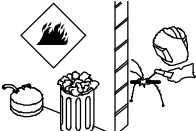

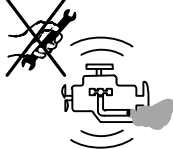

SECTION 3 – DEFINITIONS

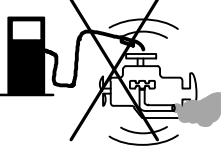
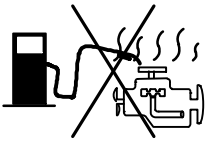
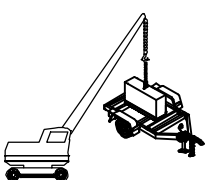
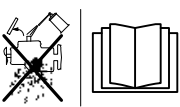
3-1. Additional Safety Symbols And Definitions

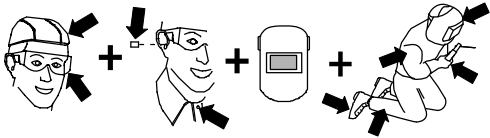
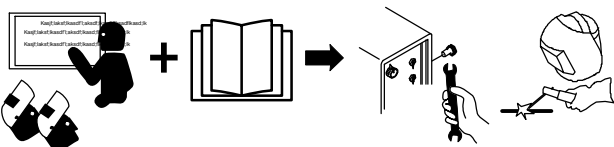
☞ Some symbols are found only on CE products.

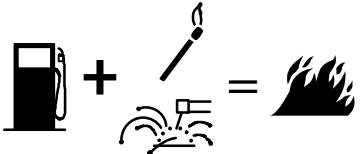
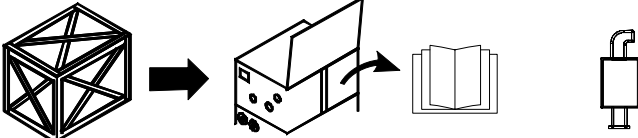

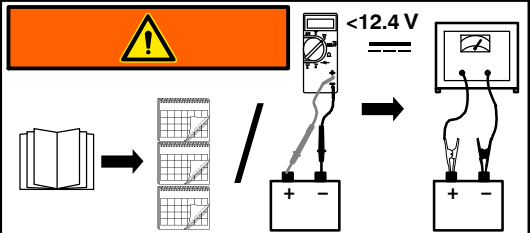
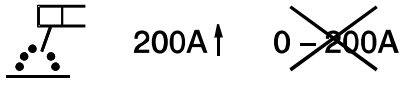

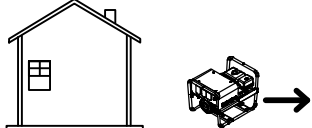













	<p>Warning! Watch Out! There are possible hazards as shown by the symbols.</p> <p style="text-align: right;">Safe1 2012-05</p>
	<p>Do not discard product (where applicable) with general waste. Reuse or recycle Waste Electrical and Electronic Equipment (WEEE) by disposing at a designated collection facility. Contact your local recycling office or your local distributor for further information.</p> <p style="text-align: right;">Safe37 2012-05</p>
	<p>Wear dry insulating gloves. Do not touch electrode with bare hand. Do not wear wet or damaged gloves.</p> <p style="text-align: right;">Safe2 2012-05</p>
	<p>Protect yourself from electric shock by insulating yourself from work and ground.</p> <p style="text-align: right;">Safe3 2012-05</p>
	<p>Keep your head out of the fumes.</p> <p style="text-align: right;">Safe6 2012-05</p>
	<p>Use forced ventilation or local exhaust to remove the fumes.</p> <p style="text-align: right;">Safe8 2012-05</p>
	<p>Use ventilating fan to remove fumes.</p> <p style="text-align: right;">Safe10 2012-05</p>
	<p>Keep flammables away from welding. Do not weld near flammables.</p> <p style="text-align: right;">Safe12 2012-05</p>
	<p>Welding sparks can cause fires. Have a fire extinguisher nearby, and have a watchperson ready to use it.</p> <p style="text-align: right;">Safe14 2012-05</p>
	<p>Do not weld on drums or any closed containers.</p> <p style="text-align: right;">Safe16 2012-05</p>





















	<p>Do not remove or paint over (cover) the label.</p> <p style="text-align: right;">Safe20 2012-05</p>
	<p>Do not work on unit if engine is running. Stop engine first.</p> <p style="text-align: right;">Safe21 2012-05</p>
	<p>Do not smoke while fueling or if near fuel.</p> <p style="text-align: right;">Safe22 2012-05</p>
	<p>Stop engine before fueling.</p> <p style="text-align: right;">Safe23 2012-05</p>
	<p>Do not fuel a hot engine.</p> <p style="text-align: right;">Safe24 2012-05</p>
	<p>Use lift eye to lift unit and properly installed accessories only, not gas cylinders. Do not exceed maximum lift eye rating (see Specifications).</p> <p style="text-align: right;">Safe25 2012-05</p>
	<p>Do not use ether. Using ether voids warranty. See engine Owner's Manual.</p> <p style="text-align: right;">Safe89 2012-07</p>
	<p>Hot muffler and exhaust pipe can cause severe burns.</p> <p style="text-align: right;">Safe90 2012-07</p>
	<p>Welding, cutting, drilling, or grinding on base can cause fire or explosion.</p> <p style="text-align: right;">Safe91 2012-07</p>
	<p>Wear hat and safety glasses. Use ear protection and button shirt collar. Use welding helmet with correct shade of filter. Wear complete body protection.</p> <p style="text-align: right;">Safe38 2012-05</p>
	<p>Become trained and read the instructions before working on the machine or welding.</p> <p style="text-align: right;">Safe40 2012-05</p>

	<p>Engine fuel plus flames or sparks can cause fire.</p> <p style="text-align: right;">Safe45 2012-05</p>
	<p>Remove unit from shipping crate. Remove Owner's Manual from unit. Follow instructions to install muffler.</p> <p style="text-align: right;">Safe46 2012-05</p>
	<p>Read Owner's Manual. Read labels on unit.</p> <p style="text-align: right;">Safe47 2012-05</p>
	<p>Read Owner's Manual for battery maintenance information.</p> <p style="text-align: right;">Safe117 2014-06</p>
<p style="text-align: center;">0 – 50 h std</p> 	<p>During the first 50 hours of operation keep welding load above 200 amperes. Do not weld below 200 amperes of output.</p> <p style="text-align: right;">Safe54 2012-05</p>
<p style="text-align: center;">50 h std</p>  <p style="text-align: right;">API CD-MIL L 2104D, CD/SE, CD/SF</p>	<p>After the first 50 hours of operation, change the engine oil and filter.</p> <p style="text-align: right;">Safe55 2012-05</p>
	<p>Never use generator inside a home or garage, even if doors and windows are open.</p> <p style="text-align: right;">Safe87 2012-07</p>
	<p>Only use generator outside and far away from windows, doors, and vents.</p> <p style="text-align: right;">Safe88 2012-07</p>

3-2. Miscellaneous Symbols And Definitions

A	Amperage
V	Voltage
S	Suitable For Welding In An Environment With Increased Risk Of Electric Shock
≡	Direct Current (DC)
X	Duty Cycle
I₂	Rated Welding Current
U₂	Conventional Load Voltage
U₀	Rated No-Load Voltage (OCV)
I	Current
n	Rated Load Speed
n₀	Rated No-Load Speed
n₁	Rated Idle Speed
P_{1max}	Maximum Power Consumption
Hz	Hertz
~	Alternating Current (AC)
1~	Single Phase
3~	Three Phase
-	Negative
+	Positive

	Protective Earth (Ground)
	Circuit Breaker Supplementary Protector
	Output
	Off
	On
	Increase or Decrease of Quantity (Rotating)
	Do Not Switch While Welding
	Remote
	Read Operator's Manual
	Shielded Metal Arc Welding (SMAW)
	Gas Metal Arc Welding (GMAW)
	Flux Cored Arc Welding (FCAW)
	Gas Tungsten Arc Welding (GTAW) / Tungsten Inert Gas (TIG) Welding
	Starting Aid (Preheat)
	Engine
	Engine
	Engine
	Slow
	Fast

	Engine RPM
	Engine Stop
	Engine Oil
	Fuel
	Filter
	Engine Coolant
	Engine Coolant Temperature
	Engine Temperature
	Battery (Engine)
	Hour Meter
	Engine Belt
	Manual Cleaning
	Call for Maintenance
	Spark Arrestor
	Check Injectors/Pump
	Check Valve Clearance
	Certified/Trained Mechanic
	Air Filter
	Air Cleaner
	Check Air Cleaner

SECTION 4 – SPECIFICATIONS

4-1. Serial Number And Rating Label Locations

The serial number and rating information for this product is located on the right side. Use rating label to determine input power requirements and/or rated output. For future reference, write serial number in space provided on back cover of this manual.

4-2. Weld, Power, And Engine Specifications

Welding Mode	Weld Output Range	Rated Welding Output	Maximum Open-Circuit Voltage	Generator Power Rating
CC/DC (Stick)	20 – 500 A	500 A, 30 Volts DC, 40% Duty Cycle 450 A, 33 Volts DC, 60% Duty Cycle 400 A 36 Volts DC, 100% Duty Cycle	92 V* Nominal	Independent of Weld Output Single-Phase, 4 kVA/kW, 34/17 A, 120/240 V AC, 50/60 Hz 3-Phase Generator (In Addition To Standard 4 kVA/kW Generator) Single-Phase/Three-Phase, 12/15 kVA/kW, 50/36 A, 120/240 VAC, 50/60 Hz Three-Phase Export Models 400 VAC, 22 A
CC/DC (TIG)	20 – 500 A	500 A, 30 Volts DC, 40% Duty Cycle 450 A, 28 Volts DC, 60% Duty Cycle 400 A 26 Volts DC, 100% Duty Cycle		
CV/DC (MIG)	14 – 40 V	500 A, 30 Volts DC, 40% Duty Cycle 450 A, 33 Volts DC, 60% Duty Cycle 400 A 34 Volts DC, 100% Duty Cycle		
Engine: Perkins 404.22 Liquid-Cooled, Four Cylinder, 32.6HP Diesel Engine			Fuel Tank Capacity: 25 gal (95 L)	

* With Low OCV switch (Voltage Reducing Device, VRD) enabled, open-circuit voltage is 13 to 15 volts DC until arc initiation.

4-3. Dimensions, Weights, And Operating Angles

Dimensions	
Height	54 in. (1372 mm) (to top of exhaust)
Width	28-1/2 in. (724 mm) (mtg. brackets turned in)
	30-3/4 in. (781mm) (mtg. brackets turned out)
Depth	65.075 in. (1653 mm)
A	65.075 in. (1653 mm)
B*	58.975 in. (1498 mm)
C*	52.875 in. (1343 mm)
D*	6.1 in. (155 mm)
E	27.5 in. (699mm)
F	1 in. (25 mm)
G	29.81 in. (757 mm)
H	9/16 in. (14 mm) Dia. 4 Holes
* With mounting brackets in center position. Dimensions vary with location of mounting brackets.	
Weight	
No fuel: 1550 lb (680 kg)	
Lifting Eye Weight Rating: 2500 lb (1135 kg) Maximum	

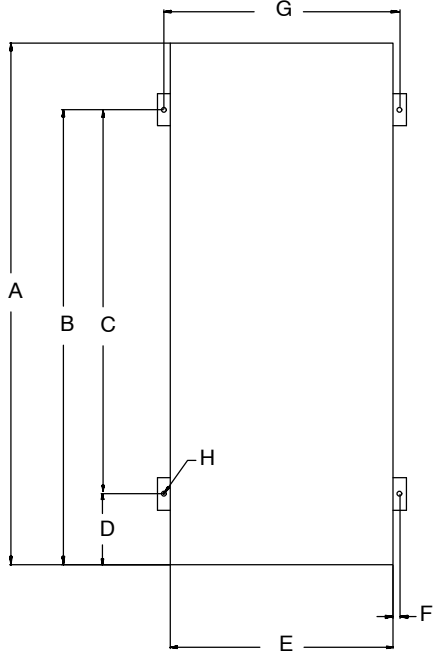



⚠ Do not exceed tilt angles or engine could be damaged or unit could tip.

⚠ Do not move or operate unit where it could tip.

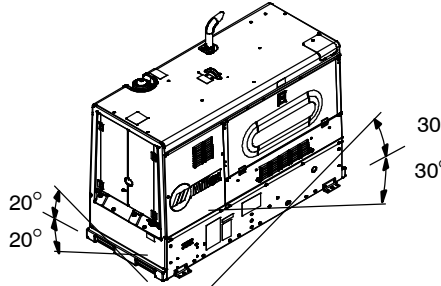

907 677-1

4-4. Environmental Specifications

IP Rating	Operating Temperature Range
IP23S	-40 to 104°F (-40 to +40°C)
This equipment is designed for outdoor use. It may be stored, but is not intended to be used for welding outside during precipitation unless sheltered.	

4-5. Duty Cycle And Overheating

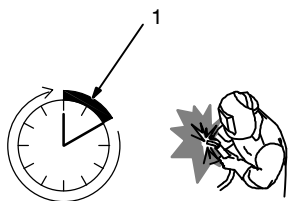
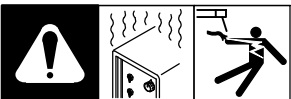

1 100% Duty Cycle

Duty Cycle is percentage of 10 minutes that unit can weld at rated load without overheating.

This unit is rated for welding at 400 amperes continuously.

NOTICE – Exceeding duty cycle can damage unit and void warranty.

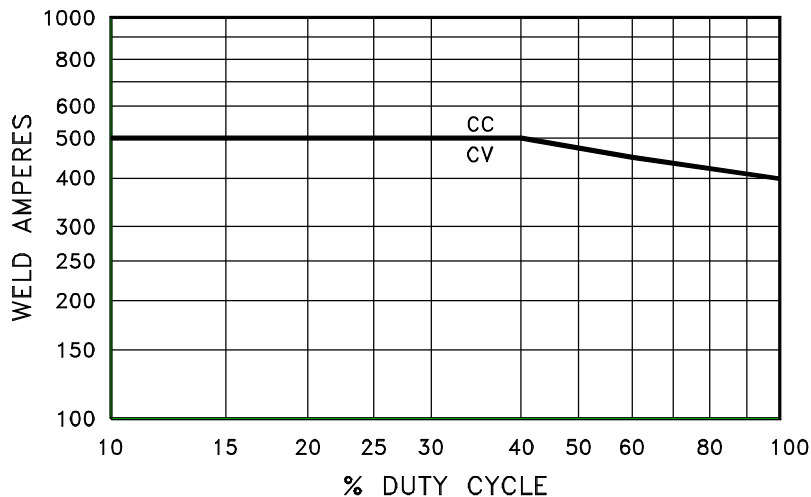

269 536-A

4-6. Fuel Consumption

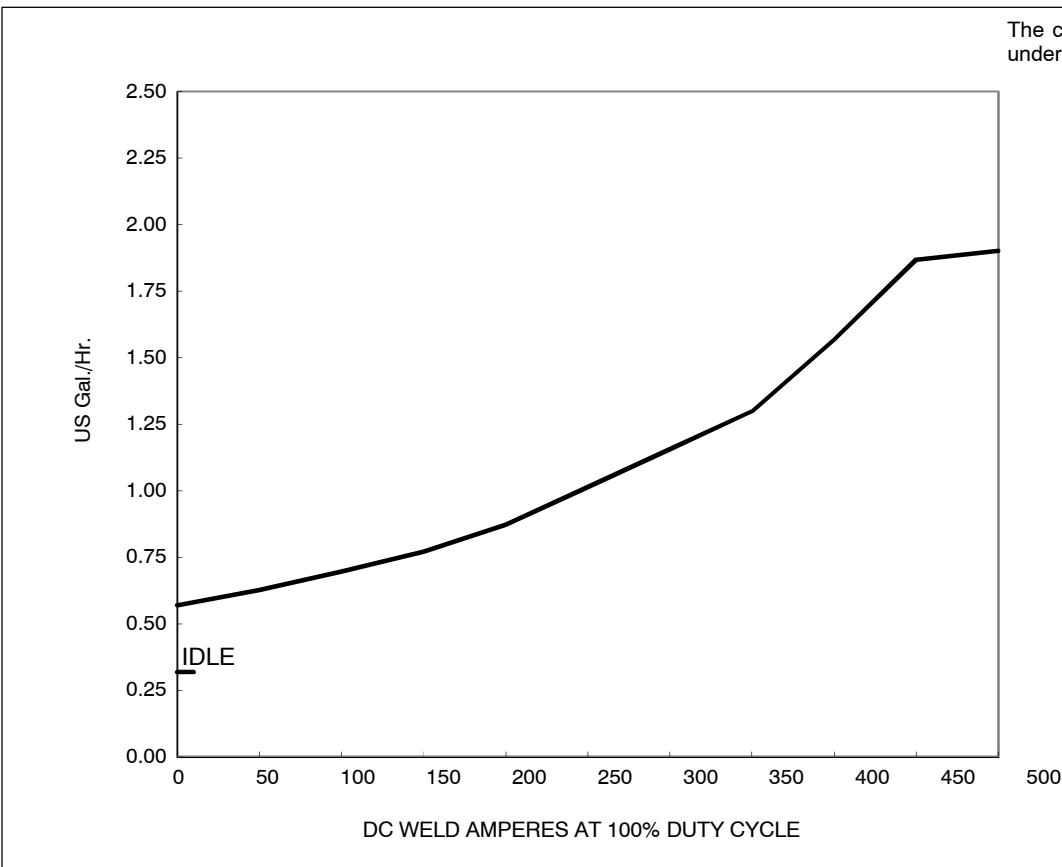

The curve shows typical fuel use under weld or power loads.

270 587-A

4-7. Volt-Ampere Curves

A. Stick

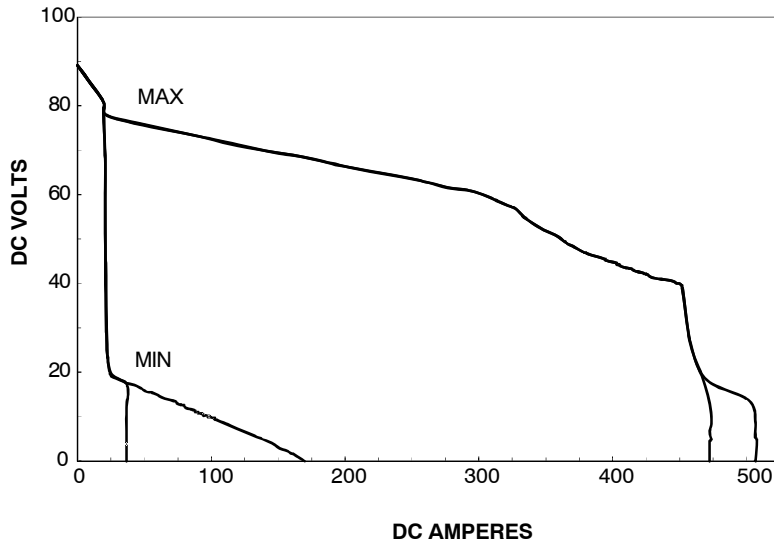

The volt-ampere curves show the minimum and maximum voltage and amperage output capabilities of the welder/generator. Curves of other settings fall between the curves shown.

A. TIG

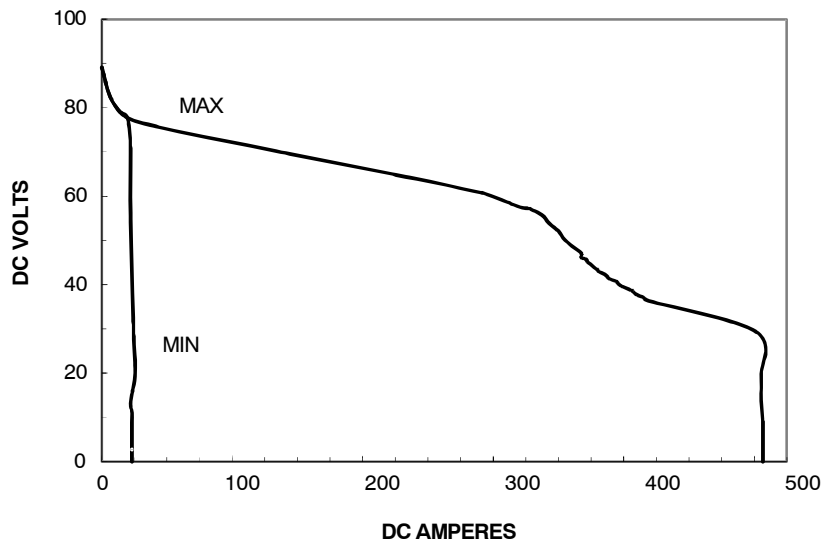

A. MIG

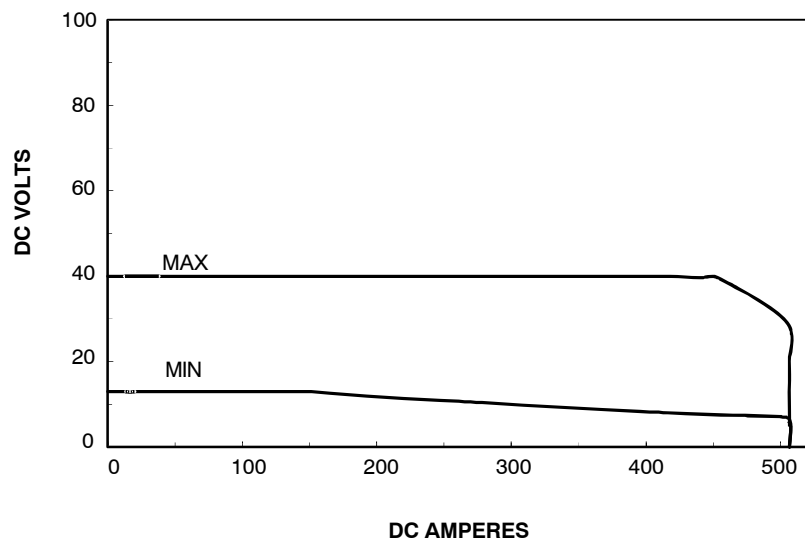

4-8. Generator Power Curves

A. Single Phase 4 kW

The AC power curves show the generator output in amperes.

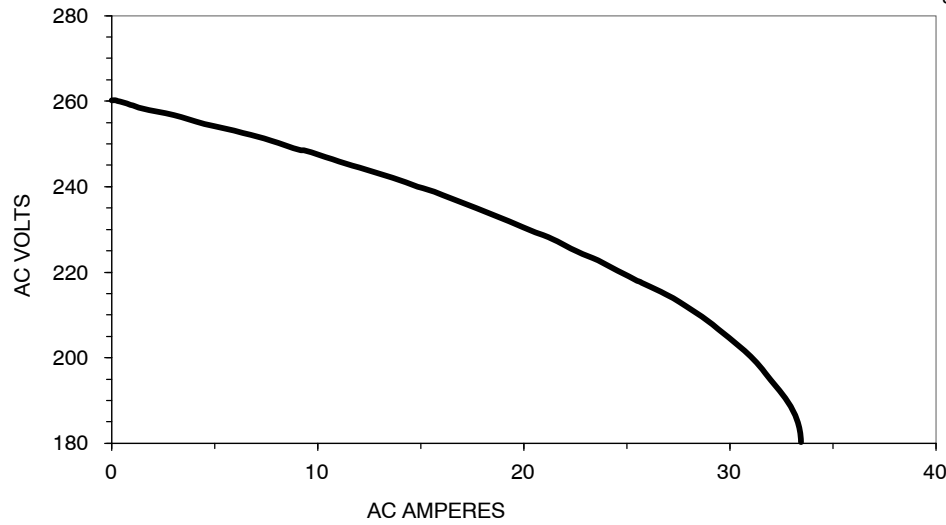

A. Single Phase 12 kW

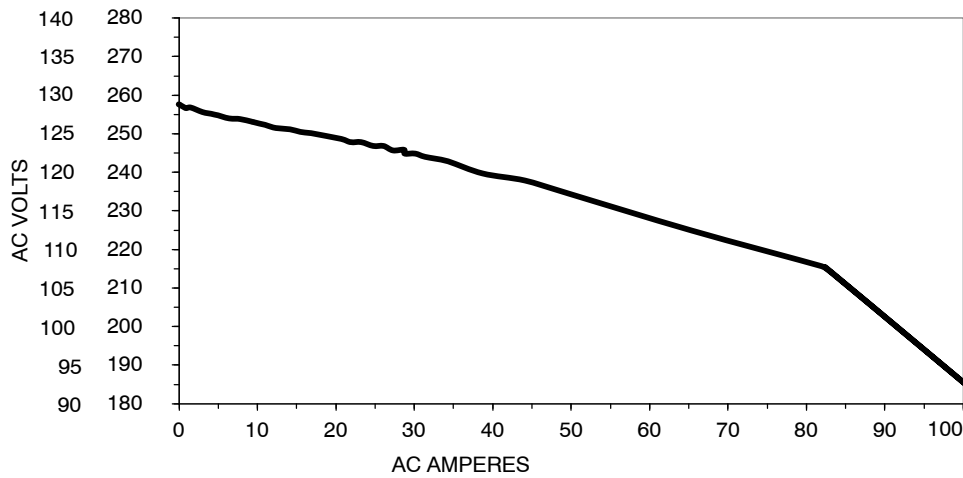

A. Three Phase 15 kW

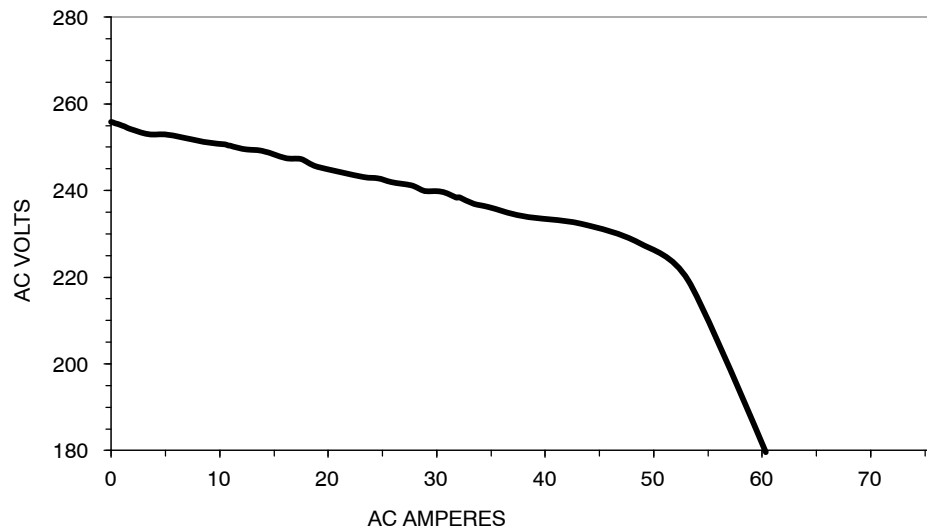

SECTION 5 – INSTALLATION

5-1. Installing Welder/Generator

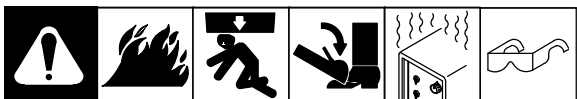

Airflow Clearance

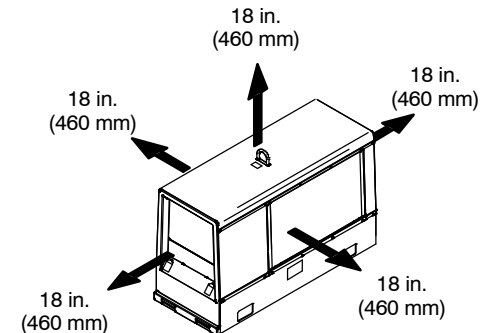

Movement

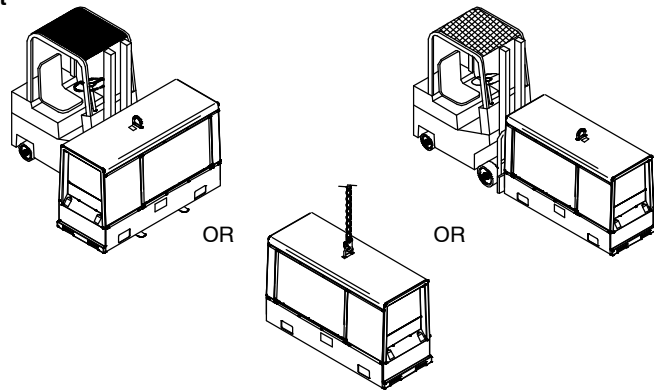

Location/Mounting

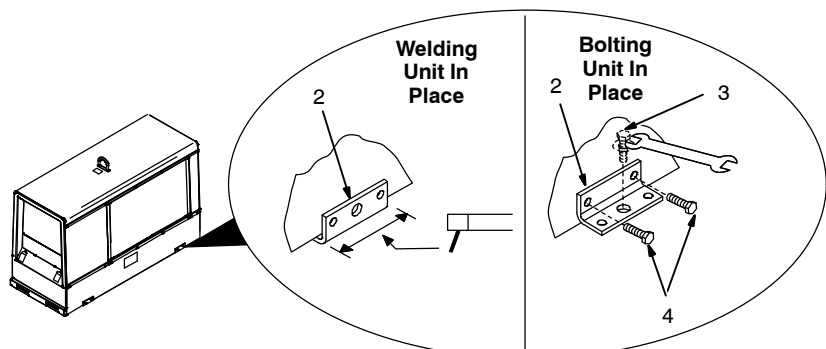

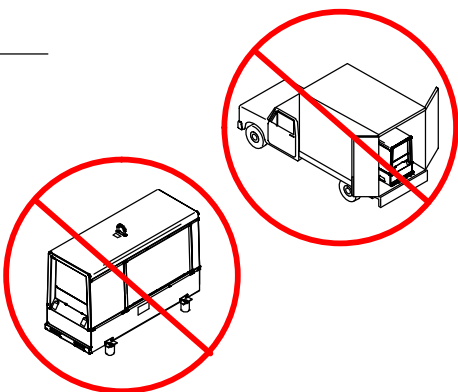

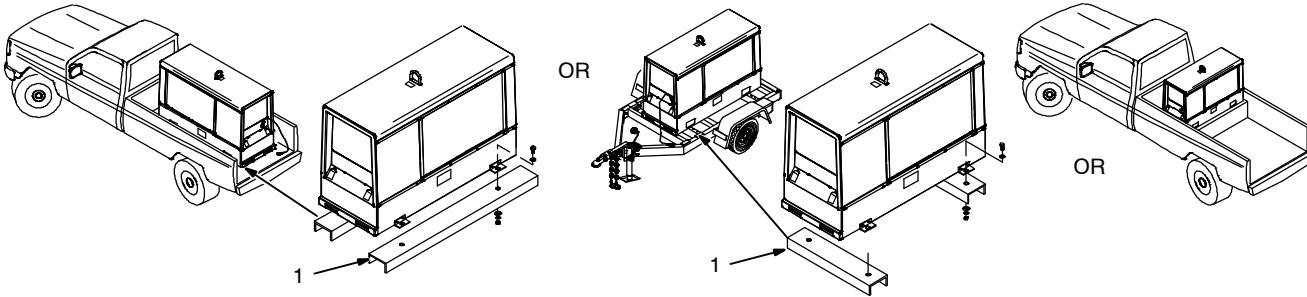

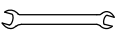
Tools Needed:
 9/16 in.

Movement

⚠ Do not move or operate unit where it could tip.

 See Section 4-3 for lifting eye rating.

Airflow Clearance

NOTICE – Do not install unit where air flow is restricted or engine may overheat.

Location/Mounting

⚠ Always securely fasten welder/generator onto transport vehicle or trailer and comply with all DOT and other applicable codes.

⚠ Do not weld on base. Welding on base can cause fuel tank fire or explosion. Weld only on the four mounting brackets or bolt unit down.

NOTICE – Do not mount unit by supporting the base *only* at the four mounting brackets. Use cross-supports to adequately support unit and prevent damage to base.

- 1 Cross-Supports
- 2 Mounting Brackets (Supplied)

Mount unit on flat surface or use cross-supports to support base. Secure unit with mounting brackets.

- 3 1/2 in Bolt And Washer (Minimum – Not Supplied)
- 4 3/8-16 x 1 in. Screws (Supplied)

To Bolt Unit In Place:

Remove hardware securing the four mounting brackets to the base. Reverse brackets and reattach to base with original hardware.

Mount unit to truck or trailer with 1/2 in. (12 mm) or larger hardware (not supplied).

To Weld Unit In Place:

Weld unit to truck or trailer only at the four mounting brackets.

install3 2013-06 – Ref. 800 652 / Ref. 800 477-A / 803 274 / 804 712

5-2. Grounding Generator To Truck Or Trailer Frame

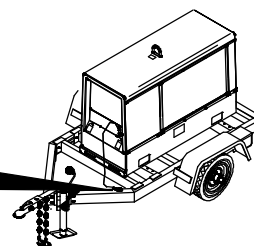
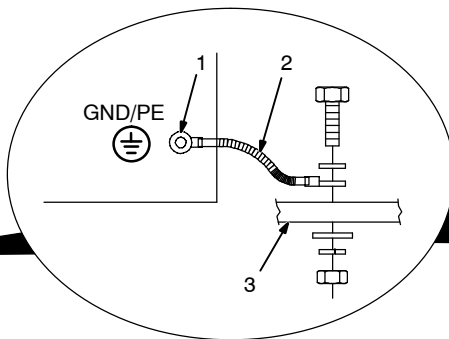
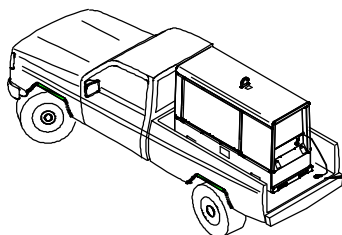

rot_grnd2 2012-03 - 800 652-D

- ⚠ Always ground generator frame to vehicle frame to prevent electric shock and static electricity hazards.
- ⚠ Also see AWS Safety & Health Fact Sheet No. 29, Grounding of Portable And Vehicle Mounted Welding Generators.
- ⚠ Bed liners, shipping skids, and some running gear insulate the welder/generator from the vehicle

frame. Always connect a ground wire from the generator equipment grounding terminal to bare metal on the vehicle frame as shown.

- ⚠ Use GFCI protection when operating auxiliary equipment. If unit does not have GFCI receptacles, use GFCI-protected extension cord. Do not use GFCI receptacles to power life support equipment.

- 1 Equipment Grounding Terminal (On Front Panel)
- 2 Grounding Cable (Not Supplied)
- 3 Metal Vehicle Frame

Connect cable from equipment ground terminal to metal vehicle frame. Use #8 AWG or larger insulated copper wire.

☞ Electrically bond generator frame to vehicle frame by metal-to-metal contact.

5-3. Installing Exhaust Pipe

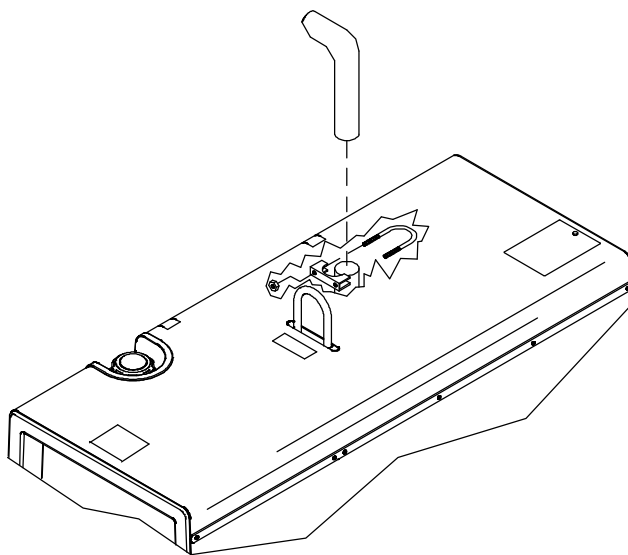
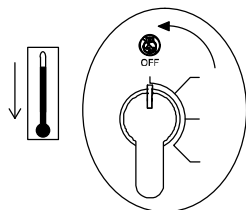

- ⚠ Stop engine and let cool.

☞ Point exhaust pipe in desired direction but always away from front panel and direction of travel.

Tools Needed:

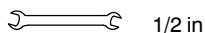

1/2 in

Exhaust1 2008-01 Ref. 803 604 / Ref. 215 664

5-5. Engine Prestart Checks

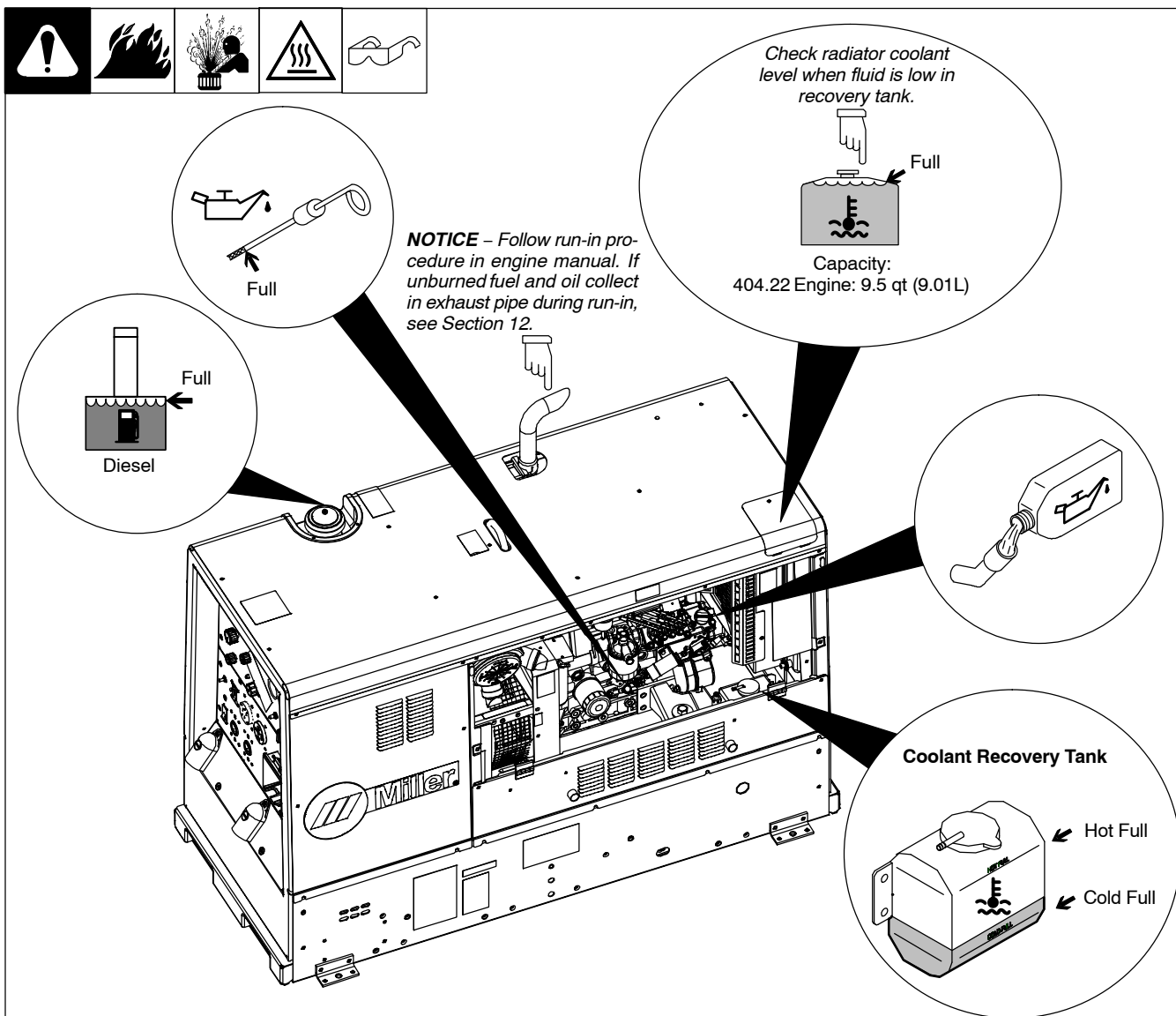

NOTICE – Follow run-in procedure in engine manual. If unburned fuel and oil collect in exhaust pipe during run-in, see Section 12.

Check radiator coolant level when fluid is low in recovery tank.

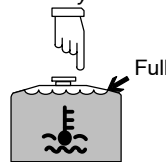

Capacity:
404.22 Engine: 9.5 qt (9.01L)

Coolant Recovery Tank

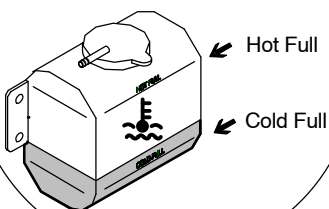

907 667-TP2

☞ Check all engine fluids daily.

Engine must be cold and on a level surface.

Automatic shutdown system stops engine if oil pressure is too low or coolant temperature is too high.

☞ This unit has a low oil pressure shutdown switch. However, some conditions may cause engine damage before the engine shuts down. Check oil level often and do not use the oil pressure shutdown system to monitor oil level.

NOTICE – Diesel engines in MILLER equipment are meant to operate optimally at moderate to rated load. Using light or no load for extended periods of time may cause wet-stacking or engine damage. Follow run-in procedure in engine manual. If unburned fuel and oil collect in exhaust pipe during run-in, see Section 12.

Fuel

NOTICE – Do not use gasoline. Gasoline will damage engine.

Add fresh diesel fuel before starting (see engine maintenance label for fuel specifications). Leave filler neck empty to allow room for expansion.

Engine stops if fuel level is low.

Oil

After fueling, check oil with unit on level surface. If oil is not up to full mark on dipstick, add oil (see maintenance label).

Coolant

Check coolant level in radiator before starting unit the first time. If necessary, add coolant to radiator until coolant level is at bottom of filler neck.

Check coolant level in recovery tank daily. If necessary, add coolant to recovery tank until coolant level is between Cold Full and Hot Full levels. If recovery tank coolant level was low, also check coolant level in radiator. Add coolant if level is below bottom of radiator filler neck.

Unit is shipped with an engine coolant mixture of water and ethylene glycol base an-

tifreeze rated to -34°F (-37°C). Add antifreeze to mixture if using the unit in temperatures below -34°F (-37°C).

Keep radiator and air intake clean and free of dirt.

NOTICE – Incorrect engine temperature can damage engine. Do not run engine without a properly working thermostat and radiator cap.

☞ To improve cold weather starting:

Use Starting Aid switch (see Section 6-2).

Keep battery in good condition. Store battery in warm area.

Use fuel formulated for cold weather (diesel fuel can gel in cold weather). Contact local fuel supplier for fuel information.

Use correct grade oil for cold weather (see Section 8-1).

5-6. Weld Output Terminals

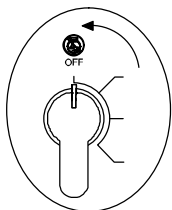

Tools Needed:

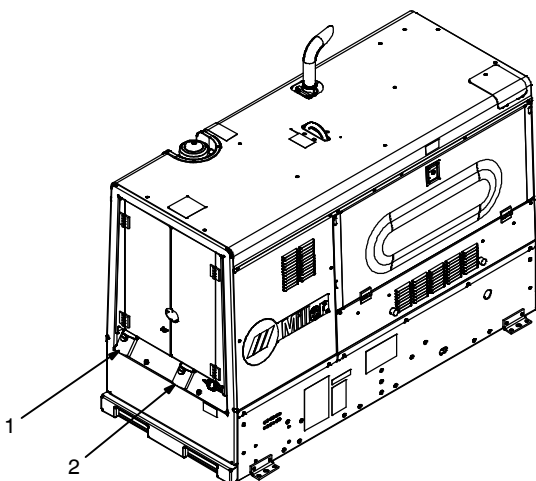
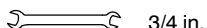

907 667-01

⚠ Stop engine.

- 1 Positive (+) Weld Output Terminal
- 2 Negative (-) Weld Output Terminal

Stick And TIG Welding

For Stick welding Direct Current Electrode Positive (DCEP), connect electrode holder cable to Positive (+) terminal on left and work cable to Negative (-) terminal on right.

For Stick and TIG Direct Current Electrode Negative (DCEN), connect electrode hold-

er cable to Negative (-) terminal on right and work cable to Positive (+) terminal on left.

If equipped with optional Polarity switch, connect electrode holder cable to Electrode (+) terminal on left and work cable to Work (-) terminal on right.

MIG And FCAW Welding

For MIG welding Direct Current Electrode Positive (DCEP), connect wire feeder cable to Positive (+) terminal on left and work cable to Negative (-) terminal on

right. Use Process/Contactor switch to select type of weld output (see Section 6-3).

For MIG and FCAW Direct Current Electrode Negative (DCEN), connect wire feeder cable to Negative (-) terminal on right and work cable to Positive (+) terminal on left. Use Process/Contactor switch to select type of weld output (see Section 6-3).

If equipped with optional Polarity switch, connect wire feeder cable to Electrode (+) terminal on left and work cable to Work (-) terminal on right.

5-7. Connecting To Weld Output Terminals



Tools Needed:

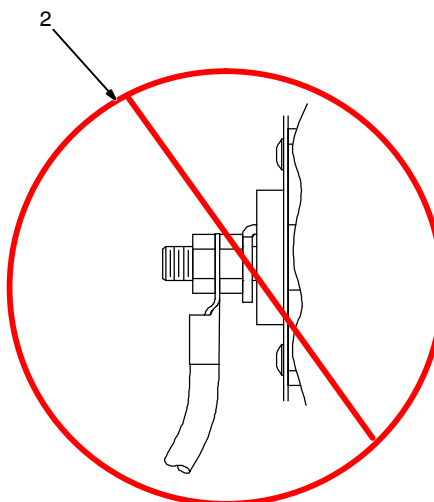
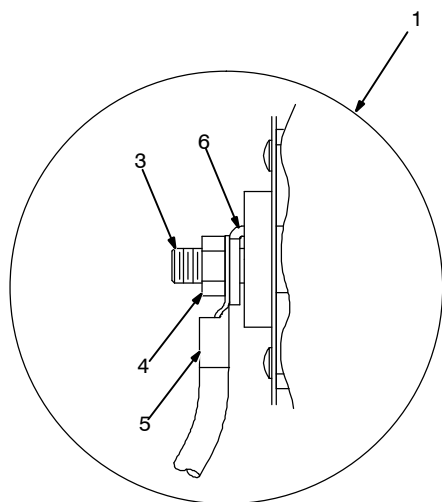
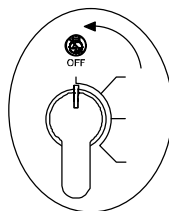
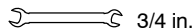

⚠ Stop engine.

⚠ Failure to properly connect weld cables may cause excessive heat and start a fire, or damage your machine.

ⓘ Do not place anything between weld cable terminal and copper bar. Make sure that the surfaces of the weld cable terminal and copper bar are clean.

- 1 Correct Weld Cable Connection
- 2 Incorrect Weld Cable Connection
- 3 Weld Output Terminal
- 4 Supplied Weld Output Terminal Nut
- 5 Weld Cable Terminal
- 6 Copper Bar

Remove supplied nut from weld output terminal. Slide weld cable terminal onto weld output terminal and secure with nut so that weld cable terminal is tight against copper bar.

803 778-B

5-8. Weld Output Terminals And Selecting Cable Sizes*

NOTICE – The Total Cable Length in Weld Circuit (see table below) is the combined length of both weld cables. For example, if the power source is 100 ft (30 m) from the workpiece, the total cable length in the weld circuit is 200 ft (2 cables x 100 ft). Use the 200 ft (60 m) column to determine cable size.

Welding Amperes	Weld Cable Size** and Total Cable (Copper) Length in Weld Circuit Not Exceeding***							
	100 ft (30 m) or Less		150 ft (45 m)	200 ft (60 m)	250 ft (70 m)	300 ft (90 m)	350 ft (105 m)	400 ft (120 m)
	10 – 60% Duty Cycle AWG (mm ²)	60 – 100% Duty Cycle AWG (mm ²)	10 – 100% Duty Cycle AWG (mm ²)					
100	4 (20)	4 (20)	4 (20)	3 (30)	2 (35)	1 (50)	1/0 (60)	1/0 (60)
150	3 (30)	3 (30)	2 (35)	1 (50)	1/0 (60)	2/0 (70)	3/0 (95)	3/0 (95)
200	3 (30)	2 (35)	1 (50)	1/0 (60)	2/0 (70)	3/0 (95)	4/0 (120)	4/0 (120)
250	2 (35)	1 (50)	1/0 (60)	2/0 (70)	3/0 (95)	4/0 (120)	2x2/0 (2x70)	2x2/0 (2x70)
300	1 (50)	1/0 (60)	2/0 (70)	3/0 (95)	4/0 (120)	2x2/0 (2x70)	2x3/0 (2x95)	2x3/0 (2x95)
350	1/0 (60)	2/0 (70)	3/0 (95)	4/0 (120)	2x2/0 (2x70)	2x3/0 (2x95)	2x3/0 (2x95)	2x4/0 (2x120)
400	1/0 (60)	2/0 (70)	3/0 (95)	4/0 (120)	2x2/0 (2x70)	2x3/0 (2x95)	2x4/0 (2x120)	2x4/0 (2x120)
500	2/0 (70)	3/0 (95)	4/0 (120)	2x2/0 (2x70)	2x3/0 (2x95)	2x4/0 (2x120)	3x3/0 (3x95)	3x3/0 (3x95)
600	3/0 (95)	4/0 (120)	2x2/0 (2x70)	2x3/0 (2x95)	2x4/0 (2x120)	3x3/0 (3x95)	3x4/0 (3x120)	3x4/0 (3x120)
700	4/0 (120)	2x2/0 (2x70)	2x3/0 (2x95)	2x4/0 (2x120)	3x3/0 (3x95)	3x4/0 (3x120)	3x4/0 (3x120)	4x4/0 (4x120)
800	4/0 (120)	2x2/0 (2x70)	2x3/0 (2x95)	2x4/0 (2x120)	3x4/0 (3x120)	3x4/0 (3x120)	4x4/0 (4x120)	4x4/0 (4x120)



Weld Output Terminals

- ⚠ Turn off power before connecting to weld output terminals.
- ⚠ Do not use worn, damaged, undersized, or repaired cables.

* This chart is a general guideline and may not suit all applications. If cable overheats, use next size larger cable.

**Weld cable size (AWG) is based on either a 4 volts or less drop or a current density of at least 300 circular mils per ampere. () = mm² for metric use

***For distances longer than those shown in this guide, call a factory applications rep. at 920-735-4505 (Miller) or 1-800-332-3281 (Hobart).

Ref. S-0007-K 2013-09

5-9. Connecting To Remote 14 Receptacle

*The remaining sockets are not used.

Accessories depend on unit capabilities.

Rmt14_1 2010-04

REMOTE 14	Socket*	Socket Information
⚠ Not all models have contactor control. See description of front panel controls and circuit diagram.		
24 VOLTS AC OUTPUT (CONTACTOR)	A	24 volts AC. Protected by supplementary protector.
	B	Contact closure to A completes 24 volt AC contactor control circuit.
REMOTE OUTPUT CONTROL	C	Output to remote control: +10 volts DC in MIG mode; 0 to +10 volts DC in Stick or TIG mode.
	D	Remote control circuit common.
	E	DC input command signal: 0 to +10 volts from min. to max. of remote control with Voltage/Amperage Adjust control at maximum.
A/V AMPERAGE VOLTAGE	F	Current feedback: 1 volt per 100 amperes.
	H	Voltage feedback: 1 volt per 10 arc volts.
GND	K	Chassis common.
NEUTRAL	G	Circuit common for 24 volt AC circuit.

SECTION 6 – OPERATING WELDER / GENERATOR

6-1. Front Panel Controls (See Section 6-2)

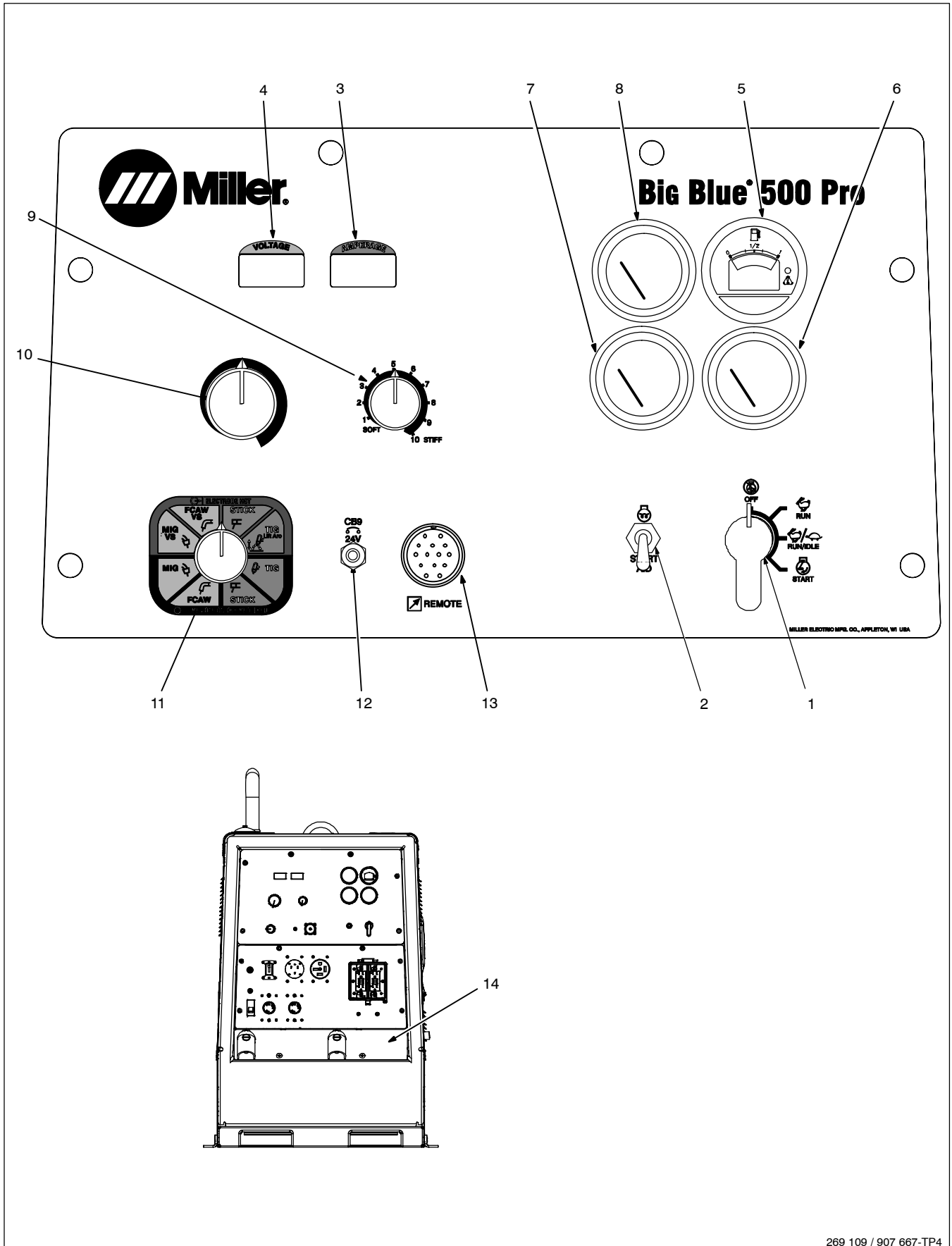

6-3. Process/Contactor Switch

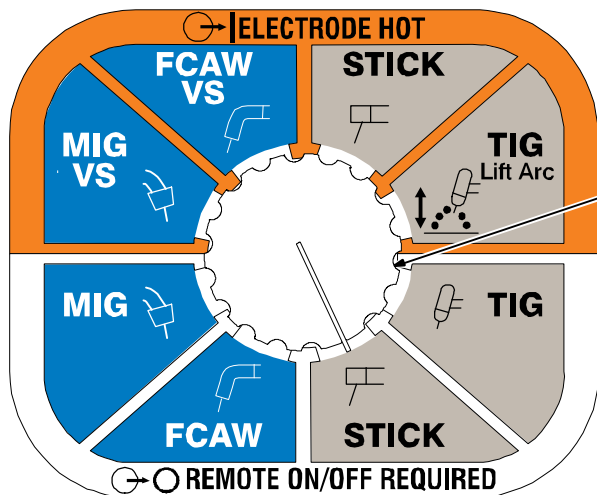

1 Process/Contactor Switch
⚠ Weld output terminals are energized when Process/Contactor switch is in an Electrode Hot position and the engine is running.

Use switch to select weld process and weld output on/off control (see table below).

Place switch in Remote On/Off Switch Required positions to turn weld output on and off with a device connected to the Remote 14 receptacle.

Place switch in Electrode Hot positions for weld output to be on whenever the engine is running.

Use Stick mode for air carbon arc (CAC-A) cutting and gouging.

Use the Lift-Arc TIG mode for TIG (GTAW) welding using the Lift-Arc TIG starting procedure (see Section 6-7).

Ref. 258 833-A

	Switch Setting	Typical Process Applications (DC Only)
ELECTRODE HOT	Electrode Hot – MIG VS	MIG solid wire uses a voltage sensing (VS) feeder that does not require a control cable back to the welder/generator.
	Electrode Hot – FCAW VS	FCAW (Flux Cored Arc Welding) uses a voltage sensing (VS) feeder that does not require a control cable back to the welder/generator.
	Electrode Hot - Stick	Stick welding with or without a remote amperage control. Strike an arc to start welding.
	Electrode Hot – TIG Lift Arc	Lift Arc TIG: touch tungsten to work and lift to start welding. Uses circuitry internal to the welder/generator to aid arc start. Can be used with or without a remote control.
REMOTE ON/OFF REQUIRED	Remote ON/OFF Required - TIG	High Frequency TIG or Scratch Start TIG welding. High frequency TIG starting with remote foot control allows remote On/Off and Amperage control. Another typical application is a simple TIG rig with a remote control device.
	Remote On/Off Required - Stick	Stick welding with RFC-14 control allows remote On/Off and Amperage control. This can help eliminate accidental arc strikes.
	Remote On/Off Required - FCAW	FCAW using a constant speed feeder. Use feeders with remote voltage control, or use a Spoolmatic 30A with WC 24 control.
	Remote On/Off Required - MIG	MIG solid wire using a constant speed feeder. Use feeders with remote voltage control, or use a Spoolmatic 30A with WC 24 control.

6-4. Arc Control



1 Arc Control

Stick

Control adjusts Dig when Stick is selected on mode switch.

When control is set toward minimum, short-circuit amperage at low arc voltage is the same as normal welding amperage.

When set toward maximum, short-circuit amperage is increased at low arc voltage to help prevent the electrode from sticking while welding.

Select setting best suited for application.

FCAW/MIG

Control adjusts inductance when FCAW or MIG position is selected on the mode switch. Inductance determines the "wetness" of the weld puddle. Increasing Arc Control setting decreases inductance, thereby increasing puddle fluidity ("wetness"). Decreasing Arc Control setting increases inductance, decreasing puddle fluidity.

TIG

When the control is set below 1, Auto Stop is a variable function of pre-set weld amperage. This is used with a short arc length where flare at arc shutdown cannot be tolerated.

When the control is set above 1, Auto Stop voltage threshold is a set value based on pre-set weld amperage (I) as follows:

$I \leq 50 \text{ A}, V=17$
 $I > 50 \text{ to } \leq 100 \text{ A}, V=22$
 $I > 100 \text{ to } \leq 190 \text{ A}, V=25$
 $I > 190 \text{ A}, V=30$

This allows for a longer arc length (such as when "walking the cup"), where nuisance shutdowns are undesirable.

Control is not functional when TIG Remote mode is selected.

Suggested Arc Control Settings

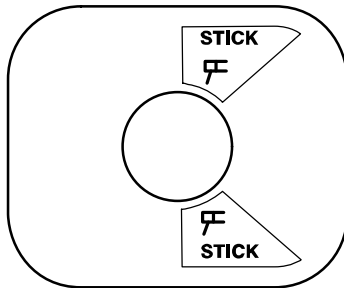

STICK MODE

EXX10: 6.5
 Cellulosic Electrodes
EXX18: 2
 Low Hydrogen Electrodes

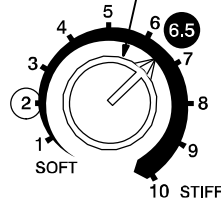

ARC CONTROL

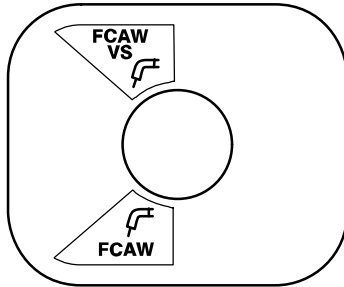

FCAW MODE

FCAW-G: 4
 Gas-Shielded Flux Core
FCAW-S: 10
 Self-Shielded Flux Core

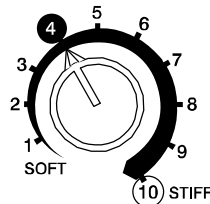

ARC CONTROL

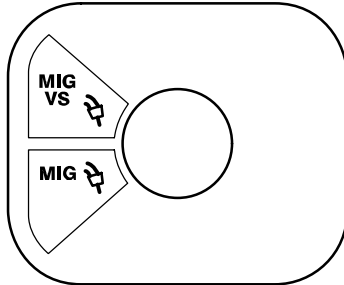

MIG MODE

Solid Wire: **5**

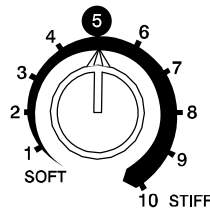

ARC CONTROL

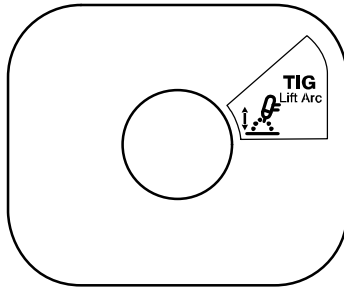

TIG MODE

"Walking the Cup Method": **2**
 Other Methods: **0**

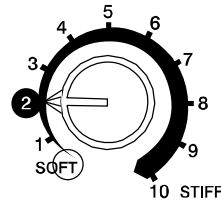

ARC CONTROL

257145-A

6-5. Low Open-Circuit Voltage (VRD) Switch Mode



1 Voltage Reducing Device (VRD) Switch

The VRD switch can be set for low open-circuit voltage operation in Stick mode. When the unit is configured for low open-circuit voltage operation only a low sensing voltage (approximately 15 volts DC) is present between the electrode and workpiece prior to the electrode touching the workpiece.

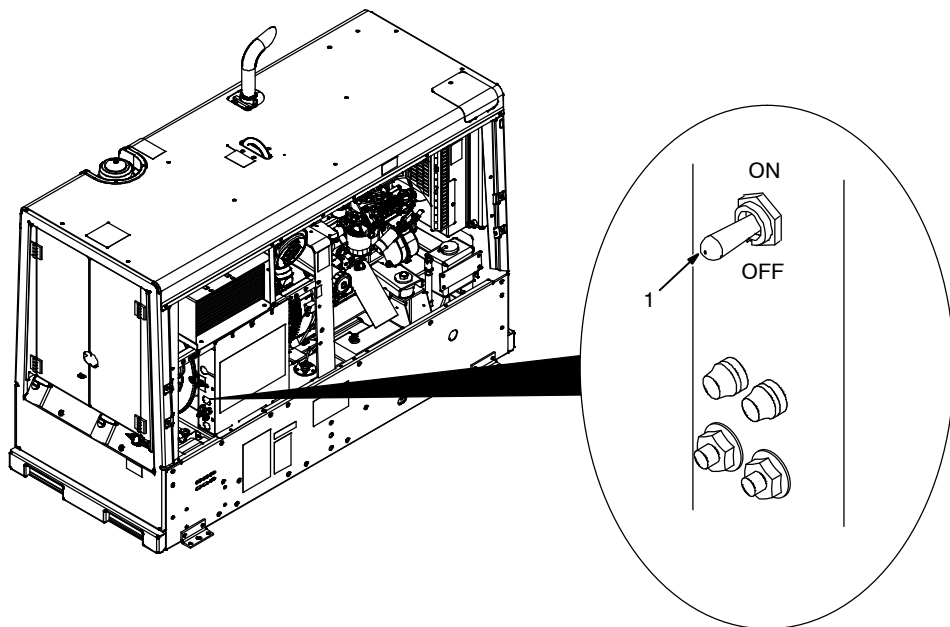

907 667-2

6-6. Stick Start Procedure – Scratch Start Technique



With Stick selected, start arc as follows:

- 1 Electrode
- 2 Workpiece
- 3 Arc

Drag electrode across workpiece like striking a match; lift electrode slightly after touching work. If arc goes out electrode was lifted to high. If electrode sticks to workpiece, use a quick twist to free it.

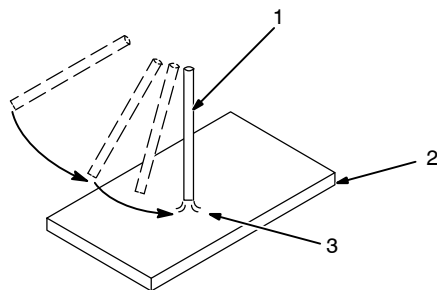

VRD Switch On: Normal open-circuit voltage is not present before electrode touches workpiece; only a low sensing voltage is present between electrode and workpiece. For optimal starting performance, a good clean contact must be made between the electrode and workpiece.

6-8. Remote Voltage/Amperage Control

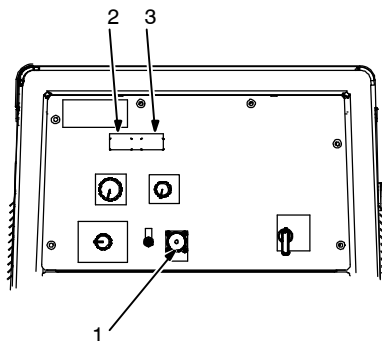

1 Remote 14 Receptacle
Connect optional remote control to receptacle (see Section 5-9).

☞ When a remote control is connected to the Remote receptacle, the Auto Sense Remote feature automatically switches voltage/amperage control to the remote control. When a device is connected to the Remote receptacle, remote voltage/amperage control is always available regardless of the position of the Process/Contactor switch.

- 2 Voltmeter
- 3 Ammeter

CC Welding

In Example:
Min = 20 A DC
Max = 205 A DC

Voltmeter Shows Open-Circuit Voltage When Not Welding, Arc Voltage While Welding

85

205

Ammeter Shows Preset Output When Not Welding, Actual Amperage While Welding

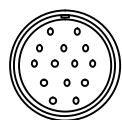

REMOTE

Connect Remote Control To Remote Receptacle RC14

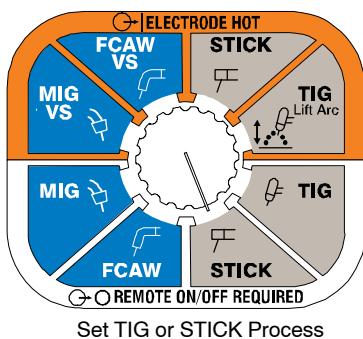

Set TIG or STICK Process

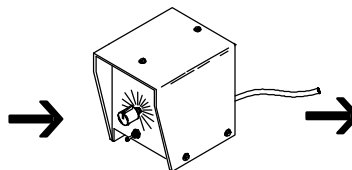

Turn Remote Control On. Adjust Optional Remote Control to 100%

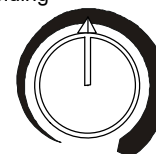

Set V/A Control To Desired Maximum Weld Output Using Weld Meters

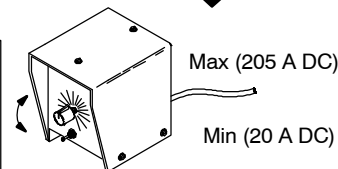

Adjust Optional Remote Control to desired weld output

CV Welding

Electrode Hot: Voltmeter toggles between preset and actual output when not welding, actual voltage while welding.

Remote On/Off Required: Voltage shown is preset.

28

0

Ammeter Shows Zero

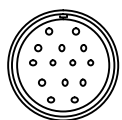

REMOTE

Connect Remote Control To Remote Receptacle RC14

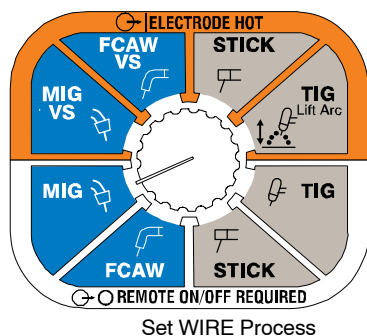

Set WIRE Process

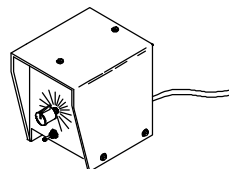

Adjust Optional Remote Control to desired weld output

6-9. Fuel/Hour Gauge Descriptions

FUEL/HOUR GAUGE DESCRIPTIONS	
	<p>ENGINE HOURS: Gauge will display engine hours while engine is running. To display engine hours while the engine is off, place Engine Control switch in position “3”.</p>
	<p>OIL CHANGE INTERVAL: Gauge will display hours remaining before oil change is due with Engine Control switch in position “2” (with engine off).</p>
	<p>OIL CHANGE DUE: Gauge will display blinking wrench when oil change is due (0 to -99 hours).</p> <p>To Reset: Toggle Engine Control switch between position “2” and “3” three times within 5 seconds (engine off).</p>
	<p>LOW FUEL PREWARNING: Fault indicator flashes when fuel level reaches 2 bars. Flashing rate increases as fuel level drops.</p> <p>LOW FUEL: Fuel level low when fuel icon and last bar in fuel gauge blink.</p> <p>To Reset: Refuel.</p>
	<p>NO FUEL: Engine shuts down before fuel runs out. Display shows “noFuel”, and fuel icon and fault indicator flash.</p> <p>To Reset: Refuel.</p>
	<p>LOW OIL PRESSURE: Engine shuts down when oil pressure is low. Display shows “LO OIL”, fault indicator flashes and wrench is displayed.</p> <p>To Reset: Place Engine Control switch in OFF position.</p>
	<p>HIGH COOLANT TEMP: Engine shuts down when coolant temperature is high. Display shows “HI H2O” and fault indicator flashes.</p> <p>To Reset: Place Engine Control switch in OFF position.</p>
<p>Note: Switch positions are numbered to illustrate that there are four switch positions. Actual graphics on front panel will vary. 238 650-B</p>	

SECTION 7 – OPERATING AUXILIARY EQUIPMENT

7-1. North American Auxiliary Power Receptacles

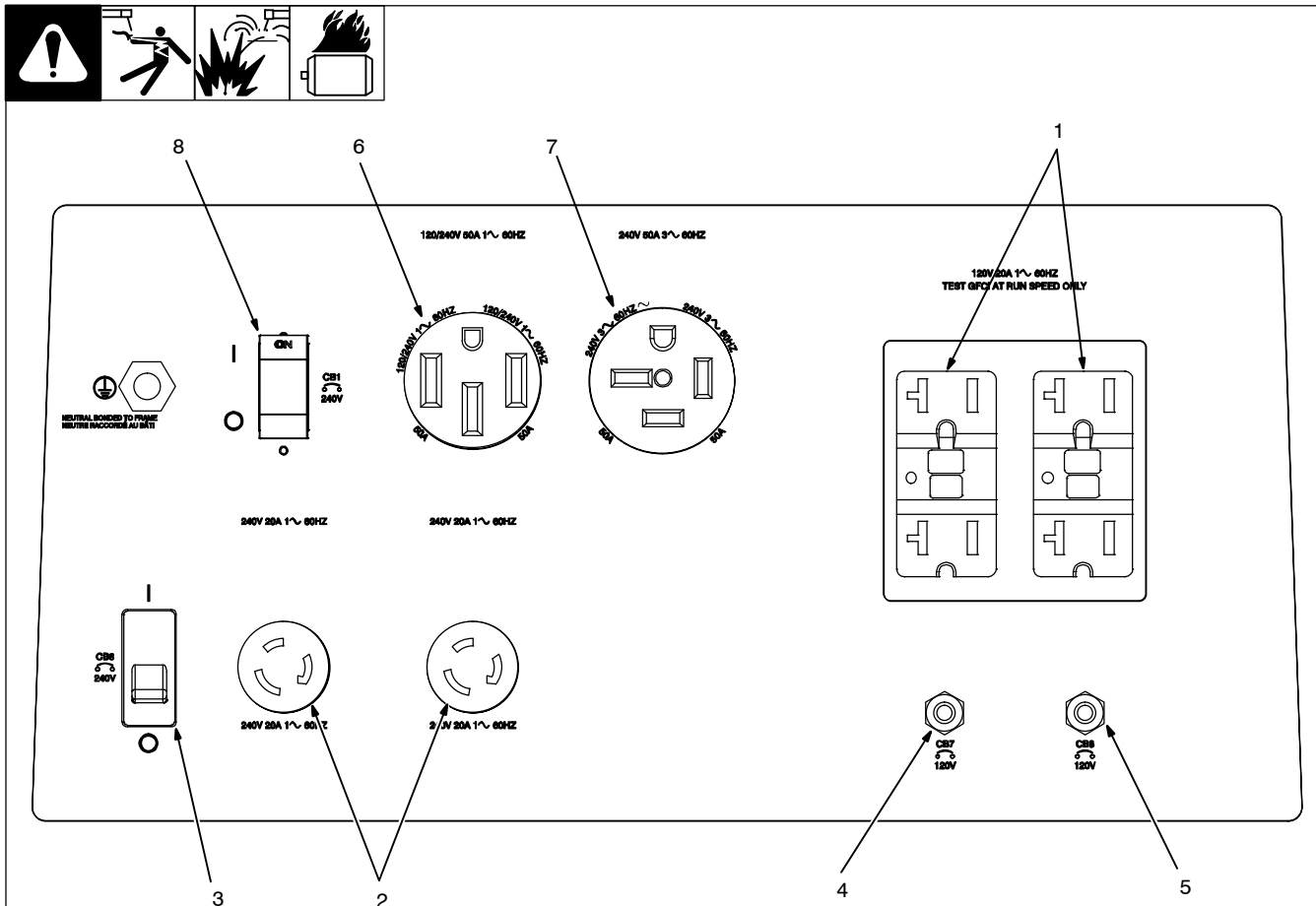

264 773-A

Single-Phase Generator Power

- ⚠ Use GFCI protection when operating auxiliary equipment. If unit does not have GFCI receptacles, use GFCI-protected extension cord. Do not use GFCI receptacles to power life support equipment.**
- ⚠ Unplug power cord before attempting to service accessories or tools.**

- 1 120 V 20 A AC GFCI Receptacle GFCI1 or GFCI2

- ⚠ Test GFCI monthly. See Section 7-3 for GFCI information and for resetting and testing procedures.**

- 2 240 V 30 A AC Twistlock Receptacle RC1 or RC2

Receptacles supply 60 Hz single-phase power at weld/power speed.

- 3 Supplementary Protector CB6
- 4 Supplementary Protector CB7
- 5 Supplementary Protector CB8

CB6 protects RC1 and RC2, and the generator winding from overload. If CB6 opens, RC1, RC2, GFCI1 and GFCI2 do not work. Place switch in On position to reset.

CB7 protects GFCI1 from overload. If CB7 opens, GFCI1 does not work. Press button to reset.

CB8 protects GFCI2 from overload. If CB8 opens, GFCI2 does not work. Press button to reset.

⚠ If a supplementary protector continues to open, contact Factory Authorized Service Agent.

⚠ Generator power is not affected by weld output.

Maximum output is 2.4 kVA/kW from GFCI1 and 4 kVA/kW from RC1. Maximum output from all receptacles is 4 kVA/kW.

EXAMPLE: If 13 A is drawn from RC1, only 7 A is available at GFCI1:

$$(240 \text{ V} \times 13 \text{ A}) + (120 \text{ V} \times 7 \text{ A}) = 4.0 \text{ kVA/kW}$$

- 6 120/240 V 50 A Receptacle RC5

RC5 is connected to the three-phase generator and supplies 60 Hz single-phase power at weld/power speed. Maximum output from RC5 is 12 kVA/kW. Power available at RC5 is reduced when welding.

Three-Phase Generator Power

- 7 240 V 50 A Three-Phase Receptacle RC4

RC4 is connected to the three-phase generator and supplies 60 Hz three-phase power at weld/power speed. Maximum output from RC4 is 20 kVA/kW. Power available at RC4 is reduced when welding.

- 8 Supplementary Protector CB1

Supplementary protector CB1 protects three-phase receptacle RC4, single-phase receptacle RC5, and the load wires from overload. If CB1 opens, all generator output stops and the receptacles do not work.

7-2. Export Auxiliary Power Receptacles

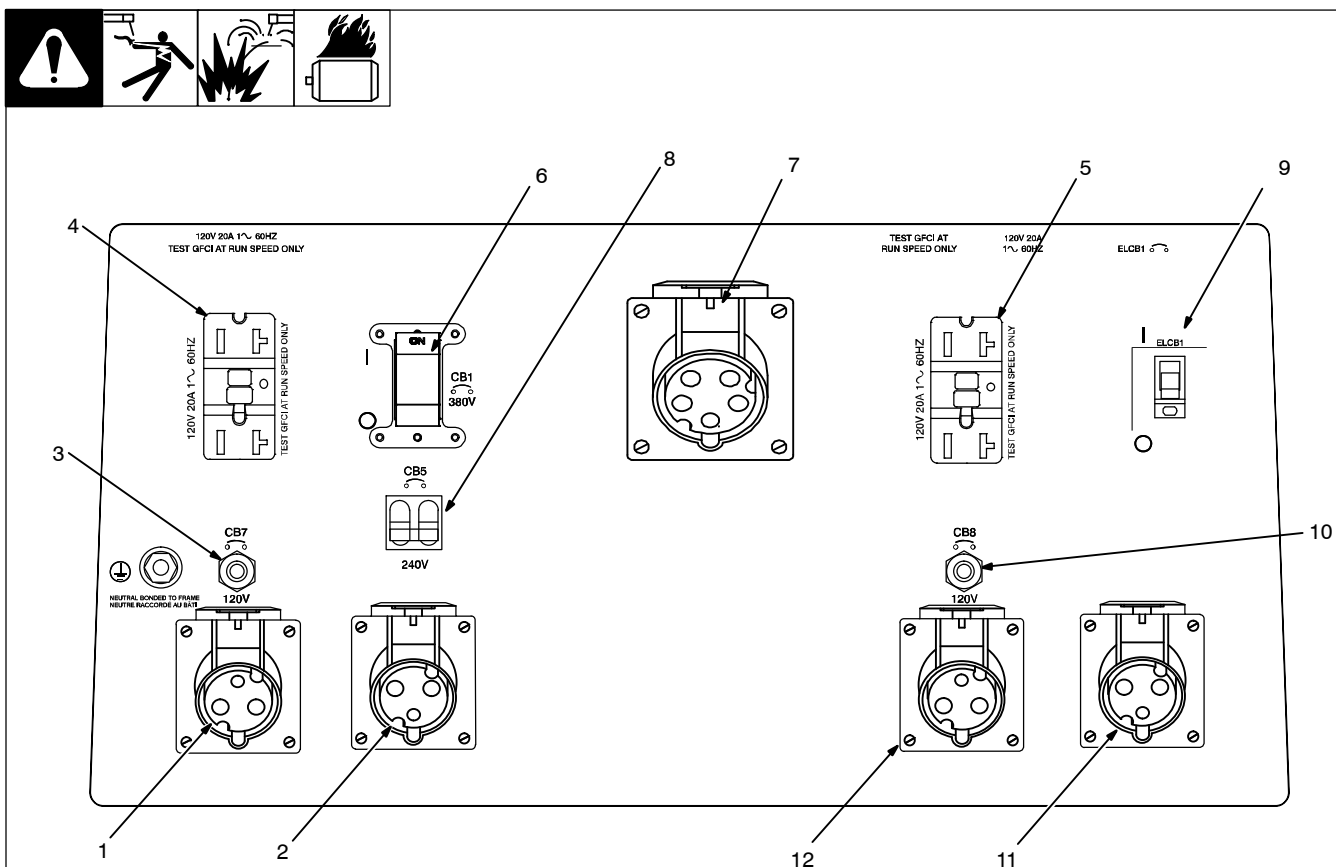

Ref. 264 998

- 1 110 V 16 A AC Receptacle RC1
- 2 220 V 16 A AC Receptacle RC3

Receptacles supply 50/60 Hz single-phase power.

- 3 Supplementary Protector CB7

CB7 protects GFCI1 and RC1 from overload. If supplementary protector opens, the receptacles do not work. Press button to reset.

⚠ Use GFCI protection when operating auxiliary equipment. If unit does not have GFCI receptacles, use GFCI-protected extension cord. Do not use GFCI receptacles to power life support equipment.

⚠ Unplug power cord before attempting to service accessories or tools.

- 4 110 V 20 A AC Receptacle GFCI1
- 5 110 V 20 A AC Receptacle GFCI2

⚠ Test GFCI monthly. See Section 7-3 for GFCI information and for resetting and testing procedures.

- 6 Supplementary Protector CB1 (Deluxe Model)

CB1 protects RC5 from overload. If supplementary protector opens, the receptacle does not work. Place switch in On position to reset.

- 7 400 V 30 A 3-Phase Receptacle RC5 (Deluxe Model)

Receptacle supplies 50/60 Hz three-phase power

- 8 Supplementary Protector CB5

CB5 protects the auxiliary power winding from over current. If CB5 opens, the 110 volt receptacles and 220 volt receptacles do not work. Place switch in up position to reset.

- 9 Earth Leakage Circuit Breaker ELCB1

ELCB1 protects receptacles RC3 and RC4 from overload and earth leakage fault. If circuit breaker opens, the receptacles do not work. Place switch in On position to reset circuit breaker.

- 10 Supplementary Protector CB8

CB8 protects GFCI2 and RC2 from overload. If supplementary protector opens, the receptacles do not work. Press button to reset.

- 11 220 V 16 A AC Receptacle RC4
- 12 110 V 16 A AC Receptacle RC2

Receptacles supply 50/60 Hz single-phase power.

Maximum combined output of all standard receptacles is 4 kVa/kW.

⚠ At least once a month, run engine at weld/power speed and press test button to verify ELCB1 is working properly.

⚠ If a supplementary protector or circuit breaker continues to open, contact Factory Authorized Service Agent.

⚠ Generator power decreases as weld output increases.

7-3. GFCI Receptacle Information, Resetting And Testing

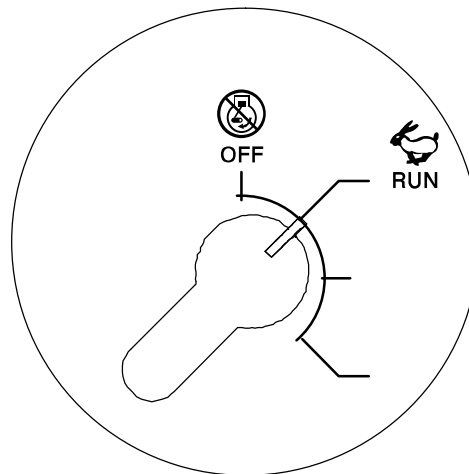
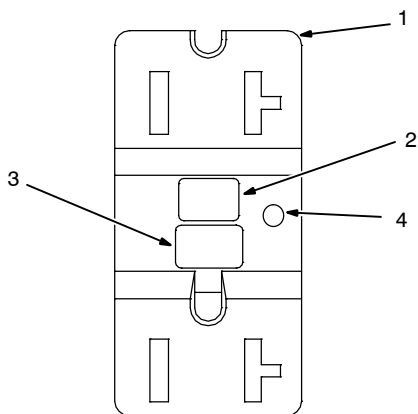

⚠ Test and reset GFCI only at Run speed.

RotGFCI1 2014-09

⚠ Use GFCI protection when operating auxiliary equipment. If unit does not have GFCI receptacles, use GFCI-protected extension cord. Do not use GFCI receptacle to power life support equipment.

⚠ Unplug power cord before attempting to service accessories or tools.

- 1 120 V 20 A AC GFCI Receptacle
- 2 GFCI Receptacle Test Button
- 3 GFCI Receptacle Reset Button
- 4 GFCI Indicator Light (LED)

GFCI Receptacles

GFCI receptacles protect the user from electric shock if a ground fault occurs in equipment connected to the receptacle. A ground fault occurs when electrical current takes the shortest path to ground (which could be through a person) rather than follow its intended safe path.

If a ground fault is detected, the GFCI Reset button pops out, and the circuit opens to disconnect power to the faulty equipment. A GFCI receptacle does not protect against circuit overloads, short circuits, or shocks not related to ground faults. Reset and test GFCI receptacle according to the following procedures.

Resetting/Testing GFCI Receptacle

- ⚠** Test GFCI monthly. See Testing GFCI Receptacle.
- ⚠** Do not test or reset GFCI receptacles at idle speed/low voltage or the GFCI will be damaged and not provide protection from electric shock caused by a ground fault.
- ⚠** If LED blinks, stop using GFCI receptacle and have it replaced by a Factory Authorized Service Agent.
- ⚠** Extension cords with bad insulation or of extended length can allow enough leakage current to trip the GFCI circuit. Reset and test as follows.

Resetting GFCI Receptacles

If a GFCI fault occurs, stop engine and disconnect equipment from GFCI receptacle. Check for damaged or wet tools, cords, plugs, etc. connected to the receptacle. Start engine and operate at Run (weld/power) speed. Press GFCI Reset button. Reconnect equipment to GFCI receptacle. If GFCI Reset button pops out again, check the equipment and repair or replace if faulty.

Testing GFCI Receptacles

☞ GFCI testing must be done with engine running at Run (weld/power) speed.

Start engine and operate at Run (weld/power) speed.

Press the GFCI Test button. The GFCI Reset button should pop out.

Press the GFCI Reset button.

Have GFCI replaced by a Factory Authorized Service Agent if any of the following occur:

- GFCI does not trip when tested**
- LED blinks**
- GFCI does not reset.**

SECTION 8 – MAINTENANCE

8-1. Maintenance Label

Perkins Engine North American office:
Perkins USA & Canada Office:
 Perkins Engines Inc.
 N4-AC6160, PO Box 610
 Mossville, Illinois, 61552-0610

- Toll Free Number: 1-888-PERK-ENG
 - Telephone 1.309.578.7364
 - Fax 1.309.578.7329

To find a service distributor, go to:
<http://www.perkins.com/distributor>

PERKINS 404.22 (32.6 HP) DIESEL ENGINE

12 V
BCI 24
650 A @ 0° F (-18° C)



8 h std.

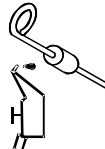



DIESEL
24.75 gal (93.7 L)

DIN 51 601
BS 2869: A1, A2
ASTM D 975-81: 1-D, 2-D
VW-F 800C: DF-A, DF-1, DF-2
S < = .5%

100 h std.

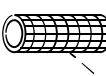
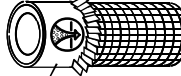
(Optional)
MILLER 192939
Donaldson P822769
WIX 46490

MILLER 192938**
Donaldson P822768
WIX 46489





250 h std.

1/2 in
(13 mm)

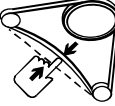
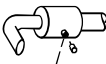
MILLER 197944
Perkins 080109107







500 h std.

API: CD/CE/CF-4
9.3 qt (8.8 L)

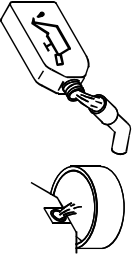
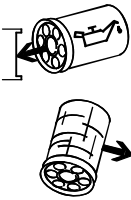
Check engine dipstick.

MILLER 197899**
Perkins 140516130
Fram PH2844

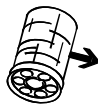
1000 h std.

9.5 qt
(9.01 L)

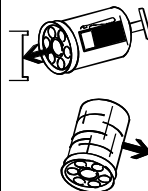

Thermostat
Perkins 145206180

72° F (20° C)
in.- 0.0078 in (0.2 mm)
ex.- 0.0078 in (0.2 mm)

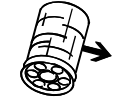
2000 h std.











Perkins 131406360

** FILTER KIT 246985
contains noted filters.

220539-C

8-2. Routine Maintenance













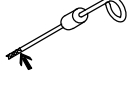

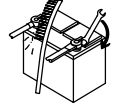

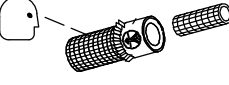



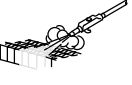
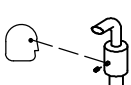
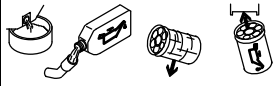
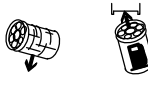

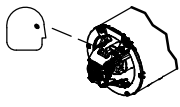

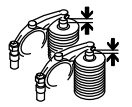
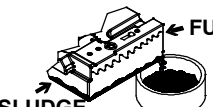
⚠ Stop engine before maintaining.

📖 See *Engine Manual and Maintenance Label* for important start-up, service, and storage information. Service engine more often if used in severe conditions.



Recycle engine fluids.

	✓ = Check ◇ = Change ● = Clean ☆ = Replace * To be done by Factory Authorized Service Agent			Reference	
Every 8 Hours	 ✓ Primary Fuel Filter ● = Clean unit exterior, including stainless steel, frequently to prevent rust and corrosion.	 See engine manual for fuel specifications. ✓ Fuel Level	 ✓ Oil Level	 ● Oil, Fuel Spills	Section 5-1
Every 100 Hours	 ● Battery Terminals	 ✓ Air Cleaner Hoses	 ✓ Air Cleaner Element	 ● Weld Terminals	Section 8-3
Every 250 Hours	 ☆ Unreadable Labels	 (1/2 in. (13 mm)) ✓ Fan Belt Tension	 ● Cooling System	 ✓ ● Spark Arrestor	Engine Manual
Every 500 Hours	 ◇ Oil ◇ Oil Filter	<p>NOTICE – Change engine oil and filter after initial 50 to 75 hours of use. See engine manual for oil specifications.</p>	 ◇ Fuel Filters	 ✓ ☆ Weld Cables	Section 8-8, and Engine Manual
Every 1000 Hours	 ✓ ● Slip Rings* ✓ ☆ Brushes*	 ● Inside Unit	 ✓ Valve Clearance*	 FUEL SLUDGE ● Drain Sludge	Section 8-8 and Engine Manual
Every 3000 Hours	 ● Injectors*				
Every 6000 Hours or 5 Years	 ✓ ☆ Engine Timing Belt				

8-3. Servicing Air Cleaner

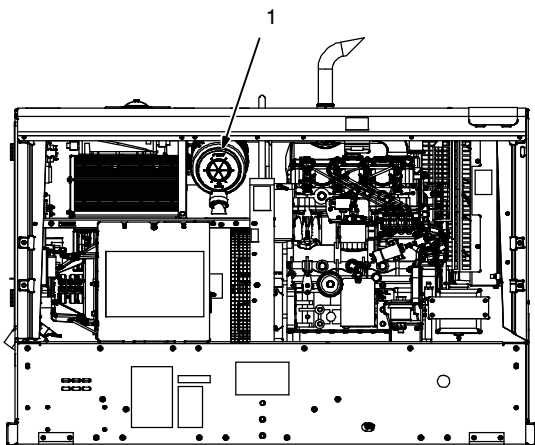
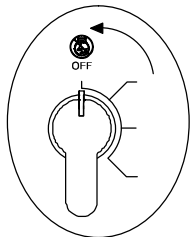

- Stop engine.**
- Do not run engine without air cleaner or with dirty element. Engine damage caused by using a damaged element is not covered by the warranty.**

The air cleaner primary element can be cleaned but the dirt holding capacity of the filter is reduced with each cleaning. The chance of dirt reaching the clean side of the filter while cleaning and the possibility of filter damage makes cleaning a risk. Consider the risk of unwarrantable equipment damage when determining whether to clean or replace the primary element.

If you decide to clean the primary element, we strongly recommend installing an optional safety element to provide additional engine protection. **Never clean a safety element.** Replace the safety element after servicing the primary element three times.

1 Engine Air Cleaner

Clean or replace primary element if dirty (see note above before cleaning). **Replace** primary element if damaged. Replace primary element yearly or after six cleanings.

- 2 Housing
- 3 Safety Element (Optional)
- 4 Primary Element
- 5 Cover
- 6 Dust Ejector

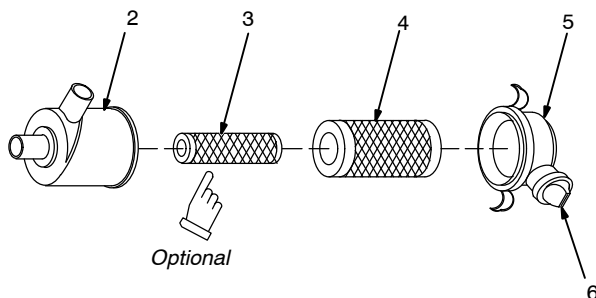

To clean air filter:

Wipe off cover and housing. Remove cover and dump out dust. Remove element(s). Wipe dust from inside cover and housing with damp cloth. Reinstall cover.

- Do not clean housing with air hose.**

Clean primary element with compressed air only.

Air pressure must not exceed 100 psi (690 kPa). Use 1/8 in. (3 mm) nozzle and keep nozzle at least 2 in. (51 mm) from inside of element. Replace primary element if it has holes or damaged gaskets.

Reinstall primary element and cover (dust ejector down).

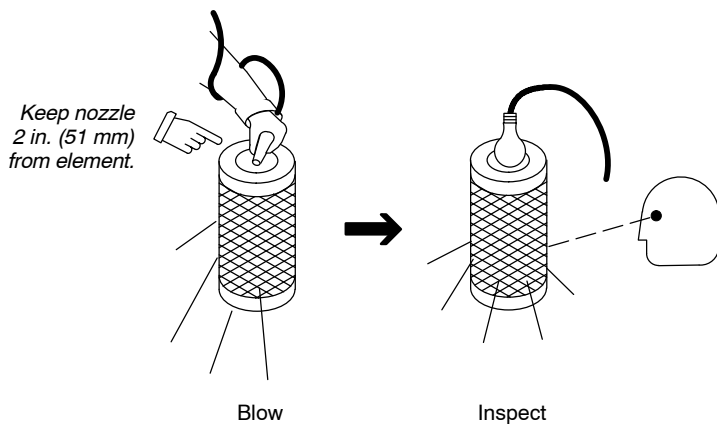

8-4. Engine Speed Adjustment



Engine Speed (No Load)	
	1850 rpm max (61.6 Hz)
	1250 rpm (41.6 Hz)

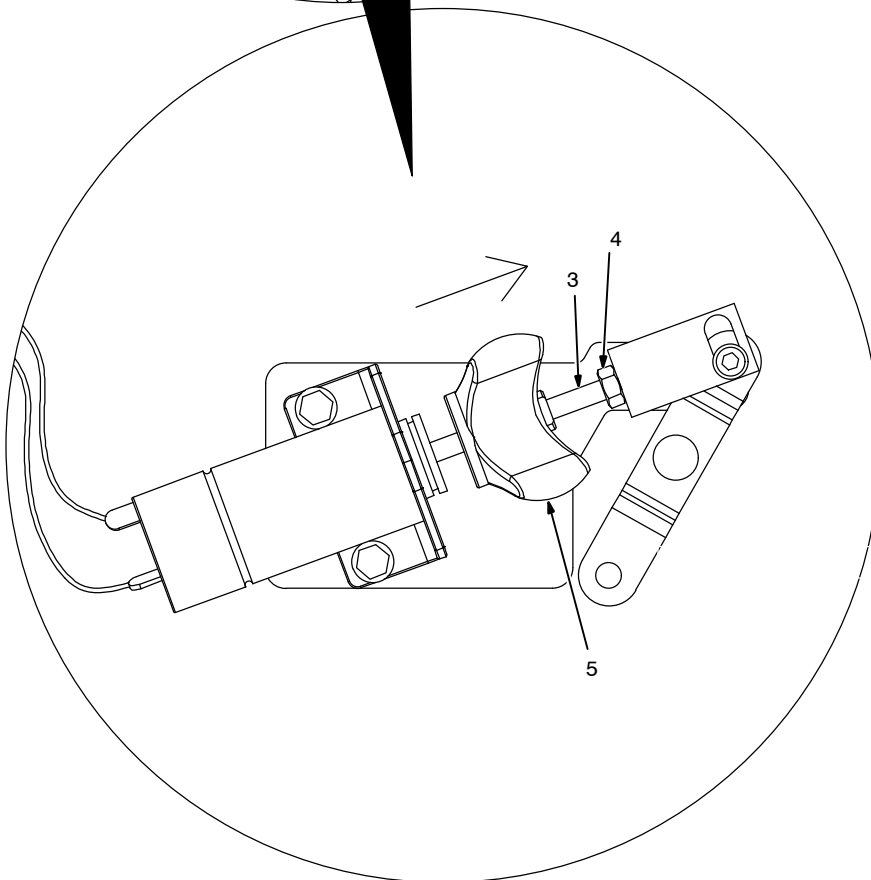
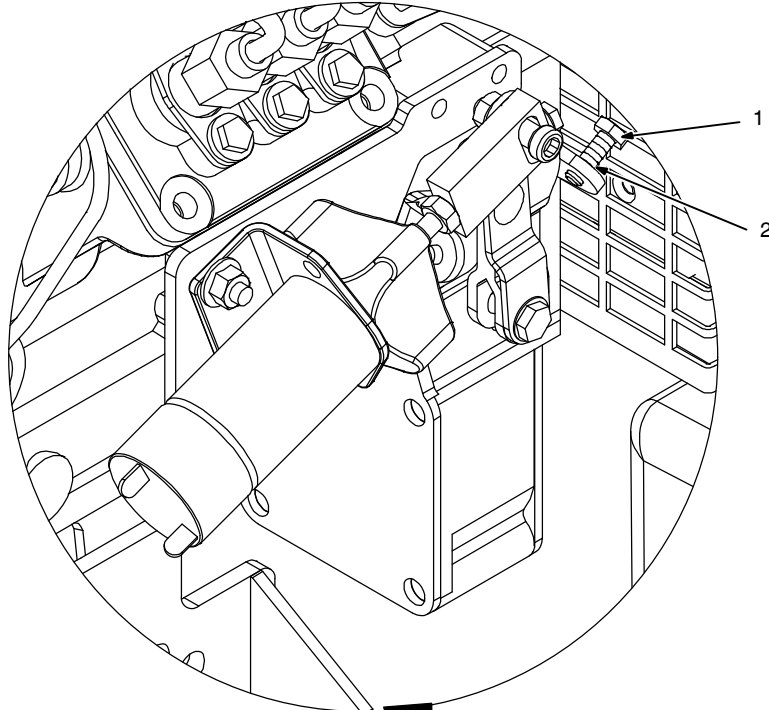

Engine Speed Adjustment

After tuning engine, check engine speed with tachometer or frequency meter. See table for proper no load speed. If necessary, adjust speed as follows:

Start engine and run until warm.

Turn Process/Contactor switch to Stick – Weld Terminals Always On position.

Standard Model Idle Speed Adjustment

- 1 Adjustment Screw
- 2 Lock Nut

Loosen lock nut. Turn screw until engine runs at idle speed. Tighten nut.

Models With Automatic Idle Option

- 3 Throttle Rod / Plunger
- 4 Lock Nut
- 5 Rubber Boot

Adjustment screw is not used to adjust engine speed when automatic idle option is installed.

☞ To prevent solenoid damage, be sure a 1/8 in. (3 mm) gap exists between the engine low speed screw and throttle lever when the solenoid is held in the energized position.

Unhook rubber boot from the solenoid housing but leave connected to plunger.

Loosen lock nut. Place Engine Control Switch in Auto position.

Turn throttle rod and plunger until engine runs at idle speed. Tighten lock nut.

Hook rubber boot back onto solenoid housing.

☞ Be sure solenoid plunger pulls all the way in ("bottoms") when energized.

Weld/Power Speed Adjustment

☞ Weld/power speed adjustment must be done by the engine manufacturer's factory authorized service agent. Tampering with adjustments other than shown may affect engine warranty.

⚠ Stop engine.

8-5. Checking Generator Brushes

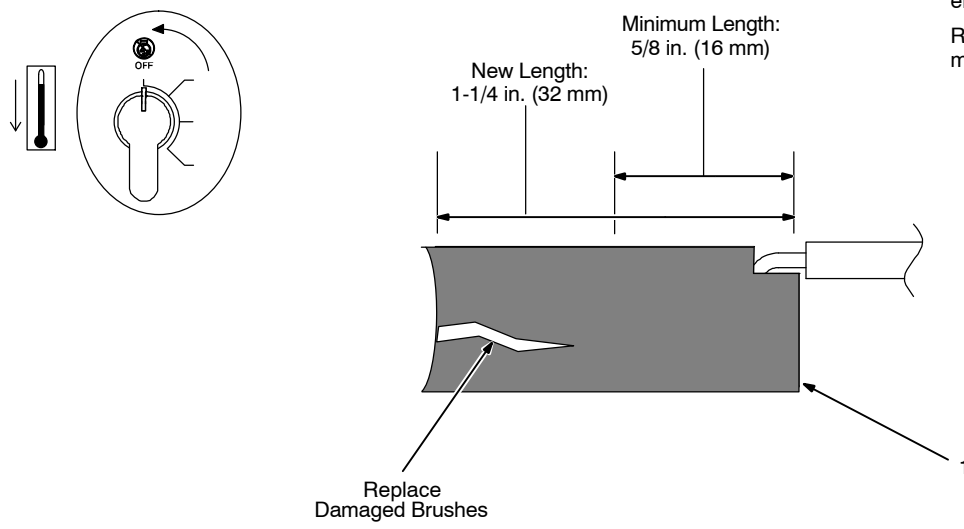
⚠ Stop engine and let cool.

1 Generator Brush

Mark and disconnect leads at brush holder cap. Remove brushes.

Replace brushes if damaged or if brush material is at or near minimum length.

GenBrush1 2014-10 / Ref 190 823

8-6. Battery Replacement



⚠ Stop engine.

1 Battery Locator Bracket Mounting Holes

Access battery as shown in Section 5-4. Disconnect battery.

Remove J-bolts securing battery and remove battery.

Battery locator brackets can be moved to accommodate batteries of different physical sizes.

Install and secure replacement battery.

⚠ Connect negative (-) battery cable last.

Viewed From Top of Unit

Larger Battery

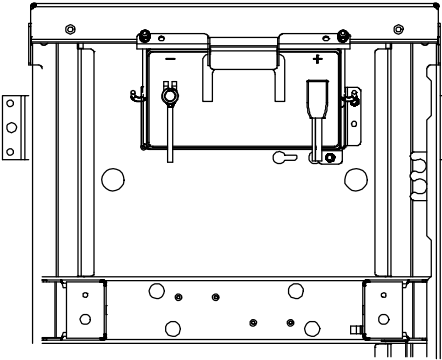

Smaller Battery

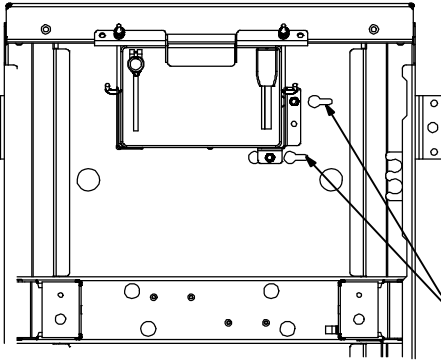

Tools Needed:

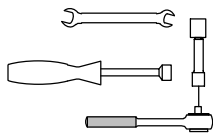

255 858

8-7. Battery Maintenance

Lead acid batteries discharge when stored in any temperature. Units that are stored should have the battery recharged every three months and before being put into service. To preserve optimum battery performance and life, recharge battery in storage when the open-circuit voltage drops to 12.4 volts DC when measured across the battery terminals.

8-8. Servicing Fuel And Lubrication Systems



Tools Needed:

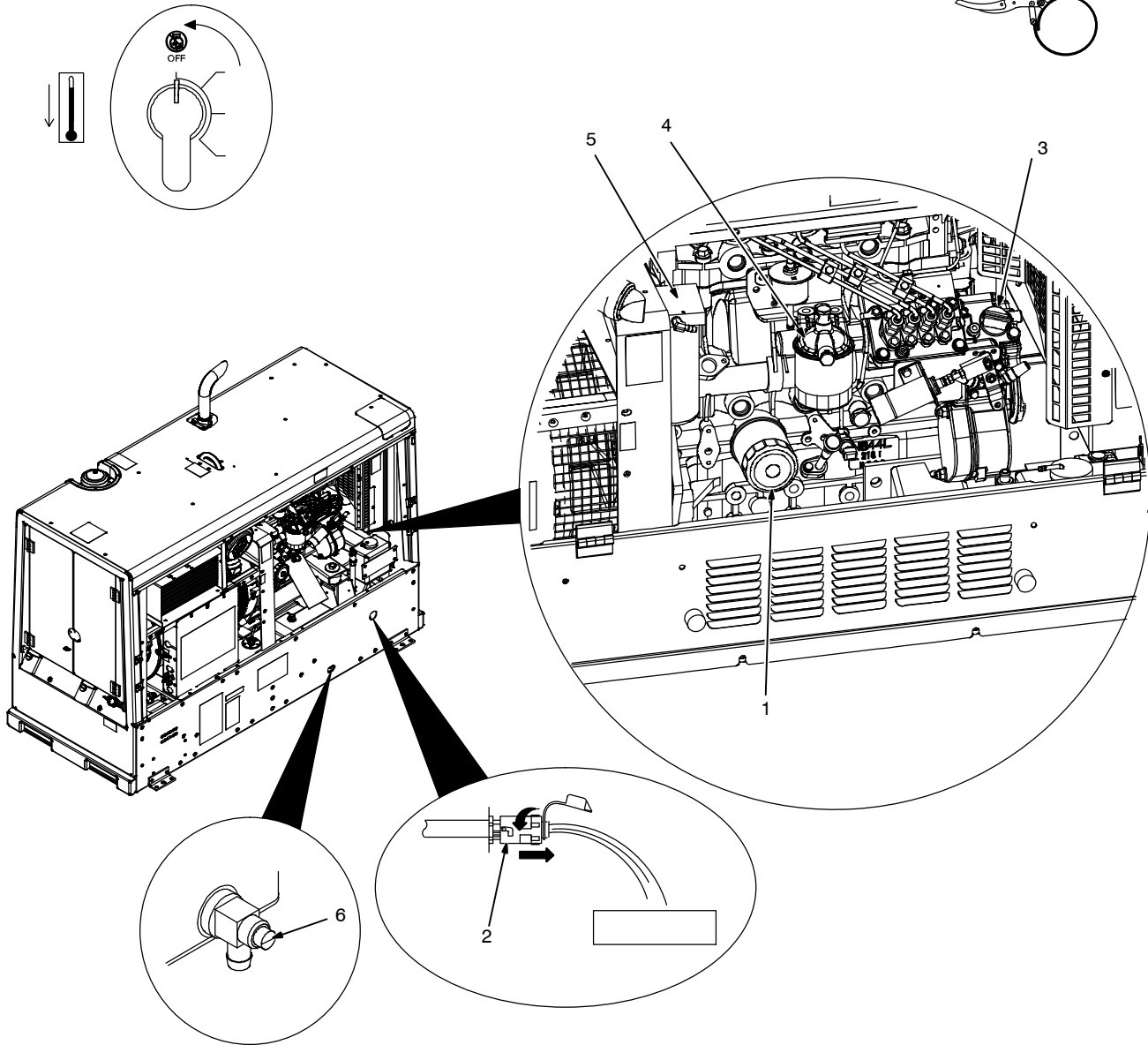
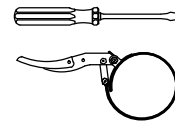

907 603-TP2 / 907 603-TP3

⚠ Stop engine and let cool.

⚠ After servicing, start engine and check for fuel leaks. Stop engine, tighten connections as necessary, and wipe up spilled fuel.

- 1 Oil Filter
- 2 Oil Drain Valve And Hose
- 3 Oil Fill Cap
- 4 Primary Fuel Filter
- 5 Secondary Fuel Filter
- 6 Fuel Tank Sludge Drain Valve

To change oil and filter:

Route oil drain hose and valve through hole in base. See engine manual and engine maintenance label for oil/filter change information.

To replace fuel filters:

For primary fuel filter, disconnect water sensor connection.

Turn filter counterclockwise. Remove filter.

Apply thin coat of fuel to gasket on new filter. Fill filter with fuel. Install filter and turn clockwise. For primary fuel filter, reconnect water sensor. Bleed air from fuel system according to engine manual.

Inspect fuel line, and replace if cracked or worn.

Close doors.

To drain sludge from fuel tank:

⚠ Beware of fire. Do not smoke and keep sparks and flames away from drained fuel. Dispose of drained fuel in an environmentally-safe manner. Do not leave unit unattended while draining fuel tank.

⚠ Properly lift unit and secure in a level position. Use adequate blocks or stands to support unit while draining fuel tank.

Attach 1/2 ID hose to drain valve. Put metal container under drain, and use screwdriver to open sludge drain valve. Close valve when sludge has drained. Remove hose.

8-9. Engine/Generator Overload Protection

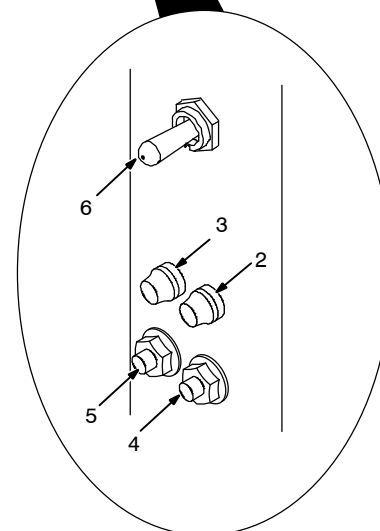
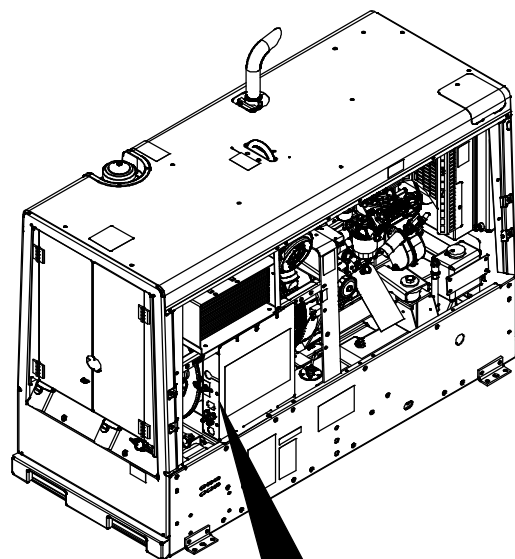
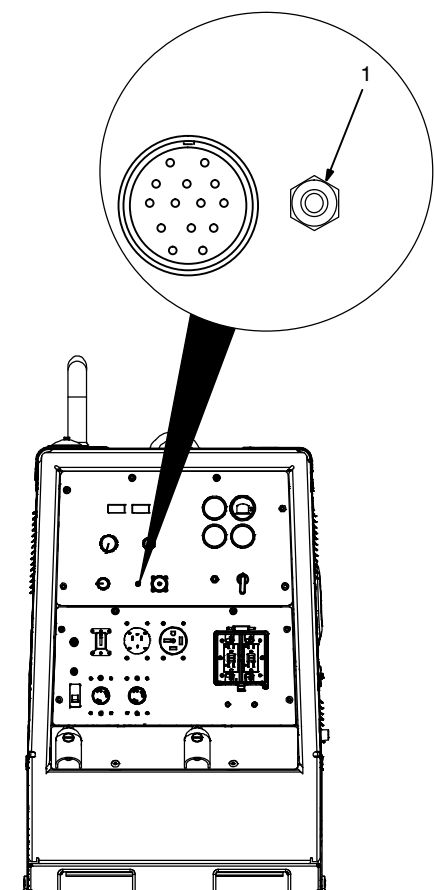

907 667-TP4 / 803 229

Stop engine.

When a supplementary protector, circuit breaker or fuse opens, it usually indicates a more serious problem exists. Contact Factory Authorized Service Agent.

1 Supplementary Protector CB9

CB9 protects the 24 volt AC output to remote receptacle. If CB9 opens, weld output and 24 volt output to remote receptacle stops.

- 2 Fuse F1
- 3 Fuse F2

F1 and F2 protect the stator exciter winding from overload. If F1 opens, weld and generator power is low or stops entirely. If F2 opens, weld output is low or stops entirely. 4 kVA/kW generator power is still available.

4 Supplementary Protector CB3

CB3 protects the weld control circuit. If CB3 opens, weld output stops, meters will be blank; however, generator power is still available.

CB4 protects the field flashing circuit. If CB4 opens, the generator may not excite at start-up and weld and generator power output may not be available.

6 VRD Switch

See Section 6-5 for VRD switch information.

7 Circuit Breaker CB10 (Not Shown)

CB10 protects the engine battery circuit. If CB10 opens, the engine will not crank. CB10 automatically resets when the fault is corrected.

8 Circuit Breaker CB13 (Not Shown)

CB13 protects the glow plug circuit. If CB13 opens, the glow plug will not operate. CB13 automatically resets when the fault is corrected.

8-10. Voltmeter/Ammeter Help Displays

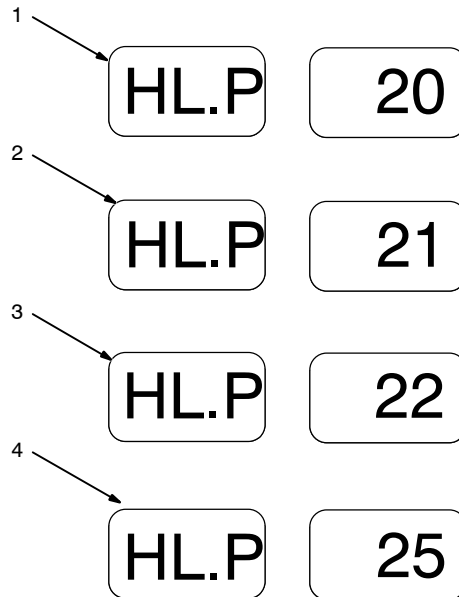

Use the Voltmeter/Ammeter help displays to diagnose and correct fault conditions.

☞ *When a help code is displayed normally weld output has stopped but generator power output may be okay.*

☞ *To reset help displays, stop unit and then restart. See item 4 below to reset Help 25 display.*

1 Help 20 Display

Indicates a failure of meter display module PC2, or the wiring between PC2 and main control module PC1, or PC1. If this display is shown, have Factory Authorized Ser-

vice Agent check PC1, PC2, and the wiring between PC1 and PC2.

2 Help 21 Display

Thermistor TH1 in the IGBT module on the heat sink has failed. If this display is shown, have Factory Authorized Service Agent check TH1, and the wiring between TH1 and PC1.

3 Help 22 Display

Indicates the IGBT module heat sink has overheated. If this display is shown, check generator cooling system and/or reduce duty cycle. Keep engine access door closed when running to maintain proper cooling air flow past the heat sink. Allow

unit to cool before restarting. If problem continues, have Factory Authorized Service Agent check unit.

4 Help 25 Display

Indicates a remote device connected to Remote Receptacle RC14 may be faulty. Help 25 is also displayed whenever a remote device has been connected to RC14 and then disconnected. Clear fault by stopping and restarting the unit or by turning Process/Contactor switch to another position. If problem continues, have Factory Authorized Service Agent check the remote device, filter board PC6, and main control module PC1.

SECTION 9 – TROUBLESHOOTING

9-1. Troubleshooting



☞ Also see Voltmeter/Ammeter help displays to assist in troubleshooting weld problems (see Section 8-10).

A. Welding

Trouble	Remedy
No weld output; generator power output okay at AC receptacles.	Place Process/Contactor switch in an Electrode Hot position, or place switch in a Remote On/Off Required position and connect remote contactor to Remote 14 receptacle (see Sections 5-9).
	Reset supplementary protector CB3 (see Section 8-9).
	Reset supplementary protector CB9 (see Section 8-9). Check for faulty remote device connected to Remote 14 receptacle.
	Check and secure connections to Remote 14 receptacle (see Section 5-9).
	If VRD switch S5 is On, check voltage feedback wires at output terminals and have Factory authorized Service Agent check Main Control board PC1.
	Have Factory Authorized Service Agent check filter board PC5 and connections.
No weld output or generator power output at AC receptacles.	Check fuse F2, and replace if open (see Section 8-9). Have Factory Authorized Service Agent check brushes and slip rings, weld excitation circuit, and the rotor.
	Disconnect equipment from generator power receptacles during start-up.
	Reset supplementary protector CB4 (see Section 8-9).
	Check fuses F1 and F2, and replace if open (see Section 8-9). Have Factory Authorized Service Agent check integrated rectifier SR2, capacitor C6, and the rotor.
Erratic weld output.	Have Factory Authorized Service Agent check brushes and slip rings, and field excitation circuit.
	Check and tighten connections inside and outside unit.
	Be sure connection to work piece is clean and tight.
	Use dry, properly stored electrodes.
	Remove excessive coils from weld cables.
High weld output.	Have Factory Authorized Service Agent check brushes and slip rings.
	Check position of Voltage/Amperage Adjust control.
Low weld output.	Have Factory Authorized Service Agent check voltage feedback circuit.
	Check position of Voltage/Amperage Adjust control.
	Check fuses F1 and F2, and replace if open (see Section 8-9). Have Factory Authorized Service Agent check integrated rectifier SR2, capacitor C6, and the rotor.
Low open-circuit voltage.	Place VRD switch S5 in Off position and try welding. If machine operates normally, have Factory Authorized Service Agent check S5 and Main Control board PC1.
	Check position of VRD switch.
High open-circuit voltage with VRD switch S5 On.	Check position of Process/Contactor switch.
	Have Factory Authorized Service Agent check IGBT Modules 1 and 2; check and replace Main Control board PC1.
No remote fine amperage or voltage control.	Check and secure connections to Remote 14 receptacle (see Section 5-9).
	Repair or replace remote control device.
	Have Factory Authorized Service Agent check current sensing devices, and connections.

Trouble	Remedy
Constant speed wire feeder does not work.	Reset supplementary protector CB9 (see Section 8-9).
	Check and secure connections to Remote 14 receptacle (see Section 5-9).
	Repair or replace wire feeder.
Low CV weld output.	Increase Voltage/Amperage Adjust Control setting.
Min or max CV weld output only.	Check position of Voltage/Amperage Adjust control and Process/Contactor switch.
	Repair or replace remote control device.
	Have Factory Authorized Service Agent check Amperage/Voltage Adjust Control and field current regulator board.
With VRD switch S5 On, machine does not return to low open-circuit voltage at the end of weld.	Have Factory Authorized Service Agent check and replace Main Control board PC1.

A. Standard Generator Power

Trouble	Remedy
No generator power output at AC receptacles; weld output okay.	Reset receptacle supplementary protectors. Reset GFCI receptacle.
	Check fuse F1, and replace if open (see Section 8-9). Have Factory Authorized Service Agent check integrated rectifiers SR1 and SR2, resistor R3, and capacitor C6.
No generator power or weld output.	Disconnect equipment from generator power receptacles during start-up.
	Check fuses F1 and F2, and replace if open (see Section 8-9). Have Factory Authorized Service Agent check integrated rectifiers SR1 and SR2, capacitor C6, and the rotor.
	Reset supplementary protector CB4. Have Factory Authorized Service Agent check integrated rectifier SR1 .
	Have Factory Authorized Service Agent check brushes and slip rings, and field excitation circuit.
High output at generator power AC receptacles.	Have Factory Authorized Service Agent adjust generator power field current resistor R3.
Low output at generator power AC receptacles.	Check fuse F1, and replace if open (see Section 8-9). Have Factory Authorized Service Agent check integrated rectifier SR2, resistor R3, and capacitor C6.
	Have Factory Authorized Service Agent check brushes and slip rings.

A. Three-Phase Generator Power

Trouble	Remedy
No or low output at three-phase generator/receptacle RC5.	Reset supplementary protector CB1 (see Section 7-1).
	Have Factory Authorized Service Agent check brushes and slip rings.
Erratic output at three-phase generator/receptacle RC5.	Have Factory Authorized Service Agent check brushes and slip rings.

A. Engine

Trouble	Remedy
Engine will not crank.	Supplementary protector CB2 open. Reset CB2.
	Check battery connections and tighten if necessary. Check battery, and replace if necessary.
	Circuit breaker CB10 may be open. CB10 automatically resets when fault is corrected (see Section 8-9). Have Factory Authorized Service Agent check engine wiring harness and components.
	Check engine wiring harness plug connections.
	Have Factory Authorized Service Agent check control relay CR5 and Engine Control switch S1.
Engine cranks but does not start.	Check fuel level.
	Check battery and replace if necessary. Check engine charging system according to engine manual.
	Have Factory Authorized Service Agent check control relay CR5. Have engine Factory Authorized Service Agent check fuel pump and fuel system.
	Air in fuel system. See engine manual.
Engine starts, but stops when Engine Control switch is released.	Check oil level. Automatic shutdown system stops engine if oil pressure is too low or engine temperature is too high (see Section 5-5). Automatic shutdown system is inhibited for 30 seconds after start-up.
	Have Factory Authorized Service Agent check control relay CR5.
Engine hard to start in cold weather.	Keep battery in good condition. Store battery in warm area off cold surface.
	Use fuel formulated for cold weather (diesel fuel can gel in cold weather). Contact local fuel supplier for fuel information.
	Use correct grade oil for cold weather (see engine manual).
Engine suddenly stops.	Check oil level. Automatic shutdown system stops engine if oil pressure is too low or engine temperature is too high (see Section 5-5). Automatic shutdown system is inhibited for 30 seconds after start-up.
	See engine manual.
Engine slowly stopped and cannot be restarted.	Check fuel level.
	Check engine air and fuel filters (see Sections 8-3 and 8-8).
	See engine manual.
Battery discharges between uses.	Turn Engine Control switch off when unit is not running.
	Clean top of battery with baking soda and water solution; rinse with clear water.
	Recharge or replace battery if necessary.
	Periodically recharge battery (approximately every 3 months).
Engine idles, but does not come up to weld speed.	Have engine Factory Authorized Service Agent check speed control.
Engine does not run at idle speed.	Circuit breaker CB14 may be open. CB14 automatically resets when fault is corrected (see Section 8-9). Have engine Factory Authorized Service Agent check speed control.
	Have Factory Authorized Service Agent check control relays CR3 and CR4.
Engine uses oil during run-in period; wetstacking occurs.	Dry engine according to run-in procedure (see Section 12).

SECTION 11 – ELECTRICAL DIAGRAMS

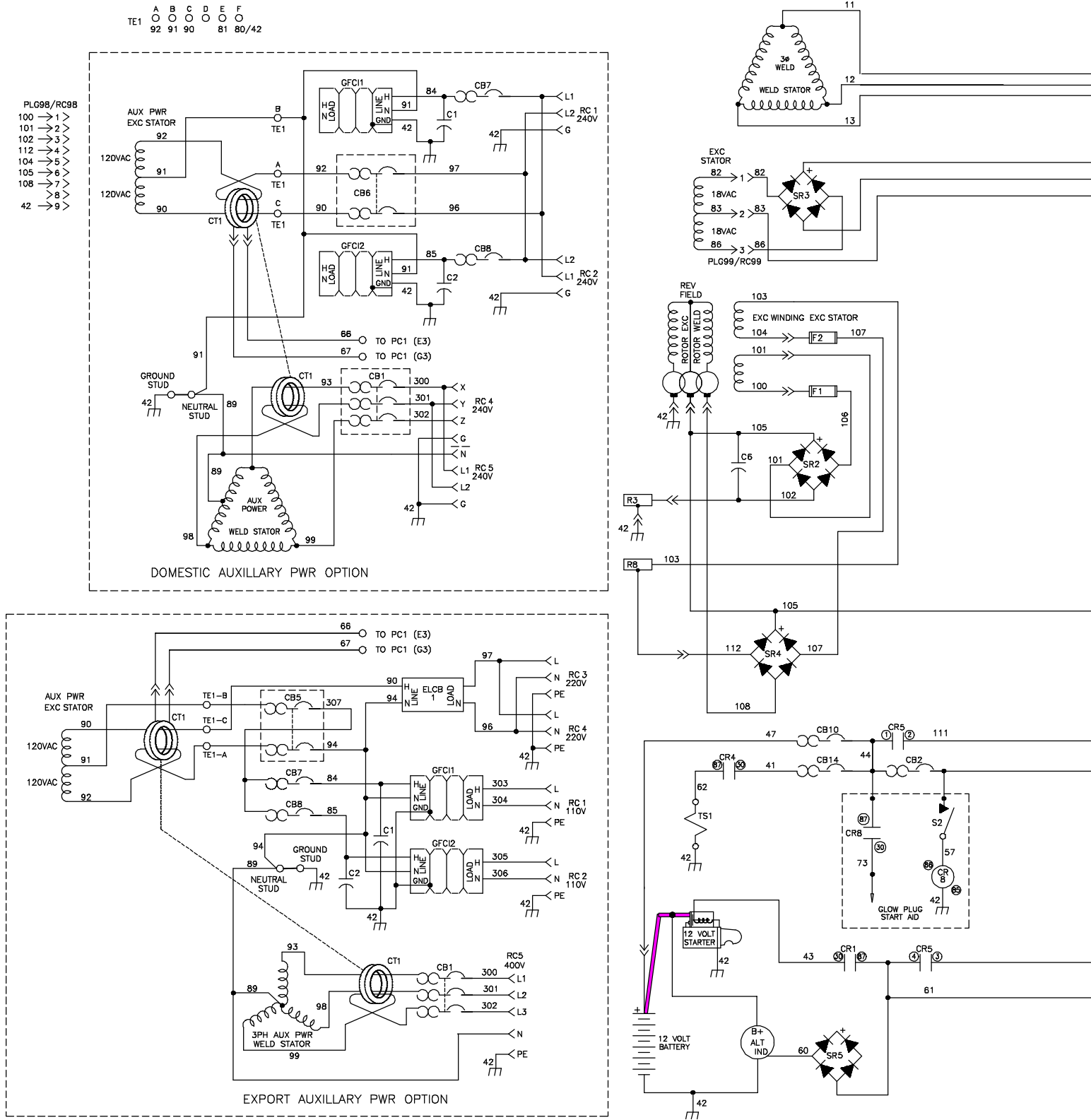
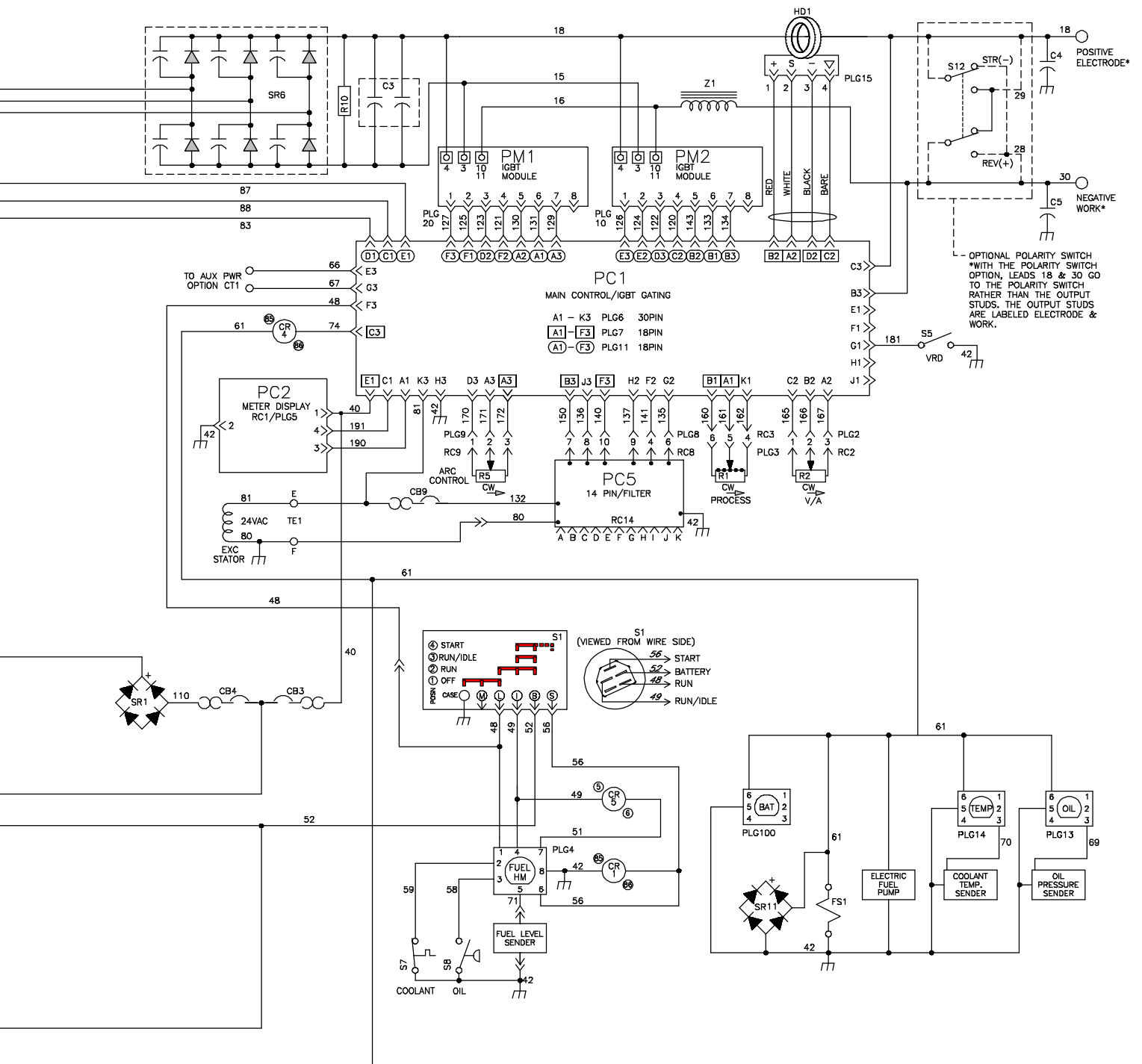

Figure 11-1. Circuit Diagram For Welder / Generator



⚠ WARNING

ELECTRIC SHOCK HAZARD

- Do not touch live electrical parts.
- Disconnect input power or stop engine before servicing.
- Do not operate with covers removed.
- Have only qualified persons install, use, or service this unit.

SECTION 12 – RUN-IN PROCEDURE

run_in1 2014-09

NOTICE – Diesel engines in MILLER equipment are meant to operate optimally at moderate to rated load. Using light or no load for extended periods of time may cause wetstacking or other engine damage. Do not idle engine longer than necessary.

12-1. Wetstacking

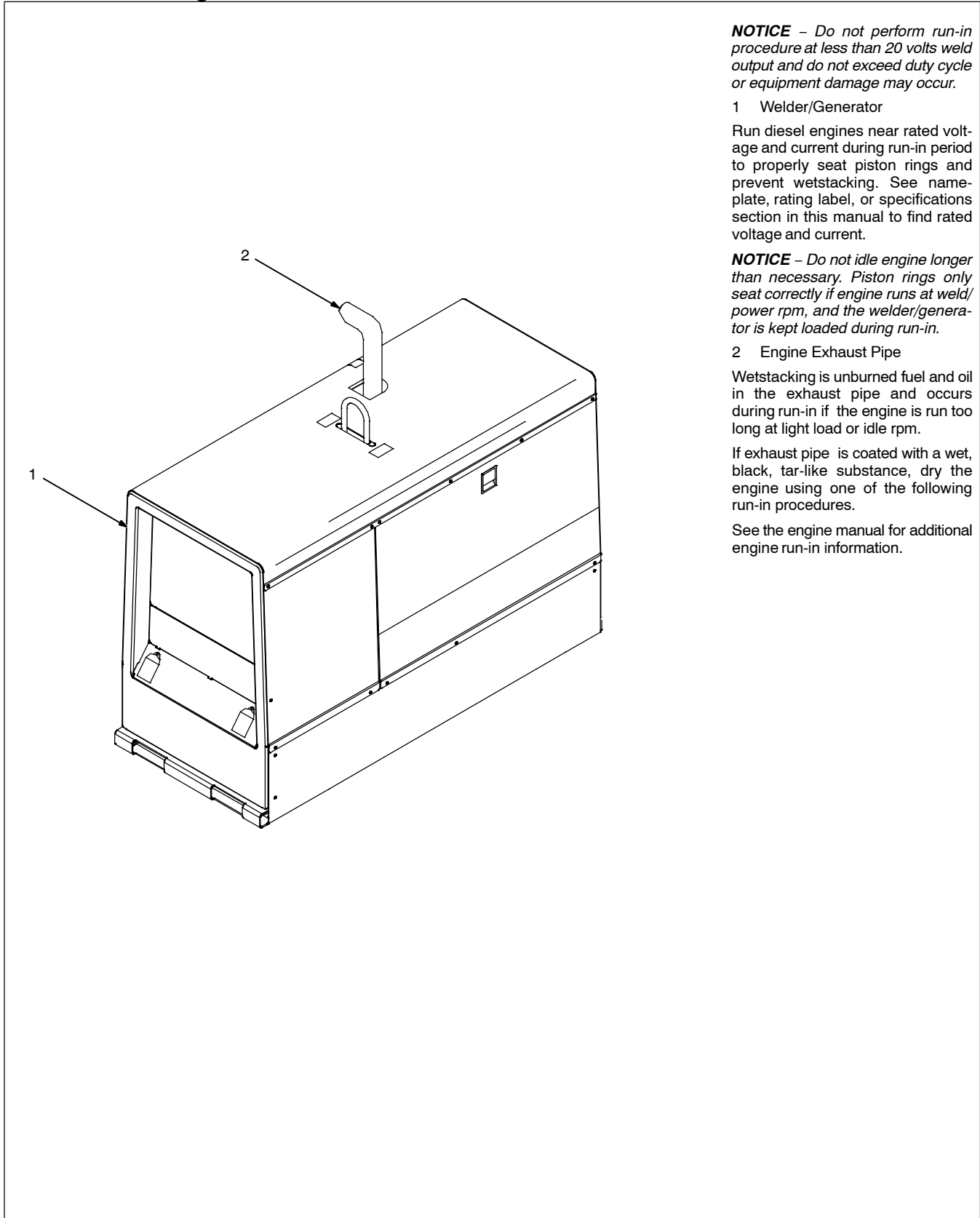

NOTICE – Do not perform run-in procedure at less than 20 volts weld output and do not exceed duty cycle or equipment damage may occur.

1 Welder/Generator

Run diesel engines near rated voltage and current during run-in period to properly seat piston rings and prevent wetstacking. See nameplate, rating label, or specifications section in this manual to find rated voltage and current.

NOTICE – Do not idle engine longer than necessary. Piston rings only seat correctly if engine runs at weld/power rpm, and the welder/generator is kept loaded during run-in.

2 Engine Exhaust Pipe

Wetstacking is unburned fuel and oil in the exhaust pipe and occurs during run-in if the engine is run too long at light load or idle rpm.

If exhaust pipe is coated with a wet, black, tar-like substance, dry the engine using one of the following run-in procedures.

See the engine manual for additional engine run-in information.

12-2. Run-In Procedure Using Load Bank Or Resistance Grid

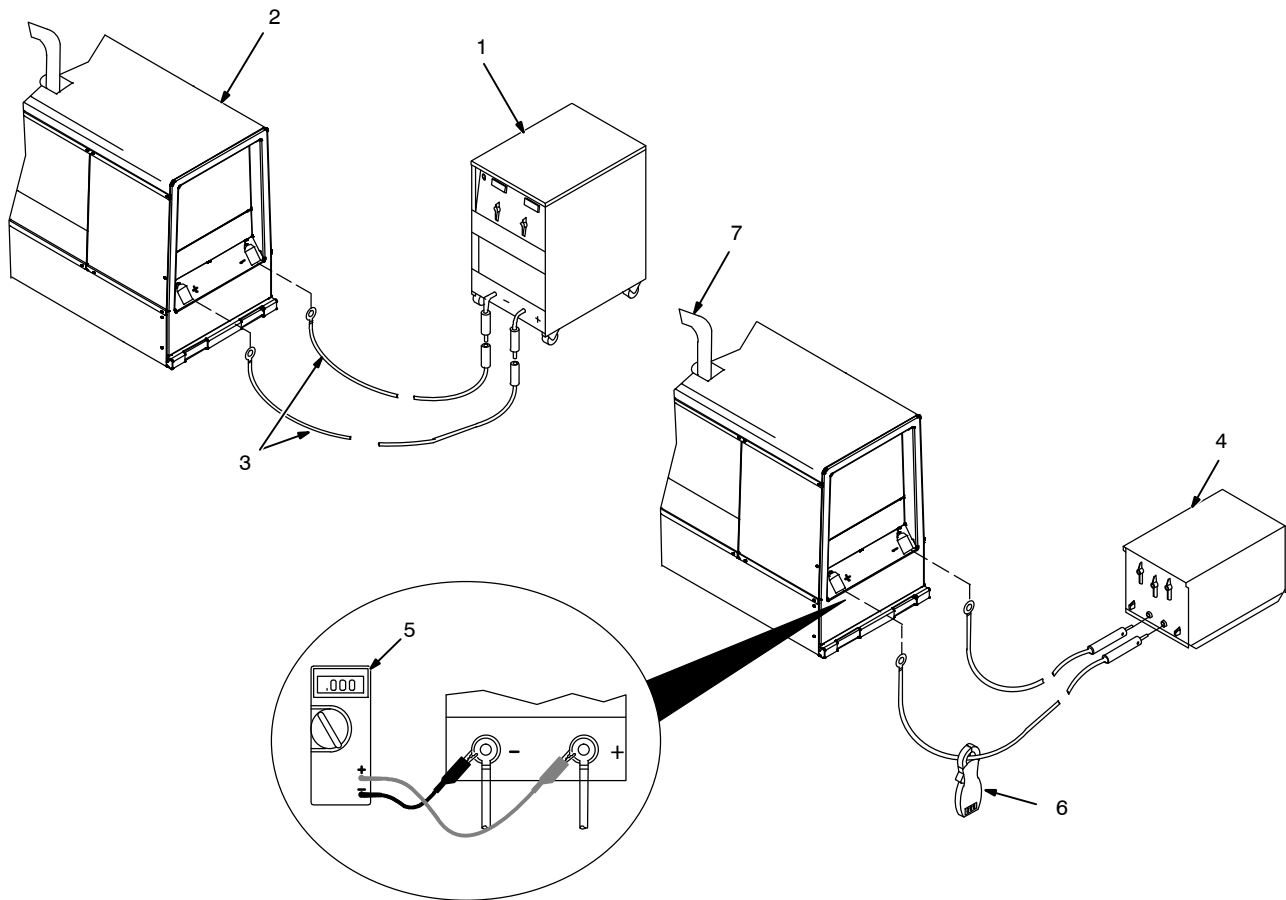

S-0683 / S-0684

- ⚠ Stop engine.**
- ⚠ Do not touch hot exhaust pipe, engine parts, or load bank/grid.**
- ⚠ Keep exhaust and pipe away from flammables.**

NOTICE – Do not perform run-in procedure at less than 20 volts weld output and do not exceed duty cycle or equipment damage may occur.

1 Load Bank

Turn all load bank switches Off. If needed, connect load bank to 115 volts ac wall receptacle or generator auxiliary power receptacle.

2 Welder/Generator

Place A/V range switch in maximum position, A/V control in minimum position, and Output Selector switch (if present) in either DC position.

3 Weld Cables

4 Resistance Grid

Use grid sized for generator rated output.

Turn Off grid.

5 Voltmeter

6 Clamp-On Ammeter

Connect voltmeter and ammeter as shown, if not provided on generator.

Start engine and run for several minutes.

For Load Bank

Set load bank switches and then adjust generator A/V control so load equals rated voltage and current of generator (see nameplate, rating label, or the specifications section in this manual).

For Resistance Grid

Set grid switches and then adjust generator A/V control so load equals rated

voltage and current of the generator (see nameplate, rating label, or the specifications section in this manual).

Check generator and meters after first five minutes then every fifteen minutes to be sure generator is loaded properly.

NOTICE – Check oil level frequently during run-in; add oil if needed.

It is recommended to run the welder/generator for two hours minimum and up to four hours under load. Place A/V control in minimum position, then shut down load bank or grid to remove load. Run engine several minutes at no load.

- ⚠ Stop engine and let cool.**



7 Engine Exhaust Pipe

Repeat procedure if wetstacking is present.

SECTION 13 – GENERATOR POWER GUIDELINES

The views in this section are intended to be representative of all engine-driven welder/generators. Your unit may differ from those shown.

13-1. Selecting Equipment



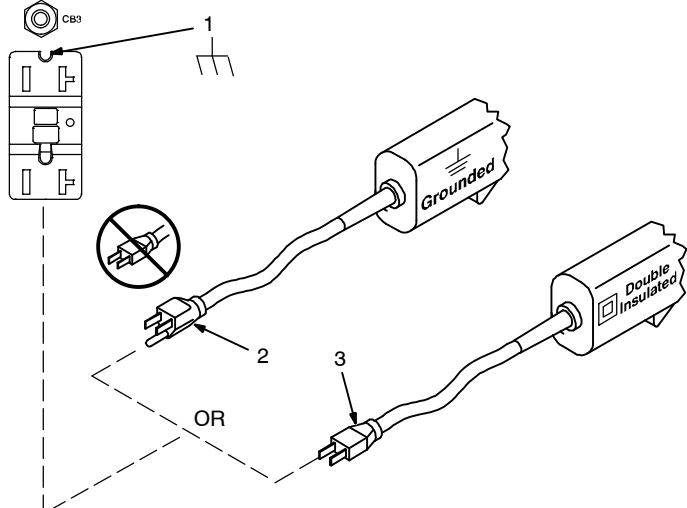

- 1 Generator Power Receptacles – Neutral Bonded To Frame
- 2 3-Prong Plug From Case Grounded Equipment
- 3 2-Prong Plug From Double Insulated Equipment

Be sure equipment has double insulated symbol and/or wording on it.

Do not use 2-prong plug unless equipment is double insulated.

gen_pwr 2014-09 – ST-800 577

13-2. Grounding Generator To Truck Or Trailer Frame

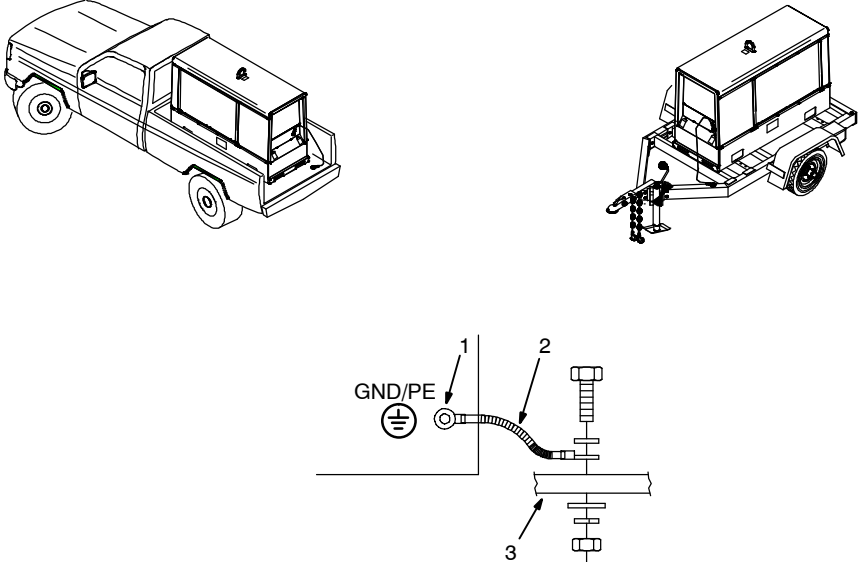

800 652-D

Always ground generator frame to vehicle frame to prevent electric shock and static electricity hazards.

Also see AWS Safety & Health Fact Sheet No. 29, Grounding of Portable And Vehicle Mounted Welding Generators.

- 1 Equipment Grounding Terminal (On Front Panel)
- 2 Grounding Cable (Not Supplied)
- 3 Metal Vehicle Frame

Connect cable from equipment ground terminal to metal vehicle frame. Use #8 AWG or larger insulated copper wire.

Electrically bond generator frame to vehicle frame by metal-to-metal contact.

Bed liners, shipping skids, and some running gear insulate the welder/generator from the vehicle frame. Always connect a ground wire from the generator equipment grounding terminal to bare metal on the vehicle frame as shown.

Use GFCI protection when operating auxiliary equipment. If unit does not have GFCI receptacles, use GFCI-protected extension cord. Do not use GFCI receptacles to power life support equipment.

13-3. Grounding When Supplying Building Systems

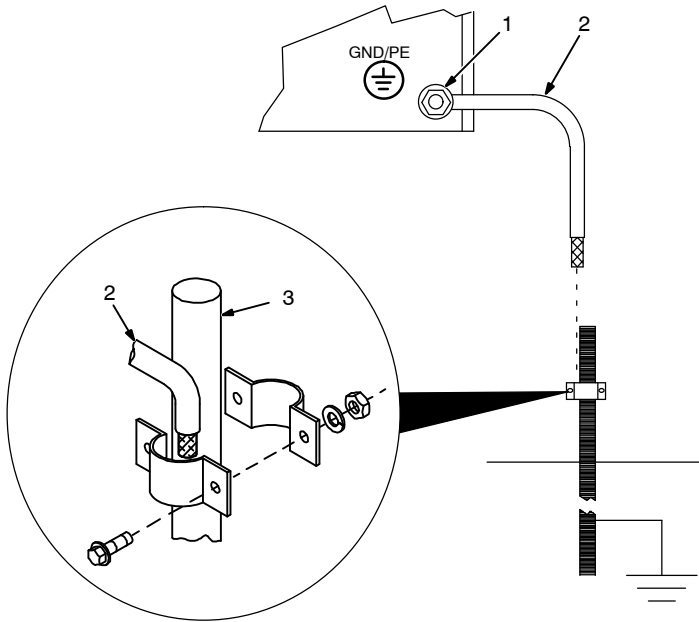

- 1 Equipment Grounding Terminal
 - 2 Grounding Cable
- Use #8 AWG or larger insulated copper wire.
- 3 Ground Device

☞ Use ground device as stated in electrical codes.

⚠ Ground generator to system earth ground if supplying power to a premises (home, shop, farm) wiring system.

⚠ Also see AWS Safety & Health Fact Sheet No. 29, Grounding of Portable And Vehicle Mounted Welding Generators.

ST-800 576-B

13-4. How Much Power Does Equipment Require?

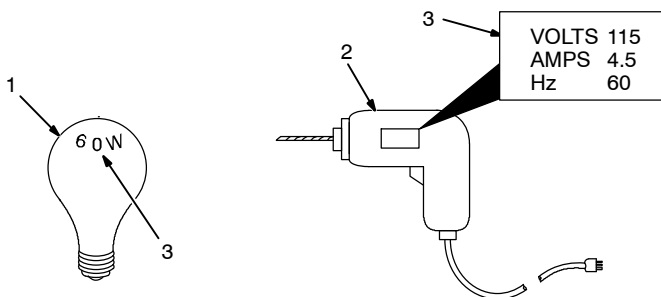

- 1 Resistive Load

A light bulb is a resistive load and requires a constant amount of power.

- 2 Non-Resistive Load

Equipment with a motor is a non-resistive load and requires approximately six times more power while starting the motor than when running (see Section 13-8).

- 3 Rating Data

Rating shows volts and amperes, or watts required to run equipment.

Amperes x Volts = Watts

Example 1: If a drill uses 4.5 amperes at 115 volts, calculate its running power requirement in watts.

$$4.5 \text{ A} \times 115 \text{ V} = 520 \text{ W}$$

The load applied by the drill is 520 watts.

Example 2: If three 200 watt flood lamps are used with the drill from Example 1, add the individual loads to calculate total load.

$$(3 \times 200\text{W}) + 520 \text{ W} = 1120 \text{ W}$$

The total load applied by the three flood lamps and drill is 1120 watts.

S-0623

13-5. Approximate Power Requirements For Industrial Motors

Industrial Motors	Rating	Starting Watts	Running Watts
Split Phase	1/8 HP	800	300
	1/6 HP	1225	500
	1/4 HP	1600	600
	1/3 HP	2100	700
	1/2 HP	3175	875
Capacitor Start-Induction Run	1/3 HP	2020	720
	1/2 HP	3075	975
	3/4 HP	4500	1400
	1 HP	6100	1600
	1-1/2 HP	8200	2200
	2 HP	10550	2850
	3 HP	15900	3900
Capacitor Start-Capacitor Run	5 HP	23300	6800
	1-1/2 HP	8100	2000
	5 HP	23300	6000
	7-1/2 HP	35000	8000
Fan Duty	10 HP	46700	10700
	1/8 HP	1000	400
	1/6 HP	1400	550
	1/4 HP	1850	650
	1/3 HP	2400	800
	1/2 HP	3500	1100

13-6. Approximate Power Requirements For Farm/Home Equipment



Farm/Home Equipment	Rating	Starting Watts	Running Watts
Stock Tank De-Icer		1000	1000
Grain Cleaner	1/4 HP	1650	650
Portable Conveyor	1/2 HP	3400	1000
Grain Elevator	3/4 HP	4400	1400
Milk Cooler		2900	1100
Milker (Vacuum Pump)	2 HP	10500	2800
FARM DUTY MOTORS	1/3 HP	1720	720
Std. (e.g. Conveyors,	1/2 HP	2575	975
Feed Augers, Air	3/4 HP	4500	1400
Compressors)	1 HP	6100	1600
	1-1/2 HP	8200	2200
	2 HP	10550	2850
	3 HP	15900	3900
	5 HP	23300	6800
High Torque (e.g. Barn	1-1/2 HP	8100	2000
Cleaners, Silo Unloaders,	5 HP	23300	6000
Silo Hoists, Bunk Feeders)	7-1/2 HP	35000	8000
	10 HP	46700	10700
3-1/2 cu. ft. Mixer	1/2 HP	3300	1000
High Pressure 1.8 Gal/Min	500 PSI	3150	950
Washer 2 gal/min	550 PSI	4500	1400
2 gal/min	700 PSI	6100	1600
Refrigerator or Freezer		3100	800
Shallow Well Pump	1/3 HP	2150	750
	1/2 HP	3100	1000
Sump Pump	1/3 HP	2100	800
	1/2 HP	3200	1050

13-7. Approximate Power Requirements For Contractor Equipment

Contractor	Rating	Starting Watts	Running Watts
Hand Drill	1/4 in.	350	350
	3/8 in.	400	400
	1/2 in.	600	600
Circular Saw	6-1/2 in.	500	500
	7-1/4 in.	900	900
	8-1/4 in.	1400	1400
Table Saw	9 in.	4500	1500
	10 in.	6300	1800
Band Saw	14 in.	2500	1100
Bench Grinder	6 in.	1720	720
	8 in.	3900	1400
	10 in.	5200	1600
Air Compressor	1/2 HP	3000	1000
	1 HP	6000	1500
	1-1/2 HP	8200	2200
	2 HP	10500	2800
Electric Chain Saw	1-1/2 HP, 12 in.	1100	1100
	2 HP, 14 in.	1100	1100
Electric Trimmer	Standard 9 in.	350	350
	Heavy Duty 12 in.	500	500
Electric Cultivator	1/3 HP	2100	700
Elec. Hedge Trimmer	18 in.	400	400
Flood Lights	HID	125	100
	Metal Halide	313	250
	Mercury	1000	
	Sodium Vapor	1400	1000
Submersible Pump	400 GPH	600	200
Centrifugal Pump	900 GPH	900	500
Floor Polisher	3/4 HP, 16 in.	4500	1400
	1 HP, 20 in.	6100	1600
High Pressure Washer	1/2 HP	3150	950
	3/4 HP	4500	1400
	1 HP	6100	1600
55 gal Drum Mixer	1/4 HP	1900	700
Wet & Dry Vac	1.7 HP	900	900
	2-1/2 HP	1300	1300

13-8. Power Required To Start Motor

Single-Phase Induction Motor Starting Requirements								
Motor Start Code	G	H	J	K	L	M	N	P
KVA/HP	6.3	7.1	8.0	9.0	10.0	11.2	12.5	14.0

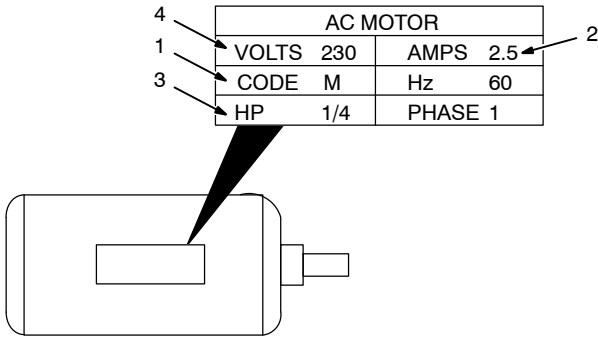

AC MOTOR			
VOLTS	230	AMPS	2.5
CODE	M	Hz	60
HP	1/4	PHASE	1

- 1 Motor Start Code
- 2 Running Amperage
- 3 Motor HP
- 4 Motor Voltage

To find starting amperage:

Step 1: Find code and use table to find kVA/HP. If code is not listed, multiply running amperage by six to find starting amperage.

Step 2: Find Motor HP and Volts.

Step 3: Determine starting amperage (see example).

Welder/generator amperage output must be at least twice the motor's running amperage.

(kVA/HP x HP x 1000) / Volts = Starting Amperage

Example: Calculate starting amperage required for a 230 V, 1/4 HP motor with a motor start code of M.



Volts = 230, HP = 1/4, kVA/HP = 11.2

$(11.2 \times 1/4 \times 1000) / 230 = 12.2A$

Starting the motor requires 12.2 amperes.

S-0624

13-9. How Much Power Can Generator Supply?

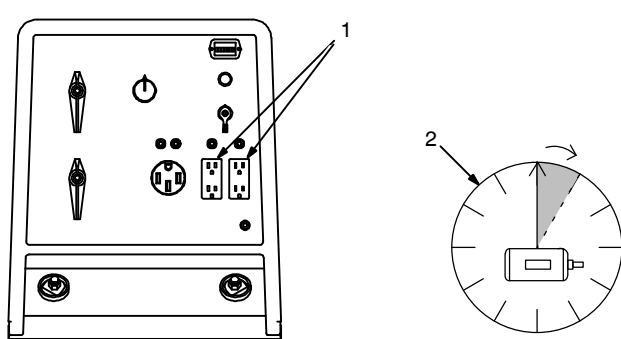

- 1 Limit Load To 90% Of Generator Output

Always start non-resistive (motor) loads in order from largest to smallest, and add resistive loads last.

- 2 5 Second Rule

If motor does not start within 5 seconds, turn off power to prevent motor damage. Motor requires more power than generator can supply.

Ref. ST-800 396-A / S-0625

13-10. Typical Connections To Supply Standby Power

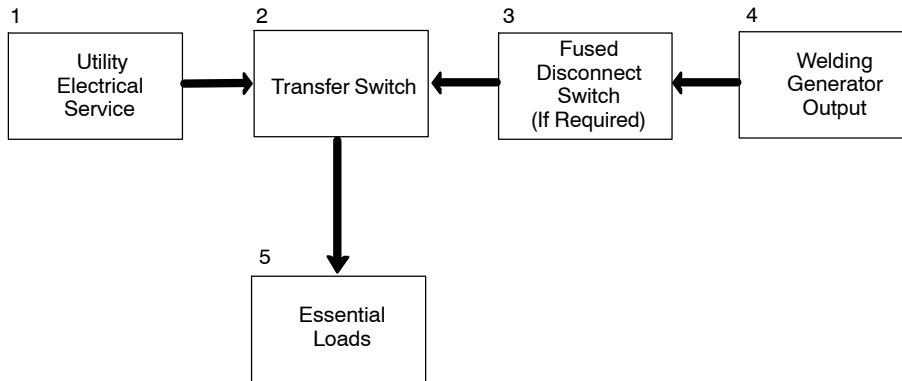

⚠ Have only qualified persons perform these connections according to all applicable codes and safety practices.

⚠ Properly install, ground, and operate this equipment according to its Owner's Manual and national, state, and local codes.

ⓘ *Customer-supplied equipment is required if generator will supply standby power during emergencies or power outages.*

1 Utility Electrical Service

2 Transfer Switch (Double-Throw)

Switch transfers the electrical load from electric utility service to the generator. Transfer load back to electric utility when service is restored.

Install correct switch (customer-supplied). Switch rating must be same as or greater than the branch overcurrent protection.

3 Fused Disconnect Switch

Install correct switch (customer-supplied) if required by electrical code.

4 Welder/Generator Output

Generator output voltage and wiring must be consistent with regular (utility) system voltage and wiring.

Connect generator with temporary or permanent wiring suitable for the installation.

Turn off or unplug all equipment connected to generator before starting or stopping engine. When starting or stopping, the engine has low speed which causes low voltage and frequency.

5 Essential Loads

Generator output may not meet the electrical requirements of the premises. If generator does not produce enough output to meet all requirements, connect only essential loads (pumps, freezers, heaters, etc. – See Section 13-4).

13-11. Selecting Extension Cord (Use Shortest Cord Possible)

Cord Lengths for 120 Volt Loads							
							
⚠ Use GFCI protection when operating auxiliary equipment. Do not use GFCI receptacles to power life support equipment.							
Current (Amperes)	Load (Watts)	Maximum Allowable Cord Length in ft (m) for Conductor Size (AWG)*					
		4	6	8	10	12	14
5	600			350 (106)	225 (68)	137 (42)	100 (30)
7	840		400 (122)	250 (76)	150 (46)	100 (30)	62 (19)
10	1200	400 (122)	275 (84)	175 (53)	112 (34)	62 (19)	50 (15)
15	1800	300 (91)	175 (53)	112 (34)	75 (23)	37 (11)	30 (9)
20	2400	225 (68)	137 (42)	87 (26)	50 (15)	30 (9)	
25	3000	175 (53)	112 (34)	62 (19)	37 (11)		
30	3600	150 (46)	87 (26)	50 (15)	37 (11)		
35	4200	125 (38)	75 (23)	50 (15)			
40	4800	112 (34)	62 (19)	37 (11)			
45	5400	100 (30)	62 (19)				
50	6000	87 (26)	50 (15)				

*Conductor size is based on maximum 2% voltage drop

Cord Lengths for 240 Volt Loads							
							
⚠ Use GFCI protection when operating auxiliary equipment. Do not use GFCI receptacles to power life support equipment.							
Current (Amperes)	Load (Watts)	Maximum Allowable Cord Length in ft (m) for Conductor Size (AWG)*					
		4	6	8	10	12	14
5	1200			700 (213)	450 (137)	225 (68)	200 (61)
7	1680		800 (244)	500 (152)	300 (91)	200 (61)	125 (38)
10	2400	800 (244)	550 (168)	350 (107)	225 (69)	125 (38)	100 (31)
15	3600	600 (183)	350 (107)	225 (69)	150 (46)	75 (23)	60 (18)
20	4800	450 (137)	275 (84)	175 (53)	100 (31)	60 (18)	
25	6000	350 (107)	225 (69)	125 (38)	75 (23)		
30	7000	300 (91)	175 (53)	100 (31)	75 (23)		
35	8400	250 (76)	150 (46)	100 (31)			
40	9600	225 (69)	125 (38)	75 (23)			
45	10,800	200 (61)	125 (38)				
50	12,000	175 (53)	100 (31)				

*Conductor size is based on maximum 2% voltage drop

TRUE BLUE[®]

WARRANTY

Effective January 1, 2014

(Equipment with a serial number preface of ME or newer)

This limited warranty supersedes all previous Miller warranties and is exclusive with no other guarantees or warranties expressed or implied.

Warranty Questions?

Call
1-800-4-A-MILLER
for your local
Miller distributor.

Your distributor also gives you ...

Service

You always get the fast, reliable response you need. Most replacement parts can be in your hands in 24 hours.

Support

Need fast answers to the tough welding questions? Contact your distributor. The expertise of the distributor and Miller is there to help you, every step of the way.

LIMITED WARRANTY – Subject to the terms and conditions below, Miller Electric Mfg. Co., Appleton, Wisconsin, warrants to its original retail purchaser that new Miller equipment sold after the effective date of this limited warranty is free of defects in material and workmanship at the time it is shipped by Miller. THIS WARRANTY IS EXPRESSLY IN LIEU OF ALL OTHER WARRANTIES, EXPRESS OR IMPLIED, INCLUDING THE WARRANTIES OF MERCHANTABILITY AND FITNESS.

Within the warranty periods listed below, Miller will repair or replace any warranted parts or components that fail due to such defects in material or workmanship. Miller must be notified in writing within thirty (30) days of such defect or failure, at which time Miller will provide instructions on the warranty claim procedures to be followed.

Miller shall honor warranty claims on warranted equipment listed below in the event of such a failure within the warranty time periods. All warranty time periods start on the delivery date of the equipment to the original end-user purchaser, and not to exceed twelve months after the equipment is shipped to a North American distributor or eighteen months after the equipment is shipped to an International distributor.

1. 5 Years Parts — 3 Years Labor
 - * Original Main Power Rectifiers Only to Include SCRs, Diodes, and Discrete Rectifier Modules
2. 3 Years — Parts and Labor
 - * Auto-Darkening Helmet Lenses (Except Classic Series) (No Labor)
 - * Engine Driven Welding Generators
(NOTE: Engines are Warranted Separately by the Engine Manufacturer.)
 - * Inverter Power Sources (Unless Otherwise Stated)
 - * Plasma Arc Cutting Power Sources
 - * Process Controllers
 - * Semi-Automatic and Automatic Wire Feeders
 - * Transformer/Rectifier Power Sources
3. 2 Years — Parts and Labor
 - * Auto-Darkening Helmet Lenses – Classic Series Only (No Labor)
 - * Fume Extractors – Capture 5, Filtair 400 and Industrial Collector Series
4. 1 Year — Parts and Labor Unless Specified
 - * Automatic Motion Devices
 - * CoolBelt and CoolBand Blower Unit (No Labor)
 - * External Monitoring Equipment and Sensors
 - * Field Options
(NOTE: Field options are covered for the remaining warranty period of the product they are installed in, or for a minimum of one year — whichever is greater.)
 - * RFCS Foot Controls (Except RFCS-RJ45)
 - * Fume Extractors – Filtair 130, MWX and SWX Series
 - * HF Units
 - * ICE/XT Plasma Cutting Torches (No Labor)
 - * Induction Heating Power Sources, Coolers
(NOTE: Digital Recorders are Warranted Separately by the Manufacturer.)
 - * LiveArc Welding Performance Management System
 - * Load Banks
 - * Motor Driven Guns (except Spoolmate Spoolguns)
 - * PAPR Blower Unit (No Labor)
 - * Positioners and Controllers
 - * Racks
 - * Running Gear/Trailers
 - * Spot Welders
 - * Subarc Wire Drive Assemblies
 - * Water Coolant Systems
 - * TIG Torches (No Labor)
 - * Wireless Remote Foot/Hand Controls and Receivers
 - * Work Stations/Weld Tables (No Labor)

5. 6 Months — Parts
 - * Batteries
 - * Bernard Guns (No Labor)
 - * Tregaskiss Guns (No Labor)
6. 90 Days — Parts
 - * Accessory (Kits)
 - * Canvas Covers
 - * Induction Heating Coils and Blankets, Cables, and Non-Electronic Controls
 - * M-Guns
 - * MIG Guns and Subarc (SAW) Guns
 - * Remote Controls and RFCS-RJ45
 - * Replacement Parts (No labor)
 - * Roughneck Guns
 - * Spoolmate Spoolguns

Miller's True Blue[®] Limited Warranty shall not apply to:

1. **Consumable components; such as contact tips, cutting nozzles, contactors, brushes, relays, work station table tops and welding curtains, or parts that fail due to normal wear. (Exception: brushes and relays are covered on all engine-driven products.)**
2. Items furnished by Miller, but manufactured by others, such as engines or trade accessories. These items are covered by the manufacturer's warranty, if any.
3. Equipment that has been modified by any party other than Miller, or equipment that has been improperly installed, improperly operated or misused based upon industry standards, or equipment which has not had reasonable and necessary maintenance, or equipment which has been used for operation outside of the specifications for the equipment.

MILLER PRODUCTS ARE INTENDED FOR PURCHASE AND USE BY COMMERCIAL/INDUSTRIAL USERS AND PERSONS TRAINED AND EXPERIENCED IN THE USE AND MAINTENANCE OF WELDING EQUIPMENT.

In the event of a warranty claim covered by this warranty, the exclusive remedies shall be, at Miller's option: (1) repair; or (2) replacement; or, where authorized in writing by Miller in appropriate cases, (3) the reasonable cost of repair or replacement at an authorized Miller service station; or (4) payment of or credit for the purchase price (less reasonable depreciation based upon actual use) upon return of the goods at customer's risk and expense. Miller's option of repair or replacement will be F.O.B., Factory at Appleton, Wisconsin, or F.O.B. at a Miller authorized service facility as determined by Miller. Therefore no compensation or reimbursement for transportation costs of any kind will be allowed.

TO THE EXTENT PERMITTED BY LAW, THE REMEDIES PROVIDED HEREIN ARE THE SOLE AND EXCLUSIVE REMEDIES. IN NO EVENT SHALL MILLER BE LIABLE FOR DIRECT, INDIRECT, SPECIAL, INCIDENTAL OR CONSEQUENTIAL DAMAGES (INCLUDING LOSS OF PROFIT), WHETHER BASED ON CONTRACT, TORT OR ANY OTHER LEGAL THEORY.

ANY EXPRESS WARRANTY NOT PROVIDED HEREIN AND ANY IMPLIED WARRANTY, GUARANTY OR REPRESENTATION AS TO PERFORMANCE, AND ANY REMEDY FOR BREACH OF CONTRACT TORT OR ANY OTHER LEGAL THEORY WHICH, BUT FOR THIS PROVISION, MIGHT ARISE BY IMPLICATION, OPERATION OF LAW, CUSTOM OF TRADE OR COURSE OF DEALING, INCLUDING ANY IMPLIED WARRANTY OF MERCHANTABILITY OR FITNESS FOR PARTICULAR PURPOSE, WITH RESPECT TO ANY AND ALL EQUIPMENT FURNISHED BY MILLER IS EXCLUDED AND DISCLAIMED BY MILLER.

Some states in the U.S.A. do not allow limitations of how long an implied warranty lasts, or the exclusion of incidental, indirect, special or consequential damages, so the above limitation or exclusion may not apply to you. This warranty provides specific legal rights, and other rights may be available, but may vary from state to state.

In Canada, legislation in some provinces provides for certain additional warranties or remedies other than as stated herein, and to the extent that they may not be waived, the limitations and exclusions set out above may not apply. This Limited Warranty provides specific legal rights, and other rights may be available, but may vary from province to province.

miller_warr 2014-04-14





Owner's Record

Please complete and retain with your personal records.

Model Name

Serial/Style Number

Purchase Date

(Date which equipment was delivered to original customer.)

Distributor

Address

City

State

Zip



For Service

Contact a DISTRIBUTOR or SERVICE AGENCY near you.

Always provide Model Name and Serial/Style Number.

Contact your Distributor for:

Welding Supplies and Consumables

Options and Accessories

Personal Safety Equipment

Service and Repair

Replacement Parts

Training (Schools, Videos, Books)

Technical Manuals (Servicing Information and Parts)

Circuit Diagrams

Welding Process Handbooks

To locate a Distributor or Service Agency visit www.millerwelds.com or call 1-800-4-A-Miller

Contact the Delivering Carrier to:

File a claim for loss or damage during shipment.

For assistance in filing or settling claims, contact your distributor and/or equipment manufacturer's Transportation Department.

Miller Electric Mfg. Co.

An Illinois Tool Works Company
1635 West Spencer Street
Appleton, WI 54914 USA

International Headquarters—USA

USA Phone: 920-735-4505 Auto-Attended
USA & Canada FAX: 920-735-4134
International FAX: 920-735-4125

For International Locations Visit
www.MillerWelds.com

