



OM-222 166AE

2015-07

Processes

Induction Heating

Description



Induction Heating Power Source

ProHeat[®] 35

CE And Non CE Models

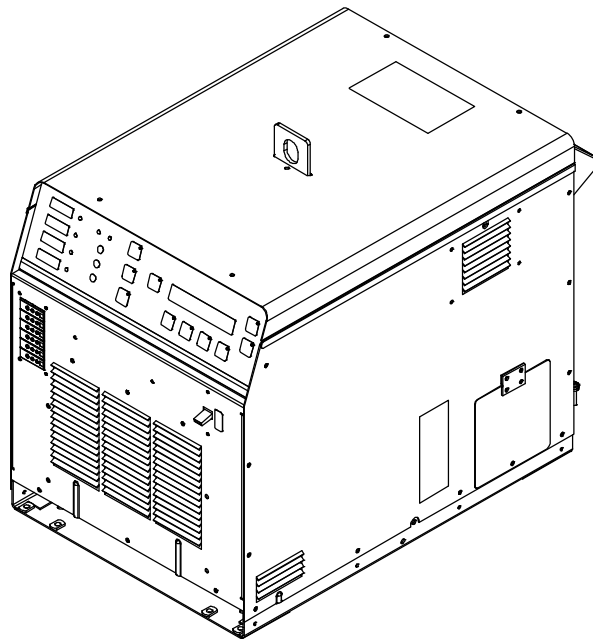

Visit our website at
www.MillerWelds.com

OWNER'S MANUAL

File: Induction Heating



From Miller to You

Thank you and congratulations on choosing Miller. Now you can get the job done and get it done right. We know you don't have time to do it any other way.

That's why when Niels Miller first started building arc welders in 1929, he made sure his products offered long-lasting value and superior quality. Like you, his customers couldn't afford anything less. Miller products had to be more than the best they could be. They had to be the best you could buy.

Today, the people that build and sell Miller products continue the tradition. They're just as committed to providing equipment and service that meets the high standards of quality and value established in 1929.

This Owner's Manual is designed to help you get the most out of your Miller products. Please take time to read the Safety precautions. They will help you protect yourself against potential hazards on the worksite.

We've made installation and operation quick and easy. With Miller you can count on years of reliable service with proper maintenance. And if for some reason the unit needs repair, there's a Troubleshooting section that will help you figure out what the problem is. The parts list will then help you to decide the exact part you may need to fix the problem. Warranty and service information for your particular model are also provided.



Miller is the first welding equipment manufacturer in the U.S.A. to be registered to the ISO 9001 Quality System Standard.

Miller Electric manufactures a full line of welders and welding related equipment. For information on other quality Miller products, contact your local Miller distributor to receive the latest full line catalog or individual specification sheets. **To locate your nearest distributor or service agency call 1-800-4-A-Miller, or visit us at www.MillerWelds.com on the web.**



Working as hard as you do – every power source from Miller is backed by the most hassle-free warranty in the business.



TABLE OF CONTENTS

SECTION 1 – SAFETY PRECAUTIONS – READ BEFORE USING	1
1-1. Symbol Usage	1
1-2. Induction Heating Hazards	1
1-3. Additional Symbols for Installation, Operation, and Maintenance	2
1-4. California Proposition 65 Warnings	3
1-5. Principal Safety Standards	3
SECTION 2 – CONSIGNES DE SÉCURITÉ – LIRE AVANT UTILISATION	4
2-1. Signification des symboles	4
2-2. Dangers relatifs au soudage à l'arc	4
2-3. Dangers supplémentaires en relation avec l'installation, le fonctionnement et la maintenance	5
2-4. Proposition californienne 65 Avertissements	6
2-5. Principales normes de sécurité	6
SECTION 3 – DEFINITIONS	7
3-1. Additional Safety Symbols And Definitions	7
3-2. Miscellaneous Symbols And Definitions	9
SECTION 4 – SPECIFICATIONS	10
4-1. Serial Number and Rating Label Location	10
4-2. Specifications	10
4-3. Environmental Specifications	10
SECTION 5 – INSTALLATION	11
5-1. Selecting A Location	11
5-2. Electrical Service Guide	12
5-3. Connecting 3-Phase Input Power For 460/575 Volt Models	14
5-4. Connecting 3-Phase Input Power For 400/460 Volt IEC And CE Models	16
5-5. Power Source Output Connections	18
5-6. Remote 14 Receptacle RC14 Information and Connections	19
5-7. Remote 14 Socket Information	19
5-8. Temperature Recorder Receptacle RC9 Information And Connections	20
5-9. Temperature Recorder Socket Information	20
5-10. Secondary Insulation Protection	21
5-11. 115 Volt AC Duplex Receptacle And Supplementary Protector	22
5-12. Locating Thermocouples	22
5-13. Attaching Welded Thermocouples	24
5-14. Using Contact Thermocouple Sensors	25
5-15. Using Non–contact Temperature Sensors	25
SECTION 6 – COMPONENTS AND CONTROLS	26
6-1. Controls	26
SECTION 7 – SETUP AND OPERATION	27
7-1. Safety Equipment	27
7-2. System Description	27
7-3. Important System Guidelines	27
7-4. Power Source/System Setup	27
7-4-1. Factory Defaults	29
7-5. Programming	29
7-5-1. Temperature-Based Control	29
7-5-1-1. Preheat	29
7-5-1-2. Bake-Out	30
7-5-1-3. PWHT (Post-Weld Heat Treat)	31
7-5-1-4. Custom Program	32

TABLE OF CONTENTS

7-5-2. Remote Control	35
7-5-3. Power vs Time Control	35
7-5-4. Manual Control	36
7-5-5. Rolling Inductor—Manual Or Temperature Control Mode	36
7-6. Run Status	38
7-6-1. Temperature Based Control	38
7-6-1-1. Preheat, Bake-Out And PWHT Run Status Screen	38
7-6-1-2. Custom Program (Not Applicable With Rolling Inductor)	38
7-6-2. Manual Control	39
7-6-3. Remote Control	39
7-6-4. Power vs Time Control	39
7-7. Parameters	39
7-8. Cooler	40
7-9. Real-Time Operation	40
7-10. System Operating Characteristics	43
SECTION 8 – MAINTENANCE	45
8-1. Routine Maintenance	45
8-2. Calibration Verification Equipment	46
8-3. Calibration Verification Procedure	46
8-3-1. Initial Set Up	46
8-3-2. TC Input/Output Check	46
8-3-3. Finishing Procedure	47
SECTION 9 – SAFETY PRECAUTIONS FOR SERVICING	50
9-1. Symbol Usage	50
9-2. Servicing Hazards	50
9-3. California Proposition 65 Warnings	51
SECTION 10 – DIAGNOSTICS & TROUBLESHOOTING	53
10-1. Operator Interface Indicators	53
10-2. Limit Conditions	54
10-3. Limit Condition Codes	54
10-4. Fault Conditions	55
10-5. Fault Condition Codes	55
10-6. System Diagnostic Screens	56
10-7. Removing Wrapper and Measuring Input Capacitor Voltage	58
10-8. Blowing Out Inside Of Unit	59
SECTION 11 – ELECTRICAL DIAGRAM	60
SECTION 12 – PARTS LIST	62
WARRANTY	



DECLARATION OF CONFORMITY

for European Community (CE marked) products.

MILLER Electric Mfg. Co., 1635 Spencer Street, Appleton, WI 54914 U.S.A. declares that the product(s) identified in this declaration conform to the essential requirements and provisions of the stated Council Directive(s) and Standard(s).

Product/Apparatus Identification:

Product	Stock Number
PROHEAT 35 W/TEMPERATURE CONTROL 400-460V, CE	907432

Council Directives:

- 2006/95/EC Low Voltage
- 2004/108/EC Electromagnetic Compatibility
- 2011/65/EU Restriction of the use of certain hazardous substances in electrical and electronic equipment

Standards:

- IEC 60974-1:2005 Arc welding equipment – Part 1: Welding power sources
- IEC 60974-10:2007 Arc Welding Equipment – Part 10: Electromagnetic compatibility (EMC) requirements
- EN 50445:2008 Product family standard to demonstrate compliance of equipment for resistance welding, arc welding and allied processes with the basic restrictions related to human exposure to electromagnetic fields (0 Hz – 300Hz)

Signatory:

October 8, 2012

David A. Werba

Date of Declaration

SECTION 1 – SAFETY PRECAUTIONS – READ BEFORE USING

ihom_2013-09

⚠ Protect yourself and others from injury — read, follow, and save these important safety precautions and operating instructions.

1-1. Symbol Usage



DANGER! – Indicates a hazardous situation which, if not avoided, will result in death or serious injury. The possible hazards are shown in the adjoining symbols or explained in the text.



Indicates a hazardous situation which, if not avoided, could result in death or serious injury. The possible hazards are shown in the adjoining symbols or explained in the text.

NOTICE – Indicates statements not related to personal injury.

 Indicates special instructions.



This group of symbols means Warning! Watch Out! ELECTRIC SHOCK, MOVING PARTS, and HOT PARTS hazards. Consult symbols and related instructions below for necessary actions to avoid the hazards.

1-2. Induction Heating Hazards



The symbols shown below are used throughout this manual to call attention to and identify possible hazards. When you see the symbol, watch out, and follow the related instructions to avoid the hazard. The safety information given below is only a summary of the more complete safety information found in the Safety Standards listed in Section 1-5. Read and follow all Safety Standards.



Only qualified persons should install, operate, maintain, and repair this unit.



During operation, keep everybody, especially children, away.



ELECTRIC SHOCK can kill.

Touching live electrical parts can cause fatal shocks or severe burns. The power circuit and output bus bars or connections are electrically live whenever the output is on. The input power circuit and machine internal circuits are also live when power is on. Incorrectly installed or improperly grounded equipment is a hazard.

- Do not touch live electrical parts.
- Enclose any connecting bus bars and coolant fittings to prevent unintentional contact.
- Wear dry, hole-free insulating gloves and body protection.
- Insulate yourself from work and ground using dry insulating mats or covers big enough to prevent any physical contact with the work or ground.
- Additional safety precautions are required when any of the following electrically hazardous conditions are present: in damp locations or while wearing wet clothing; on metal structures such as floors, gratings, or scaffolds; when in cramped positions such as sitting, kneeling, or lying; or when there is a high risk of unavoidable or accidental contact with the workpiece or ground. For these conditions, see ANSI Z49.1 listed in Safety Standards. And, do not work alone!
- Disconnect input power before installing or servicing this equipment. Lockout/tagout input power according to OSHA 29 CFR 1910.147 (see Safety Standards).
- Use only nonconductive coolant hoses with a minimum length of 18 inches (457 mm) to provide isolation.
- Properly install, ground, and operate this equipment according to its Owner's Manual and national, state, and local codes.
- Always verify the supply ground – check and be sure that input power cord ground wire is properly connected to ground terminal in disconnect box or that cord plug is connected to a properly grounded receptacle outlet.
- When making input connections, attach proper grounding conductor first – double-check connections.
- Keep cords dry, free of oil and grease, and protected from hot metal and sparks.

- Frequently inspect input power cord and ground conductor for damage or bare wiring – replace immediately if damaged – bare wiring can kill.
- Turn off all equipment when not in use.
- Do not use worn, damaged, undersized, or repaired cables.
- Do not drape cables over your body.
- Do not touch power circuit if you are in contact with the work, ground, or another power circuit from a different machine.
- Use only well-maintained equipment. Repair or replace damaged parts at once. Maintain unit according to manual.
- Wear a safety harness if working above floor level.
- Keep all panels and covers securely in place.
- Use GFCI protection when operating auxiliary equipment in damp or wet locations.

SIGNIFICANT DC VOLTAGE exists in inverter power sources AFTER removal of input power.

- Turn Off inverter, disconnect input power, and discharge input capacitors according to instructions in Maintenance Section before touching any internal parts.

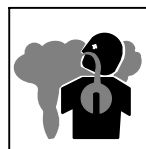

FUMES AND GASES can be hazardous.

Induction Heating of certain materials, adhesives, and fluxes can produce fumes and gases. Breathing these fumes and gases can be hazardous to your health.

- Keep your head out of the fumes. Do not breathe the fumes.
- If inside, ventilate the area and/or use local forced ventilation to remove fumes and gases. The recommended way to determine adequate ventilation is to sample for the composition and quantity of fumes and gases to which personnel are exposed.
- If ventilation is poor, wear an approved air-supplied respirator.
- Read and understand the Safety Data Sheets (SDSs) and the manufacturer's instructions for adhesives, coatings, cleaners, consumables, coolants, degreasers, fluxes, and metals.
- Work in a confined space only if it is well ventilated, or while wearing an air-supplied respirator. Always have a trained watchperson nearby. Fumes and gases from heating can displace air and lower the oxygen level causing injury or death. Be sure the breathing air is safe.
- Do not heat in locations near degreasing, cleaning, or spraying operations. The heat can react with vapors to form highly toxic and irritating gases.
- Do not overheat coated metals, such as galvanized, lead, or cadmium plated steel, unless the coating is removed from the heated area, the area is well ventilated, and while wearing an air-supplied respirator. The coatings and any metals containing these elements can give off toxic fumes if overheated. See coating SDS for temperature information.



FIRE OR EXPLOSION hazard.

- Do not overheat parts.
- Watch for fire; keep extinguisher nearby.
- Keep flammables away from work area.
- Do not locate unit on, over, or near combustible surfaces.
- Do not install unit near flammables.
- Do not operate where the atmosphere may contain flammable dust, gas, or liquid vapors (such as gasoline).
- After completion of work, inspect area to ensure it is free of sparks, glowing embers, and flames.
- Use only correct fuses or circuit breakers. Do not oversize or bypass them.
- Read and understand the Safety Data Sheets (SDSs) and the manufacturer's instructions for adhesives, coatings, cleaners, consumables, coolants, degreasers, fluxes, and metals.

- Wear body protection made from durable, flame-resistant material (leather, heavy cotton, wool). Body protection includes oil-free clothing such as leather gloves, heavy shirt, cuffless trousers, high shoes, and a cap.



INDUCTION HEATING can burn.



- Do not touch hot parts bare-handed.
- Allow cooling period before handling parts or equipment.
- Do not touch or handle induction head/coil during operation unless the equipment is designed and intended to be used in this manner as specified in the owner's manual.
- Keep metal jewelry and other metal personal items away from head/coil during operation.
- To handle hot parts, use proper tools and/or wear heavy, insulated welding gloves and clothing to prevent burns.

1-3. Additional Symbols for Installation, Operation, and Maintenance



FALLING EQUIPMENT can injure.

- Use handle and have person of adequate physical strength lift unit.
- Move unit with hand cart or similar device.
- For units without a handle, use equipment of adequate capacity to lift and support unit.
- Keep equipment (cables and cords) away from moving vehicles when working from an aerial location.
- If using lift forks to move unit, be sure forks are long enough to extend beyond opposite side of unit.
- Follow the guidelines in the Applications Manual for the Revised NIOSH Lifting Equation (Publication No. 94-110) when manually lifting heavy parts or equipment.

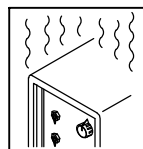

OVERUSE can cause OVERHEATING

- Allow cooling period.
- Reduce output or reduce duty cycle before starting to heat again.
- Follow rated duty cycle.

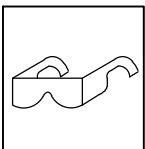

- Wear approved safety glasses with side shields or wear face shield.

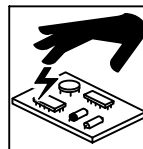

STATIC (ESD) can damage PC boards.

- Put on grounded wrist strap BEFORE handling boards or parts.
- Use proper static-proof bags and boxes to store, move, or ship PC boards.



MOVING PARTS can injure.

- Keep away from moving parts such as fans.
- Keep all doors, panels, covers, and guards closed and securely in place.
- Have only qualified persons remove doors, panels, covers, or guards for maintenance and troubleshooting as necessary.
- Reinstall doors, panels, covers, or guards when maintenance is finished and before reconnecting input power.

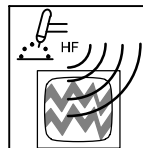

H.F. RADIATION can cause interference.

- High-frequency (H.F.) can interfere with radio navigation, safety services, computers, and communication equipment.
- Have only qualified person familiar with electronic equipment perform this installation.
- The user is responsible for having a qualified electrician promptly correct any interference problem resulting from the installation.
- If notified by the FCC about interference, stop using the equipment at once.
- Have the installation regularly checked and maintained.
- Keep high-frequency source doors and panels tightly shut.

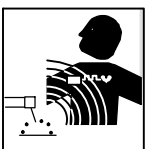

ELECTRIC AND MAGNETIC FIELDS (EMF) can affect Implanted Medical Devices.

- Wearers of Pacemakers and other Implanted Medical Devices should keep away.
- Implanted Medical Device wearers should consult their doctor and the device manufacturer before going near arc welding, spot welding, gouging, plasma arc cutting, or induction heating operations.

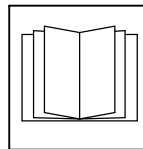

READ INSTRUCTIONS.

- Read and follow all labels and the Owner's Manual carefully before installing, operating, or servicing unit. Read the safety information at the beginning of the manual and in each section.
- Use only genuine replacement parts from the manufacturer.
- Perform maintenance and service according to the Owner's Manuals, industry standards, and national, state, and local codes.

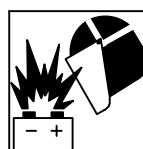

BATTERY EXPLOSION can injure.

- Do not use induction equipment to charge batteries or jump start vehicles unless it has a battery charging feature designed for this purpose.

1-4. California Proposition 65 Warnings

 **Welding or cutting equipment produces fumes or gases which contain chemicals known to the State of California to cause birth defects and, in some cases, cancer. (California Health & Safety Code Section 25249.5 et seq.)**

 **This product contains chemicals, including lead, known to the state of California to cause cancer, birth defects, or other reproductive harm. *Wash hands after use.***

1-5. Principal Safety Standards

Safety in Welding, Cutting, and Allied Processes, ANSI Standard Z49.1, is available as a free download from the American Welding Society at <http://www.aws.org> or purchased from Global Engineering Documents (phone: 1-877-413-5184, website: www.global.ihs.com).

Safety in Welding, Cutting, and Allied Processes, CSA Standard W117.2, from Canadian Standards Association, Standards Sales, 5060 Spectrum Way, Suite 100, Ontario, Canada L4W 5NS (phone: 800-463-6727, website: www.csa-international.org).

OSHA, Occupational Safety and Health Standards for General Industry, Title 29, Code of Federal Regulations (CFR), Part 1910, Subpart Q, and Part 1926, Subpart J, from U.S. Government Printing Office, Superintendent of Documents, P.O. Box 371954, Pittsburgh, PA 15250-7954 (phone: 1-866-512-1800) (there are 10 OSHA Regional Offices—phone for Region 5, Chicago, is 312-353-2220, website: www.osha.gov).

SECTION 2 – CONSIGNES DE SÉCURITÉ – LIRE AVANT UTILISATION

ihom 2013-09fre

! Pour écarter les risques de blessure pour vous-même et pour autrui — lire, appliquer et ranger en lieu sûr ces consignes relatives aux précautions de sécurité et au mode opératoire.

2-1. Signification des symboles



DANGER! – Indique une situation dangereuse qui si on l'évite pas peut donner la mort ou des blessures graves. Les dangers possibles sont montrés par les symboles joints ou sont expliqués dans le texte.



Indique une situation dangereuse qui si on l'évite pas peut donner la mort ou des blessures graves. Les dangers possibles sont montrés par les symboles joints ou sont expliqués dans le texte.

NOTE – Indique des déclarations pas en relation avec des blessures personnelles.

Indique des instructions spécifiques.



Ce groupe de symboles veut dire Avertissement! Attention! DANGER DE CHOC ELECTRIQUE, PIECES EN MOUVEMENT, et PIECES CHAUDES. Consulter les symboles et les instructions ci-dessous y afférant pour les actions nécessaires afin d'éviter le danger.

2-2. Dangers relatifs au soudage à l'arc



Les symboles présentés ci-après sont utilisés tout au long du présent manuel pour attirer votre attention et identifier les risques de danger. Lorsque vous voyez un symbole, soyez vigilant et suivez les directives mentionnées afin d'éviter tout danger. Les consignes de sécurité présentées ci-après ne font que résumer l'information contenue dans les normes de sécurité énumérées à la section 2-5. Veuillez lire et respecter toutes ces normes de sécurité.



L'installation, l'utilisation, l'entretien et les réparations ne doivent être confiés qu'à des personnes qualifiées.



Au cours de l'utilisation, tenir toute personne à l'écart et plus particulièrement les enfants.



UNE DÉCHARGE ÉLECTRIQUE peut entraîner la mort.

Le contact de composants électriques peut provoquer des accidents mortels ou des brûlures graves. Le circuit électrique et les barres collectrices ou les connexions de sortie sont sous tension lorsque

l'appareil fonctionne. Le circuit d'alimentation et les circuits internes de la machine sont également sous tension lorsque l'alimentation est sur marche. Des équipements installés ou reliés à la borne de terre de manière incorrecte sont dangereux.

- Ne pas toucher aux pièces électriques sous tension.
- Protéger toutes les barres collectrices et les raccords de refroidissement pour éviter de les toucher par inadvertance.
- Porter des gants isolants et des vêtements de protection secs et sans trous.
- S'isoler de la pièce à couper et du sol en utilisant des housses ou des tapis assez grands afin d'éviter tout contact physique avec la pièce à couper ou le sol.
- D'autres consignes de sécurité sont nécessaires dans les conditions suivantes : risques électriques dans un environnement humide ou si l'on porte des vêtements mouillés ; sur des structures métalliques telles que sols, grilles ou échafaudages ; en position coincée comme assise, à genoux ou couchée ; ou s'il y a un risque élevé de contact inévitable ou accidentel avec la pièce à souder ou le sol. Dans ces conditions, voir ANSI Z49.1 énuméré dans les normes de sécurité. En outre, ne pas travailler seul !
- Couper l'alimentation d'entrée avant d'installer l'appareil ou d'effectuer l'entretien. Verrouiller ou étiqueter la sortie d'alimentation selon la norme OSHA 29 CFR 1910.147 (se reporter aux Principales normes de sécurité).
- N'utiliser que des tuyaux de refroidissement non conducteurs ayant une longueur minimale de 457 mm pour garantir l'isolation.

- Installer le poste correctement et le mettre à la terre convenablement selon les consignes du manuel de l'opérateur et les normes nationales, provinciales et locales.
- Toujours vérifier la terre du cordon d'alimentation. Vérifier et s'assurer que le fil de terre du cordon d'alimentation est bien raccordé à la borne de terre du sectionneur ou que la fiche du cordon est raccordée à une prise correctement mise à la terre.
- En effectuant les raccordements d'entrée, fixer d'abord le conducteur de mise à la terre approprié et revérifier les connexions.
- Les câbles doivent être exempts d'humidité, d'huile et de graisse ; protégez-les contre les étincelles et les pièces métalliques chaudes.
- Vérifier fréquemment le cordon d'alimentation et le conducteur de mise à la terre afin de s'assurer qu'il n'est pas altéré ou dénudé –, le remplacer immédiatement s'il l'est –, Un fil dénudé peut entraîner la mort.
- L'équipement doit être hors tension lorsqu'il n'est pas utilisé.
- Ne pas utiliser des câbles usés, endommagés, de grosseur insuffisante ou mal épissés.
- Ne pas enrouler les câbles autour du corps.
- Ne pas toucher le circuit électrique si l'on est en contact avec la pièce, la terre ou le circuit électrique d'une autre machine.
- N'utiliser qu'un matériel en bon état. Réparer ou remplacer sur-le-champ les pièces endommagées. Entretenir l'appareil conformément à ce manuel.
- Porter un harnais de sécurité si l'on doit travailler au-dessus du sol.
- S'assurer que tous les panneaux et couvercles sont correctement en place.
- Utiliser une protection différentielle lors de l'utilisation d'un équipement auxiliaire dans des endroits humides ou mouillés.

Il reste une TENSION DC NON NÉGLIGEABLE dans les sources de soudage onduleur UNE FOIS le moteur coupé.

- Avant de toucher des organes internes, couper l'onduleur, débrancher l'alimentation et décharger les condensateurs d'alimentation conformément aux instructions indiquées dans la partie maintenance.

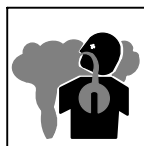

LES FUMÉES ET LES GAZ peuvent être dangereux.

Le chauffage à induction de certains matériaux, adhésifs et flux génère des fumées et des gaz. Leur inhalation peut être dangereuse pour votre santé.

- Ne pas mettre sa tête au-dessus des vapeurs. Ne pas respirer ces vapeurs.
- À l'intérieur, ventiler la zone et/ou utiliser une ventilation forcée au niveau de l'arc pour l'évacuation des fumées et des gaz. Pour déterminer la bonne ventilation, il est recommandé de procéder à un prélèvement pour la composition et la quantité de fumées et de gaz auxquels est exposé le personnel.
- Si la ventilation est médiocre, porter un respirateur anti-vapeurs approuvé.
- Lire et comprendre les fiches de données de sécurité et les instructions du fabricant concernant les adhésifs, les revêtements, les nettoyeurs, les consommables, les produits de refroidissement, les dégraisseurs, les flux et les métaux.
- Travailler dans un espace fermé seulement s'il est bien ventilé ou en portant un respirateur. Demander toujours à un surveillant dûment formé de se tenir à proximité. Des fumées et des gaz provenant du chauffage peuvent déplacer l'air, abaisser le niveau d'oxygène et provoquer des lésions ou des accidents mortels. S'assurer que l'air ambiant ne présente aucun danger.
- Ne pas chauffer dans des endroits se trouvant à proximité d'opérations de dégraissage, de nettoyage ou de pulvérisation. La chaleur peut réagir en présence de vapeurs et former des gaz hautement toxiques et irritants.
- Ne pas surchauffer des métaux munis d'un revêtement tels que l'acier galvanisé, plaqué au plomb ou au cadmium, à moins que le revêtement ne soit enlevé de la zone chauffée, que la zone soit bien ventilée et, si nécessaire, en portant un respirateur. Les revêtements et tous les métaux contenant ces éléments peuvent dégager des fumées toxiques s'ils sont surchauffés. Voir les informations concernant la température dans les spécifications de revêtement SDS.



Risque D'INCENDIE OU D'EXPLOSION.

- Ne pas surchauffer les composants .
- Attention aux risques d'incendie: tenir un extincteur à proximité.

- Stocker des produits inflammables hors de la zone de travail.

- Ne pas placer l'appareil sur, au-dessus ou à proximité de surfaces inflammables.
- Ne pas installer l'appareil à proximité de produits inflammables.
- Ne pas faire fonctionner l'appareil si l'air ambiant est chargé de particules, gaz, ou vapeurs inflammables (vapeur d'essence, par exemple).
- Une fois le travail achevé, assurez-vous qu'il ne reste aucune trace d'étincelles incandescentes ni de flammes.
- Utiliser exclusivement des fusibles ou coupe-circuits appropriés. Ne pas augmenter leur puissance; ne pas les ponter.
- Lire et comprendre les fiches de données de sécurité et les instructions du fabricant concernant les adhésifs, les revêtements, les nettoyeurs, les consommables, les produits de refroidissement, les dégraisseurs, les flux et les métaux.
- Porter un équipement de protection pour le corps fait d'un matériau résistant et ignifuge (cuir, coton robuste, laine). La protection du corps comporte des vêtements sans huile comme par ex. des gants de cuir, une chemise solide, des pantalons sans revers, des chaussures hautes et une casquette.



LE CHAUFFAGE PAR INDUCTION peut provoquer des brûlures.

- Ne pas toucher des parties chaudes à mains nues.
- Laisser refroidir les composants ou équipements avant de les manipuler.
- Ne pas toucher ou manipuler les câbles/enroulements d'induction durant l'opération à moins que l'équipement soit conçu à cet effet comme indiqué dans le manuel d'utilisateur.

- Tenir les bijoux et autres objets personnels en métal éloignés de la tête/de l'enroulement pendant le fonctionnement.
- Ne pas toucher aux pièces chaudes, utiliser les outils recommandés et porter des gants de soudage et des vêtements épais pour éviter les brûlures.

2-3. Dangers supplémentaires en relation avec l'installation, le fonctionnement et la maintenance



LA CHUTE DE L'ÉQUIPEMENT peut provoquer des blessures.

- Utiliser la poignée et demander à une personne ayant la force physique nécessaire pour soulever l'appareil.

- Déplacer l'appareil à l'aide d'un chariot ou d'un engin similaire.
- Pour les unités sans poignée, utiliser un équipement de levage de capacité suffisante pour lever l'appareil.
- Tenir l'équipement (câbles et cordons) à distance des véhicules mobiles lors de toute opération en hauteur.
- En utilisant des fourches de levage pour déplacer l'unité, s'assurer que les fourches sont suffisamment longues pour dépasser du côté opposé de l'appareil.
- Suivre les consignes du Manuel des applications pour l'équation de levage NIOSH révisée (Publication N°94-110) lors du levage manuelle de pièces ou équipements lourds.

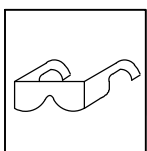

DES PIÈCES DE METAL ou DES SALETES peuvent provoquer des blessures dans les yeux.

- Porter des lunettes de sécurité à coques latérales ou un écran facial.



DES ORGANES MOBILES peuvent provoquer des blessures.

- S'abstenir de toucher des organes mobiles tels que des ventilateurs.
- Maintenir fermés et verrouillés les portes, panneaux, recouvrements et dispositifs de protection.

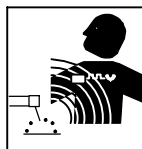

Les CHAMPS ÉLECTROMAGNÉTIQUES (CEM) peuvent affecter les implants médicaux.

- Les porteurs de stimulateurs cardiaques et autres implants médicaux doivent rester à distance.
- Les porteurs d'implants médicaux doivent consulter leur médecin et le fabricant du dispositif avant de s'approcher de la zone où se déroule du soudage à l'arc, du soudage par points, du gougeage, de la découpe plasma ou une opération de chauffage par induction.

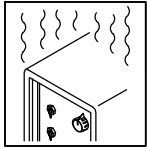

L'EMPLOI EXCESSIF peut SURCHAUFFER L'ÉQUIPEMENT.

- Prévoir une période de refroidissement
- Réduire le courant de sortie ou le facteur de marche avant de recommencer le chauffage.

- Respecter le cycle opératoire nominal.

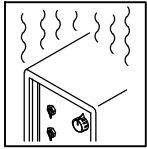

LES CHARGES ÉLECTROSTATIQUES peuvent endommager les circuits imprimés.

- Établir la connexion avec la barrette de terre AVANT de manipuler des cartes ou des pièces.

- Utiliser des pochettes et des boîtes antistatiques pour stocker, déplacer ou expédier des cartes PC.

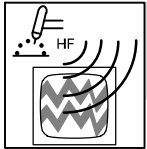

LE RAYONNEMENT HAUTE FRÉQUENCE (HF) risque de provoquer des interférences.

- Le rayonnement haute fréquence (HF) peut provoquer des interférences avec les équipements de radio-navigation et de communication, les services de sécurité et les ordinateurs.

- Demander seulement à des personnes qualifiées familiarisées avec des équipements électroniques de faire fonctionner l'installation.

- L'utilisateur est tenu de faire corriger rapidement par un électricien qualifié les interférences résultant de l'installation.
- Si le FCC signale des interférences, arrêter immédiatement l'appareil.
- Effectuer régulièrement le contrôle et l'entretien de l'installation.
- Maintenir soigneusement fermés les portes et les panneaux des sources de haute fréquence.

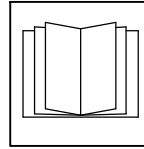

LIRE LES INSTRUCTIONS.

- Lire et appliquer les instructions sur les étiquettes et le Mode d'emploi avant l'installation, l'utilisation ou l'entretien de l'appareil. Lire les informations de sécurité au début du manuel et dans chaque section.

- N'utiliser que les pièces de rechange recommandées par le constructeur.

- Effectuer l'entretien en respectant les manuels d'utilisation, les normes industrielles et les codes nationaux, d'état et locaux.

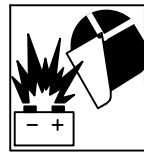

L'EXPLOSION DE LA BATTERIE peut provoquer des blessures.

- Ne pas utiliser l'appareil de soudage pour charger des batteries ou faire démarrer des véhicules à l'aide de câbles de démarrage, sauf si l'appareil dispose d'une fonctionnalité de charge de batterie destinée à cet usage.

2-4. Proposition californienne 65 Avertissements

⚠ Les équipements de soudage et de coupe produisent des fumées et des gaz qui contiennent des produits chimiques dont l'État de Californie reconnaît qu'ils provoquent des malformations congénitales et, dans certains cas, des cancers. (Code de santé et de sécurité de Californie, chapitre 25249.5 et suivants).

⚠ Ce produit contient des éléments chimiques, dont le plomb, reconnus par l'État de Californie pour leur caractère cancérigène ainsi que provoquant des malformations congénitales ou autres problèmes de procréation. *Se laver les mains après toute manipulation.*

2-5. Principales normes de sécurité

Safety in Welding, Cutting, and Allied Processes, ANSI Standard Z49.1, from Global Engineering Documents (phone: 1-877-413-5184, website: www.global.ihs.com).

Safety in Welding, Cutting, and Allied Processes, CSA Standard W117.2, from Canadian Standards Association, Standards Sales, 5060 Spectrum Way, Suite 100, Ontario, Canada L4W 5N5 (phone: 800-463-6727, website: www.csa-international.org).

OSHA, Occupational Safety and Health Standards for General Industry, Title 29, Code of Federal Regulations (CFR), Part 1910, Subpart Q, and









Part 1926, Subpart J, from U.S. Government Printing Office, Superintendent of Documents, P.O. Box 371954, Pittsburgh, PA 15250-7954 (phone: 1-866-512-1800) (there are 10 OSHA Regional Offices—phone for Region 5, Chicago, is 312-353-2220, website: www.osha.gov).

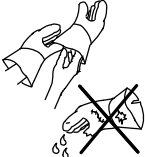
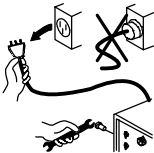

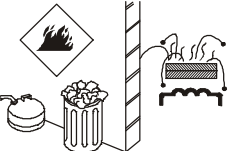

National Electrical Code, NFPA Standard 70, from National Fire Protection Association, Quincy, MA 02269 (phone: 1-800-344-3555, website: www.nfpa.org and www.sparky.org).

SECTION 3 – DEFINITIONS

3-1. Additional Safety Symbols And Definitions

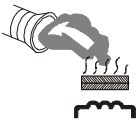
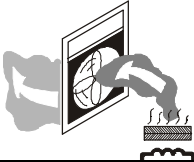
 Some symbols are found only on CE products.

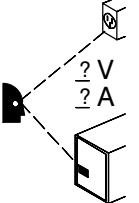
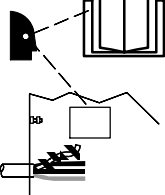
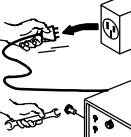
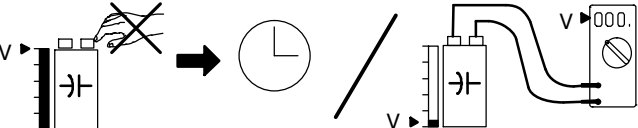

	<p>Warning! Watch Out! There are possible hazards as shown by the symbols.</p> <p style="text-align: right;">Safe1 2012-05</p>
	<p>Wear dry insulating gloves. Do not wear wet or damaged gloves.</p> <p style="text-align: right;">Safe56 2012-05</p>
	<p>Disconnect input plug or power before working on machine.</p> <p style="text-align: right;">Safe5 2012-05</p>
	<p>Induction heating can cause injury or burns from hot items such as rings, watches, or parts.</p> <p style="text-align: right;">Safe74 2012-07</p>
	<p>Do not wear metal jewelry and other metal personal items such as rings and watches during operation.</p> <p style="text-align: right;">Safe75 2012-07</p>
	<p>Induction heating sparks can cause fire. Do not overheat parts and adhesives.</p> <p style="text-align: right;">Safe76 2012-07</p>
	<p>Keep flammables away from heating operation. Do not heat near flammables.</p> <p style="text-align: right;">Safe77 2012-07</p>
	<p>Heating sparks can cause fires. Have a fire extinguisher nearby and have a watchperson ready to use it.</p> <p style="text-align: right;">Safe78 2012-07</p>
	<p>Breathing heating fumes can be hazardous to your health. Read Material Safety Data Sheets (MSDSs) and manufacturer's instructions for material used.</p> <p style="text-align: right;">Safe79 2012-07</p>
	<p>Keep your head out of the fumes.</p> <p style="text-align: right;">Safe80 2012-07</p>

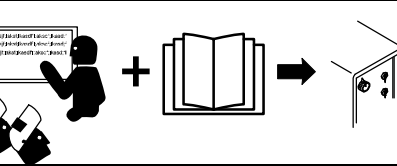
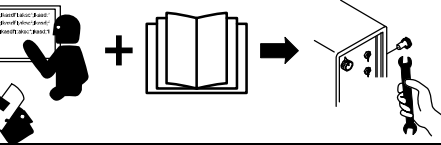
	<p>Use forced ventilation or local exhaust to remove the fumes.</p> <p style="text-align: right;">Safe81 2012-07</p>
	<p>Use ventilating fan to remove fumes.</p> <p style="text-align: right;">Safe82 2012-07</p>
	<p>Always wear safety glasses or goggles during and around heating operations to prevent possible injury.</p> <p style="text-align: right;">Safe83 2012-07</p>
	<p>Wear either safety glasses or full goggles depending on type of operation and nearby processes.</p> <p style="text-align: right;">Safe84 2012-07</p>
	<p>Do not remove or paint over (cover) the label.</p> <p style="text-align: right;">Safe20 2012-05</p>
	<p>Do not discard product (where applicable) with general waste. Reuse or recycle Waste Electrical and Electronic Equipment (WEEE) by disposing at a designated collection facility. Contact your local recycling office or your local distributor for further information.</p> <p style="text-align: right;">Safe37 2012-05</p>
	<p>Consult rating label for input power requirements.</p> <p style="text-align: right;">Safe34 2012-05</p>
	<p>Become trained and read the instructions and labels before working on machine.</p> <p style="text-align: right;">Safe35 2012-05</p>
	<p>Disconnect input plug or power before working on machine.</p> <p style="text-align: right;">Safe30 2012-05</p>
	<p>Hazardous voltage remains on input capacitors after power is turned off. Do not touch fully charged capacitors. Always wait after power is turned off before working on unit, OR check input capacitor voltage, and be sure it is near 0 before touching any parts.</p> <p style="text-align: right;">Safe42 2012-05</p>



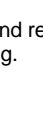

	<p>Connect green or green/yellow grounding conductor to ground terminal. Connect input conductors (L1, L2 And L3) to line terminals.</p> <p style="text-align: right;">Safe86 2012-06</p>
	<p>Become trained and read the instructions before working on the machine or heating.</p> <p style="text-align: right;">Safe85 2012-06</p>

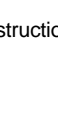
3-2. Miscellaneous Symbols And Definitions

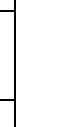
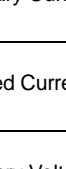
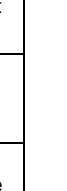
 Some symbols are found only on CE products.

A	Amperage
V	Volts
~	Alternating Current
X	Duty Cycle
IP	Degree Of Protection
Hz	Hertz
	Circuit Protection
	Output
	Increase

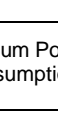
	Line Connection
I₁	Primary Current
I₂	Rated Current
U₁	Primary Voltage
U₂	Load Voltage
	Read Instructions
	Three Phase Static Frequency Converter-Transformer-Frequency Converter
I_{1max}	Rated Maximum Supply Current
P_{1max}	Maximum Power Consumption

3~	Three Phase
%	Percent
	Remote
	Panel/Local
	High Temperature
	Voltage Input
○	Off
	On
	Induction Heating

SECTION 4 – SPECIFICATIONS

4-1. Serial Number and Rating Label Location

The serial number and rating information for the power source is located on the front of the machine. Use the rating labels to determine input power requirements and/or rated output. For future reference, write serial number in space provided on back cover of this manual.

4-2. Specifications

 Do not use information in unit specifications table to determine electrical service requirements. See Sections 5-2, 5-3 and 5-4 for information on connecting input power.

Output Frequency	Rated Output		Required Reflective Inductance	Amperes Input at Rated Load Output 50 or 60 Hz, Three-Phase			kVA	kW	Overall Dimensions	Weight
	Single Output	Dual Output		400 V	460 V	575 V				
5 To 30 kHz	35 kW At 100% Duty Cycle 350 A (RMS), 700 V (RMS)	35 kW At 100% Duty Cycle 700 A (RMS), 700 V (RMS)	2.5 To 50 μ h	60 A	50 A	40 A	39	37	Length: 36-3/4 in. (993 mm) Width: 21-1/2 in. (546 mm) Height: 29 in. (737 mm)	227 lb (103 kg)

4-3. Environmental Specifications

A. IP Rating

IP Rating	Storage Temperature Range
IP23C This equipment is designed for outdoor use. It may be stored, but is not intended to be used for welding outside during precipitation unless sheltered.	-40 to 122 °F (-40 to 50°C)

IP23C 2014-06

B. Information On Electromagnetic Compatibility (EMC)

 **This Class A equipment is not intended for use in residential locations where the electrical power is provided by the public low-voltage supply system. There may be potential difficulties in ensuring electromagnetic compatibility in those locations, due to conducted as well as radiated disturbances.**

This equipment complies with IEC61000-3-11 and IEC 61000-3-12 and can be connected to public low-voltage systems provided that the public low-voltage system impedance Z_{max} at the point of common coupling is less than 33.37m Ω (or the short-circuit power S_{sc} is greater than 4,795,346 VA). It is the responsibility of the installer or user of the equipment to ensure, by consultation with the distribution network operator if necessary, that the system impedance complies with the impedance restrictions.

ce-emc 1 2014-07

SECTION 5 – INSTALLATION

5-1. Selecting A Location



Movement

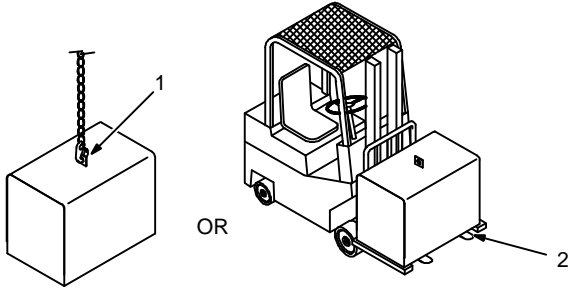

⚠ Do not move or operate unit where it could tip.

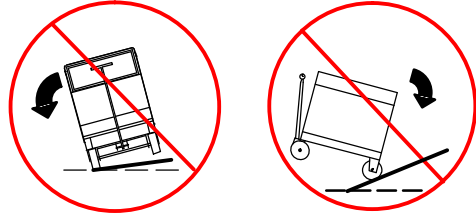

Location And Airflow

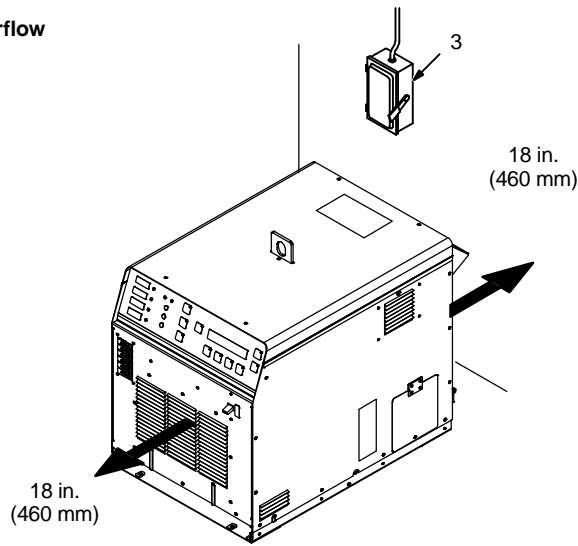

⚠ Special installation may be required where gasoline or volatile liquids are present – see NEC Article 511 or CEC Section 20.

- 1 Lifting Eye
- 2 Lifting Forks

Use lifting eye or lifting forks to move unit.

If using lifting forks, extend forks beyond opposite side of unit.

- 3 Line Disconnect Device

Locate unit near correct input power supply.

803992-B loc_large 2015-04

5-3. Connecting 3-Phase Input Power For 460/575 Volt Models

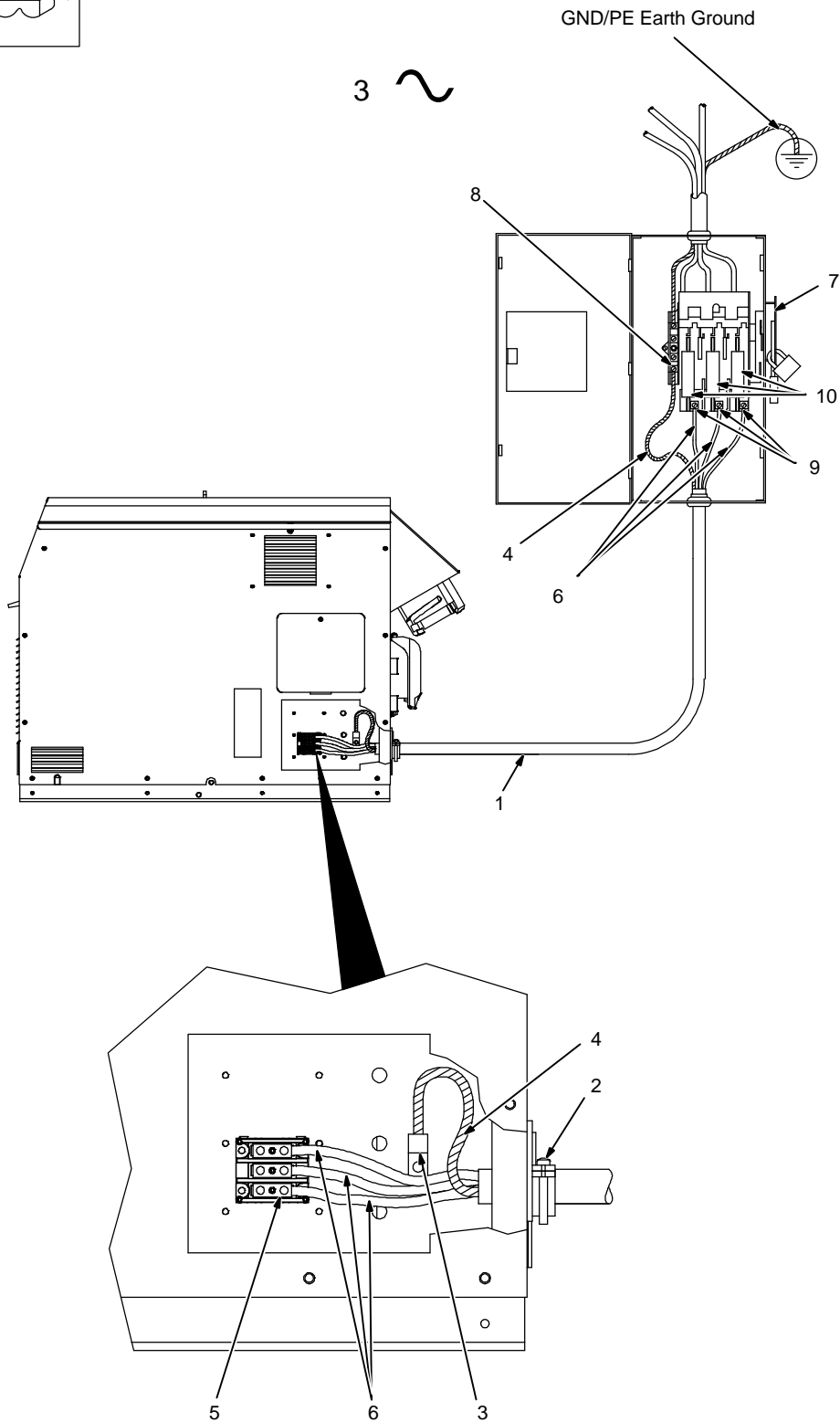

Tools Needed:

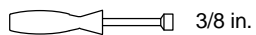

5-4. Connecting 3-Phase Input Power For 400/460 Volt IEC And CE Models

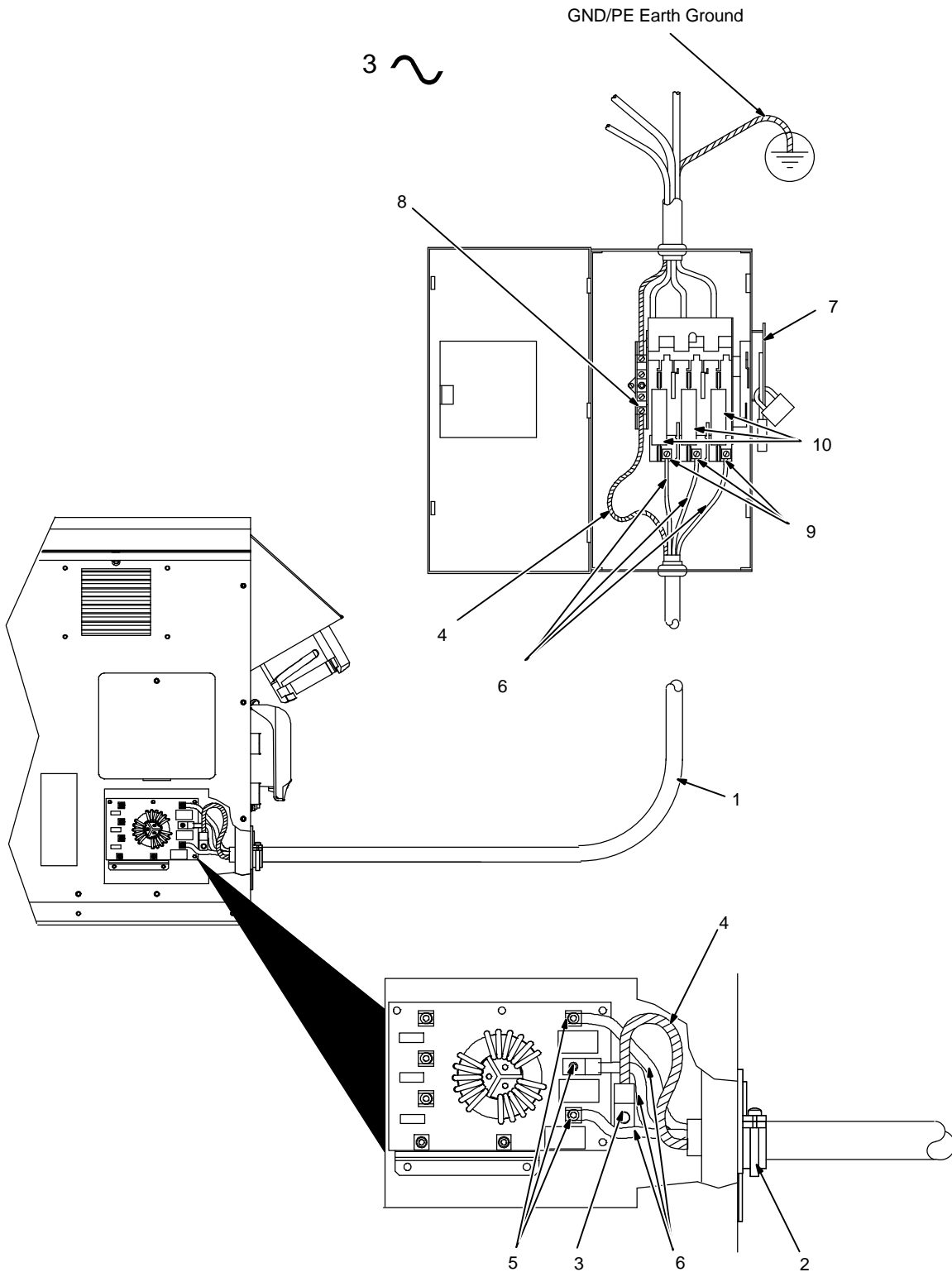

Tools Needed:

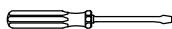

Input3 2015-01 / Ref. 804 430-B

5-5. Power Source Output Connections

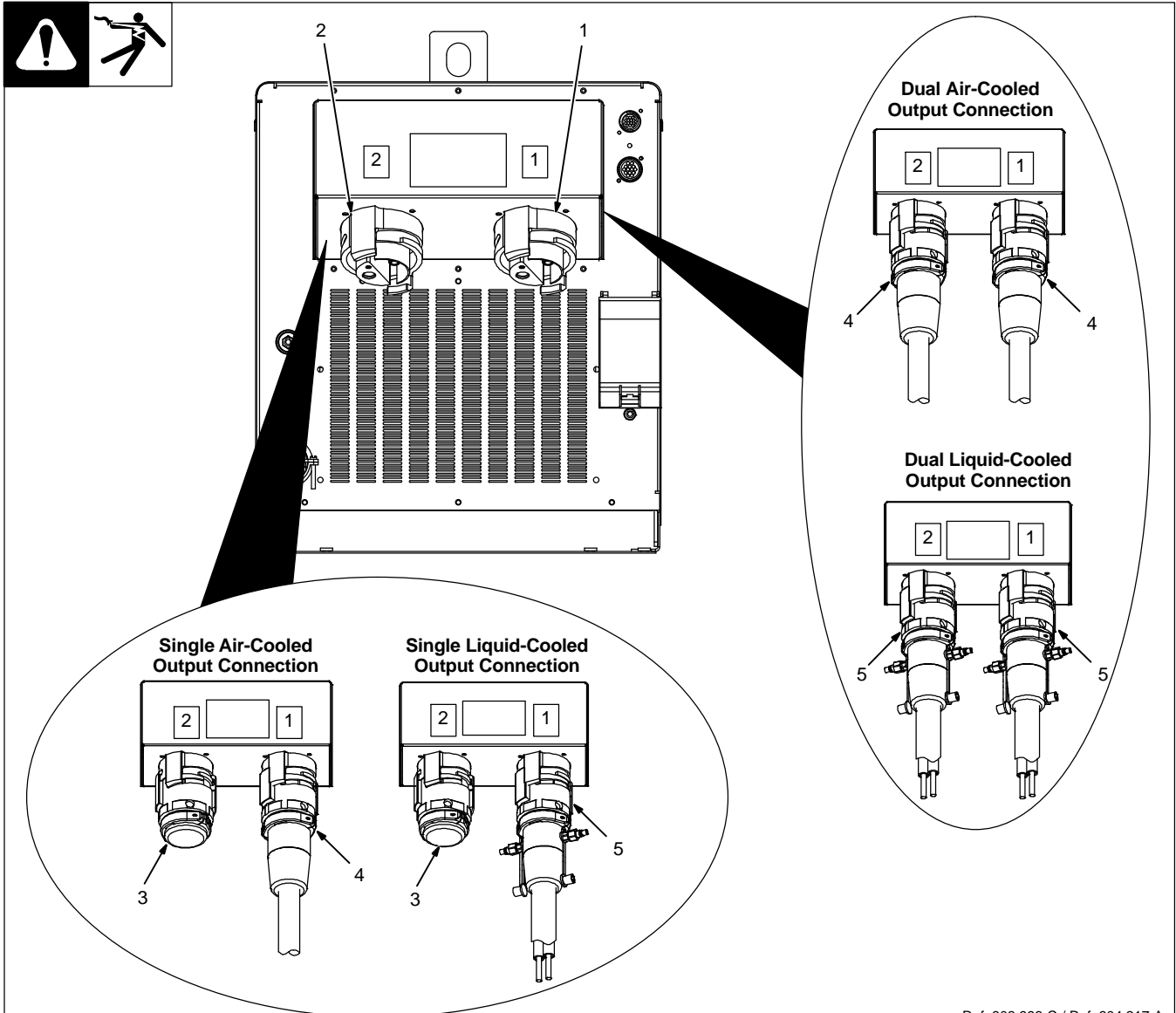

⚠ Steam and hot coolant can burn. Hose may rupture if coolant overheats. Never disconnect both ends of hose when installed on hot workpiece. If coolant flow stops, leave one end of hose connected to allow hot coolant to return to cooler and relieve pressure. Remove hose from hot workpiece to prevent damage.

- 1 Output Connector 1
- 2 Output Connector 2
- 3 Protective Plug
- 4 Air-Cooled Extension Cable
- 5 Liquid-Cooled Extension Cable

The power source is capable of single or dual output. When connected for single power output, up to 35 kW is available at the single output connection. When connected for dual power, output power is divided between the two output connections.

⚠ Do not move or disconnect cables while output is on.

Single Air-Cooled Output Connection

Connect air-cooled output extension cable to Output Connector 1 or Output Connector 2. Connect Protective Plug to remaining Output Connector.

Single Liquid-Cooled Output Connection

Connect liquid-cooled output extension cable to Output Connector 1 or Output Connector 2. Connect Protective Plug to remaining Output Connector.

Dual Air-Cooled Output Connection

Connect air-cooled output extension cables to Output Connector 1 and Output Connector 2.

☞ Extension cables must be the same length: 25 ft (7.6 m), 50 ft (15.2 m), or 75 ft (22.8 m).

Ref. 803 993-C / Ref. 804 217-A
☞ Blankets must be the same size.

Dual Liquid-Cooled Output Connection

Connect liquid-cooled output extension cables to Output Connector 1 and Output Connector 2.

☞ Extension cables must be the same length: 10 ft (3 m), 25 ft (7.6 m), or 50 ft (15.2 m).

☞ Heating cables must be the same length: 30ft (9.1 m), 50 ft (15.2 m), 80ft (24.2 m), or 140 ft (42.7 m).

☞ Total length of heating and extension cables must not exceed 360 ft (110 m). The extension cable is counted twice the length because it has a supply and return hose.

NOTICE – Use only Miller ProHeat accessories with a Miller ProHeat power source.

5-6. Remote 14 Receptacle RC14 Information and Connections

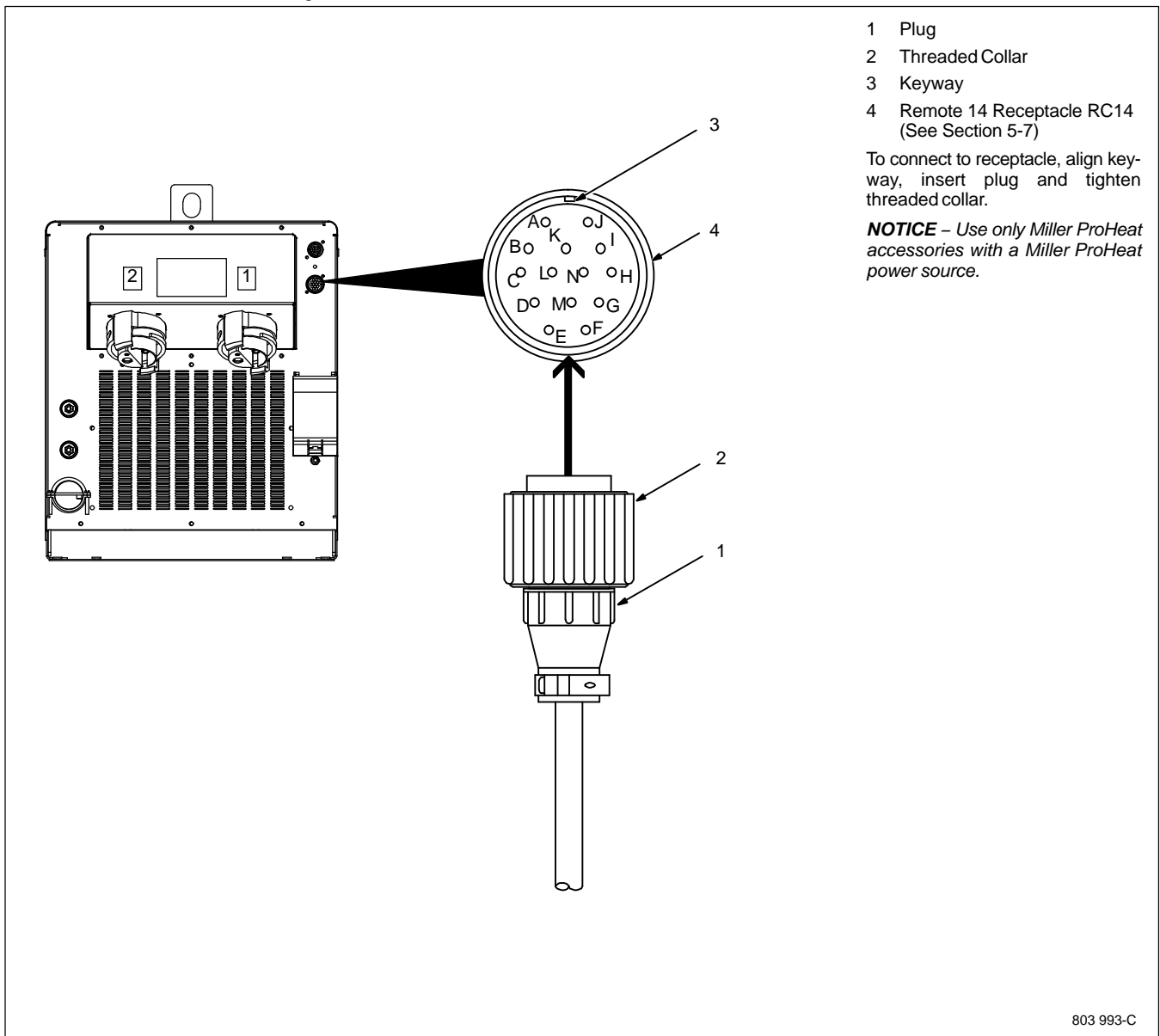

5-7. Remote 14 Socket Information

Socket	 REMOTE 14	Socket Information
A B	Remote Contactor	+24 volts DC. Contact closure to A completes 24 volts DC contactor control circuit.
C D E G	Remote Output Control	Command reference; +10 volts DC. Control circuit common. Input command signal (potentiometer wiper or 0 to +10 volts DC). Not used.
F, J	Power Source Fault	Absence of internal contact closure between F and J signals power source fault to remote control device (an external power source must be used).
H I L M N K	Remote Metering	Not used. Actual frequency output signal (1 volt/10 kHz). Average power output signal (1 volt/10 kW). Voltage output signal RMS (1 volt/100 volts). Total current output signal RMS (1 volt/100 amperes). Chassis common.

5-8. Temperature Recorder Receptacle RC9 Information And Connections

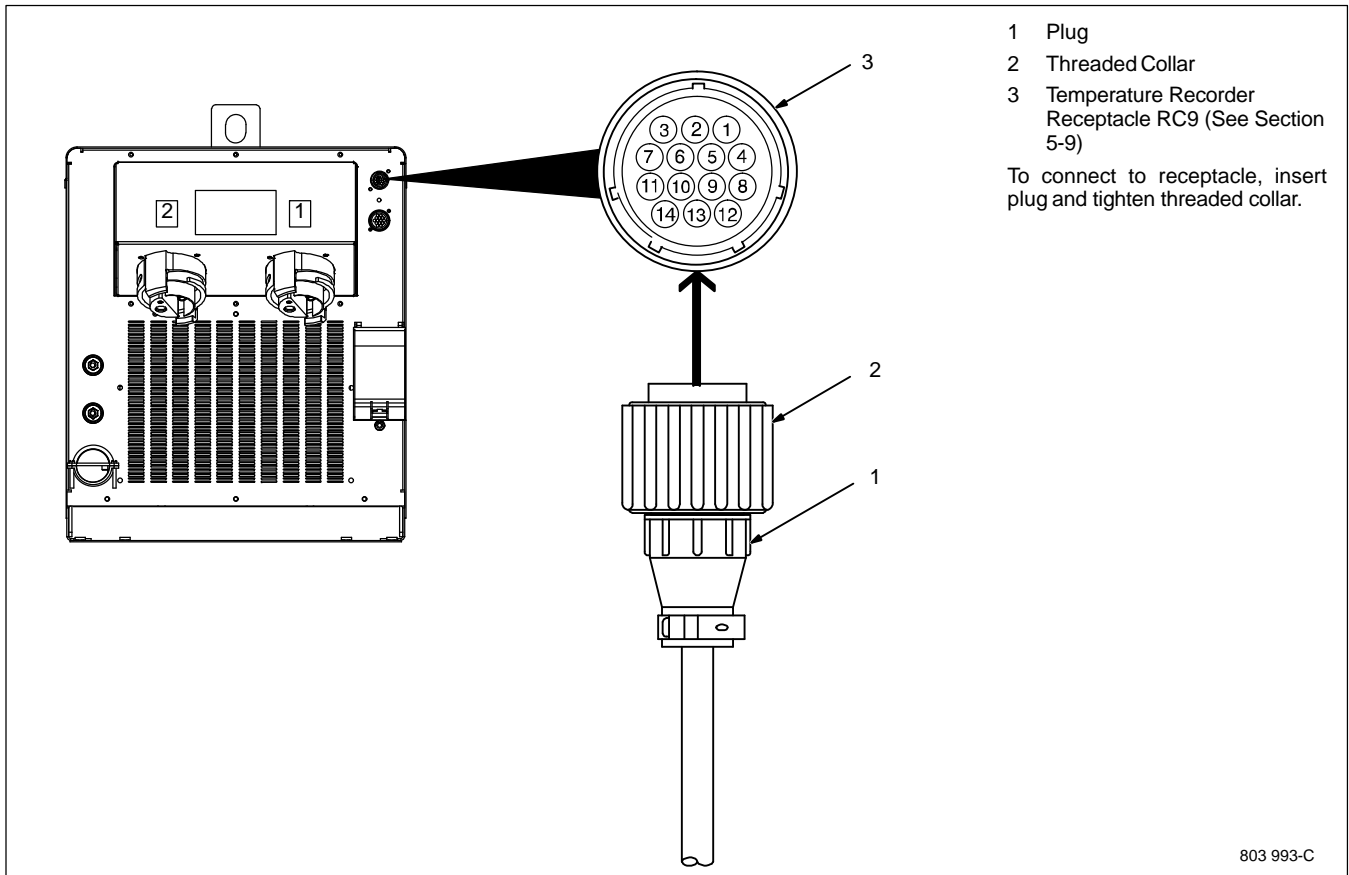

5-9. Temperature Recorder Socket Information

	Socket No.	Socket Information
	1	Thermocouple No. 1 (TC1), 0-10 volt DC signal [0V = -50° F (-46° C), 10V = 1500° F (816° C)]
	2	Thermocouple No. 2 (TC2), 0-10 volt DC signal [0V = -50° F (-46° C), 10V = 1500° F (816° C)]
	3	Thermocouple No. 3 (TC3), 0-10 volt DC signal [0V = -50° F (-46° C), 10V = 1500° F (816° C)]
	4	Thermocouple No. 4 (TC4), 0-10 volt DC signal [0V = -50° F (-46° C), 10V = 1500° F (816° C)]
	5	Signal Common
	6	Thermocouple No. 5 (TC5), 0-10 volt DC signal [0V = -50° F (-46° C), 10V = 1500° F (816° C)]
	7	Thermocouple No. 6 (TC6), 0-10 volt DC signal [0V = -50° F (-46° C), 10V = 1500° F (816° C)]
	8	Unused
	9	Unused
	10	Chassis Ground
	11	Unused
	12	Unused
	13	Unused
14	Unused	

* The voltage to temperature calculation is:

$$(\text{DC Volts Out} \times 155) - 50 = ^\circ\text{F}$$

$$(\text{DC Volts Out} \times 86.1) - 45.4 = ^\circ\text{C}$$

The ProHeat display should read ± 6 °F or ± 3.3 °C.

5-10. Secondary Insulation Protection

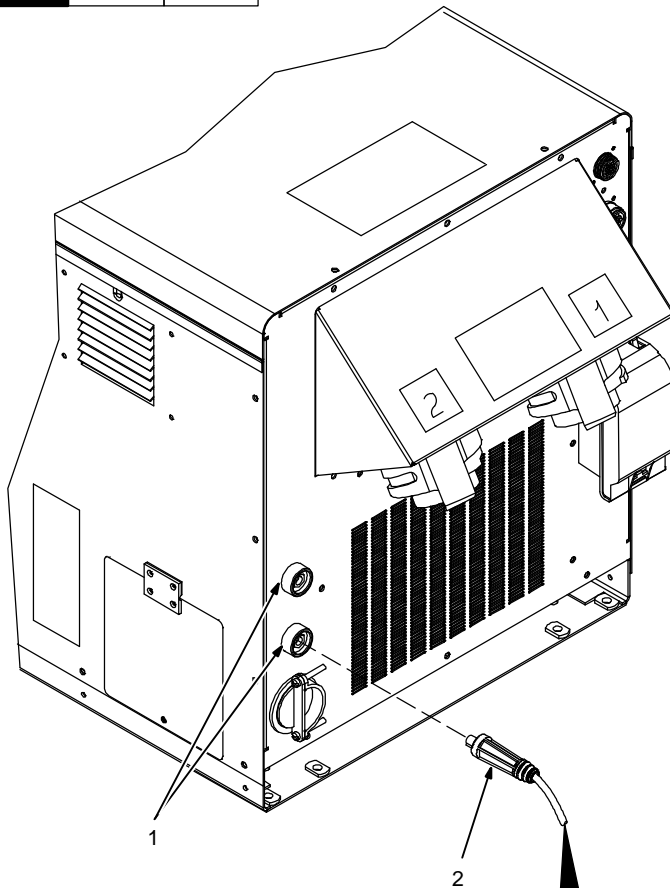

⚠ Connect supplied ground lead(s) between the workpiece and power source to provide proper secondary insulation protection from a short in the output circuit. For single output, only one ground lead is required. For dual output, use both ground leads.

Secondary insulation protection circuitry automatically shuts down the power source output if a potentially hazardous condition exists at the heating device connected to the power source (e.g. insulation has broken down on a heating blanket causing the conductor to come into contact with the workpiece or a heating coil touches the workpiece causing a short in the output circuit).

1 Receptacles

2 Plug

To connect plug, align key with key-way, insert end into receptacle, and rotate plug until tight.

3 Handle

4 Magnet

ⓘ *The secondary isolation magnet must be in contact with bare metal (free from rust, paint, grease, etc.).*

5 Workpiece

Use handle to place magnet on the workpiece.

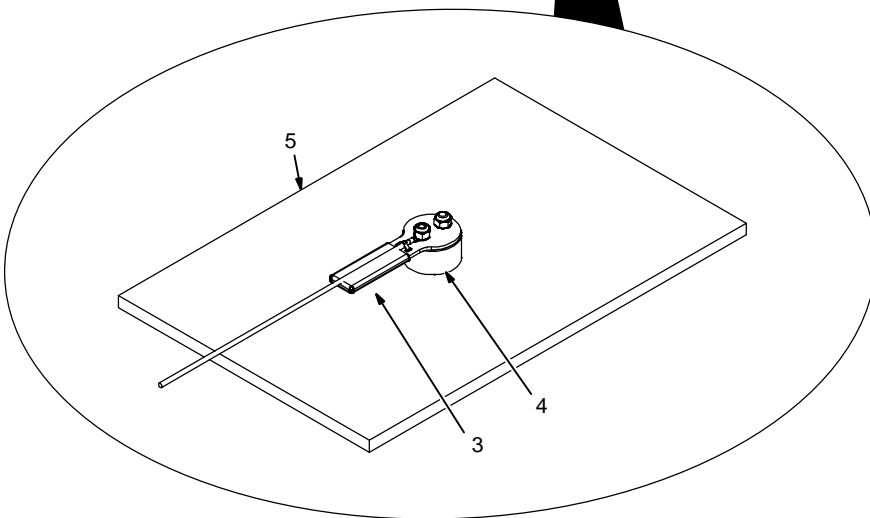

5-11. 115 Volt AC Duplex Receptacle And Supplementary Protector

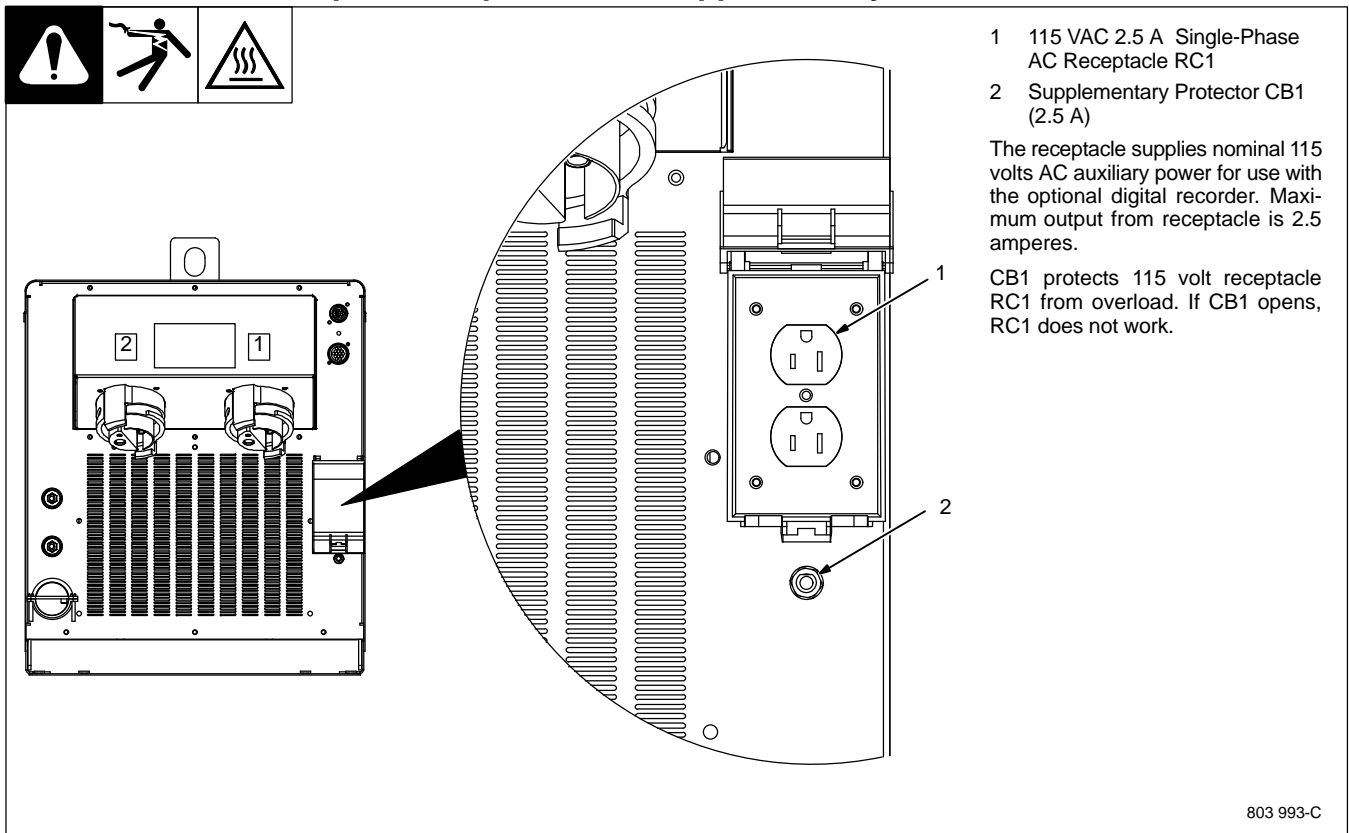

5-12. Locating Thermocouples



Thermocouple location is one of the most critical steps in the Heat Treatment Operation.

Thermocouples shall be located as follows to provide a survey of heating uniformly and enable time and temperature control:

1. Locate thermocouples to ensure that the full area of the heat band is monitored.
 - Locate thermocouples to ensure that the full area of the heat band is monitored.
 - The code normally specifies the number of thermocouples to be used based on the pipe diameter.
 - The control thermocouple is placed in the plane of the weld (center of the heat zone).
 - The control thermocouple is placed at the top of the pipe in a standard pipe joint configuration. In other applications, the thermocouple should be located in the hottest portion of the weldment to be stress relieved.
2. Consider all nozzles and other welded attachments that cause potential heat sinks through metal mass or cold spots due to heat convection or conduction, and have additional thermocouples applied.
3. Attach a spare thermocouple beside control thermocouples.
4. Attach thermocouples to ensure uniformity of temperature in both thin and thick workpieces.
5. Physically inspect all thermocouples for continuity and mark them by an identification number corresponding to the recorder channel.
6. Match the drawings of the workpiece indicating the numerous thermocouple locations, controlling thermocouple locations, etc. to weld identification information.
7. The system is equipped with 3-pin thermocouple connections at the front of the unit. Six thermocouples can be attached to the power source.
 - The system is equipped with 3-pin connectors to accommodate shielded extension cables. The shielded cables protect from electrical interference.
8. Type K thermocouple wire has a positive and negative wire. The positive wire is marked as solid yellow or striped yellow. The connector screw terminals are marked positive and negative. Be sure to attach the wire to the connector with proper polarity.
9. Multiple type K thermocouple devices are supported, such as contact TC probes, welded on TC wire, and IR sensors with type K output. IR sensors with 4–20 mA outputs are also supported.

10. The following describes the thermocouple routing from work to power source.

- Type K thermocouple wire (two wire) is attached directly to the workpiece using a Thermocouple Attachment Unit (see next section for information on attaching thermocouples).
- The other end is fitted with a 2-pin type K connector.
- The 2-pin connector plugs into the 3-pin composite extension cable. The extension cable has a six-channel block of 3-pin female connectors. The pin size locates the position of the 2-pin connector on the extension.
- The extension cable contains six, 3-wire bundles of shielded cable.
- The 3-pin male extension cable plugs into the 3-pin female connector on the front of the power source.

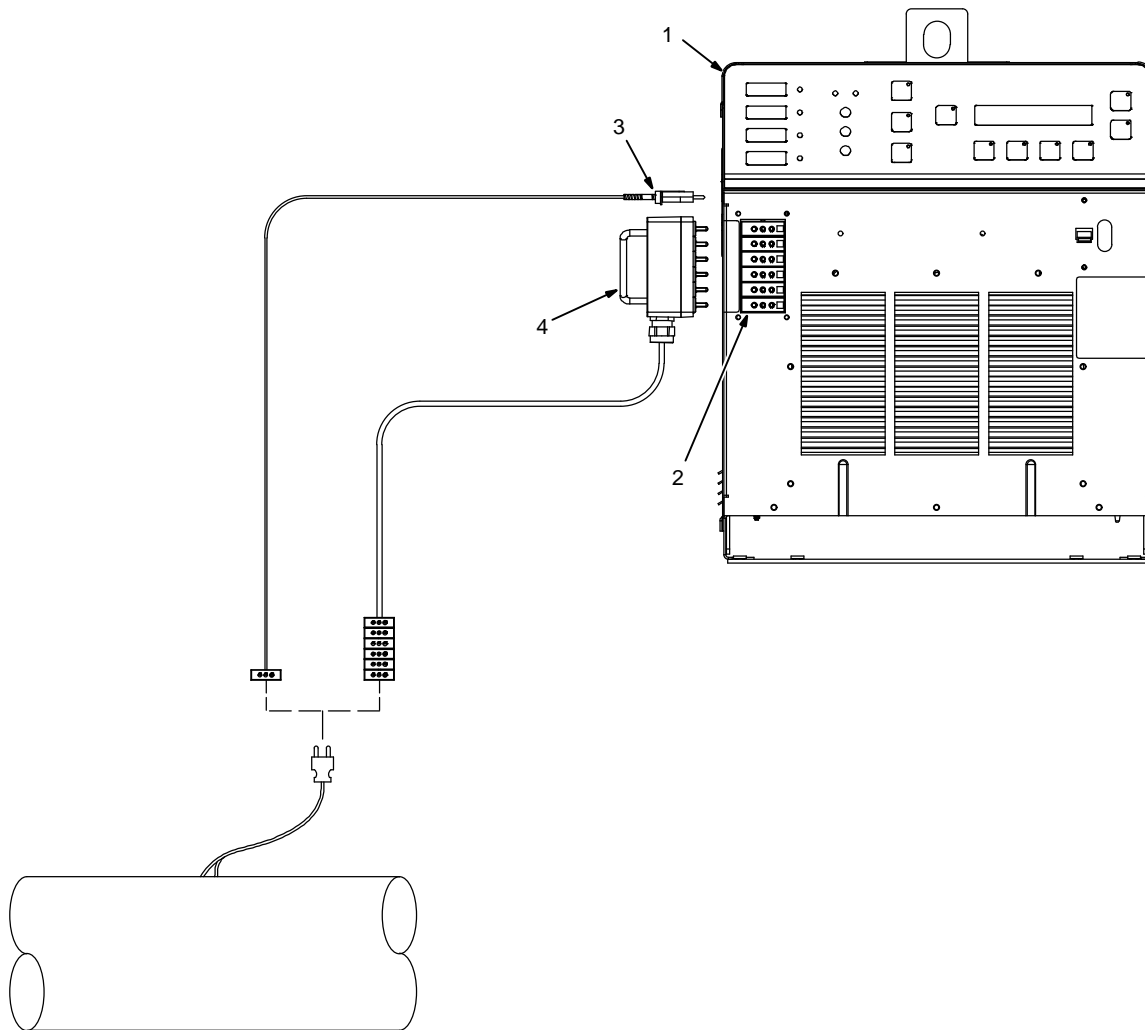

804 320-A

For temperature control mode, the power source must have (as a minimum) one thermocouple connected to receptacle TC1. If multiple thermocouples are desired, either use individual thermocouple plugs or the thermocouple extension cable.

To connect thermocouples to the power source, proceed as follows:

⚠ Do NOT weld thermocouples to workpiece while thermocouple cable is connected to the power source.

Turn Off power source.

- 1 Power Source
- 2 Thermocouple Receptacles

3 Individual Thermocouple Extension Cable

4 Multiple Thermocouple Extension Cable

Align plug pin(s) with receptacle socket(s) and push plug into receptacle.

5-13. Attaching Welded Thermocouples

 Do NOT weld thermocouples while connected to power source.

1. Attach thermocouples using a portable Thermocouple Attachment Unit (TAU). This unit spot welds thermocouple wire directly to the workpiece. This method of thermocouple attachment ensures accurate temperature measurement.
2. Clean (file or grind) any loose scale or rust from the workpiece at the places where the wires will be attached.
3. Clean the location for the lead magnet to minimize resistance. Place the magnet as near to the thermocouple positions as possible.
4. Strip 1/4 in. of insulation from the thermocouple wires.
5. Set the output variable control of the TAU to about eighty percent (80%).
6. Grasp one of the stripped wires with the tip of the jaws of the application pliers.

 Don't touch both wires of the thermocouple to the pliers at the same time when energizing the Thermocouple Attachment Unit. This will cause the thermocouple wire to fuse to the pliers, rather than the workpiece.

7. Press the end of the wire to the workpiece at ninety degrees to the surface, and maintain a firm pressure. Make sure the Thermocouple Attachment Unit is charged and wait for the ready light to glow.
8. Press discharge button, and the wire should weld to the workpiece. There will be a sharp crack and a slight arc flash.
9. Repeat the process with the other wire, placing it approximately 1/4 in. away from the first wire. Attach a spare thermocouple, and support both thermocouples approximately 18 in. back from the connection with a band or fiber tape.
10. Carefully bend the wire over at right angles. This brings the thermocouple wires out along or parallel to the workpiece. It also tests the strength of the weld. If the weld shows signs of breaking, remove the wire, restrip the end, and repeat the process.

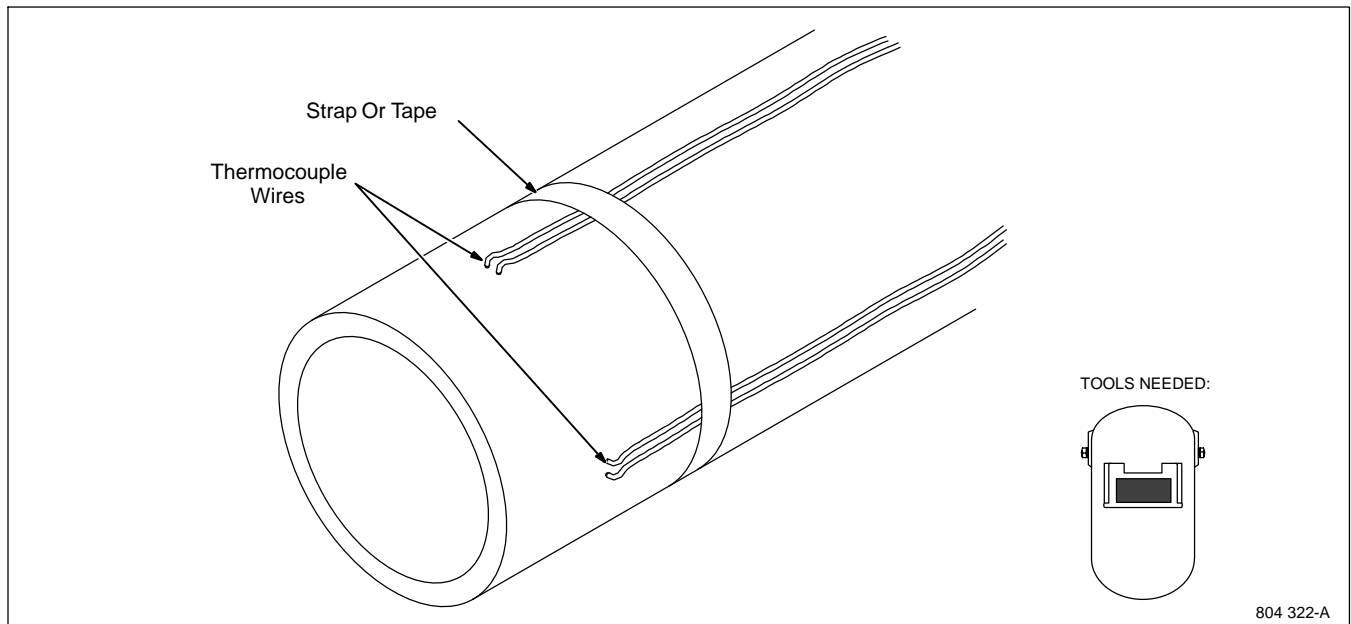

5-14. Using Contact Thermocouple Sensors

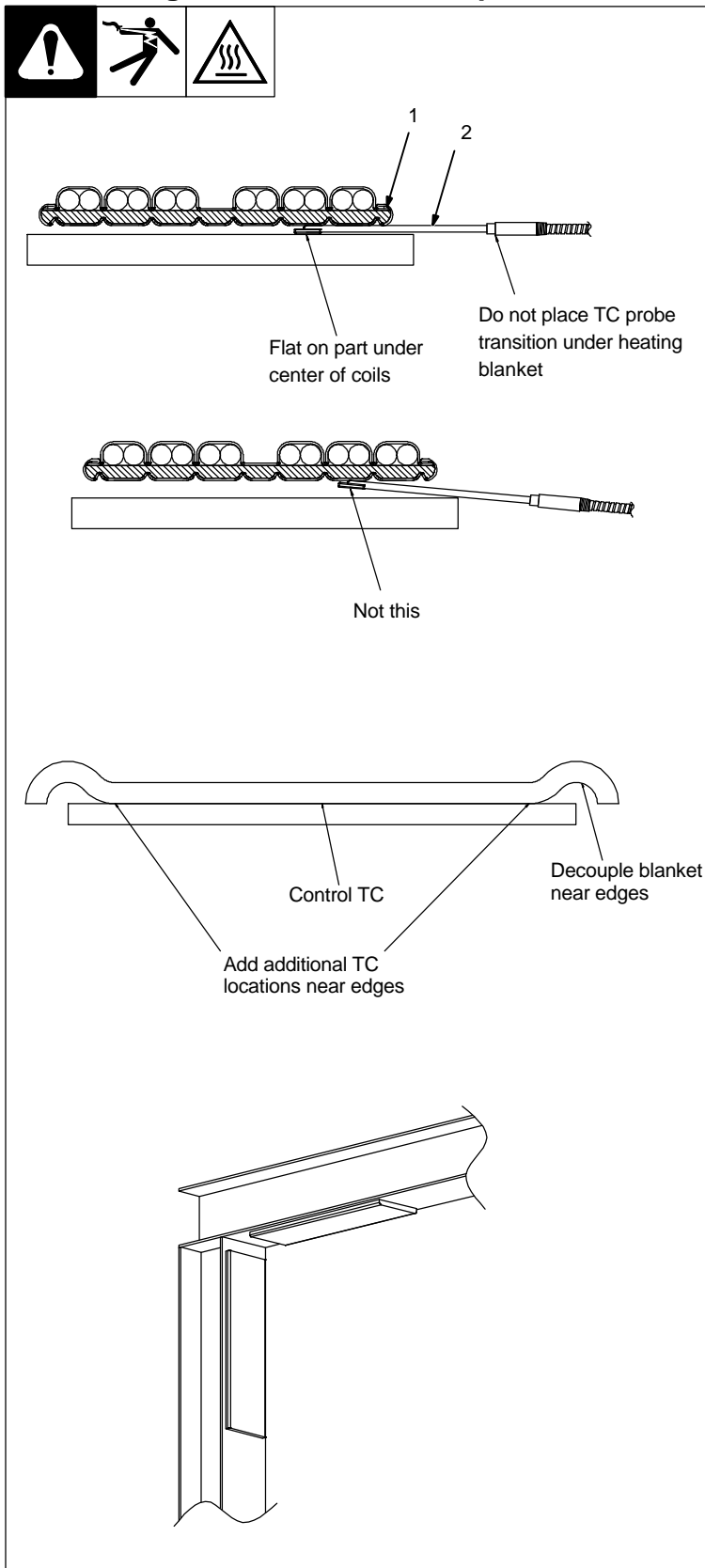

- 1 Blanket
- 2 Contact Thermocouple Sensor
(See Product Literature Sheet)

The welded thermocouples discussed previously can be used for preheating or stress relieving. Welded thermocouples are normally used in stress relieving applications because of their accuracy and ability to withstand high temperatures.

As an alternative, in preheating applications a contact thermocouple sensor can be used. This eliminates the need to weld thermocouples and the sensor can be moved during the preheat process to check temperatures at other locations on the joint. (Contact thermocouple sensors are limited to 500° F [260° C].)

If the contact thermocouple sensor is removed, the temperature recorder (if used) will display a short duration of heat drop.

The contact thermocouple sensor can be plugged into the thermocouple extension cable or a Type K 25 ft. armored extension cable. One of these extensions is required for each sensor.

In preheating applications, the sensor must be placed under the induction coil. To be accurate, the sensor flat end must be held against the heated surface. If liquid-cooled or air-cooled coils overlap at any location in your installation, it is recommended that a second sensor be placed at that location.

NOTICE – Failure to follow these recommendations could cause heat damage in the blanket or coil.

Temperatures at the weld joint can be checked with temperature sensitive crayons to verify the preheat temperature.

Placing Contact Thermocouple Sensor

Place sensor between blanket and metal material. The sensor must be flat and in firm contact with the material being heated. The tip of the sensor should be positioned under the center of the wires of the blanket anywhere along the blanket length.

To prevent thermocouple sensor from pulling out of position, contact TC sensor securing band 301 073 is available.

NOTICE – When using a contact thermocouple with air cooled blankets, position is critical. If any part of the blanket exceeds 400°F (200°C) for extended periods of time, damage to the blanket will occur.

Additional sensors may be placed at the ends of the part to protect from overheating. If a blanket is hanging off the end of the part or goes over a cutout, insulation may be added between the blanket and metal, slightly decoupling the coil, which causes the area to receive less eddy currents and generate less heat.

NOTICE – When heating next to a joint, control sensor (TC#1) must be under the heating coil. A separate sensor may be placed at the joint to monitor joint temperature.

When positioning blankets in vertical or overhead positions, ensure the non-insulated side of the blanket is able to radiate heat. Do not cover blanket with insulation, wood, etc. Trapping heat in the blanket may damage the blanket.

273 097-A

5-15. Using Non-contact Temperature Sensors

It is important to locate non-contact temperature sensors so that they are measuring as close to the heat zone as possible to achieve consistent temperature control of the system. The greater the distance between the heat zone and the area read by the sensor, the more the control loop will fluctuate around the target temperature.

The spot measurement location should be within two inches (50 mm) of the heat zone.

SECTION 6 – COMPONENTS AND CONTROLS

6-1. Controls

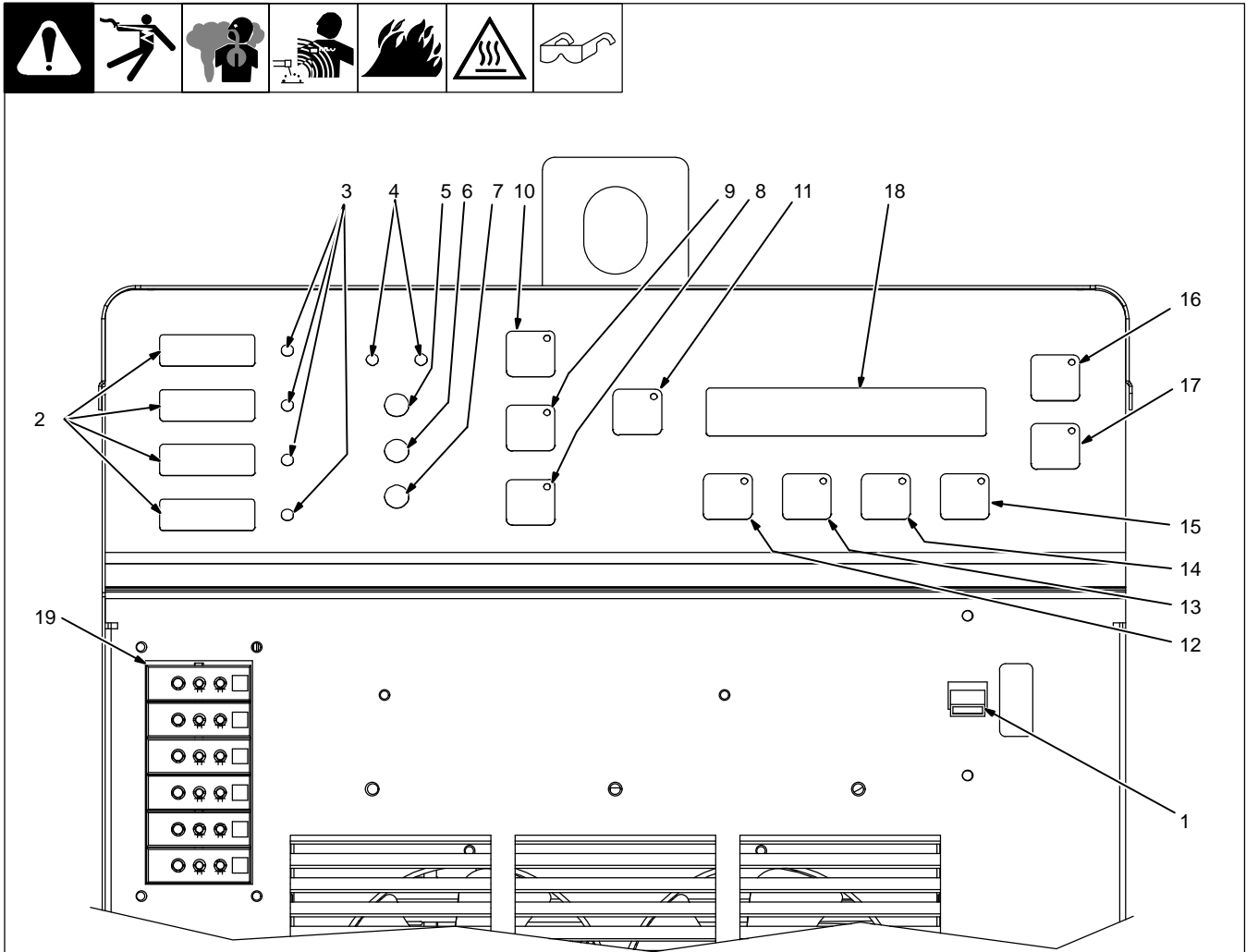

803 995-B

 When a control panel button is pushed the yellow lamp lights to indicate activation.

1 Power Switch

Use switch to turn power source On and Off.

2 TC1–4 Temperature Display

Provides temperature display of thermocouples 1 through 4.

3 Control Thermocouple LEDs

LEDs indicate which thermocouples (1–4) are used to control the heating process.

4 Temperature Units LEDs

LEDs indicate units for temperature measurements (°F or °C).

5 Fault LED

LED lights to indicate a system fault condition.

6 Limit LED

LED lights to indicate a system limit condition.

7 Heat On LED

LED lights to indicate the power source output is energized.

8 Stop Button

Use button to stop a heating process.

9 Hold Button

Use button to hold a heating process.

10 Run Button

Use button to run a heating process.

11 Cursor Button

Use button to move selection cursor in the 4 x 40 LCD display (item 18).

12 Program Button

Use button to program the process control.

13 Run Status Button

Use button to display real time operating status.

14 Parameter Button

Use button to display real time power source operating parameters.

15 Cooler Button

Use button to turn cooler On and Off.

16 Increase Button

Use button to increase values in set-up screen.

17 Decrease Button

Use button to decrease value in program screen.

18 4 x 40 LCD Display

Displays programming, runs status, parameter, fault and limit conditions, and troubleshooting guide.

19 Thermocouple Input Receptacles

Use receptacles for type K thermocouple inputs.

SECTION 7 – SETUP AND OPERATION

7-1. Safety Equipment



⚠ Do not wear rings or watches during operation.

Wear the following during operation:

- 1 Dry, Insulating Gloves
- 2 Safety Glasses With Side Shields

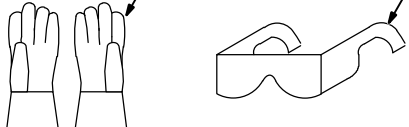

sb3.1* 1/94

7-2. System Description

The ProHeat 35 Induction Heating Power Source is designed to function either as an air-cooled system or a liquid-cooled system. Depending on the system type (including Air-cooled, Liquid-cooled, and Rolling Inductor), the power source is automatically configured to operate and provide an output appropriate for the type of connected heating device.

A special identifier, embedded within the extension cable connector, provides the means for the power source to configure itself by recognizing the type of extension cable(s) attached to its output connectors.

Designed to provide a single level of output (up to 35 kW), the ProHeat 35 power source has two panel mounted connectors that are connected in parallel to the power source output. This design allows the system to operate with either a single output extension cable or two output extension cables.

If a single output extension cable is used, a protective plug (provided with the system) **MUST** be placed on the unused output connector or the system will not operate. If two output extension cables are used, they both **MUST** be of the same type (either both air-cooled or both liquid-cooled) or the system will not operate (in this case, the protective plug is not used). When two extension cables and heating devices are utilized on the system, the extension cable lengths and heating devices **MUST** be identical (see Section 5-5).

The ProHeat 35 is intelligent to the point that it will automatically adjust output power levels if internal system operating parameters or internal temperatures reach or exceed specific set limits (see Section 10).

7-3. Important System Guidelines

NOTICE – When using multiple ProHeat systems on the same workpiece, keep the the coil(s) from each system at least 1 ft (30 cm) apart. The ProHeat 35 may be damaged if coils are placed closer together.

NOTICE – Some residual heating can occur in ferrous materials placed near the output cables. Moving the output cables away from the ferrous materials could reduce inadvertent heating.

Non-ferrous materials can be used for fixturing depending on part temperature. Examples include glastic, pegboard, wood, PVC, and fiberglass. If metallic materials need to be used, consider limited amounts of aluminum, brass, or copper.



7-4. Power Source/System Setup

To view the System Setup screen, simultaneously press the Parameters  and Program  buttons and the following screen will appear on the display:

System Setup Screen 1

Deg Units...:>°F	SYSTEM SETUP1
Tolerance...: ±25	
Max Output...: 35 KW	RI Clr Purge: 60s
Control Mode: Temp	RI Init KW: 0.0KW

To change a setting:

- Press the Cursor  button to move the cursor to the parameter to be changed.
- Press Increase  or Decrease  button to select desired set-up feature.

Possible selections:

Degree Units: °F / °C

Tolerance: ±5 to 99 in °F (±3 to 55 in °C)

Control Mode: Temp / Remote / Time / Manual

Temperature Mode

- Initial kW value used in Rolling Inductor mode only
- Uses IR to control power

Time Mode

- Does not use Initial kW setting
- IR sensors can monitor temperature but not control power

Remote Mode

- Functions same as Manual Mode but from a remote
- IR sensors can monitor temperature but not control power

Manual Mode

- Initial kW value not used
- IR sensors can monitor temperature but not control power

Rolling Inductor Initial kW: 0.0–35.0 kW

Power Output: 1 to 35 kW

Rolling Inductor Cooler Purge Time: 30–240 seconds

Degree Units – Selection will drive the °F / °C indicator LEDs.

- The factory default is °F.
- Changing from °F to °C will convert stored program values: ramp temperature, soak temperature, ramp rate, and temperature tolerance.

Tolerance – The factory default is ±25 °F.

Control Mode – Either Temperature, Remote, or Power vs Time (Time), or Manual. For more details about methods of control, see Section 7-5.

- The factory default is temperature based control.

Rolling Inductor Initial kW – The factory default is 0.0. Max setting is dependant on Max Output setting.

Power Output – The factory default is 35 kW.

Rolling Inductor Cooler Purge Time – The factory default is 60 seconds.

Simultaneously press the Parameters  and Program  buttons a second time, and the following screen will appear on the display:

System Setup Screen 2

TC1,2 Type... :>IR4-20	SYSTEM SETUP2
IR Input Max.: 750	Trvl Detect... : On
IR Input Min.: 212	Trvl Speed... : IPM
Decouple Fault: On	

Possible selections:

Input Type: K TC / IR 4–20 ma (TC 3–6 are fixed at K TC)

IR Input Max: Set the IR sensor's (20 mA) equivalent value

Travel Detect: On / Off. Functions as an On/Off switch with air and liquid cooled cables. See Table 7-2 for functionality with Rolling Inductor.

IR Input Min: Set the IR sensor's (4 mA) equivalent value

Travel Speed IPM / CPM (inches per minute/centimeters per minute)



Decouple Fault: On / Off

Turning off the Decouple Fault allows the system to run with poorly coupled coils. This feature is only available when using liquid cooled cables. A message will display each time the ProHeat is turned on to remind that the circuit is turned off.

```
F73: Decoupled/Open Coil
      Fault Disabled for
      Liquid Cooled Cables Only
      Press (-) to Acknowledge
```

Press the Decrease  button on the front panel to acknowledge the message.





If using a remote On/Off switch, cycling from Off to On 2 times within 3 seconds will also acknowledge the message.

Display Contrast – press and hold the cursor and press the Increase  button to darken, or press the Decrease  button to lighten the contrast.

All parameters in System Setup are considered global, and any changes to the system set-up parameters will apply to all programs.

The option to turn backlight on/off was removed at software revision 1.26. Backlight is now always on.

7-4-1. Factory Defaults

To reset the system back to factory default settings, turn off the power source, and wait until the display goes blank. Turn on the power source. When the display lights, press and hold the Increase  and Decrease  buttons. A message will display Press Program to reset factory defaults. Release the Increase  and Decrease  buttons, and press the Program  button.

7-5. Programming

Programming allows the operator to setup a program for a particular heating process. The selections available are Temperature, Remote, Manual, or Power vs Time (Time).

7-5-1. Temperature-Based Control



Temperature-based control operates the system and controls the heating process based on temperature feedback from thermocouple inputs. Thermocouples must be used for this mode of operation or the system will not operate. Within the temperature-based mode there are four different processes available as follows: Preheat, Bakeout, PWHT (Post-Weld Heat Treat), and Custom Program.



Press the Program button to access the programming mode. Use the cursor button to move the cursor to the desired temperature-based process, then press the Program button again to select the process.

7-5-1-1. Preheat

The preheat process is a simple method of heating material to a desired temperature and holding that temperature for a specific period of time. When this process is selected, the following screen will appear on the LCD display:

```
Preheat Screen
Mode.....: Preheat
Control TC.:>1
Temperature: 400
Soak Time..: 01:00:00
```

The default position of the cursor is next to Control TC. Press the Increase  or Decrease  button to select the number of control thermocouples to be used for the program. Selections are as follows: 1, 1,2, 1,2,3, or 1,2,3,4. TC1 **MUST** always be a control thermocouple. TC2 thru TC4 can be used for controlling or monitoring. When a thermocouple is selected as control, the LED adjacent to the seven-segment display illuminates.

Use the Cursor  button to move the cursor to the desired selection (Temperature or Soak Time), and press the Increase  or Decrease  button to change the value to the desired setting.

 The minimum and maximum temperature settings for preheat are 0 and 1450° F (-18 and 788° C). The minimum and maximum soak times are 0 and 100 hours or Extended. When the system is utilizing air-cooled blankets, the maximum temperature setting is 400° F (204° C). If the program setting is above 400° F (204° C), the following screen will appear on the LCD display when the Run button is pressed:

Maximum Temperature Message Screen



Cannot enter Run mode
 Programmed temperature settings
 exceed air cooled limits
 (400 °F, 204 °C)



7-5-1-2. Bake-Out

The bake-out process allows the operator to program a temperature and soak time as well as a cooling rate from bake-out if desired. When this process is selected, the following screen appears on the display:

Bake-Out Screen

Mode.....: Bake-Out
 Control TC:>1
 Soak Temp.: 600 Soak Time: 01:00:00
 Cool Temp.: 200 Cool Rate: 600 °/Hr

The default position of the cursor is next to Control TC. Press the Increase  or Decrease  button to select the number of control thermocouples to be used for the program. Selections are as follows: 1, 1,2, 1,2,3, or 1,2,3,4. TC1 **MUST** always be a control thermocouple. TC2 thru TC4 can be used for controlling or monitoring. When a thermocouple is selected as control, the LED adjacent to the seven-segment display illuminates.

Use the Cursor  button to move the cursor to the desired selection (Soak Temperature, Soak Time, Cool Temperature, or Cool Rate), and press the Increase  or Decrease  button to change the value to the desired setting.

 The minimum and maximum soak and cool temperature settings for bake-out are 0 and 1450° F (-18 and 788° C). The minimum and maximum soak times are 0 and 100 hours or Extended. The minimum and maximum cool rates are 10 and 9999 °/hr. When the system is utilizing air-cooled blankets, the maximum temperature setting is 400° F (204° C). If the program setting is above 400° F (204° C), the following screen will appear on the LCD display when the Run button is pressed:

Maximum Temperature Message Screen



Cannot enter Run mode
Programmed temperature settings
exceed air cooled limits
(400 °F, 204 °C)



7-5-1-3. PWHT (Post-Weld Heat Treat)

The post-weld heat treat process allows the operator to program a post-weld heat treat where ramp temperature (on increase and decrease) and ramp rates are the same. When this process is selected, the following screen appears on the display:

PWHT Screen

```
Mode.....: PWHT
Control TC:>1,2
Ramp Temp.: 200 Ramp Rate: 600 °/Hr
Soak Temp.: 400 Soak Time: 01:00:00
```

The default position of the cursor is next to Control TC. Press the Increase  or Decrease  button to select the number of control thermocouples to be used for the program. Selections are as follows: 1, 1,2, 1,2,3, or 1,2,3,4. TC1 **MUST** always be a control thermocouple. TC2 thru TC4 can be used for controlling or monitoring. When a thermocouple is selected as control, the LED adjacent to the seven-segment display illuminates.

Use the Cursor  button to move the cursor to the desired selection (Ramp Temperature, Ramp Rate, Soak Temperature, or Soak Time), and press the Increase  or Decrease  button to change the value to the desired setting.

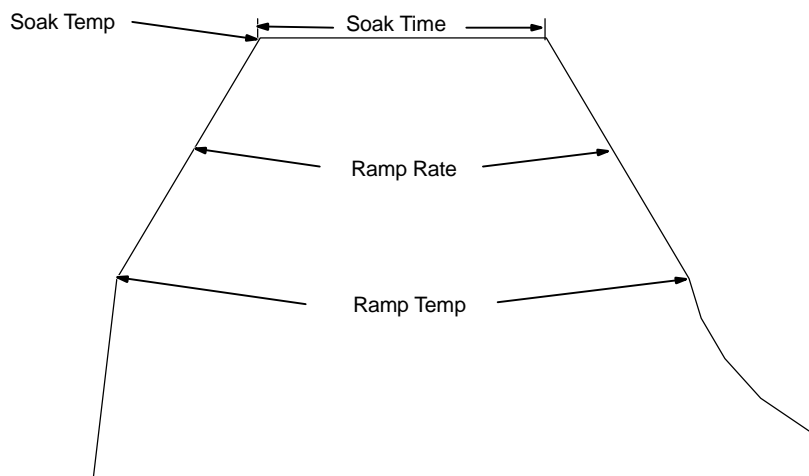



Figure 6-1. Soak Parameters

 The minimum and maximum ramp temperature settings for PWHT are 0 and 1450 °F (-18 and 788 °C). The minimum and maximum ramp rates are 10 and 9999 °F/hr (6 and 5555 °C/hr). The minimum and maximum soak temperatures are 0 and 1450 °F (-18 and 788 °C). The minimum and maximum soak times are 0 and 100 hours or Extended. When the system is utilizing air-cooled blankets, the maximum temperature setting is 400 °F (204 °C). If the program setting is above 400 °F (204 °C), the following screen will appear on the LCD display when the Run button is pressed.

Maximum Temperature Message Screen

Cannot enter Run mode
Programmed temperature settings
exceed air cooled limits
(400 °F, 204 °C)



7-5-1-4. Custom Program





In Custom Program, the operator can create a custom program with multiple steps or nonsymmetrical heat treat programs where the heating and cooling rates and temperatures are different. When this process is selected, the following screen appears on the display:

 This is the screen for initial use of the system. Subsequent use of custom program will revert to the last program used.

Custom Program Screen

Mode.....: Custom Program
Segment....: 1
Type.....: End
Control TC.: 1

The default position of the cursor is next to Segment. Press the Increase  or Decrease  button to increase or decrease the segment number, unless the segment type is End. In this case, the segment number will advance to segment 1.

Use the Cursor  button to move the cursor to the desired selection (Type or Control TC), and press the Increase  or Decrease  button to change the value to the desired setting. When the cursor is moved to the Type selection, pressing the Increase  or

Decrease  button changes the segment type to Step, Ramp, Soak, or End. The functions of each segment type are as follows:



- Step increases the temperature in the part at full-programmed power. A maximum temperature of 1450° F (788° C) can be programmed.
- Ramp increases or decreases the temperature in the part at a controlled rate in degrees per hour. A maximum temperature of 1450° F (788° C) and a maximum rate of 9999° F/hr (5555° C/hr) can be programmed.
- Soak will hold the temperature for a programmed time. The minimum and maximum soak times are 0 and 100 hours or Extended.
- End is programmed to indicate the completion of the cycle and termination of output power.

Step Function

When type is set to Step, the following screen appears on the display:

Custom Program Screen

Mode.....: Custom Program
Segment....: 1
Type.....:>Step
Temperature: 600



Use the Cursor  button to move the cursor to the Temperature position and the initial temperature can be adjusted using the Increase  or Decrease  button.

Pressing the Cursor  button again automatically advances the program to the next segment number.

Ramp Function

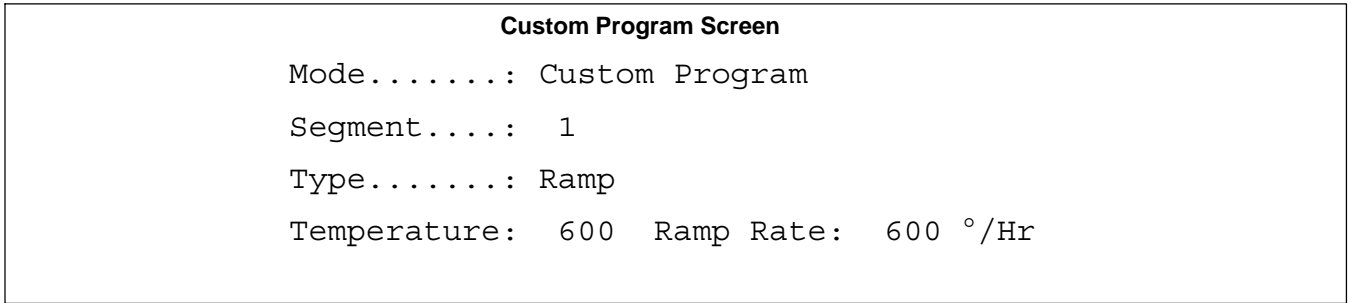
When type is set to Ramp, the following screen appears on the display:







Use the Cursor  button to move the cursor to the Temperature or Ramp Rate position and use the Increase  or Decrease  button to set the desired value.

When the cursor is in the Ramp Rate position, pressing the Cursor  button again automatically advances the program to the next segment number.

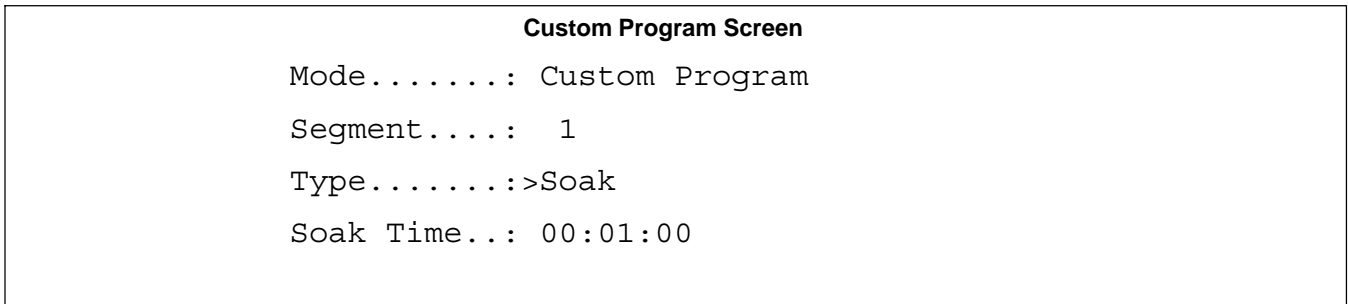
Soak Function

When type is set to Soak, the following screen appears on the display:



Use the Cursor  button to move the cursor to the Soak Time position and use the Increase  or Decrease  button to set the desired value.

When the cursor is in the Soak Time position, pressing the Cursor  button again automatically advances the program to the next segment number.



End Function



When type is set to End, the following screen appears on the display:

Custom Program Screen

Mode.....: Custom Program
Segment.....: > 2
Type.....: End
Control TC.: 1

The only changeable parameter in the End segment is selecting the number of thermocouples. Use the Cursor  button to move the cursor

to the Control TC position. Press the Increase  or Decrease  button to select the number of control thermocouples to be used for the program. Selections are as follows: 1, 1,2, 1,2,3, or 1,2,3,4. TC1 **MUST** always be a control thermocouple. TC2 thru TC4 can be used for controlling or monitoring. When a thermocouple is selected as control, the LED adjacent to the seven-segment display illuminates.

A custom program can contain up to 10 segments. To view Program parameters, position the cursor at segment and use the Increase  or Decrease  button to advance through the segment numbers until the End segment. When a segment number is changed, appropriate segment parameter information appears on the display.

Typical 5-Segment Custom Program

Custom Program Screen

Mode.....: Custom Program
Segment.....: 1
Type.....:>Step
Temperature: 600

Temperature increases to 600 degrees at full-programmed power.

Custom Program Screen



Mode.....: Custom Program
Segment.....: 2
Type.....: Ramp
Temperature:>1250 Ramp Rate: 600 °/Hr



Controlled heating to 1250 degrees F at a ramp of 600 degrees per hour.

Custom Program Screen

Mode.....: Custom Program
Segment.....: 3
Type.....: Soak
Soak Time...:>01:00:00

Soak at 1250 degrees F for a period of 1 hour.

The default position of the cursor is next to Program. Press the Increase  or Decrease  button.

Use the Cursor  button to move the cursor to the desired selection, and press the Increase  or Decrease  button to change the value to the desired setting.

Possible selections Timed:

Segment: 1 – 10

Type: Power Level, Slope, End

Power: 0.0 – 35 Time: 00:00:00 – 99:59:59 or Extended

7-5-4. Manual Control





Manual control allows programming of a specific power level for a specific period of time. When this process is selected, the following screen appears on the display:

Manual Program Screen			
Mode :	Manual	Power . . . :	0.0 KW
Command . . :	0.0 KW	Current :	0 A
Run Time :	00:03:00	Voltage :	0 V
		Frequency :	4.5 KHz

The only programmable selections are Command power and Run Time. Command can be adjusted to deliver up to 35 KW (based on maximum power selected in the set-up screen) for a period of up to 99 hours, 59 minutes, 59 seconds.

Power source operating power, current, voltage, and frequency are shown on the right-hand side of the display.

To reset the system back to factory default settings, turn off the power source, and wait until the display goes blank. Turn on the power source. When

the display lights, press and hold the Increase  and Decrease  buttons. A message will display Press Program to reset factory defaults. Release the Increase  and Decrease  buttons, and press the Program  button.

7-5-5. Rolling Inductor—Manual Or Temperature Control Mode



NOTICE – When using a Rolling Inductor, infrared temperature measurement and travel detection are highly recommended. The Rolling Inductor induces up to 20 kW into a small area, which can quickly heat a part to over 600° F (315° C) if it is not moving fast enough. This can damage the inductor or part. Using the travel detector, the system reduces output as travel speed decreases and disables output when travel stops.



-  The travel detector is a sensitive instrument that can measure travel speeds down to one IPM. Once the part travel is stopped, there is a three second delay before output can be re-energized. Vibrations that are present for more than three seconds from sources such as fork lift traffic, trains, grinding, and handling the part, can trigger the sensor, and energize the output. Always press Stop on the ProHeat front panel when part travel is stopped, to prevent inadvertent heating of the part.

Travel Detection

The Travel Detector can be mounted on the left or right side of the Rolling Inductor. It can also be mounted off of the inductor in a location that provides a similar travel speed as that of the inductor. A bracket of 3.75 inches long by 2.5 inches wide (96 by 64 mm) will allow for mounting of the Travel Detector.

-  Connect Rolling Inductor(s) to power source before turning power on.

To view the System Setup screen, simultaneously press the Parameters  and Program  buttons and the following screen will appear on the display:

- Press Cursor  button to move cursor to the parameter to change. Press Increase  or Decrease  button to set parameters.

SYSTEM SETUP SCREEN 1

Deg Units...:>°F	SYSTEM SETUP1
Tolerance...: ±25	
Max Output...: 35 KW	RI Clr Purge: 60S
Control Mode: Temp	RI Init KW: 0.0KW

Set Deg Units to F or C as required.

Set Tolerance value if required.

Set Control Mode to Manual or Temp as required.

Set Rolling Inductor Initial kW to a value between 0.0 and 35.0 kW

- The Rolling Inductor Initial kW can be increased when working on larger mass parts. It is recommended that the first part is heated with the kW set to a low value. Observe the maximum kW level that the heat cycle achieves and then set the starting kW to that value or less.
- Max Output kW can be reduced on smaller mass parts to minimize heat input.

Rolling Inductor Cooler Purge Time: 30–240 seconds

- The default Rolling Inductor Cooler Purge Time is set to 60 seconds for applications using the 60-foot inductor cables. This can be set down to 30 seconds for the standard Rolling Inductor with 30-foot cables. The ProHeat automatically doubles the time when two Rolling Inductors are connected.

Simultaneously press the Parameters  and Program  buttons a second time, and the following screen will appear on the display:

SYSTEM SETUP SCREEN 2

TC1,2 Type...:>IR4-20	SYSTEM SETUP2
IR Input Max...: 750	Trvl Detect...: On
IR Input Min...: 212	Trvl Speed...: IPM
Decouple Fault: On	

Set Trvl Detect to On if using travel detection.

Travel detection is recommended for all Rolling Inductor applications. It assists in maintaining an even heat input to the part and regulates output power based on travel speed in Temp mode.

Set Trvl Speed units as needed.

 IPM = Inches Per Minute:

$$PI = 3.14159$$

r = Radius (distance from center of rotating part to travel detect wheel)

s = Seconds per rotation.

$$IPM = (2 * PI * r * 60) / s$$

Example: For a 24 in. diameter pipe, the radius = 12 in. If it takes 45 seconds to make one complete rotation, the formula would be:

$$IPM = (2 * 3.14159 * 12 * 60) / 45$$

$$IPM = (4523.9) / 45$$

$$IPM = 100.5$$

 IPM information can be seen on the Run Status menu while heating.

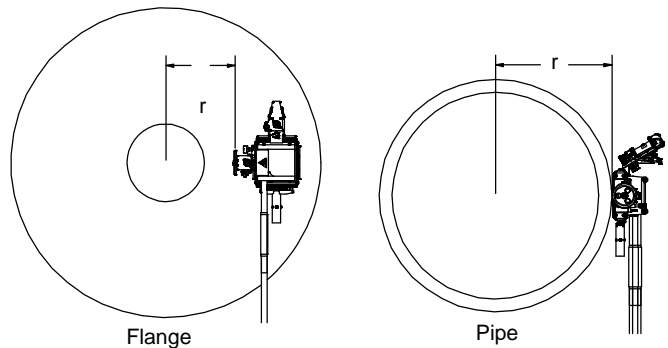

Press Program  button once to enter the Rolling Inductor Program screen.

The screen should look as shown below.

Rolling Inductor Program Screen			
Mode :	Manual	Power . . . :	0.0 KW
Command . :	>0.0 KW	Current :	0 A
Run Time :	00:03:00	Voltage :	0 V
		Frequency :	4.5 kHz

Plug one end of the thermocouple extension cable into TC5 on the power source and the other end into the back of the Rolling Inductor.

If running two Rolling Inductors on the same power source, connect a second thermocouple extension cable from the second Rolling Inductor to TC6 on the power source.

 *Workpieces should be the same size and material when using two Rolling Inductors on one power source.*

NOTICE – TC5 and TC6 are the Rolling Inductor protection measurement, not the pipe temperature. The Proheat will limit the output power if the internal temperature reaches 320° F (160° C) and will turn off output power if the internal temperature reaches 340° F (171° C). Pipe temperature will still require monitoring using the preferred method of temperature measurement.

7-6. Run Status

Run status allows the operator to check status of a program during in-process heating. Depending on the control mode (Temperature or Manual) and the temperature based mode (Preheat, Bake-Out, PWHT, or Custom), different style screens appear on the display. Run status is for monitoring purposes only and has no selectable or changeable parameters.

7-6-1. Temperature Based Control

7-6-1-1. Preheat, Bake-Out And PWHT Run Status Screen

Run Status Screen			
Mode :	Preheat	TC5 :	77
Target Temp :	----	TC6 :	77
Countdown . . :	--:--:--	TvlIPM (Off) :	0
Status :	Stopped		

Mode displays the programming mode (Preheat, Bake-Out, PWHT, or Custom Program). During active operation, Target Temp shows the target temperature based on the specific program, Countdown shows the time remaining in a soak segment, and Status shows the program segment type (step, soak, ramp, hold, or stopped). TC5 and TC6 display the temperature of thermocouples 5 and 6. This screen is for monitoring purposes only.

7-6-1-2. Custom Program (Not Applicable With Rolling Inductor)

Run Status Screen			
Mode :	Custom Program	TC5 :	77
Target Temp :	----	TC6 :	77
Countdown . . :	--:--:--	Segment :	1
Status :	Stopped		

During active operation, Target Temp shows the target temperature based on the active segment, Countdown shows the time remaining in a soak segment, and Status shows the program segment type (step, soak, ramp, hold, or stopped) of the active segment and the active segment number. TC5 and TC6 display the temperature of thermocouples 5 and 6. This screen is for monitoring purposes only.

7-6-2. Manual Control

Run Status Screen			
Mode.....:	Manual	TC5:	77
Power.....:	0.0 KW	TC6:	77
Countdown:	--:--:--	TvlIPM(Off):	0
Status...:	Stopped		

During active operation, Power shows the actual power delivered from the power source, Countdown shows the time remaining in the heating cycle, and Status indicates if the system is running or stopped. TC5 and TC6 display the temperature of thermocouples 5 and 6. This screen is for monitoring purposes only.

 No changes can be made to the run status screen, and the Cursor, Increase and Decrease buttons are not functional.

7-6-3. Remote Control

Run Status Screen			
Mode.....:	Remote	TC5:	77
Power.....:	0.0 KW	TC6:	77
Countdown:	00:00:00	TvlIPM (Off):	0
Status...:	Stopped		

During active operation, Power shows the actual power delivered from the power source, Countdown shows the time remaining of the heating cycle, and Status indicates if the system is running or stopped. This screen is for monitoring purposes only.

 No changes can be made to the run status screen, and the Cursor, Increase and Decrease buttons are not functional.

7-6-4. Power vs Time Control

Run Status Screen			
Mode...:	Power vs Time	TC5:	OPEN
Segment:	1	TC6:	OPEN
Type...:	--:--:--	TvlIPM(Off):	0
Power..:	0.0 KW	Type:	End

Mode displays the control mode. Also displayed are the present program segment, Segment type, current power level and remaining time of the current segment.





7-7. Parameters

During active operation, the Parameters screen allows the operator to monitor the power source output operating parameters. These parameters include output power, output amperage, output voltage, and output frequency. In addition, temperatures of thermocouples TC5 and TC6 are also displayed. The Parameters screen is for monitoring purposes only and has no selectable or changeable parameters.

Parameters Screen

Power....: 0.2 KW TC5: OPEN
Current...: 20 A TC6: OPEN
Voltage...: 52 V Power Level
Frequency: 11.7 KHz Countdown: 00:14:36

7-8. Cooler

The Cooler  button is used to turn the cooler On or Off on systems using liquid-cooled output cables. Systems using liquid-cooled output cables will not deliver output unless the cooler is On. If the cooler is not started prior to initiating a heating cycle, the system will automatically start the cooler when the Run  button is pressed. Pressing the Stop  button does not shut off the cooler. The cooler must be shut off separately by pressing the Cooler  button.

When power source output is energized, the cooler cannot be turned off. If the Cooler  button is pressed while output is energized, the following screen will appear on the display:

Cooler Message Screen

Cooler cannot be turned off
while output is on

 The Cooler button is inactive when no cooler is detected and no liquid-cooled output cable is attached.

 When a Rolling Inductor is connected to the power source, the cooler will purge for time set in SYSTEM SETUP1 RI Clr Purge, which is typically 30–60 seconds per rolling inductor before allowing output to be enabled.

7-9. Real-Time Operation

Each time the unit is first turned On it initiates a system check routine that includes verification of communication between circuit boards and checking for output isolation faults. During this check routine, all displays and LEDs illuminate and the following screen appears on the display:



Power Up Message Screen

ProHeat
Firmware Revision X.XX
Copyright (c) 2005 - 2015
Miller Electric Mfg. Co.

X.XX indicates the firmware revision number installed in the unit.

If an error is detected during the check routine, the system fault LED illuminates and an error message screen appears on the display (see Section 10-5).

When the check routine is completed successfully, the operator interface defaults to the following:

- The Stop  button indicator LED illuminates to indicate no heating cycle is in process.
- The temperature displays indicate actual temperature from the TC's (thermocouples). If no thermocouples are connected, the displays indicate OPEN.
- Control LEDs illuminate to indicate the number of control TC's in the last program.
- The appropriate degree units (°F or °C) light illuminates.
- The display defaults to the Run Status screen from the last program used and the Run Status  button indicator LED illuminates.
- If no fault or limit conditions are present, system status lights are not illuminated.

Once set up is complete for the desired program procedure (see Section 7-4), pressing the Run  button will initiate a heating cycle. When a

program run is initiated, the Run  button yellow indicator LED illuminates and the Heat On blue indicator LED illuminates to indicate output is

present to the coil. The cycle will continue until the end of the program is reached or the Stop  button is pressed.

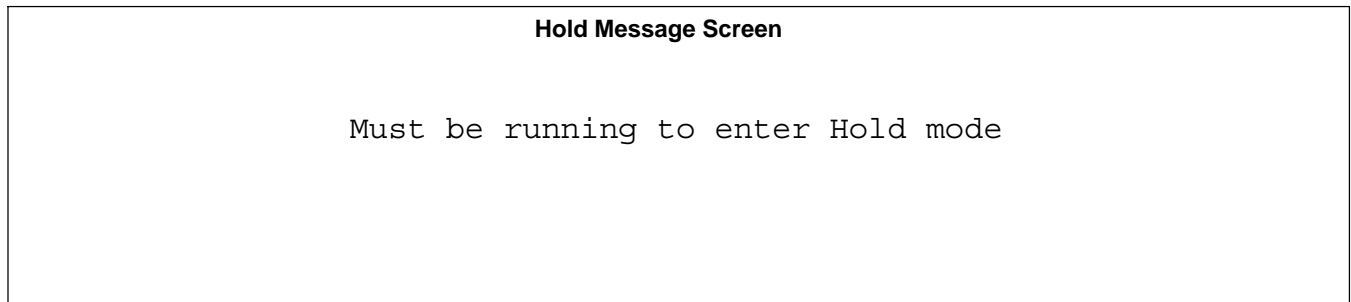

The system has a hold function that will maintain a temperature or hold the soak time of any active temperature controlled program. Pressing the Hold  button will only activate the hold function while in the run mode. If the system is not in the run mode, the following screen will appear on the display:





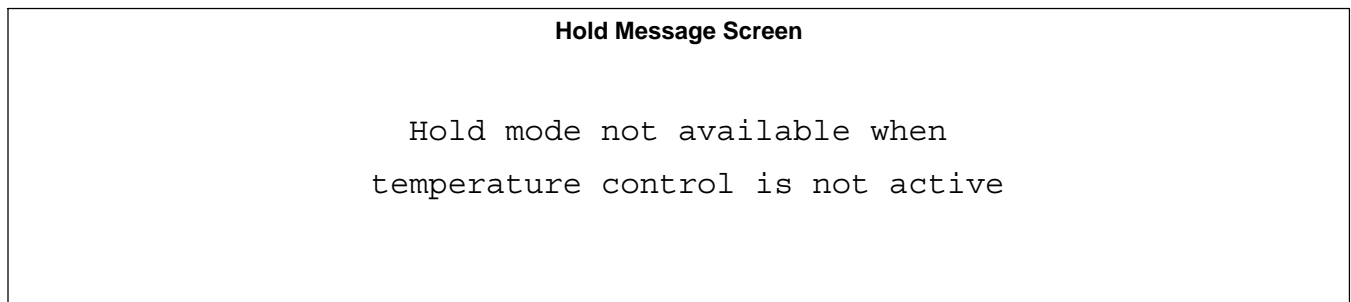





In addition, when running in Manual operating mode, the Hold  button is not functional. If the system is running in Manual operating mode,

pressing the Hold  button will cause the following screen to appear on the display:



Pressing the Hold  button will activate the hold function while running a temperature controlled program. While in the hold mode, the parameters for the program in process can be modified. The cycle will continue after pressing the Run  button. A change of program parameters during the hold will not change the original program. The original program parameters are maintained for the next heating cycle.

To make changes to a program while in run mode, press the Hold  button and the yellow indicator LED will illuminate, and the Run  button yellow indicator LED will turn off. When in hold, the system will maintain the actual temperature of the hottest thermocouple while the program is being changed.

- Press the Program  button and the yellow indicator LED will illuminate. The display will change to show the current mode of operation or the current segment of a Custom Program.
- Use the Cursor  button to move the cursor to the parameter that will be changed.
- Press the Increase  or Decrease  button to make desired changes.
- Press the Run  button to resume program operation and the yellow indicator LED will illuminate, and the Hold  button yellow indicator LED will turn off.

Any program parameter (temperatures, rates, times, or number of TC's) can be changed while in hold. In a custom based program, any segment number can be changed; however, if the operation of a segment has already been completed in a program, the change to that segment will not affect the program function.

- Press the Stop  button to end the program.

7-10. System Operating Characteristics

The power source delivers a high-frequency alternating current output that energizes the coil creating the magnetic field used to heat the workpiece. The power source output characteristics are a function of the configuration, type and number of coils used as shown in the following table:

Table 7-1. Power Source Output Characteristics

Output Type	Maximum Amperage	Maximum Voltage	Frequency Range
Air Cooled Single and Dual	250 A per output for 15 minutes. After 15 minutes, power steps down to limit current to 150 amperes per output for continuous operation.	700 V	5 – 25.7 kHz
	See Note 1	700 V	25.7 – 30 kHz
Single Liquid Cooled	350 A	700 V	5 – 20 kHz
	See Note 2	700 V	20 – 30 kHz
Dual Liquid Cooled	350 A per output/700 A total	700 V	5 – 20 kHz
	See Note 2	700 V	20 – 30 kHz

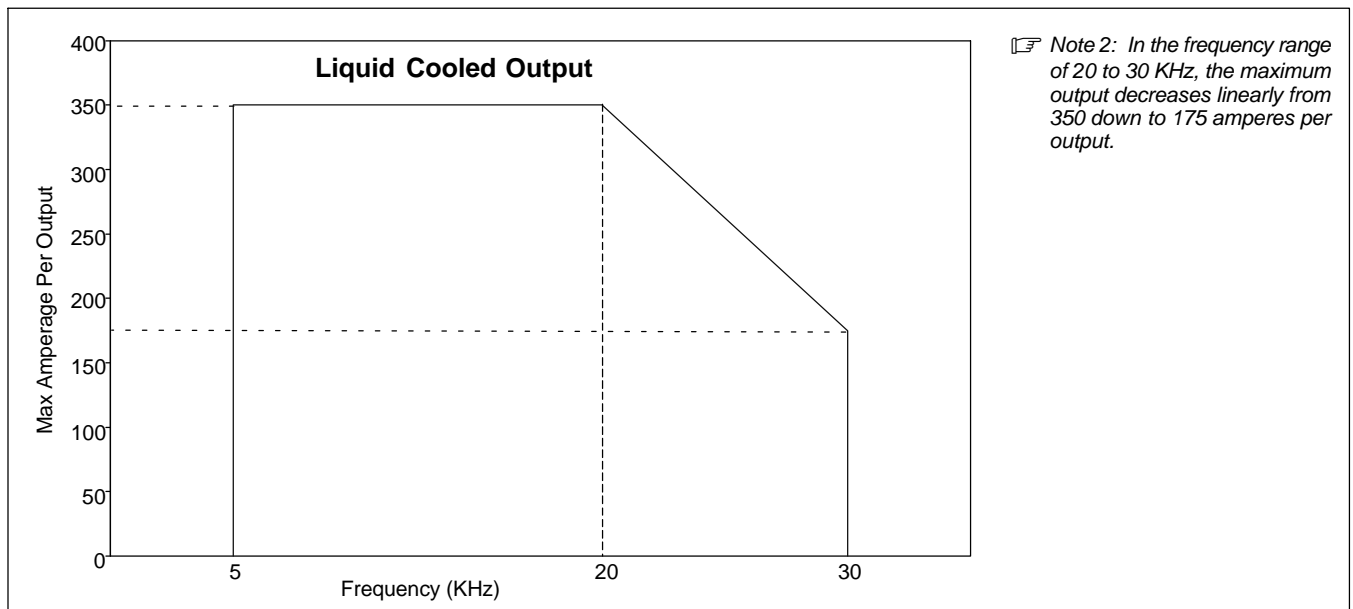
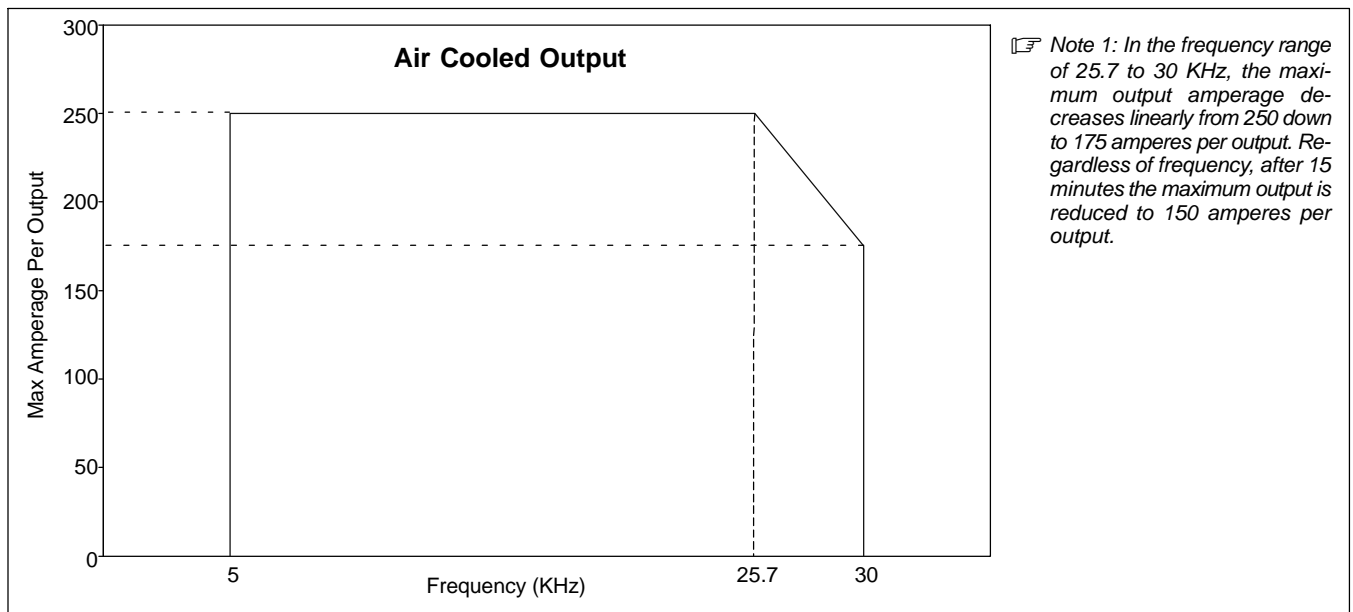
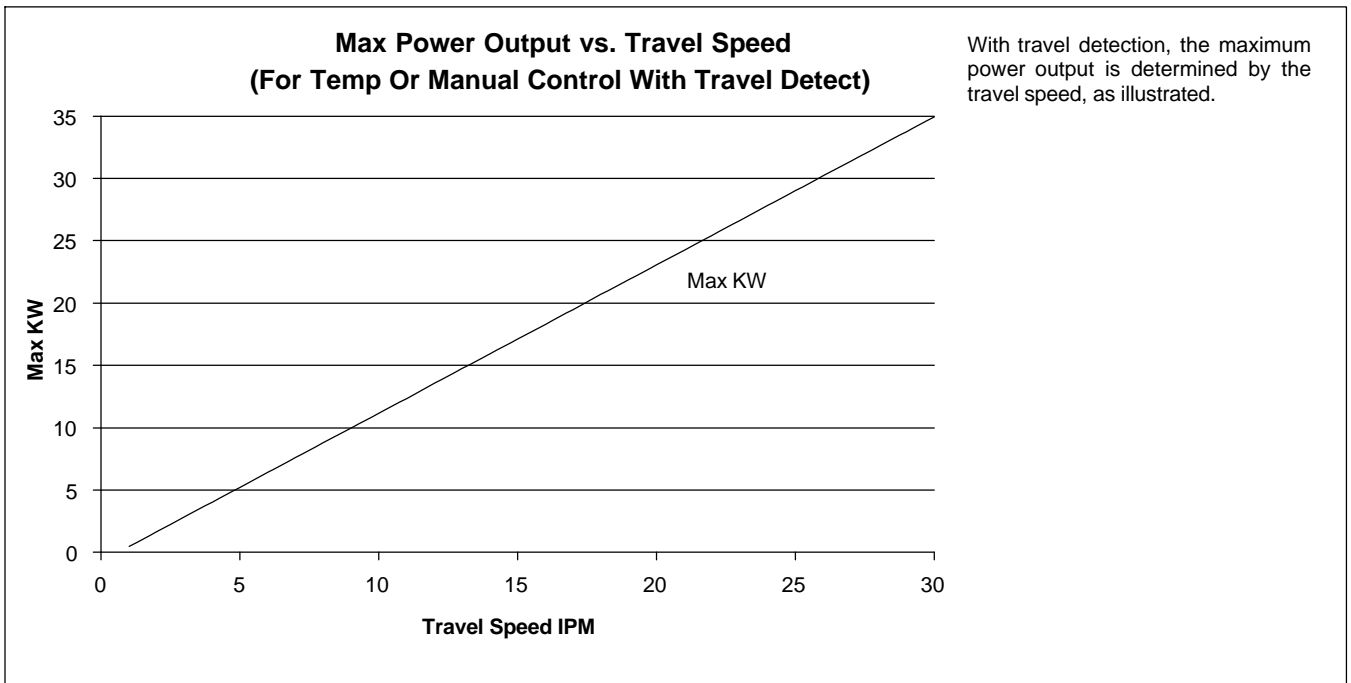
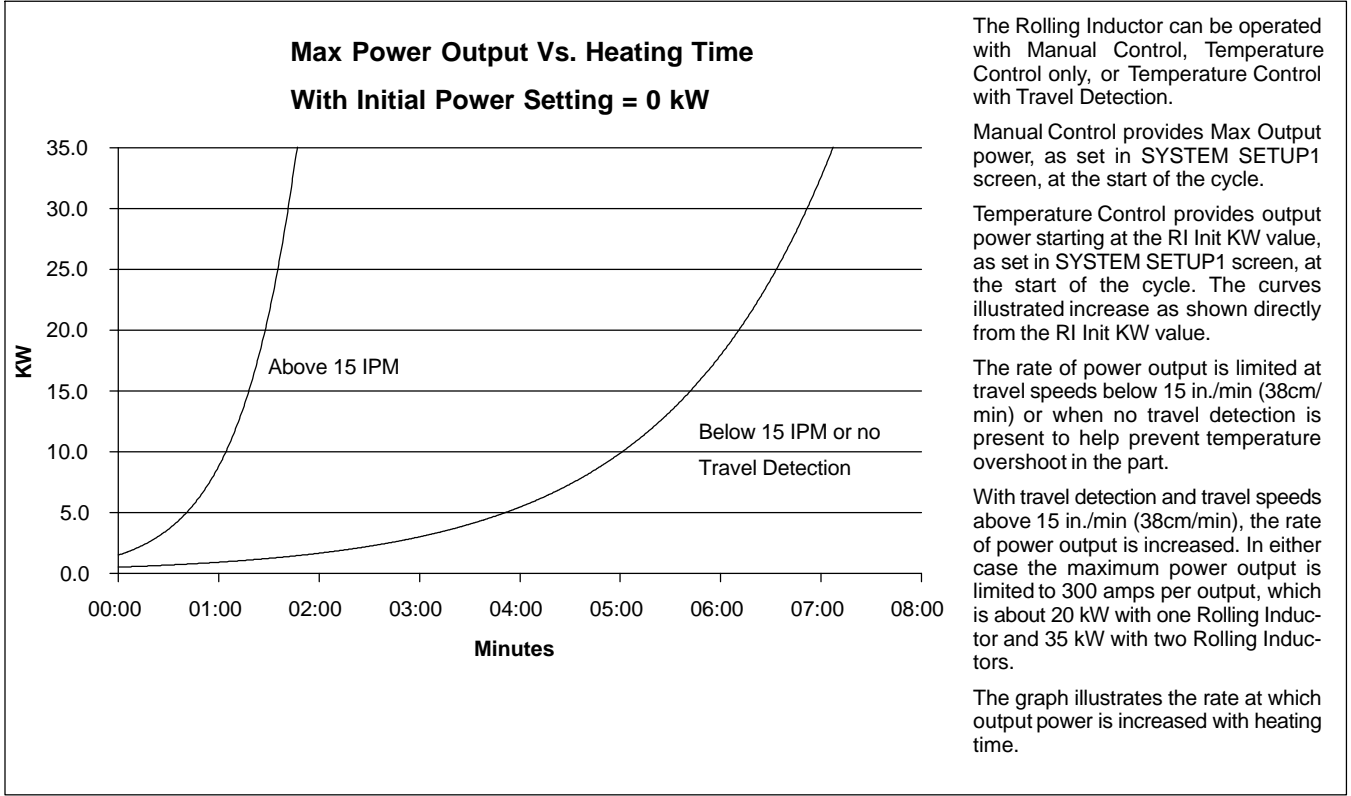

Table 7-2. Rolling Inductor Output Characteristics

Output Type	Maximum Amperage
Single Rolling Inductor	300 A
Dual Rolling Inductor	300 A Per Output* *The system maximum power is 35 kW, so each output will have approximately 17.5 kW, which uses less than 300 A



SECTION 8 – MAINTENANCE

8-1. Routine Maintenance

						<p> Disconnect power before maintaining.</p>	<p> <i>Maintain more often during severe conditions.</i></p>
--	--	--	--	--	--	---	--

		✓ = Check ◇ = Change ● = Clean * To be done by Factory Authorized Service Agent	☆ = Replace	Reference	
Daily					
	✓ Visually inspect condition of cords and cables. ☆ Damaged cords or cables.				
Every 3 Months					Section 5-5, 5-10
	☆ Damaged or Unreadable Labels	● Output Connector Contacts	● Ground Sense Lead Receptacles	● Operator Interface Overlay	
	✓ Integrity Of Protective Plug, Replace If Necessary	✓ ☆ Cracked Cables			
Every 6 Months					Section 10-8
	● Inside Unit				
Every Year					Sections 8-2, 8-3
	✓ Verify Unit Calibration				

8-2. Calibration Verification Equipment

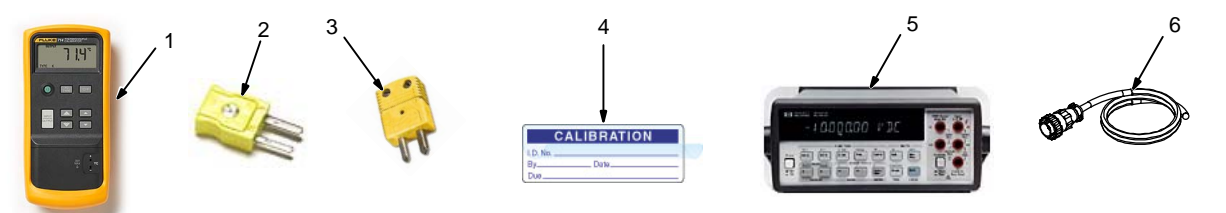

1 Thermocoupler Calibrator
Suggested calibrator from Fluke item 714 or equivalent.

2 Type K Mini Connector
Suggested connector from Fluke item 80CK-M or equivalent.
A length of type K thermocouple wire is required. Connect red to negative and

3 Type K 2-Pin Male Connector
Suggested connector from Newport item OST-K-M or equivalent.

4 Calibration Label
Suggested label from Q-CEES item QCC306BU or equivalent.

5 Precision Digital Voltmeter (DVM)
yellow to positive when wiring connectors.

6 Interconnecting Cable
Suggested meters are Agilent Multimeter or Hewlett Packard Multimeter Model 34401A or equivalent. DVM must be able to read to three decimal places (0.000).
MILLER Part No. 300168 can be used to connect the Recorder to the DC power supply.

8-3. Calibration Verification Procedure

Calibration verification should be done every year. Use appropriate Certificate of Calibration to record calibration information. A spreadsheet could also be used to record the information.

8-3-1. Initial Set Up

1. Power switch off
2. Have qualified person connect primary power to ProHeat 35.
3. Turn ProHeat 35 power switch on.
4. Press and hold the Program button, then press Parameters to enter setup mode.
5. Press Cursor button 4 times to get to Control Mode line.
6. Press the Decrease button to change to Manual, if necessary.
7. Press the Run Status button. (TC5 and TC6 will show in upper right-hand corner of display)
8. Let unit idle for a minimum of 15 minutes before checking calibration.
9. Turn on Fluke 714 Thermocouple Calibrator and Precision DVM. Leave them on for a minimum of 15 minutes before checking calibration.

8-3-2. TC Input/Output Check

1. Connect precision DVM (DC Volts set to display in thousandths) to RC9. This is the top connector located on the back of the ProHeat 35. Red lead to pin 1 and black to pin 5.
2. Set TC calibrator to 382.0 °F or 194.5 °C. Connect to TC1 input jack on front of ProHeat.
3. Verify TC display value of ($\pm 3^\circ\text{F}$) or ($\pm 2^\circ\text{C}$). RC9 output has a tolerance of ($\pm 6^\circ\text{F}$) or ($\pm 3.3^\circ\text{C}$). DVM reads 2.787 VDC (± 0.038) (2.749 – 2.825).
4. Enter DVM values into calibration certificate. If you are creating your own spreadsheet use the following calculation.

The voltage to temperature calculation is:

$$(\text{DC Volts Out} \times 155) - 50 = ^\circ\text{F}$$

$$(\text{DC Volts Out} \times 86.1) - 45.4 = ^\circ\text{C}$$

5. Repeat steps 1.–4. for TC2 – TC6 input jacks.

For TC2 move red precision DVM lead to RC9 pin 2.

For TC3 move red precision DVM lead to RC9 pin 3.

For TC4 move red precision DVM lead to RC9 pin 4.

For TC5 move red precision DVM lead to RC9 pin 6.

For TC6 move red precision DVM lead to RC9 pin 7.

Note: TC5 and TC6 will show in upper right-hand corner of display.

6. Repeat steps 1.–5. with TC calibrator set to 882.0 °F or 472.2 °C, verify TC display value ($\pm 3^\circ\text{F}$) or ($\pm 2^\circ\text{C}$). RC9 output has a tolerance of ($\pm 6^\circ\text{F}$) or ($\pm 3.3^\circ\text{C}$). DVM reads 6.013 VDC (± 0.038) (5.975 – 6.041).
7. Repeat steps 1.–5. with TC calibrator set to 1382.0 °F or 750 °C, verify TC display value ($\pm 3^\circ\text{F}$) or ($\pm 2^\circ\text{C}$). RC9 output has a tolerance of ($\pm 6^\circ\text{F}$) or ($\pm 3.3^\circ\text{C}$). DVM reads 9.239 VDC (± 0.038) (9.201 – 9.277).

Company Name
 Street
 PO Box
 City, State, Zip Code

CERTIFICATE OF CALIBRATION

TCI Serial Number:
Certified by:

Calibration Date:
Re-Calibration Date:

Company name _____ does hereby certify the above instrument was calibrated against standards maintained by Company name _____ and meets or exceeds all published specifications. The accuracy of these standards is directly traceable to the National Institute of Standards and Technology.

	PRIMARY STANDARD			PRIMARY STANDARD			PRIMARY STANDARD		
	382 (°F)			882 (°F)			1382 (°F)		
	Voltage Out (V)	Equivalent Temp (°F)		Voltage Out (V)	Equivalent Temp (°F)		Voltage Out (V)	Equivalent Temp (°F)	
CHANNEL 1									
CHANNEL 2									
CHANNEL 3									
CHANNEL 4									
CHANNEL 5									
CHANNEL 6									

Instrumentation Used:

Thermocouple Calibrator:
Calibrated Multimeter:

Serial Number:
Serial Number:

Company Name
 Street
 PO Box
 City, State, Zip Code

CERTIFICATE OF CALIBRATION

TCI Serial Number:
Certified by:

Calibration Date:
Re-Calibration Date:

Company name _____ does hereby certify the above instrument was calibrated against standards maintained by Company name _____ and meets or exceeds all published specifications. The accuracy of these standards is directly traceable to the National Institute of Standards and Technology.

	PRIMARY STANDARD			PRIMARY STANDARD			PRIMARY STANDARD		
	Voltage	Equivalent	Temp (°C)	Voltage	Equivalent	Temp (°C)	Voltage	Equivalent	Temp (°C)
CHANNEL 1									
CHANNEL 2									
CHANNEL 3									
CHANNEL 4									
CHANNEL 5									
CHANNEL 6									

Instrumentation Used:

Thermocouple Calibrator:
Calibrated Multimeter:

Serial Number:
Serial Number:

SECTION 9 – SAFETY PRECAUTIONS FOR SERVICING

 Protect yourself and others from injury — read, follow, and save these important safety precautions and operating instructions.

9-1. Symbol Usage

OM-222 166AD - 06-2015, safety_ihtm 2013-09



DANGER! – Indicates a hazardous situation which, if not avoided, will result in death or serious injury. The possible hazards are shown in the adjoining symbols or explained in the text.



Indicates a hazardous situation which, if not avoided, could result in death or serious injury. The possible hazards are shown in the adjoining symbols or explained in the text.

NOTICE – Indicates statements not related to personal injury.

 Indicates special instructions.



This group of symbols means Warning! Watch Out! ELECTRIC SHOCK, MOVING PARTS, and HOT PARTS hazards. Consult symbols and related instructions below for necessary actions to avoid the hazards.

9-2. Servicing Hazards



The symbols shown below are used throughout this manual to call attention to and identify possible hazards. When you see the symbol, watch out, and follow the related instructions to avoid the hazard.



Only qualified persons should service, test, maintain, and repair this unit.



During servicing, keep everybody, especially children, away.



ELECTRIC SHOCK can kill.

- Do not touch live electrical parts.
- Turn Off induction heating power source and disconnect and lockout input power using line disconnect switch, circuit breakers, or by removing plug from receptacle, or stop engine before servicing unless the procedure specifically requires an energized unit.

- Insulate yourself from ground by standing or working on dry insulating mats big enough to prevent contact with the ground.
- Do not leave live unit unattended.
- If this procedure requires an energized unit, have only personnel familiar with and following standard safety practices do the job.
- When testing a live unit, use the one-hand method. Do not put both hands inside unit. Keep one hand free.
- Disconnect input power conductors from deenergized supply line BEFORE moving an induction heating power source.

SIGNIFICANT DC VOLTAGE exists in inverter power sources AFTER removal of input power.

- Turn Off inverter, disconnect input power, and discharge input capacitors according to instructions in Troubleshooting Section before touching any parts.

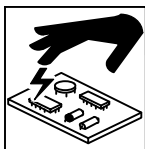

STATIC (ESD) can damage PC boards.

- Put on grounded wrist strap BEFORE handling boards or parts.
- Use proper static-proof bags and boxes to store, move, or ship PC boards.



FIRE OR EXPLOSION hazard.

- Do not place unit on, over, or near combustible surfaces.
- Do not service unit near flammables.

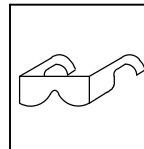

FLYING METAL or DIRT can injure eyes.

- Wear safety glasses with side shields or face shield during servicing.
- Be careful not to short metal tools, parts, or wires together during testing and servicing.



INDUCTION HEATING can burn.

- Do not touch hot parts bare handed.
- Allow cooling period before handling parts on equipment.
- Do not touch or handle induction head/coil during operation.
- Keep metal jewelry and other metal personal items away from head/coil during operation.
- To handle hot parts, use proper tools and/or wear heavy, insulated welding gloves and clothing to prevent burns.



EXPLODING PARTS can injure.

- Failed parts can explode or cause other parts to explode when power is applied to inverters.
- Always wear a face shield and long sleeves when servicing inverters.

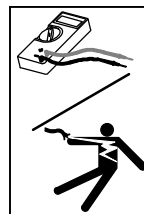

SHOCK HAZARD from testing.

- Turn Off induction heating power source before making or changing meter lead connections.
- Use at least one meter lead that has a self-retaining spring clip such as an alligator clip.
- Read instructions for test equipment.



FALLING EQUIPMENT can injure.

- Use lifting eye to lift unit only, NOT running gear, gas cylinders, or any other accessories.
- Use equipment of adequate capacity to lift and support unit.
- If using lift forks to move unit, be sure forks are long enough to extend beyond opposite side of unit.
- Follow the guidelines in the Applications Manual for the Revised NIOSH Lifting Equation (Publication No. 94-110) when manually lifting heavy parts or equipment.



MOVING PARTS can injure.

- Keep away from moving parts such as fans.
- Have only qualified persons remove doors, panels, covers, or guards for maintenance and troubleshooting as necessary.
- Keep hands, hair, loose clothing, and tools away from moving parts.
- Reinstall doors, panels, covers, or guards when maintenance is finished and before reconnecting input power.



ELECTRIC AND MAGNETIC FIELDS (EMF) can affect Implanted Medical Devices.

- Wearers of Pacemakers and other Implanted Medical Devices should keep away from servicing areas until consulting their doctor and the device manufacturer.

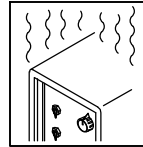

OVERUSE can cause OVERHEATING.

- Allow cooling period; follow rated duty cycle.
- Reduce current or reduce duty cycle before using induction heating equipment again.
- Do not block or filter airflow to unit.

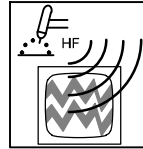

H.F. RADIATION can cause interference.

- High-frequency (H.F.) can interfere with radio navigation, safety services, computers, and communications equipment.
- Have only qualified persons familiar with electronic equipment install, test, and service H.F. producing units.
- The user is responsible for having a qualified electrician promptly correct any interference problem resulting from the installation.
- If notified by the FCC about interference, stop using the equipment at once.
- Have the installation regularly checked and maintained.
- Keep high-frequency source doors and panels tightly shut, keep spark gaps at correct setting, and use grounding and shielding to minimize the possibility of interference.

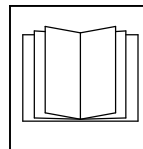

READ INSTRUCTIONS.

- Use Testing Booklet (Part No. 150 853) when servicing this unit.
- Consult the Owner's Manual for welding safety precautions.
- Use only genuine replacement parts from the manufacturer.
- Read and follow all labels and the Technical Manual carefully before installing, operating, or servicing unit. Read the safety information at the beginning of the manual and in each section.
- Perform maintenance and service according to the Technical Manual, industry standards, and national, state, and local codes.

9-3. California Proposition 65 Warnings

 Welding or cutting equipment produces fumes or gases which contain chemicals known to the State of California to

cause birth defects and, in some cases, cancer. (California Health & Safety Code Section 25249.5 et seq.)

SECTION 10 – DIAGNOSTICS & TROUBLESHOOTING

The ProHeat 35 power source has on-board capabilities to aid in troubleshooting problems should any conditions occur during operation. This troubleshooting capability consists of the Fault LED, Limit LED, and message screens that appear on the front panel LCD display.

10-1. Operator Interface Indicators

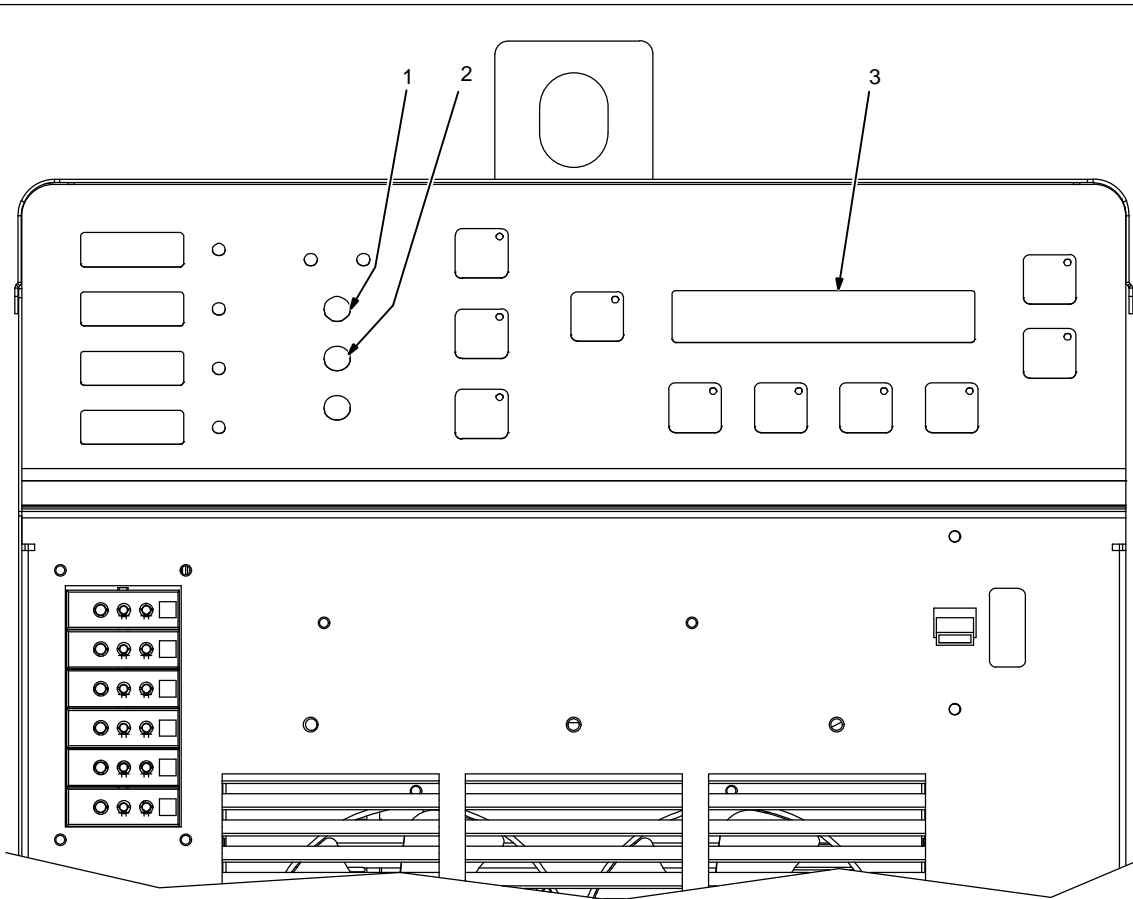

803 995-B

1 Fault LED

LED lights to indicate a system fault condition.

2 Limit LED

LED lights to indicate a system limit condition.

3 4 x 40 LCD Display

Displays programming, run status, parameters, fault and limit conditions, and troubleshooting guide.

10-2. Limit Conditions

A limit condition indicates that the system has encountered an open thermocouple or is outside the range of its optimum operating conditions or parameters. Should a limit condition occur during operation, the yellow Limit LED will flash to indicate a problem. If the active screen on the LCD display is Run Status or Parameters, a message describing the particular limit condition will appear on the display. If the active screen is Program, press the

Run Status  button to display the limit condition.



In a limit condition, the power source will continue to deliver output power and protect itself from damage by reducing the output power. This situation allows the operator time to determine the best action to correct the problem as described by the limit message on the LCD display.

If a limit condition occurs, there are two selectable options:

- Acknowledge the limit and continue operation.
- Terminate operation to correct the problem causing the limit.



Pressing the Decrease  button will acknowledge the limit and continue operation with the existing set up. In the acknowledge state, the yellow

Limit LED will stop flashing and remain on continuously. The LCD display will revert to an active screen once the Program  button, Run Status

 button, or Parameters  button is pressed.

If a new limit condition should occur after the first is acknowledged, the yellow Limit LED will start flashing to indicate a new problem. To display the limit condition, press the Run Status  button and the LCD display will show a message describing the new and previous limit messages.

To obtain additional information regarding the limit condition and suggested solutions to resolve the limit, press the Increase  button, and the LCD display will indicate possible solutions based on the type of limit condition.



If the operator determines that the best course of action is to terminate operation and make suggested changes to the setup to eliminate the limit condition, press the Stop  button. After changes are made to the setup, press the Run  button to restart the process.

10-3. Limit Condition Codes

Limit Condition	Additional Information
L01: Thermocouple #1 Open	Check for open temperature sensor and repair Change to back-up temperature sensor
L02: Thermocouple #2 Open	Check for open temperature sensor and repair Change to back-up temperature sensor
L03: Thermocouple #3 Open	Check for open temperature sensor and repair Change to back-up temperature sensor
L04: Thermocouple #4 Open	Check for open temperature sensor and repair Change to back-up temperature sensor
L05: Thermocouple #5 Open	Check for open temperature sensor and repair Change to back-up temperature sensor
L06: Thermocouple #6 Open	Check for open temperature sensor and repair Change to back-up temperature sensor
L07: Output Voltage Limit	Tighten blanket against pipe surface Shorten extension cable
L08: Output Voltage Limit	Increase number of turns Increase coil space Shorten extension cable Increase insulation width
L09: Output Current Limit	Tighten blanket against pipe surface
L10: Output Current Limit	Increase number of turns Decrease coil space Tighten cable on insulation

Limit Condition	Additional Information
L11: Coolant Overtemp Limit	Check coolant flow and level Clean coolant filters and heat exchanger Increase number of turns Verify appropriate insulation thickness
L12: Power Source Overtemp Limit	Check for blocked vents Clean wind tunnel heat sinks
L13: Cable Connection	Check for loose/open output connection Verify all output cables are same type Verify receptacle plug connected Check cable 1 and cable 2 identification on diagnostic screen DIAG1 (see Section 10-6) Rolling Inductor only: Verify TC5, TC6 connection.
L14: Accessory Temperature Limit	Check Accessory TC connection Wait for accessory to cool
L15: Low Travel Speed	Increase travel speed Check travel detector

10-4. Fault Conditions

A fault condition occurs if the system encounters an isolation fault, encounters operating conditions outside operational limits, or if there is a serious problem with the system. Should a fault condition occur, the output is immediately turned off, the red Fault LED flashes and the Stop  button LED flashes. If the active screen on the LCD display is Run Status or Parameters, a message describing the particular fault condition will appear on the display. If the active screen is Program, press the Run Status  button to display the fault condition.

Pressing the Decrease  button will acknowledge the fault and the red Fault LED will stop flashing and remain on continuously. However, the

Stop  button LED will continue to flash indicating that the process has stopped.

To obtain additional information regarding the fault condition and suggested solutions to resolve the fault, press the Increase  button, and the LCD display will indicate possible solutions based on the type of fault condition. In most cases, a fault condition will indicate that service is required.



10-5. Fault Condition Codes

Fault Condition	Additional Information
F51: Thermocouple #1 Internal Fault	Service required
F52: Thermocouple #2 Internal Fault	Service required
F53: Thermocouple #3 Internal Fault	Service required
F54: Thermocouple #4 Internal Fault	Service required
F55: Thermocouple #5 Internal Fault	Service required
F56: Thermocouple #6 Internal Fault	Service required
F57: CJT Sensor Internal Fault	Service required
F58: Output Voltage Fault	Air cooled systems: Tighten blanket against pipe surface Reduce length of extension cable Liquid cooled systems: Increase number of turns Increase coil space Reduce length of extension cable Increase insulation width Service required
F59: Output Current Fault	Service required
F60: Temperature Sensor Fault	Check control TC connections Check control TC extension cable Check control TC type in SYSTEM SETUP2
F61: Coolant Flow Fault	Check for coolant leak Clean for coolant blockage Check coolant filter and level Check coolant connections

Fault Condition	Additional Information
F62: Isolation Fault	Check for exposed conductor or for moisture on blanket Using conductive coolant in cooler (043810 low conductivity coolant is recommend).
F63: Line Voltage Fault	Check line voltage Check voltage values on diagnostic screen DIAG2 (see Section 10-6)
F64: Power Source Overtemp Fault	Verify power source vents and wind tunnel are unobstructed
F65: Current Source Fault	Service required
F66: Under Frequency Fault	Check for loose or open connections in output cable Decrease number of turns or add a second output Decrease coil space Service required
F67: Over Frequency Fault	Verify heating cable properly wrapped Verify material being heated is magnetic
F68: Cable Connection Fault	Check for loose/open output connection Verify all output cables are same type Verify receptacle plug connected Check cable 1 and cable 2 identification on diagnostic screen DIAG1 (see Section 10-6) Rolling Inductor only: Verify TC5, TC6 connection.
F69: Coolant Overtemp Fault	Check coolant flow and level Clean coolant filters and heat exchanger Increase number of turns Verify appropriate insulation thickness
F70: Internal Communication Fault	Service required
F71: Internal Thermistor Fault	Service required
F72: Coolant Thermistor Fault	Service required
F73: Decoupled/Open Coil	Check for loose/open output connection. Tighten coil/blanket. Increase number of turns
F74: Isolation Fault Self-Test Error	Service required
F75: Internal Power Supply Fault	Service required
F76: Current Source Control Fault	Service required
F77: Power Source Internal Comm Fault	Service required
F78: Output Current Sense Fault	Check for loose/open output connection or an extension cable connected with no coil attached at the end. Service required
F79: Accessory 1 overtemp fault	Check accessory TC connection Wait for accessory to cool
F80: Accessory 2 overtemp fault	Check accessory TC connection Wait for accessory to cool

10-6. System Diagnostic Screens

Additional system diagnostics are available and accessible through the operator interface. Detail operational parameters can be accessed by pressing

and holding the Run Status  button and pressing the Parameters  button.

When this feature is initially activated, the following screen appears on the LCD display:

System Diagnostic Screen			
RemCmd:	1023 Off	Cable1:	LQD DIAG1
OutI1:	0 A	Cable2:	LQD
OutI2:	0 A	ClntFR:	0.60 GPM
IsrcFb:	0 A	ClrSts:	Flowing

RemCmd – This is the value of the remote command and the status of the remote contactor.

 Remote controls can be used to enable/disable output in all control modes. They only affect output power level when the control mode is set to Remote.

Out I1 – This is the value of the output current on output 1.

Out I2 – This is the value of the output current on output 2.

Isrc FB – This is the value of the amperage in the current source inverter.

Cable 1 – This is the cable type hooked up to output number one. Possible labels:

- AIR – for an air-cooled cable
- LQD – for a liquid-cooled cable
- PLUG – for a protective plug
- OPEN – no cable or plug in place



Cable 2 – This is the cable type hooked up to output number two. Possible labels:

- AIR – for an air-cooled cable
- LQD – for a liquid-cooled cable
- PLUG – for a protective plug
- OPEN – no cable or plug in place

ClntFR – This is the coolant flow rate (in GPM) from the cooler on a liquid-cooled system.

ClrSts – This is the status of the cooler. Possible labels:

- Off
- Flowing

The second diagnostic screen is available by again pressing and holding the Run Status  button and pressing the Parameters  button.

System Diagnostic Screen

VLnA-B: 460V	Therm1: 75	DIAG2
VLnB-C: 460V	Therm2: 75	Therm5: OPEN
VLnC-A: 460V	Therm3: 75	ClrTmp: 77
VBus: 650V	Therm4: OPEN	

VLnA-B – This is the phase to phase line voltage between phases A and B.

VLnB-C – This is the phase to phase line voltage between phases B and C.

VLnC-A – This is the phase to phase line voltage between phases C and A.

VBus – This is the DC bus voltage.

Therm1 – This is the temperature of the current source primary heatsink.

Therm2 – This is the temperature of the bridge heatsink.

Therm3 – This the the temperature of the current source secondary heatsink.

Therm4 – Open (not used).

Therm5 – Open (not used).

ClrTmp – This is the temperature of the coolant on a liquid-cooled system.

- OPEN – no cooler is detected.

RmtFlw – This is the status of the relay contacts for remote coolant flow on a liquid-cooled system.

- OFF
- ON

 RmtFlw feature is unsupported on the current platform.

10-7. Removing Wrapper and Measuring Input Capacitor Voltage



Tools Needed:

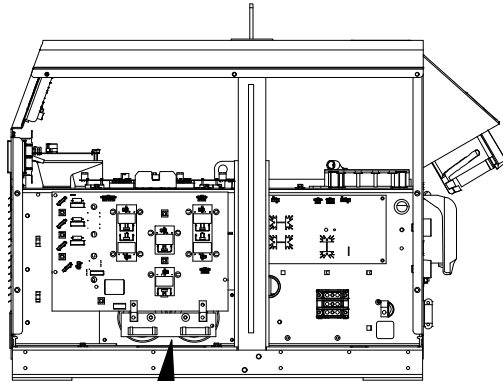
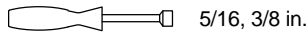

⚠ Turn Off welding power source, and disconnect input power.

⚠ Significant DC voltage can remain on capacitors after unit is Off. Always check the voltage as shown to be sure the input capacitors have discharged before working on unit.

Remove right side panel and disconnect fan motor FM3.

1 Current Source Interconnect Board PC4

2 Voltmeter

Measure the dc voltage across the + bus terminal and – bus terminal on PC4 as shown until voltage drops to near 0 (zero) volts.

☞ If the capacitor voltage does not drop to near zero after several minutes, use a bleeder resistor of between 200 and 500 ohms, at least 10 watts, and #16 AWG 600 volts ac insulation rated wire to discharge the capacitor(s).

3 Typical Bleeder Resistor

An example of a typical bleeder resistor is shown on this page.

Proceed with job inside unit. Reconnect FM3 and reinstall right side panel when finished.

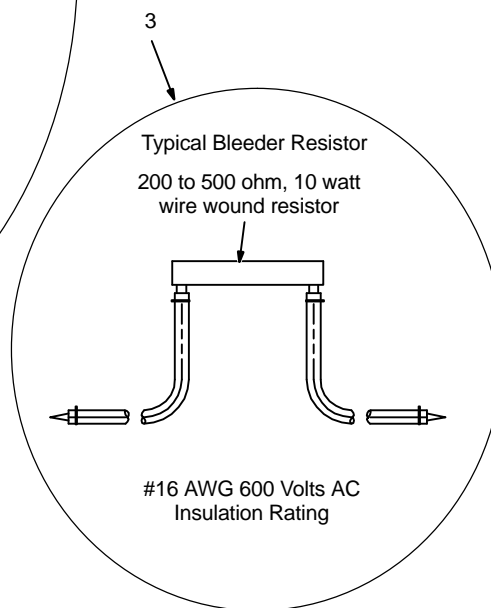
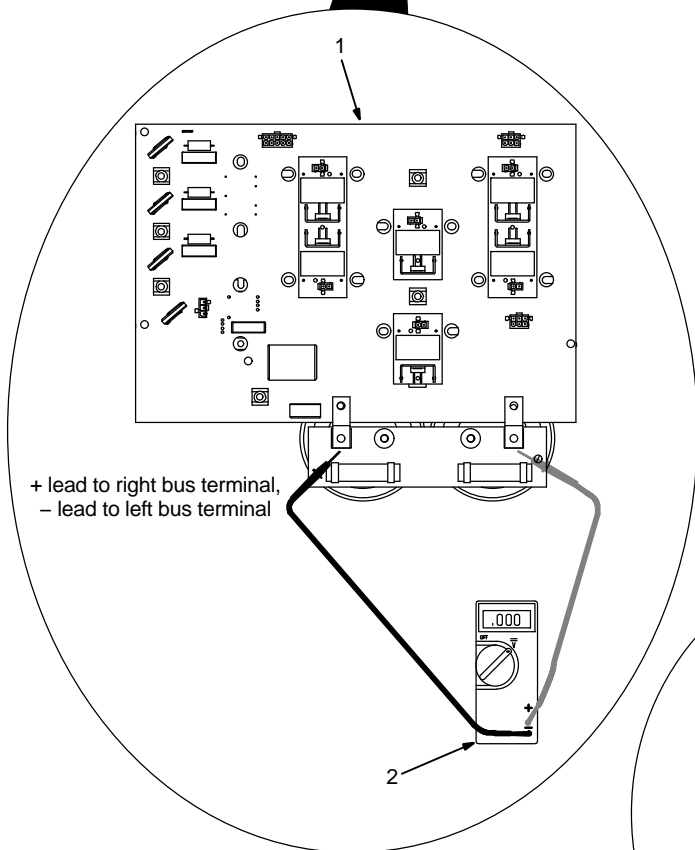

SECTION 11 – ELECTRICAL DIAGRAM



- ⚠ WARNING**
- Do not touch live electrical parts.
 - Disconnect input power or stop engine before servicing.
 - Do not operate with covers removed.
 - Have only qualified persons install, use, or service this unit.
- ELECTRIC SHOCK HAZARD**

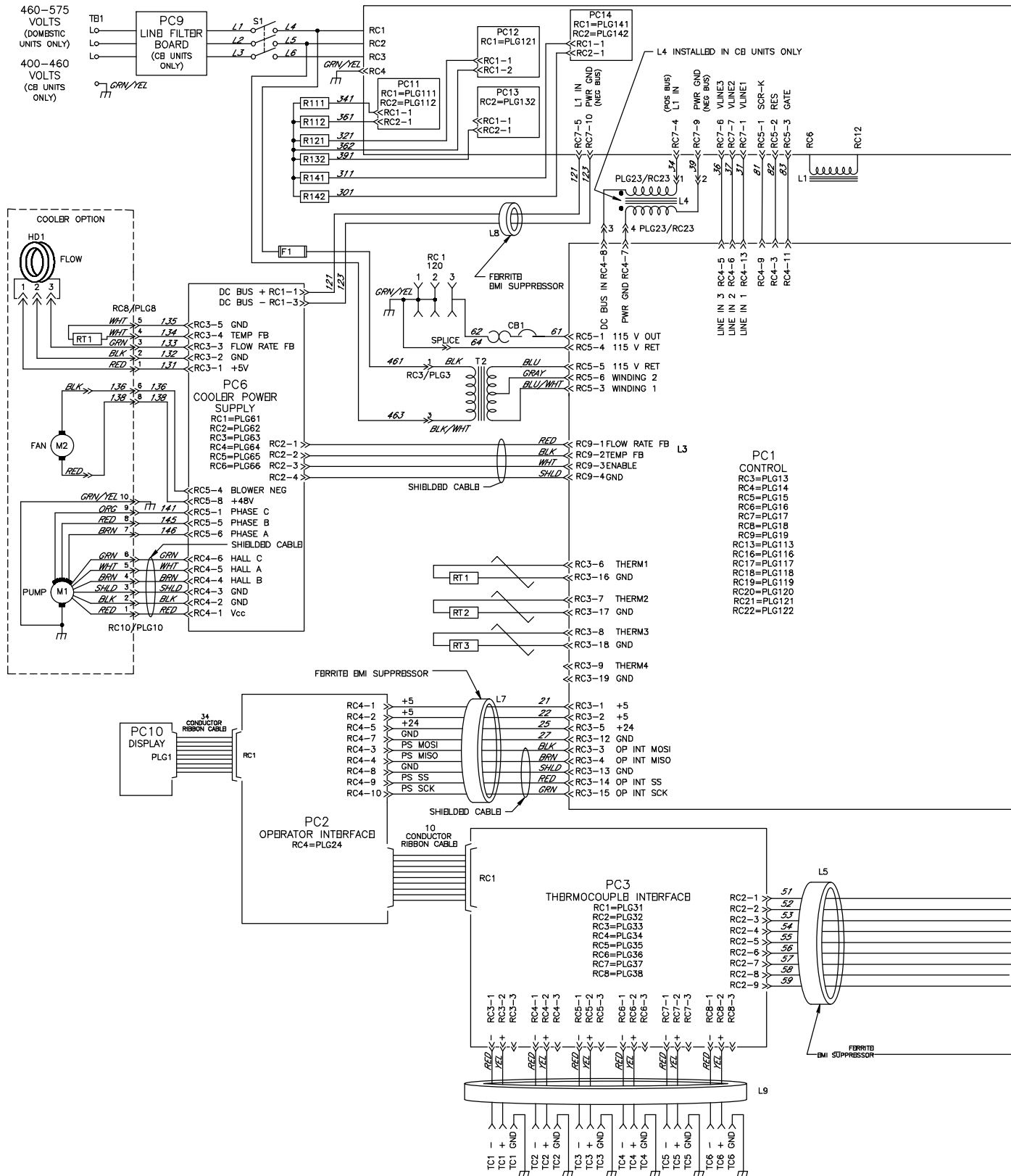
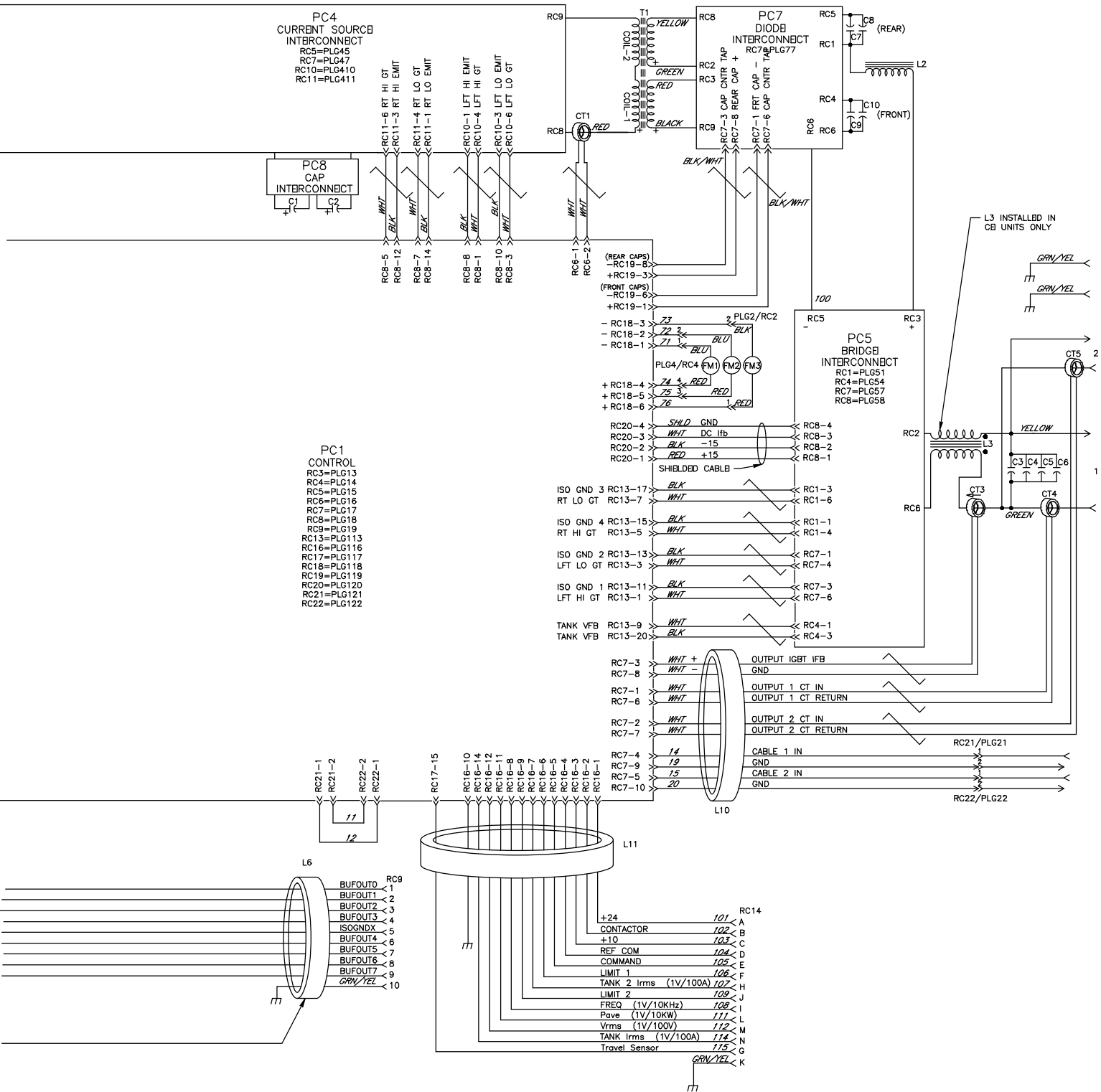

Figure 11-1. Circuit Diagram



PC4
CURRENT SOURCE
INTERCONNECT
RC5=PLG45
RC7=PLG47
RC10=PLG410
RC11=PLG411

PC8
CAP
INTERCONNECT
C1
C2

PC1
CONTROL
RC3=PLG13
RC4=PLG14
RC5=PLG15
RC6=PLG16
RC7=PLG17
RC8=PLG18
RC9=PLG19
RC13=PLG113
RC16=PLG116
RC17=PLG117
RC18=PLG118
RC19=PLG119
RC20=PLG120
RC21=PLG121
RC22=PLG122

- +24 101 A
- CONTACTOR 102 B
- +10 103 C
- REF COM 104 D
- COMMAND 105 E
- LIMIT 1 106 F
- TANK 2 Irms (1V/100A) 107 H
- LIMIT 2 109 J
- FREQ (1V/10KHz) 108 I
- Pave (1V/10KW) 111 L
- Vrms (1V/100V) 112 M
- TANK Irms (1V/100A) 114 N
- Travel Sensor 115 G

SECTION 12 – PARTS LIST

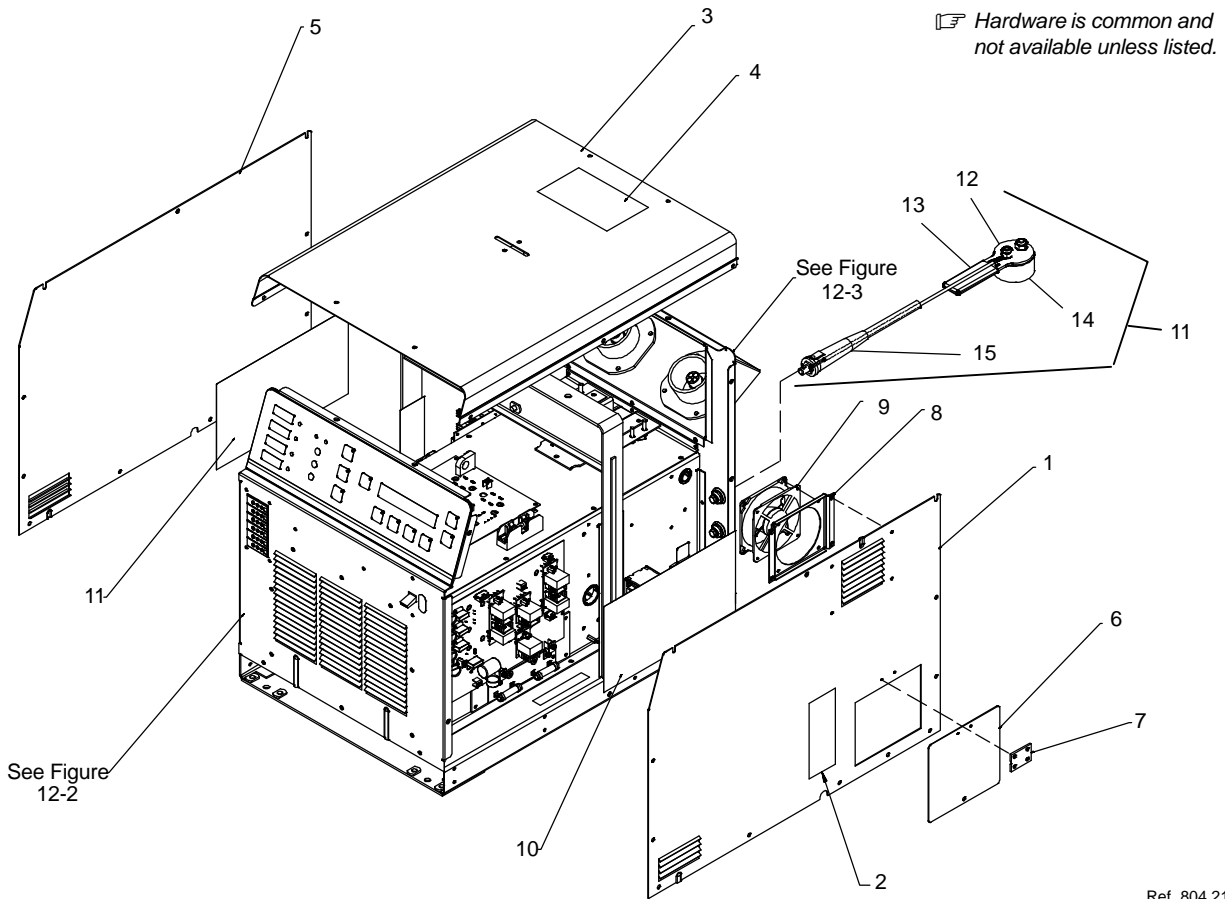

Figure 12-1. Wrappers

Ref. 804 218-D

Item No.	Dia. Mkgs.	Part No.	Description	Quantity
----------	------------	----------	-------------	----------

Figure 12-1. Wrappers

1		+217470	Panel, Side RH	1
2		217860	Label, Warning Electric Shock And Input Pwr (Fr)	1
2		194466	Label, Warning Electric Shock And Input Pwr (Ce)	1
3		+217325	Cover, Top	1
4		147876	Label, Warning General Precautionary Induction Heat	1
4		190025	Label, Warning General Precautionary Wordless Induction Heat	1
5		217334	Panel, Side Lh	1
6		217468	Door, Primary Board	1
7		218280	Hinge, Cont Polyolefin Copolymer	1
8		222106	Bracket, Mtg Fan	1
9	FM3	236263	Fan, Muffin 24vdc 3000 Rpm 130 CFM	1
10		206270	Insulator, Side RH	2
11		197900	Cable, Work Ground (Includes)	1
12		271878	Handle	1
13		271466	Grip, Handle	1
14		271842	Magnet, Permanent	1
15		127836	Plug, Tw Lk Insul Male	1
	RC2	135635	Housing Plug+Pins, (Service Kit)	1
	PLG2	131054	Housing Rcpt+Skts, (Service Kit)	1
	PLG61	131204	Housing Plug+Skts, (Service Kit)	1
	PLG63	115094	Housing Plug+Skts, (Service Kit)	1

+When ordering a component originally displaying a precautionary label, the label should also be ordered.

To maintain the factory original performance of your equipment, use only Manufacturer's Suggested Replacement Parts. Model and serial number required when ordering parts from your local distributor.

☞ Hardware is common and not available unless listed.

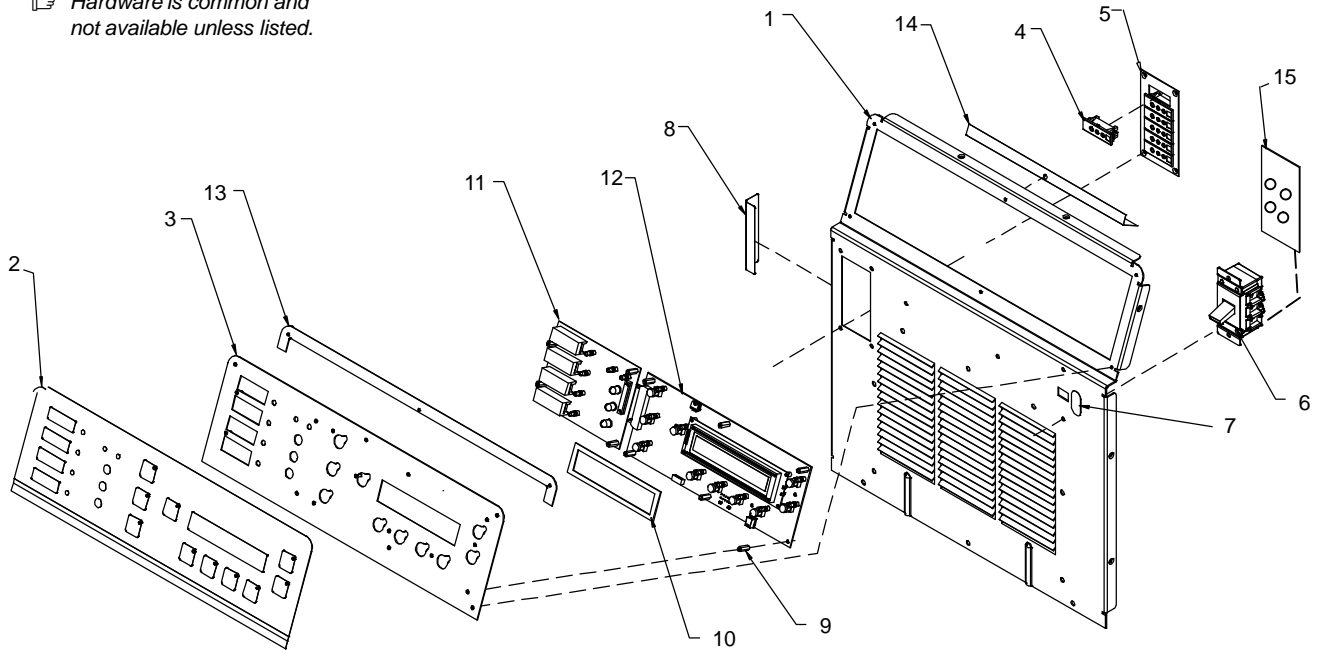

Ref. 804 219-D

Figure 12-2. Front Panel

Item No.	Dia. Mkgs.	Part No.	Description	Quantity
----------	------------	----------	-------------	----------

Figure 12-2. Front Panel

...	1	217323	.. Panel, Front	1
...	2	216225	.. Nameplate, Proheat 35	1
...	3	216224	.. Panel, Operator Interface	1
...	4	TC1-TC6	.. Receptacle Assy, Thermocouple	6
...	5	217327	.. Plate, Tc Receptacle	1
...	6	S1	.. Switch, Tgl 3pst 40a 600vac Scr Term Wide Tgl	1
...	7	252731	.. Label, Warning Read Labels On/Off Storage Temp	1
...	8	221493	.. Label, TC 1-6	1
...	9	115440	.. Standoff, No 6-32	14
...	10	224143	.. Gasket, Meter Lens	1
...	11	PC10	.. Circuit Card Assy, Display	1
...	12	PC2	.. Circuit Card Assy, Operator Interface W/Program	1
...		PLG24	.. Housing Plug+Skts, (Service Kit)	1
...	13	247615	.. Gasket, Operator Interface Proheat	1
...	14	246430	.. Deflector	1
...	15	203310	.. Insulator, Switch Power	1

To maintain the factory original performance of your equipment, use only Manufacturer's Suggested Replacement Parts. Model and serial number required when ordering parts from your local distributor.

☞ Hardware is common and not available unless listed.

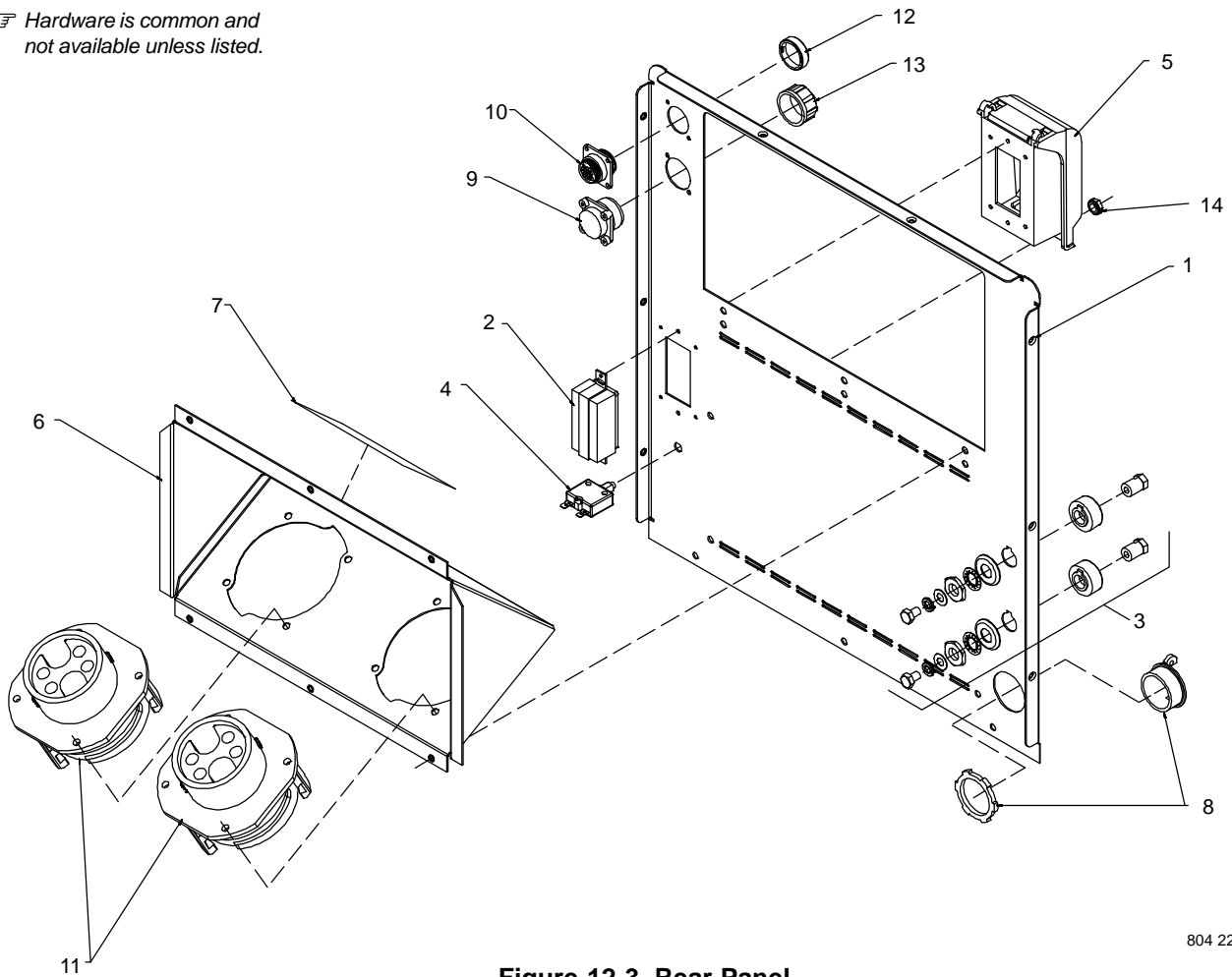

804 220-A

Figure 12-3. Rear Panel

Item No.	Dia. Mkgs.	Part No.	Description	Quantity
----------	------------	----------	-------------	----------

Figure 12-3. Rear Panel

...	1	217324	.. Panel, Rear	1
...	2	RC1 252561	.. Receptacle, W/Leads	1
...	3	127837	.. Receptacle, Tw Lk Insul Fem (Dinse Type)	2
...	4	CB1 089807	.. Supplementary Protector, Man Reset 1p 2.5 A 250 Vac	1
...	5	220824	.. Cover, Receptacle Weatherproof Duplex	1
...	6	+218689	.. Panel, Rear Output	1
...	7	602498	.. Label, Danger High Voltage	1
...	8	010467	.. Connector, Clamp Cable 1.250	1
...	9	RC14 143976	.. Rcpt W/Skts, (Service Kit)	1
...	10	RC9 047637	.. Housing Plug+Pins, (Service Kit)	1
...	11	224989	.. Receptacle Assy, Output (With Leads)	2
...		234531	.. Shell, W/Contact Pin And Socket (Service Kit For 224 989)	0
...	12	224042	.. Connector, Circ Cpc Protective Cap	1
...	13	170391	.. Connector, Circ Ms Protective Cap	1
...	14	147195	.. Nut, 375-27 .54 Hex .25 H Nyl	1
...		RC21,22 135635	.. Housing Plug+Pins, (Service Kit)	2
...		PLG21,22 131054	.. Housing Rcpt+Skts, (Service Kit)	2

+When ordering a component originally displaying a precautionary label, the label should also be ordered.

To maintain the factory original performance of your equipment, use only Manufacturer's Suggested Replacement Parts. Model and serial number required when ordering parts from your local distributor.

 Hardware is common and not available unless listed.

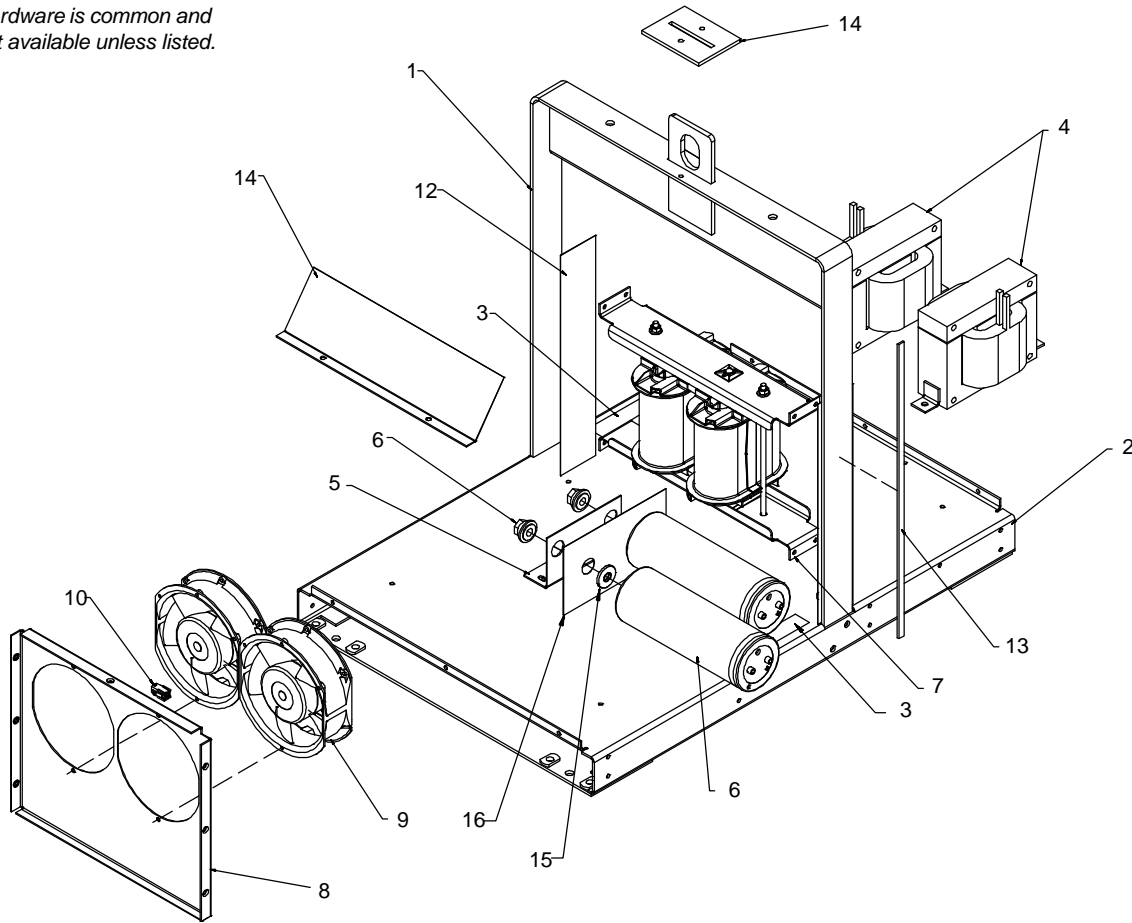

Figure 12-4. Base w/Components

804 221-D

Item No.	Dia. Mkgs.	Part No.	Description	Quantity
----------	------------	----------	-------------	----------

Figure 12-4. Base w/Components

...	1	217328	.. Frame, Lifting	1
...	2	213865	.. Base Assy	1
...	3	213939	.. Label, Warning Electric Shock Can Kill Significant	2
...	3	22 085	.. Label, Warning Electric Shock Can Kill Wordless 150	2
...	4	L1,L2	218692 .. Inductor	2
...	5	216815	.. Bracket, Cap Support	1
...	6	C1,2	213870 .. Capacitor, Elctlt	2
...	7	T1	213583 .. Transformer, HF	1
...	7	T1	227065 .. Transformer, Hf (400v Model)	1
...	8	216629	.. Bracket, Fan	1
...	9	FM1,FM2	224694 .. Fan, Muffin 24 V	2
...	10	RC4	115090 .. Housing Plug+Pins, (Service Kit)	1
...	11	217992	.. Baffle, Air Bottom	1
...	12	224973	.. Insulator, Lift Frame	2
...	13	603115	.. Weatherstripping	2
...	14	026627	.. Gasket, Lifting Eye Cover	1
...	PLG4	115094	.. Housing Plug+Skts, (Service Kit)	1
...	15	226837	.. Washer, Rubber .343 Id X .875 Od X .093 Thk	2
...	16	226838	.. Insulator, Capacitor	1

To maintain the factory original performance of your equipment, use only Manufacturer's Suggested Replacement Parts. Model and serial number required when ordering parts from your local distributor.

Hardware is common and not available unless listed.

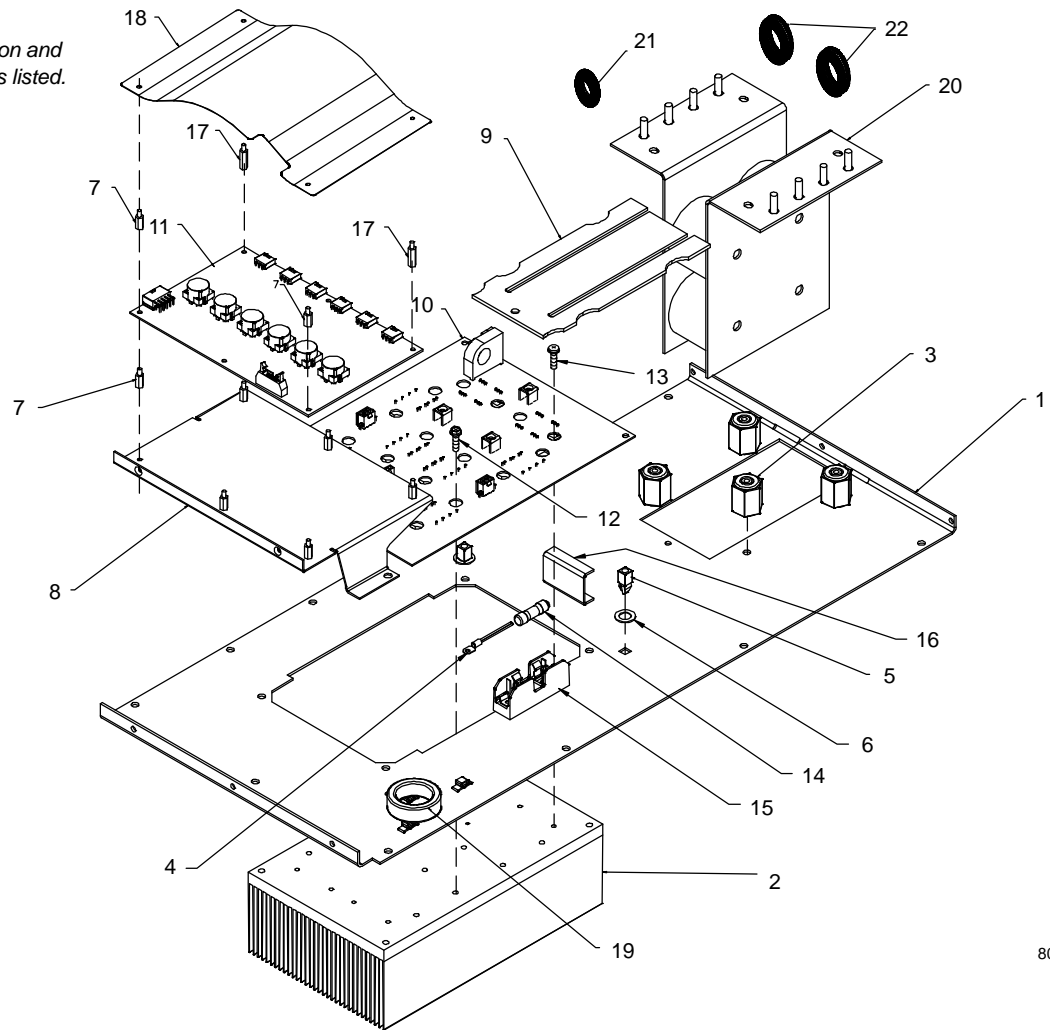

804 222-F

Figure 12-5. Top Windtunnel

Item No.	Dia. Mkgs.	Part No.	Description	Quantity
----------	------------	----------	-------------	----------

Figure 12-5. Top Windtunnel

1		218424	Windtunnel, Top	1
2		218684	Heat Sink, AC Commutator	1
3		025248	Standoff, Insul .250-20 X 1.250 Lg X .437 Thd	4
4	RT2	222327	Thermistor, Ntc 30 K Ohm At 25 Deg C 24 In. Lead	1
5		083147	Grommet, Scr No 8/10 Panel Hole .312 Sq .500 High	2
6		605339	Washer, Tooth .377 ID X 0.507 OD X .022t Stl Pld	2
7		098691	Stand-Off, No 6-32 X .500 Lg .250 Hex Stl M&F	6
8		217326	Bracket, TC Interface	1
9		250975	Insulator, Tank Cap	1
10	PC5	229382	Support, Leads Bridge Output	1
11	PC3	239257	Kit, Circuit Card Assy Intrcnct Bridge	1
12		239236	Circuit Card Assy, Tc Interface	1
13		208591	Screw, M 5- .8 x 12 Soc Hd-Torx Stl Pld Sems	12
14	F1	212038	Screw, M4 - .7 X 8.5 Pan Hd-Phl Stl Pld	8
15		225514	Fuse, Crtg 2. Amp 600 V Time Delay	1
16		225553	Holder, Fuse Crtg 30 A 600 V 13/32 X 1-1/2 Lg	1
17		229382	Support, Leads Bridge Output	1
18		227863	Stand-Off, No 6-32 X .750 Lg .250 Hex Stl M&F	1
19		247231	Cover, TC Board	1
20		246866	Choke, Common Mode 12 Turn W/Rcpt	1
21		251158	Capacitor Assy	1

Item No.	Dia. Mkgs.	Part No.	Description	Quantity
----------	------------	----------	-------------	----------

Figure 12-5. Top Windtunnel (continued)

... 21 ...	CT3	220822	Xfmr, Current Bridge	1
... 22 .	CT4, CT5	220823	Xfmr, Current Output	2
.....	PLG32	115091	Housing Plug+Skts, (Service Kit)	1
.....	PLG33-38,54	131204	Housing Plug+Skts, (Service Kit)	7
.....	PLG51,57	11 5093	Housing Plug+Skts, (Service Kit)	2
.....	PLG58	115094	Housing Plug+Skts, (Service Kit)	1
.....		227082	Choke, Common Mode (400 V Model Only)	1

To maintain the factory original performance of your equipment, use only Manufacturer's Suggested Replacement Parts. Model and serial number required when ordering parts from your local distributor.

☞ Hardware is common and not available unless listed.

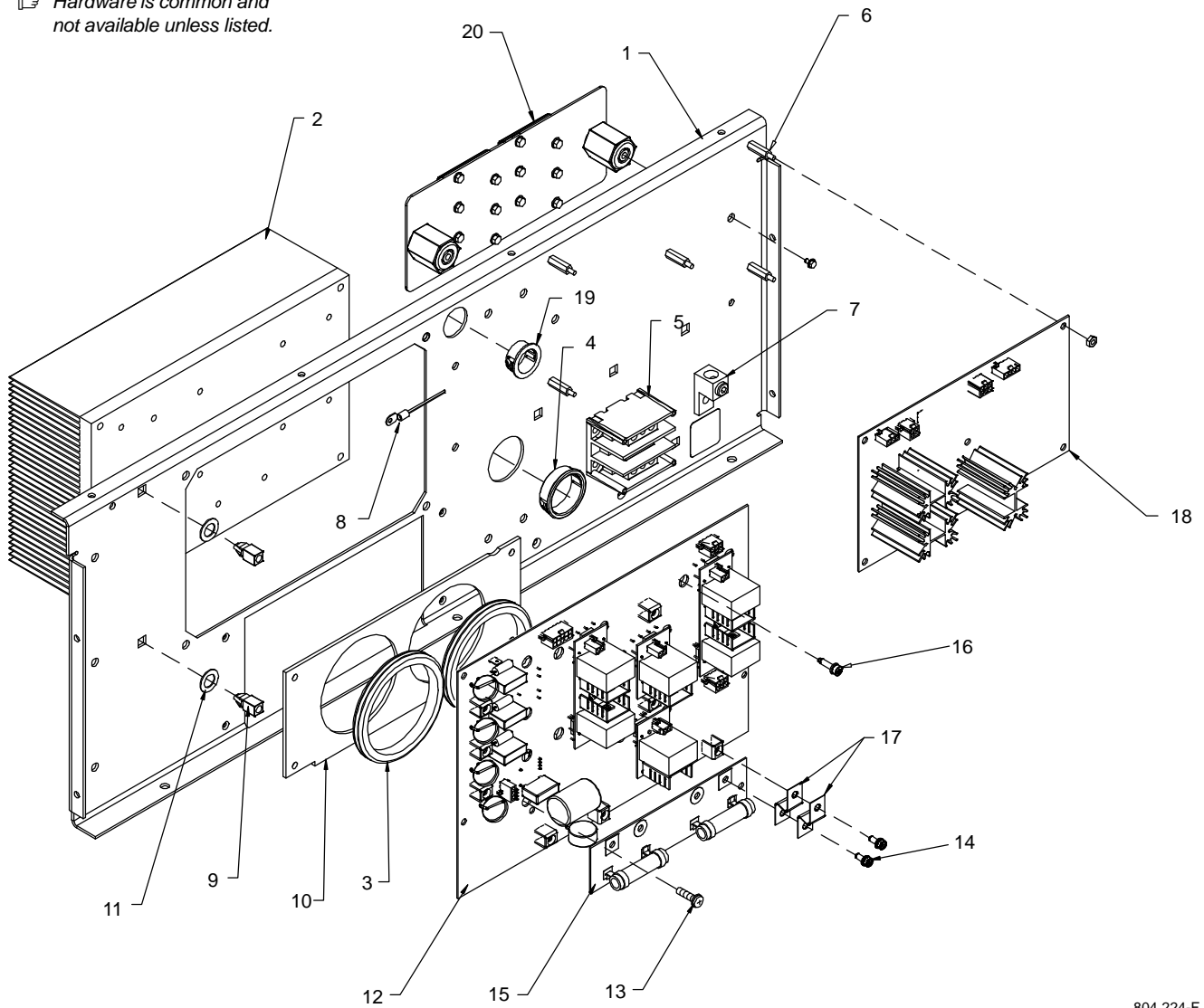

804 224-F

Figure 12-6. Right Windtunnel

Item No.	Dia. Mkgs.	Part No.	Description	Quantity
----------	------------	----------	-------------	----------

Figure 12-6. Right Windtunnel

...	1	216230	.. Windtunnel, RH	1
...	2	213873	.. Heat Sink, Current Source	1
...	3	213871	.. Grommet, Rbr Sil 3.000 Id X 3.250 Mtg Hole	2
...	4	170647	.. Bushing, Snap-In Nyl 1.312 Id X 1.500 Mtg Hole	1
...	5	223120	.. Block, Term 115 Amp 3 Pole Screw Term	1
...	6	115443	.. Stand-Off, No 6-32 X .750 Lg .250 Hex	5
...	7	145743	.. Lug, Univ W/Scr 600V 2-14 Wire .250 Stud	1
...	8	RT1	222326 .. Thermistor, NTC 30 K Ohm At 25 Deg C 34 In Lead	1
...	9	083147	.. Grommet, Scr No 8/10 Panel Hole .312 Sq .500 High	2
...	10	224391	.. Panel, Insulating Mtg Capacitor	1
...	11	605339	.. Washer, Tooth .377 ID X 0.507 OD X .022t Stl Pld	2
...	12	PC4	239240 .. Kit, Circuit Card Assy Intrcnct I Srce Inpt	1
...	13	212038	.. Screw, M4 - .7 X 8.5 Pan Hd-Phl Stl Pld	2
...	14	176879	.. Screw, M5 - .8 X 12 Hex Hd-Phl 8.8 Pld	12
...	15	PC8	239275 .. Circuit Card Assy, Bus Intrcnct	1
...	16	208591	.. Screw, M 5- .8x 12 Soc Hd-Torx Stl Pld Sems	14

Item No.	Dia. Mkgs.	Part No.	Description	Quantity
----------	------------	----------	-------------	----------

Figure 12-6. Right Windtunnel (Continued)

... 17		229728	.. Strap, Connecting	4
... 18	PC6	239262	.. Circuit Card Assy, Cooler Control	1
... 19		030170	.. Bushing, Snap-In Nyl .750 ID X 1.000 Mtg Hole	1
... 20		245842	.. Assy, Resistor	1
.....	PLG64,410,			
	411	115093	.. Housing Plug+Skts, (Service Kit)	3
.....	PLG47	115091	.. Housing Plug+Skts, (Service Kit)	1
.....	PLG45,61	131204	.. Housing Plug+Skts, (Service Kit)	2
.....	PLG62	201665	.. Housing Plug+Skts, (Service Kit)	1
.....	PLG63	115094	.. Housing Plug+Skts, (Service Kit)	1
.....	PLG111, 112			
	121, 132,			
	141, 142	131054	.. Housing Rcpt+Skts, (Service Kit)	6

To maintain the factory original performance of your equipment, use only Manufacturer's Suggested Replacement Parts. Model and serial number required when ordering parts from your local distributor.

☞ Hardware is common and not available unless listed.

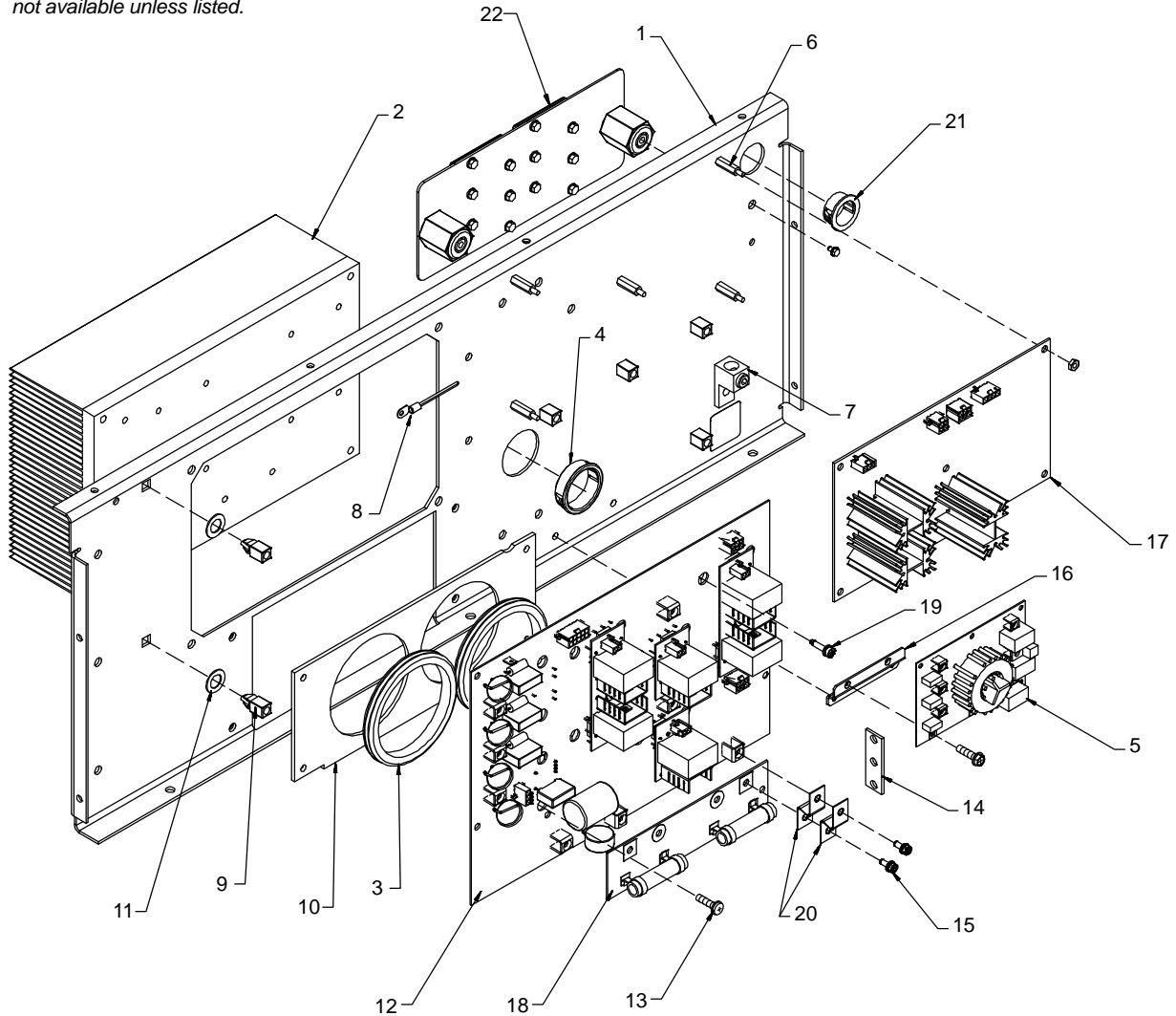

804 431-E

Figure 12-7. Right Windtunnel (400 V Model Only)

Item No.	Dia. Mkgs.	Part No.	Description	Quantity
----------	------------	----------	-------------	----------

Figure 12-7. Right Windtunnel (400 V Model Only)

...	1	253366	.. Windtunnel, RH	1
...	2	213873	.. Heat Sink, Current Source	1
...	3	213871	.. Grommet, Rbr Sil 3.000 ID X 3.250 Mtg Hole	2
...	4	170647	.. Bushing, Snap-In Nyl 1.312 ID X 1.500 Mtg Hole	1
...	5	PC9	239284 .. Circuit Card Assy, Input Filter	1
...	6	115443	.. Stand-Off, No 6-32 X .750 Lg .250 Hex	5
...	7	148743	.. Lug, Univ W/Scr 600v 2-14 Wire .250 Stud	1
...	8	RT1	222326 .. Thermistor, NTC 30 K Ohm At 25 Deg C 34 In Lead	1
...	9	083147	.. Grommet, Scr No 8/10 Panel Hole .312 Sq .500 High	6
...	10	224391	.. Panel, Insulating Mtg Capacitor	1
...	11	605339	.. Washer, Tooth .377 ID X 0.507 OD X .022t Stl Pld	2
...	12	PC4	239240 .. Kit, Circuit Card Assy Intrcnc I Srce Inpt	1
...	13	212038	.. Screw, M4 - .7 X 8.5 Pan Hd-Phl Stl Pld	2
...	14	226579	.. Spacer, Leads	1
...	15	176879	.. Screw, M5 - .8 X 12 Hex Hd-Phl 8.8 Pld	12
...	16	226041	.. Bracket, Mtg CE Filter Ground Plane	1

Item No.	Dia. Mkgs.	Part No.	Description	Quantity
----------	------------	----------	-------------	----------

Figure 12-7. Right Windtunnel (400 V Model Only) (Continued)

... 17 ...	PC6	239262	Circuit Card Assy, Cooler Control	1
... 18 ...	PC8	239275	Circuit Card Assy, Bus Intrcnct	1
... 19		208591	Screw, M 5- .8x 12 Soc Hd-Torx Stl Pld Sems	14
... 20		229728	Strap, Connecting	4
... 21		030170	Bushing, Snap-In Nyl .750 ID X 1.000 Mtg Hole	1
... 22		245842	Assy, Resistor	1
.....	PLG64,410, 411	115093	Housing Plug+Skts, (Service Kit)	3
.....	PLG47	115091	Housing Plug+Skts, (Service Kit)	1
.....	PLG45,61	131204	Housing Plug+Skts, (Service Kit)	2
.....	PLG62	201665	Housing Plug+Skts, (Service Kit)	1
.....	PLG63	115094	Housing Plug+Skts, (Service Kit)	1
.....	PLG111, 112, 121, 132, 141, 142	131054	Housing Rcpt+Skts, (Service Kit)	6

To maintain the factory original performance of your equipment, use only Manufacturer's Suggested Replacement Parts. Model and serial number required when ordering parts from your local distributor.

☞ Hardware is common and not available unless listed.

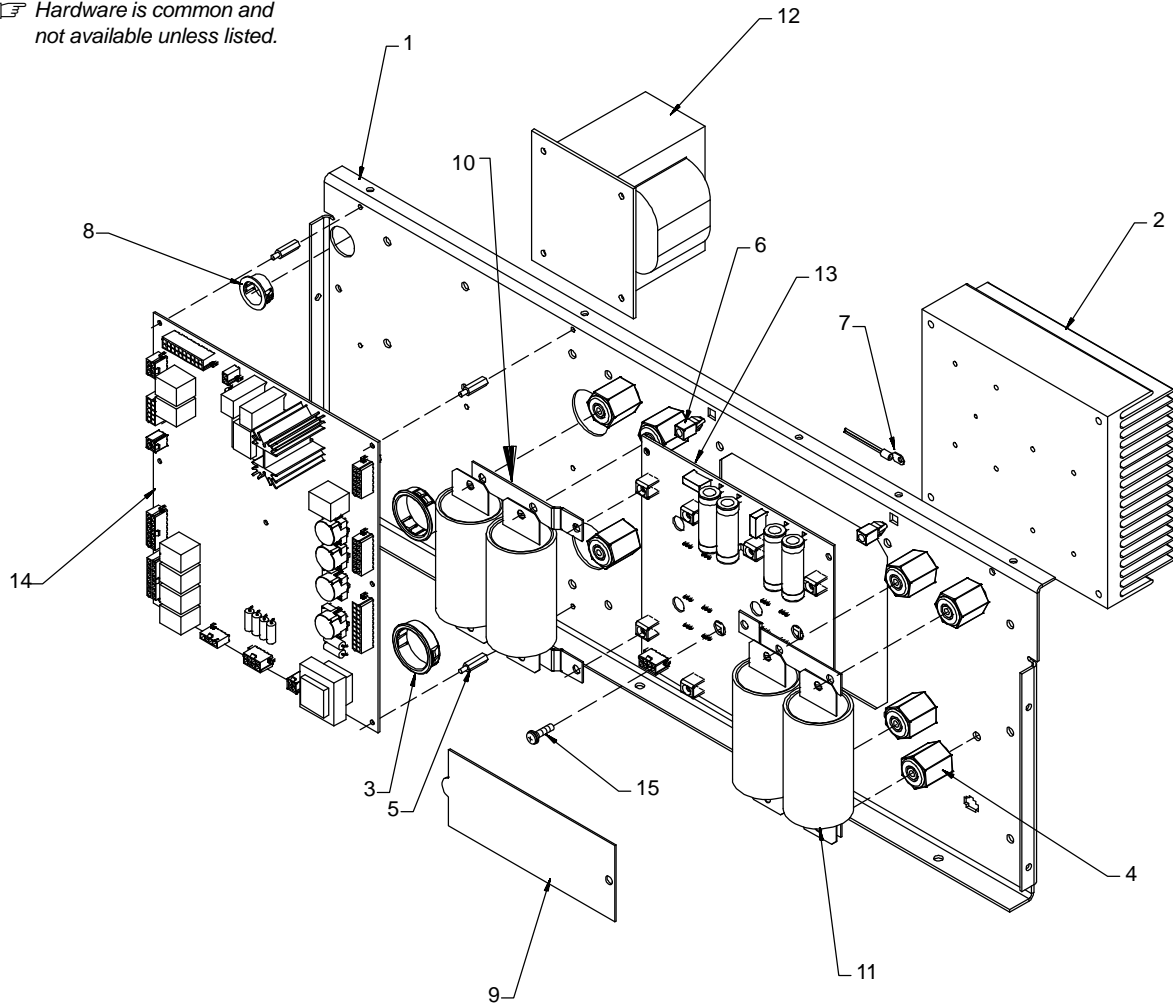

804 225-A

Figure 12-8. Left Windtunnel

Item No.	Dia. Mkgs.	Part No.	Description	Quantity
...	Figure 12-8. Left Windtunnel	...
...	...	216631	Windtunnel, LH	1
...	...	218683	Heat Sink, Diode	1
...	...	170647	Bushing, Snap-In Nyl 1.312 ID X 1.500 Mtg Hole	2
...	...	025248	Stand-Off, Insul .250-20 X 1.250 Lg X .437 Thd	8
...	...	115443	Stand-Off, No 6-32 X .750 Lg .250 Hex	7
...	...	083147	Grommet, Scr No 8/10 Panel Hole .312 Sq .500 High	2
...	RT3	222327	Thermistor, Ntc 30 K Ohm At 25 Deg C 24 In. Lead	1
...	...	030170	Bushing, Snap-In Nyl .750 Id X 1.000 Mtg Hole	1
...	...	218430	Cover, Access	1
...	...	220825	Bus Bar, Capacitor	4
...	C7-C10	218687	Capacitor, Polyp Film 1.35 UF 700 Vac +5% -0%	4
...	C7-C10	225775	Capacitor, Polyp Film 1.10 UF 700 Vac +5% -0% (400 V Model Only)	4
...	T2	219002	Transformer, Control	1
...	PC7	239266	Kit, Circuit Card Assy Intrcnct I Srce Out	1
...	PC1	273113	Circuit Card Assy, W/Plug (Service Kit)	1
...	...	212038	Screw, M4 - .7 X 8.5 Pan Hd-Phl Stl Pld Slffmg	8

Item No.	Dia. Mkgs.	Part No.	Description	Quantity
.....	PLG16, 121,122 131054	.. Housing Rcpt+Skts, (Service Kit) 3
.....	PLG19, 120 115094	.. Housing Plug+Skts, (Service Kit) 2
.....	PLG15, 118 115093	.. Housing Plug+Skts, (Service Kit) 2
.....	PLG77, 119 115092	.. Housing Plug+Skts, (Service Kit) 2
.....	PLG17 115091	.. Housing Plug+Skts, (Service Kit) 1
.....	PLG18, 116 131056	.. Housing Rcpt+Skts, (Service Kit) 2
.....	PLG13, 113 162382	.. Housing Plug+Skts, (Service Kit) 2
.....	PLG14 130203	.. Housing Plug+Skts, (Service Kit) 1

Figure 12-8. Left Windtunnel (Continued)

To maintain the factory original performance of your equipment, use only Manufacturer's Suggested Replacement Parts. Model and serial number required when ordering parts from your local distributor.

☞ Hardware is common and not available unless listed.

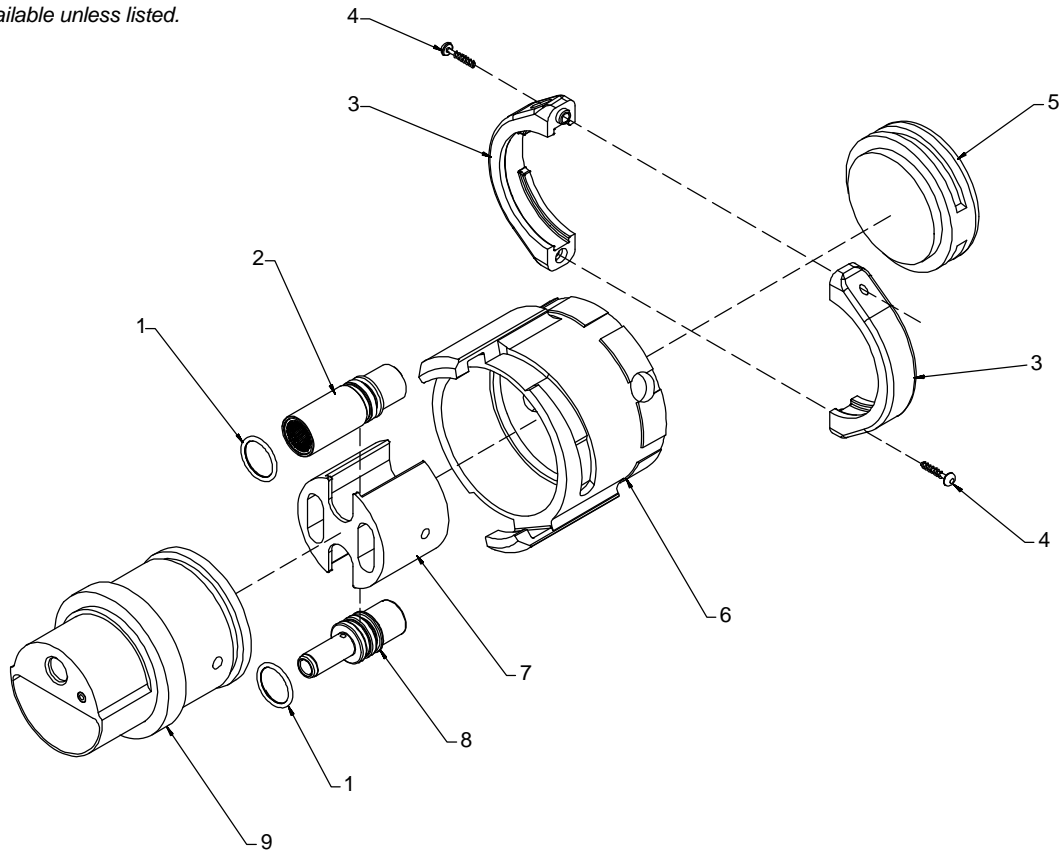

804 300-A

Figure 12-9. Hermaphroditic Blank Plug Assy

Item No.	Dia. Mkgs.	Part No.	Description	Quantity
----------	------------	----------	-------------	----------

Figure 12-9. Hermaphroditic Blank Plug Assy 224 260

...	1	221440	O-Ring, .737 Id X .103 Cs	2
...	2	252628	Socket, 14mm Blank Plug	1
...	3	221099	Clamp, Strain Relief	2
...	4	136343	Screw, K50 X 20 Pan Hd-Phi Stl Pld Pt	2
...	5	224261	Cap, Plug Assy	1
...	6	254886	Collar, Coupling	1
...	7	254885	Retainer, Contact	1
...	8	252627	Pin, 14mm Blank Plug	1
...	9	253842	Shell Assy, Connector - Protective Plug	1

To maintain the factory original performance of your equipment, use only Manufacturer's Suggested Replacement Parts. Model and serial number required when ordering parts from your local distributor.

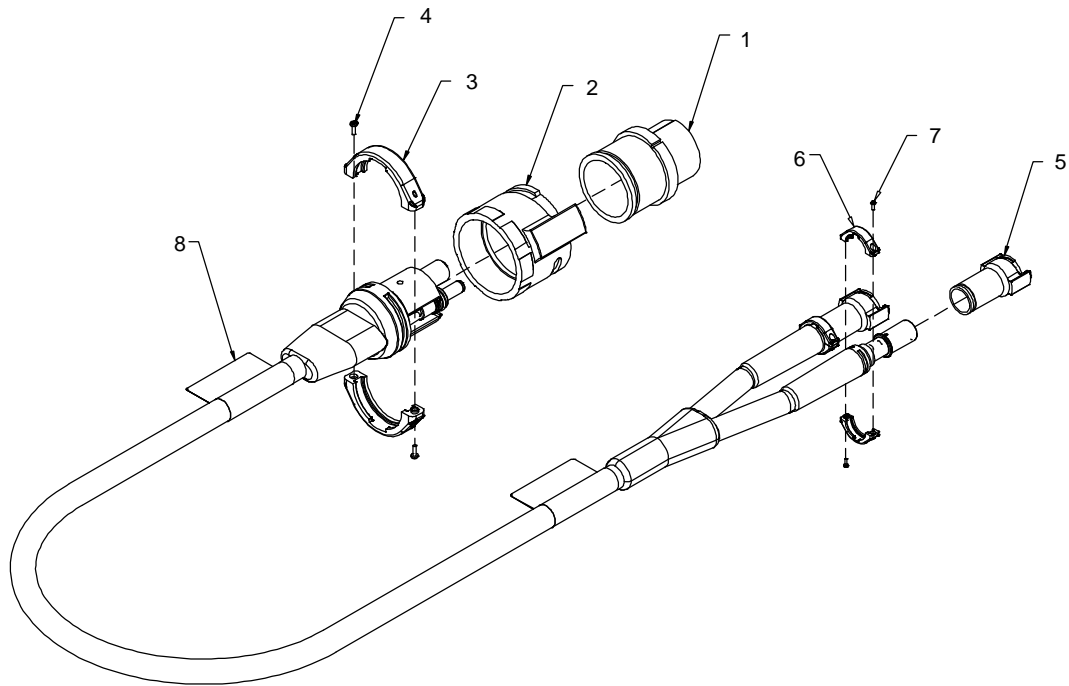

804 324-A

Figure 12-10. Air-Cooled Output Extension Cables

Item No.	Dia. Mkgs.	Part No.	Description	Quantity
----------	------------	----------	-------------	----------

Figure 12-10. Air-Cooled Output Extension Cables 195 404, 195 405, And 300 362

... 1	253841	.. Shell Assy, Connector – Air Cooled	1
... 2	254886	.. Collar, Coupling	1
... 3	221099	.. Clamp, Strain Relief	2
... 4	136343	.. Screw, K50 x 20 Pan Hd–Phl Stl Pld Pt Thread Forming	2
... 5	254887	.. Shell, Connector Cable Female With Seal	2
... 6	224259	.. Clamp, Strain Relief Socket	4
... 7	228296	.. Screw, Ka35x10 Pan Hd–Phl Sst Pln Pt Thread Forming	4
... 8	197635	.. Label, Warning Flexible Induction Cords	2

To maintain the factory original performance of your equipment, use only Manufacturer's Suggested Replacement Parts. Model and serial number required when ordering parts from your local distributor.

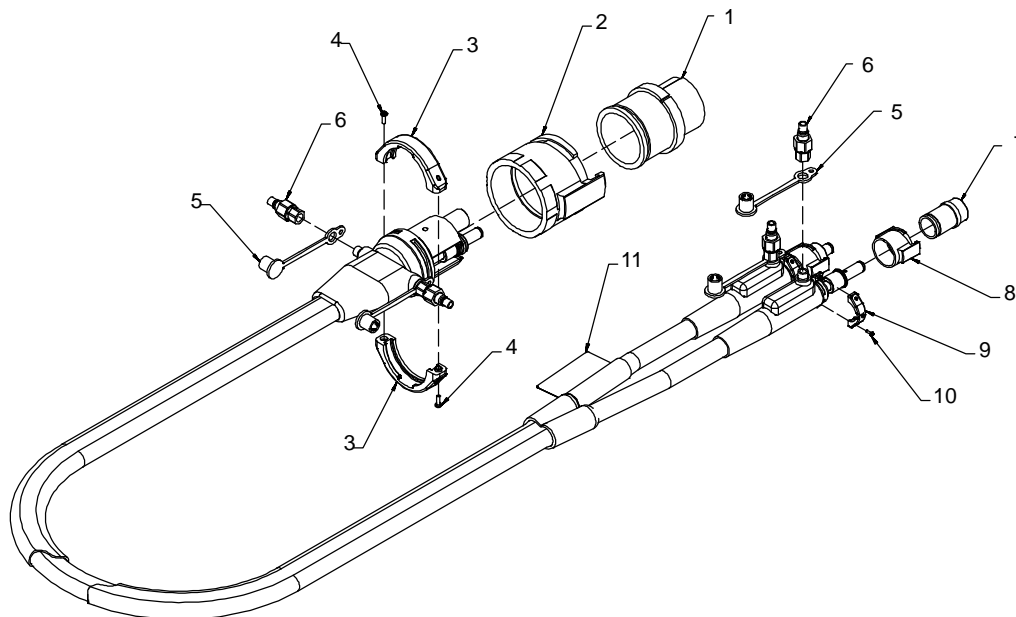

804 411-A

Figure 12-11. Liquid-Cooled Output Extension Cables

Item No.	Dia. Mkgs.	Part No.	Description	Quantity
----------	------------	----------	-------------	----------

Figure 12-11. Liquid-Cooled Output Extension Cables (195 402, 195 403, 300 180, And 300 598)

... 1	...	253840	.. Connector Shell	1
... 2	...	254886	.. Coupling Collar	1
... 3	...	221099	.. Strain Relief Clamp	2
... 4	...	136343	.. Screw K50 X 20	2
... 5	...	210912	.. Protective Cap	4
... 6	...	204954	.. Quick Connect Fitting	4
... 7	...	254889	.. Connector Shell	2
... 8	...	254890	.. Coupling Collar	2
... 9	...	224258	.. Strain Relief Pin Clamp	4
... 10	...	228296	.. Screw Ka35x10	4
... 11	...	197635	.. Warning Label	1

To maintain the factory original performance of your equipment, use only Manufacturer's Suggested Replacement Parts. Model and serial number required when ordering parts from your local distributor.

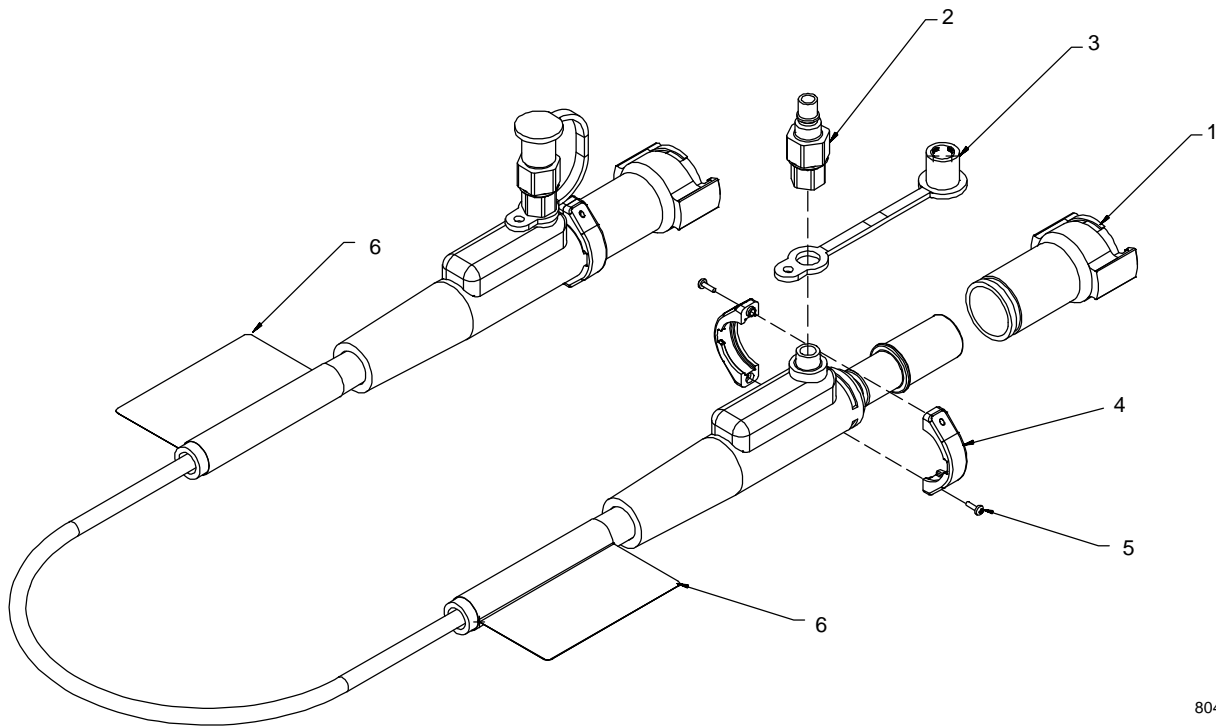

804 404-A

Figure 12-12. Heating Cables

Item No.	Dia. Mkgs.	Part No.	Description	Quantity
Figure 12-12. Heating Cables (300 045, 300 046, 300 047, And 300 049)				
1		254887	Connector Shell	2
2		204954	Plastic Fitting	2
3		210912	Protective Cap	2
4		224259	Strain Relief Clamp	4
5		228296	Screw, Ka35x10	4
6		197635	Warning Label	2

To maintain the factory original performance of your equipment, use only Manufacturer's Suggested Replacement Parts. Model and serial number required when ordering parts from your local distributor.

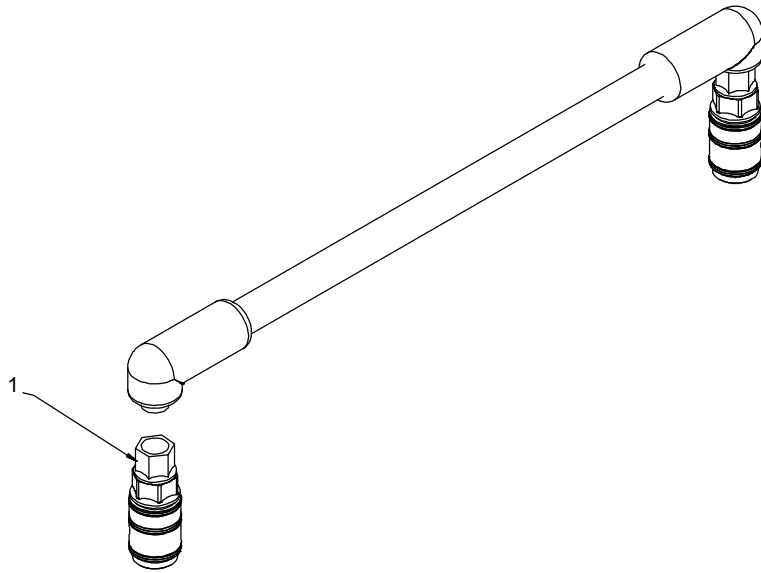

201 432-G

Figure 12-13. Quick Connect To Quick Connect Hose

Item No.	Dia. Mkgs.	Part No.	Description	Quantity
Figure 12-13. Quick Connect To Quick Connect Hose (204 877)				
...	1	...	204955 .. Ftg, Plstc Coupler Qdisc X 1/4 Npt Female	...

To maintain the factory original performance of your equipment, use only Manufacturer's Suggested Replacement Parts. Model and serial number required when ordering parts from your local distributor.

☞ Hardware is common and not available unless listed.

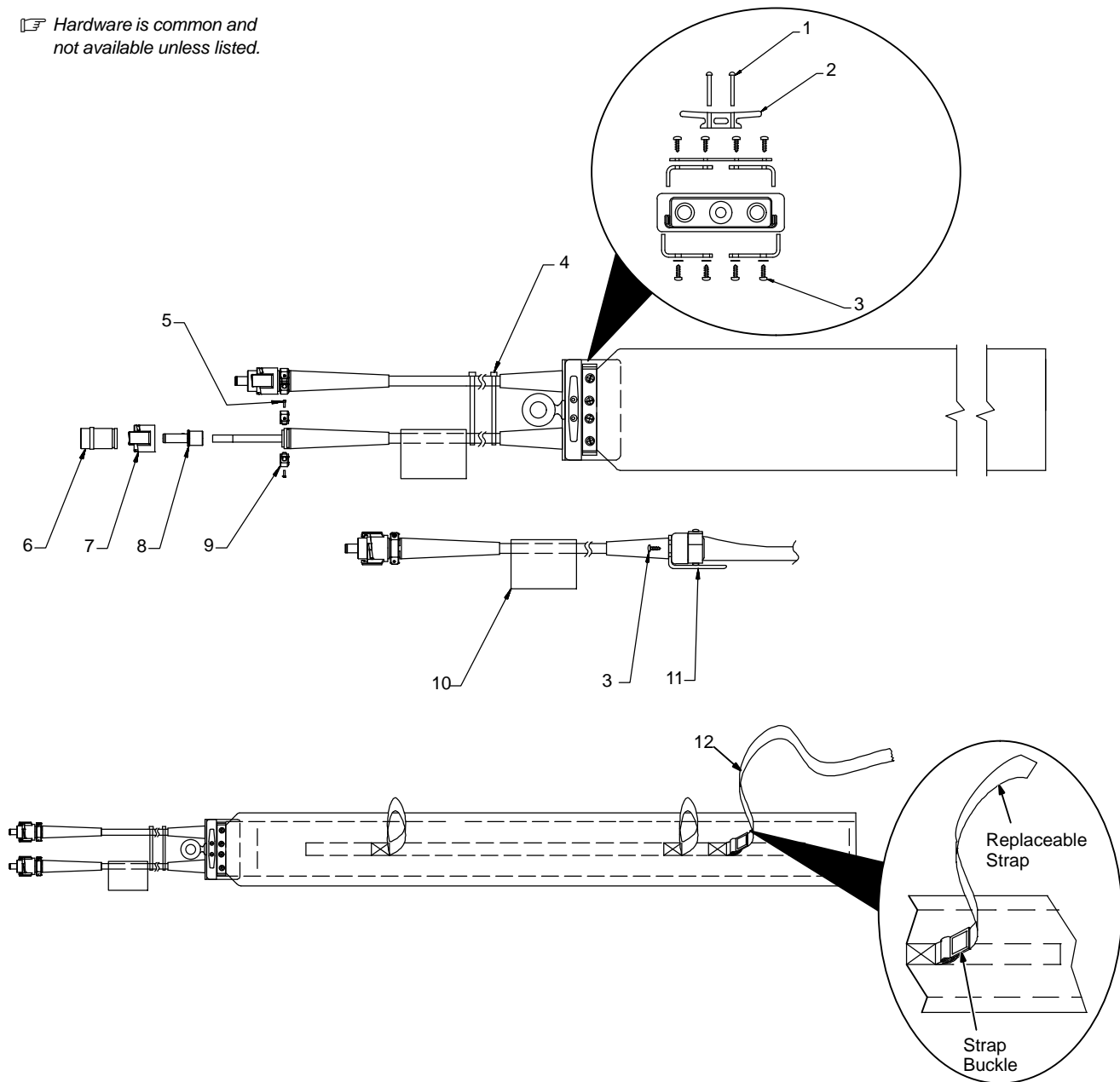

805 176-A / Ref. 805 174-A

Figure 12-14. Induction Blanket And Sleeve

Item No.	Part No.	Description	Quantity
Figure 12-14. Induction Blanket And Sleeve			
...	1	196666 .. Screw, 008-32 X 1.50 Rnd Hd-Slt Brs	2
...	2	196665 .. Cleat, Rope 4 In. Nylon	1
...	3	196669 .. Screw, 010-12 X .63 Pan Hd-Phi Sst Pln Sht Met Ab	6
...	4	020265 .. Cable Tie, 0-1 .750 Bundle Dia Sst2s-Mp	2
...	5	228296 .. Screw, Ka35 X 10 Pan Hd-Phi Sst Pln Pt Thread Forming	4
...	6	254889 .. Shell, Connector Cable Male	2
...	7	254890 .. Collar, Coupling	2
...	8	224145 .. Pin, Radsok 14mm Cable End	2
...	9	224258 .. Clamp, Strain Relief Pin	4
...	10	197635 .. Label, Warning Flexible Induction Cords	1
...	11	196965 .. Wearplate, Induction Blanket	1
...	12	197866 .. Strap, Replacement	1

To maintain the factory original performance of your equipment, use only Manufacturer's Suggested Replacement Parts.

☞ Hardware is common and not available unless listed.

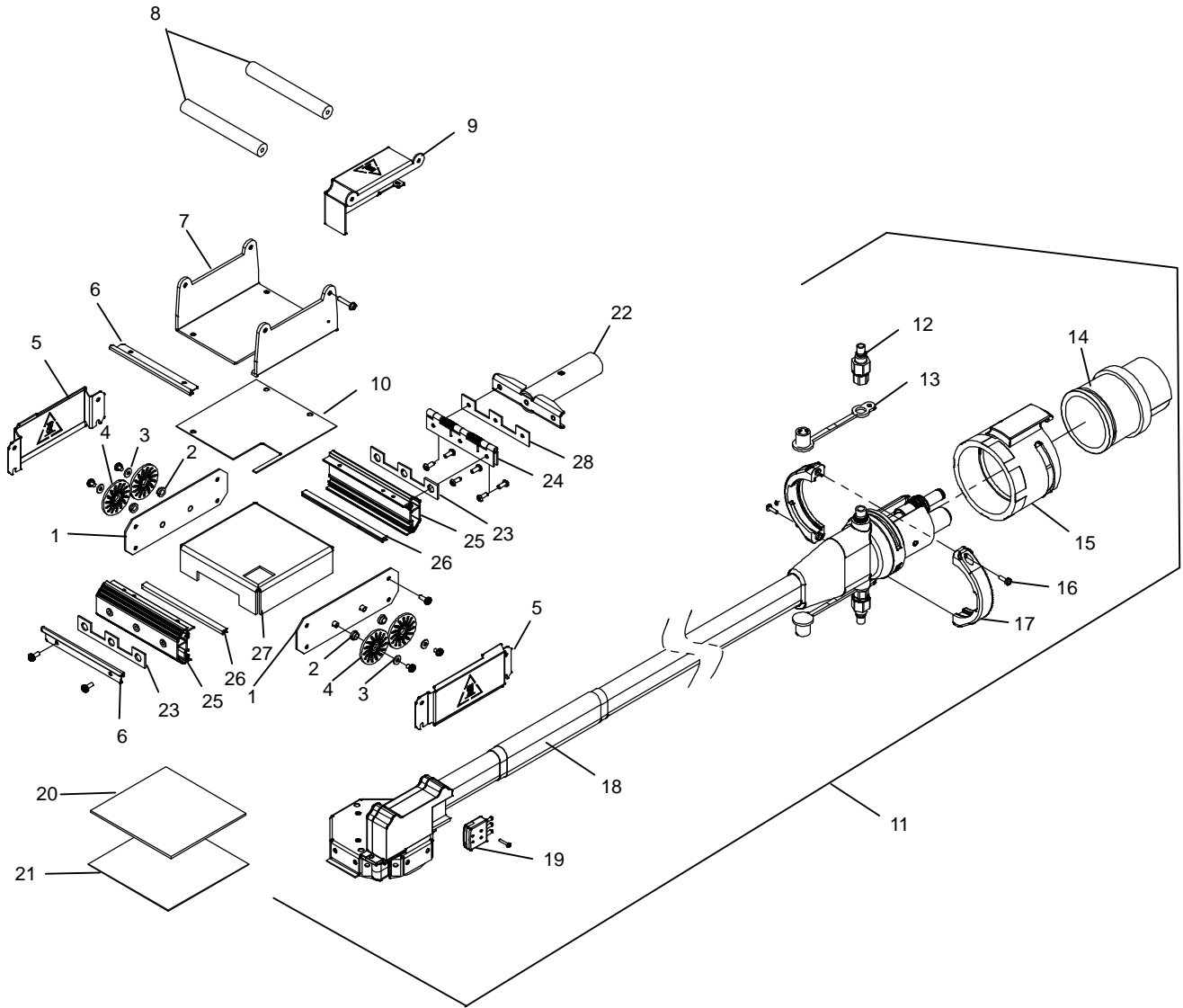

Figure 12-15. Rolling Inductor Complete Assembly

Ref. 263 983-C

Item No.	Dia. Mkgs.	Part No.	Description	Quantity
Figure 12-15. Rolling Inductor Complete Assembly				
1		262163	Plate, Side W/Pems Rolling Inductor	2
2		263693	Bearing	4
3		263696	Washer, Thrust	4
4		263530	Wheel, Rolling Inductor	4
5		265978	Bracket, Travel Sensor Mtg Rails	2
6		263213	Bracket, Mtg Temperature Feedback	2
7		262268	Plate, Top W/Coating	1
8		262166	Handle, Plastic Rolling Inductor	2
9		263854	Bracket, Rolling Inductor Strain Relief Cover	1
10		263690	Spacer, Glass Polyester	1
11		263271	Coil Assy, 8 Turn 2 Layer W/Leads Molded 30ft Leads (Includes)	1
12		204954	Ftg, Plstc Nipple Qdisc X 1/4 Npt Female	2
13		210912	Cap, Protective Rbr Quick Connect Nipple Black	2
14		264119	Shell Assy, Connector - Rolling Inductor	1
15		254886	Collar, Coupling	1
16		136343	Screw, K5 0x 20 Pan Hd-phl Stl Pld Pt Thread Forming	2
17		221099	Clamp, Strain Relief	2
18		263904	Label, Warning Flexible Induction Cords 9672 PSA	1
19		194962	Connector, TC Type K 3-pin Male	1
20		262174	Insulation, Bottom	1
21		262194	Wearplate, Mica	1
22		262172	Handle Assy, Arm	1
23		259455	Spacer, Hinge	2
24		263732	Hinge, Spring	1
25		263697	Extrusion, W/Rivnuts	2
26		262173	Insert, Extrusion Channel	2
27		262183	Insulation, Top	1
28		263986	Spacer, Hinge	1
		263854	Bracket, Mtg IR Connector	1

To maintain the factory original performance of your equipment, use only Manufacturer's Suggested Replacement Parts. Model and serial number required when ordering parts from your local distributor.

☞ Hardware is common and not available unless listed.

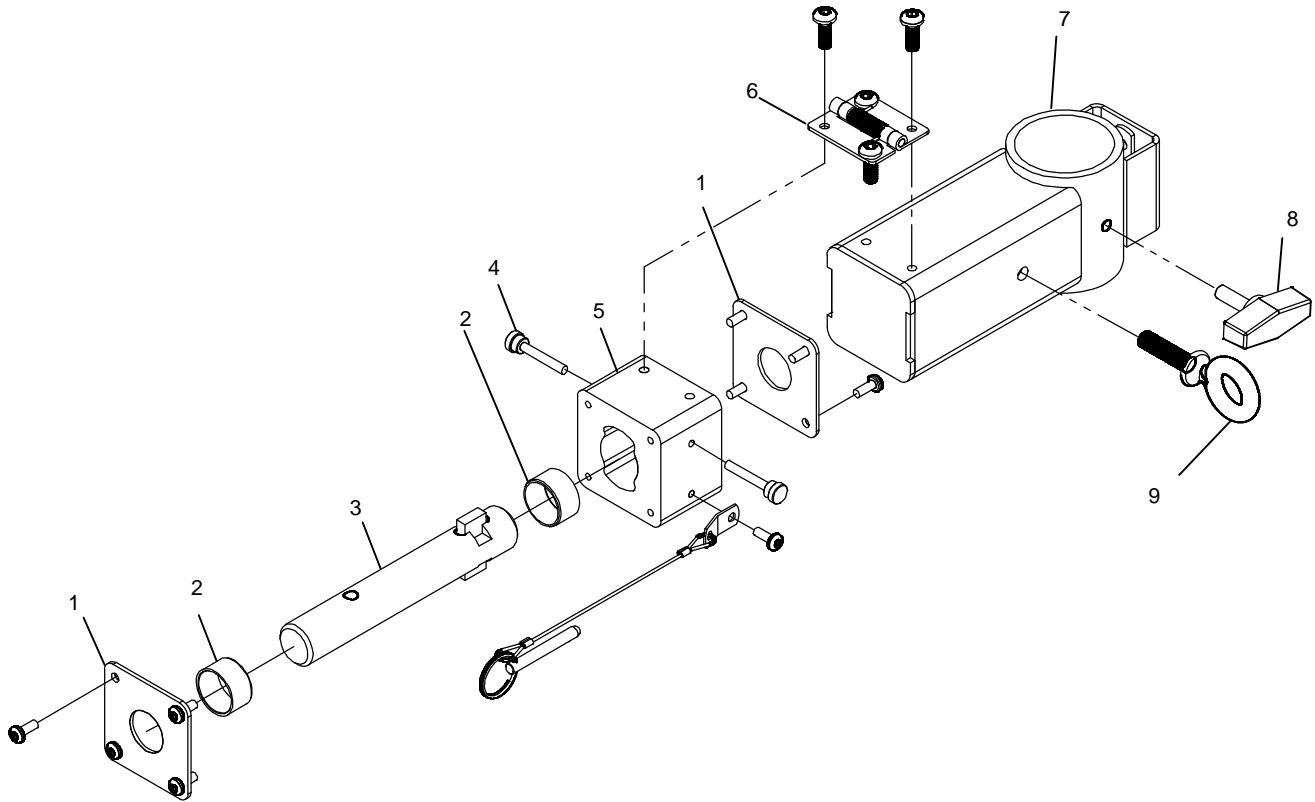

264 092-B

Figure 12-16. Rolling Inductor Mounting Arm Assembly

Item No.	Dia. Mkgs.	Part No.	Description	Quantity
----------	------------	----------	-------------	----------

Figure 12-16. Rolling Inductor Mounting Arm Assembly

...	1	263529	.. Plate, Swivel Induction Arm	2
...	2	263665	.. Bushing, Swivel Induction Arm	2
...	3	263533	.. Assy, Swivel Shaft Induction Arm	1
...	4	264044	.. Screw, Thumb Sst 10-32 X 1.00 Knurled	2
...	5	263528	.. Housing, Swivel Induction Arm	1
...	6	261778	.. Hinge, Spring Induction Arm	1
...	7	263534	.. Assy, Induction Arm Attachment Welded	1
...	8	124778	.. Knob, T 2.000 Bar W/.312-18 Stud 1.000 Lg	1
...	9	259968	.. Bolt, Eye Shld Thd Stem .375-16 X 1.500 Fbrgls	1

To maintain the factory original performance of your equipment, use only Manufacturer's Suggested Replacement Parts. Model and serial number required when ordering parts from your local distributor.

☞ Hardware is common and not available unless listed.

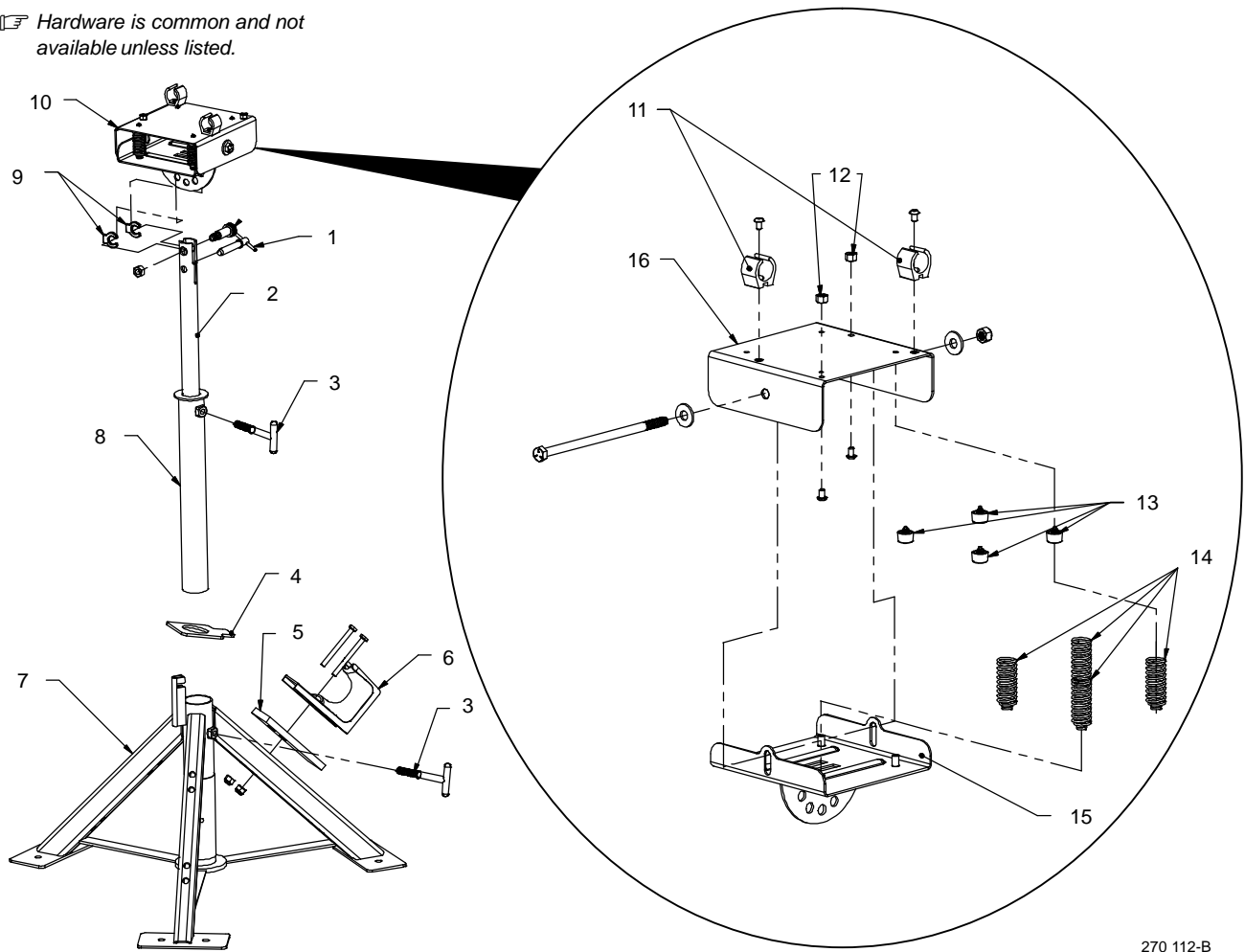

270 112-B

Figure 12-17. Rolling Inductor Stand

Item No.	Dia. Mkgs.	Part No.	Description	Quantity
----------	------------	----------	-------------	----------

Figure 12-17. Rolling Inductor Stand

.. 1	..	269173	.. Pin, Quick Release .375 Dia X 1.300 Usable LG	1
.. 2	..	269165	.. Tube Assy, Small Welded Rolling Inductor Stand	1
.. 3	..	269174	.. Bolt, T-handle 375-16 X 3.688 L Stl	2
.. 4	..	269169	.. Plate, Locking Rolling Inductor Stand	1
.. 5	..	271153	.. Spacer, Cable Mount .375 THK GFPC	1
.. 6	..	271152	.. Support, Cable J-Hook Nylon 2.000in Bundle Blk	1
.. 7	..	+269153	.. Assy, Welded Base Rolling Inductor Stand	1
..	..	269519	.. Label, Warning Rolling Inductor Stand	1
.. 8	..	269159	.. Tube Assy, Middle Welded Rolling Inductor Stand	1
.. 9	..	269678	.. Clip, C .500ID X .938OD X .150THK Nylon w/tab	2
.. 10	..	269406	.. Assy, Head Rolling Inductor Stand (Includes)	1
.. 11	..	192362	.. Bracket, Mtg Nyl 1/2 Conduit	2
.. 12	..	269448	.. Stand-Off, No 10-32 X .250 Lg .375 Hex SST	2
.. 13	..	269171	.. Foot, Push Rivet .59ODX.35H .04-.08THK .165 Mtg Blk	4
.. 14	..	269170	.. Spring, Rolling Inductor Stand	4
.. 15	..	269161	.. Bracket Assy, Welded Rolling Inductor Stand	1
.. 16	..	269166	.. Bracket Assy, Top Rolling Inductor Stand	1

+ When ordering a component originally displaying a precautionary label, the label should also be ordered.

To maintain the factory original performance of your equipment, use only Manufacturer's Suggested Replacement Parts. Model and serial number required when ordering parts from your local distributor.

 Hardware is common and not available unless listed.

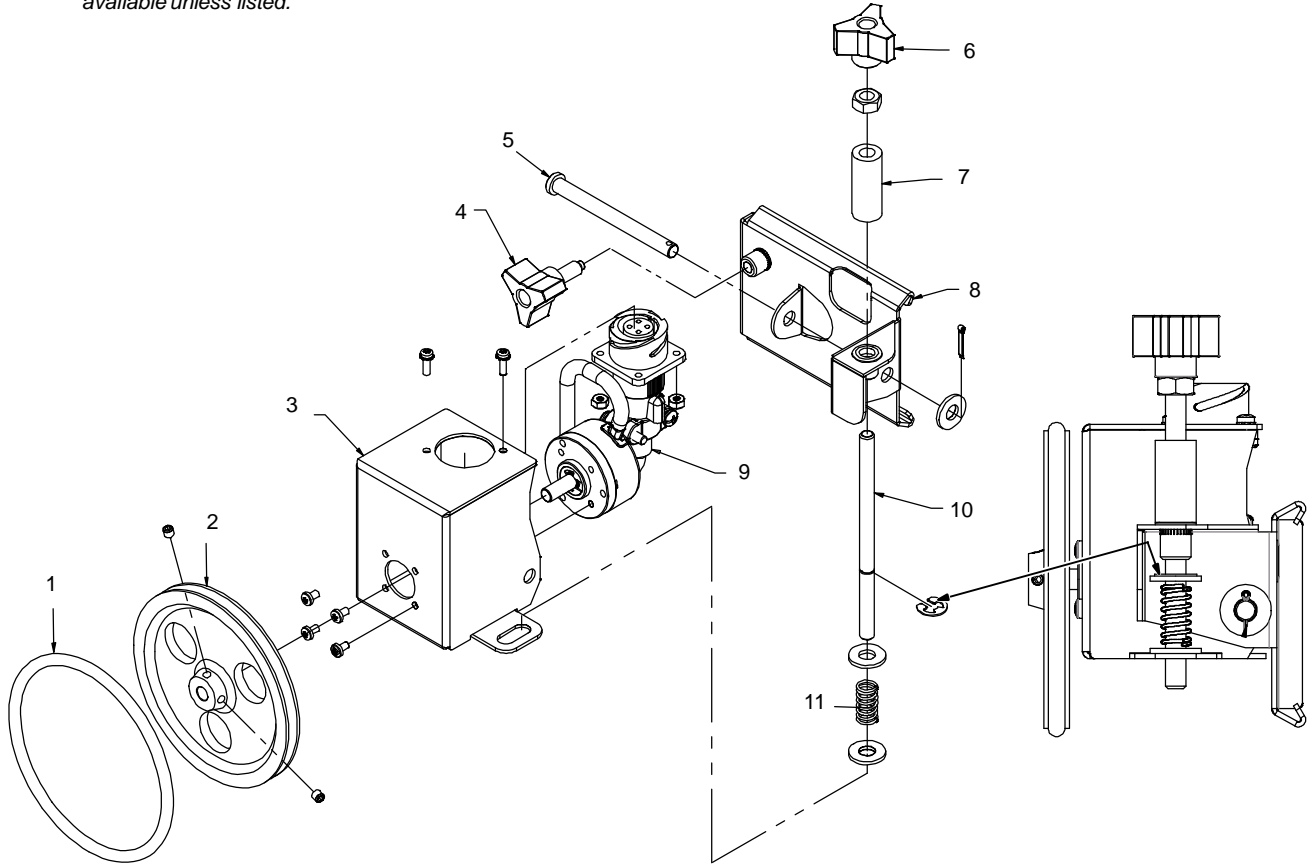

266 226-B

Figure 12-18. Travel Sensor Assembly w/Mounting Bracket

Item No.	Dia. Mkgs.	Part No.	Description	Quantity
Figure 12-18. Travel Sensor Assembly w/Mounting Bracket				
.. 1	..	266229	.. O-Ring, 3.350 ID X 3.770 OD Silicone	1
.. 2	..	266228	.. Wheel, Travel Sensor	1
.. 3	..	266074	.. Bracket, Travel Sensor Mtg	1
.. 4	..	267352	.. Knob Assy, Bracket Retention	1
.. 5	..	266224	.. Pin, Clevis .250 OD X 2.750 LG W/.094 Hole Stls	1
.. 6	..	262553	.. Knob, Threaded Three Arm Phenolic	1
.. 7	..	266751	.. Spacer, AL .250 ID X .500 OD X 1.00 LG	1
.. 8	..	266223	.. Clamp, Travel Sensor Pivot Assembly	1
.. 9	..	264069	.. Sensor, Travel Assembly	1
.. 10	..	265988	.. Shaft, Force Adjustment	1
.. 11	..	266225	.. Spring, Cprsn .360 OD X .041 Wire X .750 Free Stn	1
..	..	266215	.. Cable, Extension Travel Sensor (Not Shown)	1
..	..	141162	.. Housing Plug+ Pins, (Service Kit) 14 - 18 GA	1
..	..	152568	.. Housing Plug+ Skts, (Service Kit) 20 - 24 GA	1
..	..	267601	.. Conn, Circ MS/MET 4Pin Size 14S Plug Solder	1

To maintain the factory original performance of your equipment, use only Manufacturer's Suggested Replacement Parts. Model and serial number required when ordering parts from your local distributor.

☞ Hardware is common and not available unless listed.

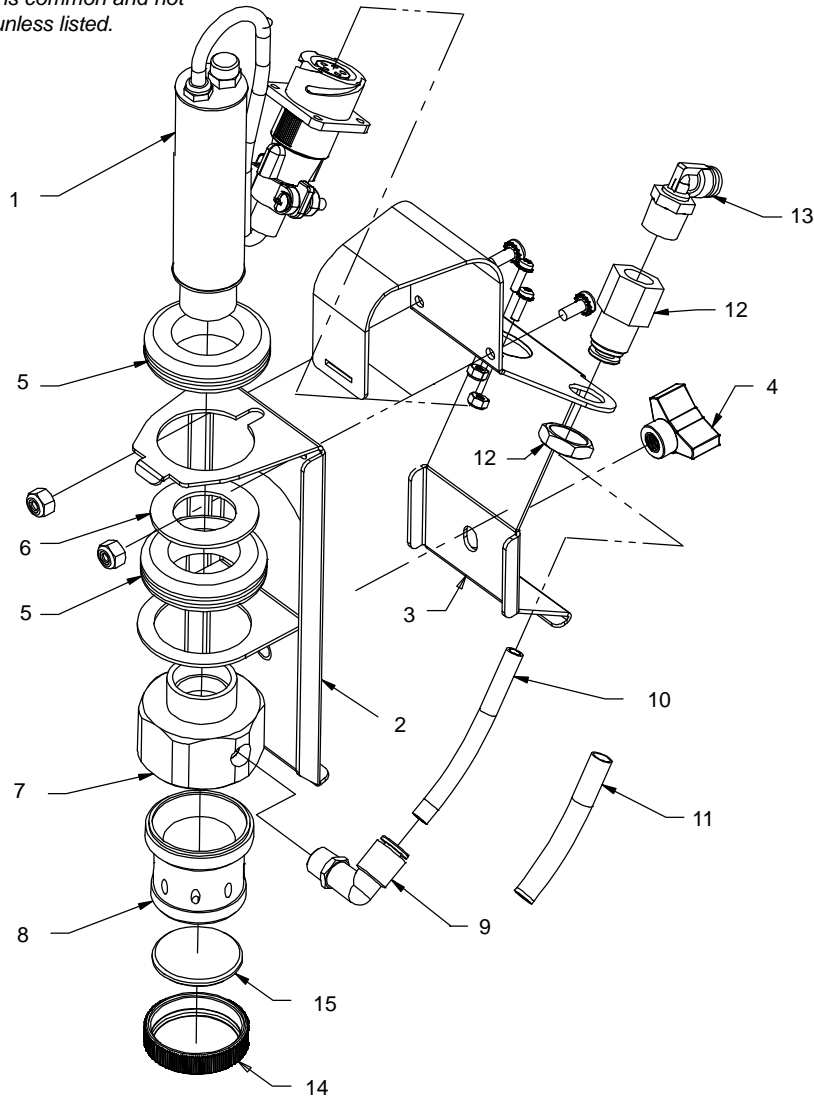

265 181-D

Figure 12-19. IR Assembly w/Mounting Bracket

Item No.	Dia. Mkgs.	Part No.	Description	Quantity
----------	------------	----------	-------------	----------

Figure 12-19. IR Assembly w/Mounting Bracket

.. 1	265076 ..	Sensor, Temperature IR Assembly ..	1
.. 2	265079 ..	Bracket, IR Mounting Assembly ..	1
.. 3	265081 ..	Clamp, Ir Mounting Bracket ..	1
.. 4	262553 ..	Knob, Threaded Three Arm Phenolic ..	1
.. 5	265082 ..	Grommet, Rbr Hi Temp 1.000 Id X 1.375 Mtg Hole .062 ..	2
.. 6	265083 ..	Washer, Flat .812idx1.375odx.062t Stnls Stl ..	1
.. 7	265084 ..	Collar, IR Temperature Sensor Upper ..	1
.. 8	265085 ..	Collar, IR Temperature Sensor Lower ..	1
.. 9	263855 ..	Ftg, Brs Elbow Qdisc 1/8 Npt X .250 Tbg Swivl ..	1
.. 10	265116 ..	Tubing, Pneumatic V-0 .250 Od X .170 ID ..	3.50 in.
.. 11	265117 ..	Tubing, Gl Acryl .258-.278 Id Blk ..	3.0 in.
.. 12	264070 ..	Ftg, Air Bulkhead Panel Mtg Qdisc 1/4 Npt X .250tbg ..	1
.. 13	267465 ..	Ftg, Brs Elbow Qdisc 1/4 Npt X .250 Tbg Swivl ..	1
.. 14	270580 ..	Ring, Quartz Window Retaining ..	1
.. 15	270581 ..	Window, Quartz ..	1

To maintain the factory original performance of your equipment, use only Manufacturer's Suggested Replacement Parts. Model and serial number required when ordering parts from your local distributor.

☞ Hardware is common and not available unless listed.

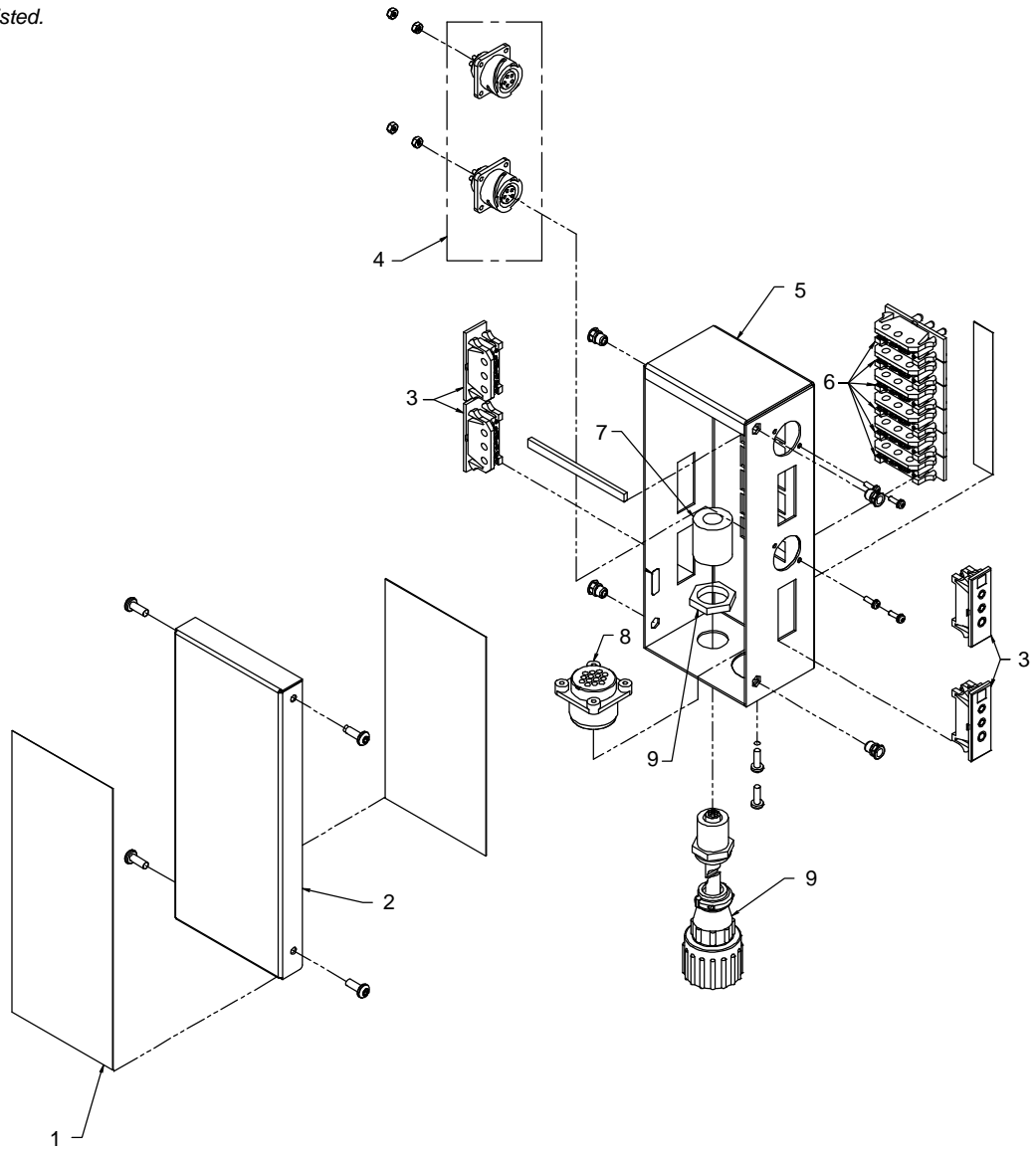

265 916-F

Figure 12-20. IR TC Control Box

Item No.	Dia. Mkgs.	Part No.	Description	Quantity
Figure 12-20. IR TC Control Box				
.. 1		268033	.. Label, IR Connection Box	1
.. 2		265118	.. Cover, TC Connection Enclosure Assembly	1
.. 3		268037	.. Receptacle Assy, Thermocouple W/Leads IR Box	4
.. 4		268044	.. Plug Assy, PC1	1
.. 5		266808	.. Enclosure, TC Connection With Rivet Nuts (Includes)	1
		263831	.. Enclosure, TC Connection	1
		267916	.. Gasket, Epfm 3.500 X .250 X .125 Thk W/Psa	1
		221493	.. Label, TC1-6	1
		260811	.. Nut, 010-32 Hex Stl Pld Insert	0
.. 6		197063	.. Plug, Thermocouple Type K Panel Mount	6
.. 7		246958	.. Core, Ferrite 25.90mm Od X 12.80mm Id X 28.60mm Lg	1
.. 8		134735	.. Conn, Circ Ms/Cpc 14skt Size 20 Rcpt Panel Pushin	1
.. 9		266220	.. Cable,Pigtail W/14-Pin Male	1

To maintain the factory original performance of your equipment, use only Manufacturer's Suggested Replacement Parts. Model and serial number required when ordering parts from your local distributor.

☞ Hardware is common and not available unless listed.

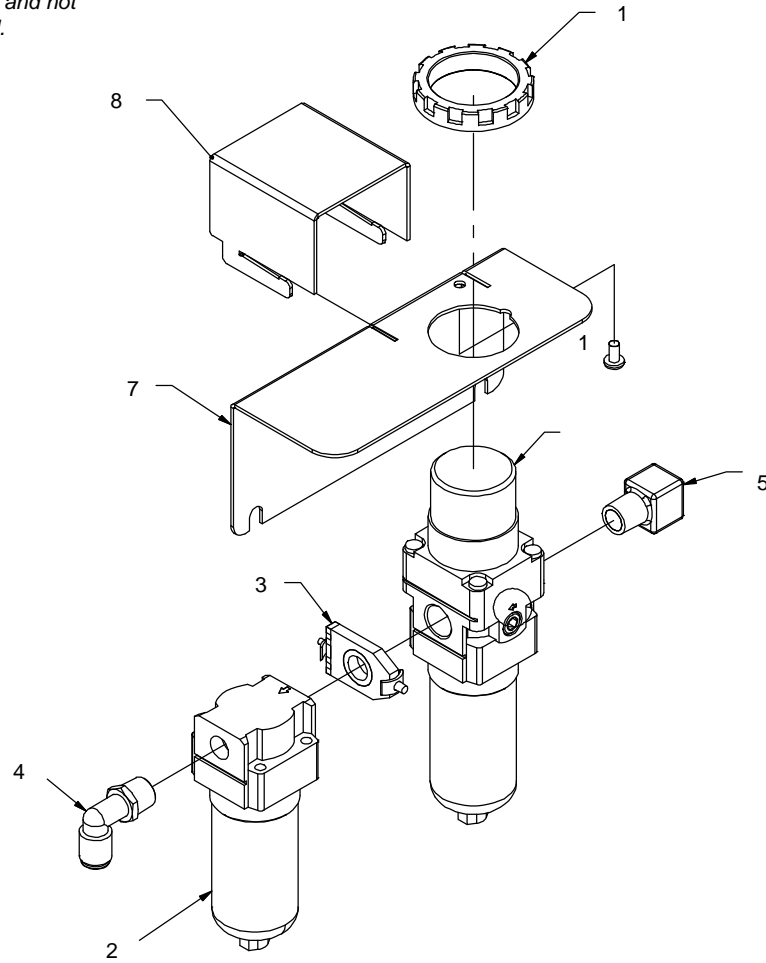

265149-C

Figure 12-21. Regulator-Filter Air/Oil Separator Assembly

Item No.	Dia. Mkgs.	Part No.	Description	Quantity
.. 1	..	265146	.. Filter-Reg, 1/4 Npt 5 Micron 0-30psi Auto Drain W/N	1
.. 2	..	265147	.. Separator, Oil/Air Filter Auto Drain	1
.. 3	..	265148	.. Coupler, Air Regulator-Filter	1
.. 4	..	204005	.. Ftg, Plstc/Brs Elbow Qdisc 1/4 Npt X .250 Tbg Swivl	1
.. 5	..	176518	.. Ftg, Pipe Brs Elbow St 1/4 Npt	1
.. 6	..	265155	.. Bracket, Mtg Air Regulator-Filter	1
.. 7	..	265075	.. Bracket, Cover Air Regulator	1
.. 8	..	265075	.. Bracket, Cover air Regulator	1
..	..	*227877	.. Filter, Air Element (Not Shown)	0
..	..	*264232	.. Filter, Oil Separator (Not Shown)	0

*Recommended Spare Parts.

To maintain the factory original performance of your equipment, use only Manufacturer's Suggested Replacement Parts. Model and serial number required when ordering parts from your local distributor.

TRUE BLUE[®]

WARRANTY

Effective January 1, 2015

(Equipment with a serial number preface of MF or newer)

This limited warranty supersedes all previous Miller warranties and is exclusive with no other guarantees or warranties expressed or implied.

Warranty Questions?

Call
1-800-4-A-MILLER
for your local
Miller distributor.

Your distributor also gives you ...

Service

You always get the fast, reliable response you need. Most replacement parts can be in your hands in 24 hours.

Support

Need fast answers to the tough welding questions? Contact your distributor. The expertise of the distributor and Miller is there to help you, every step of the way.

LIMITED WARRANTY – Subject to the terms and conditions below, Miller Electric Mfg. Co., Appleton, Wisconsin, warrants to its original retail purchaser that new Miller equipment sold after the effective date of this limited warranty is free of defects in material and workmanship at the time it is shipped by Miller. THIS WARRANTY IS EXPRESSLY IN LIEU OF ALL OTHER WARRANTIES, EXPRESS OR IMPLIED, INCLUDING THE WARRANTIES OF MERCHANTABILITY AND FITNESS.

Within the warranty periods listed below, Miller will repair or replace any warranted parts or components that fail due to such defects in material or workmanship. Miller must be notified in writing within thirty (30) days of such defect or failure, at which time Miller will provide instructions on the warranty claim procedures to be followed. If notification is submitted as an online warranty claim, the claim must include a detailed description of the fault and the troubleshooting steps taken to identify failed components and the cause of their failure.

Miller shall honor warranty claims on warranted equipment listed below in the event of such a failure within the warranty time periods. All warranty time periods start on the delivery date of the equipment to the original end-user purchaser, and not to exceed twelve months after the equipment is shipped to a North American distributor or eighteen months after the equipment is shipped to an International distributor.

1. 5 Years Parts — 3 Years Labor
 - * Original Main Power Rectifiers Only to Include SCRs, Diodes, and Discrete Rectifier Modules
2. 3 Years — Parts and Labor
 - * Auto-Darkening Helmet Lenses (Except Classic Series) (No Labor)
 - * Engine Driven Welder/Generators
(NOTE: Engines are Warranted Separately by the Engine Manufacturer.)
 - * Inverter Power Sources (Unless Otherwise Stated)
 - * Plasma Arc Cutting Power Sources
 - * Process Controllers
 - * Semi-Automatic and Automatic Wire Feeders
 - * Transformer/Rectifier Power Sources
3. 2 Years — Parts and Labor
 - * Auto-Darkening Helmet Lenses – Classic Series Only (No Labor)
 - * Fume Extractors – Capture 5, Filtair 400 and Industrial Collector Series
4. 1 Year — Parts and Labor Unless Specified
 - * Automatic Motion Devices
 - * CoolBelt and CoolBand Blower Unit (No Labor)
 - * Desiccant Air Dryer System
 - * External Monitoring Equipment and Sensors
 - * Field Options
(NOTE: Field options are covered for the remaining warranty period of the product they are installed in, or for a minimum of one year — whichever is greater.)
 - * RFCS Foot Controls (Except RFCS-RJ45)
 - * Fume Extractors – Filtair 130, MWX and SWX Series HF Units
 - * ICE/XT Plasma Cutting Torches (No Labor)
 - * Induction Heating Power Sources, Coolers
(NOTE: Digital Recorders are Warranted Separately by the Manufacturer.)
 - * LiveArc Welding Performance Management System
 - * Load Banks
 - * Motor-Driven Guns (except Spoolmate Spoolguns)
 - * PAPR Blower Unit (No Labor)
 - * Positioners and Controllers
 - * Racks
 - * Running Gear/Trailers
 - * Spot Welders
 - * Subarc Wire Drive Assemblies
 - * Water Coolant Systems
 - * TIG Torches (No Labor)
 - * Wireless Remote Foot/Hand Controls and Receivers
 - * Work Stations/Weld Tables (No Labor)

5. 6 Months — Parts
 - * Batteries
 - * Bernard Guns (No Labor)
 - * Tregaskiss Guns (No Labor)
6. 90 Days — Parts
 - * Accessory (Kits)
 - * Canvas Covers
 - * Induction Heating Coils and Blankets, Cables, and Non-Electronic Controls
 - * M-Guns
 - * MIG Guns and Subarc (SAW) Torches
 - * Remote Controls and RFCS-RJ45
 - * Replacement Parts (No labor)
 - * Roughneck Guns
 - * Spoolmate Spoolguns

Miller's True Blue[®] Limited Warranty shall not apply to:

1. **Consumable components; such as contact tips, cutting nozzles, contactors, brushes, relays, work station table tops and welding curtains, or parts that fail due to normal wear. (Exception: brushes and relays are covered on all engine-driven products.)**
2. Items furnished by Miller, but manufactured by others, such as engines or trade accessories. These items are covered by the manufacturer's warranty, if any.
3. Equipment that has been modified by any party other than Miller, or equipment that has been improperly installed, improperly operated or misused based upon industry standards, or equipment which has not had reasonable and necessary maintenance, or equipment which has been used for operation outside of the specifications for the equipment.

MILLER PRODUCTS ARE INTENDED FOR PURCHASE AND USE BY COMMERCIAL/INDUSTRIAL USERS AND PERSONS TRAINED AND EXPERIENCED IN THE USE AND MAINTENANCE OF WELDING EQUIPMENT.

In the event of a warranty claim covered by this warranty, the exclusive remedies shall be, at Miller's option: (1) repair; or (2) replacement; or, where authorized in writing by Miller in appropriate cases, (3) the reasonable cost of repair or replacement at an authorized Miller service station; or (4) payment of or credit for the purchase price (less reasonable depreciation based upon actual use) upon return of the goods at customer's risk and expense. Miller's option of repair or replacement will be F.O.B., Factory at Appleton, Wisconsin, or F.O.B. at a Miller authorized service facility as determined by Miller. Therefore no compensation or reimbursement for transportation costs of any kind will be allowed.

TO THE EXTENT PERMITTED BY LAW, THE REMEDIES PROVIDED HEREIN ARE THE SOLE AND EXCLUSIVE REMEDIES. IN NO EVENT SHALL MILLER BE LIABLE FOR DIRECT, INDIRECT, SPECIAL, INCIDENTAL OR CONSEQUENTIAL DAMAGES (INCLUDING LOSS OF PROFIT), WHETHER BASED ON CONTRACT, TORT OR ANY OTHER LEGAL THEORY.

ANY EXPRESS WARRANTY NOT PROVIDED HEREIN AND ANY IMPLIED WARRANTY, GUARANTY OR REPRESENTATION AS TO PERFORMANCE, AND ANY REMEDY FOR BREACH OF CONTRACT TORT OR ANY OTHER LEGAL THEORY WHICH, BUT FOR THIS PROVISION, MIGHT ARISE BY IMPLICATION, OPERATION OF LAW, CUSTOM OF TRADE OR COURSE OF DEALING, INCLUDING ANY IMPLIED WARRANTY OF MERCHANTABILITY OR FITNESS FOR PARTICULAR PURPOSE, WITH RESPECT TO ANY AND ALL EQUIPMENT FURNISHED BY MILLER IS EXCLUDED AND DISCLAIMED BY MILLER.

Some states in the U.S.A. do not allow limitations of how long an implied warranty lasts, or the exclusion of incidental, indirect, special or consequential damages, so the above limitation or exclusion may not apply to you. This warranty provides specific legal rights, and other rights may be available, but may vary from state to state.

In Canada, legislation in some provinces provides for certain additional warranties or remedies other than as stated herein, and to the extent that they may not be waived, the limitations and exclusions set out above may not apply. This Limited Warranty provides specific legal rights, and other rights may be available, but may vary from province to province.

miller_warr 2015-01





Owner's Record

Please complete and retain with your personal records.

Model Name

Serial/Style Number

Purchase Date

(Date which equipment was delivered to original customer.)

Distributor

Address

City

State

Zip



For Service

Contact a **DISTRIBUTOR** or **SERVICE AGENCY** near you.

Always provide Model Name and Serial/Style Number.

Contact your Distributor for:

Welding Supplies and Consumables

Options and Accessories

Personal Safety Equipment

Service and Repair

Replacement Parts

Training (Schools, Videos, Books)

Technical Manuals (Servicing Information and Parts)

Circuit Diagrams

Welding Process Handbooks

To locate a Distributor or Service Agency visit www.millerwelds.com or call 1-800-4-A-Miller

Contact the Delivering Carrier to:

File a claim for loss or damage during shipment.

For assistance in filing or settling claims, contact your distributor and/or equipment manufacturer's Transportation Department.

Miller Electric Mfg. Co.

An Illinois Tool Works Company
1635 West Spencer Street
Appleton, WI 54914 USA

International Headquarters—USA

USA Phone: 920-735-4505 Auto-Attended
USA & Canada FAX: 920-735-4134
International FAX: 920-735-4125

For International Locations Visit
www.MillerWelds.com

