

## DESIGN ENVELOPE

### Intelligent Variable Speed pumps

#### SOLUTION OUTLINE



# DESIGN ENVELOPE

OPTIMUM  
PERFORMANCE  
ANY GIVEN TIME



**A**rmstrong Design Envelope pumps are a complete solution for heating, cooling and plumbing systems. The integration of a perfectly matched pump, motor and intelligent variable speed controller creates the highest value pumping solution.

Whether driven by social, environmental or fiscal responsibility, forward-thinking organizations must embrace energy-saving technologies and practices.

Through design advances, Armstrong has eliminated the cost trade-offs that are frequently attached to sustainable choices. Design Envelope offers the lowest installed cost and the lowest life cost of any pumping solution today.



UP TO  
**65%**  
INSTALLED COST SAVINGS

UP TO  
**80%**  
ENERGY SAVINGS

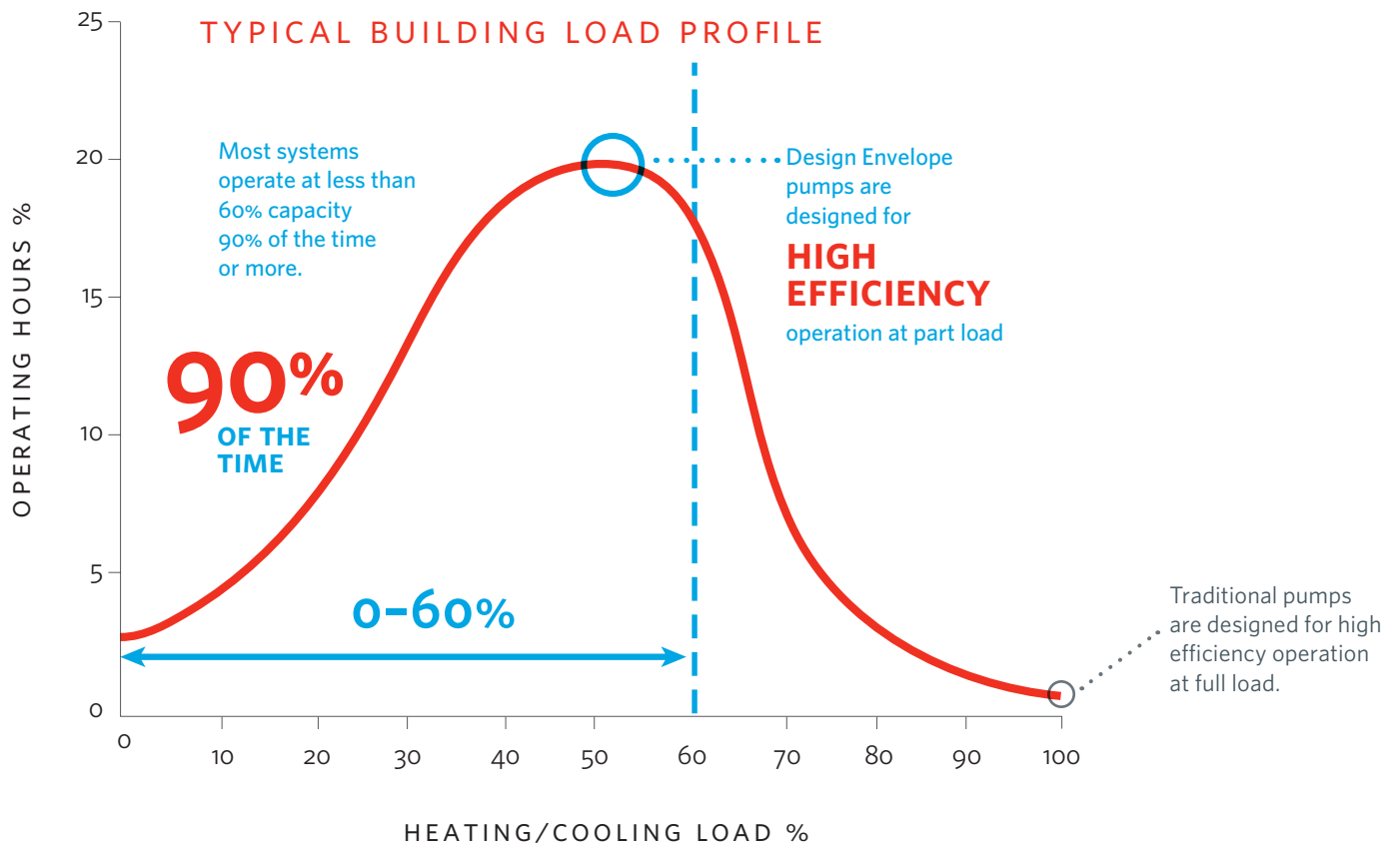

Design Envelope solutions reduce pumping costs through variable speed, demand-based operation — consuming only the energy required, based on current system demand.

Design Envelope pumps use a combination of optimized impeller size and speed control for energy efficient operation within a given performance

envelope. The performance envelopes are selected for the best pump efficiency where variable flow systems operate most often. This ensures a building's pumping system consumes as little energy as possible. It also ensures that the installation meets or exceeds ASHRAE 90.1 guidelines requiring 70% energy savings at 50% of peak load.

# EVOLUTION OF PUMPING

## & INSTALLED COSTS

### DESIGN ENVELOPE TANGO/DUALARM

- > Managed redundancy and parallel operation replaces duty/standby
- > Reporting and proactive management
- > Smaller units are easier to handle
- > Two rotating devices sharing one casing
- > Optimized lifetime performance

### DESIGN ENVELOPE VERTICAL IN-LINE

- > Integrated, sensorless variable speed controller
- > Eliminates wiring from vFD to pump and shaft grounding
- > Supports smaller motor selections
- > No feedback sensor or wiring required
- > Internal harmonic filter
- > No requirement for wall space
- > One-touch auto-flow balancing
- > Onboard Web services and connectivity

Saves an additional \$2000 on average

### VERTICAL IN-LINE WITH VARIABLE SPEED CONTROL

- > Wall/rack mounted vFD
- > System feedback sensor
- > Partially reduces energy costs

### VERTICAL IN-LINE SPLIT-COUPLING

- > **Eliminates the need for:** housekeeping pads, inertia base, flex connections, grouting and alignment
- > Reduced installation labor costs
- > Smaller mechanical room footprint (50-75%)

15 minute seal change: saves up to \$700

Saves over \$5000 for an 8" pump

### BASE-MOUNTED END SUCTION

- > Legacy design
- > Base case for comparison
- > Time intensive seal change

AVERAGE ENERGY SAVINGS

15%

VARIABLE SPEED PUMP WALL-MOUNTED CONTROLLER/2-WAY VALVE

- > Constant reduced speed
- > Reduce motor speed in lieu of throttling flow

CONSTANT SPEED PUMP 3-WAY VALVE

VARIABLE SPEED PUMP WITH CONTROLS DISABLED (PUMP IN HAND)

- > Constant speed operation
- > Base case for pump energy usage
- > Pump runs at design point, controlled by throttling

DESIGN ENVELOPE TANGO

VS.

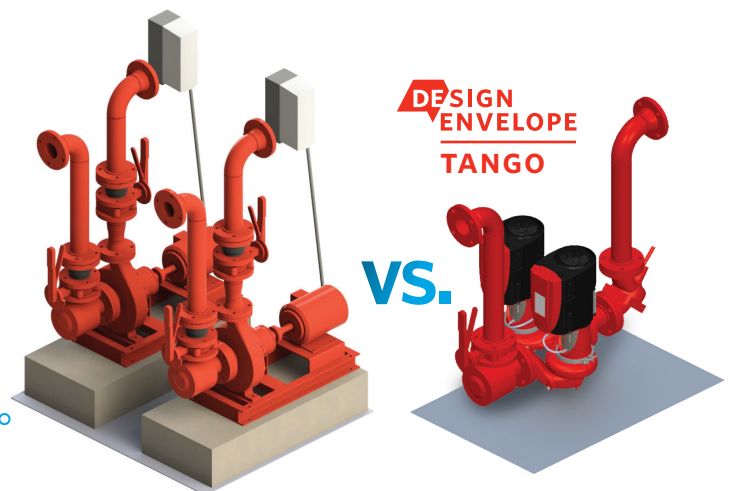



# SUPERIOR PERFORMANCE

## & ENERGY SAVINGS

UP TO  
**50%**  
ENERGY  
SAVINGS

VARIABLE SPEED PUMP  
WALL-MOUNTED  
CONTROLLER/2-WAY VALVE

- > Sensor in mechanical room
- > Maintain constant design head
- > No savings if sensor stops working

UP TO  
**65%**  
ENERGY  
SAVINGS

VARIABLE SPEED PUMP/  
WALL-MOUNTED  
CONTROLLER/2-WAY VALVE

- > Inefficient induction motor operation
- > Pump selected to design point
- > Sensor located at remote load
- > Maintain pressure at remote zone
- > No savings if sensor stops working

UP TO  
**70%+**  
ENERGY  
SAVINGS

DESIGN ENVELOPE 3.1

- > Pump speed control through Sensorless technology
- > Detailed mapping of performance curve
- > Smaller motor selection on 25% of projects
- > Integrated controller — higher motor efficiency
- > Flow measurement accuracy of  $\pm 5\%$
- > Optimized selection against load profile

UP TO  
**80%+**  
ENERGY  
SAVINGS

DESIGN ENVELOPE  
GENERATION 5

- > Advanced digital controls
- > Control tuned to specific motor
- > iECM motor: 115 efficiency rating
- > Advanced hydraulics



**NEXT  
LEVEL  
THINKING**

- > Multi-pump load sharing
- > Best-efficiency staging (Parallel Sensorless Pump Control)
- > Onboard diagnostics and trending
- > Real-time performance management

## ENERGY SAVINGS

**A**rmstrong Design Envelope variable speed technology fundamentally changes the operation of a pump within the larger HVAC system. The variable speed intelligence embedded in the Armstrong Design Envelope controller adjusts the pump operation to meet the immediate demand. The pump responds instantaneously and draws only the power required to meet that demand.

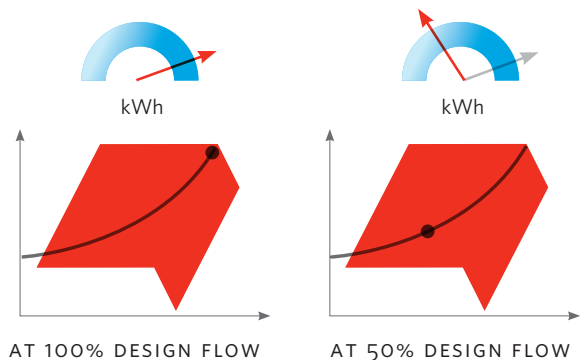

# HOW IT

## THE SENSOR WITHIN

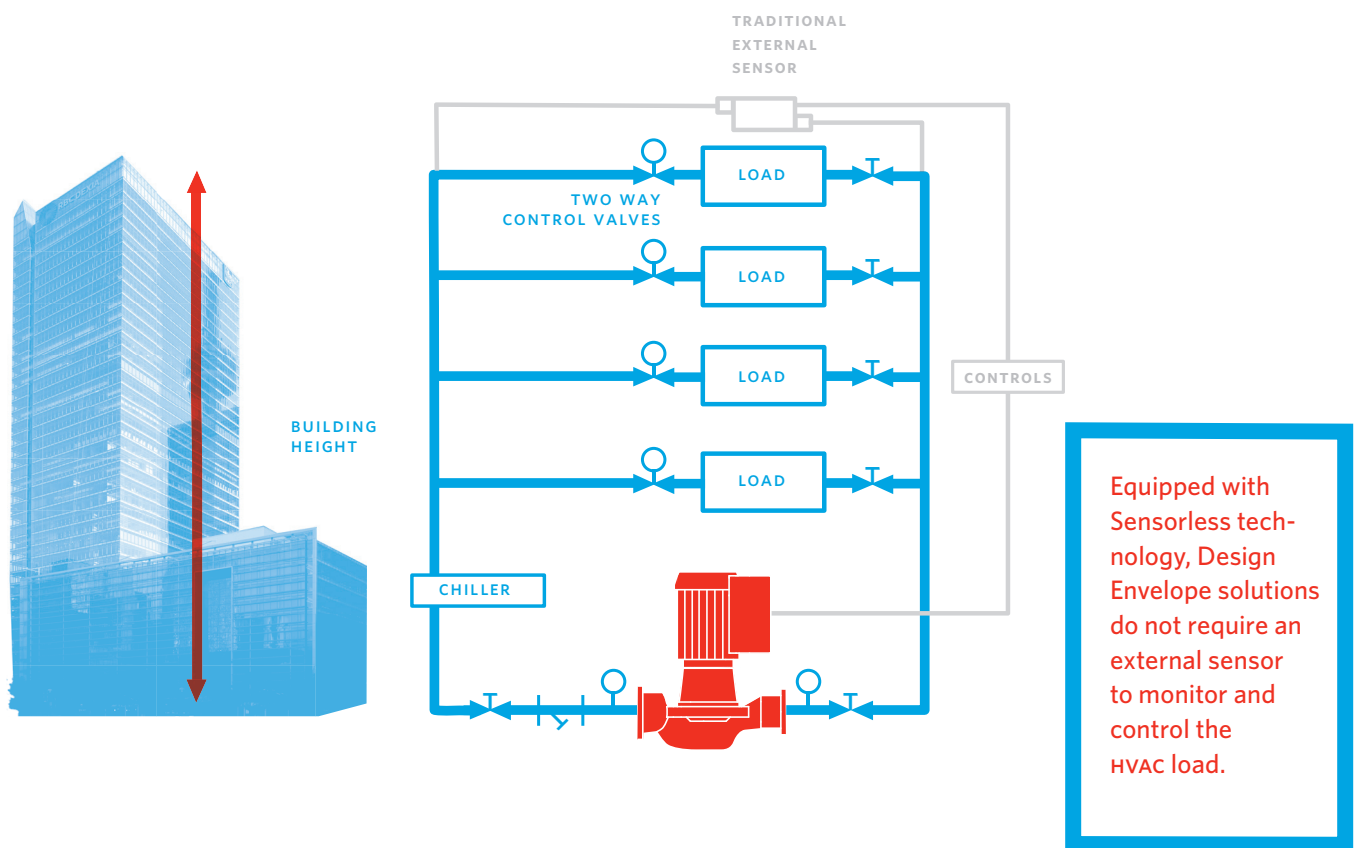

**I**n a chilled water system, a building's temperature controls influence the local flow of control valves that modulate the flow to the cooling coils (load). As the control valves open for more chilled water flow, the differential pressure across the valve decreases.

The controller reacts to this change by increasing the pump speed. If the control valves close to reduce the chilled water flow, the differential pressure across the valve increases and the controller reduces the pump speed.

# WORKS

## MONITOR POWER & SPEED

## CONTROL HEAD & FLOW

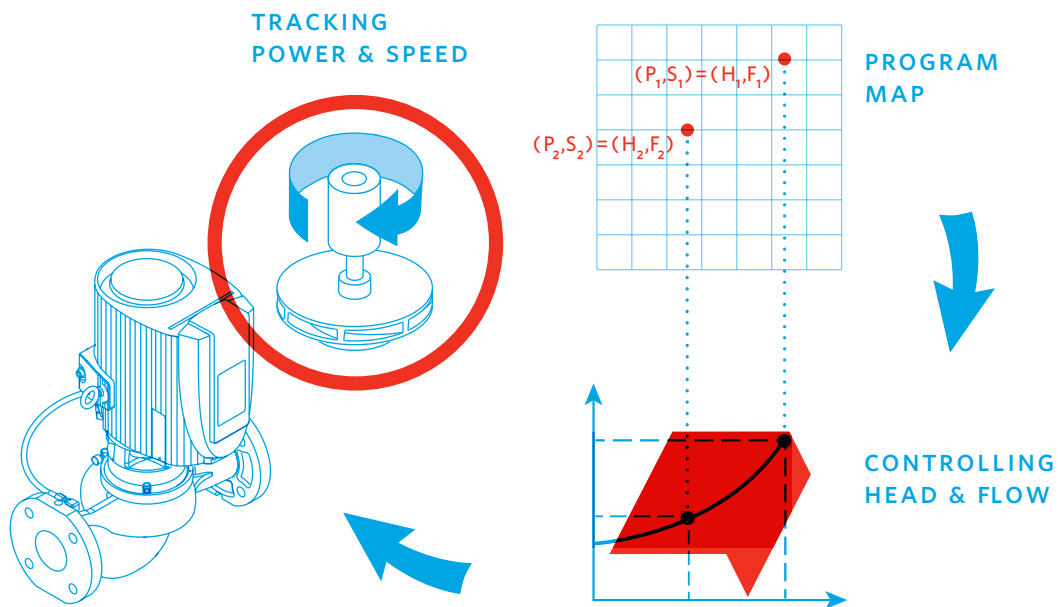

**E**quipped with Sensorless technology, a Design Envelope pump's performance characteristic curve (power draw and RPM) and operating curve are pre-programmed into the controller. During operation, the controller monitors the power and speed of the pump and establishes the hydraulic performance and position

of the pump's head-flow condition relative to the system requirements. As the building's control valves open or close to regulate flow to the cooling coils and maintain building occupant comfort, the Sensorless controller automatically adjusts the pump speed to match the required system pressure and flow.

# LIVING

## LOWEST INSTALLED COST

UP TO 65% SAVINGS COMPARED TO INDUSTRY STANDARD SOLUTIONS

- Smaller footprint
- Reduced overall weight
- Fewer connecting components
- Reduced labour cost
- Auto commissioning for immediate maximum efficiency

## LOWEST OPERATING COST

UP TO 80% SAVINGS COMPARED TO INDUSTRY STANDARD SOLUTIONS

- Lowest maintenance costs of any pumping configuration
- Extended high-efficiency performance

## LOWEST RISK

- Maximum reliability
- Maximum flexibility
- Managed redundancy without duty/standby

## EXTENDED PERFORMANCE

Pump Manager is a performance management service to help operators maintain optimized long-term efficiency.

- > Early detection of changes in pump condition
- > Notification of changes in equipment settings
- > Insight into pump status, performance and efficiency
- > Extended lifespan and optimum performance with Tango and dualArm configurations

**Parallel Sensorless Pump Control (PSPC) is a technology that minimizes the energy costs of multi-pump installations using best efficiency staging.**

**M**ost multi-pump control systems stage pumps on the basis of capacity. The PSPC control logic draws on detailed mapping of pump efficiency curves to determine the best possible combination of pumps and operating speeds for any flow requirement.

When the PSPC calculates that a pump array would operate more efficiently with one more pump added to the current set of operating pumps, the control logic turns on one more pump and coordinates the operating speeds of all the operating pumps to share the load.

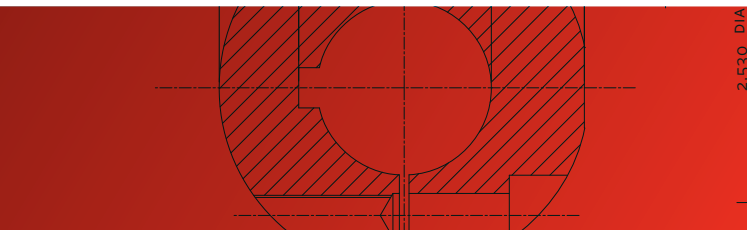



# PERFORMANCE

Armstrong has re-invented and redesigned pumping solutions to include connectivity and performance management services. Design Envelope pumps deliver optimal lifetime efficiency through:

Flow meter functionality delivers accuracy of +/- 5%, optimizing the performance of the entire HVAC system for improved efficiency and reduced operating costs

Expanded performance range and options

One-touch auto-flow balancing

Pump speed modulation based on an adjustable quadratic control curve for best part-load efficiency

On-board data and diagnostics to provide performance information and notifications

## PERFORMANCE PACKAGES

## FUNCTIONS INCLUDED



**Sensorless Bundle (standard)**

- Sensorless control
- Flow meter
- Constant flow
- Constant pressure



**Parallel Sensorless (standard on Tango and dualArm)**

- Parallel Sensorless control



**Energy Performance Bundle**

- Auto-flow balancing
- Maximum flow control



**Protection Bundle**

- Minimum flow control
- Bypass valve control



**Zone optimization**

- Accept up to two dP sensor control signals



**Dual-season setup**

- Pre-set heating and cooling parameters for two-pipe systems

## PUMP MANAGER

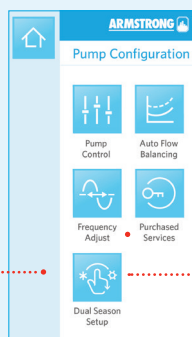
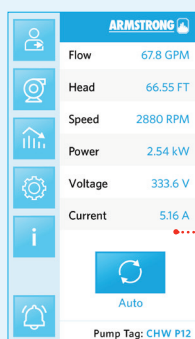

## CONNECTIVITY

Built-in Wi-Fi capability supports remote control, real-time monitoring and management for lowest operating costs

Local and remote access from any smart device

Adaptive browser-compatible software and intuitive user interface

# INDUSTRY-LEADING

## DESIGN ENVELOPE

Design Envelope technology offers advanced HVAC performance management, the simplest and fastest commissioning and optimized lifetime performance through real-time insight and action.



**HIGHEST**  
ENERGY EFFICIENCY



**LOWEST**  
INSTALLED  
COST



**LOWEST**  
OPERATING COST



**LOWEST**  
ENVIRONMENTAL  
COST



**LOWEST**  
PROJECT  
& OPERATING RISK

## CAPABILITIES

**Extended intelligence:** integrated controller provides on-board diagnostics, trending, alerts, automatic flow-balancing and optional Parallel Sensorless pump control.

**Advanced controls:** colour touchpad with intuitive HMI and access to real-time performance and pump conditions.

**Real-time connectivity:** options include BACnet, BACnet IP, and Modbus. Built-in Wi-Fi and wired connectivity supports web-based control or local control from a handheld unit.

**Armstrong intelligent motors:** with integrated controls deliver IE5 levels of energy efficiency (on select models) and lowest energy consumption.

## VALUE

### BUILDING OWNERS

- Lowest operating costs over the life of the pumps
- Additional capacity provides future proofing against changing building loads
- Unmatched space savings, efficiency and redundancy with Tango and dualArm multi-pump configurations

### DESIGN ENGINEERS





- Broad range of performance leads to reduced iterations of pump selection and reduced performance risk
- UL STD 778 and CSA STD c22.2 No.108 certified

### CONTRACTORS

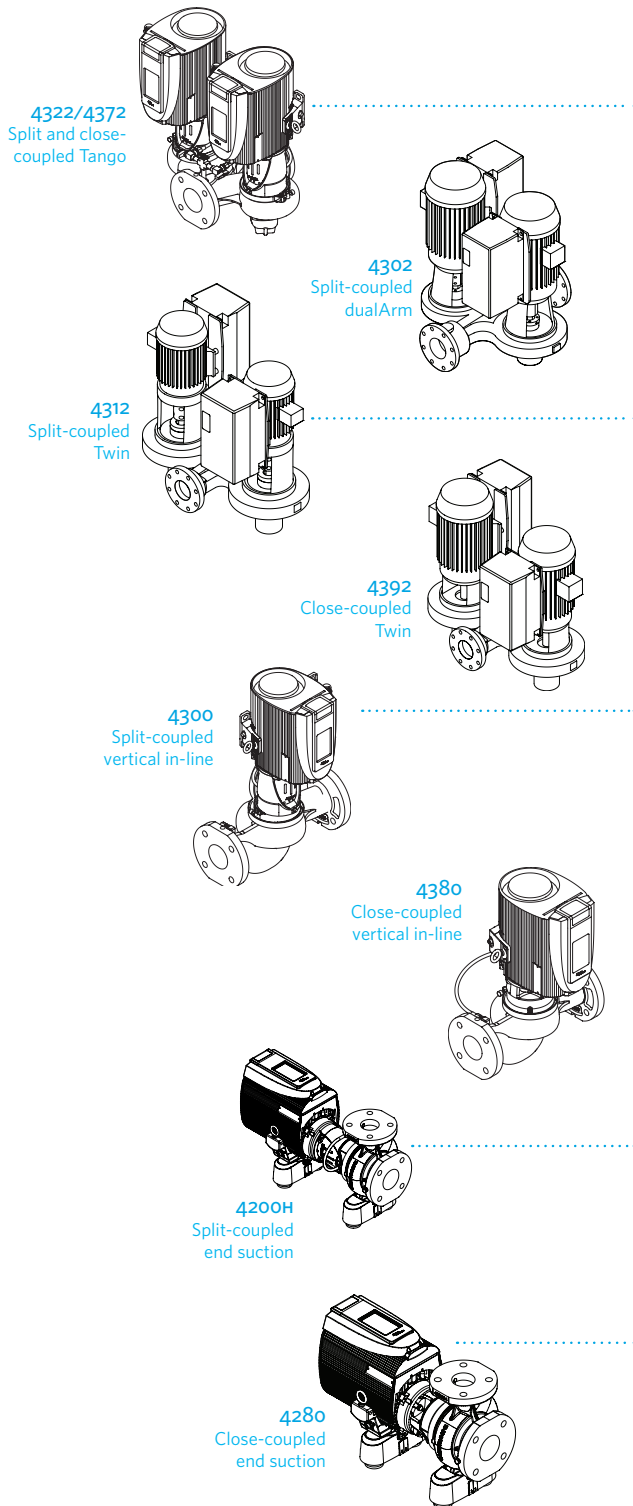
- Easy installation and commissioning
- Express models available for quick delivery
- Single source accountability for all aspects of an integrated pumping solution

# DESIGN ENVELOPE PUMP RANGE\*



<b>INDOOR</b>	<b>OUTDOOR</b>
0.33-10 hp	1-10 hp
Express models available 	
<b>INDOOR</b>	<b>OUTDOOR</b>
1-100 hp	1-100 hp
<b>INDOOR</b>	<b>OUTDOOR</b>
1-40 hp	1-40 hp
<b>INDOOR</b>	<b>OUTDOOR</b>
1-7.5 hp	1-7½ hp
<b>INDOOR</b>	<b>OUTDOOR</b>
0.33-450 hp	1-125 hp
Standalone 450 hp-1250 hp	
Express models available 	
<b>INDOOR</b>	<b>OUTDOOR</b>
0.33-10 hp	1-10 hp
Stainless steel 1 hp-2 hp	
Express models available 	
<b>INDOOR</b>	<b>OUTDOOR</b>
1-125 hp	N/A
Express models available 	
<b>INDOOR</b>	<b>OUTDOOR</b>
1-10 hp	N/A
Express models available	



\* Single phase available to 7½ hp / 5½ kW

## OUTDOOR APPLICATIONS

- Rated for UL type 4X with TEFC motor standard.
- Epoxy coated controller electronics protect against condensation.
- Stainless steel backplate prevents corrosion between the backplate and the heat sink.
- Stainless steel overhead weather shield protects the keypad from UV rays, prevents overheating due to sun exposure, and prevents accumulation of ice on sensitive areas.

**TORONTO**

23 BERTRAND AVENUE  
TORONTO, ONTARIO  
CANADA  
M1L 2P3  
+1 416 755 2291

**BUFFALO**

93 EAST AVENUE  
NORTH TONAWANDA, NEW YORK  
U.S.A.  
14120-6594  
+1 716 693 8813

**BIRMINGHAM**

HEYWOOD WHARF, MUCKLOW HILL  
HALESOWEN, WEST MIDLANDS  
UNITED KINGDOM  
B62 8DJ  
+44 (0) 8444 145 145

**MANCHESTER**

WOLVERTON STREET  
MANCHESTER  
UNITED KINGDOM  
M11 2ET  
+44 (0) 8444 145 145

**BANGALORE**

#59, FIRST FLOOR, 3RD MAIN  
MARGOSA ROAD, MALLESWARAM  
BANGALORE, INDIA  
560 003  
+91 (0) 80 4906 3555

**SHANGHAI**

UNIT 903, 888 NORTH SICHUAN RD.  
HONGKOU DISTRICT, SHANGHAI  
CHINA  
200085  
+86 (0) 21 5237 0909

**SÃO PAULO**

RUA JOSÉ SEMIÃO RODRIGUES AGOSTINHO,  
1370 GALPÃO 6  
EMBU DAS ARTES  
SAO PAULO, BRAZIL  
+55 11 4785 1330

**ARMSTRONG FLUID TECHNOLOGY**  
ESTABLISHED 1934

ARMSTRONGFLUIDTECHNOLOGY.COM

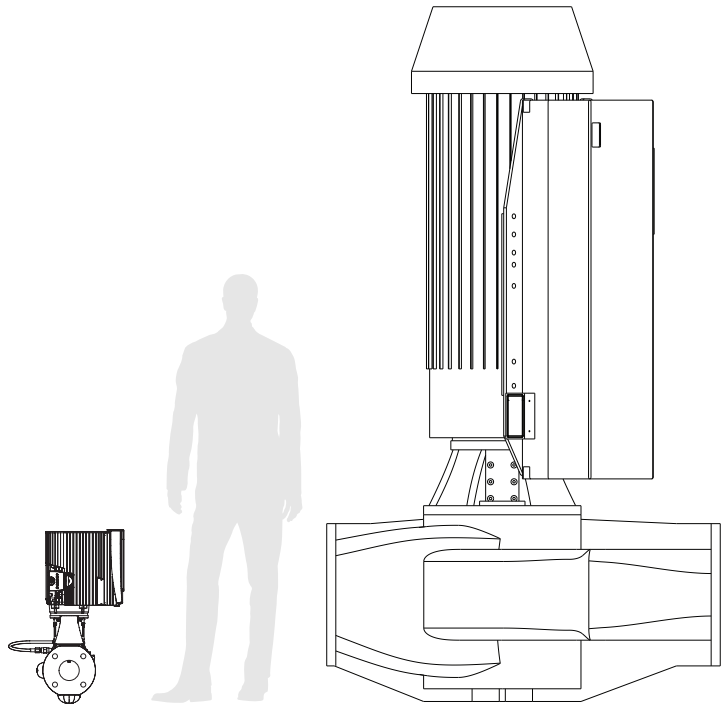

**0.33 hp**

**450 hp**

**SELECT & CONFIGURE**

Use ADEPT Select to quickly and easily choose  
Armstrong products that are right for your projects. Visit  
[adept.armstrongfluidtechnology.com](http://adept.armstrongfluidtechnology.com) to learn more.

**MAKE ENERGY SENSE™**