

# æra™

models: 795 and 796



Pilot's Guide



**OVERVIEW**

**GPS NAVIGATION**

**FLIGHT PLANNING**

**HAZARD AVOIDANCE**

**ADDITIONAL FEATURES**

**APPENDICES**

**INDEX**

Blank Page

Copyright © 2011-2019 Garmin Ltd. or its subsidiaries. All rights reserved.

This manual reflects the operation of System Software version 5.60 or later. Some differences in operation may be observed when comparing the information in this manual to earlier or later software versions.

Garmin International, Inc., 1200 East 151st Street, Olathe, Kansas 66062, U.S.A.

Garmin AT, Inc., 2345 Turner Road SE, Salem, OR 97302, U.S.A.

Garmin (Europe) Ltd., Liberty House, Hounsdown Business Park  
Southampton, Hampshire SO40 9LR U.K.

Garmin Corporation, No. 68, Zhangshu 2nd Road, Xizhi District, New Taipei City, Taiwan

Aviation Support: [www.flygarmin.com](http://www.flygarmin.com)

Except as expressly provided herein, no part of this manual may be reproduced, copied, transmitted, disseminated, downloaded or stored in any storage medium, for any purpose without the express written permission of Garmin. Garmin hereby grants permission to download a single copy of this manual and of any revision to this manual onto a hard drive or other electronic storage medium to be viewed for personal use, provided that such electronic or printed copy of this manual or revision must contain the complete text of this copyright notice and provided further that any unauthorized commercial distribution of this manual or any revision hereto is strictly prohibited.

Garmin®, FliteCharts®, SafeTaxi®, and MapSource® are registered trademarks of Garmin Ltd. or its subsidiaries. aera™ is a trademark of Garmin Ltd. or its subsidiaries. These trademarks may not be used without the express permission of Garmin.

Jeppesen® is a registered trademark of Jeppesen, Inc.

NavData™ is a trademark of Jeppesen, Inc.

SiriusXM® is a registered trademark of SiriusXM Satellite Radio, Inc.

AC-U-KWIK® is a registered trademark of Penton Business Media, Inc.

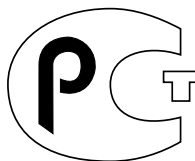

**MPI02**



---

**WARNING:** Navigation and terrain separation must NOT be predicated upon the use of the terrain function. The aera 795/796 Terrain Proximity feature is NOT intended to be used as a primary reference for terrain avoidance and does not relieve the pilot from the responsibility of being aware of surroundings during flight. The Terrain Proximity feature is only to be used as an aid for terrain avoidance and is not certified for use in applications requiring a certified terrain awareness system. Terrain data is obtained from third party sources. Garmin is not able to independently verify the accuracy of the terrain data.

---



---

**WARNING:** The displayed minimum safe altitudes (MSAs) are only advisory in nature and should not be relied upon as the sole source of obstacle and terrain avoidance information. Always refer to current aeronautical charts for appropriate minimum clearance altitudes.

---



---

**WARNING:** The altitude calculated by aera 795/796 GPS receivers is geometric height above Mean Sea Level and could vary significantly from the altitude displayed by pressure altimeters. Always use pressure altitude displayed by the aircraft altimeter when determining or selecting aircraft altitude.

---



---

**WARNING:** Do not use outdated database information. Databases used in the aera 795/796 system must be updated regularly in order to ensure the information remains current. Pilots using any outdated database do so entirely at their own risk.

---



---

**WARNING:** Do not use data link weather information for maneuvering in, near, or around areas of hazardous weather. Information contained with in data link weather products may not accurately depict current weather conditions.

---



---

**WARNING:** Do not use the indicated data link weather product age to determine the age of the weather information shown by the datalink weather product. Due to time delays inherent in gathering and processing weather data for data link transmission, the weather information shown by the data link weather product may be significantly older than the indicated weather product age.

---



---

**WARNING:** To reduce the risk of unsafe operation, carefully review and understand all aspects of the aera 795/796 Pilot's Guide documentation and the Pilot's Operating Handbook of the aircraft. Thoroughly practice basic operation prior to actual use. During flight operations, carefully compare indications from the aera 795/796 to all available navigation sources, including the information from other NAVAIDs, visual sightings, charts, etc. For safety purposes, always resolve any discrepancies before continuing navigation.

---



---

**WARNING:** For safety reasons, aera 795/796 operational procedures must be learned on the ground.

---



---

**WARNING:** When installing the aera™ 795/796, place the unit so it does not obstruct the field of view or interfere with operating controls.

---



---

**WARNING:** The indicators represented on the Panel are based on GPS-derived data and may differ from the instruments in the aircraft.

---



---

**WARNING:** The United States government operates the Global Positioning System and is solely responsible for its accuracy and maintenance. The GPS system is subject to changes which could affect the accuracy and performance of all GPS equipment. Portions of the Garmin aera 795/796 utilize GPS as a precision electronic NAVigation AID (NAVAID). Therefore, as with all NAVAIDs, information presented by the aera 795/796 can be misused or misinterpreted and, therefore, become unsafe.

---



---

**WARNING:** The data contained in the terrain and obstacle databases comes from government agencies. Garmin accurately processes and cross-validates the data, but cannot guarantee the accuracy and completeness of the data.

---



---

**WARNING:** Do not use basemap (land and water data) information for primary navigation. Basemap data is intended only to supplement other approved navigation data sources and should be considered as an aid to enhance situational awareness.

---

**BATTERY WARNINGS:**

*If these guidelines are not followed, the internal lithium-ion battery may experience a shortened life span or may present a risk of damage to the GPS device, fire, chemical burn, electrolyte leak, and/or injury.*

- *Do not leave the device exposed to a heat source or in a high-temperature location. To prevent damage, remove the device from the aircraft or store it out of direct sunlight.*
- *Do not puncture or incinerate the device or battery.*
- *When storing the device for an extended time, store within the following temperature range: from 32° to 77°F (from 0° to 25°C)*
- *Do not operate the device outside of the following temperature range: from -4° to 131°F (from -20° to 55°C).*
- *Contact your local waste disposal department to dispose of the device/battery in accordance with applicable local laws and regulations.*

**Additional User-Replaceable Battery Warnings:**

- *Do not use a sharp object to remove the battery.*
- *Keep the battery away from children.*
- *Do not disassemble, puncture, or damage the battery.*
- *Only replace the battery with the correct replacement battery. Using another battery presents a risk of fire or explosion. To purchase a replacement battery, see your Garmin dealer or the Garmin Web site.*



**WARNING:** *Do not rely solely upon the display of traffic information for collision avoidance maneuvering. The traffic display does not provide collision avoidance resolution advisories and does not, under any circumstances or conditions, relieve the pilot's responsibility to see and avoid other aircraft.*



**WARNING:** *Do not rely solely upon the display of traffic information to accurately depict all of the traffic within range of the aircraft. Due to lack of equipment, poor signal reception, and/or inaccurate information from aircraft or ground stations, traffic may be present that is not represented on the display.*





---

**CAUTION:** Avoid using any chemical or abrasive cleaners on the touchscreen and/or plastic casing. Clean the touchscreen with a soft, clean, lint-free cloth. Use water, isopropyl alcohol, or eyeglass cleaner, if needed.

---



---

**CAUTION:** The Garmin aera 795/796 does not contain any user-serviceable parts. Repairs should only be made by an authorized Garmin service center. Unauthorized repairs or modifications could void both the warranty and the pilot's authority to operate this device under FAA/FCC regulations.

---



---

**NOTE:** The Garmin aera 795/796 has a very high degree of functional integrity. However, the pilot must recognize that providing monitoring and/or self-test capability for all conceivable system failures is not practical. Although unlikely, it may be possible for erroneous operation to occur without a fault indication shown by the aera 795/796. It is thus the responsibility of the pilot to detect such an occurrence by means of cross-checking with all redundant or correlated information available in the cockpit.

---



---

**NOTE:** All visual depictions contained within this document, including screen images of the aera 795/796 panel and displays, are subject to change and may not reflect the most current aera 795/796 system and aviation databases. Depictions of equipment may differ slightly from the actual equipment.

---



---

**NOTE:** This product, its packaging, and its components contain chemicals known to the State of California to cause cancer, birth defects, or reproductive harm. This notice is being provided in accordance with California's Proposition 65. If you have any questions or would like additional information, please refer to our web site at [www.garmin.com/prop65](http://www.garmin.com/prop65).

---



---

**NOTE:** Use of polarized eyewear may cause the display to appear dim or blank.

---



---

**NOTE:** Temporary Flight Restriction (TFR) data is provided by the FAA and may not be updated outside of normal business hours. Confirm data currency through alternate sources and contact your local FSS for interpretation of TFR data.

---

Blank Page

Part Number	Change Summary
190-01194-00	Initial release

Rev	Date	Description
A	August, 2011	Production Release
B	August, 2012	Added GDL 39 Support
C	September, 2012	Added TargetTrend™ Support
D	April, 2016	Updated to reflect aera 7xx software version 4.80
E	July, 2017	Added GDL 51/52 support Added display of SXM composite NEXRAD data Added method to navigate to latitude/longitude coordinates on the direct-to page Added terrain status icon to map page Added menu option to Bluetooth setup to manage paired devices Added Connex Setup for Flight Plan transfer Added support for the GTX 345 transponder setup and wiring
F	August, 2017	Added deliverables zip to archive
G	March, 2019	Updated to reflect aera 7xx software version 5.60 Updated to reflect FIS-B weather products
H	March, 2019	Added deliverables zip to archive
J	October, 2019	Updated GNX 375 wiring diagram Added note to Smart Airspace

Blank Page

**SECTION 1 OVERVIEW** ..... 1

**1.1 Unit Overview** ..... 1

**1.2 Getting Started**..... 2

        Battery Installation ..... 2

        Charging the Battery ..... 3

        Mounting the aera 795/796 in the Aircraft..... 4

        Turning the Unit On/Off ..... 4

        GPS Receiver Status ..... 6

        Display Orientation..... 8

**1.3 Operation** ..... 8

        Basic Touchscreen Operation ..... 8

        Dedicated Icons..... 10

        Page Buttons (Optional) ..... 10

        Main Menu ..... 11

**1.4 Menus and Data Entry**..... 15

        Option Menus ..... 15

        Data Entry..... 15

**1.5 Using Map Displays**..... 18

        Map Range ..... 18

        Map Panning ..... 19

        Map Overlays..... 22

        Map Symbols ..... 22

**1.6 System Settings**..... 23

        Display..... 24

        Sound ..... 26

        Bluetooth® ..... 26

        Connex ..... 27

        Additional Settings..... 27

**1.7 Nearest Airport Criteria Settings** ..... 29

**1.8 Present Position**..... 29

        Position..... 29

        New Location..... 30

        Simulator Mode ..... 30

**SECTION 2 GPS NAVIGATION** ..... 33

**2.1 Introduction**..... 33

        Data Fields..... 34

        Numeric Flight Data ..... 37

        Compass Arc..... 38

**2.2 HSI/Panel** ..... 39

        Setting the Bug Indicator ..... 40

        Manually Setting a Course..... 40

<b>2.3 Vertical Navigation (VNAV)</b> .....	41
Using the VNAV Feature .....	42
<b>2.4 Map Display Setup</b> .....	44
Map Orientation.....	45
Airports, Nav aids, Cities & Roads .....	46
Airways .....	47
<b>2.5 Waypoints</b> .....	48
Waypoint Information.....	49
Waypoint Frequencies.....	50
Waypoint Weather and NOTAM Information.....	51
Airport Directory Waypoint Information .....	51
Viewing Chart Information by Identifier.....	52
Nearest Information .....	53
Textual Weather and NOTAM Information .....	55
Accessing Additional information.....	57
<b>2.6 Direct-to Navigation</b> .....	66
<b>SECTION 3 FLIGHT PLANNING</b> .....	69
<b>3.1 Introduction</b> .....	69
Data Fields.....	69
<b>3.2 Flight Plan Creation</b> .....	70
Adding Waypoints to an Existing Flight Plan.....	72
Graphical Flight Planning.....	73
<b>3.3 Flight Plan Storage</b> .....	75
<b>3.4 Flight Plan Activation</b> .....	76
<b>3.5 Flight Plan Editing</b> .....	77
Editing Speed and Fuel Flow.....	77
Copying Flight Plans.....	78
Deleting Flight Plans .....	78
Inverting a Flight Plan .....	79
Importing/Exporting Flight Plans.....	80
Connex .....	80
<b>3.6 Approaches</b> .....	80
Selecting an Approach.....	81
<b>SECTION 4 HAZARD AVOIDANCE</b> .....	85
<b>4.1 Weather</b> .....	85
Compatible Devices.....	85
Weather Source.....	85
SiriusXM® Weather .....	86
Using Weather Data .....	99
Data Link Weather (FIS-B) (795 and 796).....	103

<b>4.2 Terrain</b> .....	122
Terrain Information.....	123
Obstacle Information.....	123
Terrain and Obstacle Color Code.....	125
Terrain Views.....	125
Terrain Alerts & Setup.....	126
<b>4.3 Traffic</b> .....	129
Traffic Information Service (TIS-A) .....	129
Data Link Traffic .....	133
<b>SECTION 5 ADDITIONAL FEATURES</b> .....	147
<b>5.1 3D Vision</b> .....	147
3D Vision Operation .....	148
<b>5.2 Airport Directory Data</b> .....	150
<b>5.3 ChartView</b> .....	152
Aircraft Symbol.....	154
Chart Range.....	155
Jeppesen Database-published NOTAMS .....	155
<b>5.4 FliteCharts</b> .....	156
Aircraft Symbol.....	160
FliteChart Range .....	160
FliteCharts Cycle Number and Expiration Date .....	161
<b>5.5 VFR/IFR Chart Viewing</b> .....	161
<b>5.6 SafeTaxi</b> .....	162
SafeTaxi Cycle Number and Revision .....	163
<b>5.7 SiriusXM® Radio (aera 796)</b> .....	163
Compatible SiriusXM Devices .....	164
Activating SiriusXM Satellite Radio Services .....	164
Using SiriusXM Radio .....	165
<b>5.8 Electronic Checklists</b> .....	170
<b>SECTION 6 APPENDICES</b> .....	171
<b>Appendix A: Messages, Alerts &amp; Data Field Options</b> .....	171
Miscellaneous Message Advisories.....	171
Airspace Messages.....	172
Data Field & Numeric Data Options .....	173
Aural Alerts.....	176
<b>Appendix B: Abnormal Operation</b> .....	177
Loss of GPS Position.....	177
Hazard Display with Loss of GPS Position.....	177
<b>Appendix C: SD Cards and Databases</b> .....	179
SD Card Use.....	179
Databases.....	180

**Appendix D: Installation and Interfacing** ..... 185

- Mounting the aera 795/796 in the Aircraft..... 185
- Connecting to a Computer ..... 188
- Interfacing ..... 189
- Connecting to a Garmin VHF Comm Radio..... 191
- Connecting the GXM 40/42 Antenna (aera 796) ..... 193
- Connecting to a GTX 330 Mode S Transponder ..... 194
- Configuring aera for a GTX 345 or GNX 375..... 195
- Configuring aera for a GDL 39..... 197
- Configuring aera for a GDL 51/52..... 198
- Pairing a Device via Bluetooth ..... 199
- Pairing the GDL 51/52 as an Audio Device..... 200
- Using an External GPS Antenna (Optional)..... 200
- Connecting to a Flight Stream 110/210 ..... 200

**Appendix E: Battery and Care Information** ..... 201

- Battery Information ..... 201
- Changing the Cigarette Lighter Adapter Fuse..... 201
- Cleaning the Casing ..... 202
- Cleaning the Touchscreen..... 202
- Protecting the Unit..... 202

**Appendix F: General TIS-A Information** ..... 203

- TIS-A vs. TAS/TCAS ..... 203
- TIS-A Limitations..... 204

**Appendix G: Utilities** ..... 207

- Document Viewer ..... 207
- Scratch Pad..... 207
- Flight Log..... 208
- Track Log ..... 210
- Heading Line..... 212
- EGB Calculator ..... 213
- Aircraft Profile..... 216
- Weight & Balance ..... 217
- Proximity Waypoints ..... 219

**Appendix H: Display Symbols** ..... 223

- VFR Symbols ..... 223
- IFR Symbols ..... 224
- Airspace Symbols ..... 226

**Appendix I: Map Datum and Location Formats** ..... 229

- Map Datums..... 229
- Location Formats..... 229

**Appendix J: Glossary** ..... 231



**Appendix K: License Agreement and Warranty**..... 237

- Contact Garmin..... 237
- Software License Agreement..... 237
- Aviation Limited Warranty ..... 238
- AOPA Airport Directory Notice ..... 239
- AC-U-KWIK LICENSE AGREEMENT..... 239
- SIRIUSXM Satellite Radio Service Agreement ..... 240
- Weather Data Warranty ..... 240
- FCC Compliance..... 241
- Industry Canada Compliance ..... 241

Blank Page

# SECTION 1 OVERVIEW

## 1.1 UNIT OVERVIEW

The aera 795/796 presents GPS-derived analog flight instrumentation, position, navigation, and hazard avoidance information to the pilot using a 7" WVGA high brightness display with capacitive Touch Screen.



**Unit Overview (Left Side)**



**Unit Overview (Right Side)**

## 1.2 GETTING STARTED

### BATTERY INSTALLATION



**NOTE:** Refer to Appendix E for additional battery information.



**CAUTION:** Always keep the battery installed when the unit is on.



**WARNING:** The product contains a lithium-ion battery. To prevent damage, remove the unit from the aircraft or store it out of direct sunlight.

#### Installing the battery:

- 1) Locate the lithium-ion battery that came in the product box.
- 2) Locate the metal contacts on the end of the lithium-ion battery.
- 3) Insert the battery so the metal contacts on the battery line-up with the metal contacts inside the battery compartment.
- 4) Insert the battery into the battery compartment, and push until it clicks into place.



Unit Overview (Back - Battery Out)

## CHARGING THE BATTERY



**NOTE:** While in Charge Mode the unit draws a current from the aircraft. To avoid discharging the aircraft's battery, disconnect the external power cable from the unit when not in use for several days.

Charge the aera 795/796 for at least 4 hours before using on battery power. Charge the battery by connecting the aviation power cable or the AC adapter.

Plug the unit into a 12-Volt or 24-Volt connector to charge. The unit can be used while it is charging. Charge the unit within the following temperature range: 32° to 104°F (0° to 40°C).

### Charging the unit's battery using the aircraft's power outlet:

- 1) Mount the aera 795/796 in the aircraft and connect the power cable to the aircraft power outlet (cigarette lighter receptacle).
- 2) Route the power cable so that it does not interfere with aircraft operation. The unit begins charging as soon as external power is applied.

## USING CHARGE MODE

Applying external power to the aera 795/796 automatically turns on the unit for full operation. If the battery is present and needs to be charged, the external power source charges the battery while the unit is in use.

If you do not want to use the unit, but you would like to charge the battery, you can put the unit into Charge Mode. Connect the unit to an external power supply. Press and hold the  **POWER** Button. Instead of completely turning off, the unit now goes into Charge Mode.

The unit will run cooler and may allow more current to be available while in Charge Mode, when XM is unplugged, the backlight is turned down, etc.

## MOUNTING THE aera 795/796 IN THE AIRCRAFT

Refer to Appendix D 'Installation & Interfacing' for information on mounting the aera 795/796 in the aircraft.

## TURNING THE UNIT ON/OFF

Press and hold the  **POWER** Button to turn the unit on or off.



**NOTE:** If the display appears dark or dim, adjust the display backlighting as necessary after applying system power. The aera 795/796 retains the backlighting settings between power cycles. Backlighting may have been set to a level not suitable for the current ambient lighting. For more information on display backlighting see section 1.4 (System Settings).

The power button can be used to quickly set the backlight intensity. A momentary press of the power button (after the unit is powered on) will display a window showing the current backlight setting. From this window the backlight setting can be adjusted with the on screen controls, or a second momentary press of the POWER Button changes the backlight level to full bright (10).

The first time the unit is turned on, the receiver must collect satellite data and establish its present location. To ensure proper initialization, the aera 795/796 is shipped from the factory in AutoLocate mode, which allows the receiver to “find itself” anywhere in the world.

During initialization, current database information is displayed. Database information includes valid operating dates, cycle number, and database type. When this information has been reviewed for currency (to ensure that no databases have expired), the pilot is prompted to continue.

Touching the **Press To Accept** Button acknowledges this information, and the **Main Menu** is displayed.



aera 795



aera 796

### Database Initialization

## GPS RECEIVER STATUS

The receiver status displays one of the following conditions:

- AutoLocate—Receiver is looking for any satellite whose almanac has been collected, which can take up to 5 minutes
- Searching the Sky—Receiver is looking for satellites
- Acquiring Satellites—Receiver is looking for and collecting data from satellites visible at its last known or initialized location, but has not acquired a fix
- 2D GPS Location—At least three satellites have been acquired and a two-dimensional location fix has been calculated. “2D Differential” appears when you are receiving DGPS corrections in 2D mode
- 3D GPS Location—At least four satellites have been acquired and a three-dimensional fix has been calculated. “3D Differential” appears when you are receiving DGPS corrections in 3D mode
- Lost Satellite Reception—the receiver is no longer tracking enough satellites for a 2D or 3D fix



GPS Status



## Viewing the GPS status:

From the **Main Menu**, touch **Tools** > **GPS Status**.

## ACQUIRING SATELLITES

The  bars located at the top of the screen indicate the GPS signal strength.

When the receiver is in the process of acquiring enough satellite signals for navigation, the receiver uses satellite orbital data (collected continuously from the satellites) and last known position to determine the satellites that should be in view. 'Acquiring Satellites' is indicated as the solution until a sufficient number of satellites have been acquired for computing a solution.

When the receiver is in the process of acquiring a 3D differential GPS solution, '3D GPS Location' is indicated as the solution until the 3D differential fix has finished acquisition.

## SATELLITE INFORMATION

Satellites currently in view are shown at their respective positions on a satellite constellation diagram. The outer circle of the constellation diagram represents the horizon, the inner circle represents 45° above the horizon, and the center point shows the position directly overhead. Each satellite is represented by a square containing the Pseudo-Random Noise (PRN) number (i.e., satellite identification number).

**GPS Status** can be helpful in troubleshooting weak (or missing) signal levels due to poor satellite coverage or installation problems. As the GPS receiver locks onto satellites, a signal strength bar is displayed for each satellite in view, with the appropriate satellite PRN number (01-32 or 33-64 for WAAS) below each bar. The progress of satellite acquisition is shown in three stages, as indicated by signal bar appearance:

- No bar—Receiver is looking for the indicated satellite
- Gray bar—Receiver has collected the necessary data and the satellite signal can be used
- Green bar—Satellite is being used for the GPS solution

## DISPLAY ORIENTATION

The aera 795/796 can be viewed in either Portrait or Landscape Mode.

### Changing the display orientation:

- 1) From the **Main Menu**, touch **Tools** > **Setup** > **Display**

**Or:**

Press the Power Button once quickly.

- 2) Touch the 'Display Orientation' datafield to select **Portrait** or **Landscape**.

## 1.3 OPERATION

### BASIC TOUCHSCREEN OPERATION

Touch the desired selection. The icon, view, menu option, datafield, etc., will momentarily turn blue when selected.



Basic Touchscreen Operation

## SCROLLING AND PANNING

### Scrolling and panning on the touchscreen:

Drag up or down to scroll menus, documents, etc.

**Or:**

Drag in any direction to pan maps or charts.

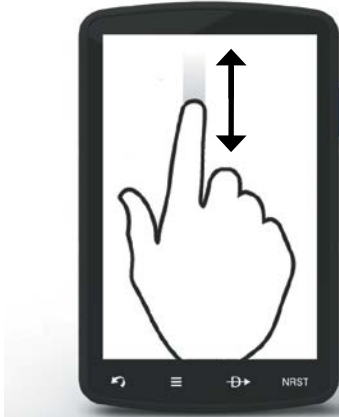

Scrolling

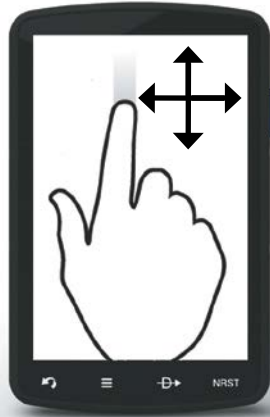

Panning

## ZOOMING

### Zooming in and out on the touchscreen map displays:

Pinch fingers together (zoom out), or pull fingers apart (zoom in).



Zoom Out



Zoom In

## DEDICATED ICONS

Located on the bezel (below the touchscreen) are four dedicated touch icons. Touch, or touch and hold, the following icons to perform the associated function:



### Dedicated Icons

	<b>Back</b>	Returns to previous screen. Cancels the map pointer.
	<b>Main Menu (Shortcut)</b>	Touch and hold to display the Main Menu.
	<b>Menu</b>	Displays the context sensitive option menu.
	<b>Direct-to</b>	Displays the <b>Direct-to</b> function.
	<b>NRST</b>	Displays the Nearest Icons. Touch and hold to quickly access the nearest airports.

## PAGE BUTTONS (OPTIONAL)



**NOTE:** The aera 795/796 Optional Page Buttons are User Configurable.

Six different configurable Page Buttons are located above the Dedicated Icons. The Page Buttons default to **Map**, **WPT Info**, **Weather** (aera 796), **Terrain**, **3D Vision**, and **Charts**.



### Page Buttons

### Configuring the Page Buttons:













- 1) **Main Menu**, touch **Tools > Setup > Display > Choose Buttons**
- 2) From the available Page Buttons at the top half of the screen, touch the new Page Button that will replace one of the current Page Buttons.
- 3) From the current Page Buttons along the bottom of the screen, touch the Page Button that will be replaced by the new Page Button. The current Page Button is now replaced by the new Page Button.
- 4) Touch **Save**.

## MAIN MENU

Touch and hold the  icon at any time to display the **Main Menu**.

### MAIN MENU ICONS











Touch the following icons to display the associated function:

	<b>Map</b>	Displays the Map View.
	<b>Terrain</b>	Displays the Terrain View.
	<b>3D Vision</b>	Displays 3D Vision.
	<b>WPT Info</b>	Displays the Waypoint Information.
	<b>FPL List</b>	Displays the Flight Plan List.
	<b>Active FPL</b>	Displays the Active Flight Plan.
	<b>Traffic</b>	Displays the dedicated Traffic Page.
	<b>Numbers</b>	Displays flight data (moved to the Tools Menu if XM and a compatible SiriusXM device are configured).
	<b>Doc Viewer</b>	Displays the document viewer.
	<b>Charts</b>	Displays the VFR or IFR charts.
	<b>Weather</b>	Displays second-level Weather Icons.
	<b>SiriusXM</b>	Displays SiriusXM Radio (aera 796).
	<b>Tools</b>	Displays second-level Tools Icons.

## NEAREST ICONS

Touch the **NRST** icon at any time to access the second-level Nearest icons.







Touch the following icons to display the associated function:











	<b>Airport</b>	Displays nearest airports.
	<b>Airport WX</b>	Displays nearest airport weather.
	<b>VOR</b>	Displays nearest VORs.
	<b>NDB</b>	Displays nearest NDBs.
	<b>Intersection</b>	Displays nearest intersections.
	<b>VRP</b>	Displays nearest Visual Reporting Point (VRP) (Atlantic).
	<b>User WPT</b>	Displays nearest user waypoints.
	<b>City</b>	Displays nearest cities.
	<b>ARTCC</b>	Displays nearest ARTCCs (Air Route Traffic Control Centers).
	<b>FSS</b>	Displays nearest Flight Service Stations (FSS).
	<b>Airspace</b>	Displays nearest airspace.

## WEATHER ICONS

From the **Main Menu**, touch the **Weather** icon to access the second-level Weather Icons.











Touch the following second-level Icons to display the weather product:

	<b>NEXRAD</b>	Displays NEXRAD (NEXt-generation RADar).
	<b>Cloud Fcst</b>	Displays cloud top height contours.
	<b>Echo Tops</b>	Displays Echo Tops.
	<b>Winds</b>	Displays Winds Aloft.
	<b>Temps</b>	Displays Temperatures Aloft.
	<b>Lightning</b>	Displays Lightning Strikes.

	<b>Storm Cells</b>	Displays Storm Cells.
	<b>METAR</b>	Displays METARs.
	<b>AIRMET</b>	Displays AIRMETs.
	<b>SIGMET</b>	Displays SIGMETs.
	<b>TFR</b>	Displays TFRs.
	<b>PIREP</b>	Displays PIREPs.
	<b>Freeze Lvl</b>	Displays Freezing Levels.
	<b>Turb Fcst</b>	Displays the Turbulence Forecast.
	<b>Icing Fcst</b>	Displays the Icing Forecast.
	<b>WX Fcst</b>	Displays Forecast Information (current, 12, 24, 36, & 48).
	<b>Pressure</b>	Displays Surface Pressure.

## TOOLS

From the **Main Menu**, touch the **Tools** Icon to access the second-level Tools icons. Touch the following second-level icons to display the associated function:

	<b>Setup</b>	Displays third-level Setup Icons.
	<b>User WPT</b>	Displays User Waypoints and Proximity Waypoints.
	<b>Flight Log</b>	Displays Flight Logs.
	<b>Track Log</b>	Displays Track Logs.
	<b>VNAV</b>	Displays Vertical Navigation parameters.
	<b>Profile</b>	Displays Aircraft Profiles.
	<b>E6B Calc</b>	Displays the E6B Calculator.
	<b>Weight/Bal</b>	Displays the Weight & Balance.
	<b>Data Link</b>	Displays Data Link Information.
	<b>Database</b>	Displays database and software version information.

**Scratchpad**

Displays the scratchpad.

**Position**

Displays the aircraft's Present Position.

**Checklists**

Displays the checklists (if available on the SD card).

**GPS Status**

Displays GPS status information.

**SETUP ICONS**

From the **Main Menu**, touch the **Tools > Setup** to access the third-level Setup Icons.

Touch the following third-level icons to perform the associated function:

**Display**

Displays backlight intensity/timeout and color mode settings.

**Sound**

Displays sound settings.

**Units**

Displays unit settings.

**Time**

Displays time settings.

**Map**

Displays Navigation Map settings.

**Position**

Displays position settings.

**Interface**

Displays interface settings.

**Alarms**

Displays alarm settings.

**SUA Alarms**

Displays Special Use Airspace alarm settings.

**Connex**

Displays Flight Plan Transfer settings.

**Weather**

Displays Weather source settings.

**Bluetooth®**

Displays Bluetooth connection settings.

**Power**

Displays Power Loss Warning settings.

**Keyboard**

Displays keyboard layout settings.



# 1.4 MENUS AND DATA ENTRY

## OPTION MENU

The aera 795/796 has a dedicated  icon that displays a context-sensitive list of menu options available.

### Navigating the option menu:





- 1 Touch the  icon
- 2 Touch the desired menu option.



## DATA ENTRY

### DATA ENTRY ICONS

The following icons are displayed on the data entry screen.

	<b>OK</b>	Exits the keypad function and accepts the changes.
	<b>BKSP</b>	Erases the current data.
	<b>Numeric/ Alpha/Symbol</b>	Displays the numeric, alpha, or symbol keypad.
	<b>Cancel</b>	Cancels a value that has been edited.

### Entering alphanumeric data:

- 1 When alphanumeric data can be entered, a keypad will appear after touching the desired datafield.
- 2 Touch the keypad to enter the desired data.
- 3 Touch **OK**.



### Entering predetermined data options:

- 1 Touch the Data Option Button to display a vertical list of data options (if applicable), or to toggle two data options (i.e., **On/Off**).

**Or:**

Touch the  buttons to cycle through a horizontal list (if more than two data options are available).

- 2 If using the vertical list, touch the desired data option from the list.



## 1.5 USING MAP DISPLAYS



**NOTE:** Refer to the GPS Navigation section for more information on Map Display Setup.



Map displays are used extensively in the aera 795/796 to provide situational awareness in flight. Most aera 795/796 maps can display the following information:

- Airports, NAVAIDs, airspaces, airways, land data (highways, cities, lakes, rivers, borders, etc.) with names
- Map Pointer information (distance and bearing to pointer, location of pointer, name, and other pertinent information)
- Map range
- Aircraft icon (representing present position)
- Flight plan legs
- User waypoints
- Track vector
- Topography data

### MAP RANGE

There are 23 different map ranges available, from 200 feet to 800 nm. The current map range is indicated in the lower right. The scale bar represents the map scale.

#### Changing the map range:

Use the  (out) or  (in) icons to zoom 'out' (increasing), or zoom 'in' (decreasing).

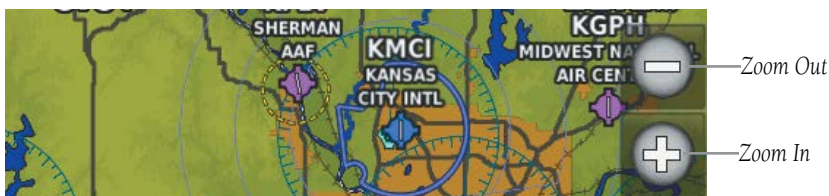

Or:

Pinch fingers together (zoom out), or pull fingers apart (zoom in).

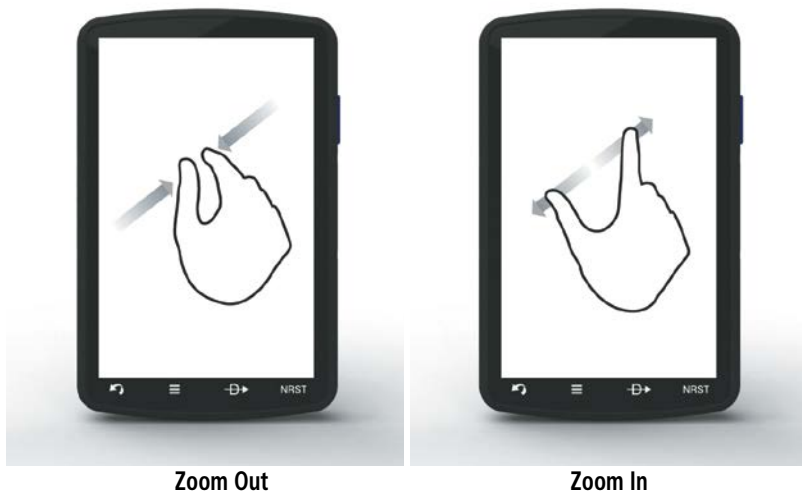

## AUTO ZOOM

Auto Zoom allows the aera 795/796 to change the map display range to the smallest range clearly showing the active waypoint. Auto Zoom can be overridden by adjusting the range and remains that way until the active waypoint changes, a terrain or traffic alert occurs, or the aircraft takes off.

### Enabling/disabling auto zoom:

- 1) From the **Main Menu**, touch **Map > Menu > Set Up Map**.
- 2) Touch the  buttons to select the '**General**' Category.
- 3) Touch the **On/Off** Data Option Button for 'Autozoom'.

## MAP PANNING

Map panning allows the pilot to:

- View parts of the map outside the displayed range without adjusting the map range
- Highlight and select locations on the map
- Review information for a selected airport, NAVAID, or user waypoint

- Designate locations for use in flight planning
- View airspace and airway information

When the panning function is selected by touching anywhere on the Map, the Map Pointer is displayed. An Information Window also appears at the bottom of the map display showing the bearing, distance, and time to the pointer from the aircraft's present position, the elevation of the land at the position of the pointer, or the object's (airports, obstacles, etc.) elevation, if known.

When the Map Pointer is over a map feature, the map feature is highlighted, an information box appears on the map, and the highlighted map feature is displayed on the Map Feature Button (even if the name was not originally displayed on the map).

Touching the **Map Feature** Button displays additional information for the highlighted map feature. If multiple features are present at the Map Pointer position, green arrows will appear on the Map Feature Button. Touching the will cycle through the list of map features present at that position.

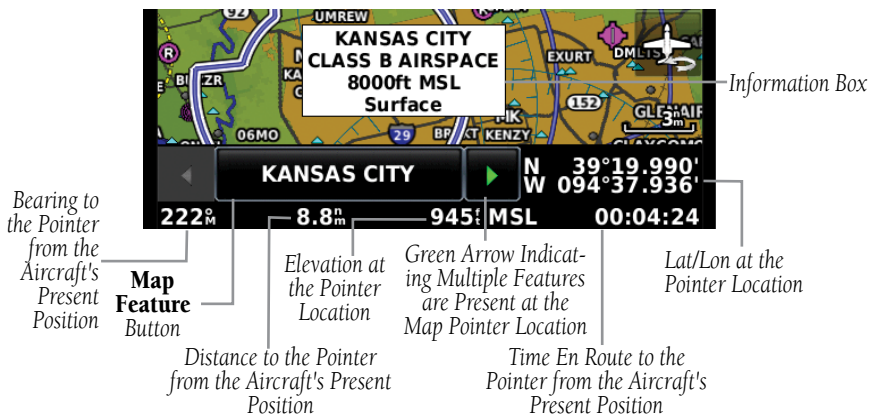

Map Panning (Navigation Map)







### Activating the map pointer:

While viewing a Map Display, touch anywhere on the map to activate the map pointer. Touch the icon or icon to cancel the map pointer.

### Panning the map:

While viewing a Map Display, touch anywhere on the map and drag.

### Reviewing information for a map feature:

- 1 While viewing a Map Display, touch anywhere on the map to activate the map pointer. When the Map Pointer is over a map feature, the map feature is highlighted, an information box appears on the map, and the highlighted map feature is displayed on the Map Feature Button (the button located between the   buttons). If multiple features are present at the Map Pointer position, green arrows will appear on the Map Feature Button.
- 2 If necessary, touch the   buttons to cycle through the list of map features present at that position. Touching the   buttons changes the highlight and description.
- 3 Touch the Map Feature Button to review information for the Map Feature.
- 4 If desired, touch the **Direct-to**  Icon to navigate to the map feature.

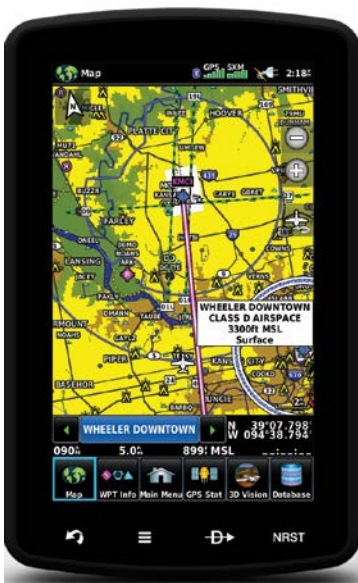

## MAP OVERLAYS

The Weather, Topography, and Terrain map overlays can be displayed or removed.



### Displaying/removing map overlays:

- 1) From the **Main Menu**, touch **Map > Menu > Show/Hide**.
- 2) Touch the '**Show/Hide**' Data Option Button for the desired overlay.

## MAP SYMBOLS

Refer to Appendix H for a list of map symbols.

### DECLUTTER

The map can be adjusted to declutter (remove unwanted items, such as highways) the map.

### Adjusting the declutter level of the Navigation Map:

- 1) From the **Main Menu**, touch **Map > Menu > Declutter**.
- 2) Touch the desired level (**none**, **-1**, **-2**, **-3**) at the bottom of the screen. The currently selected level is highlighted blue.
- 3) Touch the  icon to remove the detail options.



## MAP DETAIL

The map detail can also be adjusted. Map detail changes the amount of detail with respect to the zoom scale.

### Adjusting the map detail:

- 1) From the **Main Menu**, touch **Map > Menu > Set Up Map**.
- 2) Touch the  buttons to select the '**General**' Category.
- 3) Touch **Detail Level** Data Option Button, and touch the desired option from the list (**Least, Less, Normal, More, or Most**).

## 1.6 SYSTEM SETTINGS

The third-level **Setup** Icons allow management of the following system parameters:

- Display
- Sound
- Units
- Time
- Map
- Position
- Interface
- Alarms
- SUA Alarms
- Data Link
- Weather
- Bluetooth
- Power
- Keyboard
- Connex

### Restoring system setting defaults:

- 1) From the **Main Menu**, touch **Tools > Setup**.
- 2) Touch the desired Setup Icon (**Display, Sound, Units, Date & Time, Map, Position, Interface, Bluetooth, etc.**).
- 3) Touch **Menu > Restore Default**.

**Or:**

From the **Main Menu**, touch **Tools > Setup > Menu > Restore All Settings**.

## DISPLAY



**NOTE:** Display Setup can also be accessed through the 'Quick Settings' by pressing the  POWER Button once quickly. Two quick presses of the POWER Button will change the backlight intensity to full bright (10).

## DISPLAY ORIENTATION

The aera 795/796 can be viewed in either Portrait or Landscape Mode.

### Changing the display orientation:

- 1) From the **Main Menu**, touch **Tools** > **Setup** > **Display**  
**Or:**  
Press the Power Button once quickly.
- 2) Touch the 'Display Orientation' datafield to select **Portrait** or **Landscape**.

## PAGE BUTTONS

### Configuring the Page Buttons:

- 1) **Main Menu**, touch **Tools** > **Setup** > **Display** > **Choose Buttons**
- 2) Touch one of the available Page Buttons at the top half of the screen to replace one of the current Page Buttons.
- 3) Touch one of the current Page Buttons along the bottom of the screen to replace it with the new Page Button.
- 4) Touch **Save**.

### Displaying/removing the Page Buttons:



- 1) From the **Main Menu**, touch **Tools** > **Setup** > **Display**.
- 2) Touch the '**Show/Hide**' Data Option Button for the 'Page Buttons'

## BACKLIGHT INTENSITY

### Adjusting backlight intensity:

- 1) From the **Main Menu**, touch **Tools** > **Setup** > **Display**.
- 2) Touch the  buttons to adjust the backlight intensity.

**Or:**

Press the  POWER Button and enter the desired backlight intensity using .

## BACKLIGHT TIMEOUT

After a specified period of inactivity the backlight will turn off to save battery power.

### Adjusting backlight timeout:

- 1) From the **Main Menu**, touch **Tools > Setup > Display**.
- 2) Touch the '**Backlight Timeout**' Data Option Button, and touch the desired option from the list (**Stays On, 15 Seconds, 30 Seconds, 1 Minute, or 2 Minutes**).

## ZOOM BUTTONS

### Displaying/removing the Zoom Buttons:

- 1) From the **Main Menu**, touch **Tools > Setup > Display**.
- 2) Touch the '**Show/Hide**' Data Option Button for the 'Zoom Buttons'.

## COLOR MODE

### Adjusting the color mode:

- 1) From the **Main Menu**, touch **Tools > Setup > Display**.
- 2) Touch the '**Color Mode**' Data Option Button, and touch the desired option from the list (**Auto, Day, or Night**).

## SCREENSHOT

### Enable/disable screenshots:

- 1) From the **Main Menu**, touch **Tools > Setup > Display**.
- 2) Touch the 'Screenshot' '**On/Off**' Data Option Button.
- 3) If enabling screenshots, touch '**OK**'. A camera button appears at the top of the screen. Touch the camera button to save a screenshot to the screenshot folder on the 'Garmin' drive.

## AIRCRAFT POSITION ON MAP/CHARTS

### Displaying/removing the aircraft position on maps/charts:

- 1) From the **Main Menu**, touch **Tools > Setup > Display**.
- 2) Touch the 'Aircraft Position' '**Show/Hide**' Data Option Button.

## SOUND



**NOTE:** Sound Settings can also be accessed through the 'Quick Settings' by pressing the  POWER Button once quickly.

Sound is broken down into 'Master', 'Alerts', and 'Media'. 'Master' controls ALL sound. 'Alerts' and 'Media' are a percentage of the 'Master' sound. 'Alerts' refers to navigation phrases (e.g. "Pull Up"), and 'Media' refers to the XM radio volume. The Terrain Audio and Key Tones can also be toggled On/Off.

### Adjusting the sound:

1) From the **Main Menu**, touch **Tools** > **Setup** > **Sound**.

2) Touch the  buttons to adjust the sound.

**Or:**

1) Press the  POWER Button to quickly access the **Master** volume/mute.

2) Touch **Menu** > **Sound Setup** to access ALL volume settings.

### Enabling/disabling Terrain Audio, TIS-A Audio, and/or Key Tones:

1) From the **Main Menu**, touch **Tools** > **Setup** > **Sound**.

2) Touch the '**On/Off**' Data Option Button to toggle Terrain Audio, TIS-A Audio, or Key Tones on/off.

### Muting the sound:

1) From the **Main Menu**, touch **Tools** > **Setup** > **Sound**.

2) Touch the  icon to mute the **Master**, **Alerts**, or **Media** audio. A blue 'X' will appear over the icon.

## BLUETOOTH<sup>®</sup>



**NOTE:** Only one Bluetooth connection is allowed at a time.

### Connecting/Pairing to a weather/traffic device via Bluetooth:

1) Ensure the weather/traffic device is turned ON. From the **Main Menu**, touch **Tools** > **Setup** > **Bluetooth** > **On**.

2) Touch **Not Connected** next to the device name. A Bluetooth Passkey window will open.

3) Touch **OK**. The weather/traffic device is now connected.

The Bluetooth Setup Menu provides several options for connecting to Bluetooth devices. **Manage Paired Devices** can enable Automatic Reconnect and remove connections on a per-device basis. **Rename** is used to change the name the aera shows other devices while pairing. **Restore Default** will disable Bluetooth and remove all Bluetooth connections.

**Managing Connected Bluetooth Devices:**

From the **Main Menu**, touch **Tools > Setup > Bluetooth > Menu > Manage Devices**.

**CONNEXT**



**NOTE:** Connex features require a Bluetooth or RS-232 serial connection to an external Connex device.

The Connex Setup Menu can configure how the aera sends and receives flight plans from other Connex devices. Flight plans received from other devices will be added to the aera's Flight Plan List.

	No Transfer	Require Action	Automatic
<b>Incoming Flight Plan Mode</b>	Do not accept flight plans from other devices.	aera will prompt to accept or decline a flight plan sent from other devices.	aera will automatically accept flight plans from any connected device.
<b>Outgoing Flight Plan Mode</b>		aera will prompt to confirm sending a flight plan to another device.	aera will send flight plans to other devices with no prompt.

Connex Flight Plan Mode Options

**ADDITIONAL SETTINGS**

**Changing settings (Display, Sound, Units, Date & Time, Map, Position, Interface, Bluetooth, etc.):**

- 1) From the **Main Menu**, touch **Tools > Setup**.
- 2) Touch the desired Settings Icon (**Display, Sound, Units, Date & Time, Map, Position, Interface, Bluetooth, etc.**).

- 3) Touch the desired setting to change. If only two options are available, touching the field will toggle the two settings. If more than two options are available, a vertical list is displayed with a blue outline around the current setting. Touch the '+' or '-' buttons to increase/decrease the numerical values (if necessary).
- 4) Touch and hold  to return to the **Main Menu**.

Icon	Available Settings
<b>Display</b>	Display Orientation, Page Buttons, Customize Page Buttons, Backlight Intensity, Backlight Timeout, Zoom Buttons, Color Mode, Screenshot
<b>Sound</b>	Master (Mute, 0-10), Alerts (Mute, 0-10), Media (Mute, 0-10), Key Tone, Terrain Audio, Audio Mode
<b>Units</b>	Distance, Speed, Direction Display, Temperature, Altitude, Vertical Speed, Pressure, Fluid Volume
<b>Time</b>	Time Format, Auto UTC Offset
<b>Map</b>	All available map settings
<b>Position</b>	Location Format, Map Datum, Heading, Magnetic Variation
<b>Interface</b>	Serial Port, Serial Data Format
<b>Alarms</b>	Arrival, Next WPT, Proximity, Fuel Tank Reminder
<b>SUA Alarms</b>	Class B/TMA, Class C/TCA, Class D, Restricted, MOA, Other/ADIZ, Parachute Area
<b>Data Link</b>	Aircraft type, ADS-B Traffic Data
<b>Weather</b>	Weather Data Source
<b>Bluetooth</b>	On/Off, Connections
<b>Power</b>	Power Loss Warning
<b>Keyboard</b>	Keyboard layout settings
<b>Connex</b>	Incoming Flight Plan Mode, Outgoing Flight Plan Mode

## 1.7 NEAREST AIRPORT CRITERIA SETTINGS

The Nearest Airports function allows the pilot to filter out airports that do not meet a defined criteria. Specific surface types and runway lengths can be defined, as well as the option to include private airports and/or heliports.

Runway Surface—allows you to set criteria for the type of surface on the runway:

- **Hard Only**—shows only runways with a concrete, asphalt, or similar sealed surface.
- **Hard or Soft**—shows all runways except water landing facilities.
- **Water Only**—shows only water landing facilities.
- **Any**—shows any runway, regardless of surface type, including water landing facilities.

Minimum Runway Length—allows the pilot to enter a specific length for the shortest runway allowed.

### Entering airport criteria:

- 1) Touch **NRST > Airport > Menu > Set Airport Criteria**.
- 2) Touch the desired setting to change ('**Runway Surface**', '**Include Private Apts**', '**Include Heliports**') or touch the '+' or '-' buttons to increase/decrease the **Minimum Runway Length**.

### Restoring airport criteria defaults:

Touch **NRST > Airport > Menu > Restore Default**.

## 1.8 PRESENT POSITION

### POSITION

The Present Position function displays latitude, longitude, GPS altitude, reference waypoint, type, distance, direction, and bearing. The reference waypoint is designed to display the current position in relation to a prominent landmark. The pilot can change the reference waypoint 'Nearest Type' using the 'Change Nearest Type' menu option. By default the Nearest Type is set to 'Automatic', which will display the nearest large airport, enroute VOR, or city (in that order).

### Changing the Nearest Type:

- 1) From the **Main Menu**, touch **Tools** > **Position** > **Menu** > **Change Nearest Type**.
- 2) Touch the desired nearest type ('**Automatic**', '**Airport**', '**VOR**', '**NDB**', '**Intersection**', '**City**', or '**Waypoint**').

### Viewing the present position:

From the **Main Menu**, touch **Tools** > **Position**.

## NEW LOCATION

---

The 'New Location' menu option is used when the GPS Receiver is having trouble finding the satellites it expects to be there. If 'Automatic' is selected, the GPS will attempt to figure out the new location.

### Changing the New Location setting to automatic:

- 1) From the **Main Menu**, touch **Tools** > **Position** > **Menu** > **New Location**.
- 2) Touch '**Automatic**'. The GPS will attempt to figure out the new location.

### Entering a new location:

- 1) From the **Main Menu**, touch **Tools** > **Position** > **Menu** > **New Location**.
- 2) Touch '**Use Map**' or '**Use Identifier**'.
- 3) After selecting your approximate position using the map pointer or entering an identifier, touch **OK**.
- 4) The GPS Receiver will begin a new search based on the location entered.

## SIMULATOR MODE

---

Simulator Mode is helpful for practicing with the unit indoors or when satellite or XM signals are unavailable. All waypoints and routes created in Simulator Mode are retained in memory for future use.



**NOTE:** Do not attempt to navigate using Simulator Mode. When the unit is set to Simulator Mode, the GPS receiver is turned off. Any Satellite Signal Strength Bars shown are only simulations and do not represent the strength of actual satellite signals.

---



### Starting/Stopping Simulator Mode:

From the **Main Menu**, touch **Tools > Position > Menu > Start/Stop Simulator**.

### Adjusting the simulated altitude, track, speed, waypoint, & position:

- 1) From the **Main Menu**, touch **Tools > Position > Menu > Start Simulator**.
- 2) Touch **Menu > Drive Simulator**.
- 3) Enter the desired data by touching the fields or using the +/- buttons. Refer to Section 1.4 'Data Entry' for more information.

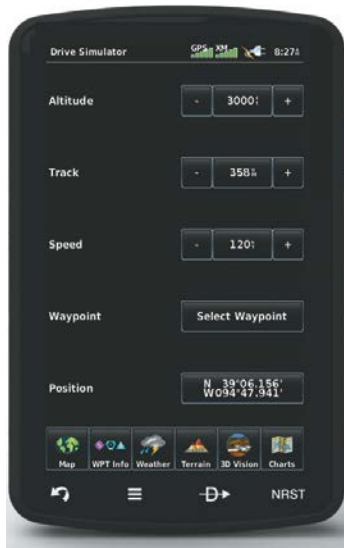

Drive Simulator

### Distance Measuring Tool

The Measure Distance feature can be used to measure the relative distance and bearing between two arbitrary points on the current map. The Map mode uses the standard Map Pointer along with a Reference Point, signified by a blue pushpin icon. When both the Map Pointer and Reference Point are placed, the Information Window will appear showing latitude and longitude, elevation, and nearby features as normal, but also shows the distance and bearing between the two.

Measuring map distances:

- 1) From the **Main Menu**, touch **Map**.
- 2) Touch **Menu > Measure Distance**.
- 3) Touch any position on the map to place the Map Pointer.
- 4) Touch and drag on the screen to move the map, or zoom into or out of the map, to reveal new areas. Touch any position to relocate the Map Pointer.
- 5) Touch the **Set Ref** button to relocate the Reference Point to the Map Pointer. Touch another position on the map to relocate the Map Pointer again.
- 6) Touch the  icon to remove the Distance Measuring Tool.



Distance Measuring Tool

# SECTION 2 GPS NAVIGATION

## 2.1 INTRODUCTION

The Navigation Map displays aviation data (e.g., airports, VORs, airways, airspaces), geographic data (e.g., cities, lakes, highways, borders), and topographic data (map shading indicating elevation). The Navigation Map can be oriented three different ways: North Up (NORTH UP), Track Up (TRK UP) or Desired Track Up (DTK UP).

An aircraft icon is placed on the Navigation Map at the location corresponding to the calculated present position. The aircraft position and the flight plan legs are accurately based on GPS calculations. The basemap upon which these are placed is from a source with less resolution, therefore the relative position of the aircraft to map features is not exact. The leg of the active flight plan currently being flown is shown as a magenta line on the Navigation Map. The other legs are shown in white.

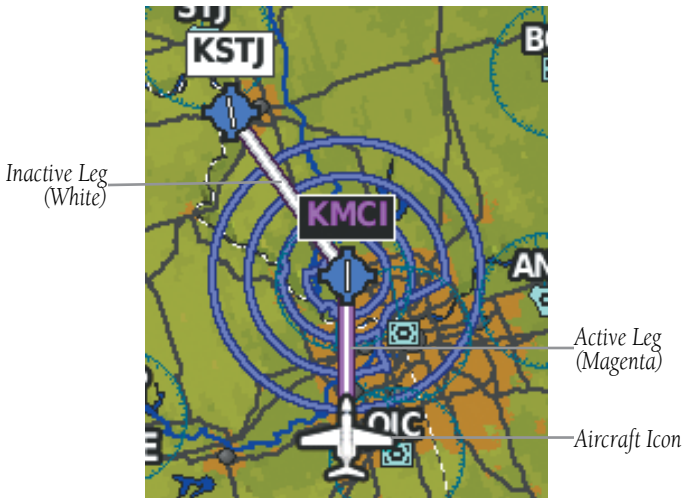

**Flight Plan Legs (Navigation Map)**

## DATA FIELDS

The data fields on the Navigation Map can be independently configured by the user.



**Data Fields (Navigation Map)**

By default, the Data Fields are set to display Ground Speed (GS), Distance - Next (DIST NEXT), Vertical Speed Required (VSR), and Time En Route - Next (ETE NEXT). These four data fields can be changed to display any of the Data Field Options.

### Changing the information shown in the data fields:

- 1 From the **Main Menu**, touch the **Map Icon**.
- 2 Touch **Menu**.
- 3 Touch the '**Change Data Fields**' menu option.
- 4 Touch the desired Data Field to change. A list of available Data Field Options is displayed.
- 5 Touch the desired Data Field Option.
- 6 Touch the **OK** Icon.



## DATA FIELD OPTIONS

- Accuracy
- Altitude
- Bearing (BRG)
- Course to Steer (CTS)
- Desired Track (DTK)
- Distance (Destination) (DIST DEST)
- Distance (Next) (DIST NEXT)
- En Route Safe Altitude (ESA)
- Flight Timer (FLT TIMER)
- Fuel Timer
- Glide Ratio (G/R)
- Ground Speed (GS)
- Ground Track (TRK)
- Minimum Safe Altitude (MSA)
- Next Waypoint (NEXT WPT)
- Sunrise
- Sunset
- Time En Route (Destination) (ETE DEST)
- Time En Route (Next) (ETE NEXT)
- Time of Arrival (Destination) (ETA DEST)
- Time of Arrival (NEXT) (ETA NEXT)
- Time to VNAV (VNAV TIME)
- Time (Local)
- Time (UTC)
- Vertical Speed (VS)
- Vertical Speed Required (VSR)
- Wx (Altimeter) (WX ALTIM)
- Wx (Dew Point) (WX DEW PT)
- Wx (Rel. Humidity) (WX HUMIDITY)
- Wx (Temperature) (WX TEMP)
- Wx (Wind) (WX WIND)

## NUMERIC FLIGHT DATA

The numeric flight data can be independently configured by the user.



**NOTE:** For units that support XM and are connected to a compatible SiriusXM device, the 'Numbers' icon is moved to the Tools Page.

### Accessing numeric flight data:

From the **Main Menu**, touch **Numbers**.

### Changing numeric flight data fields:

- 1) From the **Main Menu**, touch **Numbers**.
- 2) Touch the desired data field to change. The available data fields are displayed.
- 3) Touch the desired data field.
- 4) Touch **OK**.

### Restoring default numeric flight data:

From the **Main Menu**, touch **Numbers** > **Menu** > **Restore Default**.



Numeric Flight Data

## COMPASS ARC

A compass arc appears by default on the Navigation Map. The route line represents the course and the magenta bug indicator (similar to the bug indicator on the HSI) can be set to 'Bearing' (default), 'Course to Steer', a specific heading reference ('User Selected'), or 'Off'.





**NOTE:** The Compass Arc is hidden while on the ground.

Magenta Bug Indicator



Compass Arc (Navigation Map)

### Displaying/Removing the Compass Arc from the Navigation Map:

- 1) From the **Main Menu**, touch **Map > Menu > Set Up Map**
- 2) Touch the   buttons to select the '**General**' Category (if necessary).
- 3) Touch the **On/Off** Button in the 'Compass Arc' datafield.

### Setting the Compass Arc Bug Indicator:

- 1) From the **Main Menu**, touch **Map > Menu > Set Bug Indicator** (only available when the compass arc is displayed).
- 2) Touch the desired menu option ('**User Selected**', '**Bearing**', '**Course to Steer**', or '**Off**').



## 2.2 HSI/PANEL

The HSI/Panel shows GPS-derived data in a graphical format. Keep in mind the differences between the GPS-derived panel and mechanical instruments, as mechanical panel instruments use sensors that provide information different from that derived using GPS.



The Panel shows a graphic Horizontal Situation Indicator (HSI) surrounded by additional indicators.

The graphic HSI depicts the course to the destination or the next waypoint in a flight plan, current ground track, off course error, and a To/From indication. The rotating compass indicates your current ground track.

The course pointer and course deviation needle indicate the course and whether you are on the course. The Bug Indicator can be set to 'Bearing' (default), 'Course to Steer', a specific heading reference ('User Selected'), or 'Off'.

Bearing is the compass direction from the present position to a destination waypoint. Course to Steer is the recommended direction to steer in order to reduce cross-track error and return to the course line.

The Course Deviation Indicator, or needle, indicates how far off course, left or right, based on its placement along the course deviation scale.

The course deviation scale appears on the lower right corner of the HSI. There are four CDI Scale settings ('Automatic', '0.25 nm', '1.25 nm', and '5.00 nm'). Three factors are used to determine the distance from the center of the CDI to full left or right limits when the CDI Scale is set to 'Automatic':

- CDI scale = 0.25 - on an approach leg or within 2 nm of the FAF or MAP.
- CDI scale = 1.25 - within 30 nm of any airport in the active route.
- CDI scale = 5.0 - if the previous two conditions do not exist.

### Displaying/Removing the HSI/Panel:

- 1) From the **Main Menu**, touch **Map > Menu > Show/Hide...**
- 2) Touch the **Show/Hide** Button in the 'Panel' datafield.

### Changing the CDI scale:

- 1) With the Panel displayed, from the '**Home**' Screen, touch **Map > Menu > Set CDI Scale**.
- 2) Touch the desired CDI Scale ('**Automatic**', '**0.25 nm**', '**1.25 nm**', or '**5.00 nm**').

## SETTING THE BUG INDICATOR

---

The Bug Indicator can be set from the **Map** option menu.

### Setting the Bug Indicator:

- 1) From the **Main Menu**, touch **Map > Menu > Set Bug Indicator**.
- 2) Touch the desired menu option ('**User Selected**', '**Bearing**', '**Course to Steer**', or '**Off**').

## MANUALLY SETTING A COURSE

---

Use the 'Set OBS and Hold' menu option from the **Map** option menu to manually set your course to the destination.

### Manually setting a course to the destination waypoint:

- 1) From the **Main Menu**, touch the **Map** or the **Active FPL** Icon.
- 2) Touch **Menu**.
- 3) Touch the **Set OBS and Hold** (only available when navigating a Direct To or Flight Plan).

- 4) Touch the '+' or '-' Buttons to increase/decrease the value

**Or:**

Touch the Radial Button to enter the desired radial using the keypad and touch the **OK** Icon.



Map Option Menu



Set OBS

Radial Button

**Returning to automatic sequencing of route waypoints:**

- 1) From the **Main Menu**, touch the **Map** or the **Active FPL** Icon.
- 2) Touch **Menu**.
- 3) Touch the **Release Hold** menu option (only available when navigating a Direct To or Flight Plan).

## 2.3 VERTICAL NAVIGATION (VNAV)

The VNAV function provides settings for the vertical navigation. These settings create a three-dimensional profile from the present location and altitude to a final (target) altitude at a specified location.

When the VNAV profile is defined, the pilot is informed of the progress by message alerts. The teal bar on the HSI (when displayed) shows the VNAV profile.

The Vertical Navigation feature is only available when navigating a Direct To or flight plan, and the ground speed is greater than 35 knots.

The "Approaching VNAV Profile" message appears one minute prior to the initial descent point. The descent angle locks to prevent changes in speed from altering the profile. The VNAV feature does not take into account any changes in groundspeed that occur during the transition from level flight to descent or climb.

### Approaching VNAV profile

At 500 ft above the target altitude, the “Approaching Target Altitude” message appears, the ‘Estimated Time To VNAV’ goes blank, and the VNAV indicator disappears from the HSI.



**CAUTION:** The aera 795/796 is a VFR navigation tool and should not be used to perform instrument approaches.



**CAUTION:** VNAV is only a VFR navigation aid and is not intended for instrument approaches.

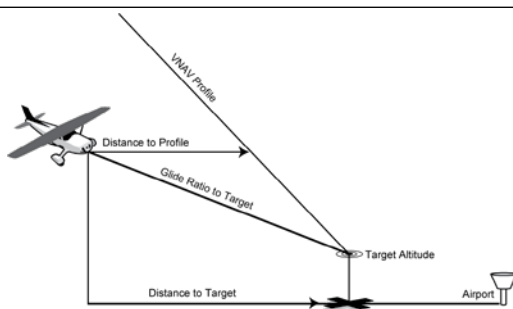

Visual Representation of VNAV

## USING THE VNAV FEATURE

Use the VNAV (Vertical Navigation) feature to ensure the aircraft is at the proper altitude. The VNAV Indicator appears on the HSI (when displayed) as a horizontal teal bar. A message appears when approaching the VNAV Profile. When the bar is in the vertical center of the HSI, the aircraft is at the proper altitude for the VNAV Profile.

### Configuring a VNAV profile:

- 1) From the **Main Menu**, touch **Tools > VNAV**
- 2) Touch the desired fields ('**Profile**', '**Altitude**', etc.) to enter the VNAV profile.
- 3) Touch and hold the **Back** Icon to return to the '**Main Menu**.'



### Vertical Navigation

- **Waypoint**—Enter any waypoint along the currently active route as the reference waypoint. The reference waypoint defines the target location.
- **Profile**—Enter the descent rate.
- **Altitude**—Enter the desired reference waypoint altitude. Select 'Above Waypoint' to use field elevation for airports in the navigation database or 'MSL' to specify an exact MSL altitude target.
- **By**—Enter the target location with settings of distance 'Before' or 'After' a reference waypoint. To set a target location at a reference waypoint, enter a distance of zero.
- **VNAV Messages**—Select 'On' or 'Off' to enable/disable VNAV alert messages.

### Enabling/disabling the VNAV indicator:

- 1) From the **Main Menu**, touch the **Map** Icon.
- 2) Touch **Menu**.
- 3) Touch the '**Enable VNAV Indicator**' or '**Disable VNAV Indicator**' menu option (only available when the Panel is shown).

### Capturing/cancelling VNAV profile:

- 1) Enter a valid VNAV profile (see 'Configuring a VNAV Profile' above) and begin navigation.
- 2) From the **Main Menu**, touch the **Map** Icon.
- 3) Touch **Menu**.

- 4) Touch the **'Capture VNAV Profile'** or **'Cancel Capture'** menu option (only available when navigating a Direct To or Flight Plan).

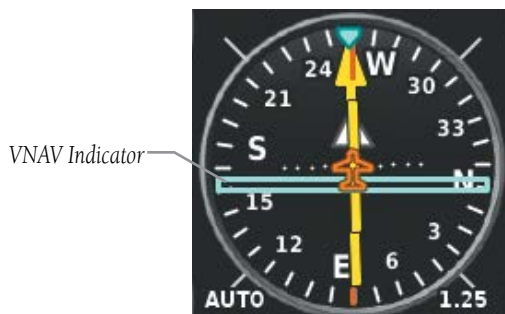

VNAV Indicator (Panel)

## 2.4 MAP DISPLAY SETUP

Map displays are used extensively in the aera 795/796 to provide situational awareness in flight. The Navigation Map, Terrain Map, Weather Map, VFR/IFR Charts, Helicopter Charts, and the 3D Vision Map can display the following information:

- Airports, NAVAIDs, airspaces, airways, land data (highways, cities, lakes, rivers, borders, etc.) with names
- Map Pointer information (distance and bearing to pointer, location of pointer, name, and other pertinent information)
- Map range
- Aircraft icon (representing present position)
- Flight plan legs
- User waypoints
- Track vector
- Topography data

## MAP ORIENTATION

Maps are shown in one of three different orientation options, allowing flexibility in determining aircraft position relative to other items on the map (North Up) or for determining where map items are relative to where the aircraft is going (Track Up), or desired track up (DTK UP).

- North Up aligns the top of the map display to north (default setting).
- Track Up aligns the top of the map display to the current ground track.
- Desired Track (DTK) Up aligns the top of the map display to the desired course.



**NOTE:** *The Map Orientation setting only affects the Navigation Map, Terrain Map, and the 3D Vision Map.*



**NOTE:** *The Compass Arc will change depending on the Map Orientation selected (i.e., 'North Up' = No Compass Arc displayed, 'Track Up' = Compass Arc displayed, 'Desired Track' = Compass displayed around the aircraft).*



### Changing the Map orientation:

- 1) From the **Main Menu**, touch **Map** > **Menu** > **Set Up**.
- 2) Touch the  buttons to select the '**General**' Category (if necessary).
- 3) Touch the 'Orientation' data option button.
- 4) Touch the desired option ('**North Up**', '**Track Up**', or '**DTK Up**').

## AIRPORTS, NAVAIDS, CITIES & ROADS

Airport information can be customized to display a variety of information including: runway extension lines, and runway numbers.

### Setting up and customizing airports, NAVAIDS, cities & roads for the Navigation Map:

- 1) From the **Main Menu**, touch **Map > Menu > Set Up**.
- 2) Touch the  buttons to select the 'Airport', 'Navaid', 'City', or 'Road' Category.
- 3) Touch the  buttons to select the desired settings (if available), or touch the Data Option Button to select from a list of options.



Map Setup (Airport)



## AIRWAYS

Low Altitude Airways (or Victor Airways) primarily serve smaller piston-engine, propeller-driven airplanes on shorter routes and at lower altitudes. Airways are eight nautical miles wide and start 1,200 feet above ground level (AGL) and extend up to but not including 18,000 feet mean sea level (MSL). Low Altitude Airways are designated with a "V" before the airway number (hence the name "Victor Airways") since they run primarily between VORs.

High Altitude Airways (or Jet Routes) primarily serve airliners, jets, turboprops, and turbocharged piston aircraft operating above 18,000 feet MSL. Jet Routes start at 18,000 feet MSL and extend upward to 45,000 feet MSL (altitudes above 18,000 feet are called "flight levels" and are described as FL450 for 45,000 feet MSL). Jet Routes are designated with a "J" before the route number.

Low Altitude Airways are drawn in gray. High Altitude Airways are drawn in green. When both types of airways are displayed, high altitude airways are drawn on top of Low Altitude Airways.

When airways are selected for display on the map, the airway waypoints (VORs, NDBs and Intersections) are also displayed.

### Displaying/removing airways:

- 1) From the **Main Menu**, touch **Map > Menu > Set Up**.
- 2) Touch the  buttons to select the '**Navaid**' Category.
- 3) Touch the 'Airways' data option button to select the desired setting ('**Off**', '**Low**', '**High**', or '**Both**').

## 2.5 WAYPOINTS

Waypoints are predetermined geographical positions (internal database) or pilot-entered positions, and are used for all phases of flight planning and navigation.

Waypoints can be selected by entering the ICAO identifier, entering the name of the facility, or by entering the city name.

The waypoint function allows the pilot to review airport/runway information, frequencies, Airport Directory information (if available), weather information (if available) and Terminal Procedure Charts, by touching the desired tab (**Info**, **Freq**, **WX**, **AOPA**, or **Charts**). The pilot can manually enter the identifier or the aera 795/796 will choose the most appropriate identifier based on the current position and phase of flight.







Waypoint Information (Info Tab)

## WAYPOINT INFORMATION



The following descriptions and abbreviations are used:

- Usage type: Public, Military, or Private
- Runway surface type: Hard, Turf, Sealed, Gravel, Dirt, Soft, Unknown, or Water
- Runway lighting type: No Lights, Part Time, Full Time, Unknown, or PCL Freq (for pilot-controlled lighting)
- COM Availability: TX (transmit only), RX (receive only), PT (part time), \* (additional information available)

### Selecting an airport for review by identifier, facility name, or city:

- 1) From the **Main Menu**, touch **WPT Info** > **Info** Tab (if necessary).
- 2) Touch the Waypoint Identifier Button (top of page).
- 3) Enter the desired waypoint:
  - a) Touch the   buttons to display the desired search option on the 'Search' Button ('**Search by Identifier**', '**Search by Facility Name**', '**Search by City**', '**Search by Address**' (only available with the optional City Navigator data), or '**Search by Crossroads**' (only available with the optional City Navigator data)).
  - b) Touch the 'Search' Button (between the  .
  - c) Enter the desired data using the keypad. If duplicate entries are displayed, touch the desired duplicate from the list.
  - d) Touch **OK**.

**Or:**

  - a) Touch the   buttons to cycle through the waypoint categories ('**Flight Plan Waypoints**', '**Nearest Airports**', or '**Recent Waypoints**').
  - b) Touch the desired waypoint from the list.

### Selecting a runway for review by identifier, facility name, or city:

- 1) From the **Main Menu**, touch **WPT Info** > **Info** Tab.
- 2) Touch the Waypoint Identifier Button.

- 3) Enter the desired waypoint:
  - a) Touch the buttons to display the desired search option on the 'Search' Button ('**Search by Identifier**', '**Search by Facility Name**', '**Search by City**', '**Search by Address**' (only available with the optional City Navigator data), or '**Search by Crossroads**' (only available with the optional City Navigator data).
  - b) Touch the 'Search' Button (between the .
  - c) Enter the desired data using the keypad. If duplicate entries are displayed, touch the desired duplicate from the list.
  - d) Touch **OK**.

**Or:**

  - a) Touch the buttons to cycle through the waypoint categories ('**Flight Plan Waypoints**', '**Nearest Airports**', or '**Recent Waypoints**').
  - b) Touch the desired waypoint from the list.
- 4) Touch the desired Runway Button. The map range zooms in and centers on the desired runway. Touch the Runway Button again to return to the previous map range.

## WAYPOINT FREQUENCIES

### Selecting additional information for a frequency:

- 1) From the **Main Menu**, touch **WPT Info** > **Freq** Tab.
- 2) Touch the frequency denoted with an \*.

### FREQUENCY ABBREVIATIONS

Communication Frequencies				Nav Frequencies
Approach *	Class B *	Gate	Radar	ILS
Arrival *	Class C *	Ground	Ramp	LOC
ASOS	Clearance	Helicopter	Terminal*	
ATIS	Control	Multicom	TMA *	
AWOS	CTA *	Other	Tower	
Center	Departure *	Pre-Taxi	TRSA *	
			Unicom	
* May include Additional Information				







### Frequency Abbreviations

## WAYPOINT WEATHER AND NOTAM INFORMATION





**NOTE:** NOTAM information on the weather tab is only available when connected to a compatible ADS-B/SiriusXM device.

### Viewing airport weather and NOTAM information:

- 1) From the **Main Menu**, touch the **WPT Info** Icon.
- 2) Enter the desired waypoint:
  - a) Touch the   buttons to display the desired search option on the 'Search' Button ('**Search by Identifier**', '**Search by Facility Name**', '**Search by City**', '**Search by Address**' (only available with the optional City Navigator data), or '**Search by Crossroads**' (only available with the optional City Navigator data).
  - b) Touch the 'Search' Button (between the  .
  - c) Enter the desired data using the keypad. If duplicate entries are displayed, touch the desired duplicate from the list.
  - d) Touch **OK**.
- Or:**
  - a) Touch the   buttons to cycle through the waypoint categories ('**Flight Plan Waypoints**', '**Nearest Airports**', or '**Recent Waypoints**').
  - b) Touch the desired waypoint from the list.
- 3) Touch the **WX or WX/NOTAM** Tab.

## AIRPORT DIRECTORY WAYPOINT INFORMATION

### Viewing Airport Directory information:

- 1) From the **Main Menu**, touch the **WPT Info** Icon.
- 2) Enter the desired waypoint:
  - a) Touch the   buttons to display the desired search option on the 'Search' Button ('**Search by Identifier**', '**Search by Facility Name**', '**Search by City**', '**Search by Address**' (only available with the optional City Navigator data), or '**Search by Crossroads**' (only available with the optional City Navigator data).





- b) Touch the 'Search' Button (between the .
- c) Enter the desired data using the keypad. If duplicate entries are displayed, touch the desired duplicate from the list.
- d) Touch **OK**.

**Or:**

- a) Touch the  buttons to cycle through the waypoint categories ('**Flight Plan Waypoints**', '**Nearest Airports**', or '**Recent Waypoints**').
  - b) Touch the desired waypoint from the list.
- 3) Touch the **AOPA or Directory** Tab.

## VIEWING CHART INFORMATION BY IDENTIFIER

### Viewing Chart information:

- 1) From the **Main Menu**, touch the **WPT Info** Icon.
  - 2) Enter the desired waypoint:
    - a) Touch the  buttons to display the desired search option on the 'Search' Button ('**Search by Identifier**', '**Search by Facility Name**', '**Search by City**', '**Search by Address**' (only available with the optional City Navigator data), or '**Search by Crossroads**' (only available with the optional City Navigator data)).
    - b) Touch the 'Search' Button (between the .
    - c) Enter the desired data using the keypad. If duplicate entries are displayed, touch the desired duplicate from the list.
    - d) Touch **OK**.
- Or:**
- a) Touch the  buttons to cycle through the waypoint categories ('**Flight Plan Waypoints**', '**Nearest Airports**', or '**Recent Waypoints**').
  - b) Touch the desired waypoint from the list.
- 3) Touch the **Charts** Tab.
- 4) Touch the  buttons to cycle through the available Charts.

## NEAREST INFORMATION

The aera 795/796 provides a Nearest function which gives the pilot quick access to nearest airport, weather, VOR, NDB, intersection, VRP (Atlantic Unit), user waypoint, city, ARTCC, FSS, and airspace information. If there are none available, "None Within 200 NM" is displayed.

The Nearest functions contain the following information.

- Airport—city/facility, identifier, bearing, distance, length of the longest runway, and common traffic advisory (CTAF) or tower frequency.
- Airport WX (Airport Weather)—identifier, bearing, distance, METAR text, and ATIS, AWOS, or ASOS frequency.
- VOR (VHF Omnidirectional Radio Beacon)—facility name, identifier, facility type (symbol), bearing, distance, and frequency.
- NDB (Non Directional Beacons)—identifier, facility, type (symbol), bearing, distance, and frequency.
- Intersection—identifier, bearing, and distance.
- VRP (Visual Reporting Point) (Atlantic Unit Only)—identifier, bearing, and distance.
- USR WPT (User Waypoints)—name, bearing, and distance.
- City—name, bearing, and distance.
- ARTCC (Air Route Traffic Control Center)—bearing, distance, and a list of frequencies.
- FSS (Flight Service Station)—name, bearing, distance, VOR (if applicable), and a list of frequencies.
- Airspace—name, time to entry (while in flight), and status.

### Viewing nearest information:

- 1) Touch **NRST**.
- 2) Touch the desired Nearest Icon (**Airport, Airport WX, VOR, NDB, Intersection, VRP, User WPT, City, ARTCC, FSS, or Airspace**).
- 3) Touch the desired nearest option from the list twice for additional information.

#### Or:

If viewing Nearest ARTCCs or FSSs, touch the  buttons to cycle through the list.

- 4) Touch the **Back** Icon to return to the second level Nearest Icons.

**Or:**

Touch **Direct To** ➔, then the Activate Button to navigate Direct-to the selected waypoint.



Nearest Airports List

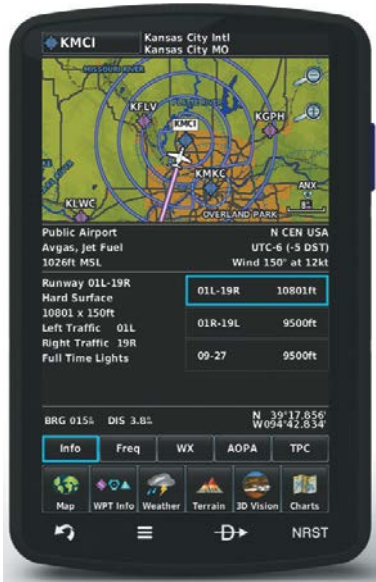

Additional Airport Information

## NEAREST AIRPORT CRITERIA

The pilot can define the minimum runway length and surface type used when determining the 15 nearest airports to display. A minimum runway length and/or surface type can be entered to prevent airports with small runways or runways that are not appropriately surfaced from being displayed. Default settings are 0 feet (or meters) for runway length and "Any" for runway surface type. Private airports and Heliports can also be included.

The Nearest Airports Option Menu also allows the pilot to choose between displaying the facility names and city names.

### Setting nearest airport criteria:





Refer to Section 1.7 'Airport Criteria Settings'.





## TEXTUAL WEATHER AND NOTAM INFORMATION

Textual weather information can be viewed several different ways. NOTAMs for the weather tab are only available with a compatible ADS-B/SiriusXM device.

### Viewing textual airport weather information:

- 1) From the **Main Menu**, touch the **WPT Info** icon.
- 2) Enter the desired waypoint:
  - a) Touch the   buttons to display the desired search option on the 'Search' Button ('**Search by Identifier**', '**Search by Facility Name**', '**Search by City**', '**Search by Address**' (only available with the optional City Navigator data), or '**Search by Crossroads**' (only available with the optional City Navigator data).
  - b) Touch the 'Search' Button (between the  .
  - c) Enter the desired data using the keypad. If duplicate entries are displayed, touch the desired duplicate from the list.
  - d) Touch **OK**.

**Or:**

  - a) Touch the   buttons to cycle through the waypoint categories ('**Flight Plan Waypoints**', '**Nearest Airports**', or '**Recent Waypoints**').
  - b) Touch the desired waypoint from the list.
- 3) Touch the **WX or WX/NOTAM** Tab.
- 4) If desired, touch **Menu > Show Raw Text/Show Decoded Text** to switch from raw data to decoded data.
 

**Or:**

  - 1) Touch **NRST > Airport WX**.
  - 2) Touch the desired Nearest Airport Weather from the list.

**Or:**

  - 1) From the **Main Menu**, touch **Weather > METAR**.
  - 2) Touch the desired METAR flag.
  - 3) Touch the Map Feature Button with the desired identifier displayed (refer to 'Map Panning' in the Overview Section for more information). The weather information is displayed.

- 4) If desired, touch **Menu > Show Raw Text/Show Decoded Text** to switch from raw data to decoded data.

**Or:**

- 1) From the **Main Menu**, touch **Map**.
- 2) Touch the desired METAR Flag (If the METAR flags are not displayed, adjust the settings from the 'Set Up Map' menu option).
- 3) Touch the Map Feature Button with the desired identifier displayed (refer to 'Map Panning' in the Overview Section for more information). The weather information is displayed.
- 4) If desired, touch **Menu > Show Raw Text/Show Decoded Text** to switch from raw data to decoded data.

*METAR Selected*

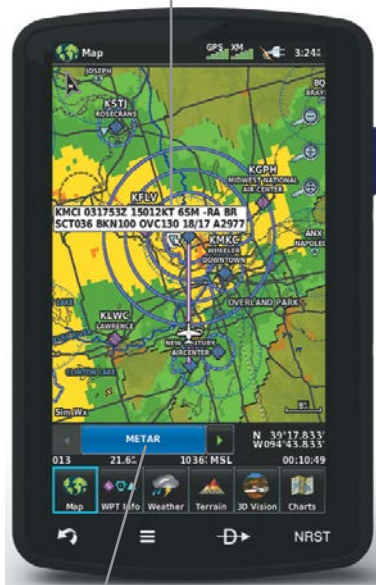

*Map Feature Button*

**Weather Information**

## ACCESSING ADDITIONAL INFORMATION

In addition to airport and weather information, additional information for VORs, NDBs, Intersections, User Waypoints, Cities, ARTCCs, FSSs, and Airspace can be viewed by touching the **WPT Info** Icon, the **NRST** Icon, or by using the Map Pointer.

Additional Information									
	Airport	VOR	NDB	Intersection	User Wpt	City	ARTCC	FSS	Airspace
Identifier	+	+	+	+	+				
Frequency	+	+	+				+	+	+
Name	+	+	+	+	+				+
City	+	+	+			+			+
State	+	+	+			+			
Type	+	+	+						
Morse Code		+	+						
Radial		+							
Region	+	+	+	+	+				
Bearing	+	+	+	+	+	+	+	+	
Distance	+	+	+	+	+	+	+	+	+
Lat/Long	+	+	+	+	+	+			
Elevation (MSL)	+				+				
Fuel Available	+								
Time Zone (UTC Offset)	+								
Runway Information	+								
AOPA	+								
Weather/NOTAMS	+								
Controlling Agency									+
Vertical Boundaries									+
Class									+
TERPs/Chart NOTAMS	+								

## INTERSECTIONS

Intersection information can be viewed using the Waypoint Information function, the Nearest function, or the Map Panning function.

The Nearest Intersection function can be used to quickly find an intersection close to the flight path. The list only includes Intersections that are within 200nm.

### Select an intersection:

- 1) From the **Main Menu**, touch the **WPT Info** Icon.
- 2) Touch the Waypoint Identifier Field to enter the desired intersection. Refer to the Overview Section on 'Data Entry' for more information.

**Or:**

- 1) Touch **NRST > Intersection**.
- 2) Touch the desired Nearest Intersection twice. The intersection information is displayed.
- 3) If desired, touch **Menu > Show Map** or **Show Chart**.

**Or:**

- 1) From the **Main Menu**, touch the **Map** Icon.
- 2) Touch the desired Intersection on the map.
- 3) Touch the Map Feature Button with the desired intersection displayed (refer to the Overview Section on 'Map Panning' for more information). The intersection information is displayed.

## NDBs

NDB information can be viewed using the Waypoint Information function, the Nearest function, or the Map Panning function.

The Nearest NDB function can be used to quickly find a NDB close to the flight path. The list only includes NDBs that are within 200nm.

### Select an NDB:

- 1) From the **Main Menu**, touch the **WPT Info** Icon.
- 2) Touch the Waypoint Identifier Field to enter the desired NDB. Refer to the Overview Section on 'Data Entry' for more information.

**Or:**

- 1) Touch **NRST > NDB**.
- 2) Touch the desired Nearest NDB from the list. The NDB information is displayed.
- 3) If desired, touch **Menu > Show Map** or **Show Chart**.

**Or:**

- 1) From the **Main Menu**, touch the **Map** Icon.
- 2) Touch the desired NDB on the map.
- 3) Touch the Map Feature Button with the desired NDB displayed (refer to the Overview Section on 'Map Panning' for more information). The NDB information is displayed.

## VORs

VOR information can be viewed using the Waypoint Information function, the Nearest function, or the Map Panning function.

The Nearest VOR function can be used to quickly find a VOR close to the flight path. The list only includes VORs that are within 200nm.

Localizer information cannot be viewed for the VOR. If a VOR station is combined with a TACAN station it is listed as a VORTAC, and if it includes only DME it is displayed as VOR-DME.

### Select an VOR:

- 1) From the **Main Menu**, touch the **WPT Info** Icon.
- 2) Touch the Waypoint Identifier Field to begin entering the desired VOR. Refer to the Overview Section on 'Data Entry' for more information.

**Or:**

- 1) Touch **NRST > VOR**.
- 2) Touch the desired Nearest VOR from the list. The Nearest VOR information is displayed.
- 3) If desired, touch **Menu > Show Map** or **Show Chart**.

**Or:**

- 1) From the **Main Menu**, touch the **Map** Icon.
- 2) Touch the desired VOR on the map.

- 3) Touch the Map Feature Button with the desired VOR displayed (refer to the Overview Section on 'Map Panning' for more information). The VOR information is displayed.

## USER WAYPOINTS

The aera 795/796 can create and store up to 3,000 user-defined waypoints. Once a waypoint has been created, it can be renamed, deleted, or moved.



User Waypoints

### Creating user waypoints:

- 1) Touch the desired point on the map.
- 2) Touch **Menu > Create Waypoint**
- 3) Enter the desired user waypoint name (up to 20 characters). Refer to the Overview Section on 'Data Entry' for more information.
- 4) Touch **OK**.

### Selecting and viewing nearest user waypoints:

- 1) Touch **NRST > User WPT**.
- 2) Touch the desired User Waypoint twice to display the User Waypoint information.

**Editing or renaming a user waypoint:**

- 1) From the **Main Menu**, touch **Tools > User WPT**.
- 2) Touch the desired User Waypoint.
- 3) Touch **Menu**.
- 4) Touch the '**Edit Waypoint**' menu option.
- 5) Touch the desired field to edit:
- 6) Edit the desired information and touch **OK**.

**Deleting user waypoints:**

- 1) From the **Main Menu**, touch **Tools > User WPT**.
- 2) Delete a single waypoint, delete all waypoints, delete by symbol or delete by distance:
  - a) Touch the desired User Waypoint.
  - b) Touch **Menu**.
  - c) Touch the '**Delete Waypoint**' menu option. The confirmation window will appear.

**Or:**

- a) Touch **Menu**.
- b) Touch the '**Delete All**' menu option. The confirmation window will appear.

**Or:**

- a) Touch **Menu**.
- b) Touch the '**Delete by Symbol**' menu option.
- c) Touch the desired symbol to delete. The symbol will be highlighted blue.
- d) Touch **OK**. The confirmation window will appear.

**Or:**

- a) Touch **Menu**.
- b) Touch the '**Delete by Distance**' menu option.
- c) If desired, touch the **From** Field and touch '**Current Location**' (default), '**Use Identifier**', or '**Use Map**' from the option menu.
- d) If desired, touch the '**Less Than/More Than**' Button, and touch the **Distance** Field to enter the desired distance.

e) Touch **OK**. The confirmation window will appear.

3) Touch **Yes**.

## CITIES

City information can be viewed using the Waypoint Information function, the Nearest function, or the Map Panning function.

The Nearest City function can be used to quickly find a city near the aircraft's current position. The list only includes cities that are within 200nm.

### Select a city:

- 1) Touch **NRST > City**.
- 2) Touch the desired Nearest City from the list.

**Or:**

- 1) From the **Main Menu**, touch **Map**.
- 2) Touch the desired city symbol on the map.
- 3) Touch the Map Feature Button with the desired city displayed (refer to the Overview Section on 'Map Panning' for more information). The city information is displayed.

## ARTCC

ARTCC information can be viewed using the Nearest function.

The Nearest ARTCC function can be used to quickly find a ARTCC close to the flight path. The list only includes ARTCC that are within 200nm.

### Select an ARTCC:

- 1) Touch **NRST > ARTCC**.
- 2) Touch the  buttons to cycle through the list. The associated bearing, distance, and frequencies are displayed.





## FSS

FSS information can be viewed using the Nearest function.

The Nearest FSS function can be used to quickly find a FSS close to the flight path. The list only includes FSS that are within 200nm.

FSS frequencies and phone numbers can also be found using the **AOPA** Tab when reviewing information for an airport. Refer to the Additional Features Section on 'AOPA' for more information.

### Select an FSS:

- 1) Touch **NRST** > **FSS**.
- 2) Touch the   buttons to cycle through the list. The associated bearing, distance, and frequencies are displayed.

## AIRSPACE

The Nearest Airspace function and Airspace Alerts provide information about airspaces and the location of the aircraft in relationship to them. The Nearest Airspace function can be used to quickly find airspaces close to the flight path.

The Nearest Airspace function displays the class of airspace, controlling agency, vertical boundaries, and status.

### Selecting and viewing nearest airspaces:

- 1) Touch **NRST** > **Airspace**.
- 2) Touch the desired airspace from the list (the Nearest Airspaces list is not available on the ground). The airspace information is displayed.
- 3) If desired, touch '**Frequencies**' to view frequencies associated with that airspace.

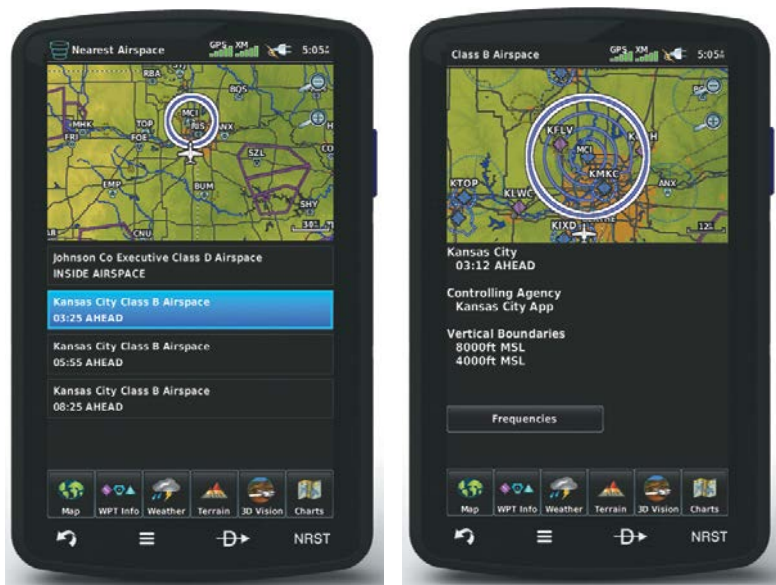

Nearest Airspace

## AIRSPACE ALERT MESSAGES

If airspace alarms are set to 'On' (default is 'Off'), the aera 795/796 will display a message which includes the airspace name, time to entry (if applicable), and status. Touch the message to acknowledge it.



**NOTE:** *Airspace Alert Messages do not work while on the ground.*

There are four types of status information:

- Ahead—Projected to enter the airspace within the next 10 minutes or less
- Near—Within two nautical miles of an airspace but not projected to enter it.
- Near & Ahead—Project to enter the airspace within two nautical miles.
- Inside Airspace—Within the boundaries of the airspace.

### Airspace alert setup:

- 1) From the **Main Menu**, touch **Tools > Setup > SUA Alarms**.
- 2) Touch the desired **On/Off** Button(s).

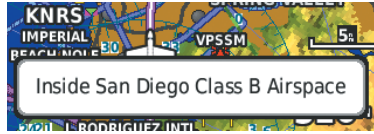

Airspace Alert Message

### SMART AIRSPACE™

Smart Airspace shows airspace at and immediately surrounding the aircraft's current altitude in bold. Airspaces at all other altitudes are de-emphasized.

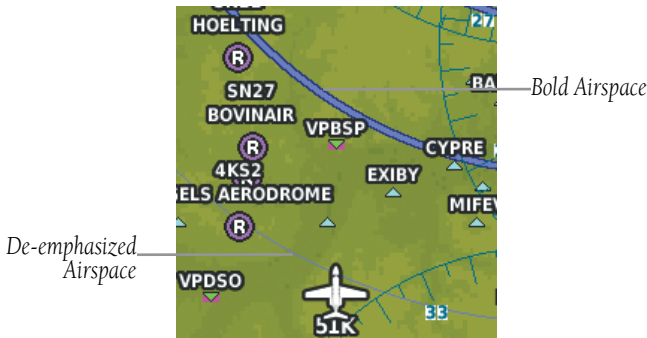

Smart Airspace™

### Smart Airspace setup:



**NOTE:** *Smart Airspace selection is not available if the Map Type is set to 'IFR' instead of 'VFR' since IFR flights do not have the same operational concerns with airspace.*

- 1) From the **Main Menu**, touch **Map > Menu > Set Up Map**.
- 2) Touch the  buttons to select the **Airspace** Category.
- 3) Touch the 'Smart Airspace' **On/Off** Button.

## 2.6 DIRECT-TO NAVIGATION

The Direct-to method of navigation, initiated by pressing the **Direct To**  icon is quicker to use than a flight plan when the desire is to navigate to a single point such as a nearby airport.

Once a direct-to is activated, the aera 795/796 establishes a point-to-point course line from the present position to the selected direct-to destination. Course guidance is provided until the direct-to is replaced with a new direct-to or flight plan, or cancelled.



Direct-to

Direct To (Activate)

Direct To (Stop Navigation)

**Entering a waypoint identifier, facility name, or city as a direct-to destination:**

- 1) Touch the **Direct To**  icon.
- 2) Touch **Menu > Resume Navigation** (if available).

**Or:**

- a) Touch **'More...'**
- b) Touch the **'Search by Identifier', 'Search by Facility Name',** or **'Search by City'** fields.

c) Enter the desired Identifier, Facility Name, or City using the keypad. Refer to the Overview Section on 'Data Entry' for more information.

d) Touch **OK**.

**Or:**

a) Touch '**More...**'.

b) Touch the   buttons to view '**Flight Plan Waypoints**', '**Nearest Airports**', or '**Recent Waypoints**'.

c) Touch the desired waypoint from the list.

3) Touch the **Activate** Icon (if necessary).

### Selecting a nearby airport as a direct-to destination:

1) Touch **NRST > Airport**.

2) Touch the desired nearest airport.

3) Touch **Direct To** .

4) Touch **Activate**.

### Selecting a waypoint as a direct-to destination using the pointer:

1) With the Navigation Map, Terrain Map, Weather Map, VFR/IFR Charts, or Helicopter Charts displayed, activate the map pointer by touching the desired waypoint. If no airport, NAVAID, or User Waypoint exists at the desired location, a temporary waypoint named 'Map Pointer' is automatically created at the location of the map pointer.

2) Touch **Direct To** .

3) Touch **Activate**.

### Selecting latitude and longitude coordinates as a direct-to destination:

1) From the main menu, touch **Direct To**  **> Menu > Enter Coordinates**.

2) Enter the desired location using the arrows.

3) Touch **OK**.

4) Touch **Activate**.

## Canceling a direct-to:

Touch **Direct To**  > **Stop Nav.**

**Or:**

From the **Main Menu**, touch **Active FPL** > **Menu** > **Stop Navigation.**

## SECTION 3 FLIGHT PLANNING

### 3.1 INTRODUCTION

Flight planning on the aera 795/796 consists of building a flight plan by entering waypoints one at a time and inserting approaches as needed.

Up to 50 flight plans with up to 300 waypoints each can be created and stored in memory. One flight plan can be activated at a time and becomes the active flight plan. The active flight plan is erased when the destination is reached and the system is turned off. When storing flight plans with an approach, the aera 795/796 uses the waypoint information from the current database to define the waypoints. If the database is changed or updated, the aera 795/796 automatically updates the information if the procedure has not been modified. If an approach is no longer available, the procedure is deleted from the affected stored flight plan(s), and an alert is displayed.

Whenever an approach is loaded into the active flight plan it replaces the destination airport with a sequence of waypoints for the selected approach. The airport must have a published instrument approach and only the final course segment (usually from final approach fix to missed approach point) of the published approach is available in the aera 795/796.

### DATA FIELDS

The Active and Saved Flight Plan Data Fields can be changed by touching the Data Field Buttons at the top of the flight plan.

#### Changing the information shown in the flight plan data fields:

- 1) From the **Main Menu**, touch the **Active FPL** icon.  
**Or:**
  - a) From the **Main Menu**, touch **FPL List**.
  - b) Touch the desired Saved Flight Plan from the list. Press it again to review, or press **MENU** for other available menu options.
  - c) Touch the '**Review Flight Plan**' menu option.
- 2) Touch the desired Data Field Button at the top of the Flight Plan.

- 3) Touch the desired Data Field. The currently selected Data Field is outlined blue.
- 4) Touch **OK**.
- 5) If desired, repeat Steps 2-4 for the remaining Data Field.

Data Field Button



Flight Plan Data Fields

## 3.2 FLIGHT PLAN CREATION

The active flight plan is the flight plan to which the aera 795/796 is currently providing guidance, and is shown on the navigation maps. Stored flight plans are flight plans available for activation (becomes the active flight plan).



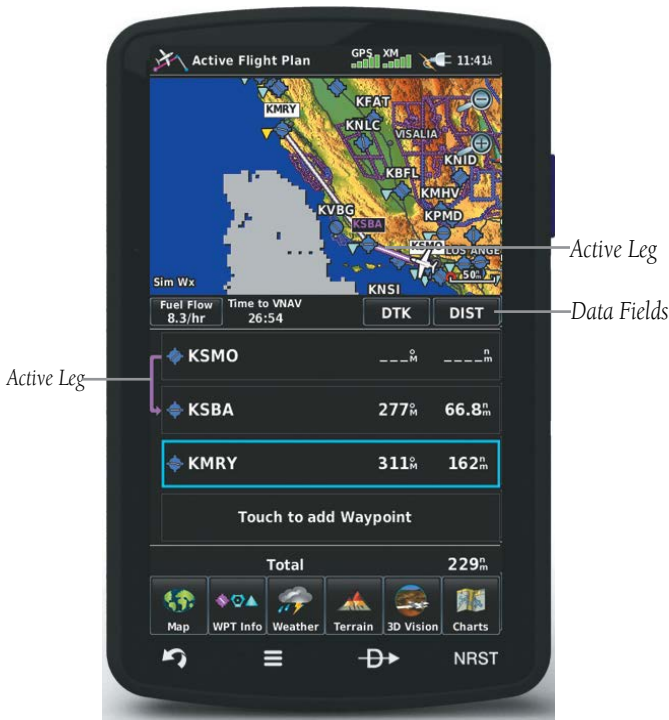



Active Flight Plan

### Creating an active flight plan:

- 1) From the **Main Menu**, touch the **Active FPL** icon.
  - 2) Touch the '**Touch to add Waypoint**' button.
  - 3) Enter the desired waypoint:
    - a) Touch the buttons to display the desired search option on the 'Search' button ('**Search by Identifier**', '**Search by Facility Name**', '**Search by City**', '**Search by Address**' (only available with the optional City Navigator data), or '**Search by Crossroads**' (only available with the optional City Navigator data).
    - b) Touch the 'Search' button (between the .
    - c) Enter the desired data using the keypad. If duplicate entries are displayed, touch the desired duplicate from the list.
    - d) Touch **OK**.
- Or:**

a) Touch the   buttons to cycle through the waypoint categories ('Flight Plan Waypoints', 'Nearest Airports', or 'Recent Waypoints').

b) Touch the desired waypoint from the list.



4) Repeat Steps 2-3 to enter each additional waypoint.

### Creating a stored flight plan:

1) From the **Main Menu**, touch **FPL List** > **Menu** > **New Flight Plan**.

2) Touch the '**Touch to add Waypoint**' Button.

3) Enter the desired waypoint:



a) Touch the   buttons to display the desired search option on the 'Search' Button ('Search by Identifier', 'Search by Facility Name', 'Search by City', 'Search by Address' (only available with the optional City Navigator data), or 'Search by Crossroads' (only available with the optional City Navigator data).

b) Touch the 'Search' Button (between the  .

c) Enter the desired data using the keypad. If duplicate entries are displayed, touch the desired duplicate from the list.

d) Touch **OK**.

**Or:**

a) Touch the   buttons to cycle through the waypoint categories ('Flight Plan Waypoints', 'Nearest Airports', or 'Recent Waypoints').

b) Touch the desired waypoint from the list.







4) Repeat Steps 2-3 to enter each additional waypoint.

## ADDING WAYPOINTS TO AN EXISTING FLIGHT PLAN

Waypoints can be added to the active flight plan or any stored flight plan. Choose the flight plan, select the desired point of insertion, enter the waypoint, and it is added in front of the selected waypoint. Flight plans are limited to 300 waypoints (including approach waypoints).





### Adding a waypoint to an active or stored flight plan:

1) With an active or saved flight plan displayed, touch the desired point of insertion. The new waypoint will be added in front of the selected waypoint. Press **MENU**.

- 2) Touch the '**Insert Waypoint**' menu option.
- 3) Enter the desired waypoint:
  - a) Touch the   buttons to display the desired search option on the 'Search' Button ('**Search by Identifier**', '**Search by Facility Name**', '**Search by City**', '**Search by Address**' (only available with the optional City Navigator data), or '**Search by Crossroads**' (only available with the optional City Navigator data).
  - b) Touch the 'Search' Button (between the  .
  - c) Enter the desired data using the keypad. If duplicate entries are displayed, touch the desired duplicate from the list.
  - d) Touch **OK**.
- Or:**
  - a) Touch the   buttons to cycle through the waypoint categories ('**Flight Plan Waypoints**', '**Nearest Airports**', or '**Recent Waypoints**').
  - b) Touch the desired waypoint from the list.
- 4) Repeat Steps 2-3 to enter each additional waypoint.

## GRAPHICAL FLIGHT PLANNING

### Creating a Flight Plan Graphically:

- 1) For Active FPL, from the **Main Menu**, touch the **Active FPL** Icon.
- Or:** For stored Flight Plan, from the **Main Menu**, touch **FPL List > Menu > New Flight Plan**.
- 2) Touch the '**Touch to add Waypoint**' Button.
  - 3) Enter the departure point by:
    - a) Touching the   buttons to display the desired search option on the 'Search' Button ('**Search by Identifier**', '**Search by Facility Name**', '**Search by City**', '**Search by Address**' (only available with the optional City Navigator data), or '**Search by Crossroads**' (only available with the optional City Navigator data).
    - b) Touch the 'Search' Button (between the  .
    - c) Enter the desired data using the keypad. If duplicate entries are displayed, touch the desired duplicate from the list.

d) Touch **OK**.

**Or:**

a) Touching the  buttons to cycle through the waypoint categories ('**Flight Plan Waypoints**', '**Nearest Airports**', or '**Recent Waypoints**').

b) Touch the desired waypoint from the list. Once a departure point is entered add additional waypoints Graphically.

4) Touch **Menu > Edit on Map**.

5) Touch anywhere on the map. Navigation features (NAVAIDS, Highways, user waypoints, airports, etc.) near the touched location will appear as buttons at the top center of the Map Page. Select the desired navigation feature button to append to the flight plan. If there are no navigation features, touch '**Map Pointer**' to create a user waypoint. Repeat to add additional waypoints.

6) Touch '**Undo**' to undo the most recent action.

7) Touch '**Cancel**' to exit without saving or '**Save**' to save and exit Graphical Flight Plan Editing Mode.

### Editing an Active Flight Plan Graphically:

1) On a Map/Chart Page touch **Menu > Edit Flight Plan**.

**Or:** To graphically edit a stored flight plan, from the **Main Menu**, touch **FPL List**. Select the flight plan to edit from the list of stored flight plans. Touch **Menu > Edit on Map**.

2) Touch an existing flight plan leg to edit. When an existing flight plan leg is selected, it will be highlighted in cyan. Touch a new location on the map to split the flight plan leg. Navigation features (NAVAIDS, Highways, user waypoints, airports, etc.) near the touched location will appear as buttons at the top center of the Map Page. Select the desired navigation feature button to append to the flight plan. If there are no navigation features, touch '**Map Pointer**' to create a user waypoint. Repeat to split additional flight plan legs.



**Graphical Flight Planning**

- 3) To add additional waypoints to the flight plan, touch a new location on the map. Select the desired navigation feature button to append to the flight plan. If there are no navigation features, touch **'Map Pointer'** to create a user waypoint. Repeat to add additional waypoints.
- 4) To remove a waypoint from the flight plan, touch the waypoint on the map and select **'Remove'**.
- 5) Touch **'Undo'** to undo the most recent action.
- 6) Touch **'Cancel'** to exit without saving or **'Save'** to save and exit Graphical Flight Plan Editing Mode.

### 3.3 FLIGHT PLAN STORAGE

The aera 795/796 can store up to 50 flight plans. The active flight plan is erased when another flight plan is activated. Details about each stored flight plan can be viewed using the Flight Plan List function.

#### Viewing information about a stored flight plan:

- 1) From the **Main Menu**, touch **FPL List**.
- 2) Touch the desired saved flight plan, then touch it, again, to review.

### Storing an active flight plan:

- 1) With the Active Flight Plan displayed, touch the **Menu**.
- 2) Touch the '**Save Flight Plan**' menu option. A confirmation window appears.
- 3) Touch **Yes**. A copy of the flight plan is stored in the next available position in the Flight Plan List.

## 3.4 FLIGHT PLAN ACTIVATION

Activating a stored flight plan erases the active flight plan and replaces it with a copy of the flight plan being activated. Inverting a stored flight plan reverses the waypoint order, erases the active flight plan, and replaces it with the flight plan being activated (the stored flight plan is not changed).

### Activating a stored flight plan:

- 1) From the **Main Menu**, touch **FPL List**.
- 2) Touch the desired saved flight plan. Touch **MENU**.
- 3) Touch the '**Activate Flight Plan**' menu option. A confirmation window appears.
- 4) Touch **Yes**.

### Activating a Flight Plan Leg:

- 1) From the **Main Menu**, touch the **Active FPL** Icon.
- 2) While navigating an active flight plan, touch the endpoint of the leg to be activated.
- 3) Touch **Direct-to** twice. The "Activate Leg XXXXX-XXXXX?" window is displayed.
- 4) Touch **Yes** to activate. To cancel, touch **No** or **Back**.

## 3.5 FLIGHT PLAN EDITING

### EDITING SPEED AND FUEL FLOW

#### Adjusting the Flight Plan cruise speed and fuel flow:

From the **Main Menu**, touch **Active FPL**, and touch the **Fuel Flow** Button to enter the desired fuel flow using the keypad.

Or:

- 1) From the **Main Menu**, touch **Tools > Profile**.
- 2) If necessary, touch the Aircraft Button, and touch the desired aircraft from the vertical list.
- 3) Touch the **Cruise Speed** and/or **Fuel Flow** Fields to enter the desired value using the keypad or by touching the '+' or '-' Buttons.

Fuel Flow Button

Aircraft Button

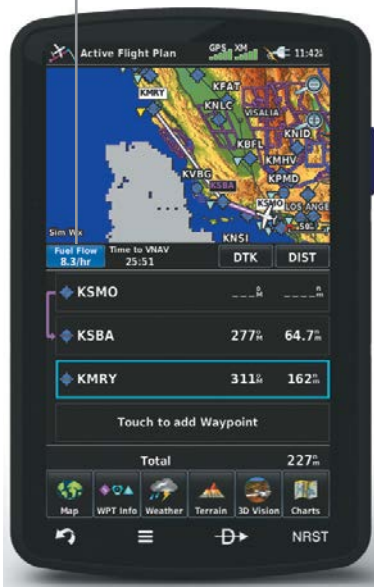

Speed & Fuel Flow

## COPYING FLIGHT PLANS

The aera 795/796 allows copying a flight plan into a new flight plan memory slot, allowing editing, etc., without affecting the original flight plan. This can be used to duplicate an existing stored flight plan for use in creating a modified version of the original stored flight plan.

### Copying a stored flight plan:

While reviewing the desired Stored Flight Plan, touch **Menu > Copy Flight Plan > Yes**.

## DELETING FLIGHT PLANS

Individual or all stored flight plans can be deleted from the aera 795/796 memory.

### Deleting a stored flight plan:

While reviewing the desired Stored Flight Plan, touch **Menu > Delete Flight Plan > Yes**.

**Or:**

With the Flight Plan List displayed, touch the desired flight plan to delete, touch **Menu > Delete Flight Plan > Yes**.

### Deleting all stored flight plans:

From the **Main Menu**, touch **FPL List > Menu > Delete All > Yes**.

### Deleting the Active Flight Plan:

From the **Main Menu**, touch **Active FPL > Menu > Stop Navigation**.

### Deleting an individual waypoint from the active flight plan:

- 1) From the **Main Menu**, touch the **Active FPL** icon.
- 2) While navigating an active flight plan, touch the waypoint to be deleted.
- 4) Touch **Menu > Remove Waypoint**. A confirmation window appears.
- 5) Touch **Yes**.

**Or:**

- 1) From the **Main Menu**, touch the **Active FPL** icon.
- 2) Touch **Menu > Edit on Map**.
- 3) Touch the waypoint on the map, to be removed.
- 4) Touch **Remove** to remove the selected waypoint from the flight plan.



## Deleting an individual waypoint from a saved flight plan:

- 1) From the **Main Menu**, touch **FPL List**.
- 2) Touch the desired saved flight plan. The saved flight plan is displayed.
- 3) Touch the desired waypoint, to be deleted.
- 4) Touch **Menu > Remove Waypoint**. A confirmation window appears.
- 5) Touch **Yes**.

### Or:

- 1) From the **Main Menu**, touch **FPL List**.
- 2) Touch the desired saved flight plan. The saved flight plan is displayed.
- 3) Touch **Menu > Edit on Map**.
- 4) Touch the waypoint on the map, to be removed.
- 5) Touch **Remove** to remove the selected waypoint from the flight plan.



**NOTE:** *The changes made to the active flight plan affect navigation as soon as they are entered. Editing the active flight plan does not affect any saved flight plans. Waypoints in the final approach segment (such as the FAF or MAP) can not be deleted individually.*

## INVERTING A FLIGHT PLAN

Any flight plan may be inverted (reversed) for navigation back to the original departure point.

### Inverting the active flight plan:

From the **Main Menu**, touch **Active FPL > Menu > Invert Flight Plan > Yes**.

### Inverting a saved flight plan:

- 1) From the **Main Menu**, touch **FPL List**
- 2) Touch the desired saved flight plan. An option menu is displayed.
- 3) Touch the '**Review Flight Plan**' menu option.
- 4) Touch **Menu**.
- 5) Touch the '**Invert Flight Plan**' menu option. A confirmation window appears.
- 6) Touch **Yes**.

## IMPORTING/EXPORTING FLIGHT PLANS

---

### Importing flight plans:

- 1) Insert an SD Card containing one or more flight plans into the SD Card Slot.
- 2) From the **Main Menu**, touch **FPL List** > **Menu** > **Import Flight Plans**
- 3) Touch the desired flight plan(s) to import.

### Exporting flight plans:

- 1) Insert an SD Card into the SD Card Slot.
- 2) From the **Main Menu**, touch **FPL List**
- 3) Touch the desired flight plan to export (a list of menu options appears).
- 4) Touch the '**Export Flight Plan**' menu option.

## CONNEXT

---



**NOTE:** Connext features require a Bluetooth or RS-232 serial connection to an external Connext device.

---

The Connext Setup Menu can configure how the aera sends and receives flight plans from other Connext devices. Flight plans received from other devices will be added to the aera's Flight Plan List.

The aera will not accept flight plans from other devices if Incoming Mode is set to No Transfer. Setting either Incoming or Outgoing Modes to Require Action will prompt the user to confirm sending or receiving a flight plan. Setting to Automatic will send or receive with no need for user input.

## 3.6 APPROACHES

---



**WARNING:** Do not rely solely upon the aera 795/796 for flight into instrument meteorological conditions (IMC). The approaches provided are for monitoring purposes only. Only the final course segment (final approach fix (FAF) to missed approach point (MAP)) of the published approach is available for monitoring.

---

An approach can be loaded at any airport that has one available, and provides guidance for non-precision and precision approaches to airports with published instrument approach procedures. Only one approach can be loaded at a time in a flight plan. If an approach is loaded when another approach is already in the active flight plan, the new approach replaces the previous approach. Only the final course segment (Final Approach Fix (FAF) to Missed Approach Point (MAP)) of the published approach is available for monitoring.



**Approach Selection**

## SELECTING AN APPROACH

When selecting an approach, it replaces the destination airport with the sequence of waypoints for the selected approach. Keep in mind the airport must have a published approach (GPS, RNAV, VOR, NDB, localizer, or ILS) and only the final course segment (final approach fix to missed approach point) of the published approach is available in the aera 795/796. If the airport does not have a published approach, the 'Select Approach' menu option is not available.

An approach can be selected using the Direct-to, Active Flight Plan, and the Saved Flight Plan functions.

## Selecting an approach from the active or saved flight plan:

- 1) From the **Main Menu**, touch the **Active FPL** Icon.

**Or:**

- a) From the **Main Menu**, touch the **FPL List** Icon.
  - b) Touch the desired Saved Flight Plan from the list. Press it again to review.
- 2) With the flight plan displayed, touch **Menu**.
  - 3) Touch the '**Select Approach**' menu option (only available if the destination airport has a published approach).
  - 4) Touch the approach name to display a vertical list of all available approaches. Touch the desired approach from the list.
  - 5) For Active FPL, touch **Load Approach**, to add the final approach fix and missed approach point to the flight plan.

**Or:** Touch **Activate Approach**, to activate and immediately begin navigation to the final approach fix.

**Or:** Touch **Activate Vectors-to-Final**, the aera 795/796 creates an extension of the final course, beyond the final approach waypoint in the database (final approach fix [FAF]). A Vector to Final symbol appears beside the first approach waypoint in the Active Flight Plan. The aera 795/796 provides no guidance to the inbound course. The course deviation needle on the graphic HSI remains off-center until established on the final approach course. The map shows an extension of the final approach course using a bold magenta line.

**Or:** For stored FPL, touch **Select Approach** to add the final approach fix and missed approach point to the saved flight plan.

## Selecting an approach using the Direct To function:

- 1) With an active airport that contains published approach data selected, touch **Direct To > Menu**.
- 2) Touch the '**Select Approach**' menu option.
- 3) Touch the approach name to display a vertical list of all available approaches; select the desired approach from the list.
- 4) Touch **Load Approach**, to add the final approach fix and missed approach point to the flight plan.

- Or:** Touch **Activate Approach**, to activate and immediately begin navigation to the final approach fix.
- Or:** Touch **Activate Vectors-to-Final**, to load the FAF and MAP waypoints into the active flight plan. The aera 795/796 creates an extension of the final course, beyond the final approach waypoint in the database (final approach fix [FAF]). A Vector to Final symbol appears beside the first approach waypoint in the Active Flight Plan. The aera 795/796 provides no guidance to the inbound course. The course deviation needle on the graphic HSI remains off-center until established on the final approach course. The map shows an extension of the final approach course using a bold magenta line.

### Removing or Activating an approach:

- 1) Using a flight plan with an approach loaded, touch the **Active FPL** icon on the **Main Menu**.
    - Or:**
      - a) From the **Main Menu**, touch **FPL List**.
      - b) From the list, touch the Saved Flight Plan with an approach loaded. Press it again to review.
  - 2) Press **Menu**. Touch the '**Remove Approach**' menu option (only available if an approach is loaded).
- Or:** Touch an approach waypoint.
- a) Press **Menu**; select '**Remove Approach**'.
- Or:**
- b) Press approach waypoint again to review. Touch '**Remove Approach**' to Remove, **Activate Approach** to activate (Active FPL only), or **Activate Vectors-to-Final** to activate vectors-to-final (Active FPL only).

Blank Page

## SECTION 4 HAZARD AVOIDANCE

### 4.1 WEATHER

#### COMPATIBLE DEVICES

---

Compatible SiriusXM Devices
GXM 40/42
GDL 51/51R
GDL 52/52R

Compatible GDL FIS-B Devices
GDL 39/39R
GDL 39-3D
GTX 345/345R/45R
GNX 375
GDL 50/50R
GDL 52/52R

#### WEATHER SOURCE

---

With a SiriusXM compatible device and subscription, and a FIS-B compatible device, there are three weather data source options available: AUTO, SiriusXM, and GDL FIS-B. The default selection is 'AUTO.' With AUTO selected, the device selects the optimal weather source based on the connections and data available. The device may automatically switch to a different data source if the currently selected weather source becomes unavailable.

By selecting a specific weather data source (i.e., other than AUTO), only the selected source is used to display weather information, and no automatic source switching will occur.

### Switching Weather Sources:

- 1) From the **Main Menu**, touch **Weather > Menu > Set Up Weather**.
- 2) Use the  buttons to cycle through the available weather sources (AUTO, SiriusXM or GDL FIS-B).

**Or:**

- 1.) From the **Main Menu**, touch **Tools > Setup > Weather**.
- 2.) Touch the desired weather source (AUTO, SiriusXM, or GDL FIS-B).

## SIRIUSXM<sup>®</sup> WEATHER



**NOTE:** The displayed weather products are dependant on the SiriusXM Weather Data Service Package purchased.

## ACTIVATING SERVICES

Before SiriusXM Satellite Weather can be used, the service must be activated. Service is activated by providing SiriusXM Satellite Radio with a Radio ID unique to the compatible SiriusXM device.

SiriusXM Satellite Radio uses the Radio ID to send an activation signal that allows the aera to display weather data and/or entertainment programming provided through the compatible SiriusXM device.

Refer to the compatible SiriusXM device Owner's Manual for more information on activating SiriusXM Satellite Radio.

## SIRIUSXM WEATHER INFORMATION

- Radio ID—Eight-digit ID number used for activation.
- Service Level—SiriusXM Weather subscription plan purchased.
- Weather Products—List of weather features and age of weather data in minutes.



## Accessing the Radio ID:

From the **Main Menu**, touch **Tools > Data Link**.



Accessing the SiriusXM Radio ID

## SIRIUSXM SATELLITE WEATHER PRODUCTS

### NEXRAD

NEXRAD (NEXT-generation RADar), is a network of multiple high-resolution Doppler radar sites that are operated by the National Weather Service (NWS). NEXRAD data provides centralized meteorological information for the continental United States and selected overseas locations.

The maximum range of a single NEXRAD radar site is 250 nm. In addition to a wide array of services, the NEXRAD network provides important information about severe weather and air traffic safety.

NEXRAD data is not real-time. The lapsed time between collection, processing, and dissemination of NEXRAD images can be significant and may not reflect the current radar synopsis. Due to the inherent delays and the relative age of the data, it should be used for long-range planning purposes only. Never use NEXRAD data or any radar data to maneuver in or near areas of hazardous weather. Rather, use it in an early-warning capacity of pre-departure and enroute evaluation.

Data from all the NEXRAD radar sites in the United States is shown. This data represents the base reflectivity from the individual radar sweeps. The display of the information is color-coded to indicate the weather severity level.

The display of radar coverage is always active when NEXRAD is selected. Areas where NEXRAD radar coverage is not currently available or is not being collected are indicated in grayish-purple. Radar capability exists in these areas, but it is not active or is off-line.

## NEXRAD ABNORMALITIES

There are possible abnormalities regarding displayed NEXRAD images. Some, but not all, of those include:

- Ground clutter
- Strokes and spurious radar data
- Sun strokes, when the radar antenna points directly at the sun
- Military aircraft deploy metallic dust (chaff) which can cause alterations in radar scans
- Interference from buildings or mountains, which may cause shadows

## NEXRAD LIMITATIONS

Certain limitations exist regarding the NEXRAD radar displays. Some, but not all, are listed for the user's awareness:

- NEXRAD does not provide sufficient information to determine cloud layers or precipitation characteristics (hail vs. rain). For example, it is not possible to distinguish between wet snow, wet hail, and rain.
- NEXRAD base reflectivity is sampled at the minimum antenna elevation angle. An individual NEXRAD site cannot depict high altitude storms at close ranges, and has no information about storms directly over the site.
- The composite reflectivity is the maximum dBZ reflectivity from any of the reflectivity angles of the NEXRAD weather radar. (CONUS area only)

### NEXRAD INTENSITY

Colors are used to identify the different NEXRAD echo intensities (reflectivity) measured in dBZ (decibels of Z). "Reflectivity" (designated by the letter Z) is the amount of transmitted power returned to the radar receiver. The dBZ values increase as returned signal strength increases. Precipitation intensity is displayed using colors corresponding to the dBZ values.

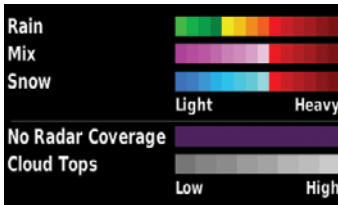

RADAR Legend

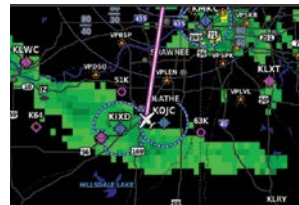

NEXRAD Data

### SATELLITE MOSAIC

Satellite observation of clouds is represented as temperature data, where colder cloud tops are typically found at higher altitudes. Satellite Mosaic data indicates the height of the cloud top in levels with increments of 5000 feet.

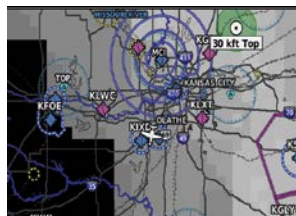

Satellite Mosaic

## ECHO TOPS

Echo Tops are derived from NEXRAD radar and indicate the highest altitude at which precipitation is falling. Echo Tops at or above the altitude you select are displayed, in 5,000 foot increments up to 70,000 ft. Echo Tops can be helpful in determining the severity of thunderstorms.

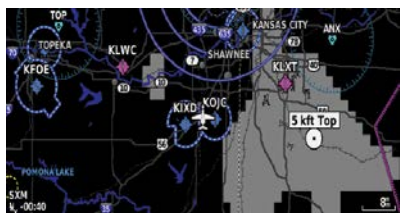

Echo Tops Data



Echo Tops Altitudes

## WINDS ALOFT

Winds Aloft data shows the forecasted wind speed and direction at the surface and at selected altitudes.

Winds Aloft are displayed using wind barbs or a wind streamline depending on the selected range. The wind barbs indicate wind speed and direction. The wind streamline indicates wind direction with arrows.

The wind barbs always point in the direction the wind is coming from. The wind speed is depicted using flags at the end of the wind barb. A short wind flag is 5 knots, a long wind flag is 10 knots, and a triangle flag is 50 knots.

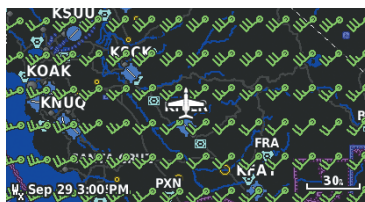

Winds Aloft Data



Winds Aloft Altitudes



Winds Streamlines

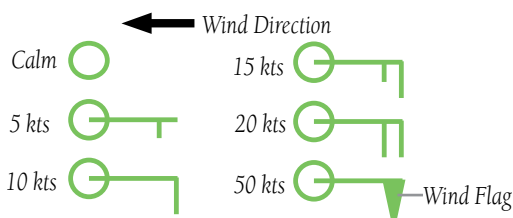

Winds Barbs

### SIRIUSXM LIGHTNING

Lightning data shows the approximate location of cloud-to-ground lightning strikes. A strike icon represents a strike that has occurred within a two-kilometer region and within the last seven minutes. The exact location of the lightning strike is not displayed.

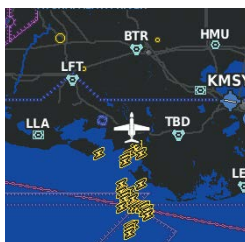

Lightning Data

### STORM CELLS

The Storm Cells feature displays storms as well as the storm's projected path in the immediate future.

The direction of the storm is displayed by an arrow. The map range at which the arrow is displayed depends on the storm cell's speed. The tip of the arrow indicates where the storm should be in 15 minutes. Critical information about the storm cell (tops and intensity) can be viewed by selecting the storm cell with the map pointer. Touching the Map Feature Button will display additional information.

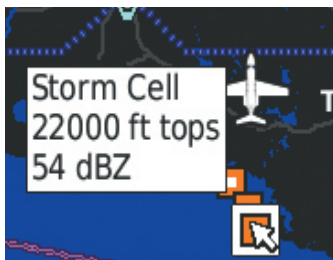

Storm Cell Data (Map)

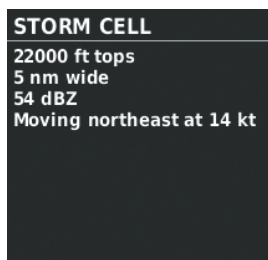

Additional Storm Cell Information

## METARS AND TAFS



**NOTE:** METAR information is only displayed within the installed aviation database service area.

METAR (METeoro logical Aerodrome Report) is an international code used for reporting weather observations. METARs are updated hourly or as needed. METARs typically contain information about the temperature, dewpoint, wind, precipitation, cloud cover, cloud heights, visibility, and barometric pressure. They can also contain information on precipitation amounts, lightning, and other critical data. If METAR data is available for an airport, a color-coded flag is shown next to the airport.

TAF (Terminal Area Forecast) is the standard format for 24-hour weather forecasts. TAFs may contain some of the same code as METAR data. It typically forecasts significant weather changes, temporary changes, probable changes, and expected changes in weather conditions.

The abbreviated METAR can be viewed by selecting the METAR flag with the map pointer. Touching the Map Feature Button will display additional information. METAR and TAF data can be displayed as raw or decoded text.

METAR Selected with Map Pointer

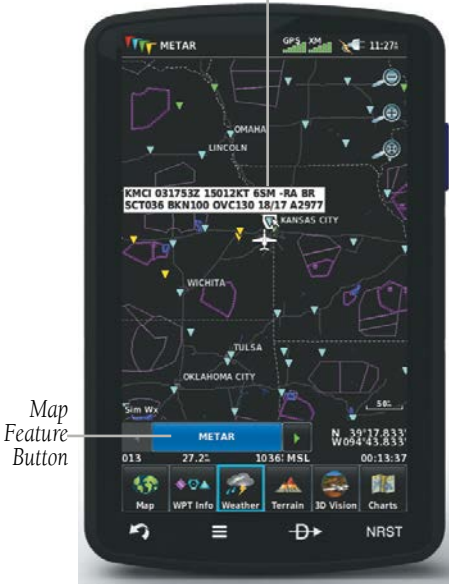





METAR Data (Map)



Additional METAR Data

The METAR flag color is determined by the information in the METAR text.

-  VFR (ceiling greater than 3000 feet AGL and visibility greater than 5 miles)
-  Marginal VFR (ceiling 1000-3000 feet AGL and/or visibility 3-5 miles)
-  IFR (ceiling 500 to below 1000 feet AGL and/or visibility 1 mile to less than 3 miles)
-  Low IFR (ceiling below 500 feet AGL or visibility less than 1 mile)
-  METAR text does not contain adequate information to determine flight conditions

## AIRMETS

An AIRMET (AIRMen's METeorological Information) can be especially helpful for pilots of light aircraft that have limited flight capability or instrumentation. An AIRMET must affect or be forecast to affect an area of at least 3,000 square miles at any one time. AIRMETS are routinely issued for six-hour periods and are amended as necessary due to changing weather conditions. AIRMETS are displayed as green (surface winds), magenta and red (IFR / mountain obscuration), orange (turbulence), or blue (icing) shaded areas on the map display.

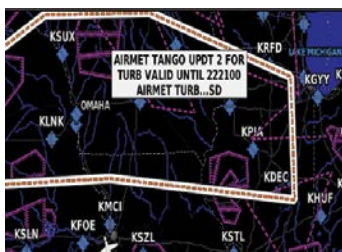

AIRMET Selected

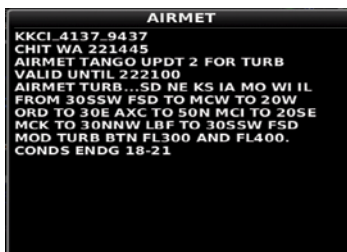

Additional AIRMET Data

## SIGMETS

A SIGMET (SIGnificant METeorological Information) advises of weather that is potentially hazardous to all aircraft. In the contiguous United States, the following items are covered: severe icing, severe or extreme turbulence, volcanic ash, dust storms, and sandstorms that lower visibility to less than three statute miles.

A Convective SIGMET is issued for the following conditions: thunderstorms, isolated severe thunderstorms, embedded thunderstorms, hail at the surface, and tornadoes.

A SIGMET is widespread and must affect or be forecast to affect an area of at least 3,000 square miles. SIGMETs are displayed as a yellow-dashed line.



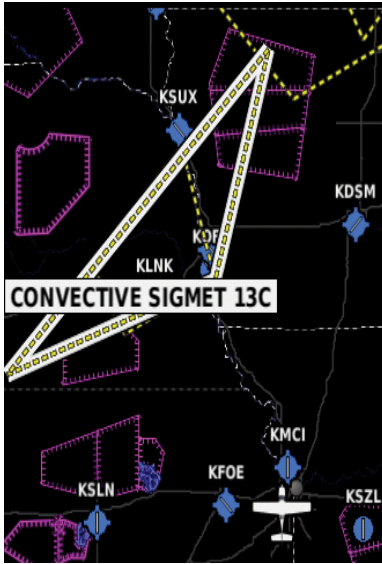

SIGMET Selected

CONVECTIVE SIGMET 13C  
 VALID UNTIL 2355Z  
 IA NE FROM 50NW FOD-10SSW  
 OVR-80SSW OBH-50NW FOD AREA SEV TS  
 MOV FROM 23025KT. TOPS ABV FL450.  
 HAIL TO 2.5 IN...WIND GUSTS TO 60KT  
 POSS.

Additional SIGMET Data

## TEMPORARY FLIGHT RESTRICTIONS (TFR)



**NOTE:** Do not rely solely upon data link services to provide Temporary Flight Restriction TFR information. Always confirm TFR information through official sources such as Flight Service Stations of Air Traffic Control.

Temporary Flight Restrictions, or TFRs, temporarily restrict all aircraft from entering the selected airspace unless a waiver has been issued. TFRs are routinely issued for activities such as sporting events, dignitary visits, military depots, and forest fires. TFRs are represented as an area highlighted by red (active) or yellow (not yet active).



TFR Data Selected

TFR NM 2/6042  
 Fire TFR  
 Surface to 13700ft  
 Caution - Graphical Depiction is Approximated

TFR NOTAM 2/6042 NM.. FLIGHT RESTRICTIONS 1 E GLENWOOD, NM. EFFECTIVE 1200-0600 UTC DAILY UNTIL FURTHER NOTICE. PURSUANT TO 14 CFR SECTION 91.137(A)(2) TEMPORARY FLIGHT RESTRICTIONS ARE IN EFFECT WITHIN AN AREA BOUNDED BY: 330000N/1085200W OR THE SILVER CITY /SVC/ VORTAC 288 DEGREE RADIAL AT 41.7 NAUTICAL MILES THEN TO 333800N/1085200W OR THE SILVER CITY /SVC/ VORTAC 316 DEGREE RADIAL AT 69.4 NAUTICAL MILES THEN TO 333800N/1082000W OR THE SILVER CITY /SVC/ VORTAC 339 DEGREE RADIAL AT 60.2 NAUTICAL MILES THEN TO 332500N/1080000W OR THE SILVER CITY /SVC/ VORTAC 357 DEGREE RADIAL AT 47.3 NAUTICAL MILES THEN TO 330000N/1080000W OR THE SILVER CITY /SVC/ VORTAC 8 DEGREE RADIAL AT 23.1 NAUTICAL MILES BACK TO THE ORIGINAL POINT AT AND BELOW 13700 FEET MSL TO PROVIDE A SAFE ENVIRONMENT FOR FIRE FIGHTING. SOUTHWEST COORDINATION CENTER TELEPHONE 505-842-3473 OR FREQUENCY 118.500/WHITE- WATER-BALDY FIRE IS IN CHARGE OF THE OPERATION. ALBUQUERQUE /ZAB/ ARTCC TELEPHONE 505-856-4580 IS THE FAA COORDINATION FACILITY. EFFECTIVE UNTIL FURTHER NOTICE

Additional TRF Information

## PIREPS

Pilot Weather Reports (PIREPs) provide timely weather information for a particular route of flight. When significant weather conditions are reported or forecast, Air Traffic Control (ATC) facilities are required to solicit PIREPs. A PIREP may contain unforecast adverse weather conditions, such as low in-flight visibility, icing conditions, wind shear, and turbulence. PIREPs are issued as either Routine (UA) (blue) or Urgent (UUA) (yellow).



PIREP Selected

PIREP

Pilot Report

Location GLL  
 Time 10:30 AM  
 Altitude 17000 ft  
 Aircraft Fairchild Dornier 328JET  
 Temperature -22°F  
 Icing Light - moderate rime  
 Remarks FL170 - FL250...ZDV FD

---

GXY UA /OV GLL/TM 1530/FL170/TP J328/TA M30/IC LGT-MOD RIME/RM FL170-FL250...ZDV FD

Additional PIREP Data

## FREEZING LEVEL

Freezing Level shows contours for the lowest forecast altitude where icing conditions are likely to occur.

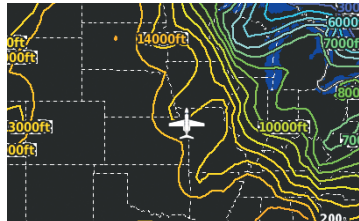

Freezing Level Data

## TURBULENCE FORECAST

Turbulence data identifies the potential for erratic movement of high-altitude air mass associated winds. Turbulence is classified as light, moderate, or severe. Turbulence data is intended to supplement AIRMETs and SIGMETs.



Turbulence Forecast Legend

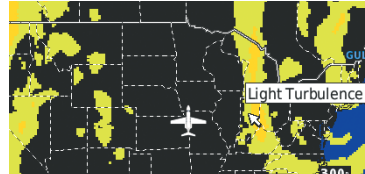

Light Turbulence Selected

## ICING FORECAST (CIP & SLD)

Current Icing Product (CIP) data shows a graphical view of the current icing environment. Icing severity is displayed in four categories: light, moderate, severe, and extreme (not specific to aircraft type). The CIP product is not a forecast, but a representation of the current conditions at the time of the analysis.

Supercooled Large Droplet (SLD) icing conditions are characterized by the presence of relatively large, super cooled water droplets indicative of freezing drizzle and freezing rain aloft.

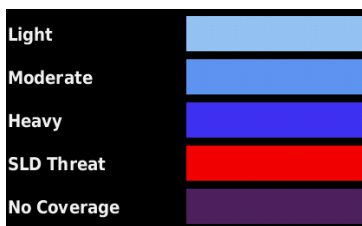

Icing Forecast Legend

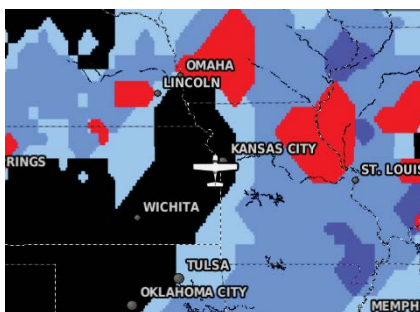

Icing Potential

## WX FORECAST

Forecast information is available for current and forecast weather conditions. Forecasts are available for intervals of 12, 24, 36, and 48 hours.



Forecast Data Selected

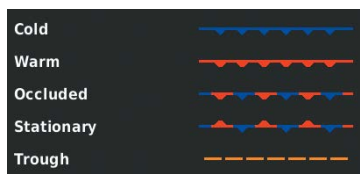

Fronts Legend

## SURFACE PRESSURE

This feature displays pressure isobars and pressure centers. The isobars connect points of equal pressure. Pressure readings can help determine weather and wind conditions.

High pressure areas are generally associated with fair weather. Low pressure areas are generally associated with clouds and the chance of precipitation. Isobars that are packed closely together show a strong pressure gradient.

Surface Pressure information is available for current and forecast weather conditions. Surface Pressure forecasts are available for intervals of 12, 24, 36, and 48 hours. Strong gradients are associated with areas of stronger winds. Pressure units can be displayed in Millibars (mb), Hectopascals (pa), or Inches of Mercury (in).



Surface Pressure Data

## WATER TEMPERATURE

The surface temperatures of coastal and large inland bodies of water are displayed.

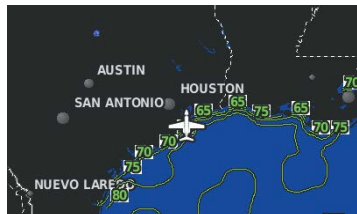

Water Temperature Data

## USING WEATHER DATA



**WARNING:** Do not use data link weather information for maneuvering in, near, or around areas of hazardous weather. Information contained within data link weather products may not accurately depict current weather conditions.



**WARNING:** Do not use the indicated data link weather product age to determine the age of the weather information shown by the datalink weather product. Due to time delays inherent in gathering and processing weather data for data link transmission, the weather information shown by the data link weather product may be significantly older than the indicated weather product age.

SiriusXM Weather Products can be displayed on the Navigation Map Page and individually on the Weather Maps.

The setup menu for the Navigation Map controls the map range settings above which weather products are decluttered from the display. If a map range larger than the weather product map range setting is selected, the weather product data is removed from the map. For weather products such as Lightning and Storm Cells, the weather product is displayed when a map range “smaller” than the weather product map range setting is selected (Cloud Tops works inversely). The menu also provides a means for enabling/disabling display of other SXM weather products.

Additional information about the following can be displayed by panning over the display on map:

- Storm Cells
- SIGMETs
- AIRMETs
- METARs
- TFRs

Additional information is also available for the following weather products on the Weather Map (not displayed on the Navigation Map):

- Forecast
- PIREPs

### Viewing Weather products on the Navigation Map:

- 1) From the **Main Menu** touch **Map**:
- 2) Touch **Menu**.
- 3) Touch '**Show/Hide**' menu option.
- 4) Touch the **Weather 'Show/Hide'** Button.

### Viewing Weather products on the Weather Map:

- 1) From the **Main Menu** touch **Weather**.
- 2) Touch the desired second-level Weather Icon.
- 3) If necessary, touch the  buttons to scroll through the list of available altitudes, AIRMET types, or forecast times.
- 4) Touch the desired weather product on the Weather Map to display abbreviated weather product information (if available).
- 5) With the desired weather product highlighted, touch the Map Feature Button to display additional, detailed information (if available).

METAR Selected with Map Pointer

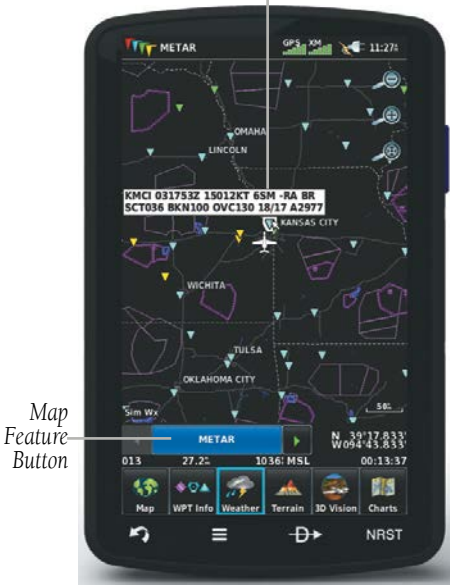

METAR Data (Map)



Additional METAR Data

### Setting up and customizing weather data for the Navigation Map:

- 1) From the **Main Menu** touch the **Map** Icon.
- 2) Touch **Menu**.
- 3) Touch the '**Set Up Map**' menu option.
- 4) Touch the  buttons to select '**Weather, FIS-B Weather, or XM Weather**' Category.

- 5) Touch the desired setting to change.
- 6) Touch the ◀▶ buttons (if available) to select the desired settings or touch the **On/Off** Button (if available).

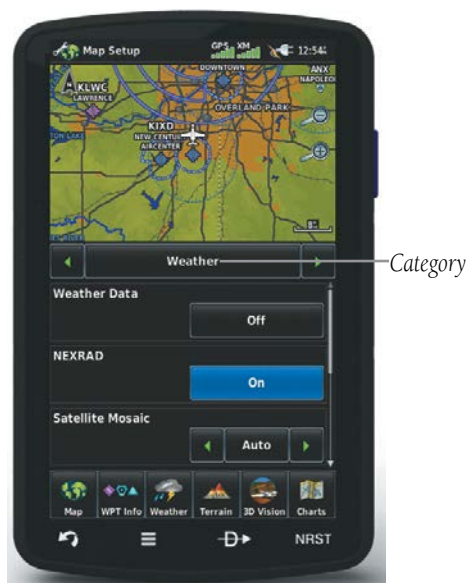

Map Setup (Weather Category)

### Restoring default weather data for the Navigation Map:

- 1) From the **Main Menu**, touch **Map > Menu > Set Up Map**.
- 2) Touch the ◀▶ buttons until the '**Weather, FIS-B Weather, or XM Weather**' Category is displayed.
- 3) Touch **Menu**.
- 4) Touch the '**Restore Weather Defaults**' menu option.

### Viewing legends for displayed weather products:

- 1) From the **Main Menu**, touch the **Map** Icon.  
**Or:**
  - a) From the '**Home**' Screen, touch the **Weather** Icon.
  - b) Touch the desired second-level weather icon.
- 2) Press **Menu**.
- 3) Touch the '**Weather Legend**' menu option.



- 4) If desired, touch the  buttons until the desired legend is displayed.

**Or:**

Touch the **Back** Icon to return to the map.

### Animating SiriusXM weather:

- 1) From the **Main Menu**, touch the **Map** Icon (weather must be enabled).

**Or:**

- a) From the **Main Menu**, touch the **Weather** Icon.

- b) Touch the **NEXRAD** Icon or the **Satellite** Icon.

- 2) Touch **Menu**.

- 3) Touch the '**Animate Weather**' menu option.

## DATA LINK WEATHER (FIS-B) (795 AND 796)



**NOTE:** *The Flight Information Service (FIS-B) weather data provides information for avoiding hazardous weather. Do not use FIS-B information to penetrate hazardous weather.*

The aera 795/796 is compatible with Garmin data link radios. These devices are Bluetooth® enabled receive-only data link radios with on-board GPS, 978 MHz (the Universal Access Transceiver frequency band), and 1090 MHz Extended Squitter (1090 ES) receivers. It is designed to receive, process, and output traffic (ADS-B air-to-air, and TIS-B traffic information), and weather (Flight Information Service-Broadcast (FIS-B)) information to the aera 795/796 through a power/data cable. As a UAT receiver, a data link radio can receive and, when connected to the aera 795/796, display Flight Information Service-Broadcast (FIS-B) weather products as well as traffic.

FIS-B is a free weather service that is broadcast by Ground Based Transceivers (GBTs) over the 978 MHz UAT frequency band as part of the FAA's Next Generation Air Transportation System (NextGen). To receive FIS-B weather information, the compatible device must be within range and line-of-sight of an operating GBT. Reception may be affected by altitude, terrain, and other factors.

FIS-B Weather Product	Connection	
	Bluetooth	RS-232
NEXRAD	✓	✓
Cloud Tops Forecast	✓	
Winds and Temperatures Aloft	✓	✓
Lightning	✓	
METARs/TAFs	✓	✓
TAFs	✓	✓
AIRMETs	✓	✓
SIGMETs	✓	✓
PIREPs	✓	✓
NOTAM (D)/FDC (Including TFRs)	✓	✓
Turbulence Forecast	✓	
Icing Forecast	✓	

Available FIS-B Weather Products by Connection

## Switching Weather Sources:

- 1) Touch the **Weather > Menu > Set Up Weather**.
- 2) Use the buttons to cycle through the available weather sources (AUTO, SiriusXM, or FIS-B).

## Viewing Weather Product Status:

- 1) From the **Main Menu** touch **Weather**.
- 2) Touch **Menu > Information**.

## Viewing Ground Station Status:

- 1) From the **Main Menu**, touch **Tools**.

- 2) Touch **Data Link**.
- 3) Touch **Menu > Ground Stations**.

**Or:**

- 1) From the **Main Menu** touch **Weather**.
- 2) Touch **Menu > Information**.
- 3) Touch **Menu > Data Link info**.
- 4) Touch **Menu > Ground Stations**.



---

**NOTE:** *The Weather Status Information shown on the Weather Information Page will depend on the current configured weather source.*

---

## FIS-B WEATHER PRODUCTS

FIS-B weather broadcasts are updated regularly and may take approximately ten minutes to transmit all available weather data. Therefore, weather data is not immediately available. No pilot action is required to receive FIS-B weather information. Weather product status can be viewed on the dedicated Weather Page, or the Data Link Page from the Tools menu.

When a FIS-B weather product is active on a map, the age of the data is displayed on the screen in the lower left corner. The age of the product is based on the time difference between when the data was assembled on the ground and the current GPS time. Weather products are broadcast at specific intervals (see broadcast interval in the table below).

If, for any reason, a weather product is not refreshed within the Expiration Time intervals (see table), the data is considered expired and is removed from the display. This ensures that only data that is consistent with FIS-B broadcast data is displayed. If more than half of the expiration time has elapsed, the color of the product age displayed changes to yellow. The system displays dashes instead of a product age when a product has expired. If a weather product is not available or has not been received, the system displays 'N/A' instead of a product age.

The table below shows the FIS-B weather expiration time and the broadcast interval. The broadcast interval represents the interval at which FIS-B GBTs broadcast new signals that may or may not contain new weather data. It does not represent the rate at which weather data is updated or new content is received by a compatible FIS-B weather device.

FIS-B Products	Expiration Time	Update Interval (Minutes)	Broadcast Interval (Minutes)
NEXRAD Composite Reflectivity (CONUS)	75 minutes	~5 minutes precipitation mode 10 minutes for clear air	15
NEXRAD Composite Reflectivity (Regional)	75 minutes	As Available	2.5
METAR	8 hours	1 minute (where available), As Available otherwise	5
TAF	12 hours	8 hours	10
AIRMET	12 hours	As Available	5
SIGMET	12 hours	As Available, then at 15 minute intervals for 1 hour	5
PIREP	4 hours	As Available	10
Winds and Temperatures Aloft	12 hours	12 hours	10
NOTAM (D)/FDC (Including TFRs)	12 hours	As Available	10
Cloud Tops Forecast	105 minutes	1 hour	15
Icing Forecast	105 minutes	1 hour	15
Lightning	75 minutes	5 minutes	5
Turbulence Forecast	105 minutes	1 hour	15

### Weather Product Timing

## NEXRAD

NEXRAD (NEXT-generation RADar), is a network of multiple high-resolution Doppler radar sites that are operated by the National Weather Service (NWS). NEXRAD data provides centralized meteorological information for the continental United States and selected overseas locations. The maximum range of a single NEXRAD radar site is 250 nm. In addition to a wide array of services, the NEXRAD network provides important information about severe weather and air traffic safety.

NEXRAD data is not real-time. The lapsed time between collection, processing, and dissemination of NEXRAD images can be significant and may not reflect the current radar synopsis. Due to the inherent delays and the relative age of the data, it should be used for long-range planning purposes only. Never use NEXRAD data or any radar data to maneuver in or near areas of hazardous weather. Rather, use it in an early-warning capacity of pre-departure and enroute evaluation.

Composite data from all the NEXRAD radar sites in the United States is shown. This data is composed of the maximum reflectivity from the individual radar sweeps. The display of the information is color-coded to indicate the weather severity level.

The display of radar coverage is always active when NEXRAD is selected. Areas where NEXRAD radar coverage is not currently available or is not being collected are indicated in grayish-purple. Radar capability exists in these areas, but it is not active or is off-line.

### NEXRAD Abnormalities

There are possible abnormalities regarding displayed NEXRAD images. Some, but not all, of those include:

- Ground clutter
- Strokes and spurious radar data
- Sun strobes, when the radar antenna points directly at the sun
- Military aircraft deploy metallic dust (chaff) which can cause alterations in radar scans
- Interference from buildings or mountains, which may cause shadows

- Poor reception from Ground Based Transceivers (GBTs) can cause portions of the received radar imagery to not be displayed

## NEXRAD Limitations

Certain limitations exist regarding the NEXRAD radar displays. Some, but not all, are listed for the user’s awareness:

- NEXRAD base reflectivity does not provide sufficient information to determine cloud layers or precipitation characteristics (hail vs. rain). For example, it is not possible to distinguish between wet snow, wet hail, and rain.
- NEXRAD base reflectivity is sampled at the minimum antenna elevation angle. An individual NEXRAD site cannot depict high altitude storms at close ranges, and has no information about storms directly over the site.

## NEXRAD INTENSITY

Colors are used to identify the different NEXRAD echo intensities (reflectivity) measured in dBZ (decibels of Z). “Reflectivity” (designated by the letter Z) is the amount of transmitted power returned to the radar receiver. The dBZ values increase as returned signal strength increases. Precipitation intensity is displayed using colors corresponding to the dBZ values.

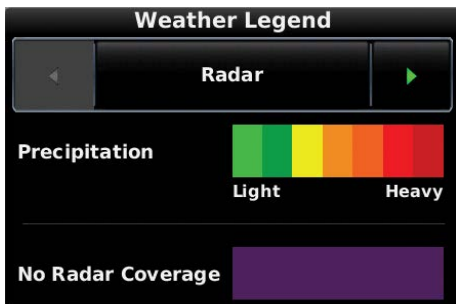

RADAR Legend

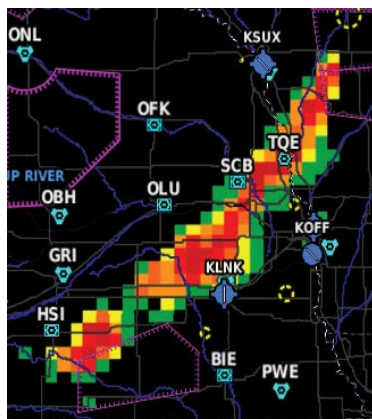

NEXRAD Data

### FIS-B RADAR PRODUCTS

FIS-B weather provides two different Radar products, CONUS and Regional. The system can display each individually or a composite (COMBINED). When Regional Radar is displayed, only precipitation for your current region is displayed. The subdued (grayish-purple colored) area represents the area not covered by the regional radar product. When Combined radar data is viewed, Regional Radar data is displayed on top of CONUS data and the time shown in the lower left corner is associated with Regional Radar data only.



FIS-B Radar CONUS



FIS-B Radar Regional



FIS-B Radar Combined



## CLOUD TOPS FORECAST

Cloud Tops Forecast data displays forecasted cloud top heights. Heights are indicated in 1,500 foot increments from 1,500 feet up to 15,000 feet and in 3,000 foot increments from 15,000 feet up to 24,000 feet. .

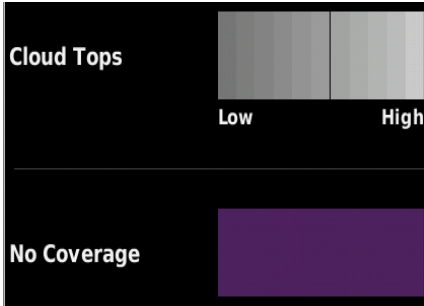

Cloud Fcst Legend



Cloud Fcst

## WINDS ALOFT

Winds Aloft data shows the forecasted wind speed and direction for select altitudes.

The wind barbs indicate wind speed and direction, and always point in the direction the wind is coming from. The wind speed is depicted using flags at the end of the wind barb. A short wind flag is 5 knots, a long wind flag is 10 knots, and a triangle flag is 50 knots.



Winds Aloft Data



Winds Aloft Altitudes



Winds Barbs

## TEMPERATURES ALOFT

Temperature Aloft data shows the forecasted temperatures aloft for select altitudes in 3,000-foot increments up to 39,000 feet MSL. For altitudes above 18,000 feet, the relative ISA temperature is shown. Temperatures are color coded with temperatures near and below freezing are shown as shades of blue, green for temperatures just above freezing, and shades of orange are used for warmer temperatures.



Temperatures Aloft

### LIGHTNING

Lightning data shows the approximate location, number, and polarity of lightning strikes. A strike icon represents the amount of lightning strikes that have recently occurred within an approximately one nautical mile region. The exact location of the lightning strikes are not displayed. The strike icon indicates Polarity(+) if any of the strikes in that region were positive polarity.

Overview

GPS Navigation

Flight Planning

Hazard Avoidance

Additional Features

Appendices

Index

1 Strike	
2-5 Strikes	
> 5 Strikes	
Polarity(+)	
No Coverage	

Lightning Legend

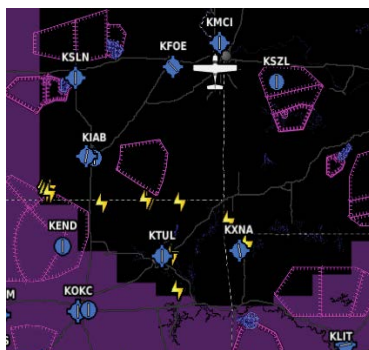

Lightning Data

### METARS AND TAFS



**NOTE:** METAR information is only displayed within the installed aviation database service area.

METAR (METeorological Aerodrome Report) is an international code used for reporting weather observations. METARs are updated hourly or as needed. METARs typically contain information about the temperature, dewpoint, wind, precipitation, cloud cover, cloud heights, visibility, and barometric pressure. They can also contain information on precipitation amounts, lightning, and other critical data. If METAR data is available for an airport, a color-coded flag is shown next to the airport.

TAF (Terminal Area Forecast) is the standard format for 24-hour weather forecasts. TAFs may contain some of the same code as METAR data. It typically forecasts significant weather changes, temporary changes, probable changes, and expected changes in weather conditions.

An abbreviated version can be viewed by selecting the METAR flag with the map pointer. Touching the Map Feature Button will display additional information. METAR and TAF data can be displayed as raw or decoded text.





*METAR Selected with Map Pointer*



**METAR Data (Map)**

**Additional METAR Data**

The METAR flag color is determined by the information in the METAR text.

-  VFR (ceiling greater than 3000 feet AGL and visibility greater than 5 miles)
-  Marginal VFR (ceiling 1000-3000 feet AGL and/or visibility 3-5 miles)
-  IFR (ceiling 500 to below 1000 feet AGL and/or visibility 1 mile to less than 3 miles)
-  Low IFR (ceiling below 500 feet AGL or visibility less than 1 mile)
-  Undetermined (METAR text does not contain adequate information to determine flight conditions)



Temporary Flight Restrictions, or TFRs, temporarily restrict all aircraft from entering the selected airspace unless a waiver has been issued. TFRs are routinely issued for activities such as sporting events, dignitary visits, military depots, and forest fires. TFRs are represented as an area highlighted by red (active), yellow (not yet active), or undetermined (orange).



**TFR Data Selected**

```

TFR NM 2/6042
Fire TFR
Surface to 13700ft
Caution - Graphical Depiction is Approximated

TFR NOTAM 2/6042 NM - FLIGHT RESTRICTIONS 1 E
GLENWOOD, NM, EFFECTIVE 1200-0600 UTC DAILY
UNTIL FURTHER NOTICE, PURSUANT TO 14 CFR
SECTION 91.137(A)(2) TEMPORARY FLIGHT
RESTRICTIONS ARE IN EFFECT WITHIN AN AREA
BOUNDED BY: 33000N/1085200W OR THE SILVER
CITY /SVC VORTAC 288 DEGREE RADIAL AT 43.7
NAUTICAL MILES THEN TO 33300N/1085200W OR
THE SILVER CITY /SVC VORTAC 316 DEGREE
RADIAL AT 69.8 NAUTICAL MILES THEN TO
33300N/1082000W OR THE SILVER CITY /SVC
VORTAC 339 DEGREE RADIAL AT 60.2 NAUTICAL
MILES THEN TO 332500N/1080000W OR THE
SILVER CITY /SVC VORTAC 357 DEGREE RADIAL AT
47.3 NAUTICAL MILES THEN TO
33000N/1080000W OR THE SILVER CITY /SVC
VORTAC 8 DEGREE RADIAL AT 23.1 NAUTICAL
MILES BACK TO THE ORIGINAL POINT AT AND
BELOW 13700 FEET MSL TO PROVIDE A SAFE
ENVIRONMENT FOR FIRE FIGHTING. SOUTHWEST
COORDINATION CENTER TELEPHONE 505-852-3473
OR FREQUENCY 131.500/WHITE-WATER-BALDY
FIRE IS IN CHARGE OF THE OPERATION.
ALBUQUERQUE /ZAB/ ARTCC TELEPHONE
505-456-4300 IS THE FAA COORDINATION
FACILITY. EFFECTIVE UNTIL FURTHER NOTICE
                    
```

**Additional TFR Information**

## PIREPS

Pilot Weather Reports (PIREPs) provide timely weather information for a particular route of flight. When significant weather conditions are reported or forecast, Air Traffic Control (ATC) facilities are required to solicit PIREPs. A PIREP may contain unforecast adverse weather conditions, such as low in-flight visibility, icing conditions, wind shear, and turbulence. PIREPs are issued as either Routine (UA) (blue) or Urgent (UUA) (yellow).



**PIREP Selected**

```

PIREP
FFL pilot report
Location 47 nm nne of KIRKSVILLE vortac (035°
radial)
Time Sep 29 4:10 PM
Altitude 7500 ft
Aircraft Type Cessna 206 Stationair
Visibility and Weather Visibility unrestricted
Temperature 8 °C
Turbulence Negative

FFL UA /OV IRK035047 /TM 2110 /FL075 /TP C206
/WX FV99SM /TA 08 /TB NEG
                    
```

**Additional PIREP Data**

**TURBULENCE FORECAST**

Turbulence data identifies the potential for erratic movement of high-altitude air mass associated winds. Turbulence is classified as light, moderate, severe, or extreme. Turbulence data is intended to supplement AIRMETs and SIGMETs.

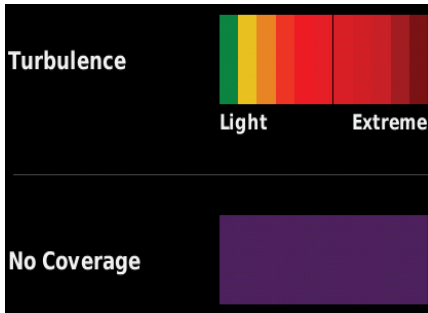

FIS-B Turbulence Legend

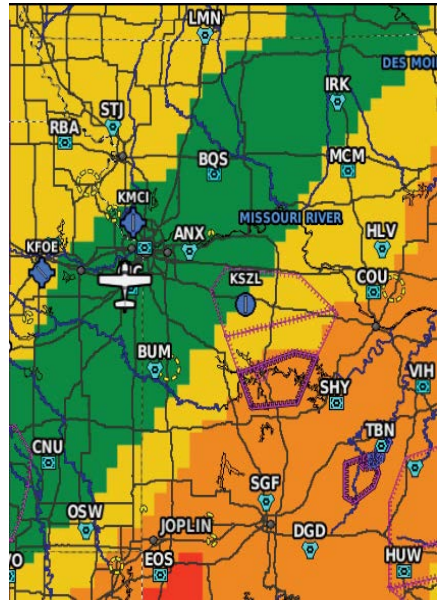

FIS-B Turbulence Selected

**ICING FORECAST**

Icing Forecast data shows a graphical view of the forecasted icing environment. Icing severity is displayed in four categories: trace, light, moderate, and heavy (not specific to aircraft type).

Supercooled Large Droplet icing conditions are characterized by the presence of relatively large, super cooled water droplets indicative of freezing drizzle and freezing rain aloft.

Overview

GPS Navigation

Flight Planning

**Hazard Avoidance**

Additional Features

Appendices

Index

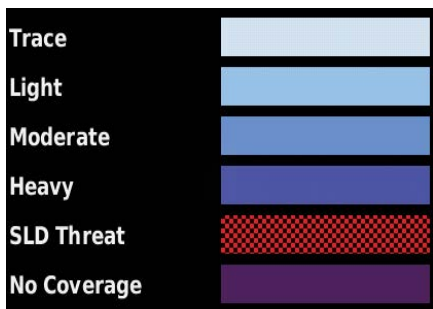

FIS-B Icing Legend

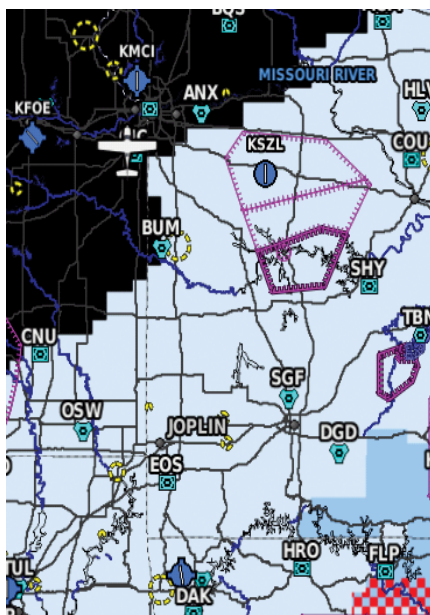

FIS-B Icing Selected

## USING FIS-B WEATHER PRODUCTS



**WARNING:** Do not use data link weather information for maneuvering in, near, or around areas of hazardous weather. Information contained within data link weather products may not accurately depict current weather conditions.





**WARNING:** Do not use the indicated data link weather product age to determine the age of the weather information shown by the datalink weather product. Due to time delays inherent in gathering and processing weather data for data link transmission, the weather information shown by the data link weather product may be significantly older than the indicated weather product age.

FIS-B Weather Products can be displayed on the Navigation Map Page and individually on the Weather (WX) Page.



## Switching Weather Sources:

- 1) Touch **Weather > Menu > Set Up Weather**.
- 2) Use the   buttons to cycle through the available weather sources (AUTO, XM, or FIS-B).

The setup menu for the Navigation Map controls the map range settings above which weather products are decluttered from the display. If a map range larger than the weather product map range setting is selected, the weather product data is removed from the map. The menu also provides a means for enabling/disabling display of 'Airmets', 'Sigmets', 'Weather Data', and/or 'NEXRAD' on the Map Page. 'METAR' and 'Radar Coverage' also may be enabled/disabled on the Navigation Map Page.



Additional information about the following can be displayed by panning over the display on the Weather Page or the Map Page: The Weather Page can overlay several data products simultaneously on a basic map. This map shows roads and borders, airports, airspaces, and nav aids, and touching one of these features will show basic information. The primary purpose, though, is viewing FIS-B weather data. This includes all eight products, NEXRAD, Winds Aloft, Temps Aloft, METARs, AIRMETs, SIGMETs, Temporary Flight Restrictions, and Pilot Reports.

While the Weather Page is displaying a weather product, additional altitude controls only display "Winds Aloft" or "Temps Aloft" displayed. While "Winds Aloft" or "Temps Aloft" are selected, controls for filtering the data by altitude are displayed.

## Viewing FIS-B Weather products on the Navigation Map:

- 1) From the **Main Menu** touch **Map**.
- 2) Touch **Menu**.
- 3) Touch the '**Show/Hide...**' menu option.
- 4) Touch the **Weather 'Show/Hide'** Button.

## Viewing FIS-B Weather products on the Weather Map:

- 1) From the **Main Menu** touch the **Weather** Icon.
- 2) Touch the desired second-level Weather Icon.
- 3) If necessary, touch the   buttons to scroll through the list of available altitudes, or AIRMET types.
- 4) Touch the desired weather product to get abbreviated information about the selected weather product (if available).

- With the desired weather product highlighted, touch the Map Feature Button to get detailed information (if available).

*METAR Selected with Map Pointer*



METAR Data (Map)

Additional METAR Data

## Setting up and customizing weather data for the Navigation Map:

- From the **Main Menu**, touch **Map**,
- Touch **Menu**.
- Touch the '**Set Up Map**' menu option.
- Touch the buttons to select the '**Weather, FIS-B Weather, or SiriusXM Weather**' Category.
- Touch the desired setting to change.
- Touch the buttons (if available) to select the desired settings or touch the **On/Off Button** (if available).

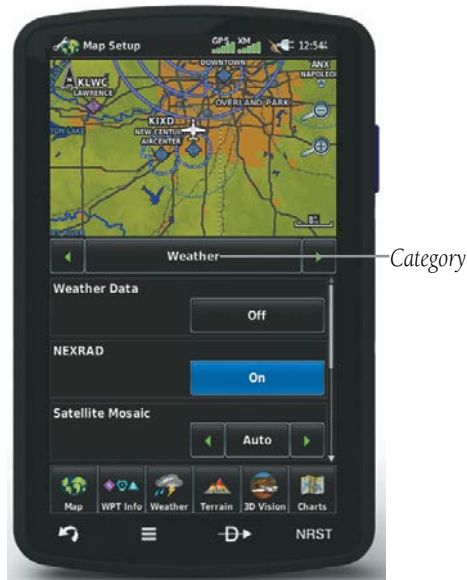

**Map Setup (Weather Category)**

**Restoring default weather data for the Navigation Map:**

- 1) From the **Main Menu**, touch **Map > Menu > Set Up Map**.
- 2) Touch the **◀▶** buttons until the '**Weather, FIS-B Weather, or XM Weather**' Category is displayed.
- 3) Touch **Menu**.
- 4) Touch the '**Restore Weather Defaults**' menu option.

**Viewing legends for displayed weather products:**

- 1) From the **Main Menu**, touch the **Map** Icon.  
**Or:**
  - a) From the '**Home**' Screen, touch the **Weather** Icon.
  - b) Touch the desired second-level weather icon.
- 2) Press the **Menu** Icon.
- 3) Touch the '**Weather Legend**' menu option.
- 4) If desired, touch the **◀▶** buttons until the desired legend is displayed.  
**Or:**  
 Touch the **Back** Icon to return to the map.

### Animating weather:

- 1) From the **Main Menu**, touch **Map** (weather must be enabled).  
**Or:**
  - a) From the **Main Menu**, touch **Weather**; select NEXRAD.
- 2) Touch **Menu**.
- 3) Touch '**Animate Weather**' menu option.

## 4.2 TERRAIN



---

**WARNING:** Do not use Terrain information for primary terrain avoidance. Terrain information is intended only to enhance situational awareness.

---



---

**NOTE:** Terrain depicted in the Profile View is always “ahead” of the aircraft, and will change as ground track changes.

---

The Terrain function displays altitudes of terrain and obstructions relative to the aircraft position and altitude with reference to a database that may contain inaccuracies. Terrain and obstructions are shown only if they are in the database. Terrain and obstacle information should be used as an aid to situational awareness. They should never be used to navigate or maneuver around terrain.

Note that all obstructions may not be available in the terrain and obstacle database. No terrain and obstacle information is shown without a valid 3-D GPS position.

The aera 795/796 GPS receiver provides the horizontal position and altitude of the aircraft. Aircraft GPS altitude is derived from satellite position. GPS altitude is then converted to a mean sea level (MSL)-based altitude (GPS-MSL altitude) and is used to determine terrain and obstacle proximity. GPS-MSL altitude accuracy is affected by satellite geometry, but is not subject to variations in pressure and temperature that normally affect pressure altitude sensors. GPS-MSL altitude does not require local altimeter settings to determine MSL altitude. It is a widely-used MSL altitude source.

Terrain and obstacle databases are referenced to MSL. Using the GPS position and altitude, the Terrain feature portrays a 2D picture of the surrounding terrain and obstacles relative to the position and altitude of the aircraft. GPS position and GPS-MSL altitude are used to calculate and predict the aircraft's flight path in relation to the surrounding terrain and obstacles. In this way, the pilot can view predicted dangerous terrain and obstacle conditions.

Alert windows appear to inform the pilot of proximity to the terrain and obstacles, as well as an unsafe descent rate. These alerts depend on user-defined parameters in the Terrain Setup.

## **TERRAIN INFORMATION**

Two views are displayed by the Terrain function: the Map View, and the Profile View. The areas of the terrain shaded red are predicted to be within 100 feet below or above the aircraft. The yellow terrain areas are between the user-defined Caution Elevation and 100 feet below the aircraft. By default, the Caution Elevation is 1,000 feet; therefore, the areas in yellow are between 1,000 feet and 100 feet below the aircraft. The black areas are further than the Caution Elevation. A projected point of impact is marked with an "X" symbol.

## **OBSTACLE INFORMATION**

Obstacles are shown on the Terrain Map View, at or below the map range of 12 nm. Obstacles are also shown on the Navigation Map when the map range is set to 5 nm or below.

Standard aeronautical chart symbols are used for lighted or unlighted obstacles taller than 200 feet Above Ground Level (AGL). Refer to the Obstacle Icons legend below.

When selecting an obstacle with the Map Pointer, each obstacle displays the altitude at the top of the obstacle, or Mean Sea Level (MSL). Each obstacle also lists the actual height of the obstacle, or Above Ground Level (AGL).

Unlighted Obstacle		Lighted Obstacle		Potential Impact Points	Obstacle Location
< 1000' AGL	> 1000' AGL	< 1000' AGL	> 1000' AGL		
					WARNING: Red obstacle is above or within 100' below current aircraft altitude
					CAUTION: Yellow obstacle is between 100' and 1000' below current aircraft altitude

## MAP STATUS ICONS

These icons will appear in the upper right corner of the map to show what obstacles are represented on the map.

Icon	Description
	Point Obstacles such as buildings, towers, and radio masts
	Wire Obstacles such as power lines
	Terrain shading is active with valid GPS position
	Terrain shading is active with invalid GPS position

## TERRAIN AND OBSTACLE COLOR CODE

Red—terrain or obstacle is above or within 100 feet below the aircraft.

Yellow—terrain or obstacle is between the user-defined Caution Elevation and 100 feet below the aircraft.

### Enabling/Disabling Terrain Shading on the Navigation Map:

- 1) From the **Main Menu** touch the **Map** Icon.
  - 2) Touch **Menu**.
    - a) Touch the '**Show/Hide...**' menu option.
    - b) Touch the **Terrain 'Show/Hide'** Button to toggle the terrain overlay **On/Off**.
- Or:**
- a) Touch the '**Set Up Map**' menu option.
  - b) Touch the  buttons until the '**Map**' Category is displayed.
  - c) Touch the **Terrain Shading** Field.
  - d) Touch the **On/Off** Button.

## TERRAIN VIEWS

Two terrain views can be displayed: 'Map with Profile' or 'Map Only'.

### Changing the terrain view:

- 1) From the **Main Menu** touch the **Terrain** Icon.
- 2) Touch the **Menu** Icon.
- 3) Touch the '**Select Page Layout**' menu option. An option menu is displayed.
- 4) Touch the desired menu option ('**Map with Profile**' or '**Map Only**').



Terrain Map

## TERRAIN ALERTS & SETUP

### Enabling/Disabling terrain alerts:

- 1) From the **Main Menu** touch the **Terrain** Icon.
- 2) Touch the **Menu** Icon.
- 3) Touch the '**Enable Alerts**' or '**Disable Alerts**' menu option.

Use the Terrain Setup Menu to set levels for terrain alerts as well as obstacles in or near your flight path.

- **Caution Elevation**—The aera 795/796 will provide an alert if the terrain or obstacle is within the default Caution Elevation or user-defined Caution Elevation.



- **Look Ahead Time**—Determines the maximum time when an alert annunciation occurs. For example, if 120 seconds is selected, the aera 795/796 provides an alert up to 120 seconds before you reach the terrain or obstacle.
- **Alert Sensitivity**—The three Alert Sensitivity settings (Terrain, Obstacle, and Descent Rate) determine what level of alerts are annunciated. The aera 795/796 defaults to 'High' sensitivity, which annunciates all red and yellow alerts at the time set in Look Ahead Time. 'Medium' sensitivity annunciates all of the red and the highest priority of yellow alerts. 'Low' only annunciates red alerts. 'Off' disables the alert.



### Setting the Caution Elevation:

- 1) From the **Main Menu** touch the **Terrain** Icon.
- 2) Touch the **Menu** Icon.
- 3) Touch the '**Set Up Terrain**' menu option.
- 4) Touch the 'Caution Elevation' Datafield Button and select the desired caution elevation from the list ('**500ft Below**', '**750ft Below**', and '**1000ft Below**').

### Setting the Look Ahead Time:

- 1) From the **Main Menu** touch the **Terrain** Icon.
- 2) Touch the **Menu** Icon.
- 3) Touch the '**Set Up Terrain**' menu option.
- 4) Touch the 'Look Ahead Time' Datafield Button and select the desired Look Ahead Time from the list ('**60 Seconds**', '**90 Seconds**', and '**120 Seconds**').

### Adjusting the Alert Sensitivity:

- 1) From the **Main Menu** touch the **Terrain** Icon.
- 2) Touch the **Menu** Icon.
- 3) Touch the '**Set Up Terrain**' menu option.
- 4) Touch the   buttons to cycle through the list of available sensitivity settings (**Off**, **Low**, **Medium**, or **High**) for Terrain Alerts, Obstacle Alerts, and Descent Rate.

Terrain, Obstacle, and Descent Rate Alerts are issued when flight conditions meet parameters that are set within the software algorithms. Terrain alerts typically employ a CAUTION or a WARNING alert severity level, or both. When an alert is issued, visual annunciations are displayed and aural alerts are simultaneously issued. When the aircraft descends through 500 feet above the destination airport an audible “Five Hundred” altitude reminder occurs.

The Terrain Alert Annunciation is shown to the lower left corner of the screen. If the Terrain Map is not displayed, a pop-up alert appears. The Range Rings on the pop-up alert are spaced every whole mile/kilometer/nautical mile. Touch the Terrain Alert Annunciation to acknowledge the pop-up and/or aural alert.

## AURAL ALERTS

- “Five Hundred”—when the aircraft descends through 500 feet above the destination airport.

The following aural terrain alerts are issued when flight conditions meet parameters that are set within the software algorithms, and are dependant on the sensitivity level set in the Terrain Setup Menu.

Alert	Terrain	Obstacle	Descent Rate
<b>Caution</b>	“caution, terrain” “caution, terrain ahead”	“caution, obstacle” “caution, obstacle ahead”	“caution, sink rate”
<b>Warning</b>	“terrain ahead! pull up!” “terrain! terrain! pull up! pull up!”	“obstacle ahead! pull up!” “obstacle! obstacle! pull up! pull up!”	“sink rate, pull up!” “pull up!”

Aural Alerts Summary

### Adjusting terrain alert audio:

- 1) From the **Main Menu**, touch **Tools > Setup > Sound**.
- 2) Touch the **Terrain Audio On/Off** Button to toggle the terrain audio on/off, or touch the **Alerts**  icon to mute both Terrain and TIS-A alerts.

**Or:**

Touch the **Alerts**  buttons to select an alert volume (0-10).

## 4.3 TRAFFIC

### TRAFFIC SOURCE

The aera 795/796 is compatible with two different traffic sources: TIS-A traffic via a compatible Garmin Mode S Transponder, or ADS-B/TIS-B traffic via a compatible ADS-B device. If more than one traffic source is configured, the current traffic source is annunciated in the upper left corner of the Traffic Page.

- If the compatible transponder is not receiving TIS-A traffic data, ADS-B traffic will be displayed.
- If the compatible ADS-B device is receiving both air-to-air ADS-B traffic data and ground uplink TIS-B traffic, then the ADS-B traffic will be displayed.
- If the compatible transponder is receiving TIS-A traffic, and the compatible ADS-B device is not receiving ground uplink TIS-B traffic, then TIS-A traffic will be displayed.

If more than one traffic source is configured, the current traffic source is annunciated in the upper left corner of the Traffic Page.

Traffic Source	Description
<b>GTX TIS-A Operating</b>	Displaying TIS-A traffic from a Mode S transponder.
<b>GDL ADS-B Operating Normal</b>	Displaying ADS-B/TIS-B traffic from a compatible device.

### TRAFFIC INFORMATION SERVICE (TIS-A)





**NOTE:** Refer to Appendix F for general information regarding TIS-A. Refer to Appendix D for configuration information.

The aera 795/796 supports TIS-A input from a Garmin Mode S transponder.

## TIS-A SYMBOLOGY

TIS-A traffic is shown according to TCAS symbology, graphically shown on the Navigation Map, and in the Traffic Warning Window. A Traffic Advisory (TA) symbol appears as a solid yellow circle. All other traffic is shown as a hollow white diamond. Altitude deviation from own aircraft altitude is shown above the target symbol if traffic is above own aircraft altitude, and below the symbol if they are below own aircraft altitude. Altitude trend is shown as an up arrow ( $>+500$  ft/min), down arrow ( $<-500$  ft/min), or no symbol if less than 500 ft/min rate in either direction.

TIS-A Symbol	Description
	Traffic Advisory (TA)
	Other Traffic

TIS-A Traffic Symbols

## TIS-A ALERTS

A TIS-A audio alert is generated whenever the number of Traffic Advisories on the aera 795/796 screen increases from one scan to the next. Limiting Traffic Advisories only reduces the “nuisance” alerting due to proximate aircraft. For example, when the first Traffic Advisories appear on the TIS-A display, the user is alerted audibly. So long as a single aircraft remains on the TIS-A display, no further audio alert is generated. If a second (or more) aircraft appears on the screen, a new audio alert is sounded.

If the number of Traffic Advisories on the TIS-A display decreases and then increases, a new audio alert is sounded. The TIS-A audio alert is also generated whenever TIS-A service becomes available. The following TIS-A audio alerts are available:

- “Traffic”—TIS-A traffic alert received.
- “Traffic Not Available”—TIS-A service is not available or out of range.



## Disabling/Enabling the traffic alerts:



**NOTE:** Traffic alerts are reset to 'enabled' on the next power cycle.

- 1) From the **Main Menu**, touch **Traffic**.
- 2) Touch **Menu > Disable/Enable Alerts**.

### Adjusting alert volume:

- 1) From the **Main Menu**, touch **Tools > Setup > Sound**.
- 2) Touch the **Traffic Audio On/Off** Button to toggle the terrain audio **On/Off**, or touch the **Alerts**  Icon to mute both TIS and Terrain alerts.  
**Or:**  
Touch the **Alerts**  buttons to select an alert volume (0-10).

## TRAFFIC WARNING WINDOW

The Traffic Warning Window is shown when a compatible ADS-B device issues a traffic advisory (TA). The Traffic Warning Window shows a small pop-up thumbnail map in the lower left corner. The Range Rings on the pop-up alert are spaced every whole mile/kilometer/nautical mile. Touch the Traffic Warning Window to acknowledge and remove it.



**NOTE:** The Traffic Warning Window is disabled when the aircraft ground speed is less than 30 knots or when on the approach leg of a route.

## TRAFFIC GROUND TRACK

Traffic ground track is indicated on the aera 795/796 screen by a "target track vector", a short line shown in 45-degree increments, extending in the direction of target movement.

## DISPLAYING TRAFFIC DATA

TIS-A traffic can be displayed on the Navigation Map.

### Enabling/disabling traffic data on the Map Page:

- 1) From the **Main Menu** touch **Map**.
- 2) Touch **Menu**.

3) Touch the **'Show/Hide...'** menu option.

4) Touch the **Traffic 'Show/Hide'** Button.

**Or:**

1) From the **Main Menu** touch **Map**.

2) Touch **Menu**.

3) Touch the **'Set Up Map'** menu option.

4) Touch the buttons to select the **Traffic** Category.

5) Touch **Traffic Data On/Off** Button to toggle the traffic data On/Off.

### Displaying TIS-A information using the map pointer:

With traffic displayed on the Navigation Map, touch the desired TIS-A symbol on the map. The traffic type and altitude separation are displayed.



TIS-A (Navigation Map)

## DATA LINK TRAFFIC

The following compatible devices are designed to receive, process, and output traffic (ADS-B air-to-air, and TIS-B traffic information), and weather (Flight Information Service-Broadcast (FIS-B)) information to the aera 795/796 through a power/data cable.

Compatible ADS-B Devices
GDL 39/39R
GDL 39-3D
GTX 345/345R/45R
GNX 375
GDL 50/50R
GDL 52/52R

ADS-B (Automatic Dependent Surveillance-Broadcast) is a surveillance technology deployed across the United States as the cornerstone of the FAA’s Next Generation Air Transportation System (NextGen). ADS-B enables improved surveillance services, both air-to-air and air-to-ground, especially in areas where radar is ineffective due to terrain or where it is impractical or cost prohibitive. Initial applications of air-to-air ADS-B are for “advisory” use only, enhancing a pilot’s visual acquisition of other nearby ADS-B equipped aircraft either when airborne or on the airport surface.

For the purpose of distinguishing between levels of ADS-B service, there are three classifications of aircraft or system capability; ADS-B In, ADS-B Out, and ADS-B participating. ADS-B In refers to the capability to receive ADS-B information. ADS-B Out refers to the capability to transmit ADS-B information. ADS-B participating refers to the capability to both send and receive ADS-B information. Aircraft lacking either ADS-In, ADS-B Out, or both ADS-B capabilities may also be referred to as ADS-B non-participating aircraft.

Currently, rule-compliant ADS-B Out capability in the United States requires a TSO'ed SBAS-enabled GPS, such as a Garmin GPS 400W or similar, and one of two possible data links: 1090 ES transponder or a 978 MHz UAT. Either data link system is capable of transmitting the aircraft's position, velocity, identification, and other information every second to compatible aircraft and ground stations called Ground Based Transceivers (GBTs).

Because 1090 ES transponders and UATs operate on different frequencies, aircraft not similarly equipped cannot transmit/receive data link information directly to/from each other. Instead, operation within range of a GBT is required to receive data link information on both frequencies. The compatible ADS-B devices are unique in their ADS-B In capability since they can receive data link information from both 1090 ES transponders and UATs.

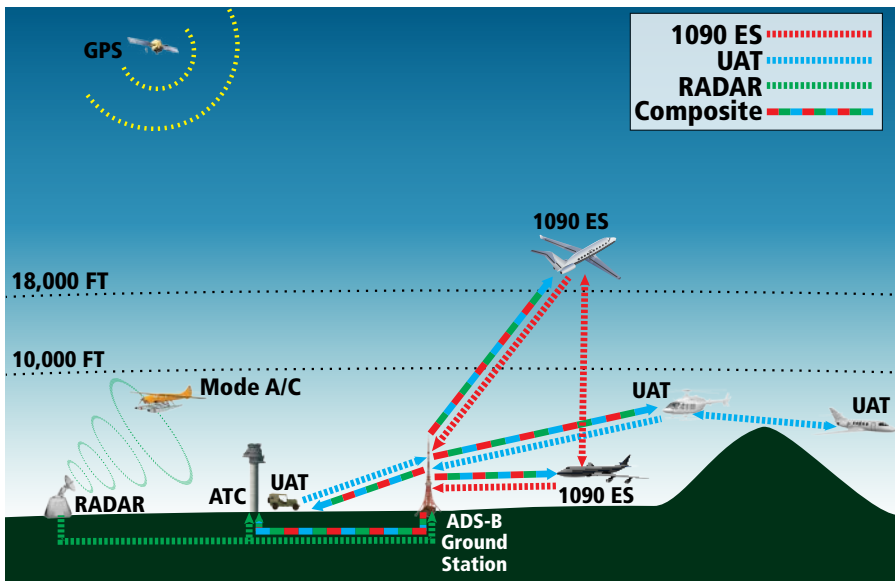

ADS-B System



Thus, the compatible ADS-B device receives traffic information directly from any ADS-B Out aircraft within range as well as the rebroadcast of ADS-B information from any nearby GBT. This rebroadcast is called Automatic Dependent Surveillance-Rebroadcast (ADS-R) and is automatically triggered by the detection of an ADS-B participating aircraft within the service volume of the GBT. As a 978 MHz (UAT frequency) receiver, the compatible device can receive both the Traffic Information Service-Broadcast (TIS-B) and Flight Information Service-Broadcast (FIS-B) provided in conjunction with ADS-R services when in range of a GBT.

FIS-B service is provided continuously, but ADS-R including TIS-B will only be broadcast by a GBT when an ADS-B participating aircraft is within the GBT's defined service volume. In this case, a GBT will only rebroadcast TIS-B information relative to the ADS-B participating aircraft.

**Only traffic that is within 15 nm lateral and 3,500' vertical of the ADS-B participating aircraft is provided in the broadcast.** Non-participating traffic aircraft located farther than 15 nm laterally and 3,500' vertically from the participating aircraft is are excluded from the information transmitted by the GBT.

TIS-B traffic information includes non-participating aircraft detected by ATC surveillance radar. As TIS-B data is derived from ATC surveillance radar data, TIS-B traffic position updates typically occur every three to thirteen seconds. **Therefore, TIS-B traffic may be displayed with degraded positional accuracy. Aircraft without operating transponders are invisible to TIS-B. Aircraft operating outside of the ATC radar coverage area are also not displayed.**

Since the compatible ADS-B device is receive only, even when used onboard an aircraft equipped with a qualifying GPS and 1090 ES transponder, a GBT may not identify the device as an ADS-B participating aircraft. The squitter of some 1090 ES transponders must be configured to communicate the aircraft has 978 MHz receive capability in order to be identified as an ADS-B participating aircraft.



**WARNING:** *Do not rely solely upon the display of traffic information for collision avoidance maneuvering. The traffic display does not provide collision avoidance resolution advisories and does not under any circumstances or conditions relieve the pilot's responsibility to see and avoid other aircraft.*



**WARNING:** Do not rely solely upon the display of traffic information to accurately depict all of the traffic within range of the aircraft. Due to lack of equipment, poor signal reception, and/or inaccurate information from aircraft or ground stations, traffic may be present that is not represented on the display.

**Viewing Traffic and Weather Status:**

- 1) From the **Main Menu** touch the **Tools** Icon.
- 2) From the **Tools** menu touch **Data Link**.

**Or:**

- 1) From the **Main Menu** touch the **Weather** Icon.
- 2) Touch **Menu > Information**.
- 3) Touch **Menu > Data Link Info**.



**Or:**

- 1) From the **Main Menu** touch the **Traffic** Icon.
- 2) Touch **Menu > Information**.

**SYSTEM STATUS**

The traffic system status is annunciated in the upper right corner of the Map Page, as well as the lower left corner of the dedicated Traffic Page.

Traffic Icon	System Status
	<p>Full traffic services available for an ADS-B participating aircraft (ground linked TIS-B, FIS-B and ADS-R, and Air-to-Air ADS-B). If you are using a compatible ADS-B device on a non-participating aircraft, you may still see this when you are within the service area of any participating aircraft. As a non-participating aircraft, you are only receiving TIS-B traffic information for traffic within 15 nm and 3,500' of the participating aircraft.</p>

Traffic Icon	System Status
	Limited traffic services available (may be limited to Air-to-Air ADS-B)
	No Traffic Data Available

The compatible ADS-B device may also have pressure altitude sensors to aid in displaying the relative altitude of received traffic information. If a compatible ADS-B device is used onboard a pressurized aircraft, the pressure altitude sensor should be turned off.

**Configuring a compatible ADS-B device for Pressurized or Non-Pressurized Aircraft:**













- 1) From the **Main Menu** touch the **Tools** Icon.
- 2) From the **Tools** menu touch **Data Link**.
- 3) Touch **Menu > Device Pressurization**.
- 4) Touch **Aircraft Type** (Pressurized or Not Pressurized).

**Or:**

- 1) From the **Main Menu** touch the **Traffic** Icon.
- 2) Touch **Menu > Information > Menu > Device Pressurization**.
- 3) Touch **Aircraft Type** (Pressurized or Not Pressurized).

**TRAFFIC DESCRIPTION**

ADS-B traffic operation is similar to TIS-A discussed previously, but ADS-B adds additional symbology and capabilities. The symbols used to display ADS-B traffic are shown in the table below. The traffic identifier and altitude are displayed below the traffic symbol. A small up or down arrow next to the traffic symbol indicates the traffic is climbing or descending at a rate of at least 500 feet per minute. The vector line that extends from the traffic symbol is just further indication of the intruder aircraft track. For directional traffic symbols, the arrow head points in the direction of aircraft's ground track.

Symbol	Description
	Non-threat, non-directional airborne traffic
	Non-threat directional airborne Traffic with track vector. Points in the direction of the aircraft track.
	Non-directional airborne Proximity Advisory (PA). Proximity Advisories are issued for any traffic within 6 nautical miles and +/- 1,200'.
	Directional airborne Proximity Advisory (PA) with track vector. Points in the direction of the aircraft track. Proximity Advisories are issued for any traffic within 6 nautical miles and +/- 1,200'.
	Non-directional airborne Traffic Advisory (TA)
	Non-directional off-scale airborne Traffic Advisory (TA). Displayed at outer range ring at proper bearing.
	Directional airborne Traffic Advisory (TA) with track vector. Points in the direction of the aircraft track.
	Directional off-scale airborne Traffic Advisory (TA). Points in the direction of the aircraft track.
	*Ground traffic without directional information. Ground traffic is only displayed when own aircraft is below 1,500 feet AGL or on the ground.
	*Directional surface traffic. Ground traffic is only displayed when own aircraft is below 1,500 feet AGL or on the ground.
	*Non-directional non-aircraft ground traffic. Ground traffic is only displayed when own aircraft is below 1,500 feet AGL or on the ground.
	*Directional non-aircraft ground traffic. Ground traffic is only displayed when own aircraft is below 1,500 feet AGL or on the ground.
*Ground traffic is only displayed on the Map Page when the aircraft is on the ground or below 1,500 feet AGL. Ground traffic is always displayed on the dedicated traffic page.	

## TRAFFIC ADVISORIES (TA)

The compatible ADS-B device automatically adjusts the Traffic Advisory (TA) sensitivity level to reduce the likelihood of nuisance TA alerts during various phases of flight. TAs are issued for traffic when they are predicted to be within a specified volume of airspace around your aircraft in a specified amount of time. The protected volume and time interval varies based on the current geodetic altitude and groundspeed. Thus, the protected volume of airspace increases with altitude and ground speed. Refer to the following table for details.

Altitude (Geodetic)	Look Ahead Time (sec.)	Vertical Separation (ft.)	Horizontal Separation (nm.)
Below 5,000	30	+/-850	.35
5,000-10,000	40	+/-850	.55
10,000-20,000	45	+/-850	.80
20,000-42,000	48	+/-850	1.10
Above 42,000	48	+/-1,200	1.10

## TRAFFIC ALERTS (ADS-B TIS-B)

A traffic audio alert is generated whenever the number of Traffic Advisories on the aera 795/796 display increases. Limiting Traffic Advisories only reduces the “nuisance” alerting due to proximate aircraft. For example, when the first Traffic Advisories appear on the display, the user is alerted audibly. So long as a single aircraft remains on the display, no further audio alert is generated. If a second (or more) aircraft appears on the screen, a new audio alert is sounded. Traffic Advisories can only be issued when the compatible ADS-B device knows its own altitude and the altitude of the intruder aircraft.

If the number of Traffic Advisories on the traffic display decreases and then increases, a new audio alert is sounded. The traffic audio alert is also generated whenever TIS-B service becomes available. The following traffic audio alerts are available:

- “Traffic”—TIS-B/ADS-B traffic alert received.
- “Traffic Not Available”—TIS-B/ADS-B service is not available or out of range.

## Disabling/Enabling the traffic alerts:



**NOTE:** Traffic alerts are reset to 'enabled' on the next power cycle.

- 1) From the **Main Menu**, touch **Traffic**.
- 2) Touch **Menu > Disable/Enable Alerts**.

### Adjusting alert volume:

- 1) From the **Main Menu**, touch **Tools > Setup > Sound**.
- 2) Touch the **Traffic Audio On/Off** Button to toggle the traffic audio on/off, or touch the **Alerts**  Icon to mute both Traffic and Terrain alerts.

**Or:**

Touch the **Alerts**  buttons to select an alert volume (0-10).

## TRAFFIC WARNING WINDOW

The Traffic Warning Window is shown when the compatible ADS-B device issues a traffic advisory (TA). The Traffic Warning Window shows a small pop-up thumbnail map in the lower left corner. The Range Rings on the pop-up alert are spaced every whole mile/kilometer/nautical mile. Touch the Traffic Warning Window to acknowledge and remove it.



Traffic Warning Window (Navigation Map)

## DISPLAYING TRAFFIC DATA

Traffic is displayed by default on the Map Page and in the Traffic Warning Window. Traffic Symbol and Traffic Label (i.e., relative altitude, altitude trend and absolute motion vectors) settings selects the maximum range at which traffic labels or symbols are shown. Traffic Labels can also be turned off.



### Enabling/disabling traffic data on the Map Page:

- 1) From the **Main Menu** touch the **Map** Icon.
- 2) Touch **Menu**.
- 3) Touch the '**Show/Hide...**' menu option.
- 4) Touch the **Traffic 'Show/Hide'** Button.

### Or:

- 1) From the **Main Menu** touch the **Map** Icon.
- 2) Touch **Menu**.
- 3) Touch the '**Set Up Map**' menu option.
- 4) Touch the  buttons to select the **Traffic** Category.
- 5) Touch **Traffic Data On/Off** Button to toggle the traffic data on/off.

### Customizing the traffic data on the Map Page:

- 1) From the **Main Menu** touch the **Map** Icon.
- 2) Touch **Menu**.
- 3) Touch the '**Set Up Map**' menu option.
- 4) Touch the  buttons to select the **Traffic** Category.
- 5) For Traffic Symbol or Traffic Label, touch the  buttons to select the desired settings ('**Off**', '**Auto**', or range settings).

### Displaying Traffic information using the map pointer:

With traffic displayed on the Navigation Map, touch the desired Traffic symbol on the map. The traffic's aircraft ID, type, altitude, closure rate, ground track, and groundspeed are displayed.



Traffic (Map Page)

## DEDICATED TRAFFIC PAGE (TRF)

Altitude filter settings from the Traffic Page are carried to the Map Page.

### Viewing the Traffic Page:

- 1) From the **Main Menu** touch the **Traffic** icon.

### Changing the altitude range:

- 1) On the Traffic Page, select the **Menu > Altitude Filter**.
- 2) Select one of the following:
  - **Unrestricted:** All traffic is displayed.
  - **Normal:** Displays non-threat and proximity traffic from 2700 feet above the aircraft to 2700 feet below the aircraft. Typically used during enroute phase of flight.



- **Above:** Displays non-threat and proximity traffic from 9000 feet above the aircraft to 2700 feet below the aircraft. Typically used during climb phase of flight.
- **Below:** Displays non-threat and proximity traffic from 2700 feet above the aircraft to 9000 feet below the aircraft. Typically used during descent phase of flight.

### FLIGHT ID DISPLAY

The Flight IDs of other aircraft (when available) can be displayed on the Traffic Page. When a Flight ID or call sign is received, it will appear below the corresponding traffic symbol when enabled.



Example ADS-B Traffic Symbol

### Enabling/Disabling Flight ID Display:

On the Traffic Page, select **Menu > Enable/Disable Target Identifiers**.



Traffic Page (with a compatible ADS-B device)

## MOTION VECTORS

There are two pilot-selectable and mutually exclusive types of motion vectors, Absolute and TargetTrend, which are differentiated by color and function. Absolute vectors are white and indicate ground track as reported by the traffic. TargetTrend vectors are green and indicate the flight path and position, relative to your aircraft, at which the traffic will be after the passing of one of four predetermined time intervals. The end of the TargetTrend vector indicates the traffic's predicted location relative to your predicted location at the end of the look-ahead time. For example, if traffic is ahead of you and traveling along the same track but at a slower rate, the motion vector would point opposite of its indicated direction of flight showing that you are overtaking the traffic.



**TargetTrend™ (with a compatible ADS-B device)**

The TargetTrend look-ahead time interval is automatically adjusted from 30 seconds to five minutes and corresponds to the traffic display range setting. The greater the range setting, the longer the time interval and vice versa. Refer to the table below for more details.

Traffic Page Range Ring Settings	TargetTrend Look-ahead
.5nm to 2nm	30 seconds
2nm to 6nm	60 seconds
6nm to 12nm	2 minutes
12nm to 40nm	5 minutes

Motion vector selection is made from the Traffic Page Menu by enabling/disabling TargetTrend. Absolute vectors are selected by default and are replaced when TargetTrend is enabled.

### Enabling/Disabling TargetTrend:

On the Traffic Page, select **Menu > Enable/Disable TargetTrend**.

## SECTION 5 ADDITIONAL FEATURES



**NOTE:** With the availability of SafeTaxi and FliteCharts in electronic form, it is still advisable to carry another source of charts on board the aircraft.

The following additional features are included with the aera 795 and/or 796 depending on the unit.

Additional Features	Unit			
	aera 796	aera 795 Americas	aera 795 Atlantic	aera 795 Pacific
3D Vision	+	+	+	+
Airport Directory	+	+	+	+
Chart View	+	+	+	+
FliteCharts®	+	+		
European FliteCharts®			+	
VFR/IFR Chart Viewing	+	+		
SafeTaxi®	+	+	+	
SiriusXM®	+			
Electronic Checklists	+	+	+	+

### 5.1 3D VISION

3D Vision provides a three-dimensional view of terrain features as seen from outside the aircraft. 3D Vision imagery shows the relevant features in relation to the aircraft.



**WARNING:** Use appropriate systems for navigation, and for terrain, obstacle, and traffic avoidance. 3D Vision does not provide either the accuracy or reliability upon which to base decisions and/or plan maneuvers to avoid terrain, obstacles, or traffic.

3D Vision is a visual enhancement to the aera 795/796. 3D Vision depicts the topography as seen from outside the aircraft. The depicted imagery is derived from the aircraft's three-dimensional position, and databases of terrain, obstacles, and other relevant features. Loss of the GPS signal, will cause 3D Vision to be disabled until it is restored.

The 3D Vision terrain display shows land contours (colors are consistent with those of the topographical map display), large water features, towers, and other obstacles over 200' AGL that are included in the obstacle database (if present). Cultural features on the ground such as roads, highways, railroad tracks, cities, and state boundaries are not displayed even if those features are found on the Navigation Map. The terrain display also includes a north-south east-west grid with lines oriented with true north.

Terrain is integrated within 3D Vision to provide visual and auditory alerts to indicate the presence of terrain and obstacle threats relevant to the projected flight path. Terrain alerts are displayed in red and yellow shading.

When the aera 795/796 is connected to a compatible attitude device, the 3D Vision mode also shows the aircraft's attitude. The 3D view of the terrain and horizon will reflect pitch and roll, and the 3D Vision mode will also show a slip/skid indicator.



---

**WARNING:** *The attitude information provided by the GDL 51/52 is not intended to be used as a source of attitude information for flight in instrument meteorological conditions (IMC) and should not be used under these conditions.*

---

3D Vision does not provide the accuracy or fidelity on which to base decisions and plan maneuvers to avoid terrain or obstacles. Navigation should not be predicated upon the use of the terrain or obstacle data displayed by 3D Vision.

Touch and drag the three-dimensional view to change the perspective.

## 3D VISION OPERATION

---

3D Vision is accessed from the **Main Menu**.

### Viewing 3D Vision:

From the **Main Menu**, touch **3D Vision**

### Show/Hide 3D Vision Tapes:

From the **Main Menu**, touch **3D Vision** > **Menu** > **Show/Hide Tapes**.

### Selecting 3D Vision Page Layout:

From the **Main Menu**, touch **3D Vision** > **Menu** > **Select Page Layout**

### Setting the 3D Vision Bug Indicator:

From the **Main Menu**, touch **3D Vision** > **Menu** > **Set Bug Indicator**

### Resetting the 3D Vision Aircraft Attitude:

From the **Main Menu**, touch **3D Vision** > **Menu** > **Reset Pitch/Roll**  
(feature available when connected to an attitude source)

### Changing the information shown in the data fields:

- 1) With the Data Fields shown on the Navigation Map and the '3D Vision with Map' layout selected, from the **Main Menu**, touch **3D Vision** > **Menu** > **Change Data Fields**.
- 2) Touch the desired Data Field to change. A list of available Data Fields is displayed.
- 3) Touch the desired Data Field Option.
- 4) Touch **OK**. The changes made will be mirrored on the Navigation Map.



3D Vision









3D Vision with attitude capabilities

Slip/skid  
ball

## 5.2 AIRPORT DIRECTORY DATA

The Airport Directory contains airport statistics such as pattern altitudes, noise abatement information, FBO phone numbers, hours of operation, local attractions, ground transportation, lodging, and services.



### Viewing Airport Directory information:

- 1) From the **Main Menu**, touch **WPT Info** > **AOPA/Directory** Tab.
  - 2) Touch the Waypoint Identifier Button.
  - 3) Enter the desired waypoint:
    - a) Touch the   buttons to display the desired search option on the 'Search' Button ('**Search by Identifier**', '**Search by Facility Name**', '**Search by City**', '**Search by Address**' (only available with the optional City Navigator data), or '**Search by Crossroads**' (only available with the optional City Navigator data).
    - b) Touch the 'Search' Button (between the  .
    - c) Enter the desired data using the keypad. If duplicate entries are displayed, touch the desired duplicate from the list.
    - d) Touch **OK**.
- Or:**
- a) Touch the   buttons to cycle through the waypoint categories ('**Flight Plan Waypoints**', '**Nearest Airports**', or '**Recent Waypoints**').
  - b) Touch the desired waypoint from the list.
- Or:**
- 1) From the Navigation Map, Weather map, Terrain Map, VFR/IFR Charts, or Helicopter Chart, highlight an airport using the Map Pointer.
  - 2) Touch the Map Feature Button.
  - 3) Touch the **AOPA/Directory** Tab (if necessary).

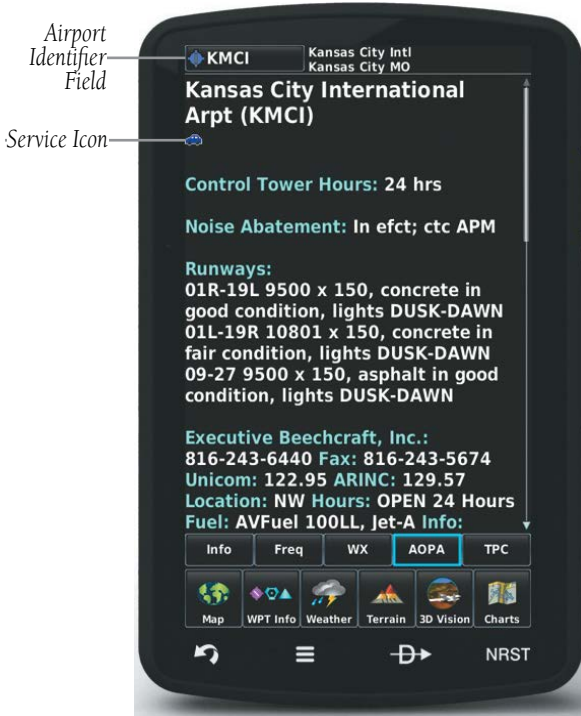



**Airport Directory Data**

Icon	Description
	Restaurant on Field
	Self Serve Fuel
	Courtesy Car

## 5.3 CHARTVIEW



**NOTE:** *Either ChartView or FliteCharts may be used at one time, but not both.*

ChartView resembles the paper version of Jeppesen terminal procedure charts. The aircraft position is displayed on the moving map in the plan view of the approach charts and on airport diagrams.

The geo-referenced aircraft position is indicated by an aircraft symbol displayed on the chart when the current position is within the boundaries of the chart. Inset boxes are not considered within the chart boundaries. Therefore, when the aircraft symbol reaches a chart boundary line, or inset box, the aircraft symbol is removed from the display.

The figure below, shows examples of off-scale areas, indicated by the grey shading. Note, the grey shading is for illustrative purposes only and will not appear on the published chart or display. These off-scale areas appear on the chart to convey supplemental information. However, the depicted geographical position of this information, as it relates to the chart planview, is not the actual geographic position. Therefore, when the aircraft symbol appears within one of these areas, the aircraft position indicated is relative to the chart planview, not to the off-scale area.

The ChartView database subscription is available from Jeppesen, Inc. Available data includes:

- Arrivals (STAR)
- Departure Procedures (DP)
- Approaches
- Airport Diagrams
- NOTAMs

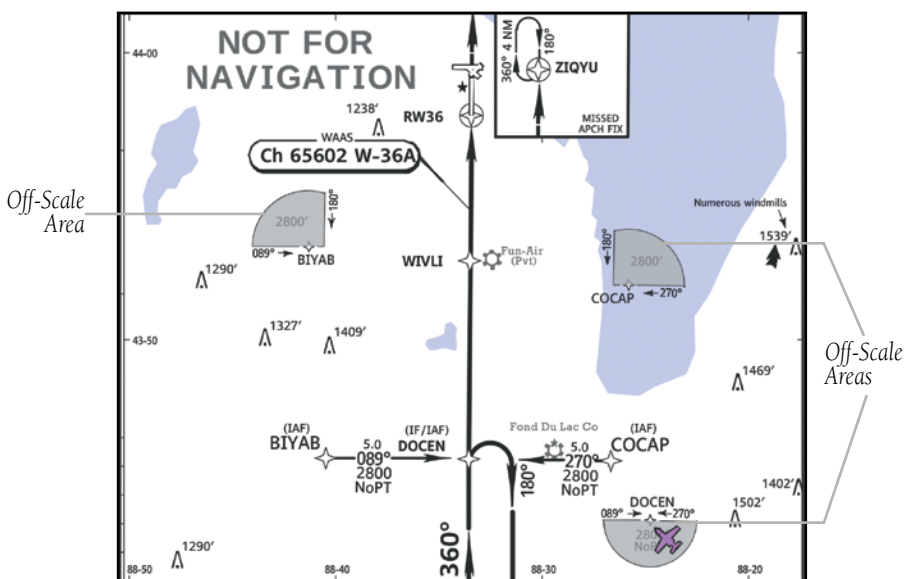

Sample Chart Indicating Off-Scale Areas

### Displaying ChartView:

- 1) From the **Main Menu**, touch **WPT Info** > **Charts** Tab (if necessary).
  - 2) Touch the Waypoint Identifier Button (top of page).
  - 3) Enter the desired waypoint:
    - a) Touch the buttons to display the desired search option on the 'Search' Button ('**Search by Identifier**', '**Search by Facility Name**', '**Search by City**', '**Search by Address**' (only available with the optional City Navigator data), or '**Search by Crossroads**' (only available with the optional City Navigator data).
    - b) Touch the 'Search' Button (between the .
    - c) Enter the desired data using the keypad. If duplicate entries are displayed, touch the desired duplicate from the list.
    - d) Touch **OK**.
- Or:**
- a) Touch the buttons to cycle through the waypoint categories ('**Flight Plan Waypoints**', '**Nearest Airports**', or '**Recent Waypoints**').

b) Touch the desired waypoint from the list.

- 4) Touch the  buttons to cycle through the available Charts or touch the Chart Field and touch the desired Chart from the vertical list.

**Or:**

- 1) From the map, highlight an airport using the Map Pointer.
- 2) Touch **Charts** (if necessary).
- 3) Touch the Map Feature Button.
- 4) Touch the  buttons to cycle through the available Charts or touch the Chart Field and touch the desired Chart from the vertical list.

### Displaying ChartView in Full Screen Mode:

- 1) From the **Main Menu**, touch **WPT Info** > **Charts** (if necessary).
- 2) With the desired chart displayed touch **Charts** again.
- 3) Touch the  icon to exit Full Screen Mode.

When a terminal procedure chart is not available for the requested airport or there is an error rendering the data, the banner "CHART NOT AVAILABLE" appears on the screen. The "CHART NOT AVAILABLE" banner does not refer to the ChartView subscription, but rather the availability of a particular airport chart selection or procedure for a selected airport.



Chart Not Available Banner

## AIRCRAFT SYMBOL

The aircraft symbol is shown in magenta on the chart only if the chart is to scale and the aircraft position is within the boundaries of the chart. The aircraft symbol is not displayed when the Aircraft Symbol Not Shown Icon (X over the aircraft symbol) appears in the lower right corner. The Aircraft Symbol Not Shown Icon may appear at certain times (e.g., a loss of GPS), even if the chart is displayed to scale.

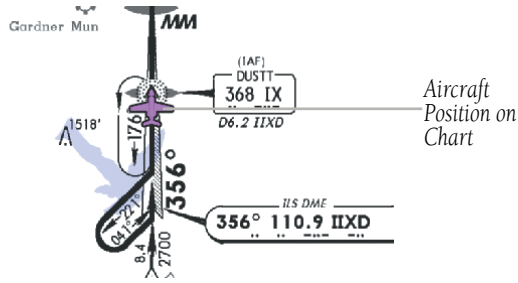

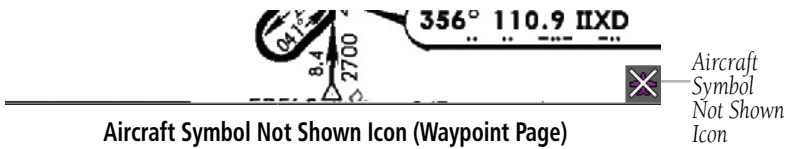

Aircraft Symbol Displayed on Chart (Waypoint Page)  
Single Display



Aircraft Symbol Not Shown Icon (Waypoint Page)

## CHART RANGE

### Changing the ChartView range:

Use the  (out) or  (in) icons to zoom 'out' (increasing), or zoom 'in' (decreasing).

Or:

Pinch fingers together (zoom out), or pull fingers apart (zoom in).

## JEPPESEN DATABASE-PUBLISHED NOTAMS



**NOTE:** Only NOTAMs for the selected airport are shown (when available). There may be other NOTAMs available pertaining to the flight that may not be displayed. Contact Jeppesen for more information regarding Jeppesen database-published NOTAMs.

Recent NOTAMs applicable to the current ChartView cycle are included in the ChartView database. If NOTAMs are available for the selected airport, a 'Chart NOTAMs' option will be displayed at the bottom of the drop-down menu of available charts. Select the 'Chart NOTAMs' option from the chart menu to display the applicable NOTAM information.

## 5.4 FLITECHARTS



**NOTE:** *Either ChartView or FliteCharts may be used at one time, but not both.*

FliteCharts resemble the paper version of National Aeronautical Charting Office (NACO) terminal procedures charts. The charts are displayed with high-resolution and in color for applicable charts.

The geo-referenced aircraft position is indicated by an aircraft symbol displayed on the chart when the current position is within the boundaries of the chart. An aircraft symbol may be displayed within an off-scale area depicted on some charts.

The figure below shows examples of off-scale areas, indicated by the grey shading. Note, these areas are not shaded on the published chart. These off-scale areas appear on the chart to convey supplemental information. However, the depicted geographical position of this information, as it relates to the chart planview, is not the actual geographic position. Therefore, when the aircraft symbol appears within one of these areas, the aircraft position indicated is relative to the chart planview, not to the off-scale area.

FliteCharts database subscription is available from Garmin. Available data includes:

- Arrivals (STAR)
- Departure Procedures (DP)
- Approaches
- Airport Diagrams
- Takeoff Minimums
- Alternate Minimums

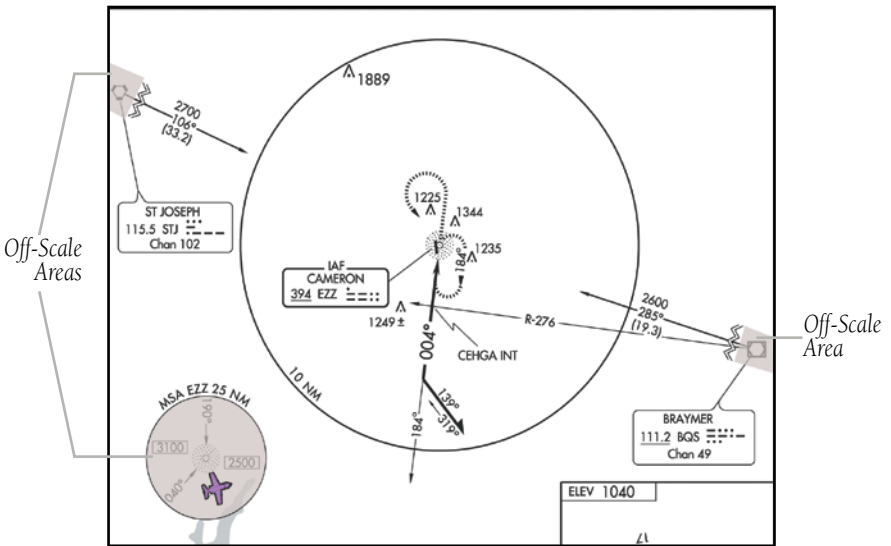
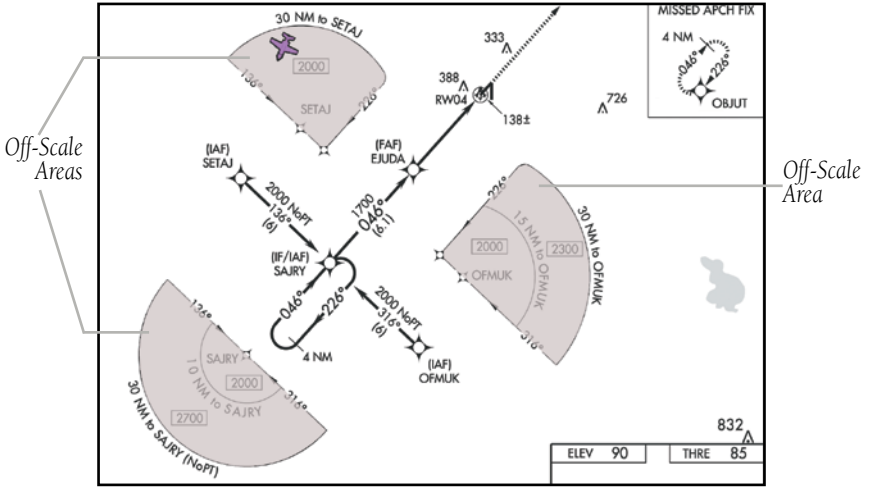



Sample Chart Indicating Off-Scale Areas





**NOTE:** Do not maneuver the aircraft based solely upon the geo-referenced aircraft symbol.

## Displaying FliteCharts:

- 1) From the **Main Menu**, touch **WPT Info** > **Charts** Tab (if necessary).
- 2) Touch the Waypoint Identifier Button (top of page).
- 3) Enter the desired waypoint:
  - a) Touch the  buttons to display the desired search option on the 'Search' Button ('**Search by Identifier**', '**Search by Facility Name**', '**Search by City**', '**Search by Address**' (only available with the optional City Navigator data), or '**Search by Crossroads**' (only available with the optional City Navigator data)).
  - b) Touch the 'Search' Button (between the .
  - c) Enter the desired data using the keypad. If duplicate entries are displayed, touch the desired duplicate from the list.
  - d) Touch **OK**.



**Or:**

  - a) Touch the  buttons to cycle through the waypoint categories ('**Flight Plan Waypoints**', '**Nearest Airports**', or '**Recent Waypoints**').
  - b) Touch the desired waypoint from the list.
- 4) Touch the  buttons to cycle through the available FliteCharts or touch the Chart Field and touch the desired FliteChart from the vertical list.

**Or:**

  - 1) From the map, highlight an airport using the Map Pointer.
  - 2) Touch the Map Feature Button.
  - 3) Touch the **Charts** Tab (if necessary).
  - 4) Touch the  buttons to cycle through the available FliteCharts or touch the Chart Field and touch the desired FliteChart from the vertical list.

## Displaying FliteCharts in Full Screen Mode:

- 1) From the **Main Menu**, touch **WPT Info** > **Charts** (if necessary).
- 2) Touch the  buttons to select a chart.
- 3) With the desired chart displayed touch **Charts** again.
- 4) Touch the  icon to exit Full Screen Mode.



When a terminal procedure chart is not available for the requested airport or there is an error rendering the data, the banner "CHART NOT AVAILABLE" appears on the screen. The "CHART NOT AVAILABLE" banner does not refer to the FliteCharts subscription, but rather the availability of a particular airport chart selection or procedure for a selected airport.



FliteCharts

## AIRCRAFT SYMBOL

The aircraft symbol is shown in magenta on the chart only if the chart is to scale and the aircraft position is within the boundaries of the chart. The aircraft symbol is not displayed when the Aircraft Symbol Not Shown Icon appears. The Aircraft Symbol Not Shown Icon may appear at certain times, even if the chart is displayed to scale.

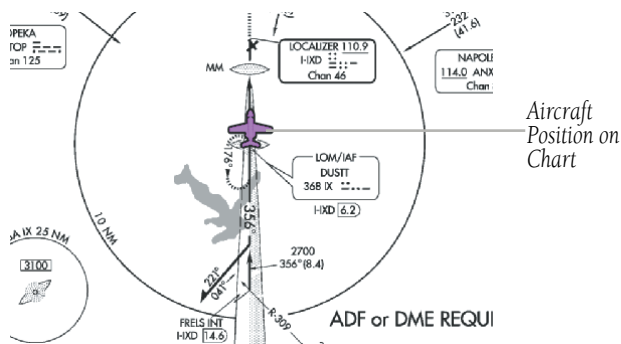

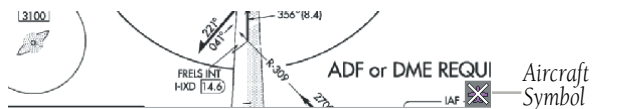

Aircraft Symbol Displayed on Chart (Waypoint Page)



Aircraft Symbol Not Shown Icon (Waypoint Page)

## FLITECHART RANGE

### Changing the FliteChart range:

Use the  (out) or  (in) icons to zoom 'out' (increasing), or zoom 'in' (decreasing).

**Or:**

Pinch fingers together (zoom out), or pull fingers apart (zoom in).

## FLITECHARTS CYCLE NUMBER AND EXPIRATION DATE

FliteCharts data is revised every 28 days. The aera 795/796 indicates any of five different possible criteria for chart availability. These indications are whether the databases are not configured, not available, current, out of date, or disabled.

## 5.5 VFR/IFR CHART VIEWING



**NOTE:** VFR, IFR, TPC, and Helicopter Charts can be obtained by visiting the 'flyGarmin' website ([www.fly.garmin.com](http://www.fly.garmin.com)).

### Accessing VFR, IFR, TPC, and Helicopter Charts:

- 1) Obtain the desired charts from the 'flyGarmin' website.
- 2) From the **Main Menu**, touch **Charts**.
- 3) Touch **Menu**. The 'Chart Type' Menu is displayed.
- 4) Touch the desired chart type ('VFR', 'IFR Low', or 'IFR High').



### Activating the chart pointer on a VFR, IFR, TPC, and Helicopter chart:

While viewing a Chart, touch anywhere on the Chart to activate the map pointer.

### Panning VFR, IFR, TPC, and Helicopter Charts:

While viewing a Chart, touch anywhere on the chart and drag.

### Reviewing information for a VFR, IFR, TPC, and Helicopter chart feature:

- 1) While viewing a chart, touch anywhere on the chart to activate the chart pointer. When the Chart Pointer is over a chart feature an information box appears on the map, and the chart feature is displayed on the Chart Feature Button (the button located between the   buttons). If multiple features are present at the Chart Pointer position, green arrows will appear on the Chart Feature Button.
- 2) Touch the Chart Feature Button to review information for the Chart Feature.
- 3) If desired touch the **Direct-to**  Icon to navigate to the chart feature.

## 5.6 SAFETAXI

SafeTaxi is an enhanced feature that gives greater map detail when viewing airports at close range. When viewing at ranges close enough to show the airport detail, the map reveals taxiways with identifying letters/numbers, runway incursion "Hot Spots", and airport landmarks including ramps, buildings, control towers, and other prominent features. Resolution is greater at lower map ranges. The SafeTaxi features can be seen when panning over the airport on the Navigation Map.

Designated Hot Spots are recognized at airports with many intersecting taxiways and runways, and/or complex ramp areas. Airport Hot Spots are outlined to caution pilots of areas on an airport surface where positional awareness confusion or runway incursions happen most often. Hot Spots are defined by a red shaded area.

During ground operations the aircraft's position is displayed in reference to taxiways, runways, and airport features. When panning over the airport, features such as runway holding lines and taxiways are shown at the cursor.



SafeTaxi Depiction

### Enabling/disabling SafeTaxi:

- 1) From the **Main Menu**, touch **Map > Menu > Set Up Map**.
- 2) Touch the  buttons to display the 'Airport' Category.
- 3) Touch the 'Safetaxi' On/Off Button.

## SAFETAXI CYCLE NUMBER AND REVISION

SafeTaxi database is revised every 56 days. SafeTaxi is always available for use after the expiration date. When turning on the aera 795/796, the database initialization indicates whether the databases are current, out of date, or not available. The database initialization shows the SafeTaxi database is current when the SafeTaxi name and expiration date are shown in white. When the SafeTaxi cycle has expired, the SafeTaxi name and expiration date will appear in yellow.

The SafeTaxi Region, Cycle, Effective date, and Expiration date of the database cycle can also be found from the **Main Menu**, by touching the **Tools > Database**.

The SafeTaxi database is provided by Garmin. Refer to Appendix C for instructions on updating the SafeTaxi database.

## 5.7 SiriusXM® RADIO (aera 796)



**NOTE:** SiriusXM Satellite Radio is only available with the aera 796.



**NOTE:** Refer to the Hazard Avoidance Section for information about SiriusXM Weather products.



**NOTE:** You **MUST** have a compatible SiriusXM device connected to your aera 796 and a subscription to SiriusXM Radio to use SiriusXM Radio features.



**NOTE:** Audio interference can occur while using some audio panels. Use of a Ground Loop Isolator can eliminate this interference.

## COMPATIBLE SiriusXM DEVICES

Compatible SiriusXM Devices
GXM 40/42
GDL 51/51R
GDL 52/52R

SiriusXM Satellite Radio offers a variety of radio programming over long distances without having to constantly search for new stations. Based on signals from satellites, coverage far exceeds land-based transmissions. SiriusXM Satellite Radio services are subscription-based.

### Accessing SiriusXM Radio:

From the **Main Menu**, touch the **SiriusXM** Icon.

## ACTIVATING SiriusXM SATELLITE RADIO SERVICES

The service is activated by providing SiriusXM Satellite Radio with a coded ID (Radio ID).

SiriusXM Satellite Radio uses the Radio ID to send an activation signal that, when received by the compatible SiriusXM device, allows it to play entertainment programming.

Refer to the compatible SiriusXM device Owner's Manual for more information on activating SiriusXM Satellite Radio.

### Accessing the Radio ID:

From the **Main Menu**, touch **SiriusXM** > **Menu** > **Information**.

**Or:**

The Radio ID is also displayed on channel '0'. Channel '0' is the first channel listed in the '**All Channels**' Category.

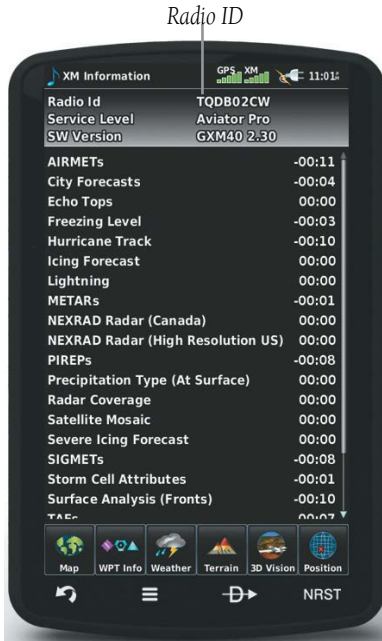

Accessing the SiriusXM Radio ID (SiriusXM Information)



Accessing the SiriusXM Radio ID (Channel 0)

## USING SiriusXM RADIO

The SiriusXM Radio function provides information and control of the audio entertainment features of the SiriusXM Satellite Radio.



SiriusXM Radio Overview

## CATEGORY

The Category Field cycles through a horizontal list of categories such as jazz, rock, or news.

### Selecting a category:

- 1) From the **Main Menu** touch the **SiriusXM** Icon.
- 2) Touch the  buttons to cycle through the horizontal category list. The list automatically refreshes with the selected category.



Category Navigation



**'Favorites' category shortcut:**

Touch and hold the **Category** Button to view the 'Favorites' Category.



'Favorites' Category Shortcut

**ACTIVE CHANNEL AND CHANNEL LIST**

The Channel List shows a list of the available channels for the selected category. The active channel is outlined blue (in the Channel List).

**Selecting a channel from the channel list:**

- 1) Scroll through the Channel List by touching and dragging the list up/down or touching and dragging the scrollbar up/down.
- 2) Touch the desired channel. The channel is outlined blue to show it is the active channel.

**Entering a channel number:**

- 1) From the **Main Menu**, touch **SiriusXM > Menu > Enter Channel**.
- 2) Touch the '+' or '-' Buttons to enter the desired channel and touch the **Tune** Button.

**Or:**

Touch the 'Channel Number' Button, enter the desired channel using the numeric keypad, and touch **OK**.



Channel Number Entry

## USING FAVORITES

Favorites is a customized category of up to 30 of your SiriusXM Radio favorites.

### To add a channel to Favorites:

- 1) From the **Main Menu** touch the **SiriusXM** Icon.
- 2) Touch and hold the desired channel. A confirmation window is displayed.
- 3) Touch **Yes**.

### Or:

With the desired channel selected, touch the **Menu** Icon and touch the **'Add To Favorites'** Menu Option. A confirmation window is displayed.

- 4) Touch **Yes**. The channel is added to the **'Favorites'** Category.

### Selecting Favorites:

- 1) From the **Main Menu** touch the **SiriusXM** Icon.

- 2) Touch the  buttons to cycle through the horizontal category list until the '**Favorites**' Category is displayed.

**Or:**

Touch and hold the **Category** Button.

- 3) Scroll through the Channel List by touching and dragging the list up/down.
- 4) Touch the desired channel.

### To delete channel(s) from Favorites:

- 1) With the Favorites Category selected, touch the **Menu** Key.
- 2) Touch the '**Remove Favorites**' Menu Option.

**Or:**

Touch the '**Remove All Favorites**' Menu Option and skip to step 5. The 'Remove all favorites?' Window is displayed.

- 3) Touch the check box next to the channel to be deleted. A red x will appear in the box.



Delete Channel Checkbox

- 4) Touch **Remove**. The 'Remove selected favorites?' Window is displayed.

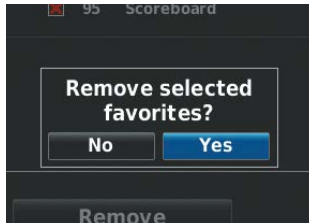

Remove Favorites Window

- 5) Touch **Yes**. The channels are removed from the '**Favorites**' Category.

## VOLUME

Volume is broken down into 'Master', 'Alerts', and 'Media'. The 'Master' volume controls all sound. The 'Alerts' volume refers to system alerts (TIS-A, Terrain), and the 'Media' volume refers to SiriusXM radio volume.

### Adjusting the volume:

- 1) From the **Main Menu** touch the **SiriusXM** Icon.
- 2) Touch the **Menu** Icon.
- 3) Touch the '**Volume**' Menu Option.
- 4) Touch the  buttons to increase/decrease the volume.

### Sound Setup shortcut:

Touch and hold the **Media**  Icon to quickly access the sound settings.

### Muting SiriusXM Audio:

- 1) From the **Main Menu**, touch the **SiriusXM** Icon.
- 2) Touch the **Media**  Icon.

**Or:**

- a) Touch the **Menu** Icon.
- b) Touch the '**Volume**' menu option. 'Sound Setup' is displayed.
- c) Touch the **Media**  Icon.

## 5.8 ELECTRONIC CHECKLISTS



**NOTE:** The information described in this section is not intended to replace the checklist information described in the pertinent aircraft manual.



**NOTE:** Garmin does not create, modify, or update aera 795/796 checklists and thus cannot be responsible for the availability and/or content.



**NOTE:** Checklists cannot be edited from within the system.

The aera 795/796 is capable of displaying checklists which allow a pilot to quickly find the proper procedure on the ground and during each phase of flight. The aera 795/796 accesses the checklist file (\*.ace) located on the SD card. If a checklist file is available on the SD card, the 'Checklists' option can be accessed by touching **Main Menu > Tools > Checklists**.

Garmin ACE (Aircraft Checklist Editor) is available from the garmin website at no cost.

## SECTION 6 APPENDICES

# APPENDIX A: MESSAGES, ALERTS & DATA FIELD OPTIONS

### MISCELLANEOUS MESSAGE ADVISORIES

Message	Comments
<b>Approaching target altitude</b>	Aircraft is 500 feet above VNAV target altitude.
<b>Approaching VNAV profile</b>	The aircraft is within the distance set for the arrival alarm.
<b>Arriving at XXX</b>	The aircraft is nearing the destination.
<b>Battery Low</b>	The battery needs to be recharged.
<b>Can't unlock databases</b>	No applicable unlock code for one or more databases was found.
<b>Can't unlock maps</b>	No applicable unlock code for one or more maps was found. All MapSource maps are not accessible.
<b>Check XM Antenna</b>	Internal problem with the XM antenna. Contact Garmin Product Support.
<b>Database Error</b>	Internal problem with the system. Contact your dealer or Garmin Product Support to have the unit repaired.
<b>Switch fuel tanks</b>	A reminder for switching fuel tanks. The reminder message repeats at the specified interval after the beginning of each trip.
<b>GPS antenna shorted to ground</b>	The GPS antenna connection detects the GPS antenna RF connector is shorted to ground.
<b>Lost Satellite Reception</b>	The system is unable to receive satellite signals.
<b>Memory full</b>	System memory is full, no further data can be saved.
<b>Next DTK XXX</b>	The aircraft is within the distance, or time, set for the next waypoint alarm.

Message	Comments
<b>Proximity alarm memory full</b>	No additional proximity waypoints can be saved.
<b>Proximity waypoints overlap</b>	The radius of two proximity waypoints overlap.
<b>Route already exists</b>	A route name that already exists has been entered.
<b>Route memory full</b>	No additional routes can be saved.
<b>Route truncated</b>	Uploaded route from another device has more than 300 waypoints.
<b>Route waypoint memory full</b>	No additional route waypoints can be saved.
<b>Steep turn ahead</b>	Approaching a turn that requires a bank angle in excess of 25 degrees to stay on course.
<b>Track already exists</b>	A saved track with the same name already exists.
<b>Track log full</b>	The track log is full and track recording was turned off. To record more track points, you need to clear the track log and turn track recording on.
<b>VNAV cancelled</b>	VNAV function has been cancelled due to a change in the active route.
<b>Waypoint already exists</b>	A waypoint with the same name already exists.
<b>Waypoint memory full</b>	The unit has stored the maximum number of waypoints.

## AIRSPACE MESSAGES

Message	Comments
<b>Inside XXX Airspace</b>	Inside the boundaries of the airspace.
<b>XXX Airspace Near and ahead</b>	Within two nautical miles of the airspace and your current course takes you inside the airspace.
<b>XXX Airspace Ahead, Within 10 minutes</b>	The projected course takes you inside the airspace within the next 10 minutes or less.
<b>XXX Airspace Near, Within 2 nm</b>	Within two nautical miles of the airspace but not projected to enter it.

## DATA FIELD & NUMERIC DATA OPTIONS

Data Field/Numeric Data	Definition
<b>Accuracy</b>	The current accuracy of the GPS determined location.
<b>Altitude</b>	The current altitude in geometric height above Mean Sea Level (MSL).
<b>Bearing</b>	The compass direction from the present position to a destination waypoint.
<b>Climb Gradient (Alt per nm)</b>	Altitude gained per nautical mile traveled.
<b>Climb Gradient (Percent)</b>	Ratio of altitude gained to distance traveled.
<b>Course to Steer</b>	The recommended direction to steer in order to reduce cross-track error and return to the course line.
<b>Crosstrack Error</b>	The distance the aircraft is off a desired course in either direction, left or right.
<b>Desired Track</b>	The desired course between the active "from" and "to" waypoints.
<b>Distance (Destination)</b>	The distance to the destination waypoint in the Active Flight Plan.
<b>Distance (Next)</b>	The distance to the next waypoint in the Active Flight Plan.
<b>En Route Safe Altitude</b>	The recommended minimum altitude within ten miles left or right of the desired course on an active flight plan or direct-to.
<b>Flight Timer</b>	Total time in-flight of active, or most recent, flight (HH:MM).
<b>Fuel Timer</b>	Elapsed time since the Fuel Tank Reminder Alarm was last issued (HH:MM).
<b>Glide Ratio</b>	The estimated distance an aircraft will move forward for any given amount of lost altitude.

Data Field/Numeric Data	Definition
<b>Ground Speed</b>	The velocity the aircraft is traveling relative to a ground position.
<b>Ground Track</b>	The direction of aircraft movement relative to a ground position.
<b>Minimum Safe Altitude</b>	Uses Grid MORAs to determine a safe altitude within ten miles of the aircraft's present position.
<b>Next Waypoint</b>	The next waypoint in the flight plan or direct-to route.
<b>Sunrise</b>	The time at which the sun rises on this day (current location).
<b>Sunset</b>	The time at which the sun sets on this day (current location).
<b>Estimated Time En Route (Destination)</b>	The estimated time to reach the destination waypoint from the present position, based upon current ground speed.
<b>Estimated Time En Route (Next)</b>	The estimated time to reach the next waypoint from the present position, based upon current ground speed.
<b>Estimated Time of Arrival (Destination)</b>	The estimated time at which the aircraft should reach the destination waypoint, based upon current speed and track.
<b>Estimated Time of Arrival (Next)</b>	The estimated time at which the aircraft should reach the next waypoint, based upon current speed and track.
<b>Sirius XM (Now Playing) (aera 796)</b>	Currently selected XM channel.



<b>Data Field/Numeric Data</b>	<b>Definition</b>
<b>Time to VNAV</b>	The estimated time to reach the initial VNAV descent point from the present position, based upon current ground speed.
<b>Time (Local)</b>	The current time in the selected 12- or 24-hour format.
<b>Time (UTC)</b>	The current Universal (UTC) time.
<b>Vertical Speed</b>	The rate of climb or descent (GPS-derived).
<b>Vertical Speed Required</b>	The vertical speed necessary to descend/climb from a current position and altitude to the previously selected VNAV position and altitude, based upon current groundspeed.
<b>Weather (Altimeter) (aera 796)</b>	The altimeter setting at the nearest METAR reporting station.
<b>Weather (Dew Point) (aera 796)</b>	The dew point at the nearest weather reporting station.
<b>Weather (Rel. Humidity) (aera 796)</b>	The relative humidity at the nearest weather reporting station.
<b>Weather (Temperature) (aera 796)</b>	The temperature at the nearest weather reporting station.
<b>Weather (Wind) (aera 796)</b>	The wind speed and direction at the nearest weather reporting station.

## AURAL ALERTS

### TRAFFIC

- "Traffic" —TIS-A or TIS-B traffic alert received.
- "Traffic Not Available" —TIS-A or TIS-B service is not available or out of range.

### TERRAIN

- "Five Hundred" —when the aircraft descends through 500 feet above the destination airport.

The following aural terrain alerts are issued when flight conditions meet parameters that are set within the software algorithms, and are dependant on the sensitivity level set in the Terrain Setup Menu.

Alert Severity	Terrain	Obstacle	Descent Rate
<b>Caution</b>	"caution, terrain" "caution, terrain ahead"	"caution, obstacle" "caution, obstacle ahead"	"caution, sink rate"
<b>Warning</b>	"terrain ahead! pull up!" "terrain! terrain! pull up! pull up!"	"obstacle ahead! pull up!" "obstacle! obstacle! pull up! pull up!"	"sink rate, pull up!" "pull up!"

# APPENDIX B: ABNORMAL OPERATION

## LOSS OF GPS POSITION

When the aera 795/796 loses the GPS signal for any reason, the following will occur:

- A flashing red question mark will appear over the airplane icon on the map.
- The 'Lost Satellite Reception' message will display.
- Any GPS dependent data fields will not be available.

## HAZARD DISPLAY WITH LOSS OF GPS POSITION

If the Terrain function does not have at least a 3D fix (i.e., altitude unknown), a Red X will be displayed.

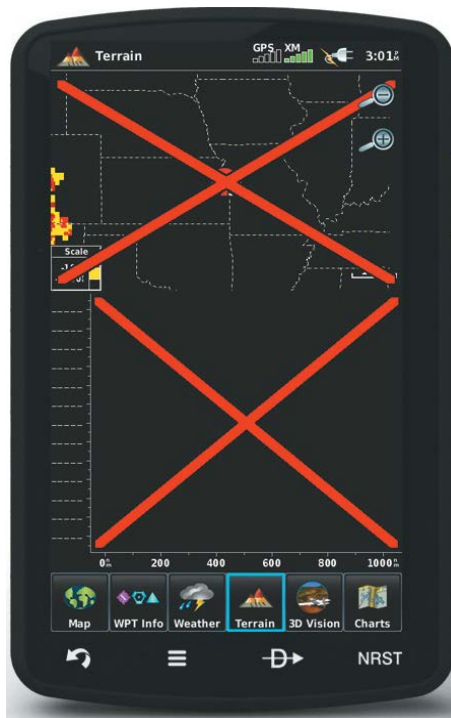

Terrain Red X

Blank Page

## APPENDIX C: SD CARDS AND DATABASES



**NOTE:** When database files are loaded to the SD Card, any previously loaded database files of the same type residing on the SD Card will be overwritten. This includes loading a database of a different coverage area or data cycle than that currently residing on the SD Card.

### SD CARD USE

The aera 795/796 uses an SD Card for checklist files, Chartview, importing/exporting Flight Plans, and for storing PDF files for use in the aera 795/796 Document Viewer. Garmin recommends using a 4 GB SanDisk or Toshiba SD Card.

### INSTALLING AND REMOVING SD CARDS

Install the SD Card in the slot located on the top, right side of the unit. Install or remove the SD Card at any time, whether the unit is on or off.

You can buy pre-programmed SD Cards to use with your aera 795/796.

SD Cards are not waterproof. They should not be exposed to moisture or excessive static charges, and should be stored in the case supplied with the card.

#### Installing an SD Card:

- 1) Insert the card into the slot on the top, right side of the unit. Be sure the label is facing the back of the unit.
- 2) Firmly push the card into the unit. It is not necessary to force the card. The handle is still exposed when it is properly inserted.
- 3) The unit takes a few seconds to read the card.

If you insert an SD Card and get a card format not recognized message, try removing the card and reinserting it. If the card is still not recognized, contact Garmin Product Support or your Garmin dealer.

#### Removing an SD Card:

- 1) Push the card into the unit until it stops.
- 2) Release the card. The card should eject for easy removal.
- 3) With the card ejected, pull the card out of the slot.

## DATABASES

The following databases are included with the aera 795/796 depending on the unit (Americas, Atlantic, or Pacific). See the Additional Features section for information on Airport Directory, FliteCharts®, and SafeTaxi®. See the Hazard Avoidance section for information on Obstacles and Terrain.

Database	Americas Unit	Atlantic Unit	Pacific Unit
Worldwide Basemap	+	+	+
Airport Directory	+	+	+
Jeppesen® Navigation Database	+	+	+
FliteCharts®	+		
European FliteCharts®		+	
SafeTaxi®	+		
Obstacle	+	+	
Worldwide Terrain	+	+	+
IFR/VFR Charts	+		

Databases

## GARMIN DATABASE INFORMATION

The following databases are provided by Garmin:

- Worldwide Basemap
- Worldwide Terrain
- Obstacle
- SafeTaxi
- FliteCharts
- IFR/VFR/Helicopter Charts

### WORLDWIDE BASEMAP

The basemap database contains data for the topography and land features, such as rivers, lakes, and towns. It is updated only periodically, with no set schedule. There is no expiration date.

### FLITECHARTS

The FliteCharts database contains procedure charts for the United States only. This database is updated on a 28-day cycle.

### VFR, IFR, AND HELICOPTER CHARTS

The IFR/VFR Chart database contains Sectionals, Hi-Altitude, Low-Altitude, World Aeronautical Charts (WAC), Terminal Area Charts (TAC) and Helicopter Charts. This database is updated on a 28-day cycle.

### SAFETAXI

The SafeTaxi database contains detailed airport diagrams for selected airports. These diagrams aid in following ground control instructions by accurately displaying the aircraft position on the map in relation to taxiways, ramps, runways, terminals, and services. This database is updated on a 56-day cycle.

### OBSTACLE

The obstacle database contains data for obstacles, such as towers, that pose a potential hazard to aircraft. Obstacles 200 feet and higher are included in the obstacle database. It is very important to note that not all obstacles are necessarily charted and therefore may not be contained in the obstacle database. This database is updated on a 56-day cycle.

## WORLDWIDE TERRAIN



**NOTE:** The data contained in the navigation, terrain and obstacle databases comes from government agencies. Garmin accurately processes and cross-validates the data, but cannot guarantee the accuracy and completeness of the data.

The terrain database is updated periodically and has no expiration date.

## GARMIN AVIATION DATABASE UPDATES

The Garmin aviation database updates can be downloaded directly to the unit by visiting the 'flyGarmin' website ([fly.garmin.com](http://fly.garmin.com)).

After the databases have been updated, verify the appropriate databases are initialized and displayed on the start-up screen.

## OTHER DATABASE INFORMATION

### AIRPORT DIRECTORY DATABASES

The AOPA Airport Directory provides data on airports and heliports throughout the U.S. and it is updated on a 56-day cycle. Detailed information for over 5,300 U.S. airports, along with the names and phone numbers of thousands of FBOs can be viewed. This service allows the pilot to plan an overnight, choose fuel stops, find ground transportation, etc.

Optional airport directory databases such as AC-U-KWIK are also supported. AC-U-KWIK provides complete listings of FBOs, charter companies, fuel suppliers, ground transportation, maintenance and catering services at public airports across the world.



## NAVIGATION DATABASE

The aera 795/796 includes an internal navigation database that provides location and facility information for thousands of airports, VORs, NDBs, and more. Updates to the navigation database are available every 28 days online ([www.fly.garmin.com](http://www.fly.garmin.com)). There are two navigation database products available: the Jeppesen Navigation Database, which is sourced by Jeppesen, and the US VFR Navigation Database sourced by AeroNav Products, a division of the FAA. The update program is designed to operate on Windows®-compatible, and Mac OS 10.8 and higher, PCs. It requires the included USB cable to connect your aera 795/796 to the PC's USB port. The following information is provided from the internal navigation database:



**NOTE:** *Although the Jeppesen Navigation Database and the US VFR Navigation Database contain much of the same information, pilots may notice differences in behavior, nearest list functionality, direct-to functionality, and map page display due to data content variations. The US VFR Navigation Database, by AeroNav Products, does not contain any approach data.*

- \*Airport—identifier, facility name, city/state/country, latitude/longitude, field elevation, available fuel types, runway designations and layout, runway surface, runway length, runway width, runway lighting, communication frequencies, and published approaches (Jeppesen Navigation Database only).
- Weather—frequencies associated with an airport (ASOS, ATIS, and AWOS).
- \*VORs—identifier, facility name, city/state/country, location (latitude/longitude), frequency, service volume (high, low, terminal), and type (such as VOR-DME, TACAN, and VORTAC).
- \*NDBs—identifier, facility name, city/state/country, location (latitude/longitude), and frequency.
- Intersections—identifier, nearest VOR, radial and distance from nearest VOR, location (latitude/longitude), and region/country.
- ARTCC—Air Route Traffic Control Centers.
- Airspace—boundaries (Class B, Class C, Control Zones, SUAs, and MOAs), controlling agency, and vertical boundaries.

- FSS—Flight Service Stations.

\* Symbology used for NDBs, VORs, and airports is consistent with those used on a sectional chart.



---

**NOTE:** After performing a navigation database update, verify all flight plan(s) (routes) are current. If there is an obsolete aviation point in a saved route, the route is locked and unusable. A new route with current navigation database points will need to be created.

---

## CHARTVIEW

ChartView database is revised every 14 days. Charts are still viewable during a period that extends from the cycle expiration date to the disables date. ChartView is disabled 70 days after the expiration date and is no longer available for viewing.

ChartView data is downloaded from Jeppesen<sup>®</sup> onto an SD card. Appendix D: Installation and Interfacing

## APPENDIX D: INSTALLATION AND INTERFACING

### MOUNTING THE aera 795/796 IN THE AIRCRAFT

The aera 795/796 is designed to fit the majority of conventional aircraft yokes and center column controls.

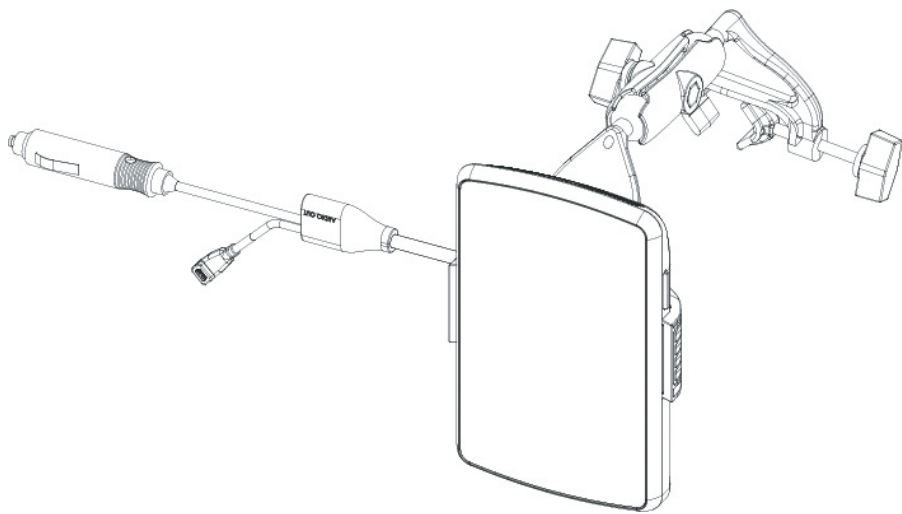

**WARNING:** It is the sole responsibility of the owner/operator of the aera 795/796 to place this mount and secure the unit so that it will not interfere with the aircraft's operating controls and safety devices, or cause damage or personal injury in the event of an accident or turbulence. Do not mount the aera 795/796 where the pilot or passengers are likely to impact it in an accident, collision, or turbulence. The mounting hardware provided by Garmin is not warranted against turbulence, collision damage, or related consequences.



**NOTE:** After installation, verify flight controls are free and clear per the flight manual of the applicable aircraft and the aera 795/796 yoke mount and wiring do not cause any interference with the flight controls.



**NOTE:** Readjust the position of the aera 795/796 to provide the best view of the display screen as lighting conditions change.

## Attaching the yoke mount assembly to the aera cradle:

Join the yoke mount assembly to the aera cradle using the provided screws (4 ea), nuts (4 ea), and washers (8 ea) as shown in the two following drawings. The optional rectangular plate (013-00277-07) is included with the yoke mount.

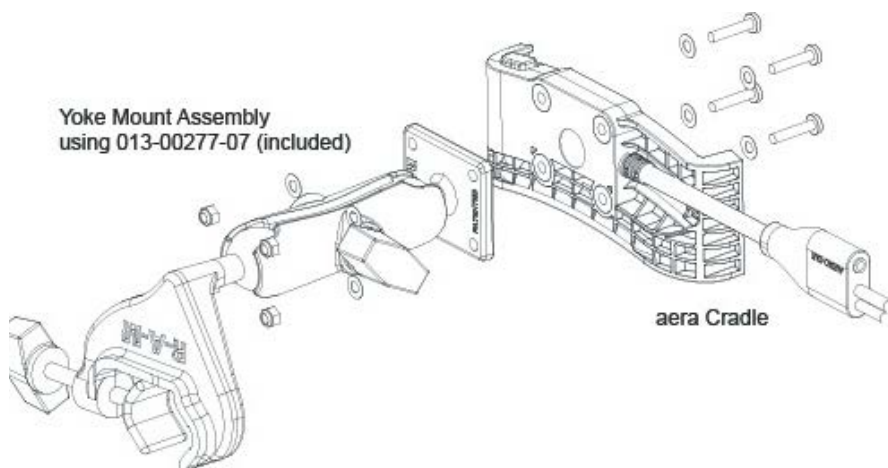
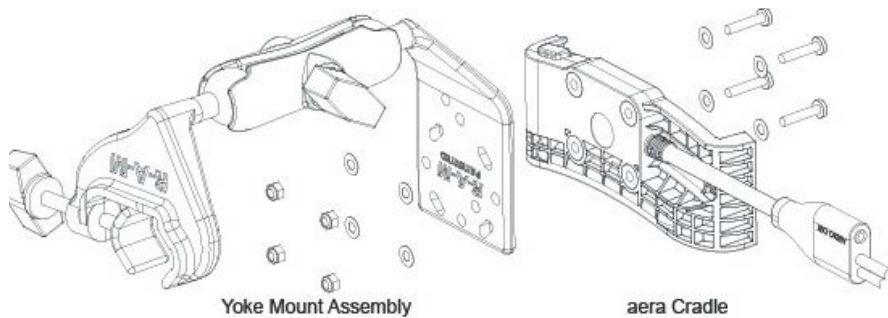

## Attaching the yoke mount to the yoke shaft or control arm (see following figure):

- 1) Open the clamp by turning the Clamp Adjustment Knob until it can be easily placed over the yoke shaft or control arm. Install the yoke mount as far from the panel as is practical.
- 2) When in place, tighten the Clamp Adjustment Knob to secure the yoke mount to the yoke shaft or control arm.
- 3) Loosen the Cradle Adjustment Knob, then orient the cradle as desired.
- 4) Tighten the Cradle Adjustment Knob to hold the cradle in place.

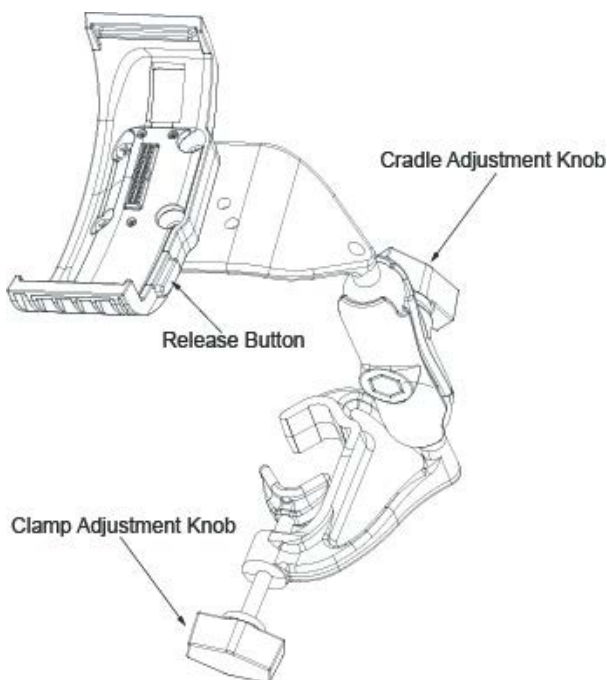

### Connecting the cable:

Make all applicable cable connections per the following figure.

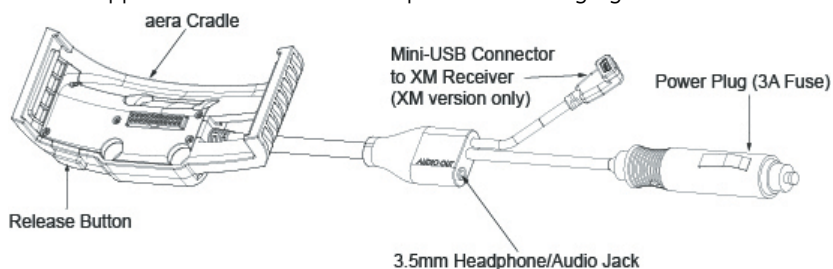

### Attaching the aera (portrait orientation) to the yoke mount:

- 1) Fit the left side of the aera into the cradle.
- 2) Press the right side of the aera into the cradle until it snaps into place.

### Attaching the aera (landscape orientation) to the yoke mount:

- 1) Fit the bottom of the aera into the cradle.
- 2) Tilt the aera back until it snaps into place.

**Removing the aera from the yoke mount:**

- 1) Press the Release Button on the side of the cradle to release the aera.
- 2) Remove the aera from the cradle.

**Removing the yoke mount from the yoke shaft (or control arm):**

- 1) Disconnect the power plug, audio jack, and mini-USB connector (if applicable).
- 2) Loosen the clamp by turning the Clamp Adjustment Knob until the yoke mount assembly can be easily removed from the yoke shaft or control arm.

**CONNECTING TO A COMPUTER**



The aera 795/796 can be connected to a computer using the included USB-PC Interface Cable to connect to a USB data port.

**Connecting the aera 795/796 to a computer:**

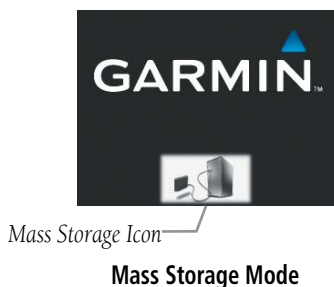
- 1) (Optional Step) Insert a memory card into the memory card slot. Press it in until it clicks.
- 2) Turn the aera 795/796 on.
- 3) Connect the small end of the USB cable to the USB connector on the unit.
- 4) Connect the larger end of the USB cable to a USB port on the computer. The Mass Storage Icon appears on the screen. The aera 795/796 and memory card appear as removable drives in My Computer in Windows and as mounted volumes on Mac computers.



### Safely disconnecting the USB cable:

- 1) **Windows:** Click  in the toolbar (system tray). **Mac:** Drag the volume icon to the trash can .
- 2) Disconnect the USB cable from the computer.

## INTERFACING

The following formats are supported for connection of external devices: NMEA 0180, 0182, 0183 (versions 1.5, 2.0, 2.3, 3.01), ASCII Text Output, and Garmin proprietary formats for connecting to a Mode S transponder for TIS-A data, and to a Garmin aviation NAV/COM radio.

The following are the Approved Sentences for NMEA 0183, version 3.01 output: GPRMC, GPGGA, GPGSA, GPGSV, GPGLL, GPBOD, GPRTE, and GPWPL. The following are the Proprietary Sentences for NMEA 0183, version 3.01 output: PGRME, PGRMZ, PGRMM, and PGRMH.

Garmin's proprietary communication protocol is available from the Web site ([www.garmin.com](http://www.garmin.com)).

### GENERAL INTERFACE SETUP

The Interface Setup controls the input/output format used when connecting the unit to external devices.

#### Selecting an interface:

- 1) From the **Main Menu**, touch **Tools > Setup > Interface**.
- 2) Touch 'Serial Data Format' datafield button. A vertical list is displayed.
- 3) Touch the desired data format from the list ('**Garmin Data Transfer**', '**NMEA Out**', '**Aviation In**', '**Aviation In/NMEA & VHF Out**', '**Connex 57600 Baud**', '**TIS-A In**', '**TIS-A In/NMEA & VHF Out**', or '**None**').
- 4) If a description is needed, touch **Menu > Description** or touch the '?'.

#### Restoring interface defaults:

From the **Main Menu**, touch **Tools > Setup > Interface > Menu > Restore Default**.

## SERIAL DATA FORMATS

- Garmin Data Transfer—the proprietary format used to exchange data with a PC, compatible device, or another Garmin aera.
- NMEA Out—transmits NMEA position, velocity, and navigation data.
- Aviation In—the proprietary format used for connection to a Garmin panel-mounted GPS receiver. This eliminates the need to enter the destination on both units.
- Aviation In/NMEA & VHF Out—receives aviation data and transmits out both NMEA data, at 9600 baud, and VHF frequency tuning information to a Garmin Nav/Comm radio.
- Connex 57600 Baud—Connex datalink source. Used to receive ADS-B traffic and weather data if connected to a compatible receiver.
- TIS-A In—receives TIS-A data from a Garmin Mode S transponder or other compatible device.
- TIS-A In/NMEA & VHF Out—receives TIS-A data and transmits out both NMEA data, at 9600 baud, and VHF frequency tuning information to a Garmin Nav/Comm radio.
- None—provides no interfacing capabilities.

## ADVANCED NMEA OUTPUT SETUP

If interfacing the aera 795/796 with another piece of equipment (such as an autopilot), the unit needs to be set to output NMEA data. If the NMEA output mode is set to 'Fast', the unit will output a minimum number of NMEA sentences at 1-second intervals. If the NMEA output is set to 'Normal', the unit will output a greater number NMEA sentences at 2-second intervals.

### Setting NMEA output mode:

- 1) From the **Main Menu**, touch **Tools > Setup > Interface**.
- 2) Touch the 'Serial Data Format' datafield. A vertical list is displayed.
- 3) Touch '**NMEA Out**'.
- 4) Touch the 'NMEA Output Mode' **Normal/Fast** toggle button.

NMEA Sentence Output:



- Normal Mode: GPRMB, GPRMC, GPGBA, GPGSA, GPGSV, GPGLL, GPBWC, GPVTG, GPXTE, GPBOD, GPRTE, GPWPL, GPAPB, PGRME, PGRMZ, PGRMM, and PGRMH.
- Fast Mode: GPRMB, GPRMC, PGRMZ, and PGRMH.

### CONNECTING TO A GARMIN VHF COMM RADIO

The aera 795/796 can also output frequency data to a Garmin aviation radio. Currently the five models supported are the SL30 nav/comm, SL40 comm, and the GTR 200/225 comms, and the GNC 255 comm.



**NOTE:** For additional information refer to the SL30 nav/comm, the SL40 comm, or the GTR 200 comm installation manual.



**NOTE:** When connecting aera audio output to a mono audio input, use Audio Common (Green) and Audio Left (Brown) wires.



**CAUTION:** This interface does not have an FAA installation airworthiness approval. If any abnormalities with SL 30/40 or GTR 200 tuning or operation are encountered, disconnect the aera 795/796 from the SL 30/40 or GTR 200 tuning interface.

#### Output frequency data to an SL40/SL30/GTR200 nav/comm radio:

- 1) Connect the aera 795/796 to an SL30/SL40/GTR200 using the Aviation Bare Wire Connector (optional accessory).

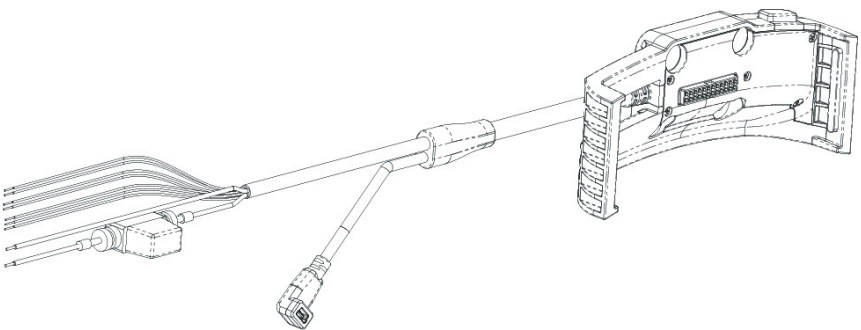

aera 795/796 Aviation Bare Wire Connector

Connection	Wire Color
Power	Red
Power Ground/Data Ground	Black
TX1 (Data Out)	Blue
RX1 (Data In)	Yellow
TX2 (Data Out)	Orange
RX2 (Data In)	Purple
Audio Right	White
Audio Common	Green
Audio Left	Brown

**era 795/796 Aviation Bare Wire Connections**

- 2) From the **Main Menu**, touch **Tools > Setup > Interface**.
- 3) Touch the 'Serial Data Format' datafield button. A vertical list is displayed.
- 4) Touch '**Aviation In/NMEA & VHF Out**' or '**TIS-A In/NMEA & VHF Out**' from the list. These comm modes send both NMEA data and VHF frequency information.

The following features are now available on the radio:

- Remote frequency lists for departure, enroute, and arrival airports.
- Nearest VOR frequencies (SL30 and GNC 255 only).

The era 795/796 can also directly tune a standby frequency.

### Selecting a standby comm frequency:

- 1) From the **Main Menu**, touch **WPT Info > Freq Tab**
- 2) Touch the desired frequency from the list. The frequency is now tuned in standby.

**Or:**

- a) If the frequency has additional information (denoted with an \*). Touch the desired frequency from the list.
- b) Touch the '**Tune**' Button.

**CONNECTING THE GXM 40/42 ANTENNA (aera 796)**

Connect the GXM 40/42 antenna to the aera 796 to access SiriusXM Satellite Weather and SiriusXM Radio. For more information about the GXM 40/42 antenna, see the GXM 40/42 Owner’s Manual.



**NOTE:** You must subscribe to SiriusXM Radio and/or SiriusXM Satellite Weather to use the SiriusXM Radio and/or SiriusXM Weather features on your aera 796.

**Connecting the GXM 40/42 antenna:**

- 1) Position the antenna where it has a clear view of the sky. This can be done behind the windscreen.
- 2) Plug the GXM 40/42 cable into the USB Connector on the appropriate Aviation Mount.

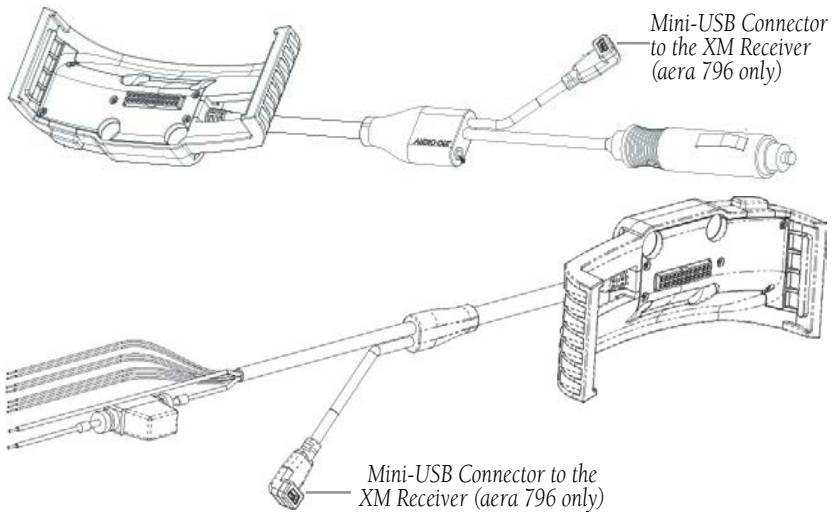

**USB Connector to GXM 40 Antenna (XM Aviation Mounts)**

## CONNECTING TO A GTX 330 MODE S TRANSPONDER

To receive Mode S TIS-A traffic data from a GTX 330 transponder on your aera 795/796, connect an available RS-232 OUT wire on the transponder to the Data In wire on the aera 795/796. (You do not need to connect the transponder to the aera's Data Out wire.) Then, set the corresponding RS-232 output configuration on the transponder to REMOTE + TIS and set the aera's Serial Data Format to TIS-A In or TIS-A In/NMEA & VHF Out. For more information, see the GTX 330 Transponder Installation Manual.

### Configuring TIS-A input:

- 1) Connect the aera 795/796 to the GTX 330 using the Aviation Bare Wire Connector (optional accessory).
- 2) From the **Main Menu**, touch **Tools** > **Setup** > **Interface**.
- 3) Touch the 'Serial Data Format' datafield button. A vertical list is displayed.
- 4) Touch '**TIS-A In**' or '**TIS-A In/NMEA & VHF Out**'.

The TIS-A Status field indicates one of the following messages:

- Waiting For Data—searching for a valid TIS-A data stream.
- Data Available—receiving TIS-A data from the transponder.
- Data Unavailable—connection to transponder established, but TIS-A service is unavailable.
- Lost Connection—an error occurred or the connection to the transponder was lost.

## CONFIGURING AERA FOR A GTX 345 OR GNX 375

Version 4.90 and later of the aera 795/796 software can connect to a compatible Garmin transponder with either Connex Bluetooth or a hard wired RS-232 connection using the Aviation Bare Wire Connector (optional accessory, P/N 010-11756-01). This provides ADS-B traffic and weather and attitude information to the aera 795/796. The aera can use the provided attitude data for full 3D Vision functionality.

### Installation Guidance for GTX 345:

- 1) To connect via RS-232, either of the two serial ports on the area 795/796 may be connected.
- 2) The Aviation Bare Wire Connector uses the blue wire for TX, and the yellow wire for RX on serial port 1, and uses the orange wire for TX and the purple wire for RX on serial port 2.
- 3) Any of the four serial ports on the GTX 345 may be connected and should be set to "Connex FMT 1." For more information, see the transponder installation manual.

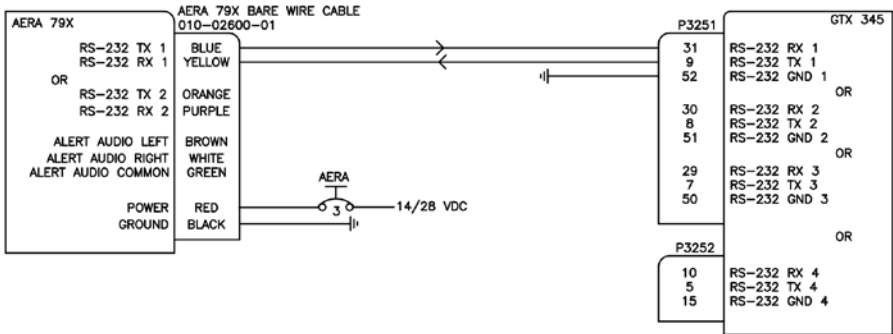

**GTX 345 Serial Interface to Aera 795/796**

## Installation Guidance for GNX 375:

- 1) To connect via RS-232, either of the two serial ports on the area 795/796 may be connected.
- 2) The Aviation Bare Wire Connector uses the blue wire for TX, and the yellow wire for RX on serial port 1, and uses the orange wire for TX and the purple wire for RX on serial port 2.
- 3) Any of the five serial ports on the GNX 375 may be connected and should be set to "Connex 57600." For more information, see the transponder installation manual.

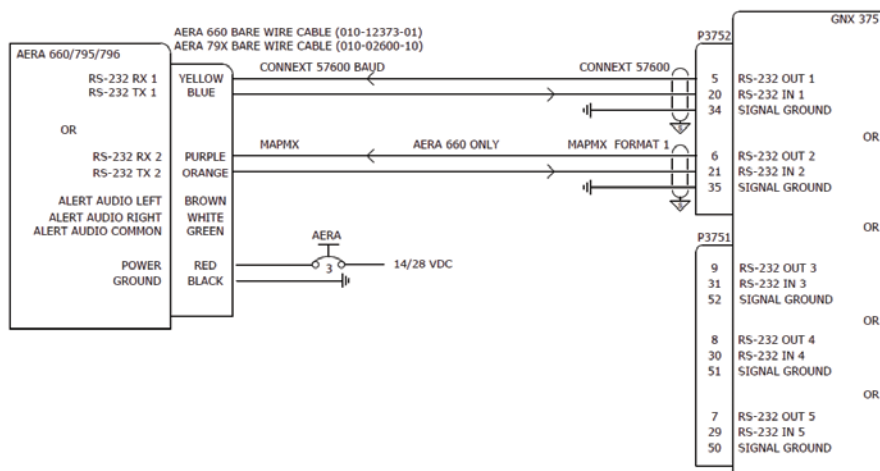

## Configuring aera for serial communications with a compatible Garmin transponder.

- 1) Connect the aera 795/796 to the transponder using the Aviation Bare Wire Connector (optional accessory).
- 2) From the **Main Menu**, touch **Tools > Setup > Interface**.
- 3) Touch the '**Serial Data Format**' datafield button. A vertical list is displayed.
- 4) Touch '**Connex 57600 baud**'.

## CONFIGURING AERA FOR A GDL 39

To receive weather and traffic information from the GDL 39, the GDL 39 must be connected to the aera using the 'GDL 39 Power/Data Cable to Aera 795/796' (P/N 010-11686-50), using a Bluetooth connection, or through a bare wire installation (aera bare wire cable P/N 010-11756-01 to GDL 39 bare wire cable P/N 010-11686-40). The GDL 39 can only be connected to Serial Port 1 on the aera. The aera must also be configured correctly to receive traffic and weather information from the GDL 39 as described below.

### Configuring aera for a GDL 39:

- 1) Connect the aera 795/796 to the GDL 39 through the Power/Data Cable.
- 2) From the **Main Menu**, touch **Tools > Setup > Interface**.
- 3) Touch the '**Serial Data Format**' field. A vertical list is displayed.
- 4) Touch '**Garmin Data Transfer**'. Garmin Data Transfer is only available on Serial Port 1.
- 5) From the **Main Menu**, touch **Tools > Data Link** to view GDL 39 connection status.



**CAUTION:** Never remove power from the aera or GDL 39 during a software update. Anytime the aera software is updated it may also contain firmware updates for products such as the GDL 39. The aera software will update first, after the unit reboots it will update the firmware of a connected GDL 39. You can view the GDL 39 update progress on the Data Link Information Page.

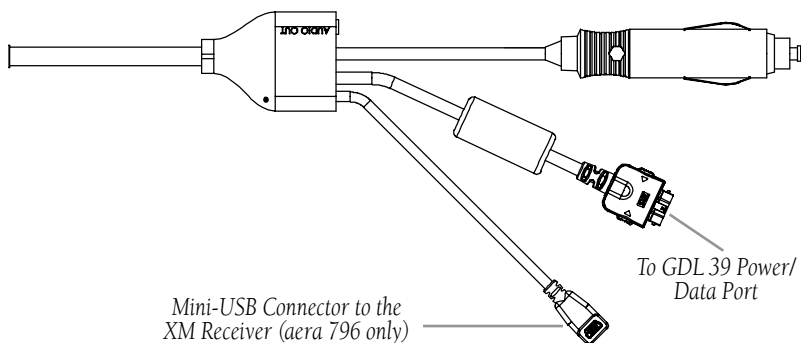

**GDL 39 Power/Data Cable to Aera 795/796**

Connection	aera 7xx Bare Wire Color	GDL 39 Bare Wire Color
TX1 (Data Out) from aera 795/796	TX1 Blue Wire	White/Green Wire
RX1 (Data In) into aera 795/796	RX1 Yellow Wire	Green Wire

### aera 795/796 Aviation Bare Wire Connections to GDL 39

## CONFIGURING AERA FOR A GDL 51/52

To receive weather and traffic information from the GDL 51/52, the GDL 51/52 must be connected to the aera using the 'GDL 51/52 Power/Data Cable to Aera 795/796' (P/N 010-11686-50), using a Bluetooth connection, or through a bare wire installation (aera bare wire cable P/N 010-11756-01 to GDL 39 bare wire cable P/N 010-11686-40). The GDL 51/52 can only be connected to Serial Port 1 on the aera. The aera must also be configured correctly to receive traffic and weather information from the GDL 51/52 as described below.

### Configuring aera for a GDL 51/52:

- 1) Connect the aera 795/796 to the GDL 51/52 through the Power/Data Cable.
- 2) From the **Main Menu**, touch **Tools** > **Setup** > **Interface**.
- 3) Touch the '**Serial Data Format**' field. A vertical list is displayed.
- 4) Touch '**Connex 57600 Baud**'.
- 5) From the **Main Menu**, touch **Tools** > **Data Link** to view GDL 51/52 connection status.



**CAUTION:** Never remove power from the aera or GDL 51/52 during a software update. Anytime the aera software is updated it may also contain firmware updates for products such as the GDL 51/52. The aera software will update first, after the unit reboots it will update the firmware of a connected GDL 51/52. You can view the GDL 51/52 update progress on the Data Link Information Page.



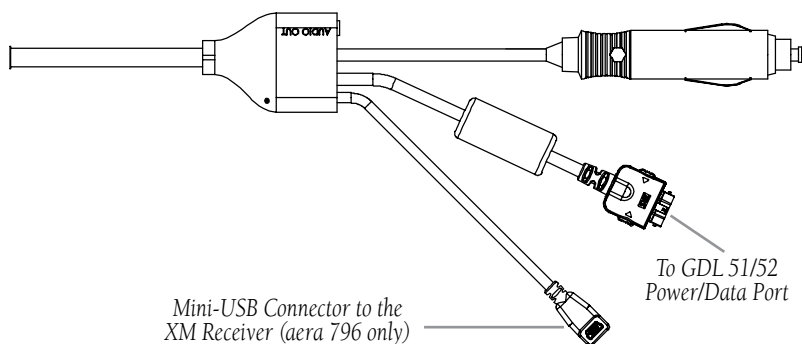

GDL 51/52 Power/Data Cable to Aera 795/796

Connection	aera 7xx Bare Wire Color	GDL 51/52 Bare Wire Color
TX1 (Data Out) from aera 795/796	TX1 Blue Wire	White/Green Wire
RX1 (Data In) into aera 795/796	RX1 Yellow Wire	Green Wire

aera 795/796 Aviation Bare Wire Connections to GDL 51/52

## PAIRING A DEVICE VIA BLUETOOTH

### Pairing a device via Bluetooth:

- 1) From the **Main Menu**, touch **Tools > Setup > Bluetooth**.
- 2) Touch Bluetooth **On/Off** to turn on the Bluetooth.
- 3) Touch **Not Connected** next to the device name. A Bluetooth Passkey window will open.
- 4) Touch **OK**.
- 5) Touch **Connected** to disconnect.

The Bluetooth Setup Menu provides several options for connecting to Bluetooth devices. **Manage Paired Devices** can enable Automatic Reconnect and remove connections on a per-device basis.

## PAIRING THE GDL 51/52 AS AN AUDIO DEVICE

The GDL 51/52 can also be paired using its internal Bluetooth connection to play audio.

### Pairing the GDL 51/52 as an audio device:

- 1) From the **Main Menu**, touch **Tools** > **Data Link**.
- 2) Touch **Menu** > **Manage Connex Bluetooth**.
- 3) Touch **Menu**.
  - a) To add a device, touch **Add Audio Devices** > **Pair Device**.
  - b) To remove a device, touch **Remove Paired Devices** and touch the red X to select the desired device.

## USING AN EXTERNAL GPS ANTENNA (OPTIONAL)

The optional GA27C or GA25 external antenna can be used. Connect the antenna to the connector located on the left side of the unit.

## CONNECTING TO A FLIGHT STREAM 110/210

Connecting the aera 795/796 to a Flight Stream 110/210 using the Connex Bluetooth interface allows the aera to communicate with the non-Bluetooth avionics device connected to the Flight Stream. This includes devices such as the GDL 84/88 ADS-B datalinks. The Flight Stream 210 can additionally provide attitude information with its on-board attitude sensors.

### Pairing a Flight Stream 110/210 via Bluetooth:

- 1) From the **Main Menu**, touch **Tools** > **Setup** > **Bluetooth**.
- 2) Touch Bluetooth **On/Off** to turn on the Bluetooth.
- 3) Touch **Not Connected** next to the device name. A Bluetooth Passkey window will open.
- 4) Touch **OK**.
- 5) Touch **Connected** to disconnect.

## APPENDIX E: BATTERY AND CARE INFORMATION

### BATTERY INFORMATION

The aera 795/796 contains a user-replaceable, lithium-ion battery. To maximize the lifetime of the battery, do not leave the aera 795/796 in direct sunlight, and avoid prolonged exposure to excessive heat.

The  battery icon in the top right of the screen indicates the status of the aera 795/796 battery. To increase the accuracy of the battery gauge, fully discharge the battery and fully charge it. Do not unplug the aera 795/796 until it is fully charged.

#### MAXIMIZING THE BATTERY LIFE

- Turn down the backlight (refer to the 'System Settings').
- Unplug the SiriusXM antenna (if applicable).
- Do not leave the unit in direct sunlight. When storing the device for an extended time, store within the following temperature range: -0° to 40°C).
- Do not operate the unit outside of the following temperature range: -4° to 131°F (-20° to 55°C).
- Avoid prolonged exposure to excessive heat.

#### REPLACING THE BATTERY IN THE AERA 795/796

To replace the battery, purchase a Garmin lithium-ion replacement battery at <http://buy.garmin.com>. Contact your local waste disposal department for information about properly disposing of the battery.

### CHANGING THE CIGARETTE LIGHTER ADAPTER FUSE

If the unit does not charge, the fuse may need to be replaced.

- 1) Unscrew the round end piece, and remove it.
- 2) Remove the fuse (glass and silver cylinder), and replace with a 3A fast-blow fuse.
- 3) Ensure the silver tip is placed in the end piece. Screw on the end piece.

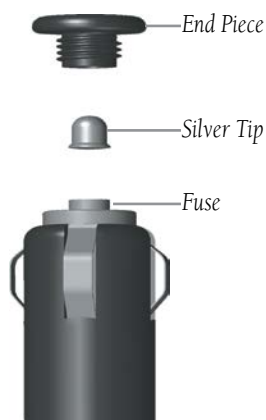

## CLEANING THE CASING

---

The aera 795/796 is constructed of high-quality materials and does not require user maintenance other than cleaning. Clean the outer casing (not the touchscreen) using a cloth dampened with a mild detergent solution, and then wipe dry. Avoid chemical cleaners and solvents that can damage plastic components.

## CLEANING THE TOUCHSCREEN

---

Clean the touchscreen with the included cloth or a soft, clean, lint-free cloth. Use water, isopropyl alcohol, or eyeglass cleaner, if needed. Apply the liquid to the cloth, and then gently wipe the touchscreen.

## PROTECTING THE UNIT

---

- Do not store the aera 795/796 where prolonged exposure to extreme temperature can occur.
- Never use a hard or sharp object to operate the touchscreen.

## APPENDIX F: GENERAL TIS-A INFORMATION



**NOTE:** Aircraft without an operational transponder are invisible to TIS-A.



**WARNING:** Do not rely solely upon the display of traffic information for collision avoidance maneuvering. The traffic display does not provide collision avoidance resolution advisories and does not under any circumstances or conditions relieve the pilot's responsibility to see and avoid other aircraft.



**WARNING:** Do not rely solely upon the display of traffic information to accurately depict all of the traffic within range of the aircraft. Due to lack of equipment, poor signal reception, and/or inaccurate information from aircraft or ground stations, traffic may be present that is not represented on the display.

The Traffic Information Service (TIS-A) provides traffic advisory information to non-TAS/TCAS-equipped aircraft. TIS-A is a ground-based service providing the relative locations of all ATCRBS (Air Traffic Control Radar Beacon System) Mode-A and Mode-C transponder equipped aircraft within a specified service volume. The TIS-A ground sensor uses real-time track reports to generate traffic notification. The aera 795/796 displays TIS-A traffic information on the Navigation Map. Surveillance data includes all transponder-equipped aircraft within the coverage volume. The aera 795/796 displays up to eight traffic targets within a 7.5-nm radius, from 3,000 feet below, to 3,500 feet above the requesting aircraft.

### TIS-A VS. TAS/TCAS

The main difference between the Traffic Information System (TIS-A) and Traffic Advisory (TAS) or Traffic Collision Avoidance Systems (TCAS) is the source of surveillance data. TAS/TCAS uses an airborne interrogator with a half-second update rate, while TIS-A utilizes the terminal Mode-S ground interrogator and accompanying data link to provide a five-second update rate. TIS-A and TAS/TCAS have similar ranges.

## TIS-A LIMITATIONS

---

TIS-A relies on surveillance of the Mode-S radar system, which is a “secondary surveillance” radar system similar to that used by ATCRBS. Many limitations are inherent in secondary radar surveillance. Information provided by TIS-A is neither better nor more accurate than the information used by ATC. TIS-A is intended only to assist in visual acquisition of other aircraft in visual meteorological conditions (VMC). While TIS-A is a useful aid for visual traffic avoidance, system limitations must be considered to ensure proper use. No recommended avoidance maneuvers are given, nor authorized, as a direct result of a TIS-A intruder display or TIS-A advisory.

- TIS-A operation may be intermittent during turns or other maneuvering.
- TIS-A is dependent on two-way, line-of-sight communications between the aircraft and the Mode-S radar antenna. Whenever the structure of the aircraft comes between the transponder antenna and the ground-based radar antenna, the signal may be temporarily interrupted.



---

**NOTE:** Refer to the *TIS-A Limitations* section of the *Aeronautical Information Manual (AIM)* for a more comprehensive explanation of limitations and anomalies associated with TIS-A.

---



---

**NOTE:** TIS-A is unavailable at low altitudes in many areas of the United States. This is often the case in mountainous regions.

---



---

**NOTE:** Garmin is not responsible for Mode S geographical coverage. Operation of the ground stations is the responsibility of the FAA. Refer to the AIM for a Terminal Mode S radar site map.

---

TIS-A information is collected during a single radar sweep. Collected information is then sent through the Mode S uplink on the next radar sweep. Because of this, the surveillance information is approximately five seconds old. TIS-A ground station tracking software uses prediction algorithms to compensate for this delay. These algorithms use track history data to calculate expected intruder positions consistent with the time of display. Occasionally, aircraft maneuvering may cause variations in this calculation and create slight errors on the Navigation Map which affect relative bearing information and the target track vector and may delay display of the intruder information. However, intruder distance and altitude typically remain relatively accurate and may be used to assist in spotting traffic. The following errors are common examples:

- When the client or intruder aircraft maneuvers excessively or abruptly, the tracking algorithm may report incorrect horizontal position until the maneuvering aircraft stabilizes.
- When a rapidly closing intruder is on a course that intercepts the client aircraft course at a shallow angle (either overtaking or head-on) and either aircraft abruptly changes course within 0.25 nm, TIS-A may display the intruder aircraft on the incorrect side of the client aircraft.

These are rare occurrences and are typically resolved within a few radar sweeps once the client/intruder aircraft course stabilizes.

Pilots using TIS-A can provide valuable assistance in the correction of malfunctions by reporting observations of undesirable performance. Reports should identify the time of observation, location, type and identity of the aircraft, and describe the condition observed. Reports should also include the type of transponder and transponder software version. Since TIS-A performance is monitored by maintenance personnel, not ATC, malfunctions should be reported in the following ways:

- By telephone to the nearest Flight Service Station (FSS) facility
- By FAA Form 8000-7, Safety Improvement Report (postage-paid card can be obtained at FAA FSSs, General Aviation District Offices, Flight Standards District Offices, and General Aviation Fixed Base Operators)

Overview

GPS Navigation

Flight Planning

Hazard Avoidance

Additional Features

Appendices

Index

Blank Page



## APPENDIX G: UTILITIES

### DOCUMENT VIEWER

Refer to Appendix C: Managing Files and Databases, for information on how to store documents on the aera 795/796.

#### Accessing a PDF Document using the aera 795/796 Document Viewer:

- 1) From the **Main Menu**, touch **Doc Viewer**.
- 2) Touch the Open Button.
- 3) Touch the desired document from the list.

### SCRATCH PAD

The Scratch Pad feature allows the pilot to quickly draw or write down information using only the touchscreen.

#### Accessing the Scratch Pad:

- 1) From the **Main Menu**, touch **Tools > Scratchpad**
- 2) Touch the screen to begin drawing.

#### Viewing a previously created Scratch Pad:

- 1) From the **Main Menu**, touch **Tools > Scratchpad > Menu > Open...**
- 2) Touch the desired scratchpad file name from the list.

#### Clearing the Scratch Pad screen:

With the desired Scratchpad displayed, touch **Menu > Clear Screen**.

#### Saving a Scratch Pad:

With the desired Scratchpad displayed, touch **Menu > Save**.

#### Deleting a Scratch Pad:

With the desired Scratchpad displayed, touch **Menu > Delete**.

#### Changing the Scratch Pad pen color:

- 1) With the desired Scratchpad displayed, touch **Menu > Setup**.
- 2) Touch the 'Pen Color' datafield and select the desired color from the horizontal list.

### Changing the Scratch Pad pen width:

- 1) With the desired Scratchpad displayed, touch **Menu** > **Setup**.
- 2) In the 'Pen Width' datafield, touch the  buttons select the desired pen width.

## FLIGHT LOG

The Flight Log shows a list of any recorded flights, including date, route of flight, and flight time. The aera 795/796 saves up to 50 recorded flights. Entries on this list are automatically created for each flight.

Recording begins when your speed exceeds 30 knots and you gain 250 feet of altitude. If you land and groundspeed drops below 30 knots, the flight entry is saved and a new entry is recorded when you depart the airport. A touch-and-go or brief stop of less than 10 minutes appends to the current flight record, rather than starting a new entry.

### VIEWING THE FLIGHT LOG

Select any listed entry in the log to view additional information, including a map displaying the actual path flown.

#### Viewing details for a flight:

- 1) From the **Main Menu**, touch **Tools** > **Flight Log**.
- 2) Touch the desired flight log.

#### Show/Hide hours and minutes for a flight:

- 1) From the **Main Menu**, touch **Tools** > **Flight Log**.
- 2) Touch the desired flight log (if applicable).
- 3) Touch **Menu**.
- 4) Touch '**Show/Hide Hours and Minutes**'.

### DELETING FLIGHT LOG RECORDS

You can delete the highlighted flight record or delete all flight records from the Flight Log.

#### Deleting flight records:

- 1) From the **Main Menu**, touch **Tools** > **Flight Log**.

- 2) Touch the desired flight log to delete (if applicable).
- 3) Touch **Menu**.
- 4) Touch '**Delete Flight**' or '**Delete All**'.
- 5) Touch **Yes**.

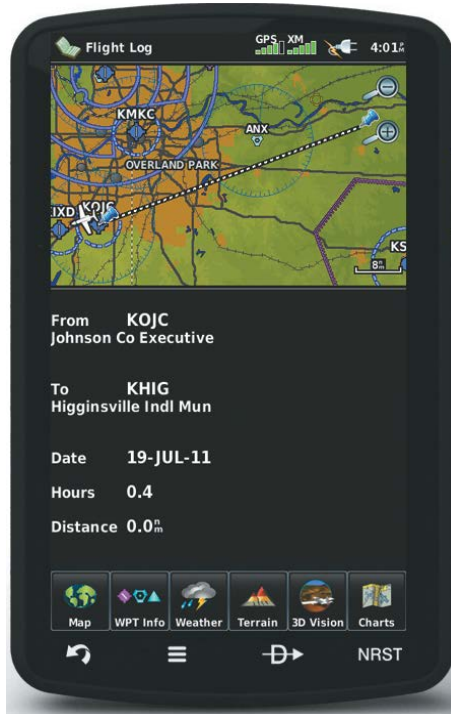

Flight Log

## TRACK LOG

The aera 795/796 draws an electronic breadcrumb trail or “track log” on the Navigation Map. The track log contains points along its path, including time, and location for each point.

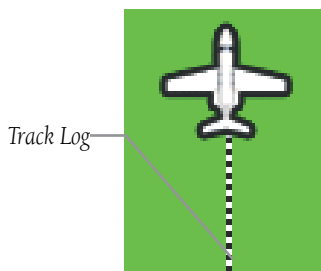

Track Log (Map)

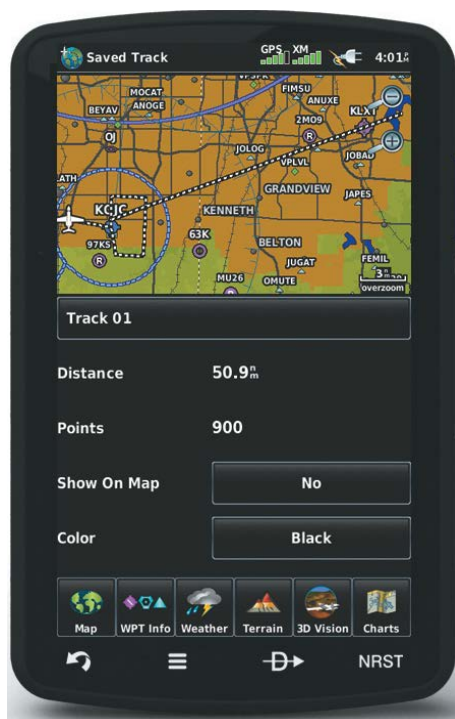

Track Log

The track log starts recording as soon as the aera 795/796 gets a location fix. For the best results, clear the track log before each flight.

The percentage of memory used by the current track log appears at the top of the Track Log Window. After the track log is cleared, it shows zero percent. When the screen reaches 100%, the most recent track points start to overwrite the least recent track points (if 'Wrap' is selected in the Record Mode Field). To avoid losing track points, save the track log when it approaches the 99% mark.

The Save feature allows storage of up to 15 track logs.

### Showing/hiding the track log on the Navigation Map:

- 1) From the **Main Menu**, touch **Map > Menu > Set Up Map**.
- 2) Touch the  buttons to display the '**Line**' Category.
- 3) Touch **Track Log**.
- 4) Touch the **Show/Hide** Button.

### Changing the track log record mode:

- 1) From the **Main Menu**, touch **Map > Menu > Set Up Map**.
- 2) Touch the  buttons to display the '**Line**' Category.
- 3) Touch the 'Track Record Mode' datafield button, and touch the desired mode from the horizontal list ('**Off**', '**Fill**', or '**Wrap**').

### Changing the track log interval:

- 1) From the **Main Menu**, touch **Map > Menu > Set Up Map**.
- 2) Touch the  buttons to display the '**Line**' Category.
- 3) Touch the 'Track Interval' datafield button, and touch the desired interval from the horizontal list ('**Auto**', '**Distance**', or '**Time**').

### Changing the track log color:

- 1) From the **Main Menu**, touch **Map > Menu > Set Up Map**.
- 2) Touch the  buttons to display the '**Line**' Category.
- 3) Touch the 'Track Color' datafield button, and touch the desired color from the horizontal list.

Track Log settings are also available from the Track Log Option Menu

- Track Log—Select '**Show**' or '**Hide**' to display/remove the track log on the map.

- Track Record Mode—'Off' disables track log recording. 'Fill' records a track log until the track log is full (100%). 'Wrap' records over the oldest tracks when the track log reaches 100%.
- Track Interval—'Distance' records track points after a specified distance has been traveled. 'Time' creates track points after a specified time has elapsed. 'Automatic' saves points that occur after changes in navigation.
- Track Color—Select a color for the track when it appears on the map.

### Clearing the track log:

- 1) From the **Main Menu**, touch **Tools** > **Track Log**.
- 2) Touch the desired track log (if applicable).
- 3) Touch **Menu**.
- 4) Touch 'Delete Saved Track' or 'Delete All Saved Tracks'.
- 5) Touch **Yes**.

### Saving a track log:

- 1) From the **Main Menu**, touch **Tools** > **Track Log** > **Menu** > **Save Active Track**.
- 2) Touch the  buttons to select 'Entire Active Track', 'Past 24 Hours', 'Past 7 Days', or 'Specific Dates'.
- 3) Enter the Specific Dates (if applicable) and touch **OK**.

### Editing a track log:

- 1) From the **Main Menu**, touch **Tools** > **Track Log**.
- 2) Touch the desired track log.
- 3) Touch desired field to edit (**Track Name**, **Show On Map**, or **Color**).

## HEADING LINE

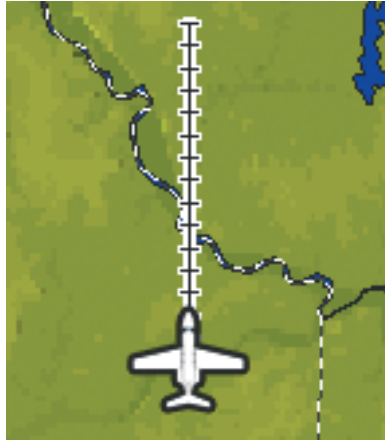

---

The aera 795/796 draws an electronic "heading line" on the Navigation Map. The heading line can be set to time or distance.



Heading Line

### Changing the heading line settings on the Navigation Map:

- 1) From the **Main Menu**, touch **Map > Menu > Set Up Map**.
- 2) Touch the   buttons to display the 'Line' Category.
- 3) Touch the 'Heading Line' datafield button, and touch the desired line setting from the horizontal list ('Off', 'Time', or 'Distance').

## E6B CALCULATOR

The E6B Calculator calculates Density Altitude, True Airspeed, Tail Wind, Wind From, and Wind Speed, based on information you enter.

From the **Main Menu**, touch **Tools > E6B**.

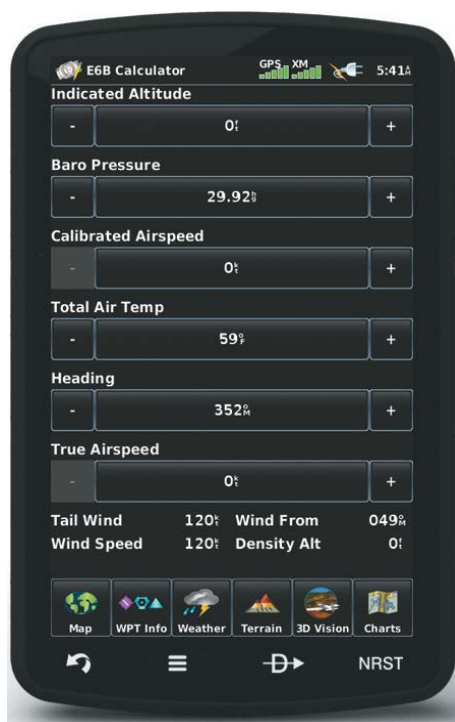

E6B Calculator

- **Indicated Altitude**—required entry for density altitude/true airspeed calculation. Enter the aircraft's altimeter reading.
- **Baro Pressure**—when the unit is receiving XM weather information, the field automatically updates to the barometric pressure of the nearest METAR. If XM weather information is not available you need to enter the current barometric pressure.
- **Calibrated Airspeed**— required entry for density altitude/true airspeed calculation. Enter the aircraft's airspeed indicator value.
- **Total Air Temp**— required entry for density altitude/true airspeed calculation. Total Air Temperature (TAT) is the temperature of the air including the heating effect caused by speed. The temperature reading on a standard outside air temperature gauge found on most piston aircraft is TAT.



- **Heading**— required entry for winds aloft calculation. Use heading from the aircraft's heading indicator or directional gyro.
- **True Airspeed**— (calculated or user-entered figure) determined from entry of calibrated airspeed, barometric pressure, and total air temperature. This can also be entered directly for winds aloft calculations.
- **Tail Wind**— (calculated figure) determined from entry of heading and true airspeed.
- **Wind From**—(calculated figure) determined from entry of heading and true airspeed.
- **Wind Speed**—(calculated figure) determined from entry of heading and true airspeed.
- **Density Altitude**— (calculated figure) determined from entry of indicated altitude, barometric pressure and total air temperature.

### Calculating true airspeed and density altitude:

- 1) From the **Main Menu**, touch **Tools > E6B**, enter the altitude shown on the altimeter into the 'Indicated Altitude' datafield.
- 2) Repeat for 'Calibrated Airspeed', 'Baro Pressure', and 'Total Air Temperature' datafields. (For Calibrated Airspeed, use the speed shown on the airspeed indicator. Use the current altimeter setting for Baro Pressure. Total Air Temperature is the temperature of the outside air including the heating effect caused by speed. For most aircraft, this is the temperature reading on a standard outside air temperature gauge.) The calculated figures for True Airspeed and Density Altitude are shown in the designated fields.

### Calculating winds aloft:

- 1) From the **Main Menu**, touch **Tools > E6B**, calculate or enter the true airspeed into the 'True Airspeed' datafield.
- 2) Enter the aircraft heading shown on the directional gyro or compass into the 'Heading' datafield. Tail Wind, Wind From, and Wind Speed are calculated.



**NOTE:** If True North is selected as the heading reference, a heading referenced to True North must be used to calculate winds accurately.

## Restoring E6B calculator defaults:

From the **Main Menu**, touch **Tools** > **E6B** > **Menu** > **Restore Default** > **Yes..**

## AIRCRAFT PROFILE

The Aircraft Profile allows the pilot to select cruising speed, maximum speed, fuel flow, and map symbol. The unit can save up to 10 aircraft profiles.

The maximum speed is used to define the range for airspeed on the Panel and is automatically updated if you exceed this figure.

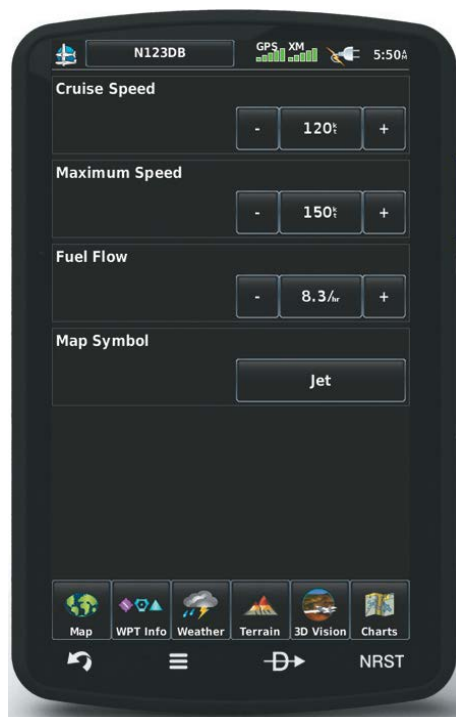

### Accessing the aircraft profile:

From the **Main Menu**, touch **Tools** > **Profile**.



Aircraft Profile

### Entering an aircraft profile:

- 1) From the **Main Menu**, touch **Tools > Profile > Menu > New**.
- 2) Enter the Aircraft Name using the keypad, and touch **OK**.
- 3) Enter the **Cruise Speed, Maximum Speed**, or **Fuel Flow** using the +/- buttons or the keypad.
- 4) Touch the 'Map Symbol' datafield button.
- 5) Touch the   buttons to cycle through the available symbols and touch **OK**.

### Selecting a saved aircraft profile:

- 1) From the **Main Menu**, touch **Tools > Profile**.
- 2) Touch the Aircraft Name Button to access a vertical list of saved profiles (if only two profiles are available touch the Aircraft Name Button to toggle between the two).
- 3) Touch the desired profile from the list.

### Renaming a saved aircraft profile:

- 1) From the **Main Menu**, touch **Tools > Profile**.
- 2) Touch the Aircraft Name Button to access a vertical list of saved profiles.
- 3) Touch the desired profile from the list.
- 4) Touch **Menu > Rename**.
- 5) Enter the new Aircraft Name using the keypad, and touch **OK**.

### Deleting a saved aircraft profile:

- 1) From the **Main Menu**, touch **Tools > Profile**.
- 2) Touch the Aircraft Name Button to access a vertical list of saved profiles.
- 3) Touch the desired profile from the list.
- 4) Touch **Menu > Delete**.
- 5) Touch **Yes**.

## WEIGHT & BALANCE

Weight & Balance may be used during pre-flight preparations to verify the weight and balance conditions of the aircraft. By entering the weight and arm values, the aera 795/796 can calculate the total weight, moment, and center of gravity (CG).

Before entering the various figures, the empty weight of the airplane and the arm (or “station”) for each weight should be determined. These figures should be determined using the pilot’s operating handbook for the airplane, which also notes the weight limitations and fore/aft CG limits. Compare those figures to the values calculated by the aera 795/796.

### To perform weight and balance calculations:

- 1) From the **Main Menu**, touch **Tools** > **Weight/Bal.**
- 2) Touch the datafields to enter the desired weights and arms (or “stations”). The calculated moment, weight, and CG figures appear at the bottom of the screen. Keep in mind the “Aircraft” (empty weight/arm) figures must be entered as a reference to calculate a valid moment, weight, and CG.
- 3) To empty the aircraft, touch **Menu** > **Empty Aircraft.**



---

**NOTE:** *This information is only for flight planning purposes. Consult the aircraft’s pilot operating handbook for the official weight and balance data.*

---

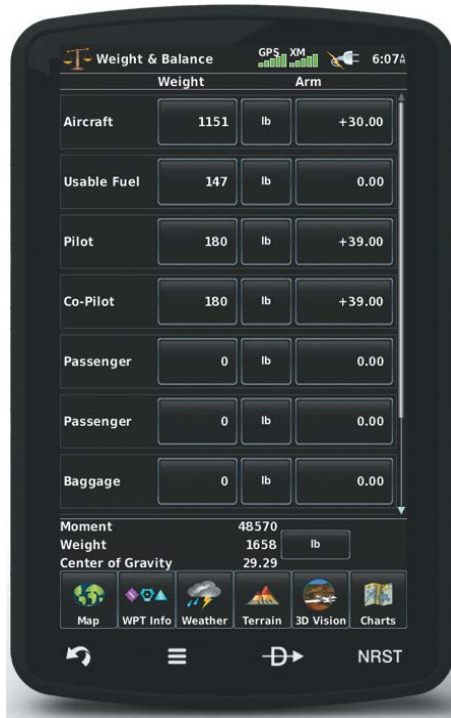

Weight & Balance

## PROXIMITY WAYPOINTS

The Proximity Waypoints allows the pilot to define an alarm circle around a waypoint location.

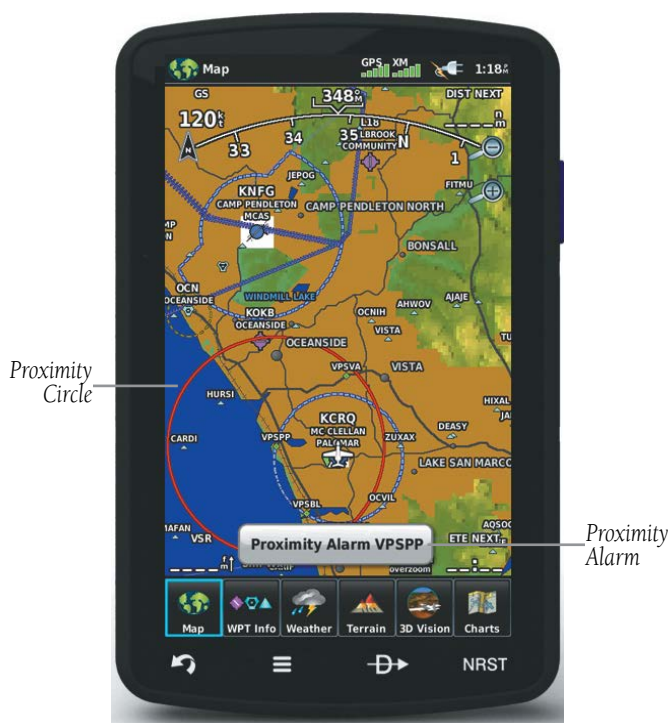

Proximity Waypoints



### Defining proximity waypoints:

- 1) From the **Main Menu**, touch **Tools** > **User WPT** > **Proximity Tab** > **Menu** > **New Proximity Waypoint**.
- 2) Touch 'Use Identifier' or 'Use Map'.
- 3) Enter the desired identifier or pan the map.
- 4) Touch the newly created Proximity Waypoint, and touch 'Edit Radius'.
- 5) Enter the desired Radius and touch **OK**.

### Setting up and customizing proximity waypoints for the navigation map:

From the **Main Menu**, touch **Tools** > **User WPT** > **Proximity Tab** > **Menu** > **Enable/Disable Proximity Alarms**.

**Or:**

- 1) From the **Main Menu**, touch **Map > Menu > Set Up Map**.
- 2) Touch the  buttons to display the '**Point**' Category.
- 3) Touch the 'Proximity Circle'  buttons to select the desired settings ('**Off**', '**Auto**', or Range Settings).

### Deleting proximity waypoints:

- 1) From the **Main Menu**, touch **Tools > User WPT > Proximity** Tab.
  - a) Touch the desired proximity waypoint.
  - b) Touch the '**Delete Proximity Waypoint**' menu option.

**Or:**











  - a) Touch the **Menu** Icon
  - b) Touch the '**Delete All**' menu option.
- 2) Touch **Yes**.

Blank Page









# APPENDIX H: DISPLAY SYMBOLS

## VFR SYMBOLS

Item	Symbol
Unknown	
Non-towered, Non-serviced	
Towered, Non-serviced	
Non-towered, Serviced	
Towered, Serviced	
Soft Surface, Non-serviced	
Soft Surface, Serviced	
Soft Surface, Private	
Paved, Private	
Seaplane Base	
Heliport	

**Americas/Pacific Database Airports**

Item	Symbol
Civilian, Non-serviced	
Military, Non-serviced	
Civilian, Serviced	
Military, Serviced	
Civilian, Soft/Unknown Surface, Non-serviced	
Civilian, Soft/Unknown Surface, Serviced	

**Atlantic Database Airports**

Item	Symbol
Intersection	
Visual Reporting Point	
LOM (compass locator at outer marker)	
NDB (non-directional radio beacon)	
VOR	
VOR/DME	
ILS/DME or DME only	
VORTAC	
TACAN	

Nav aids

Item	Symbol
Interstate Highway	
US Highway	
State Highway	
National Highway	
Small City	
Medium City	
Large City	

Miscellaneous











## IFR SYMBOLS

Item	Symbol
VFR, Soft/unknown Surface, Non-serviced	
VFR, Soft/unknown Surface, Serviced	









Atlantic Database Airports

Item	Symbol
Low-Altitude	
High-Altitude	

Airways

Item	Symbol
Unknown	
VFR Airport, Non-serviced	
IFR Airport, Non-serviced	
VFR Airport, Serviced	
IFR Airport, Serviced	
VFR, Soft Surface, Non-serviced	
VFR, Soft Surface, Serviced	
VFR, Soft Surface, Private	
VFR, Paved, Private	
VFR Seaplane Base	
VFR Heliport	

**Americas/Pacific Database Airports**

Item	Symbol
Intersection	
LOM (compass locator at outer marker)	
NDB (non-directional radio beacon)	
VOR	
VOR/DME	
ILS/DME or DME Only	
VORTAC	
TACAN	

**Nav aids**



# AIRSPACE SYMBOLS

Item	Symbol
Class B, Class E, CTA	
Class A, Class C, TMA	
Class D	
Mode C Veil	
TRSA	
MOA	
Danger, Alert, or Training Area	
Restricted, Prohibited, or Warning Area	
Radar Area	
ATZ, TIZ	
MATZ	
ADIZ	
Misc/Unknown	

VFR Americas/Pacific Database

Item	Symbol
Class B, Class E, CTA	
Class A, Class C, TMA, TRSA	
Class D	
MOA	
Danger, Alert, or Training Area	
Restricted, Prohibited, or Warning Area	
Radar Area	
ATZ, TIZ	
Misc/Unknown	

IFR Americas/Pacific Database

Item	Symbol
Danger or Alert Area	
Restricted, Prohibited, or Warning Area	
Training Area	

**VFR Atlantic Database Exceptions**

Item	Symbol
Training Area	

**IFR Atlantic Database Exceptions**

Blank Page

# APPENDIX I: MAP DATUM AND LOCATION FORMATS

## MAP DATUMS

---

A datum is a mathematical model of the Earth that approximates the shape of the Earth and enables calculations to be carried out in a consistent and accurate manner. The datum is physically represented by a framework of ground monuments (such as trig. stations) whose locations have been accurately measured and calculated on this reference surface. Lines of latitude and longitude on a chart are referenced to a specific map datum. Every chart has a map datum reference and the aera 795/796 can be set to match most of those commonly used.

## LOCATION FORMATS

---

Your current location can be viewed on the GPS in the form of coordinates. Since different charts use different location formats, Garmin GPS units allow you to choose the correct coordinate system for the type of chart you are using. The most common format is latitude and longitude, which is used by all Garmin units. You can change the location format to use with other coordinate systems. Several other grids, including a user-definable grid (for the advanced user), are available.

Blank Page



## APPENDIX J: GLOSSARY

ADIZ	Air Defense Identification Zone
ADS-B	Automatic Dependant Surveillance -Broadcast
ADS-B In	Ability to receive ADS-B information from other aircraft and Ground Based Transceivers (GBTs)
ADS-B Out	Ability to transmit ADS-B data on 1090 ES or 978 MHz
ADS-B Participating Aircraft	An aircraft that has both ADS-B In and ADS-B Out capabilities.
ADS-R	Automatic Dependent Surveillance-Rebroadcast
AGL	Above Ground Level
AIRMET	Airman’s Meteorological Information
ARTCC	Air Route Traffic Control Center
ASOS	Automated Surface Observing System
ATC	Air Traffic Control
ATIS	Automatic Terminal Information Service
AWOS	Automated Weather Observing System
Bearing	The compass direction from the present position to a destination waypoint.
°C	degrees Celsius
Calibrated Airspeed	Indicated airspeed corrected for installation and instrument errors.
cm	centimeter
COM	communication radio
Course	The line between two points to be followed by the aircraft.
Course to Steer	The recommended direction to steer in order to reduce course error or stay on course. Provides the most efficient heading to get back to the desired course and proceed along the flight plan.
Crosstrack Error	The distance the aircraft is off a desired course in either direction, left or right.

## Overview

dBZ	decibels 'Z' (radar return)
deg	degree
Desired Track	The desired course between the active "from" and "to" waypoints.
DIS	distance

## GPS Navigation

Distance	The 'great circle' distance from the present position to a destination waypoint.
DME	Distance Measuring Equipment
DTK	Desired Track

## Flight Planning

Enroute Safe Altitude	The recommended minimum altitude within ten miles left or right of the desired course on an active flight plan or direct-to.
ESA	Enroute Safe Altitude
Estimated Time of Arrival	The estimated time at which the aircraft should reach the destination waypoint, based upon current speed and track.

## Hazard Avoidance

Estimated Time Enroute	The estimated time it takes to reach the destination waypoint from the present position, based upon current ground speed.
ETA	Estimated Time of Arrival
ETE	Estimated Time Enroute

## Additional Features

°F	degrees Fahrenheit
FAA	Federal Aviation Administration
FAF	Final Approach Fix
FCC	Federal Communication Commission
FIS-B	Flight Information Service-Broadcast
fpm	feet per minute
FSS	Flight Service Station
ft	foot/feet

## Appendices

gal	gallon(s)
geodetic altitude	GPS calculated altitude

## Index

Glide Ratio, G/R	The estimated distance an aircraft will move forward for any given amount of lost altitude.
gph	gallons per hour
GPS	Global Positioning System
Grid MORA	Grid Minimum Off-Route Altitude; one degree latitude by one degree longitude in size and clears the highest elevation reference point in the grid by 1000 feet for all areas of the grid
Ground-Based Transceiver	Provides ADS-R, TIS-B and FIS-B broadcasts to ADS-B participating aircraft.
Groundspeed	The velocity the aircraft is travelling relative to a ground position.
Ground Track	see Track
GS	Ground speed
Heading	The direction an aircraft is pointed, based upon indications from a magnetic compass or a properly set directional gyro.
Hg	mercury
hPa	hectopascal
hr	hour
HSI	Horizontal Situation Indicator
Hz	Hertz
IAF	Initial Approach Fix
IAT	Indicated Air Temperature
ICAO	International Civil Aviation Organization
IFR	Instrument Flight Rules
ILS	Instrument Landing System
IMC	Instrument Meteorological Conditions
in	inch
Indicated	Information provided by properly calibrated and set instrumentation on the aircraft panel.
in HG	inches of mercury

## Overview

kg	kilogram
kHz	kilohertz
km	kilometer
kt	knot

## GPS Navigation

LAT	latitude
lb	pound
Leg	The portion of a flight plan between two waypoints.

## Flight Planning

LOC	localizer
LON	longitude

## Hazard Avoidance

m	meter
MAP	Missed Approach Point
METAR	Meteorological Aviation Routine
MHz	megahertz
Minimum Safe Altitude	Uses Grid MORAs to determine a safe altitude within ten miles of the aircraft present position.

## Additional Features

MOA	Military Operations Area
MSA	Minimum Safe Altitude
MSL	Mean Sea Level

## Appendices

NAVAID	NAVigation AID
NDB	Non-directional Beacon
NEXRAD	Next Generation Radar
nm	nautical mile(s)

## Index

OAT	Outside Air Temperature
OBS	Omni Bearing Selector
psi	pounds per square inch

QTY	quantity
rpm	revolutions per minute
SBAS	Satellite-Based Augmentation System
SD	Secure Digital
sec	second(s)
SIGMET	Significant Meteorological Information
TA	Traffic Advisory
TACAN	Tactical Air Navigation System
TAF	Terminal Aerodrome Forecast
TAS	True Airspeed
TCAS	Traffic Collision Avoidance System
TFR	Temporary Flight Restriction
TIS-A	Traffic Information Service
TIS-B	Traffic Information Service-Broadcast
Track	Direction of aircraft movement relative to a ground position; also 'Ground Track'
TRSA	Terminal Radar Service Area
UTC	Coordinated Universal Time
VFR	Visual Flight Rules
VHF	Very High Frequency
VNAV	vertical navigation
VOR	VHF Omni-directional Range
VORTAC	very high frequency omnidirectional range station and tactical air navigation
VSI	Vertical Speed Indicator

VSR	Vertical Speed Required
VTF	vector to final
WAAS	Wide Area Augmentation System
WX	weather

# APPENDIX K: LICENSE AGREEMENT AND WARRANTY

## CONTACT GARMIN

---

Contact Garmin if you have any questions while using your aera 795/796 go to [www.flygarmin.com](http://www.flygarmin.com).

## SOFTWARE LICENSE AGREEMENT

---

BY USING THE aera 795/796, YOU AGREE TO BE BOUND BY THE TERMS AND CONDITIONS OF THE FOLLOWING SOFTWARE LICENSE AGREEMENT. PLEASE READ THIS AGREEMENT CAREFULLY.

Garmin grants you a limited license to use the software embedded in this device (the “Software”) in binary executable form in the normal operation of the product. Title, ownership rights, and intellectual property rights in and to the Software remain with Garmin.

BY USING THE DEVICE, COMPONENT OR SYSTEM MANUFACTURED OR SOLD BY GARMIN (“THE GARMIN PRODUCT”), YOU AGREE TO BE BOUND BY THE TERMS AND CONDITIONS OF THE FOLLOWING SOFTWARE LICENSE AGREEMENT. PLEASE READ THIS AGREEMENT CAREFULLY. Garmin Ltd. and its subsidiaries (“Garmin”) grants you a limited license to use the software embedded in the Garmin Product (the “Software”) in binary executable form in the normal operation of the Garmin Product. Title, ownership rights, and intellectual property rights in and to the Software remain with Garmin and/or its third-party providers. You acknowledge that the Software is the property of Garmin and/or its third-party providers and is protected under the United States of America copyright laws and international copyright treaties. You further acknowledge that the structure, organization, and code of the Software are valuable trade secrets of Garmin and/or its third-party providers and that the Software in source code form remains a valuable trade secret of Garmin and/or its third-party providers. You agree not to reproduce, decompile, disassemble, modify, reverse assemble, reverse engineer, or reduce to human readable form the Software or any part thereof or create any derivative works based on the Software. You agree not to export or re-export the Software to any country in violation of the export control laws of the United States of America.

## AVIATION LIMITED WARRANTY

All Garmin avionics products are warranted to be free from defects in materials or workmanship for the earlier of: 2 years or 800 flight hours from the date of purchase for new TSO remote-mount and TSO panel-mount products; 1 year or 400 flight hours from the date of purchase for new Non-TSO remote-mount\* and Non-TSO panel-mount\*, portable products and any purchased newly-overhauled products; 6 months or 200 flight hours for factory repaired or newly-overhauled products exchanged through a Garmin Authorized Service Center.

Within the applicable period, Garmin will, at its sole option, repair or replace any components that fail in normal use. Such repairs or replacement will be made at no charge to the customer for parts or labor, provided that the customer shall be responsible for any transportation cost. This Limited Warranty does not apply to: (i) cosmetic damage, such as scratches, nicks and dents; (ii) consumable parts, such as batteries, unless product damage has occurred due to a defect in materials or workmanship; (iii) damage caused by accident, abuse, misuse, water, flood, fire, or other acts of nature or external causes; (iv) damage caused by service performed by anyone who is not an authorized service provider of Garmin; or (v) damage to a product that has been modified or altered without the written permission of Garmin. In addition, Garmin reserves the right to refuse warranty claims against products or services that are obtained and/or used in contravention of the laws of any country.

This Limited Warranty also does not apply to, and Garmin is not responsible for, any degradation in the performance of any Garmin navigation product resulting from its use in proximity to any handset or other device that utilizes a terrestrial broadband network operating on frequencies that are close to the frequencies used by any Global Navigation Satellite System (GNSS) such as the Global Positioning Service (GPS). Use of such devices may impair reception of GNSS signals.

TO THE MAXIMUM EXTENT PERMITTED BY APPLICABLE LAW, THE WARRANTIES AND REMEDIES CONTAINED IN THIS LIMITED WARRANTY ARE EXCLUSIVE AND IN LIEU OF, AND GARMIN EXPRESSLY DISCLAIMS, ALL OTHER WARRANTIES AND REMEDIES, WHETHER EXPRESS, IMPLIED, STATUTORY, OR OTHERWISE, INCLUDING WITHOUT LIMITATION ANY IMPLIED WARRANTY OF MERCHANTABILITY OR FITNESS FOR A PARTICULAR PURPOSE, STATUTORY REMEDY OR OTHERWISE. THIS LIMITED WARRANTY GIVES YOU SPECIFIC LEGAL RIGHTS, AND YOU MAY HAVE OTHER LEGAL RIGHTS WHICH VARY FROM STATE TO STATE. IF IMPLIED WARRANTIES CANNOT BE DISCLAIMED, THEN SUCH WARRANTIES ARE LIMITED IN DURATION TO THE DURATION OF THIS LIMITED WARRANTY. SOME STATES DO NOT ALLOW LIMITATIONS ON HOW LONG AN IMPLIED WARRANTY LASTS, SO THE ABOVE LIMITATION MAY NOT APPLY TO YOU.

IN NO EVENT SHALL GARMIN BE LIABLE FOR ANY INCIDENTAL, SPECIAL, INDIRECT OR CONSEQUENTIAL DAMAGES, WHETHER RESULTING FROM THE USE, MISUSE OR INABILITY TO USE THE PRODUCT OR FROM DEFECTS IN THE PRODUCT. SOME STATES DO NOT ALLOW THE EXCLUSION OF INCIDENTAL OR CONSEQUENTIAL DAMAGES, SO THE ABOVE LIMITATIONS MAY NOT APPLY TO YOU.

Garmin retains the exclusive right to repair or replace (with a new or newly-overhauled replacement product) the product or software or offer a full refund of the purchase price at its sole discretion. SUCH REMEDY SHALL BE



## YOUR SOLE AND EXCLUSIVE REMEDY FOR ANY BREACH OF WARRANTY.

Online auction purchases: Products purchased through online auctions are not eligible for warranty coverage. Online auction confirmations are not accepted for warranty verification. To obtain warranty service, an original or copy of the sales receipt from the original retailer is required. Garmin will not replace missing components from any package purchased through an online auction.

International purchases: A separate warranty may be provided by international distributors for devices purchased outside the U.S., depending on the country. If applicable, this warranty is provided by the local in-country distributor and this distributor provides local service for your device. Distributor warranties are only valid in the area of intended distribution. Devices purchased in the U.S. or Canada must be returned to the Garmin service center in the U.K., the U.S., Canada or Taiwan for service.

\*All new G3X units, including Non-TSO remote-mount or Non-TSO panel-mount, are warranted to be free from defects in materials or workmanship for the earlier of: 2 years or 800 flight hours from the date of purchase.

## AOPA AIRPORT DIRECTORY NOTICE

AOPA MEMBERSHIP PUBLICATIONS, INC. AND ITS RELATED ORGANIZATIONS (HEREINAFTER COLLECTIVELY "AOPA") EXPRESSLY DISCLAIM ALL WARRANTIES, WITH RESPECT TO THE AOPA INFORMATION INCLUDED IN THIS DATA, EXPRESS OR IMPLIED, INCLUDING, BUT NOT LIMITED TO, THE IMPLIED WARRANTIES OF MERCHANTABILITY AND FITNESS FOR A PARTICULAR PURPOSE. THE INFORMATION IS PROVIDED "AS IS" AND AOPA DOES NOT WARRANT OR MAKE ANY REPRESENTATIONS REGARDING ITS ACCURACY, RELIABILITY, OR OTHERWISE. UNDER NO CIRCUMSTANCES INCLUDING NEGLIGENCE, SHALL AOPA BE LIABLE FOR ANY INCIDENTAL, SPECIAL OR CONSEQUENTIAL DAMAGES THAT RESULT FROM THE USE OR INABILITY TO USE THE SOFTWARE OR RELATED DOCUMENTATION, EVEN IF AOPA OR AN AOPA AUTHORIZED REPRESENTATIVE HAS BEEN ADVISED OF THE POSSIBILITY OF SUCH DAMAGES. USER AGREES NOT TO SUE AOPA AND, TO THE MAXIMUM EXTENT ALLOWED BY LAW, TO RELEASE AND HOLD HARMLESS AOPA FROM ANY CAUSES OF ACTION, CLAIMS OR LOSSES RELATED TO ANY ACTUAL OR ALLEGED INACCURACIES IN THE INFORMATION ARISING OUT OF GARMIN'S USE OF THE INFORMATION IN THE DATASETS. SOME JURISDICTIONS DO NOT ALLOW THE LIMITATION OR EXCLUSION OF IMPLIED WARRANTIES OR LIABILITY FOR INCIDENTAL OR CONSEQUENTIAL DAMAGES SO THE ABOVE LIMITATIONS OR EXCLUSIONS MAY NOT APPLY TO YOU.

## AC-U-KWIK LICENSE AGREEMENT

AC-U-KWIK AND ITS RELATED ORGANIZATIONS (HEREINAFTER COLLECTIVELY "AC-U-KWIK ORGANIZATIONS") EXPRESSLY DISCLAIM ALL WARRANTIES WITH RESPECT TO THE AC-U-KWIK INFORMATION INCLUDED IN THIS DATA, EXPRESS OR IMPLIED, INCLUDING, BUT NOT LIMITED TO, THE IMPLIED WARRANTIES OF MERCHANTABILITY AND FITNESS FOR A PARTICULAR PURPOSE. THE INFORMATION IS PROVIDED "AS IS" AND AC-U-KWIK ORGANIZATIONS DO NOT WARRANT OR MAKE ANY REPRESENTATIONS REGARDING ITS ACCURACY, RELIABILITY, OR OTHERWISE. LICENSEE AGREES NOT TO SUE AC-U-KWIK ORGANIZATIONS AND, TO THE MAXIMUM EXTENT ALLOWED BY LAW, TO RELEASE AND HOLD HARMLESS AC-U-KWIK ORGANIZATIONS FROM ANY CAUSES OF ACTION, CLAIMS OR LOSSES RELATED TO ANY ACTUAL OR ALLEGED INACCURACIES IN THE INFORMATION ARISING OUT OF GARMIN'S USE OF THE INFORMATION IN THE DATASETS. SOME JURISDICTIONS DO NOT ALLOW THE LIMITATION OR EXCLUSION OF IMPLIED WARRANTIES OR LIABILITY FOR INCIDENTAL OR CONSEQUENTIAL DAMAGES SO THE ABOVE LIMITATIONS OR EXCLUSIONS MAY NOT APPLY TO LICENSEE.

## SIRIUSXM SATELLITE RADIO SERVICE AGREEMENT

SiriusXM Satellite Radio Inc.

Hardware and required monthly subscription sold separately. Subscription fee is consumer only. Other fees and taxes, including a one-time activation fee may apply. All programming fees and weather data subject to change. SiriusXM WX weather data displays and individual product availability vary by hardware equipment. Reception of the SiriusXM signal may vary depending on location. Subscriptions subject to Customer Agreement included with the SiriusXM Welcome Kit and available at xmradio.com. Available only in the 48 contiguous United States. SiriusXM WX is a trademark of SiriusXM Satellite Radio Inc.

Contact SiriusXM Satellite Radio by phone at 800.985.9200 to subscribe to SiriusXM WX Weather and/or SiriusXM Radio.

### WEATHER DATA WARRANTY

THE WEATHER DATA SOFTWARE PRODUCT IS PROVIDED "AS IS." ALL OTHER WARRANTIES, EXPRESSED OR IMPLIED, INCLUDING ANY WARRANTY OF MERCHANTABILITY OR FITNESS FOR A PARTICULAR PURPOSE OR OF NON-INFRINGEMENT ARE HEREBY EXCLUDED.

#### USER SAFETY

If you use SiriusXM Services it is your responsibility to exercise prudent discretion and observe all safety measures required by law and your own common sense. You assume the entire risk related to your use of the Services. SiriusXM and Garmin assume no responsibility for accidents resulting from or associated with use of the Services. Your Radio Service includes traffic and weather information, and you acknowledge that such information is not for "safety for life", but is merely supplemental and advisory in nature, and therefore cannot be relied upon as safety-critical in connection with any aircraft, sea craft or automobile usage. This information is provided "as is" and SiriusXM and Garmin disclaim any and all warranties, express and implied, with respect thereto or the transmission or reception thereof. SiriusXM and Garmin further do not warrant the accuracy, reliability, completeness or timeliness of the traffic and weather information disclosed on the Radio Service. In no event will SiriusXM and Garmin, their data suppliers, service providers, marketing/distribution, software or Internet partners or hardware manufacturers be liable to you or to any third party for any direct, indirect, incidental, consequential, special, exemplary or punitive damages or lost profits resulting from use of or interruptions in the transmission or reception of the Services.

#### LIMITS ON OUR RESPONSIBILITY

##### a) DISCLAIMERS.

EXCEPT AS EXPRESSLY PROVIDED HEREIN, WE MAKE NO WARRANTY OR REPRESENTATION, EITHER EXPRESS OR IMPLIED, REGARDING THE RADIO SERVICE. YOUR USE OF THE SERVICE IS AT YOUR SOLE RISK. THE CONTENT AND FUNCTIONALITY OF THE SERVICE IS PROVIDED "AS IS" WITHOUT ANY WARRANTY OF ANY KIND, EXPRESS OR IMPLIED. ALL SUCH WARRANTIES OR REPRESENTATIONS (INCLUDING, WITHOUT LIMITATION, THE IMPLIED WARRANTIES OF MERCHANTABILITY, FITNESS FOR A PARTICULAR PURPOSE, TITLE AND NON-INFRINGEMENT) ARE HEREBY DISCLAIMED.

##### b) LIMITATIONS OF LIABILITY.

WE ARE NOT RESPONSIBLE FOR ANY SPECIAL, INCIDENTAL, OR CONSEQUENTIAL DAMAGES OR LOSSES RELATING TO THE USE OF THE RADIO SERVICE, WHETHER BASED ON NEGLIGENCE OR OTHERWISE. OUR TOTAL LIABILITY TO YOU AND ANY OTHER PERSONS RECEIVING OUR SERVICES, REGARDLESS OF THE CAUSE, WILL IN NO EVENT EXCEED THE AMOUNTS THAT YOU HAVE PAID TO US FOR THE SERVICE THAT YOU RECEIVED DURING THE SIX (6) MONTH PERIOD IMMEDIATELY PRIOR TO THE SPECIFIC EVENT THAT GAVE RISE TO THE APPLICABLE DAMAGE OR LOSS. THIS ALLOCATION OF RISK IS REFLECTED IN OUR PRICES. YOU MAY HAVE GREATER RIGHTS THAN DESCRIBED ABOVE UNDER YOUR STATE'S LAWS

This product was developed using DAFIF™, a product of the National Geospatial-Intelligence Agency. This product has not been endorsed or otherwise approved by the National Geospatial-Intelligence Agency, or the United States Department of Defense (10 U.S.C. 425)

- a. Under 10 U.S.C. 456, no civil action may be brought against the United States on the basis of the content of a navigational aid prepared or disseminated by either the former Defense Mapping Agency (DMA), National Imagery and Mapping Agency (NIMA), or the National Geospatial-Intelligence Agency (NGA).
- b. The DAFIF™ product is provided “as is,” and no warranty, express or implied, including, but not limited to the implied warranties of merchantability and fitness for particular purpose or arising by statute or otherwise in law or from a course of dealing or usage in trade, is made by NGA as to the accuracy and functioning of the product.
- c. Neither NGA nor its personnel will be liable for any claims, losses, or damages arising from or connected with the use of this product. The user agrees to hold harmless the United States National Geospatial-Intelligence Agency. The user’s sole and exclusive remedy is to stop using the DAFIF product.

## FCC COMPLIANCE

This device complies with part 15 of the FCC Rules. Operation is subject to the following two conditions: (1) this device may not cause harmful interference, and (2) this device must accept any interference received, including interference that may cause undesired operation.

This equipment has been tested and found to comply with the limits for a Class B digital device, pursuant to part 15 of the FCC rules. These limits are designed to provide reasonable protection against harmful interference in a residential installation. This equipment generates, uses, and can radiate radio frequency energy and may cause harmful interference to radio communications if not installed and used in accordance with the instructions. However, there is no guarantee that interference will not occur in a particular installation. If this equipment does cause harmful interference to radio or television reception, which can be determined by turning the equipment off and on, the user is encouraged to try to correct the interference by one of the following measures:

- Reorient or relocate the receiving antenna.
- Increase the separation between the equipment and the receiver.
- Connect the equipment into an outlet that is on a different circuit from the GPS unit.
- Consult the dealer or an experienced radio/TV technician for help.

This product does not contain any user-serviceable parts. Repairs should only be made by an authorized Garmin service center. Unauthorized repairs or modifications could result in permanent damage to the equipment, and void your warranty and your authority to operate this device under Part 15 regulations.

## INDUSTRY CANADA COMPLIANCE

Category I radio communication devices comply with Industry Canada Standard RSS-210.A

Blank Page

**A**

- Abnormal Operation 177
- Acquiring Satellites 6
- AC-U-KWIK 182
- Additional Features 147
- ADS-B 143
- Aircraft Profile 216
- AIRMETs 94, 115
- Airspace 63
  - Alert Messages 64
  - Smart 65
- Airspace Messages 172
- Airways 47
- Alerts 171
  - Terrain 126
- AOPA 182
- AOPA Data 147, 150, 161
- Approach
  - Selecting 81
- ARTCC 62
- Aural Alerts 128, 176
- Autolocate 6, 214
- Autozoom 19

**B**

- Backlight 25
- Baro Pressure 215
- Battery
  - Charging 3
  - Information 201
  - Installation 2
  - Life 201
  - Replacement 201
- BKSP 15
- Bluetooth 26, 27, 199, 200
- Bug Indicator 38, 40

**C**

- cards, data 179
- Category 166
- Channel List 167
- Charge Mode 4
- Charging, the battery 3
- Chart Not Available 154, 159
- Cities 62
- Compass Arc 38
  - Bug Indicator 38
- Computer, connecting to 188, 189
- Copying, Flight Plans 78
- Course, setting 40

**D**

- Databases 179
- data card 179
- Data Entry 15
  - Alphanumeric Data 16
  - Predetermined Data Option 17
- Data Field
  - Options 36
- Data Field Options 171
- Data Fields 34, 173
- Declutter 22
- Dedicated Icons 10
- Direct-to 10, 66
  - Cancelling 68
- Display
  - Backlight Intensity 24
  - Backlight Timeout 25
- Display Orientation 8

**E**

- Echo Tops 90
- Edit on Map 74
- external GPS Antenna 200

**F**

- Favorites 168
- Flight Log 207, 208
- Flight Plan
  - Activation 76, 77
  - Active 71
  - Copying 78
  - Creation 70
  - Data Fields 69
  - Deleting 78
  - Fuel Flow 77
  - Inverting 79
  - Storage 72
- FliteCharts 156
  - Range 155
- Forecast 98
- Freezing Levels 97
- FSS 63
- Fuel Flow 77
- Fuse, changing 201

**G**

- GDL 39 26, 103, 104, 106, 129, 144, 145
- GPS Navigation 33
- GPS Receiver Status 6
- Graphical Flight Plan 74, 75
- GTX 330 194
- GXM 40 Antenna 193

**H**

- Hazard Display 177
- Heading Line 212, 213
- HSI/Panel 39

**I**

- Icing Forecast 97

- Interfacing 189
- Intersections 58
- Inverting, flight plans 79

**L**

- Location Formats 229
- Loss of GPS Position 177
- Lost Satellite Reception 6

**M**

- Map
  - Autozoom 19
  - Declutter 22
  - Detail 23
  - Display Setup 44
  - Orientation 45
  - Overlays 22
  - Panning 19
  - Range 18, 19
  - Symbols 22, 223
- Map Datum 229
- Map Feature
  - Button 20
  - Information 21, 161
- Message Advisories 171
- Messages 171
- METARs 92, 113
- Mounting, in aircraft 185

**N**

- NDBs 58
- Nearest 12, 51, 53
  - Airport Criteria 54
- Nearest Airport Criteria 29
  - Entering 29
  - Restoring 29
- Nearest Type, Changing 30
- New Location 30

NEXRAD 88, 108  
 NMEA 190  
 Numeric Data Options 173  
 Numeric Flight Data 37

**O**

Obstacle  
   Color Code 125  
 Obstacles 123  
 Option Menu 15  
 Orientation, map 45  
 Overlay  
   Terrain 22  
   Topography 22  
   Weather 22  
 Overlays  
   Displaying/removing 22, 24, 25

**P**

Panel 39  
 Panning 9  
 PIREPs 96, 116  
 POWER Button 4  
 Present Position 29  
 Proximity Waypoints 219

**R**

Red X 177  
 Runways 49

**S**

SafeTaxi 152, 162  
 Satellite Information 7  
 Scrolling 9  
 SD Card 179  
 Searching the Sky 6  
 Settings 23  
 SIGMETs 94, 115

Simulator Mode 30  
 Smart Airspace 65  
 Sound  
   Adjusting 26  
   Muting 26  
 Storm Cells 91  
 Supercooled Large Droplet (SLD) 97  
 Surface Pressure 98  
 System Settings  
   Display 24

**T**

TAFs 92, 113  
 Temperatures Aloft 112  
 Terrain 122  
   Alerts 126  
   Audio 128  
   Aural Alerts 128  
   Views 125  
 Tools 13  
 Touchscreen 8  
 Touchscreen, cleaning 202  
 Track Log 210  
 Traffic Data 131  
 Traffic Ground Track 131  
 Traffic Information Service (TIS) 129  
   Alerts 130  
   Configuring 194, 195, 196, 197, 198  
   Symbology 129  
 traffic warning window 140  
 Transponder 194  
 Turbulence Forecast 97

**U**

User Waypoints 60  
   Creating 60  
   Deleting 61  
 Utilities 207

**V**

- Vertical Navigation (VNAV) 41
  - Profile 43
- VHF Comm Radio 191
- VORs 59

**W**

- Water Temperature 99
- Waypoints 48
  - Proximity 219
  - User 60
- Weather 55
- Weather Products 87
- Weight & Balance 217
- Winds Aloft 90, 111

**X**

- XM
  - Activating 86
  - Animating 103, 122
  - Legends 102, 121
  - Radio 163
  - Radio ID 86
  - Weather Products 87
  - XM Satellite Radio 170

**Z**

- Zooming 9







Garmin International, Inc.  
1200 East 151st Street  
Olathe, Kansas 66062, U.S.A.

Garmin AT, Inc.  
2345 Turner Road SE  
Salem, OR 97302, U.S.A.

Garmin (Europe) Ltd.  
Liberty House, Hounsdown Business Park  
Southampton, Hampshire SO40 9LR U.K.

Garmin Corporation  
No. 68, Zhangshu 2nd Road  
Xizhi District, New Taipei City, Taiwan

[www.flygarmin.com](http://www.flygarmin.com)