

# HYUNDAI



## ***OWNER'S MANUAL***

**Operation  
Maintenance  
Specifications**

**All information in this Owner's Manual is current at the time of publication. However, Hyundai reserves the right to make changes at any time so that our policy of continual product improvement may be carried out.**

**This manual applies to all models of this vehicle and includes descriptions and explanations of optional as well as standard equipment. As a result, you may find material in this manual that does not apply to your specific vehicle.**

### **CAUTION: MODIFICATIONS TO YOUR HYUNDAI**

Your Hyundai should not be modified in any way. Such modifications may adversely affect the performance, safety or durability of your Hyundai and may, in addition, violate conditions of the limited warranties covering the vehicle. Certain modifications may also be in violation of regulations established by the U.S. Department of Transportation and other federal or state agencies.

### **TWO-WAY RADIO OR CELLULAR TELEPHONE INSTALLATION**

Your vehicle is equipped with electronic fuel injection and other electronic components. It is possible for an improperly installed/adjusted two-way radio or cellular telephone to adversely affect electronic systems. For this reason, we recommend that you carefully follow the radio manufacturer's instructions or consult your Hyundai dealer for precautionary measures or special instructions if you choose to install one of these devices.

## SAFETY AND VEHICLE DAMAGE WARNING

This manual includes information titled as WARNING, CAUTION and NOTICE.  
These titles indicate the following:

### **WARNING**

**This indicates that a situation may result in harm, serious injury or death to you or other persons if the warning is not heeded. Follow the advice provided with the warning.**

### **CAUTION**

***This indicates that a situation may result in damage to your vehicle or its equipment if the caution is not heeded. Follow the advice provided with the caution.***

### **\* NOTICE**

**This indicates that interesting or helpful information is being provided.**

## FOREWORD

Thank you for choosing Hyundai. We are pleased to welcome you to the growing number of discriminating people who drive Hyundais. The advanced engineering and high-quality construction of each Hyundai we build is something of which we are very proud.

Your Owner's Manual will introduce you to the features and operation of your new Hyundai. It is suggested that you read it carefully because the information it contains can contribute greatly to the satisfaction you receive from your new car.

The manufacturer also recommends that all service and maintenance on your car be performed by an authorized Hyundai dealer. Hyundai dealers are prepared to provide high-quality service, maintenance and any other assistance that may be required.

## HYUNDAI MOTOR AMERICA

### CAUTION

***Severe engine and transmission damage may result from the use of poor quality fuels and lubricants that do not meet Hyundai specifications. You must always use high quality fuels and lubricants that meet the specifications listed on Page 8-5 in the Vehicle Specifications section of the Owner's Manual.***

**Note :** Because future owners will also need the information included in this manual, if you sell this Hyundai, please leave the manual in the vehicle for their use. Thank you.

Copyright 2015 Hyundai Motor America. All rights reserved. No part of this publication may be reproduced, stored in any retrieval system or transmitted in any form or by any means without the prior written permission of Hyundai Motor America.

## Guide to Hyundai Genuine Parts

### 1. What are Hyundai Genuine Parts?

Hyundai Genuine Parts are the same parts used by Hyundai Motor Company to manufacture vehicles. They are designed and tested for the optimum safety, performance, and reliability to our customers.

### 2. Why should you use genuine parts?

HYUNDAI Genuine Parts are engineered and built to meet rigid manufacturing requirements. Damage caused by using imitation, counterfeit or used salvage parts is not covered under the HYUNDAI New Vehicle Limited Warranty or any other HYUNDAI warranty.



In addition, any damage to or failure of HYUNDAI Genuine Parts caused by the installation or failure of an imitation, counterfeit or used salvage part is not covered by any HYUNDAI Warranty.

### 3. How can you tell if you are purchasing Hyundai Genuine Parts?

Look for the Hyundai Genuine Parts Logo on the package (see below).

Hyundai Genuine Parts are exported packaged with labels written only in English.

Hyundai Genuine Parts are only sold through authorized Hyundai Dealerships.

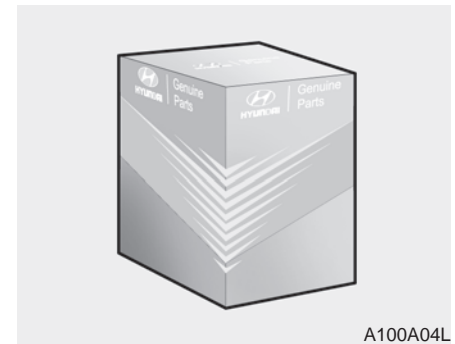
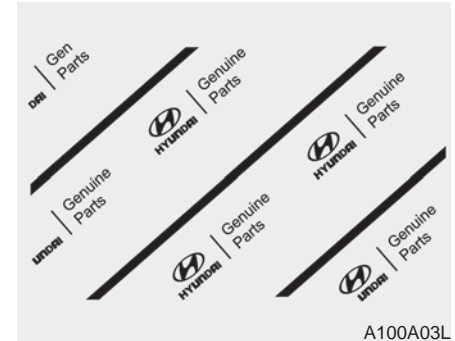
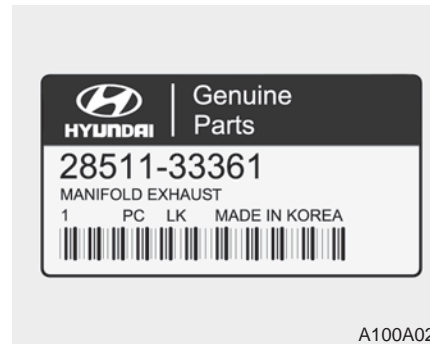



## TABLE OF CONTENTS

### **Introduction**

How to use this manual / Fuel requirements / Vehicle break-in process /  
Vehicle data collection and event data recorders

**1**

### **Your vehicle at a glance**

Exterior overview / Interior overview / Instrument panel overview / Engine compartment

**2**

### **Safety features of your vehicle**

Seats / Seat belts / Child restraint system / Air bag

**3**

### **Features of your vehicle**

Keys / Door locks / Trunk / Windows / Hood / Fuel filler lid / Sunroof / Steering wheel / Mirrors /  
Instrument cluster / Lighting / Wipers & Washers / Climate control system / Multimedia system / Etc.

**4**

### **Driving your vehicle**

Before driving / Engine start/stop button / Transaxle / Brake system / Cruise control system /  
Active ECO system / Winter driving / Vehicle load limit / Etc.

**5**

### **What to do in an emergency**

Road warning / Emergency while driving / Emergency starting / Engine overheat / TPMS / Flat tire / Towing / Etc.

**6**

### **Maintenance**

Engine compartment / Maintenance service / Engine oil / Engine coolant / Brake fluid / Washer fluid /  
Parking brake / Air cleaner / Wiper blades / Battery / Tire and wheels / Fuses / Light bulbs / Etc.

**7**

### **Specifications, Consumer information and Reporting safety defects**

**8**

### **Index**

**I**

# Introduction

<b>How to use this manual</b> .....	<b>1-2</b>
• Symbols used in this manual .....	1-2
<b>Fuel requirements</b> .....	<b>1-3</b>
• Gasoline containing alcohol and methanol.....	1-4
• Other fuels .....	1-4
• Do not use methanol .....	1-5
• Fuel Additives .....	1-5
• Operation in foreign countries.....	1-5
<b>Vehicle break-in process</b> .....	<b>1-6</b>
<b>Vehicle data collection and event data recorders.</b> .	<b>1-7</b>



### HOW TO USE THIS MANUAL

We want to help you get the greatest possible driving pleasure from your vehicle. Your Owner's Manual can assist you in many ways. We strongly recommend that you read the entire manual. In order to minimize the chance of death or injury, you must read the **WARNING** and **CAUTION** sections in the manual.

Illustrations complement the words in this manual to best explain how to enjoy your vehicle. By reading your manual, you will learn about features, important safety information, and driving tips under various road conditions.

The general layout of the manual is provided in the Table of Contents. Use the index when looking for a specific area or subject; it has an alphabetical listing of all information in your manual.

**Sections:** This manual has eight sections plus an index. Each section begins with a brief list of contents so you can tell at a glance if that section has the information you want.

You will find various types of safety instructions in this manual. These instructions were prepared to enhance your personal safety. Carefully read and follow **ALL** procedures and recommendations provided in these instructions.

### Symbols used in this manual

#### *Warnings, cautions and Notices*

#### **WARNING**

**A WARNING indicates a situation in which harm, serious bodily injury or death could result if the warning is ignored.**

#### **CAUTION**

**A CAUTION indicates a situation in which damage to your vehicle could result if the caution is ignored.**

#### **\* NOTICE**

**A NOTICE indicates interesting or helpful information is being provided.**

### *Symbols used in illustrations*

#### **Safety symbol**



This symbol means to "Avoid" or "Do not do anything".

#### **Arrows**



Indicates the location.



Indicates the action (pressing, turning, etc.) or outcome of an operation.

## **FUEL REQUIREMENTS**

Your new vehicle is designed to use only unleaded fuel having a pump octane number  $((R+M)/2)$  of 87 (Research Octane Number 91) or higher. (Do not use methanol blend-fuels)

Your new vehicle is designed to obtain maximum performance with UNLEADED FUEL, as well as minimize exhaust emissions and spark plug fouling.

Never add any fuel system cleaning agents to the fuel tank other than what has been specified. (Consult an authorized HYUNDAI dealer for details.)

### **⚠ WARNING - Refueling**

- Do not "top off" after the nozzle automatically shuts off when refueling. Attempts to force more fuel into the tank can cause fuel overflow onto you and the ground causing a risk of fire.
- Always check that the fuel cap is installed securely to prevent fuel spillage in the event of an accident.

### **\* NOTICE**

Tighten the cap until it clicks one time, otherwise the warning light "Check Fuel Cap" will illuminate on the LCD display.

### ***Gasoline containing alcohol and methanol***

Gasohol, a mixture of gasoline and ethanol (also known as grain alcohol), and gasoline or gasohol containing methanol (also known as wood alcohol) are being marketed along with or instead of leaded or unleaded gasoline.

Do not use gasohol containing more than 10% ethanol, and do not use gasoline or gasohol containing any methanol. Either of these fuels may cause drivability problems and damage to the fuel system, engine control system and emission control system.

Discontinue using gasohol of any kind if drivability problems occur.

Vehicle damage or drivability problems may not be covered by the manufacturer's warranty if they result from the use of:

1. Gasohol containing more than 10% ethanol.
2. Gasoline or gasohol containing methanol.
3. Leaded fuel or leaded gasohol.

"E85" fuel is an alternative fuel comprised of 85 percent ethanol and 15 percent gasoline, and is manufactured exclusively for use in Flexible Fuel Vehicles. "E85" is not compatible with your vehicle. Use of "E85" will result in poor engine performance and may damage to your vehicle's engine and fuel system. HYUNDAI recommends that customers do not use fuel with an ethanol content exceeding 10 percent.

### **\* NOTICE**

**Your New Vehicle Limited Warranty does not cover damage to the fuel system or any performance problems caused by the use of "E85" fuel.**

### ***Other fuels***

Using fuels such as;

- Silicone (Si) contained fuel,
- Ferrocene (Fe) contained fuel, and
- Other metallic additives contained fuels,

may cause vehicle and engine damage or cause plugging, misfiring, poor acceleration, engine stalling, catalyst melting, abnormal corrosion, life cycle reduction, etc. Also, the Malfunction Indicator Lamp (MIL) may illuminate.

### **\* NOTICE**

**Damage to the fuel system or performance problem caused by the use of these fuels may not be covered by your New Vehicle Limited Warranty.**

### ***Gasoline containing MMT***

Some gasoline contains harmful manganese-based fuel additives such as MMT (Methylcyclopentadienyl Manganese Tricarbonyl).

HYUNDAI does not recommend the use of gasoline containing MMT.

This type of fuel can reduce vehicle performance and affect your emission control system.

The malfunction indicator lamp on the cluster may come on.

### ***Do not use methanol***

Fuels containing methanol (wood alcohol) should not be used in your vehicle. This type of fuel can reduce vehicle performance and damage components of the fuel system, engine control system and emission control system.

### **\* NOTICE**

**Your New Vehicle Limited Warranty may not cover damage to the fuel system and any performance problems that are caused by the use of fuels containing methanol.**

### ***Fuel Additives***

HYUNDAI recommends that you use good quality gasolines treated with detergent additives such as TOP TIER Detergent Gasoline, which help prevent deposit formation in the engine. These gasolines will help the engine run cleaner and enhance performance of the Emission Control System. For more information on TOP TIER Detergent Gasoline, please go to the website ([www.top-tiergas.com](http://www.top-tiergas.com))

For customers who do not use TOP Tier Detergent Gasoline regularly, and have problems starting or the engine does not run smoothly, additives that you can buy separately may be added to the gasoline. If TOP TIER Detergent Gasoline is not available, one bottle of additive added to the fuel tank at every 7,500 miles or 12 months is recommended. Additives are available from your authorized HYUNDAI dealer along with information on how to use them. Do not mix other additives.

### ***Operation in foreign countries***

If you are going to drive your vehicle in another country, be sure to:

- Observe all regulations regarding registration and insurance.
- Determine that acceptable fuel is available.

## VEHICLE BREAK-IN PROCESS

No special break-in period is needed. By following a few simple precautions for the first 600 miles (1,000 km) you may add to the performance, economy and life of your vehicle.

- Do not race the engine.
- While driving, keep your engine speed (rpm, or revolutions per minute) between 2,000 rpm and 4,000 rpm.
- Do not maintain a single speed for long periods of time, either fast or slow. Varying engine speed is needed to properly break-in the engine.
- Avoid hard stops, except in emergencies, to allow the brakes to seat properly.

### **⚠ CALIFORNIA PROPOSITION 65 WARNING**

**Items contained in motor vehicles or emitted from them are known to the State of California to cause cancer and birth defects or reproductive harm. These include:**

- **Gasoline and its vapors**
- **Engine exhaust**
- **Used engine oil**
- **Interior passenger compartment components and materials**
- **Component parts which are subject to heat and wear**

**In addition, battery posts, terminals and related accessories contain lead, lead compounds and other chemicals known to the State of California to cause cancer and reproductive harm.**

## VEHICLE DATA COLLECTION AND EVENT DATA RECORDERS

This vehicle is equipped with an event data recorder (EDR). The main purpose of an EDR is to record, in certain crash or near crash-like situations, such as an air bag deployment or hitting a road obstacle, data that will assist in understanding how a vehicle's systems performed. The EDR is designed to record data related to vehicle dynamics and safety systems for a short period of time, typically 30 seconds or less. The EDR in this vehicle is designed to record such data as:

- How various systems in your vehicle were operating;
- Whether or not the driver and passenger safety belts were buckled/fastened;
- How far (if at all) the driver was depressing the accelerator and/or brake pedal; and,
- How fast the vehicle was traveling.

These data can help provide a better understanding of the circumstances in which crashes and injuries occur. **NOTE:** EDR data are recorded by your vehicle only if a non-trivial crash situation occurs; no data are recorded by the EDR under normal driving conditions and no personal data (e.g., name, gender, age, and crash location) are recorded. However, other parties, such as law enforcement, could combine the EDR data with the type of personally identifying data routinely acquired during a crash investigation.

To read data recorded by an EDR, special equipment is required, and access to the vehicle or the EDR is needed. In addition to the vehicle manufacturer, other parties, such as law enforcement, that have the special equipment, can read the information if they have access to the vehicle or the EDR.

## Your vehicle at a glance

Exterior overview I .....	2-2
Exterior overview II .....	2-3
Interior overview .....	2-4
Instrument panel overview .....	2-5
Engine compartment .....	2-6

## EXTERIOR OVERVIEW I

■ Front view

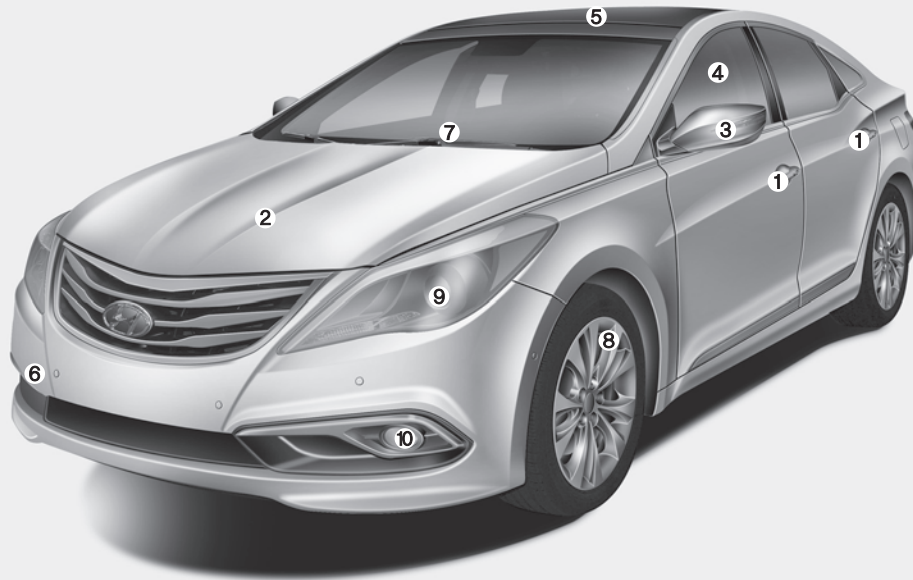

- 1. Door handle .....4-6
- 2. Hood .....4-29
- 3. Outside rearview mirror .....4-54
- 4. Windows .....4-25
- 5. Panorama sunroof .....4-35
- 6. Removable towing hook .....6-22
- 7. Wiper blade .....7-32
- 8. Tires and wheels .....7-37
- 9. Headlamp .....7-63
- 10. Fog light .....7-63

The actual shape may differ from the illustration.

OHG015005N



## EXTERIOR OVERVIEW II

■ Rear view

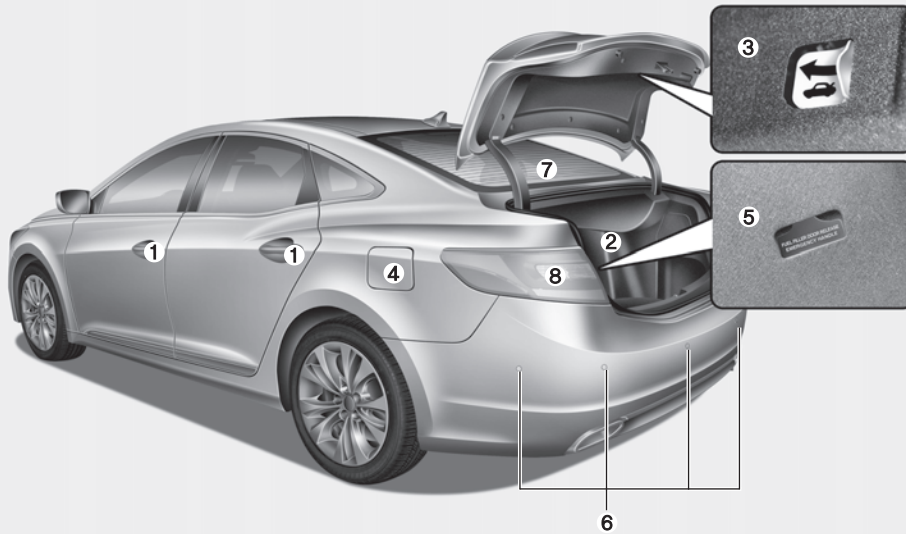

- 1. Door .....4-15
- 2. Trunk .....4-19
- 3. Emergency trunk safety release .....4-20
- 4. Fuel filler lid .....4-31
- 5. Emergency fuel filler lid release .....4-34
- 6. Rear parking assist system .....4-95
- 7. Glass antenna .....4-145
- 8. Rear combination lamp .....7-67

The actual shape may differ from the illustration.

OHG015006N

## INTERIOR OVERVIEW

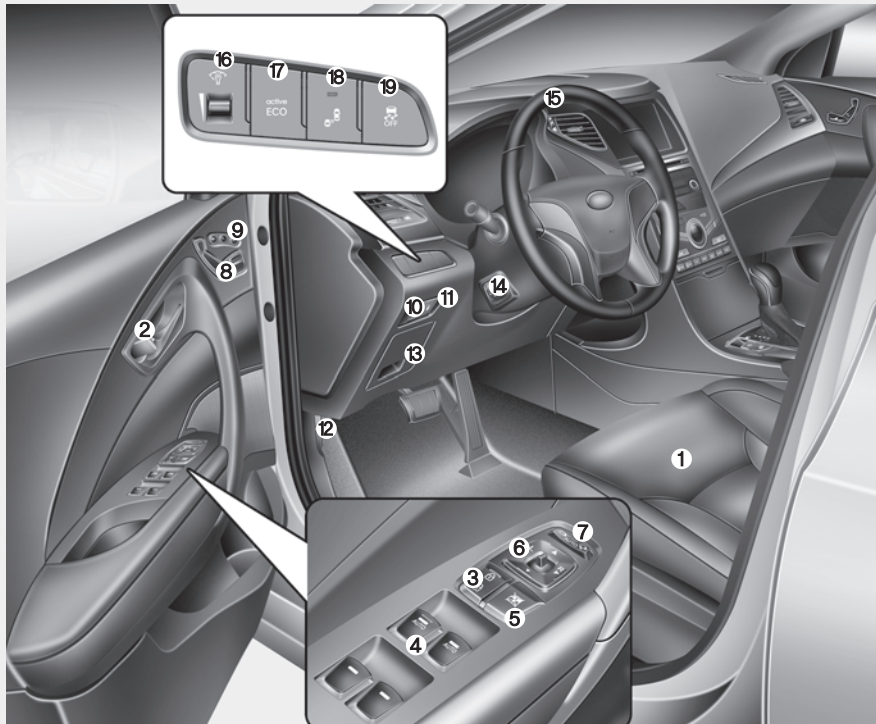

The actual shape may differ from the illustration.

- 1. Seat .....3-2
- 2. Door lock/unlock button .....4-16
- 3. Central door lock switch.....4-17
- 4. Power window switches .....4-26
- 5. Power window lock button .....4-28
- 6. Outside rearview mirror control switch .....4-54
- 7. Outside rearview mirror folding button .....4-56
- 8. Seat adjustment .....3-4
- 9. Driver's position memory system\* .....4-40
- 10. Trunk lid release button or lever.....4-19
- 11. Fuel filler lid release button.....4-31
- 12. Hood release lever.....4-29
- 13. Fuse box .....7-52
- 14. Steering wheel tilt control .....4-44
- 15. Steering wheel .....4-43
- 16. Instrument panel illumination control switch .....4-59
- 17. Active ECO button .....5-56
- 18. Blind spot detection system button\* .....5-57
- 19. ESC OFF button .....5-30

\* : if equipped

OHG015001N

## INSTRUMENT PANEL OVERVIEW

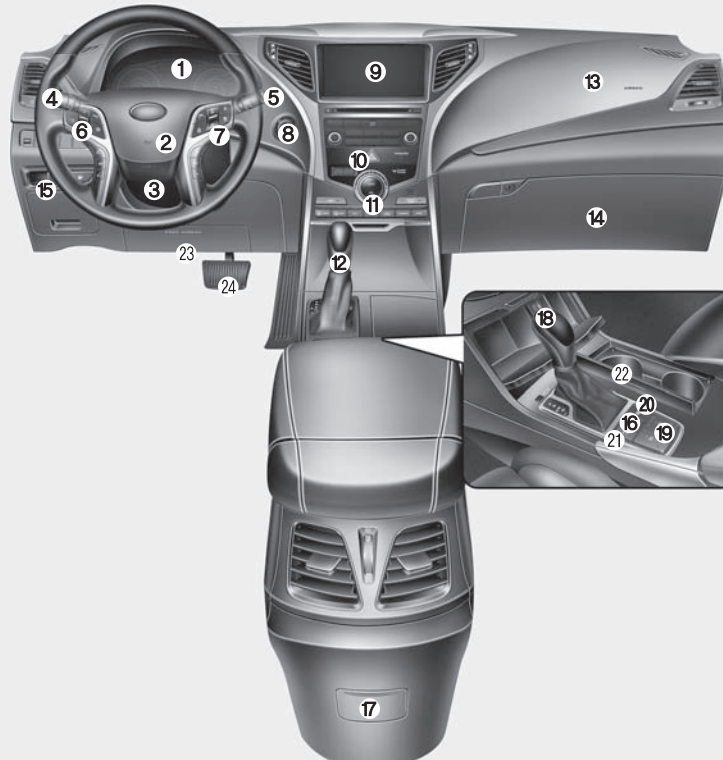

The actual shape may differ from the illustration.

- 1. Instrument cluster .....4-58
- 2. Horn .....4-45
- 3. Driver's front air bag .....3-47
- 4. Light control/Turn signals .....4-102
- 5. Wiper/Washer .....4-107
- 6. Steering wheel audio control .....4-145
- 7. Cruise control switch or  
Smart cruise control switch\* .....5-38, 5-42
- 8. Engine start/stop button .....5-5
- 9. Navigation/Audio system .....4-147
- 10. Hazard warning flasher .....4-100/6-2
- 11. Climate control system .....4-113, 4-124
- 12. Shift lever .....5-10
- 13. Passenger's front air bag .....3-47
- 14. Glove box .....4-137
- 15. Electronic parking brake (EPB)  
switch\* .....5-19
- 16. Auto hold control switch\* .....5-25
- 17. Power outlet .....4-140
- 18. Aux, iPod® and USB .....4-147
- 19. Seat warmer or Seat warmer  
with air ventilation .....3-9, 3-10
- 20. Rear curtain button\* .....4-144
- 21. Rear parking assist system  
OFF button\* .....4-95
- 22. Cup holder or Ashtray .....4-139
- 23. Driver's knee air bag .....3-47
- 24. Brake pedal .....5-16

\* : if equipped

OHG016002N

## ENGINE COMPARTMENT



- 1. Engine oil dipstick .....7-23
- 2. Engine oil filler cap .....7-23
- 3. Engine coolant reservoir .....7-24
- 4. Radiator cap .....7-26
- 5. Brake fluid reservoir .....7-27
- 6. Windshield washer fluid reservoir .....7-28
- 7. Air cleaner .....7-29
- 8. Positive battery terminal .....7-34
- 9. Negative battery terminal .....7-34
- 10. Fuse box .....7-53

The actual engine room in the vehicle may differ from the illustration.

OHG010004A

# Safety features of your vehicle

<b>Seats</b> . . . . .	3-2	<b>Air bag - advanced supplemental restraint system</b> .	3-36
• Front seat . . . . .	3-4	• How does the air bag system operate . . . . .	3-37
• Rear seat . . . . .	3-12	• Air bag warning indicator . . . . .	3-39
<b>Seat belts</b> . . . . .	3-17	• SRS components and functions . . . . .	3-39
• Seat belt restraint system . . . . .	3-17	• Occupation classification system . . . . .	3-42
• Pre-tensioner seat belt . . . . .	3-22	• Driver's and passenger's front air bag . . . . .	3-47
• Seat belt precautions . . . . .	3-24	• Side impact air bag . . . . .	3-50
• Care of seat belts . . . . .	3-27	• Curtain air bag . . . . .	3-51
<b>Child restraint system</b> . . . . .	3-28	• SRS care . . . . .	3-58
• Using a child restraint system . . . . .	3-29	• Additional safety precautions . . . . .	3-59
- Automatic locking mode . . . . .	3-30	• Air bag warning label . . . . .	3-60
- Tether Anchor system . . . . .	3-33		
- Lower anchor system . . . . .	3-34		

## SEATS

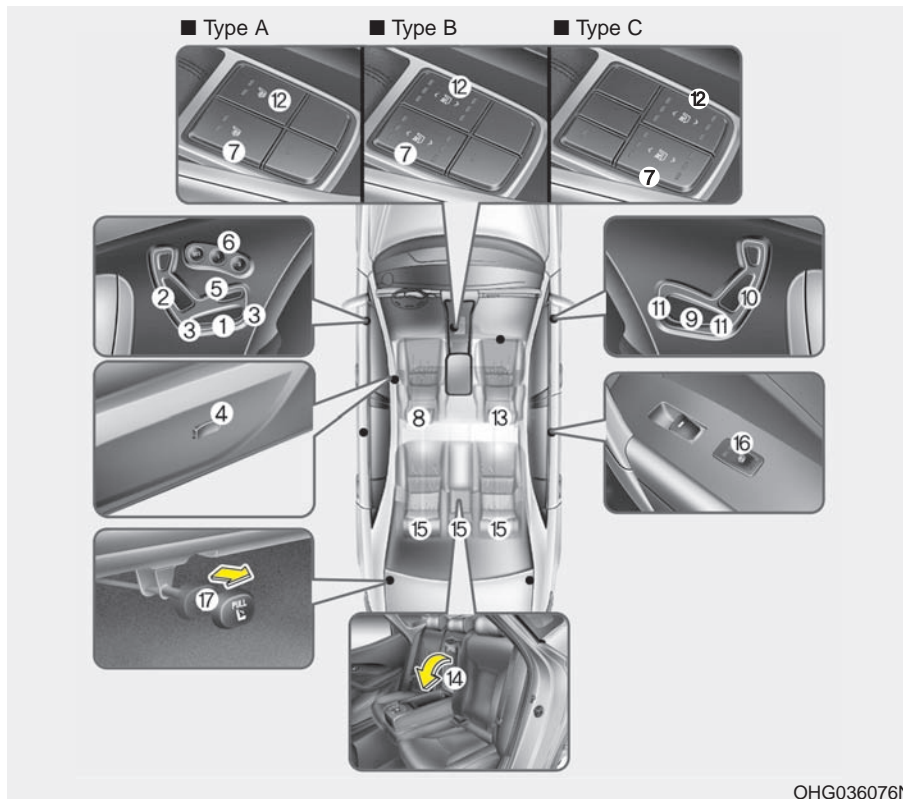

### Driver's seat

- (1) Forward and rearward
- (2) Seatback angle
- (3) Seat cushion height
- (4) Lumbar support
- (5) Cushion extension\*
- (6) Driver position memory system\*
- (7) Seat warmer\*/  
Seat warmer with air ventilation\*
- (8) Headrest

### Front passenger's seat

- (9) Forward and rearward
- (10) Seatback angle
- (11) Seat cushion height
- (12) Seat warmer\*/  
Seat warmer with air ventilation\*
- (13) Headrest

### Rear seat

- (14) Armrest
- (15) Headrest
- (16) Seat warmer\*
- (17) Seat folding

\* : if equipped

**⚠ WARNING - Loose objects**  
Loose objects in the driver's foot area could interfere with the operation of the foot pedals, possibly causing an accident. Do not place anything under the front seats.

**⚠ WARNING**  
- Driver responsibility for passengers  
The driver must advise the passenger to keep the seatback in an upright position whenever the vehicle is in motion. If a seat is reclined during an accident, the occupant's hips may slide under the lap portion of the seat belt applying great force to the unprotected abdomen. Serious or fatal internal injuries could result.

**⚠ WARNING**  
Occupants should never sit on seat cushions. The passenger's hips may slide under the lap portion of the seat belt during an accident or a sudden stop. Serious or fatal internal injuries could result because the seat belt cannot operate normally.

**⚠ WARNING - Driver's seat**  
To avoid serious injury or death:

- Never attempt to adjust the seat while the vehicle is moving. This could result in loss of control, and an accident causing death, serious injury, or property damage.
- Do not allow anything to interfere with the normal position of the seatback. Storing items against a seatback or in any other way interfering with proper locking of a seatback could result in serious or fatal injury in a sudden stop or collision.
- In order to avoid unnecessary and perhaps severe air bag injuries, always sit as far back as possible from the steering wheel while maintaining comfortable control of the vehicle. A distance of at least 10 inches from your chest to the steering wheel is recommended.

**⚠ WARNING - Rear seatbacks**

Always lock the rear seatback before driving. Failure to do so could result in passengers or objects being thrown forward injuring vehicle occupants.

**⚠ WARNING - Seat adjustment**

- Do not adjust the seat while wearing seat belts. Moving the seat cushion forward may cause strong pressure on the abdomen.
- Use extreme caution so that hands or other objects are not caught in the seat mechanisms while the seat is moving.
- Use extreme caution when picking small objects trapped under the seats or between the seat and the center console. Your hands might be cut or injured by the sharp edges of the seat mechanism.

**Front seat**

**Automatic adjustment**

The front seat can be adjusted by using the control switch located on the door and outside of the seat cushion. Before driving, adjust the seat to the proper position so as to easily control the steering wheel, pedals and switches on the instrument panel.

**⚠ WARNING**

The power seat is operable with the ignition OFF. Therefore, children should never be left unattended in the vehicle.

**⚠ CAUTION**

- *The power seat is driven by an electric motor. Stop the motor operation once the adjustment is completed. Excessive operation may damage the electrical equipment.*
- *When in operation, the power seat consumes a large amount of electrical power. To prevent unnecessary charging system drain, do not adjust the power seat longer than necessary while the engine is not running.*
- *Do not operate two or more power seat control switches at the same time. Doing so may result in power seat motor or electrical component malfunction.*



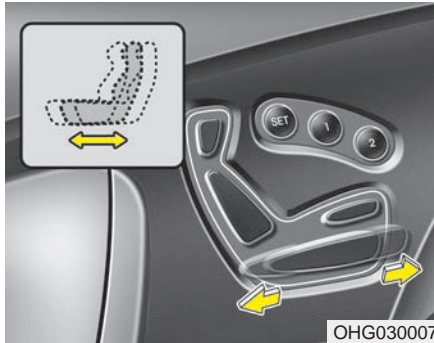

#### Forward and rearward

1. Push the control switch forward or rearward to move the seat to the desired position.
2. Release the switch once the seat reaches the desired position.

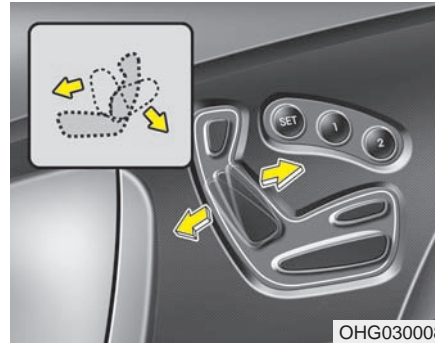

#### Seatback angle

1. Push the upper part of the control switch forward or rearward to move the seatback to the desired angle.
2. Release the switch once the seat reaches the desired position.

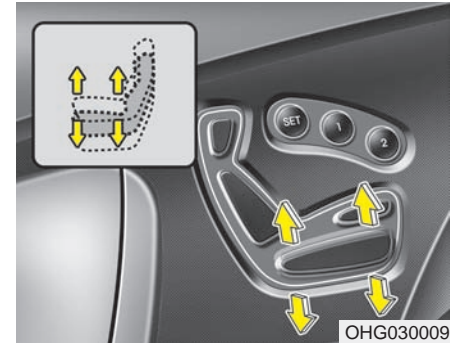

#### Seat cushion height

1. Push the front portion of the control switch up to raise or down to lower the front part of the seat cushion. Push the rear portion of the control switch up to raise or down to lower the rear part of the seat cushion.
2. Release the switch once the seat reaches the desired position.

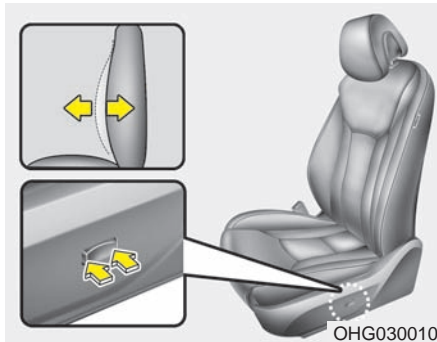

### **Lumbar support (for driver's seat)**

1. Press the front portion of the switch to increase support or the rear portion of the switch to decrease support.
2. Release the switch once it reaches the desired position.

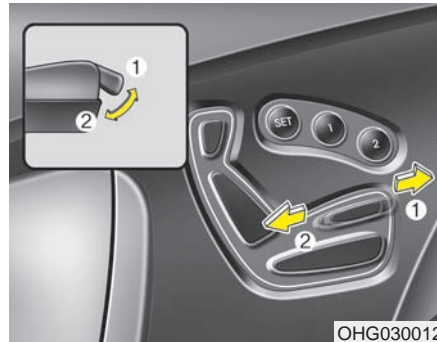

### **Cushion extension (for driver's seat, if equipped)**

1. Push the switch forward to raise the cushion extension. Push the switch rearward to lower the cushion extension.
2. Release the switch once the cushion extension reaches the desired position.

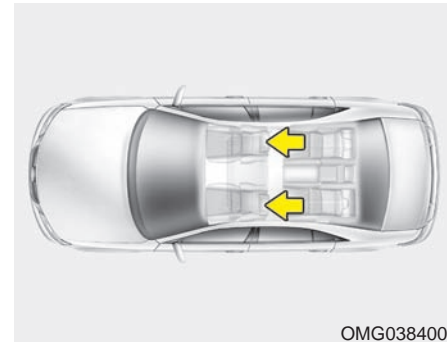

### **Headrest**

The driver's and front passenger's seats are equipped with a headrest for the occupant's safety and comfort. The headrest not only provides comfort for the driver and front passenger, but also helps to protect the head and neck in the event of a collision.

For maximum effectiveness in case of an accident, the headrest should be adjusted so the middle of the headrest is at the same height of the center of gravity of an occupant's head. Generally, the center of gravity of most people's head is similar in height as the top of their eyes.

Also, adjust the headrest as close to your head as possible.

For this reason, the use of a cushion that holds the body away from the seatback is not recommended.

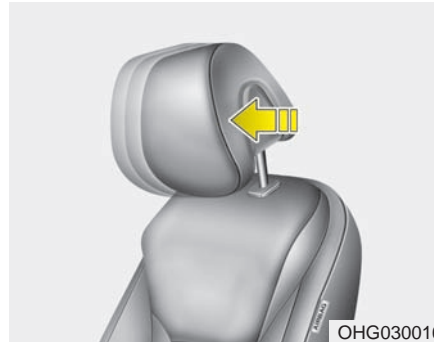

#### Forward and rearward adjustment

The headrest may be adjusted forward to 4 different positions by pulling the headrest forward to the desired detent. To adjust the headrest to it's furthest rearward position, pull it fully forward to the farthest position and release it. Adjust the headrest so that it properly supports the head and neck.

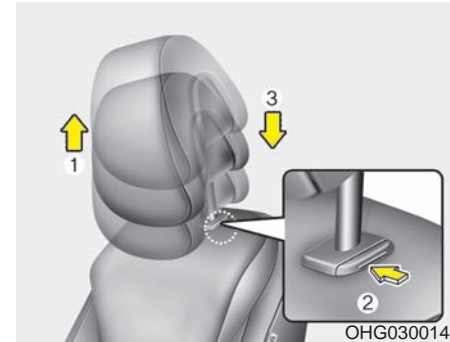

#### Adjusting the height up and down

To raise the headrest, pull it up to the desired position (1). To lower the headrest, push and hold the release button (2) on the headrest support and lower the headrest to the desired position (3).

#### **⚠ WARNING**

- Do not operate the vehicle with the headrests removed as severe injury to the occupants may occur in the event of an accident. Headrests can provide critical neck and head support in a crash.
- Do not adjust the headrest height while the vehicle is in motion. Driver may lose control of the vehicle.

**⚠ CAUTION**

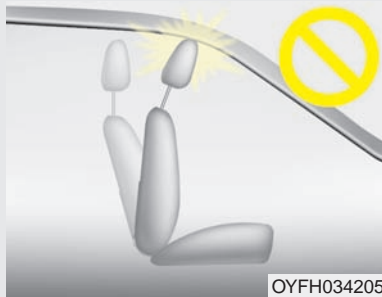

*If you recline the seatback towards the front with the head restraint and seat cushion raised, the head restraint may come in contact with the sunvisor or other parts of the vehicle.*

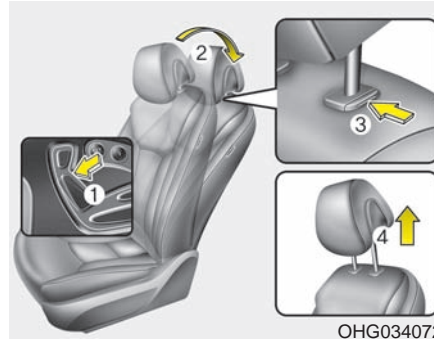

**Removal**

To remove the headrest:

1. Recline the seatback (2) with the recline switch (1).
2. Raise headrest as far as it can go.
3. Press the headrest release button (3) while pulling the headrest up (4).

**⚠ WARNING**

**NEVER** allow anyone to ride in a seat with the headrest removed.

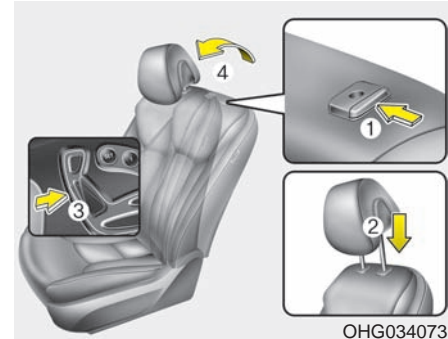

**Reinstall**

To reinstall the headrest:

1. Put the headrest poles (2) into the holes while pressing the release button (1).
2. Recline the seatback (4) with the recline switch (3).
3. Adjust the headrest to the appropriate height.

**⚠ WARNING**

**Always** make sure the headrest locks into position after re-installing and adjusting it properly.

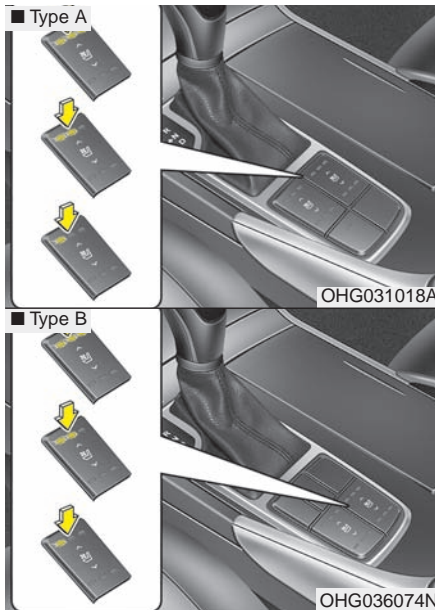

### Seat warmer

The seat warmer is provided to warm the front seats during cold weather. With the ignition switch in the ON position, push either of the switches to warm the driver's seat or the front passenger's seat.

During mild weather or under conditions where the operation of the seat warmer is not needed, keep the switches in the "OFF" position.

- Each time you press the button, the temperature setting of the seat will change as follows :

#### ■ Type A

OFF → HIGH (☀☀☀) → LOW (☀)  
 ↑

#### ■ Type B

OFF → HIGH (☀☀☀)  
 ↑ ↓  
 LOW (☀) ← MIDDLE (☀☀)

- The seat warmer defaults to the OFF position whenever the ignition switch is turned on.
- With the seat warmer switch in the ON position, the heating system in the seat turns off or on automatically depending on the seat temperature.

### ⚠ CAUTION

- *When cleaning the seats, do not use an organic solvent such as paint thinner, benzene, alcohol or gasoline. Doing so may damage the surface of the heater or seats.*
- *To prevent overheating of the seat warmer, do not place anything on the seats that insulates against heat, such as blankets, cushions or seat covers while the seat warmer is in operation.*
- *Do not place heavy or sharp objects on seats equipped with seat warmers. Damage to the seat warming components could occur.*

**⚠ WARNING - Seat warmer burns**

Never allow passengers who may not be able to take care of themselves to be exposed to the risk of seat warmer burns. These include:

1. Infants, children, elderly or disabled persons, or hospital outpatients
2. Persons with sensitive skin or those that burn easily
3. Fatigued individuals
4. Intoxicated individuals
5. Individuals taking medication that can cause drowsiness or sleepiness (sleeping pills, cold tablets, etc.)

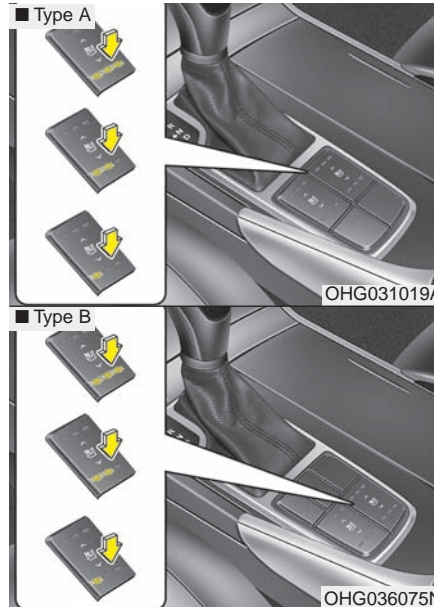

**Air ventilation seat**

The air ventilation is provided to cool the front seats during hot weather by blowing air through small vent holes on the surface of the seats and seat-backs. While the engine is running, press the rear portion of the switch to cool the driver's seat or the front passenger's seat.

When the operation of the air ventilation is not needed, keep the switches in the OFF position.

- Each time you press the switch, the airflow changes as follows:

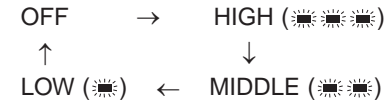

- When the air ventilation seat is turned on, the seat may get cooler after about 5 minutes.
- The air ventilation seat defaults to the OFF position whenever the ignition switch is turned to the ON position.

**⚠ CAUTION - Seat damage**

- *When cleaning the seats, do not use an organic solvent such as paint thinner, benzene, alcohol or gasoline. Doing so may damage the air ventilation seat.*
- *Do not place heavy or sharp objects on the seat. Those things may damage the air ventilation seat.*
- *Be careful not to spill liquid such as water or beverages on the seat. If you spill some liquid, wipe the seat with a dry towel. Before using the air ventilation seat, dry the seat completely.*



Seatback pockets

**⚠ WARNING**

For proper operation of the occupant classification system:

- Do not place any items cumulatively weighing over 2.2 lbs (1 kg) in the passenger's seatback pocket or on the passenger's seat.
- Do not hang onto the front passenger seatback.

**⚠ WARNING - Seatback pockets**

Do not put heavy or sharp objects in the seatback pocket. An occupant could contact such objects in a crash. Heavy objects in the front passenger seatback could also interfere with the occupant sensing system.

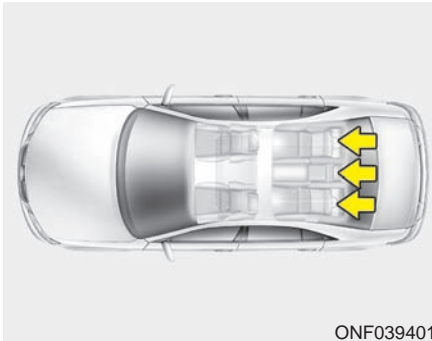

### Rear seat

#### Headrest

The rear seat is equipped with headrests for the occupant's safety and comfort.

The headrest not only provides comfort for passengers, but also helps to protect the head and neck in the event of a collision.

For maximum effectiveness in case of an accident, the headrest should be adjusted so the middle of the headrest is at the same height of the center of gravity of an occupant's head. Generally, the center of gravity of most people's head is similar in height as the top of their eyes.

Also adjust the headrest as close to your head as possible. For this reason, the use of a cushion that holds the body away from the seatback is not recommended.

#### **⚠ WARNING**

- **Do not operate the vehicle with the headrests removed as severe injury to the occupants may occur in the event of an accident. Headrests can provide critical neck and head support in a crash.**
- **Do not adjust the headrest height while the vehicle is in motion. Driver may lose control of the vehicle.**

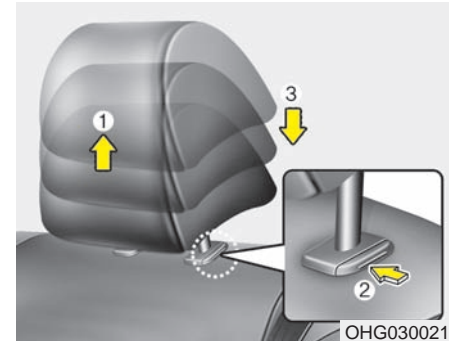

#### Adjusting the height up and down

To raise the headrest, pull it up to the desired position (1). To lower the headrest, push and hold the release button (2) on the headrest support and lower the headrest to the desired position (3).



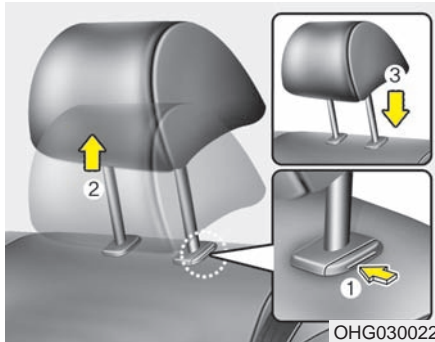

### Removal and reinstallation

- To remove the headrest, raise it as far as it can go then press the release button (1) while pulling upward (2).
- To reinstall the headrest, put the headrest poles (3) into the holes while pressing the release button (1). Then adjust it to the appropriate height and ensure that it locks in position.

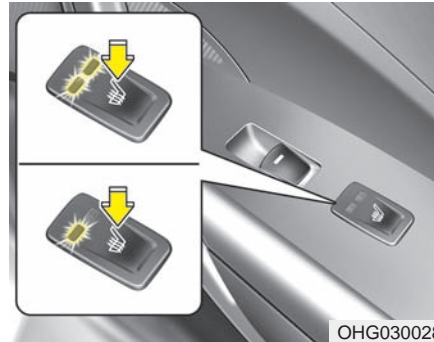

### Seat warmer

The seat warmer is provided to warm the rear seats during cold weather. With the ignition switch in the ON position, push either of the switches to warm the seat. During mild weather or under conditions where the operation of the seat warmer is not needed, keep the switches in the OFF position.

- Each time you press the button, the temperature setting of the seat will change as follows :

OFF → HIGH (☀☀☀) → LOW (☀)  
 ↑

- The seat warmer defaults to the OFF position whenever the ignition switch is turned on.
- With the seat warmer switch in the ON position, the heating system in the seat turns off or on automatically depending on the seat temperature.

**⚠ CAUTION**

- *When cleaning the seats, do not use an organic solvent such as paint thinner, benzene, alcohol or gasoline. Doing so may damage the surface of the heater or seats.*
- *To prevent overheating of the seat warmer, do not place anything on the seats that insulates against heat, such as blankets, cushions or seat covers while the seat warmer is in operation.*
- *Do not place heavy or sharp objects on seats equipped with seat warmers. Damage to the seat warming components could occur.*

**⚠ WARNING - Seat warmer burns**

Never allow passengers who may not be able to take care of themselves to be exposed to the risk of seat warmer burns. These include:

1. Infants, children, elderly or disabled persons, or hospital outpatients
2. Persons with sensitive skin or those that burn easily
3. Fatigued individuals
4. Intoxicated individuals
5. Individuals taking medication that can cause drowsiness or sleepiness (sleeping pills, cold tablets, etc.)

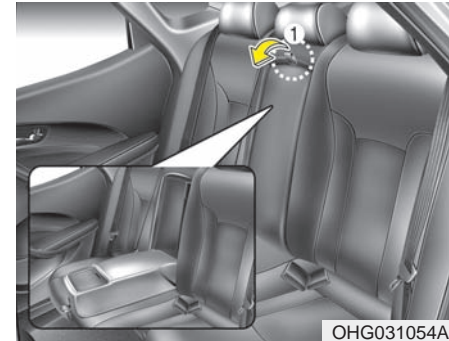

**Armrest**

To use the armrest, swing down the armrest to the lowest position (1).

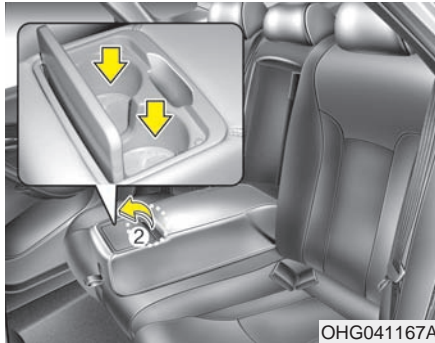

### Cup holder

To use the cup holder, pull up the cover (2).

### Folding the rear seat

The rear seatbacks can be folded to facilitate carrying long items or to increase the luggage capacity of the vehicle.

#### **⚠ WARNING**

- **Never allow passengers to sit on top of the folded down seatback while the vehicle is moving. This is not a proper seating position and no seat belts are available for use. This could result in serious injury or death in case of an accident or sudden stop.**
- **Objects carried on the folded down seatback should not extend higher than the top of the front seatbacks. This could allow cargo to slide forward and cause injury or damage during sudden stops.**

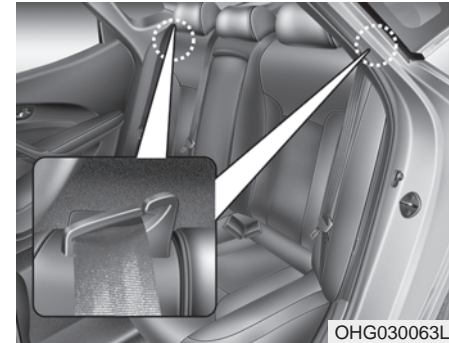

### To fold down the rear seatback:

1. Make sure the rear seat belt webbing is in the guide to prevent the seat belt from being damaged.
2. Set the front seatback to the upright position and if necessary, slide the front seat forward.
3. Lower the rear headrests to the lowest position.

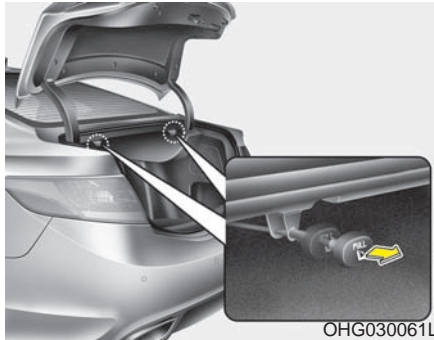

4. Pull out the seatback folding lever, then fold the seat toward the front of the vehicle.

5. To use the rear seat, lift and push the seatback backward. Push back the seatback firmly until it clicks into place. Make sure the seatback is locked in place.
6. Return the rear seat belt to the proper position.

When returning the rear seatbacks to the upright position, remember to return the rear shoulder belts to their proper position.

**⚠ WARNING - Rear seatback**  
When returning the rear seatback from a folded to an upright position, hold the seatback and return it slowly. Ensure that the seatback is completely locked into its upright position by pushing on the top of the seatback. In an accident or sudden stop, the unlocked seatback could allow cargo to move forward with great force and enter the passenger compartment, which could result in serious injury or death.

**⚠ WARNING - Cargo**  
Do not place heavy objects in the rear seats, since they cannot be properly secured and may hit vehicle occupants in a frontal collision causing serious injury or death.

## SEAT BELTS

### Seat belt restraint system

Seat belts are designed to bear upon the bony structure of the body, and should be worn low across the front of the pelvis or the pelvis, chest and shoulders, as applicable; wearing the lap section of the belt across the abdominal area must be avoided.

Seat belts should be adjusted as firmly as possible, consistent with comfort, to provide the protection for which they have been designed.

A slack belt will greatly reduce the protection afforded to the wearer.

Care should be taken to avoid contamination of the webbing with polishes, oils and chemicals, and particularly battery acid. Cleaning may safely be carried out using mild soap and water. The belt should be replaced if webbing becomes frayed, contaminated or damaged.

- For maximum restraint system protection, the seat belts must always be used whenever the vehicle is moving. A properly positioned shoulder belt should be positioned midway over your shoulder across your collarbone.

- Never allow children to ride in the front passenger seat. See child restraint system section for further discussion.
- No modifications or additions should be made by the user which will either prevent the seat belt adjusting devices from operating to remove slack, or prevent the seat belt assembly from being adjusted to remove slack.

**⚠ WARNING - Shoulder belt**  
**Never wear the shoulder belt under your arm or behind your back. An improperly positioned shoulder belt cannot protect the occupant in a crash.**

**⚠ WARNING - Damaged seat belt**  
**Replace the entire seat belt assembly if any part of the webbing or hardware is damaged as you can no longer be sure that a damaged seat belt will provide protection in a crash.**

**⚠ WARNING - Twisted seat belt**

**Make sure your seat belt is not twisted when worn. A twisted seat belt may not properly protect you in an accident and could even cut into your body.**

**⚠ WARNING - Seat belt buckle**

**Do not allow foreign material (gum, crumbs, coins, etc.) to obstruct the seat belt buckle. This may prevent the seat belt from fastening securely. An improperly fastened seat belt can result in serious injury or death.**

**⚠ WARNING**

**Always wear both the shoulder portion and lap portion of the lap/shoulder belt.**

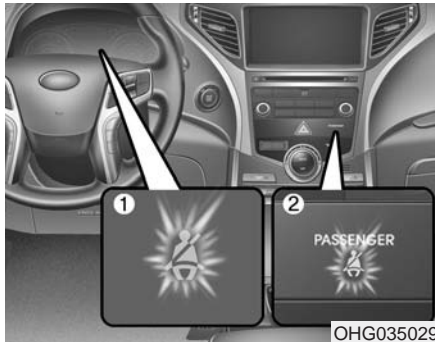

**Seat belt warning**

As a reminder to the driver and passenger, the seatbelt warning light will blink and warning chime will sound as follows:

**Driver's side (1)**

Conditions		Warning Pattern	
Seat Belt	Vehicle Speed	Light-Blink	Chime-Sound
Unbuckled	-	6 seconds	
Buckled*1	-	6 seconds	None
Buckled → Unbuckled	Below 3 mph (5 km/h)	6 seconds	None
	3 mph~6 mph	6 seconds	
	Above 6 mph (10 km/h)	6 sec. on / 24 sec. off (11 times)	
Unbuckled	Above 6 mph (10 km/h)	6 seconds *2	
	↓ Below 3 mph (5 km/h)	↓ Stop *3	

\*1 The warning light blinks 6 seconds whenever the ignition switch is in ON position.

\*2 Warning pattern repeats 11 times with an interval of 24 seconds. If the driver's seat belt is buckled, the light will stop within 6 seconds and chime will stop immediately.

\*3 The light will stop within 6 seconds and chime will stop immediately.

**Front passenger's side (2)**

Conditions		Warning Pattern
Seat Belt	Vehicle Speed	Light-Blink
Unbuckled	-	6 seconds
Buckled*1	-	6 seconds
Unbuckled	Above 6mph (10 km/h)	Continuously
Buckled → Unbuckled	Above 6mph (10 km/h)	Continuously *2
	Below 6mph (10 km/h)	None

\*1 The warning light blinks 6 seconds whenever the ignition switch is in ON position.

\*2 The seat belt warning light will go off if the vehicle speed decreases below 3 mph (5 km/h). If the vehicle speed increases above 3 mph (5 km/h), the warning light will blink again.

- You can find the front passenger's seat belt warning light on the center fascia panel.
- Although the front passenger seat is not occupied, the seat belt warning light will blink for 6 seconds.
- The seat belt warning light can blink when a briefcase or purse is placed on the front passenger seat.

**⚠ WARNING**

**Riding in an improper position adversely affects the front passenger's seat belt warning system. It is important for the driver to instruct the passenger as to the proper seating instructions as contained in this manual.**

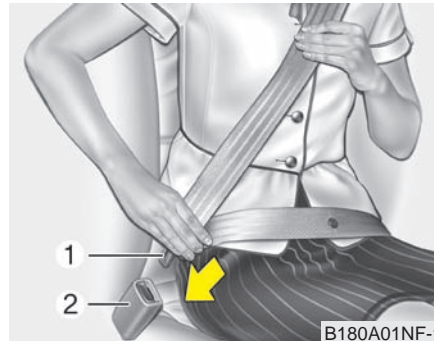

***Seat belt - Driver's 3-point system with emergency locking retractor***

**To fasten your seat belt:**

To fasten your seat belt, pull it out of the retractor and insert the metal tab (1) into the buckle (2). There will be an audible "click" when the tab locks into the buckle.

The seat belt automatically adjusts to the proper length only after the lap belt portion is adjusted manually so that it fits snugly around your hips. If you lean forward in a slow, easy motion, the belt will extend and let you move around. If there is a sudden stop or impact, however, the belt will lock into position.

It will also lock if you try to lean forward too quickly.

If you are not able to pull out the seat belt from the retractor, firmly pull the belt out and release it. Then you will be able to pull the belt out smoothly.

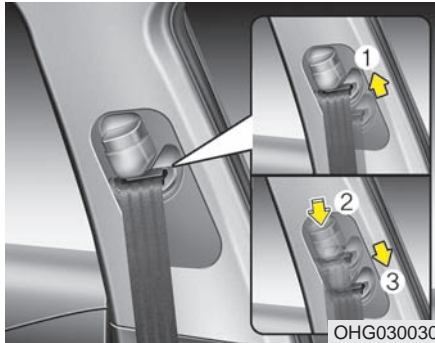

### Height adjustment (front seat)

You can adjust the height of the shoulder belt anchor to one of the 4 positions for maximum comfort and safety.

The height of the adjusting seat belt should not be too close to your neck. The shoulder portion should be adjusted so that it lies across your chest and midway over your shoulder near the door and not your neck.

To adjust the height of the seat belt anchor, lower or raise the height adjuster into an appropriate position.

To raise the height adjuster, pull it up (1). To lower it, push it down (3) while pressing the height adjuster button (2).

Release the button to lock the anchor into position. Try sliding the height adjuster to make sure that it has locked into position.

### **⚠ WARNING** - Shoulder belt position

**Never position the shoulder belt across your neck or face. Improperly positioned seat belts can cause serious injuries in an accident.**

### **⚠ WARNING** - Seat belt replacement

**Replace your seat belts after being in an accident. Failure to replace seat belts after an accident could leave you with damaged seat belts that will not provide protection in the event of another collision.**

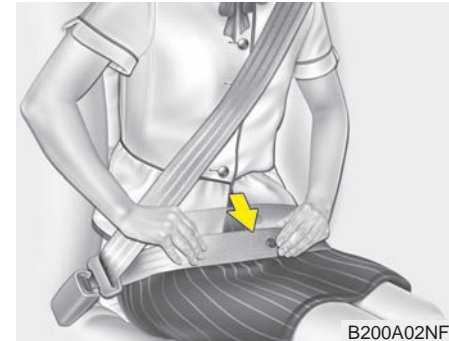

You should place the lap belt portion as low as possible and snugly across your hips. If the lap belt is located too high on your waist, it may increase the chance of injury in the event of a collision.

The arm closest to the seat belt buckle should be over the belt while the other arm should be under the belt as shown in the illustration.



***Seat belts - Front passenger and rear seat 3-point system with combination locking retractor***

**To fasten your seat belt:**

Combination retractor type seat belts are installed in the rear seat positions to help accommodate the installation of child restraint systems. Although a combination retractor is also installed in the front passenger seat position, it is strongly recommended that children always be seated in the rear seat. NEVER place any infant restraint system in the front seat of the vehicle.

This type of seat belt combines the features of both an emergency locking retractor seat belt and an automatic locking retractor seat belt. To fasten your seat belt, pull it out of the retractor and insert the metal tab into the buckle. There will be an audible "click" when the tab locks into the buckle. When not securing a child restraint, the seat belt operates in the same way as the driver's seat belt (Emergency Locking Retractor Type).

It automatically adjusts to the proper length only after the lap belt portion of the seat belt is adjusted manually so that it fits snugly around your hips.

When the seat belt is fully extended from the retractor to allow the installation of a child restraint system, the seat belt operation changes to allow the belt to retract, but not to extend (Automatic Locking Retractor Type). Refer to "Using a child restraint system" in this section.

To convert from the automatic locking feature to the emergency locking operation mode, allow the unbuckled seat belt to fully retract.

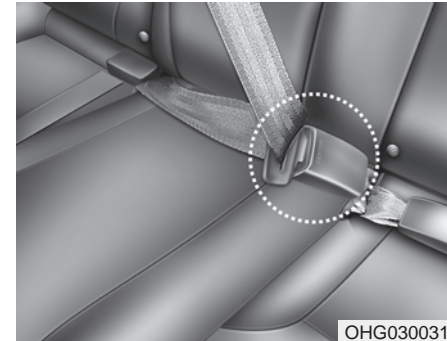

OHG030031

When using the rear center seat belt, the buckle with the "CENTER" mark must be used.

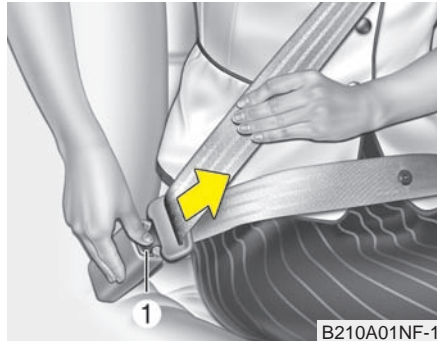

### To release the seat belt:

The seat belt is released by pressing the release button (1) in the locking buckle. When it is released, the belt should automatically draw back into the retractor.

If this does not happen, check the belt to be sure it is not twisted, then try again.



### Pre-tensioner seat belt

Your vehicle is equipped with driver's and front passenger's pre-tensioner seat belts. The purpose of the pre-tensioner is to make sure that the seat belts fit tightly against the occupant's body in certain frontal collisions or side collisions. The pre-tensioner seat belts may be activated in crashes where the frontal collision or side collision is severe enough.

When the vehicle stops suddenly, or if the occupant tries to lean forward too quickly, the seat belt retractor will lock into position. In certain frontal collisions or side collision, the pre-tensioner will activate and pull the seat belt into tighter contact against the occupant's body.

If the system senses excessive tension on the driver or passenger's seat belt when the pre-tensioner activates, the load limiter inside the pre-tensioner will release some of the pressure on the affected seat belt.

### \* NOTICE

The pre-tensioner will activate not only in a frontal collision but also in a side collision or rollover, if the vehicle is equipped with a side or curtain air bag.

### **⚠ WARNING**

Do not put anything near the buckle. Placing objects near the buckle can adversely affect the anchor pre-tensioner and may increase the risk of personal injury in the event of a collision.

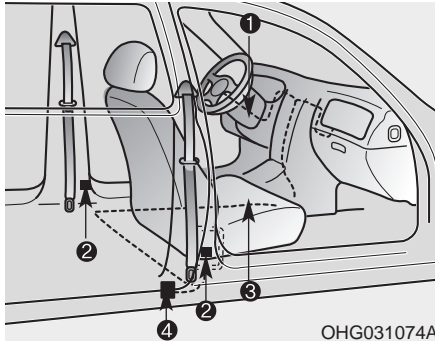

The seat belt pre-tensioner system consists mainly of the following components. Their locations are shown in the illustration:

1. SRS air bag warning light
2. Retractor pre-tensioner assembly
3. SRS control module
4. Anchor pre-tensioner assembly

Both the driver's and front passenger's pre-tensioner seat belts may be activated in certain frontal collisions, side collisions or rollover.

The pre-tensioners will not be activated if the seat belts are not being worn at the time of the collision.

**⚠ WARNING**

To obtain maximum benefit from a pre-tensioner seat belt:

1. The seat belt must be worn correctly and adjusted to the proper position. Please read and follow all of the important information and precautions about your vehicle's occupant safety features – including seat belts and air bags – that are provided in this manual.
2. Be sure you and your passengers always wear seat belts properly.

**\* NOTICE**

- When the pre-tensioner seat belts are activated, a loud noise may be heard and fine dust, which may appear to be smoke, may be visible in the passenger compartment. These are normal operating conditions and are not hazardous.
- Wash all exposed skin areas thoroughly after an accident in which the pre-tensioner seat belts were activated. The fine dust from the pre-tensioner activation may cause skin irritation and should not be breathed for prolonged periods.

- Because the sensor that activates the SRS air bag is connected with the pre-tensioner seat belt, the SRS air bag warning light (⚠) on the instrument panel will illuminate for approximately 6 seconds after the ignition switch has been turned to the ON position, and then it should turn off.
- If the pre-tensioner seat belt is not working properly, this warning light will illuminate even if there is no malfunction of the SRS air bag. If the SRS air bag warning light does not illuminate when the ignition switch is turned ON, or if it remains illuminated after illuminating for approximately 6 seconds, or if it illuminates while the vehicle is being driven, please have an authorized HYUNDAI dealer inspect the pre-tensioner seat belt and SRS air bag system as soon as possible.

### \* NOTICE

Do not attempt to service or repair the pre-tensioner seat belt system in any manner. Do not attempt to inspect or replace the pre-tensioner seat belts yourself. This must be done by an authorized HYUNDAI dealer.

### ⚠ WARNING

Do not touch the pre-tensioner seat belt assemblies for several minutes after they have been activated. When the pre-tensioner seat belt mechanism fires during a collision the pre-tensioner becomes hot and can burn you.

Pre-tensioners are designed to operate only one time. After activation, pre-tensioner seat belts must be replaced. If the pre-tensioner seat belt must be replaced, contact an authorized HYUNDAI dealer.

### Seat belt precautions

#### ⚠ WARNING

All occupants of the vehicle must wear their seat belts at all times. Seat belts and child restraints reduce the risk of serious or fatal injuries for all occupants in the event of a collision or sudden stop. Without a seat belt, occupants could be shifted too close to a deploying air bag, strike the interior structure or be thrown from the vehicle. Properly worn seat belts greatly reduce these hazards. Even with advanced air bags, unbelted occupants can be severely injured by a deploying air bag.

Always follow the precautions about seat belts, air bags and occupant safety contained in this manual.

***Infant or small child***

All 50 states have child restraint laws. You should be aware of the specific requirements in your state. Child and/or infant seats must be properly placed and installed in the rear seat. For more information about the use of these restraints, refer to “Child restraint system” in this section.

** WARNING**

**Every person in your vehicle needs to be properly restrained at all times, including infants and children. Never hold a child in your arms or lap when riding in a vehicle. The violent forces created during a crash will tear the child from your arms and throw the child against the interior. Always use a child restraint appropriate for your child's height and weight.**

**\* NOTICE**

**Small children are best protected from injury in an accident when properly restrained in the rear seat by a child restraint system that meets the requirements of the Federal Motor Vehicle Safety Standards. Before buying any child restraint system, make sure that it has a label certifying that it meets Federal Motor Vehicle Safety Standard 213. The restraint must be appropriate for your child's height and weight. Check the label on the child restraint for this information. Refer to “Child restraint system” in this section.**

***Larger children***

Children who are too large for child restraint systems should always occupy the rear seat and use the available lap/shoulder belts. The lap portion should be fastened snug on the hips and as low as possible. Check if the belt fits periodically. A child's squirming could put the belt out of position. Children are given the most safety in the event of an accident when they are restrained by a proper restraint system in the rear seat. If a larger child (over age 12) must be seated in the front seat, the child should be securely restrained by the available lap/shoulder belt and the seat should be placed in the rear-most position. Children age 12 and under should be restrained securely in the rear seat. NEVER place a child age 12 and under in the front seat. NEVER place a rear facing child seat in the front seat of a vehicle.

If the shoulder belt portion slightly touches the child's neck or face, try placing the child closer to the center of the vehicle. If the shoulder belt still touches their face or neck they need to be returned to a child restraint system.

**⚠ WARNING - Small children**  
Do not allow small children to ride in the vehicle without an appropriate child restraint system. If the shoulder belt comes in contact with your child's neck or face your child is too small to ride in the vehicle. In a crash the seat belt will inflict injury to your child's neck, throat and face.

### ***Pregnant women***

The use of a seat belt is recommended for pregnant women to lessen the chance of injury in an accident. When a seat belt is used, the lap belt portion should be placed as low and snugly as possible on the hips, not across the abdomen. For specific recommendations, consult a physician.

**⚠ WARNING - Pregnant women**

Pregnant women must never place the lap portion of the seat belt above or on the abdomen where the fetus is located. The force of the seat belt during a collision will crush the fetus.

### ***Injured person***

A seat belt should be used when an injured person is being transported. When this is necessary, you should consult a physician for recommendations.

### ***One person per belt***

Two people (including children) should never attempt to use a single seat belt. This could increase the severity of injuries in case of an accident.

### ***Do not lie down***

To reduce the chance of injuries in the event of an accident and to achieve maximum effectiveness of the restraint system, all passengers should be sitting up and the front seats should be in an upright position when the vehicle is moving. A seat belt cannot provide proper protection if the person is lying down in the rear seat or if the front seat is in a reclined position.

### Care of seat belts

Seat belt systems should never be disassembled or modified. In addition, care should be taken to assure that seat belts and belt hardware are not damaged by seat hinges, doors or other abuse.

**▲ WARNING - Pinched seat belt**

**Make sure that the webbing and/or buckle does not get caught or pinched in the rear seat when returning the rear seatback to its upright position. A caught or pinched webbing/buckle may become damaged and could fail during a collision or sudden stop resulting in serious injury or death.**

### *Periodic inspection*

All seat belts should be inspected periodically for wear or damage of any kind. Any damaged parts should be replaced as soon as possible.

### *Keep belts clean and dry*

Seat belts should be kept clean and dry. If belts become dirty, they can be cleaned by using a mild soap solution and warm water. Bleach, dye, strong detergents or abrasives should not be used because they may damage and weaken the fabric.

### *When to replace seat belts*

The entire in-use seat belt assembly or assemblies should be replaced if the vehicle has been involved in an accident. This should be done even if no damage is visible. Additional questions concerning seat belt operation should be directed to an authorized HYUNDAI dealer.

## CHILD RESTRAINT SYSTEM

Children riding in the vehicle should sit in the rear seat and must always be properly restrained to minimize the risk of injury in an accident, sudden stop or sudden maneuver. According to accident statistics, children are safer when properly restrained in the rear seats than in the front seat. Larger children not in a child restraint should use one of the seat belts provided.

You should be aware of the specific requirements in your state. Child and/or infant safety seats must be properly placed and installed in the rear seat. You must use a commercially available child restraint system that meets the requirements of the Federal Motor Vehicle Safety Standards (FMVSS).

Child restraint systems are designed to be secured in vehicle seats by lap belts or the lap belt portion of a lap/shoulder belt, or by a LATCH system.

Children could be injured or killed in a crash if their restraints are not properly secured. For small children and babies, a child seat or infant seat must be used.

Before buying a particular child restraint system, make sure it fits your car seat, seat belts and your child.

Follow all the instructions provided by the manufacturer when installing the child restraint system.

### **WARNING - Restraint location**

**Never install a child or infant seat on the front passenger's seat. A child riding in the front passenger seat can be forcefully struck by an inflating airbag and severely injured or killed.**

### **WARNING - Hot child restraint**

**A child restraint system can become very hot if it is left in a closed vehicle on a sunny day. Be sure to check the seat cover, buckles and latches before placing a child in the restraint system.**

When the child restraint system is not in use, store it in the luggage area or fasten it with a seat belt so that it will not be thrown forward in case of a sudden stop or an accident.



**⚠ WARNING - Holding children**

Never hold a child in your arms or lap when riding in a vehicle. The violent forces created during a crash will tear the child from your arms and throw the child against the vehicle's interior causing serious injury or death. Always use a child restraint system which is appropriate for your child's height and weight.

**⚠ WARNING**

Never use an infant carrier or a child safety seat that "hooks" over a seatback, it may not provide adequate security in an accident.

**⚠ WARNING - Unattended Children**

Never leave children unattended in a vehicle. The vehicle can heat up very quickly, resulting in serious injuries or death to the child in the vehicle.

**⚠ WARNING - Seat belt use**

Do not use one seat belt for two occupants at the same time. This will eliminate any safety benefit provided by the seat belt to the occupants resulting in serious injury or death.

■ Rearward-facing child restraint system

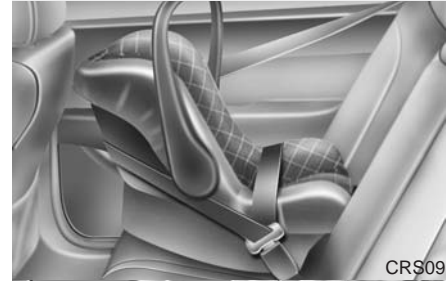

■ Forward-facing child restraint system



**Using a child restraint system**

For small children and babies, the use of a child seat or infant seat is required. This child seat or infant seat should be of appropriate size for the child and should be installed in accordance with the manufacturer's instructions.

For safety reasons, we recommend that the child restraint system be used in the rear seats.

Since all passenger seat belts move freely under normal conditions and only lock under extreme or emergency conditions (emergency locking mode), you must manually change these seat belts to the automatic locking mode to secure a child restraint.

If the seat belt does not operate as described in this section, have the system checked immediately by your authorized HYUNDAI dealer.

### **⚠ WARNING - Child seat installation**

- **Always follow the instructions provided by the child restraint system manufacturer. Child restraint system manufacturers know their products best.**
- **Failure to observe this manual's instructions regarding child restraint system and the instructions provided with the child restraint system could result in the improper installation of the child restraint system which may reduce the protection to your child in a crash or a sudden stop. This could increase the chance and/or severity of injury in an accident.**
- **If the vehicle headrest prevents proper installation of a child seat (as described in the child seat system manual), the headrest of the respective seating position shall be readjusted or entirely removed.**

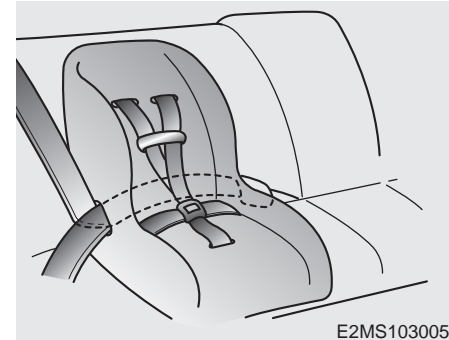

### ***Placing a passenger seat belt into the automatic locking mode***

The automatic locking mode will help prevent the normal movement of the child in the vehicle from causing the seat belt to loosen and compromise the child restraint system. To secure a child restraint system, use the following procedure.

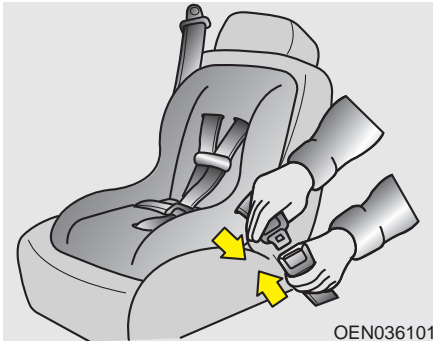

To install a child restraint system on the outboard or center rear seats, do the following:

1. Place the child restraint system on the seat and route the lap/shoulder belt around or through the restraint, following the restraint manufacturer's instructions. Be sure the seat belt webbing is not twisted.
2. Fasten the lap/shoulder belt latch into the buckle. Listen for the distinct "click" sound.

*Position the release button so that it is easy to access in case of an emergency.*

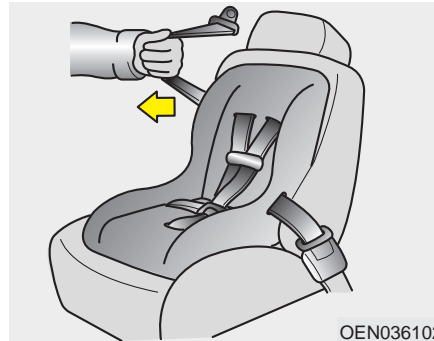

3. Pull the shoulder portion of the seat belt all the way out. When the shoulder portion of the seat belt is fully extended, it will shift the retractor to the "Automatic Locking" (child restraint) mode.

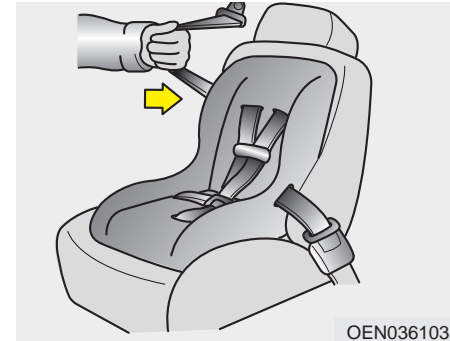

4. Slowly allow the shoulder portion of the seat belt to retract and listen for an audible "clicking" or "ratcheting" sound. This indicates that the retractor is in the "Automatic Locking" mode. If no distinct sound is heard, repeat steps 3 and 4.

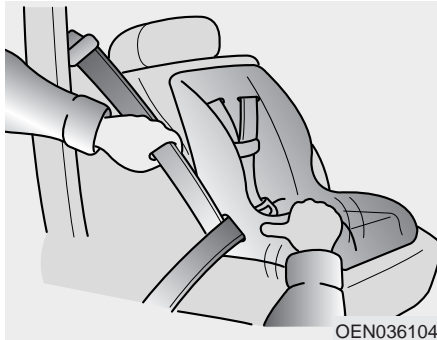

5. Remove as much slack from the belt as possible by pushing down on the child restraint system while feeding the shoulder belt back into the retractor.
6. Push and pull on the child restraint system to confirm that the seat belt is holding it firmly in place. If it is not, release the seat belt and repeat steps 2 through 6.
7. Double check that the retractor is in the “Automatic Locking” mode by attempting to pull more of the seat belt out of the retractor. If you cannot, the retractor is in the “Automatic Locking” mode.

The lap/shoulder belt automatically returns to the “emergency lock mode” whenever the belt is allowed to retract fully.

Therefore, the preceding seven steps must be followed each time a child restraint is installed.

To remove the child restraint, press the release button on the buckle and then pull the lap/shoulder belt out of the restraint and allow the seat belt to retract fully.

**When the seat belt is allowed to retract to its fully stowed position, the retractor will automatically switch from the “Automatic Locking” mode to the emergency lock mode for normal adult usage.**

**⚠ WARNING - Auto locking mode**

**Set the retractor to Automatic Locking mode when installing any child restraint system. If the retractor is not in the Automatic Locking mode, the child restraint can move when your vehicle turns or stops suddenly, seriously injuring or killing the child.**

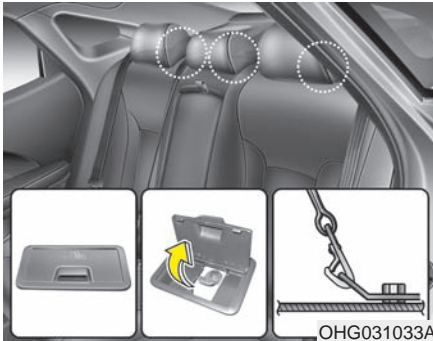

**Securing a child restraint seat with "Tether Anchor" system**

Child restraint hook holders are located on the package tray.



1. Route the child restraint seat tether strap over the seatback.

For vehicles with adjustable headrests, route the tether strap under the headrest and between the headrest posts, otherwise route the tether strap over the top of the seatback.

For more information about the use of the headrests, refer to "Adjusting the height up and down - Rear seat" in this section.

2. Connect the tether strap hook to the appropriate child restraint hook holder and tighten to secure the seat.

**⚠ WARNING - Tether strap**  
 Never mount more than one child restraint to a single tether anchor or to a single lower anchorage point. The increased load caused by multiple seats may cause the tethers or lower anchorage points to break.

**⚠ WARNING**  
 - Child restraint check  
 Check that the child restraint system is secure by pushing and pulling it in different directions. Incorrectly fitted child restraints may swing, twist, tip or separate causing death or serious injury.

**⚠ WARNING**

**- Child restraint anchorage**

Child restraint anchorages are designed to withstand only those loads imposed by correctly fitted child restraints. Under no circumstances are they to be used for adult seat belts or harnesses or for attaching other items or equipment to the vehicle.

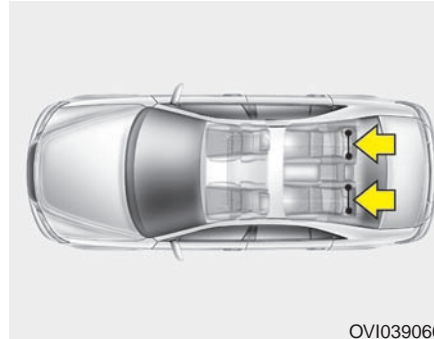

***Securing a child restraint seat with child seat lower anchor system***

Some child seat manufacturers make child restraint seats that are labeled as LATCH or LATCH-compatible child restraint seats. LATCH stands for "Lower Anchors and Tethers for Children". These seats include two rigid or webbing mounted attachments that connect to two LATCH anchors at specific seating positions in your vehicle. This type of child restraint seat eliminates the need to use seat belts to attach the child seat in the rear seats.

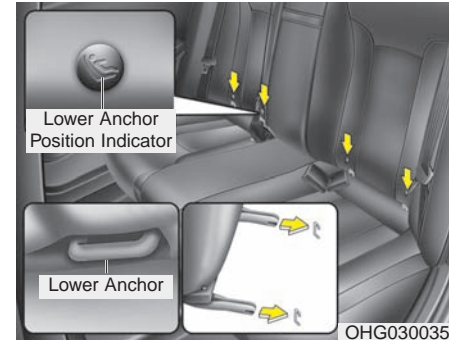

Child restraint symbols are located on the left and right rear seat backs to indicate the position of the lower anchors for child restraints.

**⚠ WARNING - Unused rear seatbelts**

**Always fasten the seatbelts behind the child restraint seat when they are not used to secure the child seat. Failure to do so may result in child strangulation.**

**⚠ WARNING**

**Do not place anything around the lower anchors. Also make sure that the seat belt is not caught in the lower anchors.**

LATCH anchors have been provided in your vehicle. The LATCH anchors are located in the left and right outboard rear seating positions. Their locations are shown in the illustration. There is no LATCH anchor provided for the center rear seating position.

The LATCH anchors are located between the seatback and the seat cushion of the rear seat left and right outboard seating positions. When you install your child's restraint system using the LATCH anchors, buckle the shoulder lap belt, then lock the retractor and pull the belt to remove the slack in the belt so it lies flat against the vehicle seat.

Follow the child seat manufacturer's instructions to properly install child restraint seats with LATCH or LATCH-compatible attachments.

Once you have installed the LATCH child restraint, assure that the seat is properly attached to the LATCH and tether anchors.

Also, test the child restraint seat before you place the child in it. Tilt the seat from side to side. Also try to tug the seat forward. Check to see if the anchors hold the seat in place.

**⚠ WARNING**

**If the child restraint is not anchored properly, the risk of a child being seriously injured or killed in a collision greatly increases.**

**⚠ WARNING**

**- LATCH lower anchors**

**Never attempt to attach a LATCH equipped seat in the center seating position. LATCH lower anchors are only to be used with the left and right rear outboard seating positions. You may damage the anchors or the anchors may fail and break in a collision.**

**\* NOTICE**

The recommended weight for the LATCH system is under 65 lbs (30 kg).

How to calculate the child restraint weight :

Child restraint weight =  
65 lbs (30 kg) - Child weight

## AIR BAG - SUPPLEMENTAL RESTRAINT SYSTEM (SRS)

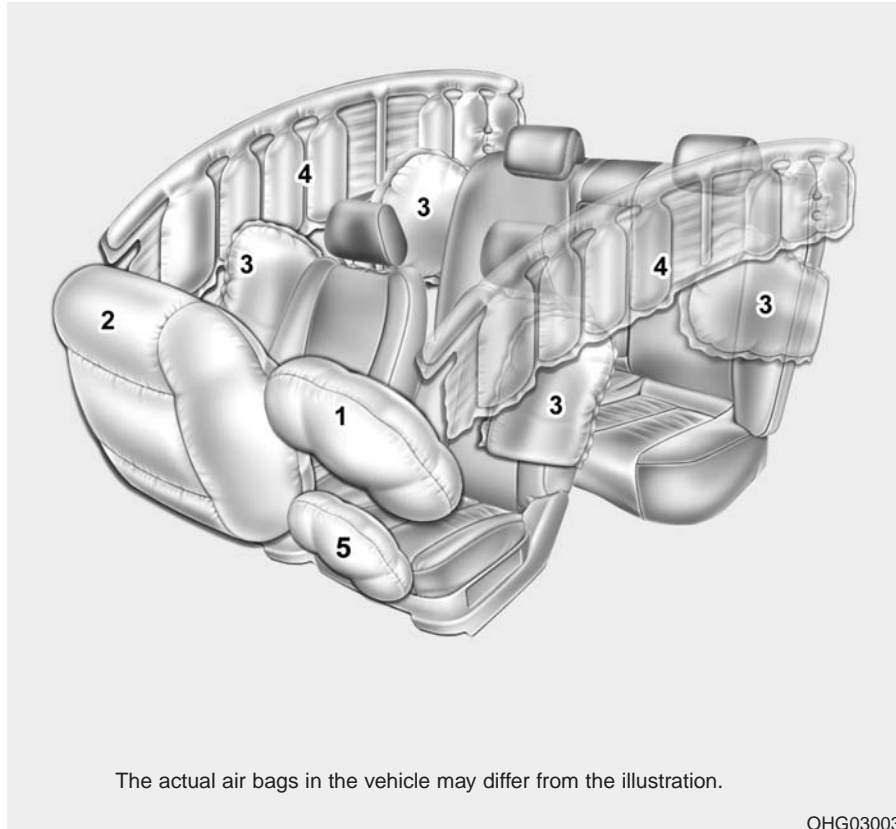

- (1) Driver's front air bag
- (2) Passenger's front air bag
- (3) Side impact air bag
- (4) Curtain air bag
- (5) Driver's knee air bag

**⚠ WARNING - Seat belts**

Even in vehicles with air bags, you and your passengers must always wear the safety belts provided in order to minimize the risk and severity of injury in the event of a collision or rollover.

The actual air bags in the vehicle may differ from the illustration.

OHG030036



### How does the air bag system operate

- Air bags are activated (able to inflate if necessary) only when the ignition switch is changed to the ON or START position.
- Air bags inflate instantly in the event of a serious frontal or side collision in order to help protect the occupants from serious physical injury.
- There is no single speed at which the air bags will inflate.

Generally, air bags are designed to inflate based upon the severity of a collision and its direction. These two factors determine whether the sensors produce an electronic deployment/ inflation signal.

- Air bag deployment depends on a number of factors including vehicle speed, angles of impact and the density and stiffness of the vehicles or objects which your vehicle hits in the collision. The determining factors are not limited to those mentioned above.

- The front air bags will completely inflate and deflate in an instant.

It is virtually impossible for you to see the air bags inflate during an accident.

It is much more likely that you will simply see the deflated air bags hanging out of their storage compartments after the collision.

- In addition to inflating in certain side collisions, vehicles equipped with a rollover sensor, side impact air bags and curtain air bags will inflate if the sensing system detects a rollover.

When a rollover is detected, side impact air bags and curtain air bags will remain inflated longer to help provide protection from ejection, especially when used in conjunction with the seat belts.

- In order to help provide protection in a severe collision, the air bags must inflate rapidly. The speed of air bag inflation is a consequence of the extremely short time in which a collision occurs and the need to inflate the air bag between the occupant and the vehicle structures before the occupant impacts those structures.

This speed of inflation reduces the risk of serious or life-threatening injuries in a severe collision and is thus a necessary part of air bag design.

However, air bag inflation can also cause injuries which can include facial abrasions, bruises and broken bones because the inflation speed also causes the air bags to expand with a great deal of force.

- **There are even circumstances under which contact with the steering wheel air bag can cause fatal injuries, especially if the occupant is positioned excessively close to the air bag.**

**⚠ WARNING - Air bag inflation**

**Sit as far back as possible from the steering wheel while still maintaining comfortable control of your vehicle. A distance of at least 10" from your chest to the steering wheel is recommended. Failure to do so can result in severe personal injuries or death caused by a deploying air bag.**

### **Noise and smoke**

When the air bags inflate, they make a loud noise and they leave smoke and powder in the air inside of the vehicle. This is normal and is a result of the ignition of the air bag inflator. After the air bag inflates, you may feel substantial discomfort in breathing due to the contact of your chest with both the seat belt and the air bag, as well as from breathing the smoke and powder. **Open your doors and/or windows as soon as possible after impact in order to reduce discomfort and prevent prolonged exposure to the smoke and powder.**

Though the smoke and powder are non-toxic, they may cause irritation to the skin (eyes, nose and throat, etc). If this is the case, wash and rinse with cold water immediately and consult a doctor if the symptom persists.

**⚠ WARNING - Hot components**  
**Do not touch the air bag storage area's internal components immediately after airbag inflation. The air bag related parts in the steering wheel, instrument panel and the roof rails above the front and rear doors are very hot. Hot components can result in burn injuries.**



### ***Never install a child restraint in the front passenger seat.***

Never place a rear-facing child restraint in the front passenger's seat. If the air bag deploys, it could impact the rear-facing child restraint, causing serious or fatal injury.

In addition, do not place front-facing child restraints in the front passenger's seat either. If the front passenger air bag inflates, it could cause serious or fatal injuries to the child.

**⚠ WARNING - Air bag deployment**

When children are seated in the rear outboard seats of a vehicle equipped with side and/or curtain air bags, install the child restraint system as far away from the door side as possible. Inflation of the side and/or curtain air bags could cause serious injury or death to an infant or child.



**Air bag warning indicator**

*Air bag warning light*

The purpose of the air bag warning light in your instrument panel is to alert you of a potential problem with your air bag - Supplemental Restraint System (SRS).

When the ignition switch is turned ON, the warning light should illuminate for approximately 6 seconds, then go off.

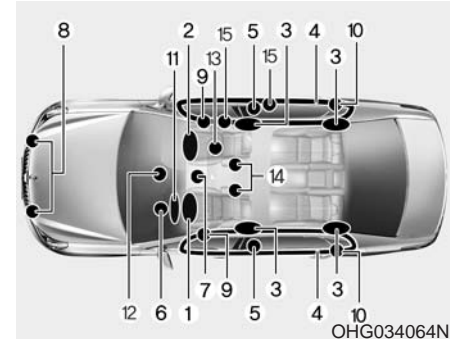

**SRS components and functions**

The SRS consists of the following components:

1. Driver's front air bag module
2. Passenger's front air bag module
3. Side impact air bag modules
4. Curtain air bag modules
5. Retractor pre-tensioner assemblies
6. Air bag warning light
7. SRS control module (SRSCM)/ Rollover sensor
8. Front impact sensors
9. Side impact sensors
10. Rear side impact sensors
11. Driver's knee air bag module

## Safety features of your vehicle

12. Passenger's front air bag ON/OFF indicator (front passenger's seat only)
13. Occupant classification system (front passenger's seat only)
14. Driver's and front passenger's seat belt buckle sensors
15. Anchor pretensioner assembly

The SRSCM continually monitors all SRS components while the ignition switch is ON to determine if a crash impact is severe enough to require air bag deployment or pre-tensioner seat belt deployment.

The SRS air bag warning light "🚗" on the instrument panel will illuminate for about 6 seconds after the ignition switch is turned to the ON position, after which the SRS air bag warning light "🚗" should go out.

If any of the following conditions occurs, this indicates a malfunction of the SRS. Have an authorized HYUNDAI dealer inspect the air bag system immediately.

- The light does not turn on briefly when you turn the ignition ON.
- The light stays on after illuminating for approximately 6 seconds.
- The light comes on while the vehicle is in motion.
- The light blinks continuously when the ignition switch is in ON position.



The front air bag modules are located both in the center of the steering wheel, in the front passenger's panel above the glove box and/or in the driver's side knee bolster. When the SRSCM detects a sufficiently severe impact to the front of the vehicle, it will automatically deploy the front air bags.

■ Driver's front air bag (2)



■ Driver's front air bag (3)



■ Passenger's front air bag

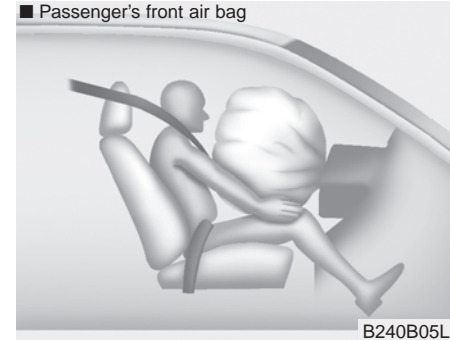

Upon deployment, tear seams molded directly into the pad covers will separate under pressure from the expansion of the air bags. Further opening of the covers then allows full inflation of the air bags.

A fully inflated air bag, in combination with a properly worn seat belt, slows the driver's or the passenger's forward motion, reducing the risk of head and chest injury.

After complete inflation, the air bag immediately starts deflating, enabling the driver to maintain forward visibility and the ability to steer and operate other controls.

**⚠ WARNING**  
**- Air bag obstructions**

**Do not install or place any accessories on the steering wheel, instrument panel, or on the front passenger's panel above the glove box in a vehicle. Such objects may become dangerous projectiles and cause serious injury if the air bag deploys.**

### \* NOTICE

Before you replace a fuse or disconnect a battery terminal, change the ignition switch to the OFF position. Never remove or replace the air bag related fuse(s) when the ignition switch is in the ON position. Failure to heed this warning will cause the SRS air bag warning light to illuminate.



### Occupant classification system

Your vehicle is equipped with an occupant classification system in the front passenger's seat.

The occupant classification system is designed to detect the presence of a properly-seated front passenger and determine if the passenger's front air bag should be enabled (may inflate) or not. The driver's front air bag is not affected or controlled by the occupant classification system.

### *Main components of occupant classification system*

- A detection device located within the front passenger seat cushion.
- Electronic system to determine whether passenger air bag systems should be activated or deactivated.
- A warning light located on the instrument panel which illuminates the words PASSENGER AIR BAG "OFF" indicating the front passenger air bag system is deactivated.
- The instrument panel air bag warning light is interconnected with the occupant classification system.

If the front passenger seat is occupied by a person that the system determines to be of adult size, and he/she sits properly (sitting upright with the seatback in an upright position, centered on the seat cushion with their seat belt on, legs comfortably extended and their feet on the floor), the PASSENGER AIR BAG “OFF” indicator will turn off and the front passenger's air bag will be able to inflate, if necessary, in frontal crashes.

You will find the PASSENGER AIR BAG “OFF” indicator on the center fascia panel.

This system detects conditions 1–4 in the following table and activates or deactivates the front passenger air bag based on these conditions.

Always be sure that you and all vehicle occupants are seated and restrained properly (sitting upright with the seat in an upright position, centered on the seat cushion, with the person’s legs comfortably extended, feet on the floor, and wearing the safety belt properly) for the most effective protection by the air bag and the seat belt.

- The OCS (Occupant Classification System) may not function properly if the passenger takes actions which can affect the classification system. These include:
  - (1) Failing to sit in an upright position.
  - (2) Leaning against the door or center console.
  - (3) Sitting towards the sides or the front of the seat.
  - (4) Putting legs on the dashboard or resting them on other locations which reduce the passenger weight on the front seat.
  - (5) Improperly wearing the seat belt.
  - (6) Reclining the seat back.

### **Condition and operation in the front passenger occupant classification system**

Condition detected by the occupant classification system	Indicator/Warning light		Devices
	"PASSENGER AIR BAG OFF" indicator light	SRS warning light	Front passenger air bag
1. Adult or child *1	Off	Off	Activated
2. Child restraint system*2	On	Off	Deactivated
3. Unoccupied	On	Off	Deactivated
4. There is a malfunction in the system	Off	On	Activated

- \*1) The system judges a person of adult size as an adult. When a smaller adult sits in the front passenger seat, the system may recognize him/her as a child depending on his/her physique and posture.
- \*2) Do not allow children to ride in the front passenger seat. When a larger child who has outgrown a child restraint system sits in the front passenger seat, the system may recognize him/her as an adult depending on his/her physique or posture.
- \*3) Never install a child restraint system on the front passenger seat.

**⚠ WARNING - OCS system**  
**Riding in an improper position adversely affects the occupant classification system (OCS) and may result in the deactivation of front passenger airbag. It is important for the driver to instruct the passenger as to the proper seating instructions as contained in this manual.**  
**(Continued)**



(Continued)



OVQ036013N

- Never put a heavy load in the front passenger seat or seat-back pocket.

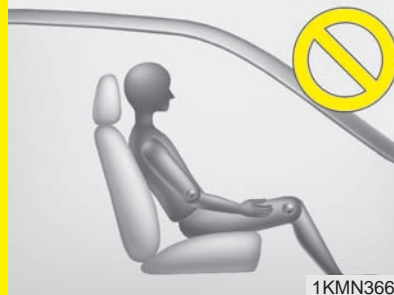

1KMN3663

- Never sit with the hips shifted towards the front of the seat.



1KMN3665

- Never place the feet on the dashboard.



OHG031073A

- Never sit on the front passenger seat with anything attached such as a blanket or cushion.

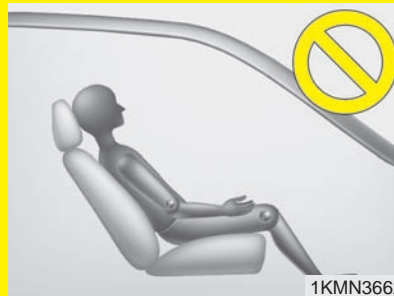

1KMN3662

- Never excessively recline the front passenger seatback.



1KMN3664

- Never lean on the door or center console.  
- Never sit on one side of the front passenger seat.

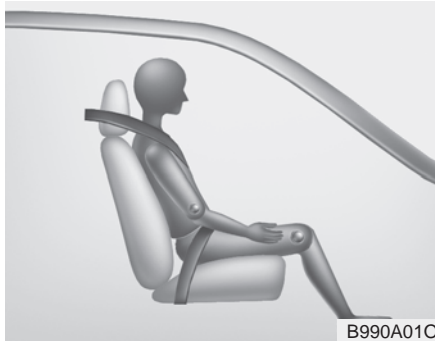

When an adult is seated in the front passenger seat, if the PASSENGER AIR BAG “OFF” indicator is on, change the ignition switch to the OFF position and ask the passenger to sit properly (sitting upright with the seat back in an upright position, centered on the seat cushion with their seat belt on, legs comfortably extended and their feet on the floor). Restart the engine and have the person remain in that position. This will allow the system to detect the person and to enable the passenger air bag.

If the PASSENGER AIR BAG “OFF” indicator is still on, ask the passenger to move to the rear seat.

**⚠ WARNING - AIR BAG  
“OFF” light**

**Do not allow an adult passenger to ride in the front seat when the PASSENGER AIR BAG “OFF” indicator is illuminated, because the air bag will not deploy in the event of a crash. The driver must instruct the passenger to reposition himself in the seat. Failure to properly position yourself may lead to airbag deactivation resulting in airbag non-deployment in a collision. If the PASSENGER AIR BAG “OFF” indicator remains illuminated after the passenger repositions themselves properly and the vehicle is restarted, it is recommended the passenger move to the rear seat because the passenger's front air bag will not deploy.**

**\* NOTICE**

The PASSENGER AIR BAG “OFF” indicator illuminates for about 4 seconds after the ignition switch is changed to the ON position or after the engine is started. If the front passenger seat is occupied, the occupant classification sensor will then classify the front passenger after several more seconds.

Any child age 12 and under should ride in the rear seat. Children too large for child restraints should use the available lap/shoulder belts. No matter what type of crash, children of all ages are safer when restrained in the rear seat.

**\* NOTICE**

**Do not modify or replace the front passenger seat. Do not place anything on or attach anything such as a blanket, front seat covers or after market seat heater to the front passenger seat. This can adversely affect the occupant classification system.**

If the occupant classification system is not working properly, the SRS air bag warning light on the instrument panel will illuminate because the passenger's front air bag is connected with the occupant classification system. If there is a malfunction of the occupant detection system, the PASSENGER AIR BAG "OFF" indicator will not illuminate and the passenger's front air bag will inflate in frontal impact crashes even if there is no occupant in the front passenger's seat.

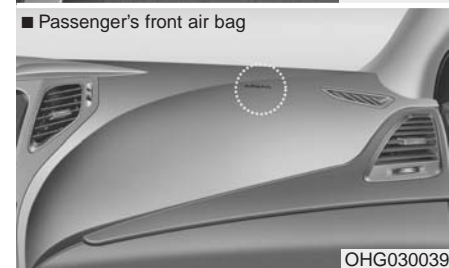
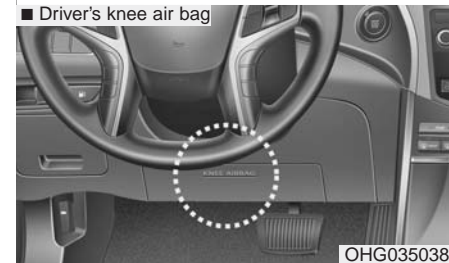

**Driver's and passenger's front air bag**

Your vehicle is equipped with an Advanced Supplemental Restraint (Air Bag) System (SRS) and the lap/shoulder belts at both the driver and passenger seating positions.

The indications of the system's presence are the letters "AIR BAG" embossed on the air bag pad cover in the steering wheel and/or on the cover of the driver's side knee bolster located below the steering wheel and the passenger's side front panel pad above the glove box.

The SRS consists of air bags installed under the pad covers in the center of the steering wheel, in the knee bolster below the steering wheel column and the passenger's side front panel above the glove box. The purpose of the SRS is to provide the vehicle's driver and/or the front passenger with additional protection than that offered by the seat belt system alone in case of a frontal impact of sufficient severity. The SRS uses sensors to gather information about the driver's and front passenger's seat belt usage and impact severity.

The seat belt buckle sensors determine if the driver and front passenger's seat belts are fastened.

These sensors provide the ability to control the SRS deployment based on whether or not the seat belts are fastened, and how severe the impact is.

The advanced SRS offers the ability to control the air bag inflation within two levels. A first stage level is provided for moderate-severity impacts. A second stage level is provided for more severe impacts.

According to the impact severity and seat belt usage, the SRSCM (SRS Control Module) controls the air bag inflation. Failure to properly wear seat belts can increase the risk or severity of injury in an accident.

Additionally, your vehicle is equipped with an occupant classification system in the front passenger's seat. The occupant classification system detects the presence of a passenger in the front passenger's seat and will turn off the front passenger's air bag under certain conditions. For more detail, see "Occupant classification system" in this section.

### **WARNING**

- **Do not place any objects underneath the front seats as they could interfere with the occupant classification system.**
- **Do not place or charge an electronic device such as a laptop computer on the front passenger seat. Its electronic field may cause the OCS to switch to the "on" condition and thus allow the passenger air bag to deploy needlessly in a collision, increasing your repair costs.**

Manufacturers are required by government regulations to provide a contact point concerning modifications to the vehicle for persons with disabilities, which modifications may affect the vehicle's advanced air bag system. That contact is HYUNDAI Customer Assistance center at 1-800-633-5151. However, HYUNDAI does not endorse nor will it support any changes to any part or structure of the vehicle that could affect the advanced air bag system, including the occupant classification system.

**⚠ WARNING - Replacement/ Modifications**

The front passenger seat, dashboard or door should not be replaced except by an authorized HYUNDAI dealer using original HYUNDAI parts designed for this vehicle and model. Any other such replacement or modification could adversely affect the operation of the occupant classification system and your advanced air bags.

Advanced air bags are combined with pre-tensioner seat belts to help provide enhanced occupant protection in frontal crashes. Front air bags are not intended to deploy in collisions in which sufficient protection can be provided by the pre-tensioner seat belt.

**⚠ WARNING - SRS Wiring**

Do not tamper with or disconnect SRS wiring or other components of the SRS system. Doing so could result in injury, due to accidental deployment of the air bags or by rendering the SRS inoperative.

**\* NOTICE**

Air bags can only be used once – have an authorized HYUNDAI dealer replace the air bag immediately after deployment.

Front air bags are not intended to deploy in side-impact, rear-impact or rollover crashes. In addition, front air bags will not deploy in frontal crashes below the deployment threshold.

## Safety features of your vehicle

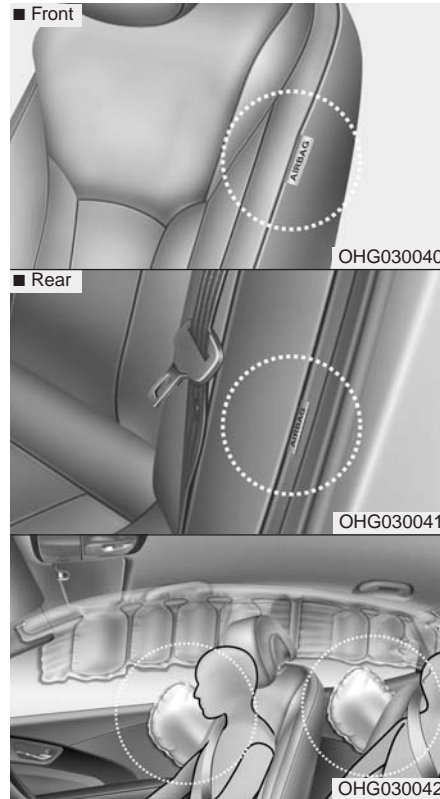
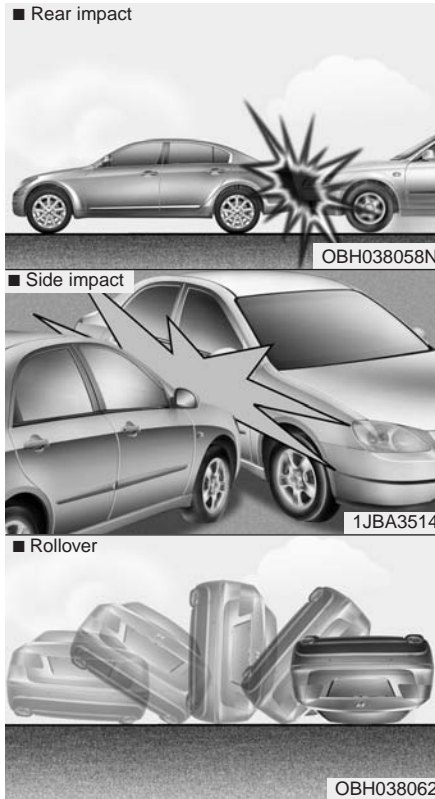

Side impact air bag

Your vehicle is equipped with a side impact air bag in each front and out-board rear seat. The purpose of the air bag is to provide occupants with additional protection than that offered by the seat belt alone.

The side impact air bags are designed to deploy only during certain side-impact collisions, depending on the crash severity, angle, speed and point of impact. The side air bags are not designed to deploy in all side impact situations or in all rollover situations. Side impact airbags are deployed if the rollover or the possible rollover event is detected by ACU (Airbag Control Unit).

**⚠ WARNING - Unexpected deployment**

**Avoid impact to the side impact air bag sensor when the ignition switch is ON to prevent unexpected deployment of the side impact air bag.**

Side impact air bags are supplemental to the seat belt systems and are not a substitute for them. Therefore your seat belts must be worn at all times while the vehicle is in operation. For best protection from the side air bag system and to avoid being injured by the deploying side air bag, all seat occupants should sit in an upright position with the seat belt properly fastened.

The driver's hands should be placed on the steering wheel at the 9:00 and 3:00 positions. The passenger's arms and hands should be placed on their laps.

**⚠ WARNING - Deployment**

**Do not install any accessories including seat covers, on the side or near the side impact air bag as this may affect the deployment of the side air bags.**

If seat or seat cover is damaged, have the vehicle checked and repaired by an authorized HYUNDAI dealer.

**⚠ WARNING - Flying objects**

**Do not place any objects (an umbrella, bag, etc.) between the door and seat. Such objects may become dangerous projectiles if the side airbag inflates, which may result in serious injuries to the occupants.**

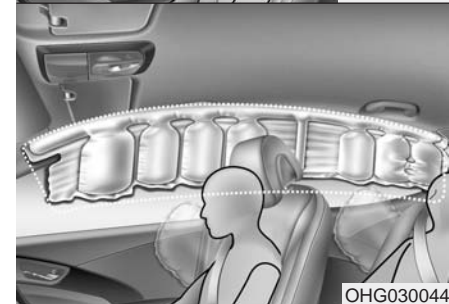
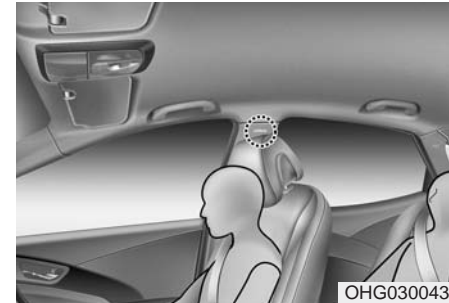

**Curtain air bag**

Curtain air bags are located along both sides of the roof rails above the front and rear doors.

They are designed to help protect the heads of the front seat occupants and the rear outboard seat occupants in certain side impact collisions.

The curtain air bags are designed to deploy only during certain side impact collisions, depending on the crash severity, angle, speed and impact. The curtain air bags are not designed to deploy in all side impact situations or in all rollover situations. Curtain airbags are deployed if the rollover or the possible rollover event is detected by ACU (Airbag Control Unit).

### **WARNING**

**Do not allow the passengers to lean their heads or bodies onto doors, put their arms on the doors, stretch their arms out of the window, or place objects between the doors and passengers when they are seated on seats equipped with side impact and/or curtain air bags. Failure to follow this instruction could result in injury or death to vehicle occupants in a crash.**

### **\* NOTICE**

**Never try to open or repair any components of the side curtain air bag system. This should only be done by an authorized HYUNDAI dealer.**



**Why didn't my air bag go off in a collision? (Inflation and non-inflation conditions of the air bag)**

There are many types of accidents in which the air bag would not be expected to provide additional protection.

These include rear impacts, second or third collisions in multiple impact accidents, as well as low speed impacts.

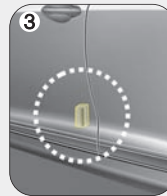
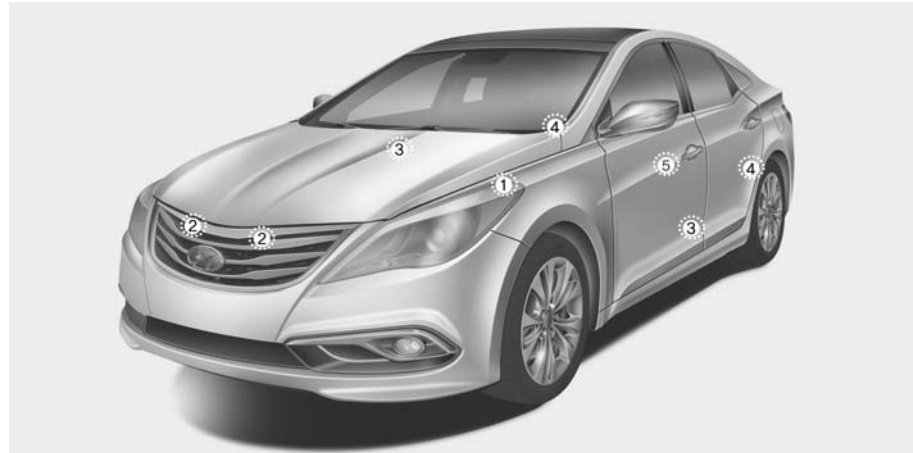

OHG035045N/OHG031046A/OHG035047N/OHG035075/OHG030049/OHG035075N

**Air bag collision sensors**

- (1) SRS control module/  
Rollover sensor
- (2) Front impact sensor
- (3) Side impact sensor (front)

- (4) Side impact sensor (rear)
- (5) Side impact sensor-Pressure  
(front)

**⚠ WARNING - Air bag sensors**

- Do not hit or allow any objects to impact the locations where air bags or sensors are installed.

This may cause unexpected air bag deployment, which could result in serious personal injury or death.

- If the installation location or angle of the sensors is altered in any way, the air bags may deploy when they should not or they may not deploy when they should, causing severe injury or death.

Therefore, do not try to perform maintenance on or around the air bag sensors. Have the vehicle checked and repaired by an authorized HYUNDAI dealer.

- Problems may arise if the sensor installation angles are changed due to the deformation of the front bumper, body or B/C pillars or front door where side collision sensors are installed. Have the vehicle checked and repaired by an authorized HYUNDAI dealer.
- Installing aftermarket bumper guards or replacing a bumper with non-genuine parts may adversely affect your vehicle's collision and air bag deployment performance.

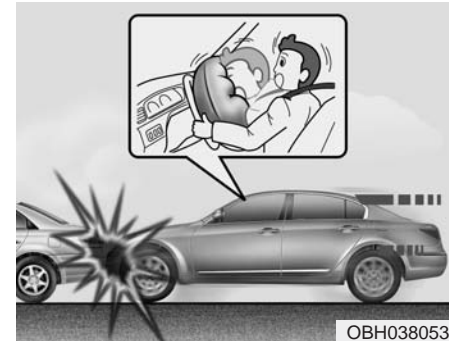

***Air bag inflation conditions***

**Front air bags**

Front air bags are designed to inflate in a frontal collision depending on the force, speed and angles of impact of the front collision.

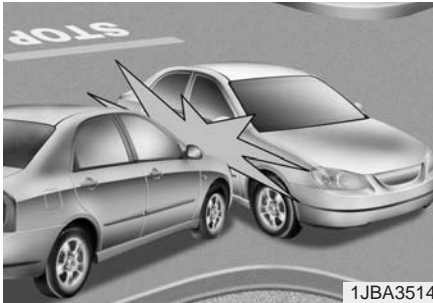

1JBA3514



OHG030050

### Side impact and curtain air bags

Side impact and curtain air bags are designed to inflate when an impact is detected by side collision sensors depending on the force, speed and angles of impact resulting from a side impact collision.

Although the front air bags (driver's and front passenger's air bags) are designed to inflate in frontal collisions, they also may inflate in other types of collisions if the front impact sensors detect a sufficient frontal force in another type of impact. Side and curtain air bags are designed to inflate only in side impact collisions or rollover situations, but they may inflate in other collisions if the side impact sensors detect a sufficient impact.

If the vehicle chassis is impacted by bumps or objects on unimproved roads or sidewalks, air bags may deploy. Drive carefully on unimproved roads or on surfaces not designed for vehicle traffic to prevent unintended air bag deployment.

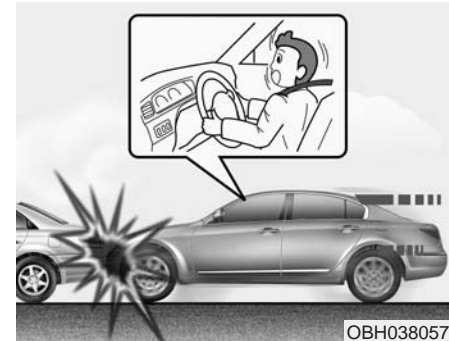

OBH038057

### Air bag non-inflation conditions

- In certain low-speed collisions the air bags may not deploy. The air bags are designed not to deploy in such cases because they may not provide benefits beyond the protection of the seat belts in such collisions.

## Safety features of your vehicle



- Air bags are not designed to inflate in rear collisions. Because occupants are moved backward by the force of the impact. In this case, inflated air bags would not provide additional benefits.

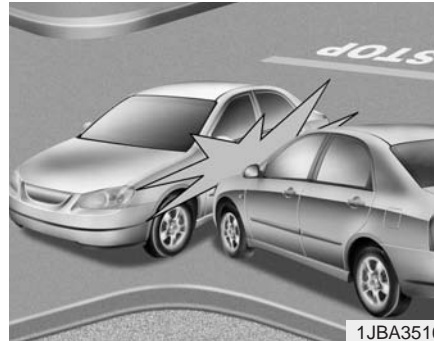

- Front air bags may not inflate in side impact collisions. Occupants typically move to the direction of the collision and frontal air bag deployment would not provide additional occupant protection in side impacts.  
However, side impact and curtain air bags may inflate depending on the force, vehicle speed and angles of impact.

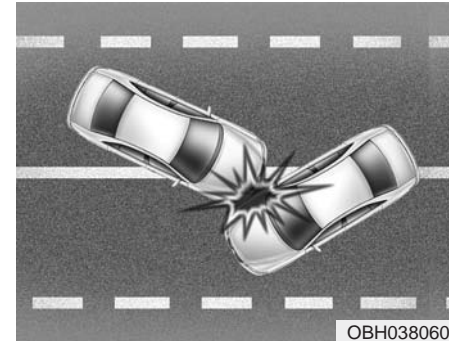

- In an angled collision, the force of impact may direct the occupants in a direction where the air bags would not be able to provide any additional benefit, and thus the system may not deploy the air bags.

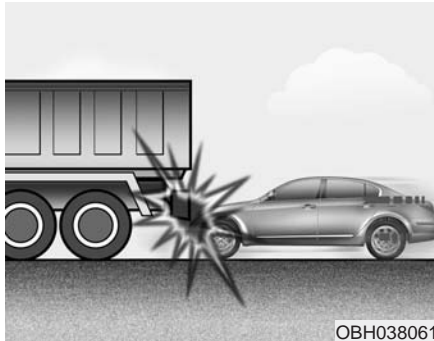

- Just before impact, drivers often brake heavily. Such heavy braking lowers the front portion of the vehicle causing it to “ride” under a vehicle with a higher ground clearance. Air bags may not inflate in this “under-ride” situation because deceleration forces that are detected by sensors may be significantly reduced by such “under-ride” collisions.

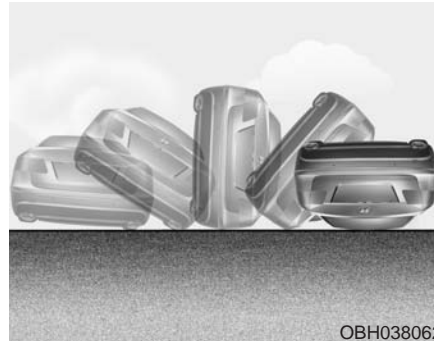

- They are deployed if the rollover or the possible rollover event is detected by ACU (Airbag Control Unit). They are not designed to be deployed in all rollover situations.

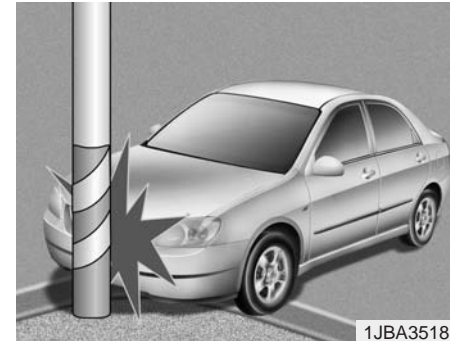

- Air bags may not inflate if the vehicle collides with objects such as utility poles or trees, where the point of impact is concentrated to one area and the deceleration forces are significantly reduced.

### SRS Care

The SRS is virtually maintenance-free and so there are no parts you can safely service by yourself. If the SRS air bag warning light (  ) does not illuminate when you turn the ignition ON, or if it continuously remains on, have your vehicle immediately inspected by an authorized HYUNDAI dealer.

Any work on the SRS system, such as removing, installing, repairing, or any work on the steering wheel, the front passenger's panel, front seats and roof rails must be performed by an authorized HYUNDAI dealer. Improper handling of the SRS system may result in serious personal injury.

For cleaning the air bag pad covers, use only a soft, dry cloth or one which has been moistened with plain water. Solvents or cleaners could adversely affect the air bag covers and proper deployment of the system.

#### **WARNING**

- **Modification to SRS components or wiring, including the addition of any kind of badges to the pad covers or modifications to the body structure, can adversely affect SRS performance and lead to possible injury.**
- **No objects should be placed over or near the air bag modules on the steering wheel, instrument panel, and the front passenger's panel above the glove box, because any such object could cause harm if the vehicle is in a crash severe enough to cause the air bags to inflate.**

#### **\* NOTICE**

- **If the air bags inflate, they must be replaced by an authorized HYUNDAI dealer.**
- **If your vehicle was flooded and has soaked carpeting or water on the flooring, you should not try to start the engine; have the vehicle towed to an authorized HYUNDAI dealer.**

#### **WARNING - Tampering with SRS**

**Do not tamper with or disconnect SRS wiring, or other components of the SRS system. Doing so could result in the accidental inflation of the air bags or render the SRS inoperative and lead to possible serious injury.**

If components of the air bag system must be discarded, or if the vehicle must be scrapped, certain safety precautions must be observed. An authorized HYUNDAI dealer knows these precautions and can give you the necessary information. Failure to follow these precautions and procedures could increase the risk of personal injury.

### Additional safety precautions

- All occupants should sit upright, fully back in their seats with their seat belts on and their feet on the floor.
- **Passengers should not move out of or change seats while the vehicle is moving.** A passenger who is not wearing a seat belt during a crash or emergency stop can be thrown against the inside of the vehicle, against other occupants, or out of the vehicle.
- **Each seat belt is designed to restrain one occupant.** If more than one person uses the same seat belt, they could be seriously injured or killed in a collision.
- **Do not use any accessories on seat belts.** Devices claiming to improve occupant comfort or reposition the seat belt can reduce the protection provided by the seat belt and increase the chance of serious injury in a crash.
- **Passengers should not place hard or sharp objects between themselves and the air bags.** Carrying hard or sharp objects on your lap or in your mouth can result in injuries if an air bag inflates.
- **Keep occupants away from the air bag covers.** All occupants should sit upright, fully back in their seats with their seat belts on and their feet on the floor. If occupants are too close to the air bag covers, they could be injured if the air bags inflate.
- **Do not attach or place objects on or near the air bag covers.** Any object attached to or placed on the front or side air bag covers could interfere with the proper operation of the air bags.
- **Do not modify the front seats.** Modification of the front seats could interfere with the operation of the supplemental restraint system sensing components or side air bags.
- **Do not place items under the front seats.** Placing items under the front seats could interfere with the operation of the supplemental restraint system sensing components and wiring harnesses.
- **Never hold an infant or child on your lap.** The infant or child could be seriously injured or killed in the event of a crash. All infants and children should be properly restrained in appropriate child safety seats or seat belts in the rear seat.

### Adding equipment to or modifying your air bag-equipped vehicle

If you modify your vehicle by changing your vehicle's frame, bumper system, front end or side sheet metal or ride height, this may affect the operation of your vehicle's air bag system.

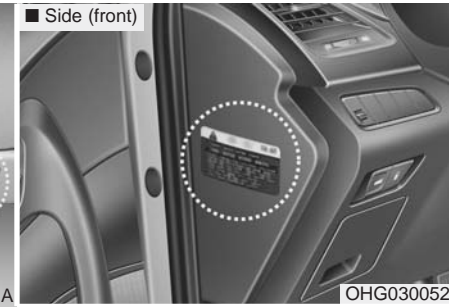
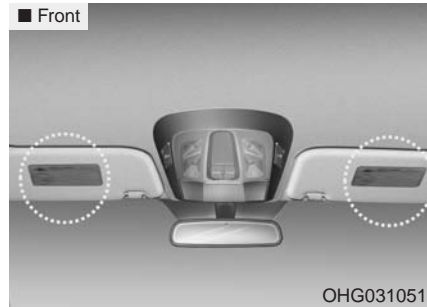

### Air bag warning label

Air bag warning labels, some required by the U.S. National Highway Traffic Safety Administration (NHTSA), are attached to alert the driver and passengers of potential risks of the air bag system.

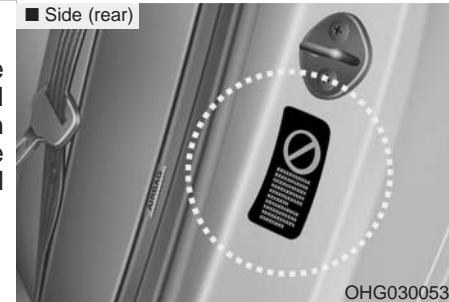



# Features of your vehicle

Keys . . . . .	4-3	Steering wheel . . . . .	4-43
• Record your key number . . . . .	4-3	• Tilt and telescopic steering . . . . .	4-44
• Immobilizer system . . . . .	4-4	• Horn . . . . .	4-45
Smart key . . . . .	4-6	Mirrors . . . . .	4-46
• Smart key functions . . . . .	4-6	• Inside rearview mirror . . . . .	4-46
• Remote keyless entry system operations . . . . .	4-8	• Outside rearview mirror . . . . .	4-54
• Smart key precautions . . . . .	4-9	• Reverse parking aid function . . . . .	4-57
• Battery replacement . . . . .	4-10	Instrument cluster . . . . .	4-58
• Armed stage . . . . .	4-12	• Instrument panel illumination . . . . .	4-59
Theft-alarm system . . . . .	4-12	• Gauges . . . . .	4-59
Door locks . . . . .	4-15	• LCD display control . . . . .	4-62
• Operating door locks from outside the vehicle . . . . .	4-15	LCD display . . . . .	4-63
• Operating door locks from inside the vehicle . . . . .	4-16	• LCD modes . . . . .	4-63
• Door lock/unlock features . . . . .	4-18	• Trip computer mode . . . . .	4-64
• Child-protector rear door lock . . . . .	4-18	Trip computer . . . . .	4-73
Trunk . . . . .	4-19	Warnings and indicators (Instrument cluster) . . . . .	4-77
Smart trunk . . . . .	4-21	Rear parking assist system . . . . .	4-95
Windows . . . . .	4-25	Rearview camera . . . . .	4-99
Hood . . . . .	4-29	Hazard warning flasher . . . . .	4-100
Fuel filler lid . . . . .	4-31	Lighting . . . . .	4-100
Panoramic sunroof . . . . .	4-35	• Headlight (Headlamp) escort function . . . . .	4-101
Driver position memory system . . . . .	4-40	• Headlight (Headlamp) welcome function . . . . .	4-101
		• Daytime running light . . . . .	4-101
		• Lighting control . . . . .	4-102

- High beam operation ..... 4-103
- Smart High Beam ..... 4-104
- Turn signals and lane change signals ..... 4-105
- Front fog light ..... 4-106
- Windshield wiper/washer ..... 4-107
- Interior light ..... 4-109
  - Room lamp ..... 4-110
  - Trunk room lamp ..... 4-110
  - Door courtesy lamp ..... 4-111
  - Glove box lamp ..... 4-111
  - Vanity mirror lamp ..... 4-111
- Defroster ..... 4-112
- Automatic climate control system (Type A).... 4-113
- Automatic climate control system (Type B).... 4-124
- Windshield defrosting and defogging..... 4-135
- Storage compartments..... 4-137
  - Center console storage ..... 4-137
  - Glove box ..... 4-137
  - Sunglass holder ..... 4-138

- Interior features ..... 4-139
  - Ashtray ..... 4-139
  - Cup holder ..... 4-139
  - Sunvisor ..... 4-140
  - Power outlet ..... 4-141
  - Digital clock ..... 4-142
  - Clothes hanger ..... 4-143
  - Floor mat anchor(s)..... 4-143
  - Rear curtain ..... 4-144
  - Side curtain ..... 4-145
- Multimedia system ..... 4-145
  - Steering wheel audio control ..... 4-146
  - Audio system ..... 4-147
  - *Bluetooth*® Wireless Technology..... 4-147
  - Navigation system ..... 4-147
  - Aux, USB and iPod® port ..... 4-147

## KEYS

### Record your key number



The key code number is stamped or printed on the key code tag attached to the key set. Should you lose your keys, contact an authorized HYUNDAI dealer. Remove the key code tag and store it in a safe place. Also, record the key code number and keep it in a safe and handy place, but not in the vehicle.

#### **⚠ WARNING - Smart key**

Leaving children unattended in a vehicle with the smart key is dangerous even if the ENGINE START/STOP button is in the ACC or ON position. Children copy adults and they could press the ENGINE START/STOP button. The smart key would enable children to operate power windows or other controls, or even make the vehicle move, which could result in serious bodily injury or even death. Never leave the keys in your vehicle with unsupervised children, when the Engine is running.

### Key operations

- Used to start the engine.
- Used to lock and unlock the doors.
- Used to lock and unlock the glove box.

#### **⚠ WARNING - Aftermarket keys**

**Use only HYUNDAI original parts for the ignition key in your vehicle. If an aftermarket key is used, the ignition switch may not return to ON after START. If this happens, the starter will continue to operate causing possible fire due to excessive current in the wiring.**

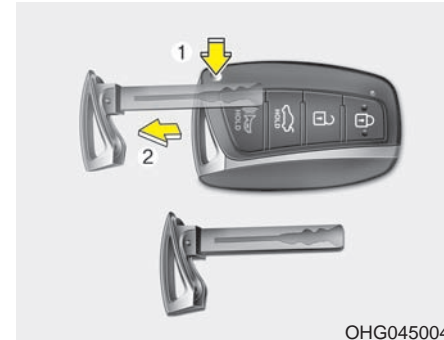

OHG045004

To remove the mechanical key, press and hold the release button(1) and remove the mechanical key(2).

To reinstall the mechanical key, put the key into the hole and push it until a click sound is heard.

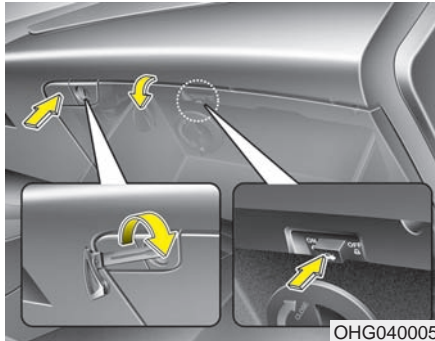

### Restrictions in handling keys

To activate the trunk lock system so that the trunk can only be opened with the mechanical key, perform the following:

1. Press and hold the release button and remove the mechanical key.
2. Unlock the glove box by using the mechanical key then open it.
3. Set the trunk lid control button to the OFF position (unpressed).
4. Close and lock the glove box using the mechanical key.

When leaving your keys with a parking lot attendant or valet, perform above steps 1 to 4, remove the mechanical key from the smart key and leave the smart key with the attendant. In this manner the smart key can only be used to start the engine and operate door locks.

### Lock release

To release the trunk lock feature, open the glove box with the mechanical key and set the trunk lid control button to the ON position (pressed). In this position the trunk will open with the trunk lid button or smart key.

### Immobilizer system

Your vehicle is equipped with an electronic engine immobilizer system to reduce the risk of unauthorized vehicle use.

Whenever the ENGINE START/STOP button is changed to the ON position, the immobilizer system checks and verifies if the key is valid or not.

If the key is valid, the engine will start. If the key is invalid, the engine will not start.

**To deactivate the immobilizer system**

Change the ENGINE START/STOP button to the ON position.

**To activate the immobilizer system**

Change the ENGINE START/STOP button to the OFF position. The immobilizer system activates automatically. Without a valid smart key for your vehicle, the engine will not start.

**\* NOTICE**

Your immobilizer password is a customer unique password and should be kept confidential. Do not leave this number anywhere in your vehicle.

**⚠ CAUTION**

**Keep each key separate in order to avoid a starting malfunction.**

**⚠ CAUTION**

**Do not put metal accessories near the smart key.**

**The engine may not start because the metal accessories may interrupt the transponder signal from transmitting normally.**

If you need additional keys or lose your keys, consult an authorized HYUNDAI dealer.

**⚠ CAUTION - Immobilizer damage**

**Do not expose your immobilizer system to moisture, static electricity and rough handling. This may damage your immobilizer.**

**⚠ CAUTION - Immobilizer alterations**

**Do not change, alter or adjust the immobilizer system because it could cause the immobilizer system to malfunction.**

**This device complies with Part 15 of the FCC rules.**

Operation is subject to the following two conditions:

1. This device may not cause harmful interference, and
2. This device must accept any interference received, including interference that may cause undesired operation.

**⚠ CAUTION**

**Changes or modifications not expressly approved by the party responsible for compliance could void the user's authority to operate the equipment.**

## SMART KEY



### Smart key functions

1. Door lock
2. Door unlock
3. Trunk open
4. Alarm

With a smart key, you can lock or unlock a door (and trunk) and even start the engine without inserting the key. Refer to the following, for more details.

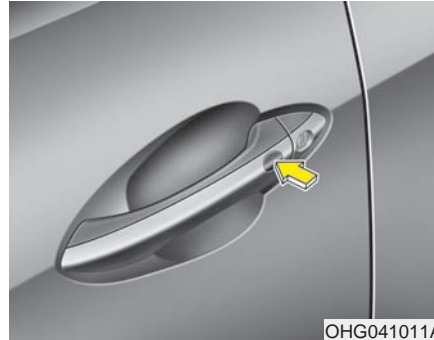

### Using the door and trunk handle switch

#### Locking

1. Carry the smart key.
2. Close all doors, engine hood and trunk.
3. Press the switch of the outside door handle.
4. All doors and trunk will lock. The hazard warning lights will blink and the chime will sound once.
5. Make sure that doors are locked by checking the door lock button inside the vehicle or pulling the outside door handle.

You can activate or deactivate the Lock Sound (chime sound) function in the vehicle. Refer to "User Settings Mode" in this section.

### \* NOTICE

- The switch will only operate when the smart key is within 28~40 in. (0.7~1 m) from the outside door handle.
- Even though you press the outside door handle switch, the doors will not lock and the chime will sound for 3 seconds if any of following occur:
  - The smart key is in the vehicle.
  - The ENGINE START/STOP button is in ACC or ON position.
  - Any door except the trunk is open.

**Unlocking**

1. Press the switch of the driver's outside door handle.
2. The driver's door will unlock. The hazard warning lights will blink and the chime will sound twice.
3. Press the button once more within 4 seconds.
4. All doors and trunk will unlock and the hazard warning lights will blink and the chime will sound twice.

You can activate or deactivate the Two Turn Unlock and Unlock Sound (chime sound) function in the vehicle. Refer to "User Settings Mode" in this section.

**\* NOTICE**

- **The switch will only operate when the smart key is within 28~40 in. (0.7~1 m) from the outside door handle.**
- **When the smart key is recognized in the area of 0.7~1 m (28~40 in.) from the front outside door handle, other people can also open the door without possession of the smart key.**
- **After unlocking all doors, the doors will lock automatically unless a door is opened.**

**Trunk open**

1. Carry the smart key.
2. Press the trunk handle switch.
3. The trunk will open.

**\* NOTICE**

- Once the trunk is opened and then closed, the trunk will lock automatically when all doors are locked.
- The switch will only operate when the smart key is within 0.7 m (28 in.) from the trunk handle.

**Start-up**

You can start the engine without inserting the key. For detailed information refer to "ENGINE START/STOP button" in section 5.



### Remote keyless entry system operations

#### Lock (1)

1. Carry the smart key.
2. Close all doors, engine hood and trunk.
3. Press the lock button(1).
4. All doors and trunk will lock. The hazard warning lights will blink and the chime will sound once.
5. Make sure that doors are locked by checking the door lock button inside or pulling the outside door handle.

If any door, trunk or engine hood remains open, the hazard warning lights will not operate. If all doors, trunk and engine hood are closed after the lock button is pressed, the hazard warning lights will blink once.

You can activate or deactivate the Lock Sound (chime sound) function in the vehicle. Refer to "User Settings Mode" in this section.

#### Unlock (2)

1. Press the unlock button(2).
2. The driver's door will unlock. The hazard warning lights will blink and the chime will sound twice.
3. Press the unlock button(2) once more within 4 seconds.
4. All doors and trunk will unlock. The hazard warning lights will blink and the chime will sound twice.

You can activate or deactivate the Two Turn Unlock and Unlock Sound (chime sound) function in the vehicle. Refer to "User Settings Mode" in this section.

#### \* NOTICE

- The button will only operate when the smart key is within 28~40 in. (0.7~1 m) from the outside door handle.
- After unlocking the driver's door or all doors, the door(s) will lock automatically unless a door is opened.

#### Trunk open (3)

1. Press the trunk open button(3) for more than 1 second.
2. The trunk will open. The hazard warning light will blink twice to indicate the trunk is opened.

#### \* NOTICE

- Once the trunk is opened and closed, the trunk will lock automatically when all doors are locked.
- The switch/button will only operate when the smart key is within 28~40 in. (0.7~1m) from the trunk handle.



**Alarm (4)**

1. Press the alarm button(4) for more than 1 second.
2. The horn sounds and hazard warning light flashes for about 30 seconds.

To stop the horn and lights, press any button on the smart key.

**Smart key precautions**

- If you lose your smart key, you will not be able to start the engine. Tow the vehicle, if necessary, and contact an authorized HYUNDAI dealer.
- A maximum of 2 smart keys can be registered to a single vehicle. If you lose a smart key, you should immediately take the vehicle and the second key to your authorized HYUNDAI dealer to protect it from potential theft.
- The smart key will not work if any of following occurs:
  - The smart key is close to a radio transmitter such as a radio station or an airport which can interfere with normal operation of the smart key.
  - The smart key is near a mobile two-way radio system or a cellular phone.
  - Another vehicle's smart key is being operated close to your vehicle.

When the smart key does not work correctly, open and close the door with the mechanical key. If you have a problem with the smart key, contact an authorized HYUNDAI dealer.

- If the smart key is in close proximity to your cell phone or smart phone, the signal from the smart key could be blocked by normal operation of your cell phone or smart phone. This is especially important when the phone is active such as making call, receiving calls, text messaging, and/or sending/receiving emails. Avoid placing the smart key and your cell phone or smart phone in the same pants or jacket pocket and maintain adequate distance between the two devices.

**CAUTION - Smart key**

***Keep the smart key away from water or any liquid and fire. If the inside of the smart key gets damp (due to drinks or moisture), or is heated, internal circuit may malfunction, excluding the car from the warranty.***

### **This device complies with Part 15 of the FCC rules.**

Operation is subject to the following two conditions:

1. This device may not cause harmful interference, and
2. This device must accept any interference received, including interference that may cause undesired operation.

### **⚠ CAUTION**

*Changes or modifications not expressly approved by the party responsible for compliance could void the user's authority to operate the equipment. If the keyless entry system is inoperative due to changes or modifications not expressly approved by the party responsible for compliance, it will not be covered by your manufacturer's vehicle warranty.*

### **Battery replacement**

A smart key battery should last for several years, but if the smart key is not working properly, try replacing the battery with a new one. If you are unsure how to use your smart key or replace the battery, contact an authorized HYUNDAI dealer.

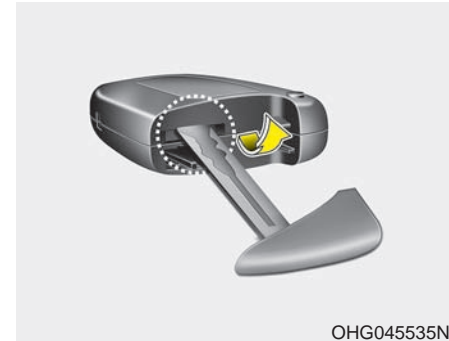

OHG045535N

1. Insert a slim tool into the slot and gently pry open the cover.

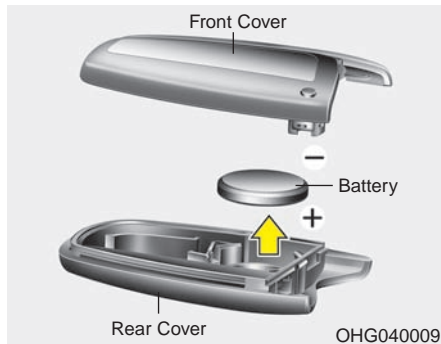

2. Remove the old battery and insert a new battery (CR2032). Make sure the battery position is correct.
3. Reinstall the rear cover of the smart key.

- The smart key is designed to give you years of trouble-free use, however it can malfunction if exposed to moisture or static electricity. If you are unsure how to use or replace the battery, contact an authorized HYUNDAI dealer.
- Using the wrong battery can cause the smart key to malfunction. Be sure to use the correct battery.
- If you suspect that your smart key might have sustained some damage, or you feel your smart key is not working correctly, contact an authorized HYUNDAI dealer.
- An inappropriately disposed battery can be harmful to the environment and human health. Dispose the battery according to your local law(s) or regulation.

**⚠ CAUTION - Smart key damage**

***Do not drop, get wet or expose the smart key to heat or sunlight, or it will be damaged.***

## THEFT-ALARM SYSTEM (IF EQUIPPED)

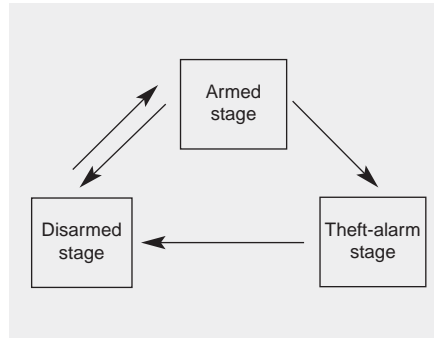

This system is designed to provide protection from unauthorized entry into the car. This system is operated in three stages: the first is the "Armed" stage, the second is the "Theft-alarm" stage, and the third is the "Disarmed" stage. If triggered, the system provides an audible alarm with blinking of the hazard warning lights.

### Armed stage

Park the vehicle and stop the engine. Arm the system as described below.

1. Turn off the engine.
2. Make sure that all doors, the engine hood and trunk lid are closed and latched.
3. Lock the doors by pressing the switch of the front outside door handle with the smart key in your possession.

After completion of the steps above, the hazard warning lights operate once to indicate that the system is armed.

If any door remains opened, the doors will not lock and the chime will sound for 3 seconds. Close the door and try again to lock the doors.

If trunk lid or engine hood remains opened, the hazard warning lights will not operate and theft-alarm will not arm. After the trunk lid and engine hood are closed, the hazard warning lights will blink once.

- Lock the doors by pressing the lock button on the smart key or with the mechanical key.

After completion of the steps above, the hazard warning lights will operate once to indicate that the system is armed.

If any door, trunk lid or engine hood remains opened, the hazard warning lights will not operate and theft-alarm will not arm. After the doors, trunk lid and engine hood are closed, the hazard warning lights will blink once.

**Do not arm the system until all passengers have left the vehicle. If the system is armed while a passenger(s) remains in the vehicle, the alarm may be activated when the remaining passenger(s) leave the vehicle. If any door, trunk lid or engine hood is opened within 30 seconds after entering the armed stage, the system is disarmed to prevent unnecessary alarm.**

### **Theft-alarm stage**

The alarm will be activated if any of the following occurs while the system is armed.

- A door is opened without using the smart key.
- A door is opened without using the mechanical key.
- The trunk is opened without using the smart key.
- The engine hood is opened.

The horn will sound and the hazard warning lights will blink continuously for approximately 30 seconds. To turn off the system, unlock the doors with the smart key.

### **Opening the trunk with the alarm armed (if equipped)**

When the alarm is armed, the alarm will not sound if the trunk lid is opened with the smart key.

Once the trunk is opened and then closed, the trunk will be locked automatically and the system will be armed again.

Also, if any of the doors or hood is opened while the trunk lid is opened and the alarm armed, the alarm will sound.

### Disarmed stage

The system will be disarmed when:

- The door unlock button is pressed on the smart key.
- The switch of the front outside door is pressed while carrying the smart key.
- The door is opened with the mechanical key.
- The engine is started. (within 3 seconds).

After the doors are unlocked, the hazard warning lights will blink twice to indicate that the system is disarmed.

After pressing the unlock button, if any door (or trunk) is not opened within 30 seconds, the system will be rearmed.

- Avoid trying to start the engine while the alarm is activated. The vehicle starter motor is disabled during the theft-alarm stage.
- If you lose your keys, consult your authorized HYUNDAI dealer.

 **CAUTION - Theft-alarm system alteration**

***Do not change, alter or adjust the theft-alarm system because it could cause the theft-alarm system to malfunction and should only be serviced by an authorized HYUNDAI dealer.***

***Malfunctions caused by improper alterations, adjustments or modifications to the theft-alarm system are not covered by your vehicle manufacturer warranty.***

## DOOR LOCKS

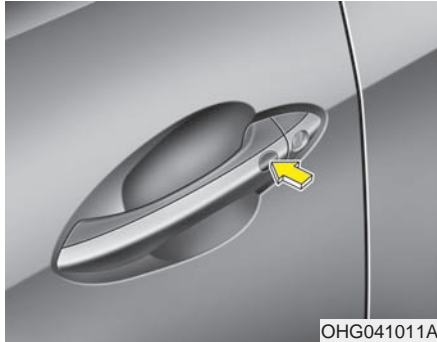

### Operating door locks from outside the vehicle

#### *With the smart key*

- Doors can be locked and unlocked pressing the switch of the outside door handle with the smart key in your possession.
- Doors can be locked and unlocked by pressing the button on the smart key.
- Once the doors are unlocked, they may be opened by pulling the door handle.
- When closing the door, push the door by hand. Make sure that doors are closed securely.

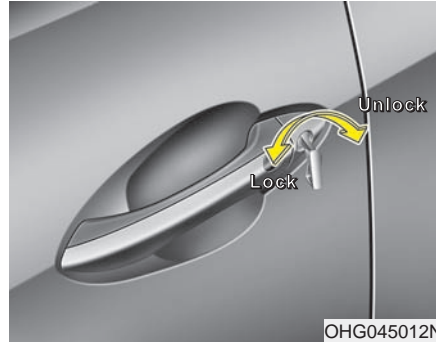

#### *With the mechanical key*

- Turn the key toward the rear of the vehicle to unlock and toward the front of the vehicle to lock.
- If you lock the driver's door with a key, all doors will lock.
- From the driver's door, turn the key to the right once to unlock the driver's door and once more within 4 seconds to unlock all doors.
- Once the door is unlocked, it may be opened by pulling the door handle.
- When closing the door, push the door by hand. Make sure that doors are closed securely.

### \* NOTICE

- In cold and wet climates, door locks and door mechanisms may not work properly due to freezing conditions.
- If the door is locked/unlocked multiple times in rapid succession with either the vehicle key or door lock switch, the system may stop operating temporarily in order to protect the circuit and prevent damage to system components.

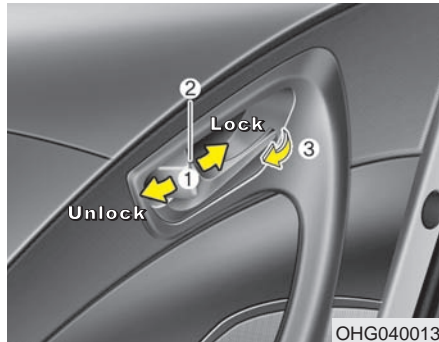

### Operating door locks from inside the vehicle

#### *With the door lock button*

- To unlock a door, push the door lock button(1) to the “Unlock” position. The red mark(2) on the door lock button will be visible.
- To lock a door, push the door lock button(1) to the “Lock” position. If the door is locked properly, the red mark(2) on the door lock button will not be visible.
- To open a door, pull the door handle(3) outward.

- If the inner door handle of the driver’s or front passenger’s door is pulled when the door lock button is in the lock position, the door unlocks and opens.
- A door cannot be locked if the smart key is in the vehicle and a door is opened.

If a power door lock fails to function while you are in the vehicle, try one or more of the following:

- Operate the door unlock feature repeatedly (both electronic and manual) while simultaneously pulling on the door handle.
- Operate the other door locks and handles, front and rear.
- Lower a front window and use the key to unlock the door from outside.





**With central door lock switch**

Operate by pressing the central door lock switch.

- When you press the front portion(1) of the switch, all vehicle doors will lock.
- When you press the rear portion(2) of the switch, all vehicle doors will unlock.
- If the smart key is in the vehicle and a door is opened, the doors will not lock even though the front portion(1) of central door lock switch is pressed.

**\* NOTICE**

Once the doors are locked with the smart key, the doors cannot be unlocked with the central door lock/unlock switch.

**⚠ WARNING - Doors**

The doors should always be fully closed and locked while the vehicle is in motion to prevent accidental opening of the door. Opening a door when the vehicle is moving could cause serious harm to occupants or someone outside the vehicle.

**⚠ WARNING**

**- Unattended children/ animals**

Never leave children or animals unattended in your vehicle. An enclosed vehicle can become extremely hot, causing death or severe injury to unattended children or animals who cannot escape the vehicle.

### Door lock/unlock features

#### *Impact sensing door unlock system*

All doors will automatically unlock when an impact causes the air bags to deploy.

#### *Shift lever door lock/unlock system*

- All doors will automatically lock when the shift lever is moved out of P (Park).
- All doors will automatically unlock when the shift lever is moved into P (Park).

You can activate or deactivate the Auto Door Lock/Unlock features in the vehicle. Refer to "User Settings Mode" in this section.

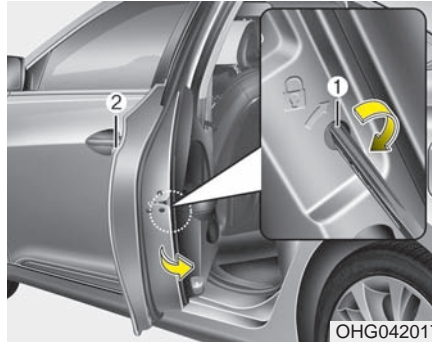

#### **Child-protector rear door lock**

The child safety lock is provided to help prevent children from accidentally opening the rear doors from inside the vehicle. The rear door safety locks should be used whenever children are in the vehicle.

1. Open the rear door.
2. Insert a key (or screwdriver) into the hole (1) and turn it to the lock (🔒) position. When the child safety lock is in the lock position, the rear door will not open even though the inner door handle is pulled.

3. Close the rear door.

To open the rear door, pull the outside door handle (2).

Even though the doors may be unlocked, the rear door will not open by pulling the inner door handle until the rear door child safety lock is unlocked.

#### **⚠️ WARNING - Rear door locks**

**Use the rear door safety locks whenever children are in the vehicle. If a child accidentally opens the rear doors while the vehicle is motion, they can fall out resulting in severe injury or death.**

## TRUNK

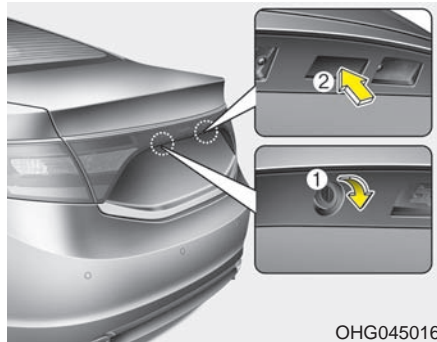

### Opening the trunk

- Press the trunk unlock button for more than 1 second on the smart key.
- Press the switch on the trunk handle with the smart key in your possession (2).
- Insert the mechanical key of the smart key into the lock and turn it clockwise (1).

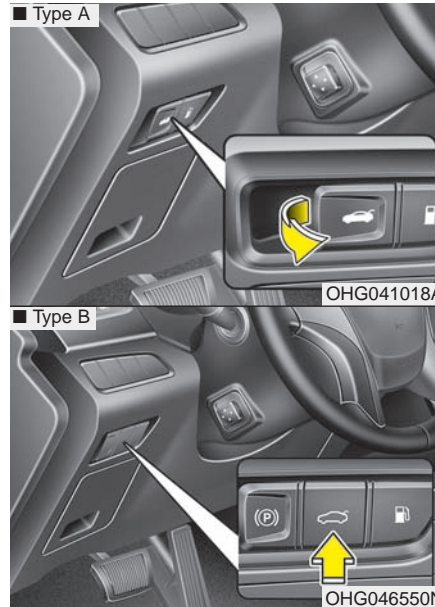

To open the trunk from inside the vehicle :

- Type A : Pull out the trunk lid release lever.
- Type B : Push the trunk lid release button.

The trunk swings upward. Make sure no objects or people are near the rear of the vehicle when opening the trunk.

### \* NOTICE

In cold and wet climates, trunk lock and trunk mechanisms may not work properly due to freezing conditions.



### CAUTION - Trunk lift cylinders

*Make certain that you close the trunk before driving your vehicle. Possible damage may occur to the trunk lift cylinders and attached hardware if the trunk is not closed prior to driving.*

### Closing the trunk

To close, lower the trunk lid, then press down on it until it locks. To be sure the trunk lid is securely fastened, always check by trying to pull it up again.

Once the trunk is opened and then closed, the trunk locks automatically.

#### **⚠ WARNING - Exhaust fumes**

The trunk lid should be always kept completely closed while the vehicle is in motion. If it is left open or ajar, toxic exhaust gases may enter the vehicle and serious illness or death may result.

#### **\* NOTICE**

If the trunk is closed with the smart key in it, the chime will sound for approximately 3 seconds and the trunk will not lock.

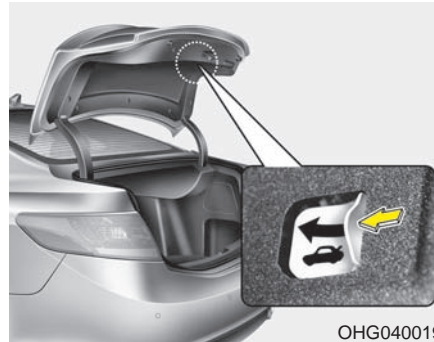

### Emergency trunk safety release

Your vehicle is equipped with an emergency trunk release cable located inside the trunk. If someone is inadvertently locked in the trunk, moving the handle in the direction of the arrow will release the trunk latch mechanism and open the trunk.

#### **⚠ WARNING**

- No person should be allowed to occupy the trunk of the vehicle at any time. If the trunk is partially or totally latched and the person is unable to get out, severe injury or death could occur due to lack of ventilation, exhaust fumes and rapid heat build-up, or because of exposure to cold or hot weather conditions. The trunk is also a highly dangerous location in the event of a crash because it is not a protected occupant space and is a part of the vehicle's crush zone.
- Your vehicle should be kept locked and keys be kept out of the reach of children. Parents should teach their children about the potential dangers of playing in trunks.

## SMART TRUNK (IF EQUIPPED)

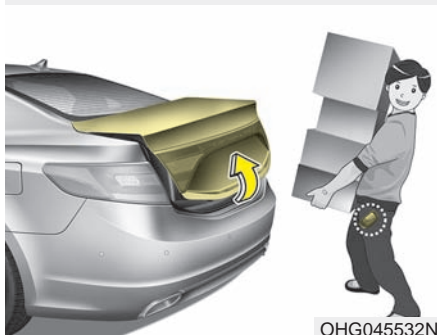

On a vehicle equipped with a smart key, the trunk can be opened with no-touch activation using the Smart Trunk system.

### How to use the Smart Trunk

The trunk can be opened with no-touch activation satisfying all the conditions below.

- After 15 seconds when all doors are closed and locked
- Positioned in the detecting area for more than 3 seconds.

### \* NOTICE

- The Smart Trunk does not operate when:
  - The smart key is detected within 15 seconds after the doors are closed and locked, and is continuously detected.
  - The smart key is detected within 15 seconds after the doors are closed and locked, and 60 in. (1.5 m) from the front door handles. (for vehicles equipped with Welcome Light)
  - A door is not locked or closed.
  - The smart key is in the vehicle.



### 1. Setting

To activate the Smart Trunk, go to User Settings Mode and select Smart Trunk on the LCD display.

For more details, refer to "LCD Display" in this chapter.

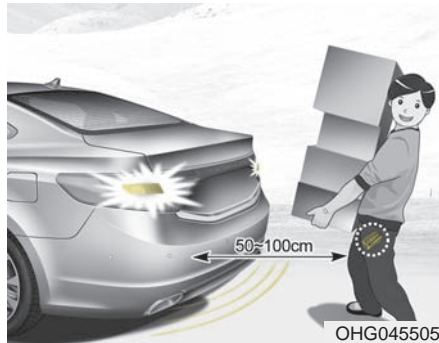

### 2. Detect and Alert

If you are positioned in the detecting area (20 ~ 40 in. (50 ~ 100 cm) behind the vehicle) carrying a smart key, the hazard warning lights will blink and chime will sound for about 3 seconds to alert you the smart key has been detected and the trunk will open.

### \* NOTICE

Do not approach the detecting area if you do not want the trunk to open. If you have unintentionally entered the detecting area and the hazard warning lights and chime starts to operate, leave the detecting area with the smart key. The trunk will stay closed.

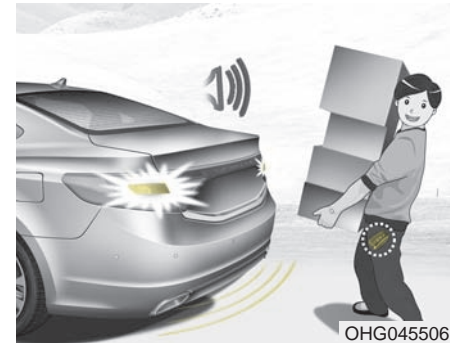

### 3. Automatic opening

The hazard warning lights will blink and chime will sound 2 times and then the trunk will slowly open.

**⚠ WARNING**

- Make sure the trunk is closed before driving the vehicle.
- Make sure there are no people or objects around the trunk before opening or closing the trunk.
- Make sure objects in the trunk do not come out when opening the trunk on a slope. It may cause serious injury.
- Make sure to deactivate the Smart Trunk when washing your vehicle. Otherwise, the trunk may open inadvertently.
- The key should be kept out of reach of children. Children may inadvertently open the Smart Trunk while playing around the rear area of the vehicle.



OHG045007

***How to deactivate the Smart Trunk function using the smart key***

1. Door lock
2. Door unlock
3. Trunk open
4. Alarm

If you press any button of the smart key during the Detect and Alert stage, the Smart Trunk function will be deactivated.

Make sure to be aware of how to deactivate the Smart Trunk function for emergency situations.

**\* NOTICE**

- If you press the door unlock button (2), the Smart Trunk function will be deactivated temporarily. But, if you do not open any door for 30 seconds, the smart trunk function will be activated again.
- If you press the trunk open button (3) for more than 1 second, the trunk opens.
- If you press the door lock button (1) or trunk open button (3) when the Smart Trunk function is not in the Detect and Alert stage, the smart trunk function will not be deactivated.
- In case you have deactivated the Smart Trunk function by pressing the smart key button and opened a door, the smart trunk function can be activated again by closing and locking all doors.



### ***Detecting area***

- The Smart Trunk operates with a welcome alert if the smart key is detected within 20 ~ 40 in. (50 ~ 100 cm) from the trunk.
- The alert stops at once if the smart key is positioned outside the detecting area during the Detect and Alert stage.

### **\* NOTICE**

- **The Smart Trunk function will not work if any of the following occurs:**
  - The smart key is close to a radio transmitter such as a radio station or an airport which can interfere with normal operation of the transmitter.
  - The smart key is near a mobile two way radio system or a cellular phone.
  - Another vehicle's smart key is being operated close to your vehicle.
- **The detecting range may decrease or increase when :**
  - One side of the tire is raised to replace a tire or to inspect the vehicle.
  - The vehicle is slantingly parked on a slope or unpaved road, etc.



## WINDOWS

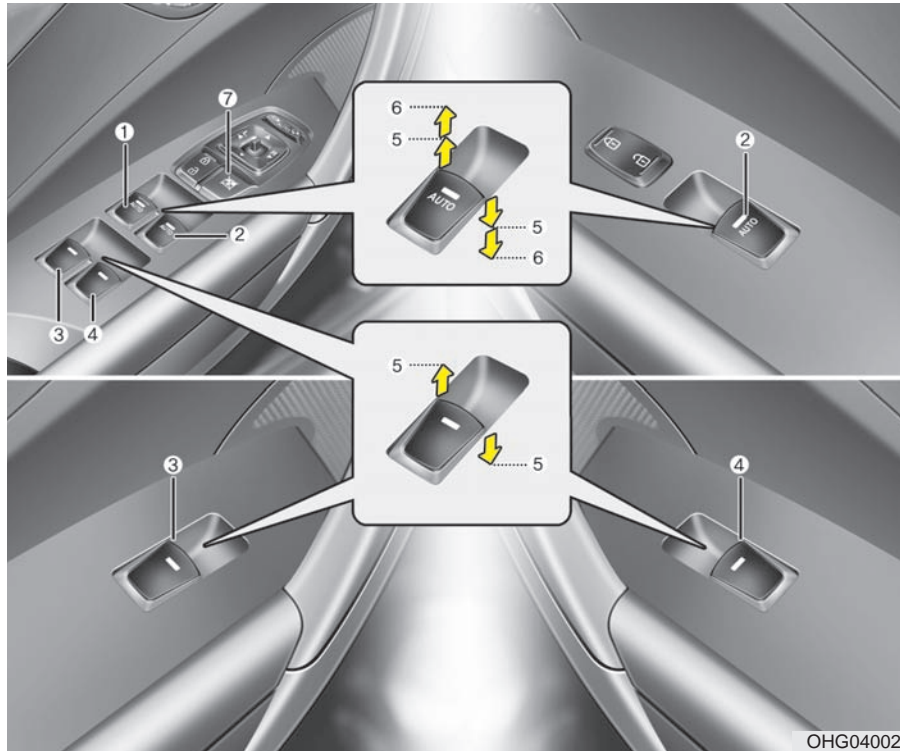

- (1) Driver's door power window switch
- (2) Front passenger's door power window switch
- (3) Rear door (left) power window switch
- (4) Rear door (right) power window switch
- (5) Window opening and closing
- (6) Automatic power window up/down
- (7) Power window lock switch

### Power windows

The ignition switch must be in the ON position for power windows to operate. Each door has a power window switch that controls the door's window. The driver's door has a master power window switch that controls all the windows in the vehicle. Also, the driver has a power window lock switch which can block the operation of passenger windows.

The power windows can be operated for approximately 30 seconds after the ignition key is in the ACC or OFF position. However, if the front doors are opened, the power windows cannot be operated within the 30 second period.

### \* NOTICE

While driving with the rear windows down or with the sunroof (if equipped) in an open (or partially open position), your vehicle may demonstrate a wind buffeting or pulsation noise. This noise is a normal occurrence and can be reduced or eliminated by taking the following actions. If the noise occurs with one or both of the rear windows down, partially lower both front windows approximately one inch. If you experience the noise with the sunroof open, slightly reduce the size of the sunroof opening.

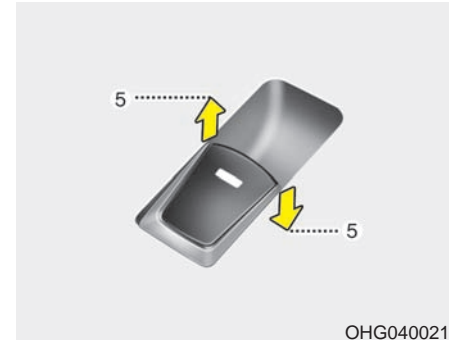

OHG040021

### ***Window opening and closing***

To open or close a window, press down or pull up the front portion of the corresponding switch to the first detent position(5).



OHG040022

### Auto up/down window

Pressing or pulling up the power window switch momentarily to the second detent position(6) completely lowers or lifts the window even when the switch is released. To stop the window at the desired position while the window is in operation, pull up or press and release the switch to the opposite direction of the movement.

If the power window is not operated correctly, the automatic power window system must be reset as follows:

1. Turn the ignition switch to the ON position.
2. Close the window and continue pulling up on the power window switch for at least 1 second after the window is completely closed.

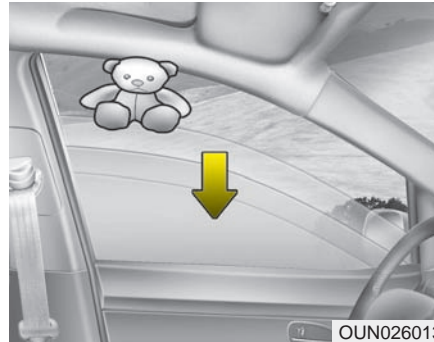

OUN026013

### Automatic reversal

If the upward movement of the window is blocked by an object or part of the body, the window will detect the resistance and will stop upward movement. The window will then lower approximately 11.8 in. (30 cm) to allow the object to be cleared.

If the window detects the resistance while the power window switch is pulled up continuously, the window will stop upward movement then lower approximately 1 in. (2.5 cm).

And if the power window switch is pulled up continuously again within 5 seconds after the window is lowered by the automatic window reversal feature, the automatic window reversal will not operate.

### \* NOTICE

The automatic reverse feature for the window is only active when the “auto up” feature is used by fully pulling up the switch. The automatic reverse feature will not operate if the window is raised using the halfway position on the power window switch.

### **⚠ WARNING - Obstructions**

**Always check for obstructions before raising any window to avoid injuries or vehicle damage. If an object less than 0.16 inch. (4mm) in diameter is caught between the window glass and the upper window channel, the automatic reverse window may not detect the resistance and will not stop and reverse direction.**



### **Power window lock button**

The driver can disable the power window switches on the rear passengers' doors by pressing the power window lock switch to the lock position (pressed).

When the power window lock switch is pressed:

- The driver's master control can operate all the power windows.
- The front passenger's control can operate the front passenger's power window.
- The rear passenger's control cannot operate the rear passenger's power window.

### **⚠ CAUTION - Opening/ Closing window**

*To prevent possible damage to the power window system, do not open or close two windows or more at the same time. This will also ensure the longevity of the fuse.*

Always double check to make sure all arms, hands, head and other obstructions are safely out of the way before closing a window.

### **⚠ WARNING - Power windows**

- **Never leave the keys in your vehicle with unsupervised children, when the Engine is running.**
- **Do not allow children to play with the power windows. Keep the driver's door power window lock button in the LOCK position (pressed). Serious injury can result from unintentional window operation by the child.**

## HOOD

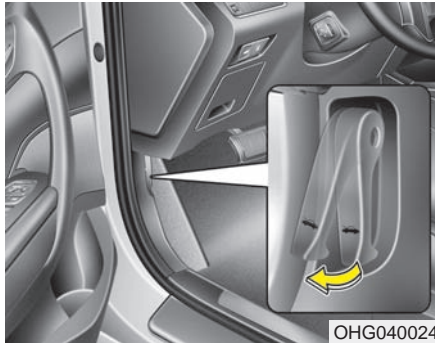

OHG040024

### Opening the hood

Open the hood after turning off the engine on a flat surface, move the shift lever to the P(Park) position and set the parking brake.

1. Pull the release lever to unlatch the hood. The hood should pop open slightly.

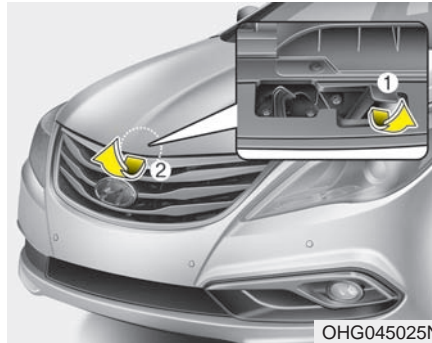

OHG045025N

2. Go to the front of the vehicle, raise the hood slightly, pull up the secondary latch (1) inside of the hood center and lift the hood (2).
3. Raise the hood. It will raise completely by itself after it has been raised about halfway.

### Closing the hood

1. Before closing the hood, check the following:
  - All filler caps in engine compartment must be correctly installed.
  - Gloves, rags or any other combustible material must be removed from the engine compartment.
2. Lower the hood halfway and push it down to securely lock in place.

**⚠ WARNING - Fire risk**  
**Do not leave gloves, rags or any other combustible material in the engine compartment. Doing so may cause a heat-induced fire.**

### **⚠ WARNING**

- Always double check to be sure that the hood is firmly latched before driving away. If the engine hood is not secured properly, it is likely to fly up blocking your vision and causing a crash.
- Do not move the vehicle with the hood raised. The view will be blocked and the hood could fall or be damaged.

## FUEL FILLER LID

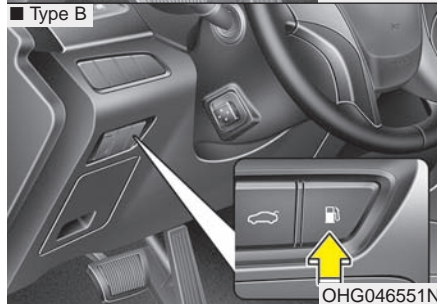
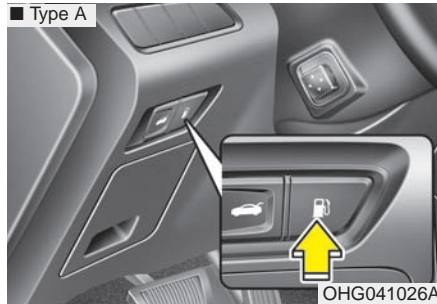

If the fuel filler lid will not open because ice has formed around it, tap lightly or push on the lid to break the ice and release the lid. Do not pry on the lid. If necessary, spray around the lid with an approved de-icer fluid (do not use radiator anti-freeze) or move the vehicle to a warm place and allow the ice to melt.

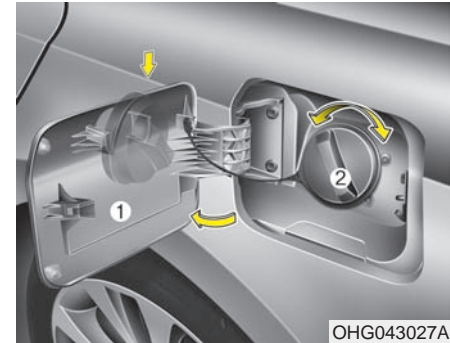

1. Stop the engine.
2. To open the fuel filler lid, push the fuel filler lid opener button.
3. Pull the fuel filler lid (1) out to fully open.
4. To remove the cap, turn the fuel tank cap (2) counterclockwise.
5. Refuel as needed.

### Opening the fuel filler lid

The fuel filler lid must be opened from inside the vehicle by pushing the fuel filler lid opener button.

### Closing the fuel filler lid

1. To install the cap, turn it clockwise until it clicks one time. This indicates that the cap is securely tightened.
2. Close the fuel filler lid and push it lightly and make sure that it is securely closed.

#### **⚠ WARNING - Refueling**

Always remove the fuel cap carefully and slowly. If the cap is venting fuel or if you hear a hissing sound, wait until the condition stops before completely removing the cap.

If pressurized fuel sprays out, it can cover your clothes or skin and subject you to the risk of fire and burns.

#### **\* NOTICE**

Tighten the cap until it clicks one time, otherwise the warning light “Check Fuel Cap” will illuminate on the LCD display.

#### **⚠ WARNING**

Always check that the fuel cap is installed securely to prevent fuel spillage in the event of an accident. Spilled fuel in the presence of an ignition source could result in a fire.

#### **⚠ WARNING - Fire / explosion risk**

Read and follow all warnings posted at the gas station facility. Failure to follow all warnings will result in severe personal injury, severe burns or death due to fire or explosion.

#### **⚠ WARNING - Static electricity**

- Before touching the fuel nozzle, you should eliminate potentially dangerous static electricity discharge by touching another metal part of the vehicle, a safe distance away from the fuel filler neck, nozzle, or other gas source. Static electricity discharge can ignite fuel vapors resulting in rapid burning.
- Do not get back into a vehicle once you have begun refueling since you can generate static electricity by touching, rubbing or sliding against any item or fabric (polyester, satin, nylon, etc.) capable of producing static electricity. Static electricity discharge can ignite fuel vapors resulting in rapid burning.

(Continued)



(Continued)

If you must re-enter the vehicle, you should once again eliminate potentially dangerous static electricity discharge by touching a metal part of the vehicle, away from the fuel filler neck, nozzle or other gasoline source.

**⚠ WARNING**

When using an approved portable fuel container, be sure to place the container on the ground prior to refueling. Static electricity discharge from the container can ignite fuel vapors causing a fire. Once refueling has begun, contact with the vehicle should be maintained until the filling is complete. Use only approved portable plastic fuel containers designed to carry and store gasoline.

**⚠ WARNING - Cell phone fires**

Do not use cellular phones while refueling. Electric current and/or electronic interference from cellular phones can potentially ignite fuel vapors causing a fire.

**⚠ CAUTION - Exterior paint**

*Do not spill fuel on the exterior surfaces of the vehicle. Any type of fuel spilled on painted surfaces may damage the paint.*

**⚠ WARNING - Refueling & Vehicle fires**

When refueling, always shut the engine off. Sparks produced by electrical components related to the engine can ignite fuel vapors causing a fire. Once refueling is complete, check to make sure the filler cap and filler door are securely closed, before starting the engine.

### **⚠ WARNING - Smoking**

**DO NOT** use matches or a lighter and **DO NOT SMOKE** or leave a lit cigarette in your vehicle while at a gas station especially during refueling. Automotive fuel is highly flammable and can, when ignited, result in fire.

Make sure to refuel your vehicle according to the “Fuel requirements” suggested in section 1.

If the fuel filler cap requires replacement, use only a genuine HYUNDAI cap or the equivalent specified for your vehicle. An incorrect fuel filler cap can result in a serious malfunction of the fuel system or emission control system.



### **Emergency fuel filler lid release**

If the fuel filler lid does not open using the remote fuel filler lid release, you can open it manually by pulling the handle outward slightly.

### **⚠ CAUTION**

***Do not pull the handle excessively, otherwise the luggage area trim or release handle may be damaged.***

## PANORAMIC SUNROOF (IF EQUIPPED)



If your vehicle is equipped with a sunroof, you can slide or tilt your sunroof with the sunroof control lever located on the overhead console.

The sunroof can only be opened, closed, or tilted when the ignition switch is in the ON position.

- In cold and wet climates, the sunroof may not work properly due to freezing conditions.
- After the vehicle is washed or in a rainstorm, be sure to wipe off any water that is on the sunroof before operating it.

**⚠ CAUTION - Sunroof control lever**

***Do not continue to move the sunroof control lever after the sunroof is fully opened, closed, or tilted. Damage to the motor or system components could occur.***

**⚠ WARNING**

**Never adjust the sunroof or sunshade while driving. This could result in loss of control and an accident that may cause death, serious injury, or property damage.**



### Sunroof open warning (if equipped)

If the driver turns off the engine, the warning chime will sound for approximately 7 seconds and a message “Sunroof Open” will appear on the LCD display.

Close the sunroof securely when leaving your vehicle.

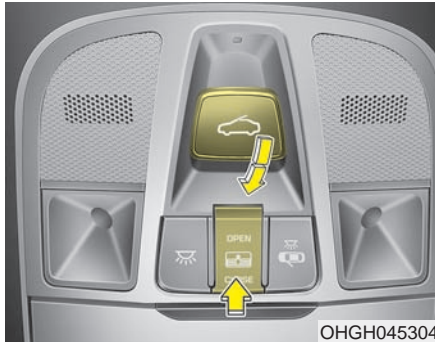

### Sunshade

- To open the sunshade :  
Press the sunshade control switch(1).
- To close the sunshade :
  - When the sunroof glass is opened  
If you press the sunshade control switch(2) once, the sunroof glass will close then the sunshade will close.
  - When the sunroof glass is closed  
If you press the sunshade control switch(2) once or press the sunroof control lever(3), the sunshade will close.

To stop the sliding at any point, press the sunshade control switch momentarily.

### \* NOTICE

It is normal for wrinkles to form on the blind because of its material characteristic.



### Sliding the sunroof

#### *When the sunshade is closed*

If you pull the sunroof control lever rearward, the sunshade will slide all the way open then the sunroof glass will slide all the way open. To stop the sunroof movement at any point, pull or push the sunroof control lever momentarily.

***When the sunshade is opened***

If you pull the sunroof control lever rearward, the sunroof glass will slide all the way open. To stop the sunroof movement at any point, pull or push the sunroof control lever momentarily.

**\* NOTICE**

Only the front glass of the panorama sunroof opens and closes.



**Tilting the sunroof**

***When the sunshade is closed***

If you push the sunroof control lever upward, the sunshade will slide all the way open then the sunroof glass will tilt.

To stop the sunroof movement at any point, pull or push the sunroof control lever momentarily.

***When the sunshade is opened***

If you push the sunroof control lever upward, the sunroof glass will tilt.

To stop the sunroof movement at any point, pull or push the sunroof control lever momentarily.

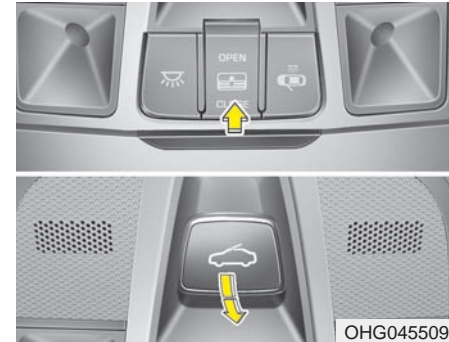

**Closing the sunroof**

Press the sunshade CLOSE button. The sunroof glass will close then the sunshade will close. To stop the sunroof movement at any point, press the sunshade control switch momentarily.

If you want to close the sunroof glass only, push the sunroof control lever. Push the sunroof control lever again to close the sunshade. To stop the sunroof movement at any point, pull or push the sunroof control lever momentarily.

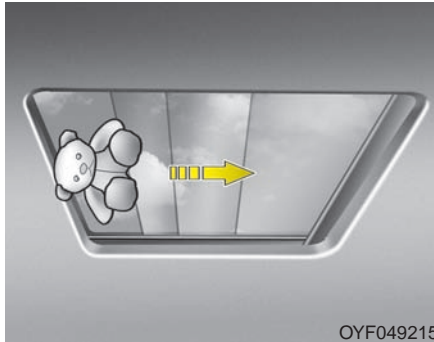

### ***Automatic reversal***

If an object or part of the body is detected while the sunroof glass or sunshade is closing automatically, it will reverse the direction, and then stop.

The auto reverse function does not work if a tiny obstacle is between the sliding glass or sunshade and the sunroof sash. You should always check that all passengers and objects are away from the sunroof before closing it.

Do not extend the face, neck, arms or body outside the sunroof while driving.

Periodically remove any dirt that may accumulate on the guide rail.

### **⚠ CAUTION - Sunroof motor damage**

- *If you try to open the sunroof when the temperature is below freezing or when the sunroof is covered with snow or ice, the glass or the motor could be damaged.*
- *If the sunshade or sunroof is completely closed or opened, stop pressing the control switch. Pressing the control switch longer than necessary may damage the motor.*

### **⚠ CAUTION**

*If you drive with the sunroof opened right after a car wash or rain, water may get inside the vehicle.*

**⚠ WARNING**

A panoramic sunroof is made of glass, therefore it may break in an accident. If you do not have your seat belt on, you may go through the broken glass and get injured or killed. For all passengers safety, have the appropriate protection on (ex. seat belt, child restraint seat, etc.).



**Resetting the sunroof**

Sunroof needs to be reset if (in the followings)

- Battery is discharged or disconnected or the related fuse has been replaced or disconnected
- The one-touch sliding function of the sunroof does not normally operate

1. Turn the engine on and close the sunroof glass and sunshade completely.
2. Release the control lever.

3. Push the sunroof control lever forward in the direction of close (about 10 seconds) until the sunroof is moved a little. Then, release the lever.
4. Push the sunroof control lever forward in the direction of close until the sunroof operates as follows;

SUNSHADE OPEN → TILT OPEN  
 → SLIDE OPEN → SLIDE CLOSE  
 → SUNSHADE CLOSE

Then, release the control lever.

When this is complete, the sunroof system is reset.

For more detailed information, contact an authorized HYUNDAI dealer.

**\* NOTICE**

**If you do not reset the sunroof, it may not work properly.**

## DRIVER POSITION MEMORY SYSTEM (IF EQUIPPED)

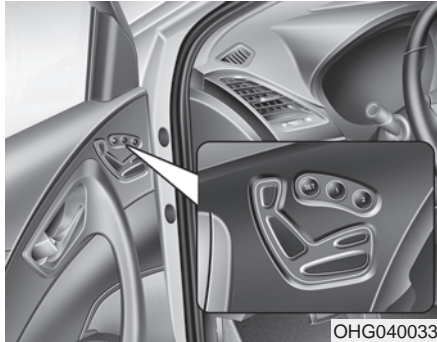

The driver position memory system stores and recalls the driver's seat, outside mirror, and steering wheel positions, as well as the instrument panel illumination intensity. By saving the desired positions, different drivers can recall different settings according to their preference. If the battery is disconnected, the memory will be erased.

### **⚠ WARNING**

- **Never attempt to operate the driver position memory system while the vehicle is moving. This could result in loss of control, and an accident causing death, serious injury, or property damage.**
- **Do not adjust the seat while wearing seat belts. Moving the seat cushion forward may cause strong pressure on the abdomen.**

### **Storing positions into memory using the buttons on the door**

#### *Storing driver's seat positions*

1. Move the shift lever into P while the Engine Start/Stop button is in the ON position.
2. Adjust the driver's seat, outside mirrors, steering wheel position and instrument panel illumination.
3. Press the SET button on the control panel. The system will beep once.
4. Press one of the memory buttons (1 or 2) within 5 seconds after pressing the SET button. The system will beep twice when memory has been successfully stored.



5.



"Driver 1(or 2) settings saved" will appear on the instrument cluster LCD display.

**Recalling positions from memory**

1. Move the shift lever into P while the Engine Start/Stop button is in the ON position.
2. To recall the position in memory, press the desired memory button (1 or 2). The system will beep once, then the driver's seat, outside mirrors, steering wheel and the instrument panel illumination will automatically adjust to the stored positions.

Adjusting the control switch for the driver's seat, outside rearview mirror, steering wheel and the instrument panel illumination while the system is recalling the stored position will cause the movement to stop and move in the direction that the control switch is moved.

3.



"Driver 1 (or 2) settings is applied" will appear on the instrument cluster LCD display.

### **Easy access function (if equipped)**

With the shift lever in the P (Park) position, the system will move the driver's seat and steering wheel automatically so you can comfortably enter and exit the vehicle.

- The steering wheel will move away from the driver and the seat will move rearward, when the ENGINE START/ STOP button is in the OFF position.
- The steering wheel will move toward the driver and the seat will move forward, when the ENGINE START/STOP button is in the ACC position.

You can activate or deactivate this feature. Refer to "User Settings Mode" in this section.

## STEERING WHEEL

### Electronic power steering (EPS)

The power steering uses a motor to assist you in steering the vehicle. If the engine is off or if the power steering system becomes inoperative, the vehicle may still be steered, but it will require increased steering effort.

The motor driven power steering is controlled by a power steering control unit which senses the steering wheel torque and vehicle speed to command the motor.

The steering becomes heavier as the vehicle's speed increases and becomes lighter as the vehicle's speed decreases for optimum steering control.

Should you notice any change in the effort required to steer during normal vehicle operation, have the power steering checked by an authorized HYUNDAI dealer.

### \* NOTICE

The following symptoms may occur during normal vehicle operation:

- **The steering effort is high immediately after the engine starts. This happens as the system performs the EPS system diagnostics. When the diagnostics is completed, the steering wheel will return to its normal condition.**
- **A click noise may be heard from the EPS relay after the ignition switch is changed to the ON or OFF position.**
- **Motor noise may be heard when the vehicle is at a stop or at a low driving speed.**
- **When you operate the steering wheel in low temperature, abnormal noise could occur. If temperature rises, the noise will disappear. This is a normal condition.**

(Continued)

(Continued)

- **When the vehicle is stationary, if you turn the steering wheel all the way to the left or right continuously, the steering wheel effort increases. This is not a system malfunction. As time passes, the steering wheel effort will return to its normal condition.**

If the Electronic Power Steering System does not operate normally, the warning light (⊕!) will illuminate on the instrument cluster. The steering wheel may become difficult to control or operate abnormally. Take your vehicle to an authorized HYUNDAI dealer and have the vehicle checked as soon as possible.

### Tilt and telescopic steering

Tilt and telescopic steering allows you to adjust the steering wheel before you drive. You can also raise it to give your legs more room when you exit and enter the vehicle.

The steering wheel should be positioned so that it is comfortable for you to drive, while permitting you to see the instrument panel warning lights and gauges.

#### **⚠ WARNING - Steering wheel adjustment**

**Never adjust the angle and height of the steering wheel while driving. You may lose steering control and cause serious personal injury, death, or accidents.**

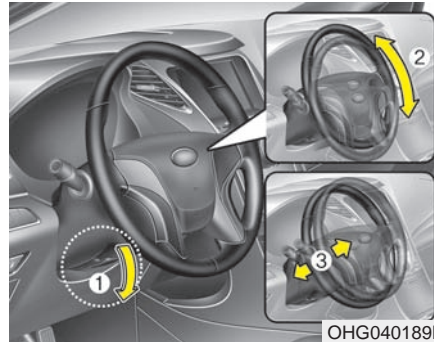

#### **Manual type**

To change the steering wheel angle and height:

1. Pull down the lock-release lever (1).
2. Adjust the steering wheel to the desired angle (2) and height (3).
3. Pull up the lock-release lever to lock the steering wheel in place.

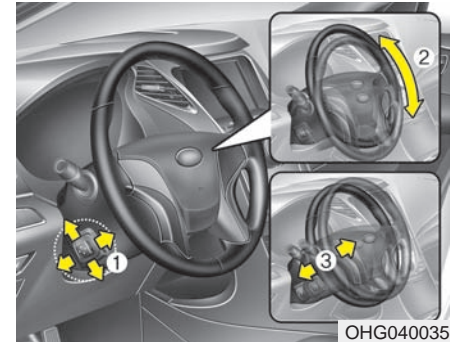

#### **Electric type**

To change the steering wheel angle and height:

- Move the switch (1) up and down to adjust the angle (2).
- Move the switch forward or rearward to adjust the height (3).



OHG040038

## Horn

To sound the horn, press the area indicated by the horn symbol on your steering wheel (see illustration). The horn will operate only when this area is pressed.

Check the horn regularly to be sure it operates properly.

## MIRRORS

### Inside rearview mirror

Adjust the rearview mirror so that the center view through the rear window is seen. Make this adjustment before you start driving.

Do not place objects in the rear seat or cargo area which would interfere with your vision through the rear window.

### *Electric chromic mirror (ECM) with HomeLink® system and compass*

Your vehicle may be equipped with a Gentex Automatic-Dimming Mirror with a Z-Nav™ Electronic Compass Display and an Integrated HomeLink® Wireless Control System. During nighttime driving, this feature will automatically detect and reduce rearview mirror glare while the compass indicates the direction the vehicle is pointed. The HomeLink® Universal Transceiver allows you to activate your garage door(s), electric gate, home lighting, etc.

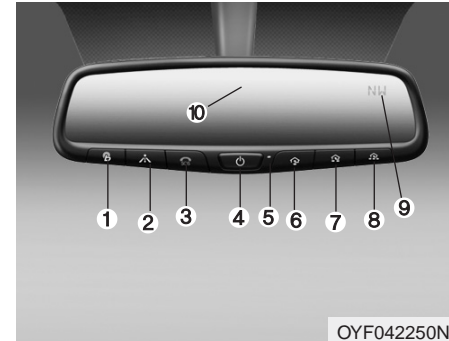

- (1) Telematics button
- (2) Telematics button
- (3) Telematics button
- (4) Compass control button & Dimming ON/OFF button
- (5) Status indicator LED
- (6) Channel 1 button
- (7) Channel 2 button
- (8) Channel 3 button
- (9) Compass display
- (10) Rear light sensor

### **Automatic-Dimming Night Vision Safety™ (NVS®) Mirror**

The NVS® Mirror in your vehicle is the most advanced way to reduce annoying glare in the rearview mirror during any driving situation. For more information regarding NVS® mirrors and other applications, please refer to the Gentex website:



[www.gentex.com](http://www.gentex.com)

### **\* NOTICE**

**The NVS® Mirror automatically reduces glare during driving conditions based upon light levels monitored in front of the vehicle and from the rear of the vehicle. These light sensors are visible through openings in the front and rear of the mirror case. Any object that obstructs either light sensor will degrade the automatic dimming control feature.**

### **Automatic-dimming function**

Your mirror will automatically dim upon detecting glare from the vehicles traveling behind you. The auto-dimming function can be controlled by the Dimming ON/OFF button:

1. Pressing and holding the  button for 3 seconds turns the autodimming function OFF which is indicated by the green Status Indicator LED turning off.
2. Pressing and holding the  button for 3 seconds again turns the auto-dimming function ON which is indicated by the green Status Indicator LED turning on.



The mirror defaults to the ON position each time the vehicle is started.

### **Z-Nav™ Compass Display**

The NVS™ Mirror in your vehicle is also equipped with a Z-Nav™ Compass that shows the vehicle Compass heading in the Display Window using the 8 basic cardinal headings (N, NE, E, SE, etc.).

### Compass function

The Compass can be turned ON and OFF and will remember the last state when the ignition is cycled. To turn the display feature ON/OFF:

1. Press and release the  button within 1 second to turn the display feature OFF.
2. Press and release the  button again within 1 second to turn the display back ON.

Additional options can be set with press and hold sequences of the  button and are detailed below.

There is a difference between magnetic north and true north. The compass in the mirror can compensate for this difference when it knows the Magnetic Zone in which it is operating. This is set either by the dealer or by the user. The operating Zone Numbers for North America are shown in the figure on the following section.

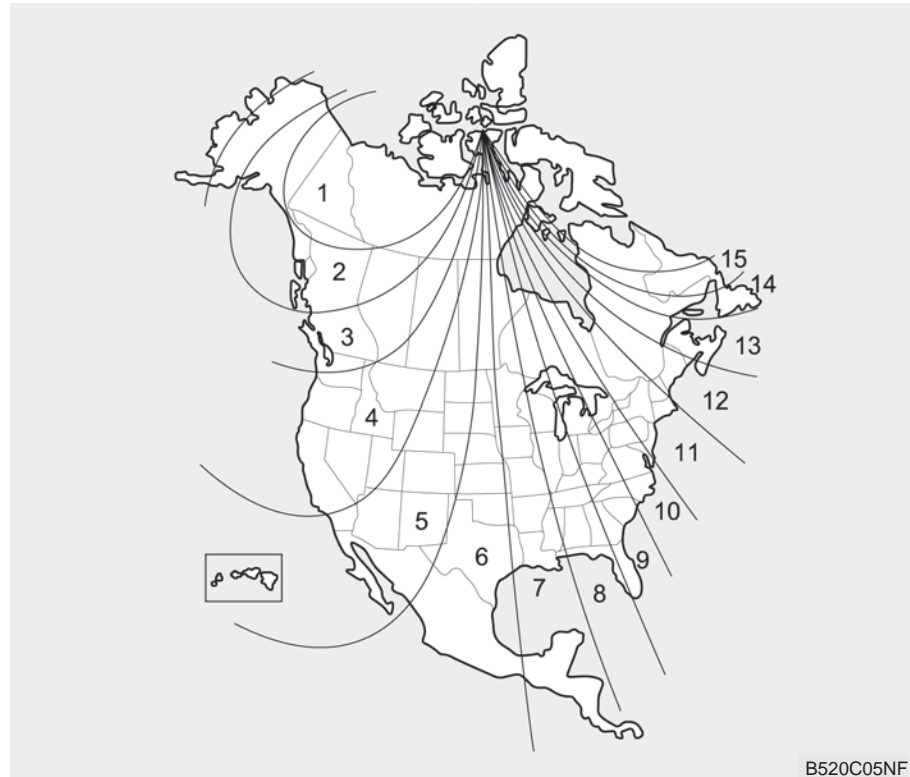



To adjust the Zone setting:

1. Determine the desired Zone Number based upon your current location on the Zone Map.
2. Press and hold the  $\odot$  button for 6 seconds, the current Zone Number will appear on the display.
3. Pressing and holding the  $\odot$  button again will cause the numbers to increment (Note: they will repeat ...13, 14, 15, 1, 2, ...). Releasing the button when the desired Zone Number appears on the display will set the new Zone.
4. Within about 5 seconds the compass will start displaying a compass heading again.

There are some conditions that can cause changes to the vehicle magnets, such as installing a ski rack or a CB antenna. Body repair work on the vehicle can also cause changes to the vehicle's magnetic field. In these situations, the compass will need to be re-calibrated to quickly correct these changes. To re-calibrate the compass:

1. Press and hold the  $\odot$  button for more than 9 seconds. When the compass memory is cleared a "C" will appear in the display.
2. To calibrate the compass, drive the vehicle in 2 complete circles at less than 5 mph (8 km/h).

### **Integrated HomeLink® Wireless Control System**

The HomeLink® Wireless Control System provides a convenient way to replace up to three hand-held radio-frequency (RF) transmitters with a single built-in device. This innovative feature will learn the radio frequency codes of most current transmitters to operate devices such as gate operators, garage door openers, entry door locks, security systems, even home lighting. Both standard and rolling code-equipped transmitters can be programmed by following the outlined procedures. Additional HomeLink® information can be found at: [www.homelink.com](http://www.homelink.com) or by calling 1-800-355-3515.

### **WARNING**

Before programming HomeLink® to a garage door opener or gate operator, make sure that people and objects are out of the way of the device to prevent potential harm or damage. Do not use HomeLink® with any garage door opener that lacks the safety stop and reverse features required by U.S. federal safety standards (this includes any garage door opener model manufactured before April 1, 1982). A garage door that cannot detect an object - signaling the door to stop and reverse - does not meet current U.S. federal safety standards. Using a garage door opener without these features increases the risk of serious injury or death.

Retain the original transmitter of the RF device you are programming for use in other vehicles as well as for future HomeLink® programming. It is also suggested that upon the sale of the vehicle, the programmed HomeLink® buttons be erased for security purposes.

### **\* NOTICE - Programming HomeLink®**

- When programming a garage door opener, it is advised to park the vehicle outside of the garage.
- It is recommended that a new battery be placed in the hand-held transmitter of the device being programmed to HomeLink® for quicker training and accurate transmission of the radio-frequency signal.
- Some vehicles may require the ignition switch to be turned to the second (or "accessories") position for programming and/or operation of HomeLink®.
- In the event that there are still programming difficulties or questions after following the programming steps listed below, contact HomeLink® at: [www.homelink.com](http://www.homelink.com) or 1-800-355-3515.

## Programming

To train most devices, follow these instructions:

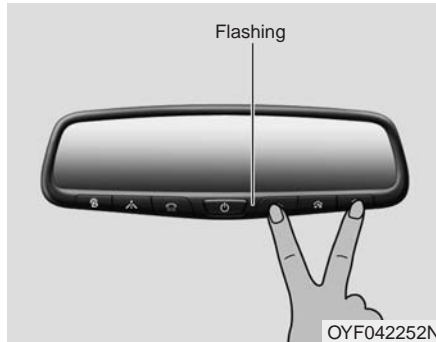

1. For first-time programming, press and hold the two outside buttons (🔑, 📶), HomeLink® Channel 1 and Channel 3, until the indicator light begins to flash (after 10 seconds). Release both buttons. Do not hold the buttons for longer than 20 seconds.

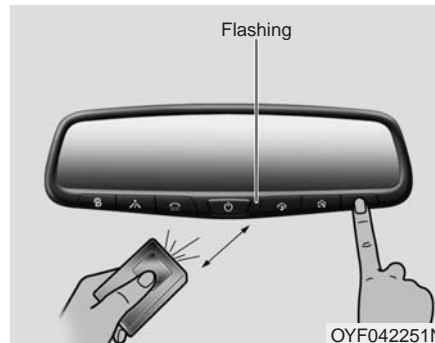

2. Position the end of your hand-held transmitter 1-3 inches (2-8 cm) away from the HomeLink® button you wish to program while keeping the indicator light in view.
3. Simultaneously press and hold both the HomeLink® and hand-held transmitter buttons until the HomeLink® indicator light changes from a slow to a rapid blinking light. Now you may release both the HomeLink® and hand-held transmitter buttons.

## \* NOTICE

Some devices may require you to replace this Programming step 3 with procedures noted in the "Gate Operator/Canadian Programming" section. If the HomeLink® indicator light does not change to a rapidly blinking light after performing these steps, contact HomeLink® at [www.homelink.com](http://www.homelink.com).

4. Firmly press, hold for 5 seconds and release the programmed HomeLink® button up to two separate times to activate the door. If the door does not activate, press and hold the just-trained HomeLink® button and observe the indicator light.
  - If the indicator light stays on constantly, programming is complete and your device should activate when the HomeLink® button is pressed and released.
  - If the indicator light blinks rapidly for 2 seconds and then turns to a constant light, continue with "Programming" steps 5-7 to complete the programming of a rolling code equipped device (most commonly a garage door opener).
5. At the garage door opener receiver (motor-head unit) in the garage, locate the "learn" or "smart" button. This can usually be found where the hanging antenna wire is attached to the motor-head unit.
6. Firmly press and release the "learn" or "smart" button. (The name and color of the button vary by manufacturer). There are 30 seconds to initiate step 7.
7. Return to the vehicle and firmly press, hold for 2 seconds and release the programmed HomeLink® button. Repeat the "press/hold/release" sequence a second time, and, depending on the brand of the garage door opener (or other rolling code equipped device), repeat this sequence a third time to complete the programming process.

HomeLink® should now activate your rolling code equipped device.

### **Gate operator & Canadian programming**

During programming, your handheld transmitter may automatically stop transmitting. Continue to press the Integrated HomeLink® Wireless Control System button (note steps 2 through 4 in the Standard Programming portion of this document) while you press and re-press ("cycle") your handheld transmitter every two seconds until the frequency signal has been learned. The indicator light will flash slowly and then rapidly after several seconds upon successful training.

### **Operating HomeLink®**

To operate, simply press and release the programmed HomeLink® button. Activation will now occur for the trained device (i.e. garage door opener, gate operator, security system, entry door lock, home/office lighting, etc.). For convenience, the hand-held transmitter of the device may also be used at any time.

### Reprogramming a single HomeLink® button

To program a device to HomeLink® using a HomeLink® button previously trained, follow these steps:

1. Press and hold the desired HomeLink® button. DO NOT release the button.
2. The indicator light will begin to flash after 20 seconds. Without releasing the HomeLink® button, proceed with "Programming" step 2.

For questions or comments, contact HomeLink® at [www.homelink.com](http://www.homelink.com) or 1-800-355-3515.

### Erasing HomeLink® buttons

Individual buttons cannot be erased. However, to erase all three programmed buttons:

1. Press and hold the two outer HomeLink® buttons until the indicator light begins to flash after 10 seconds.
2. Release both buttons. Do not hold for longer than 20 seconds.

The Integrated HomeLink® Wireless Control System is now in the training (learn) mode and can be programmed at any time following the appropriate steps in the Programming sections above.

**FCC ID: NZLTMHL4**

**IC: 4112A-TLMHL4**

### This device complies with Part 15 of the FCC Rules.

Operation is subject to the following two conditions:

1. This device may not cause harmful interference, and
2. This device must accept any interference received, including interference that may cause undesired operation.

### **WARNING**

**The transceiver has been tested and complies with FCC and Industry Canada rules. Changes or modifications not expressly approved by the party responsible for compliance could void the user's authority to operate the device.**

NVS® is a registered trademark and Z-Nav™ is a trademark of the Gentex Corporation, Zeeland, Michigan. HomeLink® is a registered trademark owned by Johnson Controls, Incorporated, Milwaukee, Wisconsin.

### Outside rearview mirror

Be sure to adjust mirror angles before driving.

Your vehicle is equipped with both left-hand and right-hand outside rearview mirrors. The mirrors can be adjusted remotely with the remote switch. The mirror heads can be folded back to prevent damage during an automatic car wash or when passing through a narrow street.

The right outside rearview mirror is convex. Objects seen in the mirror are closer than they appear.

Use your interior rearview mirror or direct observation to determine the actual distance of following vehicles when changing lanes.



### **CAUTION - Rearview mirror**

***Do not scrape ice off the mirror face; this may damage the surface of the glass. If ice should restrict movement of the mirror, do not force the mirror for adjustment. To remove ice, use a deicer spray, or a sponge or soft cloth with very warm water.***



### **WARNING - Mirror adjustment**

**Do not adjust or fold the outside rearview mirrors while the vehicle is moving. This could result in loss of control, and an accident which could cause death, serious injury or property damage.**

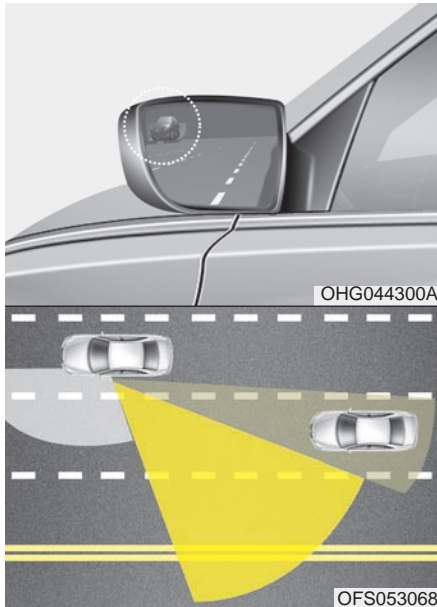

**Blind zone mirror (if equipped)**

The blind zone mirror (BZM) is supplemental mirror to help reduce a driver's blind zone that will show the rear side territory of your vehicle. The blind zone mirror is equipped with the left-hand outside rearview mirror.

**⚠ WARNING**

- Always check the road condition while driving for unexpected situations even though the vehicle is equipped with a blind zone mirror.
- The blind zone mirror is a device made for convenience. Do not solely rely on the mirror but always pay attention to drive safely.



**Adjusting the outside rearview mirror**

The electric remote control mirror switch allows you to adjust the position of the left and right outside rearview mirrors.

To adjust the position of the mirrors:

1. Place the ignition switch in the ACC position.
2. Move the lever(1) to R (right) or L (left) to select the right side mirror or the left side mirror.
3. Press a corresponding point on the mirror adjustment control to position the selected mirror up, down, left or right.

4. After the adjustment, position the lever in the center to prevent inadvertent movement.

**⚠ CAUTION - Outside mirror**

- *The mirrors stop moving when they reach the maximum adjusting angles, but the motor continues to operate while the switch is pressed. Do not press the switch longer than necessary, the motor may be damaged.*
- *Do not attempt to adjust the outside rearview mirror by hand. Doing so may damage the related parts.*



### *Folding/unfolding the outside rearview mirror*

#### **Manual type**

To fold the outside rearview mirror, grasp the housing of the mirror and then fold it toward the rear of the vehicle.

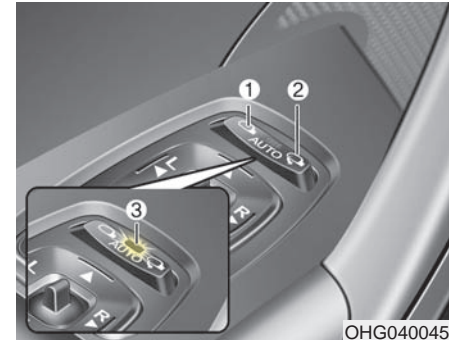

#### **Electric type (if equipped)**

The outside rearview mirror can be folded or unfolded by pressing the switch as below.

**Left (1) :** The mirror will unfold.

**Right (2) :** The mirror will fold.

#### **Center (AUTO, 3) :**

The mirror will fold or unfold automatically as follows:

- The mirror will fold or unfold when the door is locked or unlocked by the smart key.
- The mirror will fold or unfold when the door is locked or unlocked by the button on the outside door handle.



- The mirror will unfold when you approach the vehicle (all doors closed and locked) with a smart key in possession. (if equipped)

**CAUTION**

*The electric type outside rearview mirror operates even though the ENGINE START/STOP button is in the OFF position. However, to prevent unnecessary battery discharge, do not adjust the mirrors longer than necessary while the engine is not running.*

**CAUTION**

*In case it is an electric type outside rearview mirror, don't fold it by hand. It could cause motor failure.*

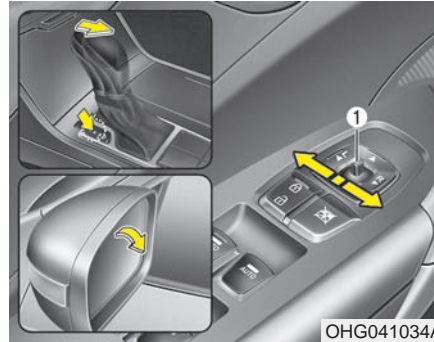

**Reverse parking aid function (if equipped)**

While the vehicle is moving rearward, the outside rearview mirror(s) will move downward to aid reverse parking. According to the position of the outside rearview mirror switch (1), the outside rearview mirror(s) will operate as follows:

**L/R** : When the remote control outside rearview mirror switch is selected to the L (left) or R (right) position, both outside rearview mirrors will move downward.

**Neutral** : When the remote control outside rearview mirror switch is placed in the middle, the outside rearview mirrors will not operate while the vehicle is moving rearward.

The outside rearview mirrors will automatically revert to their original positions under the following conditions:

1. The ignition switch is in the OFF position.
2. Shift lever is moved to any position except R (Reverse).
3. Remote control outside rearview mirror switch is placed in the middle.

## INSTRUMENT CLUSTER

■ Type A



1. Tachometer
2. Turn signal indicators
3. Speedometer
4. LCD display
5. Fuel gauge
6. Engine coolant temperature gauge
7. Warning and indicator lights

■ Type B

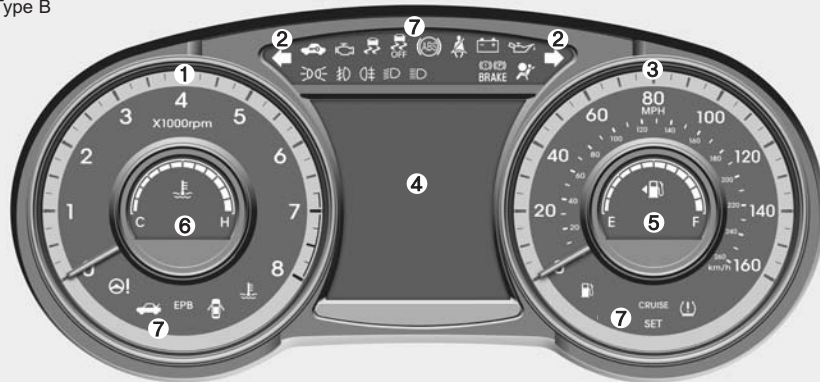

For more details, refer to "Gauges" in the next pages.

The actual cluster in the vehicle may differ from the illustration.

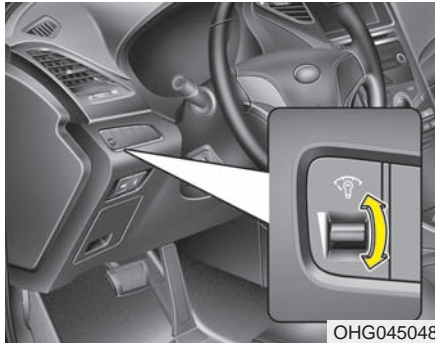

### Instrument panel illumination

The instrument panel illumination intensity can be adjusted as follows:

- Ignition switch in the ON position
- Pushing the control switch up or down

The illumination intensity is shown on the instrument cluster LCD display.

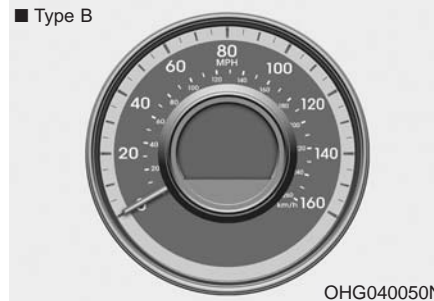

### Gauges

#### Speedometer

The speedometer indicates the vehicle speed.

The speedometer is calibrated in miles per hour and/or kilometers per hour.

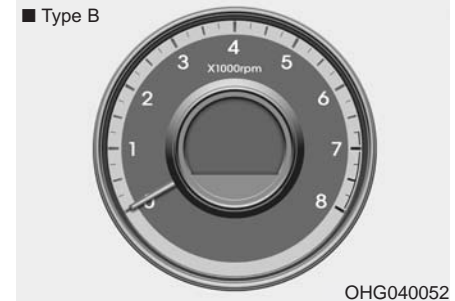
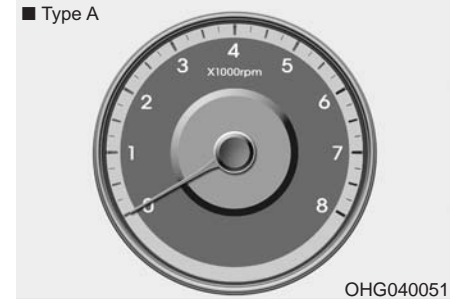

#### Tachometer

The tachometer indicates the engine speed in revolutions per minute (rpm).

Use the tachometer to select the correct shift points and to prevent lugging and/or over-revving the engine.

**⚠ CAUTION - Red zone**  
*Do not operate the engine within the tachometer's RED ZONE. This may cause severe engine damage.*

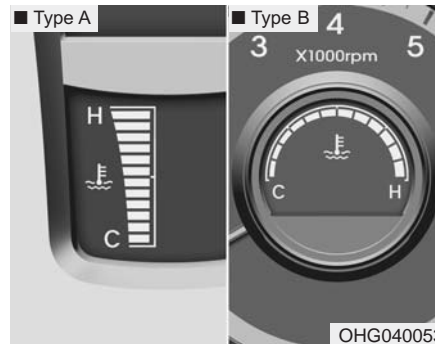

**Engine coolant temperature gauge**

This gauge shows the temperature of the engine coolant when the ignition switch is ON.

Do not continue driving with an overheated engine. If your vehicle overheats, refer to “If the engine overheats” in section 6.

If the segment level moves beyond the normal range area toward the “H” position, it indicates overheating that may damage the engine.

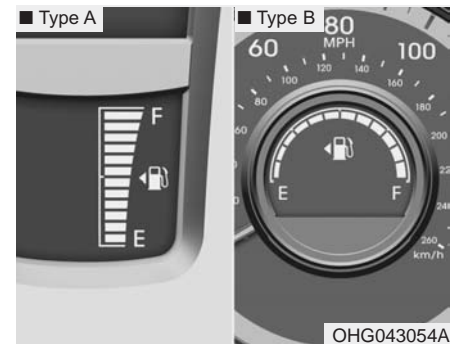

**Fuel gauge**

The fuel gauge indicates the approximate amount of fuel remaining in the fuel tank.

- The fuel tank capacity is given in section 12.
- The fuel gauge is supplemented by a low fuel warning light, which will illuminate when the fuel tank is nearly empty.
- On inclines or curves, the fuel gauge segment level may fluctuate or the low fuel warning light may come on earlier than usual due to the movement of fuel in the tank.

**⚠ WARNING - Fuel gauge**

Stop and obtain additional fuel as soon as possible after the warning light comes on or when the gauge level comes close to the E level. Running out of fuel can expose vehicle occupants to danger.

**⚠ CAUTION - Low fuel**

Avoid driving with a extremely low fuel level. Running out of fuel could cause the engine to misfire, damaging the catalytic converter.

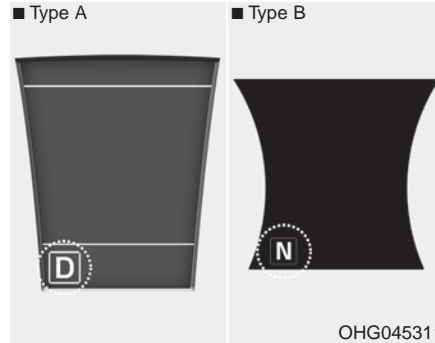

**Transaxle Shift Indicator**

**Automatic Transaxle Shift Indicator**

This indicator displays which automatic transaxle shift lever is selected.

- Park : P
- Reverse : R
- Neutral : N
- Drive : D
- Sports Mode : 1, 2, 3, 4, 5, 6

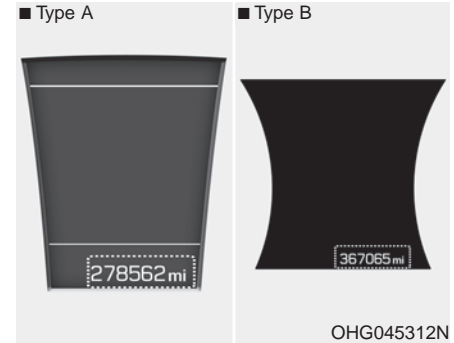



**Odometer**

The odometer indicates the total distance that the vehicle has been driven and should be used to determine when periodic maintenance should be performed.



### LCD display control







The LCD display modes can be changed by using the control buttons.

- (1)  : MODE button for changing modes
- (2)  : MOVE switch for changing items
- (3) OK : SELECT/RESET button for setting or resetting the selected item

**For the LCD modes, refer to “LCD Display” in this chapter.**

## LCD DISPLAY

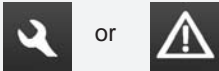
### LCD modes

Modes	Symbol	Explanation
Trip Computer		This mode displays driving information like the tripmeter, fuel economy, and so on. For more details, refer to "Trip Computer" in this chapter.
Turn By Turn (TBT) (if equipped)		This mode displays the state of the navigation.
LDWS (if equipped)		This mode displays the state of the Lane Departure Warning System (LDWS). For more details, refer to "Lane Departure Warning System (LDWS)" in chapter 5.
A/V (If equipped)		This mode displays the state of the A/V system.
Information	 or 	This mode informs of the service interval (mileage or days) and warning messages related to the Blind Spot Detection system, and so on.
User Settings		On this mode, you can change settings of the doors, lamps, and so on.

For controlling the LCD modes, refer to "LCD Display Control" in this chapter.

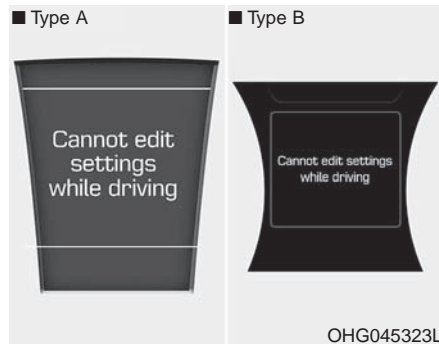

### ***Cannot edit settings while driving***

This warning message illuminates if you try to select the other User Settings item when driving.

For safety, change the User Settings after parking the vehicle, applying the parking brake and moving the shift lever to P (Park) position.

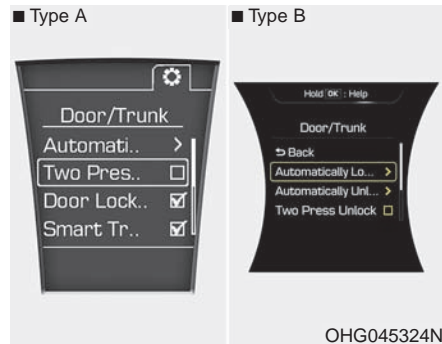

### ***Quick guide (Help, if equipped)***

If you press and hold the OK button in the User Settings Mode, explanation about the selected item is displayed in the cluster.

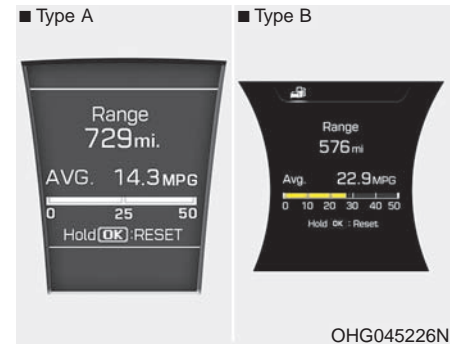

### **Trip computer mode**

This mode displays driving information like the tripmeter, fuel economy, and so on.

**For more details, refer to “Trip Computer” in this chapter.**



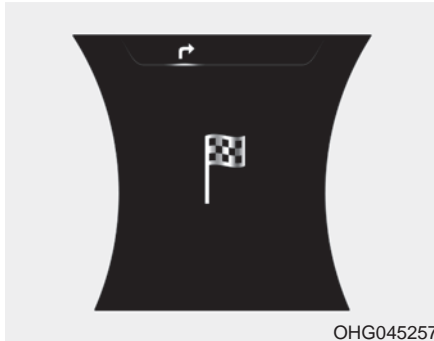

**Turn By Turn (TBT) mode  
(if equipped)**

This mode displays the state of the navigation.



**LDWS Mode (if equipped)**

This mode displays the state of the Lane Departure Warning System (LDWS).

For more information, refer to "Lane Departure Warning System (LDWS)" in chapter 5.



**A/V mode**

This mode displays the state of the A/V system.



### Information mode

#### *Service interval*

#### Service in

It calculates and displays when you need a scheduled maintenance service (mileage or days).

If the remaining mileage or time reaches 900 miles (1,500 km) or 30 days, "Service in" message is displayed for several seconds each time you set the Engine Start/Stop button to the ON position.

**For the setting of the service interval, refer to "User Settings Mode" of the LCD display.**

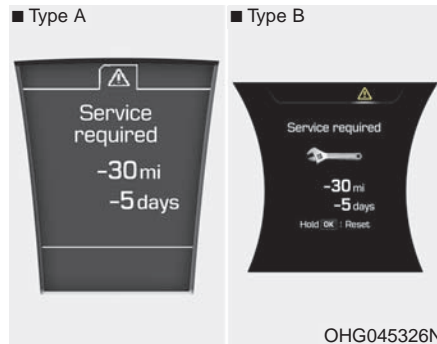

### Service required

If you do not have your vehicle serviced according to the already inputted service interval, "Service required" message is displayed for several seconds each time you set the Engine Start/Stop button to the ON position.

To reset the service interval to the mileage and days you inputted before:

- Press the OK button for more than 1 second.

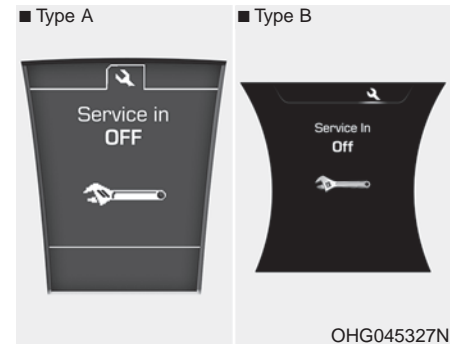

### Service in OFF

If the service interval is not set, "Service in OFF" message is displayed on the LCD display.

### \* NOTICE

**If any of the following conditions occurs, the mileage and days may be incorrect.**

- The battery cable is disconnected.
- The fuse switch is turned off.
- The battery is discharged.

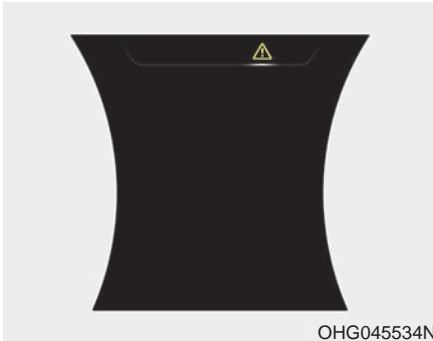

***Warning Message***

If one of followings occurs, warning messages will be displayed on the information mode for several seconds.

- Malfunction of below systems
  - Blind Spot Detection (BSD)
  - Forward Collision Warning System (FCWS)
  - Tire Pressure Monitoring System (TPMS), and so on.
- Low washer fluid, etc.

### User settings mode

On this mode, you can change setting of the instrument cluster, doors, lamps, and so on.

### Driving Assist (if equipped)

Items	Explanation
FCWS (Forward Collision Warning System)	<ul style="list-style-type: none"><li>• Off: The FCW system will be deactivated.</li><li>• Late/Normal/Early: The warning point of time may be adjusted.</li></ul> <p><b>For more details, refer to "Forward Collision Warning System (FCWS)" in chapter 5.</b></p>
RCTA (Rear Cross Traffic Alert)	<p>To activate or deactivate the RCTA system.</p> <p><b>For more details, refer to "Rear Cross Traffic Alert (RCTA)" in chapter 5.</b></p>

**Door/Trunk**

Items	Explanation
Automatically Lock	<ul style="list-style-type: none"> <li>• Off (Disable) : The auto door lock operation will be deactivated.</li> <li>• Enable on Speed: All doors will be automatically locked when the vehicle speed exceeds 9.3mph (15km/h).</li> <li>• Enable on Shift: All doors will be automatically locked if the automatic transaxle shift lever is shifted from the P (Park) position to the R (Reverse), N (Neutral), or D (Drive) position.</li> </ul>
Automatically Unlock	<ul style="list-style-type: none"> <li>• Off (Disable) : The auto door unlock operation will be deactivated.</li> <li>• Vehicle Off: All doors will be automatically unlocked when the Engine Start/Stop button is set to the OFF position.</li> <li>• Driver Door Unlock: All doors will be automatically unlocked if the driver's door is unlocked.</li> <li>• On Shift to P: All doors will be automatically unlocked if the automatic transaxle shift lever is shifted to the P (Park) position.</li> </ul>
Two Press Unlock	<ul style="list-style-type: none"> <li>• OFF : The two press unlock function will be deactivated. Therefore, all doors will unlock if the door is unlocked.</li> <li>• ON : The driver's door will unlock if the door is unlocked. When the door is unlocked again within 4 seconds, all doors will unlock.</li> </ul>
Door Lock Sound (Lock/Unlock Sound)	To activate or deactivate the lock sound when locking doors.
Smart Trunk	To activate or deactivate the Smart Trunk system. <b>For more details, refer to "Smart Trunk" in this chapter.</b>

### Lights/Sound

Items	Explanation
One Touch Turn Signal	<ul style="list-style-type: none"><li>• Off: The one touch turn signal function will be deactivated.</li><li>• 3, 5, 7 Flashes : The lane change signals will blink 3, 5, or 7 times when the turn signal lever is moved slightly.</li></ul> <b>For more details, refer to “Light” in this chapter.</b>
Ambient Light	<ul style="list-style-type: none"><li>• Off : The ambient light of interior will turn off.</li><li>• 1, 2, 3, 4 Level : The brightness of the ambient light may be adjusted.</li></ul> <b>For more details, refer to “Light” in this chapter.</b>
Head Lamp Delay	<ul style="list-style-type: none"><li>• On: The head lamp delay function will be activated.</li><li>• Off: The headlamp delay function will be deactivated.</li></ul> <b>For more details, refer to “Light” in this chapter.</b>
BSD (Blind Spot Detection) Sound	<ul style="list-style-type: none"><li>• Off : The BSD sound function will be deactivated.</li><li>• On : The BSD sound function will be activated.</li></ul>
Welcome Sound	<ul style="list-style-type: none"><li>• Off : The welcome sound function will be deactivated.</li><li>• On : The welcome sound function will be activated.</li></ul>

**Convenient**

Items	Explanation
Seat Easy Access	<ul style="list-style-type: none"> <li>• None: The seat easy access function will be deactivated.</li> <li>• Normal/Extended:               <ul style="list-style-type: none"> <li>- When you turn off the engine, the driver's seat will automatically move rearward short (Normal) or long (Extended) for you to enter or exit the vehicle more comfortably.</li> <li>- If you change the Engine Start/Stop button from OFF position to the ACC, ON, or START position, the driver's seat will return to the original position.</li> </ul> </li> </ul> <p><b>For more details, refer to “Driver Position Memory System” in this chapter.</b></p>
Steering Easy Access	<ul style="list-style-type: none"> <li>• On: The steering wheel will automatically move forward or rearward for the driver to enter or exit the vehicle comfortably.</li> <li>• Off: The steering easy access function will be deactivated.</li> </ul> <p><b>For more details, refer to “Driver Position Memory System” in this chapter.</b></p>
Steering Position	<ul style="list-style-type: none"> <li>• Off : The steering position function will be deactivated.</li> <li>• On : The steering position function will be activated.</li> </ul>
Fuel Economy Auto Reset	<ul style="list-style-type: none"> <li>• Off : The average fuel economy will not reset automatically whenever refueling.</li> <li>• On (Auto Reset) : The average fuel economy will reset automatically when refueling.</li> </ul> <p><b>For more details, refer to “Trip Computer” in this chapter.</b></p>
Fuel Economy Unit	Choose the fuel economy unit. (US gallon, UK gallon)

### Service interval

Items	Explanation
Service Interval	<p>On this mode, you can activate the service interval function with mileage (km or mi.) and period (months).</p> <ul style="list-style-type: none"><li>• Off : The service interval function will be deactivated.</li><li>• On : You can set the service interval (mileage and months).</li></ul>



## TRIP COMPUTER

### Overview

#### Description

The trip computer is a microcomputer-controlled driver information system that displays information related to driving.

#### \* NOTICE

Some driving information stored in the trip computer (for example Average Vehicle Speed) resets if the battery is disconnected.

### Trip modes

To change the trip mode, press the MOVE switch “▼” on the steering wheel.

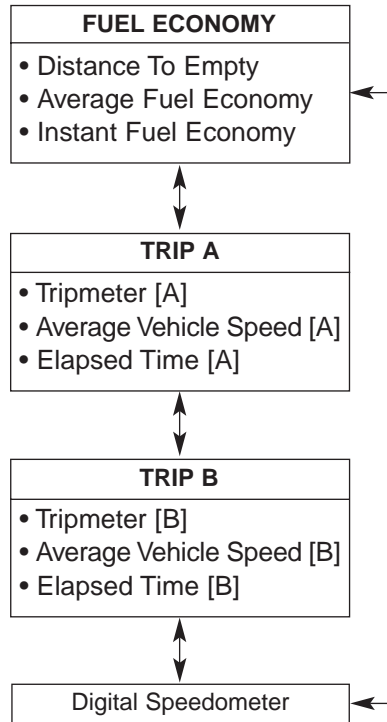

### Trip A/B

#### Tripmeter (1)

- The tripmeter is the total driving distance since the last tripmeter reset.
  - Distance range: 0.0 ~ 9999.9 mi. or km.
- To reset the tripmeter, press the [OK] button on the steering wheel for more than 1 second when the tripmeter is displayed.

### **Average Vehicle Speed (2)**

- The average vehicle speed is calculated by the total driving distance and driving time since the last average vehicle speed reset.
  - Speed range: 0 ~ 999 MPH or km/h
- To reset the average vehicle speed, press the [OK] button on the steering wheel for more than 1 second when the average vehicle speed is displayed.

### **\* NOTICE**

- The average vehicle speed is not displayed if the driving distance is less than 0.19 miles (300 meters) or the driving time is less than 10 seconds since the Engine Start/Stop button is turned to ON.
- Even if the vehicle is not in motion, the average vehicle speed keeps calculating while the engine is running.

### **Elapsed Time (3)**

- The elapsed time is the total driving time since the last elapsed time reset.
  - Time range (hh:mm): 00:00 ~ 99:59
- To reset the elapsed time, press the [OK] button on the steering wheel for more than 1 second when the elapsed time is displayed.

### **\* NOTICE**

Even if the vehicle is not in motion, the elapsed time keeps calculating while the engine is running.

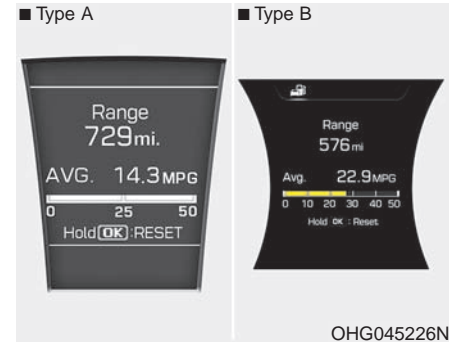

### **Fuel economy**

#### **Distance To Empty (1)**

- The distance to empty is the estimated distance the vehicle can be driven with the remaining fuel.
  - Distance range: 1 ~ 9999 mi. or 1 ~ 9999 km.
- If the estimated distance is below 1 mi. (1 km), the trip computer will display “---” as distance to empty.

**\* NOTICE**

- If the vehicle is not on level ground or the battery power has been interrupted, the distance to empty function may not operate correctly.
- The distance to empty may differ from the actual driving distance as it is an estimate of the available driving distance.
- The trip computer may not register additional fuel if less than 1.6 gallons (6 liters) of fuel are added to the vehicle.
- The fuel economy and distance to empty may vary significantly based on driving conditions, driving habits, and condition of the vehicle.

**Average Fuel Economy (2)**

- The average fuel economy is calculated by the total driving distance and fuel consumption since the last average fuel economy reset.
  - Fuel economy range: 0.0 ~ 99.9 MPG or L/100km, km/L
- The average fuel economy can be reset both manually and automatically.

**Manual reset**

To clear the average fuel economy manually, press the [OK] button on the steering wheel for more than 1 second when the average fuel economy is displayed.

**Automatic reset**

To make the average fuel economy be reset automatically whenever refueling, select the "Auto Reset" mode in User Setting menu of the LCD display (**Refer to "LCD Display"**).

Under "Auto Reset" mode, the average fuel economy will be cleared to zero (---) when the vehicle speed exceeds 1 km/h after refueling more than 1.6 gallons (6 liters).

**\* NOTICE**

**The average fuel economy is not displayed for more accurate calculation if the vehicle does not drive more than 10 seconds or 0.19 miles (300 meters) since the Engine Start/Stop button is turned to ON.**

**Instant Fuel Economy (3)**

- This mode displays the instant fuel economy during the last few seconds when the vehicle speed is more than 6.2 MPH (10 km/h).
  - Fuel economy range: 0 ~ 50 MPG or 0 ~ 30 L/100km



### **Digital Speedometer**

This message shows the speed of the vehicle (MPH, km/h).

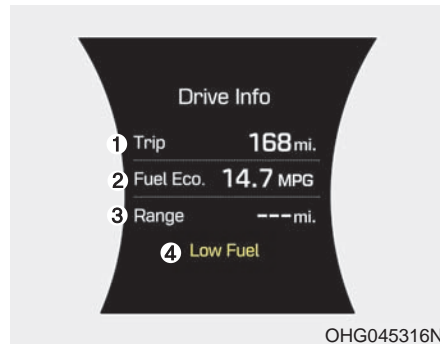

### **One time driving information mode**

This display shows trip distance (1), average fuel economy (2) and the vehicle can be driven with the remaining fuel (3).

This information is displayed for a few seconds when you turn off the engine and then goes off automatically. The information provided is calculated according to each trip.

If the estimated distance is below 1km (1 mi.), the distance to empty (3) will display as "---" and a refuel message will appear (4).

### **\* NOTICE**

If "Sunroof Open" warning message is displayed in the cluster, this display may not be displayed in the cluster.

## WARNINGS AND INDICATORS (INSTRUMENT CLUSTER)

All warning lights are checked by turning the ignition switch ON (do not start the engine). Any light that does not illuminate should be checked by an authorized HYUNDAI dealer.

After starting the engine, check to make sure that all warning lights are off. If any are still on, this indicates a situation that needs attention.

### *Air bag warning light*



This warning light will illuminate for approximately 6 seconds each time you turn the ignition switch to the ON position.

This light also comes on when the Supplemental Restraint System (SRS) is not working properly. If the SRS air bag warning light  does not come on, or continuously remains on after operating for about 6 seconds when you turn the ignition switch to the ON position or start the engine, or if it comes on while driving, have the SRS inspected by an authorized HYUNDAI dealer.

### *Seat belt warning*



As a reminder to the driver, the seat belt warning light will blink for approximately 6 seconds each time you turn the ignition switch ON regardless of belt fastening.

For more details, refer to the “Seat Belt” in section 3.

### *Turn signal indicator*

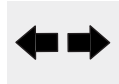

The blinking green arrows on the instrument panel show the direction indicated by the turn signals. If the arrow comes on but does not blink, blinks more rapidly than normal, or does not illuminate at all, a malfunction in the turn signal system is indicated. Your dealer should be consulted for repairs.

### *Front fog light indicator*



This light comes on when the front fog lights are ON.

### *High beam indicator*



This indicator illuminates when the headlights are on and in the high beam position or when the turn signal lever is pulled into the Flash-to-Pass position.

### *Smart High Beam indicator (if equipped)*



#### **This warning light illuminates :**

- When the high-Beam is on with the light switch in the AUTO light position.
- If your vehicle detects oncoming or preceding vehicles, the Smart High Beam system will switch the high beam to low beam automatically.

### *Position (Parking) / Tail light indicator*

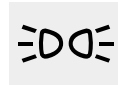

This indicator illuminates when the position lights are on.

**Engine oil pressure warning light**

This warning light indicates the engine oil pressure is low.

If the warning light illuminates while driving:

1. Drive safely to the side of the road and stop.
2. With the engine off, check the engine oil level. If the level is low, add oil as required.

If the warning light remains on after adding oil or if oil is not available, call an authorized HYUNDAI dealer.

**⚠ CAUTION - Engine damage**

***If the engine is not stopped immediately after the engine oil pressure warning light is illuminated and stays on while the engine is running, serious engine damage may result.***

The oil pressure warning light comes on whenever there is insufficient oil pressure. In normal operation, it should come on when the ignition switch is turned on, then go out when the engine is started. If the oil pressure warning light stays on while the engine is running, there is a serious malfunction.

**⚠ CAUTION**

***If the oil pressure warning light stays on while the engine is running, serious engine damage may result. The oil pressure warning light comes on whenever there is insufficient oil pressure. In normal operation, it should come on when the ignition switch is turned on, then go out when the engine is started. If the oil pressure warning light stays on while the engine is running, there is a serious malfunction.***

***If this happens, stop the vehicle as soon as it is safe to do so, turn off the engine and check the oil level. If the oil level is low, fill the engine oil to the proper level and start the engine again. If the light stays on with the engine running, turn the engine off immediately. In any instance where the oil light stays on when the engine is running, the engine should be checked by an authorized HYUNDAI dealer before the car is driven again.***

### ***Parking brake & brake fluid warning light***



#### **Parking brake warning**

This light is illuminated when the parking brake is applied with the ignition switch in the START or ON position. The warning light should go off when the parking brake is released while the engine is running.

The parking brake warning chime will sound to remind you that the parking brake is applied when you are driving above 6 mph (10 km/h). Always release the parking brake before you drive.

#### **Low brake fluid level warning**

If the warning light remains on, it may indicate that the brake fluid level in the reservoir is low.

If the warning light remains on:

1. Drive carefully to the nearest safe location and stop your vehicle.
2. With the engine stopped, check the brake fluid level immediately and add fluid as required. Then check all brake components for fluid leaks.

3. Do not drive the vehicle if leaks are found, the warning light remains on or the brakes do not operate properly. Have the vehicle towed to any authorized HYUNDAI dealer for a brake system inspection and necessary repairs.

Your vehicle is equipped with dual-diagonal braking systems. This means you still have braking on two wheels even if one of the dual systems should fail. With only one of the dual system working, more than normal pedal travel and greater pedal pressure are required to stop the car. Also, the car will not stop in as short a distance with only a portion of the brake system working. If the brakes fail while you are driving, shift to a lower gear for additional engine braking and stop the car as soon as it is safe to do so.

To check bulb operation, check whether the parking brake and brake fluid warning light illuminates when the ignition switch is in the ON position.

### ***Anti-lock brake system (ABS) warning light***



This light illuminates if the ignition switch is turned ON and goes off in approximately 3 seconds if the system is operating normally.

If the ABS warning light remains on, comes on while driving, or does not come on when the ignition switch is turned to the ON position, this indicates that there may be a malfunction with the ABS.

If this occurs, have your vehicle checked by an authorized HYUNDAI dealer as soon as possible. The normal braking system will still be operational, but without the assistance of the anti-lock brake system.



**Electronic brake force distribution (EBD) system warning light**



If these two warning lights shown illuminate at the same time while driving, the ABS and EBD system may have malfunctioned.

In this case, your ABS and regular brake system may not work normally. Have the vehicle checked by an authorized HYUNDAI dealer as soon as possible.

If the ABS warning light or EBD warning light is on and stays on, the speedometer or odometer/tripmeter may not work. In this case, have your vehicle checked by an authorized HYUNDAI dealer as soon as possible.

***Charging system warning light***



This warning light indicates a malfunction of either the generator or electrical charging system.

If the warning light comes on while the vehicle is in motion:

1. Drive to the nearest safe location.
2. With the engine off, check the generator drive belt for looseness or breakage.
3. If the belt is adjusted properly, a problem exists somewhere in the electrical charging system. Have an authorized HYUNDAI dealer correct the problem as soon as possible.

**⚠ WARNING - ABS/brake lights**

**If both ABS and brake warning lights are on and stay on, your vehicle's brake system will not work normally during sudden braking. Loss of braking could result in an accident, serious injury, or death. In this case, avoid high speed driving and abrupt braking. Have your vehicle checked by an authorized HYUNDAI dealer as soon as possible.**

### ***Door ajar warning light***



This warning light illuminates when a door is not closed securely.

### ***Trunk lid open warning light***



This warning light illuminates when a trunk lid is not closed securely.

### ***Immobilizer indicator***



If any of the following occurs in a vehicle equipped with the smart key, the immobilizer indicator illuminates, blinks or the light goes off.

- When the smart key is in the vehicle, if the ENGINE START/STOP button is in the ACC or ON position, the indicator will illuminate. However, when the smart key is not in the vehicle, if the ENGINE START/STOP button is pressed, the indicator will blink 10 times to indicate that you will not be able to start the engine.
  - When the ENGINE START/STOP button is in the ON position and the indicator turns off after 2 seconds, the system may have a problem. Have the vehicle checked by an authorized HYUNDAI dealer.
- When the battery is weak, if the ENGINE START/STOP button is pressed, the indicator will blink and you will not be able to start the engine. However, you may still be able to start the engine by directly pressing the engine start/stop button with the smart key. If smart key system related parts have a problem, the indicator will blink.

**EPB (Electric Parking Brake) malfunction indicator (if equipped)**

**EPB**

The EPB malfunction indicator will illuminate when the ignition switch is turned ON, but should go off after approximately 3 seconds. If the warning light does not come on, or continuously remains on take your vehicle to an authorized HYUNDAI dealer and have the system checked.

Also, the EPB malfunction indicator may illuminate when the ESC indicator comes on to indicate that the ESC is not working properly, but if this occurs, it does not indicate the EPB has malfunctioned.

**AUTO HOLD indicator light (if equipped)**

**AUTO HOLD**

If you press the AUTO HOLD switch, the AUTO HOLD indicator on the cluster comes on white. And when you stop the vehicle completely by pressing the brake pedal, the indicator changes from white to green.

If the AUTO HOLD malfunction indicator lights up yellow, the AUTO HOLD is not working properly. Take your vehicle to an authorized HYUNDAI dealer and have the system checked.

**For more information, refer to "AUTO HOLD" in section 5.**

**EPS (Electronic Power Steering) system warning light**



This indicator light comes on after the ignition key is turned to the ON position and then goes out after approximately 6 seconds.

This light also comes on when the EPS has some problems. If it comes on while driving, have your vehicle checked by an authorized HYUNDAI dealer.

**Engine coolant temperature warning light**



The warning light illuminates if the temperature of the engine coolant is above 125±2.5°C (257±4.5°F).

Do not continue driving with an overheated engine. If your vehicle overheats, refer to "Overheating" in section 6.

### **Low fuel level warning light**



This warning light indicates the fuel tank is nearly empty. When it comes on, you should add fuel as soon as possible. Driving with the fuel level warning light on or with the fuel level below "E" can cause the engine to misfire and damage the catalytic converter.

### **Malfunction indicator light (MIL) (check engine light)**



This indicator light is part of the Engine Control System which monitors various emission control system components. If this light illuminates while driving, it indicates that a potential malfunction has been detected somewhere in the emission control system.

This light will also illuminate when the ignition switch is turned to the ON position, and will go out in a few seconds after the engine is started. If it illuminates while driving, or does not illuminate when the ignition switch is in the ON position, take your vehicle to your nearest authorized HYUNDAI dealer and have the system checked.

Generally, your vehicle will continue to be drivable, but have the system checked by an authorized HYUNDAI dealer promptly.



### **CAUTION - MIL illumination**

- ***Prolonged driving with the Malfunction Indicator Light illuminated may cause damage to the emission control systems which could effect drivability and/or fuel economy.***
- ***If the Emission Control Malfunction Indicator Light illuminates, potential catalytic converter damage is possible which could result in loss of engine power. Have the Engine Control System inspected as soon as possible by an authorized HYUNDAI dealer.***

*ECO indicator*

**ECO**

**Active ECO system**

When active ECO is operating the ECO indicator is green.

For more details, refer to “Active ECO” in section 5.

*ESC (Electronic Stability Control) indicator*



The ESC indicator will illuminate when the ignition switch is turned ON, but should go off after approximately 3 seconds. When the ESC is on, it monitors the driving conditions. Under normal driving conditions, the ESC indicator will remain off. When a slippery or low traction condition is encountered, the ESC will operate, and the ESC indicator will blink to indicate the ESC is operating.

But, if the ESC system malfunctions the indicator illuminates and stays on. Take your vehicle to an authorized HYUNDAI dealer and have the system checked.

*ESC OFF indicator*



The ESC OFF indicator will illuminate when the ignition switch is turned ON, but should go off after approximately 3 seconds. To switch to ESC OFF mode, press the ESC OFF button. The ESC OFF indicator will illuminate indicating the ESC is deactivated.

***Cruise indicator  
(if equipped)***  
**CRUISE indicator**

**CRUISE**

The indicator light illuminates when the cruise control system is enabled. The cruise indicator light in the instrument cluster is illuminated when the cruise control CRUISE button on the steering wheel is pushed. The indicator light turns off when the cruise control CRUISE button is pushed again.

For more details, refer to "Cruise Control System" in section 5.

**Cruise SET indicator**

**SET**

The indicator light illuminates when the cruise function switch (SET- or RES+) is ON. The cruise SET indicator light in the instrument cluster is illuminated when the cruise control switch (SET- or RES+) is pushed. The cruise SET indicator light does not illuminate when the cruise control switch (CANCEL) is pushed or the system is disengaged.

For more details, refer to "Cruise Control System" in section 5.

***TPMS (Tire Pressure Monitoring System) indicator***

**Low tire pressure telltale /  
TPMS malfunction indicator**



The low tire pressure telltale/TPMS malfunction indicator comes on for 3 seconds after the ignition switch is in the ON position.

The TPMS malfunction indicator will illuminate after it blinks for approximately 1 minute when there is a problem with the Tire Pressure Monitoring System.

If this occurs, have the system checked by an authorized HYUNDAI dealer as soon as possible.

For more details, refer to "TPMS" in section 6.

**⚠ WARNING - Low tire pressure**

**Significantly low tire pressure makes the vehicle unstable and can contribute to loss of vehicle control and increased braking distances.**

**Continued driving on low pressure tires will cause the tires to overheat and fail.**

- The TPMS cannot alert you to severe and sudden tire damage caused by external factors.
- If you feel any vehicle instability, immediately take your foot off the accelerator pedal, apply the brakes gradually and with light force, slowly move to a safe position off the road.

### LCD display warning (if equipped)

#### Key not in vehicle

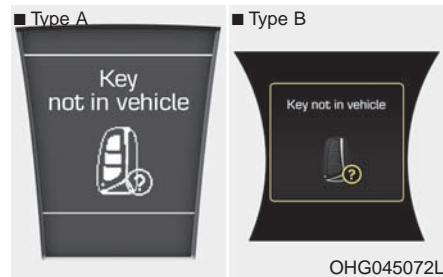

If the smart key is not in the vehicle and if any door is opened or closed with the ENGINE START/STOP button in the ACC, ON, or START position, the warning illuminates on the LCD display. Also, the chime sounds for 5 seconds when the smart key is not in the vehicle and the door is closed.

Always have the smart key with you.

#### Key not detected

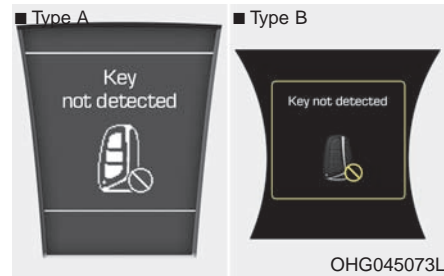

If the smart key is not in the vehicle or is not detected and you press the ENGINE START/STOP button, the warning illuminates on the LCD display for 10 seconds. Also, the immobilizer indicator blinks for 10 seconds.

#### Low key battery

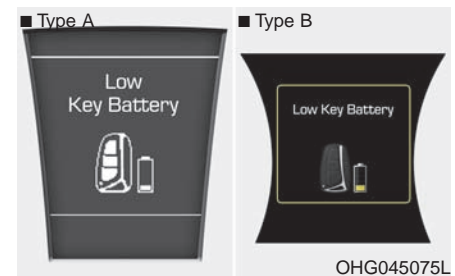

If the ENGINE START/STOP button changes to the OFF position when the smart key in the vehicle discharges, the warning illuminates on the LCD display for about 10 seconds. Also, the warning chime sounds once.

Replace the battery with a new one.



### Press brake pedal to start engine

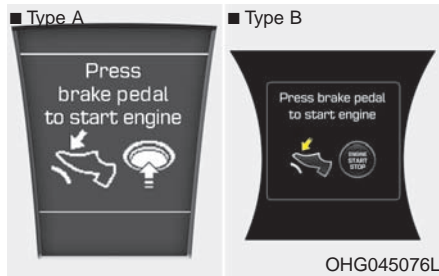

If the ENGINE START/STOP button changes to the ACC position twice by pressing the button repeatedly without depressing the brake pedal, the warning illuminates on the LCD display for about 10 seconds to indicate that you should depress the brake pedal to start the engine.

### Shift to "P" position

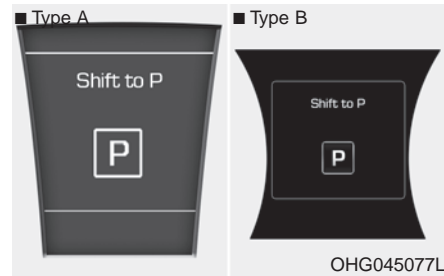

If you try to turn off the engine without the shift lever in the P (Park) position, the ENGINE START/STOP button changes to the ACC position. If the button is pressed once more it will change to the ON position. The warning illuminates on the LCD display for about 10 seconds to indicate that you should press the ENGINE START/STOP button with the shift lever in the P (Park) position to turn off the engine.

Also, the warning chime sounds for about 10 seconds. (if equipped)

### Press start button again

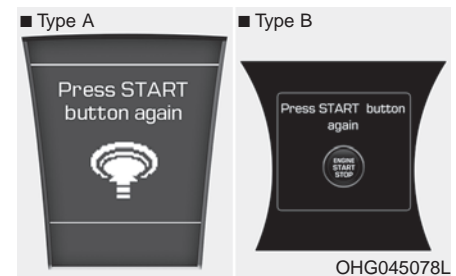

If you can not operate the ENGINE START/STOP button when there is a problem with the ENGINE START/STOP button system, the warning illuminates for 10 seconds and the chime sounds to indicate that you could start the engine by pressing the ENGINE START/STOP button once more.

The chime will stop if the ENGINE START/STOP button system works normally or the theft alarm system is armed.

If the warning illuminates each time you push the start/stop button, we recommend that the system be checked by an authorized HYUNDAI dealer.

### Shift to "P" or "N" to start the engine

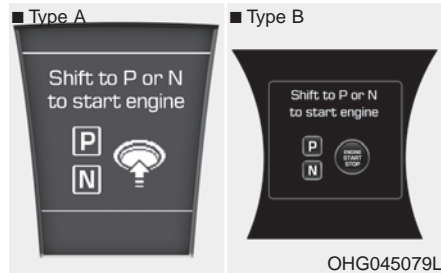

If you try to start the engine with the shift lever not in the P (Park) or N (Neutral) position, the warning illuminates for about 10 seconds on the LCD display.

You can also start the engine with the shift lever in the N (Neutral) position, but for your safety start the engine with the shift lever in the P (Park) position.

### Please press start button with key

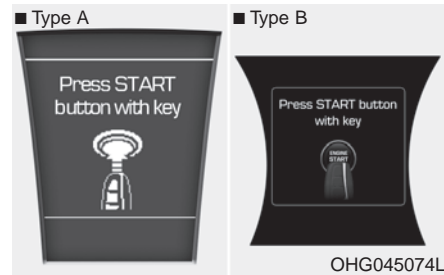

If you press the ENGINE START/STOP button while the warning "Key is not detected" illuminates the warning "Press the start button with key" illuminates for 10 seconds on the LCD display. Also, the immobilizer indicator blinks for 10 seconds.

### Check "Brake switch" fuse

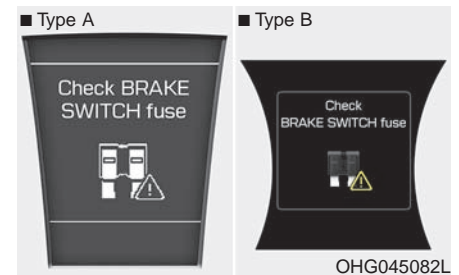

When the brake switch fuse is disconnected, the warning illuminates for 10 seconds on the LCD display. Replace the fuse with a new one. If that is not possible you can start the engine by pressing the ENGINE START/STOP button for 10 seconds in ACC.

### Door /Trunk open

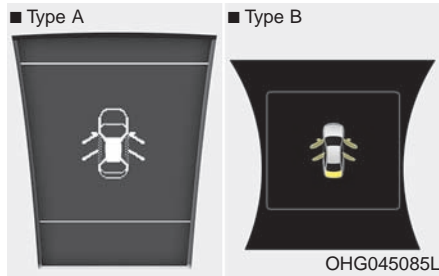

This indicator displays which door (or trunk) is opened.

### Sunroof open (if equipped)

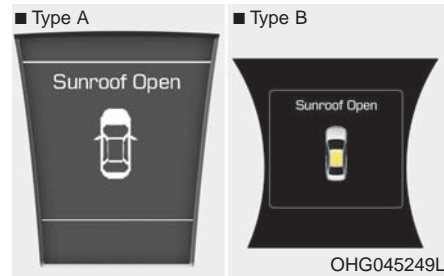

This warning message illuminates if you turn off the engine when the sunroof is open.

### Illumination

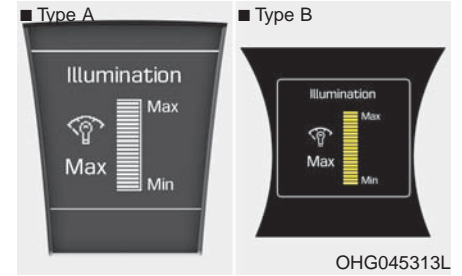

The illumination intensity of the instrument panel is shown when adjusting it with the illumination control switch.

### Low washer fluid

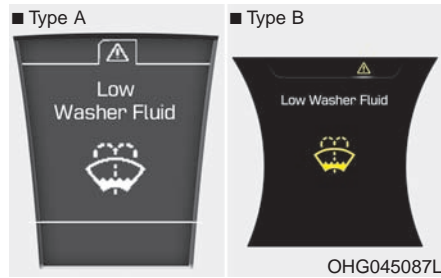

This warning light illuminates for 12 seconds when the washer fluid reservoir is nearly empty. Refill the washer fluid as soon as possible.

### Parking assist warning

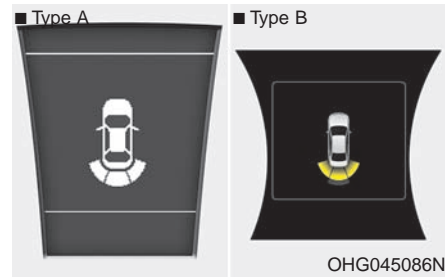

Displays the area an obstacle is detected while moving forward or rearward.

### Low Tire Pressure

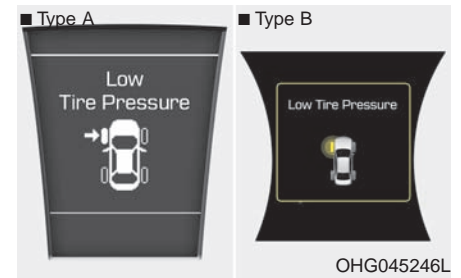

This warning message illuminates if the tire pressure is low with the Engine/Start button in ON position.

**For more details, refer to "Tire Pressure Monitoring System (TPMS)" in chapter 6.**

### Turn on "FUSE SWITCH"

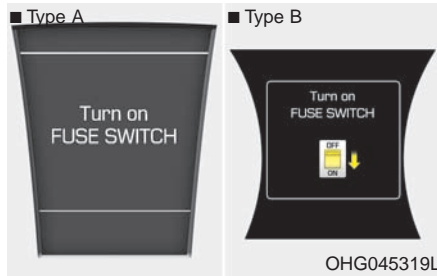

This warning message illuminates if the fuse switch located on the fuse box under the steering wheel is OFF. It means that you should turn the fuse switch on.

**For more details, refer to "Fuses" in chapter 7.**

### Align steering wheel (if equipped)

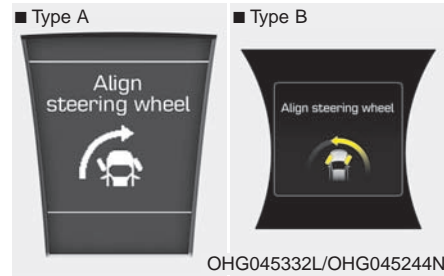

This warning message illuminates if you start the engine when the steering wheel is turned to more than 90 degrees to the left or right. It means that you should turn the steering wheel and make the angle of the steering wheel be less than 30 degrees.

### Steering wheel aligning is completed (if equipped)

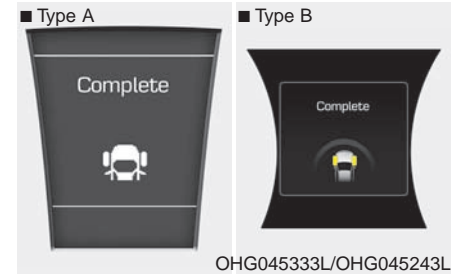

If the steering wheel aligning is completed after "Align steering wheel" warning message is displayed, this message is displayed for 2 seconds.

### Low Fuel

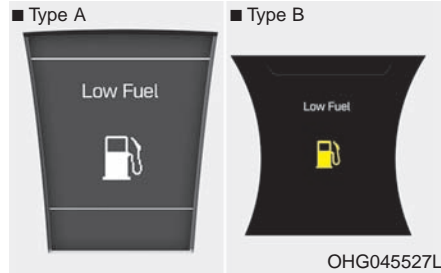

This warning message illuminates if the fuel tank is nearly empty.

- When the low fuel level warning light is illuminates.
- When the trip computer displays "-- mile (or km)" as distance to empty.

Add fuel as soon as possible.

### Engine has overheated

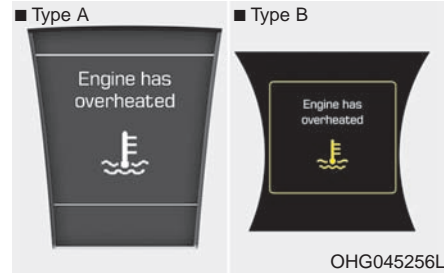

This warning message illuminates when the engine coolant temperature is above 120°C (248°F). This means that the engine is overheated and may be damaged.

**If your vehicle is overheated, refer to "Overheating" in chapter 6.**

## REAR PARKING ASSIST SYSTEM (IF EQUIPPED)

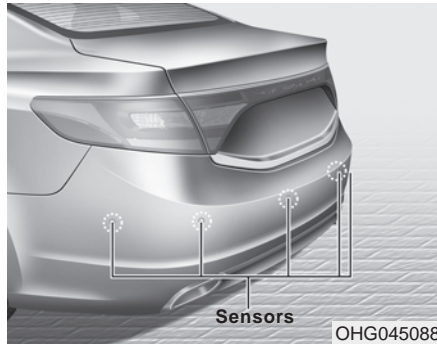

The rear parking assist system assists the driver during reverse movement of the vehicle by chiming if any object is sensed within a distance of 47 in. (120 cm) behind the vehicle. This system is a supplemental system and it is not intended to nor does it replace the need for extreme care and attention of the driver. The sensing range and objects detectable by the back sensors are limited. Whenever backing-up, pay as much attention to what is behind you as you would in a vehicle without a rear parking assist system.

### **⚠ WARNING - Rear parking**

The rear parking assist system is a supplementary function only. The operation of the rear parking assist system can be affected by several factors (including environmental conditions). To avoid collision with children, pedestrians, objects, or vehicles, the driver should always check the area behind the vehicle before and while backing up, otherwise serious injuries could occur.

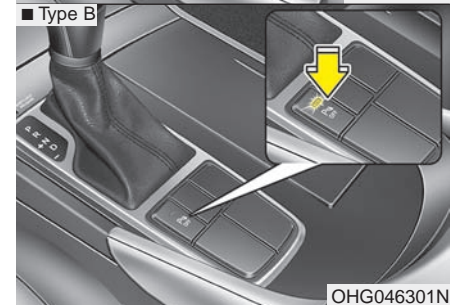
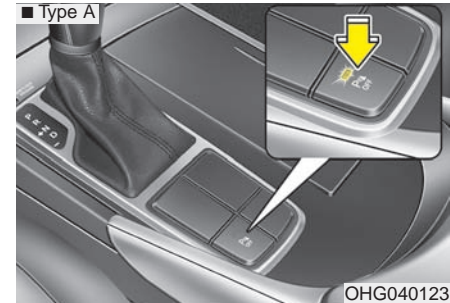

### **Rear parking assist system OFF button**

To turn off the rear parking assist system, push the button (the indicator light will illuminate).

## Operation of the rear parking assist system



### Operating condition

- This system will activate when backing up with the ignition switch ON.
- The sensing distance while the rear parking assist system is in operation is approximately 47 in. (120 cm).
- When more than two objects are sensed at the same time, the closest one will be recognized first.

### \* NOTICE

The parking assist system may not operate if the vehicle's distance from the object is already less than approximately 12 in (30 cm) when the system is ON.

### Types of warning sound and indicator

Types of warning sound	Indicator
When an object is 47 in. to 24 in. (120 cm to 60 cm) from the rear bumper : Buzzer beeps intermittently.	
When an object is 24 in. to 12 in. (60 cm to 30 cm) from the rear bumper : Buzzer beeps more frequently.	
When an object is within 12 in. (30 cm) of the rear bumper : Buzzer beeps continuously.	

### \* NOTICE

- The indicator may differ from the illustration according to the objects or sensors status.
- If the indicator blinks, have the system checked by an authorized HYUNDAI dealer.
- The actual indicator in the vehicle may be different from the illustration.



### **Non-operational conditions of rear parking assist system**

#### **The rear parking assist system may not operate properly when:**

1. Moisture is frozen to the sensor. (It will operate normally when the moisture has been cleared.)
2. The sensor is covered with foreign matter, such as snow or water, or the sensor cover is blocked. (It will operate normally when the material is removed or the sensor is no longer blocked.)
3. Driving on uneven road surfaces (unpaved roads, gravel, bumps, gradient).
4. Objects generating excessive noise (vehicle horns, loud motorcycle engines, or truck air brakes) are within range of the sensor.
5. Heavy rain or water spray exists.
6. Wireless transmitters or mobile phones are within range of the sensor.
7. The sensor is covered with snow.
8. Trailer towing

#### **The detecting range may decrease when:**

1. The sensor is stained with foreign matter such as snow or water. (The sensing range will return to normal when removed.)
2. Outside air temperature is extremely hot or cold.

#### **The following objects may not be recognized by the sensor:**

1. Sharp or slim objects such as ropes, chains or small poles.
2. Objects which tend to absorb the sensor frequency such as clothes, spongy material or snow.
3. Undetectable objects smaller than 40 in. (1 m) in height and narrower than 6 in. (14 cm) in diameter.

### **Rear parking assist system precautions**

- The rear parking assist system may not sound sequentially depending on the speed and shapes of the objects detected.
- The rear parking assist system may malfunction if the vehicle bumper height or sensor installation has been modified or damaged. Any non-factory installed equipment or accessories may also interfere with the sensor performance.
- The sensor may not recognize objects less than 9.84 in. (25 cm) from the sensor, or it may sense an incorrect distance. Use caution.
- When the sensor is frozen or stained with snow, dirt, or water, the sensor may be inoperative until the stains are removed using a soft cloth.
- Do not push, scratch or strike the sensor. Sensor damage could occur.

This system can only sense objects within the range and location of the sensors; it can not detect objects in other areas where sensors are not installed. Also, small or slim objects, such as poles or objects located between sensors may not be detected by the sensors.

Always visually check behind the vehicle when backing up.

Be sure to inform any drivers of the vehicle that may be unfamiliar with the system regarding the systems capabilities and limitations.

**⚠ WARNING - Objects**  
**Pay close attention when the vehicle is driven close to objects on the road, particularly pedestrians, and especially children. Be aware that some objects may not be detected by the sensors, due to the object's distance, size or material, all of which can limit the effectiveness of the sensor. To avoid collisions with children, pedestrians, objects, and vehicles, always perform a visual inspection to make sure the vehicle is clear of all obstructions before moving the vehicle in any direction. Otherwise serious injuries could occur.**

### Self-diagnosis

When you shift the gear to the R (Reverse) position and if one or more of the below occurs you may have a malfunction in the rear parking assist system.

- You do not hear an audible warning sound or if the buzzer sounds intermittently.
-  is displayed.

(blinks)

If this occurs, have your vehicle checked by an authorized HYUNDAI dealer as soon as possible.

### \* NOTICE

Your new vehicle warranty does not cover any accidents or damage to the vehicle or injuries to its occupants due to a rear parking assist system malfunction. Always drive safely and cautiously.

## REARVIEW CAMERA (IF EQUIPPED)



OHG043095A

The rearview camera will activate when the back-up light is ON with the ignition switch ON and the shift lever in the R (Reverse) position.

This system is a supplemental system that shows behind the vehicle through the display monitor while backing-up.

Always keep the camera lens clean. If the lens is covered with foreign matter, the camera may not operate normally.

### **⚠ WARNING - Rearview camera**

The rear view camera is not a safety device. It only serves to assist the driver in identifying objects directly behind the middle of the vehicle. The camera does **NOT** cover the complete area behind the vehicle. While the camera's display is generally accurate, objects can be much closer than they appear in the display screen and can be distorted in both size and proportion.

### **⚠ WARNING - Backing & using camera**

Never rely solely on the rear view camera when reversing. You must always view the area behind you including looking over both shoulders as well as continuously checking all three rear view mirrors. Due to the difficulty of ensuring that the area behind you remains clear, always back slowly and stop immediately if you even suspect that a person, and especially a child, might be behind you. Otherwise serious injury or death could occur.

### HAZARD WARNING FLASHER



The hazard warning flasher should be used whenever you find it necessary to stop the car in a hazardous location. When you must make such an emergency stop, always pull off the road as far as possible.

The hazard warning lights are turned on by pushing in the hazard switch. This causes all turn signal lights to blink. The hazard warning lights will operate even though the key is not in the ignition switch.

To turn the hazard warning lights off, push the switch a second time.

- You can operate the turn signals when the hazard flasher is on. The hazard flasher will rework when you turn off the turn signals.
- The hazard flasher will stop if you push the switch one time while the turn signals and the hazard flasher work simultaneously. To turn the hazard warning lights on again, push the switch a second time.

### LIGHTING

#### Battery saver function

- The purpose of this feature is to prevent the battery from being discharged. The system automatically turns off the parking lights when the driver turns off the engine and opens the driver-side door.
- With this feature, the parking lights will be turned off automatically if the driver parks on the side of the road at night.

If necessary, to keep the lights on when the engine is turned off, perform the following:

- 1) Open the driver-side door.
- 2) Turn the parking lights OFF and ON again using the light switch on the steering column.

#### CAUTION

***If the driver gets out of the vehicle through other doors, the battery saver function does not operate.***

***Therefore, it causes the battery to be discharged. In this case, make sure to turn off the lamp before getting out of the vehicle.***

### Headlight (Headlamp) escort function

If you turn the ignition switch to the ACC or OFF position with the headlights ON, the headlights (and/or parking light) remain on for about 5 minutes. However, if the driver's door is opened and closed, the headlights (and/or parking light) turn off after 15 seconds.

The headlights (and/or parking light) can be turned off by pressing the lock button on the smart key twice or turning the light switch to the OFF or Parking light position.

You can activate or deactivate this feature. Refer to “User Settings Mode” in this section.

### Headlight (Headlamp) welcome function

When the headlight is in the ON or AUTO position and all doors (and trunk) are closed and locked, if you press the door unlock button on the smart key, the headlights (and/or parking light) will come on for about 15 seconds. At this time, if you press the door lock or unlock button, the headlights (and/or parking light) will turn off immediately.

You can activate or deactivate this feature. Refer to “User Settings Mode” in this section.

### Daytime running light

Daytime Running Lights (DRL) can make it easier for others to see the front of your vehicle during the day. DRL can be helpful in many different driving conditions, and it is especially helpful after dawn and before sunset.

- The DRL system turns ON when:
  1. The light switch is in the AUTO light position.
  2. The light switch is in the Parking light position.
- The DRL system turns OFF when:
  1. The multifunction switch is in the DRL OFF position.
  2. The headlights are ON.
  3. The turn signal is ON. (the blinking side of the DRL will turn off)
  4. The hazard warning light is ON.
  5. The parking brake is applied.
  6. Engine stops.

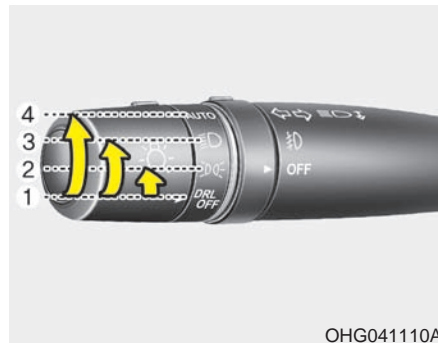

### Lighting control

The light switch has a Headlight and a Parking light position.

To operate the lights, turn the knob at the end of the control lever to one of the following positions:

- (1) OFF position
- (2) Parking light position
- (3) Headlight position
- (4) Auto light position (if equipped)



### Parking light position (P)

When the light switch is in the parking light position, the position, license and instrument panel lights are ON and the position light indicator is ON.



### Headlight position (H)

When the light switch is in the headlight position, the head, position and license plate lights are ON.

The ignition switch must be in the ON position to turn on the headlights.

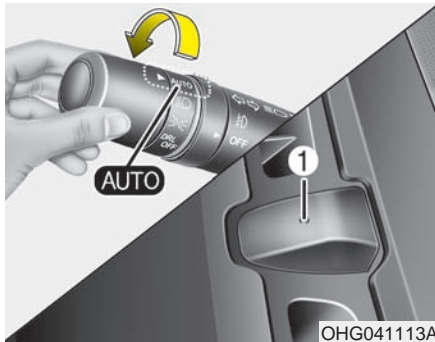

### Auto light position

When the light switch is in the AUTO light position, the parking lights and headlights will be turned ON or OFF automatically depending on the amount of light outside the vehicle.

- Never place anything over sensor (1) located on the instrument panel. This will ensure better auto-light system control.
- Do not clean the sensor using a window cleaner. The cleaner may leave a light film which could interfere with sensor operation.
- If your vehicle has window tint or other types of metallic coating on the front windshield, the Auto light system may not work properly.

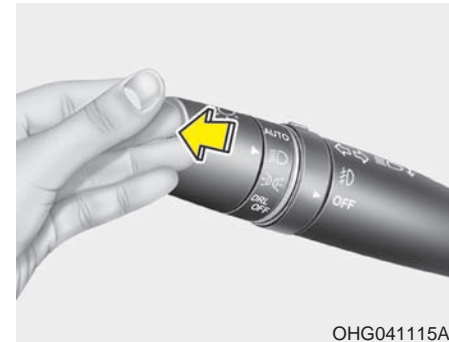

### High beam operation

To turn on the high beam headlights, push the lever away from you. Pull it back for low beams.

The high beam indicator will light when the headlight high beams are switched on.

To prevent the battery from being discharged, do not leave the lights on for a prolonged time while the engine is not running.



To flash the headlights, pull the lever towards you. It will return to the normal (low beam) position when released. The headlight switch does not need to be on to use the flashing feature.

### **⚠ WARNING**



**Do not use high beam when there are surrounding vehicles. Using high beam could obstruct the other driver's vision.**



### **Smart High Beam (if equipped)**

The Smart High Beam is a system that automatically adjusts the headlamp range (switches between high beam and low beam) according to the brightness of other vehicles and road conditions.

### **Operating condition**

1. Place the light switch in the AUTO position.
2. Turn on the high beam by pushing the lever away from you.  
The smart high beam (  ) indicator will illuminate.
3. The Smart High Beam will turn on when vehicle speed is above 28 mph (45km/h).
  - If the lever is pushed away when the Smart High Beam is operating, the Smart High Beam will turn off and the high beam will be on continuously. The smart high beam (  ) indicator will turn off.
  - If the lever is pulled towards you when the Smart High Beam is operating, the Smart High Beam will turn off. The smart high beam (  ) indicator will turn off.
4. If the light switch is placed to the headlamp position, the Smart High Beam will turn off and the low beam will be on continuously.



The high beam switches to low beam in the below conditions.

- When the Smart High Beam is off.
- When the light switch is not in the AUTO position.
- When the headlamp is detected from the on-coming vehicle.
- When the tail lamp is detected from the front vehicle.
- When the surrounding is bright enough high beams are not needed.
- When streetlights or other lights are detected.
- When vehicle speed is below 22 mph (35 km/h).

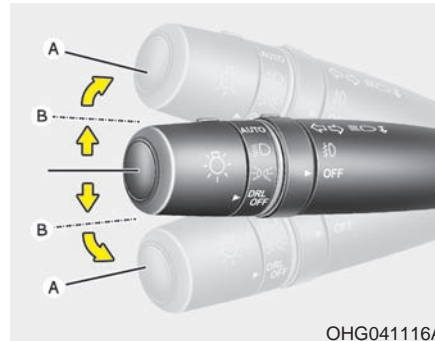

### Turn signals and lane change signals

The ignition switch must be on for the turn signals to function. To turn on the turn signals, move the lever up or down (A). Green arrow indicators on the instrument panel indicate which turn signal is operating. They will self-cancel after a turn is completed. If the indicator continues to flash after a turn, manually return the lever to the OFF position.

To signal a lane change, move the turn signal lever slightly and hold it in position (B). The lever will return to the OFF position when released.

If an indicator stays on and does not flash or if it flashes abnormally, one of the turn signal bulbs may be burned out and will require replacement.

### ***One-touch turn signal***

To activate the one-touch turn signal move the turn signal lever slightly and then release it. The lane change signals will blink 3, 5 or 7 times.

You can activate or deactivate the One-touch turn signal function or choose the number of blinking (3, 5, or 7) from the User Settings Mode on the LCD display.

### **\* NOTICE**

**If an indicator flash is abnormally quick or slow, a bulb may be burned out or have a poor electrical connection in the circuit.**



### **Front fog light**

Fog lights are used to provide improved visibility and avoid accidents when visibility is poor due to fog, rain or snow etc.

The fog lights will turn on when :

1. The headlight is turned on.
2. The fog light switch is turned to the ON position.

To turn off the fog lights, turn the fog light switch (1) to the OFF position or turn off the head lights.

When in operation, the fog lights consume large amounts of vehicle electrical power. Only use the fog lights when visibility is poor.

## WIPERS AND WASHERS

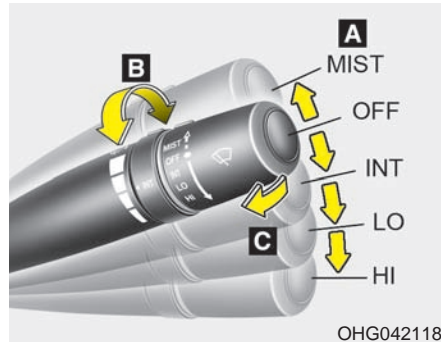

### Windshield wiper/washer

#### A : Wiper speed control

- MIST – Single wipe
- OFF – Off
- INT – Intermittent wipe
- LO – Normal wiper speed
- HI – Fast wiper speed

#### B : Intermittent wipe time adjustment

#### C : Wash with brief wipes

### Windshield wipers

Operates as follows when the ignition switch is turned ON.

**MIST** : For a single wiping cycle, move the lever to the MIST position and release it with the lever in the OFF position. The wipers will operate continuously if the lever is held in this position.

**OFF** : Wiper is not in operation.

**INT** : Wiper operates intermittently at the same wiping intervals. Use this mode in a light rain or mist. To vary the speed setting, turn the speed control knob.

**LO** : Normal wiper speed

**HI** : Fast wiper speed

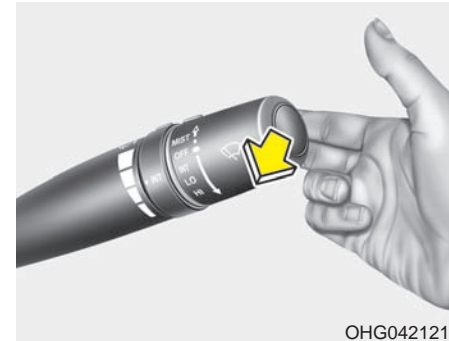

### Windshield washers

In the OFF position, pull the lever gently toward you to spray washer fluid on the windshield and to run the wipers 1-3 cycles.

Use this function when the windshield is dirty.

The spray and wiper operation will continue until you release the lever.

If the washer does not work, check the washer fluid level. If the fluid level is not sufficient, you will need to add appropriate non-abrasive windshield washer fluid to the washer reservoir.

The reservoir filler neck is located in the front of the engine compartment on the passenger side.

 **CAUTION - Washer pump**  
*To prevent possible damage to the washer pump, do not operate the washer when the fluid reservoir is empty.*

 **WARNING - Obscured visibility**  
Do not use the washer in freezing temperatures without first warming the windshield with the defrosters; the washer solution could freeze on contact with the windshield and obscure your vision.

 **CAUTION - Wipers & Windshields**

- *To prevent possible damage to the wipers or windshield, do not operate the wipers when the windshield is dry.*
- *To prevent damage to the wiper blades, do not use gasoline, kerosene, paint thinner, or other solvents on or near them.*
- *To prevent damage to the wiper arms and other components, do not attempt to move the wipers manually.*

## INTERIOR LIGHT

### ⚠ CAUTION

*Do not use the interior lights for extended periods when the engine is not running. It may cause battery discharge.*

### ⚠ WARNING - Interior light

**Do not use the interior lights when driving in the dark. The glare from the interior lights may obstruct your view and cause an accident.**

### Automatic turn off function (if equipped)

The interior lights automatically turn off approximately 20 minutes after the ignition switch is turned off.

With the theft alarm system, the interior lights automatically turns off approximately 5 seconds after the system is in the armed stage.



OHG045122

### Map lamp

- , : Push the switch (1) to turn the map lamp on or off. This light produces a spot beam for convenient use as a map lamp at night or as a personal lamp for the driver and the front passenger.

- When the door switch is pushed:
  - The map lamp and room lamp comes on when a door is opened and closed. The lamps go out after approximately 30 seconds.
  - The map lamp and room lamp comes on for approximately 30 seconds when doors are unlocked with a smart key as long as the doors are not opened.
  - The map lamp and room lamp will stay on for approximately 20 minutes if a door is opened with the ignition switch in the ACC or OFF position.
  - The map lamp and room lamp will stay on continuously if the door is opened with the ignition switch in the ON position.
  - The map lamp and room lamp will go out immediately if the ignition switch is changed to the ON position or all doors are locked.
  - Push the switch once more to turn off the door switch.

## Features of your vehicle

- ☀️ : Press this button to turn the front and rear room lamps on and off.

### Mood lamp (2, if equipped)

- The mood lamp turns on when the ENGINE START/STOP button is in the ACC or above position.
- The mood lamp will turn off when the ENGINE START/STOP button is in the OFF position.

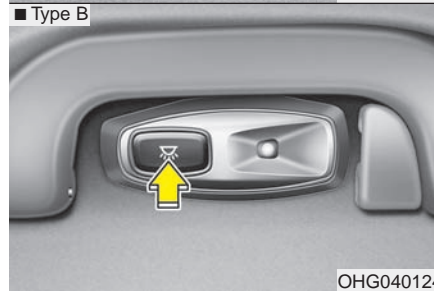
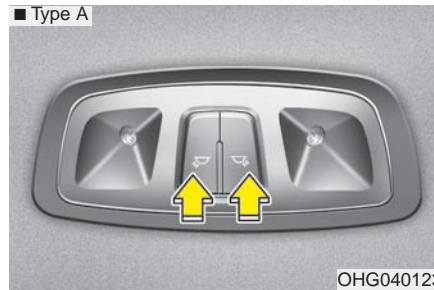

### Room lamp

Press the button to turn the light on or off.

### ⚠️ CAUTION

*Do not leave the lamp switches on for an extended period of time when the vehicle is not running.*

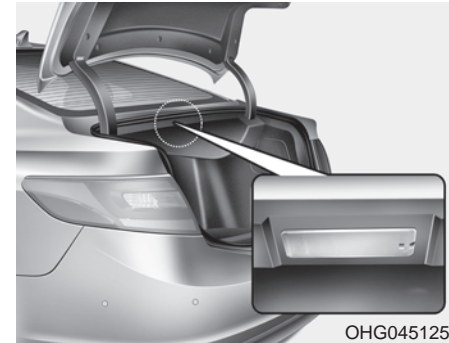

### Trunk room lamp

The trunk room lamp comes on for 20 minutes when the trunk is opened.

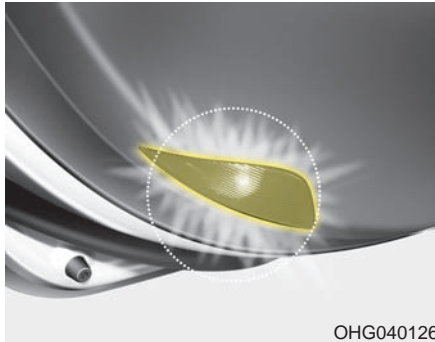

### Door courtesy lamp

The door courtesy lamp comes ON when the door is opened to assist entering or exiting the vehicle. It also serves as a warning to passing vehicles that the vehicle door is opened.

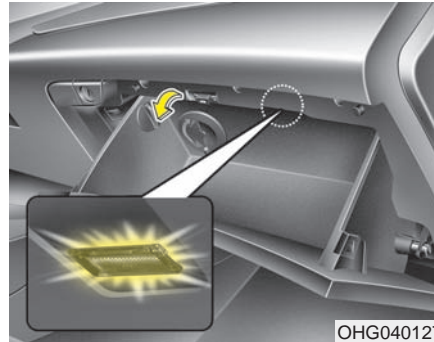

### Glove box lamp

The glove box lamp comes on when the glove box is opened. The parking lights or headlights must be ON for the glove box lamp to function.

**⚠ CAUTION**

*To prevent unnecessary charging system drain, close the glove box securely after using the glove box.*



### Vanity mirror lamp

Opening the lid of the vanity mirror will automatically turn on the mirror light.

**⚠ CAUTION**

*To prevent unnecessary charging system drain, close the vanity mirror cover after using the mirror.*

## DEFROSTER

**⚠ CAUTION - Conductors**  
*To prevent damage to the conductors bonded to the inside surface of the rear window, never use sharp instruments or window cleaners containing abrasives to clean the window.*

### \* NOTICE

If you want to defrost and defog the front windshield, refer to “Windshield defrosting and defogging” in this section.

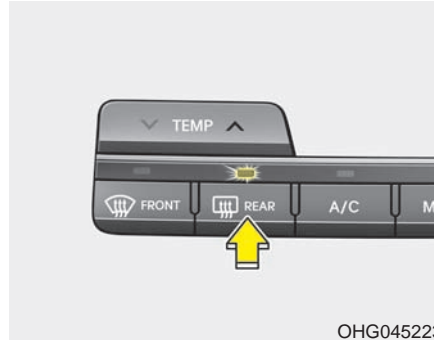

### Rear window defroster

The defroster heats the window to remove frost, fog and thin ice from the rear window, while the engine is running.

- To activate the rear window defroster, press the rear window defroster button located in the center facia switch panel.
- The indicator on the rear window defroster button illuminates when the defroster is ON.
- The rear window defroster automatically turns off after approximately 20 minutes or when the ignition switch is turned off.

- To turn off the defroster, press the rear window defroster button again.

If there is heavy accumulation of snow on the rear window, brush it off before operating the rear defroster.

### *Outside rearview mirror defroster (if equipped)*

If your vehicle is equipped with the outside rearview mirror defrosters, they will operate at the same time you turn on the rear window defroster.



## AUTOMATIC CLIMATE CONTROL SYSTEM (TYPE A)



1. Fan speed control knob
2. AUTO (automatic control) button
3. OFF button
4. Driver's temperature control switch
5. Passenger's temperature control switch
6. Front windshield defroster button
7. Rear window defroster button
8. Air conditioning button
9. Mode selection button
10. Air intake control button
11. SYNC button

OHG045516L



### Automatic heating and air conditioning

1. Push the AUTO button.

The modes, fan speeds, air intake and air-conditioning will be controlled automatically by setting the temperature.

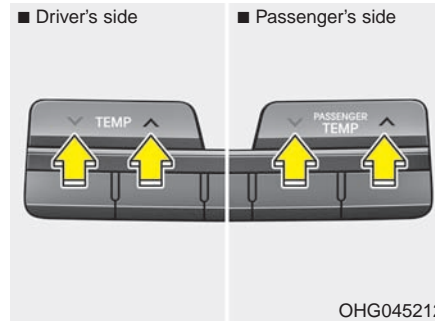

2. Set the temperature to the desired temperature.

### \* NOTICE

- To turn the automatic operation off, select any button or switch of the following:
  - Mode selection switch
  - Air conditioning button
  - Front windshield defroster button (Press the button one more time to deselect the front windshield defroster function. The 'AUTO' sign will illuminate on the information display once again.)
  - Air intake control button
  - Fan speed control knobThe selected function will be controlled manually while other functions operate automatically.
- For your convenience and to improve the effectiveness of the climate control, use the AUTO button and set the temperature to 73°F (23°C).

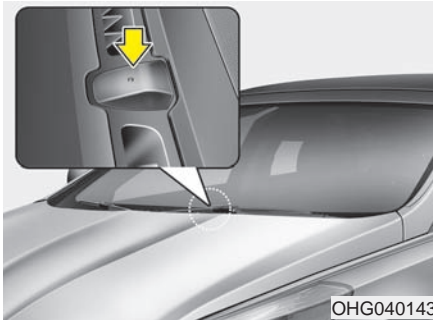



Never place anything over the sensor located on the instrument panel to ensure better control of the heating and cooling system.

### Manual heating and air conditioning

The heating and cooling system can be controlled manually by pushing buttons other than the AUTO button. In this case, the system works sequentially according to the order of buttons selected.

When pressing any button except the AUTO button while using automatic operation, the functions not selected will be controlled automatically.

1. Start the engine.
  2. Set the mode to the desired position.  
To improve the effectiveness of heating and cooling:
    - Heating: 
    - Cooling: 
  3. Set the temperature control to the desired position.
  4. Set the air intake control to the outside (fresh) air position.
  5. Set the fan speed control to the desired speed.
  6. If air conditioning is desired, turn the air conditioning system on.
- Press the AUTO button in order to convert to full automatic control of the system.

## Features of your vehicle

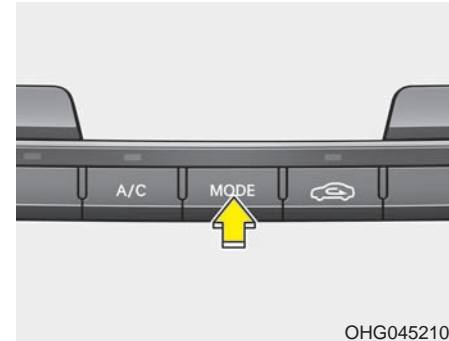
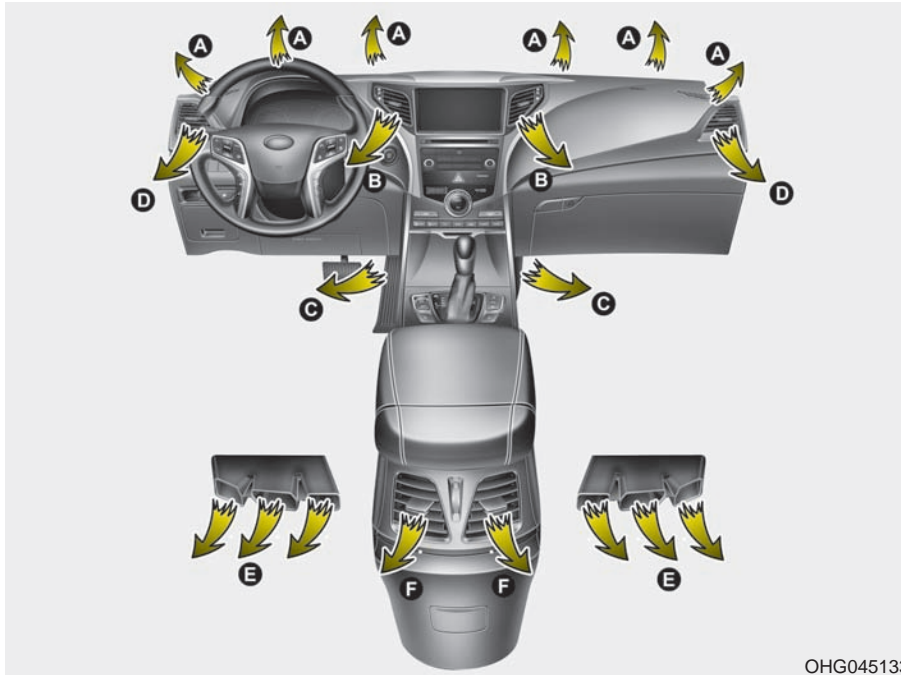

### **Mode selection**

The mode selection switch controls the direction of the air flow through the ventilation system.

The air flow outlet port is converted as follows:





**Floor-Level (A, C, D, E)**

Most of the air flow is directed to the floor, with a small amount of air directed to the windshield and side window defrosters.



**Bi-Level (B, C, D, E, F)**

Air flow is directed towards the face and the floor.



**Face-Level (B, C, D, E, F)**

Air flow is directed toward the upper body and face. Additionally, each outlet can be controlled to direct the air discharged from the outlet.



**Floor & Defrost (A, C, D, E)**

Most of the air flow is directed to the floor and the windshield with a small amount directed to the side window defrosters.

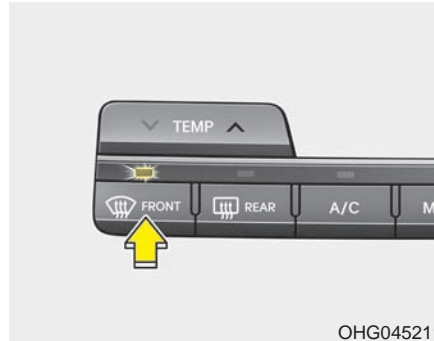

OHG045211

**Defrost-Level**

Most of the air flow is directed to the windshield with a small amount of air directed to the side window defrosters.

**\* NOTICE**

The defrost mode is more effective when a warmer air temperature setting is selected.

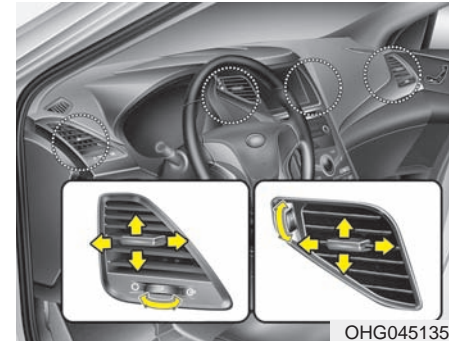

OHG045135

**Instrument panel vents**

The outlet vents can be opened or closed separately using the thumb-wheel.

Also, you can adjust the direction of air delivery from these vents using the vent control lever as shown.

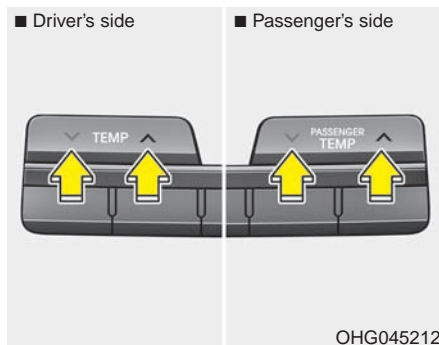

### Temperature control

The temperature will increase to the maximum (HIGH) by pressing  part of the switch.

The temperature will decrease to the minimum (LOW) by pressing  part of the switch.

When pressing the switch, the temperature will increase or decrease by 1°F (0.5 °C). When set to the lowest temperature setting, the air conditioning may operate.

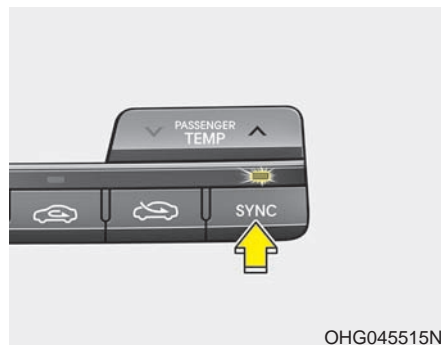

### Adjusting the driver and passenger side temperature equally

- Press the “SYNC” button to adjust the driver and passenger side temperature equally.

The passenger side temperature will be set to the same temperature as the driver side temperature.

- Operate the driver side temperature control. The driver and passenger side temperature will be adjusted equally.

### Adjusting the driver and passenger side temperature individually

- Press the “SYNC” button again to adjust the driver and passenger side temperature individually. The illumination of button turns off.
- Operate the driver side temperature control to adjust the driver side temperature.
- Operate the passenger side temperature control to adjust the passenger side temperature.

### Temperature conversion

If the battery has been discharged or disconnected, the temperature mode display will reset to Centigrade.

This is a normal condition. You can switch the temperature mode between Centigrade to Fahrenheit as follows;

While pressing the OFF button, press the AUTO button for 3 seconds or more. The display will change from Centigrade to Fahrenheit, or from Fahrenheit to Centigrade.

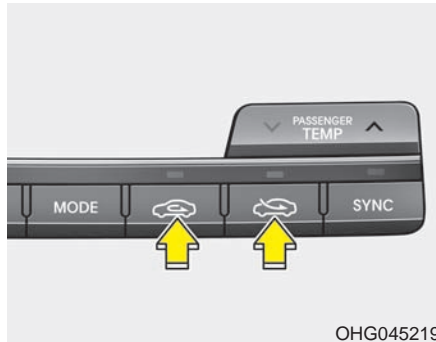

OHG045219

### ***Air intake control***

This is used to select the outside (fresh) air position or recirculated air position.

To change the air intake control position, push the control button.

### **Recirculated air position**



With the recirculated air position selected, air from the passenger compartment will be drawn through the heating system and heated or cooled according to the function selected.

### **Outside (fresh) air position**



With the outside (fresh) air position selected, air enters the vehicle from outside and is heated or cooled according to the function selected.

### **\* NOTICE**

While driving at high speed with the recirculation air position mode, fresh air may automatically enter the vehicle to provide ventilation of the inside air.

### **⚠ WARNING**

- **Continuous use of the climate control system in the recirculated air position can cause drowsiness or sleepiness, and loss of vehicle control. Set the air intake control to the outside (fresh) air position as much as possible while driving.**
- **Continued climate control system operation in the recirculated air position may allow humidity to increase inside vehicle which may fog the glass and obscure visibility.**
- **Do not sleep in a vehicle with the air conditioning or heating system on. It may cause serious harm or death due to a drop in the oxygen level and/or body temperature.**

It should be noted that prolonged operation of the heating in recirculated air position will cause fogging of the windshield and side windows and the air within the passenger compartment will become stale.

In addition, prolonged use of the air conditioning with the recirculated air position selected, will result in excessively dry air in the passenger compartment.



### ***Fan speed control***

The fan speed control knob allows you to control the fan speed of the airflow in the vehicle.

To change the fan speed:

- Turn the knob to the right (+) to increase fan speed.
- Turn the knob to the left (-) to decrease fan speed.

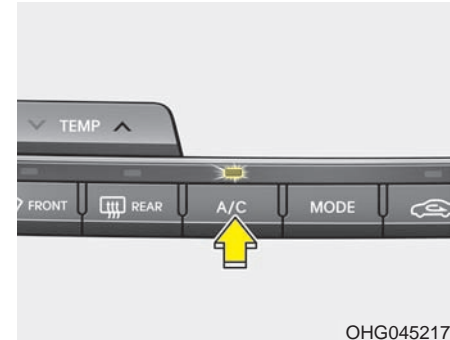

### ***Air conditioning***

Press the A/C button to turn the air conditioning system on (indicator light will illuminate).

Press the button again to turn the air conditioning system off.





OHG045218

### OFF mode



Press the OFF button to turn off the air climate control system. However, you can still operate the mode and air intake buttons as long as the ignition switch is in the ON position.

## System operation

### Ventilation

1. Set the mode to the  position.
2. Set the air intake control to the outside (fresh) air position.
3. Set the temperature control to the desired position.
4. Set the fan speed control to the desired speed.

### Heating

1. Set the mode to the  position.
2. Set the air intake control to the outside (fresh) air position.
3. Set the temperature control to the desired position.
4. Set the fan speed control to the desired speed.
5. If dehumidified heating is desired, turn the air conditioning system (if equipped) on.
  - If the windshield fogs up, set the mode to the  or  position.

### Operation Tips

- To keep dust or unpleasant fumes from entering the vehicle through the ventilation system, temporarily set the air intake control to the recirculated air position. Be sure to return the control to the fresh air position when the irritation has passed to keep fresh air in the vehicle. This will help keep the driver alert and comfortable.
- Air for the heating/cooling system is drawn in through the grilles just ahead of the windshield. Care should be taken that these are not blocked by leaves, snow, ice or other obstructions.
- To prevent interior fog on the windshield, set the air intake control to the fresh air position and fan speed to the desired position, turn on the air conditioning system, and adjust the temperature control to desired temperature.

### **Air conditioning**

HYUNDAI Air Conditioning Systems are filled with environmentally friendly R-134a refrigerant.

1. Start the engine. Press the air conditioning button.
2. Set the mode to the  position.
3. Set the air intake control to the outside air or recirculated air position.
4. Adjust the fan speed control and temperature control to maintain maximum comfort.

### **\* NOTICE - Excessive A/C**

**When using the air conditioning system, monitor the engine coolant closely while driving up hills or in heavy traffic when outside temperatures are high. Air conditioning system operation may cause engine overheating and potential engine damage. Continue to use the blower fan but turn the air conditioning system off if the engine coolant temperature gauge indicates engine overheating.**

### **Air conditioning system operation tips**

- If the vehicle has been parked in direct sunlight during hot weather, open the windows for a short time to let the hot air inside the vehicle escape.
  - To help reduce moisture inside of the windows on rainy or humid days, decrease the humidity inside the vehicle by operating the air conditioning system.
  - During air conditioning system operation, you may occasionally notice a slight change in engine speed as the air conditioning compressor cycles. This is a normal system operation characteristic.
  - Use the air conditioning system every month only for a few minutes to ensure maximum system performance.
  - When using the air conditioning system, you may notice clear water dripping (or even puddling) on the ground under the passenger side of the vehicle. This is a normal system operation characteristic.
- Operating the air conditioning system in the recirculated air position provides maximum cooling, however, continual operation in this mode may cause the air inside the vehicle to become stale. After sufficient cooling has been achieved, switch back from the recirculated air to the fresh outside air position.
  - During cooling operation, you may occasionally notice a misty air flow because of rapid cooling and humid air intake. This is a normal system operation characteristic.

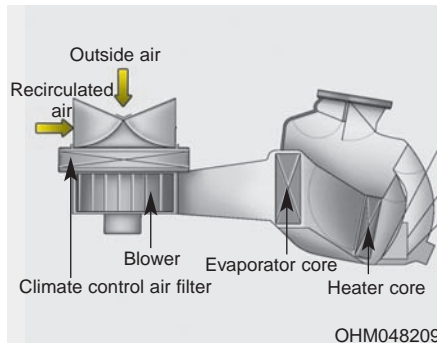

### Climate control air filter

The climate control air filter installed behind the glove box filters the dust or other pollutants that come into the vehicle from the outside through the heating and air conditioning system. If dust or other pollutants accumulate in the filter over a period of time, the air flow from the air vents may decrease, resulting in moisture accumulation on the inside of the windshield even when the outside (fresh) air position is selected. If this happens, have the climate control air filter replaced by an authorized HYUNDAI dealer.

### \* NOTICE

- Replace the filter according to the Maintenance Schedule. If the vehicle is being driven in severe conditions such as dusty or rough roads, more frequent air conditioner filter inspections and changes are required.
- When the air flow rate suddenly decreases, the system should be checked at an authorized HYUNDAI dealer.

### Checking the amount of air conditioner refrigerant and compressor lubricant

When the amount of refrigerant is low, the performance of the air conditioning is reduced. Overfilling also has a negative impact on the air conditioning system.

Therefore, if abnormal operation is found, have the system inspected by an authorized HYUNDAI dealer.

### CAUTION - Compressor damage

*It is important that the correct type and amount of oil and refrigerant is used. Otherwise, damage to the compressor and abnormal system operation may occur.*

The air conditioning system should be serviced by an authorized HYUNDAI dealer.

## AUTOMATIC CLIMATE CONTROL SYSTEM (TYPE B)



1. Fan speed control knob
2. AUTO (automatic control) button
3. OFF button
4. Driver's temperature control switch
5. Passenger's temperature control switch
6. Front windshield defroster button
7. Rear window defroster button
8. Air conditioning button
9. Mode selection button
10. Air intake control button
11. Climate information screen selection button
12. SYNC button

OHG045514L



OHG045216

### Automatic heating and air conditioning

1. Push the AUTO button.

The modes, fan speeds, air intake and air-conditioning will be controlled automatically by setting the temperature.

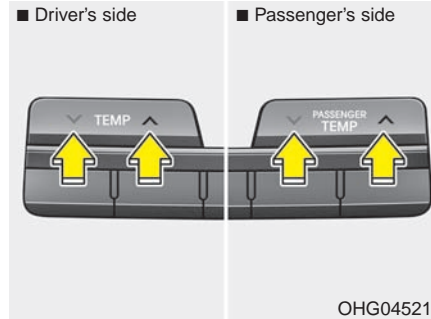

OHG045212

2. Set the temperature to the desired temperature.

### \* NOTICE

- To turn the automatic operation off, select any button or switch of the following:
  - Mode selection switch
  - Air conditioning button
  - Front windshield defroster button (Press the button one more time to deselect the front windshield defroster function. The 'AUTO' sign will illuminate on the information display once again.)
  - Air intake control button
  - Fan speed control knob
 The selected function will be controlled manually while other functions operate automatically.
- For your convenience and to improve the effectiveness of the climate control, use the AUTO button and set the temperature to 73°F (23°C).

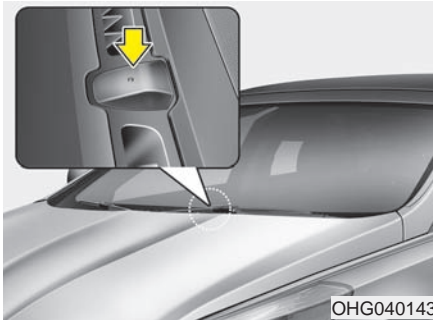

Never place anything over the sensor located on the instrument panel to ensure better control of the heating and cooling system.

### Manual heating and air conditioning

The heating and cooling system can be controlled manually by pushing buttons other than the AUTO button. In this case, the system works sequentially according to the order of buttons selected.

When pressing any button except the AUTO button while using automatic operation, the functions not selected will be controlled automatically.

1. Start the engine.
2. Set the mode to the desired position.

To improve the effectiveness of heating and cooling:

- Heating: 

- Cooling: 

3. Set the temperature control to the desired position.
4. Set the air intake control to the outside (fresh) air position.
5. Set the fan speed control to the desired speed.
6. If air conditioning is desired, turn the air conditioning system on.

Press the AUTO button in order to convert to full automatic control of the system.

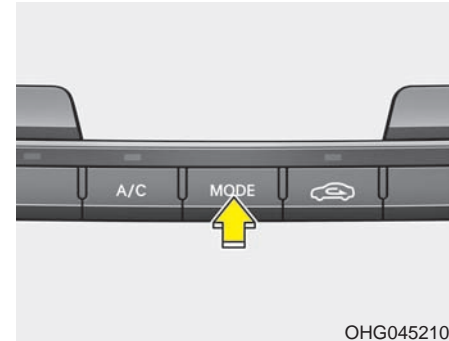
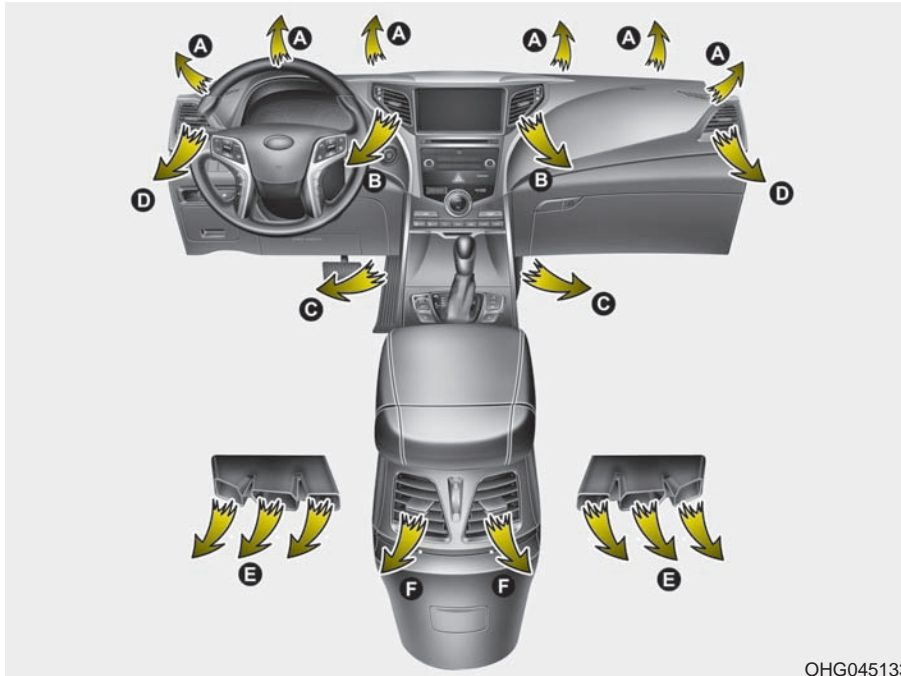

**Mode selection**

The mode selection switch controls the direction of the air flow through the ventilation system.

The air flow outlet port is converted as follows:





### Floor-Level (A, C, D, E)

Most of the air flow is directed to the floor, with a small amount of air directed to the windshield and side window defrosters.



### Bi-Level (B, C, D, E, F)

Air flow is directed towards the face and the floor.



### Face-Level (B, C, D, E, F)

Air flow is directed toward the upper body and face. Additionally, each outlet can be controlled to direct the air discharged from the outlet.



### Floor & Defrost (A, C, D, E)

Most of the air flow is directed to the floor and the windshield with a small amount directed to the side window defrosters.

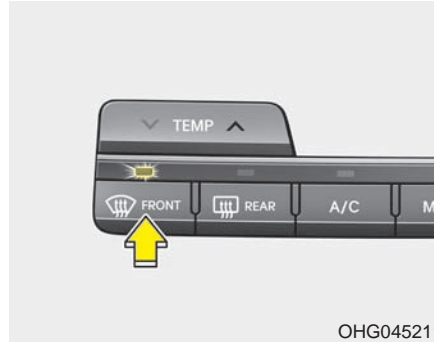

### Defrost-Level

Most of the air flow is directed to the windshield with a small amount of air directed to the side window defrosters.

### \* NOTICE

The defrost mode is more effective when a warmer air temperature setting is selected.

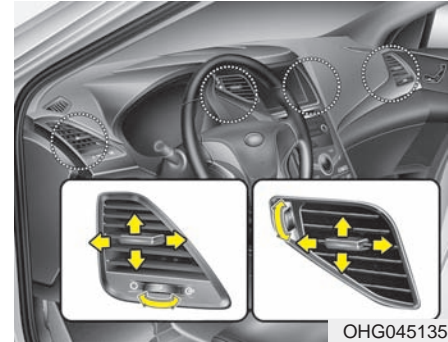

### Instrument panel vents

The outlet vents can be opened or closed separately using the thumb-wheel.

Also, you can adjust the direction of air delivery from these vents using the vent control lever as shown.



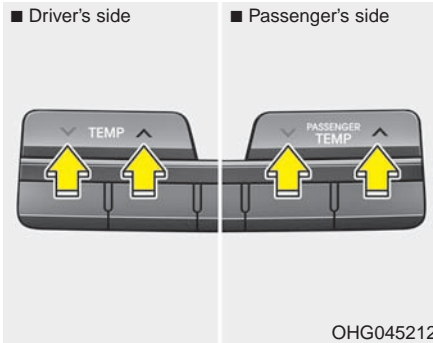

### Temperature control

The temperature will increase to the maximum (HIGH) by pressing  $\wedge$  part of the switch.

The temperature will decrease to the minimum (LOW) by pressing  $\vee$  part of the switch.

When pressing the switch, the temperature will increase or decrease by 1°F (0.5 °C). When set to the lowest temperature setting, the air conditioning may operate.

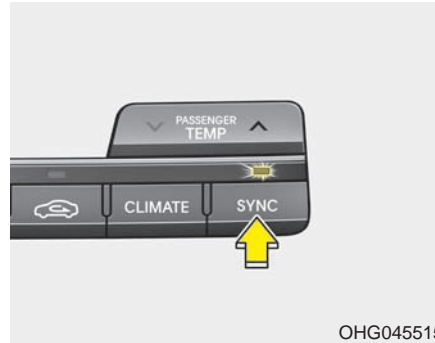

### Adjusting the driver and passenger side temperature equally

- Press the “SYNC” button to adjust the driver and passenger side temperature equally. The passenger side temperature will be set to the same temperature as the driver side temperature.
- Operate the driver side temperature control. The driver and passenger side temperature will be adjusted equally.

### Adjusting the driver and passenger side temperature individually

- Press the “SYNC” button again to adjust the driver and passenger side temperature individually. The illumination of button turns off.
- Operate the driver side temperature control to adjust the driver side temperature.
- Operate the passenger side temperature control to adjust the passenger side temperature.

### Temperature conversion

If the battery has been discharged or disconnected, the temperature mode display will reset to Centigrade.

This is a normal condition. You can switch the temperature mode between Centigrade to Fahrenheit as follows;

While pressing the OFF button, press the AUTO button for 3 seconds or more. The display will change from Centigrade to Fahrenheit, or from Fahrenheit to Centigrade.

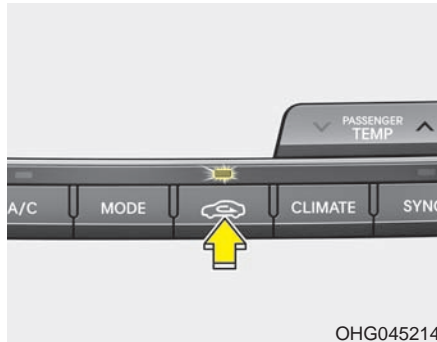

### ***Air intake control***

This is used to select the outside (fresh) air position or recirculated air position.

To change the air intake control position, push the control button.

### **Recirculated air position**



With the recirculated air position selected, air from the passenger compartment will be drawn through the heating system and heated or cooled according to the function selected.

### **Outside (fresh) air position**



With the outside (fresh) air position selected, air enters the vehicle from outside and is heated or cooled according to the function selected.

### **\* NOTICE**

While driving at high speed with the recirculation air position mode, fresh air may automatically enter the vehicle to provide ventilation of the inside air.

### **⚠ WARNING**

- Continuous use of the climate control system in the recirculated air position can cause drowsiness or sleepiness, and loss of vehicle control. Set the air intake control to the outside (fresh) air position as much as possible while driving.
- Continued climate control system operation in the recirculated air position may allow humidity to increase inside vehicle which may fog the glass and obscure visibility.
- Do not sleep in a vehicle with the air conditioning or heating system on. It may cause serious harm or death due to a drop in the oxygen level and/or body temperature.

It should be noted that prolonged operation of the heating in recirculated air position will cause fogging of the windshield and side windows and the air within the passenger compartment will become stale.

In addition, prolonged use of the air conditioning with the recirculated air position selected, will result in excessively dry air in the passenger compartment.



#### ***Fan speed control***

The fan speed control knob allows you to control the fan speed of the airflow in the vehicle.

To change the fan speed:

- Turn the knob to the right (+) to increase fan speed.
- Turn the knob to the left (-) to decrease fan speed.

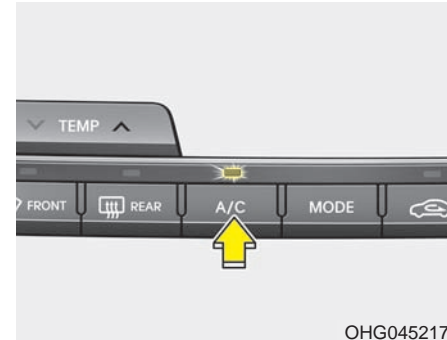

#### ***Air conditioning***

Press the A/C button to turn the air conditioning system on (indicator light will illuminate).

Press the button again to turn the air conditioning system off.



### **OFF mode**

Press the OFF button to turn off the air climate control system. However, you can still operate the mode and air intake buttons as long as the ignition switch is in the ON position.

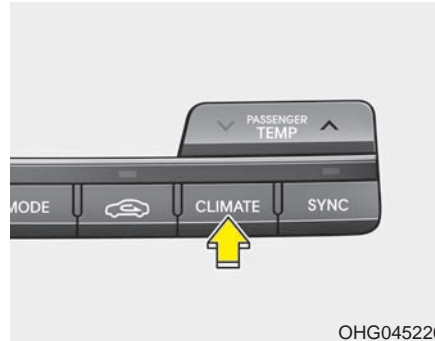

### **Climate information screen selection**



Press the climate information screen selection button to display climate information on the screen.

## **System operation**

### **Ventilation**

1. Set the mode to the  position.
2. Set the air intake control to the outside (fresh) air position.
3. Set the temperature control to the desired position.
4. Set the fan speed control to the desired speed.

### **Heating**

1. Set the mode to the  position.
2. Set the air intake control to the outside (fresh) air position.
3. Set the temperature control to the desired position.
4. Set the fan speed control to the desired speed.
5. If dehumidified heating is desired, turn the air conditioning system (if equipped) on.
  - If the windshield fogs up, set the mode to the  or  position.

**Operation Tips**

- To keep dust or unpleasant fumes from entering the vehicle through the ventilation system, temporarily set the air intake control to the recirculated air position. Be sure to return the control to the fresh air position when the irritation has passed to keep fresh air in the vehicle. This will help keep the driver alert and comfortable.
- Air for the heating/cooling system is drawn in through the grilles just ahead of the windshield. Care should be taken that these are not blocked by leaves, snow, ice or other obstructions.
- To prevent interior fog on the windshield, set the air intake control to the fresh air position and fan speed to the desired position, turn on the air conditioning system, and adjust the temperature control to desired temperature.

**Air conditioning**

HYUNDAI Air Conditioning Systems are filled with environmentally friendly R-134a refrigerant.

1. Start the engine. Press the air conditioning button.
2. Set the mode to the  position.
3. Set the air intake control to the outside air or recirculated air position.
4. Adjust the fan speed control and temperature control to maintain maximum comfort.

**\* NOTICE - Excessive A/C**

**When using the air conditioning system, monitor the engine coolant closely while driving up hills or in heavy traffic when outside temperatures are high. Air conditioning system operation may cause engine overheating and potential engine damage. Continue to use the blower fan but turn the air conditioning system off if the engine coolant temperature gauge indicates engine overheating.**

**Air conditioning system operation tips**

- If the vehicle has been parked in direct sunlight during hot weather, open the windows for a short time to let the hot air inside the vehicle escape.
- To help reduce moisture inside of the windows on rainy or humid days, decrease the humidity inside the vehicle by operating the air conditioning system.
- During air conditioning system operation, you may occasionally notice a slight change in engine speed as the air conditioning compressor cycles. This is a normal system operation characteristic.
- Use the air conditioning system every month only for a few minutes to ensure maximum system performance.
- When using the air conditioning system, you may notice clear water dripping (or even puddling) on the ground under the passenger side of the vehicle. This is a normal system operation characteristic.

- Operating the air conditioning system in the recirculated air position provides maximum cooling, however, continual operation in this mode may cause the air inside the vehicle to become stale. After sufficient cooling has been achieved, switch back from the recirculated air to the fresh outside air position.
- During cooling operation, you may occasionally notice a misty air flow because of rapid cooling and humid air intake. This is a normal system operation characteristic.

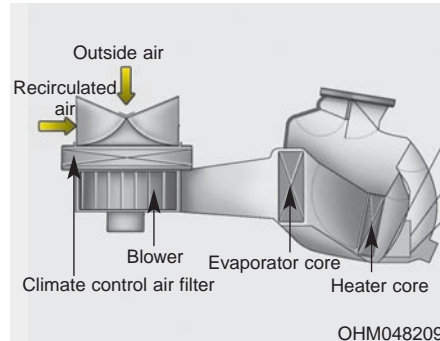

### Climate control air filter

The climate control air filter installed behind the glove box filters the dust or other pollutants that come into the vehicle from the outside through the heating and air conditioning system. If dust or other pollutants accumulate in the filter over a period of time, the air flow from the air vents may decrease, resulting in moisture accumulation on the inside of the windshield even when the outside (fresh) air position is selected. If this happens, have the climate control air filter replaced by an authorized HYUNDAI dealer.

### \* NOTICE

- Replace the filter according to the Maintenance Schedule. If the vehicle is being driven in severe conditions such as dusty or rough roads, more frequent air conditioner filter inspections and changes are required.
- When the air flow rate suddenly decreases, the system should be checked at an authorized HYUNDAI dealer.

■ Example

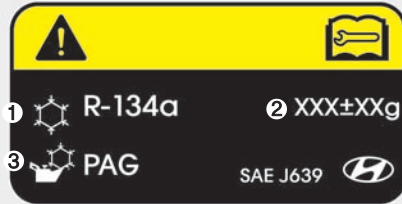

OHG045533N

### Air Conditioning refrigerant label

\* The actual Air Conditioning refrigerant label in the vehicle may differ from the illustration.

Each symbols and specification on air conditioning refrigerant label means as below ;

1. Classification of refrigerant
2. Amount of refrigerant
3. Classification of Compressor lubricant

You can find out which air conditioning refrigerant is applied your vehicle at the label inside of the engine room.

Refer to section 8 for more detail location of air conditioning refrigerant label.

### Checking the amount of air conditioner refrigerant and compressor lubricant

When the amount of refrigerant is low, the performance of the air conditioning is reduced. Overfilling also has a negative impact on the air conditioning system.

Therefore, if abnormal operation is found, have the system inspected by an authorized HYUNDAI dealer.

### **⚠ WARNING - Vehicles equipped with R-134a**





Because the refrigerant is at very high pressure, the air conditioning system should only be serviced by trained and certified technicians. It is important that the correct type and amount of oil and refrigerant is used.

**Otherwise, it may cause damage to the vehicle and personal injury.**

The air conditioning system should be serviced by an authorized HYUNDAI dealer.

## WINDSHIELD DEFROSTING AND DEFOGGING

### **⚠ WARNING - Windshield heating**

Do not use the  or  position during cooling operation in extremely humid weather. The difference between the temperature of the outside air and that of the windshield could cause the outer surface of the windshield to fog up, causing loss of visibility. In this case, set the mode selection knob or button to the  position and fan speed control knob or button to the lower speed. In addition, briefly operate the windshield wipers to clear any fog from the outer surface of the windshield.

- For maximum defrosting, set the temperature control to the extreme right/hot position and the fan speed control to the highest speed.
- If warm air to the floor is desired while defrosting or defogging, set the mode to the floor-defrost position.
- Before driving, clear all snow and ice from the windshield, rear window, outside rear view mirrors, and all side windows.
- Clear all snow and ice from the hood and air inlet in the cowl grill to improve heater and defroster efficiency and to reduce the probability of fogging up the inside of the windshield.

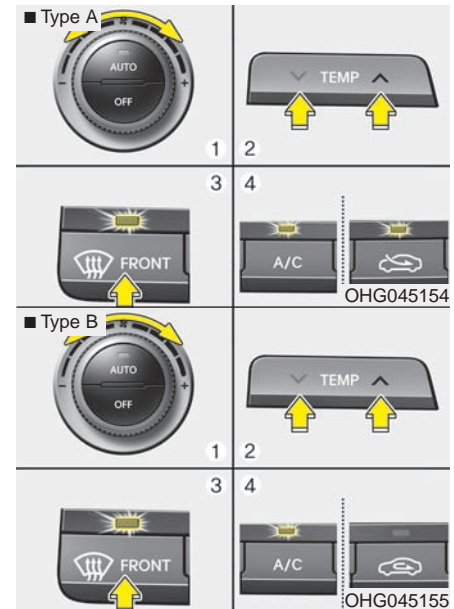

### To defog inside windshield

1. Set the fan speed to the desired position.
2. Select desired temperature.
3. Press the defroster button (.



4. The air conditioning will be turned on according to the detected ambient temperature and outside (fresh) air position will be selected automatically.

If the air conditioning and outside (fresh) air position are not selected automatically, adjust the corresponding button manually. If the  position is selected, lower fan speed is adjusted to a higher fan speed.

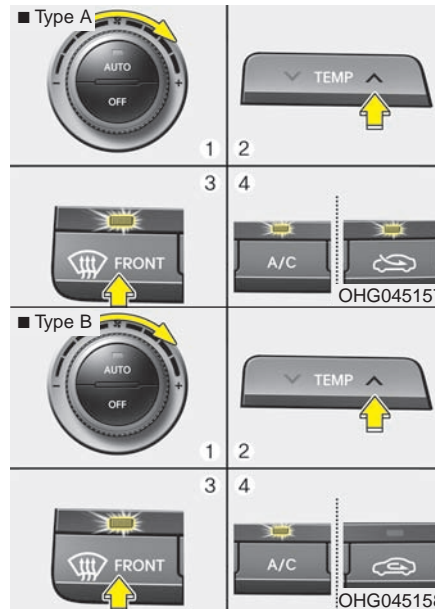



### To defrost outside windshield

1. Set the fan speed to the highest (extreme right) position.
2. Set the temperature to the extreme hot (HIGH) position.
3. Press the defroster button ()

4. The air conditioning will be turned on according to the detected ambient temperature and outside (fresh) air position will be selected automatically.

If the  position is selected, lower fan speed is adjusted to a higher fan speed.

### Defogging logic

To reduce the probability of fogging up the inside of the windshield, the air intake or air conditioning are controlled automatically according to certain conditions such as  or  position. To cancel or return the defogging logic, do the following.

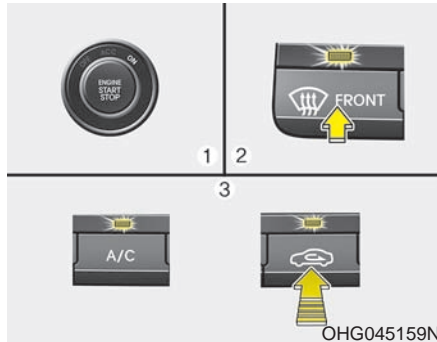

1. Turn the ignition switch to the ON position.
2. Press the defrost button ( ).
3. While holding the air conditioning button (A/C) pressed, press the air intake control button at least 5 times within 3 seconds.

The indicator on the air intake control button blinks 3 times with 0.5 second of interval. It indicates that the defogging logic is canceled or returned to the programmed status.

If the battery has been discharged or disconnected, it resets to the defog logic status.

## STORAGE COMPARTMENTS

These compartments can be used to store small items required by the driver or passengers.

### CAUTION

- *To avoid possible theft, do not leave valuables in the storage compartments.*
- *Always keep the storage compartment covers closed while driving. Do not attempt to place so many items in the storage compartment that the storage compartment cover cannot close securely.*

### WARNING - Flammable materials

**Do not store cigarette lighters, propane cylinders or other flammable/explosive materials in the vehicle. These items may catch fire and/or explode if the vehicle is exposed to hot temperature for extended periods.**

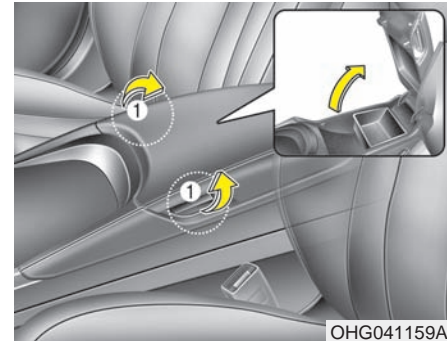

### Center console storage

To open the center console storage, pull up the lever (1).

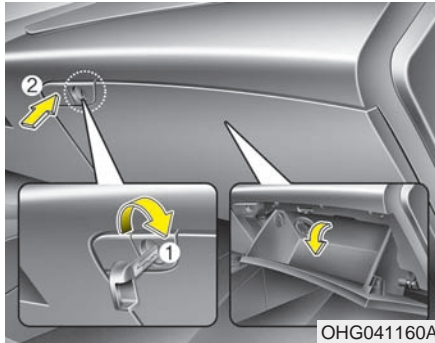

### Glove box

The glove box can be locked and unlocked with the mechanical key (1). To open the glove box, push the button (2) and the glove box will automatically open. Close the glove box after use.

#### **⚠ WARNING**

**To reduce the risk of injury in an accident or sudden stop, always keep the glove box door closed while driving.**

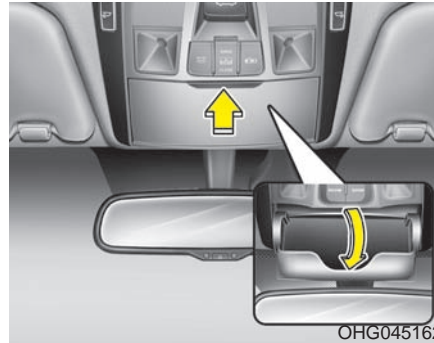

### Sunglass holder

To open the sunglasses holder, press the cover and the holder will slowly open. Place your sunglasses in the compartment door with the lenses facing out. Push to close.

#### **⚠ WARNING - Sunglass holder**

- Do not keep objects except sunglasses inside the sunglasses holder. Such objects can be thrown from the holder in the event of a sudden stop or an accident, possibly injuring the passengers in the vehicle.
- Do not put the glasses forcibly into a sunglasses holder to prevent breakage or deformation of glasses. It may cause personal injury if you try to open it forcibly when the glasses are jammed in holder.

Do not open the sunglasses holder while the vehicle is moving. The rear view mirror of the vehicle can be blocked by an open sunglasses holder.

## INTERIOR FEATURES

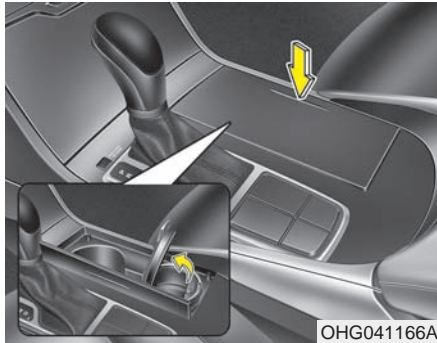

### Ashtray

To use the ashtray, open the cover.  
To clean or empty the ashtray, pull it out.

Do not use the vehicle's ashtray as waste receptacles.

**⚠ WARNING - Ashtray use**  
Putting lit cigarettes or matches in an ashtray with other combustible materials may cause a fire.

### Cup holder

**⚠ WARNING - Hot liquids**  
Do not place uncovered cups of hot liquid in the cup holder while the vehicle is in motion. If the hot liquid spills, you may burn yourself. Such a burn to the driver could lead to loss of control of the vehicle.

**⚠ WARNING - Cans and bottles**  
Keep cans or bottles out of direct sun light and do not put them in a vehicle that is heated up. It may explode.

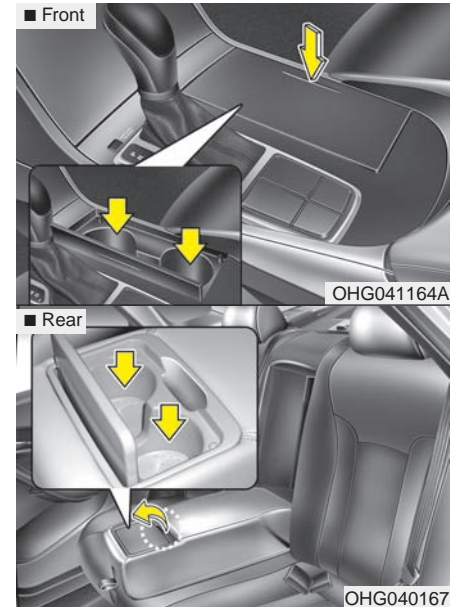

Cups or small beverage cans may be placed in the cup holders.

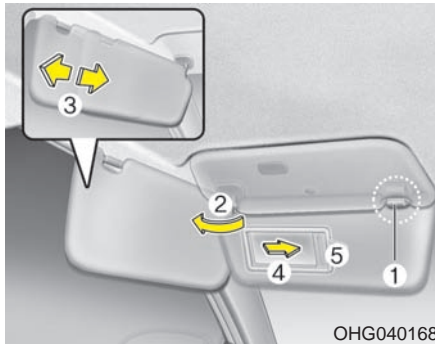

### Sunvisor

Use the sunvisor to shield direct light through the front or side windows.

To use a sunvisor, pull it downward.

To use a sunvisor for a side window, pull it downward, unsnap it from the bracket (1) and swing it to the side (2). Adjust the sunvisor extension forward or backward (3).

To use the vanity mirror, pull down the visor and slide the mirror cover (4).

The ticket holder (5) is provided for holding a tollgate ticket.

For your safety, do not block your view when using the sunvisor.

**⚠ CAUTION - Vanity mirror lamp**  
*Close the vanity mirror cover securely and return the sunvisor to its original position after use. If the vanity mirror is not closed securely, the lamp will stay on and could result in battery discharge and possible sunvisor damage.*

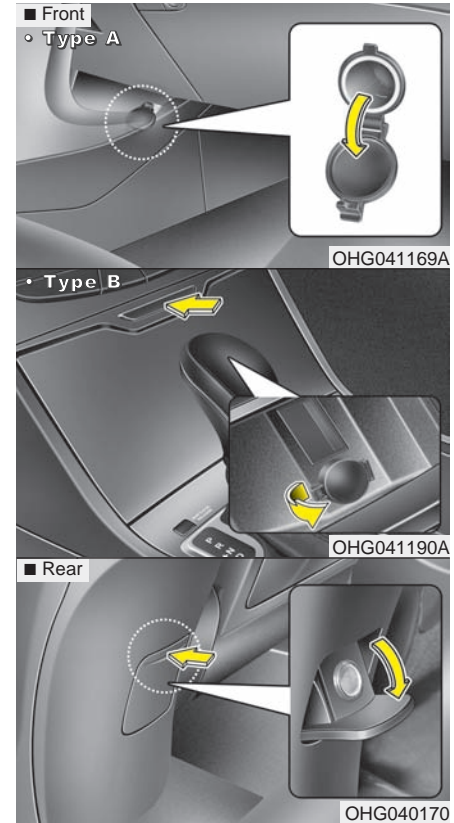

### Power outlet

The power outlet is designed to provide power for mobile telephones or other devices designed to operate with vehicle electrical systems. The devices should draw less than 10 amps with the engine running.

- Use the power outlet only when the engine is running and remove the accessory plug after use. Using the accessory plug for prolonged periods of time with the engine off could cause the battery to discharge.
- Only use 12V electric accessories which are less than 10A in electric capacity. If not, it could lead to an overheated power outlet or electric wiring in the vehicle and electric systems may malfunction.
- Adjust the air-conditioner or heater to the lowest operating level when using the power outlet.
- Close the cover when not in use.
- Some electronic devices can cause electronic interference when plugged into a vehicle's power outlet. These devices may cause excessive audio static and malfunctions in other electronic systems or devices used in your vehicle.

### CAUTION

- ***Make sure that the electric devices are plugged in securely. If not, it could cause a malfunction of electric systems.***
- ***If you use an electric device with a battery, electric current may flow from the electric device into the vehicle and may cause a malfunction of electric systems. Only use electric devices which could prevent inverse current.***

### WARNING - Electric shock

**Do not put fingers or objects (pin, coin, etc.) into a power outlet and do not touch with wet hands. You may get an electric shock.**

### Digital clock (if equipped)

Whenever the battery terminals or related fuses are disconnected, you must reset the time.

Detailed information on setting the clock is described in Audio system section 4.

### WARNING

**Do not adjust the clock while driving. You may lose your steering control and cause an accident that results in severe personal injury or death.**



**Clock with AVN system  
(if equipped)**

You can set the clock by using the Audio or Navigation.

**GPS Time check**

The clock is automatically updated through the navigation system.

**GPS Time non-check**

The clock can be manually adjusted.

1. Select the "Setup" key on the Head Unit.
2. Select the "Clock".
3. Select the "Date/Time Settings".

**For more details, please refer to the manual that was supplied with your vehicle.**



**Clothes hanger**

To use the hanger, pull down the inner portion of the assist handle.

**⚠ CAUTION - Hanging clothing**

***Do not hang heavy clothes, because they may damage the hook.***

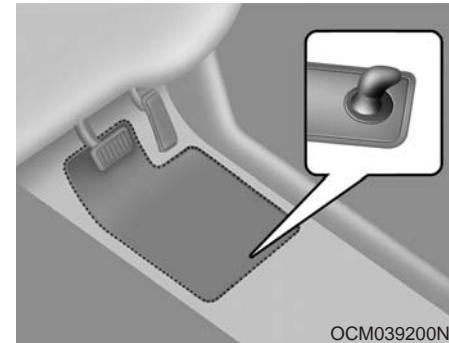

**Floor mat anchor(s)**

When using a floor mat on the front floor carpet, make sure it attaches to the floor mat anchor(s) in your vehicle. This keeps the floor mat from sliding forward.

**⚠ WARNING - Aftermarket Floor mat**

**Do not install aftermarket floor mats that are not capable of being securely attached to the vehicle's floor mat anchors. Unsecured floor mats can interfere with pedal operation and cause an accident that results in severe personal injury, death, or property damage.**

The following must be observed when installing ANY floor mat to the vehicle.

- Ensure that the floor mats are securely attached to the vehicle's floor mat anchor(s) before driving the vehicle.
- Do not use ANY floor mat that cannot be firmly attached to the vehicle's floor mat anchors.
- Do not stack floor mats on top of one another (e.g. all-weather rubber mat on top of a carpeted floor mat). Only a single floor mat should be installed in each position.

**IMPORTANT** - Your vehicle was manufactured with driver's side floor mat anchors that are designed to securely hold the floor mat in place. To avoid any interference with pedal operation, HYUNDAI recommends that only the HYUNDAI floor mat designed for use in your vehicle be installed.

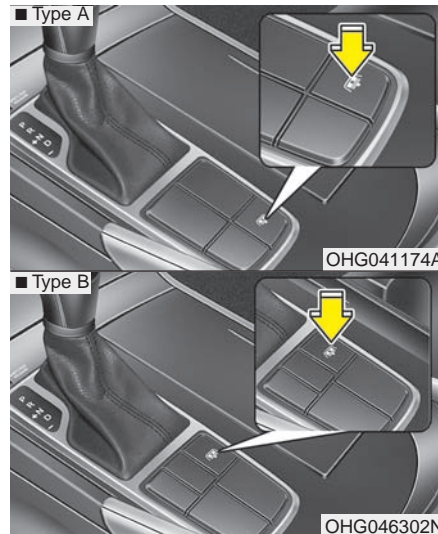

### Rear curtain (if equipped)

To fold the rear curtain, press the button. To unfold the rear curtain, press the button again.

#### CAUTION

***Do not pull or fold the rear curtain by hand. It could cause motor failure.***

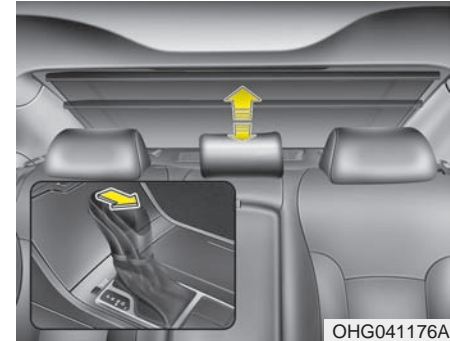

The rear curtain will fold automatically when you shift the shift lever into R (Reverse) and unfold automatically when you shift the shift lever from R (Reverse) into P (Park).

After the rear curtain is folded by shifting the shift lever into R (Reverse) and you drive more than 12 mph (20 km/h) with the shift lever in D (Drive), the rear curtain will unfold automatically.



## MULTIMEDIA SYSTEM

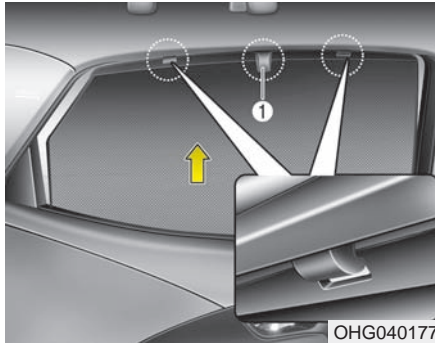

### Side curtain (if equipped)

To use the side curtain:

1. Lift the curtain by the hook (1).
2. Hang the curtain on both sides of the hook.

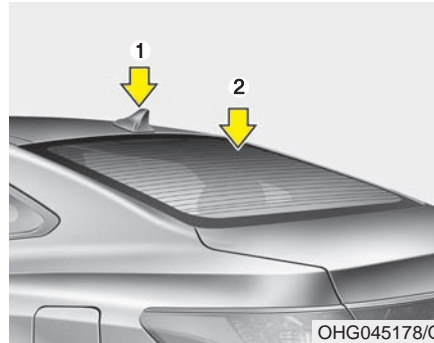

### Shark fin antenna (1)

The shark fin antenna will receive the transmit data.

### Glass antenna (2)

Your vehicle uses a glass antenna to receive both AM and FM signals.

### **⚠ CAUTION - Antenna**

- *Do not clean inside of the rear window glass with a cleaner or use a scraper to remove foreign deposits as this may cause damage to the antenna elements.*
- *Avoid adding metallic coatings such as Ni, Cd, and so on. These can disturb receiving AM and FM broadcast signals.*



### Steering wheel audio control

The steering wheel audio control button is installed for your convenience. Only press one button at a time; the control buttons may not operate when multiple buttons are pressed.

#### **VOLUME (VOL +/-) (1)**

- Push up the lever to increase volume.
- Push down the lever to decrease volume.

#### **SEEK/PRESET ( $\wedge$ / $\vee$ ) (2)**

The SEEK/PRESET button has different functions based on the system mode.

For the following functions the button should be pressed for 0.8 seconds or more.

#### **RADIO mode**

It will function as the AUTO SEEK select button. It will SEEK until you release the button.

#### **Single CD Player mode**

It will function as the FF/REW button.

If the SEEK/PRESET button is pressed for less than 0.8 seconds, it will work as follows in each mode.

#### **RADIO mode**

It will function as the PRESET STATION select buttons.

#### **Single CD Player mode**

It will function as the TRACK UP/DOWN button.

#### **MODE (3)**

Press the MODE button to select Radio, CD (Compact Disc), USB, AUX or Phone.

#### **MUTE (4)**

- Press the MUTE button to cancel the sound.
- Press the MUTE button again to activate the sound.

Detailed information for audio control buttons are described in the separately supplied Navigation System manual.

## Audio system

### \* NOTICE

- If you install an aftermarket HID head lamp, your vehicle's audio and electronic device may malfunction.
- Prevent chemicals such as perfume, cosmetic oil, sun cream, hand cleaner, and air freshener from contacting the interior parts because they may cause damage or discoloration.

## Bluetooth® Wireless Technology

A compatible phone can be used to Pair/Connect the *Bluetooth®* Wireless Technology.

Detailed information for the *Bluetooth®* Wireless Technology is described in the separately supplied Navigation System manual.

## Navigation system

The navigation system ascertains the present position of your vehicle by using information from satellites and guides you to the place you assign as the destination.

Detailed information for the navigation system is described in the separately supplied Navigation System manual.

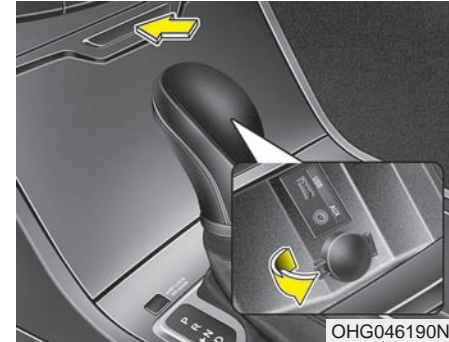

## Aux, USB and iPod® port

If your vehicle has an aux, USB (universal serial bus) port or iPod® port, you can use an aux port to connect audio devices, a USB port to plug in a USB and an iPod® port to plug in an iPod®.

When using a portable audio device connected to the power outlet, noise may occur during playback. If this happens, use the power source of the portable audio device.

\* iPod® is a trademark of Apple Inc.

### How vehicle audio works

#### FM reception

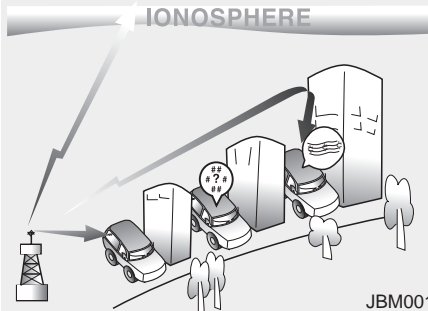

AM and FM radio signals are broadcast from transmitter towers located around your city. They are intercepted by the radio antenna on your vehicle. This signal is then processed by the radio and sent to your vehicle speakers.

When a strong radio signal has reached your vehicle, the precise engineering of your audio system ensures the best possible quality reproduction. However, in some cases the signal coming to your vehicle may not be strong and clear.

This can be due to factors, such as the distance from the radio station, closeness of other strong radio stations or the presence of buildings, bridges or other large obstructions in the area.

#### AM reception

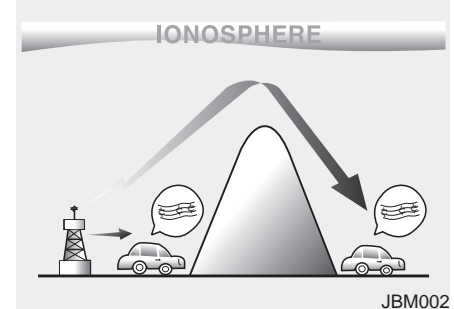

AM broadcasts can be received at greater distances than FM broadcasts. This is because AM radio waves are transmitted at low frequencies. These long distance, low frequency radio waves can follow the curvature of the earth rather than travelling straight. In addition, they curve around obstructions resulting in better signal coverage.

### FM radio station

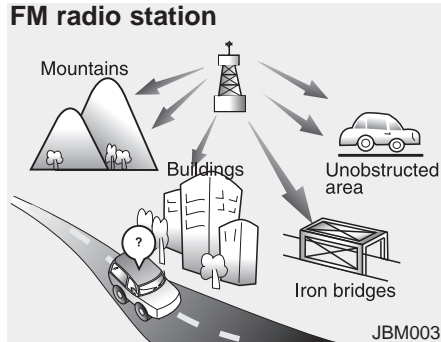

FM broadcasts are transmitted at high frequencies and do not bend to follow the earth's surface. Because of this, FM broadcasts generally begin to fade within short distances from the station. Also, FM signals are easily affected by buildings, mountains, and obstructions. This can lead to undesirable or unpleasant listening conditions which might lead you to believe a problem exists with your radio. The following conditions are normal and do not indicate radio trouble:

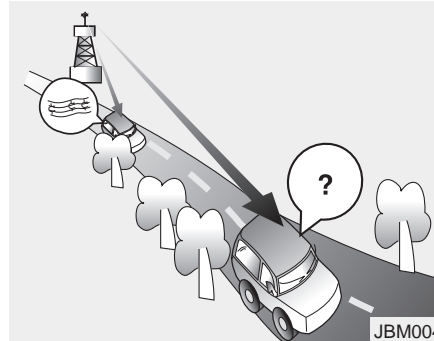

- **Fading** - As your vehicle moves away from the radio station, the signal will weaken and sound will begin to fade. When this occurs, we suggest that you select another stronger station.
- **Flutter/Static** - Weak FM signals or large obstructions between the transmitter and your radio can disturb the signal causing static or fluttering noises to occur. Reducing the treble level may lessen this effect until the disturbance clears.

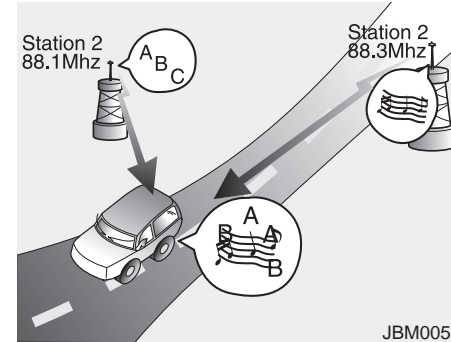

- **Station Swapping** - As an FM signal weakens, another more powerful signal near the same frequency may begin to play. This is because your radio is designed to lock onto the clearest signal. If this occurs, select another station with a stronger signal.
- **Multi-Path Cancellation** - Radio signals being received from several directions can cause distortion or fluttering. This can be caused by a direct and reflected signal from the same station, or by signals from two stations with close frequencies. If this occurs, select another station until the condition has passed.

## XM RADIO MODE

### Features of your vehicle

#### *Satellite radio reception*

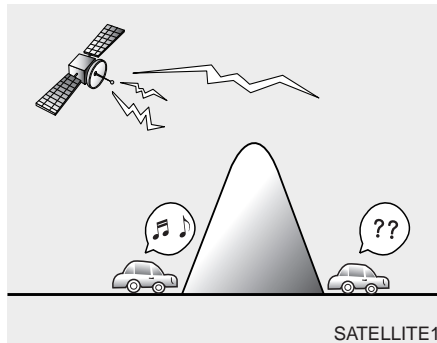

You may experience difficulties in receiving XM™ satellite radio signals in the following situations.

- If you are driving in a tunnel or a covered parking area.
- If you are driving beneath the top level of a multi-level freeway.
- If you are driving under a bridge.
- If you are driving next to a tall vehicle (such as a truck or a bus) that blocks the signal.

- If you are driving in a valley where the surrounding hills or peaks block the signal from the satellite.
- If you are driving on a mountain road where the signal is blocked by mountains.

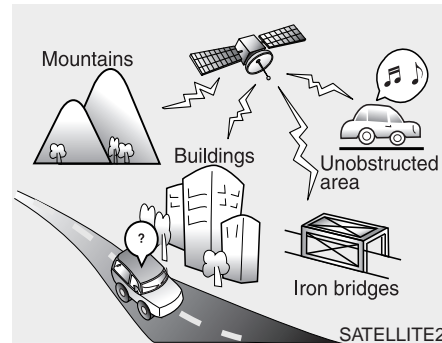

- If you are driving in an area with tall trees that block the signal (30 ft. /10m or more), for example on a road that goes through a dense forest.
- The signal can become weak in some areas that are not covered by the XM™ repeater network.

### NOTE:

There may also be additional unforeseen circumstances leading to reception problems with the XM™ satellite radio signal.

Advisory Messages, such as 'CH Unavailable' may occur when starting XM Radio.

### *Using a cellular phone or a two-way radio*

When a cellular phone is used inside the vehicle, noise may be produced from the audio system. This does not mean that something is wrong with the audio equipment. In such a case, try to operate mobile devices as far from the audio equipment as possible.

#### **CAUTION**

*When using a communication system such as a cellular phone or a radio set inside the vehicle, a separate external antenna must be fitted. When a cellular phone or a radio set is used with an internal antenna alone, it may interfere with the vehicle's electrical system and adversely affect safe operation of the vehicle.*

#### **WARNING**

**Do not use a cellular phone while driving. Stop at a safe location to use a cellular phone.**

### **Caring for disc**

- If the temperature inside the car is too high, open the car windows to ventilate before using the system.
- It is illegal to copy and use MP3/WMA files without permission. Use CDs that are created only by lawful means.
- Do not apply volatile agents, such as benzene and thinner, normal cleaners and magnetic sprays made for analogue disc onto CDs.
- To prevent the disc surface from getting damaged, hold CDs by the edges or the center hole only.
- Clean the disc surface with a piece of soft cloth before playback (wipe it from the center to the outside edge).
- Do not damage the disc surface or attach pieces of sticky tape or paper.
- Make certain only CDs are inserted into the CD player (Do not insert more than one CD at a time).
- Keep CDs in their cases after use to protect them from scratches or dirt.

- Depending on the type of CD-R/CD-RW CDs, certain CDs may not operate normally according to the manufacturing companies. In such circumstances, continued use may cause malfunctions to your audio system.

### \* NOTICE - Playing an Incompatible Copy Protected Audio CD

Some copy protected CDs, which do not comply with international audio CD standards (Red Book), may not play on your car audio. Please note that inability to properly play a copy protected CD may indicate that the CD is defective, not the CD player.

### NOTE:

#### Order of playing files (folders) :

1. Song playing order : ① to ⑭

2. Folder playing order :

\* If no song file is contained in the folder, that folder is not displayed.

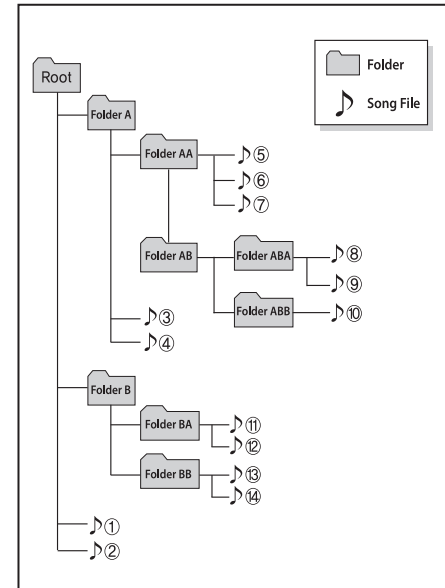
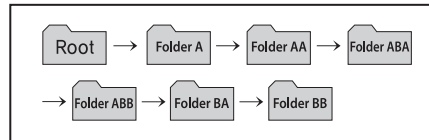



**⚠ WARNING**

- Do not stare at the screen while driving. Staring at the screen for prolonged periods of time could lead to traffic accidents.
- Do not disassemble, assemble, or modify the audio system. Such acts could result in accidents, fire, or electric shock.
- Using the phone while driving may lead to a lack of attention of traffic conditions and increase the likelihood of accidents. Use the phone feature after parking the vehicle.
- Heed caution not to spill water or introduce foreign objects into the device. Such acts could lead to smoke, fire, or product malfunction.

(Continued)

**(Continued)**

- Please refrain from use if the screen is blank or no sound can be heard as these signs may indicate product malfunction. Continued use in such conditions could lead to accidents (fires, electric shock) or product malfunctions.
- Do not touch the antenna during thunder or lightening as such acts may lead to lightning induced electric shock.
- Do not stop or park in parking-restricted areas to operate the product. Such acts could lead to traffic accidents.
- Use the system with the vehicle ignition turned on. Prolonged use with the ignition turned off could result in battery discharge.

**⚠ CAUTION**

- *Operating the device while driving could lead to accidents due to a lack of attention to external surroundings. First park the vehicle before operating the device.*
- *Adjust the volume to levels that allow the driver to hear sounds from outside of the vehicle. Driving in a state where external sounds cannot be heard may lead to accidents.*
- *Pay attention to the volume setting when turning the device on. A sudden output of extreme volume upon turning the device on could lead to hearing impairment. (Adjust the volume to a suitable levels before turning off the device.)*

(Continued)

**(Continued)**

- *If you want to change the position of device installation, please inquire with your place of purchase or service maintenance center. Technical expertise is required to install or disassemble the device.*
- *Turn on the car ignition before using this device. Do not operate the audio system for long periods of time with the ignition turned off as such operations may lead to battery discharge.*
- *Do not subject the device to severe shock or impact. Direct pressure onto the front side of the monitor may cause damage to the LCD or touch screen.*

**(Continued)**

**(Continued)**

- *When cleaning the device, make sure to turn off the device and use a dry and smooth cloth. Never use tough materials, chemical cloths, or solvents (alcohol, benzene, thinners, etc.) as such materials may damage the device panel or cause color/quality deterioration*
- *Do not place beverages close to the audio system. Spilling beverages may lead to system malfunction.*
- *In case of product malfunction, please contact your place of purchase or After Service center.*
- *Placing the audio system within an electromagnetic environment may result in noise interference.*

**\* NOTICE - USING THE DISCS**

- This device has been manufactured to be compatible with software bearing the following logo marks.
- Do not clean discs with chemical solutions, such as record sprays, antistatic sprays, antistatic liquids, benzene, or thinners.
- After using a disc, put the disc back in its original case to prevent disc scratches.
- Hold discs by their edges or within the center hole to prevent damages to disc surfaces.
- Do not introduce foreign substances into the disc insert/eject slot. Introducing foreign substances could damage the device interior.
- Do not insert two discs simultaneously.

(Continued)

(Continued)

- When using CD-R/CD-RW discs, differences in disc reading and playing times may occur depending on the disc manufacturer, production method and the recording method as used by the user.
- Clean fingerprints and dust off the disc surface (coated side) with a soft cloth.
- The use of CD-R/CD-RW discs attached with labels may result in disc slot jams or difficulties in disc removal. Such discs may also result in noise while playing.
- Some CD-R/CD-RW discs may not properly operate depending on the disc manufacturer, production method and the record method as used by the user. If problems persist, trying using a different CD as continued use may result in malfunctions.
- The performance of this product may differ depending on the CD-RW Drive Software.

(Continued)

(Continued)

- Copy-protected CDs such as S-type CDs may not function in the device. DATA discs cannot be played. (However, such discs may still operate but will do so abnormally.)
- Do not use abnormally shaped discs (8cm, heart-shaped, octagon-shaped) as such discs could lead to malfunctions.
- If the disc is straddled on the disc slot without removal for 10 seconds, the disc will automatically be re-inserted into the disc player.
- Only genuine audio CDs are supported. Other discs may result in recognition failure (e.g. copy CD-R, CDs with labels)

**\* NOTICE - USING THE USB DEVICE**

- Connect the USB device after turning on the engine. The USB device may become damaged if it is already connected when the ignition is turned on. The USB device may not operate properly if the car ignition is turned on or off with the USB device connected.
- Heed caution to static electricity when connecting/disconnecting USB devices.
- Encoded MP3 Players will not be recognized when connected as an external device.
- When connecting an external USB device, the device may not properly recognize the USB is in some states.
- Only products formatted with byte/sectors under 64Kbyte will be recognized.
- This device recognizes USB devices formatted in FAT 12/16/32 file formats. This device does not recognize files in NTFS file format.

(Continued)

(Continued)

- Some USB devices may not be supported due to compatibility issues.
- Avoid contact between the USB connector with bodily parts or foreign objects.
- Repeated connecting/disconnecting of USB devices within short periods of time may result in product malfunction.
- A strange noise may occur when disconnecting the USB.
- Make sure to connect/disconnect external USB devices with the audio power turned off.
- The amount of time required to recognize the USB device may differ depending on the type, size or file formats stored in the USB. Such differences in time are not indications of malfunctions.
- The device only supports USB devices used to play music files.
- USB images and videos are not supported.

(Continued)

(Continued)

- Do not use the USB I/F to charge batteries or USB accessories that generate heat. Such acts may lead to worsened performance or damage to the device.
- The device may not recognize the USB device if separately purchased USB hubs and extension cables are being used. Connect the USB directly with the multimedia terminal of the vehicle.
- When using mass storage USB devices with separate logical drives, only files saved to the root drive can be played.
- Files may not properly operate if application programs are installed to the USBs.
- The device may not operate normally if MP3 Players, cellular phones, digital cameras, or other electronic devices (USB devices not recognized as portable disk drives) are connected with the device.

(Continued)

(Continued)

- Charging through the USB may not work for some mobile devices.
- The device may not support normal operation when using a USB memory type besides (Metal Cover Type) USB Memory.
- The device may not support normal operation when using formats such as HDD Type, CF, or SD Memory.
- The device will not support files locked by DRM (Digital Rights Management.)
- USB memory sticks used by connecting an Adaptor (SD Type or CF Type) may not be properly recognized.
- The device may not operate properly when using USB HDDs or USBs subject to connection failures caused by vehicle vibrations. (e.g. i-stick type)

(Continued)

(Continued)

- Avoid use of USB memory products that can also be used as key chains or mobile phone accessories. Use of such products may cause damage to the USB jack.
- Connecting an MP3 device or phone through various channels, such as AUX/BT or Audio/USB mode may result in pop noises or abnormal operation.
- USB memory without the certification mark may not be recognized.



**\* NOTICE - USING THE iPod®  
DEVICE**

- iPod® is a registered trademark of Apple Inc.
- In order to use the iPod while operating the keys, you must use a dedicated iPod cable. (the cable that is supplied when purchasing iPod/iPhone products)
- If the iPod is connected to the vehicle while it is playing, a high pitch sound could occur for approximately 1-2 seconds immediately after connecting. If possible, connect the iPod to the vehicle with the iPod stopped/paused.
- During ACC ON state, connecting the iPod through the iPod cable will charge the iPod through the car audio system.
- When connecting with the iPod cable, make sure to fully insert the jack to prevent communication interference.

(Continued)

(Continued)

- When the EQ features of an external device, such as the iPod, and the audio system are both active, EQ effects could overlap and cause sound deterioration and distortion. Whenever possible, turn off the EQ feature within the external device upon use by connecting with the audio system.
- Noise may occur when an iPod or AUX device is connected. When such devices are not being used, disconnect the device for storage.
- When the iPod or AUX device power is connected to the power jack, playing the external device may result in noise. In such cases, disconnect the power connection before use.
- Skipping or improper operation may occur depending on the characteristics of your iPod/Phone device.

(Continued)

(Continued)

- If your iPhone is connected to both the *Bluetooth*® Wireless Technology and USB, the sound may not be properly played. In your iPhone, select the Dock connector or *Bluetooth*® Wireless Technology to change the sound output (source).
- iPod mode cannot be operated when the iPod cannot be recognized due to versions that do not support communication protocols.
- For fifth generation iPod Nano devices, the iPod may not be recognized when the battery level is low. Please charge the iPod for use.
- Search/play orders shown within the iPod device may differ with the orders shown within the audio system.
- If the iPod malfunctions due to an iPod device defect, reset the iPod and try again. (To learn more, refer to your iPod manual)

(Continued)

(Continued)

- Some iPods may not sync with the System depending on its version. If the Media is removed before the Media is recognized, then the system may not properly restore the previously operated mode. (iPad charging is not supported.)

**\* NOTICE - USING THE  
*Bluetooth*® Wireless  
Technology Audio Mode**

- *Bluetooth*® Wireless Technology Audio Mode can be used only when a *Bluetooth*® Wireless Technology phone has been connected.
- *Bluetooth*® Wireless Technology Audio Mode will not be available when connecting mobile phones that do not support this feature.
- While *Bluetooth*® Wireless Technology Audio is playing, if the *Bluetooth*® Wireless Technology phone is connected, then the music will also stop.
- Moving the Track up/down while playing *Bluetooth*® Wireless Technology audio mode may result in pop noises in some mobile phones.
- *Bluetooth*® Wireless Technology streaming audio may not be supported in some mobile phones.

(Continued)

(Continued)

- When returning to *Bluetooth*® Wireless Technology Audio mode after ending a call, the mode may not automatically restart in some mobile phones.
- Receiving an incoming call or making an outgoing call while playing *Bluetooth*® Wireless Technology Audio may result in audio interference.

**\* NOTICE - USING UPON  
CONNECTING *Bluetooth*<sup>®</sup>  
Wireless Technology PHONE**

- Before connecting the car audio system with the mobile phone, check to see that the mobile phone supports *Bluetooth*<sup>®</sup> Wireless Technology features.
- Even if the phone supports *Bluetooth*<sup>®</sup> Wireless Technology, the phone will not be found during device searches if the phone has been set to hidden state or the *Bluetooth*<sup>®</sup> Wireless Technology power is turned off. Disable the hidden state or turn on the *Bluetooth*<sup>®</sup> Wireless Technology power prior to searching/connecting with the car audio system.
- If you do not want to automatically connect your *Bluetooth*<sup>®</sup> Wireless Technology phone, try the following.
  1. Turn off the *Bluetooth*<sup>®</sup> feature in your mobile phone.

(Continued)

(Continued)

- For more information on *Bluetooth*<sup>®</sup> Wireless Technology features within your mobile, refer to your mobile phone user's manual.
- 2. Turn off the *Bluetooth*<sup>®</sup> Wireless Technology feature in your car audio system.
  - To turn off the *Bluetooth*<sup>®</sup> Wireless Technology feature in your car audio system, go to **SETUP** ▶ [Phone] and [turn off] the *Bluetooth*<sup>®</sup> Wireless Technology feature.
- Park the vehicle when connecting the car audio system with your mobile phone.
- *Bluetooth*<sup>®</sup> Wireless Technology connection may become intermittently disconnected in some mobile phones. Follow these steps to try again.
  1. Turn the *Bluetooth*<sup>®</sup> Wireless Technology function within the mobile phone off/on and try again.
  2. Turn the mobile phone power Off/On and try again.

(Continued)

(Continued)

3. Completely remove the mobile phone battery, reboot, and then again.
  4. Reboot the audio system and try again.
  5. Delete all paired devices, pair and try again.
- The Handsfree call volume and quality may differ depending on the mobile phone.
  - *Bluetooth*<sup>®</sup> Wireless Technology features supported within the vehicle are as follows. Some features may not be supported depending on your *Bluetooth*<sup>®</sup> Wireless Technology device.
    - Answering and placing *Bluetooth*<sup>®</sup> Wireless Technology Handsfree calls
    - Menu operation during call (Switch to Private, Switch to call waiting, Outgoing volume)
    - Download Call History
    - Download Mobile Phone book
    - Phone book/Call History Auto Download

(Continued)



(Continued)

- It is possible to pair up to five *Bluetooth*<sup>®</sup> Wireless Technology devices to the car system.
- Only one *Bluetooth*<sup>®</sup> Wireless Technology device can be connected at a time.
- Other devices cannot be paired while a *Bluetooth*<sup>®</sup> Wireless Technology device is already connected.
- When a *Bluetooth*<sup>®</sup> Wireless Technology device is being connected, the connection process cannot be canceled.
- Only *Bluetooth*<sup>®</sup> Wireless Technology Handsfree and *Bluetooth*<sup>®</sup> Wireless Technology audio related features will operate within this system.
- Normal operation is possible only for devices that support Handsfree or audio features, such as a *Bluetooth*<sup>®</sup> Wireless Technology mobile phone or a *Bluetooth*<sup>®</sup> Wireless Technology audio device.

(Continued)

(Continued)

- Only one function can be used at a time between the *Bluetooth*<sup>®</sup> Wireless Technology Handsfree and *Bluetooth*<sup>®</sup> Wireless Technology audio. (While playing *Bluetooth*<sup>®</sup> Wireless Technology audio, streaming will end upon entering the *Bluetooth*<sup>®</sup> Wireless Technology phone screen.)
- If a connected *Bluetooth*<sup>®</sup> Wireless Technology device becomes disconnected for various reasons, such as being out of range, turning the device OFF, or a *Bluetooth*<sup>®</sup> Wireless Technology communication error, *Bluetooth*<sup>®</sup> Wireless Technology devices are automatically searched and connected.
- *Bluetooth*<sup>®</sup> Handsfree is a feature that enables drivers to practice safe driving. Connecting the head unit with a *Bluetooth*<sup>®</sup> phone allows the user to conveniently make calls, receive calls, and manage the phone book. Before using the *Bluetooth*<sup>®</sup>, carefully read the contents of this user's manual.

**\* NOTICE - USING THE Voice Recognition**

- When using the voice recognition feature, only commands listed within the user's manual are supported.
- Be aware that during the operation of the voice recognition system, pressing any key other than the  key or touching the screen will terminate voice recognition mode.
- For superior voice recognition performance, position the microphone used for voice recognition above the head of the driver's seat and maintain a proper position when saying commands.
- Within the following situations, voice recognition may not function properly due to external sound.
  - When the windows and sunroof are open
  - When the wind of the cooling / heating device is strong
  - When entering and passing through tunnels

(Continued)

(Continued)

- When driving on rugged and uneven roads
- During severe rain (heavy rains, windstorms)
- Phone related voice commands can be used only when a *Bluetooth*<sup>®</sup> Wireless Technology device is connected.
- When making calls by stating a name, the corresponding contact must be downloaded and stored within the audio system.
- After downloading the *Bluetooth*<sup>®</sup> Wireless Technology phone book, it takes some times to convert the phone book data into voice information. During this time, voice recognition may not properly operate.
- Pronounce the voice commands naturally and clearly as if in a normal conversation.

■ CD Player : AC1B4HGAN, AC1B4HGG5



## COMPONENT NAMES AND FUNCTIONS

### Head Unit



(1)  (EJECT)

Press to insert or eject disc.

When press and held(3seconds) : emergency eject.

(2)  RADIO

Converts to Radio (FM, AM, XM) mode.

Each time this key is pressed, the mode is changed in order of FM1, FM2, AM, XM1, XM2, XM3.

(3)  MEDIA

Starts Media mode.

Each time this key is pressed, the mode is changed in order of CD, USB (iPod), AUX, My Music, BT Audio.

(4)  PHONE

Converts to Phone mode.

(5)  SETUP

Converts to Setup mode.

(6)  PWR/VOL knob

 Volume : Turn left/right to control volume.

(7)  SEEK,  TRACK

When pressed shortly (under 0.8 seconds).

- FM, AM mode : plays previous/next frequency.
- XM mode : plays previous/next channel.
- CD, USB, iPod, My Music mode : changes the track, file.

When pressed and held (over 0.8 seconds).

- FM, AM mode : continuously changes the frequency until the key is released and plays the current frequency.
- XM mode : continuously changes the channel until the key is released and plays the current channel.
- CD, USB, iPod, My Music mode : rewinds or fast forwards the track or file.
- During a Handsfree call, controls the call volume.



(8) **SCAN**

- FM, AM mode : previews all receivable broadcasts for 5 seconds each.
- XM mode : previews all receivable broadcasts for 10 seconds each.
- CD, USB, iPod, My Music mode : previews each song (file) for 10 seconds each.

(9) **CLOCK**

Displays the time/date/day.

Press and hold the key (over 0.8 seconds) to setting the Clock/Calendar screen.

(10) **FOLDER**, **FOLDER**

- CD MP3, USB mode : Folder Search
- XM mode: Category Search

(11) **DISP**

Turns the monitor display on/off.

(12) **MENU**

Displays supported menus within each mode.

(13) **TUNE** knob

- FM, AM mode : turn to change broadcast frequencies.
- CD, USB, iPod mode : turn to search tracks/channels/files.



(14) **1 RPT** ~ **6** (Preset)

- Radio mode : saves a frequency or receives saved frequencies.
- MEDIA mode : press the **1 RPT** key to repeat and **2 RDM** key to play in random order (shuffle).

### Steering wheel remote controller



#### (1) VOLUME

Used to control volume.

#### (2) SEEK

- When pressed shortly (under 0.8 seconds).
  - FM, AM, XM mode : searches broadcast frequencies saved to presets.
  - CD, USB, iPod, My Music, BT Audio mode : changes the track, file.
- When pressed and held (over 0.8 seconds).
  - FM, AM, XM mode : automatically searches broadcast frequencies and channels.
  - CD, USB, iPod, My Music mode : rewinds or fast forwards the track or file.

#### (3) MODE

Each time this key is pressed, the mode is changed in order of FM1, FM2, AM, XM1, XM2, XM3, CD, USB(iPod), AUX, My Music, BT Audio.

If the media is not connected or a disc is not inserted, corresponding modes will be disabled.

Press and hold the key (over 0.8 seconds) to turn the audio system on/off.

When power is off, press the key to turn power back on.

#### (4) MUTE

Mutes audio volume.

(5) 

- When pressed shortly.
  - When pressed in the phone screen, displays call history screen.
  - When pressed in the dial screen, makes a call.
  - When pressed in the incoming call screen, answers the call.
  - When pressed during call waiting, switches to waiting call (Call Waiting).
- When pressed and held (over 0.8 seconds).
  - When pressed in the *Bluetooth*<sup>®</sup> Wireless Technology Handsfree wait mode, redials the last call.
  - When pressed during a *Bluetooth*<sup>®</sup> Wireless Technology Handsfree call, switches call back to mobile phone (Private).
  - When pressed while calling on the mobile phone, switches call back to *Bluetooth*<sup>®</sup> Wireless Technology Handsfree (Operates only when *Bluetooth*<sup>®</sup> Wireless Technology Handsfree is connected).

(6) 

Ends phone call.

(7) 

- When pressed shortly
  - Starts voice recognition
  - When selecting during a voice prompt, stops the prompt and converts to voice command waiting state
- When pressed and held (over 0.8 seconds)
  - Ends voice recognition

## RADIO MODE

### Basic Mode Screen

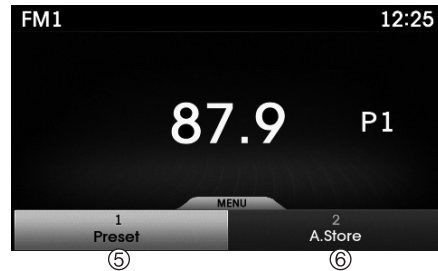
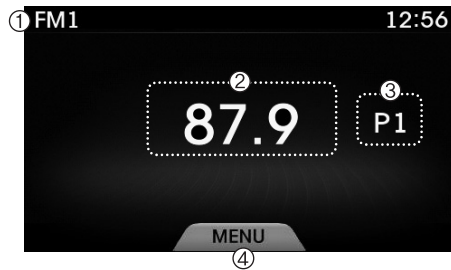

(1) Mode Display  
Displays currently operating mode.

(2) Frequency  
Displays the current frequency.

(3) Preset  
Displays currently playing preset number [1] ~ [6].

(4) MENU  
Displays Radio menus.

(5) Preset Display  
Displays saved presets.

(6) A.Store(Auto Store)  
Automatically saves frequencies with superior reception to Preset buttons.



## Switching to Radio Mode

Pressing the **RADIO** key will change the operating mode in order of FM1 → FM2 → AM → XM1 → XM2 → XM3.

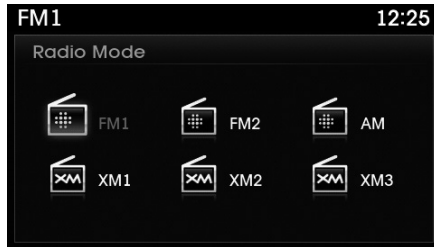

If [Mode Pop up] is turned on within **SETUP** ▶ [Display], then pressing the **RADIO** key will display the Radio mode pop up screen.

Use **TUNE** knob to move the focus. Press the **TUNE** knob to select.

## \* NOTICE

If the **RADIO** key is pressed with the system power off, then the power will turn on and the most recently played broadcast will be played.

## Searching Radio Frequencies

### Using Seek

Press the **SEEK** (up arrow) or **TRACK** (down arrow) key to play the previous/next frequency.

### Using TUNE

Turn the **TUNE** knob to select the frequency.

- FM : Increases/decreased by 200kHz
- AM : Increases/decreased by 10kHz

## Using Radio Mode

### Selecting Presets

Press the **MENU** key ▶ Select **Presets**

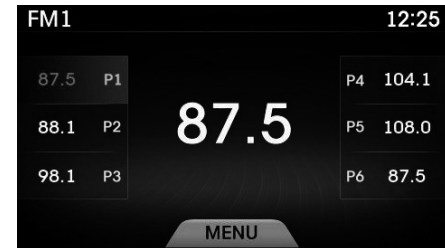

The 6 presets are displayed.

Press the **1** ~ **6** key to play the desired preset.

### Saving Presets

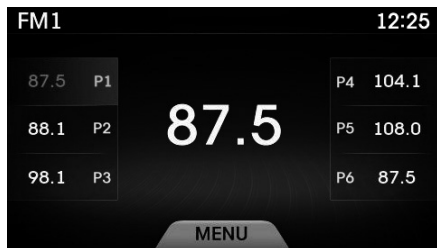

After selecting the frequency ▶ Press and hold the desired preset **1** ~ **6** key.

A 'beep' will sound and the frequency is saved to the selected preset button.

### Auto Store

After pressing the **MENU** key ▶ Select the **A.Store** button to automatically save receivable frequencies to Preset buttons.

A total of 18 frequencies with six preset frequencies each for FM1 / FM2 / AM modes can be saved.

### \* NOTICE

While Auto Store is operating, selecting the **A.Store** button again will cancel the function and restore the previous frequency.

### Scan

Press the **SCAN** key to scan all radio frequencies.

Press and hold the **SCAN** key (over 0.8 seconds) to scan preset buttons.

- Scan All : Scans frequencies with superior reception for 5 seconds each.
- Preset Scan : Scans broadcasts saved to presets for 5 seconds each.

Once scan is complete, the previously playing frequency is restored.

During Scan, pressing the **SCAN** key again will cancel the scan operation and restore the previously played frequency.

## XM RADIO MODE

### Basic Mode Screen

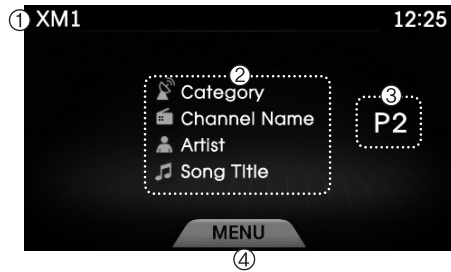

(1) Mode Display

Displays currently operating mode.

(2) Channel Information

Displays the category, channel number, channel name, artist and song title.

(3) Preset

Displays currently playing preset number [1] ~ [6].

(4) MENU

Displays XM Radio menus.

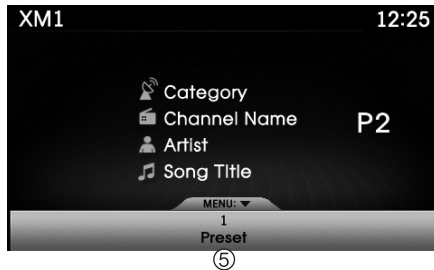

(5) Preset Display

Displays saved presets.

### Using SEEK

Press the **SEEK**, **TRACK** keys to play the previous/next channel.

\* If the "Category" icon is displayed, channels are changed within the current category.

### Using Tune

Press the **TUNE** knob to search all channels.

### Searching Categories

Select the category by using the **FOLDER**, **FOLDER** keys and press the **TUNE** knob to select.

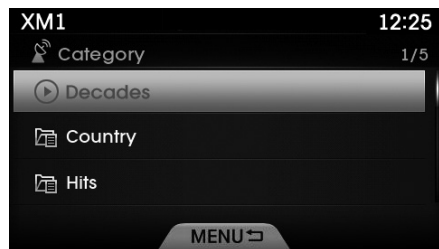

Channels for the selected category are played.

### Selecting Presets

Press the **MENU** key ▶ Select **Presets**

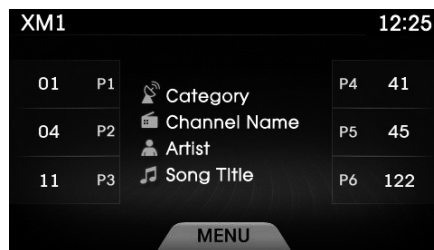
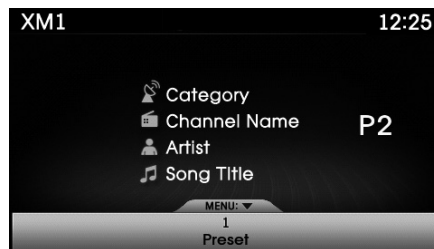

The 6 preset buttons are displayed. Press the **1** ~ **6** key to play the desired preset.

### Saving Presets

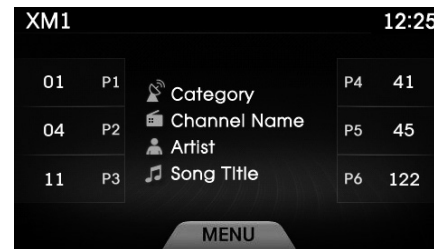

After selecting the channel ▶ Press and hold the desired preset **1** ~ **6** key.

A 'beep' will sound and the channel is saved to the selected preset button.

## SCAN

Press the **SCAN** key to scan all channels with superior reception for 10 seconds each.

Once scan is complete, the previously played channel will be restored.

During Scan, pressing the **SCAN** key again will cancel the scan operation and restore the previously played channel.

If the “Category” icon is displayed, channels are changed within the current category.

### MEDIA MODE

Pressing the **MEDIA** key will change the operating mode in order of CD→USB(iPod)→AUX→My Music → BT Audio.

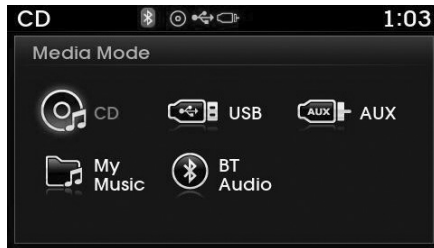

If [Mode Pop up] is turned on within **SETUP** ▶ [Display], then pressing the **MEDIA** key will display the Media mode Pop-up screen.

Use the **TUNE** knob to move the focus. Press the knob to select.

### \* NOTICE

- If the **MEDIA** key is pressed with the system power off, then the power will turn on and the most recently played media mode will be played.
- The media mode pop up screen can be displayed only when there are two or more media modes turned on.

## AUDIO CD MODE

### Basic Mode Screen



(1) Mode

Displays currently operating mode.

(2) Operation State

From Repeat / Shuffle / Scan, displays the currently operating function.

(3) Track Info

Displays information about the current track.

(4) Play State

Displays the play/pause state.

(5) Play Time

Displays the current play time.

(6) MENU

Displays the Audio CD Menu.

(7) Repeat

Turns the Repeat feature on/off.

(8) Shuffle

Turns the Shuffle feature on/off.

(9) List

Moves to the list screen.

(10) Info

Shows detailed information about the current track.

### Using Audio CD Mode

#### *Playing/Pausing CD Tracks*

Once an audio CD is inserted, the mode will automatically start and begin playing.

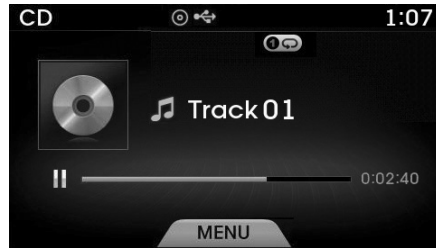

While playing, press the **TUNE** knob to pause and press again to play.

#### **\* NOTICE**

- Only genuine audio CDs are supported. Other discs may result in recognition failure (e.g. copy CD-R, CDs with labels)
- The artist and title information are displayed on the screen if track information is included within the audio CD.

#### *Changing Tracks*

Press the **SEEK**, **TRACK** key to move to the previous or next track.

#### **\* NOTICE**

- Pressing the **TRACK** key after the track has been playing for 2 seconds will start the current track from the beginning.
- Pressing the **TRACK** key before the track has been playing for 1 seconds will start the previous track.

#### *Selecting from the List*

Press the **TUNE** knob keys to search and select for the desired track.

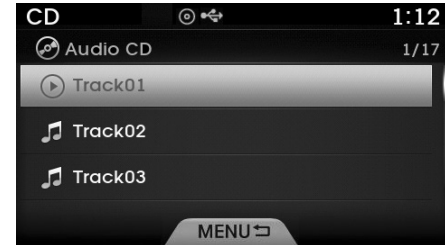

Once you find the desired track, press the **TUNE** knob to start playing.

#### *Rewinding / Fast-forwarding Tracks*

While playing, press and hold the **SEEK**, **TRACK** key (over 0.8 seconds) to rewind or fast-forward the current track.

#### *Scan*

Press the **SCAN** key to play the first 10 seconds of each track.



## Audio CD Mode Menu

If you press the **MENU** key, you will have access to the Repeat, Shuffle, List and Info features.



### Repeat

Press the **MENU** key ▶ Select **Repeat**  
Repeat :Repeats the current track.

### Shuffle

Press the **MENU** key ▶ Select **Shuffle**  
Shuffle :Plays tracks in random order

## \* NOTICE

The **1**, **2** keys are shortcut keys to set the Repeat and Shuffle features.

## List

Press the **MENU** key ▶ Select **List**

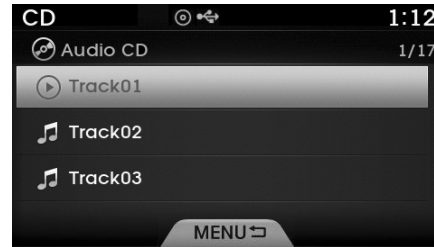

Press the **TUNE** knob to search for the desired track and press the **TUNE** knob to select.

## Info

Press the **MENU** key ▶ Select **Info**

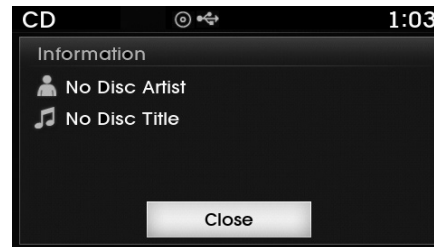

Details for the currently playing track are displayed.

## MP3 CD MODE

### Basic Mode Screen



(1) Mode

Displays currently operating mode.

(2) Operation State

From Repeat / Shuffle / Scan, displays the currently operating function.

(3) File Index

Displays the current file number.

(4) File Info

Displays information about the current file.

(5) Play State

Displays the play/pause state.

(6) Play Time

Displays the current play time.

(7) MENU

Displays the CD MP3 Menu.

(8) Repeat

Turns the Repeat feature on/off.

(9) Shuffle

Turns the Shuffle feature on/off.

(10) List

Moves to the list screen.

(11) Info

Shows detailed information about the current file.

(12) Copy

Copies the current file into My Music

## Using MP3 CD Mode

### Playing/Pausing MP3 Files

Once an MP3 disc is inserted the mode will automatically start and be playing.



While playing, press the **TUNE** knob to pause and press again to play.

### \* NOTICE

- If there are numerous files and folders within the disc, reading time could take more than 10 seconds and the list may not be displayed or song searches may not operate. Once loading is complete, try again.

### Changing Files

Press the **SEEK**, **TRACK** keys to select the previous or next file.

### \* NOTICE

- Pressing the **TRACK** key after the file has been playing for 2 seconds will start the current file from the beginning.
- Pressing the **TRACK** key before the file has been playing for 1 seconds will start the previous file.

### Selecting from the List

Press the **TUNE** knob to search and select for the desired files.

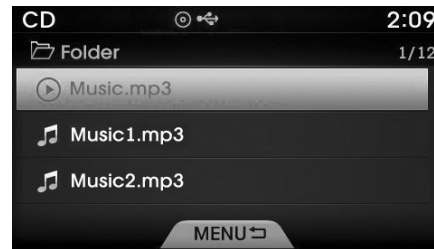

Once you find the desired file, press the **TUNE** knob to start playing.

### Rewinding / Fast-forwarding Files

While playing, press and hold the **SEEK**, **TRACK** keys (over 0.8 seconds) to rewind or fast-forward the current file.

### Scan

Press the **SCAN** key to play the first 10 seconds of each file.

### Searching Folders

Select the folder by using the **FOLDER**, **FOLDER** keys and press the **TUNE** knob to select.



The first file within the selected folder will begin playing.

### MP3 CD Mode Menu

If you press the **MENU** key, you will have access to the Repeat, Shuffle, List, Info and Copy features.



#### Repeat

Press the **MENU** key ▶ Select **Repeat**  
Each time the button is pressed, the feature changes in order of Repeat → Repeat Folder → Off.

- Repeat Once : Repeats the current file.
- Repeat Folder : Repeats all files within the current Folder.

#### Shuffle

Press the **MENU** key ▶ Select **Shuffle**  
Each time the button is pressed, the feature changes in order of Shuffle Folder → Shuffle All → Off.

- Folder Shuffle : Plays all files within the current folder in Random order.
- Shuffle All : Plays all files in Random order.

#### \* NOTICE

The **1**, **2** keys are shortcut keys to set the Repeat and Shuffle features.

#### List

Press the **MENU** key ▶ Select **List**

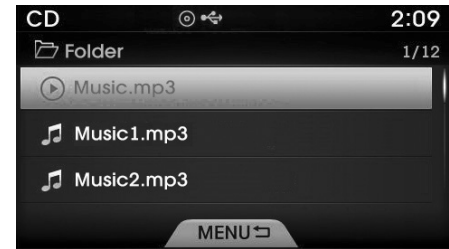

Press the **TUNE** knob to search for the desired file and press the **TUNE** knob to select.

**Info**

Press the **MENU** key ▶ Select **Info**  
Details for the currently playing file are displayed.

**\* NOTICE**

- When the 'Folder File' option is set as the default display within Display setup, the album/artist/file information are displayed as detailed file information.
- When the 'Album Artist Song' option is set as the default display, the folder name/file name are displayed as detailed file information.
- The title, artist and album info are displayed only when such information are recorded within the MP3 file ID3 tag.

**Copy Files**

Press the **MENU** key ▶ Select **Copy**  
The currently playing file is copied into My Music.

**\* NOTICE**

- Selecting another feature during copying will display a pop-up asking whether you wish to cancel copying. To cancel, select 'Yes'.

### USB MODE

#### Basic Mode Screen

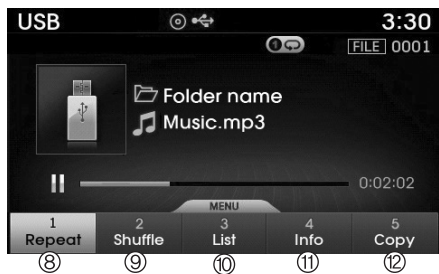
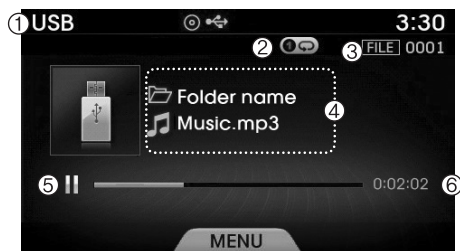

(1) Mode

Displays currently operating mode.

(2) Operation State

From Repeat / Shuffle / Scan, displays the currently operating function.

(3) File Index

Displays the current file number.

(4) File Info

Displays information about the current file.

(5) Play State

Changes the play/pause state.

(6) Play Time

Displays the current play time.

(7) MENU

Displays USB Menu.

(8) Repeat

Turns the Repeat feature on/off.

(9) Shuffle

Turns the Shuffle feature on/off.

(10) List

Moves to the list screen.

(11) Info

Displays additional information for the current file.

(12) Copy

Copies the current file into My Music.

## Using USB Mode

### Playing/Pausing USB Files

Once a USB is connected, the mode will automatically start and begin playing a USB file.

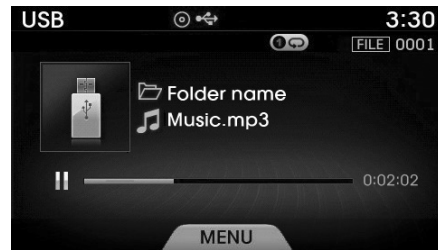

While playing, press the **TUNE** knob to pause and press again to play.

### \* NOTICE

- Loading may require additional time if there are many files and folders within the USB and result in faulty list display or file searching. Normal operations will resume once loading is complete.
- The device may not support normal operation when using a USB memory type besides (Metal Cover Type) USB Memory.

### Changing Files

Press the **SEEK**, **TRACK** keys to select the previous or next file.

### \* NOTICE

- Pressing the **TRACK** key after the file has been playing for 2 seconds will start the current file from the beginning.
- Pressing the **TRACK** key before the file has been playing for 1 seconds will start the previous file.

### Selecting from the List

Press the **TUNE** knob to search and select desired files.

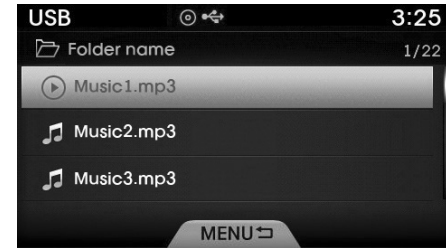

Once you find the desired file, press the **TUNE** knob to start playing.

### Rewinding / Fast-forwarding Files

While playing, press and hold the **SEEK**, **TRACK** keys (over 0.8 seconds) to rewind or fast-forward the current file.

### Scan

Press the **SCAN** key to play the first 10 seconds of each file.

### Searching Folders

Select the folder by using the **FOLDER** , **FOLDER** keys and press the **TUNE** knob to select.



The first file within the selected folder will begin playing.

### USB Mode Menu

If you press the **MENU** key, you will have access to the Repeat, Shuffle, List, Info and Copy features.

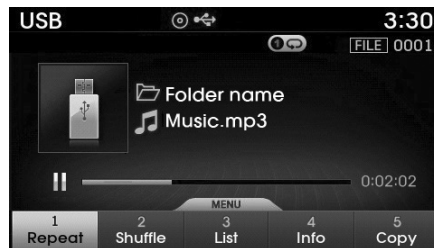

### Repeat

Press the **MENU** key ▶ Select **Repeat**  
Each time the button is pressed, the feature changes in order of Repeat → Repeat Folder → Off.

- Repeat : Repeats the current file.
- Folder Repeat : Repeats all files within the current folder.

### Shuffle

Press the **MENU** key ▶ Select **Shuffle**  
Each time the button is pressed, the feature changes in order of Shuffle Folder → Shuffle All → Off.

- Folder Shuffle : Plays the files in the current folder in random order.
- Shuffle All : Plays all files in random order.

### \* NOTICE

- The **1** , **2** keys are shortcut keys to set the Repeat and Shuffle features.



**List**

Press the **MENU** key ▶ Select **List**

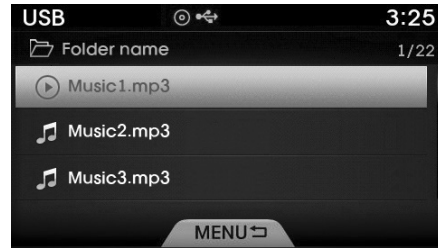

Press the **TUNE** knob to search for the desired file and press the **TUNE** knob to select.

**Info**

Press the **MENU** key ▶ Select **Info**

Details for the currently playing file are displayed.

**\* NOTICE**

- When the 'Folder File' option is set as the default display within Display setup, the album/artist/file information are displayed as detailed file information.
- When the 'Album Artist Song' option is set as the default display, the folder name/file name are displayed as detailed file information.
- The title, artist and album info are displayed only when such information are recorded within the MP3 file ID3 tag.

**Copy Files**

Press the **MENU** key ▶ Select **Copy**

The currently playing file is copied into My Music.

**\* NOTICE**

Selecting another feature during copying will display a pop-up asking whether you wish to cancel copying. To cancel, select 'Yes'.

### iPod MODE

#### Basic Mode Screen

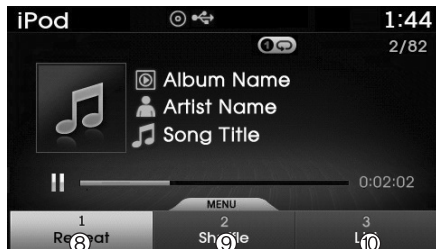
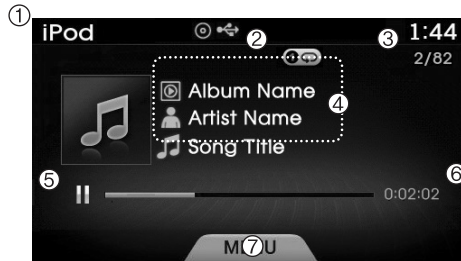

(1) Mode

Displays currently operating mode.

(2) Operation State

From Repeat / Shuffle, displays the currently operating function.

(3) Song Index

Displays the current song/total number of songs.

(4) Song Info

Displays information about the current song.

(5) Play State

Changes the play/pause state.

(6) Play Time

Displays the current play time.

(7) MENU

Displays the iPod Menu.

(8) Repeat

Turns the Repeat feature on/off.

(9) Shuffle

Turns the Shuffle feature on/off.

(10) List

Moves to the list screen.

## Using iPod Mode

### Playing/Pausing iPod Songs

Once an iPod is connected, the mode will automatically start and begin playing an iPod song.

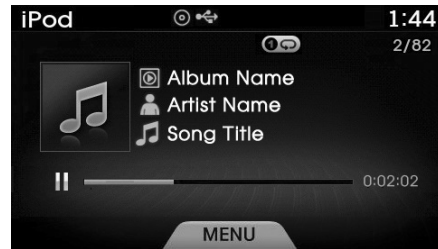

While playing, press the **TUNE** knob to pause and press again to play.

### \* NOTICE

- iPods with unsupported communication protocols may not properly operate in the audio system.

### Changing Songs

Press the **SEEK**, **TRACK** keys to select the previous or next file.

### \* NOTICE

- Pressing the **TRACK** key after the song has been playing for 2 seconds will start the current song from the beginning.
- Pressing the **TRACK** key before the song has been playing for 1 seconds will start the previous song.
- Slight time differences may exist depending your iPod product.

### Rewinding / Fast-forwarding Songs

While playing, press and hold the **SEEK**, **TRACK** keys (over 0.8 seconds) to rewind or fast-forward the current song.

### Searching Categories

Use the **TUNE** knob to search categories and press the knob to select.

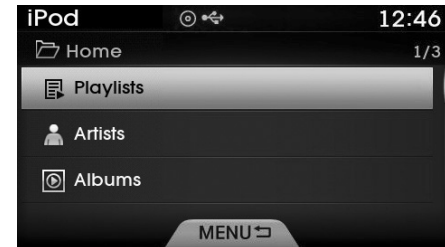

If you press the **MENU** key within the Category Menu, This button is used to move to the previous category.

### \* NOTICE

- There are eight categories that can be searched, including Playlists, Artists, Albums, Genres, Songs, Composers, Audiobooks and Podcasts.
- If the search mode is accessed while playing a song, the most recently searched category is displayed.
- Search steps upon initial connection may differ depending on the type of iPod device.

### iPod Mode Menu

If you press the **MENU** key, you will have access to the Repeat, Shuffle and List features.

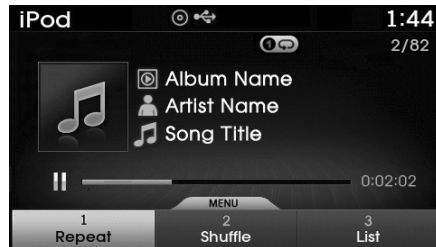

#### Repeat

Press the **MENU** key ▶ Select **Repeat**

- Repeat Once : Repeats the current song.

#### Shuffle

Press the **MENU** key ▶ Select **Shuffle**

- Shuffle Album : Plays songs within the current category in random order.
- Shuffle All : Plays all songs in Random order.

### List

Press the **MENU** key ▶ Select **List**

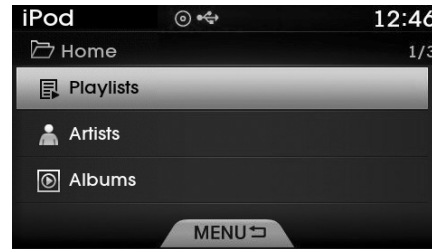

Press the **TUNE** knob to search for the desired file and press the **TUNE** knob to select.

### AUX MODE

#### Using AUX Mode

Press the **MEDIA** key ▶ Select [AUX]

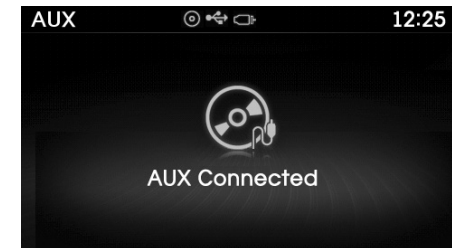

An external device can be connected to play music.

**\* NOTICE**

- If an external device connector is connected with the AUX terminal, then AUX mode will automatically operate. Once the connector is disconnected, the previous mode will be restored.
- AUX mode can be used only when an external audio player (camcorder, car VCR, etc.) has been connected.
- The AUX volume can be controlled separately from other audio modes.

**⚠ CAUTION**

- *Connecting a connector jack to the AUX terminal without an external device will convert the system to AUX mode, but only output noise. When an external device is not being used, also remove the connector jack.*
- *When the external device power is connected to the power jack, playing the external device may output noise. In such cases, disconnect the power connection before use.*
- *Fully insert the AUX cable to the AUX jack upon use.*

**Connecting an External Device**

External audio players (Camcorders, car VCR, etc.) can be played through a dedicated cable.

## MY MUSIC MODE

### Basic Mode Screen

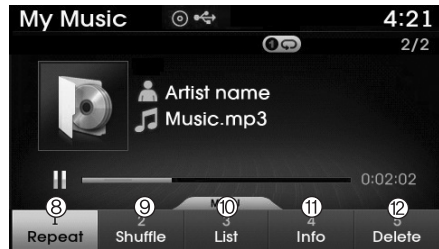
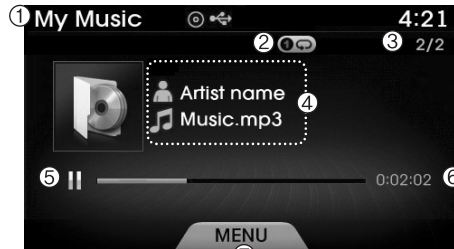

(1) Mode

Displays currently operating mode.

(2) Operation State

From Repeat / Shuffle / Scan, displays the currently operating function.

(3) File Index

Displays the current file/total number of files.

(4) File Info

Displays information about the current file.

(5) Play State

Displays the play/pause state.

(6) Play Time

Displays the current play time.

(7) MENU

Displays the My Music Menu

(8) Repeat

Turns the Repeat feature on/off.

(9) Shuffle

Turns the Shuffle feature on/off.

(10) List

Moves to the list screen.

(11) Info

Displays detailed information for the current file.

(12) Delete

Deletes the current file.

## Using My Music Mode

### Playing/Pausing My Music Files

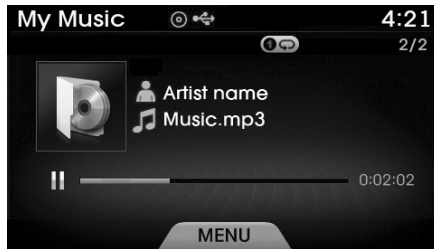

While playing, press the **TUNE** knob to pause and press again to play.

### \* NOTICE

If there are no files saved within My Music, the **My Music** button will be disabled.

### Changing Files

Press the **SEEK**, **TRACK** keys to select the previous or next file.

### \* NOTICE

- Pressing the **TRACK** key after the file has been playing for 2 seconds will start the current file from the beginning.
- Pressing the **TRACK** key before the file has been playing for 1 second will start the previous file.

### Selecting from the List

Press the **TUNE** knob to search and select desired files.

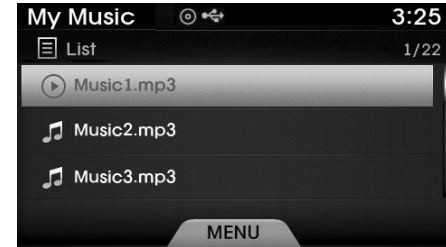

Once you find the desired file, press the **TUNE** knob to start playing.

### Rewinding / Fast-forwarding Files

While playing, press and hold the **SEEK**, **TRACK** keys (over 0.8 seconds) to rewind or fast-forward the current file.

### Scan

Press the **SCAN** key to play the first 10 seconds of each file.

### My Music Mode Menu

If you press the **MENU** key, you will have access to the Repeat, Shuffle, List, Info and Delete features.

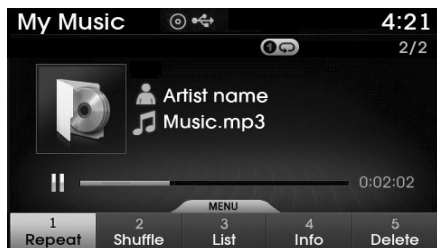

#### Repeat

Press the **MENU** key ▶ Select **Repeat**  
Repeat : Repeats the current file.

#### Shuffle

Press the **MENU** key ▶ Select **Shuffle**  
Shuffle : Plays all files in random order.

### \* NOTICE

The **1**, **2** keys are shortcut keys to set the Repeat and Shuffle features.

#### List

Press the **MENU** key ▶ Select **List**

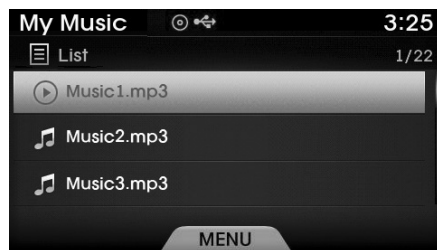

Press the **TUNE** knob to search for the desired file and press the **TUNE** knob to select.

#### Info

Press the **MENU** key ▶ Select **Info**  
Details for the currently playing file are displayed.

### \* NOTICE

The title, artist and album info are displayed only when such information is recorded within the MP3 file ID3 tag.

#### Deleting Files

Press the **MENU** key ▶ Select **Delete**  
The currently playing file is deleted.



## List Menu

From the List screen▶Press the **MENU** ▶Select [Edit].

Files saved in My Music can be selected and deleted.

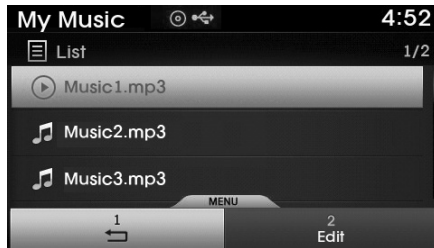

Use **TUNE** knob and the **TUNE** knob to search and select files you want to delete and select the **Delete** button from the Menu.

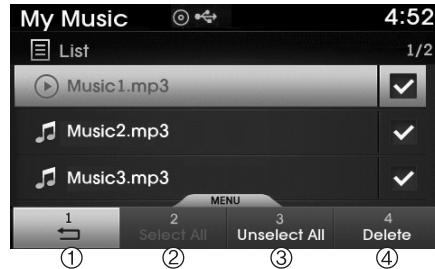

- (1) **←** : Moves to the previous screen
- (2) Select All: Selects all files
- (3) Unselect All: Deselects all selected files
- (4) Delete: Deletes selected files

## \* NOTICE

- If there is memory available, up to 6,000 files can be saved.
- Identical files cannot be copied more than 1,000 times.
- To check memory information, go to **SETUP** ▶[System] ▶[Memory Information]



## **Bluetooth® Wireless Technology AUDIO MODE**

### **Using Bluetooth® Wireless Technology Audio Mode**

#### **Playing/Pausing Bluetooth® Wireless Technology Audio**

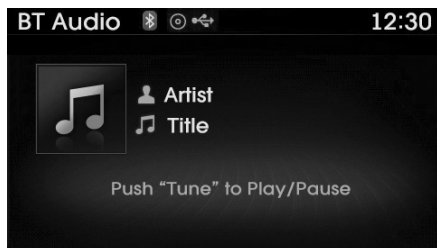
Once a *Bluetooth®* Wireless Technology device is connected, the mode will automatically start.



While playing, press the  TUNE knob to pause and press  TUNE knob to play.

#### **\* NOTICE**

The play/pause feature may operate differently depending on the mobile phone.

#### **Changing Files**

Press the ,  key to move to the previous or next file.

#### **Setting Connection**

If a *Bluetooth®* Wireless Technology device has not been connected, press the  key ▶ [Phone] button to display the *Bluetooth®* Wireless Technology connection screen.

It is possible to use the pair phone, connect/disconnect and delete features from your *Bluetooth®* Wireless Technology phone.

#### **\* NOTICE**

- If music is not yet playing from your mobile device after converting to *Bluetooth®* Wireless Technology Audio mode, pressing the play button once may start playing the mode. Check to see that music is playing from the *Bluetooth®* Wireless Technology device after converting to *Bluetooth®* Wireless Technology Audio Mode.

## Pairing a *Bluetooth*<sup>®</sup> Wireless Technology Device

### *What is Bluetooth*<sup>®</sup> *Wireless Technology Pairing?*

Pairing refers to the process of synchronizing your *Bluetooth*<sup>®</sup> Wireless Technology phone or device with the car audio system for connection. Pairing is necessary to connect and use the *Bluetooth*<sup>®</sup> Wireless Technology feature.

## Pairing **PHONE** Key / Key on the Steering Remote Controller

### *When No Devices have been Paired*

1. Press the **PHONE** key or the  key on the steering remote controller. The following screen is displayed.
2. Select the **OK** button to enter the Pair Phone screen.

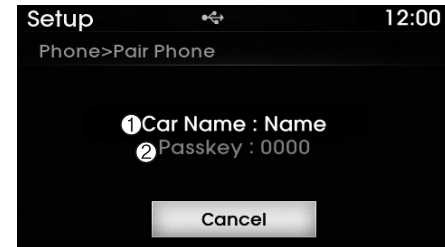
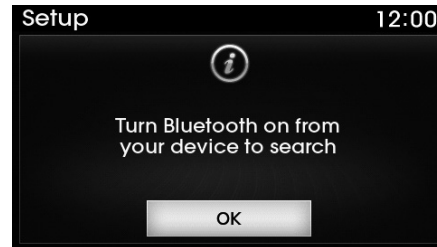

- 1) Car Name : Name of device as shown when searching from your *Bluetooth*<sup>®</sup> Wireless Technology device
- 2) Passkey : Passkey used to pair the device
3. From your *Bluetooth*<sup>®</sup> Wireless Technology device (i.e. Mobile Phone), search and select your car audio system.

[Non SSP supported device]  
(SSP: Secure Simple Pairing)

4. After a few moments, a screen is displayed where the passkey is entered.

Hear, enter the passkey "0000" to pair your *Bluetooth*® Wireless Technology device with the car audio system.

[SSP supported device]

4. After a few moments, a screen is displayed 6 digits passkey.

Hear, check the passkey on your *Bluetooth*® Wireless Technology device and confirm.

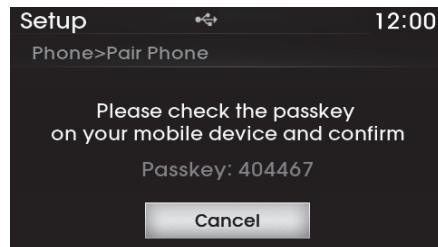

5. Once pairing is complete, the following screen is displayed.

### \* NOTICE

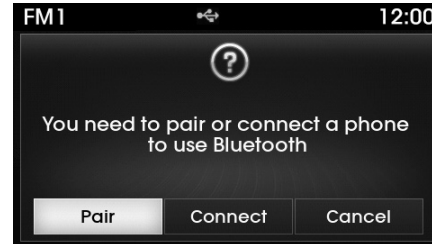

If *Bluetooth*® Wireless Technology devices are paired but none are currently connected, pressing the **PHONE** key or the  key on the steering wheel displays the following screen. Press the [Pair] button to pair a new device or press the [Connect] to connect a previously paired device.

### Pairing through [PHONE] Setup

Press the **SETUP** key ▶ Select [Phone] ▶ Select [Pair Phone] ▶ Select  TUNE knob

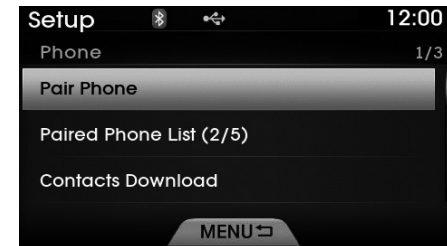

1. The following steps are the same as those described in the section "When No Devices have been Paired" on the previous page.

**\* NOTICE**

- *Bluetooth*<sup>®</sup> Wireless Technology features supported within the vehicle are as follows. Some features may not be supported depending on your *Bluetooth*<sup>®</sup> Wireless Technology device.
  - Outgoing/Incoming Handsfree calls
  - Operations during a call (Switch to Private, Switch to call waiting, MIC on/off)
  - Downloading Call History
  - Downloading Mobile Contacts
  - *Bluetooth*<sup>®</sup> Wireless Technology device auto connection
  - Bluetooth Audio Streaming
- Up to five *Bluetooth*<sup>®</sup> Wireless Technology devices can be paired to the Car Handsfree system.
- Only one *Bluetooth*<sup>®</sup> Wireless Technology device can be connected at a time.
- Other devices cannot be paired while a *Bluetooth*<sup>®</sup> Wireless Technology device is connected.

(Continued)

(Continued)

- Only *Bluetooth*<sup>®</sup> Wireless Technology Handsfree and Bluetooth audio related features are supported.
- Bluetooth related operations are possible only within devices that support Handsfree or audio features, such as a *Bluetooth*<sup>®</sup> Wireless Technology mobile phone or a Bluetooth audio device.
- If a connected *Bluetooth*<sup>®</sup> Wireless Technology device becomes disconnected due to being out of communication range, turning the device OFF, or a *Bluetooth*<sup>®</sup> Wireless Technology communication error, corresponding *Bluetooth*<sup>®</sup> Wireless Technology devices are automatically searched and reconnected.
- If the system becomes unstable due to communication errors between the car Handsfree and the *Bluetooth*<sup>®</sup> Wireless Technology device, reset the device by turning off and back on again. Upon resetting *Bluetooth*<sup>®</sup> Wireless Technology device, the system will be restored.

(Continued)

(Continued)

- After pairing is complete, a contacts download request is sent once to the mobile phone. Some mobile phones may require confirmation upon receiving a download request, ensure your mobile phone accepts the connection. Refer to your phones user's manual for additional information regarding phone pairing and connections.

### Connecting a Device

Press the **SETUP** key ▶ Select [Phone] ▶ Select [Paired Phone List]



- 1) Connected Phone : Device that is currently connected
- 2) Paired Phone : Device that is paired but not connected

From the paired phone list, select the device you want to connect and Select the **Connect** button.

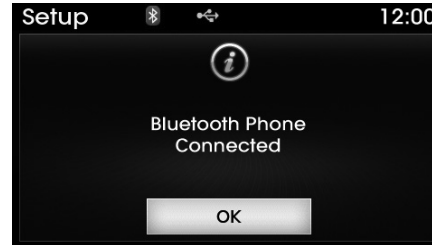

### Changing Priority

#### What is Priority?

It is possible to pair up to five *Bluetooth*® Wireless Technology devices with the car audio system. The "Change Priority" feature is used to set the connection priority of paired phones.

Press the **SETUP** key ▶ Select [Phone] ▶ Select [Paired Phone List]



From the paired phone list, select the phone you want to switch to the highest priority, then select the **Change priority** button from the Menu. The selected device will be changed to the highest priority.

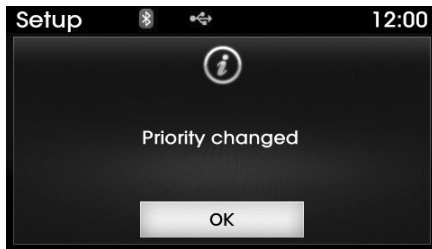

**\* NOTICE**

**Priority icon will be displayed when the selected phone is set as a priority phone.**



**Disconnecting a Device**

Press the **SETUP** key ▶ Select [Phone] ▶ Select [Paired Phone List]



From the paired phone list, select the currently connected device and select the **Disconnect** button.

### Deleting a Device

Press the **SETUP** key ▶ Select [Phone] ▶ Select [Paired Phone List]



From the paired phone list, select the device you want to delete and select the **Delete** button.

### \* NOTICE

- When deleting the currently connected device, the device will automatically be disconnected to proceed with the deleting process.
- If a paired *Bluetooth*® Wireless Technology device is deleted, the device's call history and contacts data will also be deleted.
- To re-use a deleted device, you must pair the device again.



## USING Bluetooth® Wireless Technology

### Phone Menu Screen

#### Phone Menus

With a Bluetooth® Wireless Technology device connected, press the **PHONE** key to display the Phone menu screen.

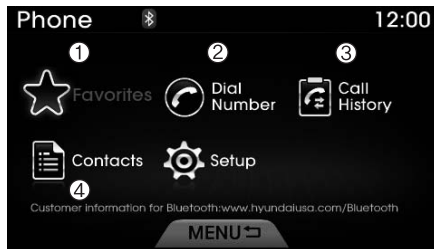

- 1) Favorite : Up to 20 frequently used contacts saved for easy access
- 2) Dial Number : Displays the dial screen where numbers can be dialed to make calls
- 3) Call History : Device the call history list screen

- 4) Contacts : Displays the Contacts list screen
- 5) Setup : Displays Phone related settings.

### \* NOTICE

- If you press the [Call History] button but there is no call history data, a prompt is displayed which asks to download call history data.
- If you press the [Contacts] button but there is no contacts data stored, a prompt is displayed which asks to download contacts data.
- This feature may not be supported in some mobile phones. For more information on download support, refer to your mobile phone user's manual.

### Favorites

Press the **PHONE** key ▶ Select [Favorites]

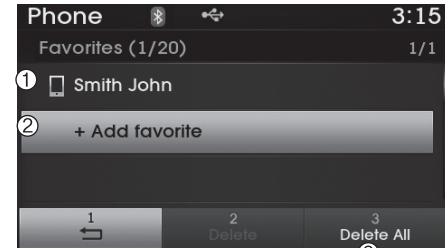

- 1) Saved favorite contact : Connects call upon selection
- 2) To add favorite : Downloaded contacts be saved as favorite.
- 3) Delete All : Delete all stored favorite contacts

### \* NOTICE

- To save Favorite, contacts should be downloaded.
- Contact saved in Favorites will not be automatically updated if the contact has been updated in the phone. To update Favorites, delete the Favorite and create a new Favorite.

### Calling by Dialing a Number

Press the **PHONE** key ▶ Select [Dial Number]



- 1) Dial Pad : Used to enter phone number
- 2) Call : If a number has been entered, calls the number. If no number has been entered, switches to call history screen
- 3) End : Deletes the entered phone number
- 4) Delete : Deletes entered numbers one digit at a time

### Answering Calls

#### *Answering a Call*

Answering a call with a *Bluetooth®* Wireless Technology device connected will display the following screen.

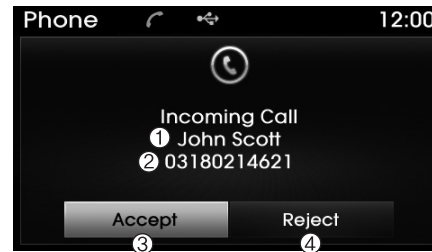

- 1) Caller : Displays the other party's name when the incoming caller is saved within your contacts
- 2) Incoming Number : Displays the incoming number
- 3) Accept : Accept the incoming call
- 4) Reject : Reject the incoming call

### \* NOTICE

- When an incoming call pop-up is displayed, most Audio and SETUP mode features are disabled. Only the call volume will operate.
- The telephone number may not be properly displayed in some mobile phones.
- When a call is answered with the mobile phone, the call mode will automatically revert to Private mode.

### During a Handsfree Call



- 1) Caller : Displays the other party's name if the incoming caller is saved within your contacts
- 2) Incoming Number : Displays the incoming number
- 3) Call time : Displays the call time
- 4) End : Ends call
- 5) Private : Converts to Private mode
- 6) Out Vol. : Sets call volume as heard by the other party
- 7) Mute : Turns Mic Mute On/Off

### \* NOTICE

If the mic is muted, the other party will not be able to hear your voice.

### Call History

Press the **PHONE** key ▶ Select [Call History]



A list of incoming, outgoing and missed calls is displayed.

Select the **Download** button to download the call history.

- 1) Call History :
  - Displays recent calls (call history)
  - Connects call upon selection
- 2) Download : Download Recent Call History
  - Call history may not be saved in the call history list in some mobile phones.

- Calls received with hidden caller ID will not be saved in the call history list.
- Calling through the call history is not possible when there is no call history stored or a *Bluetooth*® Wireless Technology phone is not connected.
- Up to 20 received, dialed and missed calls are stored in Call History.
- Time of received/dialed calls and call time information are not saved.

### Contacts

Press the **PHONE** key ▶ Select [Contacts]

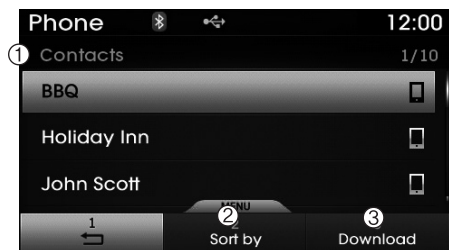

The list of saved phone book entries is displayed. Select the **Download** button to download the call history.

- 1) Contacts List :
  - Displays downloaded contacts entries
  - Connects call upon selection
- 2) Sort by : Find a contact in an alphabetical order.
- 3) Download : Download contacts entries

### \* NOTICE

- Up to 1,000 contacts saved in your *Bluetooth*® Wireless Technology phone can be downloaded into the car contacts. Contacts that have been downloaded to the car cannot be edited or deleted on the phone.
- Mobile phone contacts are managed separately for each paired *Bluetooth*® Wireless Technology device (max 5 devices x 1,000 contacts each). Previously downloaded data is maintained even if the *Bluetooth*® Wireless Technology device has been disconnected. (However, the contacts and call history saved to the phone will be deleted if a paired phone is deleted.)
- It is possible to download contacts during Bluetooth streaming audio.
- When downloading contacts, the icon will be displayed within the status bar.

(Continued)

(Continued)

- It is not possible to begin downloading a contact list when the contact download feature has been turned off within the *Bluetooth*® Wireless Technology device. In addition, some devices may require device authorization upon attempting to download contacts. If downloading does not normally occur, check the *Bluetooth*® Wireless Technology device settings or the screen state.
- The contacts download feature may not be supported in some mobile phones. For more information of supported *Bluetooth*® devices and function support, refer to your phone's user manual.

## VOICE RECOGNITION

### Using Voice Recognition

#### *Starting Voice Recognition*

Shortly press the  key on the steering wheel remote controller. Say a command.

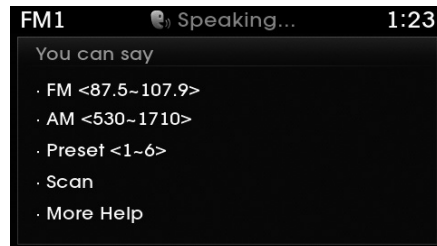

If prompt feedback is in [ON], then the system will say "Please say a command after the beep (BEEP)"

- If prompt feedback is in [OFF] mode, then the system will only say "(BEEP)"
- To change Prompt Feedback [On]/[Off], go to **SETUP** ▶ [System] ▶ [Prompt Feedback]

### \* NOTICE

**For proper recognition, say the command after the voice instruction and beep tone.**

#### Contact List Best Practices

- 1) Do not store single-name entries (e.g., "Bob", "Mom", "Kim", etc.). Instead, always use full names (including first and last names) for all contacts (e.g., use "Jacob Stevenson" instead of "Dad").
- 2) Do not use abbreviations (i.e., use "Lieutenant" instead of "Lt." or "Sergeant" instead of "Sgt.").
- 3) Do not use acronyms (i.e., use "County Finance Department" instead of "CFD").

- 4) Do not use special characters (e.g., "@", "hyphen -", "asterisk \*", "ampersand &").
- 5) If a name is not recognized from the contact list, change it to a more descriptive name (e.g., use "Grandpa Joseph" instead of "Pa Joe").

#### *Skipping Prompt Messages*

While prompt message is being stated ▶ Shortly press the  key on the steering wheel remote controller

The prompt message is immediately ended and the beep tone will sound. After the "beep", say the voice command.

#### *Re-starting Voice Recognition*

While system waits for a command ▶ Shortly press the  key on the steering wheel remote controller

The command wait state is immediately ended and the beep tone will sound. After the "beep", say the voice command.

\* Illustration on using voice commands

## • Starting voice command.

Shortly pressing the  key (under 0.8 seconds):

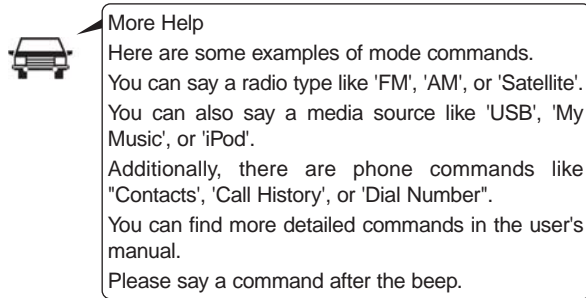
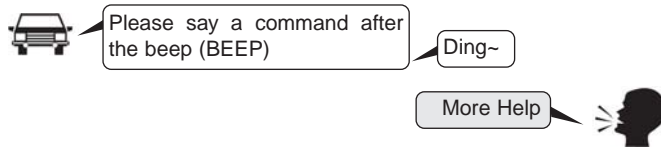

## • Skipping Voice Recognition

Shortly pressing the  key (under 0.8 seconds):

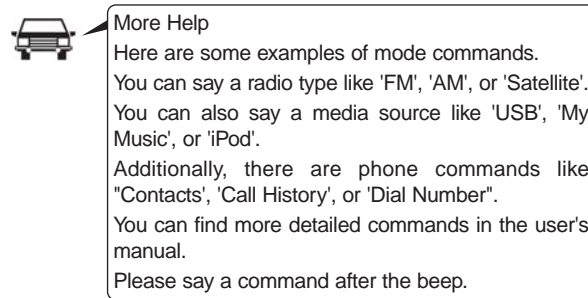

## • End voice command.

Shortly pressing the  key (under 0.8 seconds):

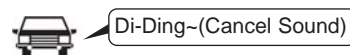
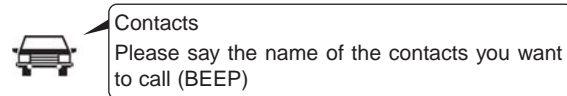
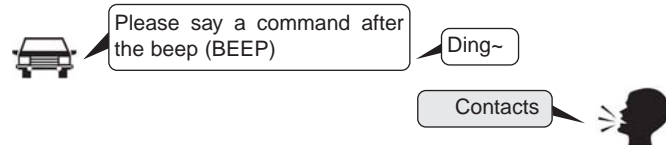

## Voice Command List

- **Common Commands:** These commands can be used in most operations. (However a few commands may not be available during certain operations)

Command	Function
More Help	Provides guidance on commands that can be used anywhere in the system.
Help	Provides guidance on commands that can be used within the current mode.
Call<Name>	Calls <Name> saved in Contacts Ex) Call "John Smith"
Phone	Provides guidance on Phone related commands. After saying this command, say "Favorites", "Dial Number", "Call History" or "Contacts" execute corresponding functions.
Favorites	Display the Favorite screen.
Call History	Displays the Call History screen.
Contacts (Call by Name)	Displays the Contacts screen. After saying this command, say the name of a contact saved in the Contacts to automatically connect the call.
Dial Number	Display the Dial number screen. After saying this command, you can say the number that you want to call.
Redial	Connects the most recently called number.
Tutorial	Provide guidance on how to use voice recognition and Bluetooth® connections.

Command	Function
Radio	<ul style="list-style-type: none"> <li>• When listening to the radio, displays the next radio screen. (FM1→FM2→AM→XM1→XM2→XM3→FM1)</li> <li>• When listening to a different mode, displays the most recently played radio screen.</li> <li>• When currently listening to the FM radio, maintains the current state.</li> <li>• When listening to a different mode, displays the most recently played FM screen.</li> </ul>
FM1(FM One)	Displays the FM1 screen.
FM2(FM Two)	Displays the FM2 screen.
AM	Displays the AM screen.
FM Preset 1-6	Plays the most recently played broadcast saved in FM Preset 1-6.
AM Preset 1-6	Plays the broadcast saved in AM Preset 1-6.
FM 87.5-107.9	Plays the FM broadcast of the corresponding frequency.
AM 530-1710	Plays the AM broadcast of the corresponding frequency.
XM (Satellite)	<ul style="list-style-type: none"> <li>• When currently listening to the XM, maintains the current state.</li> <li>• When listening to a different mode, displays the most recently played XM screen.</li> </ul>

## Features of your vehicle

---

<b>Command</b>	<b>Function</b>
XM (Satellite) 1-3	Displays the selected XM screen.
XM Channel 0-255	Plays the selected XM channel.
Media	Moves to the most recently played media screen.
CD	Plays the music saved in the CD.
USB	Plays USB music.
iPod®	Plays iPod music.

<b>Command</b>	<b>Function</b>
My Music	Plays the music saved in My Music.
AUX (Auxiliary)	Plays the connected external device.
Bluetooth® Audio	Plays the music saved in connected Bluetooth® device.
Please repeat	Repeats the most recent comment.
Mute	Mutes the sound
Cancel (Exit)	Ends voice command.



- FM/AM radio commands: available during FM, AM radio operation

Command	Function
Preset 1~6	Plays the broadcast saved in Preset 1~6.
Scan	Scans receivable frequencies from the current broadcast and plays for 10 seconds each.
Preset Scan	Moves to the next preset from the current present and plays for 10 seconds each.

- Satellite radio commands: Commands that can be used while listening to Satellite Radio.

Command	Function
Channel 0~255	Play the selected Satellite Radio channel.
Scan	Scans receivable channels from the current broadcast and plays for 10 seconds each.
Preset 1~6	Plays the broadcast saved in Preset 1~6.

## Features of your vehicle

---

- Audio CD commands: Commands available during Audio CD operation

Command	Function
Play	Plays the currently paused track.
Pause	Pauses the current track.
Shuffle	Randomly plays the tracks within the CD.
Shuffle Off	Cancels random play to play tracks in sequential order.
Repeat	Repeats the current track.
Repeat Off	Cancels repeat play to play tracks in sequential order.
Track 1~30	Plays the desired track number.

- MP3 CD / USB commands: Commands available during USB and MP3 CD operation

Command	Function
Play	Plays the currently paused file.
Pause	Pauses the current file.
Shuffle	Randomly plays the files within the current folder.
Shuffle Off	Cancels random play to play files in sequential order.
Repeat	Repeats the current file.
Repeat Off	Cancels repeat play to play files in sequential order.
Next Folder	Play the first file in the next folder
Previous Folder	Play the first file in the previous folder

- iPod® Commands: Commands available during iPod® operation

Command	Function
Play	Plays the currently paused song.
Pause	Pauses the current song.
Shuffle	Randomly plays the songs within the current category.
Shuffle Off	Cancels random play to play songs in sequential order.
Repeat	Repeats the current song.
Repeat Off	Cancels repeat play to play songs in sequential order.

- My Music Commands: Commands available during My Music operation

Command	Function
Play	Plays the currently paused file.
Pause	Pauses the current file.
Shuffle	Randomly plays all saved files.
Shuffle Off	Cancels random play to play files in sequential order.
Repeat	Repeats the current file.
Repeat Off	Cancels repeat play to play files in sequential order.
Delete	Deletes the current file. You will bypass an additional confirmation process.

## USING SETUP

### Starting Mode

Press the **SETUP** key to display the Setup screen.

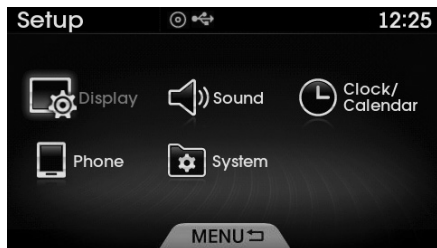

You can select and control options related to [Display], [Sound], [Clock / Calendar], [Phone] and [System].

### \* NOTICE

Once settings have been changed, press the **MENU** key to return to the previous menu.

## Display Settings

### Adjusting the Brightness

Press the **SETUP** key ▶ Select [Display] ▶ Select [Brightness]

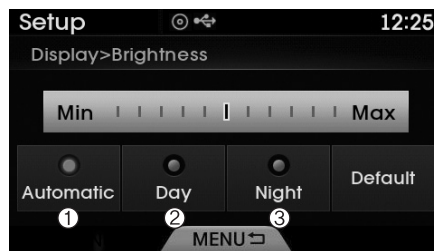

Use the **TUNE** knob to adjust the screen brightness or set the Brightness on Automatic, Daylight, or Nightmode.

- (1) Automatic : Adjusts the brightness automatically
- (2) Day : Always maintains the brightness on high
- (3) Night : Always maintains the brightness on low

### Mode Pop-up

Press the **SETUP** key ▶ Select [Display] ▶ Select [Mode Pop up]

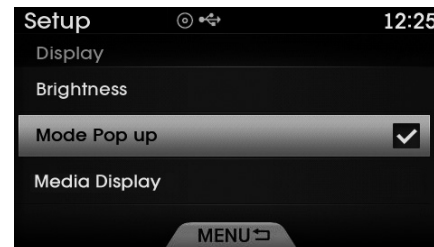

This feature is used to display the Mode Pop-up screen when entering radio and media modes.

When this feature is turned on, pressing the **RADIO** or **MEDIA** key will display the Mode Pop-up screen.

### \* NOTICE

The media Mode Pop-up screen can be displayed only when two or more media modes have been connected.

### MP3 Information Display

Press the **SETUP** key ▶ Select [Display]  
▶ Select [Media Display]

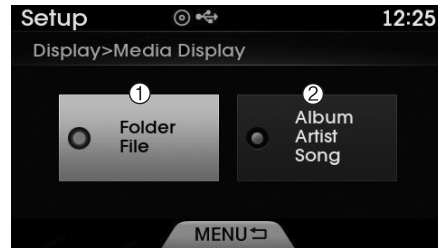

This feature is used to change the information displayed within USB and MP3 CD modes.

- (1) Folder File : Displays file name and folder name
- (2) Album Artist Song : Displays album name/artist name/song

### Sound Settings

#### Sound Settings

Press the **SETUP** key ▶ Select [Sound]  
▶ Select [Sound Setting]

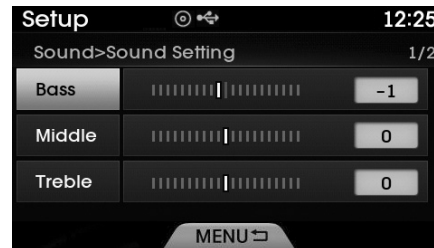

Use **TUNE** knob to adjust the Bass/Middle/Treble and Fader/ Balance settings.

After selecting the Bass / Middle / Treble, use the **TUNE** knob to adjust the settings.

After selecting the Fader / Balance, use the **TUNE** knob to move the cursor on the control screen to the desired position.

### ***SDVC (Speed Dependent Volume Control)***

Press the **SETUP** key ▶ Select [Sound] ▶ Select [Speed Dependent Vol.]

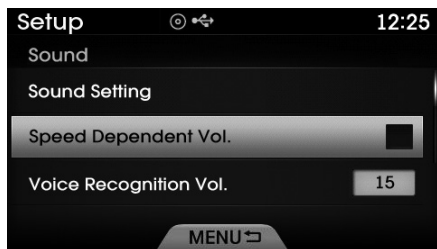

The volume level is controlled automatically according to the vehicle speed.

Use the **TUNE** knob to select from On/Off.

### ***Voice Recognition Setting***

Press the **SETUP** key ▶ Select [Sound] ▶ Select [Voice Recognition Vol.]

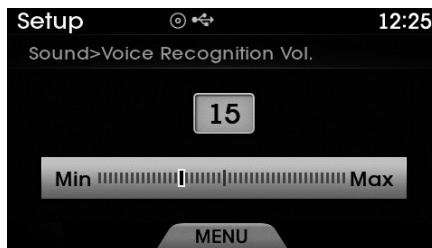

Use the **TUNE** knob to adjust the Voice Recognition volume.

### ***Blue Link Volume***

Press the **SETUP** key ▶ Select [Sound] ▶ Select [Blue Link Voice Vol.]

Use the **TUNE** knob to adjust the Blue Link Voice Recognition volume.

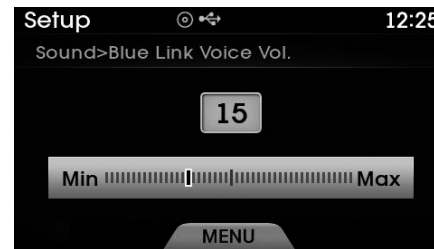

### **\* NOTICE**

This feature may not be available depending on whether your device supports Blue Link.

## Clock/Calendar Setting

### Clock Setting

Press the **SETUP** key ▶ Select [Clock/Calendar] ▶ Select [Clock Settings]

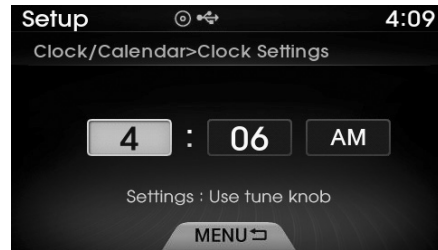

Use the **TUNE** knob to select the Hour, Minutes and AM/PM setting and use **TUNE** knob to change settings.

### Calendar Setting

Press the **SETUP** key ▶ Select [Clock/Calendar] ▶ Select [Calendar Settings]

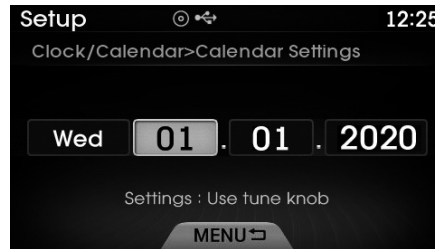

Use the **TUNE** knob to select the Month, Day, and Year and use **TUNE** knob to change settings.

### Time Format

Press the **SETUP** key ▶ Select [Clock/Calendar] ▶ Select [Time Format]

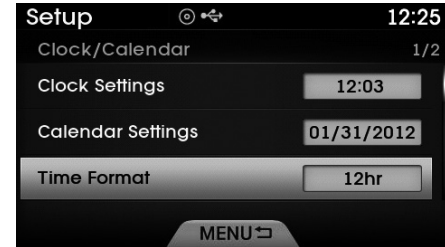

This feature is used to change the clock format between 12hr or 24hr.

### Clock Display

Press the **SETUP** key ▶ Select [Clock/Calendar] ▶ Select [Clock Display (Power off)]

This feature is used to display a clock on the screen when the audio system is turned off.

## Bluetooth® Wireless Technology Setting

### Pairing a New Device

Press the **SETUP** key ▶ Select [Phone] ▶ Select [Pair Phone]

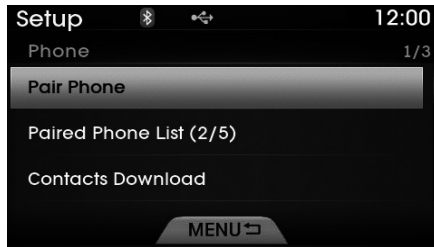

Bluetooth® Wireless Technology devices can be paired with the audio system.

For more information, refer to the "Pairing through Phone Setup" section within Bluetooth® Wireless Technology.

### Viewing Paired Phone List

Press the **SETUP** key ▶ Select [Phone] ▶ Select [Paired Phone List]



This feature is used to view mobile phones that have been paired with the audio system. Upon selecting a paired phone, the setup menu is displayed.

For more information, refer to the "Setting Bluetooth® Wireless Technology Connection" section within Bluetooth® Wireless Technology.

1) Connect/Disconnect Phone : Connect/ disconnects currently selected phone

- 2) Delete : Deletes the currently selected phone
- 3) Change Priority : Sets currently selected phone to highest connection priority



**\* NOTICE BEFORE DOWNLOADING CONTACTS**

- Only contacts within connected phones can be downloaded. Also check to see that your mobile phone supports the download feature.
- To learn more about whether your mobile phone supports contacts downloads, refer to your mobile phone user's manual.
- The contacts for only the connected phone can be downloaded.

**Downloading Contacts**

Press the **SETUP** key ▶ Select [Phone] ▶ Select [Contacts Download]

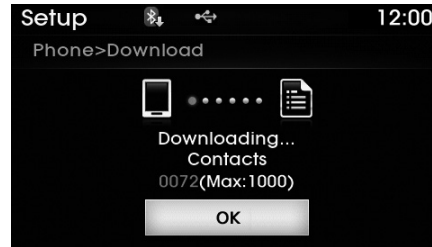

As the contacts are downloaded from the mobile phone, a download progress bar is displayed.

**\* NOTICE**

- Upon downloading phone contacts, the previous corresponding data is deleted.
- This feature may not be supported in some mobile phones.
- Voice Recognition may not operate while contacts are being downloaded.

**Auto Download (Contacts)**

Press the **SETUP** key ▶ Select [Phone] ▶ Select [Auto Download]

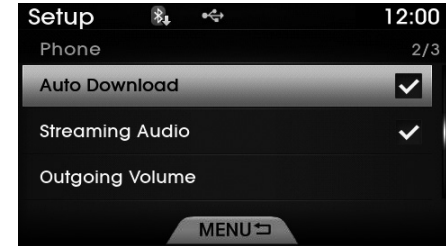

This feature is used to automatically download mobile contacts entries once a *Bluetooth®* Wireless Technology phone is connected.

**\* NOTICE**

- The Auto Download feature will download mobile contacts entries every time the phone is connected. The download time may differ depending on the number of saved contacts entries and the communication state.
- Before downloading contacts, first check to see that your mobile phone supports the contacts download feature.

### Streaming Audio

Press the **SETUP** key ▶ Select [Phone] ▶ Select [Streaming Audio]

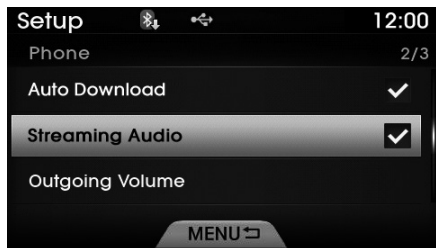

When Streaming Audio is turned on, you can play music files saved in your *Bluetooth*® Wireless Technology device through the audio system.

### Outgoing Volume

Press the **SETUP** key ▶ Select [Phone] ▶ Select [Outgoing Volume]

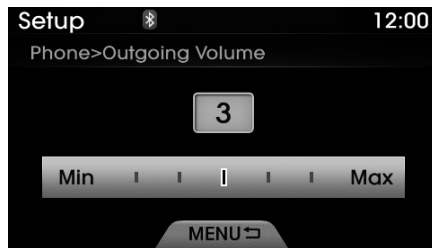

Use **TUNE** knob to adjust the outgoing volume level.

### \* NOTICE

While on a call, the volume can be changed by using the **SEEK** **TRACK** key.

### Turning Bluetooth System Off

Press the **SETUP** key ▶ Select [Phone] ▶ Select [Bluetooth System Off]

Once *Bluetooth*® Wireless Technology is turned off, *Bluetooth*® Wireless Technology related features will not be supported within the audio system.

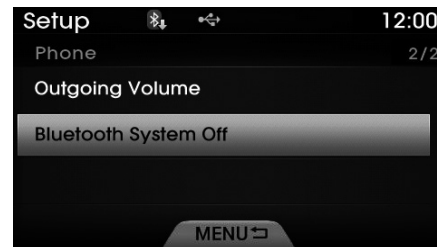

**\* NOTICE**

To turn *Bluetooth*<sup>®</sup> Wireless Technology back on, go to **SETUP** ▶ [Phone] and press “Yes”.

### System Setting

#### Memory Information

Press the **SETUP** key ▶ Select [System] ▶ Select [Memory Information]



This feature displays information related to system memory.

- (1) Using : Displays capacity currently in use
- (2) Capacity : Displays total capacity

#### Voice Recognition Mode Setting

Press the **SETUP** key ▶ Select [System] ▶ Select [Prompt Feedback]

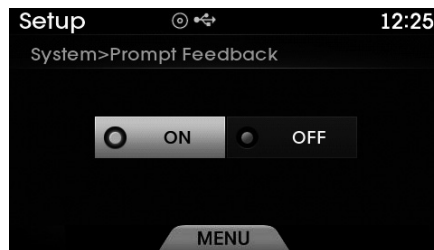

This feature is used to select the desired prompt feedback option from Normal and Expert.

- (1) ON : When using voice recognition, provides detailed guidance prompts
- (2) OFF : When using voice recognition, omits some guidance prompts

#### Language

Press the **SETUP** key ▶ Select [System] ▶ Select [Language]

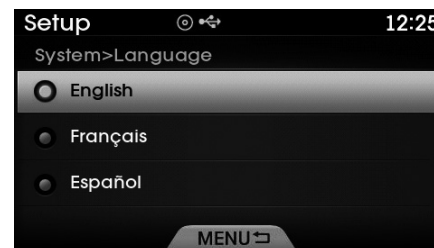

This feature is used to change the system and voice recognition language.

If the language is changed, the system will restart and apply the selected language.

## REAR VIEW CAMERA (if equipped)

- The system has been equipped with a rear view camera for user safety by allowing a wider rear range of vision.
- The rear view camera will automatically operate when the ignition key is turned ON and the transmission lever is set to R.
- The rear view camera will automatically stop operating when set to a different lever.

### CAUTION

*The rear view camera has been equipped with an optical lens to provide a wider range of vision and may appear different from the actual distance. For safety, directly check the rear and left/right sides.*

### Blue Link® (if equipped)

Hyundai aims to offer differentiated customer values through a 'Connected Car Life,' which is to provide consumers with fast and reliable IT technology. As consumers' lifestyles become more and more mobile in thanks to remarkable advances in smart phones, tablet PCs and overall wireless telecommunication, new lifestyle patterns demand seamless connection between one's office, home, outdoors and automobiles.

Automobile companies are now faced with the task of shifting their paradigm from vehicle-centered services to customer value-centered services, with the ultimate goal of securing global leadership in the field of vehicle IT and telematics.

Hyundai Motor plans to achieve this by realizing a terminal platform flexi-

ble to changes in IT technology, cooperating with global IT companies, creating an eco-system and providing the latest contents & services based on an open environment.

### Using the Room Mirror Key

Selecting the room mirror key will allow you to make service required inquiries, POI info searches, and emergency rescues by connecting to the Blue Link® Center.

Such features can be used only after subscribing to the Blue Link® service.

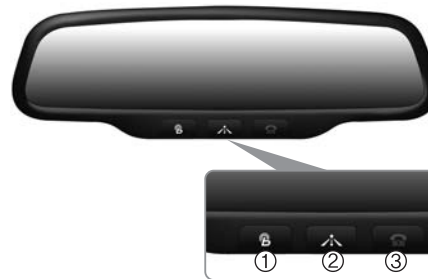

#### (1) (Blue Link® Center)

Makes requests for Blue Link® service related inquiries and consultations.

A call is connected to the Blue Link® service center employee.

Re-pressing the key will end the call.

This feature does not operate when you are on a Bluetooth® phone call.

#### (2) (Blue Link® for POI)

- Blue Link® for Voice command

Starts Blue Link® voice command.

Voice receiving voice guidance, shortly press the button to convert to voice command mode. Press and hold the button to end voice command.

- TBT VR Commands

1. Navigate to

“Navigate to” voice command is used to request the download of route data for a new destination, saved destinations, daily routes and previous destinations.



## 2. Save Destination

“Save Destination” VR command is used to assign a voice tag to the last downloaded destination and store it in a destination directory.

### NOTE:

**The Turn by Turn(TBT) feature supports the store of ten(10) destinations in the TBT destinations directory.**

## 3. Route Preview

“Route Preview” VR command allows the user to preview the route instructions (upcoming maneuver instructions) at any time during the route guidance.

## 4. Destinations List

“Destinations List” VR command allows the user to preview and delete the stored destinations with their associated voice tags in the Turn by Turn destinations directory.

## 5. Voice Guidance

“Voice Guidance” VR command allows the user to mute/unmute the Turn by Turn(TBT) direction announcements.

## 6. Suspend Route

“Suspend Route” VR command allows the user to suspend and pause Turn by Turn(TBT) route guidance while in the guidance mode.

## 7. Resume Route

“Resume Route” VR command allows the user to resume Turn by Turn(TBT) route guidance.

## (3) (Blue Link® for SOS)

In the case of an emergency, requests for help to the Blue Link® center.

Call is connected to the Blue Link® emergency rescue center. Re-pressing the key will end the call.

If already on a Bluetooth® phone call, the call will end to connect you to the Blue Link® Emergency Rescue Center.



### CAUTION

- **You cannot talk simultaneously on the Bluetooth® phone and Blue Link® phone.**
- **While on a Bluetooth® call, pressing the  key or  key will display a message indicating that you are currently on a call.**
- **A message will be displayed if you receive a Bluetooth® Wireless Technology call while already on a Blue Link® call. At this time, press the  key on the steering wheel remote controller to accept the call. The phone bell will not ring.**

## Eco Coach

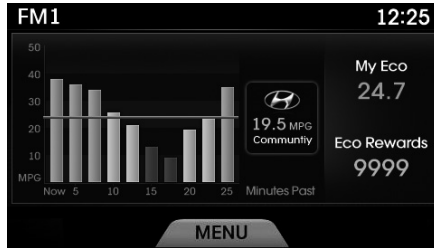

### • What is Eco Coach?

Every 2.5 minutes, Eco Coach compares your fuel economy against the government tested average (EPA) or other similar Hyundai models (community), based on your preference. Each month, or after every tank fill up, Eco Coach rates your extended average and gives you a reward star if you best the average.

See your My Hyundai web page for more information.

### • What does the bar graph and horizontal line mean?

The horizontal line is adjusted once per month or at each tank full, based on your preference; it represents the EPA combined average or community average fuel economy target.

### • What is My Eco MPG?

Your actual fuel economy average over 2.5 minutes.

This value is also shown in bar graph as your “now” rating.

### • What are Eco Rewards?

If you beat the average (the EPA or community), you will receive an Eco Reward point.

See your my Hyundai web page for more information.

[Eco Driving] will not operate if the vehicle ignition is not turned on. Please operate with the ignition turned on.

## Turn by Turn

The Turn by Turn feature can be used through Blue Link®.

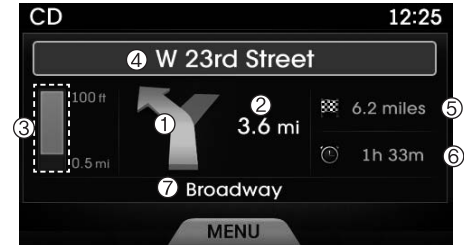

### (1) Direction Indicator Image

(2) Remaining distance until next point

(3) The Count bar is divided into a total of 9 levels.

9 Level	0.5mi	8 Level	0.4mi
7 Level	0.3mi	6 Level	0.2mi
5 Level	0.1mi	4 Level	400ft
3 Level	300ft	2 Level	200ft
1 Level	100ft		



- (4) Next Street name
- (5) Distance to destination
- (6) Expected Time Arrival
- (7) Current Street name

\* For information on specific Blue Link® operations, please refer to a separate manual.

# Driving your vehicle

Before driving . . . . .	5-3	Lane departure warning system (LDWS) . . . . .	5-65
Engine start/stop button . . . . .	5-5	Forward collision warning system (FCWS). . . . .	5-69
• Illuminated ENGINE START/STOP button . . . . .	5-5	Economical operation . . . . .	5-73
• ENGINE START/STOP button position. . . . .	5-5	Special driving conditions . . . . .	5-75
• Starting the engine . . . . .	5-7	• Hazardous driving conditions . . . . .	5-75
Automatic transaxle . . . . .	5-10	• Rocking the vehicle . . . . .	5-75
• Automatic transaxle operation. . . . .	5-10	• Smooth cornering . . . . .	5-76
Brake system. . . . .	5-16	• Driving at night . . . . .	5-76
• Power brakes . . . . .	5-16	• Driving in the rain. . . . .	5-77
• Parking brake . . . . .	5-18	• Driving in flooded areas . . . . .	5-77
• Electronic parking brake (EPB) . . . . .	5-19	• Driving off-road. . . . .	5-77
• Auto hold . . . . .	5-25	• Highway driving . . . . .	5-78
• Anti-lock brake system (ABS) . . . . .	5-29	Winter driving . . . . .	5-79
• Electronic stability control (ESC) . . . . .	5-30	Vehicle load limit . . . . .	5-83
• Vehicle stability management (VSM) . . . . .	5-34	• Tire and loading information label . . . . .	5-83
• Hill-start assist control (HAC). . . . .	5-35	• Certification label . . . . .	5-86
• Good braking practices. . . . .	5-36	Vehicle weight . . . . .	5-87
Cruise control system. . . . .	5-38	• Base curb weight . . . . .	5-87
Smart cruise control system . . . . .	5-42	• Vehicle curb weight. . . . .	5-87
Active ECO system. . . . .	5-56	• Cargo weight . . . . .	5-87
Blind spot detection system (BSD) . . . . .	5-57	• GAW (Gross axle weight) . . . . .	5-87
• BSD (Blind Spot Detection) /		• GAWR (Gross axle weight rating). . . . .	5-87
LCA (Lane Change Assist). . . . .	5-58	• GVW (Gross vehicle weight) . . . . .	5-87
• RCTA (Rear Cross Traffic Alert). . . . .	5-61	• GVWR (Gross vehicle weight rating) . . . . .	5-87
• Driver's Attention . . . . .	5-63	Trailer Towing . . . . .	5-88

**Be sure the exhaust system does not leak.**

The exhaust system should be checked whenever the vehicle is raised to change the oil or for any other purpose. If you hear a change in the sound of the exhaust or if you drive over something that strikes the underside of the vehicle, have the exhaust system checked as soon as possible by an authorized HYUNDAI dealer.

**⚠ WARNING - Engine exhaust**

Do not inhale exhaust fumes or leave your engine running in a enclosed area for a prolonged time. Exhaust fumes contain carbon monoxide, a colorless, odorless gas that can cause unconsciousness and death by asphyxiation.

**⚠ WARNING - Open trunk**

Do not drive with the trunk open. Poisonous exhaust gases can enter the passenger compartment.

If you must drive with the trunk open proceed as follows:

1. Close all windows.
2. Open side vents.
3. Set the air intake control at "Fresh", the air flow control at "Floor" or "Face" and the fan at the highest speed.

To assure proper operation of the ventilation system, be sure the ventilation air intakes located just in front of the windshield are kept clear of snow, ice, leaves or other obstructions.

**⚠ WARNING - California proposition 65**

Engine exhaust and a wide variety of automobile components and parts, including components found in the interior furnishings in a vehicle, contain or emit chemicals known to the State of California to cause cancer and birth defects and reproductive harm. In addition, certain fluids contained in vehicles and certain products of component wear contain or emit chemicals known to the State of California to cause cancer and birth defects or other reproductive harm.

## BEFORE DRIVING

### Before entering vehicle

- Be sure that all windows, outside mirror(s), and outside lights are clean.
- Check the condition of the tires.
- Check under the vehicle for any sign of leaks.
- Be sure there are no obstacles behind you if you intend to back up.

### Necessary inspections

Fluid levels, such as engine oil, engine coolant, brake fluid, and washer fluid should be checked on a regular basis, with the exact interval depending on the fluid. Further details are provided in section 7, “Maintenance”.

**⚠ WARNING - Distracted driving**

**Focus on the road while driving. The driver's primary responsibility is in the safe and legal operation of the vehicle. Use of any hand-held devices, other equipment or vehicle systems that distract the driver should not be used during vehicle operation. Distracted driving can result in injuries or death.**

### Before starting

- Close and lock all doors.
- Position the seat so that all controls are easily reached.
- Adjust the inside and outside rearview mirrors.
- Be sure that all lights work.
- Check all gauges.
- Check the operation of warning lights when the ignition switch is changed to the ON position.
- Release the parking brake and make sure the brake warning light goes out.

For safe operation, be sure you are familiar with your vehicle and its equipment.

**⚠ WARNING**

**All passengers must be properly belted whenever the vehicle is moving. Refer to “Seat belts” in section 3 for more information on their proper use.**

**⚠ WARNING - Check surroundings**

Always check the surrounding areas near your vehicle for people, especially children, before putting a vehicle into D (Drive) or R (Reverse). Otherwise, an accident may occur hurting or killing people or children around the vehicle.

**⚠ WARNING - Loose object**

Securely store items in your vehicle. When you make a sudden stop or turn the steering wheel rapidly, loose objects may drop on the floor and it could interfere with the operation of the foot pedals, possibly causing an accident.

**⚠ WARNING - Fire risk**

When you intend to park or stop the vehicle with the engine on, be careful not to depress the accelerator pedal for a long period of time. It may overheat the engine or exhaust system and cause fire.

**⚠ WARNING - Driving while intoxicated**

Do not drive while intoxicated. Drinking and driving is dangerous. Even a small amount of alcohol will affect your reflexes, perceptions and judgment. Driving while under the influence of drugs is as dangerous as or more dangerous than driving drunk. Driving while intoxicated can result in a serious accident.

## ENGINE START/STOP BUTTON



OHG055004N

### Illuminated ENGINE START/STOP button (if equipped)

Whenever the front door is opened, the ENGINE START/STOP button will illuminate for your convenience. The light will go off after about 30 seconds when the door is closed. It will also go off immediately when the theft-alarm system is armed.

### ENGINE START/STOP button position OFF

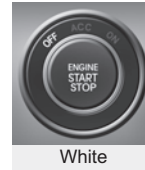

To turn off the engine (START/RUN position) or vehicle power (ON position), press the ENGINE START/STOP button with the shift lever in the P (Park) position. When you press the ENGINE START/STOP button without the shift lever in the P (Park) position, the ENGINE START/STOP button will not change to the OFF position but to the ACC position.

### \* NOTICE

In an emergency situation while the vehicle is in motion, you are able to turn the engine off and to the ACC position by pressing the ENGINE START/STOP button for more than 2 seconds or 3 times successively within 3 seconds. If the vehicle is still moving, you can restart the engine without depressing the brake pedal by pressing the ENGINE START/STOP button with the shift lever in the N (Neutral) position.

### **ACC(Accessory)**



Orange

Press the ENGINE START/STOP button while it is in the OFF position without depressing the brake pedal. The electrical accessories are operational. If the ENGINE START/STOP button is in the ACC position for more than 1 hour, the button turns off automatically to prevent battery discharge.

### **ON**



Blue

Press the ENGINE START/STOP button while it is in the ACC position without depressing the brake pedal. The warning lights can be checked before the engine is started. Do not leave the ENGINE START/STOP button in the ON position for a long time. The battery may discharge because the engine is not running.

### **START/RUN**



Not illuminated

To start the engine, depress the brake pedal and press the ENGINE START/ STOP button with the shift lever in the P (Park) or the N (Neutral) position. For your safety, start the engine with the shift lever in the P (Park) position.

**\* NOTICE**

- If you press the ENGINE START/STOP button without depressing the brake pedal the engine will not start and the ENGINE START/STOP button changes as follows: OFF → ACC → ON → OFF
- If you leave the ENGINE START/STOP button in the ACC or ON position for a long time, the battery will discharge.

**⚠ WARNING**  
 Never press the ENGINE START/STOP button while the vehicle is in motion. This would result in loss of directional control and braking function, which could cause an accident.

**Starting the engine**

**⚠ WARNING - Proper footwear**  
 Always wear appropriate shoes when operating your vehicle. Unsuitable shoes (high heels, ski boots, sandals, etc.) may interfere with your ability to use the brake and accelerator pedal. The inability to properly operate the pedals could result in serious injuries or death.

**\* NOTICE - Kick down switch**

If your vehicle is equipped with a kick down switch in the accelerator pedal, it prevents you from driving at full throttle unintentionally by making the driver require increased effort to depress the accelerator pedal. However, if you depress the pedal more than approximately 80%, the accelerator pedal can be depressed down further to full throttle. This is not a malfunction but a normal condition.

1. Carry the smart key or leave it inside the vehicle.
  2. Make sure the parking brake is firmly applied.
  3. Place the shift lever in the P (Park) position.
  4. Press the ENGINE START/STOP button while depressing the brake pedal.
- It should be started without depressing the accelerator pedal.
5. Do not wait for the engine to warm up while the vehicle remains stationary.
- Start driving at moderate engine speeds. (Steep accelerating and decelerating should be avoided.)



- Even if the smart key is in the vehicle, if it is far away from you, the engine may not start.
- When the ENGINE START/STOP button is in the ACC or ON position, if any door is opened, the system checks for the smart key. If the smart key is not in the vehicle, the warning "Key not in vehicle" will illuminate on the LCD display. If all doors are closed, the chime will sound for 5 seconds. The warning will turn off while the vehicle is moving or the smart key is detected in the vehicle. Always have the smart key with you.

The engine will start, only when the smart key is in the vehicle.

**⚠ WARNING - Unintended vehicle movement**

**Never leave the smart key in the vehicle with children or vehicle occupants who are unfamiliar with the vehicle operation.**

**Pushing the ENGINE START/STOP button while the smart key is in the vehicle may result in unintended engine activation and/or unintended vehicle movement which could result in serious injuries or death.**

If the engine stalls while the vehicle is in motion, do not attempt to move the shift lever to the P (Park) position. If the traffic and road conditions permit, you may put the shift lever in the N (Neutral) position while the vehicle is still moving and press the ENGINE START/STOP button in an attempt to restart the engine.







- If the battery is weak or the smart key does not work correctly, you can start the engine by pressing the ENGINE START/STOP button directly with the smart key.

- When the stop lamp fuse is blown, you cannot start the engine normally. Replace the fuse with a new one. If you are not able to replace the fuse, you can start the engine by pressing the ENGINE START/STOP button for 10 seconds while the ENGINE START/STOP button is in the ACC position. The engine can start without depressing the brake pedal. But for your safety always depress the brake pedal before starting the engine.

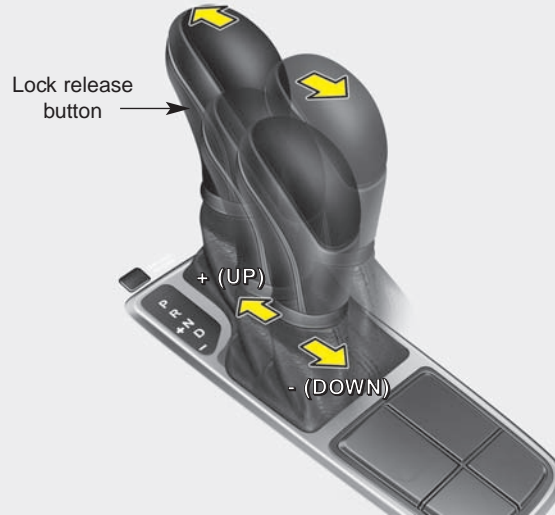
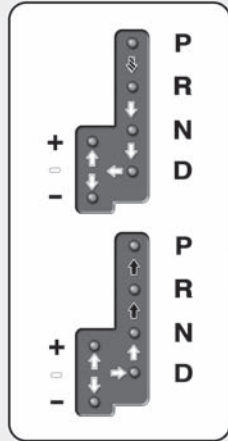
Do not press the ENGINE START/STOP button for more than 5 seconds except when the stop lamp fuse is disconnected.

## AUTOMATIC TRANSAXLE



-  Depress the brake pedal and the lock release button when shifting.
-  Press the lock release button when shifting.
-  The shift lever can be shifted freely.

### Automatic transaxle operation

The automatic transaxle has 6 forward speeds and one reverse speed. The individual speeds are selected automatically, depending on the position of the shift lever.

### \* NOTICE

The first few shifts on a new vehicle, may be somewhat abrupt. This is a normal condition, and the shifting sequence will adjust after shifts are cycled a few times by the TCM (Transaxle Control Module) or PCM (Powertrain Control Module).

OHG051012A

For smooth operation, depress the brake pedal when shifting from N (Neutral) to a forward or reverse gear.

**⚠ WARNING - Automatic transaxle**

Before leaving the driver's seat, always make sure the shift lever is in the P (Park) position; then set the parking brake fully and shut the engine off. Always make sure the shift lever is latched in the P (Park) position and set the parking brake fully. Unexpected and sudden vehicle movement can occur if these precautions are not followed, which could result in serious injury or death.

**⚠ CAUTION - Transaxle**

- *To avoid damage to your transaxle, do not accelerate the engine in R (Reverse) or any forward gear position with the brakes on.*
- *The transaxle may be damaged if you shift into P (Park) while the vehicle is in motion.*

When stopped on an upgrade, do not hold the vehicle with engine power. Use the service brake or the parking brake.

**Transaxle ranges**

The indicator in the instrument cluster displays the shift lever position when the ignition switch is in the ON position.

**P (Park)**

Always come to a complete stop before shifting into P (Park). This position locks the transaxle and prevents the drive wheels from rotating.

**⚠ WARNING**

- **Shifting into P (Park) while the vehicle is in motion will cause the drive wheels to lock which will cause you to lose control of the vehicle.**
- **Do not use the P (Park) position in place of the parking brake. Always make sure the shift lever is latched in the P (Park) position and set the parking brake fully.**
- **Never leave a child unattended in a vehicle.**

### R (Reverse)

Use this position to drive the vehicle backward.

#### CAUTION - Shifting

*Always come to a complete stop before shifting into or out of R (Reverse); you may damage the transaxle if you shift into R (Reverse) while the vehicle is in motion, except when “Rocking the Vehicle” explained in this section.*

### N (Neutral)

The wheels and transaxle are not engaged. The vehicle will roll freely even on the slightest incline unless the parking brake or service brakes are applied.

### D (Drive)

This is the normal forward driving position. The transaxle will automatically shift through a 6-gear sequence, providing the best fuel economy and power.

For extra power when passing another vehicle or climbing grades, depress the accelerator pedal fully (more than 80%) until the kick down switch operates with a clicking noise, at which time the transaxle will automatically downshift to the next lower gear.

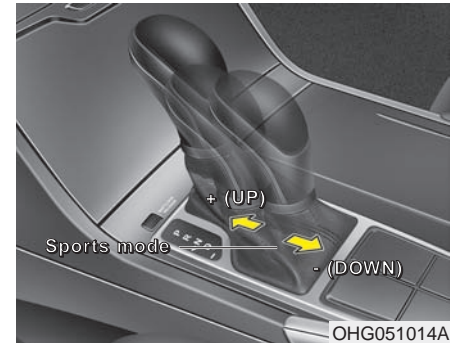

### Sports mode

Whether the vehicle is stopped or in motion, sports mode is selected by pushing the shift lever from the D (Drive) position into the manual gate. To return to D (Drive) range operation, push the shift lever back into the main gate.

In sports mode, moving the shift lever backwards and forwards will allow you to make gearshifts rapidly. In contrast to a manual transaxle, the sports mode allows gearshifts with the accelerator pedal depressed.

Up (+) : Push the lever forward once to shift up one gear.

Down (-) : Pull the lever backwards once to shift down one gear.

### **\* NOTICE**

- In sports mode, the driver must execute upshifts in accordance with road conditions, taking care to keep the engine speed below the red zone.
- In sports mode, only the 6 forward gears can be selected. To reverse or park the vehicle, move the shift lever to the R (Reverse) or P (Park) position as required.
- In sports mode, downshifts are made automatically when the vehicle slows down. When the vehicle stops, 1st gear is automatically selected.
- In sports mode, when the engine rpm approaches the red zone, the transaxle will upshift automatically to the next higher gear.
- To maintain the required levels of vehicle performance and safety, the system may not execute certain gearshifts when the shift lever is operated.

(Continued)

(Continued)

- When accelerating from a stop on a slippery road, push the shift lever forward into the +(up) position. This causes the transaxle to shift into the 2nd gear which is better for smooth driving on a slippery road. Push the shift lever to the -(down) side to shift back to the 1st gear.

### **Shift lock system**

For your safety, the automatic transaxle has a shift lock system which prevents shifting the transaxle from P (Park) into R (Reverse) unless the brake pedal is depressed. To shift the transaxle from P (Park) into R (Reverse):

1. Depress and hold the brake pedal.
2. Start the engine or change the ignition switch to the ON position.
3. Move the shift lever.

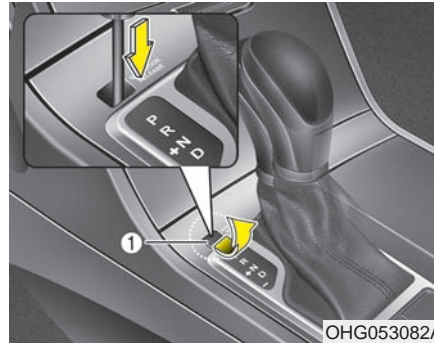

### **Shift-lock override**

If the shift lever cannot be moved from the P (Park) position into R (Reverse) position with the brake pedal depressed, continue depressing the brake pedal, then do the following:

1. Carefully remove the cap (1) covering the shift-lock override access hole.
2. Insert a screwdriver into the access hole and press down on the screwdriver.
3. Move the shift lever.
4. Have your vehicle inspected by an authorized HYUNDAI dealer immediately.

### **⚠ WARNING - Shifting from park**

**Always fully depress the brake pedal before and while shifting out of the P (Park) position into another position to avoid inadvertent motion of the vehicle which could injure persons in or around the vehicle.**

## Good driving practices

- Never move the shift lever from P (Park) or N (Neutral) to any other position with the accelerator pedal depressed.
- Never move the shift lever into P (Park) when the vehicle is in motion.
- Be sure the vehicle is completely stopped before you attempt to shift into R (Reverse) or D (Drive).
- When using sports mode, slow down before shifting to a lower gear. Otherwise, the lower gear may not be engaged.
- Always use the parking brake. Do not depend on placing the transaxle in P (Park) to keep the vehicle from moving.
- Exercise extreme caution when driving on a slippery surface. Be especially careful when braking, accelerating or shifting gears. On a slippery surface, an abrupt change in vehicle speed can cause the drive wheels to lose traction and the vehicle to go out of control.
- Optimum vehicle performance and economy is obtained by smoothly depressing and releasing the accelerator pedal.

### **⚠ WARNING**

- **Always buckle-up! In a collision, an unbelted occupant is significantly more likely to be seriously injured or killed than a properly belted occupant.**
- **Avoid high speeds when cornering or turning.**
- **Do not make quick steering wheel movements, such as sharp lane changes or fast, sharp turns.**
- **The risk of rollover is greatly increased if you lose control of your vehicle at highway speeds.**
- **Loss of control often occurs if two or more wheels drop off the roadway and the driver oversteers to reenter the roadway.**
- **In the event your vehicle leaves the roadway, do not steer sharply. Instead, slow down before pulling back into the travel lanes.**
- **Never exceed posted speed limits.**

### **⚠ WARNING**

**If your vehicle becomes stuck in snow, mud, sand, etc., then you may attempt to rock the vehicle free by moving it forward and backward. Do not attempt this procedure if people or objects are anywhere near the vehicle. During the rocking operation the vehicle may suddenly move forward or backward as it becomes unstuck, causing injury or damage to nearby people or objects.**

### ***Moving up a steep grade from a standing start***

To move up a steep grade from a standing start, depress the brake pedal, move the shift lever to D (Drive) and release the parking brake. Depress the accelerator pedal gradually while releasing the service brakes.



## BRAKE SYSTEM

### Power brakes

Your vehicle has power-assisted brakes that adjust automatically through normal usage.

In the event that the power-assisted brakes lose power because of a stalled engine or some other reason, you can still stop your vehicle by applying greater force to the brake pedal than you normally would. The stopping distance, however, will be longer.

When the engine is not running, the reserve brake power is partially depleted each time the brake pedal is applied. Do not pump the brake pedal when the power assist has been interrupted.

Pump the brake pedal only when necessary to maintain steering control on slippery surfaces.



### **CAUTION - Brake pedal**

***Do not drive with your foot resting on the brake pedal. This will create abnormally high brake temperatures which can cause excessive brake lining and pad wear.***



### **WARNING - Steep hill braking**

**Avoid continuous application of the brakes when descending a long or steep hill by shifting to a lower gear. Continuous brake application will cause the brakes to overheat and could result in a temporary loss of braking performance. Not having braking power could result in an accident and serious injuries or death.**

Wet brakes may impair the vehicle's ability to safely slow down; the vehicle may also pull to one side when the brakes are applied. Applying the brakes lightly will indicate whether they have been affected in this way.

To dry the brakes, apply them lightly while maintaining a safe forward speed until brake performance returns to normal.

***In the event of brake failure***

If service brakes fail to operate while the vehicle is in motion, you can make an emergency stop with the parking brake. The stopping distance, however, will be much greater than normal.

**⚠ WARNING - Parking brake**  
Avoid applying the parking brake to stop the vehicle while it is moving except in an emergency situation. Applying the parking brake while the vehicle is moving at normal speeds can cause a sudden loss of control of the vehicle. If you must use the parking brake to stop the vehicle, use great caution in applying the brake.

***Disc brakes wear indicator***

When your brake pads are worn and new pads are required, you may hear a high-pitched warning sound from your front brakes or rear brakes. You may hear this sound come and go or it may occur whenever you depress the brake pedal.

Please remember that some driving conditions or climates may cause a brake squeal when you first apply (or lightly apply) the brakes. This is normal and does not indicate a problem with your brakes.

**⚠ CAUTION - Replace brake pads**

***Do not continue to drive with worn brake pads. Continuing to drive with worn brake pads can damage the braking system and result in costly brake repairs.***

Always replace the front or rear brake pads as pairs.

**⚠ WARNING - Brake wear**  
Do not ignore high pitch wear sounds from your brakes. If you ignore this audible warning, you will eventually lose braking performance, which could lead to a serious accident.

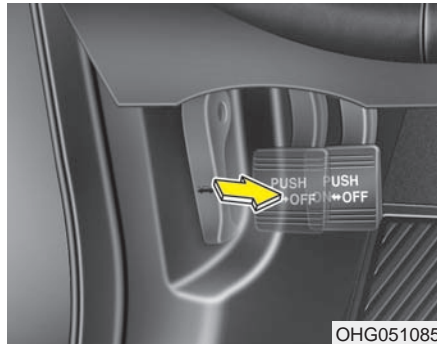

### Parking brake

#### *Applying the parking brake*

To engage the parking brake, first apply the foot brake and then depress the parking brake pedal down as far as possible.

In addition it is recommended that when parking the vehicle on an incline, the shift lever should be in the P (Park) position.

#### **⚠ CAUTION - Parking brake**

*Driving with the parking brake applied will cause excessive brake pad (or lining) and brake rotor wear.*

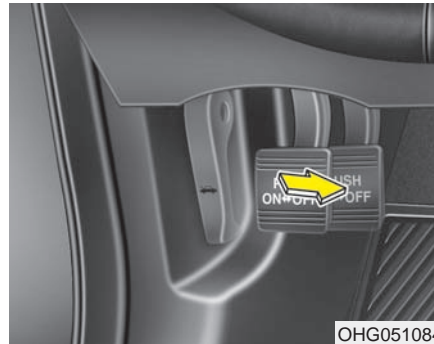

#### *Releasing the parking brake*

To release the parking brake, depress the parking brake pedal a second time while applying the foot brake. The pedal will automatically extend to the fully released position.

If the parking brake does not release or does not release all the way, have the system checked by an authorized HYUNDAI dealer.

#### **⚠ WARNING - Parking brake use**

- All vehicles should always have the parking brake fully engaged when parking to avoid inadvertent movement of the vehicle which can injure occupants or pedestrians.
- Never allow anyone who is unfamiliar with the vehicle to touch the parking brake. If the parking brake is released unintentionally, serious injury may occur.



W-75

Check the brake warning light by changing the ignition switch to ON (do not start the engine). This light will be illuminated when the parking brake is applied with the ignition switch in the START or ON position. Before driving, be sure the parking brake is fully released and the brake warning light is off.

If the brake warning light remains on after the parking brake is released while the engine is running, there may be a malfunction in the brake system. Immediate attention is necessary. If at all possible, cease driving the vehicle immediately. If that is not possible, use extreme caution while operating the vehicle and only continue to drive the vehicle until you can reach a safe location or repair shop.



OHG056095N

### **Electronic parking brake (EPB) (if equipped)**

#### *Applying the parking brake*

#### **To apply the EPB (Electronic parking brake):**

1. Make sure the vehicle is stationary.
2. Pull the EPB switch. Make sure the warning light comes on.

Also, the EPB is applied automatically if the Auto Hold button is on when the engine is turned off. However, if you press the EPB switch for about one second within 3 seconds after the engine is turned off, the EPB will not be applied.

**⚠ CAUTION**

*Do not operate the parking brake while the vehicle is moving except in an emergency situation. It could damage the vehicle system and endanger driving safety.*



***Releasing the parking brake***

**To release the EPB (electronic parking brake), press the EPB switch in the following condition:**

- Have the ignition switch or ENGINE START/STOP button in the ON position.
- Depress the brake pedal or accelerator pedal

Make sure the brake warning light goes off.

**To release EPB (electronic parking brake) automatically:**

- Shift lever in P (Park)  
With the engine running depress the brake pedal and shift out of P (Park) to R (Rear), N (Neutral) or D (Drive).
- Shift lever in N (Neutral)  
With the engine running depress the brake pedal and shift out of N (Neutral) to R (Rear) or D (Drive).
- Depress the brake pedal satisfying the following conditions.
  1. Engine running
  2. Driver's seat belt fastened
  3. Driver's door, engine hood and trunk closed
  4. Shift lever in R (Rear), D (Drive) or Sports mode

Make sure the brake warning light goes off.

**\* NOTICE**

- For your safety, you can engage the EPB even though the ignition switch or ENGINE STOP/START button is in the OFF position, but you cannot release it.
- For your safety, depress the brake pedal and release the parking brake manually with the EPB switch when you drive downhill or when backing up the vehicle.

**⚠ CAUTION**

- *If the parking brake warning light is still on even though the EPB has been released, we recommend that the vehicle be checked by an authorized HYUNDAI dealer.*
- *Do not drive your vehicle with the EPB applied. It may cause excessive brake pad and brake rotor wear.*

**When the EPB (Electronic Parking Brake) does not release:**

We recommend that you contact an authorized HYUNDAI dealer by loading the vehicle on a flatbed tow truck and have the system checked.

**EPB (Electronic Parking Brake) may be automatically applied when:**

- The rear brake is overheated
- Requested by other systems
- The engine is turned off with the EPB applied

**\* NOTICE**

If the driver turns the engine off while Auto Hold is operating, EPB will be automatically applied. However, if you press the EPB switch for about one second within 3 seconds after the engine is turned off, the EPB will not be applied.

**Warning messages*****To disengage EPB, fasten seatbelt, close door, hood, and trunk***

- If you try to drive with the EPB applied, a warning will sound and a message will appear.
- If the driver's seat belt is not fastened or the engine hood or trunk is opened, a warning will sound and a message will appear.
- If there is a problem with the vehicle, a warning may sound and a message may appear.

If the above situation occurs, depress the brake pedal and release EPB by pressing the EPB switch.

**⚠ WARNING**

- To prevent unintentional movement when stopped and leaving the vehicle, do not use the shift lever in place of the parking brake. Set the parking brake and make sure the shift lever is securely positioned in P (Park).
- Never allow anyone who is unfamiliar with the vehicle to touch the parking brake. If the parking brake is released unintentionally, serious injury may occur.
- All vehicles should always have the parking brake fully engaged when parking to avoid inadvertent movement of the car which can injure occupants or pedestrians.

**⚠ CAUTION**

- *A click sound may be heard while operating or releasing the EPB, but these conditions are normal and indicate that the EPB is functioning properly.*
- *When leaving your keys with a parking lot attendant or valet, make sure to inform him/her how to operate the EPB.*
- *The EPB may malfunction if you drive with the EPB applied.*
- *When you automatically release EPB by depressing the accelerator pedal, depress it slowly.*

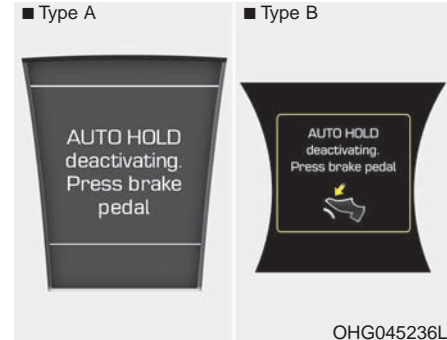

**AUTO HOLD deactivating. Press brake pedal**

When the conversion from Auto Hold to EPB is not working properly a warning will sound and a message will appear.

**⚠ CAUTION**

*Depress the brake pedal when the above message appears, for the Auto Hold and EPB may not activate.*

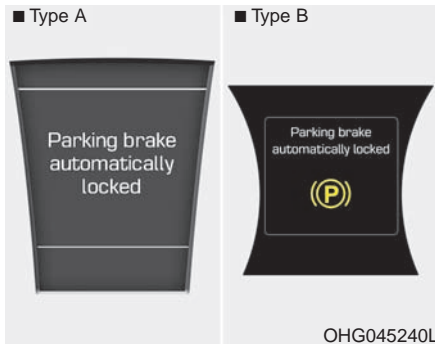

***Parking brake automatically locked***

If the EPB is applied while Auto Hold is activated, a warning will sound and a message will appear.

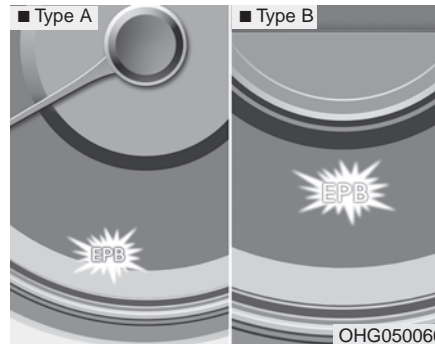

***EPB malfunction indicator (if equipped)***

This warning light illuminates if the engine start/stop button is turned to the ON position and goes off in approximately 3 seconds if the system is operation normally.

If the EPB malfunction indicator remains on, comes on while driving, or does not come on when the ignition switch or the engine start/stop button is turned to the ON position, this indicates that the EPB may have malfunctioned.

If this occurs, we recommend that the system be checked by an authorized HYUNDAI dealer.

The EPB malfunction indicator may illuminate when the ESC indicator comes on to indicate that the ESC is not working properly, but it does not indicate a malfunction of the EPB.



 **CAUTION**

- *The EPB warning light may illuminate if the EPB switch is operated abnormally or EPB is operated while the battery is weak due to personally installed equipment and so on. Shut the engine off and turn it on again after a few seconds. Then wait for a while, pull the EPB switch and push the EPB switch with brake pedal depressed. The warning light will go off and the EPB will operate normally. If Auto Hold lamp is yellow, then shut the engine off and turn it on once more. However, if the EPB warning light is still on, we recommend that the system be checked by an authorized HYUNDAI dealer.*
- *If the parking brake warning light does not illuminate or blinks even though the EPB switch was pulled, the EPB is not applied.*

*(Continued)*

*(Continued)*

- *If the parking brake warning light blinks when the EPB warning light is on, press the switch firmly then let it go back to its original position and pull it up. If the EPB warning does not go off, we recommend that the system be checked by an authorized HYUNDAI dealer.*

**Emergency braking**

If there is a problem with the brake pedal while driving, emergency braking is possible by pulling up and holding the EPB switch. Braking is possible only while you are holding the EPB switch.

 **WARNING**

**Do not operate the parking brake while the vehicle is moving except in an emergency situation.**

**\* NOTICE**

During emergency braking by the EPB, the parking brake warning light will illuminate to indicate that the system is operating.

 **CAUTION**

*If you continuously notice a noise or burning smell when the EPB is used for emergency braking, we recommend that the system be checked by an authorized HYUNDAI dealer.*

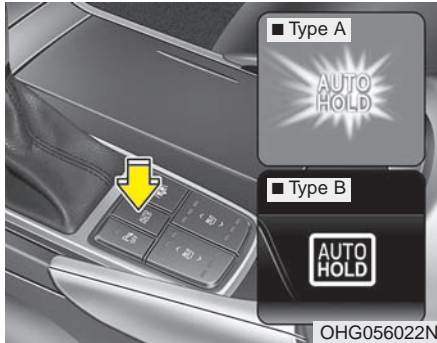

### AUTO HOLD (if equipped)

The Auto Hold maintains the vehicle in a standstill even though the brake pedal is not depressed after the driver brings the vehicle to a complete stop by depressing the brake pedal.

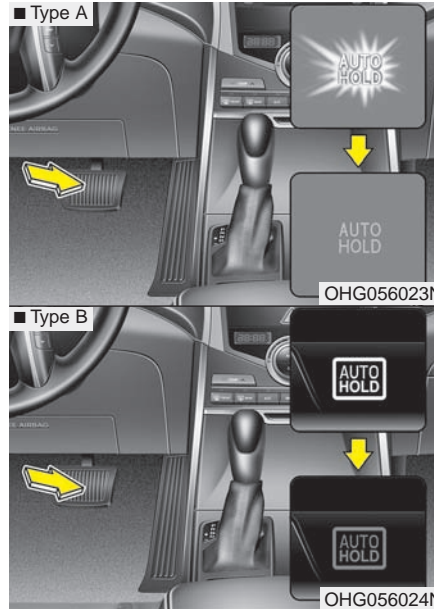

### Set up

1. With the driver's door, engine hood and trunk closed, fasten the driver's seat belt or depress the brake pedal and then press the Auto Hold button. The white AUTO HOLD indicator will come on and the system will be in the standby position.

2. When you stop the vehicle completely by depressing the brake pedal, the AUTO HOLD indicator changes from white to green.
3. The vehicle will remain stationary even if you release the brake pedal.
4. If EPB is applied, Auto Hold will be released.

### Leaving

- If you press the accelerator pedal with the shift lever in R (Reverse), D (Drive) or sports mode, the Auto Hold will be released automatically and the vehicle will start to move. The indicator changes from green to white.
- If the vehicle is restarted using the Smart cruise control switch (RES+ or SET-) while Auto Hold and Smart cruise control is operating (The green AUTO HOLD indicator), the Auto Hold will be released regardless of accelerator pedal operation.

**⚠ WARNING**

When driving off from Auto Hold by depressing the accelerator pedal, always check the surrounding area near your vehicle.

Slowly depress the accelerator pedal for a smooth launch.

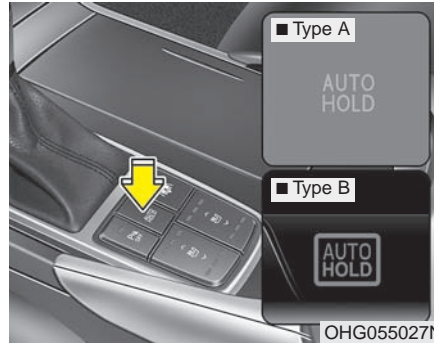

**Cancel**

To cancel the Auto Hold operation, press the Auto Hold switch while depressing the brake pedal. The AUTO HOLD indicator will go out.

If you want to release it manually, pull the EPB switch while depressing the brake pedal. The AUTO HOLD indicator changes from green to white and the system changes to the standby position.

For your safety, release the Auto Hold operation manually if the vehicle ahead is too close or during downhill driving.

**\* NOTICE**

- The Auto Hold does not operate when:
  - The driver's seat belt is unfastened and driver's door is opened
  - The engine hood is opened
  - The trunk is opened
  - The shift lever is in P (Park)
  - The EPB is applied
- For your safety, the Auto Hold automatically switches to EPB in such cases:
  - The driver's seat belt is unfastened and driver's door is opened
  - The engine hood is opened
  - The trunk is opened
  - The vehicle is in a standstill for more than 10 minutes
  - The vehicle is standing on a steep slope for a long period of time
  - The vehicle moved several times

(Continued)

(Continued)

In these cases, the brake warning light comes on, the AUTO HOLD indicator changes from green to white, and a warning sounds and a message will appear to inform you that EPB has been automatically engaged. Before driving off again, press foot brake pedal, check the surrounding area near your vehicle and release parking brake manually with the EPB switch.

- If the AUTO HOLD indicator changes to yellow, the Auto Hold is not working properly. We recommend that you contact an authorized HYUNDAI dealer.
- While operating Auto Hold, you may hear mechanical noise. However, it is normal operating noise.

### **⚠ WARNING**

- Press the accelerator pedal slowly when you start the vehicle.
- For your safety, cancel the Auto Hold when you drive downhill or back up the vehicle or park the vehicle.

### **⚠ CAUTION**

*If there is a malfunction with the driver's door, hood or trunk open detection system, the Auto Hold may not work properly.*

*We recommend that you contact an authorized HYUNDAI dealer.*

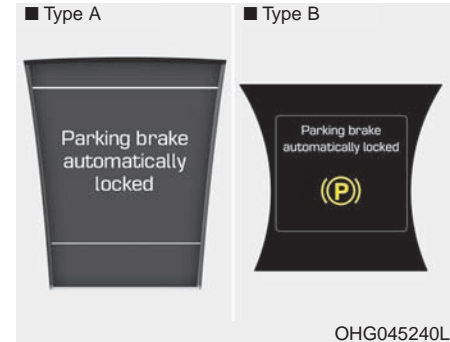

### **Warning messages**

#### ***Parking brake automatically locked***

When the EPB is applied from Auto Hold, a warning will sound and a message will appear.

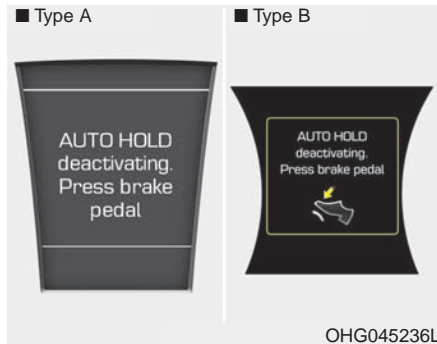

### ***AUTO HOLD deactivating. Press brake pedal***

When the conversion from Auto Hold to EPB is not working properly a warning will sound and a message will appear.

#### **⚠ CAUTION**

***Depress the brake pedal when the above message appears for the Auto Hold and EPB may not activate.***

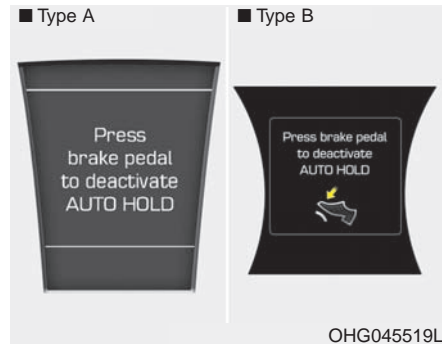

### ***Press brake pedal to deactivate AUTO HOLD***

If you did not apply the brake pedal when you release the Auto Hold by pressing the [AUTO HOLD] switch, a warning will sound and a message will appear.



### ***AUTO HOLD conditions not met. Close door, hood, trunk, and fasten seatbelt***

When you press the [AUTO HOLD] switch, if the driver's door, engine hood and trunk are not closed or the driver's seat belt is not fastened, a warning will sound and a message will appear on the LCD display. In that time, press the [AUTO HOLD] button after closing the driver's door, engine hood and trunk and fastening the seat belt.

**Anti-lock brake system (ABS)**

ABS (or ESC) will not prevent accidents due to improper or dangerous driving maneuvers. Even though vehicle control is improved during emergency braking, always maintain a safe distance between you and objects ahead. Vehicle speeds should always be reduced during extreme road conditions.

The vehicle should be driven at reduced speeds in the following circumstances:

- When driving on rough, gravel or snow-covered roads.
- When driving with tire chains installed.
- When driving on roads where the road surface is pitted or has different surface heights.

Driving in these conditions increases the stopping distance for your vehicle.

The ABS continuously senses the speed of the wheels. If the wheels are going to lock, the ABS system repeatedly modulates the hydraulic brake pressure to the wheels.

When you apply your brakes under conditions which may lock the wheels, you may hear a “tik-tik” sound from the brakes, or feel a corresponding sensation in the brake pedal. This is normal and it means your ABS is active.

In order to obtain the maximum benefit from your ABS in an emergency situation, do not attempt to modulate your brake pressure and do not try to pump your brakes. Depress your brake pedal as hard as possible or as hard as the situation warrants and allow the ABS to control the force being delivered to the brakes.

**\* NOTICE**

**A click sound may be heard in the engine compartment when the vehicle begins to move after the engine is started. This condition is normal and indicates that the anti-lock brake system is functioning properly.**

- Even with the anti-lock brake system, your vehicle still requires sufficient stopping distance. Always maintain a safe distance from the vehicle in front of you.
- Always slow down when cornering. The anti-lock brake system cannot prevent accidents resulting from excessive speeds.
- On loose or uneven road surfaces, operation of the anti-lock brake system may result in a longer stopping distance than for vehicles equipped with a conventional brake system.



W-78

The ABS warning light will stay on for approximately 3 seconds after the ignition switch is ON. During that time, the ABS will go through self-diagnosis and the light will go off if everything is normal. If the light stays on, you may have a problem with your ABS but your regular brakes will work normally. Contact an authorized HYUNDAI dealer as soon as possible.

- When you drive on a road having poor traction, such as an icy road, and have operated your brakes continuously, the ABS will be active continuously and the ABS warning light may illuminate. Pull your vehicle over to a safe place and stop the engine.
- Restart the engine. If the ABS warning light goes off, then your ABS is normal. Otherwise, you may have a problem with the ABS. Contact an authorized HYUNDAI dealer as soon as possible.

### \* NOTICE

**When you jump start your vehicle because of a drained battery, the engine may not run as smoothly and the ABS warning light may turn on at the same time. This happens because of low battery voltage. It does not mean your ABS has malfunctioned.**

- **Do not pump your brakes!**
- **Have the battery recharged before driving the vehicle.**

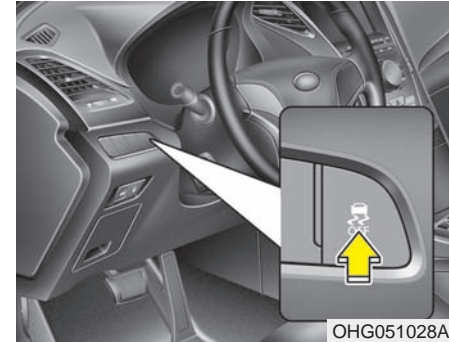

OHG051028A

### Electronic stability control (ESC)

The Electronic Stability Control (ESC) system is designed to help stabilize the vehicle during cornering maneuvers. ESC checks where you are steering and where the vehicle is actually going.

ESC applies the brakes at individual wheels and intervenes with the engine management system to help stabilize the vehicle.

Electronic stability control (ESC) will not prevent accidents. Excessive speed in turns, abrupt maneuvers and hydroplaning on wet surfaces can still result in serious accidents.

Only a safe and attentive driver can prevent accidents by avoiding maneuvers that cause the vehicle to lose traction. Even with ESC installed, always follow all the normal precautions for driving - including driving at safe speeds for the conditions.

The Electronic Stability Control (ESC) system is an electronic system designed to help the driver maintain vehicle control under adverse conditions. It is not a substitute for safe driving practices. Factors including speed, road conditions and driver steering input can all affect whether ESC will be effective in preventing a loss of control. It is still your responsibility to drive and corner at reasonable speeds and to leave a sufficient margin of safety.

When you apply your brakes under conditions which may lock the wheels, you may hear a “tik-tik” sound from the brakes, or feel a corresponding sensation in the brake pedal. This is normal and it means your ESC is active.

### **ESC operation**

#### **ESC ON condition**

- When the ignition is turned ON, ESC and ESC OFF indicator lights illuminate for approximately 3 seconds, then ESC is turned on.
- Press the ESC OFF button after turning the ignition ON to turn ESC off. (ESC OFF indicator will illuminate). To turn the ESC on, press the ESC OFF button (ESC OFF indicator light will go off).
- When starting the engine, you may hear a slight ticking sound. This is the ESC performing an automatic system self-check and does not indicate a problem.

### **When operating**



When the ESC is in operation, the ESC indicator light blinks.

- When the Electronic Stability Control is operating properly, you can feel a slight pulsation in the vehicle. This is only the effect of driving on a brake control and indicates nothing unusual.
- When moving out of mud or driving on a slippery road, depressing the accelerator pedal may not cause the rpm (revolutions per minute) to increase. This is to maintain the stability of the vehicle and is a normal condition.
- When the ESC activates, the engine may not respond to the accelerator as it does under routine conditions.



- If the Cruise Control was in use when the ESC activates, the Cruise Control automatically disengages. The Cruise Control can be reengaged when the road conditions allow. See “Cruise Control System” later in this chapter. (if equipped)

**ESC operation off**  
**ESC OFF condition**



To cancel ESC operation :

• State 1

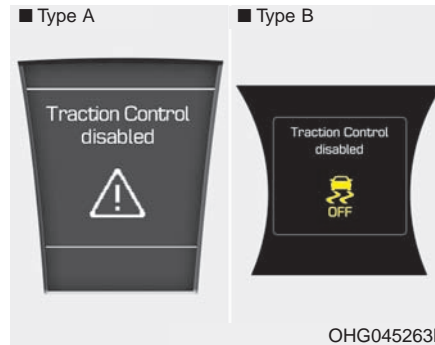

Press the ESC OFF button shortly (ESC OFF indicator light and message illuminates). At this state, the engine control function does not operate. In other words, the traction control function does not operate but only the brake control function operates.

• State 2

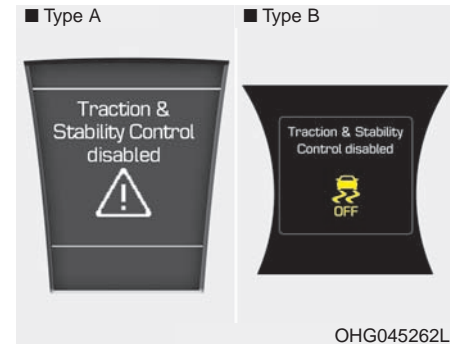

Press the ESC OFF button for more than 3 seconds. ESC OFF indicator light and message illuminates and ESC OFF warning chime will sound. At this state, the engine control function and brake control function does not operate. In other words, the vehicle stability control function does not operate any more.

If the Engine Start/Stop button is pressed to the OFF position when ESC is off, ESC remains off. Upon restarting the engine, the ESC will automatically turn on again.

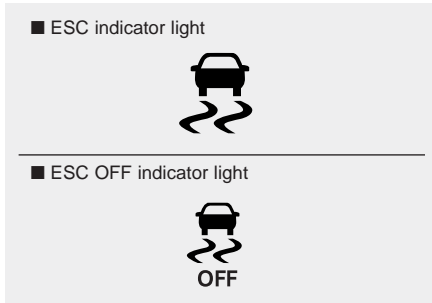

### Indicator light

When ignition switch is turned ON, the indicator light illuminates, then goes off if the ESC system is operating normally.

The ESC indicator light blinks whenever ESC is operating or illuminates when ESC fails to operate. The ESC indicator stays on when the ESC may have a malfunction. Take your vehicle to an authorized HYUNDAI dealer and have the system checked.

ESC OFF indicator light comes on when the ESC is turned off with the button.

### **⚠ WARNING - Electronic stability control**

**Drive carefully even though your vehicle has Electronic Stability Control. It can only assist you in maintaining control under certain circumstances.**

### **⚠ CAUTION**

***Driving with varying tire or wheel sizes may cause the ESC system to malfunction. When replacing tires, make sure they are the same size as your original tires. Never operate the vehicle with different diameter tires installed at the same time.***

### **ESC OFF usage**

#### **When driving**

- It's a good idea to keep the ESC turned on for daily driving whenever possible.
- To turn ESC off while driving, press the ESC OFF button while driving on a flat road surface.

### **⚠ WARNING - Operating ESC**

**Never press the ESC OFF button while ESC is operating (ESC indicator light blinks).**

**If ESC is turned off while ESC is operating, the vehicle may slip out of control.**

### **\* NOTICE**

- When operating the vehicle on a dynamometer, ensure that the ESC is turned off (ESC OFF light illuminated).
- Turning the ESC off does not affect ABS or brake system operation.

### Vehicle stability management (VSM)

This system provides further enhancements to vehicle stability and steering responses when a vehicle is driven on a slippery road or a vehicle detects changes in coefficient of friction between right wheels and left wheels when braking.

#### *VSM operation*

When the VSM is operating:

- ESC (Electronic Stability Control) light will blink.
- The steering wheel may be controlled.

When the vehicle stability management is operating properly, you can feel a slight pulsation in the vehicle. This is only the effect of brake control and indicates nothing unusual.

The VSM does not operate when:

- Driving on banked roads such as gradients or inclines
- Driving rearward
- ESC OFF indicator light (  ) remains illuminated on the instrument cluster
- EPS (Electronic Power Steering) indicator light remains illuminated on the instrument cluster

#### *VSM operation off*

If you press the ESC OFF button to turn off the ESC, the VSM will also cancel and the ESC OFF indicator light (  ) will illuminate.

To turn on the VSM, press the button again. The ESC OFF indicator light goes out.

#### *Malfunction indicator*

The VSM can be deactivated even if you do not cancel the VSM operation by pressing the ESC OFF button. It indicates that a malfunction has been detected somewhere in the EPS (Electronic Power Steering) system or VSM system. If the ESC indicator light (  ) or EPS warning light remains on, take your vehicle to an authorized HYUNDAI dealer and have the system checked.

- The VSM is designed to function above approximately 9 mph (15 km/h) on curves.
- The VSM is designed to function above approximately 18 mph (30 km/h) when a vehicle is driving or braking on a road with different grip under the individual wheels, such as having one or more tires on ice or mud and the others on dry asphalt.
- The VSM system is not a substitute for safe driving practices but a supplementary function only. It is the responsibility of the driver to always check the speed and the distance to the vehicle ahead. Always hold the steering wheel firmly while driving.

- Your vehicle is designed to activate according to the driver's intention, even with the VSM installed. Always follow all the normal precautions for driving at safe speeds for the conditions – including driving in inclement weather and on a slippery road.

**⚠ WARNING - Tire/wheel sizes**

When replacing tires and wheels, make sure they are the same size as the original tires and wheels installed. Driving with varying tire or wheel sizes may diminish any supplemental safety benefits of the VSM system.

**Hill-start assist control (HAC)**

The main intent is to help prevent the vehicle from rolling backwards while driving uphill on an inclined surface. HAC holds the braking pressure built up by the driver when the vehicle is stopped for 2 seconds after releasing the brake pedal.

During the pressure-hold period, the driver has enough time to depress the accelerator pedal to drive off.

The braking pressure is reduced as soon as the system detects the driver's intention to drive off.

**⚠ WARNING - Rolling backward**

Drivers should pay close attention when activating the HAC. The vehicle may roll backward causing an accident due to insufficient brake hold pressure, causing injury or death.

- The HAC does not operate when the transaxle shift lever is in the P (Park) or N (Neutral) position.
- The HAC activates even though the ESC is off but it does not activate when the ESC has malfunctioned.

## Good braking practices

### **⚠ WARNING**

- **Whenever leaving the vehicle or parking, always set the parking brake as far as possible and fully engage the vehicle's transaxle into the P (Park) position. Vehicles not fully engaged in P (Park) with the parking brake set are at risk for moving inadvertently and injuring yourself or others.**
- **All vehicles should always have the parking brake fully engaged when parking to avoid inadvertent movement of the vehicle which can injure occupants or pedestrians.**

- Check to be sure the parking brake is not engaged and that the parking brake indicator light is out before driving away.
- Driving through water may get the brakes wet. They can also get wet when the car is washed. Wet brakes can be dangerous! Your vehicle will not stop as quickly if the brakes are wet. Wet brakes may cause the vehicle to pull to one side.  
To dry the brakes, apply the brakes lightly until the braking action returns to normal, taking care to keep the vehicle under control at all times. If the braking action does not return to normal, stop as soon as it is safe to do so and call an authorized HYUNDAI dealer for assistance.
- Do not coast down hills with the vehicle out of gear. This is extremely hazardous. Keep the vehicle in gear at all times, use the brakes to slow down, then shift to a lower gear so that engine braking will help you maintain a safe speed.
- Do not "ride" the brake pedal. Resting your foot on the brake pedal while driving can be dangerous because the brakes might overheat and lose their effectiveness. It also increases the wear of the brake components.
- If a tire goes flat while you are driving, apply the brakes gently and keep the vehicle pointed straight ahead while you slow down. When you are moving slowly enough for it to be safe to do so, pull off the road and stop in a safe place.
- If your vehicle is equipped with an automatic transaxle, do not let your vehicle creep forward. To avoid creeping forward, keep your foot firmly on the brake pedal when the vehicle is stopped.

- Be cautious when parking on a hill. Firmly engage the parking brake and place the shift lever in P (Park). If your vehicle is facing downhill, turn the front wheels into the curb to help keep the vehicle from rolling. If your vehicle is facing uphill, turn the front wheels away from the curb to help keep the vehicle from rolling. If there is no curb or if it is required by other conditions to keep the vehicle from rolling, block the wheels.
- Under some conditions your parking brake can freeze in the engaged position. This is most likely to happen when there is an accumulation of snow or ice around or near the rear brakes or if the brakes are wet. If there is a risk that the parking brake may freeze, apply it only temporarily while you put the shift lever in P (Park) and block the rear wheels so the vehicle cannot roll. Then release the parking brake.
- Do not hold the vehicle on the upgrade with the accelerator pedal. This can cause the transaxle to overheat. Always use the brake pedal or parking brake.

## CRUISE CONTROL SYSTEM

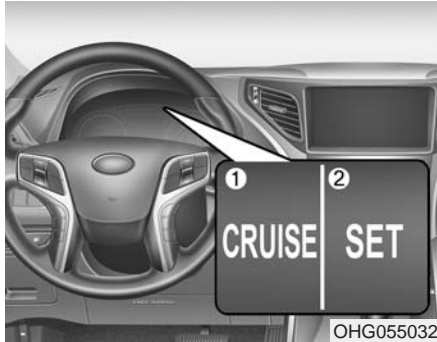

- ① Cruise indicator
- ② SET indicator

The cruise control system allows you to program the vehicle to maintain a constant speed without depressing the accelerator pedal.

This system is designed to function above approximately 25 mph.

- If the cruise control is left on (CRUISE indicator light in the instrument cluster illuminated), the cruise control can be switched on accidentally. Keep the cruise control system off (CRUISE indicator light OFF) when the cruise control is not in use, to avoid inadvertently setting a speed.
- Use the cruise control system only when traveling on open highways in good weather.
- Do not use the cruise control when driving in heavy or varying traffic, or on slippery (rainy, icy or snow-covered) or winding roads or over 6% up-hill or down-hill roads.

### \* NOTICE

- During normal cruise control operation, when the SET switch is activated or reactivated after applying the brakes, the cruise control will energize after approximately 3 seconds. This delay is normal.
- To activate cruise control, depress the brake pedal at least once after turning the ignition switch to the ON position or starting the engine. This is to check if the brake switch which is important part to cancel cruise control is in normal condition.

**⚠ WARNING - Misuse of cruise control**

**Do not use cruise control if the traffic situation does not allow you to drive safely at a constant speed and with sufficient distance to the vehicle in front.**

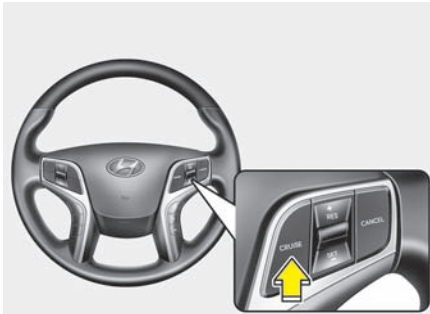

OHG055033

**To set cruise control speed:**

1. Push the CRUISE button on the steering wheel to turn the system on. The CRUISE indicator light in the instrument cluster will illuminate.
2. Accelerate to the desired speed, which must be more than 25 mph.



OHG055035

3. Push the SET- switch, and release it at the desired speed. The SET indicator light in the instrument cluster will illuminate. Release the accelerator pedal. The desired speed will automatically be maintained.

*On a steep grade, the vehicle may slow down or speed up slightly while going uphill or downhill.*



OHG055034

**To increase cruise control set speed:**

Follow either of these procedures:

- Push the RES+ switch and hold it. Your vehicle will accelerate. Release the switch at the speed you want.
- Push the RES+ switch and release it immediately. The cruising speed will increase by 1.0 mph each time the RES+ switch is operated in this manner.





**To decrease cruise control set speed:**

Follow either of these procedures:

- Push the SET- switch and hold it. Your vehicle will gradually slow down. Release the switch at the speed you want to maintain.
- Push the SET- switch and release it immediately. The cruising speed will decrease by 1.0 mph each time the SET- switch is operated in this manner.

**To temporarily accelerate with the cruise control on:**

If you want to speed up temporarily when the cruise control is on, depress the accelerator pedal. Increased speed will not interfere with cruise control operation or change the set speed.

To return to the set speed, take your foot off the accelerator pedal.

If you press the SET- switch at increased speed, the cruising speed will be set again.

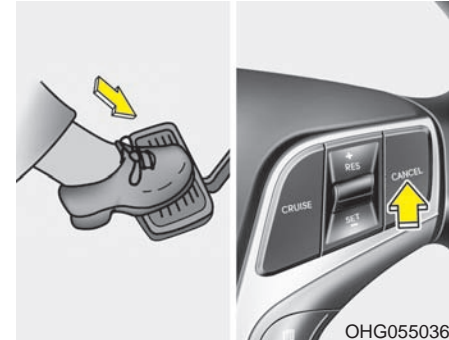

**To cancel cruise control, do one of the following:**

- Depress the brake pedal.
- Shift into N (Neutral) with an automatic transaxle.
- Press the CANCEL switch located on the steering wheel.
- Decrease the vehicle speed lower than the memory speed by 9 mph.
- Decrease the vehicle speed to less than approximately 25 mph.

Each of these actions will cancel cruise control operation (the SET indicator light in the instrument cluster will go off), but it will not turn the system off. If you wish to resume cruise control operation, push the RES+ switch located on your steering wheel. You will return to your previously preset speed.



**To resume cruising speed at more than approximately 25 mph:**

If any method other than the CRUISE switch was used to cancel cruising speed and the system is still activated, the most recent set speed will automatically resume when the RES+ switch is pushed.

It will not resume, however, if the vehicle speed has dropped below approximately 25 mph.

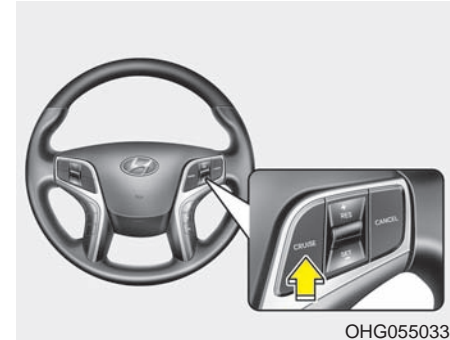

**To turn cruise control off, do one of the following:**

- Push the CRUISE button (the CRUISE indicator light in the instrument cluster will go off).
- Turn the ignition off.

*Both of these actions cancel cruise control operation. If you want to resume cruise control operation, repeat the steps provided in "To set cruise control speed" on the previous page.*

## SMART CRUISE CONTROL SYSTEM (IF EQUIPPED)

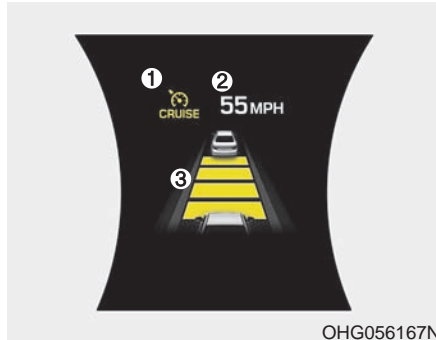

- (1) Cruise indicator
- (2) Set speed
- (3) Vehicle-to-vehicle distance

The smart cruise control system allows you to program the vehicle to maintain constant speed and distance detecting the vehicle ahead without depressing the accelerator/brake pedal.

### **⚠ WARNING**

For your safety, please read the owner's manual before using the smart cruise control system.

### **⚠ WARNING**

• If the smart cruise control is left on, (cruise indicator light in the instrument cluster illuminated) the smart cruise control can be activated unintentionally. Keep the smart cruise control system off (cruise indicator light off) when the smart cruise control is not used.

(Continued)

### (Continued)

- Use the smart cruise control system only when traveling on open highways in good weather.
- Do not use the smart cruise control when it may not be safe to keep the car at a constant speed. For instance, driving in heavy or varying traffic, or on slippery (rainy, icy or snow-covered) or winding roads or steep hills.
- Pay particular attention to the driving conditions whenever using the smart cruise control system.
- The smart cruise control system is not a substitute for safe driving. It is the responsibility of the driver to always check the speed and distance of the vehicle ahead.



OHG055053L

### Smart cruise control speed

#### To set cruise control speed:

1. Push the [cruise] button on the steering wheel to turn the system on. The CRUISE indicator light in the instrument cluster will illuminate.
2. Accelerate to the desired speed. The smart cruise control speed can be set as follows:
  - 20 mph (30 km/h) ~ 110 mph (180 km/h): when there is no vehicle in front
  - 0 mph (0 km/h) ~ 110 mph (180 km/h): when there is a vehicle in front



OHG055054L

3. Push the SET- switch, and release it at the desired speed. The SET indicator light, set speed and vehicle to vehicle distance on the LCD screen will illuminate.
4. Release the accelerator pedal. The desired speed will automatically be maintained.

*If there is a vehicle in front of you, the speed may decrease to maintain the distance to the vehicle ahead.*

*On a steep grade, the vehicle may slow down or speed up slightly while going uphill or downhill.*



OHG055055L

#### To increase cruise control set speed:

Follow either of these procedures:

- Push the RES+ switch and hold it. Your vehicle set speed will increase by 5 mph (10 km/h). Release the switch at the speed you want.
- Push the RES+ switch and release it immediately. The cruising speed will increase by 1.0 mph (1.0 km/h) each time the RES+ switch is operated in this manner.
- You can set the speed to 110 mph (180 km/h).



OHG055054L

**To decrease the cruise control set speed:**

Follow either of these procedures:

- Push the SET- switch and hold it. Your vehicle set speed will decrease by 5 mph (10 km/h). Release the switch at the speed you want.
- Push the SET- switch and release it immediately. The cruising speed will decrease by 1.0 mph (1.0 km/h) each time the SET- switch is operated in this manner.
- You can set the speed to 20 mph (30 km/h).

**To temporarily accelerate with the cruise control on:**

If you want to speed up temporarily when the cruise control is on, depress the accelerator pedal. Increased speed will not interfere with cruise control operation or change the set speed.

To return to the set speed, take your foot off the accelerator.

If you press the SET- switch the increased cruising speed will return to its set speed.

**\* NOTICE**

**Be careful when accelerating temporarily, because the speed is not controlled automatically at this time even if there is a vehicle in front of you.**

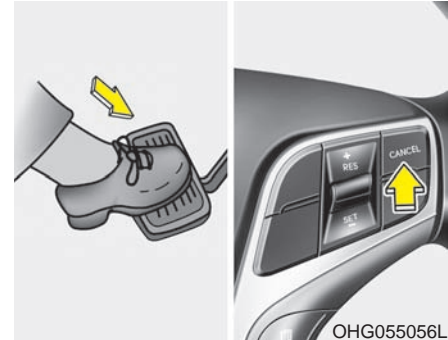

OHG055056L

**Smart Cruise control will be temporarily canceled when:**

**Cancelled manually**

- Depressing the brake pedal.
- Pressing the CANCEL button located on the steering wheel.

The Smart Cruise Control turns off temporarily when the indicator on the LCD display turns off. The CRUISE indicator is illuminated continuously.

**Cancelled automatically**

- The driver's door is opened.
- The EPB (electronic parking brake) is applied.
- The vehicle speed is over 110 mph (180 km/h)
- The vehicle stops on a steep incline.
- The ESC or ABS is operating.
- The ESC is turned off.
- The sensor or the cover is dirty or blocked with foreign matter.
- The vehicle stops and go repeatedly for a long period of time.
- The driver starts driving by depressing the accelerator pedal or pushing the RES+ switch if a vehicle stops far away ahead of the your vehicle.
- The shift lever is shifted to N (Neutral), R (Reverse), D (Drive).
- The vehicle stops on a steep incline.
- The vehicle stops and go repeatedly for a long period of time.
- The Smart Cruise Control has malfunctioned.

- The accelerator pedal is continuously depressed for more than 1 minute.

Each of these actions will cancel the smart cruise control operation. (The SET indicator, set speed and vehicle to vehicle distance on the LCD display will go off.)

In a condition the smart cruise control is cancelled automatically, the smart cruise control will not resume even though the RES+ or SET- switch is pushed. Also, the EPB (electronic parking brake) will be applied.

 **CAUTION**

***If the smart cruise control is cancelled by other than the reasons mentioned, have the system checked by an authorized HYUNDAI dealer.***



If the system is cancelled, the warning chime will sound and a message will appear for a few seconds. You must adjust the vehicle speed, as well as the distance to the vehicle ahead by depressing the accelerator or brake pedal.

Always check the road conditions. Do not rely on the warning chime.



OHG055055L

### To resume cruise control set speed:

If any method other than the [cruise] switch was used to cancel cruising speed and the system is still activated, the cruising speed will automatically resume when the SET- or RES+ switch is pushed.

If the RES+ switch is pushed, the speed will resume to the recently set speed. It will not resume if the vehicle speed has dropped below approximately 20 mph (30 km/h), when there is no vehicle ahead in a close distance. It will resume when a vehicle in front of your vehicle is detected even when the vehicle speed is below 20 mph (30 km/h).

### \* NOTICE

Always check the road conditions when pressing the RES+ switch to resume speed.



OHG055053L

### To turn cruise control off:

Push the [CRUISE] button (the CRUISE indicator light in the instrument cluster will go off).

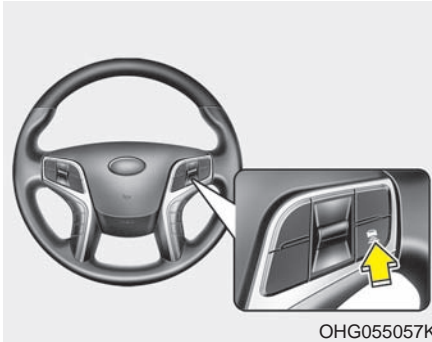

OHG055057K

### Smart cruise control vehicle to vehicle distance

#### *To set vehicle to vehicle distance:*

This function allows you to program the vehicle to maintain relative distance to the vehicle ahead without depressing the accelerator pedal or brake pedal.

The vehicle to vehicle distance will automatically activate when the smart cruise control system is on.

Select the appropriate distance according to road conditions and vehicle speed.

Each time the button is pressed, the vehicle to vehicle distance changes as follows:

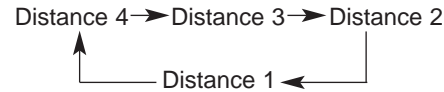

For example, if you drive at 55 mph (90 km/h), the distance maintain as follows;

- Distance 4 - approximately 172 feet (52 m)
- Distance 3 - approximately 130 feet (40 m)
- Distance 2 - approximately 106 feet (32 m)
- Distance 1 - approximately 82 feet (25 m)

### \* NOTICE

The 'Distance 4' is always set when the system is used for the first time after starting the engine.

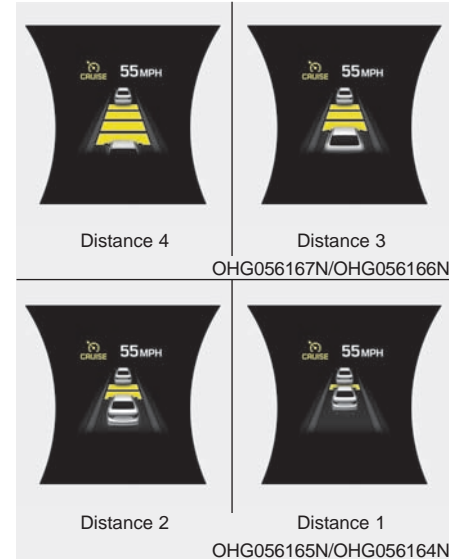

OHG056167N/OHG056166N

OHG056165N/OHG056164N

- The vehicle will maintain the set speed, when the lane ahead is clear.
- The vehicle will slow down or speed up to maintain the selected distance, when there is a vehicle ahead of you in the lane. (A vehicle will appear in front of your vehicle in the LCD display only when there is an actual vehicle in front of you)



- If the vehicle ahead speeds up, your vehicle will travel at a steady cruising speed after accelerating to the selected speed.

### CAUTION

- *The warning chime sounds and malfunction indicator blinks if it is hard to maintain the selected distance to the vehicle ahead.*
- *If the warning chime sounds, actively adjust the vehicle speed, as well as the distance to the vehicle ahead by depressing the accelerator or brake pedal.*
- *Even if the warning chime is not activated, always pay attention to the driving conditions to prevent dangerous situations from occurring.*



### CAUTION

*If the vehicle ahead (vehicle speed: less than 20 mph (30 km/h)) disappears to the next lane, the warning chime will sound and a message will appear. Adjust your vehicle speed for vehicles or objects that can suddenly appear in front of you by depressing the brake pedal according to the road condition ahead and driving condition.*

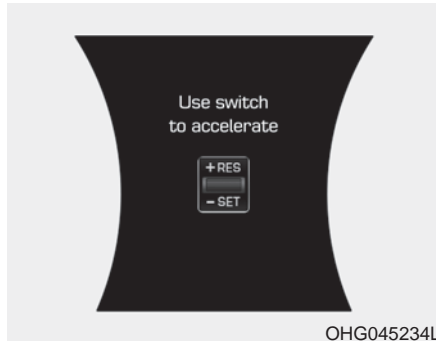

***In traffic situation***

- In traffic, your vehicle will stop if the vehicle ahead of you stops. Also, if the vehicle ahead of you starts moving, your vehicle will start as well. However, if the vehicle stops for more than 3 seconds, you must depress the accelerator pedal or push the (RES+ or SET-) switch to start driving.
- If you push the Smart cruise control switch (RES+ or SET-) while Auto Hold and Smart cruise control is operating (The green AUTO HOLD indicator), Auto Hold will be released regardless of accelerator pedal operation and the vehicle will start to move.



**Sensor to detect distance to the vehicle ahead**

The sensor detects the distance to the vehicle ahead.

If the sensor is covered with dirt or other foreign matter, the vehicle to vehicle distance control may not operate correctly.

Always keep the area in front of the sensor clean.

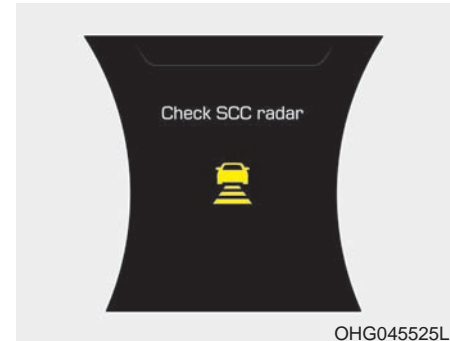

***Sensor warning message***

If the sensor or cover is dirty or obscured with foreign matter such as snow, this message will appear.

In this case, the system may not function temporarily, but it does not indicate a malfunction of the Smart Cruise Control System.

Clean the sensor or cover by using a soft cloth.



### **SCC (Smart Cruise Control) malfunction message**

The message will appear when the vehicle to vehicle distance control system is not functioning normally.

We recommend that you take your vehicle to an authorized HYUNDAI dealer and have the system checked.

### **⚠ CAUTION**

- **Do not install accessories around the sensor and do not replace the bumper by yourself. It may interfere with the sensor performance.**
- **Always keep the sensor and bumper clean.**
- **To prevent sensor cover damage from occurring, wash the car with a soft cloth.**
- **Do not damage the sensor or sensor area by a strong impact. If the sensor moves slightly off position, the smart cruise control system will not operate correctly.**  
**If this occurs, we recommend that the system be inspected by an authorized HYUNDAI dealer.**
- **Use only a genuine HYUNDAI sensor cover for your vehicle.**



### **To convert to cruise control mode:**

The driver may choose to only use the cruise control mode (speed control function) by doing as follows:

1. Turn the smart cruise control system on (the cruise indicator light will be on but the system will not be activated).
2. Push the distance to distance switch for more than 2 seconds.
3. Choose between "Smart cruise control(SCC) mode" and "Cruise control(CC) mode".

### **⚠ WARNING**

**When using the cruise control mode, you must manually access the distance to other vehicles as the system will not automatically brake to slow down for other vehicles.**

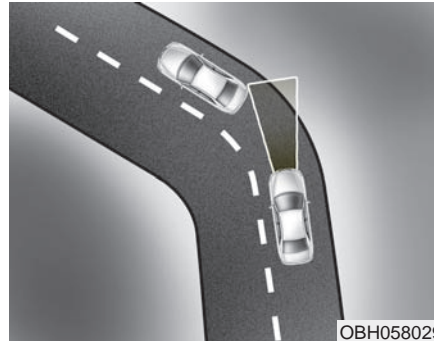

### **Limitations of the system**

The smart cruise control system may have limits to its ability to detect distance to the vehicle ahead due to road and traffic conditions.

#### *On curves*

- On curves, the smart cruise control system may not detect a moving vehicle in your lane, and then your vehicle could accelerate to the set speed. Also, the vehicle speed will slow down when the vehicle ahead is recognized suddenly.
- Select the appropriate set speed on curves and apply the brakes or accelerator pedal if necessary.

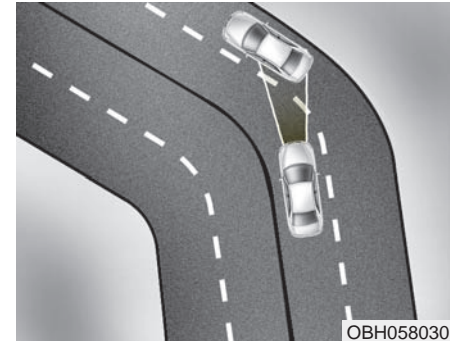

- Your vehicle speed can be reduced due to a vehicle in the adjacent lane. Apply the accelerator pedal and select the appropriate set speed. Check to be sure that the road conditions permit safe operation of the smart cruise control.

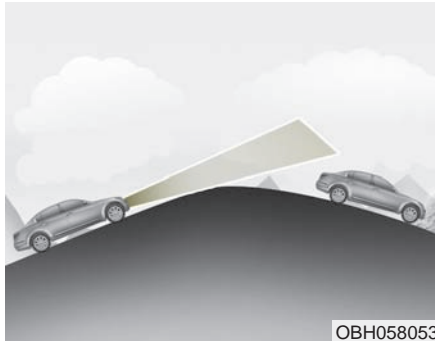

### ***On inclines***

- During uphill or downhill driving, the smart cruise control system may not detect a moving vehicle in your lane, and cause your vehicle to accelerate to the set speed. Also, the vehicle speed will slow down when the vehicle ahead is recognized suddenly.
- Select the appropriate set speed on inclines and apply the brakes or accelerator pedal if necessary.

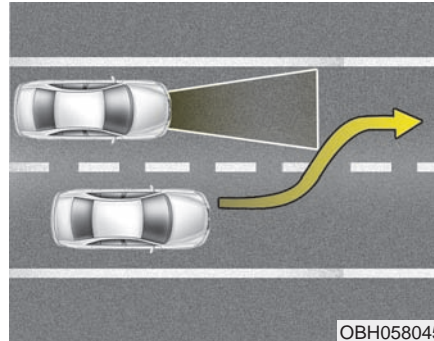

### ***Lane changing***

- A vehicle which moves into your lane from an adjacent lane cannot be recognized by the sensor until it is in the sensor's detection range.
- The sensor may not detect immediately when a vehicle cuts in suddenly. Always pay attention to the traffic, road and driving conditions.
- If a vehicle which moves into your lane is slower than your vehicle, your speed may decrease to maintain the distance to the vehicle ahead.
- If a vehicle which moves into your lane is faster than your vehicle, your vehicle will accelerate to the selected speed.

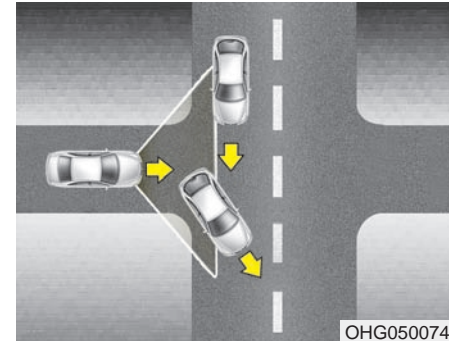

- Your vehicle may accelerate when a vehicle ahead of you disappears.
- When you are warned that the vehicle ahead of you is not detected, drive with caution.

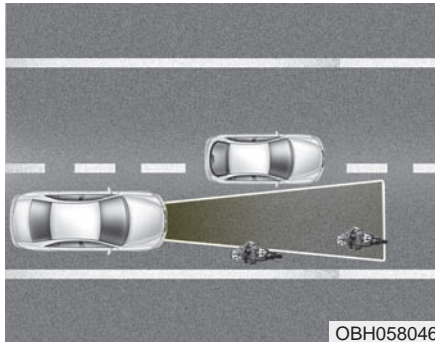

### ***Vehicle recognition***

Some vehicles ahead in your lane cannot be recognized by the sensor as follows:

- Narrow vehicles such as motorcycles or bicycles
- Vehicles offset to one side
- Slow-moving vehicles or sudden-decelerating vehicles
- Stopped vehicles
- Vehicles with small rear profile such as trailers with no loads

A vehicle ahead cannot be recognized correctly by the sensor if any of following occurs:

- When the vehicle is pointing upwards due to overloading in the trunk
- While making turns by steering
- When driving to one side of the lane
- When driving on narrow lanes or on curves

Apply the brakes or accelerator pedal if necessary.

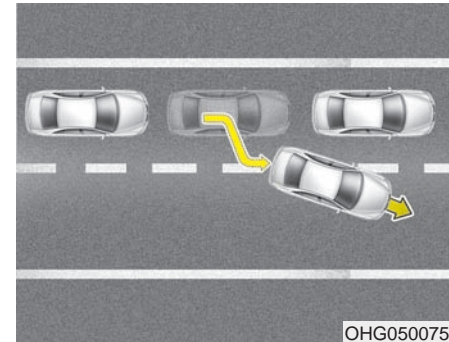

- When vehicles are at a standstill and the vehicle in front of you changes to the next lane, be careful when your vehicle starts to move because it may not recognize the stopped vehicle in front of you.

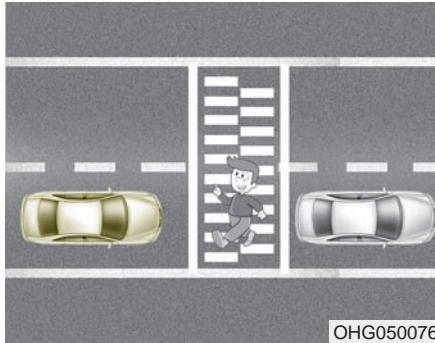

- Always look out for pedestrians when your vehicle is maintaining a distance with the vehicle ahead.

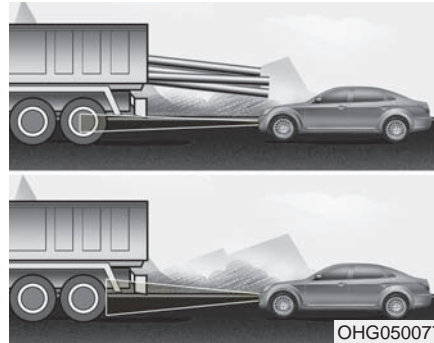

- Always be cautious for vehicles with higher height or vehicles carrying loads that sticks out to the back of the vehicle.

### **⚠ WARNING**

- The smart cruise control system cannot guarantee the stop for every emergency situation.  
If an emergency stop is necessary, you must apply the brakes.
- Keep a safe distance according to road conditions and vehicle speed. If the vehicle to vehicle distance is too close during a high-speed driving, a serious collision may result.
- The smart cruise control system cannot recognize a stopped vehicle, pedestrians or an oncoming vehicle. Always look ahead cautiously to prevent unexpected and sudden situations from occurring.

(Continued)

(Continued)

- When other vehicles are changing lanes in front of you frequently, the smart cruise control system may not operate appropriately. Always look ahead cautiously to prevent unexpected and sudden situations from occurring.
- The smart cruise control system is not a substitute for safe driving practices but a convenience function only. It is the responsibility of the driver to always check the speed and the distance to the vehicle ahead.
- Always be aware of the selected speed and vehicle to vehicle distance.
- Always maintain sufficient braking distance and decelerate your vehicle by applying the brakes if necessary.

(Continued)

(Continued)

- As the smart cruise control system may not recognize complex driving situations, always pay attention to driving conditions and control your vehicle speed.
- For safe operation, carefully read and follow the instructions in this manual before use.

**\* NOTICE**

The Smart Cruise Control System may not operate temporarily due to:

- Electrical interference
- Modifying the suspension
- Differences of tire abrasion or tire pressure
- Installing different type of tires

**This device complies with Part 15 of the FCC rules.**

Operation is subject to the following three conditions:

1. This device may not cause harmful interference, and
2. This device must accept any interference received, including interference that may cause undesired operation.
3. Changes or modifications not expressly approved by the party responsible for compliance could void the user's authority to operate the device.

Radio frequency radiation exposure information:

This equipment complies with FCC radiation exposure limits set forth for an uncontrolled environment.

This equipment should be installed and operated with minimum distance of 20 cm between the radiator (antenna) and your body.

This transmitter must not be co-located or operating in conjunction with any other antenna or transmitter.



## ACTIVE ECO SYSTEM

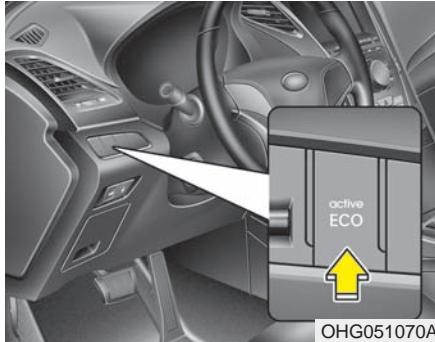

### Active ECO operation

Active ECO helps improve fuel efficiency by controlling certain engine and transaxle system operating parameters. Fuel efficiency depends on the driver's driving habit and road condition.

- When the Active ECO button is pressed the ECO indicator (green) will illuminate to show that the Active ECO is operating.
- When the Active ECO is activated, it will remain on until the Active ECO button is pressed again. Active ECO does not turn off when the engine is restarted. To turn off Active ECO, press the Active ECO button again.
- If Active ECO is turned off, the system will return to normal mode.

### Limitation of Active ECO operation:

If the following conditions occur while Active ECO is operating, the system operation is limited even though there is no change in the ECO indicator.

- When the coolant temperature is low: The system will be limited until engine temperature becomes normal.
- When driving up a hill: The system will be limited to gain power when driving uphill because the engine torque is required.
- When using sports mode: The system will be limited according to the manually selected gear.
- When the accelerator pedal is deeply depressed for a few seconds: The system will be limited, judging that the driver desires additional acceleration.

## BLIND SPOT DETECTION SYSTEM (BSD) (IF EQUIPPED)

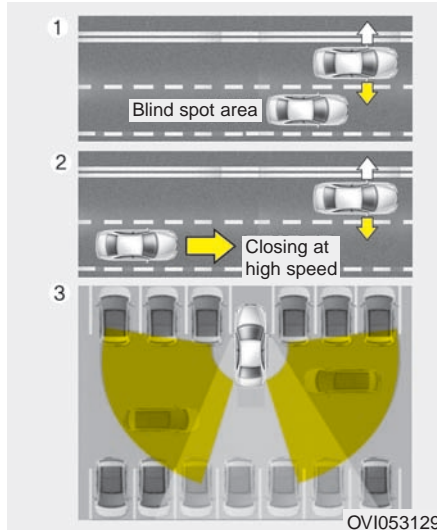

The Blind Spot Detection System (BSD) uses a radar sensor to alert the driver.

It senses the rear side territory of the vehicle and provides an indication to the driver if it detects an object approaching from these areas.

### (1) BSD (Blind Spot Detection)

The warning range depends on your vehicle speed. However, if your vehicle is much faster than the other vehicle, the system will not warn you.

### (2) LCA (Lane Change Assist)

If the system detects a vehicle approaching you at high speed, the system will warn you.

### (3) RCTA (Rear Cross Traffic Alert)

If the sensor detects an approaching vehicle from the left and right side as your vehicle moves rearward, the system will warn you.

### **⚠ WARNING**

- **Always check the road condition while driving for unexpected situations even though the Blind Spot Detection System (BSD) is operating.**

**(Continued)**

### **(Continued)**

- **The Blind Spot Detection System (BSD) is a supplemental system to assist you. Do not solely rely on the system and always pay attention and drive safely.**
- **The Blind Spot Detection System (BSD) is not a substitute for proper and safe driving. Always drive safely and use caution when changing lanes or backing the vehicle up. The Blind Spot Detection System (BSD) may not detect every object alongside the vehicle.**

### **⚠ WARNING**

**As the Blind Spot Detection (BSD) system is a supplemental device for your safe driving, it may be dangerous to rely on only the BSD information when changing the lane. Always pay attention to drive safely.**

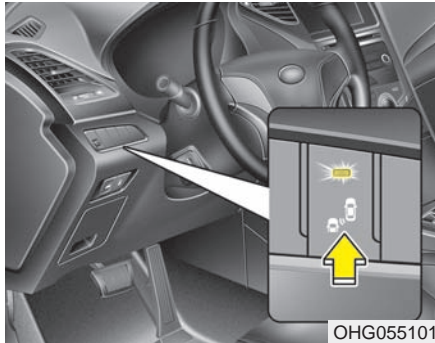

### **BSD (Blind Spot Detection) / LCA (Lane Change Assist)**

#### ***Operating conditions***

To operate:

Press the BSD switch with the Ignition switch in the ON position.

The indicator illuminates on the switch. If vehicle speed exceeds 20 mph (30 km/h) the system will activate.

To cancel:

Press the BSD switch again. The indicator on the switch will go off.

When the system is not used, turn the system off by turning off the switch.

#### **\* NOTICE**

- If the engine is turned off and on, the system returns to the previous state.
- When the system is turned on, the warning light will illuminate for 3 seconds on the outside rearview mirror.

#### ***Warning type***

The system will activate when:

1. The system is on.
2. Vehicle speed is above about 20 mph (30 km/h).
3. Other vehicles are detected in the rear side.

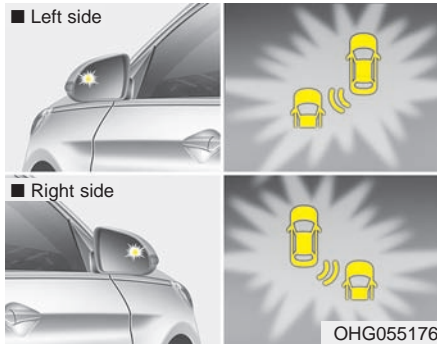

### First stage alert

If a vehicle is detected within the boundary of the system, a warning light will illuminate on the outside rearview mirror.

If the detected vehicle is not in warning range, the warning will turn off according to driving conditions.



### Second stage alert

The second stage alarm will activate when:

1. The first stage alert is on.
2. The turn signal light is on to change a lane.

When the second stage alert is activated, a warning light will blink on the outside rearview mirror.

If you turn off the turn signal light, the second stage alert will be deactivated.



### ***Detecting sensor***

The sensors are located inside of the rear bumper.

Always keep the rear bumper clean for the system to work properly.

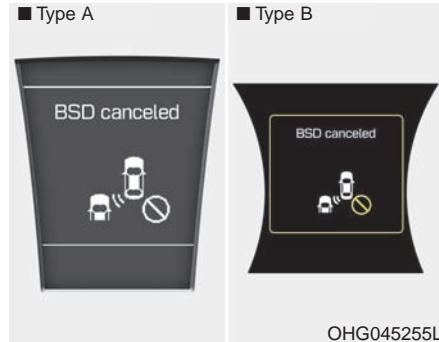

### ***Warning message***

The message will appear to notify the driver if there are foreign substances on the rear bumper. The light on the switch and the system will turn off automatically.

Remove the foreign substance on the rear bumper. After the foreign substance is removed, if you drive for approximately 10 minutes, the system will work normally.

If the system does not work normally even though the foreign substance is removed, take your vehicle to an authorized HYUNDAI dealer and have the system checked.

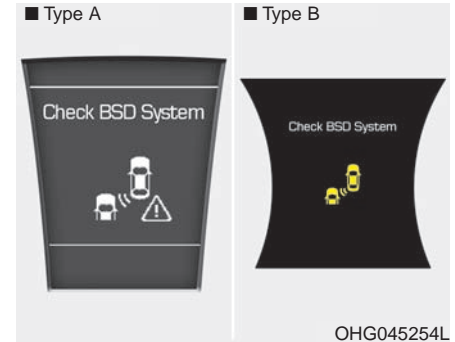

If the system does not work properly, a warning message will appear and the light on the switch will turn off. The system will turn off automatically. Have your vehicle inspected by an authorized HYUNDAI dealer.

## RCTA (Rear Cross Traffic Alert)

### *Operating conditions*

To operate:

Go to the User Settings Mode (Driving Assist) and select RCTA (Rear Cross Traffic Alert) on the LCD display (**For more details, refer to "LCD Display" in chapter 4.**). The system will turn on and standby to activate. The system will activate when vehicle speed is below 6.2 mph (10 km/h) with the shift lever in R (Reverse).

### \* NOTICE

The RCTA (Rear Cross Traffic Alert) detecting range is about 1.64 ft (0.5m) ~ 65 ft (20m). A vehicle will be detected if the vehicle speed is 2.5 mph (4 km/h) ~ 22.4 mph (36 km/h) within the detecting range. However, the detecting range may change under different conditions. Always pay attention to the surroundings.

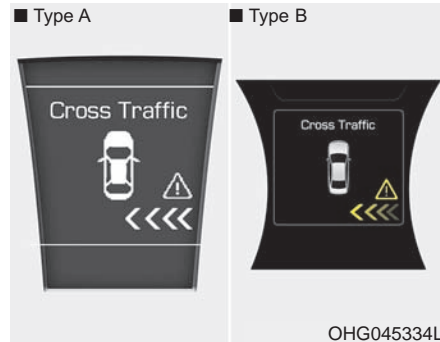

### *Warning type*

If the vehicle detected by the sensors approaches your vehicle, the warning chime will sound, the warning light on the outside rearview mirror will blink and a message will appear on the LCD display.

### \* NOTICE

- If the detected vehicle is got out from sensing range, behind your vehicle, moving opposite direction away from your vehicle or moving slow, the warning is cancelled.
- The system may not operate properly due to other factors or circumstances. Always pay attention to your surrounding.
- If your vehicle's left or right side bumper is blinded by barrier or vehicles, the system sensing ability may be reduced.

**⚠ WARNING**

- The warning light on the outside rearview mirror will illuminate whenever a vehicle is detected at the rear side by the system.

To avoid accidents, do not focus only on the warning light and neglect to see the surrounding of the vehicle.

- Drive safely even though the vehicle is equipped with a Blind Spot Detection System (BSD) and Rear Cross Traffic Alert (RCTA). Do not solely rely on the system but check your surrounding before changing lanes or backing the vehicle up.

The system may not alert the driver in some conditions so always check the surroundings while driving.

(Continued)

(Continued)

- The Blind Spot Detection System (BSD) and Rear Cross Traffic Alert (RCTA) are not a substitute for proper and safe driving practices. Always drive safely and use caution when changing lanes or backing the vehicles up. The Blind Spot Detection System (BSD) may not detect every object alongside the vehicle.

**⚠ CAUTION**

- *The system may not work properly if the bumper has been replaced or if repair work has been done near the sensor.*
- *The detection area differs according to the roads width. If the road is narrow the system may detect other vehicles in the next lane. In addition, if the road is very wide the system may not detect other vehicles.*
- *The system may turn off due to strong electromagnetic waves.*

***Non-operating condition***

**Outside rearview mirror may not alert the driver when:**

- The outside rearview mirror housing is damaged or covered with debris.
- The window is covered with debris.
- The windows are severely tinted.

**DRIVER'S ATTENTION**

The driver must be cautious in the below situations for the system may not detect other vehicles or objects in certain circumstances.

- Curved roads, tollgates, etc.
- The surrounding of the sensor is polluted with rain, snow, mud, etc
- The rear bumper near the sensor is covered or hidden with a foreign matter such as a sticker, bumper guard, bicycle stand etc.
- The rear bumper is damaged or the sensor is out of place.
- The height of the vehicle is altered such as when the trunk is loaded with heavy objects, or there is low tire pressure etc.
- Bad weather such as heavy rain or snow.
- A fixed object is near such as a guardrail, tunnel, human and animal etc.
- Metal substances are near the vehicles such as in a construction area.

(Continued)

**(Continued)**

- A big vehicle is near such as a bus or truck.
- A motorcycle or bicycle is near.
- A flat trailer is near.
- If the vehicle has started at the same time as the vehicle next to you and has accelerated.
- When the other vehicle passes by at a higher rate of speed.
- When changing lanes.
- When going down or up a steep road where the height of the lane is different.
- When the other vehicle drives very close.
- When a trailer or carrier is installed.
- When the temperature of the rear bumper is high.
- When the sensors are covered by a wall or a pillar of a parking lot.
- When your vehicle is backing up, if the detected vehicle also backs up.

(Continued)



**(Continued)**

- **Small objects like shopping carts and strollers.**
- **If there is a vehicle with decreased ride height (lowered).**
- **When the vehicle is close to another vehicle.**
- **When the vehicle in the next lane moves two lanes away from you OR when the vehicle two lanes away moves to the next lane from you.**
- **When driving through a narrow road with many trees or bushes.**

**This device complies with Part 15 of the FCC rules.**

Operation is subject to the following two conditions:

1. This device may not cause harmful interference, and
2. This device must accept any interference received, including interference that may cause undesired operation.

## LANE DEPARTURE WARNING SYSTEM (LDWS) (IF EQUIPPED)

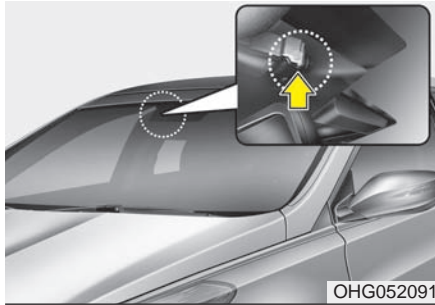

This system detects the lane with a sensor at the front windshield and notifies you if it detects that your vehicle departs from the lane.

### **⚠ WARNING - LDWS Alert**

The LDWS is only intended to provide you with information regarding your vehicle's position on the roadway. Upon receiving an LDWS alert, you must take the necessary steps to maintain control of your vehicle. The LDWS does not provide any steering inputs into the vehicle for you. It can be dangerous to make a large sudden steering input in response to an alert, since that could result in loss of control.

- The LDWS does not make the vehicle change lanes. It is the driver's responsibility to always check the road conditions.
- If the sensor cannot detect the lane or if the vehicle speed does not exceed 38 mph (60 km/h), the LDWS will not be able to notify you if the vehicle departs the lane.
- If your vehicle has window tint or other types of coating on the front windshield, the LDWS may not work properly.
- Do not allow any water or liquid to contact the LDWS sensor, or it may be damaged.
- Do not remove the LDWS parts and do not damage the sensor by a strong impact.
- Do not put objects that reflect light on the dash board.
- The operation of the LDWS can be affected by several factors (including environmental conditions). It is the responsibility of the driver to pay attention to the roadway and to maintain the vehicle in its lane at all times.



To operate the LDWS, press the button with the engine start/stop button in the ON position. The indicator (white) illuminates on the cluster. To cancel the LDWS, press the button again. The indicator will also be turned off.

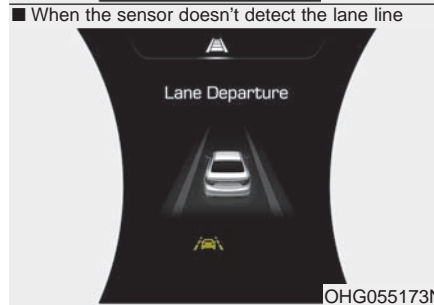
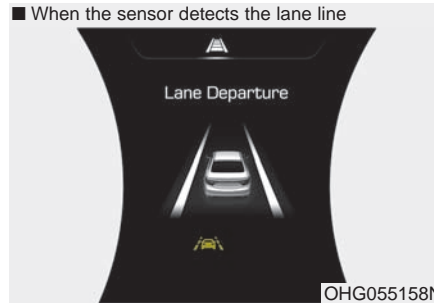

If the system detects that your vehicle is leaving the lane when the LDWS is operating and vehicle speed exceeds 38 mph (60 km/h), the warning operates as follows:



### 1. Visual warning

If you leave the lane, the lane you leave on the LCD display blinks green.

### 2. Auditory warning

If you leave the lane, the warning sound operates.



### Warning indicator

When the LDWS is not working properly, the warning light (yellow) will illuminate and the warning message will come on for a few second.

Take your vehicle to an authorized HYUNDAI dealer and have the system checked.

### The LDWS does not operate when:

- The driver turns on the turn signal to change lanes or operate the hazard warning flasher.
- Driving on the lane line.

### \* NOTICE

Always operate the turn signal before changing lanes.

### **⚠ WARNING - LDWS Limitations**

**The Lane Departure Warning System is a supplemental system. Do not solely rely on the system but always pay attention and drive safely.**

### The LDWS may not warn you even if the vehicle leaves the lane, or may warn you even if the vehicle does not leave the lane when;

- The lane can't be visible due to snow, rain, stain, a puddle or other environmental conditions.
- The brightness of the outside changes suddenly such as tunnel enter/exit.
- The headlights are off at night or in a tunnel.
- The color of the lane marking from the road is difficult to distinguish.
- Driving on a steep grade or a curve.
- Light such as street light, sunlight or oncoming vehicle light reflects from water on the road.
- The lens or windshield is stained with foreign matter.
- The sensor cannot detect the lane because of fog, heavy rain or heavy snow.

- The surrounding of the inside rear view mirror temperature is high due to a direct ray of light.
- The lane is very wide or narrow.
- The lane line is damaged or indistinct.
- The windshield is fogged by humid air in the vehicle.
- The shadow is on the lane line by a median strip.
- The sensor cannot distinguish the lane from the road due to the dust.
- There is a mark similar to a lane line.
- There is a boundary structure.
- The distance from vehicle ahead is very short or the vehicle ahead drives hiding the lane line.
- The vehicle vibrates heavily due to road conditions.
- The lane number increases or decreases or the lane lines are crossing.
- Putting something on the dashboard.
- Driving with the sun in front of you.
- Driving in areas under construction.
- The lane line is more than two in either side (Left/Right)

### **This device complies with Part 15 of the FCC rules.**

Operation is subject to the following two conditions:

1. This device may not cause harmful interference, and
2. This device must accept any interference received, including interference that may cause undesired operation.

## FORWARD COLLISION WARNING SYSTEM (FCWS) (IF EQUIPPED)

The Forward Collision Warning System helps avoid accidents by identifying critical situations early and warning the driver.



OHG045531N

### FCWS Operation

#### *To operate:*

Go to the User Settings Mode (Driving Assist) and select FCW (Forward Collision Warning) on the LCD display (**For more details, refer to "LCD Display" in chapter 4.**).

The system will turn on and standby to activate. The system will activate when vehicle speed is above 25 mph (40 km/h) and below 109 mph (175 km/h).

FCWS will default ON when vehicle is restarted even though FCWS was turned off on User Settings Mode.



OHG045228N

### Warning message

#### *Forward warning*

A warning message and chime will be provided when rapidly approaching a slower moving, braking or stopped vehicle ahead.

Immediately reduce your speed to prevent a collision.

**⚠ WARNING - Forward Collision Warning System Limitations**

- The Forward Collision Warning System is a supplemental system to assist you and its effects may differ according to road and driving conditions. Do not solely rely on the system and always pay attention to prevent dangerous situations from occurring.
- FCWS is a warning system and does not apply the brakes automatically in a near crash situation. FCWS may not provide a warning with enough time to help avoid a crash. FCWS does not detect pedestrians, animals, signs, motorcycles, bicycles, construction or other objects. It is the responsibility of the driver to pay attention to the roadway to prevent collisions.

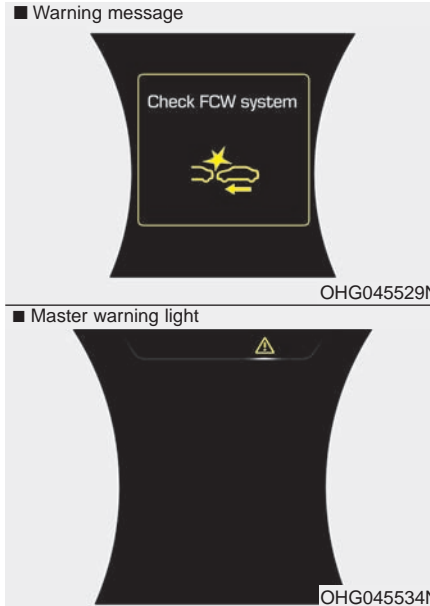

**The Forward collision warning system (FCWS) indicator (🚗) will illuminate:**

- When the Forward collision warning system (FCWS) is turned off.
- When the FCW system disabled. (ex: Blocked camera, etc.)
- When there is a malfunction with the FCW system. In this case, have your vehicle inspected by an authorized HYUNDAI dealer.

**FCWS malfunction message**

When the FCWS is not working properly, the warning message will come on for a few second. After the message disappears, the master warning light will illuminate.



### ***FCWS disabled***

When the camera is blocked from foreign matters, the warning message will come on a few second.

After the foreign substance is removed, if you drive for a few minutes, the system will work normally.

If the system does not work normally even though the foreign substance is removed, take your vehicle to an authorized HYUNDAI dealer and have the system checked.

### **Limitations of the System**

The Forward Collision Warning System may have limits to its ability to detect distance to the vehicle ahead due to road and traffic conditions.

The FCW cannot detect vehicles or objects as vehicles when:

- The camera lens is covered with dirt.
- There is heavy rain or heavy snow.
- Driving on a curve.
- Driving uphill or downhill.
- A vehicle suddenly cut in on your lane.
- The front vehicle suddenly departs from the lane or it is hidden by other objects.
- A vehicle passes by at a higher rate of speed.
- An unusual shape vehicle is ahead such as a trailer, special access vehicles or a truck with unique shaped cargo.
- The rear lamps of the vehicle ahead is missing, installed on an unusual place or installed unevenly.
- The front vehicle has a separate lamp or LED lamp at the rear of the vehicle.
- Pass through a tunnel where the difference of intensity of illumination is high.
- Driving with the sun in front of you.
- The approaching vehicle turns high beam on.
- The vehicle violently vibrates due to road conditions.
- The vehicle is tilted from a flat tire or being towed.
- The vehicle ahead is not distinguishable due to multiple or repeated shape lamps.
- The vehicle ahead is not distinguishable due to objects that can be mistaken for a vehicle.
- The surrounding environments such as shadow or markers on a road, etc. could be mistaken as a vehicle.
- When your vehicle passes by at a close distance to the vehicle ahead.
- The vehicle ahead is not distinguishable due to dark sight.
- When the back side of vehicle ahead is not distinguishable.



**This device complies with Part 15 of the FCC rules.**

Operation is subject to the following two conditions:

1. This device may not cause harmful interference, and
2. This device must accept any interference received, including interference that may cause undesired operation.

## ECONOMICAL OPERATION

Your vehicle's fuel economy depends mainly on your style of driving, where you drive and when you drive.

Each of these factors affects how many miles you can get from a gallon of fuel. To operate your vehicle as economically as possible, use the following driving suggestions to help save money in both fuel and repairs:

- Drive smoothly. Accelerate at a moderate rate. Avoid making "jack-rabbit" starts or full-throttle shifts and maintain a steady cruising speed. Don't race between stop-lights. Try to adjust your speed to that of the other traffic so you don't have to change speeds unnecessarily. Avoid heavy traffic whenever possible. Always maintain a safe distance from other vehicles so you can avoid unnecessary braking. This also reduces brake wear.
- Drive at a moderate speed. The faster you drive, the more fuel your vehicle uses. Driving at a moderate speed, especially on the highway, is one of the most effective ways to reduce fuel consumption.
- Do not "ride" the brake pedal. This can increase fuel consumption and also increase wear on these components. In addition, driving with your foot resting on the brake pedal may cause the brakes to overheat, which reduces their effectiveness and may lead to more serious consequences.
- Take care of your tires. Keep them inflated to the recommended pressure. Incorrect inflation, either too much or too little, results in unnecessary tire wear. Check the tire pressures at least once a month.
- Be sure that the wheels are aligned correctly. Improper alignment can result from hitting curbs or driving too fast over irregular surfaces. Poor alignment causes faster tire wear and may also result in other problems as well as greater fuel consumption.
- Keep your vehicle in good condition. For better fuel economy and reduced maintenance costs, maintain your vehicle in accordance with the maintenance schedule in section 7. If you drive your vehicle in severe conditions, more frequent maintenance is required (see section 7 for details).
- Keep your vehicle clean. For best operation, your vehicle should be kept clean and free of corrosive materials. It is especially important that mud, dirt, ice, etc. not be allowed to accumulate on the underside of the vehicle. This extra weight can result in increased fuel consumption and also contribute to corrosion.
- Travel lightly. Do not carry unnecessary weight in your vehicle. Weight reduces fuel economy.
- Do not let the engine idle longer than necessary. If you are waiting (and not in traffic), turn off your engine and restart only when you're ready to go.

- Remember, your vehicle does not require extended warm-up. After the engine has started, allow the engine to run for 10 to 20 seconds prior to placing the vehicle in gear. In very cold weather, however, give your engine a slightly longer warm-up period.
- Do not "lug" or "over-rev" the engine. Lugging is driving very slowly in too high a gear resulting in engine bucking. If this happens, shift to a lower gear. Over-revving is racing the engine beyond its safe limit. This can be avoided by shifting at the recommended speeds.
- Use your air conditioning sparingly. The air conditioning system is operated by engine power so your fuel economy is reduced when you use it.
- Open windows at high speeds can reduce fuel economy.
- Fuel economy is less in crosswinds and headwinds. To help offset some of this loss, slow down when driving in these conditions.

Keeping a vehicle in good operating condition is important both for economy and safety. Therefore, have an authorized HYUNDAI dealer perform scheduled inspections and maintenance.

**⚠ WARNING - Engine off during motion**  
**Never turn the engine off to coast down hills or anytime the vehicle is in motion. The power steering and power brakes will not function properly without the engine running which could cause serious injury or death. Keep the engine on and downshift to an appropriate gear for engine braking effect.**

## SPECIAL DRIVING CONDITIONS

### Hazardous driving conditions

When hazardous driving conditions are encountered such as water, snow, ice, mud, sand, or similar hazards, follow these suggestions:

- Drive cautiously and allow extra distance for braking.
- Avoid sudden movements in braking or steering.
- Do not pump the brake pedal on a vehicle equipped with ABS.
- If stalled in snow, mud, or sand, use second gear. Accelerate slowly to avoid spinning the drive wheels.
- Use sand, rock salt, tire chains, or other non-slip material under the drive wheels to provide traction when stalled in ice, snow, or mud.
- Leave the ESC system on for best traction when attempting to get vehicle unstuck.

 **WARNING - Downshifting**  
**Do not downshift with an automatic transaxle while driving on slippery surfaces. The sudden change in tire speed could cause the tires to skid and result in an accident.**

### Rocking the vehicle

If it is necessary to rock the vehicle to free it from snow, sand, or mud, first turn the steering wheel right and left to clear the area around your front wheels. Then, shift back and forth between R (Reverse) and any forward gear in vehicles equipped with an automatic transaxle. Do not race the engine, and spin the wheels as little as possible. If you are still stuck after a few tries, have the vehicle pulled out by a tow vehicle to avoid engine overheating and possible damage to the transaxle.

The ESC system should be turned OFF prior to rocking the vehicle.

 **CAUTION - Vehicle rocking**  
***Prolonged rocking may cause engine overheating, transaxle damage or failure, and tire damage.***

**⚠ WARNING - Spinning tires**  
Do not spin the wheels, especially at speeds more than 35 mph (56 km/h). Spinning the wheels at high speeds when the vehicle is stopped could cause a tire to overheat which could result in tire damage that may injure bystanders.

**⚠ WARNING - Sudden vehicle movement**  
Do not attempt to rock the vehicle if people or objects are nearby. The vehicle may suddenly move forward or backwards as it becomes unstuck.

**\* NOTICE**

The ESC system should be turned OFF prior to rocking the vehicle.



**Smooth cornering**

Avoid braking or gear changing in corners, especially when roads are wet. Ideally, corners should always be taken under gentle acceleration. If you follow these suggestions, tire wear will be held to a minimum.



**Driving at night**

Because night driving presents more hazards than driving in the daylight, here are some important tips to remember:

- Slow down and keep more distance between you and other vehicles, as it may be more difficult to see at night, especially in areas where there may not be any street lights.
- Adjust your mirrors to reduce the glare from other driver's headlights.

- Keep your headlights clean and properly aimed. Dirty or improperly aimed headlights will make it much more difficult to see at night. Headlight operation when using windshield wipers is mandatory in some states.
- Avoid staring directly at the headlights of oncoming vehicles. You could be temporarily blinded, and it will take several seconds for your eyes to readjust to the darkness.

### **Driving in the rain**

Rain and wet roads can make driving dangerous, especially if you are not prepared for the slick pavement. Here are a few things to consider when driving in the rain:

- A heavy rainfall will make it harder to see and will increase the distance needed to stop your vehicle, so slow down.
- Keep your windshield wiping equipment in good shape. Replace your windshield wiper blades when they show signs of streaking or missing areas on the windshield.
- If your tires are not in good condition, making a quick stop on wet pavement can cause a skid and possibly lead to an accident. Be sure your tires are in good shape.
- Turn on your headlights to make it easier for others to see you.
- Driving too fast through large puddles can affect your brakes. If you must go through puddles, try to drive through them slowly.
- If you believe you may have gotten your brakes wet, apply them lightly while driving until normal braking operation returns.

### **Driving in flooded areas**

Avoid driving through flooded areas unless you are sure the water is no higher than the bottom of the wheel hub. Drive through any water slowly. Allow adequate stopping distance because brake performance may be affected.

After driving through water, dry the brakes by gently applying them several times while the vehicle is moving slowly.

### **Driving off-road**

Drive carefully off-road because your vehicle may be damaged by rocks or roots of trees. Become familiar with the off-road conditions where you are going to drive before you begin driving.

## Highway driving

### *Tires*

Adjust the tire inflation pressures to specification. Low tire inflation pressures will result in overheating and possible failure of the tires.

Avoid using worn or damaged tires which may result in reduced traction or tire failure.

Never exceed the maximum tire inflation pressure shown on the tires.

**⚠ WARNING - Under/over inflated tires**

**Always check the tires for proper inflation before driving.**

**Underinflated or overinflated tires can cause poor handling, loss of vehicle control, and sudden tire failure leading to accidents, injuries, and even death. For proper tire pressures, refer to "Tires and wheels" in section 8.**

**⚠ WARNING - Tire tread**

**Always check the tire tread before driving your vehicle. Worn-out tires can result in loss of vehicle control, accidents, injuries, and even death. Worn-out tires should be replaced as soon as possible. For further information and tread limits, refer to "Tires and wheels" in section 7.**

### *Fuel, engine coolant and engine oil*

High speed travel consumes more fuel than urban motoring. Do not forget to check both engine coolant and engine oil.

### *Drive belt*

A loose or damaged drive belt may overheat the engine.

## WINTER DRIVING



Severe weather conditions in the winter result in greater wear and other problems. To minimize the risks of winter driving, you should follow these suggestions:

### Snowy or icy conditions

To drive your vehicle in deep snow, it may be necessary to use snow tires or to install tire chains on your tires. If snow tires are needed, it is necessary to select tires equivalent in size and type of the original equipment tires. Failure to do so may adversely affect the safety and handling of your vehicle. Furthermore, speeding, rapid acceleration, sudden brake applications, and sharp turns are potentially very hazardous practices. During deceleration, use engine braking to the fullest extent. Sudden brake applications on snowy or icy roads may cause skids to occur. You need to keep sufficient distance between the vehicle in operation in front and your vehicle. Also, apply the brake gently. It should be noted that installing tire chains on the tire will provide a greater driving force, but will not prevent side skids.

### \* NOTICE

**Tire chains are not legal in all states. Check state laws before fitting tire chains.**

### Snow tires

If you mount snow tires on your vehicle, make sure they are radial tires of the same size and load range as the original tires. Mount snow tires on all four wheels to balance your vehicle's handling in all weather conditions. Keep in mind that the traction provided by snow tires on dry roads may not be as high as your vehicle's original equipment tires. You should drive cautiously even when the roads are clear. Check with the tire dealer for maximum speed recommendations.

#### **⚠ WARNING - Snow tire sized**

**Snow tires should be equivalent in size and type to the vehicle's standard tires. Otherwise, the safety and handling of your vehicle may be adversely affected.**

*Do not install studded tires without first checking local, state and municipal regulations for possible restrictions against their use.*



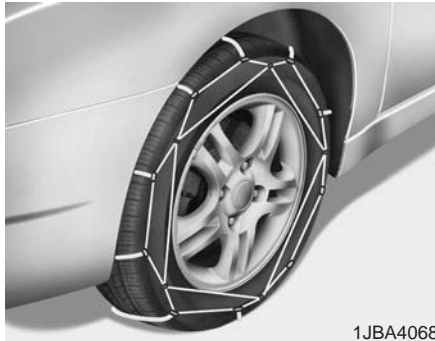

1JBA4068

### **Tire chains**

Since the sidewalls of radial tires are thinner, they can be damaged by mounting some types of snow chains on them. Therefore, the use of snow tires is recommended instead of snow chains. Do not mount tire chains on vehicles equipped with aluminum wheels; snow chains may cause damage to the wheels. If snow chains must be used, use wire-type chains with a thickness of less than 0.47 in. Damage to your vehicle caused by improper snow chain use is not covered by your vehicle manufacturer's warranty.

When using tire chains, install them on the front tires only.

### **⚠ CAUTION - Snow chains**

***Make sure the snow chains are the correct size and type for your tires. Incorrect snow chains can cause damage to the vehicle body and suspension and may not be covered by your vehicle manufacturer warranty.***

- The snow chain connecting hooks may be damaged from contacting vehicle components causing the snow chains to come loose from the tire. Make sure the snow chains are SAE class "S" certified.
- Always check chain installation for proper mounting after driving approximately 0.3 to 0.6 miles to ensure safe mounting. Retighten or remount the chains if they are loose.

### **Chain installation**

When installing chains, follow the manufacturer's instructions and mount them as tightly as you can. Drive slowly with chains installed. If you hear the chains contacting the body or chassis, stop and tighten them. If they still make contact, slow down until it stops. Remove the chains as soon as you begin driving on cleared roads.

### **⚠ WARNING - Mounting chains**

**When mounting snow chains, park the vehicle on level ground away from traffic. Turn on the vehicle Hazard Warning flashers and place a triangular emergency warning device behind the vehicle if available. Always place the vehicle in P (Park), apply the parking brake and turn off the engine before installing snow chains.**

- The use of chains may adversely affect vehicle handling.
- Do not exceed 20 mph or the chain manufacturer's recommended speed limit, whichever is lower.
- Drive carefully and avoid bumps, holes, sharp turns, and other road hazards, which may cause the vehicle to bounce.
- Avoid sharp turns or locked-wheel braking.

 **CAUTION - Snow chains**

- *Chains that are the wrong size or improperly installed can damage your vehicle's brake lines, suspension, body and wheels.*
- *Stop driving and retighten the chains any time you hear them hitting the vehicle.*

### **Use high quality ethylene glycol coolant**

Your vehicle is delivered with high quality ethylene glycol coolant in the cooling system. It is the only type of coolant that should be used because it helps prevent corrosion in the cooling system, lubricates the water pump and prevents freezing. Be sure to replace or replenish your coolant in accordance with the maintenance schedule in section 7. Before winter, have your coolant tested to assure that its freezing point is sufficient for the temperatures anticipated during the winter.

### **Check battery and cables**

Winter puts additional burdens on the battery system. Visually inspect the battery and cables as described in section 7. The level of charge in your battery can be checked by an authorized HYUNDAI dealer or a service station.

### **Change to "winter weight" oil if necessary**

In some climates it is recommended that a lower viscosity "winter weight" oil be used during cold weather. See section 8 for recommendations. If you aren't sure what weight oil you should use, consult an authorized HYUNDAI dealer.

### **Check spark plugs and ignition system**

Inspect your spark plugs as described in section 7 and replace them if necessary. Also check all ignition wiring and components to be sure they are not cracked, worn or damaged in any way.

### **To keep locks from freezing**

To keep the locks from freezing, squirt an approved de-icer fluid or glycerine into the key opening. If a lock is covered with ice, squirt it with an approved de-icing fluid to remove the ice. If the lock is frozen internally, you may be able to thaw it out by using a heated key. Handle the heated key with care to avoid injury.

### **Use approved window washer anti-freeze in system**

To keep the water in the window washer system from freezing, add an approved window washer anti-freeze solution in accordance with instructions on the container. Window washer anti-freeze is available from an authorized HYUNDAI dealer and most auto parts outlets. Do not use engine coolant or other types of anti-freeze as these may damage the paint finish.

### **Don't let your parking brake freeze**

Under some conditions your parking brake can freeze in the engaged position. This is most likely to happen when there is an accumulation of snow or ice around or near the rear brakes or if the brakes are wet. If there is a risk the parking brake may freeze, apply it only temporarily while you put the shift lever in P (Park) and block the rear wheels so the vehicle cannot roll. Then release the parking brake.

### **Don't let ice and snow accumulate underneath**

Under some conditions, snow and ice can build up under the fenders and interfere with the steering. When driving in severe winter conditions where this may happen, you should periodically check underneath the vehicle to be sure the movement of the front wheels and the steering components is not obstructed.

### **Carry emergency equipment**

Depending on the severity of the weather where you drive your vehicle, you should carry appropriate emergency equipment. Some of the items you may want to carry include tire chains, tow straps or chains, flashlight, emergency flares, sand, shovel, jumper cables, window scraper, gloves, ground cloth, coveralls, blanket, etc.

### **Don't place foreign objects or materials in the engine compartment**

Placement of foreign objects or materials which prevent cooling of the engine, in the engine compartment, may cause a failure or combustion. The manufacturer is not responsible for the damage caused by such placement.

## VEHICLE LOAD LIMIT

■ Type A

TIRE AND LOADING INFORMATION RENSEIGNEMENTS SUR LES PNEUS ET LE CHARGEMENT				
SEATING CAPACITY NOMBRE DE PLACES		TOTAL 5	FRONT AVANT 2	REAR ARRIÈRE 3
The combined weight of occupants and cargo should never exceed 410 kg or 904 lbs. Le poids total des occupants et du chargement ne doit jamais dépasser 410 kg ou 904 lbs.				
TIRE PNEU	SIZE DIMENSIONS	COLD TIRE PRESSURE PRESSION DES PNEUS À FROID		SEE OWNER'S MANUAL FOR ADDITIONAL INFORMATION VOIR LE MANUEL DE L'USAGER POUR PLUS DE RENSEIGNEMENTS
FRONT AVANT	P245/45R18	230kPa, 33psi		
REAR ARRIÈRE	P245/45R18	230kPa, 33psi		
SPARE DE SECOURS	T135/80D17	420kPa, 60psi		

OHG053083A

■ Type B

TIRE AND LOADING INFORMATION RENSEIGNEMENTS SUR LES PNEUS ET LE CHARGEMENT				
SEATING CAPACITY NOMBRE DE PLACES		TOTAL 5	FRONT AVANT 2	REAR ARRIÈRE 3
The combined weight of occupants and cargo should never exceed 410 kg or 904 lbs. Le poids total des occupants et du chargement ne doit jamais dépasser 410 kg ou 904 lbs.				
TIRE PNEU	SIZE DIMENSIONS	COLD TIRE PRESSURE PRESSION DES PNEUS À FROID		SEE OWNER'S MANUAL FOR ADDITIONAL INFORMATION VOIR LE MANUEL DE L'USAGER POUR PLUS DE RENSEIGNEMENTS
FRONT AVANT	P245/40R19	230kPa, 33psi		
REAR ARRIÈRE	P245/40R19	230kPa, 33psi		
SPARE DE SECOURS	T135/80D17	420kPa, 60psi		

OHG053084A

### Tire and loading information label

The label located on the driver's door sill gives the original tire size, cold tire pressures recommended for your vehicle, the number of people that can be in your vehicle and vehicle capacity weight.

### Vehicle capacity weight:

904 lbs. (410 kg)

Vehicle capacity weight is the maximum combined weight of occupants and cargo. If your vehicle is equipped with a trailer, the combined weight includes the tongue load.

### Seating capacity:

Total : 5 persons

(Front seat : 2 persons,  
Rear seat : 3 persons)

Seating capacity is the maximum number of occupants including a driver, your vehicle may carry.

However, the seating capacity may be reduced based upon the weight of all of the occupants, and the weight of the cargo being carried or towed.

Do not overload the vehicle as there is a limit to the total weight, or load limit including occupants and cargo, the vehicle can carry.

### ***Towing capacity:***

**We do not recommend using this vehicle for trailer towing.**

### ***Cargo capacity:***

The cargo capacity of your vehicle will increase or decrease depending on the weight and the number of occupants and the tongue load, if your vehicle is equipped with a trailer.

### ***Steps for determining correct load limit***

1. Locate the statement "The combined weight of occupants and cargo should never exceed XXX kg or XXX lbs." on your vehicle's placard.
2. Determine the combined weight of the driver and passengers that will be riding in your vehicle.
3. Subtract the combined weight of the driver and passengers from XXX kg or XXX lbs.
4. The resulting figure equals the available amount of cargo and luggage load capacity. For example, if the "XXX" amount equals 1400 lbs. and there will be five 150 lbs. passengers in your vehicle, the amount of available cargo and luggage load capacity is 650 lbs.  
(1400-750 (5 x 150) = 650 lbs.)
5. Determine the combined weight of luggage and cargo being loaded on the vehicle. That weight may not safely exceed the available cargo and luggage load capacity calculated in Step 4.
6. If your vehicle will be towing a trailer, load from your trailer will be transferred to your vehicle. Consult this manual to determine how this reduces the available cargo and luggage load capacity of your vehicle.

**Example 1**



C190F01JM

Item	Description	Total
A	Vehicle Capacity Weight	904 lbs (410 kg)
B	Subtract Occupant Weight 150 lbs (68 kg) × 2	300 lbs (136 kg)
C	Available Cargo and Luggage weight	604 lbs (274 kg)

**Example 2**



C190F02JM

Item	Description	Total
A	Vehicle Capacity Weight	904 lbs (410 kg)
B	Subtract Occupant Weight 150 lbs (68 kg) × 5	750 lbs (340 kg)
C	Available Cargo and Luggage weight	154 lbs (70 kg)

**Example 3**

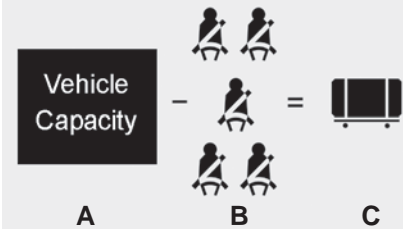

C190F03JM

Item	Description	Total
A	Vehicle Capacity Weight	904 lbs (410 kg)
B	Subtract Occupant Weight 172 lbs (78 kg) × 3	516 lbs (234 kg)
C	Available Cargo and Luggage weight	388 lbs (174 kg)

Refer to your vehicle's tire and loading information label for specific information about your vehicle's capacity weight and seating positions. The combined weight of the driver, passengers and cargo should never exceed your vehicle's capacity weight.



OBH059070

### Certification label

The certification label is located on the driver's door sill at the center pillar. This label shows the maximum allowable weight of the fully loaded vehicle. This is called the GVWR (Gross Vehicle Weight Rating). The GVWR includes the weight of the vehicle, all occupants, fuel and cargo.

This label also tells you the maximum weight that can be supported by the front and rear axles, called Gross Axle Weight Rating (GAWR).

To find out the actual loads on your front and rear axles, you need to go to a weigh station and weigh your vehicle. Your dealer can help you with this. Be sure to spread out your load equally on both sides of the centerline.

**⚠ WARNING - Overloading**  
Never exceed the GVWR for your vehicle, the GAWR for either the front or rear axle and vehicle capacity weight. Exceeding these ratings can affect your vehicle's handling and braking ability, and cause an accident.

The label will help you decide how much cargo and installed equipment your vehicle can carry.

If you carry items inside your vehicle - like suitcases, tools, packages, or anything else - they are moving as fast as the vehicle. If you have to stop or turn quickly, or if there is a crash, the items will keep going and can cause an injury if they strike the driver or a passenger.

**⚠ WARNING - Overloading**  
Do not overload your vehicle. Overloading your vehicle can cause heat buildup in your vehicle's tires and possible tire failure, increased stopping distances and poor vehicle handling-all of which may result in a crash.

**⚠ CAUTION**  
*Overloading your vehicle may cause damage. Repairs would not be covered by your warranty. Do not overload your vehicle.*

**⚠ WARNING - Loose cargo**  
Do not travel with unsecured objects in the passenger compartment of your vehicle (e.g. suit cases or unsecured child seats). These items may strike and injure occupants during a sudden stop or crash.

## VEHICLE WEIGHT

This section will guide you in the proper loading of your vehicle, to keep your loaded vehicle weight within its design rating capability. Properly loading your vehicle will provide maximum return of the vehicle design performance. Before loading your vehicle, familiarize yourself with the following terms for determining your vehicle's weight ratings, from the vehicle's specifications and the certification label:

### Base curb weight

This is the weight of the vehicle including a full tank of fuel and all standard equipment. It does not include passengers, cargo, or optional equipment.

### Vehicle curb weight

This is the weight of your new vehicle when you picked it up from your dealer plus any aftermarket equipment.

### Cargo weight

This figure includes all weight added to the Base Curb Weight, including cargo and optional equipment.

### GAW (Gross axle weight)

This is the total weight placed on each axle (front and rear) - including vehicle curb weight and all payload.

### GAWR (Gross axle weight rating)

This is the maximum allowable weight that can be carried by a single axle (front or rear). These numbers are shown on the certification label. The total load on each axle must never exceed its GAWR.

### GVW (Gross vehicle weight)

This is the Base Curb Weight plus actual Cargo Weight plus passengers.

### GVWR (Gross vehicle weight rating)

This is the maximum allowable weight of the fully loaded vehicle (including all options, equipment, passengers and cargo). The GVWR is shown on the certification label located on the driver's (or front passenger's) door sill.



## **TRAILER TOWING**

**We do not recommend using this vehicle for trailer towing.**

# What to do in an emergency

- Road warning ..... 6-2
  - Hazard warning flasher ..... 6-2
- In case of an emergency while driving..... 6-3
  - If the engine stalls at a crossroad or crossing ..... 6-3
  - If you have a flat tire while driving ..... 6-3
  - If engine stalls while driving ..... 6-3
- If the engine does not start ..... 6-4
  - If engine dose not turn over or turns over slowly .. 6-4
  - If engine turns over normally but does not start ... 6-4
- Emergency starting ..... 6-5
  - Jump starting ..... 6-5
  - Push-starting ..... 6-6
- If the engine overheats..... 6-7
- Tire pressure monitoring system (TPMS)..... 6-8
- If you have a flat tire ..... 6-13
  - Jack and tools..... 6-13
  - Removing and storing the spare tire ..... 6-14
  - Changing tires ..... 6-14
  - Jack label..... 6-20
- Towing..... 6-21
  - Towing service ..... 6-21
  - Removable towing hook ..... 6-22
  - Emergency towing ..... 6-22
  - Tie-down hook ..... 6-24

## ROAD WARNING



### Hazard warning flasher

The hazard warning flasher serves as a warning to other drivers to exercise extreme caution when approaching, overtaking, or passing your vehicle.

It should be used whenever emergency repairs are being made or when the vehicle is stopped near the edge of a roadway.

Press the flasher switch with the ignition switch in any position. The flasher switch is located in the center console switch panel. All turn signal lights will flash simultaneously.

- The hazard warning flasher operates whether your vehicle is running or not.
- You can operate the turn signals when the hazard flasher is on. The hazard flasher will rework when you turn off the turn signals.
- The hazard flasher will stop if you push the switch one time while the turn signals and the hazard flasher work simultaneously. To turn the hazard warning lights on again, push the switch a second time.

## IN CASE OF AN EMERGENCY WHILE DRIVING

### If the engine stalls at a cross-road or crossing

If the engine stalls at a crossroad or crossing, set the shift lever in the N (Neutral) position and then push the vehicle to a safe place.

### If you have a flat tire while driving

If a tire goes flat while you are driving:

1. Take your foot off the accelerator pedal and let the vehicle slow down while driving straight ahead. Do not apply the brakes immediately or attempt to pull off the road as this may cause a loss of control. When the vehicle has slowed to such a speed that it is safe to do so, brake carefully and pull off the road. Drive off the road as far as possible and park on a firm level ground. If you are on a divided highway, do not park in the median area between the two traffic lanes.
2. When the vehicle is stopped, turn on your emergency hazard flashers, set the parking brake and put the transaxle in P (Park).
3. Have all passengers get out of the vehicle. Be sure they all get out on the side of the vehicle that is away from traffic.
4. When changing a flat tire, follow the instruction provided later in this section.

### If engine stalls while driving

1. Reduce your speed gradually, keeping a straight line. Move cautiously off the road to a safe place.
2. Turn on your emergency flashers.
3. Try to start the engine again. If your vehicle will not start, contact an authorized HYUNDAI dealer or seek other qualified assistance.

## IF THE ENGINE DOES NOT START

### If engine does not turn over or turns over slowly

1. If your vehicle has an automatic transaxle, be sure the shift lever is in N (Neutral) or P (Park) and the emergency brake is set.
2. Check the battery connections to be sure they are clean and tight.
3. Turn on the interior light. If the light dims or goes out when you operate the starter, the battery is discharged.
4. Do not push or pull the vehicle to start it. See instructions for "Jump starting".

 **WARNING** - Push/pull start

**Do not push or pull the vehicle to start it. Push or pull starting may cause the catalytic converter to overload and create a fire hazard.**

### If engine turns over normally but does not start

1. Check fuel level.
2. With the ignition switch in the OFF position, check all connectors at the ignition coils and spark plugs. Reconnect any that may be disconnected or loose.
3. Check the fuel line in the engine compartment.
4. If the engine still does not start, call an authorized HYUNDAI dealer or seek other qualified assistance.

## EMERGENCY STARTING

■ Engine compartment

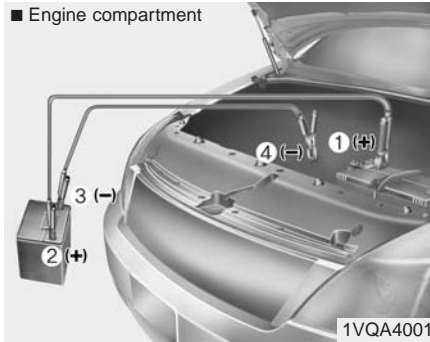

Connect cables in numerical order and disconnect in reverse order.

- ① Positive (+) battery terminal on your vehicle
- ② Positive (+) battery terminal on the booster battery
- ③ Negative (-) battery terminal on the booster battery
- ④ Negative (-) cable to a solid, stationary metallic point on the engine (such as the engine lifting bracket). DO NOT connect it directly to the negative battery terminal.

### Jump starting

Jump starting can be dangerous if done incorrectly. Therefore, to avoid harm to yourself or damage to your vehicle or battery, follow the jump starting procedures. If in doubt, we strongly recommend that you have a competent technician or towing service jump start your vehicle.

#### **⚠ CAUTION - 12 volt battery**

*Use only a 12-volt jumper system. You can damage a 12-volt starting motor, ignition system, and other electrical parts beyond repair by use of a 24-volt power supply (either two 12-volt batteries in series or a 24-volt motor generator set).*

#### **⚠ WARNING - Battery**

**Never attempt to check the electrolyte level of the battery as this may cause the battery to rupture or explode causing serious injury.**

#### **⚠ WARNING - Frozen batteries**

**Do not attempt to jump start the vehicle if the discharged battery is frozen or if the electrolyte level is low as the battery may rupture or explode causing serious injury.**

#### **⚠ WARNING - Battery**

**Keep all flames or sparks away from the battery. The battery produces hydrogen gas which will explode if exposed to flame or sparks causing serious injury.**

#### **⚠ WARNING - Sulfuric acid risk**

**When jump starting your vehicle be careful not to get acid on yourself, your clothing or on the vehicle. Automobile batteries contain sulfuric acid. This is poisonous and highly corrosive.**

### ***Jump starting procedure***

1. Make sure the booster battery is 12-volt and that its negative terminal is grounded.
2. If the booster battery is in another vehicle, do not allow the vehicles to touch.
3. Turn off all unnecessary electrical loads.
4. Connect the jumper cables in the exact sequence shown in the illustration.
  - ① Connect one end of the red jumper cable to the positive terminal on your vehicle (1).
  - ② Connect the other end of the red jumper cable to the positive terminal on the booster battery (2).
  - ③ Connect one end of the black jumper cable to the negative terminal of the booster battery (3).
  - ④ Connect the other end of the black jumper cable to a solid, stationary metallic point on the engine (such as the engine lifting bracket). **DO NOT** connect it directly to the negative battery terminal. Do not connect it to or near any part that moves when the engine is cranked.

Do not allow the jumper cables to contact anything except the correct battery terminals or the correct ground. Do not lean over the battery when making connections.

### **CAUTION - Battery cables**

***Do not connect the jumper cable from the negative terminal of the booster battery to the negative terminal of the discharged battery. This can cause the discharged battery to overheat and crack, releasing battery acid.***

5. Start the engine of the vehicle with the booster battery and let it run at 2,000 rpm, then start the engine of the vehicle with the discharged battery.
6. Once the engine has started, carefully remove the jumper cables in the reverse order of attachment.

*If the cause of your battery discharging is not apparent, you should have your vehicle checked by an authorized HYUNDAI dealer.*

### **Push-starting**

Vehicles equipped with automatic transaxle cannot be push-started.

Follow the directions in this section for jump-starting.

## IF THE ENGINE OVERHEATS

If your temperature gauge indicates overheating, you experience a loss of power, or hear loud pinging or knocking, the engine is probably too hot. If this happens, you should:

1. Pull off the road and stop as soon as it is safe to do so.
2. Place the shift lever in P (Park) and set the parking brake. If the air conditioning is on, turn it off.
3. If engine coolant is running out under the vehicle or steam is coming out from the hood, stop the engine. Do not open the hood until the coolant has stopped running or the steaming has stopped. If there is no visible loss of engine coolant and no steam, leave the engine running and check to be sure the engine cooling fan is operating. If the fan is not running, turn the engine off.

4. Check to see if the water pump drive belt is missing. If it is not missing, check to see that it is tight. If the drive belt seems to be satisfactory, check for coolant leaking from the radiator, hoses or under the vehicle. (If the air conditioning had been in use, it is normal for clear water to be draining from it when you stop).

**⚠ WARNING - Under the hood**

**While the engine is running, keep hair, hands and clothing away from moving parts such as the fan and drive belts to prevent injury.**

5. If the water pump drive belt is broken or engine coolant is leaking out, stop the engine immediately and call the nearest authorized HYUNDAI dealer for assistance.

**⚠ WARNING - Radiator cap**  
**Do not remove the radiator cap when the engine is hot. This may result in coolant being blown out of the opening and cause serious burns.**

6. If you cannot find the cause of the overheating, wait until the engine temperature has returned to normal. Then, if coolant has been lost, carefully add coolant to the reservoir to bring the fluid level in the reservoir up to the halfway mark.
7. Proceed with caution, keeping alert for further signs of overheating. If overheating happens again, call an authorized HYUNDAI dealer for assistance.

Serious loss of coolant indicates there is a leak in the cooling system and this should be checked as soon as possible by an authorized HYUNDAI dealer.



## TIRE PRESSURE MONITORING SYSTEM (TPMS)



■ Type A

■ Type B

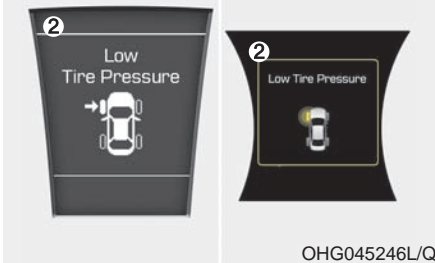

- (1) Low tire pressure telltale / TPMS malfunction indicator
- (2) Low tire pressure position telltale (Shown on the LCD display)

Each tire, including the spare (if provided), should be checked monthly when cold and inflated to the inflation pressure recommended by the vehicle manufacturer on the vehicle placard or tire inflation pressure label. (If your vehicle has tires of a different size than the size indicated on the vehicle placard or tire inflation pressure label, you should determine the proper tire inflation pressure for those tires.)

As an added safety feature, your vehicle has been equipped with a tire pressure monitoring system (TPMS) that illuminates a low tire pressure telltale when one or more of your tires is significantly under-inflated. Accordingly, when the low tire pressure telltale illuminates, you should stop and check your tires as soon as possible, and inflate them to the proper pressure. Driving on a significantly under-inflated tire causes the tire to overheat and can lead to tire failure. Under-inflation also reduces fuel efficiency and tire tread life, and may affect the vehicle's handling and stopping ability.

Please note that the TPMS is not a substitute for proper tire maintenance, and it is the driver's responsibility to maintain correct tire pressure, even if under-inflation has not reached the level to trigger illumination of the TPMS low tire pressure telltale.

Your vehicle has also been equipped with a TPMS malfunction indicator to indicate when the system is not operating properly. The TPMS malfunction indicator is combined with the low tire pressure telltale. When the system detects a malfunction, the telltale will flash for approximately one minute and then remain continuously illuminated. This sequence will continue upon subsequent vehicle start-ups as long as the malfunction exists. When the malfunction indicator is illuminated, the system may not be able to detect or signal low tire pressure as intended.

TPMS malfunctions may occur for a variety of reasons, including the installation of replacement or alternate tires or wheels on the vehicle that prevent the TPMS from functioning properly. Always check the TPMS malfunction telltale after replacing one or more tires or wheels on your vehicle to ensure that the replacement or alternate tires and wheels allow the TPMS to continue to function properly.

### \* NOTICE

Take your vehicle to the nearest authorized HYUNDAI dealer and have the system checked if any of the below happens:

1. The low tire pressure telltale/ TPMS malfunction indicator do not illuminate for 3 seconds when the ignition switch is turned to the ON position or engine is running.
2. The TPMS malfunction indicator remains illuminated after blinking for approximately 1 minute.
3. The Low tire pressure position telltale remains illuminated.



### Low tire pressure telltale



### Low tire pressure position telltale

When the tire pressure monitoring system warning indicators are illuminated, one or more of your tires is significantly under-inflated. The low tire pressure position telltale light will indicate which tire is significantly under-inflated by illuminating the corresponding position light.

If either telltale illuminates, immediately reduce your speed, avoid hard cornering and anticipate increased stopping distances. You should stop and check your tires as soon as possible. Inflate the tires to the proper pressure as indicated on the vehicle's placard or tire inflation pressure label located on the driver's side center pillar outer panel. If you cannot reach a service station or if the tire cannot hold the newly added air, replace the low pressure tire with a spare tire.

After restarting with the spare tire, the TPMS malfunction indicator and low tire pressure position telltale light will remain on about 20 minutes of continuous driving, then the TPMS malfunction indicator will blink for approximately 1 minute but the low tire pressure position telltale light will turn off.

### \* NOTICE

The compact spare tire is not equipped with a tire pressure sensor.

 **CAUTION**

*In winter or cold weather, the low tire pressure telltale may be illuminated if the tire pressure was adjusted to the recommended tire inflation pressure in warm weather. It does not mean your TPMS is malfunctioning because the decreased temperature leads to a proportional lowering of tire pressure.*

*When you drive your vehicle from a warm area to a cold area or from a cold area to a warm area, or the outside temperature is greatly higher or lower, you should check the tire inflation pressure and adjust the tires to the recommended tire inflation pressure.*

 **WARNING - Low pressure damage**

**Do not drive on low pressure tires. Significantly low tire pressure can cause the tires to overheat and fail making the vehicle unstable resulting in increased braking distances and a loss of vehicle control.**



**TPMS (Tire Pressure Monitoring System) malfunction indicator**

The TPMS malfunction indicator will illuminate after it blinks for approximately one minute when there is a problem with the Tire Pressure Monitoring System. If the system is able to correctly detect an underinflation warning at the same time as system failure then the TPMS malfunction indicator remains illuminated after blinking for approximately 1 minute and the low tire pressure position telltale will illuminate. For example, if Front Left sensor fails, the TPMS malfunction indicator remains illuminated after blinking for approximately 1 minute, but if the Front Right, Rear Left, or Rear Right tire is under-inflated, the low tire pressure position telltales may illuminate together with the TPMS malfunction indicator. Have the system checked by an authorized HYUNDAI dealer as soon as possible to determine the cause of the problem.

- The TPMS malfunction indicator may blink for approximately 1 minute and then remain continuously illuminated if the vehicle is moving around electric power supply cables or radios transmitter such as at police stations, government and public offices, broadcasting stations, military installations, airports, or transmitting towers, etc. This can interfere with normal operation of the Tire Pressure Monitoring System (TPMS).
- The TPMS malfunction indicator may blink for approximately 1 minute and then remain continuously illuminated if snow chains are used or some separate electronic devices such as notebook computer, mobile charger, remote starter or navigation etc., are used in the vehicle. This can interfere with normal operation of the Tire Pressure Monitoring System (TPMS).

### Changing a tire with TPMS

If you have a flat tire, the low Tire Pressure and Position telltales will come on. Have the flat tire repaired by an authorized HYUNDAI dealer as soon as possible or replace the flat tire with the spare tire.

#### CAUTION

***Never use a puncture-repairing agent not approved by HYUNDAI to repair and/or inflate a low pressure tire. The tire sealant not approved by HYUNDAI may damage the tire pressure sensor. The sealant on the tire pressure sensor and wheel shall be eliminated when you replace the tire with a new one.***

Each wheel is equipped with a tire pressure sensor mounted inside the tire behind the valve stem. You must use TPMS specific wheels. It is recommended that you always have your tires serviced by an authorized HYUNDAI dealer as soon as possible.

After you replace the low pressure tire with the spare tire, the TPMS malfunction indicator may blink for approximately 1 minute and then remain continuously illuminated because the TPMS sensor is not mounted on the spare wheel.

Once the low pressure tire is reinflated to the recommended pressure and installed on the vehicle is initiated by an authorized HYUNDAI dealer, the TPMS malfunction indicator and the low tire pressure and position telltales will turn off within a few minutes of driving.

If the indicators do not go off after a few minutes of driving, please visit an authorized HYUNDAI dealer.

You may not be able identify a low tire by simply looking at it. Always use a good quality tire pressure gauge to measure the tire's inflation pressure. Please note that a tire that is hot (from being driven) will have a higher pressure measurement than a tire that is cold (from sitting stationary for at least 3 hours and driven less than 1 mile during that 3 hour period).

Allow the tire to cool before measuring the inflation pressure. Always be sure the tire is cold before inflating to the recommended pressure.

A cold tire means the vehicle has been sitting for 3 hours and driven for less than 1 mile in that 3 hour period.

### CAUTION

***Do not use any tire sealant if your vehicle is equipped with a Tire Pressure Monitoring System. The liquid sealant can damage the tire pressure sensors.***

- The TPMS cannot alert you to severe and sudden tire damage caused by external factors such as nails or road debris.
- If you feel any vehicle instability, immediately take your foot off the accelerator, apply the brakes gradually and with light force, and slowly move to a safe position off the road.

### CAUTION

***Tampering with, modifying or disabling the Tire Pressure Monitoring System (TPMS) components may interfere with the system's ability to warn the driver of low tire pressure conditions and/or TPMS malfunctions. Tampering with, modifying, or disabling the Tire Pressure Monitoring System (TPMS) components may void the warranty for that portion of the vehicle.***

### **This device complies with Part 15 of the FCC rules.**

Operation is subject to the following two conditions:

1. This device may not cause harmful interference, and
2. This device must accept any interference received, including interference that may cause undesired operation.

### CAUTION

***Changes or modifications not expressly approved by the party responsible for compliance could void the user's authority to operate the equipment.***

## IF YOU HAVE A FLAT TIRE



### Jack and tools

The jack, jack handle, wheel lug nut wrench are stored in the luggage compartment. Pull up the luggage box cover to reach this equipment.

- (1) Jack handle
- (2) Jack
- (3) Wheel lug nut wrench

### Jacking instructions

The jack is provided for emergency tire changing only.

To prevent the jack from “rattling” while the vehicle is in motion, store it properly.

Follow jacking instructions to reduce the possibility of personal injury.

#### **⚠ WARNING - Changing tires**

**Never attempt vehicle repairs in the traffic lanes of a public road or highway. Doing so could result in serious injuries or death.**

- Always move the vehicle completely off the road and onto the shoulder before trying to change a tire. The jack should be used on a firm level ground. If you cannot find a firm level place off the road, call a towing service company for assistance.
- Be sure to use the correct front and rear jacking positions on the vehicle; never use the bumpers or any other part of the vehicle for jacking support.

#### **⚠ WARNING - Jack**

**Do not place any portion of your body under a vehicle that is only supported by a jack since the vehicle can easily roll off the jack causing serious injury or death. Use vehicle support stands.**

## What to do in an emergency

- Do not allow anyone to remain in the vehicle while it is on the jack.
- Make sure any children present are in a secure place away from the road and from the vehicle to be raised with the jack.

### **⚠ WARNING**

#### **- Running vehicle on jack**

**Do not start or run the engine of the vehicle while the vehicle is on the jack as this may cause the vehicle to fall off the jack resulting in serious injury or death.**

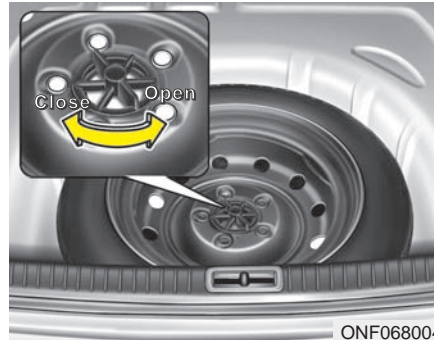

ONF068004

### **Removing and storing the spare tire**

Turn the tire hold-down wing bolt counterclockwise.

Store the tire in the reverse order of removal.

To prevent the spare tire and tools from “rattling” while the vehicle is in motion, store them properly.



OBH068002L

### **Changing tires**

1. Park on a level surface and apply the parking brake firmly.
2. Place the transaxle shift lever in P (Park).
3. Activate the hazard warning flasher.



4. Remove the wheel lug nut wrench, jack, jack handle, and spare tire from the vehicle.
5. Block both the front and rear of the wheel that is diagonally opposite from the jack position.

**\* NOTICE**

- To prevent vehicle movement while changing a tire, always set the parking brake fully, and always block the wheel diagonally opposite the wheel being changed.
- We recommend that the wheels of the vehicle be blocked, and that no person remain in a vehicle that is being jacked.



6. Insert the jack handle into the groove of the wheel cap and gently pry up the cap. (if equipped)



7. Loosen the wheel lug nuts counterclockwise one turn each, but do not remove any nut until the tire has been raised off the ground.



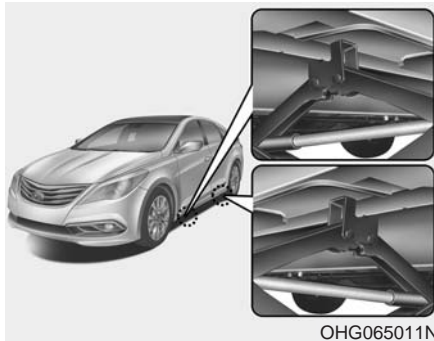

8. Place the jack at the front or rear jacking position closest to the tire you are changing. Place the jack at the designated locations under the frame. The jacking positions are plates welded to the frame with two tabs and a raised dot to index with the jack.

**⚠ WARNING - Jack location**  
To reduce the possibility of injury, be sure to use only the jack provided with the vehicle and in the correct jack position; never use any other part of the vehicle for jack support.



9. Insert the jack handle into the jack and turn it clockwise, raising the vehicle until the tire just clears the ground. This measurement is approximately 1.2 in. (30 mm).  
Before removing the wheel lug nuts, make sure the vehicle is stable and that there is no chance for movement or slippage.

10. Loosen the wheel nuts and remove them with your fingers. Slide the wheel off the studs and lay it flat so it cannot roll away. To put the wheel on the hub, pick up the spare tire, line up the holes with the studs and slide the wheel onto them. If this is difficult, tip the wheel slightly and get the top hole in the wheel lined up with the top stud. Then jiggle the wheel back and forth until the wheel can slide over the other studs.

Wheels may have sharp edges. Handle them carefully to avoid possible injury. Before putting the wheel into place, be sure that there is nothing on the hub or wheel (such as mud, tar, gravel, etc.) that prevents with the wheel from fitting firmly against the hub.

**⚠ WARNING - Installing a wheel**

Make sure the wheel makes good contact with the hub when installed. If the contact of the mounting surface between the wheel and hub is not good, the wheel nuts could come loose and cause the loss of a wheel. Loss of a wheel may result in loss of control of the vehicle, serious injury or death.

11. To install the wheel, hold it on the studs, put the wheel nuts on the studs and tighten them finger tight. The nuts should be installed with their tapered small diameter ends directed inward. Jiggle the tire to be sure it is completely seated, then tighten the nuts as much as possible with your fingers again.
12. Lower the vehicle to the ground by turning the wheel nut wrench counterclockwise.

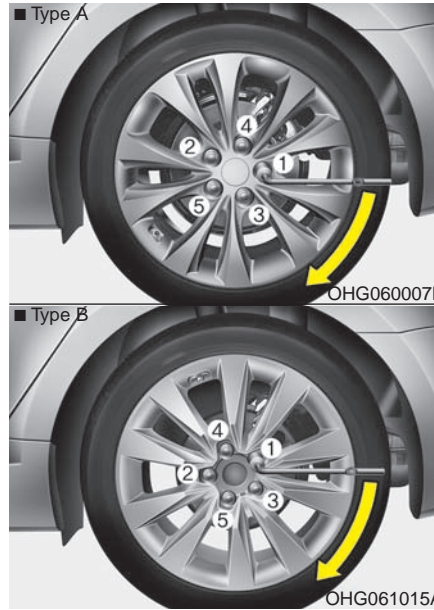

Then position the wrench as shown in the drawing and tighten the wheel nuts. Be sure the socket is seated completely over the nut. Do not stand on the wrench handle or use an extension pipe over the wrench handle. Go around the wheel tightening every nut following the numerical sequence

shown in the image until they are all tight. Then double-check each nut for tightness. After changing wheels, have an authorized HYUNDAI dealer tighten the wheel nuts to their proper torque as soon as possible.

**Wheel nut tightening torque:**

65~79 lb-ft (9~11 kg-m)

If you have a tire gauge, remove the valve cap and check the air pressure. If the pressure is lower than recommended, drive slowly to the nearest service station and inflate to the correct pressure. If it is too high, adjust it until it is correct. Always reinstall the valve cap after checking or adjusting the tire pressure. If the cap is not replaced, dust and dirt may get into the tire valve and air may leak from the tire. If you lose a valve cap, buy another and install it as soon as possible.

After you have changed the wheels, always secure the flat tire in its place and return the jack and tools to their proper storage locations.

 **CAUTION - Replacing lug nuts**

*Make certain during wheel removal that the same nuts that were removed are reinstalled - or, if replaced, that nuts with metric threads and the same chamfer configuration are used. Your vehicle has metric threads on the wheel studs and nuts. Installation of a non-metric thread nut on a metric stud will not secure the wheel to the hub properly and will damage the stud so that it must be replaced.*

Note that most lug nuts do not have metric threads. Be sure to use extreme care in checking for thread style before installing aftermarket lug nuts or wheels. If in doubt, consult an authorized HYUNDAI dealer.

 **WARNING - Wheel studs**

**Do not drive your vehicle with damaged wheel studs. If the studs are damaged, they may lose their ability to retain the wheel. This could lead to the loss of the wheel and a collision resulting in serious injuries.**

To prevent the jack, jack handle, wheel lug nut wrench and spare tire from rattling while the vehicle is in motion, store them properly.

Check the inflation pressures as soon as possible after installing the spare tire. Adjust it to the specified pressure, if necessary. Refer to "Tires and wheels" in section 8.

***Important - use of compact spare tire***

Your vehicle is equipped with a compact spare tire. This compact spare tire takes up less space than a regular-size tire. This tire is smaller than a conventional tire and is designed for temporary use only.

- You should drive carefully when the compact spare is in use. The compact spare should be replaced by the proper conventional tire and rim at the first opportunity.
- The operation of this vehicle is not recommended with more than one compact spare tire in use at the same time.

**⚠ WARNING - Spare tire**

**Do not operate your vehicle on this compact spare at speeds over 50 mph. The compact spare tire is for emergency use only. The original tire should be repaired or replaced as soon as possible to avoid failure of the spare, possibly leading to personal injury or death.**

The compact spare should be inflated to 60 psi (420 kPa).

**\* NOTICE**

**Check the inflation pressure after installing the spare tire. Adjust it to the specified pressure, as necessary.**

When using a compact spare tire, observe the following precautions:

- Under no circumstances should you exceed 50 mph; a higher speed could damage the tire.
- Ensure that you drive slowly enough for the road conditions to avoid all hazards. Any road hazard, such as a pothole or debris, could seriously damage the compact spare.
- Any continuous road use of this tire could result in tire failure, loss of vehicle control, and possible personal injury.
- Do not exceed the vehicle's maximum load rating or the load-carrying capacity shown on the sidewall of the compact spare tire.
- Avoid driving over obstacles. The compact spare tire diameter is smaller than the diameter of a conventional tire and reduces the ground clearance approximately 1 inch, which could result in damage to the vehicle.
- Do not take this vehicle through an automatic car wash while the compact spare tire is installed.
- Do not use tire chains on the compact spare tire. Because of the smaller size, a tire chain will not fit properly. This could damage the vehicle and result in loss of the chain.
- Do not use the compact spare tire on any other vehicle because this tire has been designed especially for your vehicle.
- The compact spare tire's tread life is shorter than a regular tire. Inspect your compact spare tire regularly and replace worn compact spare tires with the same size and design, mounted on the same wheel.
- The compact spare tire should not be used on any other wheels, nor should standard tires, snow tires, wheel covers or trim rings be used with the compact spare wheel. If such use is attempted, damage to these items or other vehicle components may occur.
- Do not use more than one compact spare tire at a time.
- Do not tow a trailer while the compact spare tire is installed.

## Jack label

- Example
- Type A

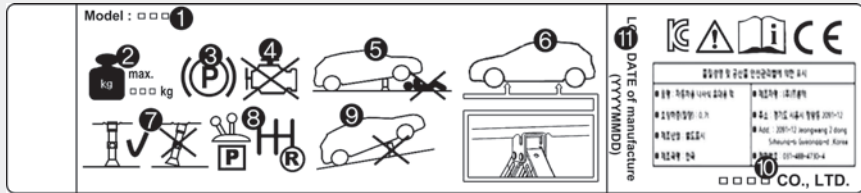

OHYK065010

- Type B

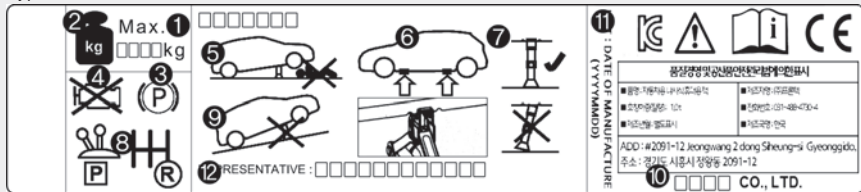

OHYK065011

- Type C



OHYK064002

1. Model Name
2. Maximum allowable load
3. When using the jack, set your parking brake.
4. When using the jack, stop the engine.
5. Do not get under a vehicle that is supported by a jack.
6. The designated locations under the frame
7. When supporting the vehicle, the base plate of jack must be vertical under the lifting point.
8. Shift into Reverse gear on vehicles with manual transaxle or move the shift lever to the P position on vehicles with automatic transaxle.
9. The jack should be used on firm level ground.
10. Jack manufacture
11. Production date
12. Representative company and address

\* The actual Jack label in the vehicle may differ from the illustration. For more detailed specifications, refer to the label attached to the jack.

## TOWING

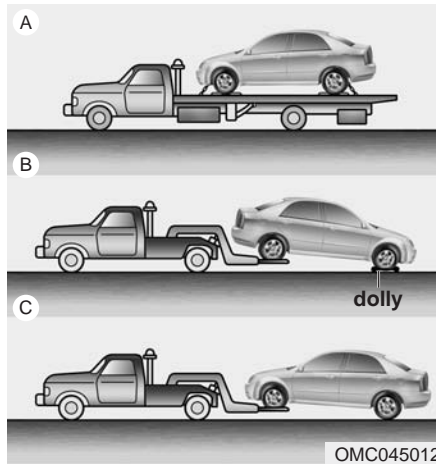

It is acceptable to tow the vehicle with the rear wheels on the ground (without dollies) and the front wheels off the ground.

If any of the loaded wheels or suspension components are damaged or the vehicle is being towed with the front wheels on the ground, use a towing dolly under the front wheels.

When being towed by a commercial tow truck and wheel dollies are not used, the front of the vehicle should always be lifted, not the rear.

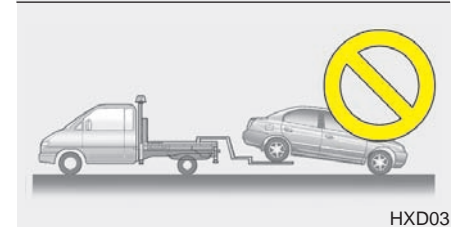
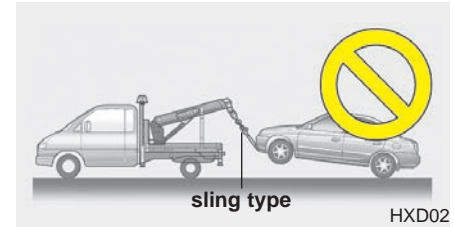

### Towing service

If emergency towing is necessary, we recommend having it done by an authorized HYUNDAI dealer or a commercial tow-truck service. Proper lifting and towing procedures are necessary to prevent damage to the vehicle. The use of wheel dollies or flatbed is recommended.

### ⚠ CAUTION

- **Do not tow with sling-type equipment. Use wheel lift or flatbed equipment.**
- **Do not tow the vehicle with the front wheels on the ground as this may cause damage to the vehicle.**

## What to do in an emergency

When towing your vehicle in an emergency without wheel dollies :

1. Set the ignition switch in the ACC position.
2. Place the shift lever in N (Neutral).
3. Release the parking brake.

### **CAUTION - Towing gear position**

*Always place the transaxle shift lever in N (Neutral) when towing your vehicle. Failure to place the transaxle shift lever in N (Neutral) may cause internal damage to the transaxle.*

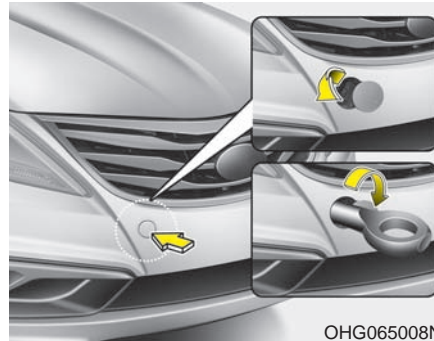

### **Removable towing hook (front, if equipped)**

1. Open the trunk, and remove the towing hook from the tool case.
2. Remove the hole cover by pressing the lower part of the cover on the front bumper.
3. Install the towing hook by turning it clockwise into the hole until it is fully secured.
4. Remove the towing hook and install the cover after use.

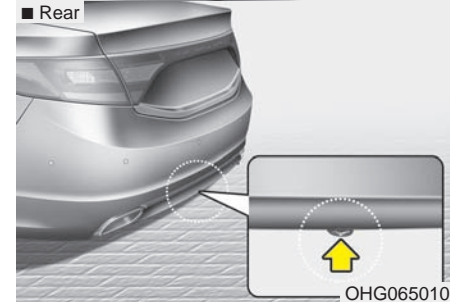
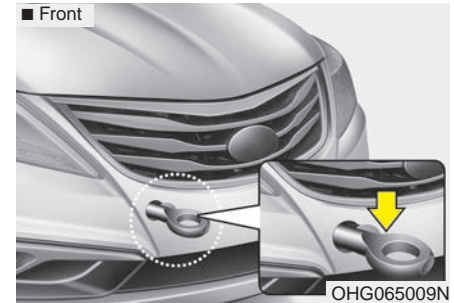

### **Emergency towing**

**If towing is necessary, we recommend you to have it done by an authorized HYUNDAI dealer or a commercial tow truck service.**

If towing service is not available in an emergency, your vehicle may be temporarily towed using a cable or chain secured to the emergency towing hook under the front/rear of the vehicle. Use extreme caution when towing the vehicle. A driver must be in the vehicle to steer it and operate the brakes.

Towing in this manner may be done only on hard-surfaced roads for a short distance and at low speeds. Also, the wheels, axles, power train, steering and brakes must all be in good condition.

- Do not use the tow hooks to pull a vehicle out of mud, sand or other conditions from which the vehicle cannot be driven out under its own power.
- Avoid towing a vehicle heavier than the vehicle doing the towing.
- The drivers of both vehicles should communicate with each other frequently.

- Attach a towing strap to the tow hook.
- Using a portion of the vehicle other than the tow hooks for towing may damage the body of your vehicle.
- Only use a cable or chain specifically intended for use in towing vehicles. Securely fasten the cable or chain to the towing hook provided.
- Before emergency towing, check that the hook is not broken or damaged.
- Fasten the towing cable or chain securely to the hook.
- Do not jerk the hook. Apply steady and even force.
- To avoid damaging the hook, do not pull from the side or at a vertical angle. Always pull straight ahead.

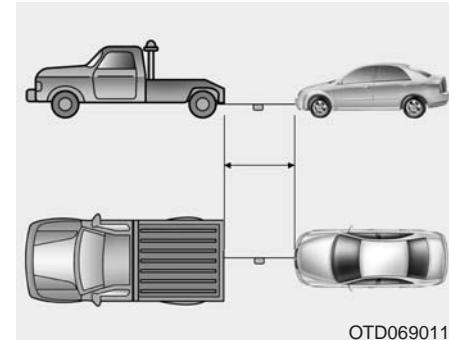

- Use a towing strap less than 16 feet long. Attach a white or red cloth (about 12 inches wide) in the middle of the strap for easy visibility.
- Drive carefully so that the towing strap is not loosened during towing.



### ***Emergency towing precautions***

- Place the ignition switch in ACC so the steering wheel isn't locked.
- Place the transaxle shift lever in N (Neutral).
- Release the parking brake.
- Depress the brake pedal with more force than normal since you will have reduced brake performance.
- More steering effort will be required because the power steering system will be disabled.
- If you are driving down a long hill, the brakes may overheat and brake performance will be reduced. Stop often and let the brakes cool off.
- If the vehicle is being towed with all four wheels on the ground, it can be towed only from the front. Be sure that the transaxle is in neutral. Be sure the steering is unlocked by placing the ignition switch in the ACC position. A driver must be in the towed vehicle to operate the steering and brakes.

### **CAUTION - Automatic transaxle**

- *To avoid serious damage to the automatic transaxle, limit the vehicle speed to 10 mph and drive less than 1 mile when towing.*
- *Before towing, check the automatic transaxle for fluid leaks under your vehicle. If the automatic transaxle fluid is leaking, flatbed equipment or a towing dolly must be used.*

### **Tie-down hook**

#### **WARNING - Tie-down hook**

**Do not use the tie-down hooks for towing purposes. These hooks are designed ONLY for transport tie-down. If the tie-down hooks are used for towing, the tie-down hooks or deflector will be damaged and this could lead to serious injury.**

# Maintenance

Engine compartment . . . . .	7-3	Tires and wheels . . . . .	7-37
Maintenance services . . . . .	7-4	• Tire care . . . . .	7-37
• Owner's responsibility . . . . .	7-4	• Recommended cold tire inflation pressures . . . . .	7-37
• Owner maintenance precautions . . . . .	7-5	• Checking tire inflation pressure . . . . .	7-38
Owner maintenance . . . . .	7-6	• Tire rotation . . . . .	7-39
• Owner maintenance schedule . . . . .	7-6	• Wheel alignment and tire balance . . . . .	7-40
Scheduled maintenance service . . . . .	7-8	• Tire replacement . . . . .	7-40
• Normal maintenance schedule . . . . .	7-9	• Wheel replacement . . . . .	7-42
• Maintenance under severe usage conditions . . . . .	7-19	• Tire traction . . . . .	7-42
Explanation of scheduled maintenance items . . . . .	7-20	• Tire maintenance . . . . .	7-42
Engine oil . . . . .	7-23	• Tire sidewall labeling . . . . .	7-43
Engine coolant . . . . .	7-24	• Low aspect ratio tire . . . . .	7-46
Brake fluid . . . . .	7-27	• Tire terminology and definitions . . . . .	7-47
Washer fluid . . . . .	7-28	• All season tires . . . . .	7-49
Parking brake . . . . .	7-28	• Summer tires . . . . .	7-49
Air cleaner . . . . .	7-29	• Snow tires . . . . .	7-49
Climate control air filter . . . . .	7-30	• Tire chains . . . . .	7-50
Wiper blades . . . . .	7-32	• Radial-ply tires . . . . .	7-50
Battery . . . . .	7-34	Fuses . . . . .	7-51
		• Instrument panel fuse replacement . . . . .	7-52
		• Engine compartment fuse replacement . . . . .	7-53
		• Fuse/relay panel description . . . . .	7-55

---

<b>Light bulbs</b> .....	<b>7-63</b>
• <b>Headlight, position light, turn signal light, front fog light bulb replacement</b> .....	<b>7-63</b>
• <b>Side repeater light bulb replacement</b> .....	<b>7-67</b>
• <b>Rear combination light bulb replacement</b> .....	<b>7-67</b>
• <b>High mounted stop light replacement</b> .....	<b>7-69</b>
• <b>License plate light bulb replacement</b> .....	<b>7-69</b>
• <b>Interior light bulb replacement</b> .....	<b>7-70</b>
<b>Appearance care</b> .....	<b>7-72</b>
• <b>Exterior care</b> .....	<b>7-72</b>
• <b>Interior care</b> .....	<b>7-78</b>
<b>Emission control system</b> .....	<b>7-79</b>
<b>California perchlorate notice</b> .....	<b>7-82</b>

## ENGINE COMPARTMENT

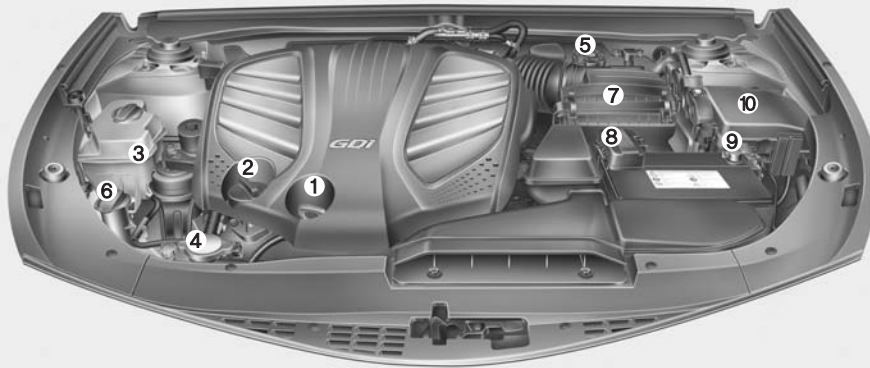

1. Engine oil dipstick
2. Engine oil filler cap
3. Engine coolant reservoir
4. Radiator cap
5. Brake fluid reservoir
6. Windshield washer fluid reservoir
7. Air cleaner
8. Positive battery terminal
9. Negative battery terminal
10. Fuse box

The actual engine compartment in the vehicle may differ from the illustration.

OHG011004A

## MAINTENANCE SERVICES

You should exercise the utmost care to prevent damage to your vehicle and injury to yourself whenever performing any maintenance or inspection procedures.

Should you have any doubts concerning the inspection or servicing of your vehicle, we strongly recommend that you have an authorized HYUNDAI dealer perform this work.

An authorized HYUNDAI dealer has factory-trained technicians and genuine HYUNDAI parts to service your vehicle properly. For expert advice and quality service, see an authorized HYUNDAI dealer.

Inadequate, incomplete or insufficient servicing may result in operational problems with your vehicle that could lead to vehicle damage, an accident, or personal injury.

### Owner's responsibility

#### \* NOTICE

**Maintenance Service and Record Retention are the owner's responsibility.**

**You should retain documents that show proper maintenance has been performed on your vehicle in accordance with the scheduled maintenance service charts shown on the following pages. You need this information to establish your compliance with the servicing and maintenance requirements of your vehicle warranties. Detailed warranty information is provided in your Owner's Handbook & Warranty Information booklet.**

Repairs and adjustments required as a result of improper maintenance or a lack of required maintenance are not covered.

We recommend you have your vehicle maintained and repaired by an authorized HYUNDAI dealer. An authorized HYUNDAI dealer meets HYUNDAI's high service quality standards and receives technical support from HYUNDAI in order to provide you with a high level of service satisfaction.

### **Owner maintenance precautions**

Improper or incomplete service may result in problems. This section gives instructions only for the maintenance items that are easy to perform.

As explained earlier in this section, several procedures can be done only by an authorized HYUNDAI dealer with special tools.

### **\* NOTICE**

Improper owner maintenance during the warranty period may affect warranty coverage. For details, read the separate **Owner's Handbook and Warranty Information** booklet provided with the vehicle. If you are unsure about any servicing or maintenance procedure, have it done by an authorized HYUNDAI dealer.

### **⚠ WARNING**

#### **- Maintenance work**

**Do not wear jewelry or loose clothing while working under the hood of your vehicle with the engine running. These can become entangled in moving parts and result in injury. If you must run the engine while working under the hood, make certain that you remove all jewelry (especially rings, bracelets, watches, and necklaces) and all neckties, scarves, and similar loose clothing before getting near the engine or cooling fans.**

## OWNER MAINTENANCE

The following lists are vehicle checks and inspections that should be performed by the owner or an authorized HYUNDAI dealer at the frequencies indicated to help ensure safe, dependable operation of your vehicle.

Any adverse conditions should be brought to the attention of your dealer as soon as possible.

These Owner Maintenance Checks are generally not covered by warranties and you may be charged for labor, parts and lubricants used.

### Owner maintenance schedule

#### *When you stop for fuel:*

- Check the engine oil level.
- Check coolant level in coolant reservoir.
- Check the windshield washer fluid level.
- Look for low or under-inflated tires.
- Check the radiator and condenser. Check if the front of the radiator and condenser are clean and not blocked with leaves, dirt or insects etc.

If any of the above parts are extremely dirty or you are not sure of their condition, take your vehicle to an authorized HYUNDAI dealer.

**⚠ WARNING - Hot coolant**  
**Be careful when checking your engine coolant level when the engine is hot. Scalding hot coolant and steam may blow out under pressure. This could cause burns or other serious injuries.**

#### *While operating your vehicle:*

- Note any changes in the sound of the exhaust or any smell of exhaust fumes in the vehicle.
- Check for vibrations in the steering wheel. Notice any increased steering effort or looseness in the steering wheel, or change in its straight-ahead position.
- Notice if your vehicle constantly turns slightly or “pulls” to one side when traveling on smooth, level road.
- When stopping, listen and check for unusual sounds, pulling to one side, increased brake pedal travel or “hard-to-push” brake pedal.
- If any slipping or changes in the operation of your transaxle occurs, check the transaxle fluid level.
- Check automatic transaxle P (Park) function.
- Check parking brake.
- Check for fluid leaks under your vehicle (water dripping from the air conditioning system during or after use is normal)

***At least monthly:***

- Check coolant level in the engine coolant reservoir.
- Check the operation of all exterior lights, including the stoplights, turn signals and hazard warning flashers.
- Check the inflation pressures of all tires including the spare.

***At least twice a year  
(i.e., every Spring and Fall):***

- Check radiator, heater and air conditioning hoses for leaks or damage.
- Check windshield washer spray and wiper operation. Clean wiper blades with clean cloth dampened with washer fluid.
- Check headlight alignment.
- Check muffler, exhaust pipes, shields and clamps.
- Check the lap/shoulder belts for wear and function.
- Check for worn tires and loose wheel lug nuts.

***At least once a year:***

- Clean body and door drain holes.
- Lubricate door hinges and checks, and hood hinges.
- Lubricate door and hood locks and latches.
- Lubricate door rubber weatherstrips.
- Check the air conditioning system.
- Inspect and lubricate automatic transaxle linkage and controls.
- Clean battery and terminals.
- Check the brake fluid level.



### **SCHEDULED MAINTENANCE SERVICE**

Follow Normal Maintenance Schedule if the vehicle is usually operated where none of the following conditions apply. If any of the following conditions apply, follow Maintenance Under Severe Usage Conditions.

- Repeated short distance driving.
- Driving in dusty conditions or sandy areas.
- Extensive use of brakes.
- Driving in areas where salt or other corrosive materials are being used.
- Driving on rough or muddy roads.
- Driving in mountainous areas.
- Extended periods of idling or low speed operation.
- Driving for a prolonged period in cold temperatures and/or extremely humid climates.
- More than 50% driving in heavy city traffic during hot weather above 90°F (32°C).

*If your vehicle is operated under the above conditions, you should inspect, replace or refill more frequently than the following Normal Maintenance Schedule. After the periods or distance shown in the chart, continue to follow the prescribed maintenance intervals.*

## NORMAL MAINTENANCE SCHEDULE

The following maintenance services must be performed to ensure good emission control and performance. Keep receipts for all vehicle emission services to protect your warranty. Where both mileage and time are shown, the frequency of service is determined by whichever occurs first.

### 7,500 miles (12,000 km) or 6 months

- Rotate tire
- Inspect battery condition
- Inspect air cleaner filter
- Inspect vacuum hose
- Replace engine oil and filter  
(7,500 miles (12,000 km) or 12 months)
- Add fuel additive \*<sup>1</sup> (7,500 miles (12,000 km) or 12 months)

### 15,000 miles (24,000 km) or 12 months

- Rotate tire
- Inspect battery condition
- Inspect air cleaner filter
- Inspect vacuum hose
- Inspect air conditioning refrigerant
- Inspect brake hoses and lines
- Inspect drive shafts and boots
- Inspect exhaust pipe and muffler
- Inspect front brake disc/pads, calipers
- Inspect rear brake disc/pads
- Inspect steering gear box, linkage & boots/lower arm ball joint, upper arm ball joint

(Continued)

(Continued)

- Inspect suspension mounting bolts
- Replace climate control air filter (for evaporator and blower unit)
- Replace engine oil and filter  
(15,000 miles (24,000 km) or 24 months)
- Add fuel additive \*<sup>1</sup>  
(15,000 miles (24,000 km) or 24 months)

### 22,500 miles (36,000 km) or 18 months

- Rotate tire
- Inspect battery condition
- Inspect air cleaner filter
- Inspect vacuum hose
- Replace engine oil and filter  
(22,500 miles (36,000 km) or 36 months)
- Add fuel additive \*<sup>1</sup>  
(22,500 miles (36,000 km) or 36 months)

\*<sup>1</sup> : If TOP TIER Detergent Gasoline is not available, one bottle of additive is recommended. Additives are available from your authorized HYUNDAI dealer along with information on how to use them. Do not mix other additives.

\* Inspect : Inspect and if necessary, adjust, correct, clean or replace.

## NORMAL MAINTENANCE SCHEDULE (CONT.)

### 30,000 miles (48,000 km) or 24 months

- Rotate tire
- Inspect battery condition
- Inspect vacuum hose
- Inspect air conditioning refrigerant
- Inspect brake hoses and lines
- Inspect exhaust pipe and muffler
- Inspect front brake disc/pads, calipers
- Inspect rear brake disc/pads
- Inspect steering gear box, linkage & boots/lower arm ball joint, upper arm ball joint
- Inspect suspension mounting bolts
- Inspect brake fluid
- Inspect fuel filter \*<sup>1</sup>
- Inspect fuel lines, fuel hoses and connections
- Inspect fuel tank air filter \*<sup>1</sup>
- Inspect parking brake
- Inspect vapor hose and fuel filler cap
- Replace climate control air filter (for evaporator and blower unit)
- Replace air cleaner filter
- Replace engine oil and filter  
(30,000 miles (48,000 km) or 48 months)
- Add fuel additive \*<sup>2</sup>  
(30,000 miles (48,000 km) or 48 months)

### 37,500 miles (60,000 km) or 30 months

- Rotate tire
- Inspect battery condition
- Inspect air cleaner filter
- Inspect vacuum hose
- Replace engine oil and filter  
(37,500 miles (60,000 km) or 60 months)
- Add fuel additive \*<sup>2</sup>  
(37,500 miles (60,000 km) or 60 months)

\*<sup>1</sup> : Fuel filter & Fuel tank air filter are considered to be maintenance free but periodic inspection is recommended for this maintenance schedule depends on fuel quality. If there are some important safety matters like fuel flow restriction, surging, loss of power, hard starting problem etc, replace the fuel filter immediately regardless of maintenance schedule and consult an authorized HYUNDAI dealer for details.

\*<sup>2</sup> : If TOP TIER Detergent Gasoline is not available, one bottle of additive is recommended. Additives are available from your authorized HYUNDAI dealer along with information on how to use them. Do not mix other additives.

※ Inspect : Inspect and if necessary, adjust, correct, clean or replace.

**NORMAL MAINTENANCE SCHEDULE (CONT.)****45,000 miles (72,000 km) or 36 months**

- Rotate tire
- Inspect battery condition
- Inspect air cleaner filter
- Inspect vacuum hose
- Inspect air conditioning refrigerant
- Inspect brake hoses and lines
- Inspect drive shafts and boots
- Inspect exhaust pipe and muffler
- Inspect front brake disc/pads, calipers
- Inspect rear brake disc/pads
- Inspect steering gear box, linkage & boots/lower arm ball joint, upper arm ball joint
- Inspect suspension mounting bolts
- Replace climate control air filter (for evaporator and blower unit)
- Replace engine oil and filter  
(45,000 miles (72,000 km) or 72 months)
- Add fuel additive \*<sup>1</sup>  
(45,000 miles (72,000 km) or 72 months)

**52,500 miles (84,000 km) or 42 months**

- Rotate tire
- Inspect battery condition
- Inspect air cleaner filter
- Inspect vacuum hose
- Replace engine oil and filter  
(52,500 miles (84,000 km) or 84 months)
- Add fuel additive \*<sup>1</sup>  
(52,500 miles (84,000 km) or 84 months)

\*<sup>1</sup> : If TOP TIER Detergent Gasoline is not available, one bottle of additive is recommended. Additives are available from your authorized HYUNDAI dealer along with information on how to use them. Do not mix other additives.

\* Inspect : Inspect and if necessary, adjust, correct, clean or replace.

## NORMAL MAINTENANCE SCHEDULE (CONT.)

### 60,000 miles (96,000 km) or 48 months

- Rotate tire
- Inspect battery condition
- Inspect vacuum hose
- Inspect air conditioning refrigerant
- Inspect brake hoses and lines
- Inspect exhaust pipe and muffler
- Inspect front brake disc/pads, calipers
- Inspect rear brake disc/pads
- Inspect steering gear box, linkage & boots/lower arm ball joint, upper arm ball joint
- Inspect suspension mounting bolts
- Inspect brake fluid
- Inspect fuel filter<sup>\*1</sup>
- Inspect fuel lines, fuel hoses and connections
- Inspect fuel tank air filter (if equipped)<sup>\*1</sup>
- Inspect parking brake
- Inspect valve clearance<sup>\*3</sup>  
(Every 60,000 miles (96,000 km) or 72 months)
- Inspect vapor hose and fuel filler cap
- Inspect drive belts<sup>\*2</sup>  
(First, 60,000 miles (96,000 km) or 72 months after that, every 15,000 miles (24,000 km) or 24 months)
- Replace climate control air filter (for evaporator and blower unit)
- Replace air cleaner filter

(Continued)

(Continued)

- Replace engine oil and filter  
(60,000 miles (96,000 km) or 96 months)
- Add fuel additive<sup>\*4</sup>  
(60,000 miles (96,000 km) or 96 months)

### 67,500 miles (108,000 km) or 54 months

- Rotate tire
- Inspect battery condition
- Inspect air cleaner filter
- Inspect vacuum hose
- Replace engine oil and filter  
(67,500 miles (108,000 km) or 108 months)
- Add fuel additive<sup>\*4</sup> (67,500 miles (108,000 km) or 108 months)

<sup>\*1</sup> : Fuel filter & Fuel tank air filter are considered to be maintenance free but periodic inspection is recommended for this maintenance schedule depends on fuel quality. If there are some important safety matters like fuel flow restriction, surging, loss of power, hard starting problem etc, replace the fuel filter immediately regardless of maintenance schedule and consult an authorized HYUNDAI dealer for details.

<sup>\*2</sup> : The drive belt should be replaced when cracks occur or tension is reduced excessively.

<sup>\*3</sup> : Inspect for excessive tappet noise and/or engine vibration and adjust if necessary.

<sup>\*4</sup> : If TOP TIER Detergent Gasoline is not available, one bottle of additive is recommended. Additives are available from your authorized HYUNDAI dealer along with information on how to use them. Do not mix other additives.

※ Inspect : Inspect and if necessary, adjust, correct, clean or replace.

**NORMAL MAINTENANCE SCHEDULE (CONT.)****75,000 miles (120,000 km) or 60 months**

- Rotate tire
- Inspect battery condition
- Inspect air cleaner filter
- Inspect vacuum hose
- Inspect air conditioning refrigerant
- Inspect brake hoses and lines
- Inspect drive shafts and boots
- Inspect exhaust pipe and muffler
- Inspect front brake disc/pads, calipers
- Inspect rear brake disc/pads
- Inspect steering gear box, linkage & boots/lower arm ball joint, upper arm ball joint
- Inspect suspension mounting bolts
- Inspect drive belts \*<sup>1</sup>  
(First, 60,000 miles (96,000 km) or 72 months after that, every 15,000 miles (24,000 km) or 24 months)
- Replace climate control air filter (for evaporator and blower unit)
- Replace engine oil and filter  
(75,000 miles (120,000 km) or 120 months)
- Add fuel additive \*<sup>2</sup>  
(75,000 miles (120,000 km) or 120 months)

**82,500 miles (132,000 km) or 66 months**

- Rotate tire
- Inspect battery condition
- Inspect air cleaner filter
- Inspect vacuum hose
- Replace engine oil and filter  
(82,500 miles (132,000 km) or 132 months)
- Add fuel additive \*<sup>2</sup>  
(82,500 miles (132,000 km) or 132 months)

\*<sup>1</sup> : The drive belt should be replaced when cracks occur or tension is reduced excessively.

\*<sup>2</sup> : If TOP TIER Detergent Gasoline is not available, one bottle of additive is recommended. Additives are available from your authorized HYUNDAI dealer along with information on how to use them. Do not mix other additives.

\* : Inspect : Inspect and if necessary, adjust, correct, clean or replace.

## NORMAL MAINTENANCE SCHEDULE (CONT.)

### 90,000 miles (144,000 km) or 72 months

- Rotate tire
- Inspect battery condition
- Inspect vacuum hose
- Inspect air conditioning refrigerant
- Inspect brake hoses and lines
- Inspect exhaust pipe and muffler
- Inspect front brake disc/pads, calipers
- Inspect rear brake disc/pads
- Inspect steering gear box, linkage & boots/lower arm ball joint, upper arm ball joint
- Inspect suspension mounting bolts
- Inspect brake fluid
- Inspect fuel filter \*<sup>1</sup>
- Inspect fuel lines, fuel hoses and connections
- Inspect fuel tank air filter \*<sup>1</sup>
- Inspect parking brake
- Inspect vapor hose and fuel filler cap
- Inspect drive belts \*<sup>2</sup>  
(First, 60,000 miles (96,000 km) or 72 months after that, every 15,000 miles (24,000 km) or 24 months)
- Replace climate control air filter (for evaporator and blower unit)
- Replace air cleaner filter

(Continued)

(Continued)

- Replace engine oil and filter  
(90,000 miles (144,000 km) or 144 months)
- Add fuel additive \*<sup>3</sup>  
(90,000 miles (144,000 km) or 144 months)

### 97,500 miles (156,000 km) or 78 months

- Rotate tire
- Inspect battery condition
- Inspect air cleaner filter
- Inspect vacuum hose
- Replace spark plugs (iridium coated)
- Replace engine oil and filter  
(97,500 miles (156,000 km) or 156 months)
- Add fuel additive \*<sup>3</sup> (97,500 miles (156,000 km) or 156 months)

\*<sup>1</sup> : Fuel filter & Fuel tank air filter are considered to be maintenance free but periodic inspection is recommended for this maintenance schedule depends on fuel quality. If there are some important safety matters like fuel flow restriction, surging, loss of power, hard starting problem etc, replace the fuel filter immediately regardless of maintenance schedule and consult an authorized HYUNDAI dealer for details.

\*<sup>2</sup> : The drive belt should be replaced when cracks occur or tension is reduced excessively.

\*<sup>3</sup> : If TOP TIER Detergent Gasoline is not available, one bottle of additive is recommended. Additives are available from your authorized HYUNDAI dealer along with information on how to use them. Do not mix other additives.

※ Inspect : Inspect and if necessary, adjust, correct, clean or replace.

**NORMAL MAINTENANCE SCHEDULE (CONT.)****105,000 miles (168,000 km) or 84 months**

- Rotate tire
- Inspect battery condition
- Inspect air cleaner filter
- Inspect vacuum hose
- Inspect air conditioning refrigerant
- Inspect brake hoses and lines
- Inspect drive shafts and boots
- Inspect exhaust pipe and muffler
- Inspect front brake disc/pads, calipers
- Inspect rear brake disc/pads
- Inspect steering gear box, linkage & boots/lower arm ball joint, upper arm ball joint
- Inspect suspension mounting bolts
- Inspect drive belts \*<sup>1</sup>  
(First, 60,000 miles (96,000 km) or 72 months after that, every 15,000 miles (24,000 km) or 24 months)
- Replace climate control air filter (for evaporator and blower unit)
- Replace engine oil and filter  
(105,000 miles (168,000 km) or 168 months)
- Add fuel additive \*<sup>2</sup>  
(105,000 miles (168,000 km) or 168 months)

**112,500 miles (180,000 km) or 90 months**

- Rotate tire
- Inspect battery condition
- Inspect air cleaner filter
- Inspect vacuum hose
- Replace engine oil and filter  
(112,500 miles (180,000 km) or 180 months)
- Add fuel additive \*<sup>2</sup>  
(112,500 miles (180,000 km) or 180 months)

\*<sup>1</sup> : The drive belt should be replaced when cracks occur or tension is reduced excessively.

\*<sup>2</sup> : If TOP TIER Detergent Gasoline is not available, one bottle of additive is recommended. Additives are available from your authorized HYUNDAI dealer along with information on how to use them. Do not mix other additives.

\* : Inspect : Inspect and if necessary, adjust, correct, clean or replace.



## NORMAL MAINTENANCE SCHEDULE (CONT.)

### 120,000 miles (192,000 km) or 96 months

- Rotate tire
- Inspect battery condition
- Inspect vacuum hose
- Inspect air conditioning refrigerant
- Inspect brake hoses and lines
- Inspect exhaust pipe and muffler
- Inspect front brake disc/pads, calipers
- Inspect rear brake disc/pads
- Inspect steering gear box, linkage & boots/lower arm ball joint, upper arm ball joint
- Inspect suspension mounting bolts
- Inspect brake fluid
- Inspect fuel filter \*<sup>1</sup>
- Inspect fuel lines, fuel hoses and connections
- Inspect fuel tank air filter \*<sup>1</sup>
- Inspect parking brake
- Inspect valve clearance \*<sup>3</sup>  
(Every 60,000 miles (96,000 km) or 72 months)
- Inspect vapor hose and fuel filler cap
- Inspect drive belts \*<sup>2</sup>  
(First, 60,000 miles (96,000 km) or 72 months after that, every 15,000 miles (24,000 km) or 24 months)

(Continued)

(Continued)

- Replace climate control air filter  
(for evaporator and blower unit)
- Replace air cleaner filter
- Replace engine oil and filter  
(120,000 miles (192,000 km) or 192 months)
- Replace coolant  
(First, 120,000 miles (192,000 km) or 120 months after that, every 30,000 miles (48,000 km) or 24 months)
- Add fuel additive \*<sup>4</sup>  
(120,000 miles (192,000 km) or 192 months)

\*<sup>1</sup> : Fuel filter & Fuel tank air filter are considered to be maintenance free but periodic inspection is recommended for this maintenance schedule depends on fuel quality. If there are some important safety matters like fuel flow restriction, surging, loss of power, hard starting problem etc, replace the fuel filter immediately regardless of maintenance schedule and consult an authorized HYUNDAI dealer for details.

\*<sup>2</sup> : The drive belt should be replaced when cracks occur or tension is reduced excessively.

\*<sup>3</sup> : Inspect for excessive tappet noise and/or engine vibration and adjust if necessary.

\*<sup>4</sup> : If TOP TIER Detergent Gasoline is not available, one bottle of additive is recommended. Additives are available from your authorized HYUNDAI dealer along with information on how to use them. Do not mix other additives.

\* Inspect : Inspect and if necessary, adjust, correct, clean or replace.

**NORMAL MAINTENANCE SCHEDULE (CONT.)****127,500 miles (204,000 km) or 102 months**

- Rotate tire
- Inspect battery condition
- Inspect air cleaner filter
- Inspect vacuum hose
- Replace engine oil and filter  
(127,500 miles (204,000 km) or 204 months)
- Add fuel additive \*<sup>2</sup>  
(127,500 miles (204,000 km) or 204 months)

**135,000 miles (216,000 km) or 108 months**

- Rotate tire
- Inspect battery condition
- Inspect air cleaner filter
- Inspect vacuum hose
- Inspect air conditioning refrigerant
- Inspect brake hoses and lines
- Inspect drive shafts and boots
- Inspect exhaust pipe and muffler
- Inspect front brake disc/pads, calipers
- Inspect rear brake disc/pads
- Inspect steering gear box, linkage &  
boots/lower arm ball joint, upper arm ball joint
- Inspect suspension mounting bolts

(Continued)

(Continued)

- Inspect drive belts \*<sup>1</sup>  
(First, 60,000 miles (96,000 km) or 72 months after that,  
every 15,000 miles (24,000 km) or 24 months)
- Replace climate control air filter (for evaporator and blower unit)
- Replace engine oil and filter  
(135,000 miles (216,000 km) or 216 months)
- Add fuel additive \*<sup>2</sup>  
(135,000 miles (216,000 km) or 216 months)

**142,500 miles (228,000 km) or 114 months**

- Rotate tire
- Inspect battery condition
- Inspect air cleaner filter
- Inspect vacuum hose
- Replace engine oil and filter  
(142,500 miles (228,000 km) or 228 months)
- Add fuel additive \*<sup>3</sup>  
(142,500 miles (228,000 km) or 228 months)

\*<sup>1</sup> : The drive belt should be replaced when cracks occur or tension is reduced excessively.

\*<sup>2</sup> : If TOP TIER Detergent Gasoline is not available, one bottle of additive is recommended. Additives are available from your authorized HYUNDAI dealer along with information on how to use them. Do not mix other additives.

\*<sup>3</sup> Inspect : Inspect and if necessary, adjust, correct, clean or replace.

## NORMAL MAINTENANCE SCHEDULE (CONT.)

### 150,000 miles (240,000 km) or 120 months

- Rotate tire
- Inspect battery condition
- Inspect vacuum hose
- Inspect air conditioning refrigerant
- Inspect brake hoses and lines
- Inspect exhaust pipe and muffler
- Inspect front brake disc/pads, calipers
- Inspect rear brake disc/pads
- Inspect steering gear box, linkage & boots/lower arm ball joint, upper arm ball joint
- Inspect suspension mounting bolts
- Inspect brake fluid
- Inspect fuel filter \*<sup>1</sup>
- Inspect fuel lines, fuel hoses and connections
- Inspect fuel tank air filter \*<sup>1</sup>
- Inspect parking brake
- Inspect vapor hose and fuel filler cap
- Inspect drive belts \*<sup>2</sup>  
(First, 60,000 miles (96,000 km) or 72 months after that,  
every 15,000 miles (24,000 km) or 24 months)

(Continued)

(Continued)

- Replace climate control air filter (for evaporator and blower unit)
- Replace air cleaner filter
- Replace engine oil and filter  
(150,000 miles (240,000 km) or 240 months)
- Replace coolant  
(First, 120,000 miles (192,000 km) or 120 months after that,  
every 30,000 miles (48,000 km) or 24 months)
- Add fuel additive \*<sup>3</sup>  
(150,000 miles (240,000 km) or 240 months)

### No check, No service required

- Automatic transaxle fluid

\*<sup>1</sup> : Fuel filter & Fuel tank air filter are considered to be maintenance free but periodic inspection is recommended for this maintenance schedule depends on fuel quality. If there are some important safety matters like fuel flow restriction, surging, loss of power, hard starting problem etc, replace the fuel filter immediately regardless of maintenance schedule and consult an authorized HYUNDAI dealer for details.

\*<sup>2</sup> : The drive belt should be replaced when cracks occur or tension is reduced excessively.

\*<sup>3</sup> : If TOP TIER Detergent Gasoline is not available, one bottle of additive is recommended. Additives are available from your authorized HYUNDAI dealer along with information on how to use them. Do not mix other additives.

\* Inspect : Inspect and if necessary, adjust, correct, clean or replace.

## MAINTENANCE UNDER SEVERE USAGE CONDITIONS

The following items must be serviced more frequently on cars normally used under severe driving conditions. Refer to the chart below for the appropriate maintenance intervals.

R : Replace      I : Inspect and, after inspection, clean, adjust, repair or replace if necessary

MAINTENANCE ITEM	MAINTENANCE OPERATION	MAINTENANCE INTERVALS	DRIVING CONDITION
ENGINE OIL AND FILTER	R	EVERY 3,750 MILES (6,000 KM) OR 6 MONTHS	A, B, C, D, E, F, G, H, I, J, K
AIR CLEANER FILTER	R	MORE FREQUENTLY	C, E
SPARK PLUGS	R	MORE FREQUENTLY	A, B, H, I, K
AUTOMATIC TRANSAXLE FLUID	R	EVERY 60,000 MILES (96,000 KM)	A, C, E, F, G, I
FRONT BRAKE DISC/PADS AND CALIPERS	I	MORE FREQUENTLY	C, D, G, H
REAR BRAKE DISC/PADS	I	MORE FREQUENTLY	C, D, G, F
PARKING BRAKE	I	MORE FREQUENTLY	C, D, G, H
STEERING GEAR BOX, LINKAGE & BOOTS/LOWER ARM BALL JOINT AND UPPER ARM BALL JOINT	I	MORE FREQUENTLY	C, D, E, F, G, H, I
DRIVE SHAFTS AND BOOTS	I	EVERY 7,500 MILES (12,000 KM) OR 6 MONTHS	C, D, E, F, G, H, I
CLIMATE CONTROL AIR FILTER (FOR EVAPORATOR AND BLOWER UNIT)	R	MORE FREQUENTLY	C, E

### SEVERE DRIVING CONDITIONS

- A - Repeatedly driving short distance of less than 5 miles (8 km) in normal temperature or less than 10 miles (16 km) in freezing temperature
- B - Extensive engine idling or low speed driving for long distances
- C - Driving on rough, dusty, muddy, unpaved, graveled or salt- spread roads
- D - Driving in areas using salt or other corrosive materials or in very cold weather

- E - Driving in sandy areas
- F - Driving in heavy traffic area over 90°F (32°C)
- G - Driving on uphill, downhill, or mountain road
- H - Towing a Trailer, or using a camper, or roof rack
- I - Driving as a patrol car, taxi, other commercial use or vehicle towing
- J - Driving over 106 mph (170 km/h)
- K - Frequently driving in stop-and-go conditions

### EXPLANATION OF SCHEDULED MAINTENANCE ITEMS

#### Engine oil and filter

The engine oil and filter should be changed at the intervals specified in the maintenance schedule. If the car is being driven in severe conditions, more frequent oil and filter changes are required.

#### Drive belts

Inspect all drive belts for evidence of cuts, cracks, excessive wear or oil saturation and replace if necessary.

#### Fuel filter

A clogged filter can limit the speed at which the vehicle may be driven, damage the emission system and cause multiple issues such as hard starting. If an excessive amount of foreign matter accumulates in the fuel tank, the filter may require replacement more frequently.

After installing a new filter, run the engine for several minutes, and check for leaks at the connections. Fuel filters should be installed by an authorized HYUNDAI dealer.

#### Fuel lines, fuel hoses and connections

Check the fuel lines, fuel hoses and connections for leakage and damage. Have an authorized HYUNDAI dealer replace any damaged or leaking parts immediately.

#### Vapor hose and fuel filler cap

The vapor hose and fuel filler cap should be inspected at those intervals specified in the maintenance schedule. Make sure that a new vapor hose or fuel filler cap is correctly replaced.

#### Vacuum crankcase ventilation hoses

Inspect the surface of hoses for evidence of heat and/or mechanical damage. Hard and brittle rubber, cracking, tears, cuts, abrasions, and excessive swelling indicate deterioration. Particular attention should be paid to examine those hose surfaces nearest to high heat sources, such as the exhaust manifold.

Inspect the hose routing to assure that the hoses do not come in contact with any heat source, sharp edges or moving component which might cause heat damage or mechanical wear. Inspect all hose connections, such as clamps and couplings, to make sure they are secure, and that no leaks are present. Hoses should be replaced immediately if there is any evidence of deterioration or damage.

### **Air cleaner filter**

A Genuine HYUNDAI air cleaner filter is recommended when the filter is replaced.

### **Spark plugs**

Make sure to install new spark plugs of the correct heat range.

### **Valve clearance**

Inspect excessive valve noise and/or engine vibration and adjust if necessary. An authorized HYUNDAI dealer should perform the operation.

### **Cooling system**

Check cooling system components, such as radiator, coolant reservoir, hoses and connections for leakage and damage. Replace any damaged parts.

### **Coolant**

The coolant should be changed at the intervals specified in the maintenance schedule.

### **Automatic transaxle fluid**

Automatic transaxle fluid does not need to be checked under normal usage conditions.

But in severe conditions, the fluid should be changed at an authorized HYUNDAI dealer in accordance to the scheduled maintenance at the beginning of this chapter.

### **\* NOTICE**

**Automatic transaxle fluid color is basically red.**

**As the vehicle is driven, the automatic transaxle fluid will begin to look darker.**

**This a normal condition and you should not judge the need to replace the fluid based upon the changed color.**

The use of a non-specified fluid could result in transaxle malfunction and failure.

Use only specified automatic transaxle fluid. (Refer to "Recommended lubricants and capacities" in section 8.)

### **Brake hoses and lines**

Visually check for proper installation, chafing, cracks, deterioration and any leakage. Replace any deteriorated or damaged parts immediately.

### **Brake fluid**

Check brake fluid level in the brake fluid reservoir. The level should be between “MIN” and “MAX” marks on the side of the reservoir. Use only hydraulic brake fluid conforming to DOT 3 or DOT 4 specification.

### **Parking brake**

Inspect the parking brake system including the parking brake pedal or lever and cables.

### **Brake discs, pads, calipers and rotors**

Check the pads for excessive wear, discs for run out and wear, and calipers for fluid leakage.

### **Suspension mounting bolts**

Check the suspension connections for looseness or damage. Retighten to the specified torque.

### **Steering gear box, linkage & boots/lower arm ball joint**

With the vehicle stopped and engine off, check for excessive free-play in the steering wheel.

Check the linkage for bends or damage. Check the dust boots and ball joints for deterioration, cracks, or damage. Replace any damaged parts.

### **Exhaust pipe and muffler**

Visually inspect the exhaust pipes, muffler and hangers for cracks, deterioration, or damage. Start the engine and listen carefully for any exhaust gas leakage. Tighten connections or replace parts as necessary.

### **Drive shafts and boots**

Check the drive shafts, boots and clamps for cracks, deterioration, or damage. Replace any damaged parts and, if necessary, repack the grease.

### **Air conditioning refrigerant**

Check the air conditioning lines and connections for leakage and damage.

## ENGINE OIL

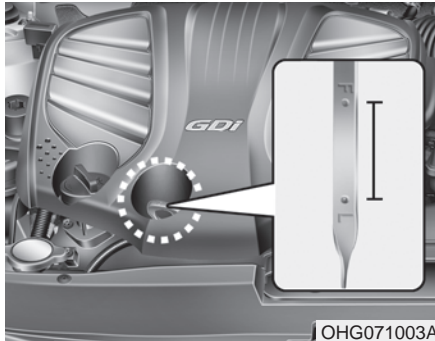

### Checking the engine oil level

1. Be sure the vehicle is on level ground.
2. Start the engine and allow it to reach normal operating temperature.
3. Turn the engine off and wait for a few minutes (about 5 minutes) for the oil to return to the oil pan.
4. Pull the dipstick out, wipe it clean, and re-insert it fully.
5. Pull the dipstick out again and check the level. The level should be between F (Full) and L (Low).

### **⚠ WARNING - Radiator hose**

Be very careful not to touch the radiator hose when checking or adding the engine oil as it may be hot enough to burn you.

### **⚠ CAUTION - When refilling engine oil**

*Do not overfill the engine oil. Engine damage may result.*

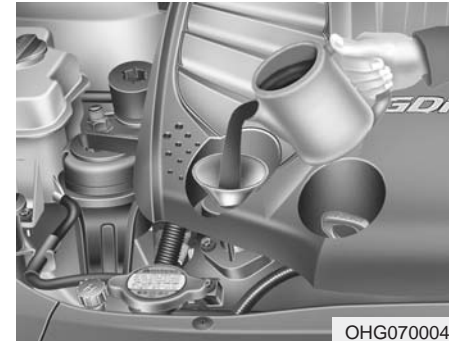

If it is near or at L (Low), add enough oil to bring the level to F (Full). **Do not overfill.**

**Use a funnel to help prevent oil from being spilled on engine components.**

*Use only the specified engine oil. (Refer to "Recommended lubricants and capacities" in section 8.)*





### Changing the engine oil and filter

Have engine oil and filter changed by an authorized HYUNDAI dealer according to the Maintenance Schedule at the beginning of this section.

#### **⚠ WARNING**

**- California proposition 65**

Engine oil contains chemicals known to the State of California to cause cancer, birth defects and reproductive harm. Used engine oil may cause irritation or cancer of the skin if left in contact with the skin for prolonged periods of time. Always protect your skin by washing your hands thoroughly with soap and warm water as soon as possible after handling used oil.

### ENGINE COOLANT

The high-pressure cooling system has a reservoir filled with year-round antifreeze coolant. The reservoir is filled at the factory.

Check the antifreeze protection and coolant level at least once a year, at the beginning of the winter season, and before traveling to a colder climate.

#### **⚠ WARNING - Cooling fan**



Use caution when working near the blade of the cooling fan. The electric motor (cooling fan) is controlled by engine coolant temperature, refrigerant pressure and vehicle speed. It may sometimes operate even when the engine is not running.

Your vehicle equipped with GDI, the electric motor (cooling fan) may operate until you disconnect the negative battery cable. Not heeding these warnings could result in serious injuries.

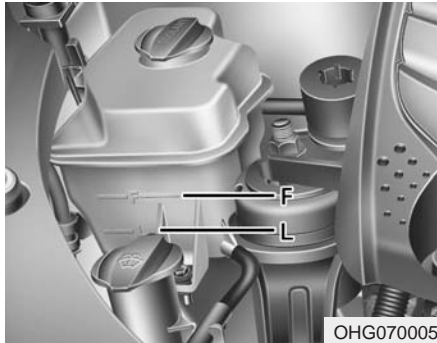

OHG070005

### Checking the coolant level

Check the condition and connections of all cooling system hoses and heater hoses. Replace any swollen or deteriorated hoses.

The coolant level should be filled between F (Full) and L (Low) marks on the side of the coolant reservoir when the engine is cool.

If the coolant level is low, add enough specified coolant to provide protection against freezing and corrosion. Bring the level to F (Full), but do not overfill. If frequent additions are required, see an authorized HYUNDAI dealer for a cooling system inspection.

### Recommended engine coolant

- When adding coolant, use only deionized water or soft water for your vehicle and never mix hard water in the coolant filled at the factory. An improper coolant mixture can result in serious malfunction or engine damage.
- The engine in your vehicle has aluminum engine parts and must be protected by an ethylene-glycol-based coolant to prevent corrosion and freezing.
- DO NOT USE alcohol or methanol coolant or mix them with the specified coolant.
- Do not use a solution that contains more than 60% antifreeze or less than 35% antifreeze, which would reduce the effectiveness of the solution.

For mixture percentage, refer to the following table.

Ambient Temperature	Mixture Percentage (volume)	
	Antifreeze	Water
5°F (-15°C)	35	65
-13°F (-25°C)	40	60
-31°F (-35°C)	50	50
-49°F (-45°C)	60	40

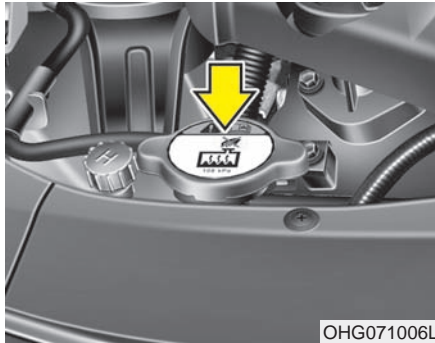

OHG071006L

**⚠ WARNING - Radiator cap**



**Do not remove the radiator cap when the engine and radiator are hot. Scalding hot coolant and steam may blow out under pressure causing serious injury.**

**⚠ CAUTION - Removing radiator cap**



***Never attempt to remove the radiator cap while the engine is operating or hot. Doing so might lead to cooling system and engine damage.***

### Changing the coolant

Have the coolant changed by an authorized HYUNDAI dealer according to the Maintenance Schedule at the beginning of this section.

Put a thick cloth around the radiator cap before refilling the coolant in order to prevent the coolant from overflowing into engine parts such as the alternator.

Turn the engine off and wait until it cools down. Use extreme care when removing the radiator cap. Wrap a thick towel around it, and turn it counterclockwise slowly to the first stop. Step back while the pressure is released from the cooling system. When you are sure all the pressure has been released, press down on the cap, using a thick towel, and continue turning counterclockwise to remove it.

## BRAKE FLUID

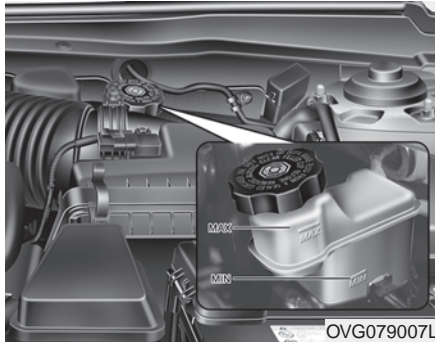

### Checking the brake fluid level

Check the fluid level in the reservoir periodically. The fluid level should be between MAX (Maximum) and MIN (Minimum) marks on the side of the reservoir.

Before removing the reservoir cap and adding brake fluid, clean the area around the reservoir cap thoroughly to prevent brake fluid contamination.

**⚠ CAUTION - Proper fluid**  
*Only use brake fluid in brake system. Small amounts of improper fluids (such as engine oil) can cause damage to the brake system.*

If the level is low, add fluid to the MAX (Maximum) level. The level will fall with accumulated mileage. This is a normal condition associated with the wear of brake linings. If the fluid level is excessively low, have the brake system checked by an authorized HYUNDAI dealer.

*Use only the specified brake fluid. (Refer to "Recommended lubricants or capacities" in section 8.)*

*Never mix different types of fluid.*

In the event the brake system requires frequent additions of fluid, the vehicle should be inspected by an authorized HYUNDAI dealer.

**⚠ WARNING - Brake fluid**  
**When changing and adding brake fluid, handle it carefully. Do not let it come in contact with your eyes. If brake fluid should come in contact with your eyes, immediately flush them with a large quantity of fresh tap water. Have your eyes examined by a doctor as soon as possible.**

**⚠ CAUTION - Brake fluid**  
**Do not allow brake fluid to contact the vehicle's body paint, as paint damage will result.**

Brake fluid, which has been exposed to open air for an extended time should never be used as its quality cannot be guaranteed. It should be disposed of properly.

## WASHER FLUID

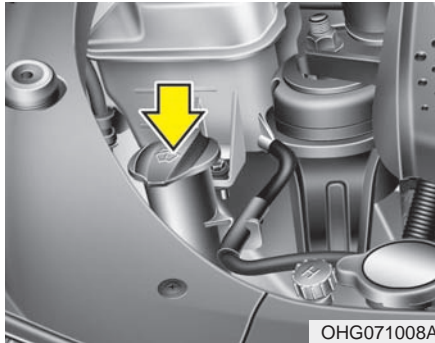

### Checking the washer fluid level

Check the fluid level in the washer fluid reservoir and add fluid if necessary. Plain water may be used if washer fluid is not available. However, use washer solvent with antifreeze characteristics in cold climates to prevent freezing.

#### **⚠ WARNING - Coolant**

- Do not use radiator coolant or antifreeze in the washer fluid reservoir.
- Radiator coolant can severely obscure visibility when sprayed on the windshield and may cause loss of vehicle control or damage to paint and body trim.

#### **⚠ WARNING - Windshield fluid**

**Do not drink the windshield washer fluid. The windshield washer fluid is poisonous to humans and animals.**

#### **⚠ WARNING - Flammable fluid**

**Do not allow the washer fluid to come in contact with open flames or sparks. The windshield washer fluid is flammable under certain circumstances. This can result in a fire which could result in serious injuries.**

## PARKING BRAKE

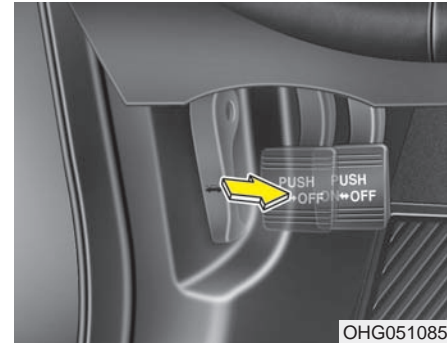

### Checking the parking brake

Check the stroke of the parking brake by counting the number of “clicks” heard while fully applying it from the released position. Also, the parking brake alone should securely hold the vehicle on a fairly steep grade.

If the stroke is more or less than specified, have the parking brake adjusted by an authorized HYUNDAI dealer.

**Stroke : 5 “clicks” at a force of 66 lbs (30 kg, 294 N).**

## AIR CLEANER

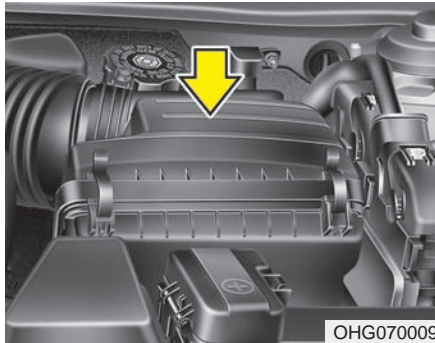

### Filter replacement

It must be replaced when necessary, and should not be washed.

You can clean the filter when inspecting the air cleaner element.

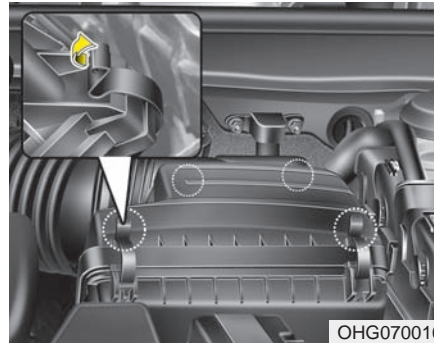

1. Loosen the air cleaner cover attaching clips and open the cover.

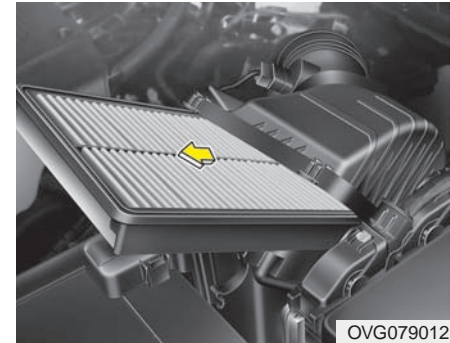

2. Wipe the inside of the air cleaner cover and the air box.
3. Replace the air cleaner filter.
4. Lock the cover with the cover attaching clips.

Replace the filter according to the Maintenance Schedule.

*If the vehicle is operated in extremely dusty or sandy areas, replace the element more often than the usual recommended intervals. (Refer to "Maintenance under severe usage conditions" in this section.)*

**⚠ CAUTION - Air filter maintenance**

- *Do not drive with the air cleaner removed; this will result in excessive engine wear.*
- *When removing the air cleaner filter, be careful that dust or dirt does not enter the air intake, or damage may result.*
- *Use a HYUNDAI genuine part. Use of non-genuine parts could damage the air flow sensor.*

## CLIMATE CONTROL AIR FILTER

### Filter inspection

If the vehicle is operated in the severely air-polluted cities or on dusty rough roads for a long period, it should be inspected more frequently and replaced earlier. When you, the owner, replace the climate control air filter, replace it performing the following procedure, and be careful to avoid damaging other components.

Replace the filter according to the maintenance Schedule.

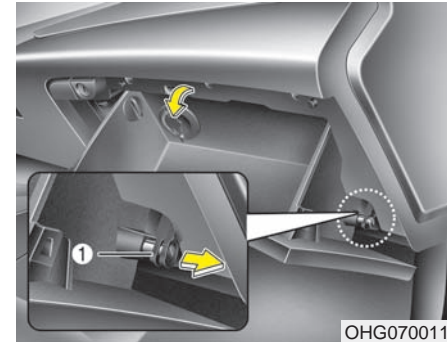

### Filter replacement

1. Open the glove box and remove the support strap (1).

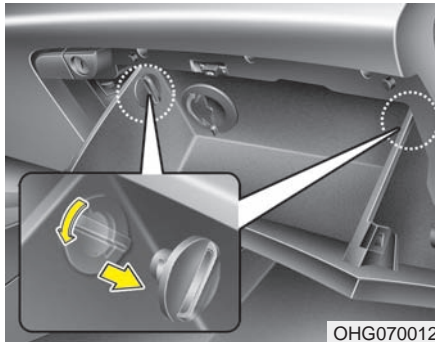

OHG070012

2. With the glove box open, remove the stoppers by turning them counterclockwise on both sides.

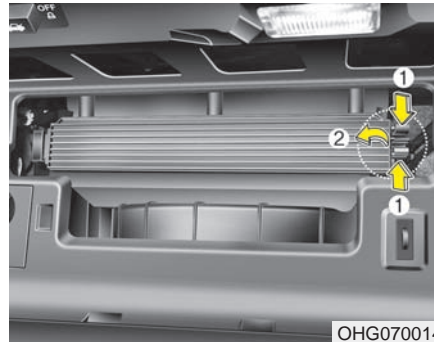

OHG070014

3. Remove the climate control air filter cover while pressing the lock on the right side of the cover.

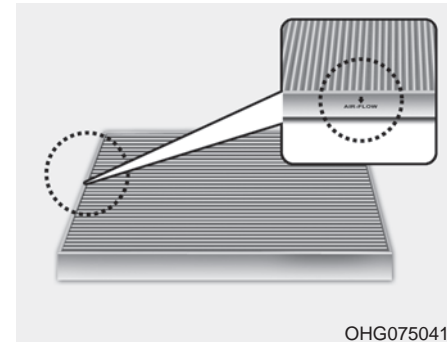

OHG075041

4. Replace the climate control air filter.  
5. Reassemble in the reverse order of disassembly.

**\* NOTICE**

Install a new climate control air filter in the correct direction with the arrow symbol (↓) facing downwards. Otherwise, the climate control effects may decrease, possibly with a noise.



## WIPER BLADES

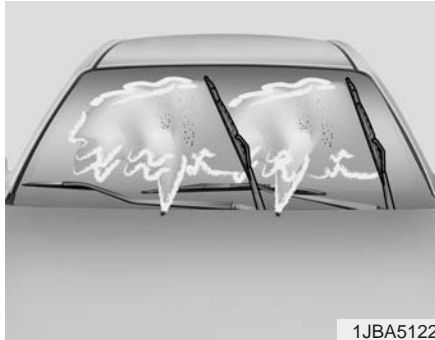

1JBA5122

### Blade inspection

Commercial hot waxes applied by automatic car washes have been known to make the windshield difficult to clean.

Contamination of either the windshield or the wiper blades with foreign matter can reduce the effectiveness of the windshield wipers. Common sources of contamination are insects, tree sap, and hot wax treatments used by some commercial car washes. If the blades are not wiping properly, clean both the window and the blades with a good cleaner or mild detergent, and rinse thoroughly with clean water

### CAUTION

*To prevent damage to the wiper blades, do not use gasoline, kerosene, paint thinner, or other solvents on or near them.*

### Blade replacement

When the wipers no longer clean adequately, the blades may be worn or cracked, and require replacement.

### CAUTION

- *To prevent damage to the wiper arms or other components, do not attempt to move the wipers manually.*
- *The use of a non-specified wiper blade could result in wiper malfunction and failure.*



OHM078059

**Front windshield wiper blade**

1. Raise the wiper arm.

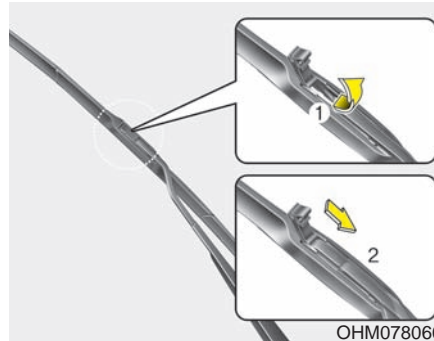

OHM078060

2. Lift up the wiper blade clip. Then pull down the blade assembly and remove it.

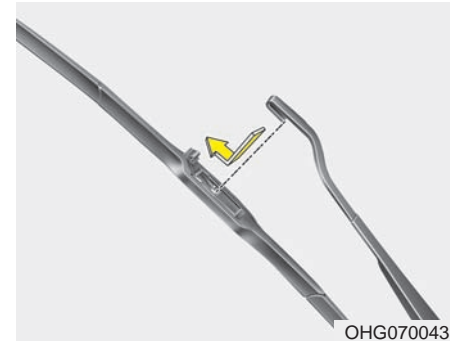

OHG070043

3. Install the new blade assembly in the reverse order of removal.

**⚠ CAUTION - Wiper arms**  
*Do not allow the wiper arm to fall against the windshield, since it may chip or crack the windshield.*



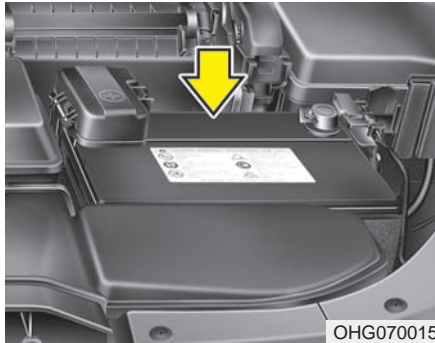

## BATTERY



### For best battery service

- Keep the battery securely mounted.
- Keep the battery top clean and dry.
- Keep the terminals and connections clean, tight, and coated with petroleum jelly or terminal grease.
- Rinse any spilled electrolyte from the battery immediately with a solution of water and baking soda.
- If the vehicle is not going to be used for an extended time, disconnect the battery cables.

### **⚠ WARNING - Battery dangers**

-  Always read the following instructions carefully when handling a battery.
-  Keep lighted cigarettes and all other flames or sparks away from the battery.
-  The battery contains hydrogen - a highly combustible gas, which will explode if it comes in contact with a flame or spark.
-  Keep batteries out of the reach of children because batteries contain highly corrosive **SULFURIC ACID** and electrolytes. Do not allow battery acid to contact your skin, eyes, clothing or paint finish.

(Continued)

### (Continued)



If any electrolyte gets into your eyes, flush your eyes with clean water for at least 15 minutes and get immediate medical attention. If electrolyte gets on your skin, thoroughly wash the contacted area. If you feel a pain or a burning sensation, get medical attention immediately.



Wear eye protection when charging or working near a battery. Always provide ventilation when working in an enclosed space.



An inappropriately disposed battery can be harmful to the environment and human health. Dispose the battery according to your local law(s) or regulation.

(Continued)

(Continued)



The battery contains lead. Do not dispose of it after use. Please return the battery to an authorized HYUNDAI dealer to be recycled.

- When lifting a plastic-cased battery, excessive pressure on the case may cause battery acid to leak, resulting in personal injury. Lift with a battery carrier or with your hands on opposite corners.
- Never attempt to recharge the battery when the battery cables are connected.
- The electrical ignition system works with high voltage. Never touch these components with the engine running or the ignition switched on.

Failure to follow the above warnings can result in serious bodily injury or death.

**⚠ WARNING - Recharging battery**

Never attempt to recharge the battery when the battery cables are connected. Some charging equipment can release a voltage spike that will damage vehicle electronics, resulting in thousands of dollars in required repair parts which are not covered by warranty if damaged by not following this warning.

When you don't use the vehicle for a long time in a low temperature area, separate the battery and keep it indoors.

**⚠ WARNING**

**- California proposition 65**

Battery posts, terminals, and related accessories contain lead and lead compounds, chemicals known to the State of California to cause cancer, birth defects and reproductive harm. Batteries also contain other chemicals known to the State of California to cause cancer. Wash hands after handling.

**⚠ WARNING - Risk of electrocution**

Never touch the electrical ignition system while the vehicle is running. This system works with high voltage which can "zap" you.

### Battery recharging

Your vehicle has a maintenance-free, calcium-based battery.

- If the battery becomes discharged in a short time (because, for example, the headlights or interior lights were left on while the vehicle was not in use), recharge it by slow charging (trickle) for 10 hours.
- If the battery gradually discharges because of high electric load while the vehicle is being used, recharge it at 20-30A for two hours.

When recharging the battery, observe the following precautions:

- The battery must be removed from the vehicle and placed in an area with good ventilation.
- Watch the battery during charging, and stop or reduce the charging rate if the battery cells begin gassing (boiling) violently or if the temperature of the electrolyte of any cell exceeds 120°F (49°C).
- Wear eye protection when checking the battery during charging.
- Disconnect the battery charger in the following order.
  1. Turn off the battery charger main switch.
  2. Unhook the negative clamp from the negative battery terminal.
  3. Unhook the positive clamp from the positive battery terminal.
- Before performing maintenance or recharging the battery, turn off all accessories and stop the engine.
- The negative battery cable must be removed first and installed last when the battery is disconnected.

### Reset items

Items should be reset after the battery has been discharged or the battery has been disconnected.

- Auto up/down window (See section 4)
- Sunroof (See section 4)
- Driver position memory system (See section 4)
- Trip computer (See section 4)
- Climate control system (See section 4)
- Clock (See section 4)
- Audio (See section 4)

## TIRES AND WHEELS

### Tire care

For proper maintenance, safety, and maximum fuel economy, you must always maintain recommended tire inflation pressures and stay within the load limits and weight distribution recommended for your vehicle.

### Recommended cold tire inflation pressures

All tire pressures (including the spare) should be checked when the tires are cold. "Cold Tires" means the vehicle has not been driven for at least three hours or driven less than 1 mile (1.6 km).

Recommended pressures must be maintained for the best ride, top vehicle handling, and minimum tire wear. For recommended inflation pressure, refer to "Tire and wheels" in section 8.

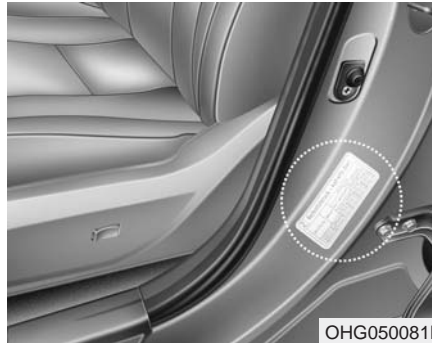

All specifications (sizes and pressures) can be found on a label attached to the vehicle.

### **⚠ WARNING - Tire under inflation**

**Inflate your tires consistent with the instructions provided in this manual. Severe underinflation can lead to severe heat build-up, causing blowouts, tread separation and other tire failures that can result in the loss of vehicle control leading to severe injury or death. This risk is much higher on hot days and when driving for long periods at high speeds.**

- Underinflation also results in excessive wear, poor handling and reduced fuel economy. Wheel deformation also is possible. Keep your tire pressures at the proper levels. If a tire frequently needs refilling, have it checked by an authorized HYUNDAI dealer.
- Overinflation produces a harsh ride, excessive wear at the center of the tire tread, and a greater possibility of damage from road hazards.
- Warm tires normally exceed recommended cold tire pressures by 4 to 6 psi (28 to 41 kPa). Do not release air from warm tires to adjust the pressure or the tires will be underinflated.
- Be sure to reinstall the tire inflation valve caps. Without the valve cap, dirt or moisture could get into the valve core and cause air leakage. If a valve cap is missing, install a new one as soon as possible.

**⚠ WARNING - Tire Inflation**  
**Overinflation or underinflation can reduce tire life, adversely affect vehicle handling, and lead to sudden tire failure. This could result in loss of vehicle control and potential injury.**

Always observe the following:

- Check tire pressure when the tires are cold. (After vehicle has been parked for at least three hours or has not been driven more than 1 mile (1.6 km) since startup.)
- Check the pressure of your spare tire each time you check the pressure of other tires.
- Never overload your vehicle. Be careful not to overload a vehicle luggage rack if your vehicle is equipped with one.
- Worn, old tires can cause accidents. If your tread is badly worn, or if your tires have been damaged, replace them.

### Checking tire inflation pressure

Check your tires once a month or more.

Also, check the tire pressure of the spare tire.

#### *How to check*

Use a good quality gage to check tire pressure. You can not tell if your tires are properly inflated simply by looking at them. Radial tires may look properly inflated even when they're underinflated.

Check the tire's inflation pressure when the tires are cold. - "Cold" means your vehicle has been sitting for at least three hours or driven no more than 1 mile (1.6 km).

Remove the valve cap from the tire valve stem. Press the tire gage firmly onto the valve to get a pressure measurement. If the cold tire inflation pressure matches the recommended pressure on the tire and loading information label, no further adjustment is necessary. If the pressure is low, add air until you reach the recommended amount.

If you overfill the tire, release air by pushing on the metal stem in the center of the tire valve. Recheck the tire pressure with the tire gage. Be sure to put the valve caps back on the valve stems. They help prevent leaks by keeping out dirt and moisture.

**⚠ WARNING**

- Inspect your tires frequently for proper inflation as well as wear and damage. Always use a tire pressure gauge.
- Tires with too much or too little pressure wear unevenly causing poor handling, loss of vehicle control, and sudden tire failure leading to accidents, injuries, and even death. The recommended cold tire pressure for your vehicle can be found in this manual and on the tire label located on the driver's side center pillar.
- Worn tires can cause accidents. Replace tires that are worn, show uneven wear, or are damaged.
- Remember to check the pressure of your spare tire. HYUNDAI recommends that you check the spare every time you check the pressure of the other tires on your vehicle.

**Tire rotation**

To equalize tread wear, it is recommended that the tires be rotated every 7,500 miles (12,000 km) or sooner if irregular wear develops.

During rotation, check the tires for correct balance.

When rotating tires, check for uneven wear and damage. Abnormal wear is usually caused by incorrect tire pressure, improper wheel alignment, out-of-balance wheels, severe braking or severe cornering. Look for bumps or bulges in the tread or side of tire. Replace the tire if you find either of these conditions. Replace the tire if fabric or cord is visible. After rotation, be sure to bring the front and rear tire pressures to specification and check lug nut tightness.

Refer to "Tire and wheels" in section 8.

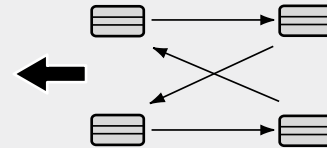
**■ Without a spare tire**

S2BLA790A

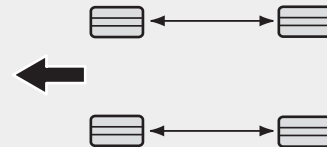
**■ Directional tires (if equipped)**

CBGQ0707A



*Disc brake pads should be inspected for wear whenever tires are rotated.*

Rotate radial tires that have an asymmetric tread pattern only from front to rear and not from right to left. Do not use the compact spare tire for tire rotation.

**⚠ WARNING - Mixing tire types**

**Do not mix bias ply and radial ply tires under any circumstances. This may cause unusual handling characteristics that could result in death, severe injury, or property damage.**

### **Wheel alignment and tire balance**

The wheels on your vehicle were aligned and balanced carefully at the factory to give you the longest tire life and best overall performance.

In most cases, you will not need to have your wheels aligned again. However, if you notice unusual tire wear or your vehicle pulling one way or the other, the alignment may need to be reset.

If you notice your vehicle vibrating when driving on a smooth road, your wheels may need to be rebalanced.

**⚠ CAUTION - Wheel weight**  
***Improper wheel weights can damage your vehicle's aluminum wheels. Use only approved wheel weights.***

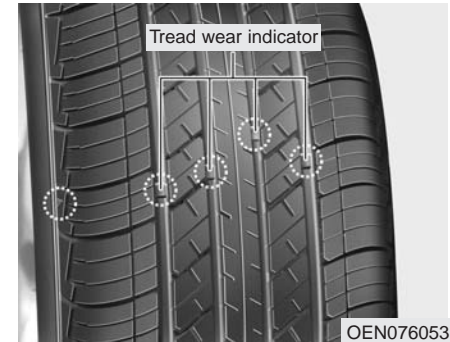

### **Tire replacement**

If the tire is worn evenly, a tread wear indicator will appear as a solid band across the tread. This shows there is less than 1/16 inch (1.6 mm) of tread left on the tire. Replace the tire when this happens.

Do not wait for the band to appear across the entire tread before replacing the tire.

**⚠ WARNING - Replacing tires**

To reduce the chance of serious or fatal injuries from an accident caused by tire failure or loss of vehicle control:

- Replace tires that are worn, show uneven wear, or are damaged. Worn tires can cause loss of braking effectiveness, steering control, and traction.
- Do not drive your vehicle with too little or too much pressure in your tires. This can lead to uneven wear and tire failure.
- When replacing tires, never mix radial and bias-ply tires on the same car. You must replace all tires (including the spare) if moving from radial to bias-ply tires.

(Continued)

**(Continued)**

- Using tires and wheels other than the recommended sizes could cause unusual handling characteristics and poor vehicle control, resulting in a serious accident.
- The ABS works by comparing the speed of the wheels. Tire size can affect wheel speed. When replacing tires, all 4 tires must use the same size originally supplied with the vehicle. Using tires of a different size can cause the ABS (Anti-lock Brake System) and ESC (Electronic Stability Control) to work irregularly.

***Compact spare tire replacement***

A compact spare tire has a shorter tread life than a regular size tire. Replace it when you can see the tread wear indicator bars on the tire. The replacement compact spare tire should be the same size and design tire as the one provided with your new vehicle and should be mounted on the same compact spare tire wheel. The compact spare tire is not designed to be mounted on a regular size wheel, and the compact spare tire wheel is not designed for mounting a regular size tire.

### Wheel replacement

When replacing the metal wheels for any reason, make sure the new wheels are equivalent to the original factory units in diameter, rim width and offset.

#### **WARNING**

**A wheel that is not the correct size may adversely affect wheel and bearing life, braking and stopping abilities, handling characteristics, ground clearance, body-to-tire clearance, snow chain clearance, speedometer and odometer calibration, headlight aim and bumper height.**

#### **WARNING - Wheel**

**Wheels that do not meet HYUNDAI's specifications may fit poorly and result in damage to the vehicle or unusual handling and poor vehicle control.**

### Tire traction

Tire traction can be reduced if you drive on worn tires, tires that are improperly inflated or on slippery road surfaces. Tires should be replaced when tread wear indicators appear. To reduce the possibility of losing control, slow down whenever there is rain, snow or ice on the road.

### Tire maintenance

In addition to proper inflation, correct wheel alignment helps to decrease tire wear. If you find a tire is worn unevenly, have your dealer check the wheel alignment.

When you have new tires installed, make sure they are balanced. This will increase vehicle ride comfort and tire life. Additionally, a tire should always be rebalanced if it is removed from the wheel.

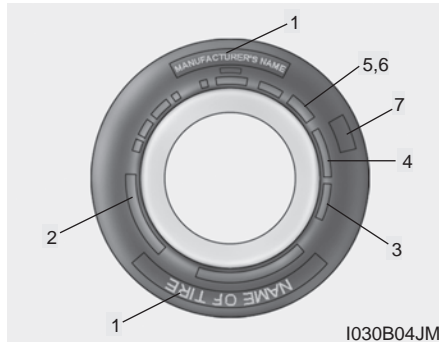

### Tire sidewall labeling

This information identifies and describes the fundamental characteristics of the tire and also provides the tire identification number (TIN) for safety standard certification. The TIN can be used to identify the tire in case of a recall.

#### 1. *Manufacturer or brand name*

Manufacturer or Brand name is shown.

### 2. *Tire size designation*

A tire's sidewall is marked with a tire size designation. You will need this information when selecting replacement tires for your car. The following explains what the letters and numbers in the tire size designation mean.

Example tire size designation:

(These numbers are provided as an example only; your tire size designation could vary depending on your vehicle.)

#### **P245/40R19 94V**

P - Applicable vehicle type (tires marked with the prefix "P" are intended for use on passenger vehicles or light trucks; however, not all tires have this marking).

P245 - Tire width in millimeters.

40 - Aspect ratio. The tire's section height as a percentage of its width.

R - Tire construction code (Radial).

19 - Rim diameter in inches.

94 - Load Index, a numerical code associated with the maximum load the tire can carry.

V - Speed Rating Symbol. See the speed rating chart in this section for additional information.

### Wheel size designation

Wheels are also marked with important information that you need if you ever have to replace one. The following explains what the letters and numbers in the wheel size designation mean.

Example wheel size designation:

#### **8.0JX19**

8.0 - Rim width in inches.

J - Rim contour designation.

19 - Rim diameter in inches.

**Tire speed ratings**

The chart below lists many of the different speed ratings currently being used for passenger car tires. The speed rating is part of the tire size designation on the sidewall of the tire. This symbol corresponds to that tire's designed maximum safe operating speed.

Speed Rating Symbol	Maximum Speed
S	112 mph (180 km/h)
T	118 mph (190 km/h)
H	130 mph (210 km/h)
V	149 mph (240 km/h)
Z	Above 149 mph (240 km/h)

**3. Checking tire life (TIN : Tire Identification Number)**

Any tires that are over 6 years old, based on the manufacturing date, (including the spare tire) should be replaced by new ones. You can find the manufacturing date on the tire sidewall (possibly on the inside of the wheel), displaying the DOT Code. The DOT Code is a series of numbers on a tire consisting of numbers and English letters. The manufacturing date is designated by the last four digits (characters) of the DOT code.

**DOT : XXXX XXXX OOOO**

The front part of the DOT means a plant code number, tire size and tread pattern and the last four numbers indicate week and year manufactured.

For example:

DOT XXXX XXXX 1615 represents that the tire was produced in the 16th week of 2015.

**⚠ WARNING - Tire age**  
**Tires degrade over time, even when they are not being used. Regardless of the remaining tread, it is recommended that tires generally be replaced after six (6) years of normal service. Heat caused by hot climates or frequent high loading conditions can accelerate the aging process. Failure to follow this warning can result in sudden tire failure, which could lead to a loss of control and an accident involving serious injury or death.**

#### ***4. Tire ply composition and material***

The number of layers or plies of rubber-coated fabric in the tire. Tire manufacturers also must indicate the materials in the tire, which include steel, nylon, polyester, and others. The letter "R" means radial ply construction; the letter "D" means diagonal or bias ply construction; and the letter "B" means belted-bias ply construction.

#### ***5. Maximum permissible inflation pressure***

This number is the greatest amount of air pressure that should be put in the tire. Do not exceed the maximum permissible inflation pressure. Refer to the Tire and Loading Information label for recommended inflation pressure.

#### ***6. Maximum load rating***

This number indicates the maximum load in kilograms and pounds that can be carried by the tire. When replacing the tires on the vehicle, always use a tire that has the same load rating as the factory installed tire.

#### ***7. Uniform tire quality grading***

Quality grades can be found where applicable on the tire sidewall between tread shoulder and maximum section width.

For example:

TREADWEAR 200  
TRACTION AA  
TEMPERATURE A

#### **Tread wear**

The tread wear grade is a comparative rating based on the wear rate of the tire when tested under controlled conditions on a specified government test course. For example, a tire graded 150 would wear one-and-a-half times ( $1\frac{1}{2}$ ) as well on the government course as a tire graded 100.

The relative performance of tires depends upon the actual conditions of their use, however, and may depart significantly from the norm due to variations in driving habits, service practices and differences in road characteristics and climate.

These grades are molded on the side-walls of passenger vehicle tires. The tires available as standard or optional equipment on your vehicle may vary with respect to grade.

Tires degrade over time, even when they are not being used. Regardless of the remaining tread, we recommend that tires be replaced after approximately six(6) years of normal service. Heat caused by hot climates or frequent high loading conditions can accelerate the aging process.

### **Traction - AA, A, B & C**

The traction grades, from highest to lowest, are AA, A, B and C. Those grades represent the tire's ability to stop on wet pavement as measured under controlled conditions on specified government test surfaces of asphalt and concrete. A tire marked C may have poor traction performance.

The traction grade assigned to this tire is based on straight-ahead braking traction tests, and does not include acceleration, cornering, hydroplaning, or peak traction characteristics.

### **Temperature -A, B & C**

The temperature grades are A (the highest), B and C representing the tire's resistance to the generation of heat and its ability to dissipate heat when tested under controlled conditions on a specified indoor laboratory test wheel.

Sustained high temperature can cause the material of the tire to degenerate and reduce tire life, and excessive temperature can lead to sudden tire failure. The grade C corresponds to a level of performance which all passenger car tires must meet under the Federal Motor Vehicle Safety Standard No. 109. Grades B and A represent higher levels of performance on the laboratory test wheel than the minimum required by law.

### **⚠ WARNING - Tire temperature**

**The temperature grade for this tire is established for a tire that is properly inflated and not overloaded. Excessive speed, underinflation, or excessive loading, either separately or in combination, can cause heat build-up and possible sudden tire failure. This can cause loss of vehicle control and serious injury or death.**

### **Low aspect ratio tire**

Low aspect ratio tires, whose aspect ratio is lower than 50, are standard equipment on this vehicle.

Because the low aspect ratio tires are optimized for handling and braking, it may be more uncomfortable to ride in and there is more noise compare with normal tires.

### **⚠ CAUTION**

***Because the sidewall of the low aspect ratio tire is shorter than the normal, the wheel and tire of the low aspect ratio tire can easily be damaged. So, follow the instructions below.***

- ***When driving on a rough road or off road, drive cautiously because tires and wheels may be damaged. And after driving, inspect tires and wheels.***
- ***When passing over a pothole, speed bump, manhole, or curb stone, drive slowly so that the tires and wheels are not damaged.***

***(Continued)***

*(Continued)*

- *If the tire is impacted, inspect the tire condition or contact an authorized HYUNDAI dealer.*
- *To prevent damage to the tire, inspect the tire condition and pressure every 1,800miles (3,000km).*

### CAUTION

- *It is not easy to recognize the tire damage with your own eyes. But if there is the slightest hint of tire damage, even though you cannot see the tire damage with your own eyes, have the tire checked or replaced because the tire damage may cause air leakage from the tire.*
- *If the tire is damaged by driving on a rough road, off road, pothole, manhole, or curb stone, it will not be covered by the warranty.*
- *You can find out the tire information on the tire sidewall.*

### Tire terminology and definitions

**Air Pressure:** The amount of air inside the tire pressing outward on the tire. Air pressure is expressed in pounds per square inch (psi) or kilopascal (kPa).

**Accessory Weight:** This means the combined weight of optional accessories. Some examples of optional accessories are, automatic transaxle, power seats, and air conditioning.

**Aspect Ratio:** The relationship of a tire's height to its width.

**Belt:** A rubber coated layer of cords that is located between the plies and the tread. Cords may be made from steel or other reinforcing materials.

**Bead:** The tire bead contains steel wires wrapped by steel cords that hold the tire onto the rim.

**Bias Ply Tire:** A pneumatic tire in which the plies are laid at alternate angles less than 90 degrees to the centerline of the tread.

**Cold Tire Pressure:** The amount of air pressure in a tire, measured in pounds per square inch (psi) or kilopascals (kPa) before a tire has built up heat from driving.

**Curb Weight:** This means the weight of a motor vehicle with standard and optional equipment including the maximum capacity of fuel, oil and coolant, but without passengers and cargo.

**DOT Markings:** A code molded into the sidewall of a tire signifying that the tire is in compliance with the U.S. Department of Transportation motor vehicle safety standards. The DOT code includes the Tire Identification Number (TIN), an alphanumeric designator which can also identify the tire manufacturer, production plant, brand and date of production.

**GVWR:** Gross Vehicle Weight Rating

**GAWR FRT:** Gross Axle Weight Rating for the Front Axle.

**GAWR RR:** Gross Axle Weight Rating for the Rear axle.



**Intended Outboard Sidewall:** The side of an asymmetrical tire, that must always face outward when mounted on a vehicle.

**Kilopascal (kPa):** The metric unit for air pressure.

**Light truck (LT) tire:** A tire designated by its manufacturer as primarily intended for use on lightweight trucks or multipurpose passenger vehicles.

**Load ratings:** The maximum load that a tire is rated to carry for a given inflation pressure.

**Load Index:** An assigned number ranging from 1 to 279 that corresponds to the load carrying capacity of a tire.

**Maximum Inflation Pressure:** The maximum air pressure to which a cold tire may be inflated. The maximum air pressure is molded onto the sidewall.

**Maximum Load Rating:** The load rating for a tire at the maximum permissible inflation pressure for that tire.

**Maximum Loaded Vehicle Weight:** The sum of curb weight; accessory weight; vehicle capacity weight; and production options weight.

**Normal Occupant Weight:** The number of occupants a vehicle is designed to seat multiplied by 150 pounds (68 kg).

**Occupant Distribution:** Designated seating positions.

**Outward Facing Sidewall:** The side of a asymmetrical tire that has a particular side that faces outward when mounted on a vehicle. The outward facing sidewall bears white lettering or bears manufacturer, brand, and/or model name molding that is higher or deeper than the same moldings on the inner facing sidewall.

**Passenger (P-Metric) Tire:** A tire used on passenger cars and some light duty trucks and multipurpose vehicles.

**Ply:** A layer of rubber-coated parallel cords

**Pneumatic tire:** A mechanical device made of rubber, chemicals, fabric and steel or other materials, that, when mounted on an automotive wheel, provides the traction and contains the gas or fluid that sustains the load.

**Production options weight:** The combined weight of installed regular production options weighing over 2.3 kg (5 lbs.) in excess of the standard items which they replace, not previously considered in curb weight or accessory weight, including heavy duty brakes, ride levelers, roof rack, heavy duty battery, and special trim.

**Recommended Inflation Pressure:** Vehicle manufacturer's recommended tire inflation pressure and shown on the tire placard.

**Radial Ply Tire:** A pneumatic tire in which the ply cords that extend to the beads are laid at 90 degrees to the centerline of the tread.

**Rim:** A metal support for a tire and upon which the tire beads are seated.

**Sidewall:** The portion of a tire between the tread and the bead.

**Speed Rating:** An alphanumeric code assigned to a tire indicating the maximum speed at which a tire can operate.

**Traction:** The friction between the tire and the road surface. The amount of grip provided.

**Tread:** The portion of a tire that comes into contact with the road.

**Treadwear Indicators:** Narrow bands, sometimes called "wear bars," that show across the tread of a tire when only 2/32 inch of tread remains.

**UTQGS:** Uniform Tire Quality Grading Standards, a tire information system that provides consumers with ratings for a tire's traction, temperature and treadwear. Ratings are determined by tire manufacturers using government testing procedures. The ratings are molded into the sidewall of the tire.

**Vehicle Capacity Weight:** The number of designated seating positions multiplied by 150 lbs. (68 kg) plus the rated cargo and luggage load.

**Vehicle Maximum Load on the Tire:** Load on an individual tire due to curb and accessory weight plus maximum occupant and cargo weight.

**Vehicle Normal Load on the Tire:** Load on an individual tire that is determined by distributing to each axle its share of the curb weight, accessory weight, and normal occupant weight and dividing by 2.

**Vehicle Placard:** A label permanently attached to a vehicle showing the original equipment tire size and recommended inflation pressure.

### All season tires

HYUNDAI specifies all season tires on some models to provide good performance for use all year round, including snowy and icy road conditions. All season tires are identified by ALL SEASON and/or M+S (Mud and Snow) on the tire sidewall. Snow tires have better snow traction than all season tires and may be more appropriate in some areas.

### Summer tires

HYUNDAI specifies summer tires on some models to provide superior performance on dry roads. Summer tire performance is substantially reduced in snow and ice. Summer tires do not have the tire traction rating M+S (Mud and Snow) on the tire side wall. If you plan to operate your vehicle in snowy or icy conditions, HYUNDAI recommends the use of snow tires or all season tires on all four wheels.

### Snow tires

If you equip your car with snow tires, they should be the same size and have the same load capacity as the original tires. Snow tires should be installed on all four wheels; otherwise, poor handling may result.

Snow tires should carry 4 psi (28 kPa) more air pressure than the pressure recommended for the standard tires on the tire label on the driver's side of the center pillar, or up to the maximum pressure shown on the tire sidewall, whichever is less.

Do not drive faster than 75 mph (120 km/h) when your vehicle is equipped with snow tires.

### Tire chains

Tire chains, if necessary, should be installed on the front wheels.

Be sure that the chains are installed in accordance with the manufacturer's instructions.

To minimize tire and chain wear, do not continue to use tire chains when they are no longer needed.

- When driving on roads covered with snow or ice, drive at less than 20 mph (30 km/h).
- Use the SAE "S" class or wire chains.
- If you hear noise caused by chains contacting the body, retighten the chain to avoid contact with the vehicle body.
- To prevent body damage, retighten the chains after driving 0.3~0.6 miles (0.5~1.0 km).
- Do not use tire chains on vehicles equipped with aluminum wheels. In unavoidable circumstance, use a wire type chain.
- Use wire chains less than 0.47 inches (12 mm) to prevent damage to the chain's connection.

### Radial-ply tires

Radial-ply tires provide improved tread life, road hazard resistance and smoother high speed ride. The radial-ply tires used on this vehicle are of belted construction, and are selected to complement the ride and handling characteristics of your vehicle. Radial-ply tires have the same load carrying capacity, as bias-ply or bias belted tires of the same size, and use the same recommended inflation pressure. Mixing of radial-ply tires with bias-ply or bias belted tires is not recommended. Any combinations of radial-ply and bias-ply or bias belted tires when used on the same vehicle will seriously deteriorate vehicle handling. The best rule to follow is: Identical radial-ply tires should always be used as a set of four.

Longer wearing tires can be more susceptible to irregular tread wear. It is very important to follow the tire rotation interval shown in this section to achieve the tread life potential of these tires. Cuts and punctures in radial-ply tires are repairable only in the tread area, because of sidewall flexing. Consult your tire dealer for radial-ply tire repairs.

## FUSES

### ■ Blade type



### ■ Cartridge type

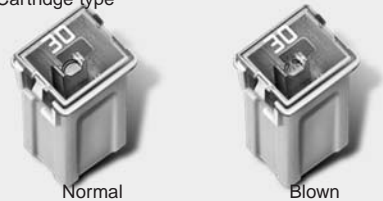

### ■ Multi fuse type

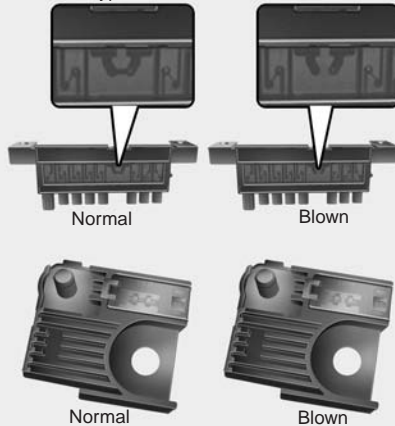

OVF071101

A vehicle's electrical system is protected from electrical overload damage by fuses.

This vehicle has 2 fuse panels, one located in the driver's side panel bolster, another is in the engine compartment.

If any of your vehicle's lights, accessories, or controls do not work, check the appropriate circuit fuse. If a fuse has blown, the element inside the fuse will be melted.

If the electrical system does not work, first check the driver's side fuse panel. Before replacing a blown fuse, disconnect the negative battery cable.

Always replace a blown fuse with one of the same rating.

If the replacement fuse blows, this indicates an electrical problem. Avoid using the system involved and immediately consult an authorized HYUNDAI dealer.

*Three kinds of fuses are used: blade type for lower amperage rating, cartridge type, and multi fuse type for higher amperage ratings.*

### **⚠ WARNING - Fuse replacement**

- **Never replace a fuse with anything but another fuse of the same rating.**
- **A higher capacity fuse could cause damage and possibly a fire.**
- **Never install a wire or aluminum foil instead of the proper fuse - even as a temporary repair. It may cause extensive wiring damage and a possible fire.**

### **⚠ CAUTION - Fuse replacement**

***Do not use a screwdriver or any other metal object to remove fuses because it may cause a short circuit and damage the system.***

**⚠ CAUTION**

- **When replacing a blown fuse or relay with a new one, make sure the new fuse or relay fits tightly into the clips. The incomplete fastening fuse or relay may cause the vehicle wiring and electric systems damage and a possible fire.**
- **Do not remove fuses, relays and terminals fastened with bolts or nuts. The fuses, relays and terminals may be fastened incompletely, and it may cause a possible fire. If fuses, relays and terminals fastened with bolts or nuts are blown, consult an authorized HYUNDAI dealer.**
- **Do not input any other objects except fuses or relays into fuse/relay terminals such as a driver or wiring. It may cause contact failure and system malfunction.**

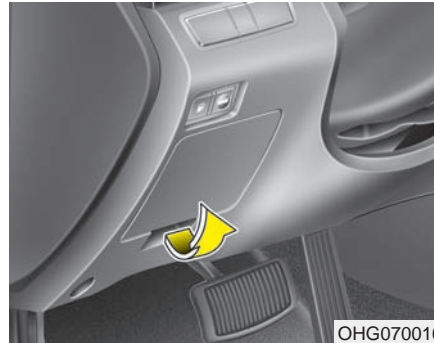

**Instrument panel fuse replacement**

1. Turn the ignition switch and all other switches off.
2. Open the fuse panel cover.

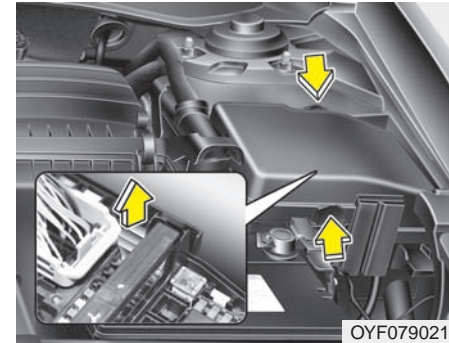

3. Pull the suspected fuse straight out. Use the removal tool provided in the engine compartment fuse panel.
4. Check the removed fuse; replace it if it is blown.
5. Push in a new fuse of the same rating, and make sure it fits tightly in the clips.

If it fits loosely, consult an authorized HYUNDAI dealer.

*If you do not have a spare, use a fuse of the same rating from a circuit you may not need for operating the vehicle, such as the power outlet fuse.*

If the headlights or other electrical components do not work and the fuses are OK, check the fuse panel in the engine compartment. If a fuse is blown, it must be replaced.



OHG070018

### Fuse switch

Always, put the fuse switch at the ON position. A notice will appear on the LCD display to notify the driver the fuse switch should be in the ON position. For more details, refer to "LCD display" in section 4.

If you move the switch to the OFF position, some items such as audio and digital clock must be reset and or smart key may not work properly.

### ⚠ CAUTION

- *Always place the fuse switch in the ON position while driving the vehicle.*
- *Do not operate the fuse switch repeatedly. The switch may be worn out.*

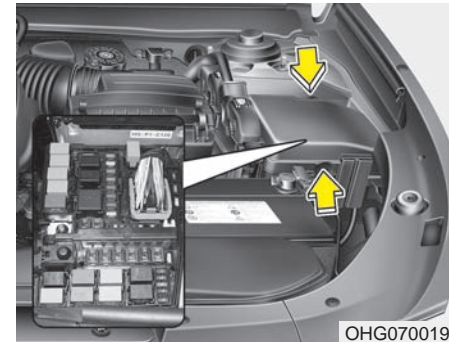

OHG070019

### Engine compartment fuse replacement

1. Turn the ignition switch and all other switches off.
2. Remove the fuse panel cover by pressing the tab and pulling it up.
3. Check the removed fuse; replace it if it is blown. To remove or insert the fuse, use the fuse puller in the engine compartment fuse panel.
4. Push in a new fuse of the same rating, and make sure it fits tightly in the clips.

If it fits loosely, consult an authorized HYUNDAI dealer.

**⚠ CAUTION - Fuse panel covers**

*After checking the fuse panel in the engine compartment, securely install the fuse panel cover to prevent electrical failures which may occur from water contact.*

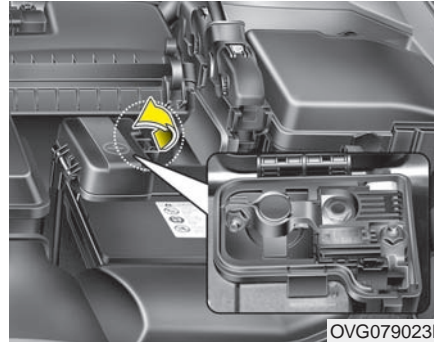

**Main fuse**

If the main fuse is blown, it must be removed as follows:

1. Turn off the engine.
2. Disconnect the negative battery cable.
3. Remove the nuts shown in the picture above.
4. Replace the fuse with a new one of the same rating.
5. Reinstall in the reverse order of removal.

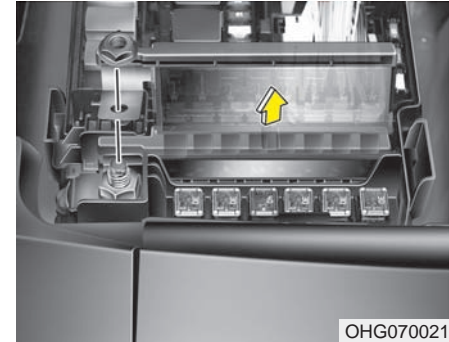

**Multi fuse**

If the multi fuse is blown, it must be removed as follows:

1. Turn off the engine.
2. Disconnect the negative battery cable.
3. Remove the fuse panel in the engine compartment.
4. Remove the nuts shown in the picture above.
5. Replace the fuse with a new one of the same rating.
6. Reinstall in the reverse order of removal.

If the multi fuse is blown, consult an authorized HYUNDAI dealer.



### Fuse/relay panel description

#### Instrument panel fuse panel

Inside the fuse/relay panel covers, you can find the fuse/relay label describing fuse/relay name and capacity.

#### \* NOTICE

Not all fuse panel descriptions in this manual may be applicable to your vehicle. It is accurate at the time of printing. When you inspect the fuse panel in your vehicle, refer to the fuse panel label.

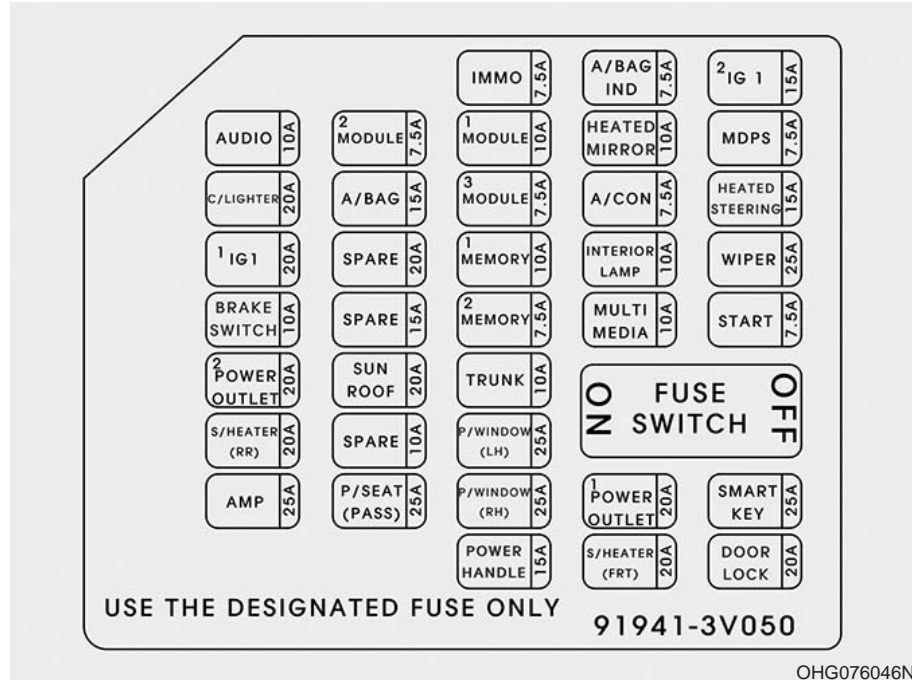



## Instrument panel (Driver's side fuse panel)

No.	Fuse rating	Symbol	Protected component
1	7.5A	IMMO	Smart Key Control Module
2	7.5A	A/BAG IND	Instrument Cluster
3	20A	SPARE	-
4	10A	AUDIO	AMP, Smart Key Control Module, Telematics Unit, E/R Junction Block (Power Outlet Relay), A/V & Navigation Head Unit, Front Monitor (Audio/Navigation), Audio, A/C Control Module
5	7.5A	MODULE 2	ESC Control Module, Rear Seat Warmer LH/RH, Console Switch, A/C Control Module, Rear Power Window Switch LH/RH, Driver IMS Module, Rear Parking Assist Sensor LH/RH/LH(Center)/RH(Center)
6	10A	MODULE 1	Driver Power Seat Switch, Driver/Passenger Seat Warmer Module, Driver/Passenger Door Module, Stop Lamp Switch, Crash Pad Switch, Driver/Passenger CCS Control Module, Steering Tilt & Telescope Module, Instrument Cluster, Blind Spot Detection Radar LH/RH, Multifunction Switch, Forward Collision Warning Unit, Lane Departure Warning Unit, Electro Chromic Mirror, ATM Lever Indicator, Tire Pressure Monitoring Module, Telematics Unit
7	10A	HTD MIRR	Driver/Passenger Power Outside Mirror, A/C Control Module
8	7.5A	MDPS	MDPS Unit
9	20A	C/LIGHTER	Center Tray Outlet
10	15A	A/BAG	SRS Control Module, Passenger Occupant Detection Sensor, A/C Control Module

No.	Fuse rating	Symbol	Protected component
11	7.5A	MODULE 3	Smart Key Control Module, Rear Seat Warmer LH/RH
12	7.5A	A/CON	A/C Control Module, E/R Junction Block (Blower Relay), Driver/Passenger Seat Warmer Module, Active Incar Sensor, Driver/Passenger CCS Control Module
13	15A	IG1 2	Steering Wheel Heater
14	20A	IG1 1	E/R Junction Block (ECU 5 10A, ECU 4 10A)
15	10A	MEMORY 1	Driver Power Seat Switch, Data Link Connector, A/C Control Module, Driver/Passenger Door Module, Instrument Cluster, Tire Pressure Monitoring Module, Auto Light & Photo Sensor
16	10A	INTERIOR LAMP	Rear Door Lamp LH/RH, MAP Lamp, Garnish Lamp LH/RH, Driver/Passenger Door Mood Lamp, Driver/Passenger Door Lamp, Driver/Passenger Foot Lamp, Driver/Passenger Door Scuff Lamp, Rear Door Mood Lamp LH/RH, Vanity Lamp Switch LH/RH, Rear Door Scuff Lamp LH/RH, Trunk Room Lamp, Rear Personal Lamp Center/LH/RH
17	25A	WIPER	Wiper Motor, E/R Junction Block (Washer Relay, Wiper (LO) Relay, Wiper (HI) Relay)
18	10A	STOP LAMP	Smart Key Control Module, Stop Lamp Switch, Start Stop Button Switch
19	7.5A	MEMORY 2	RF Receiver
20	10A	MULTI MEDIA	Front Monitor (Audio/Navigation), A/V & Navigation Head Unit, Telematics Unit, Audio
21	7.5A	START	Transaxle Range Switch, PCM

## Maintenance

No.	Fuse rating	Symbol	Protected component
22	20A	SUNROOF	Panorama Sunroof
23	10A	TRUNK	Trunk Lid Relay, Fuel Filler Door & Trunk Lid Switch
24	20A	S/HEATER RR	Rear Seat Warmer LH/RH
25	10A	DRV P/SEAT	-
26	25A	P/ WDW LH	Driver Safety Window Module, Rear Power Window Switch LH
27	25A	AMP	AMP
28	25A	PASS P/SEAT	Passenger Reclining Limit Switch, Power Seat Relay Box RH
29	25A	P/WDW RH	Passenger Safety Window Module, Rear Power Window Switch RH
30	25A	SMART KEY	Smart Key Control Module
31	15A	P/HANDLE	Sport Mode Switch, Steering Tilt & Telescopic Module
32	20A	S/HEATER FRT	Driver/Passenger Seat Warmer Module, Driver/Passenger CCS Control Module
33	20A	DR LOCK	Door Lock/Unlock Relay, ICM Relay Box (Two Turn Unlock Relay)

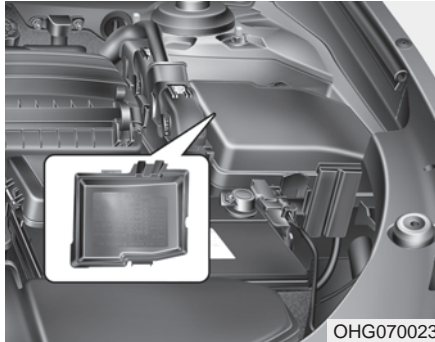

OHG070023

**Engine compartment fuse panel**

Inside the fuse/relay panel covers, you can find the fuse/relay label describing fuse/relay name and capacity.

**\* NOTICE**

Not all fuse panel descriptions in this manual may be applicable to your vehicle. It is accurate at the time of printing. When you inspect the fuse panel in your vehicle, refer to the fuse panel label.

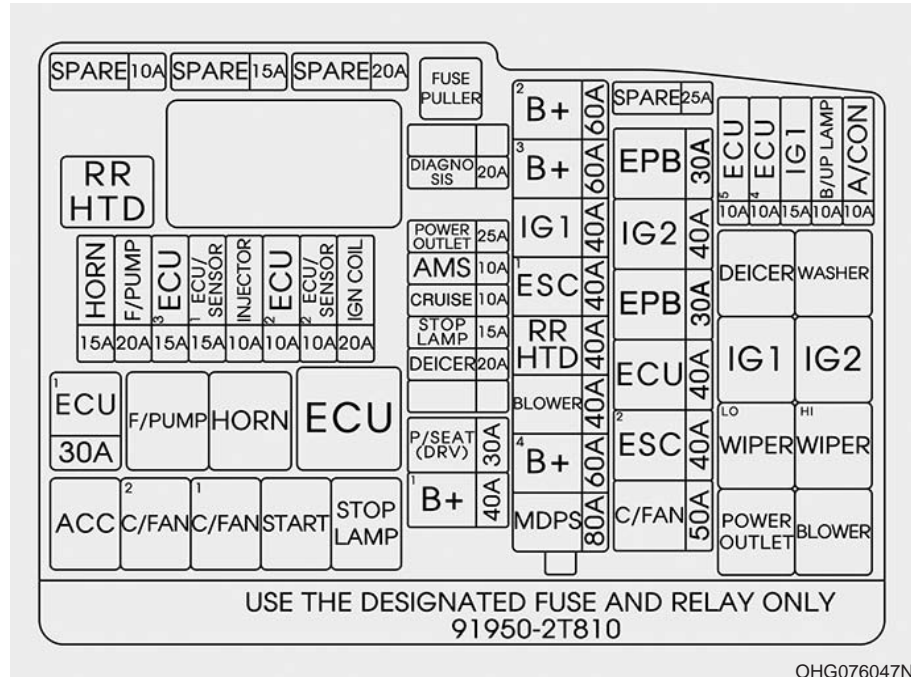

**Engine compartment main fuse panel**

No.	Fuse rating	Symbol	Protected component	
MULTI FUSE	1	60A	B+2	Smart Junction Box (P/HANDLE 15A, SUNROOF 20A, DRV P/SEAT 10A, PASS P/SEAT 25A, IPS 2, ARISU-LT 1)
	2	60A	B+3	Smart Junction Box (P/WDW 25A, P/WDW RH 25A, S/HEATER FRT 10A, TRUNK 10A, P/OUTLET 1 20A)
	3	40A	IG1	PDM 1 (ACC) Relay, PDM 2 (IG1) Relay
	4	40A	ESC1	ESC Module
	5	40A	RR HTD	RR HTD Relay
	6	40A	BLOWER	Blower Relay
	7	60A	B+4	Smart Junction Block (STOP LAMP 10A, S/HEATER RR 20A, IPS 3/4, ARISU-LT 2, AMP 25A, P/OUTLET 2 20A)
	8	80A	MDPS	MDPS Unit
FUSE	9	10A	A/CON	A/C Control Module
	10	10A	B/UP LAMP	Rear Combination Lamp (IN) LH/RH, Electro Chromic Mirror, Audio, Front Monitor
	11	10A	ECU 4	PCM, IDB(Injector Driver Box)

No.	Fuse rating	Symbol	Protected component	
FUSE	12	10A	ECU 5	Multipurpose Check Connector
	13	30A	EPB 2	Electronic Parking Brake Module
	14	40A	IG 2	Start Relay, PDM 3 (IG2) Relay
	15	30A	EPB 1	Electronic Parking Brake Module
	16	40A	B+5	EMS Block (ECU 3 15A, ECU 1 30A, F/PUMP 20A, HORN 15A)
	17	40A	ESC 2	ESC Module
	18	50A	C/FAN	C/Fan Relay
	19	20A	DIAGNOSIS	Multipurpose Check Connector
	20	10A	AMS	Battery Sensor
	21	10A	CRUISE	Smart Cruise Control Radar
	22	15A	STOP LAMP	Stop Signal Electronic Module

## Maintenance

No.	Fuse rating	Symbol	Protected component	
FUSE	23	20A	DEICER	Deicer Relay
	24	30A	DRV P/SEAT	Driver Lumbar Support Limit Switch, Driver IMS Module, Power Seat Relay Box LH, Driver Reclining Limit Switch
	25	40A	B+1	Smart Junction Box (DR LOCK 20A, SMART KEY 1 25A, Leak Current Autocut Device (Leak Current Autocut Relay, Leak Current Autocut Switch, IPS 5))
	26	20A	IGN COIL	Ignition Coil #1~#6, Condenser #1/#2
	27	10A	SENSOR 2	IDB (Injector Driver Box), PCM, Purge Control Solenoid Valve, Oil Control Valve #1 ~ #4, Variable Intake Solenoid Valve #1, #2, Canister Close Valve, E/R Junction (C/FAN Relay)
	28	10A	ECU 2	IDB (Injector Driver Box)
	29	10A	INJECTOR	PCM, EMS Box (F/Pump Relay)
	30	15A	SENSOR 1	PCM, Oxygen Sensor #1~#4
	31	15A	ECU 3	PCM, IDB (Injector Driver Box)
	32	20A	F/PUMP	EMS Block (F/Pump Relay)
	33	15A	HORN	EMS Block (Horn Relay), ICM Relay Box(Burglar Horn Relay)
	34	30A	ECU 1	EMS Block (Engine Control Relay)

## LIGHT BULBS

### **⚠ WARNING - Lights**

Prior to working on the light, firmly apply the parking brake, ensure that the ignition switch is changed to the OFF position and turn off the lights to avoid sudden movement of the vehicle and burning your fingers or receiving an electric shock.

*Use only the bulbs of the specified wattage.*

### **⚠ CAUTION - Light replacement**

*Be sure to replace the burned-out bulb with one of the same wattage rating. Otherwise, it may cause damage to the fuse or electric wiring system.*

If you do not have necessary tools, the correct bulbs and the expertise, consult an authorized HYUNDAI dealer. In many cases, it is difficult to replace vehicle light bulbs because other parts of the vehicle must be removed before you can get to the bulb. This is especially true if you have to remove the headlight assembly to get to the bulb(s). Removing/installing the headlight assembly can result in damage to the vehicle.

### **\* NOTICE**

After driving in rain or washing the vehicle, the headlight and taillight lenses could appear frosty. This condition is caused by the temperature difference between the lamp inside and outside. This is similar to the condensation on your windows inside your vehicle during the rain and doesn't indicate a problem with your vehicle. If the water leaks into the lamp bulb circuitry, have the vehicle checked by an authorized HYUNDAI dealer.



### **Headlight, position light, turn signal light, front fog light bulb replacement**

- (1) Headlight (High) / DRL (Daytime running light)
- (2) Headlight (Low)
- (3) Front turn signal light
- (4) Position (Parking) light
- (5) Front side marker
- (6) Front fog light



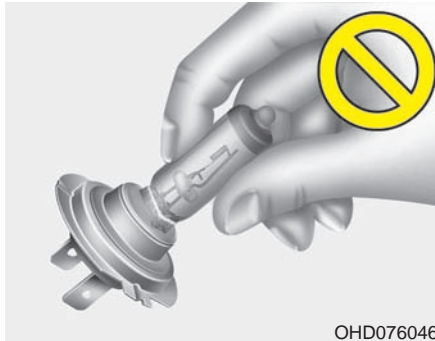

**⚠ WARNING - Halogen bulbs**

- Handle halogen bulbs with care. Halogen bulbs contain pressurized gas that will produce flying pieces of glass that could cause injuries if broken.
- Wear eye protection when changing a bulb. Allow the bulb to cool down before handling it.

- Always handle them carefully, and avoid scratches and abrasions. If the bulbs are lit, avoid contact with liquids.
- Never touch the glass with bare hands. Residual oil may cause the bulb to overheat and burst when lit.
- A bulb should be operated only when installed in a headlight.
- If a bulb becomes damaged or cracked, replace it immediately and carefully dispose of it.

***Headlight (HID type)***

If the light bulb does not operate, have the vehicle checked by an authorized HYUNDAI dealer.

**⚠ WARNING**  
- HID Headlight low beam

**Do not attempt to replace or inspect the low beam (XENON bulb) due to electric shock danger. If the low beam (XENON bulb) is not working, have your vehicle checked by an authorized HYUNDAI Dealer.**

**⚠ CAUTION**

*If your vehicle is equipped with High Intensity Discharge (HID) headlights, these headlights contain mercury. So if you need to have your vehicle disposed, you should remove the HID Headlights before disposal. The removed HID headlights should be recycled, re-used or disposed as hazardous waste.*

HID lamps have superior performance vs. halogen bulbs. HID lamps are estimated by the manufacturer to last twice as long or longer than halogen bulbs depending on their frequency of use. They will probably require replacement at some point in the life of the vehicle. Cycling the headlamps on and off more than typical use will shorten HID lamps life. HID lamps do not fail in the same manner as halogen incandescent lamps. If a headlamp goes out after a period of operation but will immediately relight when the headlamp switch is cycled it is likely the HID lamp needs to be replaced. HID lighting components are more complex than conventional halogen bulbs and thus have higher replacement cost.

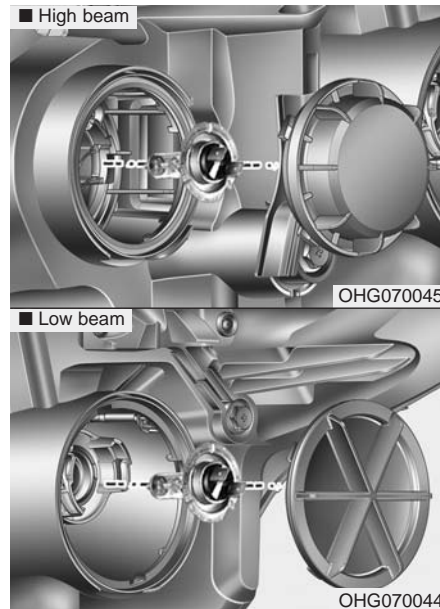

#### ***Headlight (bulb type)***

1. Turn off the engine.
2. Open the hood.
3. Remove the headlight bulb cover by turning it counterclockwise.
4. Disconnect the headlight bulb socket connector.

5. Remove the bulb from the headlight assembly.
6. Install a new headlight bulb.
7. Connect the headlight bulb socket connector.
8. Install the headlight bulb cover by turning it clockwise.

If the headlight aiming adjustment is necessary after the headlight assembly is reinstalled, consult an authorized HYUNDAI dealer.

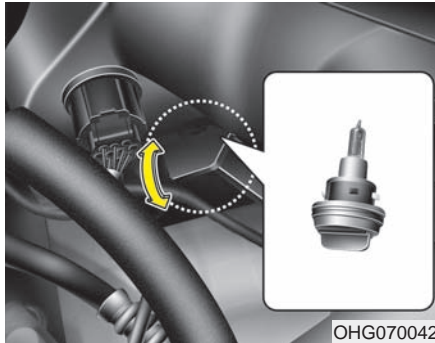

### **Turn signal light**

1. Turn off the engine.
2. Open the hood.
3. Remove the socket from the assembly by turning the socket counterclockwise until the tabs on the socket align with the slots on the assembly.
4. Remove the bulb from the socket by pressing it in and rotating it counterclockwise until the tabs on the bulb align with the slots in the socket. Pull the bulb out of the socket.

5. Insert a new bulb by inserting it into the socket and rotating it until it locks into place.
6. Install the socket in the assembly by aligning the tabs on the socket with the slots in the assembly. Push the socket into the assembly and turn the socket clockwise.

### ***Position (Parking) light, front fog light and front side marker***

If the light bulb does not operate, have the vehicle checked by an authorized HYUNDAI dealer.

### **\* NOTICE**

A skilled technician should check or repair the position, front fog lights and front side marker. Otherwise, it may damage related parts of the vehicle.



### Side repeater light bulb replacement

If the light bulb does not operate, have the vehicle checked by an authorized HYUNDAI dealer.

#### \* NOTICE

A skilled technician should check or repair the side repeater light. Otherwise, it may damage related parts of the vehicle.

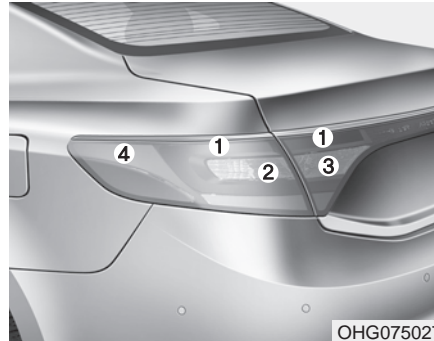

### Rear combination light bulb replacement

- (1) Stop and tail light
- (2) Rear turn signal light
- (3) Backup light
- (4) Rear side marker

### *Stop/tail light and rear side marker*

If the light bulb does not operate, have the vehicle checked by an authorized HYUNDAI dealer.

#### \* NOTICE

A skilled technician should check or repair the stop/tail light and rear side marker. Otherwise, it may damage related parts of the vehicle.

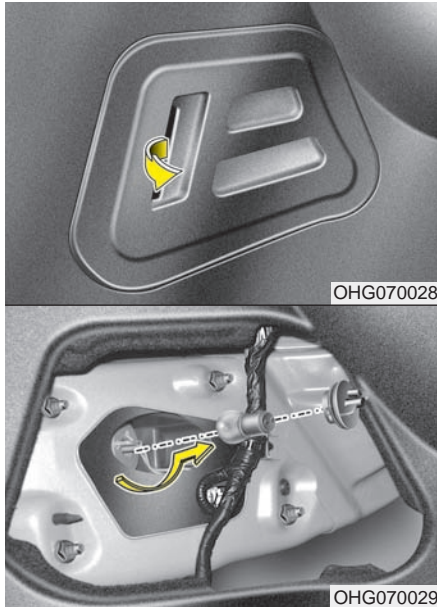

### **Rear turn signal light**

1. Turn off the engine.
2. Open the trunk.
3. Remove the service cover by pulling out the service cover.

4. Remove the socket from the assembly by turning the socket counterclockwise until the tabs on the socket align with the slots on the assembly.
5. Remove the bulb from the socket by pressing it in and rotating it counterclockwise until the tabs on the bulb align with the slots in the socket. Pull the bulb out of the socket.
6. Insert a new bulb by inserting it into the socket and rotating it until it locks into place.
7. Install the socket in the assembly by aligning the tabs on the socket with the slots in the assembly. Push the socket into the assembly and turn the socket clockwise.
8. Install the service cover by putting it into the service hole.

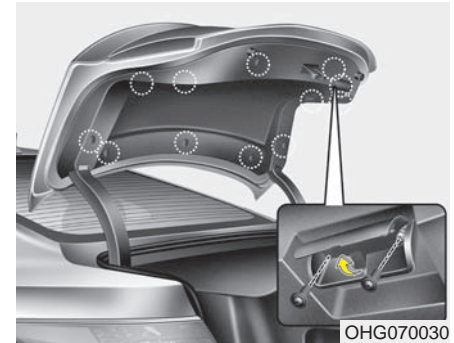

### **Backup light**

1. Turn off the engine.
2. Open the trunk.
3. Loosen the retaining screw of the trunk lid cover and then remove the cover.
4. Remove the socket from the assembly by turning the socket counter clockwise until the tabs on the socket align with the slots on the assembly.

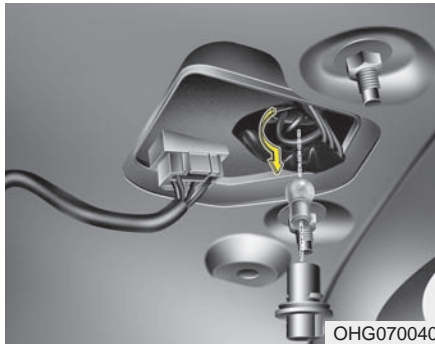

5. Remove the bulb by pulling it straight out.
6. Insert a new bulb by inserting it into the socket and rotating it until it locks into place.
7. Install the socket into the assembly by aligning the tabs on the socket with the slots in the assembly. Push the socket into the assembly and turn the socket clockwise.
8. Reinstall the trunk lid cover by pushing in the screw.

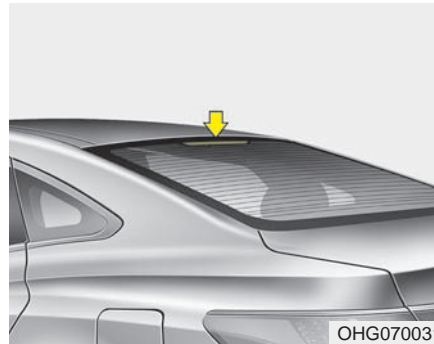

### High mounted stop light replacement

If the light bulb does not operate, have the vehicle be checked by an authorized HYUNDAI dealer.

#### \* NOTICE

**A skilled technician should check or repair the high mounted stop light. Otherwise, it may affect the performance of the curtain airbags or damage related interior parts of the vehicle.**

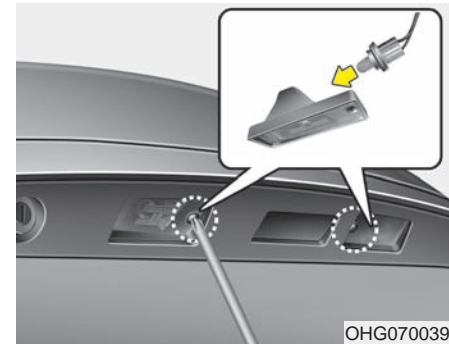

### License plate light bulb replacement

1. Turn off the engine.
2. Loosen the retaining screws with a philips head screwdriver.
3. Remove the bulb assembly by turning it counterclockwise.
4. Remove the bulb by pulling it straight out.
5. Install a new bulb.
6. Reinstall the bulb assembly securely with the retaining screws.

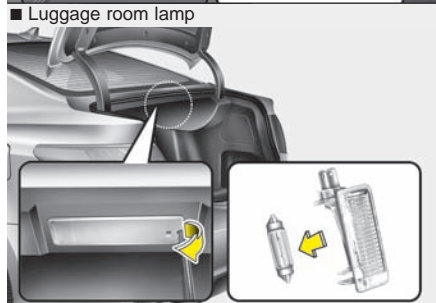
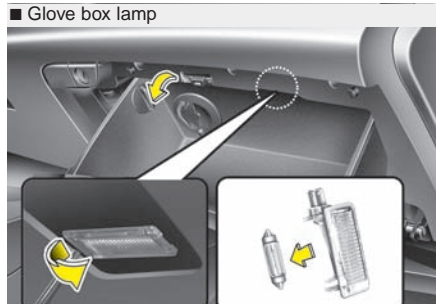

OHG070033/OHG070034

### Interior light bulb replacement

#### *Glove box lamp and luggage room lamp*

1. Using a flat-blade screwdriver, gently pry the lens from the interior light housing.
2. Remove the bulb by pulling it straight out.

**⚠ WARNING - Interior lights**  
**Prior to working on the Interior lights, ensure that the lights are off to avoid burning your fingers or receiving an electric shock.**

3. Install a new bulb in the socket.
4. Align the lens tabs with the interior light housing notches and snap the lens into place.

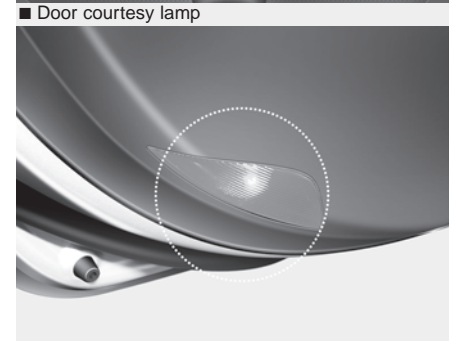

OHG045029/OHG070036

■ Room lamp

Type A

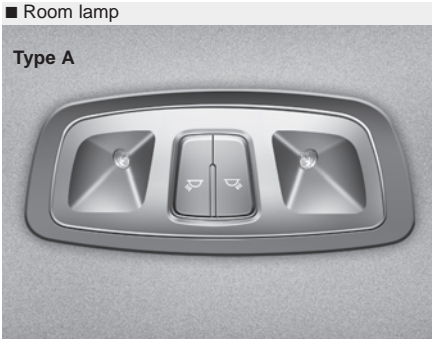

Type B



OHG070037/OHG070038

■ Vanity mirror lamp

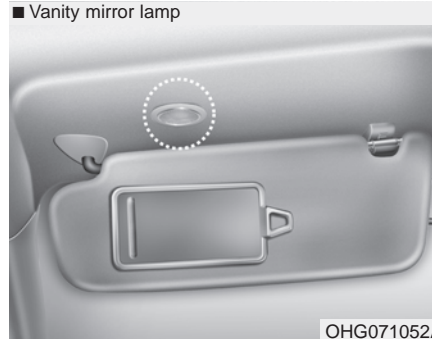

OHG071052A

***Map lamp, room lamp, door courtesy lamp and vanity mirror lamp***

If the light bulb does not operate, have the vehicle checked by an authorized HYUNDAI dealer.

**\* NOTICE**

A skilled technician should check or repair the interior lights. Otherwise, it may damage related parts of the vehicle.



## APPEARANCE CARE

### Exterior care

#### *Exterior general caution*

It is very important to follow the label directions when using any chemical cleaner or polish. Read all warning and caution statements that appear on the label.

#### *High-pressure washing*

- When using high-pressure washers, make sure to maintain sufficient distance from the vehicle. Insufficient clearance or excessive pressure can lead to component damage or water penetration.
- Do not spray the camera, sensors or its surrounding area directly with a high pressure washer. Shock applied from high pressure water may cause the device to not operate normally.
- Do not bring the nozzle tip close to boots (rubber or plastic covers) or connectors as they may be damaged if they come into contact with high pressure water.

### *Finish maintenance*

#### **Washing**

To help protect your vehicle's finish from rust and deterioration, wash it thoroughly and frequently at least once a month with lukewarm or cold water.

If you use your vehicle for off-road driving, you should wash it after each off-road trip. Pay special attention to the removal of any accumulation of salt, dirt, mud, and other foreign materials. Make sure the drain holes in the lower edges of the doors and rocker panels are kept clear and clean.

Insects, tar, tree sap, bird droppings, industrial pollution and similar deposits can damage your vehicle's finish if not removed immediately.

Even prompt washing with plain water may not completely remove all these deposits. A mild soap, safe for use on painted surfaces, may be used.

After washing, rinse the vehicle thoroughly with lukewarm or cold water. Do not allow soap to dry on the finish.

#### **CAUTION**

- ***Do not use strong soap, chemical detergents or hot water, and do not wash the vehicle in direct sunlight or when the body of the vehicle is warm.***
- ***Be careful when washing the side windows of your vehicle. Especially, with high-pressure water, water may leak through the windows and wet the interior.***
- ***To prevent damage to the plastic parts and lamps, do not clean with chemical solvents or strong detergents.***

#### **WARNING - Wet brakes**

**After washing the vehicle, test the brakes while driving slowly to see if they have been affected by water. If braking performance is impaired, dry the brakes by applying them lightly while maintaining a slow forward speed.**

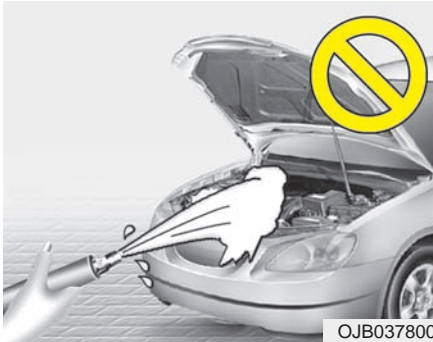

**⚠ CAUTION - Wetting engine**

- ***Water washing in the engine compartment including high pressure water washing may cause the failure of electrical circuits located in the engine compartment.***
- ***Never allow water or other liquids to come in contact with electrical/electronic components inside the vehicle as this may damage them.***

**Waxing**

A good coat of wax is a barrier between your paint and contaminants. Keeping a good coat of wax on your vehicle will help protect it.

Wax the vehicle when water will no longer bead on the paint.

Always wash and dry the vehicle before waxing. Use a good quality liquid or paste wax, and follow the manufacturer's instructions. Wax all metal trim to protect it and to maintain its luster.

Removing oil, tar, and similar materials with a spot remover will usually strip the wax from the finish. Be sure to re-wax these areas even if the rest of the vehicle does not yet need waxing.

**⚠ CAUTION - Drying vehicle**

- ***Wiping dust or dirt off the body with a dry cloth will scratch the finish.***
- ***Do not use steel wool, abrasive cleaners, or strong detergents containing highly alkaline or caustic agents on chrome-plated or anodized aluminum parts. This may result in damage to the protective coating and cause discoloration or paint deterioration.***

### ***Finish damage repair***

Deep scratches or stone chips in the painted surface must be repaired promptly. Exposed metal will quickly rust and may develop into a major repair expense.

If your vehicle is damaged and requires any metal repair or replacement, be sure the body shop applies anti-corrosion materials to the parts repaired or replaced.

### ***Bright-metal maintenance***

- To remove road tar and insects, use a tar remover, not a scraper or other sharp object.
- To protect the surfaces of bright-metal parts from corrosion, apply a coating of wax or chrome preservative and rub to a high luster.
- During winter weather or in coastal areas, cover the bright metal parts with a heavier coating of wax or preservative. If necessary, coat the parts with non-corrosive petroleum jelly or other protective compound.

### ***Underbody maintenance***

Corrosive materials used for ice and snow removal and dust control may collect on the underbody. If these materials are not removed, accelerated rusting can occur on underbody parts such as the fuel lines, frame, floor pan and exhaust system, even though they have been treated with rust protection.

Thoroughly flush the vehicle underbody and wheel openings with lukewarm or cold water once a month, after off-road driving and at the end of each winter. Pay special attention to these areas because it is difficult to see all the mud and dirt. It will do more harm than good to wet down the road grime without removing it. The lower edges of doors, rocker panels, and frame members have drain holes that should not be allowed to clog with dirt; trapped water in these areas can cause rusting.

### **Aluminum wheel maintenance**

The aluminum wheels are coated with a clear protective finish.

- Do not use any abrasive cleaner, polishing compound, solvent, or wire brushes on aluminum wheels. They may scratch or damage the finish.
- Clean the wheels when it has cooled.
- Use only a mild soap or neutral detergent, and rinse thoroughly with water. Also, be sure to clean the wheels after driving on salted roads. This helps prevent corrosion.
- Avoid washing the wheels with high-speed car wash brushes.
- Do not use any acid detergent. It may damage and corrode the aluminum wheels coated with a clear protective finish.

### **Corrosion protection**

#### **Protecting your vehicle from corrosion**

By using the most advanced design and construction practices to combat corrosion, we produce vehicles of the highest quality. However, this is only part of the job. To achieve the long-term corrosion resistance your vehicle can deliver, the owner's cooperation and assistance is also required.

#### **Common causes of corrosion**

The most common causes of corrosion on your vehicle are:

- Road salt, dirt and moisture that is allowed to accumulate underneath the vehicle.
- Removal of paint or protective coatings by stones, gravel, abrasion or minor scrapes and dents which leave unprotected metal exposed to corrosion.

### **High-corrosion areas**

If you live in an area where your vehicle is regularly exposed to corrosive materials, corrosion protection is particularly important. Some of the common causes of accelerated corrosion are road salts, dust control chemicals, ocean air and industrial pollution.

#### **Moisture breeds corrosion**

Moisture creates the conditions in which corrosion is most likely to occur. For example, corrosion is accelerated by high humidity, particularly when temperatures are just above freezing. In such conditions, the corrosive material is kept in contact with the vehicle surfaces by moisture that is slow to evaporate.

Mud is particularly corrosive because it is slow to dry and holds moisture in contact with the vehicle. Although the mud appears to be dry, it can still retain the moisture and promote corrosion.

High temperatures can also accelerate corrosion of parts that are not properly ventilated so the moisture can be dispersed. For all these reasons, it is particularly important to keep your vehicle clean and free of mud or accumulations of other materials. This applies not only to the visible surfaces but particularly to the underside of the vehicle.

### **To help prevent corrosion**

You can help prevent corrosion from getting started by observing the following:

### **Keep your vehicle clean**

The best way to prevent corrosion is to keep your vehicle clean and free of corrosive materials. Attention to the underside of the vehicle is particularly important.

- If you live in a high-corrosion area — where road salts are used, near the ocean, areas with industrial pollution, acid rain, etc.—, you should take extra care to prevent corrosion. In winter, hose off the underside of your vehicle at least once a month and be sure to clean the underside thoroughly when winter is over.
- When cleaning underneath the vehicle, give particular attention to the components under the fenders and other areas that are hidden from view. Do a thorough job; just dampening the accumulated mud rather than washing it away will accelerate corrosion rather than prevent it. Water under high pressure and steam are particularly effective in removing accumulated mud and corrosive materials.

- When cleaning lower door panels, rocker panels and frame members, be sure that drain holes are kept open so that moisture can escape and not be trapped inside to accelerate corrosion.

### **Keep your garage dry**

Do not park your vehicle in a damp, poorly ventilated garage. This creates a favorable environment for corrosion. This is particularly true if you wash your vehicle in the garage or drive it into the garage when it is still wet or covered with snow, ice or mud. Even a heated garage can contribute to corrosion unless it is well ventilated so moisture is dispersed.

### **Keep paint and trim in good condition**

Scratches or chips in the finish should be covered with "touch-up" paint as soon as possible to reduce the possibility of corrosion. If bare metal is showing through, the attention of a qualified body and paint shop is recommended.

**Bird droppings :** Bird droppings are highly corrosive and may damage painted surfaces in just a few hours. Always remove bird droppings as soon as possible.

### **Do not neglect the interior**

Moisture can collect under the floor mats and carpeting to cause corrosion. Check under the mats periodically to be sure the carpeting is dry. Use particular care if you carry fertilizers, cleaning materials or chemicals in the vehicle.

These should be carried only in proper containers and any spills or leaks should be cleaned up, flushed with clean water and thoroughly dried.

### Interior care

#### *Interior general precautions*

Prevent chemicals such as perfume, cosmetic oil, sun cream, hand cleaner, and air freshener from contacting the interior parts because they may cause damage or discoloration. If they do contact the interior parts, wipe them off immediately. See the instructions for the proper way to clean vinyl.

 **CAUTION - Electrical components**

*Never allow water or other liquids to come in contact with electrical/electronic components inside the vehicle as this may damage them.*

 **CAUTION - Leather**

*When cleaning leather products (steering wheel, seats etc.), use neutral detergents or low alcohol content solutions. If you use high alcohol content solutions or acid/alkaline detergents, the color of the leather may fade or the surface may get stripped off.*

#### *Cleaning the upholstery and interior trim*

##### **Vinyl**

Remove dust and loose dirt from vinyl with a whisk broom or vacuum cleaner. Clean vinyl surfaces with a vinyl cleaner.

##### **Fabric**

Remove dust and loose dirt from fabric with a whisk broom or vacuum cleaner. Clean with a mild soap solution recommended for upholstery or carpets. Remove fresh spots immediately with a fabric spot cleaner. If fresh spots do not receive immediate attention, the fabric can be stained and its color can be affected. Also, its fire-resistant properties can be reduced if the material is not properly maintained.

Using anything but recommended cleaners and procedures may affect the fabric's appearance and fire-resistant properties.

#### *Cleaning the lap/shoulder belt webbing*

Clean the belt webbing with any mild soap solution recommended for cleaning upholstery or carpet. Follow the instructions provided with the soap. Do not bleach or re-dye the webbing because this may weaken it.

#### *Cleaning the interior window glass*

If the interior glass surfaces of the vehicle become fogged (that is, covered with an oily, greasy or waxy film), they should be cleaned with glass cleaner. Follow the directions on the glass cleaner container.

 **CAUTION - Rear windows**

*Do not scrape or scratch the inside of the rear window. This may result in damage to the rear window defroster grid.*

## EMISSION CONTROL SYSTEM

The emission control system of your vehicle is covered by a written limited warranty. Please see the warranty information contained in the Owner's Handbook & Warranty Information booklet in your vehicle.

Your vehicle is equipped with an emission control system to meet all applicable emission regulations.

There are three emission control systems, as follows.

- (1) Crankcase emission control system
- (2) Evaporative emission control system
- (3) Exhaust emission control system

In order to assure the proper function of the emission control systems, it is recommended that you have your vehicle inspected and maintained by an authorized HYUNDAI dealer in accordance with the maintenance schedule in this manual.

### Caution for the Inspection and Maintenance Test (With Electronic Stability Control (ESC) system)

- **To prevent the vehicle from misfiring during dynamometer testing, turn the Electronic Stability Control (ESC) system off by pressing the ESC switch.**
- **After dynamometer testing is completed, turn the ESC system back on by pressing the ESC switch again.**

### 1. Crankcase emission control system

The positive crankcase ventilation system is employed to prevent air pollution caused by blow-by gases being emitted from the crankcase. This system supplies fresh filtered air to the crankcase through the air intake hose. Inside the crankcase, the fresh air mixes with blow-by gases, which then pass through the PCV valve into the induction system.

### 2. Evaporative emission control (including ORVR: Onboard Refueling Vapor Recovery) system

The Evaporative Emission Control System is designed to prevent fuel vapors from escaping into the atmosphere.

(The ORVR system is designed to allow the vapors from the fuel tank to be loaded into a canister while refueling at the gas station, preventing the escape of fuel vapors into the atmosphere.)



### **Canister**

Fuel vapors generated inside the fuel tank are absorbed and stored in the onboard canister. When the engine is running, the fuel vapors absorbed in the canister are drawn into the surge tank through the purge control solenoid valve.

### **Purge Control Solenoid Valve (PCSV)**

The purge control solenoid valve is controlled by the Engine Control Module (ECM); when the engine coolant temperature is low during idling, the PCSV closes so that evaporated fuel is not taken into the engine. After the engine warms-up during ordinary driving, the PCSV opens to introduce evaporated fuel to the engine.

### **3. Exhaust emission control system**

The Exhaust Emission Control System is a highly effective system which controls exhaust emissions while maintaining good vehicle performance.

#### **Vehicle modifications**

This vehicle should not be modified. Modification of your vehicle could affect its performance, safety or durability and may even violate governmental safety and emissions regulations.

In addition, damage or performance problems resulting from any modification may not be covered under warranty.

- If you use unauthorized electronic devices, it may cause the vehicle to operate abnormally, wire damage, battery discharge and fire. For your safety, do not use unauthorized electronic devices.

### **Engine exhaust gas precautions (carbon monoxide)**

- Carbon monoxide can be present with other exhaust fumes. Therefore, if you smell exhaust fumes of any kind inside your vehicle, have it inspected and repaired immediately. If you ever suspect exhaust fumes are coming into your vehicle, drive it only with all the windows fully open. Have your vehicle checked and repaired immediately.

#### **⚠ WARNING - Exhaust**

**Engine exhaust gases contain carbon monoxide (CO). Though colorless and odorless, it is dangerous and could be lethal if inhaled. Follow the instructions on this page to avoid CO poisoning.**

**⚠ CALIFORNIA PROPOSITION 65 WARNING**

Engine exhaust and a wide variety of automobile components and parts, including components found in the interior furnishings in a vehicle, contain or emit chemicals known to the State of California to cause cancer and birth defects and reproductive harm. In addition, certain fluids contained in vehicles and certain products of component wear contain or emit chemicals known to the State of California to cause cancer and birth defects or other reproductive harm.

- Do not operate the engine in confined or closed areas (such as garages) any more than what is necessary to move the vehicle in or out of the area.
- When the vehicle is stopped in an open area for more than a short time with the engine running, adjust the ventilation system (as needed) to draw outside air into the vehicle.
- Never sit in a parked or stopped vehicle for any extended time with the engine running.
- When the engine stalls or fails to start, excessive attempts to restart the engine may cause damage to the emission control system.

**⚠ WARNING - Catalytic converter**

Keep away from the catalytic converter and exhaust system while the vehicle is running or immediately thereafter. The exhaust and catalytic systems are very hot and may burn you.

***Operating precautions for catalytic converters (if equipped)*****⚠ WARNING - Fire**

- Do not park, idle or drive the vehicle over or near flammable objects, such as grass, vegetation, paper, leaves, etc. A hot exhaust system can ignite flammable items under your vehicle.
- Also, do not remove the heat sink around the exhaust system, do not seal the bottom of the vehicle or do not coat the vehicle for corrosion control. It may present a fire risk under certain conditions.

Your vehicle is equipped with a catalytic converter emission control device.

Therefore, the following precautions must be observed:

- Use only UNLEADED FUEL for gasoline engines.
- Do not operate the vehicle when there are signs of engine malfunction, such as misfire or a noticeable loss of performance.
- Do not misuse or abuse the engine. Examples of misuse are coasting with the ignition off and descending steep grades in gear with the ignition off.
- Do not operate the engine at high idle speed for extended periods (5 minutes or more).
- Do not modify or tamper with any part of the engine or emission control system. All inspections and adjustments must be made by an authorized HYUNDAI dealer.
- Avoid driving with an extremely low fuel level. Running out of fuel could cause the engine to misfire, damaging the catalytic converter.

Failure to observe these precautions could result in damage to the catalytic converter and to your vehicle. Additionally, such actions could void your warranties.

### **CALIFORNIA PERCHLORATE NOTICE**

Perchlorate Material-special handling may apply, See [www.dtsc.ca.gov/hazardouswaste/perchlorate](http://www.dtsc.ca.gov/hazardouswaste/perchlorate).

Notice to California Vehicle Dismantlers: Perchlorate containing materials, such as air bag inflators, seatbelt pretensioners and keyless remote entry batteries, must be disposed of according to Title 22 California Code of Regulations Section 67384.10 (a).

# Specifications, Consumer information and Reporting safety defects

Engine .....	8-2
Dimensions .....	8-2
Bulb wattage.....	8-2
Tires and wheels.....	8-3
Weight and volume .....	8-4
Air conditioning system.....	8-4
Recommended lubricants and capacities .....	8-5
• Recommended SAE viscosity number.....	8-6
Vehicle identification number (VIN) .....	8-7
Vehicle certification label .....	8-7
Tire specification and pressure label .....	8-8
Engine number.....	8-8
Refrigerant label .....	8-8
Consumer information .....	8-9
Reporting safety defects .....	8-10

## ENGINE

Item		Gasoline 3.3L
Displacement	cu. in (cc)	203.9 (3342)
Bore x Stroke	in (mm)	3.62 x 3.30 (92 x 83.8)
Firing order		1-2-3-4-5-6
No. of cylinders		6, V-type

## DIMENSIONS

Item	in (mm)	
Overall length	193.7 (4920)	
Overall width	73.2 (1860)	
Overall height	57.9 (1471)	
Front tread	P 245/45 R18	63.2 (1606)
	P 245/40 R19	63.1 (1602)
Rear tread	P 245/45 R18	63.3 (1607)
	P 245/40 R19	63.1 (1603)
Wheelbase	112.0 (2845)	

## BULB WATTAGE

Light Bulb		Wattage	Bulb type	
Front	Headlights (Low)	55 or 35 (HID)	H7 or D1S	
	Headlights (High)/DRL*1	55	H7	
	Front turn signal light	21	HY21W	
	Position light	LED	LED	
	Side repeater light	LED	LED	
	Front fog light	Type A	51	HB4
		Type B	LED	LED
	Front side marker	LED	LED	
Rear	Stop light	LED	LED	
	Tail light	LED	LED	
	Rear turn signal light	27	PY27W	
	Back-up light	16	W16W	
	High mounted stop light	LED	LED	
	License plate light	5	W5W	
	Rear side marker	LED	LED	
Interior	Map lamp	LED	LED	
	Room lamp	LED	LED	
	Luggage lamp	5	FESTOON	
	Glove box lamp	5	FESTOON	
	Vanity mirror lamp	LED	LED	

\*1 DRL : Daytime Running Light

## TIRES AND WHEELS

Item	Tire size	Wheel size	Inflation pressure bar psi (kPa)				Wheel lug nut torque lb•ft (kg•m, N•m)
			Normal load *1		Maximum load		
			Front	Rear	Front	Rear	
Full size tire	P245/45R18	7.5Jx18	33 (230)	33 (230)	33 (230)	33 (230)	65~79 (9~11, 88~107)
	P245/40R19	8.0Jx19	33 (230)	33 (230)	33 (230)	33 (230)	
Compact spare tire	T135/80D17	4.0Tx17	60 (420)	60 (420)	60 (420)	60 (420)	

\*1: Normal load : Up to 3 persons

### \* NOTICE

It is permissible to add 3psi to the standard tire pressure specification if colder temperatures are expected soon. Tires typically loose 1psi for every 12°F temperature drop. If extreme temperature variations are expected, re-check your tire pressure as necessary to keep them properly inflated.

## WEIGHT AND VOLUME

Item	Gasoline 3.3L
Gross vehicle weight lbs (kg)	4806 (2180)
Luggage volume cu ft (l)	16.0 (454)

## AIR CONDITIONING SYSTEM

Item	Weight of volume	Classification
Refrigerant	650±25g	R-134a
Compressor oil	100±10cc	PAG (FD46 X G)

## RECOMMENDED LUBRICANTS AND CAPACITIES

To help achieve proper engine and powertrain performance and durability, use only lubricants of the proper quality. The correct lubricants also help promote engine efficiency that results in improved fuel economy. These lubricants and fluids are recommended for use in your vehicle.

Lubricant	Volume	Classification
Engine oil <sup>*1</sup> <sup>*2</sup> (drain and refill) Recommends 	6.02 US qt. (5.7 l)	API Service SM <sup>*3</sup> , ILSAC GF-4 or above, ACEA A5
Automatic transaxle fluid	8.24 US qt. (7.8 l)	MICHANG ATF SP-4, SK ATF SP-4 NOCA ATF SP-4, HYUNDAI genuine ATF SP-4 or other brands meeting the above specification approved by HYUNDAI Motor Co.,
Coolant	8.88 US qt. (8.4 l)	Mixture of antifreeze and water (Ethylene glycol base coolant for aluminum radiator)
Brake fluid	0.7~0.8 US qt. (0.7~0.8 l)	FMVSS116 DOT-3 or DOT-4
Fuel	18.49 US gal. (70 l)	Unleaded gasoline

\*1 Refer to the recommended SAE viscosity numbers on the next page.

\*2 Engine oils labeled Energy Conserving Oil are now available. Along with other additional benefits, they contribute to fuel economy by reducing the amount of fuel necessary to overcome engine friction. Often, these improvements are difficult to measure in everyday driving, but in a year's time, they can offer significant cost and energy savings.

\*3 If the API service SM or ACEA A5 engine oil is not available in your country, you are able to use API service SL or ACEA A3.



### Recommended SAE viscosity number

Always be sure to clean the area around any filler plug, drain plug, or dipstick before checking or draining any lubricant. This is especially important in dusty or sandy areas and when the vehicle is used on unpaved roads. Cleaning the plug and dipstick areas will prevent dirt and grit from entering the engine and other mechanisms that could be damaged.

Engine oil viscosity (thickness) has an effect on fuel economy and cold weather operating (engine start and engine oil flowability). Lower viscosity engine oils can provide better fuel economy and cold weather performance, however, higher viscosity engine oils are required for satisfactory lubrication in hot weather. Using oils of any viscosity other than those recommended could result in engine damage.

When choosing an oil, consider the range of temperature your vehicle will be operated in before the next oil change. Proceed to select the recommended oil viscosity from the chart.

Temperature Range for SAE Viscosity Numbers										
Temperature	°C	-30	-20	-10	0	10	20	30	40	50
	(°F)	-10	0	20	40	60	80	100	120	
Gasoline Engine Oil *1		10W-30								
		5W-30								

\*1. For better fuel economy, it is recommended to use the engine oil of a viscosity grade SAE 5W-30 (API Service SM / ILSAC GF-4 / ACEA A5). However, if the engine oil is not available in your country, select the proper engine oil using the engine oil viscosity chart.



## VEHICLE IDENTIFICATION NUMBER (VIN)

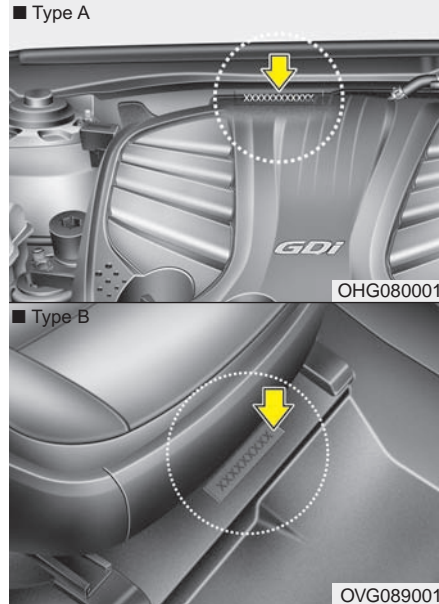

The vehicle identification number (VIN) is the number used in registering your car and in all legal matters pertaining to its ownership, etc.

The number is punched on the engine compartment bulkhead or on the floor under the front passenger's seat.

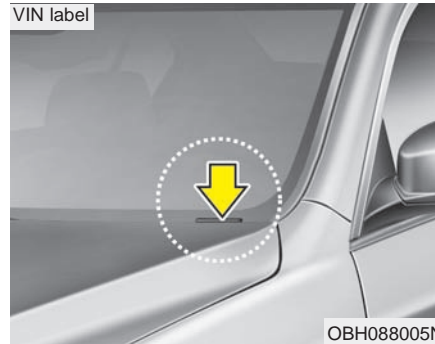

The VIN is also on a plate attached to the top of the dashboard. The number on the plate can easily be seen through the windshield from outside.

## VEHICLE CERTIFICATION LABEL

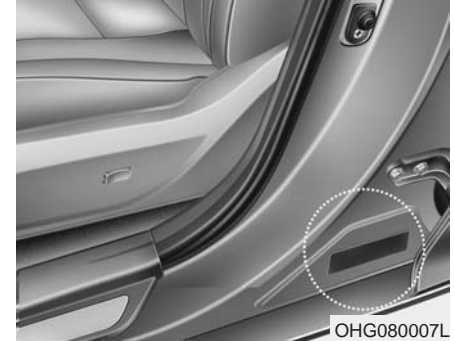

The vehicle certification label attached on the driver's (or front passenger's) side center pillar gives the vehicle identification number (VIN).

## TIRE SPECIFICATION AND PRESSURE LABEL



The tires supplied on your new vehicle are chosen to provide the best performance for normal driving. The tire label located on the driver's side center pillar gives the tire pressures recommended for your car.

## ENGINE NUMBER

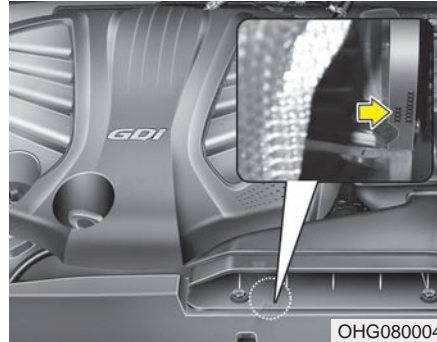

The engine number is stamped on the engine block as shown in the drawing.

## REFRIGERANT LABEL



The refrigerant label is located on the underside of the hood.

The label contains the following information:

- Type of refrigerant
- Amount of refrigerant

## CONSUMER INFORMATION

This consumer information has been prepared in accordance with regulations issued by the National Highway Traffic Safety Administration of the U.S. Department of Transportation. Your Hyundai dealer will help answer any questions you may have as you read this information.

Hyundai motor vehicles are designed and manufactured to meet or exceed all applicable safety standards.

For your safety, however, we strongly urge you to read and follow all directions in this Owner's Manual, particularly the information under the headings "**NOTICE**", "**CAUTION**" and "**WARNING**".

If, after reading this manual, you have any questions regarding the operation of your vehicle, please contact your nearest Hyundai Motor America Regional Office as listed in the following:

**Eastern Region:** Connecticut, Delaware, Maine, Massachusetts, New Hampshire, New Jersey, New York, Pennsylvania, Rhode Island, Vermont.

Eastern Region  
1122 Cranbury South River Road  
Jamesburg, NJ 08831  
(800) 633-5151

**Southern Region:** Florida, Georgia, Maryland, North Carolina, South Carolina, Virginia, West Virginia.

Southern Region  
3025 Chastain Meadows Parkway  
suite 100 Marietta, GA 30066  
(800) 633-5151

**South Central Region:** Alabama, Arkansas, Louisiana, Mississippi, New Mexico, Oklahoma, Tennessee, Texas.

South Central Region  
1421 South Beltline Road,  
Suite 400 Coppell, TX 75019  
(800) 633-5151

**Central Region:** Illinois, Indiana, Iowa, Kentucky, Michigan, Minnesota, Nebraska, North Dakota, South Dakota, Ohio, Wisconsin, Kansas, Missouri.

Central Region  
1705 Sequoia Drive  
Aurora, Illinois 60506  
(800) 633-5151

**Western Region:** Alaska, Arizona, California, Colorado, Hawaii, Idaho, Montana, Nevada, Oregon, Utah, Washington, Wyoming.

Western Region  
10550 Talbert Avenue  
P.O.Box 20850  
Fountain Valley,  
California 92728-0850  
(800) 633-5151

## **REPORTING SAFETY DEFECTS**

If you believe that your vehicle has a defect which could cause a crash or could cause injury or death, you should immediately inform the National Highway Traffic Safety Administration (NHTSA) in addition to notifying HYUNDAI MOTOR AMERICA. If NHTSA receives similar complaints, it may open an investigation, and if it finds that a safety defect exists in a group of vehicles, it may order a recall and remedy campaign. However, NHTSA cannot become involved in individual problems between you, your dealer, or HYUNDAI MOTOR AMERICA.

To contact NHTSA, you may call the Vehicle Safety Hotline toll-free at 1-888-327-4236 (TTY: 1-800-424-9153); go to <http://www.safercar.gov>; or write to: Administrator, NHTSA, 1200 New Jersey Avenue, SE West Building Washington, DC 20590. You can also obtain other information about motor vehicle safety from <http://www.safercar.gov>.

# Index

## Index

### A

Active ECO system.....	5-56
Air bag warning label .....	3-60
Air bag warning light .....	3-39
Air bags.....	3-36
Air bag warning label.....	3-60
Air bag warning light .....	3-39
Curtain air bag .....	3-51
Driver's and passenger's front air bag .....	3-47
Occupant classification system .....	3-42
Side impact air bag.....	3-50
SRS components and functions .....	3-39
Air cleaner .....	7-29
Air ventilation seat (front) .....	3-10
Anti-lock brake system (ABS) .....	5-29
Appearance care .....	7-72
Exterior care .....	7-72
Interior care .....	7-78
Armrest (rear) .....	3-14
Ashtray .....	4-139
Audio system .....	4-147
Automatic climate control system.....	4-113, 4-124
Air conditioning .....	4-120, 4-131
Automatic heating and air conditioning .....	4-114, 4-125
Climate control air filter .....	4-123, 4-133
Manual heating and air conditioning .....	4-115, 4-126

Automatic transaxle .....	5-10
Sports mode .....	5-12
Shift lock system .....	5-14
Aux, USB and iPod® port .....	4-147

### B

Base curb weight .....	5-87
Battery.....	7-34
Battery replacement (Smart key) .....	4-10
Battery saver function.....	4-100
Before driving.....	5-3
Blind spot detection system (BSD) .....	5-57
BSD (Blind Spot Detection) /	
LCA (Lane Change Assist) .....	5-58
RCTA (Rear Cross Traffic Alert) .....	5-61
<i>Bluetooth</i> ® Wireless Technology .....	4-147
Bottle holders, see cup holders.....	4-139
Brake fluid .....	7-27
Brake system.....	5-16
Electronic parking brake (EPB) .....	5-19
Auto hold .....	5-25
Anti-lock brake system (ABS).....	5-29
Electronic stability control (ESC) .....	5-30
Hill-start assist control (HAC) .....	5-35
Parking brake .....	5-18
Power brakes .....	5-16
Vehicle stability management (VSM) .....	5-34

- Bulb replacement, see light bulbs .....7-63
- Bulb wattage .....8-2
- Button start/stop, see engine start/stop button .....5-5

## C

- California perchlorate notice .....7-82
- Capacities (Lubricants) .....8-5
- Care
  - Exterior care .....7-72
  - Interior care .....7-78
  - Tire care .....7-37
- Cargo capacity .....5-84
- Cargo weight.....5-87
- Center console storage .....4-137
- Central door lock switch.....4-17
- Certification label .....5-85, 8-7
- Chains
  - Tire chains .....5-79
- Changing tires .....6-14
- Checking tire inflation pressure .....7-38
- Child restraint system .....3-28
  - Lower anchor .....3-34
  - Seat belt .....3-30
  - Tether anchor system .....3-33
- Child-protector rear door lock .....4-18
- Climate control air filter .....4-123, 4-133
- Climate control air filter replacement.....7-30
- Clock (Digital) .....4-142

- Clothes hanger .....4-143
- Combined instrument, see instrument cluster .....4-58
- Compact spare tire .....6-18
- Compact spare tire replacement .....7-41
- Coolant .....7-24
- Cooling fluid, see engine coolant .....7-24
- Crankcase emission control system .....7-79
- Cruise control system .....5-38
- Cup holder .....4-139
- Cup holder (rear) .....3-15
- Curtain air bag .....3-51

## D

- Dashboard illumination, see instrument panel
  - illumination .....4-59
- Dashboard, see instrument cluster .....4-58
- Daytime running light (DRL).....4-101
- Defogging (Windshield) .....4-135
- Defogging logic (Windshield) .....4-137
- Defroster (Rear window) .....4-112
- Defrosting (Windshield) .....4-136
- Digital clock .....4-142
- Dimensions .....8-2
- Display illumination, see instrument panel
  - illumination .....4-59
- Displays, see instrument cluster .....4-58
- Door courtesy lamp .....4-111



## Index

Door locks.....	4-15
Central door lock switch .....	4-17
Child-protector rear door lock .....	4-18
Drinks holders, see cup holders .....	4-139
Driver position memory system .....	4-41
Easy access function .....	4-42
Driver's 3-point seat belt.....	3-19
Driver's and passenger's front air bag.....	3-47
Driving at night.....	5-76
Driving in flooded areas .....	5-77
Driving in the rain.....	5-77

## E

Economical operation .....	5-73
Electric chromic mirror (ECM) with	
HomeLink® system and compass .....	4-46
Electronic power steering (EPS).....	4-43
Electronic parking brake (EPB) .....	5-19
Electronic stability control (ESC) .....	5-30
Emergency starting .....	6-5
Jump starting .....	6-5
Push starting .....	6-6
Emergency towing .....	6-22
Emergency trunk safety release .....	4-20
Emergency while driving .....	6-3

Emission control system.....	7-79
Crankcase emission control system .....	7-79
Evaporative emission control system.....	7-79
Exhaust emission control system .....	7-80
Engine (Specification) .....	8-2
Engine compartment .....	2-6, 7-3
Engine compartment fuse replacement .....	7-53
Engine coolant .....	7-24
Engine coolant temperature gauge .....	4-60
Engine number .....	8-8
Engine oil .....	7-23
Engine overheat .....	6-7
Engine start/stop button .....	5-5
Engine will not start .....	6-4
Evaporative emission control system .....	7-79
Exhaust emission control system .....	7-80
Explanation of scheduled maintenance items .....	7-20
Exterior care .....	7-72
Exterior overview (front) .....	2-2
Exterior overview (rear) .....	2-3

## F

Flat tire .....	6-13
Changing tires .....	6-14
Compact spare tire .....	6-18
Jack and tools .....	6-13
Removing and storing the spare tire .....	6-14

Floor mat anchor(s) .....	4-143
Fluid	
Brake fluid .....	7-27
Washer fluid .....	7-28
Folding the rear seat .....	3-15
Foward collision warning system (FCWS) .....	5-69
Front passenger and rear seat belt .....	3-21
Front seat adjustment .....	3-4
Cushion extension .....	3-6
Forward and rearward .....	3-5
Lumber support .....	3-6
Seat cushion height .....	3-5
Seatback angle .....	3-5
Fuel filler lid .....	4-31
Emergency fuel filler lid release .....	4-34
Fuel gauge.....	4-60
Fuel requirements .....	1-3
Fuse switch .....	7-53
Fuse/relay panel description .....	7-55
Fuses .....	7-51
Instrument panel fuse replacement .....	7-52
Engine compartment fuse replacement .....	7-53
Fuse switch.....	7-53
Fuse/relay panel description.....	7-55
Main fuse .....	7-54
Multi fuse .....	7-54

**G**

Gauge	
Engine coolant temperature gauge.....	4-52
Fuel gauge .....	4-52
GAW (Gross axle weight) .....	5-87
GAWR (Gross axle weight rating) .....	5-87
Glass antenna .....	4-145
Glassroof, see panorama sunroof .....	4-35
Glove box .....	4-138
Glove box lamp.....	4-111
GVW (Gross vehicle weight) .....	5-87
GVWR (Gross vehicle weight rating) .....	5-87

**H**

Hazard warning flasher .....	4-100, 6-2
Hazardous driving conditions .....	5-75
Headlight (Headlamp) escort function .....	4-101
Headlight (Headlamp) welcome function .....	4-101
Headrest (front).....	3-6
Headrest (rear) .....	3-12
Height adjustment (Seat belt) .....	3-20
Highway driving .....	5-78
Hill-start assist control (HAC) .....	5-35
Hood .....	4-29
Horn .....	4-45
How to use this manual .....	1-2

## Index

---

### I

Immobilizer system .....	4-4
Indicators and warnings .....	4-77
Inside rearview mirror .....	4-46
Instrument cluster .....	4-58
Engine coolant temperature gauge .....	4-60
Fuel gauge .....	4-60
Instrument panel illumination .....	4-59
LCD display .....	4-63
LCD display warnings and indicators .....	4-77
Odometer .....	4-61
Speedometer .....	4-59
Tachometer .....	4-59
Trip computer mode .....	4-64
User settings mode .....	4-68
Warning and indicators .....	4-77
Instrument panel fuse replacement .....	7-52
Instrument panel illumination .....	4-59
Instrument panel overview .....	2-5
Interior care .....	7-78
Interior features	
Ashtray .....	4-139
Clothes hanger .....	4-143
Cup holder .....	4-139
Digital clock .....	4-142

Floor mat anchor(s) .....	4-143
Power outlet .....	4-141
Rear curtain .....	4-144
Side curtain .....	4-145
Sunvisor .....	4-140
Interior light .....	4-109
Door courtesy lamp .....	4-111
Glove box lamp .....	4-111
Map lamp .....	4-109
Mood lamp .....	4-110
Room lamp .....	4-110
Trunk room lamp .....	4-110
Vanity mirror lamp .....	4-111
Interior overview .....	2-4

### J

Jack and tools .....	6-13
Jump starting .....	6-5

### K

Keys .....	4-3
------------	-----

**L**

Label

- Air bag warning label.....3-60
- Refrigerant label.....8-8
- Tire sidewall labeling.....7-43
- Tire specification and pressure label .....8-8
- Vehicle certification label.....8-7
- Jack label .....6-20
- Lane departure warning system (LDWS).....5-65
- LCD display .....4-63
  - LCD modes .....4-63
  - Trip computer mode.....4-64
  - Turn By Turn (TBT) mode.....4-65
  - LDWS Mode .....4-65
  - A/V mode.....4-65
  - Information mode.....4-66
- LCD display warnings and indicators .....4-77
- Light bulbs .....7-63
  - Headlight, position light, turn signal light, front fog light bulb replacement .....7-63
  - High mounted stop light replacement .....7-69
  - Interior light bulb replacement.....7-70
  - License plate light bulb replacement .....7-69
  - Rear combination light bulb replacement .....7-67
  - Side repeater light bulb replacement .....7-67

- Lighting.....4-100
  - Battery saver function .....4-100
  - Auto light position .....4-103
  - Daytime running light (DRL) .....4-101
  - Front fog light .....4-106
- Lighting control
  - Headlight (Headlamp) escort function.....4-101
  - Headlight (Headlamp) welcome function .....4-101
  - Headlight position .....4-102
  - High beam operation .....4-103
  - Parking light position .....4-102
  - Smart High Beam.....4-104
  - Turn signals and lane change signals.....4-105
- Lower anchor .....3-34
- Lubricants and capacities .....8-5

**M**

Maintenance

- Explanation of scheduled maintenance items .....7-20
- Maintenance services .....7-4
- Maintenance under severe usage conditions .....7-19
- Normal maintenance schedule .....7-9
- Owner maintenance .....7-6
- Scheduled maintenance service .....7-8
- Tire maintenance .....7-42

## Index

Maintenance schedule.....	7-8
Maintenance under severe usage conditions .....	7-19
Normal maintenance schedule .....	7-9
Main fuse .....	7-54
Map lamp .....	4-109
Mirrors .....	4-46
Electric chromic mirror (ECM) with	
HomeLink® system and compass .....	4-46
Inside rearview mirror .....	4-46
Outside rearview mirror .....	4-54
Reverse parking aid .....	4-57
Mood lamp .....	4-110
Moonroof, see panoramic sunroof .....	4-35
Multi fuse .....	7-54
Multimedia system .....	4-145
Audio system .....	4-147
Aux, USB and iPod® port .....	4-147
Bluetooth® Wireless Technology .....	4-147
Glass antenna .....	4-145
Navigation system .....	4-147
Shark fin antenna .....	4-145
Steering wheel audio control .....	4-146

## N

Navigation system.....	4-147
------------------------	-------

## O

Occupant classification system.....	3-42
Odometer .....	4-61
Oil (Engine) .....	7-23
Outside rearview mirror .....	4-54
Overheat (Engine).....	6-7
Owner maintenance .....	7-6

## P

Panoramic sunroof .....	4-35
Parking brake.....	5-18, 7-28
Power brakes.....	5-16
Power outlet .....	4-141
Power window lock button .....	4-28
Pre-tensioner seat belt.....	3-22
Push starting .....	6-6

## R

Rear curtain.....	4-144
Rear parking assist system .....	4-95
Rear seat .....	3-12
Rearview camera.....	4-99
Recommended cold tire inflation pressures .....	7-37

Recommended lubricants and capacities .....8-5  
 Recommended SAE viscosity number.....8-6  
 Refrigerant label .....8-8  
 Remote keyless entry system .....4-8  
 Removable towing hook .....6-22  
 Replacement light bulb, see light bulbs .....7-63  
 Reverse parking aid function .....4-57  
 Road warning .....6-2  
 Rocking the vehicle .....5-75  
 Room lamp .....4-110

**S**

Scheduled maintenance service .....7-8  
 Normal maintenance schedule .....7-9  
 Maintenance under severe usage conditions .....7-19  
 Seat belt warning .....3-18  
 Seat belts .....3-17  
 Height adjustment .....3-20  
 Pre-tensioner seat belt .....3-22  
 Seat belt - Driver's 3-point system .....3-19  
 Seat belt warning .....3-18  
 Seat belts - Front passenger and rear seat .....3-21  
 Seat warmer (front).....3-9  
 Seat warmer (rear) .....3-13  
 Seatback pocket .....3-11  
 Seating capacity .....5-83

Seats .....3-2  
 Air ventilation seat (front) .....3-10  
 Armrest (rear).....3-14  
 Cup holder (rear) .....3-15  
 Folding the rear seat.....3-15  
 Front seat adjustment .....3-4  
 Headrest (front) .....3-6  
 Headrest (rear) .....3-12  
 Rear seat .....3-12  
 Seat warmer (front) .....3-9  
 Seat warmer (rear) .....3-13  
 Seatback pocket .....3-11  
 Shift lock system .....5-14  
 Side curtain .....4-145  
 Side impact air bag .....3-50  
 Smart cruise control system .....5-42  
 Smart high beam .....4-104  
 Smart key .....4-6  
 Battery replacement .....4-10  
 Remote keyless entry system .....4-8  
 Smart trunk .....4-21  
 Smooth cornering .....5-75  
 Snow tires .....5-78  
 Spare tire  
 Compact spare tire .....6-18  
 Compact spare tire replacement .....7-41  
 Removing and storing the spare tire .....6-14

## Index

Special driving conditions .....	5-75
Driving at night .....	5-76
Driving in flooded areas.....	5-77
Driving in the rain .....	5-77
Hazardous driving conditions .....	5-75
Highway driving.....	5-78
Rocking the vehicle .....	5-75
Smooth cornering.....	5-76
Speedometer .....	4-59
Sports mode .....	5-12
SRS components and functions .....	3-38
Starting difficulties, see engine will not start .....	6-4
Steering wheel .....	4-43
Electronic power steering (EPS) .....	4-43
Horn .....	4-45
Tilt and telescopic steering.....	4-44
Steering wheel audio control .....	4-146
Steps For Determining Correct Load Limit .....	5-84
Storage compartment .....	4-137
Center console storage .....	4-137
Glove box .....	4-137
Sunglass holder .....	4-138
Sunglass holder.....	4-138
Sunroof, see panoramic sunroof .....	4-35
Sunvisor .....	4-140
Sunvisor lamp, see vanity mirror lamp.....	4-111

## T

Tachometer .....	4-59
Tether anchor system .....	3-33
Theft-alarm system .....	4-12
Tie-down hook .....	6-24
Tilt and telescopic steering.....	4-44
Tire and loading information label .....	5-83
Tire chains.....	5-80
Tire pressure monitoring system (TPMS) .....	6-8
Tire specification and pressure label .....	8-8
Tires and wheels .....	7-37
Checking tire inflation pressure .....	7-38
Compact spare tire replacement.....	7-41
Low aspect ratio tire.....	7-46
Recommended cold tire inflation pressures .....	7-37
Tire care .....	7-37
Tire maintenance .....	7-42
Tire replacement .....	7-40, 8-3
Tire rotation .....	7-39
Tire sidewall labeling .....	7-43
Tire traction .....	7-42
Wheel alignment and tire balance .....	7-40
Wheel replacement .....	7-42, 8-3

Towing .....6-21  
 Emergency towing .....6-22  
 Removable towing hook .....6-22  
 Tie-down hook .....6-24  
 Towing capacity .....5-60  
 Trailer towing .....5-64  
 Transaxle  
     Automatic transaxle .....5-10  
 Trip computer .....4-73  
 Trunk.....4-19  
     Emergency trunk safety release .....4-20  
 Trunk room lamp .....4-110  
 Turn signals and lane change signals .....4-105  
     One-touch turn signal.....4-106

**U**

User settings mode (LCD display) .....4-68

**V**

Vanity mirror lamp .....4-111  
 Vehicle break-in process .....1-6  
 Vehicle capacity weight .....5-84  
 Vehicle certification label .....8-7  
 Vehicle curb weight .....5-87  
 Vehicle data collection and event data recorders .....1-7  
 Vehicle identification number (VIN) .....8-7  
 Vehicle load limit .....5-83  
     Cargo capacity .....5-84  
     Certification label.....5-86  
     Seating capacity .....5-84  
     Steps For Determining Correct Load Limit.....5-84  
     Tire and loading information label.....5-84  
     Towing capacity .....5-84  
     Vehicle capacity weight .....5-84  
 Vehicle stability management (VSM) .....5-34  
 Vehicle weight  
     Base curb weight .....5-87  
     Cargo weight .....5-87  
     GAW (Gross axle weight) .....5-87  
     GAWR (Gross axle weight rating).....5-87  
     GVW (Gross vehicle weight).....5-87  
     GVWR (Gross vehicle weight rating) .....5-87  
     Vehicle curb weight .....5-87



**W**

Warning and indicators .....4-77

Warnings and indicators (LCD display) .....4-63

Washer fluid .....7-28

Weight and volume .....8-4

Wheel alignment and tire balance .....7-40

Wheel replacement .....7-42

Windows .....4-25

    Auto up/down window .....4-27

    Power window lock button.....4-28

Windshield defrosting and defogging.....4-135

    Defogging logic .....4-137

Winter driving .....5-79

    Snow tires .....5-79

    Tire chains .....5-80

Wiper blades .....7-32

Wipers and washers .....4-107