

BMW M5



The Ultimate Driving Machine®



# THE BMW M5.

UNTOUCHABLE.

# HIGH-PERFORMANCE LUXURY, PERFECTED.

For those seeking the ultimate in elegant thrills, there's a high-powered player in the game. The BMW M5 boasts stunning muscle, intelligent technology, sensuous comforts and distinctive visual flair – all in a package designed and integrated from the ground up to outperform the competition in all aspects. With its host of personalizing and exclusive options, the M5 is almost more of an immersive experience than it is a vehicle. Get behind the wheel – and get ready to make your mark.

## THE BMW M5.







## The BMW M5

### INSPIRING POWER, INCREDIBLY EXECUTED.

- 06 Interior**  
For the M5, every suit is a strong one.
- 08 Exterior**  
Design in the name of performance.
- 12 Performance**  
You're in for an amazing drive.
- 16 Comfort**  
A personalized experience.
- 18 Business jet**  
M5 insights from Maximilian Ahme, BMW M project engineer.

[bmwusa.com/M](http://bmwusa.com/M)

## Technology

### POWER MEETS EFFICIENCY.

- 20 M TwinPower Turbo V-8 engine**  
M Power performance with optimum efficiency.
- 22 M DCT with Drivelogic and Active M Differential**  
Perfection at the limit.
- 24 Chassis and brakes**  
From the racetrack to the road.
- 26 40 years of BMW M**
- 28 BMW ConnectedDrive**  
Convenience, infotainment and safety technologies meet in one suite.

## Equipment

### M POWER YOUR PERSONALIZATION.

- 32 Exterior and upholstery colors**
- 34 Headliner colors and interior trims**
- 35 Recommended color combinations**
- 36 Equipment features and options**

[bmwusa.com](http://bmwusa.com)

## Overview

### THE BMW M5 AT A GLANCE.

- 38 BMW M School**
- 39 Build Your Own**
- 40 Technical data**
- 42 BMW Services**  
Exclusive offers for BMW customers.

[bmwusa.com/byo](http://bmwusa.com/byo)



Want the inside scoop on BMW?  
You can find us on Facebook® at  
[facebook.com/bmwusa](https://www.facebook.com/bmwusa).

## Editorial

# A 560-HP DOUBLE AGENT.

A lightning-quick track all-star – or a boardroom baron with a serious competitive streak? Heir to BMW's high-performance heritage, the M5 raises as many questions as it answers. It's time to take a business meeting – and the BMW M5 definitely means business.

From its 560-hp M-tuned TwinPower Turbo V-8 engine, to the bespoke luxury of its spacious interior, to the meticulously designed and integrated M "specifics" – such as signature M gills and exclusive paint choices – the M5 straddles the line between high-performance superstar and sublime luxury vehicle.

Put any question of identity crisis out of your mind: like all M vehicles, the M5 performs exactly as intended without compromises, whether delivering you to the office or from the stress and confines of daily driving. Seem impossible? It's no coincidence. After all, magic also starts with the letter "M."

[bmwusa.com/M](http://bmwusa.com/M)

#### Equipment of model shown: BMW M5 Sedan

Engine:	M TwinPower Turbo V-8 engine
Nominal output:	560 hp
Wheels:	M Double Spoke (Style 343M) 20" forged light alloy wheels
Exterior color:	Monte Carlo Blue Metallic
Upholstery:	M Multi-contour front seats in Silverstone II Extended Merino Leather, including Alcantara Anthracite headliner
Interior trim:	Aluminum Trace

For information on vehicle specifications, please see pages 40-41.



Information Provided by:

**DEALER**  
E-PROCESS

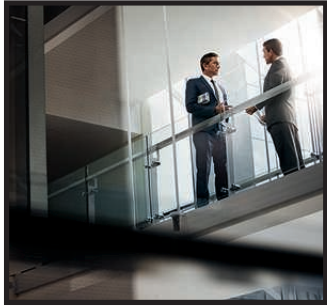

// FOR THE M5,  
EVERY SUIT IS  
A STRONG ONE.

**PERFORMANCE THAT'S PERFECTLY MATCHED TO ANY OCCASION.**

Talk about making great first impressions. At a glance, the elegant contours, aggressive styling and distinctive details of this powerhouse hint at the glory and elegance of its race-inspired heritage. But take the wheel and set foot on the

accelerator pedal, and you'll quickly know for sure the true personality of this M masterpiece. And with ample, luxurious space for five, all who step inside find the M5 the most persuasive and exhilarating conference room ever created.

European image shown.





// SHOW THEM WHAT YOU STAND FOR.

**SOMETIMES ALL IT TAKES IS ONE LOOK TO FALL IN LOVE.**

Onlookers may not be able to take in every detail of the BMW M5 as it goes by in a blur of Monte Carlo Blue Metallic paint. It may be necessary to slow down in order to show off the forged 20-inch M Double Spoke alloy wheels, the three large air intakes at the front apron, the elegantly flared wheel arches and the large high-performance compound brakes. However, the BMW M5 is that rare vehicle that looks just as stunning at high speed as it does standing still. The visual feast continues with a smorgasbord of M-exclusive cues, with aerodynamic M exterior mirrors, signature M gills, M rear spoiler and quad tailpipes all contributing to the dynamic, aggressive look of the BMW M5.

Get the latest information on BMW standard and optional features, packages and technical specifications. Visit [bmwusa.com](http://bmwusa.com), select the BMW model of your choice, and click on "Features & Specs."







// ALL IN THE NAME  
OF PERFORMANCE.

---

**INSPIRING POWER,  
INCREDIBLY EXECUTED.**

---

Engineered to leave the competition in the dust, the BMW M5 delivers all the goods associated with M vehicles – and then some. Its masterful M TwinPower Turbo V-8 yields an unexpected dividend: 10 percent more power on tap than its predecessor, yet a level of efficiency that's nearly 30 percent greater.

This is achieved through cutting-edge engine technologies like Valvetronic, BMW's throttleless intake technology. This potent combination of lean muscle and intelligent fuel consumption leads to a singular driving experience. One that we've proudly branded with the letter M.



// SET YOUR OWN PACE.

## YOU'RE IN CONTROL. AND IN FOR AN AMAZING DRIVE.

The myriad technologies and features inside the cabin of the M5 let you take your high-performance lifestyle with you. Get comfortable in the customized M Multi-contour seats, upholstered in plush Extended Merino Leather. Take hold of the specialized M Leather steering wheel, and you're ready to launch.

At a glance, the M-customized Head-up Display shows you exactly what you need to know: mph, rpm, fuel levels. Select your M Drive settings via two easy-access programmable buttons. Steering wheel-mounted paddle shifters, available with the M Double Clutch Transmission, send you from gear to gear with sporting ease. And a wealth of ConnectedDrive features keep you connected to your calendar, contacts and more.

Get the latest information on BMW standard and optional features, packages and technical specifications. Visit [bmwusa.com](http://bmwusa.com), select the BMW model of your choice, and click on "Features & Specs."



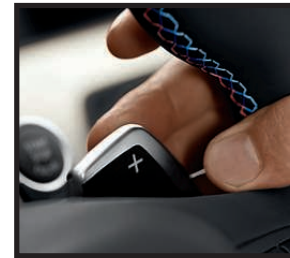

// EVERY MILE, AN ADVENTURE.  
EVERY ROAD, A REVELATION.

#### PASSION AND POWER COME ALIVE.

Lithe, graceful and domineering on every roadway, the BMW M5 moves unlike any other vehicle. That's no small feat. For every exciting mile, the M5 relies on some of BMW's most forward-thinking, track-tested engineering. In addition to the groundbreaking M-tuned V-8 engine, the M5's custom M Car suspension, extensive lightweight construction and advanced high-torque 7-speed M Double Clutch Transmission work together to produce truly staggering numbers: 560 hp, 500 lb-ft of torque, a 7000-rpm redline, and an exhilarating 0-60 time of just 4.2 seconds.<sup>1</sup>

It's not just the innovative hardware that propels the M5 forward. Advanced engine mapping and suspension technology also

contribute to its competitive spirit. There's Active M Differential – an electronically controlled multi-plate limited slip differential that maximizes traction along with sporty responsiveness and handling. Two M Drive buttons located on the steering wheel let you select from among three driving modes (COMFORT, SPORT and SPORT+), automatically recalibrating performance parameters, such as throttle response and suspension stiffness, to provide the ideal "fit" for the driver.

Taken together, these impressive driving technologies go hand-in-hand with the M5's innovative componentry to deliver incredible performance, every time.

<sup>1</sup> BMW AG preliminary test results. See page 40 for detailed technical data. BMW urges you to obey all posted speed laws and always wear safety belts.

Get the latest information on BMW standard and optional features, packages and technical specifications. Visit [bmwusa.com](http://bmwusa.com), select the BMW model of your choice, and click on "Features & Specs."

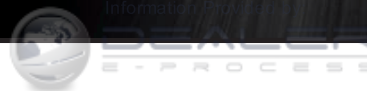





// WHEN IT COMES TO CHOICES,  
THE SKY'S THE LIMIT.

#### A PERSONAL EXPERIENCE, DESIGNED AROUND YOUR TASTES.

Prestige wears many outfits – yet few are as fitting as the BMW M5. Designed to comfort, support and inspire, the interior delivers a symphony of stylish elements. From the Anthracite Alcantara headliner to the M-exclusive door-sill finishers, every inch speaks to its racing heritage. Rich trims and accents, such as Aluminum Trace

and Dark Wood, please the eye. And for the ultimate in personalized luxury, there is a whole world of specialized paints, trims, headliners, upholstery colors and more available. However you choose to build your M5 Sedan, it's a drive you'll want to experience over and over again.

Get the latest information on BMW standard and optional features, packages and technical specifications. Visit [bmwusa.com](http://bmwusa.com), select the BMW model of your choice, and click on "Features & Specs."



# BUSINESS JET.



**Going from a meeting straight to the racetrack is possible only in the BMW M5. BMW M project engineer Maximilian Ahme is currently driving the sharpest company car in the world. We talk to him about the compelling character of this power sedan.**

For more than 25 years, the BMW M5 has been regarded as the sportiest sedan in the world. What makes the fifth-generation model even better than its predecessors?

**Ahme:** Like every previous BMW M5, it is a wolf in sheep's clothing. On the one hand it's a comfortable sedan, on the other a racing car. And both with state-of-the-art design and optimum efficiency.

So what are the figures behind this apparent contradiction?

Our V-8 engine with M TwinPower Turbo technology reaches 560 hp at 6,000–7,000 rpm and develops 500 lb-ft of torque. It is one of the few engines that unites two things: turbocharging and high engine speeds. Yet it also has

a remarkably low average fuel consumption – nearly 30 percent less than that of the previous model, even with its increased performance.

What technology enables this strong performance?

We work with two precisely responding chargers and a special manifold for the optimized exhaust system. On top of that, there's High Precision Injection, variable lift of the intake valves, and adjustable camshafts. And because our engine develops so much power, we completely filled the available space under the hood with coolers.

What are the special features of the cooling system?

It is an extremely complex solution with a lie-flat oil cooler and two external coolers for the charge air. We have one circuit for low temperatures and one for high. The charge air to each cylinder bank is cooled separately. We even air condition the engine electronics.

In addition to engine performance, BMW M5 drivers attach great importance to crisp handling and biting traction. What does the BMW M5 offer in these areas?

We continue to use the precise and sensitive hydraulic steering system. In conjunction with the powerful rear-wheel drive, the driver gets a genuine feel for the road and the forces on the front wheels. The Active M Differential lock also increases traction on the rear axle and provides even greater agility.

The previous lock was already a big plus point for high-powered driving and on fast bends or undulating roads. How is the new one better?

The Active M Differential lock adjusts electronically and in advance. The previous system locked only with wheelspin on the rear axle. Now we can steer the lock proactively. If the accelerator is engaged and the sensors anticipate wheelspin based on the current driving situation, locking torque is applied to the differential. This prevents a wheel from spinning. Power is optimally placed on the

tarmac and the driving situation is dynamically controlled. That feels better for the driver.

Are there any more advantages to the new rear-axle lock?

The new lock is completely off during normal driving, so the BMW M5 is even smoother when the driver brakes sharply or steers spontaneously. This was evident during our fine-tuning test drives on racetracks like the legendary Nürburgring. The lock also stabilizes the vehicle in high-speed lane or other load changes.

The technical finesse of the BMW M5 makes for a thrilling drive. You have already covered many miles in this sharp company car. What impresses you the most?

The unique technology. From the engine, the transmission and the electronic dampers to the completely reworked suspension, it's the perfect symbiosis of business and motorsport. On the one hand you can drive comfortably for long stretches and on the other, you can be ready for the racetrack at any time at the touch

of a button. The switch happens via the two M Drive buttons on the steering wheel. The driver can configure these in advance, according to preference. The result is a fantastic feeling: control and freedom.



The M-specific BMW Head-up Display projects all relevant driving data – and, if requested, Speed Limit Info – directly onto the windshield.



## POWER MEETS EFFICIENCY.

The numbers speak for themselves: 560 horsepower. A 7000-rpm redline. 4.2 seconds from 0-60.<sup>1</sup> The high-revving M TwinPower Turbo V-8 in the BMW M5 makes a singularly forceful statement when it comes to performance and acceleration.

Fully leveraging innovative BMW technology – Double-VANOS continuously variable camshaft timing, High Precision Direct Injection, and Valvetronic individual intake valve control that eliminates the need for a less-efficient throttle plate – the M5 generates an enormous 500 lb-ft of torque. This is available across a wide engine speed range, with emphatic forward thrust on tap from just over idle right through to high revs. A double turbocharger, combined with two large intercoolers to cool the engine and intake air, fully exploit the superb pulling power of this high-performance powerplant.

The M5's V-8 also sets benchmarks when it comes to the performance-to-fuel consumption ratio. BMW EfficientDynamics features include the energy-saving Auto Start-Stop function that turns off the engine while stopped and then restarts it automatically when you take your foot off the brake. Brake Energy Regeneration recovers energy output from the car's braking and then recycles it to help power the vehicle. The result is nearly one-third less fuel consumption than its predecessor<sup>2</sup> – exceptionally good highway fuel mileage for an ultra-high-power car.

And then there's the specially tuned M exhaust: an irresistible siren song for driving enthusiasts everywhere.

<sup>1</sup> BMW AG preliminary test results with 7-speed M DCT. See page 40 for detailed technical data. BMW urges you to obey all posted speed laws and always wear safety belts.  
<sup>2</sup> Preliminary – EU test cycle results.

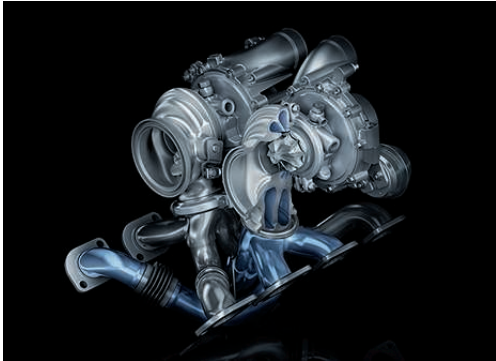

### M TwinScroll turbocharging for faster throttle response.

Turbochargers recycle exhaust pressure to drive a turbine that feeds high-pressure air to the engine. It's a clever and effective technology with one drawback: it takes time under acceleration to build exhaust pressure to spin the turbo. BMW M TwinScroll Turbo technology slashes this "turbo lag" by timing the exhaust pulses. Exhaust flows into the turbos from each of two cylinder paths with a 360-degree firing interval. This minimizes interference between exhaust pulses, optimizing energy transfer. What you feel is incredibly crisp throttle response.

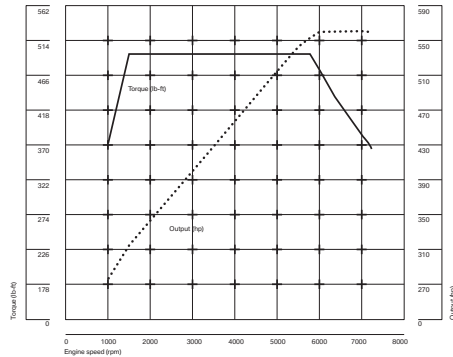

High torque is available across an extremely broad range of engine speeds – from 1500 rpm (a little more than idle) all the way to 5750 rpm. You experience power that responds fast and long across a wide range of acceleration starting points, for greater driving enjoyment.

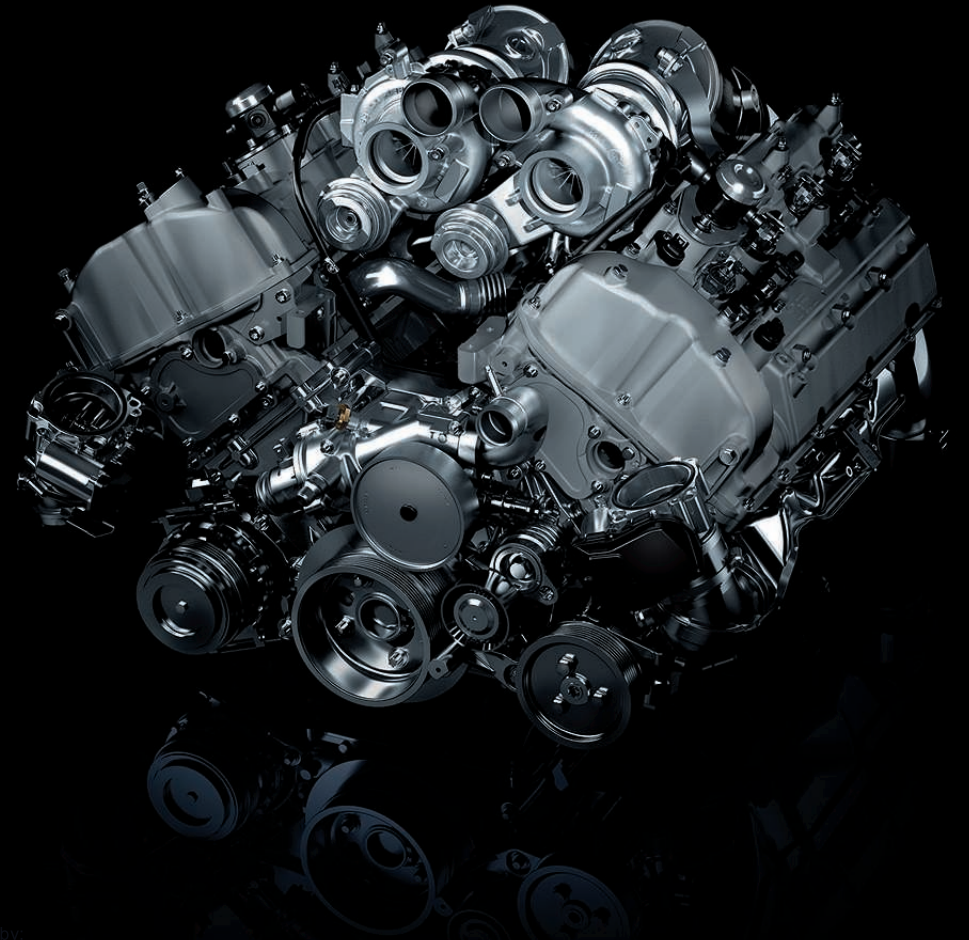

# PERFECTION AT THE LIMIT.



The extraordinary power of the BMW M5 requires the application of intelligent transmission and drivetrain systems for maximum efficiency – and driving fun. The racing-derived 7-speed M Double Clutch Transmission (M DCT) with Drivelogic can be personalized by the driver to match a wide range of preferences, from comfort to extreme sport. This dynamic transmission can operate in either fully automatic or automated manual mode. In the manual mode, you shift like a Grand Prix driver by flicking paddles just behind the steering wheel with your fingertips. Without taking your hands off the wheel – and with your foot firmly on the accelerator – you can quickly select one of seven gears, and the transmission does the rest. Whether changing gears up or down, the experience is exciting and rewarding.

Here's how it works. M Double Clutch Transmission is based on not one, but two partial transmissions housed inside the same gear case. One transmission contains gears 1, 3, 5 and 7; the other, gears 2, 4 and 6. Now here's the genius of it: say you're accelerating hard in gear 3 in one transmission. Before the shift to gear 4 is made, this next gear is already engaged and ready to go. To make the shift, M DCT doesn't push gears. Rather, it selects one of two clutches to instantly engage the next gear in the other transmission. Changing clutches, instead of physically

moving gears, is blindingly fast – and it can be executed with your right foot flat to the floor. To further improve acceleration, appropriately configured Drivelogic programs boost torque to a higher degree. Combined with the close ratio gaps between the seven gears, these programs help you feel each gear shift with an ever-increasing surge forward.

The M Double Clutch Transmission also automates a time-tested race-driving principle to improve vehicle dynamics when slowing for a corner: precisely matching engine rpm to the next-lowest gear during the shift. M DCT automates this function, precisely matching engine rpm to braking force to prevent sudden lurching when shifting down. Another aspect of Drivelogic gives you a choice of six drive programs – three in manual mode and three in automatic. Each offers a broad spectrum, from full-on sporting to smooth and effortless.

The transmission also offers another technology taken directly from racecars: Launch Control. This provides the BMW M5 with the just the right amount of power to the rear wheels for the best acceleration from a standing start to top speed. What you get is the power to apply power like never before.

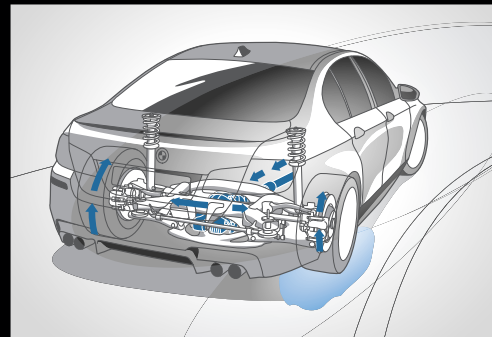

## Active M Differential optimizes traction for greater control.

This differential, the final gear unit connecting the transmission to the drive wheels, is electronically controlled and communicates with the Dynamic Stability Control (DSC) system to ensure intelligent application of engine torque in every driving situation, including high-speed cornering and variable road surfaces.



## ENGINEERED TO GO AROUND THE TRACK. OR JUST AROUND THE CORNER.

The BMW M5 Sedan doesn't conform to traditional rules. Instead, it is born of the free-spirited and innovative engineering philosophy of BMW M. This ensures a driving experience that can be configured for the track or even an easy drive to the supermarket.

The precision-built M high-performance chassis you see on the facing page has been redeveloped from scratch and tuned to perfection on the famous and demanding Northern Loop of Germany's Nürburgring, the Nordschleife. You begin to experience the effect of M when you settle into the cockpit and see the M Drive buttons on the steering wheel. These buttons connect you to pre-programmed configurations for either a sporty or a comfortable drive. One of these is M Dynamic

Mode, which helps you push the performance envelope of the M5 by raising the threshold of when Dynamic Stability Control intervenes. This works in concert with the Active M Differential that improves traction on even the most demanding corners. As a result, you can explore the limits with more confidence.

Also adding to your enjoyment is Dynamic Damping Control. This feature allows you to adjust the shock absorbers to your preference in one of three modes: COMFORT, SPORT and SPORT+. It's one more way the racing souls of BMW M engineers put a smile on your face with every drive.

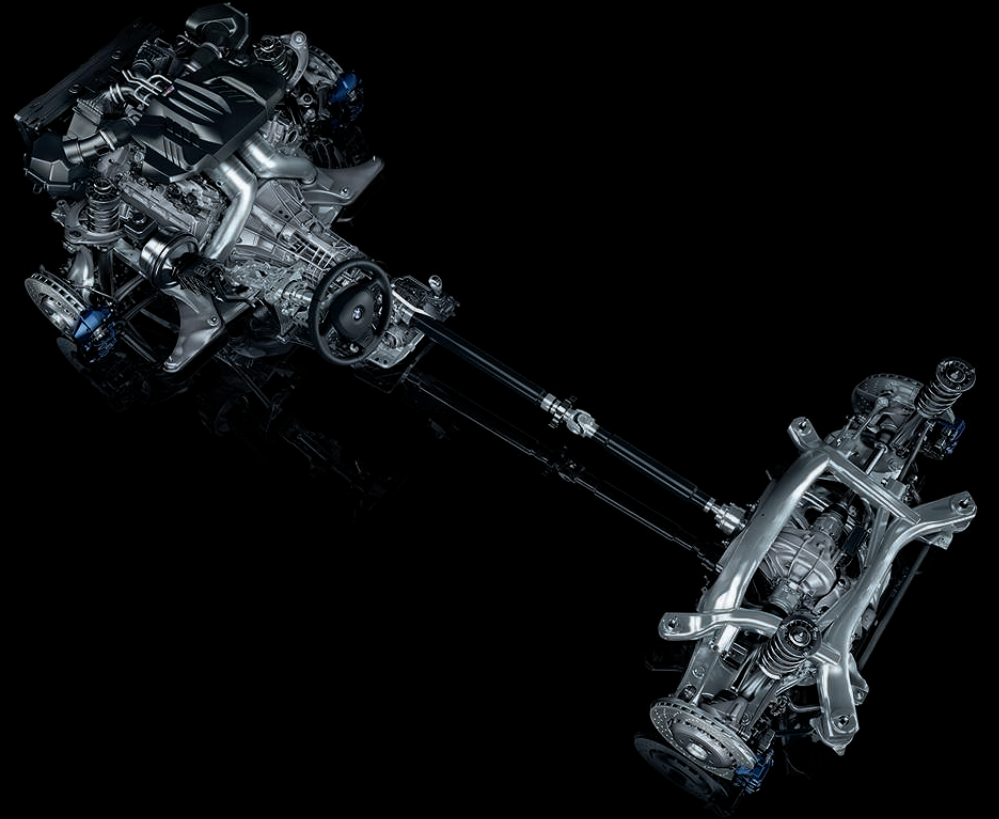

40 YEARS  
BMW M



# A LEGEND HITS 40. BMW M.



**1972** **Motorsport vision:** Bob Lutz, Sales Director of BMW AG, and his eight staffers establish **BMW Motorsport GmbH**.



**1978** **The first M.** With the **BMW M1**, BMW takes motorsport to the street – and the track – with the support of racing legends Bernie Ecclestone and Max Mosley, the car celebrates its premiere in the **Procar Series**. The BMW M1, of which only 460 are built, is every **collector's dream today**.



**1984** As BMW's first high-powered sports sedan, the **BMW M5** combines exceptional performance with superb comfort. Electric windows, central locking and a powerful six-cylinder engine: the BMW M5 features the **most innovative technologies** of its day. And, for a long time, it is **made by hand**.

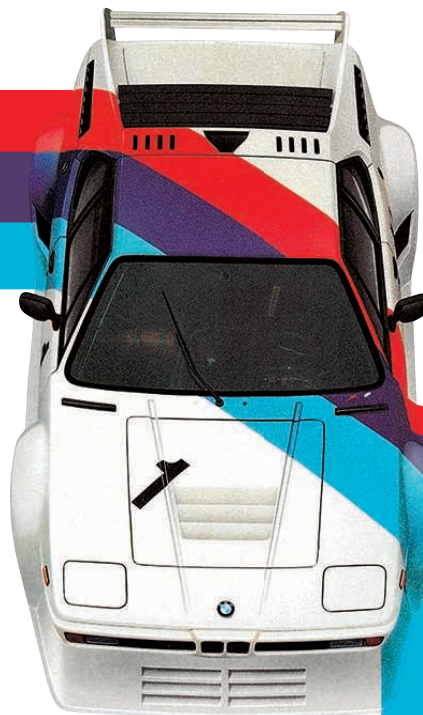

**1986** The **BMW M3** takes the motorsport world by storm: Touring Car World and European Champion in 1987, German Touring Car Champion in 1989. Demand for the **high-performance sports model** is so high that **5,000** are built in one year.



**1993** **BMW Motorsport GmbH** changes its name to **BMW M GmbH** – and ever since, that letter has stood for maximum **performance, innovation and driving enjoyment**. It is also the home of BMW Individual, which offers customers exclusive automobile compositions tailored to their wishes.



**2009** **Exploring new terrain:** The **BMW X5 M** and the **BMW X6 M** take M Power off-road. They are the first M models to feature the intelligent **BMW xDrive all-wheel-drive system**, with an M-specific set-up that **maximizes dynamic performance**.



**2012** An eye on the future: the **BMW M6** sets standards for **advanced technology**. Innovations like the high-revving M TwinPower Turbo V-8 engine or **ultra-lightweight materials** such as CFRP demonstrate what the future will look like – both in motor racing and on the road.

## M: The most powerful letter in the world. Since 1972.

Innovation, aesthetics and a passionate commitment to motor racing are the foundations on which BMW M has been crafting thrilling vehicles for more than 40 years. From the pioneering concept exploring the limits of contemporary engineering, to the successful participant in numerous international motorsport events, to the elegant, athletic production model with added driving enjoyment – trust BMW M to deliver memorable performance. The letter M will continue to represent a unique combination of advanced technology and impressive power, for a BMW driving experience that can otherwise only be found on the world's racetracks.



Information Provided by:

DEALER  
e-PROCESS





## BMW ConnectedDrive In touch with your world.

Every day, our world is becoming increasingly networked. Many BMW drivers, however, are better connected with than most, obtaining information on the road, communicating by phone or email and always updated on the latest events. BMW ConnectedDrive encompasses all these services, including traffic features which enable the networking of BMW cars and their occupants with the outside world.



**Enhanced mobile networking.** The BMW Vision ConnectedDrive is a visionary Roadster with a design that amazes at first sight. Its dynamic, flowing lines draw the eye from the distinctive front end, over the long hood and then to an extraordinary synthesis of exterior and interior. Three levels in the interior each symbolize an area of BMW ConnectedDrive – Convenience, Infotainment and Safety. Accompanying the functions and controls, information is highlighted by different colored fiber-optic lights, as well as by rhythm, motion and texture. More on this concept vehicle and further research projects can be found in the BMW Future Lab.

[bmw.com/futurelab](http://bmw.com/futurelab)

# BMW CONNECTED DRIVE: CONVENIENCE, INFOTAINMENT AND SAFETY TECHNOLOGIES MEET IN ONE SUITE.

With BMW ConnectedDrive you stay in touch, no matter where you go. Its advanced communications and entertainment features create a network between driver, vehicle and environment, at any time and wherever you are. The following pages present special highlights in the areas of convenience, infotainment and safety. For a comprehensive overview, see [bmwusa.com/connecteddrive](http://bmwusa.com/connecteddrive).

**Convenience.** These BMW ConnectedDrive innovations offer service-oriented functions, so you can always relax in your BMW.



**Speed Limit Info** shows the currently applicable speed limit in the instrument cluster as well as in the Head-up Display (if so equipped). A special camera captures the speed limit posted on signs; a control unit then processes this information together with data from the on-board Navigation system. Other components, such as the vehicle's rain sensor, are also used, so the system can even factor in variable speed limits for the driver in, for example, wet conditions.

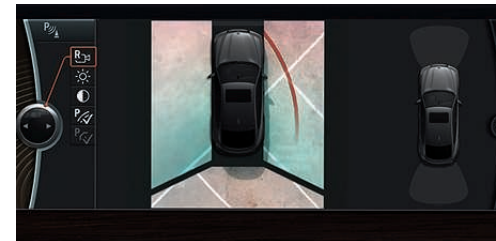

**Top-, Side- and Rear-view Cameras** around the vehicle show the surroundings on the Control Display, for enhanced visibility. The **Top-view Camera** provides a bird's-eye view of the road alongside the doors. These images, taken by cameras positioned in the exterior mirrors, help guide you when maneuvering in tight spaces. **Side-view Cameras** in the front bumpers show traffic approaching the front of the vehicle from the sides, such as when exiting a garage. The **Rear-view Camera**, located behind the BMW badge on the trunk lid, shows the area behind the vehicle. Working with Park Distance Control, interactive guidelines indicate if the vehicle can fit in a parking space, and display parking trajectories and turn angles.



### Full-color BMW Head-up Display.

The BMW Head-up Display uses a multi-color TFT display to project important travel information, such as current speed and Check Control data, on the windshield directly in your line of vision in full color. Directional arrows from the Navigation system can also be displayed.

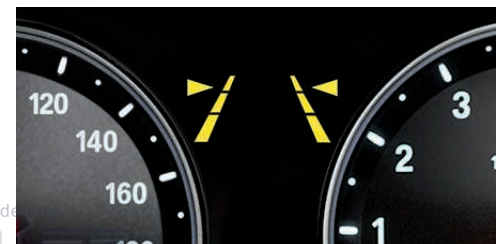

### Lane Departure Warning feature.

This feature senses when your vehicle is crossing over road lane markings or is changing lanes without signaling, and warns you by sending a mild vibration through the steering wheel. The system can be turned on and off via a button near the steering wheel. If you activate your directional signal – meaning that you intend to change lanes – no warning is given.

## STAY TOTALLY IN TOUCH WHEREVER YOU GO – WITH BMW CONNECTED DRIVE.

Whether you're far from home or just in the next town, BMW Assist™ offers convenience and peace of mind. There are new ConnectedDrive features that extend BMW's leadership in wireless communications. Marvel at an extensive array of new Mobile Office functions. Get a visual image of your callers. With BMW Assist, you enjoy all this – and more.



**BMW Apps** lets you access Social Networks, music PlugIn and Video Playback through your iPhone®, and see them on the Display screen.<sup>1</sup> Tune in to **Web radio** and search for stations from around the globe by name, location or genre. You can also store your favorite stations, find similar stations, display station information, and change the quality of the audio. Your favorite entries are stored on your iPhone, so you can take them with you from one vehicle to another.

Please note: • A broadband data link is required. The costs for this (e.g., data roaming) are regulated by the customer agreement with the mobile phone service provider.  
• Not all features available while vehicle is in motion; see dealer for details.  
• Web radio audio quality depends on the bit rate of the station, and data reception depends on your cell service. Data transfer comes over the iPhone.

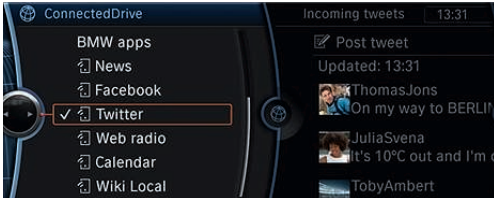

**BMW Connected App**, a suite of integrated web-connected features, can read aloud your Facebook® and Twitter™ feeds, and lets you send prewritten tweets with a single click. **Wiki Local**, a geographically based feature, finds and reads aloud Wikipedia® articles relevant to the place you select – while **Wiki Tourguide** takes you through a list of articles about nearby points of interest, prioritized by distance from your vehicle's current location. **The Last Mile Navigation and Vehicle Finder**, also included in the BMW Connected App suite, provides walking directions to your destination after you've parked – and directions back to your car later.

Please note: Local information may not be available in all areas.

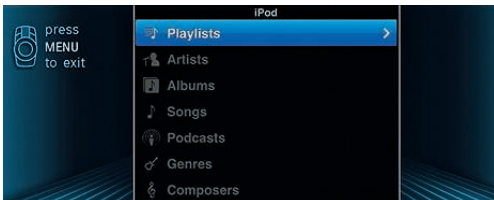

When you select **PlugIn** from the BMW Apps menu, the iPhone exports a typical iPod® look and control to your BMW through the video connection.<sup>1</sup> You can then search for your favorite music by playlist, artist, album, song, genre or composer, just as you would on your iPhone.

Please note: The BMW Connected App must be installed on your iPhone for the PlugIn to connect.

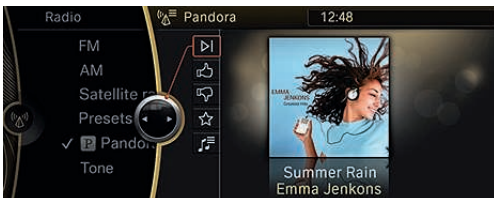

Part of BMW Apps, **Pandora Radio** is an innovative streaming audio service that delivers personalized music selections right to your BMW.<sup>1</sup> Create new stations and tailor your listening experience by rating songs with either a thumbs-up or thumbs-down. Even while listening, you can stay in touch: your BMW can still receive calls through Bluetooth® without missing a beat.

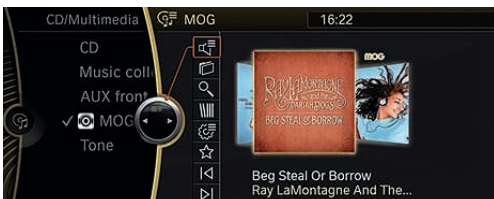

Enjoy the instant gratification of music on-demand in your BMW, thanks to **MOG**® – another part of BMW Apps. Browse, search and play any of 11 million songs in the MOG music library. Subscribing to MOG's **Primo** service allows you to take advantage of the seamless integration of MOG's mobile app.

<sup>1</sup> Requires BMW Apps option and an iPhone.

Get the latest information on BMW standard and optional features, packages and technical specifications. Visit [bmwusa.com](http://bmwusa.com), select the BMW model of your choice, and click on "Features & Specs."



Use the time you spend in your vehicle even more effectively with BMW's **Mobile Office** feature.<sup>2</sup> For example, text messages and emails can be transferred from your Bluetooth paired phone directly to the vehicle's iDrive Display and can be read back to you using Text-to-speech functionality and the vehicle's audio system. Thanks to Bluetooth audio streaming, you can enjoy wireless playback of your music files; your personal audio library can even be accessed via the iDrive Controller.

<sup>2</sup> Not all mobile phones are compatible with Mobile Office, and some compatible phones support a limited number of Mobile Office functions. For the complete list of compatible mobile phones and the details regarding which Mobile Office functions are supported by each phone, please visit [bmwusa.com/bluetooth](http://bmwusa.com/bluetooth).



**MyInfo** allows you to send business locations and street addresses to your BMW from Google Maps™. Destinations and phone numbers can be accessed and exported to your Navigation system for immediate route guidance.



**BMW Online** allows online access to up-to-date fuel prices and gas station locations; the latest weather forecasts, advisories and warnings; Dow Jones, S&P 500 and NASDAQ indices; and the powerful reach of the Google Maps database – all delivered on the Control Display inside your vehicle. Access news headlines and have them read aloud via Text-to-speech technology. "Send to Mail" pinpoints your current location and planned destination, and allows you to send the information to any smart-phone or email account. Then it's just a quick hyperlink to Google Maps for your friends and family to see where you are and where you're going.



**Enhanced functions** for the iPod and USB adapter add to the ease and pleasure of using your iPod or iPhone. Want to know which CD that song comes from? The album cover is shown on your Display screen. Don't purchase additional cables – your iPod or iPhone's original USB cable connects to your BMW's USB port. Another rare feature: with BMW Assist and Bluetooth audio streaming, you can wirelessly play music through the BMW audio system from any Bluetooth compatible music player or mobile phone, from anywhere in your vehicle. In fact, the audio library appears on the Display screen, where you can use the iDrive Controller knob to make your selection.



**BMW Assist** gives you peace of mind knowing that a friendly response specialist is there to help you 24/7, at the touch of a button. The **Safety Plan** includes Automatic Collision Notification, Emergency Request (SOS), TeleService, Enhanced Roadside Assistance, Door Unlock, Stolen Vehicle Recovery, Customer Relations and MyInfo. The **Convenience Plan** adds personalized Directions, Traffic and Weather reports, BMW Online and Concierge services for restaurant and hotel recommendations, with the destination address and phone number sent to your BMW. Make up to four operator-assisted calls per year with Critical Calling if your mobile phone is not available or its battery is discharged.



## Exterior colors.

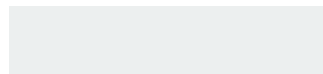

300 Alpine White (Non-metallic)



475 Black Sapphire Metallic



A17 Mojave Metallic



A29 Silverstone Metallic



A52 Space Gray Metallic



A89 Imperial Blue Metallic



B05 Monte Carlo Blue Metallic



B50 Sakhir Orange Metallic



B41 Singapore Gray Metallic



X04 Moonstone Metallic



X02 Citrin Black Metallic



S34 Azurite Black Metallic

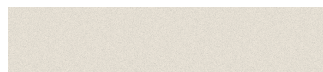

X07 Amazonite Silver Metallic



X08 Champagne Quartz Metallic

## Upholstery colors.



LKSW Black Extended Merino Leather

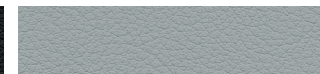

LKA9 Silverstone II Extended Merino Leather



LKDA Sakhir Orange Extended Merino Leather



X3SW Black Full Merino Leather

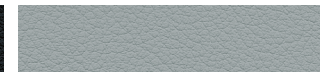

X3A9 Silverstone II Full Merino Leather



X3DA Sakhir Orange Full Merino Leather



ZAP8 Graphite Extended Merino Leather



ZAP7 Silk Gray Extended Merino Leather



ZAC8 Platinum Extended Merino Leather



ZAP6 Champagne Extended Merino Leather

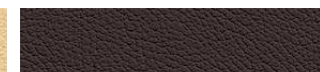

ZAWT Cohiba Brown Extended Merino Leather

The following pages show available colors and materials for the BMW M5. Use these samples to compare paint, upholstery, trim colors and combinations. Please note that these samples are printed representations; they are not exact reproductions. To see the actual colors, visit your authorized BMW center. They will be happy to show you original samples and assist you with special requests.

Leather upholstery: Leather on all seating surfaces; other components may be Leather or Leatherette. BMW Extended Merino Leather upholstery includes front and rear seats including headrests, inserts in door trims, center console including armrests, and the lower part of the instrument panel.

For details on the availability of standard and optional exterior paints and upholstery materials and colors, please visit [bmwusa.com/byo](http://bmwusa.com/byo).

## Headliners.



776 Anthracite Alcantara



BMW Individual



XD5 Silk Gray Alcantara



XD5 Platinum Alcantara



XD5 Champagne Alcantara

## Interior trim.



4L9 Aluminum Trace



4BN Dark Ash Grain Wood



4CE FineLine Anthracite Wood



BMW Individual



XE5 Dark Red Sycamore Wood



XE6 Honey Brown Satin Walnut Wood



XE7 Piano Finish Black

## Recommended color combinations.

Interior materials	BMW upholstery colors						BMW Individual upholstery colors				
	Extended Merino Leather			Full Merino Leather			BMW Individual Extended Merino Leather				
Upholstery colors	Black	Silverstone II	Sakhir Orange	Black	Silverstone II	Sakhir Orange	Graphite	Silk Gray	Platinum	Champagne	Cohiba Brown
Interior colors	Black	Black	Black	Black	Black	Black	Black	Black	Black	Black	Black
BMW exterior colors	Alpine White (Non-metallic)	*	*	*	*	*	*	*	*	*	*
Black Sapphire Metallic	*	*	*	*	*	*	*	*	*	*	*
Mojave Metallic	*	*	*	*	*	*	*	*	*	*	*
Silverstone Metallic	*	*	*	*	*	*	*	*	*	*	*
Space Gray Metallic	*	*	*	*	*	*	*	*	*	*	*
Imperial Blue Metallic	*	*	*	*	*	*	*	*	*	*	*
Monte Carlo Blue Metallic	*	*	*	*	*	*	*	*	*	*	*
Sakhir Orange Metallic	*	*	*	*	*	*	*	*	*	*	*
Singapore Gray Metallic	*	*	*	*	*	*	*	*	*	*	*
BMW Individual exterior colors	Citrin Black Metallic	*	*	*	*	*	*	*	*	*	*
Azurite Black Metallic	*	*	*	*	*	*	*	*	*	*	*
Moonstone Metallic	*	*	*	*	*	*	*	*	*	*	*
Amazonite Silver Metallic	*	*	*	*	*	*	*	*	*	*	*
Champagne Quartz Metallic	*	*	*	*	*	*	*	*	*	*	*
BMW interior trims	Aluminum Trace	*	*	*	*	*	*	*	*	*	*
Dark Ash Grain Wood	*	*	*	*	*	*	*	*	*	*	*
FineLine Anthracite Wood	*	*	*	*	*	*	*	*	*	*	*
BMW Individual interior trims	Dark Red Sycamore Wood	*	*	*	*	*	*	*	*	*	*
Honey Brown Satin Walnut Wood	*	*	*	*	*	*	*	*	*	*	*
Piano Finish Black	*	*	*	*	*	*	*	*	*	*	*

\* Recommended color combination

Leather upholstery: Leather on all seating surfaces; other components may be Leather or Leatherette.

BMW Extended Merino Leather upholstery includes front and rear seats including headrests, inserts in door trims, center console including armrests, and the lower part of the instrument panel.

For details on the availability of standard and optional exterior paints and upholstery materials and colors, please visit [bmwusa.com/byo](http://bmwusa.com/byo).





## Equipment features and options.



**Bang & Olufsen® High-End Surround Sound System** with Dirac Dimensions™ signal processing creates an open and lively soundscape and excellent acoustics. This is achieved via 16 loudspeakers, including an automatically extending center speaker. This speaker includes a midrange function and Acoustic Lens technology for consistent sound quality at any seating position. Choose between two settings: Studio for extremely clear, studio-quality sound, or Expanded for a wider sound experience. The light feature of all loudspeaker frames completes a perfect audio-visual experience.



**Gear shift lever** for the 7-speed M Double Clutch Transmission with Drivelogic includes M logo and illumination.

**6-speed manual gearbox** (not shown) is designed for optimum transmission of the M5's formidable engine power throughout the rev range. The heavy-duty clutch expertly dissipates heat for smooth shifts during heavy use.



**Door-sill finishers** with aluminum inserts and M5 lettering make a powerful statement the moment you get in.



**Extended instrument cluster** features Black Panel Display with permanently illuminated white surrounds for speedometer and tachometer plus fuel level and oil temperature displays.



**Double Spoke (Style 345M)** 19 x 9 front, 19 x 10 rear light alloy wheels with 265/40 front, 295/35 rear run-flat<sup>1</sup> performance tires.<sup>2</sup>

Wheel and tire specifications are subject to change. Get the latest information on BMW standard and optional features, packages and technical specifications. Visit [bmwusa.com](http://bmwusa.com), select the BMW model of your choice, and click on "Features & Specs."

<sup>1</sup> Run-flat tires do not come equipped with a spare tire and wheel.

<sup>2</sup> Driving over rough or damaged road surfaces, as well as debris, curbs and other obstacles, can cause serious damage to wheels, tires and suspension parts. This is more likely to occur with low-profile tires, which provide less cushioning between the wheel and the road. Be careful to avoid road hazards and reduce your speed, especially if your vehicle is equipped with low-profile tires. Performance tires are not recommended for driving in ice and snow conditions.



## CRAFT YOUR OWN BMW – AT [BMWUSA.COM/BYO](http://BMWUSA.COM/BYO).



**TAKING IT TO THE NEXT LEVEL:  
BMW M SCHOOL.**

At BMW, we want you to create your own Ultimate Driving Machine®. That's why BMW offers one of the widest model ranges of any luxury automotive manufacturer. And each BMW model offers its own universe of personalizing possibilities.

It's easy to get the latest information on your favorite BMW model. Simply visit [bmwusa.com](http://bmwusa.com) and click on the BMW model of your choice. Select "**Features & Specs**" to see all the standard features and available options and packages, as well as technical specifications.

Then create the exact BMW model that fulfills your needs by clicking on "**Build Your Own**" – or just visit [bmwusa.com/byo](http://bmwusa.com/byo). Here you'll be able to select from among the many interior and exterior colors and trims, personalizing options and value-added packages. Build a BMW model that reflects your style, then view it in 360° detail. At the press of a button, see payment and financing options, get a same-day quote, download a product brochure and even schedule a test drive. BMW makes it easier than ever to make your ultimate driving dreams come true, at [bmwusa.com](http://bmwusa.com).



Provided by:

**ALER**  
PROCESS



## M5 Sedan

## Weight

Unladen weight	lbs	4354 (4387)
Weight distribution, front / rear	%	52.3/47.7 (52.5/47.5)

## Engine

Type / cylinders / valves per cylinder		M TwinPower Turbo V-8 / 4
Displacement	cc	4395
Bore / stroke	inch	3.5 / 3.5
Nominal output / rpm	hp	560 / 6000 -7000
Maximum torque / rpm	lb-ft	500 / 1500-5750
Compression ratio	:1	10.0

## Transmission

Gear ratios – 6-speed manual		
I / II / III	:1	4.06 / 2.40 / 1.58
IV / V / VI / R	:1	1.19 / 1.00 / 0.87 / 3.68
Final drive ratio	:1	3.15

## Gear ratios – 7-speed M Double Clutch Transmission

I / II / III / IV	:1	4.81 / 2.59 / 1.70 / 1.28
V / VI / VII / R	:1	1.00 / 0.84 / 0.67 / 4.17
Final drive ratio	:1	3.15

## Performance

Top speed <sup>1</sup>	mph	155
Acceleration 0-60 mph <sup>2</sup>	sec	4.3 (4.2)

Fuel consumption<sup>3</sup>

City / highway	mpg	TBD (TBD)
Tank capacity, approximate	gal	21.1

## Tires, wheels and brakes

Run-flat performance tire dimensions <sup>4</sup>		
front		265 / 40
rear		295 / 35
Wheel dimensions – material		
front		19 x 9.0 forged alloy
rear		19 x 10.0 forged alloy
Brake diameter, front / rear – type	inch	15.7 / 15.6 – ventilated disc

Figures in ( ) apply to vehicles with 7-speed M Double Clutch Transmission.

<sup>1</sup> Top speed limited electronically.

<sup>2</sup> BMW AG preliminary test results. Actual acceleration results may vary, depending on specification of vehicle; road and environmental conditions; testing procedures and driving style. These results should be used for comparison only and verification should not be attempted on public roads; BMW urges you to obey all posted speed laws and always wear safety belts.

<sup>3</sup> EPA-estimated figures are for comparison purposes only. Fuel economy figures not available at time of printing. Please go to [bmwusa.com](http://bmwusa.com) for the most up-to-date fuel consumption information. Your actual mileage will vary, depending on speed, driving habits, trip length and driving conditions; actual mileage may be lower.

<sup>4</sup> Driving over rough or damaged road surfaces, as well as debris, curbs and other obstacles, can cause serious damage to wheels, tires and suspension parts. This is more likely to occur with low-profile tires, which provide less cushioning between the wheel and the road. Be careful to avoid road hazards and reduce your speed, especially if your vehicle is equipped with low-profile tires. Performance tires are not recommended for driving in ice and snow conditions. Please note: M5 models are not equipped with a spare tire and wheel. They include M Mobility System, which offers lifetime BMW Roadside Assistance for tire assistance. Wheel and tire specifications are subject to change.

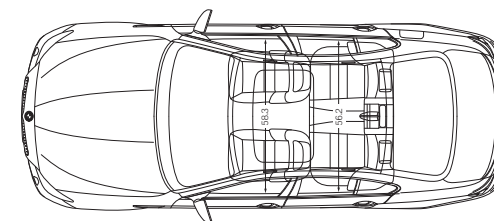
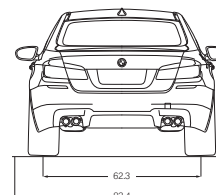
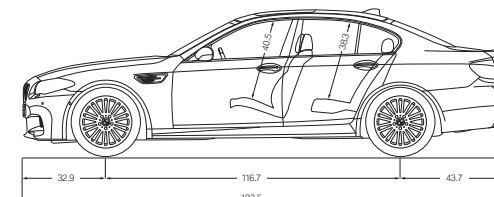
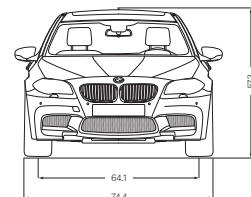

All dimensions are shown in inches.

U.S. Importer: BMW of North America, LLC, Woodcliff Lake, NJ 07677. All illustrations and specifications contained in this brochure are based on the latest product information available at the time of printing. BMW reserves the right to make changes at any time, without notice, in colors, materials, equipment, specifications and models. BMW may, subject to legal requirements, determine the Model Year designation of its vehicles. The Model Year designation on any particular model may be longer or shorter than 12 months. Some vehicles pictured may contain non-U.S. equipment. Some models may be shown with optional equipment. While BMW NA makes all reasonable efforts to provide accurate information in this brochure, there is no guarantee or warranty of accuracy. Furthermore, we do not assume any liability for the accuracy or completeness of information presented. This brochure shall not be used or relied upon as a substitute for information that is available from your BMW center. Further information can be obtained from your authorized BMW center or [bmwusa.com](http://bmwusa.com).

©2012 BMW of North America, LLC

Not to be reproduced wholly or in part without written permission of BMW NA. The BMW name, logo, model names and SAV are registered trademarks.

The Bluetooth word mark and logos are owned by the Bluetooth SIG, Inc. and any use of such marks by BMW is under license. iPhone and iPod are registered trademarks of Apple Inc. Other trademarks and trade names are the property of their respective owners.

We believe that a premium ownership experience should feature performance and luxury, as well as safety and convenience. We believe you should be able to drive a BMW to its potential, while enjoying peace of mind and reduced cost of ownership. That's the idea behind **BMW Ultimate Service**<sup>®</sup>, a suite of comprehensive programs and services that are included in every new BMW vehicle.

BMW Ultimate Service starts with the **New Vehicle/SAV Limited Warranty**,<sup>1</sup> providing you with coverage for the first four years or 50,000 miles, whichever comes first. Additionally, you have 12-year, unlimited-mileage warranty protection against corrosion and rust perforation.<sup>1</sup> The **BMW Maintenance Program**<sup>2</sup> and **BMW Assist**,<sup>3,4,5</sup> as well as **BMW Roadside Assistance** come standard.

## GOING BEYOND ENGINEERING: THE HIGH-PERFORMANCE BMW OWNERSHIP EXPERIENCE.

**BMW Maintenance Program** is one of the most comprehensive maintenance programs in its class. We cover all factory-recommended maintenance during the New Vehicle/SAV Limited Warranty coverage period. This includes scheduled oil services and inspections. Also covered is the replacement of items that are subject to normal wear and tear, such as brake pads, wiper blade inserts and engine drive belts.<sup>2</sup> And, thanks to BMW's advanced engineering, most owners enjoy a well-balanced maintenance schedule, with flexible routine service intervals that can save you time. When your vehicle requires attention, your authorized BMW center ensures that it receives only genuine BMW parts – your assurance of exacting quality standards.

For more details on BMW Ultimate Service and the BMW Maintenance Program, visit your authorized BMW center or log on to [bmwusa.com/ultimateservice](http://bmwusa.com/ultimateservice).

**BMW Assist Safety Plan**<sup>3</sup> is a four-year program that lets you enjoy peace of mind knowing that a friendly response specialist is there to help you, 24/7, at just the push of a button. The Safety Plan includes Automatic Collision Notification, Emergency Request, Enhanced Roadside Assistance, Door Unlock, Stolen Vehicle Recovery and Customer Relations. Included in the BMW Assist Safety Plan, MyInfo allows you to send business locations and street addresses with their associated phone numbers from the Google Maps™ website directly to your BMW. The destination can be sent to your Navigation system for turn-by-turn directions. With the BMW Navigation system and your mobile phone linked to your BMW via Bluetooth® technology, BMW's Mobile Office feature<sup>4</sup> transfers text messages and emails to your iDrive Display screen and reads them aloud to you. A Calendar and To-do List can also appear on your Display screen while en route. Running late? Click on the phone number in the Calendar to call your appointment. For a list of tested mobile phones, visit [bmwusa.com/bluetooth](http://bmwusa.com/bluetooth).

For the ultimate in coverage, add the optional **BMW Assist Convenience Plan**.<sup>5</sup> You'll enjoy unlimited access to personalized Directions, Traffic and Weather reports, as well as our Concierge feature, which can send a destination address and phone number, such as a restaurant or hotel, right to your BMW. You can make up to four operator-assisted calls per year with Critical Calling if your cell phone is not available, or if its battery is discharged. BMW Online allows access to up-to-date fuel prices and the latest weather forecasts, as well as Bloomberg's stock indices and the powerful reach of the Google Maps database – delivered to the iDrive Display right inside your vehicle.

BMW's unique **TeleService**, included in the BMW Assist Safety Plan, continually monitors specific parts that are subject to wear and tear – including the engine oil, micro-filter, spark plugs, brake linings and various fluids – as well as services that require attention at regular intervals, such as vehicle service inspections. This data is automatically transmitted to your authorized BMW center, which will then call you

to schedule a service appointment. You don't have to keep track of when your vehicle requires routine maintenance. An added benefit: any needed maintenance service parts will already be on hand, so your BMW is serviced and returned to you as quickly as possible. And because they use only Original BMW Parts, you can rely on expert fit and long-lasting BMW quality. For more details on TeleService, visit [bmwassist.com](http://bmwassist.com).

**BMW Roadside Assistance** is provided free of charge for the first four years – with no mileage limit. Call **1-800-332-4BMW (4269)** for friendly on-the-road help, 24/7, anywhere in the United States, Canada and Puerto Rico. This includes everything from flat-tire changes, emergency gasoline and lock-out service, to towing, alternative transportation and even trip-interruption benefits. This service also provides valuable trip-routing advice.



**BMW Virtual Center.** If you get the sudden urge to shop for a BMW but your authorized BMW center is closed, there's good news – the BMW Virtual Center is open 24 hours a day! Log on to [bmwusa.com/byo](http://bmwusa.com/byo), and choose the model that interests you. Configure the BMW of your dreams, and see what the monthly payments would be. You can even send the specifications to your authorized BMW center, apply for financing, or request a test drive – all online!

**BMW Financial Services.** Arranging to buy or lease a BMW is easier than you may think. Your authorized BMW center offers leasing and financing to suit your personal needs through BMW Financial Services.<sup>6</sup> Start the process at our website, where you can build your "dream vehicle," get an estimate on a monthly lease or financing payment, submit a credit application to BMW Financial Services – and get approval – all online!<sup>6</sup> To find out how BMW Financial Services can help put you behind the wheel of your favorite BMW model, log on to [bmwusa.com/fs](http://bmwusa.com/fs) or call, toll-free, **1-800-578-5000**.

**BMW Magazine.** A fascinating view of the latest events and products in the world of BMW, including travel reviews, personality profiles, and the latest BMW technologies. Sent to new owners and lessees two times a year, you can also read articles from **BMW Magazine** on the BMW website at [bmwusa.com](http://bmwusa.com) under the "Media Gallery & Library" heading, found in the "Experience" section.

**BMW Welt:** The **BMW Welt** ("BMW World") delivery and brand-experience center in Munich is bold proof of BMW's passion for design. When you take advantage of the BMW European Delivery Program,<sup>7</sup> this is where you will meet your new BMW – in a personalized process that is highly dramatic and totally unforgettable. (You might also realize substantial savings that just may pay for your trip.) While you're there, marvel at the historic BMWs in the Museum; learn about our engineers' newest innovations in the Technology and Design Atelier; and take a tour of the plant to experience firsthand the state-of-the-art methods used to create a BMW. Then comes the unique experience of driving your new BMW on the roads it was designed for. To learn more, visit [bmwusa.com/europeandelivery](http://bmwusa.com/europeandelivery).

<sup>1</sup> See your authorized BMW center for details on these limited warranties.

<sup>2</sup> The BMW Maintenance Program covers factory-recommended maintenance services as determined by the Service Interval Indicator for all new eligible MY 2004 and later BMW vehicles. Specific additional items that need replacement due to normal wear and tear are also covered. The maintenance coverage period is for the first 4 years or 50,000 miles, whichever comes first. Exclusions from coverage include: gasoline, gasoline additives, windshield washer fluid and additives, battery, tires, wheels, wheel alignment and tire balancing. All work must be performed by an authorized BMW center. See the Service and Warranty Information booklet for specific terms, conditions and limitations. Further information can also be obtained from your authorized BMW center.

<sup>3</sup> BMW Assist with 4 years of Safety Plan services is standard in the BMW M5. In order to receive BMW Assist services, a subscriber agreement must be completed and transferred to the BMW Assist Response Center. GPS and underlying wireless services must be available and functioning; vehicle ignition must be turned on (except for Door Unlock and Stolen Vehicle Recovery), battery charged and connected and vehicle's electrical system operational; services may be limited to certain geographic areas. Call toll-free **1-888-333-6118**, go to [bmwassist.com](http://bmwassist.com), or visit your authorized BMW center for additional program details. Services are subject to the terms and conditions of your subscriber agreement.

<sup>4</sup> Not all mobile phones are compatible with Mobile Office, and some compatible phones support a limited number of Mobile Office functions. For the complete list of compatible mobile phones and the details regarding which Mobile Office functions are supported by each phone, please visit [bmwusa.com/bluetooth](http://bmwusa.com/bluetooth).

<sup>5</sup> Requires BMW Assist Safety Plan subscription. Services are subject to the terms and conditions of your subscriber agreement. Please go to [bmwassist.com](http://bmwassist.com) for additional details on the optional Convenience Plan.

<sup>6</sup> Subject to credit approval and other terms and conditions.

<sup>7</sup> Not all models available for BMW European Delivery Program. Please go to [bmwusa.com](http://bmwusa.com) or visit your authorized BMW center for details.



## THE MOST EXCITING PLACE IN AMERICA TO DRIVE A BMW M VEHICLE.

### The BMW Performance Center in Spartanburg, SC.

Just beyond the foothills of the Carolinas' Blue Ridge Mountains lies the \$12 million BMW Performance Center. This sprawling, modern complex houses the world-famous BMW Performance Driving School, as well as the Zentrum Museum, BMW Boutique, BMW Delivery Center, and a Corporate Conference Center. Nearby is BMW's only manufacturing facility in the U.S., where models, such as the SAV,<sup>®</sup> are built for export worldwide. It's a unique place where BMW enthusiasts can spend days – or, in the surrounding area, an entire vacation.

### BMW Performance Driving School.

Whether you've been driving for decades or just got your learner's permit, we can help take your driving skills to the next level. Behind the wheel of our new BMWs and under the expert guidance of professional driving instructors, you'll hone your driving skills on a versatile driving course – 1.7 miles of asphalt that can be configured in a multitude of ways. In One- and Two-Day Schools you can tackle the skid pad, slalom course and water walls. The BMW Performance Driving School is about control and pushing a BMW to its limits – and yours.

### BMW Performance Center Delivery.

You'll always remember the fun of taking delivery of your new BMW – with BMW Performance Center Delivery. After enjoying dinner and an overnight stay at a first-class hotel, we'll take you and your companion to the Performance Center where a Product Specialist will give you an in-depth introduction to your new BMW. Then at the Performance Driving School, you'll get tips from a professional driving instructor as you explore the dynamic capabilities of a similar model. It's exciting, it's enlightening – and it's all compliments of BMW with your new vehicle.

To learn more about the BMW Performance Center, call **1-888-345-4269** or visit [bmwusa.com/performancecenter](http://bmwusa.com/performancecenter).



BMW M



The Ultimate Driving Machine®



**BMW and the environment.**

BMW is a strong proponent of the environment and social responsibility. We launched BMW EfficientDynamics back in 2000 – the philosophy of providing greater power with increased efficiency and fewer emissions. This has resulted in significant benefits today – for our customers, the climate and the environment.

That year, ecological sustainability was also declared one of BMW's core strategic principles; it is now firmly anchored in our entire production chain. It starts with the development of fuel-saving and alternative vehicle concepts, continues with environmentally friendly production processes, and ends with innovative recycling methods. This effort has been recognized worldwide; in 1999, BMW AG – the parent company of BMW of North America and BMW Manufacturing Co. in Spartanburg, SC – was the first automotive company to be represented on the Dow Jones Sustainability Group Index. It has remained on the Index ever since; moreover, since 2005, BMW has been voted the world's most sustainable automobile manufacturer. At BMW, we strive for and achieve high performance in all we do.



Information **DEALER**

BMW M recommends **EDGE**