

Vzense DCAM710 ToF Camera User Manual



Table of Contents

1	General Information.....	4
1.1	Terms of Use.....	4
1.2	Description and Features.....	5
2	Precautions.....	6
2.1	Safe Usage Instructions.....	6
2.2	Power.....	6
2.3	Usage.....	6
2.4	Temperature.....	7
3	Specifications and Requirement.....	7
3.1	General Specifications.....	7
3.2	Electrical Specifications.....	8
3.2.1	Recommended Operating Conditions.....	8
3.2.2	Power Consumption.....	8
3.3	Mechanical Specifications.....	9
3.4	Working Condition Requirements.....	10
3.4.1	Hardware Requirements.....	10
3.4.2	Software Requirements.....	10
3.4.3	Environmental Requirements.....	10
3.4.4	Coordinate of the Camera System.....	11
4	Interface with Host.....	12
4.1	Connectors.....	12
4.2	LED indication.....	13
5	Principle of Time of Flight.....	14
5.1	Vzense ToF Principle.....	14
5.2	Noise Factors.....	14
5.2.1	Ambient Light.....	14
5.2	Multipath Propagation.....	14
5.3	Reflectivity of the Target.....	15
5.4	Scattering Effect.....	15
6	Installation.....	16
6.2	Hardware Installation.....	16
6.3	Software Installation.....	17
6.3.1	Operating system.....	17
6.3.2	VZense SDK and VZenseUtool.....	17
6.3.3	Graphic Tool on windows.....	17
6.3.4	Firmware Upgrade.....	18
7	Features.....	19
5.1	Slave Trigger Mode.....	19
7.2	Range Customization.....	20
7.3	Wide Dynamic Range.....	20
7.4	Data Filtering.....	21
7.5	IR Image.....	22

8	DCAM710 Accessories and Package	23
9	Customization Service	23
	Appendix	24
	ROHS Declaration.....	24
	Eye Safety Declaration.....	24
	Reliability Declaration.....	24
	Revision History	24

1 General Information

The purpose of this document is to familiarize the customer with the correct operation of the Zense ToF Camera. This document provides important information about the camera's features, hardware specification, safe use of the camera, and installation procedures.

DCAM710 camera is a standalone ToF module, developed by Vzense team. It is packaged into small factor and a perfect choice for evaluation or study to the ToF technology. Of course the reliability is enough for many consumer or even industrial scenario.

1.1 Terms of Use

Zense offers a 1-year-warranty for this camera.

Warranty Information

Please do follow the following guidelines when using the Zense camera:

Do not remove the product's serial number label

Warranty must be void, if the label is damaged or removed and the serial number can't be read from the camera's registers.

Do not open the camera housing

Do not open the housing. Touching any internal components may damage the camera.

Prevent any objects or substances from entering the camera housing. Otherwise the camera may fail or damaged.

Avoid electromagnetic fields

Do not use the camera near strong electromagnetic fields. Prevent from electrostatic charging.

Transport in original packaging

Transport and store the camera in its original packaging only. Do not discard the packaging.

Clean with care

If you have to clean the housing of the camera, follow the guidelines in the notice as below:

- Use a soft, dry cloth that won't generate static during cleaning;
- To remove tough stains, use a soft cloth dampened with a small amount of neutral detergent(Pure water); after that wipe dry;
- Make sure no any residual detergent after cleaning, before reconnecting the camera to power

Read the manual

Do read the manual carefully before using the camera.

1.2 Description and Features

VZense TOF RGBD Camera Module DCAM710 is a long range depth camera that outputs depth video stream. In addition to depth video stream, it can provide RGB video streams. The small size of the DCAM710 subassembly provides system integrators flexibility to design into a wide range of products. The DCAM710 is ideal for system integrators, OEMs, ODM and HVM. Perfect for indoor/outdoor usage with long range depth sensing, e.g. SLAM (Simultaneous Localization and Mapping), Home Automation, Robotics, Augmented Reality, Virtual Reality, TV Entertainment, Drones or Automotive.

DCAM710 comprehend device position and orientation, providing the ability to map and navigate in the world. VZense Depth Camera Middleware enables the ability to Locate, Sense, Identify, and Interact in both the real and virtual world. DCAM710 comes with VZense Depth Camera SDK, an open source and cross platform enabling suite including rappers, sample code and tools.

DCAM710 Features:

- TOF (Time of flight) Camera technology
- Can output RGB Image and Depth Map
- Depth Camera support image size: up to 640*480@30FPS
- RGB Camera support image size: up to 1920*1080@30FPS
- Support for output formats: RAW12 (Depth), NV12 (RGB)
- 2 x Microphone to capture sound, record audio(optional)
- 6 x Axis IMU supported(optional)
- Micro USB2.0 interface
- Support OS: Android / Linux / Windows7/8/10
- Depth Sensor SDK, sample code and tools (Open NI SDK Compatible)
- Switchable short and long range modes
- IR VCSEL security level is Class 1

Usages/Markets

- SLAM (Simultaneous Localization and Mapping)
- Home Automation & Robotics
- Augmented Reality & Virtual Reality
- TV Entertainment & Micro-projection
- Drones
- Surveillance
- Automotive

2 Precautions

2.1 Safe Usage Instructions

DANGER	
	<p>Electric Shock Risk Non-standard and improper power supplies may result in fire and electric shock. You must confirm the camera power supply used that meets the Safety Extra Low Voltage(SELV) and Limited Power Supply (LPS) requirements.</p>

CAUTION	
	<p>Invisible Radiation This camera uses laser to work, improper use may damage the eye. Lasers are classified as risk group 1 (low risk) according to EN 60825 which means that the product presents no risk related to exposure limits under normal usage conditions. Eye safety is only guaranteed when the camera is used properly</p>

2.2 Power

The DCAM710 camera can be powered by standard USB Micro USB, for longer distance application which needs higher power consumption, there is an additional DC Jack power which can accept 5V~6V power. 2 A power adaptor is suggested to be in use.

2.3 Usage

Don't try to open the camera housing. Each camera has been calibrated at the factory to achieve precise measurements. Touching internal components may damage the camera and cause calibration data lost.

Incorrect plugging in and unplugging of the camera's power cable can damage the camera.

Don't try to change the position of the lens, may cause damage to the camera.

Do store the camera carefully when not in use, in original package the best.

2.4 Temperature

To avoid damaging the camera and to achieve best performance, please observe the maximum and minimum housing temperatures in Section 3.1

3 Specifications and Requirement

3.1 General Specifications

Specification	DCAM710
Technology	TOF (Time-of-flight) Depth Camera
Depth Sensor Resolution and Frame rate	640 x 480 (VGA)@30 fps
Depth Sensor Lens Focus Type	Fix Focus
Depth Sensor Field of View (FOV)	Horizontal: 69.3° (±3°) Vertical: 51°(±3°)
Depth Lens Distortion	<-2.6%
RGB Sensor Resolution and Frame rate	1920 x 1080 (1080P) @30 fps 1280 x 720 (720P) @30 fps 640 x 480 (480P) @30 fps 640 x 360 (360P) @30 fps
RGB Sensor Field of View (FOV)	Horizontal: 73°(±3°) Vertical: 40°(±3°)
RGB Lens Distortion	<-8%
Output Formats	Depth Map: RAW12 RGB Camera: H.264/MJPEG
Use Range	0.35m to 4.40m
Accuracy	<1%*
MMI	RGB LED (Indicator when stereo module is streaming data) System reset button

Power Supply	5V (Micro USB2.0)
Power Consumption	2W Ref. (3m)
Illumination	Indoor: 850nm/ Outdoor 940nm VCSEL
Dimensions (L*W*H)	Module: 103mm x 33mm x 22mm PCBA: 93mm x 28mm x 17mm
Weight	71g
Interface	Micro USB 2.0
Conformity	CE, FCC, FDA, Safety EN 60825-1:2014
Working/Storage Temperature	-10°C-50°C/-40°C-70°C
Development Environment	C/C++ SDK, OpenNI, ROS
Operation System	Windows 7, 8 and 10, Android, Linux

3.2 Electrical Specifications

3.2.1 Recommended Operating Conditions

Parameter	Symbol	Conditions	Min	Typ.	Max	Units
Supply voltage on USB VBUS	VDD		4.75	5	5.25	V
Supply voltage on DC power	VDC		5	5.5	6	V
Operating Temperature	Ta		-20		50	°C
Operating humidity			20		80	%
Storage humidity			20		80	%
Storage temperature			-30		70	°C

*: Please consider Vf range is about 1.3V

3.2.2 Power Consumption

Parameter	Conditions	Average	Max	Units
Current at range0 mode	250mm-1200mm @30 frame	468	769	mA
Current at range1 mode	500mm-2600mm @30frame	512	1011	mA
Current at range2 mode	800mm-4400mm @30frame	639	1394	mA

Note: 5V input voltage

3.3 Mechanical Specifications

This drawing contains information about the dimensions and user mounting location of the ToF Camera.

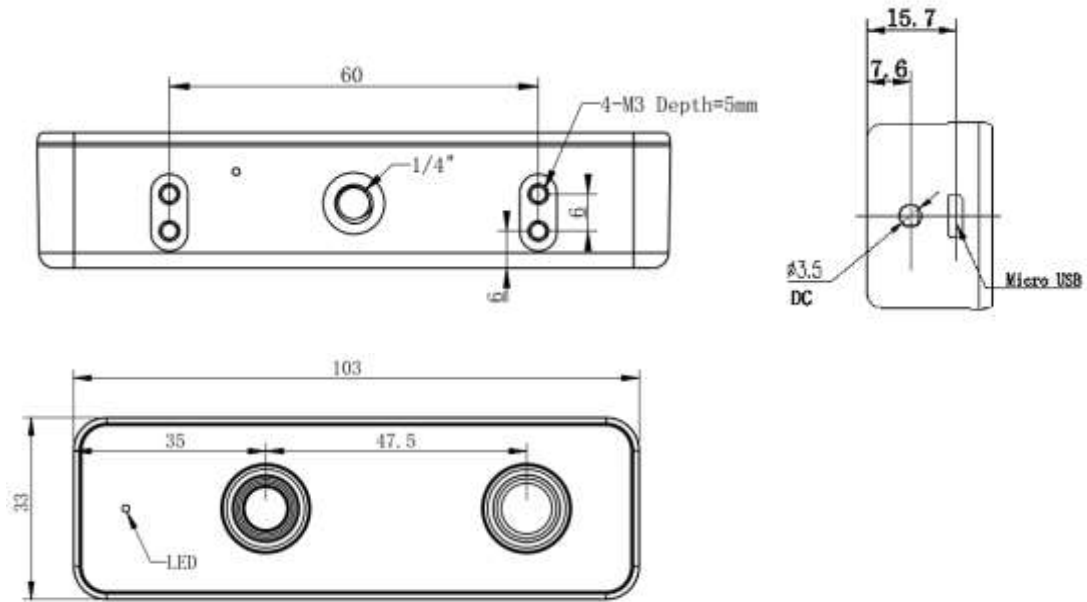

Fig. 1: ToF Camera Dimensions

Unit: mm

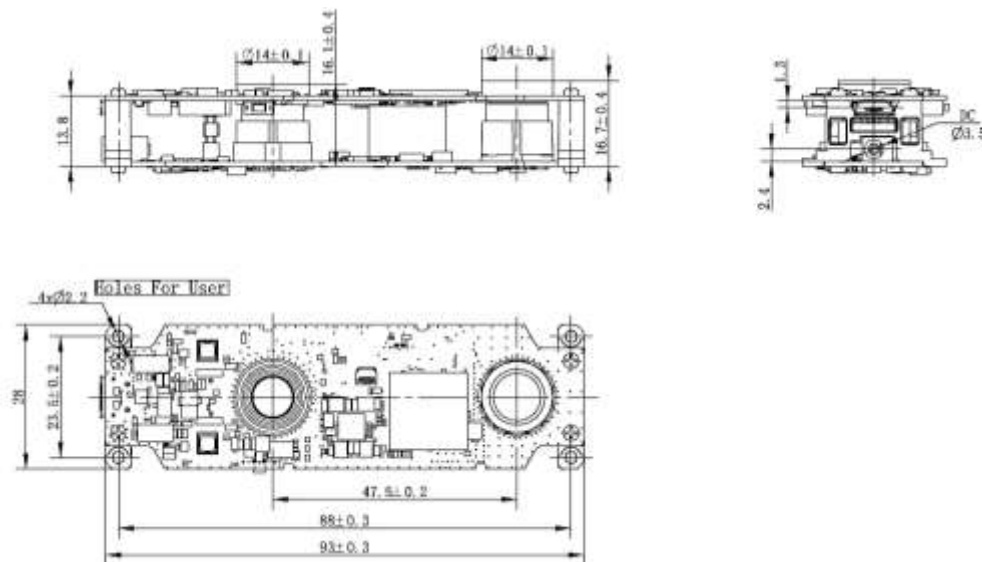

Fig. 2: PCB Module Dimension

3.4 Working Condition Requirements

3.4.1 Hardware Requirements

DCAM710 ToF Camera

- Micro USB Cable (Included in package)

If you need to use your own micro USB cable for some reason, make sure the cable itself can meet the USB standard requirement, otherwise the product may not function well.

Or

- 5V~6V/2A DC Adaptor (Not included in package)

3.4.2 Software Requirements

Operating system

- 32-bit Windows 7/10
- 64-bit Windows 7/10 (recommended)
- Linux (x86, x64)
- Android 5.0 or above

Zense ToF Driver

The Zense ToF Driver software is available for Windows, Linux and Android operating systems and includes the following:

- SDK code
- Sample code
- Software user manual

3.4.3 Environmental Requirements

Temperature and Humidity

Housing temperature during operation:	-20–50 °C
Humidity during operation:	20–80 %, relative
Storage temperature:	-30–70 °C
Storage humidity:	20–80 %, relative

Heat Dissipation

Users can provide sufficient heat dissipation, like mounting the camera on a substantial, thermally conductive component that can act as a heat sink. Or a fan can be used to provide an air flow over the camera.

3.4.4 Coordinate of the Camera System

There are two coordinate system need to be understood, one is camera coordinate system (CCS), one is world coordinate system (WCS).

CCS: CCS describe the two-dimensional data, the origin of coordinates is the optic center.

WCS: WCS describe the three-dimensional information.

The CCS data can switch to the WCS data using the camera internal parameters.

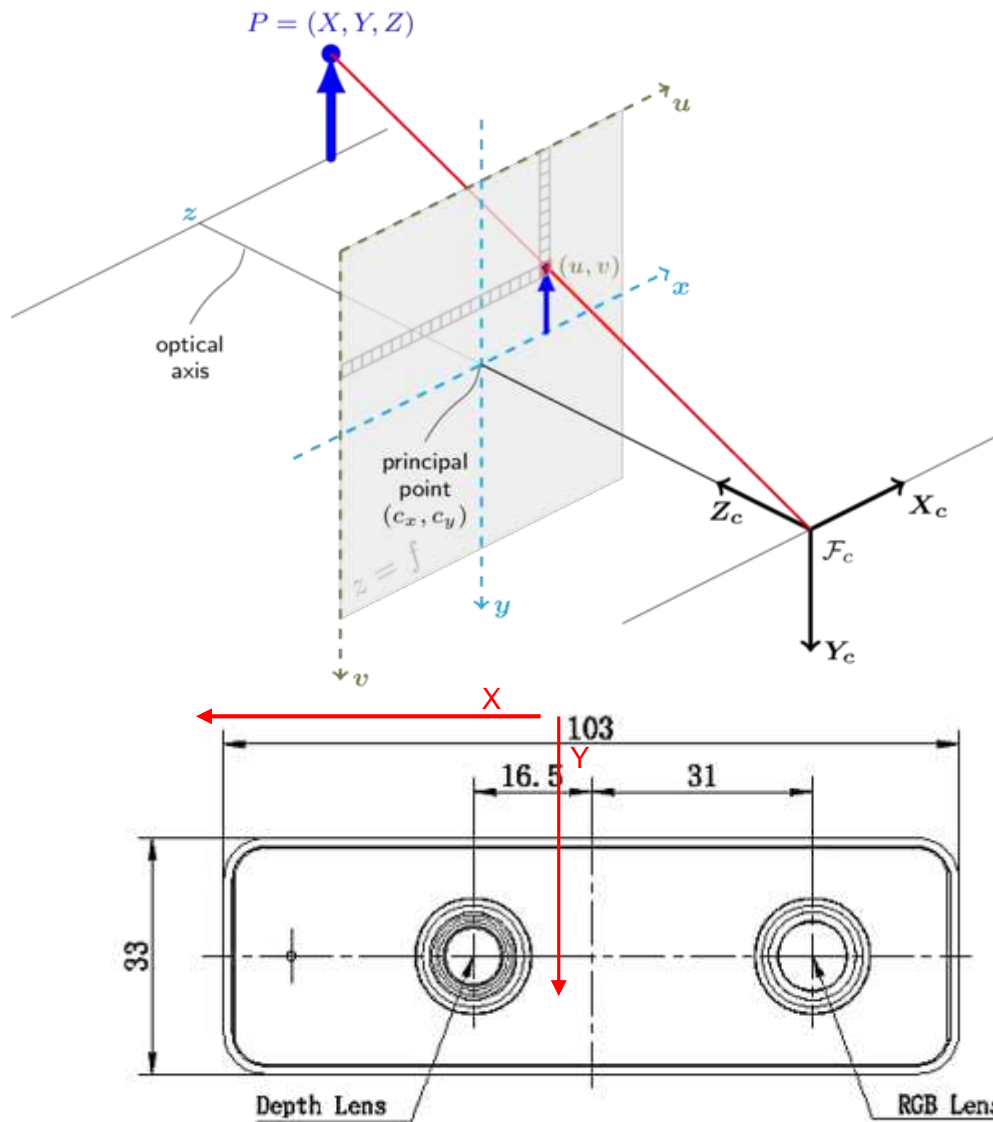

Fig. 3: Origin of the Coordinate System

Meshlab and CloudCompare tools are recommended to analyze the point cloud data saved by Zense software or SDK method.

4 Interface with Host

4.1 Connectors

DCAM710 ToF Camera is equipped with Micro USB 2.0 and DC power connector at the rear side of its housing as shown in below figure.

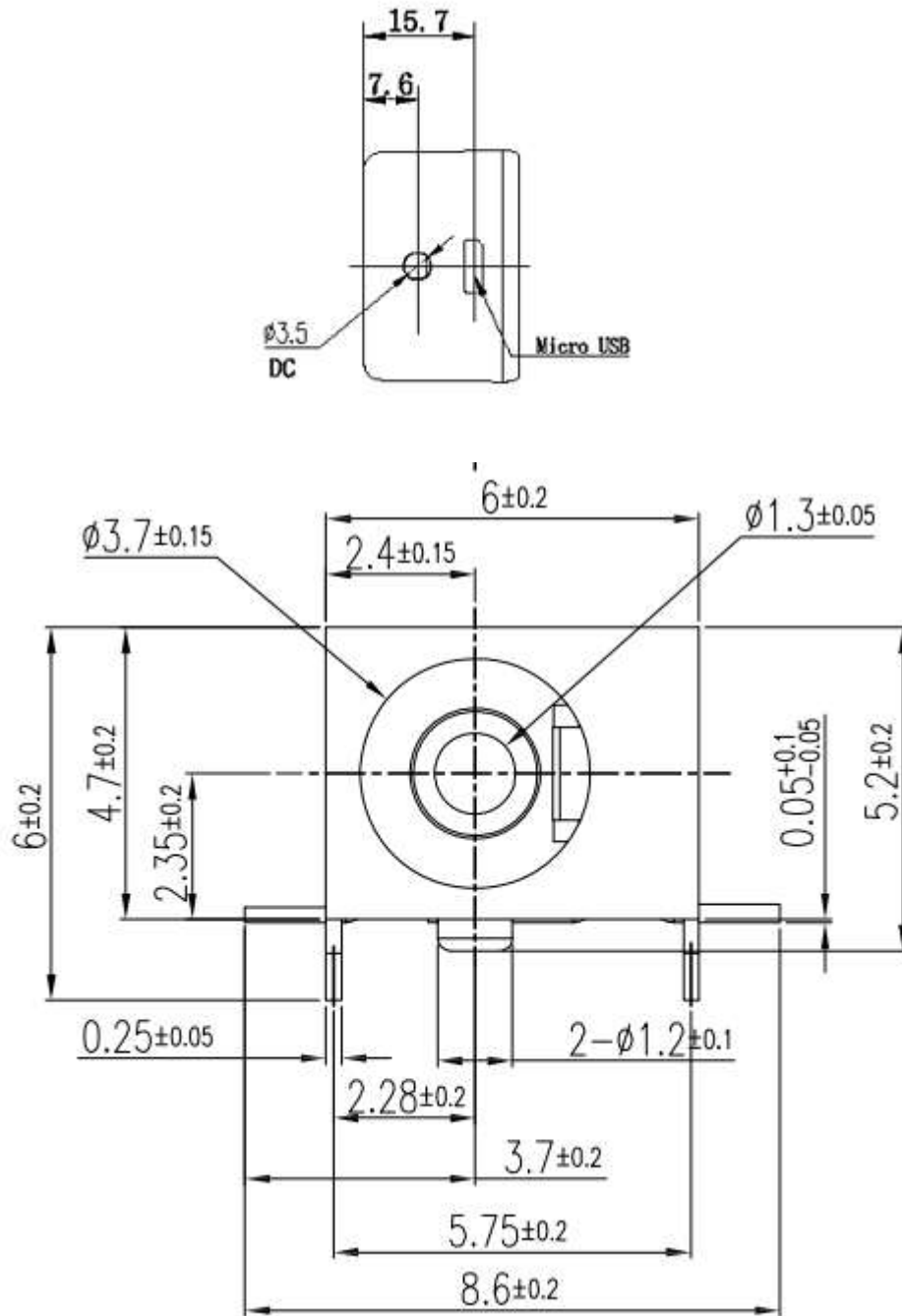

Fig. 4: DC Jack Connector

4.2 LED indication

Power supply	LED indication	
Working Mode (Powered by usb2.0)	Solid Green	
Working Mode (Powered by AC Adaptor)	Solid Red	
Standby Mode	Solid Blue	

5 Principle of Time of Flight

5.1 Vzense ToF Principle

Vzense DCAM710 product principle is based on range-gated imaging ToF solution, and the sensor inside is based on Panasonic CCD sensor MN34906.

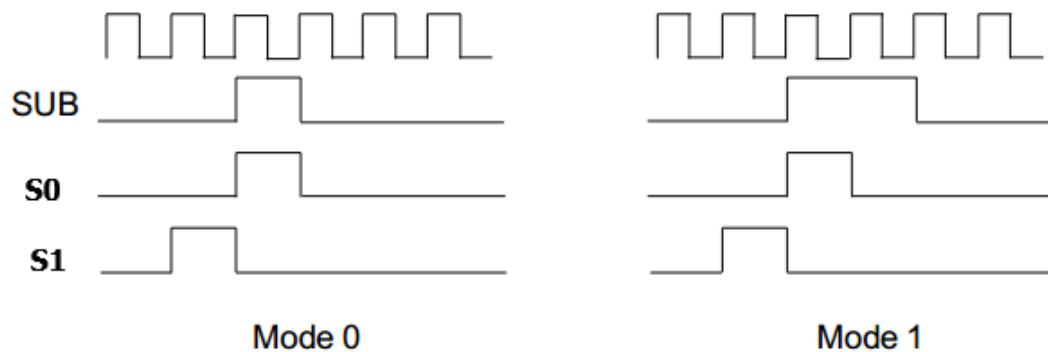

Fig. 9

◆ Mode #0:

- 1T,
- Best LD pulse number,
- good for distance from 10cm to 3.3m

$$Z = \frac{S_1}{S_0 + S_1}$$

Because the ToF distance measurement relies on the reflection of light sent out by the camera, any additional light, e.g. artificial light sources or sunlight, may influence the measurement results.

A strong ambient light may affect the accuracy and precision of the depth data, the Zense DCAM 710 is suggested to in user below 50K LUX ambient light.

5.2 Multipath Propagation

Based on the principle of ToF, Multipath effect may happen when the light reflected more one once. Any light that has been reflected several times, by other objects in the camera's field of view or the environment can cause deviation to the measurement result.

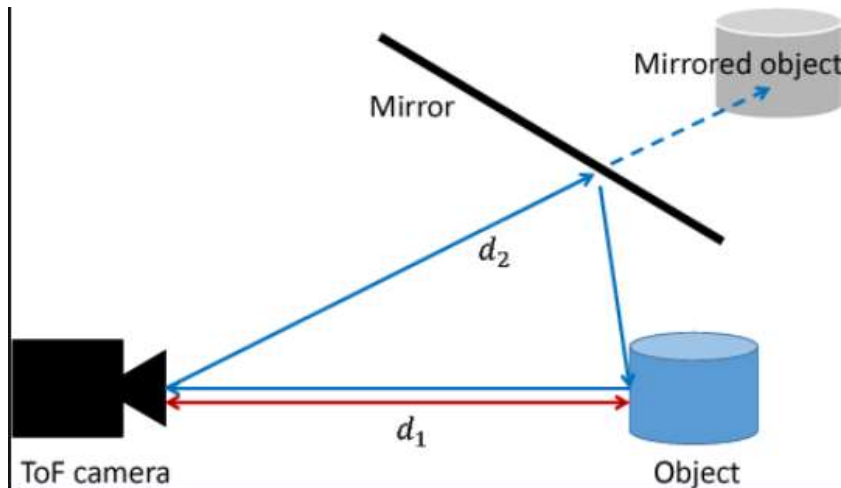

To eliminate the multipath effect, you should:

1. Keep the camera working environment as clean as possible;
2. Avoid the camera be placed at concave forms environment, like corners of a room or inside of a narrow space;
3. Highly-reflective object shall be removed far away from the measurement target;

5.3 Reflectivity of the Target

Please note that different reflectivity of the target may cause measurement result deviation, objects which have 20% to 80% reflectivity to 850nm or 940nm infrared light have the best result.

5.4 Scattering Effect

Scattering light effect is a noise factor to ToF products, it is caused by multiple reflection inside the lens of camera or the cover of camera.

To eliminate the scattering light effect, you should:

1. Keep the cover glass of the camera clean;
2. Do NOT place any other cover glass in front of the camera;
3. Keep the camera working environment as clean as possible;

6 Installation

6.2 Hardware Installation

You have read and understood the warnings listed under "Precautions" on Chapter 2; To achieve reliable distance measurements, please follow below tips:

- Better not using the camera in strong sunlight. If have to, keep the ambient light below 50k Lux.
- Do NOT place any objects in the scene that are not part of your intended target, especially mirrors or other shiny surfaces/objects.
- Maintain a stable housing temperature during operation.
- Take measures to provide cooling to camera
- Mount the camera robustly.
- All accessories are ready

The installation steps are as below:

- 1 Connect the camera module to PC USB interface through USB cable, as Figure

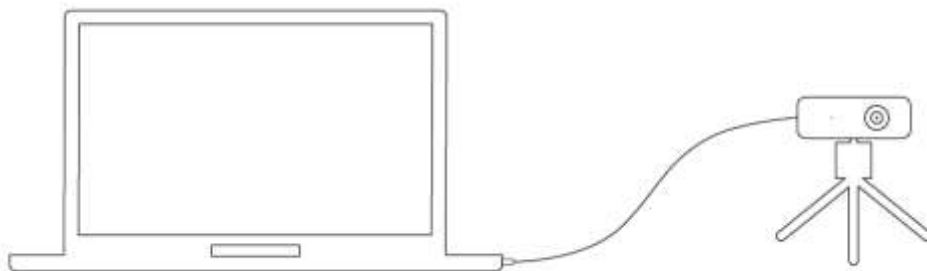

Figure 6.1 Hardware Installation

- 2 In Windows, when the camera module is successfully connected, it will pop up the notice of the device driver installation. After the driver is auto-installed successfully, it will display the VZense RGBD Camera device in Windows Device Manger.

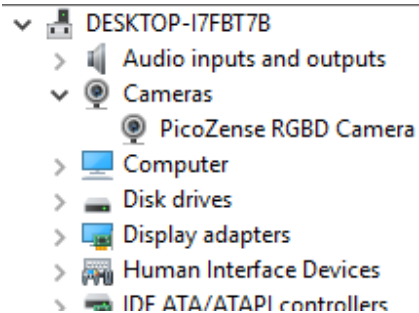

Figure 6.2 VZense RGBD Camera

6.3 Software Installation

6.3.1 Operating system

- Windows 7/8/10
- Linux
- ArmLinux
- Android

6.3.2 VZense SDK and VZenseUtool

VZense SDK is available for above systems. Download SDK from below link:

China: <https://gitee.com/Vzense>

Oversea: <https://github.com/Vzense>



6.3.3 Graphic Tool on windows







Vzense uTool is a graphic tool on windows OS for the all Vzense ToF products.

Download or clone uTool evaluation tool from our GitHub /Gitee:

China: <https://gitee.com/Vzense/UTool>

Oversea: <https://github.com/Vzense/UTool>

Please do read the Vzense_UTool_User_guide.pdf before using.

	Qt5Widgets.dll	2020/4/7 11:55	应用程序扩展	4,386 KB
	UTool.ini	2021/1/13 10:36	配置设置	1 KB
	version	2021/1/29 20:59	文件	1 KB
	vzense_api.dll	2021/1/29 20:40	应用程序扩展	1,166 KB
	Vzense_UTool_User_Guide.pdf	2020/8/25 14:20	Foxit Reader PD...	1,739 KB
	VzenseUTool.exe	2021/2/1 9:16	应用程序	1,792 KB
	VzenseUTool用户手册.pdf	2020/8/25 13:51	Foxit Reader PD...	1,840 KB

6.3.4 Firmware Upgrade

Download the VzenseUpgradeTool from below link:

China: <https://gitee.com/Vzense/VzenseUpgradeTool>













Oversea: <https://github.com/Vzense/VzenseUpgradeTool>

Download the latest firmware from below link:

China: <https://gitee.com/Vzense/DeviceFirmware-List>

Oversea: <https://github.com/Vzense/DeviceFirmware-List>

Please do read the Vzense_UpgradeTool_User_Guide.pdf in the package before you start a firmware upgrade.

	platforms	2021/7/28 9:34	文件夹	
	Upgrade	2021/7/28 9:39	文件夹	
	ImgPreProcess.dll	2021/7/16 9:30	应用程序扩展	10,632 KB
	msvcp140.dll	2021/7/16 9:30	应用程序扩展	440 KB
	Qt5Core.dll	2021/7/16 9:30	应用程序扩展	4,646 KB
	Qt5Gui.dll	2021/7/16 9:30	应用程序扩展	4,843 KB
	Qt5Widgets.dll	2021/7/16 9:30	应用程序扩展	4,348 KB
	README.md	2021/7/16 9:30	MD 文件	1 KB
	ReleaseNotes.txt	2021/7/16 9:30	文本文档	1 KB
	version	2021/7/16 9:30	文件	1 KB
	vzense_api.dll	2021/7/16 9:30	应用程序扩展	1,166 KB
	Vzense_UpgradeTool_User_Guide.pdf	2021/7/16 9:30	Foxit Reader PD...	713 KB
	VzenseUpgradeTool.exe	2021/7/16 9:30	应用程序	195 KB

7 Features

5.1 Slave Trigger Mode

At slave trigger mode, the DCAM710 product outputs image only when trigger signal happens. A customized 5pin USB cable shall be in use to implement the slave trigger mode for DCAM710.

Hardware Trigger Function

Hardware trigger mode is available only when the camera works at slave mode, in slave mode the camera will wait for the hardware trigger signal on Ext_Trigger.

The EXT_Trigger signal is for slave synchronization for each frame, External input trigger signal voltage should range 3.3V-20V, driving current ability should be more than 5mA;

You can use input pin Ext_Trigger to send a hardware trigger signal to the camera. The hardware trigger can be used to trigger the acquisition start. **A hardware debouncer circuit shall be considered on the EXT_Trigger line.**

By default, the hardware trigger is **rising edge** activated, refer to below exposure timing:

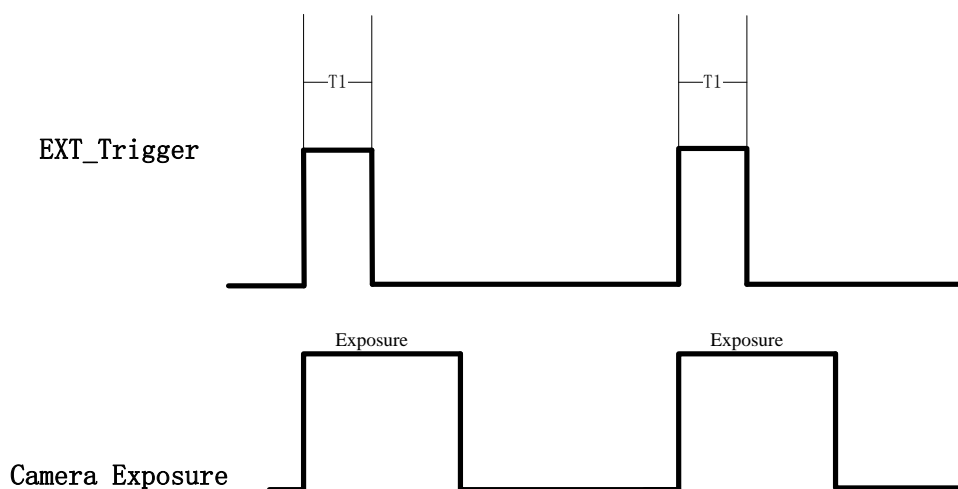

The requirement to T1 should be from 100us to 2ms.

Two ways can set the DCAM710 product at slave trigger mode before start streaming:

- 1) Call API `Ps2_SetSlaveModeEnabled(PsDeviceHandle device, uint32_t sessionIndex, bool bEnabled)`, before `Ps2_StartStream()`;
This way requires calling the API every power cycle.
- 2) Use Vzense Cofig Tool to set the the default mode as slave mode;
This way can hardcode the product as slave mode by default.

WorkMode_list	[master,slave]	
WorkMode	master	Type in master or slave

Please refer to the Vzense_ConfigTool_User_Guide.pdf.

The slave trigger mode can be used to implement multiple products synchronization, one works as master, the other works as slave.

Please refer to Multiple_ToF_Products_Synchronization_Application_Note.pdf for more information.

7.2 Range Customization

By default, there are 3 different range modes calibrated for DCAM710, please see below table for more information:

Range number	Distance range
Range 0	0.35m~1.5m
Range 1	0.5m~2.8m
Range 2	0.8m~4.4m

Please do NOT use uncalibrated modes, the measurement data will not be guaranteed. If you need other range mode requirement, you can ask Zense team to do range customization, reasonable NRE fee will be charged.

One range mode of the Zense DCAM710 camera can fulfill furthest distance be at most 5 times of nearest distance. For example, if the near limitation is 0.4m, then the furthest distance in this mode can reach about 2m.

7.3 Wide Dynamic Range

As mentioned above, Most of the ToF based 3D sensing technology has range limitation to nearest and furthest distance, due to the sensor saturation of weak light strength to far objects. One range mode of the Zense DCAM710 camera can fulfill furthest distance be at most 5 times to nearest distance. For example, if the near limitation is 0.4m, then the furthest distance in this mode can reach about 2m.

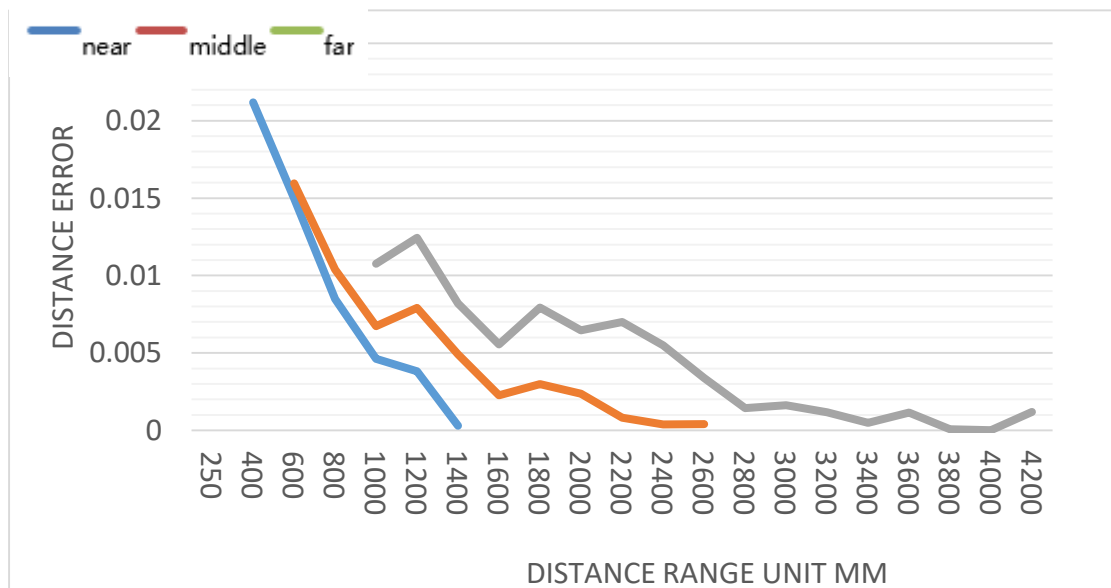

Wide dynamic range means that the camera can work at more than one range modes alternately, then the camera itself will combine the result into one depth frame, therefore can expand the range limitation from furthest distance to nearest distance. However the frame rate will be reduced.

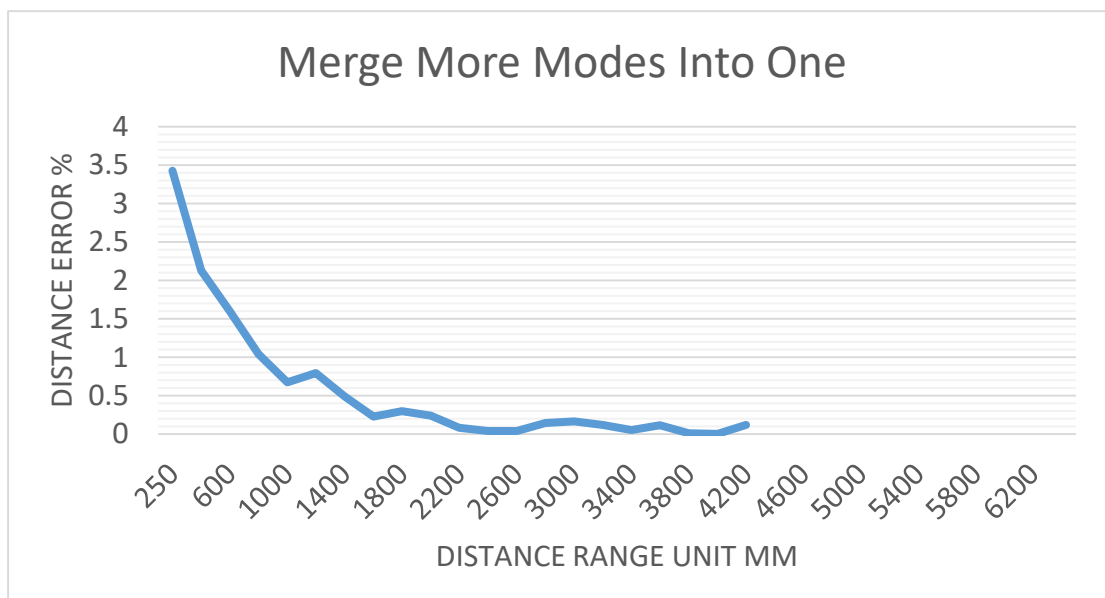
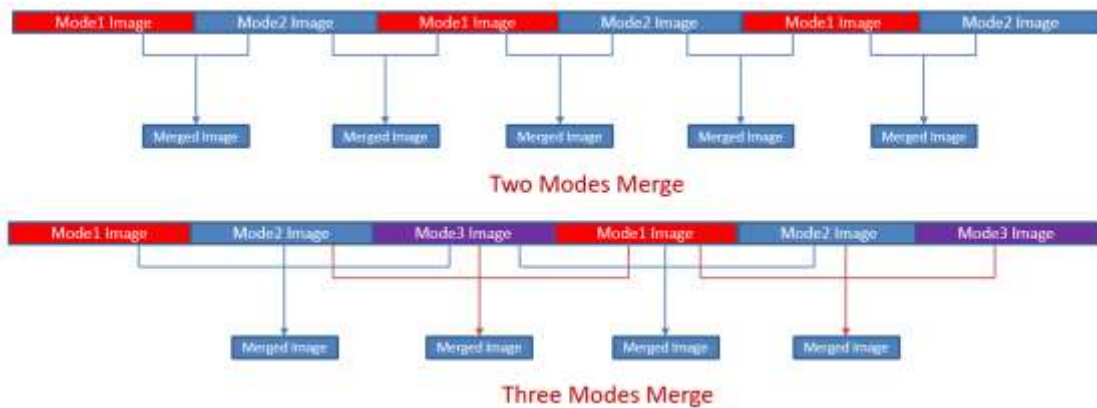

Please refer to Vzense_WDR_function_application_note.pdf for the WDR implementation steps.

7.4 Data Filtering

In the software SDK and UTool, we implemented data filtering to improve the depth data performance.

The filtering algorithm includes:

- Median filtering;
- Gaussian filtering;
- Bilateral filtering;
- Timing filtering;
- Flying pixel removing;

7.5 IR Image

Besides the depth image, Zense DCAM710 camera can also output a VGA resolution IR image. And the IR image is exactly timing synchronized with the depth image. Pixel to pixel mapping is also exactly aligned.



8 DCAM710 Accessories and Package

In package item list:

Item	Part number	Description	Quantity
1	DCAM710	Zense DCAM710 Depth Camera Module	1
2	Micro USB Cable		1
3	VZENSE-DC-5V2A-A	Additional Power Adaptor for Long Range	1

You can ask Zense to do customization to the cable or adaptor for any reason, for example extending the cable length.

Please do NOT use the accessories from other parts except Zense Company, otherwise warranty will void.

Optional item list:

Item	Component	Description	Quantity
1	5pin Trigger USB Cable	USB cable for slave mode product	1

Optional items need customer to pay for.

9 Customization Service

Zense team has rich experience in ToF product design and delivery, we welcome customer to send customization requirement besides the standard module. Reasonable NRE fee shall be charged depends on the requirement.

Appendix

ROHS Declaration

Part Name	Hazardous Substances or Elements					
	Lead (Pb)	Mercury (Hg)	Cadmium (Cd)	Hexavalent Chromium (Cr6+)	Polybrominated Biphenyl (PBB)	Polybrominated Diphenyl Ethers (PBD)
Structural Components	x	○	○	○	○	○
Circuit Module	x	○	○	○	○	○
Optical Lens	x	○	○	○	○	○
Cable	○	○	○	○	○	○
Pouch	x	○	○	○	○	○

○: Indicates that this hazardous substance contained in all the homogeneous materials for
x: Indicates that this hazardous substance contained in at least one of the homogeneous

Eye Safety Declaration

Dcam710 is classified as a Class 1 Laser Product under the EN/IEC 60825-1, Edition 3 (2014) internationally and IEC60825-1, Edition 2 (2014) in the US.

This product complies with US FDA performance standards under 21 CFR 1040.10 for laser products except for deviations pursuant to Laser Notice No. 50 dated June 24, 2007.

Camera	US FDA Accession Numbers
DCAM710	1820835-000

Reliability Declaration

Revision History