

Electronic Design[®] 14

VOL. 23 NO. 7
JULY 5, 1975

FOR ENGINEERS AND ENGINEERING MANAGERS

Take a cue in selecting op amps and don't get trapped behind the eight ball of "typical" specs. Shoot for realistic max, min and intermediate spec values. Bank

on hidden tradeoffs lying behind specs like noise and bandwidth, slew rate, offset-voltage drift and common-mode rejection. To win the op-amp game see page 44.



I want to give you a Stripswitch.

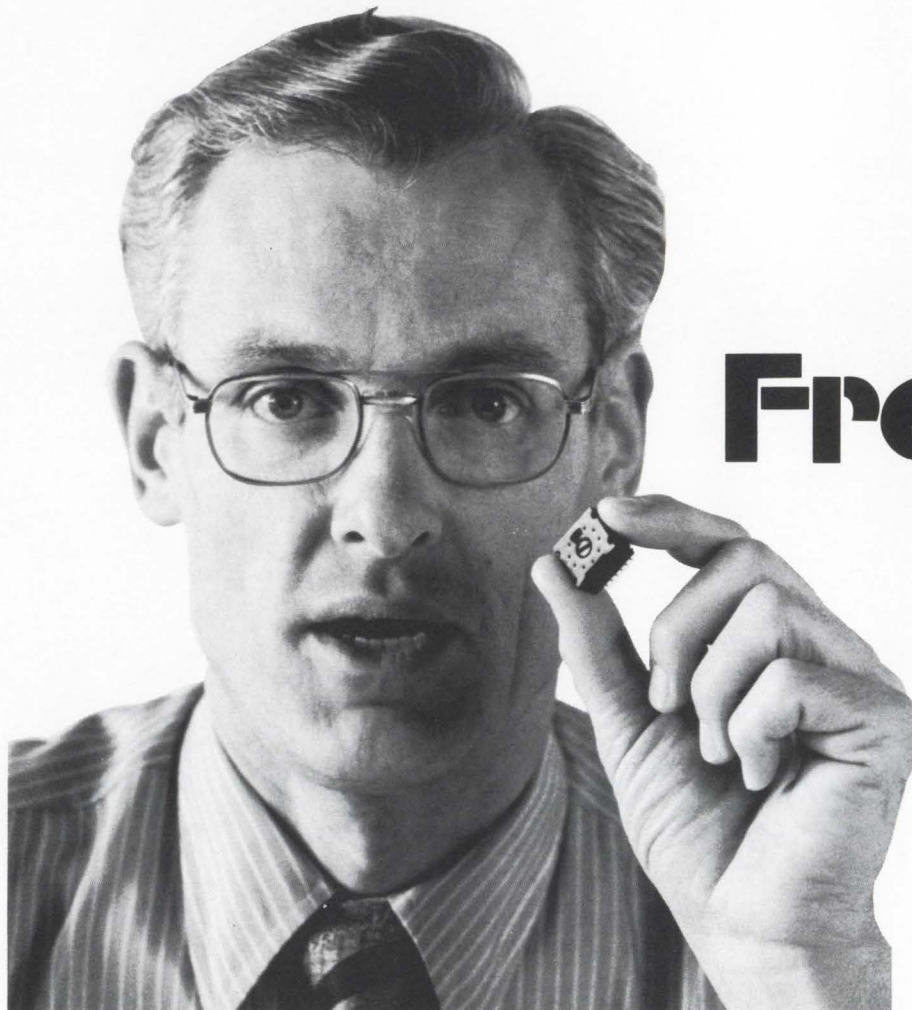

FREE.

My name is Tom Price. I am Switch Products Manager at EECO. And I will give you a real, functioning Strip-switch absolutely free if you will write me on your letterhead. There are no other qualifications or requirements.

I am doing this because I have found that Stripswitch itself is the best salesman I've got.

When you get one of these little marvels in your own hands, you'll see how beautifully it is conceived and

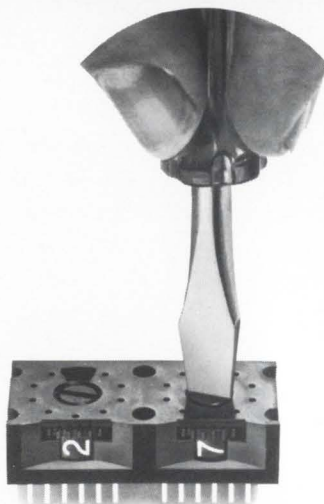

designed for circuit board applications. You'll perceive the clarity of its readout and the multiplicity of its actuation. You'll appreciate its variety of coded outputs, and all the other choices of features and options.

I can tell you all of that, as I just did, but you won't believe until you get one of your own.

Write me for your free Stripswitch. It's something to believe in. Honestly.

EECO

FOR SWITCHES

1441 East Chestnut Avenue, Santa Ana, California 92701
Phone 714/835-6000

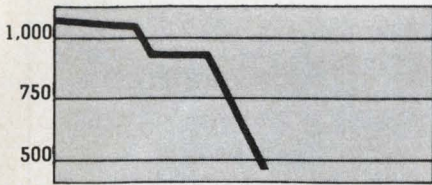

For years, we've been bullish on high-priced sweepers. Sure, there were plenty of low-priced offerings, if you wanted to speculate with hobbyist quality. But if you really wanted to make a clean sweep, you looked to the blue

chips—and to spending about a grand. But now Wavetek has issued the Model 1050, an instrument that everyone can afford (even those in a tight capital equipment spending predicament). It sweeps from 1 MHz to 400 MHz with the signal quality needed for both lab and production use. The instrument features ± 0.25 dB output flatness, 2% display linearity, spurious signals 30 dB below output, and a maximum amplitude of +10

dBm. It's available in 50-ohm and 75-ohm versions, and the price for either is just \$495. In our opinion, this is the time to buy. Write or call us for a complete statement of the Model 1050's performance. Wavetek Indiana, Inc., P.O. Box 190, Beech Grove, Indiana 46107. Tel. (317) 783-3221. TWX 810-341-3226.

WAVETEK[®]
 INFORMATION RETRIEVAL NUMBER 2

The bottom just dropped out of the sweeper market.



\$495

Be prepared...

Kit includes
Original
Swiss Army
knife at no
extra cost



for emergency needs...and design improvements

3 KHz - 750 MHz

Double-Balanced Mixer Kit \$79.95

SAVE \$41.75 AND ALSO GET AN ORIGINAL SWISS ARMY KNIFE

Be prepared to . . .

- ... meet emergency customer needs
- ... outfit breadboards and prototypes overnight
- ... customize designs without delay
- ... retrofit and update designs
- ... modify and substitute for better performance or price
- ... and to cut, skin, slice, sever, snip, saw, screw, scribe, shape, scrape, strip, pick, pry, punch, trim with the Swiss Army knife included in kit.

There's an analogy between the popular Swiss Army knife and Mini-Circuits Laboratory's new double-balanced mixer kit (DBK-4). Both have been designed to serve their owner when the need arises . . . and both products should be on hand when the need arises.

Double-balanced mixer kit (DBK-4)

BE A PLANNER AND SAVE \$41.75.

Order now and receive six double-balanced mixers (2) SRA-1, (2) SRA-1W, (1) SRA-3, (1) SRA-6) and one Swiss Army knife for only \$79.95. (A \$121.70 mixer value if purchased separately.)

MODEL	Frequency Range (MHz)	Conversion Loss (dB) Total Range	Isolation (dB)					
			Lower band edge to one decade higher		Mid range		Upper band edge to one octave lower	
			LO-RF	LO-IF	LO-RF	LO-IF	LO-RF	LO-IF
SRA-1	LO-0.5-500 RF-0.5-500 IF-DC-500	6.5 typ. 8.5 max.	50 typ. 35 min.	45 typ. 30 min.	45 typ. 30 min.	40 typ. 25 min.	35 typ. 25 min.	30 typ. 20 min.
SRA-1W	LO-1-750 RF-1-750 IF-DC-750	6.5 typ. 8.5 max.	50 typ. 45 min.	45 typ. 30 min.	45 typ. 30 min.	40 typ. 25 min.	35 typ. 25 min.	30 typ. 20 min.
SRA-3	LO-0.025-200 RF-0.025-200 IF-DC-200	6.5 typ. 8.5 max.	60 typ. 50 min.	45 typ. 35 min.	45 typ. 35 min.	40 typ. 30 min.	35 typ. 25 min.	30 typ. 20 min.
SRA-6	LO-0.003-100 RF-0.003-100 IF-DC-100	6.5 typ. 8.5 max.	60 typ. 50 min.	60 typ. 45 min.	45 typ. 30 min.	40 typ. 25 min.	35 typ. 25 min.	30 typ. 20 min.

Price \$9.95—Quant. (1-49)
Price \$24.95—Quant. (1-5)
Price \$21.95—Quant. (1-5)
Price \$29.95—Quant. (1-5)

MCL Mini-Circuits Laboratory

OUR NEW ADDRESS IS: 837-843 Utica Avenue,
Brooklyn, NY 11203 (212) 342-2500 Int'l Telex 620156

Foreign Sales Representatives: AUSTRALIA General Electronic Services, 99 Alexander Street, New South Wales, Australia 2065; ENGLAND Dale Electronics, Dale House, Wharf Road, Frimley Green, Camberley Surrey; FRANCE S. C. I. E. - D. I. M. E. S., 31 Rue George - Sand, 91120 Palaiseau, France; GERMANY, AUSTRIA, SWITZERLAND Industrial Electronics GMBH, Klüberstrasse 14, 6000 Frankfurt/Main, Germany; ISRAEL Vectronics, Ltd., 69 Gordon Street, Tel-Aviv, Israel; JAPAN Densho Kaisha, Ltd., Eguchi Building, 8-1-1 Chome Hamamatsucho Minato-ku, Tokyo; EASTERN CANADA B. D. Hummel, 2224 Maynard Avenue, Utica, NY 13502 (315) 736-7821; Netherlands, Belgium, Luxemburg: Colmex, Veldweg 11, Hattem, Holland.

US Distributors: NORTHERN CALIFORNIA Cain-White & Co., Foothill Office Center, 105 Fremont Avenue, Los Altos, CA 94022 (415) 948-6533; SOUTHERN CALIFORNIA, ARIZONA Crown Electronics, 11440 Collins Street, No. Hollywood CA 91601 (213) 877-3550

NEWS

- 23 **News Scope**
- 26 **Beam-lead integrated circuits have failed** reliability and cost tests, says Hughes Aircraft.
- 30 **Practical fiber-optic communications systems** are seen as approaching the applications stage.
- 32 **Finally, space-saving bipolar ICs** for microwave processing.
- 37 **Washington Report**

TECHNOLOGY

- 44 **FOCUS on op amps**—A special report pinpointing the problems in specifying these most universal of all linear active devices. The report also puts into perspective new developments in hybrid, monolithic and modular op amps.
- 52 **The mini's most important part** may be its operating system, but many users neglect it. Here are tradeoffs to consider in evaluating today's minicomputers.
- 58 **How fast does your CRT write?** You can get the photographic speed from the spec sheet, but the number may be fuzzy. Here's how to find out.
- 64 **Ze'ev Drori of Monolithic Memories** speaks on coping with engineers' weaknesses.
- 68 **Ideas for Design:**
 - Low distortion modulator and carrier source made at low cost with single dual op amp.
 - Digital circuit detects frequencies within adjustable difference band.
 - Constant period with variable duty cycle obtained from 555 timer with single control.
- 74 **International Technology**

PRODUCTS

- 77 **Instrumentation:** Hand-held IR thermometer has digital and analog displays.
- 83 **Power Sources:** Switching supply achieves power density of 2.3 W/in.³
- 79 Modules & Subassemblies
- 84 Discrete Semiconductors
- 86 Integrated Circuits
- 88 Data Processing
- 90 Packaging & Materials
- 92 Components
- 94 Microwaves & Lasers

DEPARTMENTS

- 41 **Editorial:** Listening with both ears
- 7 Across the Desk
- 95 Design Aids
- 96 New Literature
- 99 Vendor Report
- 104 Advertisers' Index
- 106 Product Index
- 108 Information Retrieval Card

Cover: Designed and photographed by Art Director, Bill Kelly. Op amps shown courtesy of Analog Devices, Burr-Brown, Datel Systems, Dynamic Measurements, Harris Semiconductor, Intech, Motorola Semiconductor, National Semiconductor, Precision Monolithics, RCA Solid State, Signetics, Teledyne Philbrick, Teledyne Semiconductor, Texas Instruments.

How to buy a m

Which comes first—the hardware or the software? You need both, of course, to create new products with microcomputers. The tougher question is: How do you assure product profitability? That gets you into questions of hardware availability, software support, design assistance and confidence in your supplier. When an electronics publication recently asked readers to rank their micro-computer buying criteria, it came as no surprise to Intel that availability, software support and supplier reputation topped the list.

Intel can supply you today with five general-purpose CPUs, supported by numerous peripheral, I/O and memory components, software packages and development manuals, and the industry's largest library of users' applications programs. Our five microcomputers span a 1000:1 performance range and include the lowest cost, highest performance and most popular designs available today. Their applications are

equally broad, from electronic games to high speed controllers and processors. We want to make sure that our customers don't begin designing with pieces of the hardware/software puzzle missing. To minimize development and assembly cost, each CPU is backed up by more than a score of performance-matched system components—advanced programmable I/O



INTEL MICROCOMPUTER SYSTEM FAMILIES					
MICROCOMPUTER SYSTEM	MCS™4	MCS™40	MCS™8	MCS™80	Series 3000
CENTRAL PROCESSOR	4004	4040	8008	8080	3001, 3002, 3003
Technology	PMOS	PMOS	PMOS	NMOS	Schottky Bipolar
Parallel Bits	4	4	8	8	2 per 3002 CPE
Instruction Cycle	10.8μS	10.8μS	12.5μS	2μS	100nS
SUPPORT COMPONENTS					
RAMS (including CMOS)	4	4	5	5	8
PROMS	3	3	3	4	7
ROMS	4	4	3	3	6
*Peripheral Interfaces	6	6	6	6	8
Interrupt Unit			1	1	1
Clock Generator	1	1	1	1	TTL
*I/O Units	5	5	3	3	3
Total Component Choices	23	23	22	23	33
SYSTEMS SUPPORT					
Software Packages					
Microassembler					1
Assemblers	2	2	2	2	
Compiler			1	1	
Monitor	1	1	1	1	
Simulator	1	1	1	1	
Text Editor			1	1	
Manuals	6	6	5	6	1
User's Library	Yes	Yes	Yes	Yes	Yes
Intellec® Development System	Yes	Yes	Yes	Yes	In development

* Five additional I/O and peripheral devices will be available in 2nd half of 1975.

icrocomputer.



subsystems, peripheral interfaces, clock generators, priority interrupt and other control units, and the broadest selection of erasable and bipolar PROMs, compatible metal mask ROMs, CMOS and NMOS RAMs.

Moreover, Intel software packages include resident monitors, assemblers and text editors available on Intellec® microcomputer development systems. Assemblers, simulators and compilers

are also available as cross products on magnetic tape or on leading time share networks. With these aids programs can be written and debugged in a fraction of the time required a few years ago.

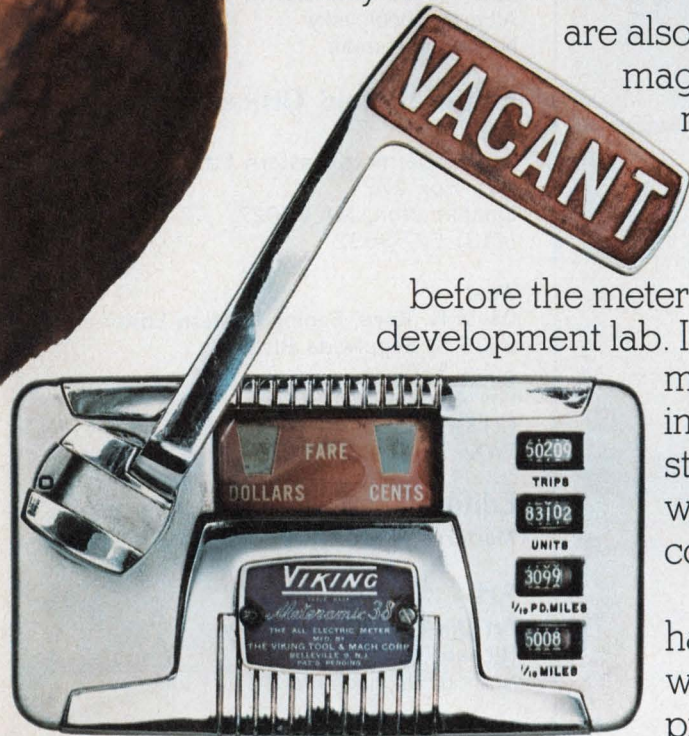

before the meter starts running in the research and development lab. Intel has the industry's most experienced microcomputer field applications engineering group. If your staff needs help to get started, we have regional training centers, workshops, seminars and on-site training courses available.

You may need design assistance With Intel, there's no shell game about hardware or software delivery, no guessing whether the supplier can handle all your production commitments. Intel has been

delivering microcomputers in volume since 1971. Our reputation speaks for itself. We've already delivered more general-purpose microcomputers than the rest of the industry combined.

If you have tough questions about which microcomputer will make your new products most profitable, call or write Intel for our solutions. Intel Corporation, 3065 Bowers Avenue, Santa Clara, California 95051 (408) 246-7501.



intel® Microcomputers. First from the beginning.

INFORMATION RETRIEVAL NUMBER 4

HARNESSES

Simple jumpers to massive power signal assemblies. Flat ribbon form or programmed, multi-purpose, multi-layer. Machine made or hand-tied. Delivered in absolute conformance to your system requirements and ready for drop-in. Flat woven cabling gives you broadest design capability, superior control and performance characteristics of individually insulated leads and precise positioning.

For maximum benefits, let us assist in planning. End those harness hang-ups. Think Woven—your complete source for flat interconnects.

WOVEN ELECTRONICS

P.O. Box 189/Mauldin, S.C. 29662
(803) 963-5131

Sr. Vice President, Publisher
Peter Coley

Editors

Editorial Offices
50 Essex St.
Rochelle Park, NJ 07662
(201) 843-0550
TWX: 710-990 5071
Cable: Haydenpubs Rochellepark

Editor-in-Chief George Rostky

Managing Editors:

Ralph Dobriner
Michael Elphick

Associate Editors:

Dave Bursky
Jules H. Gilder
Morris Grossman
John F. Mason
Stanley Runyon
Edward A. Torrero

Contributing Editors:

Peter N. Budzilovich
Alberto Socolovsky
Nathan Sussman

Editorial Field Offices

East

Jim McDermott, Eastern Editor
P.O. Box 272
Easthampton, MA 01027
(413) 527-3632

West

David N. Kaye, Senior Western Editor
8939 S. Sepulveda Blvd.,
Suite 510
Los Angeles, CA 90045
(213) 641-6544
TWX: 1-910-328-7240

Editorial Production

Marjorie A. Duffy

Art

Art Director, William Kelly
Richard Luce
Anthony J. Fischetto

Production

Manager, Dollie S. Viebig
Helen De Polo
Anne Molfetas
Maxine Correal

Circulation

Manager, Evan Phoutrides

Information Retrieval

Peggy Long

Promotion

Karen Kerrigan (Reprints)

Creative Layout Services

Manager, Albert B. Stempel

Across the Desk

Another counting idea for pocket calculators

Some pocket electronic calculators will not respond to the key-stroke technique of G. Alexandrovich's Idea for Design in "Convert Your Pocket Calculator into a Programmable Counter" (ED No. 6, March 15, 1975, p. 100). For example, Sears Roebuck Model 728.58850 is not equipped to add a constant to the accumulator, but it can multiply the accumulator by a stored constant. For these more limited calculators, in an eight-digit machine, the steps are as follows:

1. Turn on "K switch."
2. Clear accumulator and constant (C).
3. Enter 1.0000001.
4. Press the multiply key.
5. Successive key strokes of the (+=) key will then count events by incrementing the least-significant digits—1.0000002, 1.0000003, 1.0000004, etc.

An ambiguity occurs when the count ends in zero, such as 10 or 20. The right zero suppression of the calculator drops the cipher. The addition of one more count—to 11 and 21 in this example—can eliminate possible confusion.

The machine counts by multiplication of the accumulator by the constant and retention of the eight most-significant digits. For example, the count 5432 corresponds to the number 1.0005432 in the display. It is multiplied by 1.0000001 for the next count.

When the multiplication is rewritten as $(1.0 + 5432 \times 10^{-7}) (1.0 + 1.0 \times 10^{-7})$ the product is $1.0 + 5432 \times 10^{-7} + 1.0 \times 10^{-7} + 5.432 \times 10^{-11}$, which, after truncation to eight

figures, gives 1.0005433, the next count.

Because the "errors" are truncated with each successive count, the algorithm is accurate for reasonable counting ranges. When the count is in increments of one, the error does not appear in the least-significant digit until 10 million counting cycles—far more than one would reasonably attempt to count manually.

In some machines the count is not truncated, but the remainder is carried forward to compute more significant figures than those displayed.

David W. Thompson

Florida Institute of Technology
Melbourne, FL 32901.

Squaring circuit idea 'missed a good bet'

In the Idea for Design "Squaring Circuit Generates Second Harmonic for Controlled-Distortion Test Signal" (ED No. 8, April 12, 1975, p. 78), Arthur B. Williams missed a good bet when he didn't use an internally trimmed multiplier now available from several sources.

For example, our AD532 could have been used. This circuit would have required 20 fewer resistors and potentiometers and would have eliminated the need for the two op amps in Mr. Williams' circuit. Today it is unnecessary to struggle with an IC that doesn't contain the complete function in one package.

It is instructive to examine the derivation of the second harmonic from a multiplier. The multiplier inputs $E \sin \omega t$ and $V-E \sin \omega t$

(continued on page 10)

Thin-Trim[®] capacitors



 Tucked in the corner of this Pulsar Watch is a miniature capacitor which is used to trim the crystal. This Thin-Trim capacitor is one of our 9410 series, has an adjustment range of 7 to 45 pf., and is .200" x .200" x .050" thick. The Thin-Trim concept provides a variable device to replace fixed tuning techniques and cut-and-try methods of adjustment. Thin-Trim capacitors are available in a variety of lead configurations making them very easy to mount.

 A smaller version of the 9410 is the 9402 series with a maximum capacitance value of 25 pf. These are perfect for applications in sub-miniature circuits such as ladies electronic wrist watches and phased array MIC's.

Johanson Manufacturing Corporation,
Rockaway Valley Road., Boonton, N.J.
07005. Phone (201) 334-2676, TWX 710-
987-8367.

Electronic Design welcomes the opinions of its readers on the issues raised in the magazine's editorial columns. Address letters to Managing Editor, Electronic Design, 50 Essex St. Rochelle Park, N.J. 07662. Try to keep letters under 200 words. Letters must be signed. Names will be withheld on request.

**Developing this new pushbutton was
a little like coming up with a Ferrari that gets 32 mpg,
holds 12 people and costs less than a Pinto.**

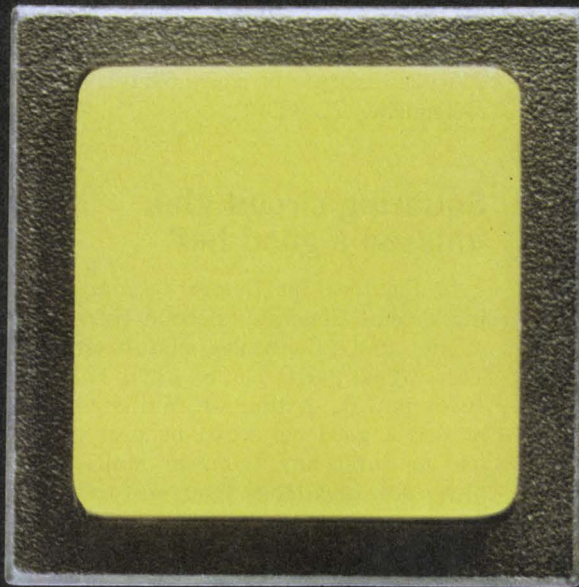

Until now, there have been some good-looking lighted pushbuttons and indicators.

And there have been others with varied electrical capabilities. But there's never been a line that gave you harmonious panel design, electrical flexibility, and low cost. All at the same time. Until now.

Introducing the MICRO SWITCH Advanced Manual Line—AML.

The most sophisticated line of pushbuttons and indicators ever designed. And you can see a few of the reasons why right here. The AML button height, bezel size and visual compatibility of the square and rectangular sizes "harmonizes" your panel. To give you a panel with a clean, good-looking geometric face. And a panel with increased efficiency, because it doesn't distract. The low-profile square and rectangular buttons are



available in five colors: white, red, yellow, green, and blue. Display capabilities include split screen, hidden color, and a unique three segment lens cap indicator. Illumination can be transmitted or projected. But what you can't see here is what helps to make these the most advanced line of lighted pushbuttons and indicators available: their extreme electrical flexibility.

Solid state operates at 5V or 6-16V with a built-in regulator, sink (TTL) and source (CMOS).

Electronic control is capable of handling low energy circuits and has a maximum rating of 3 amps, 120 VAC,



with single or double pole double throw.

And power control, DPST, with a rating of 10 amps at 120 VAC.

The AML has snap-in mounting from the front of panel and can also be subpanel mounted. There's a choice of individual or strip mounting.

All devices are the same shallow depth behind the panel to provide a unique single level termination system. The result is ease of wiring and neat appearance.



There are 5 types of terminals available: solder, quick-connect, wire-wrap, push-on or p.c. board mount.

Relamping is

accomplished from the front of the panel. And it's done without a tool. With a choice of lamps including a T-1 $\frac{3}{4}$ wedge base lamp, neon and LED. To provide international acceptance, every AML device has been designed to comply with essential IEC, CEE24, UL and CSA standards.



For more information on the AML, call your nearest MICRO SWITCH Branch Office. Or write for our literature.

What you'll see is a line of lighted pushbuttons and indicators that give you a completely harmonious panel design in the front.

And the utmost in electrical flexibility behind the panel.

All products shown on this page are actual size.

MICRO SWITCH

FREEPORT, ILLINOIS 61032

A DIVISION OF HONEYWELL

CIRCUIT DESIGNERS...

GET MORE VERSATILITY AND FLEXIBILITY IN YOUR BREADBOARDING.

Experience the convenience of

MULTI-COMP®

DIP Multiple-Section

Ceramic Capacitors

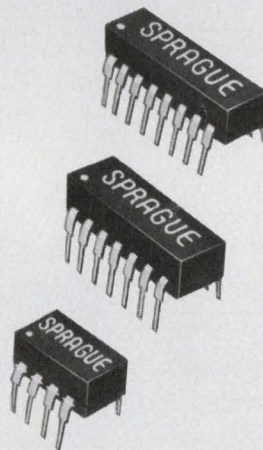

Breadboarding is a lot easier with Sprague Multi-Comp Monolythic® Ceramics. They readily plug in and out of standard DIP sockets for fast changes during experimentation. They come as 4-, 7-, and 8-section capacitors, in popular most-frequently-used capacitance values. By connecting capacitor sections in parallel, you can obtain

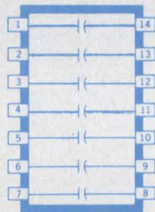

practically any value your circuit needs. With a few Multi-Comp capacitors on hand, there's no need to keep heavy stocks of individual capacitors for breadboarding purposes. There's less soldering and unsoldering, too.

And when your final capacitance determinations are made, you can either stay with DIP Multi-Comps, or switch to Sprague Single-Section Monolythic® Capacitors, which have the same layer-built construction and the same electrical characteristics.

GET THE DIP HABIT — TRY MULTI-COMP® MONOLYTHIC® CAPACITORS IN YOUR NEXT BREADBOARD DESIGN — THEY'RE READILY AVAILABLE FROM YOUR SPRAGUE INDUSTRIAL DISTRIBUTOR!

For more information, write or call
Ed Geissler, Mgr., Specialty Components
Marketing, Sprague Electric Company,
347 Marshall Street, North Adams, Mass. 01247.
Tel. 413/664-4411.



THE BROAD-LINE PRODUCER OF ELECTRONIC PARTS

INFORMATION RETRIEVAL NUMBER 8

ACROSS THE DESK
(continued from page 7)

produce an output function

$$e_o = \frac{E \sin \omega t (V - E \sin \omega t)}{10 V}$$

which reduces to

$$e_o = \frac{E}{10 V} \left(V \sin \omega t + E \frac{\cos 2\omega}{2} \right) - \frac{E^2}{20 V}$$

The $V \sin \omega t$ term is the fundamental and the

$$E \frac{\cos 2\omega}{2}$$

term is the second harmonic. The

$$\frac{E^2}{20 V}$$

term is an offset that can be nulled or capacitively blocked from the multiplier's output.

Though the AD532 uses ± 15 -V supplies and may not fit Mr. Williams' +8 and -5-V circuit, it should certainly be superior for general applications.

A. Paul Brokaw
Director, Advancement Product
Development

Analog Devices Semiconductor
829 Woburn St.
Wilmington, MA 01887.

Misplaced Caption Dept.



"Waddya wanna be a engineer for?"

Sorry. That's Murillo's "Boys Eating Melon and Grapes," which hangs at the Alte Pinakothek in Munich.

OEM buyers:
**Ask
 Control Data**

for a 60 megabyte disk storage
 unit with signal compatible
 interface options.

We have it.



CDC model 9746

- Signal compatible interface options:
 Century 215
 ISS 715
 Ampex DM 323
- TTL-compatible, single-ended transmission lines
- Absolute direct addressing

CAPACITY: 62,500,000 bytes/spindle nominal
 (based on 400 tracks/disk)
 RECORDING MODE: Double frequency
 RECORDING DENSITY: 2220 bpi
 TRACKS PER SURFACE: 406
 AVERAGE ACCESS TIME: 35 milliseconds
 DATA TRANSFER RATE: 312,000 bytes/second
 SPINDLE SPEED: 2400 rpm

21 OEM sales offices, in 11 countries,
 specializing in service to the mini OEM.

Call (612) 883-5042 or return coupon.

Ray Crowder, OEM Marketing Manager
 Control Data Corporation, Dept. ED-7555
 7801 Computer Avenue South, Minneapolis, MN 55435
 Please send information on CDC 9746 disk storage unit.

NAME		TITLE	
COMPANY		ADDRESS	
CITY			
STATE	ZIP	PHONE	



**CONTROL DATA
 CORPORATION**

The Total Services Company

Assemble prototype pots instantly.

New MOD POT Instant Prototypes equips you to put together virtually any pot you could want. And when you're ready for production, our distributors can quickly supply volume quantities to factory standards. Order a MPIP from your Allen-Bradley electronics distributor. \$97.50 apiece. Or, ask him for complete information on MOD POT... publication 5217.

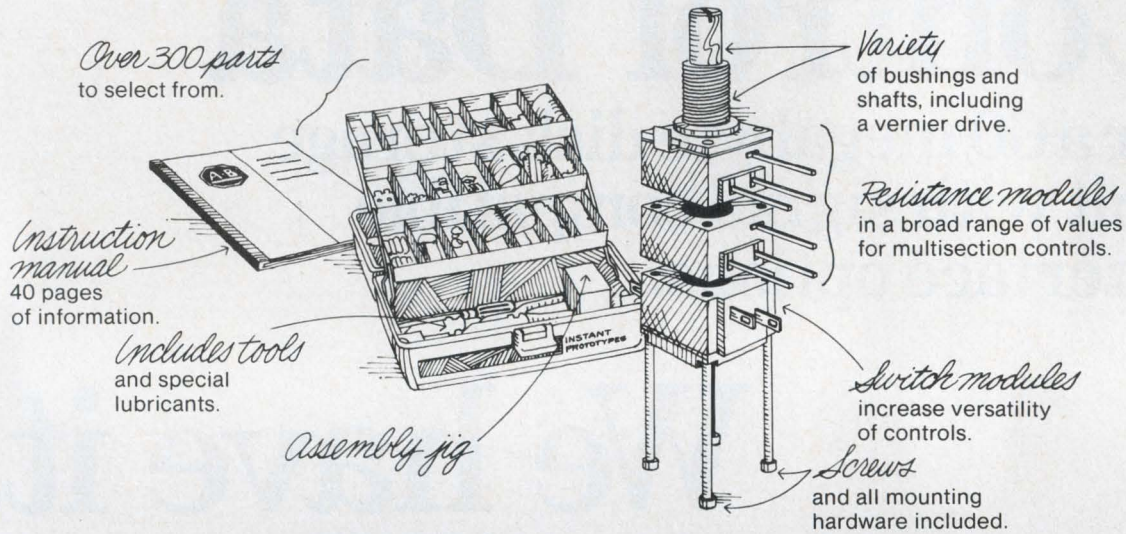

Quality in the best tradition.



ALLEN-BRADLEY

Electronics Division
Milwaukee, Wisconsin 53204

Latchproof CMOS Analog Switches

Latchproof CMOS analog switches—another reason why Siliconix, the analog switch leader, is the best source to fill your needs. Our exclusive new process (patent pending) eliminates latchup in CMOS analog switches by reducing parasitic PNP-NPN Beta to less than one!

Features:

- No latchup under any conditions—no external protection required.
- Full ± 15 V analog signal range—ideal for op amps.
- Low $r_{DS(ON)}$ for error-free operation.
- Full TTL and CMOS compatibility over the -55°C to $+125^{\circ}\text{C}$ temperature range without external components.
- Break-before-make switching action.
- New high-current capability—100mA pulse on DG200.

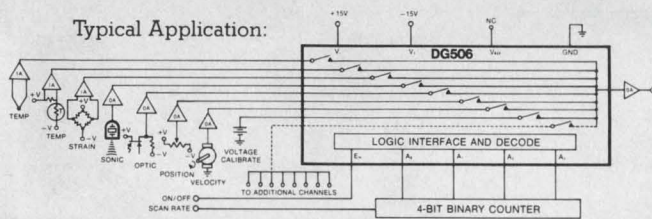

Sequential 16-Transducer Scanner (8 channels illustrated)

Siliconix latchproof CMOS analog switches are ideal for multiplexing, demultiplexing, computer interface, commutation, signal processing and many other applications. For further information or applications:

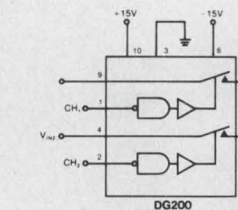

Variable-Gain Amplifier with Multiplexed Inputs

- Full signal capability even at unity gain!
- Digitally-controlled gain and channel selection!

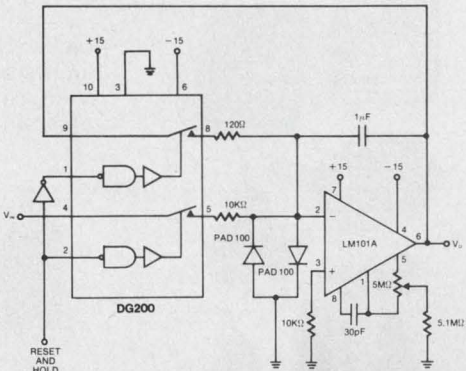

Typical Application: Integrator Reset & Hold

Take your choice from these CMOS switches:

- DG200—2-channel SPST—70 Ω max. ON resistance.
- DG201—4-channel SPST—175 Ω max. ON resistance.
- DG506—16-channel MUX—400 Ω max. ON resistance.
- DG507—8-channel differential MUX—400 Ω max. ON resistance.
- DG508—8-channel MUX—400 Ω max. ON resistance.
- DG509—4-channel differential MUX—400 Ω max. ON resistance.

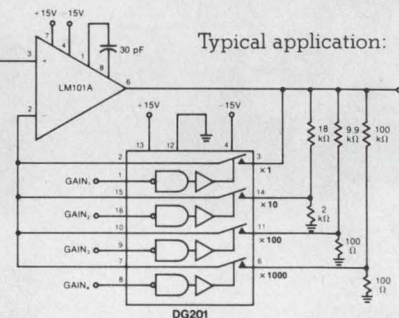

write for data

Analog Switch Applications (408) 246-8000 x 120

Siliconix CMOS is now available from your local CRAMER, ELMAR or HAMILTON/AVNET distributor outlet.



Siliconix incorporated

2201 Laurelwood Road, Santa Clara, California 95054

INFORMATION RETRIEVAL NUMBER 11

Designers'

Toggle Switches
Bat, lever lock, Designer
Line, sealed. Big, broad
choice.

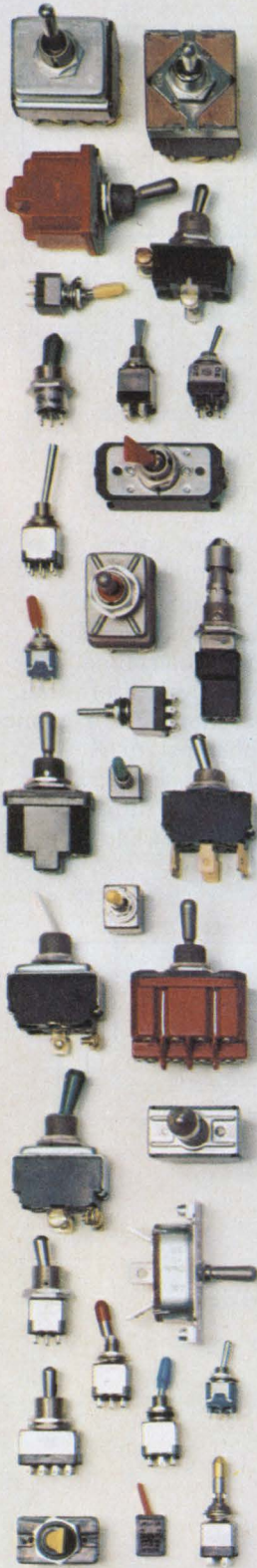

Rocker Switches
Singles and multiples.
Wide, colorful selection
range. Legends, too.

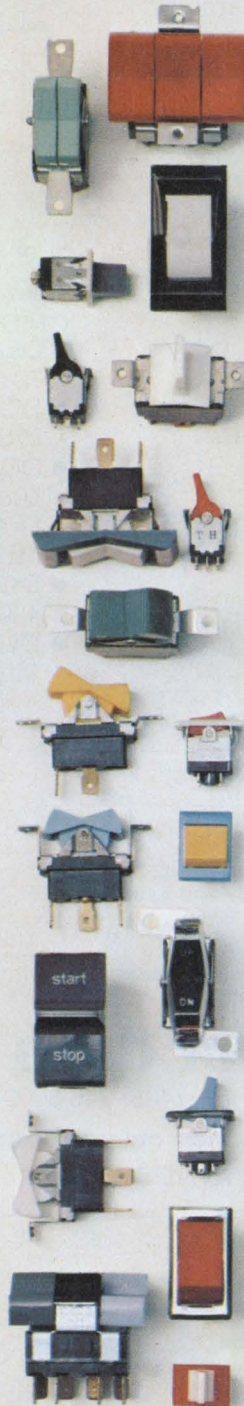

Cutler-Hammer, of course! The broadest
line. Styled to meet today's and tomorrow's
requirements. They're solid quality, look
great, work long and hard. Carried in stock
for local availability by Switch Distributors.

Backed by Cutler-Hammer sales engineers
who can deliver innovative design help for

Pushbutton Switches
Choice of sizes, colors,
circuits, ratings. Styled
to "turn you on".

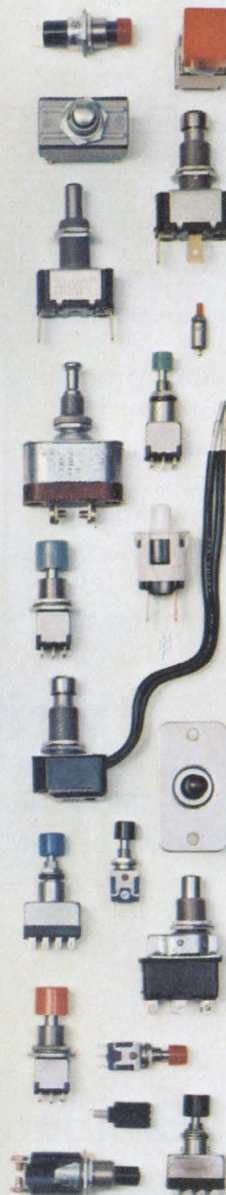

**Tool Handle &
Slide Switches**
Variable speed, reversing.
Double insulated.

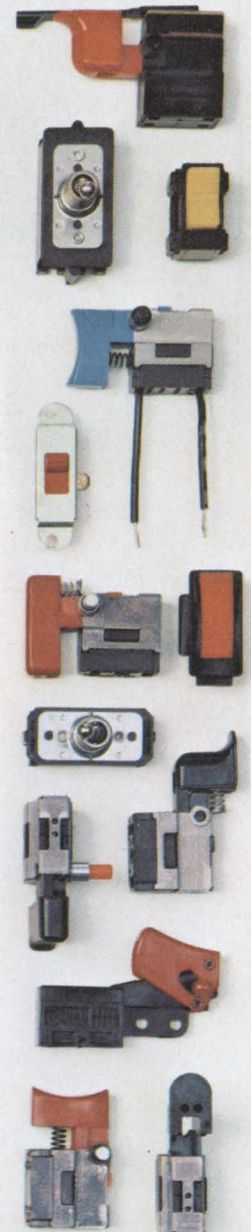

 **Switch to No.1**

Choice.

the exact switch or relay you need—when you need it.

It's no wonder so many designers specify Cutler-Hammer. For quality, reliability, availability, and style. For commercial, industrial, and military applications.

We simply offer more—of everything!

Snap Switches

Lever, roller, leaf, and pushbutton actuators. Four terminal styles.



Switch Accessories

Guards. Boots. Seals. Caps. Decorator facenuts. And much more to protect, code or customize.



Rotary Switches

Precision and general purpose. Single and multiple wafer.

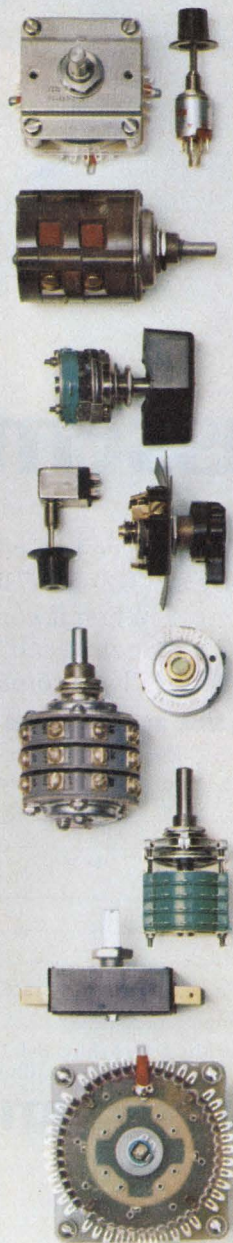

Illuminated Switches

Rockers, paddles, pushbuttons, indicators. Snap-in and bushing.

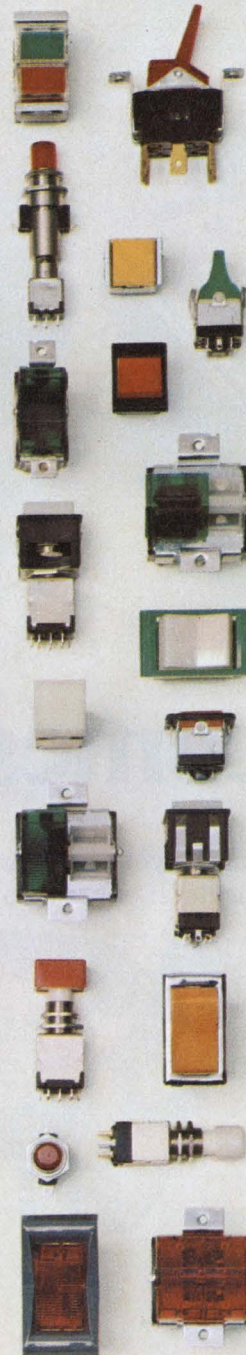

Relays

Hermetics, non-sealed, potted. Power, latching, and timing functions.

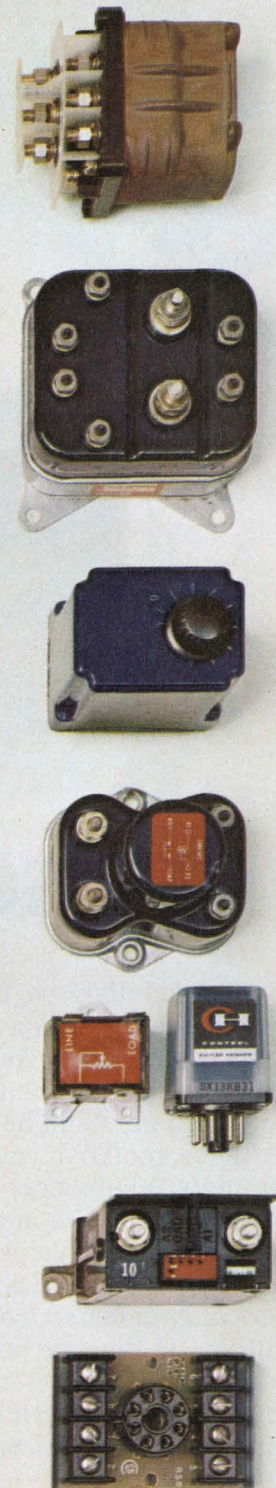

CUTLER-HAMMER

SPECIALTY PRODUCTS DIVISION, Milwaukee, Wis. 53201





It also comes assembled.

If you need dials, we have dials. If you need handsets, we have handsets. If you need Touch Calling keysets, we've got 'em by the thousands. Ringers and hookswitches, too. Or, if you need complete telephones, we have them for you in all the latest styles and colors.

You get communications components faster from GTE Automatic Electric because, outside of the Bell System, we're the largest manufacturer of telephone equipment in the U.S. If you need it, we have it.

Use the coupon below for a complete

catalog. Or if you're in a real hurry, call John Ashby at (312) 562-7100, extension 250.

When it comes to quality components, call **THE SOURCE:**
GTE Automatic Electric.



- Please send your catalog of communications components.
- Please send more information and prices on _____ of _____
(Quantity) (Product)

Name _____ Title _____
 Company _____
 Address _____
 City _____ State _____ Zip _____
 Telephone _____

Mail to: Mr. J. D. Ashby, B-4, GTE Automatic Electric,
Northlake, Illinois 60164.

GTE AUTOMATIC ELECTRIC

Benchmark: standard against which other microprocessing approaches must be measured.

Family: total of the compatible, synergistic device and support pieces comprising the whole of microprocessor use.



M6800: benchmark family for microcomputer systems.

Everything for your system: All in the M6800 Family

M6800 concept: Optimum system design

No question, the MC6800 microprocessor is head of the family. It is outstanding even as a stand alone part, as demonstrated by the high marks it scores on nearly everybody's benchmark studies. But, from the beginning at Motorola, the end system was our main concern, so the MC6800 is a

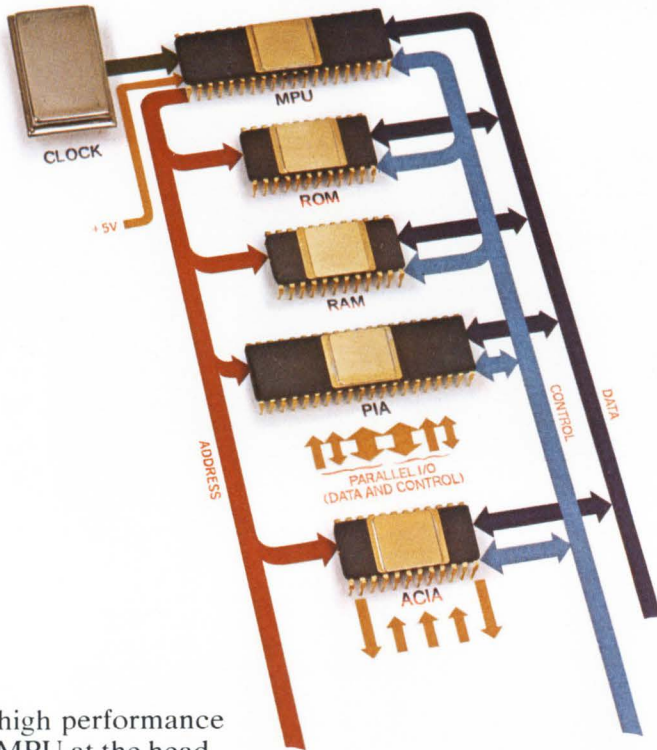

high performance MPU at the head of a modular LSI device series, totally bus compatible and fully compatible with each other.

The concept encourages systems of minimum parts, yet allows plenty of design flexibility. And, I/O is super simple with the intelligent programmable logic interface units which make the M6800 Family unique. Finally, for those who require it, the entire series of M6800 LSI devices is already second sourced.

Several MPU clocks are offered by Motorola Inc., Component Products Dept., 2553 N. Edgington, Franklin Pk., IL 60131. MC6870A is a minimum system version, MC6870B has added features, and the MC6871A is for maximum complexity systems.

Motorola's popular MEK6800D-1 introductory special design evaluation kit continues for a limited time. Contact your authorized Motorola distributor or Motorola sales office.

M6800 support: Speeds the design job, makes it easier

Hardware design tools

MEC6800 Evaluation Module. Here's a complete board, all the M6800 LSI devices plugged in so you can evaluate the parts in a basic minimum system. Even connect it to a peripheral and run programs.

M68SDT EXORciser*

The systems development tool, built with M6800 LSI devices and



pre-engineered with modular options for emulation of users' microcomputer system applications. Hardware design and development costs are drastically reduced. Debugs both system hardware and system software.



Software choices

Commercial timesharing.

M6800 software is presently available on two commercial timesharing services — G.E. and United Computing Service. Others will be added as justified by demand.

 **MOTOROLA M6800**

EXORciser package. A resident software package is available for the EXORciser system development tool.

Host Computer Cross Assembler and Simulators.

Three excellent packages are available here in either cards or tapes.

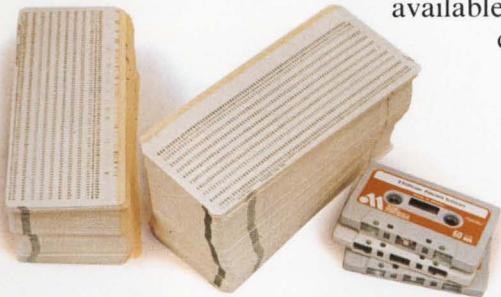

a. Standard package. The type normally supplied by vendors. We send the software; customer sets it up. No frills.

b. Extended Capability package. Includes M6800 Programming Manual. Customer still sets it up.

c. Deluxe package. Complete capability. Motorola does the set up on the customer's premises.

We wrote the book

M6800 Programming Manual. Probably the most vitally utilitarian of our growing M6800 document library.

M6800 Applications Manual. It was here that



Motorola really wrote the book; and, it's on its way to being the basic microprocessor textbook for the industry.

Low speed digital MODEM: New freedom for terminal designers

The MC6860 Low-Speed Digital MODEM is one of the communications features which makes the M6800 Family unique.

It's also freedom from MODEM slavery for terminal designers who could be building small, simple, inexpensive MODEMs into their own equipment.

The MC6860 is a Full Duplex Answer and Originate MODEM with Auto Answer and Auto Disconnect capability. It is Bell compatible and can operate on a single +5V supply. The new 100-999 price is \$24.00. Look for additional Motorola MODEM capabilities:

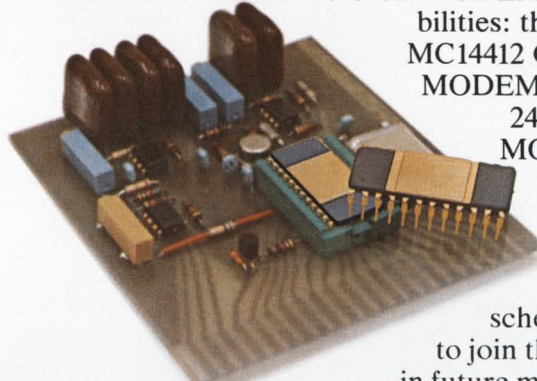

the new MC14412 CMOS MODEM and a 2400 bps MODEM

scheduled to join the mix in future months.

A new Application Note, AN747, shows how easy it is to build a space-saving MODEM right into your terminal. It even gives filter design guidelines.

M6800: It's a big family

The M6800 was designed from the very beginning to employ the synergistic effect of all these family functions working together. Yet, with all this, there's more.

MPU education.

Motorola's three day M6800 Microprocessor Course is presented monthly in Phoenix and on a continuous



schedule across the rest of the nation. No bit of fluff, the course is a complete education in designing with microprocessors, including coverage of hardware and software as well. Hundreds of companies have elected to have their people trained in this course already; and, its popularity is still climbing. Call Ron Bishop (602) 962-2345, for information.





Memories, Interface, External Logic and more. Here, Motorola's

capability as a broad line supplier contributes. A varied and growing assortment of ROMs and RAMs add options to the basic family memories. There's plenty of logic beyond the MPU-based portion of the system, CMOS for instance, and Motorola's McMOS fits in with parts like the new MC14411 Bit-Rate Generator. Bipolar Linear lines supply MPU and memory interface parts. And, out of Motorola's immense background in silicon discrete devices comes the new MPU clock buffer, the MPQ6842.

Nothing like the M6800 Family

By now it should be clear that there's nothing like the M6800 Family for designing microprocessor-based systems; and, nothing like Motorola's synergistic total package approach to the whole job.

M6800: A growing family still

N-Channel Si Gate Memories

<i>Third Quarter, '75</i>			
MCM6811	1K x 1	Static RAM,	16-pin
MCM6814	4K x 1	Dynamic RAM,	16-pin
MCM6815A	4K x 1	Dynamic RAM,	22-pin
<i>Fourth Quarter, '75</i>			
MCM6812A	256 x 4	Static RAM,	16-pin
MCM6834	16K	Static ROM,	24-pin

Bus Peripherals - Logic

<i>First Quarter, '76</i>	
MC6862	2400 bps MODEM modulator
MC6852	Synchronous Serial Data Adapter
<i>Second Quarter, '76</i>	
MC6863	2400 bps MODEM demodulator
MC6840	Programmable Timer module

Two Phase Clocks

<i>July '75</i>	
MC6870A	
MC6870B	
MC6871A	

Clip our coupon and send it to Motorola Semiconductor Products Inc., P.O. Box 20912, Phoenix, AZ 85036. Or, take direct action and contact an authorized Motorola distributor or local Motorola sales office.

*Trademark of Motorola Inc.



MOTOROLA M6800

Benchmark family for microcomputer systems.

I'm very interested in more information on your M6800 Family. Please send me the following technical information:

- Please send me a copy of your colorful new M6800 Family brochure. I understand it covers the subject matter of this ad in greater detail, plus important related materials.
- M6800 Applications Manual (my \$25.00 check or money order is enclosed)
- M6800 Programming Manual (my \$10.00 check or money order is enclosed)
- M6800 Systems Reference and Data Sheets
- G.E. Timesharing brochure U.C.S. Timesharing brochure
- AN747-MODEM Application Note
- MCM6812A Memory Advance Information Sheet
- MCM6815 Memory Advance Information Sheet
- M6800 Software Technical Information EXORciser Information brochure
- M6800 Clock Application Note - R-29-3-10
- Clock Data Sheets MC6870A MC6870B MC6871A

Name _____ Title _____

Company _____

Street _____ City _____ State _____ Zip _____

Now you can select, prepare and apply your materials to guarantee top quality and economy for each and every design.

HAYDEN SERIES IN MATERIALS FOR ELECTRICAL AND ELECTRONICS DESIGN

Alex. E. Javitz, Series Editor

Hayden's Materials Series is, simply, the greatest assemblage ever of up-to-date materials data, information and advice for the design of electrical and electronics equipment.

This unprecedented set of design handbooks maps out the entire array of current materials — in a totally unique format that can ensure the most effective materials selection, preparation and application.

A glance at the titles shows you that every design area is covered—from semi-conductor, to insulation, to structural design.

total, systematic materials coverage

For each specific area, scores of tables, diagrams and practical discussions supply all the vital engineering data on materials: properties; commercial availability; uses, advantages, disadvantages; current industrial trends. You'll find the latest, improved processing and fabrication techniques, along with valuable advice on streamlining processes — keeping costs down. Dozens of different devices are then covered, skillfully blending design techniques with invaluable materials know-how.

In short, what these handbooks offer is the total design picture — from raw materials to finished product. Never has the engineer had such a complete storehouse of practical design data and expert guidance at his fingertips.

special, "state of the art" volume

A special interdisciplinary handbook, MATERIALS SCIENCE & TECHNOLOGY FOR DESIGN ENGINEERS, gives you a rare, unified grasp of the present state of materials technology — fundamental structure and behavior of materials; major critical environments; on-going research and development; current reliability methods; and much more.

**Clip this coupon
to order your 15-day exam copies**



HAYDEN BOOK COMPANY, INC.

50 Essex Street
Rochelle Park, New Jersey 07662

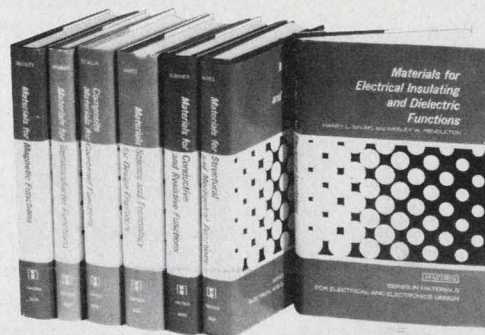

\$40 discount if you purchase the entire set!

You can order any of the volumes separately. If, however, you decide to purchase the entire set, you pay just \$99.00, which is actually \$40.00 off the regular price. And with this substantial discount comes the assurance that you have in your possession a complete, "all-points" source of modern materials know-how. Assurance that you — or your entire firm — is right on top of the latest advances. Assurance that quality and economy will be the prime ingredients in every design.

OVER 2,000 PAGES! NEARLY 1,300 ILLUSTRATIONS!

This sounds like the most comprehensive coverage of materials ever! Please send me:

- COMPLETE 7-VOLUME SET at the special price of \$99.00 (#5631-1)
A \$40.00 saving!
- Materials for Magnetic Functions, #5635-4, \$17.20
- Materials for Semiconductor Functions, #5638-9, \$15.55
- Materials for Conductive and Resistive Functions, #5636-2, \$15.95
- Materials for Structural & Mechanical Functions, #5637-0, \$15.95
- Materials for Electrical Insulating and Dielectric Functions, #5634-6, \$25.25
- Composite Materials for Combined Functions, #5639-7, \$22.95
- Materials Science and Technology for Design Engineers, #5640-0, \$27.55

Please send me the book(s) checked above to read and use FREE for 15-days. At the end of that time, I will send payment, plus postage, or return the book(s) with no further obligation.

Save money! Payment enclosed. Publisher will pay all shipping and handling charges — same 15-day guarantee.

15-DAY FREE EXAMINATION

Name _____

Firm/Institution _____

Address _____

City/State/Zip _____

“Make a million of these. Cheap!”

That's quite a challenge – especially if it can't be done. But at Coors Porcelain Company, there's always somebody around who says, “Let's do it, anyhow.”

The customer wanted a special, metallized ceramic part – more than a million a year – to be used in an electronic assembly. He wanted the first shipment in 10 to 12 weeks.

Furthermore – and here was the real pinch – the customer was dictating a very low cost.

The Bachman brothers solved the problem together. Al, a ceramics specialist, developed a high-speed cutting machine similar to a Gatling gun. And Jim came up with a low-cost

metallizing process that increased the production rate without sacrificing quality.



This is the kind of challenge we like to sink our teeth into at Coors Porcelain Company.

Problems that force us to create new technology, new processes for new or

improved ceramic products – at competitive prices.

Go ahead. Give us a challenge. Chances are we'll accept it – even if it's something that “can't be done.”

Coors Porcelain Company

600 Ninth Street / Golden, Colorado 80401 / (303) 279-6565 / Telex 45-593

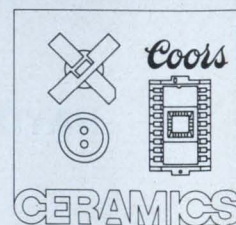

JULY 5, 1975

Data throughput doubled with new IBM link control

In what has been heralded as the most important de-facto data-communications standard since ASCII, computer scientists at IBM's Data Processing Div. in White Plains, NY, have developed a new data-transfer technique, Synchronous Data Link Control (SDLC). It promises to do the following:

- Significantly increase data-transmission efficiency.
- Permit terminals of different functional characteristics to share a single communications link.
- Make interfacing to IBM equipment more difficult.

According to G. P. Fusco, director of communications systems and storage systems marketing, transmission exchanges can be duplex or half-duplex and the channel configuration point-to-point, multi-point or loop.

As a link control, SDLC deals with the procedures between a controlling station and one or more remote stations. In addition to providing for station addressing, the technique also includes a method of detecting errors in transmission and a way of correcting them by retransmission of the information frame.

With current binary synchronous methods, Fusco points out, it is necessary to acknowledge receipt of every block of transmitted data. If a transmission error is detected, the whole block—typically 500 characters—must be re-sent.

With SDLC, however, the block of data is broken down into perhaps seven frames of data. Each frame can be sent with a sequential identification number imbedded in it, so that if an error is detected, only that frame has to be re-sent. This saves considerable time.

If the duplex mode is used, acknowledgement can be made simul-

taneously with the transmission of the data. With no need for pause and acknowledgement of each individual transmission, throughput is doubled. Applications that require 4800-baud links with binary synchronous techniques can be served by 2400-baud links when SDLC is used.

Another advantage of SDLC, Fusco notes, is that users no longer need be concerned if they have the right terminal, access method and set of communication lines for a particular application. The technique makes it possible to use different types of terminals on the same communications link. This is not always so with current communications methods.

For example, Fusco points out that it is not at all uncommon to find that a company's teleprocessing network is actually three or more separate networks, each requiring telephone lines of different characteristics to serve the requirements of different terminals—such as keyboards, video displays and printers. With Synchronous Data Link Control, he points out, all of these terminals can operate from one telephone line.

The impact of SDLC on the computer industry is expected to be great, because indications are it is the only serial-by-bit transmission method that IBM will ultimately support. Therefore every manufacturer of terminals and processors and every supplier of software who hopes to interface with IBM equipment must make his equipment compatible.

This will ultimately make the equipment more expensive, because the software and hardware required for SDLC is more sophisticated than that now in use. However, users will benefit from significant decreases in their phone bills.

Improvements forecast in microwave gear

New and improved microwave equipment was forecast by speakers at the recent International Microwave Symposium in Palo Alto, CA.

Jeffery E. Grant, manager of the High Power Dept. at Hughes Aircraft, Torrance, CA, projects the development of \$300-to-\$400 home satellite receiving stations in the next few years. He believes these will come with the wide use of communication satellites applying the 11.7-to-12.2-GHz down-link frequency band. Current commercial systems all use a 3.7-to-4.2-GHz down-link. In the 12-GHz band, Grant looks to satellite transmitter power of up to 1 kW, allowing the use of 1-meter dishes on the ground.

So that smaller ground terminals can be used with the conventional communications satellites, Grant sees the next satellite generation increasing the transmitter power from 5 W to as much as 20 W.

For ECM applications, Grant foresees TWT transmitters with up to 20-kW outputs. At present 100 W to 2 kW is used in most applications.

In addition he sees an emphasis on more bandwidth, frequencies of 30 to 40 GHz and up, efficiencies of up to 80% and dual-mode operation. He also expects higher transmitter reliability, smaller size and lower cost.

Of interest to designers of high-power mm-wave tubes is a tube developed by the Russians. Called a linear-beam gyrotron oscillator, it generates 12 kW at 107 GHz. It is a cylindrical waveguide within which the electrons are stimulated into cyclotron resonance oscillations. Not much is yet known about the principle of operation of this tube, according to Grant.

Whereas the state of the art in bipolar logic is 500-ps switching, some researchers see the switching times for transistors coming down as low as 2 ps. Bernard T. Murphy, head of the Bipolar IC Research Dept. at Bell Telephone Laboratories in Murray Hill, NJ, says: "A hypothetical transistor of minimum geometry could have a

switching time of 2 ps and a dissipation of only 2 mW. This transistor, if used in a logic gate, could give gate switching speeds of 10 to 20 ps."

However, to get the minimum geometry requires electron-beam lithography and perhaps even X-ray lithography.

"With minimum geometry," Murphy notes, "we can also expect MOS devices with switching speeds of about 100 ps and transferred electron devices that switch in 10 to 20 ps."

As to when all this will happen, Murphy says only that switching speeds tend to double every four to five years.

50-mph electric car has lead-cobalt battery

An all-electric luxury car, available for delivery in September, will take you to work in style every morning—provided work isn't more than 50 to 75 miles from home.

All you do when you get to the office is plug into a 220-V, 50-amp circuit for eight hours, and the car's battery is recharged. You do the same when you get home, and you're set for the next day. If you have only 110-V current, the recharge time is 48 hours.

Designed and sold by Fuel Propulsion Corp. in Detroit, the two-door, four-passenger coupe sells for \$16,450 without accessories. The cruising speed is given as 50 mph, with acceleration to 60 mph for passing.

Powering the car is a 180-V, tri-polar, lead-cobalt battery, designed and built by the company's plant in Troy, MI. According to Robert R. Aronson, the company president, the unit is different from other batteries in performance and design. First, with use of a special recharge unit that he expects service stations of the future to provide, the car battery can be completely recharged in 45 minutes. Most batteries take six hours.

In conventional batteries, Aronson explains, positive and negative plates are connected by bus bars at the top of the cell only.

"In our battery," he notes, "each plate is connected to the others at three places—once at the top and in two places at the bot-

tom. This increases the number of current paths by the millions and shortens the path length. Also, internal resistance is reduced, which enables the cells to operate at higher currents."

The reduction of internal resistance, Aronson explains, flattens the discharge curve. The voltage doesn't drop off during the discharge cycle, which permits the driver to maintain his high speed right down to the last.

Having three connections is also structurally better, Aronson contends: "The plates don't buckle or break. Vibration is eliminated, and the active material doesn't shed."

Cobalt is good because it forms a protective coating on the plate, reducing the ill effects of overcharging and prolonging the plate's life.

The average battery life, Aronson says, is 50 months, regardless of how much or how little the unit is used. The battery will cost \$1000 to \$2000, depending on the cost of materials.

The battery is designed to store approximately 45-kW hours of energy. The energy density is 22 W hours per pound at a 100-amp discharge rate.

The engine is controlled by an SCR unit designed to handle high voltages and currents, Aronson says. The unit operates at 220 V and 600 amps of current, whereas most controllers handle no higher than 144 V and 200 to 400 amps.

The current from the battery is fed to the motor in pulses. As the car picks up speed, the frequency of the pulses increases. At 50 mph, there's almost continuous power flowing from the battery to the motor.

Aronson plans to switch eventually to a new electronic controller—a three-in-one unit. Besides performing the functions of the present controller, the new unit will provide for regenerative braking. On deceleration, the motor will become a generator; the controller allows the generated current from the motor to feed back into the battery. And the controller will act as a charger.

Relay coil replaced by thermal actuator

An old principle has been applied to a new, low-cost DIP relay: a

thermo-electrically controlled actuator to replace the coil of the conventional relay.

The new relay is being test-marketed by Oak Industries Inc., Crystal Lake, IL. It should be in full production in nine months, according to Frank J. Zator, vice president of engineering.

The relay can function equally well on either ac or dc with no modifications, can handle up to 5 A, in contrast with a maximum 3 A for other DIP relays, and is available in either momentary or latching configurations.

The actuator of the relay is a bimetallic strip that is coated with an electrical insulator, on which is deposited a thick-film resistive material. When the film resistor heats, the bimetal bends and snaps to open or close a circuit.

Memory incorporated in electronic tuner

An MNOS nonvolatile memory, a CMOS digital-to-analog converter and ion-implanted logic have been combined in an electronic tuning system to replace the rotary mechanical tuners now used in television sets.

Developed by General Instrument of New York City, the new tuning system is called Omega and is reported to be a quarter the size of mechanical systems and more reliable.

The heart of the new tuner is a metal-nitride-oxide semiconductor (MNOS) memory that digitally stores all the tuning information for each channel. Even with no power applied, the memory retains information for up to 10 years, according to Frank G. Hickey, president of the company.

When a particular station is tuned in, information in the memory for that station is fed to a 14-bit CMOS d-to-a converter, and an analog voltage is produced. This voltage is then applied to a varactor diode, which tunes in the desired station.

The memory chip contains 100 lines of 14 bits each. Eighty-two lines are used for all the vhf and uhf stations, two are used to store the last station viewed, and the remainder are set aside for future applications.

Play the Model 1858 numbers game.

18 wins!

You get up to 18 channels in this completely self-contained data acquisition system.

8¾ wins!

The Model 1858 is an unbelievably short 8¾ inches high, including plug-in signal conditioning and internal paper take-up.

65 wins!

The 65-pound-light 1858 is easy to take anywhere, can be used in a rack, on a table, on the seat of a car or plane.

7 wins!

You get up to 7-inch trace amplitude for all channels that allow common baseline recording . . . the most useful and accurate record available.

5,000 wins!

Each channel has dc to 5,000 Hz response, (15 kHz squarewaves) and without amplitude restrictions for superior transient recording capability.

42 & 120 win!

You get 42 discrete paper speeds, from 0.1 to 120 inch/sec.

±0.1 wins!

Precision time lines, accurate to ±0.1% across record width each 0.001, 0.01, 0.1, 1.0 or 10 seconds, each tenth line accentuated and selected interval coded.

1870 wins!

New 14-channel 1870 housing permits up to 32-channel capacity, but adds only 5¼ inches to height. That's only ½-inch per channel!

1887 wins!

This new plug-in signal conditioning module (one of 7) provides simultaneous input signal conditioning for magnetic tape recording and the 1858 for parallel recording or serial record and playback from tape to the Model 1858.

And the 1858 wins in dozens of other ways you can't put a number on. Like constant trace width at all writing and chart speeds, yet without adjustment. And the elimination of overshoot and distortion of

wave pulses and other transient data.

For complete technical specifications, call or write Lloyd Moyer, Honeywell Test Instruments Division, P.O. Box 5227, Denver, CO 80217 (303) 771-4700.

FOR DEMONSTRATION CIRCLE 212

Honeywell Model 1858 Data Acquisition System

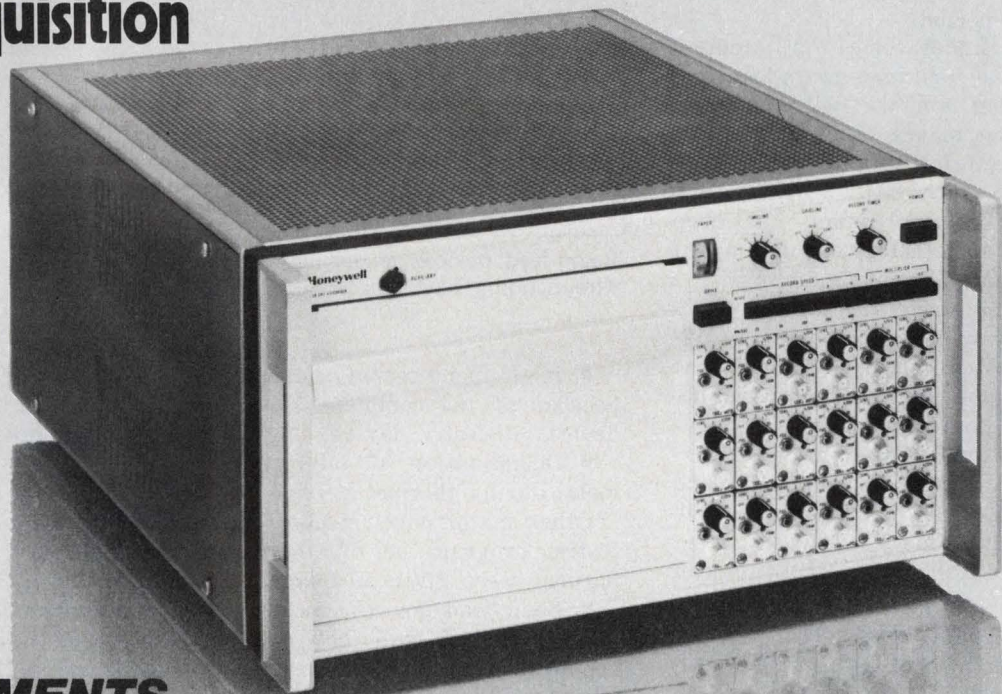

**TEST
INSTRUMENTS
DIVISION**

Honeywell

INFORMATION RETRIEVAL NUMBER 17

Hughes reports beam-lead ICs fail reliability and cost tests

In a program that tested over 4000 beam-lead ICs and logged over 2.5 million device hours of testing, the promises of increased reliability and decreased cost for the devices were not met, an engineering manager told the recent Electronic Components Conference.

The report given by J.J. Mazenko of the Hughes Aircraft Co., Fullerton, CA, was promptly attacked by Bell Telephone Laboratories and Western Electric spokesmen during a question-and-answer period.

Bell Laboratories is credited with the original beam-lead development, and the Bell phone system now makes extensive use of this packaging technique. Bell's experience with beam-leads, according to its spokesman, has been entirely satisfactory and does not at all support Mazenko's findings.

The Hughes report to the conference, which was held May 12-14 in Washington, DC, said that the beam-lead devices were developed to reduce failure modes—such as ionic contamination, interconnect corrosion and lead-bond failures—and to eliminate the need for hermetic packaging.

But Mazenko noted: "Beam-lead devices are more complex and require more processing steps to produce. Thus they introduce failure modes that do not exist in other interconnect methods."

The new failure modes brought out in the tests, he said, included the following:

- Poor adhesion between interconnect metal and the device.
- Presence of voids in the nitride.

Morris Grossman
Associate Editor

Failure-mode analysis

Cause of failure	Vendor type	Digital devices				Linear devices					Total devices analyzed
		SC148	SC149	SC150	SC151	SC152	SC153	SC154	SC155	SC156	
		W 5473	X RF100	W 5400	Z 5410	W 741	Y 741	Z 741	X RM101	W 710	
Gold migration		1	5	2	4	6	4	8	5	10	45
Interconnect shorts		1			1	2	2			1	7
Interconnect delamination						1				1	2
Exposed junctions			1			4					5
Channeling		1	1		2	5	7	10	6	6	38
Nitride voids		1	2	1	1	2	2	1	1	2	13
Shorted devices (internal)		9	15	11	9	15	13	11	6	14	103
Open device (internal)		5	5	8	11	7	6	8	4	6	60
TOTAL		18	29	22	28	42	34	38	22	40	273

Beam-lead devices in solving one set of problems associated with chip-and-wire bonding have introduced new problems.

- High incidence of channeling because of the complexity of the devices' dielectric layers.

- Delamination of interconnect metal during thermal stress.

Other major conclusions of this testing program—all of a negative nature—were given as follows:

- Beam-lead devices, even when polymer-coated, will not operate reliably in nonhermetic environments.

- There is no standard beam-lead technology. There are wide variations in materials, dimensions and methods among vendors for a given device type, and thus different substrate layouts are needed for each source.

- The generally accepted 0.005%/1000 h failure rate for beam-lead devices was considerably exceeded in the tests.

- Because both failure rates and costs are high, beam-lead devices are not cost-effective.

Tests were conducted on both analog and digital circuits from several vendors. The analog units tested were types μ A741, MC 1596 and MC 710, and the digital group included 5476, 5400, 5490 and 5493 ICs. The test procedures followed MIL-STD-883, and the work was done under contract to the Rome (NY) Air Development Center.

Lower rejection rate found

On the other hand, Thomas B. Gillis, an engineer with the Raytheon Co., Quincy, MA, in a paper on "A Second Look at Beam Leads—Are They Cost-Effective?" reported that "the beam-lead devices

think random access

think disc memories

think General Instrument

You've heard about the new solid state memories. But did you know they cost 20 to 30 times as much as complete random access disc memories? This means you can buy a reliable head-per-track disc for less than 0.02 cent per bit. Complete and ready to plug in. And when you do, General Instrument has a great family of disc memories to select from.

Choose from models ranging from a few million bits to our new model 530 at 80 million bits. Up to 1024 data tracks. 1800 or 3600 rpm rotational speed. Fast access times. And up to 3320 bpi recording density.

With over 10,000 units in the field, we have experience. In military and commercial applications. In areas like process control, key entry devices, seismic, numeric control and communication switching systems.

You'll see why we've become the leading independent supplier of high performance rotating memories. Quality. Service. Support.

We're in most major U.S. cities and in Europe. Call (213) 973-1741 or write General Instrument Corporation, Rotating Memory Products, 13040 South Cerise Avenue, Hawthorne, Calif. 90250.



GENERAL INSTRUMENT CORPORATION
ROTATING MEMORY PRODUCTS

13040 South Cerise Avenue · Hawthorne, California 90250 · (213) 973-1741

INFORMATION RETRIEVAL NUMBER 18

NEWS

exhibit a lower reject rate electrically and also a significantly lower ratio, visually."

Gillis' MIL-STD-883 visual inspection provided a rejection rate of 8.1% for conventional chip-and-wire technique and only 0.54% for the beam-lead method. Electrical defect rates were given as 3.2% and 0.75%, respectively.

Nevertheless, based upon a subjective weighted evaluation (see table) Gillis concluded that "there is really no advantage to going to a beam-lead construction." The overriding factor in this conclusion is cost.

"Even allowing for improved module yields," he said, "beam-lead devices increase the semiconductor costs by a factor of 4 to 6 for complex circuits and by 3 to 4 for simple circuits."

He went on to explain:

"Raytheon established a program to convert existing thick-film, high reliability military hybrids from conventional chip-and-wire to beam-lead construction. Because of uncertainty of device availability, conversion to beam-lead was done in parallel with existing chip-and-wire construction. This provided an excellent opportunity to make an in-depth, one-for-one comparison of both techniques.

The beam-lead and conventionally terminated semiconductors were both purchased from a variety of vendors and therefore Raytheon could make an unprejudiced comparison as a user rather than vendor."

No MIL specs for chips

By contrast, there was general agreement at a panel session on "The Hybrid Standard Program." Though there are plenty of discrete-component chips in hybrid circuits and many hybrid circuits in military equipment, the chips, suprisingly, are not covered by a MIL spec. The reason, said Roberto Gonzalez of the Solid State Devices Group at Defense Electronics Standardization Center (DESC), is that his agency does not procure chips. "So why spec them?" he asked.

But his audience pointed to a reason: to avoid the proliferation of chip sizes and values.

Screening and stress results

	Digital			Linear		
	Tested	Failed	% Failed	Tested	Failed	% Failed
First electrical test	979	74	7.6	1133	124	10.9
High temperature storage	905	10	1.1	1009	20	2.0
Temperature cycle	895	12	1.3	989	6	0.6
Thermal shock	883	5	0.6	983	3	0.3
168 Hours HTRB	878	14	1.6	980	164	16.7
1000 Hours HTRB	864	13	1.5	816	109	13.4
168 Hours bias moisture life	851	15	1.8	707	132	18.7
1000 Hours bias moisture life	836	131	15.7	575	165	28.7
Boiling H ₂ O	705	103	14.6	410	96	23.4
Salt atmosphere	602	70	11.6	314	63	20.1
Totals		447	45.6		882	77.8

A suprisingly high percentage of beam-lead devices did not survive the initial screening and subsequent stress tests. The linear devices were particularly vulnerable to the stress test, conducted by Hughes.

Beam-lead vs chip-and-wire assembly

Item	Simple circuit		Complex circuit	
	C&W	BL	C&W	BL
Ease of layout (Minor × 1)	5	2	5	2
Substrate manufacture (Major × 3)	5	3	5	2
Device availability (Major × 3)	5	3	5	2
Device cost (Major × 3)	5	2	5	1
Device quality (as received)				
Visual (Normal × 2)	5	7	5	8
Electrical (Normal × 2)	5	5	5	7
Training costs (Minor × 1)	5	6	5	8
Assembly costs (Major × 3)	5	6	5	8
Analysis & repair costs (Normal × 2)	5	4	5	3
Visual yields (Major × 3)	5	8	5	9
Electrical yields (Major × 3)	5	6	5	8
Box score:	120	118	120	132

Subjective evaluation by Thomas B. Gillis of Raytheon rates the devices on a scale from 1 (poor) to 10 (good). Chip and wire (C&W) is given a nominal evaluation of 5, and each item is weighted (multiplied) by a factor of 1 (minor effect) to 3 (major effect).

David S. Walker, engineering supervisor of Sperry Gyroscope, Great Neck, NY, who represented the Joint Electronic Device Engineering Council on the panel, reported that JEDEC's JC-13.3 Committee was ready to submit chip-spec guidelines to the council. If approved, JEDEC could then submit them to DESC.

Gonzalez said DESC would co-

operate in developing such specs. But he cautioned that the standardization program might take a year to develop.

The prospect of a long wait didn't seem to bother Walker. As chairman of JEDEC's JC-13.3 group, he recently spearheaded a drive to modify MIL-M-38510, which applies to both monolithic and hybrid ICs. ■■

VACTEC brings you BLUE

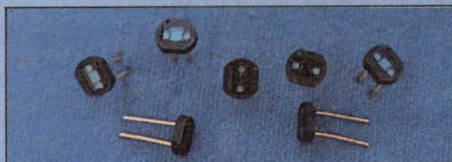

Unlike our little Japanese friend, photodetectors have always been insensitive to blue. Until now.

Vactec's latest development is a new Blue Enhanced Silicon (BES) photodiode with exceptionally low dark current for efficient response in the blue region (200 - 400 nm). Made in Missouri, U.S.A., it performs equally well in an expensive Japanese SLR camera or in an American-made colorimetric analyzer as well. And you'll like the price, which could be as big a breakthrough as blue sensitivity. Vactec also introduces a new line of PIN photodiodes that operate at high voltages, low noise levels, and fast rise times, with about half the blue sensitivity of the BES photodiode. For larger areas, Vactec offers a complete range of Blue Enhanced Silicon photovoltaic cells up to 1 1/8" diameter.

Vactec now supplies the broadest line of photodetectors in the industry, including:

- silicon solar cells
- hi-speed/low-leakage silicon cells
- NPN phototransistors
- NPN photodarlington
- CdS & CdSe photoconductors
- CMOS & bi-polar custom ICs
- opto-couplers
 - a) LED/photoconductor
 - b) LED/phototransistor or darlington
 - c) lamp/photoconductor
- selenium photovoltaic cells

Call or write today:

Vactec, Inc.

**2423 Northline Industrial Blvd.
Maryland Heights, Mo. 63043
(314) 872-8300**

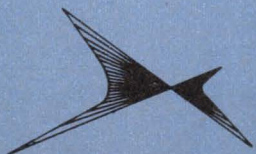

Fiber-optic communications seen approaching applications stage

Feasible fiber-optic transmission systems should be available to the communications industry in the near future, engineers were told at the Electronic Components Conference recently.

Speakers at a session on "Fiber-Optical Communications—Components and Applications" discussed all aspects of systems, from optical cables and connectors to carry the signals to light sources used to produce them.

David Klein, a researcher for the Naval Air Systems Command in Washington, DC, saw fiber optics as a replacement for conventional wiring in complex, highly sophisticated systems. The benefits, he said, go far beyond the large time-bandwidth product of fiber optics as a data carrier. Because of its immunity to electromagnetic energy and its inherent nonradiation and good electrical insulation, he went on, fiber optics is an excellent candidate for overcoming many problems now encountered with wire cables.

Problems such as grounding, crosstalk and short-arcing can be eliminated, Klein said. In addition, he reported, fiber optics leads to simplified installation.

Fiber optics can replace conventional wires on a one-for-one basis. While this alone doesn't save much on the components count, Klein pointed out, with fiber optics, it becomes possible to use extensive multiplexing. Data capability of between 50 and 100 MHz can be expected. This, the researcher noted, compares with 100 kHz for a twisted-wire pair. Tens of conventional wires can be replaced by a single fiber optic

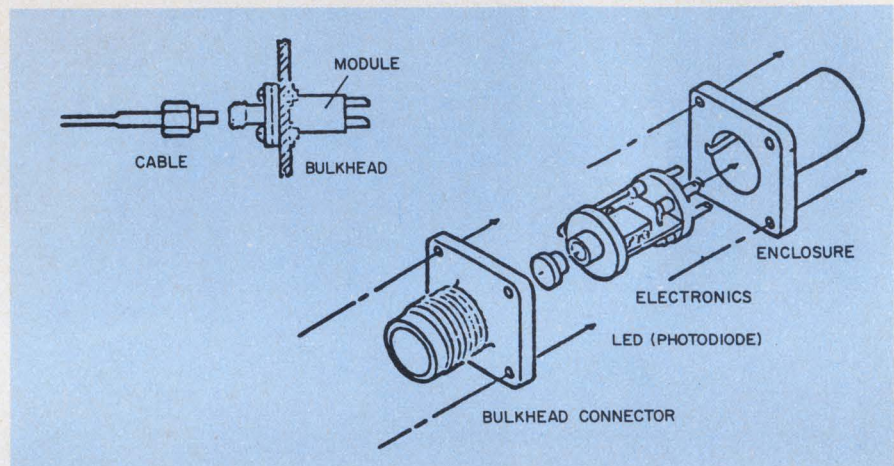

Fiber-optic connectors that use standard electrical connector shells are being used by the Navy to replace conventional wires with fiber optics.

Properties of data transmission cables

	Fiber optics	Coax	Twisted pair
Low cost	X		X
Temperatures to 300 C	X	X	X
Vibration tolerant	X	X	X
Low cross talk	X	X	
No cross talk	X		
RFI/EMI/noise immunity	X		
Total electrical isolation	X		
No spark/fire hazards	X		
No short-circuit loading	X		
No ringing echoes	X		
EMP immunity	X		
Temperatures to 1000 C	X		
No contact discontinuity	X		
Signal bandwidth (300 m)	200 MHz	20 MHz	1 MHz

cable, with major reductions in component count and power, as well as size, weight and cost.

But there are two major problems with fiber-optic waveguides: fiber breakage and increased optical attenuation from packaging.

In a paper on "Fiber Packaging," R. A. Miller, a researcher at the Corning Glass Works, Corning, NY, noted that since glass is a brittle material, glass fibers, unlike metal wires, fail suddenly. Failure, he observed, always re-

Jules H. Gilder
Associate Editor

New series of generic PROMs— a family affair.

Stand alone PROM designs are now a thing of the past. Now the diverse requirements for density, modularity and performance within a system can be satisfied with Harris' new family of PROMs featuring generic characteristics.

This generic concept of PROMs offers many unique advantages. For instance, each device within the series will feature identical DC electrical specifications plus common programming requirements, permitting easy use of other family elements. So learning is just once per family.

In addition, these PROMs have fast programming speeds. Equivalent I/O

characteristics for easy upgrading. Faster access time, guaranteed over temperature and voltage. Improved testability.

Right now, the first two PROM devices are in volume production. The 256 x 4 organization (1K) and the 512 x 4 (2K). Other PROM devices will be available in the months ahead (see table).

So instead of settling for PROMs with unique performance capability and diverse programming requirements, get the new Harris generic family of PROMs. Lower your system costs and make your life easier.

For details see your Harris distributor or representative.

Important features of Harris' new generic family of PROMs.

- Simple, high speed programming procedure (Typically less than 1 second per thousand bits).
- Inputs and outputs TTL compatible; Low input current: 400 μ A logic "0," 40 μ A logic "1." Full output drive: 15 mA sink, 2 mA source.
- Fast access time—guaranteed over voltage and temperature (see table).
- Expandable—three-state or open collector—"wired-or" outputs with chip select.
- Industry standard pin-out.

Device #	No. of Bits	Organization	No. of Pins	Max. Access Time* comm./mil.	Availability
HM-7602 (open coll.) HM-7603 (three-state)	256	32 x 8	16	40/50ns	August
HM-7610 (open coll.) HM-7611 (three-state)	1024	256 x 4	16	60/75ns	in stock
HM-7620 (open coll.) HM-7621 (three-state)	2048	512 x 4	16	70/85ns	in stock
HM-7640 (open coll.) HM-7641 (three-state)	4096	512 x 8	24	70/85ns	August
HM-7642 (open coll.) HM-7643 (three-state)	4096	1024 x 4	18	70/85ns	January '76
HM-7644 (active pullup)	4096	1024 x 4	16	70/85ns	January '76

*Access time guaranteed over full temperature and voltage range.

Industrial ($T_A = 0^\circ\text{C}$ to 70°C , $V_{CC} \pm 5\%$)

Military ($T_A = -55^\circ\text{C}$ to 125°C , $V_{CC} \pm 10\%$)



P.O. Box 883, Melbourne, Florida 32901 (305) 724-7412

WHERE TO BUY THEM: OEM SALES OFFICES: CALIFORNIA: Long Beach, (213) 426-7687; Palo Alto, (415) 964-6443 **FLORIDA:** Melbourne, (305) 727-5826 **ILLINOIS:** Hinsdale, (312) 325-4242 **MASSACHUSETTS:** Wellesley Hills, (617) 237-5430 **MINNESOTA:** Minneapolis, (612) 835-2505 **NEW YORK:** Endwell, (607) 754-5464; Melville, L.I., (516) 249-4500 **OHIO:** Dayton, (513) 226-0636 **PENNSYLVANIA:** Wayne, (215) 687-6680 **TEXAS:** Richardson, (214) 231-9031.

SALES REPRESENTATIVES: ARIZONA: Scottsdale, (602) 948-5590 **CALIFORNIA:** San Diego, (714) 565-9444 **COLORADO:** Denver, (303) 771-4920 **FLORIDA:** Boca Raton, (305) 395-6108; Oviedo, (305) 365-3283 **KANSAS:** Olathe, (913) 782-1177 **MARYLAND:** Randallstown, (301) 922-1248 **MICHIGAN:** Bloomfield Hills, (313) 642-0203 **MISSOURI:** Hazelwood, (314) 731-5200 **NEW YORK:** Albany, (518) 489-7408 or 4777 **NORTH CAROLINA:** Raleigh, (919) 828-0575 **OREGON:** Beaverton, (503) 643-1644 **TENNESSEE:** Shelbyville, (615) 684-4544 **VIRGINIA:** Falls Church, (703) 534-1673; Troutville, (703) 345-3283; Virginia Beach, (804) 481-7200 **WASHINGTON:** Bellevue, (206) 454-0300.

sults from a tensile stress.

Miller noted that, in theory, the strength of glass is on the order of 700 kg/mm. In practice, however, its strength varies widely, depending on the size and frequency distributions of surface flaws.

Commercial multichannel fiber cable is now available at \$13.50 per meter from Corning, the speaker noted. It contains six fiber-optic waveguides, with attenuation for the individual fibers a maximum of 20 dB/km at a wavelength of 820 nm.

The longest length of Corning cable available is 500 feet. So if larger distances must be covered, cable connectors are required.

Several connectors are available

In a paper on "Fiber-Optic Connectors," at the same session, Ronald L. McCartney, a designer from ITT Cannon Electric, Santa Ana, CA, noted that fiber optic connectors fall into four categories: (1) Source to fiber; (2) Fiber to fiber; (3) Fiber to detector, and (4) Branching.

Source-to-fiber connectors, McCartney said, must house and attach a light source—such as a light-emitting diode—to a fiber-optic cable. Such a connector, he continued, must also provide EMI

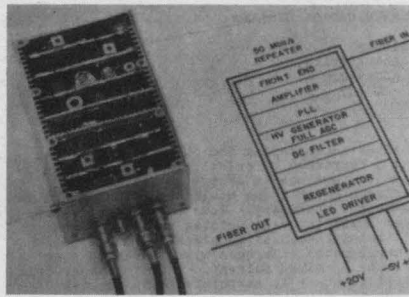

An experimental 50 Mb/s repeater developed by Bell Laboratories can be used to regenerate optical data.

protection and incorporate a heat sink, so that the temperature rises that cause inefficiencies in LEDs will be controlled.

The heat-sinking and shielding can be easily achieved, McCartney pointed out, if the LED is placed in a metal connector shell.

Fiber-to-detector connectors are constructed in much the same way, McCartney went on. The only differences are that the heat-sinking is not needed and the LED is replaced by a photodetector.

While the coupling of LEDs to fibers is difficult, coupling photodiodes to fibers is easy. The reason, McCartney pointed out, is that a photodiode has a high numerical aperture and thus will accept light from fibers at nearly any angle. Also, most photodiodes have large-diameter acceptance

windows, which make reception relatively insensitive to spaces between the fiber and the connector.

As to the availability of present optical connectors, McCartney noted that devices that use standard military electrical connector hardware are being sold.

Repeater works at 50 Mb/s

Any long-distance fiber-optic communication system will require regeneration of the signal at intervals to prevent it from degrading. With this in mind, researchers at Bell Laboratories in Holmdel, NJ, have developed several optical repeaters. One is a 50-Mb/s device that uses gallium-aluminum-arsenide LEDs for transmitters and field-effect transistors for receiver front-end amplifiers.

According to Tingye Li, a Bell researcher, a relatively low bit-rate digital system using LEDs and photodiodes can have a repeater span that corresponds to about 50 dB of fiber loss. A similar repeater span is possible for higher bit-rate systems that use lasers.

This means that if a 5-dB/km fiber cable were available, repeater spans of about 10 km would be possible. This, Li said, makes fiber-optic systems potentially attractive for intra-city and long-haul applications. ■■

Finally, space-saving bipolar ICs for microwave signal processors

For a long time, microwave signal-processing designers have had to live with hybrid and discrete circuits while their colleagues working at lower frequencies went on to space-saving, high-speed monolithic ICs. But now a family of bipolar-logic ICs has been developed that can process digital data up to 1 gigabit/sec, bringing to the low microwave range many advantages long accepted as conventional for lower frequencies.

The result: Signal-processing systems can be made smaller with

increased reliability. And they can be digital or analog, an additional benefit that promises to extend further the family's range of applications.

The new ICs, developed by the Motorola Government Electronics Div., Scottsdale, AZ, were described by Dr. Carl Ryan at the 1975 Microwave Symposium in Palo Alto, CA. Ryan, group leader for wideband systems, delivered a paper on "Bipolar ICs for Microwave Signal Processing." The ICs aren't available commercially but have been used in systems delivered to military organizations, Motorola says.

The chips employ emitter-coupled-logic (ECL) techniques to obtain three basic digital functions: flip-flop, four-input OR/NOR gate and an Exclusive-OR gate that also provides a signal-switch function.

By using these functions as building blocks, designers at Motorola have constructed a wide range of communication subsystems. They include rather complex circuitry, such as quadriphase (QPSK) modulators, demodulators and adaptive equalizers.

The use of logic elements differs from the standard design approach. Typically microwave techniques are employed, and these involve

Edward A. Torrero
Associate Editor

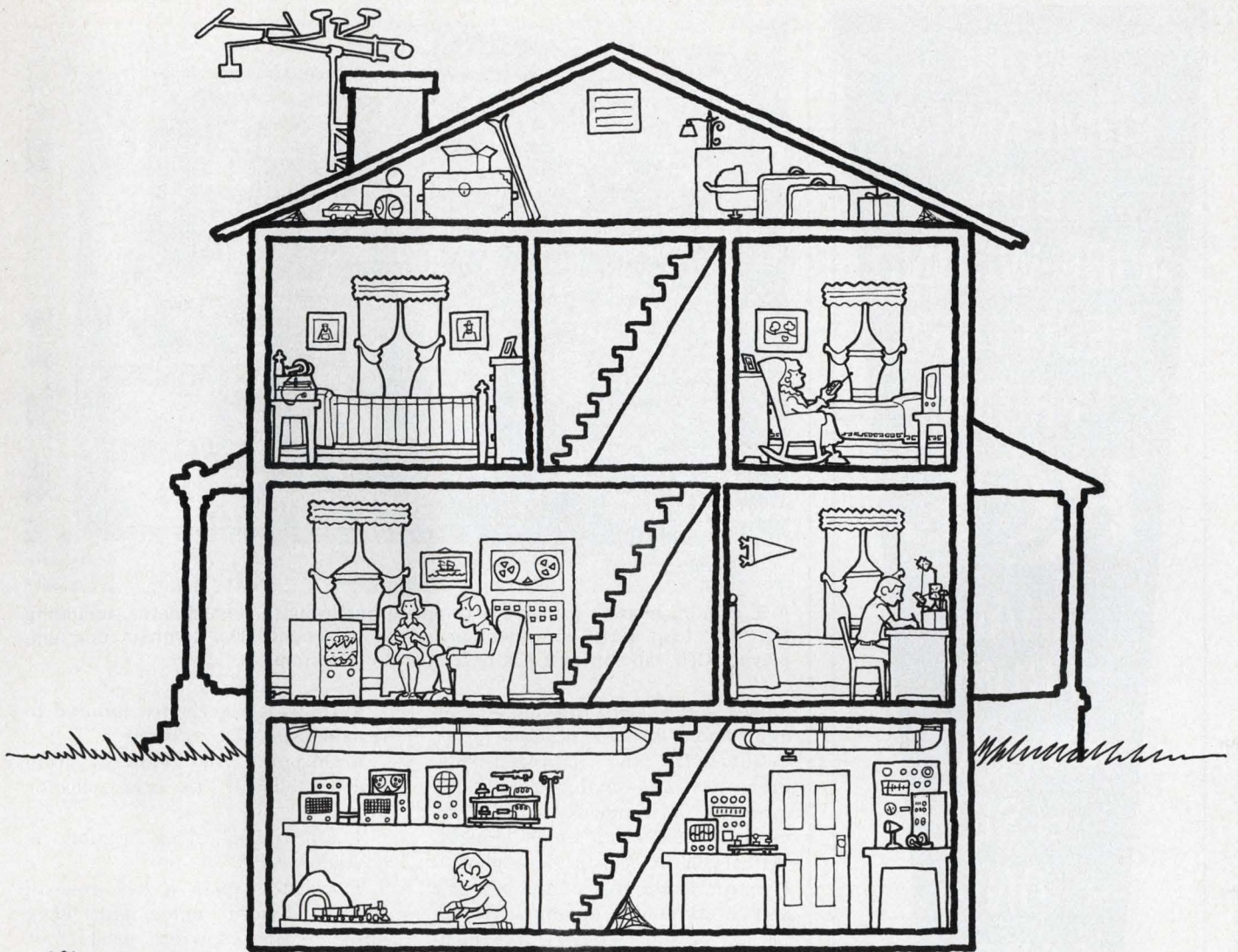

Engineers gotta have fun, too!

Here are 10 hobby and project books that let the engineer use his special talents for improving his home or just having fun.

1. **HOW TO SELECT AND INSTALL ANTENNAS**, #0786-8, \$4.90. All aspects of antenna selection and installation. Instructions for putting up UHF, VHF, FM antennas or complete master TV systems.

2. **20 SOLID-STATE HOME AND HOBBY PROJECTS**, #0134-7, \$4.55. Two-station intercom, electronic siren, power regulator, metal detector, water-operated alarm, etc. Complete instructions, parts lists, diagrams.

3. **25 SOLID-STATE PROJECTS**, #5881-0, \$4.90. Auto burglar alarm, programmable auto-speed-minder, indoor-outdoor electrothermometer, telephone call timer, electronic dice, TV remote-sound system, etc., etc.

4. **50 IC PROJECTS YOU CAN BUILD**, #0723-x, \$4.55. Hi-fi headphone amp, auto tachometer, intercom, TV commercial killer, etc. Each project can be put together in one night with these simple instructions.

5. **BUILDING THE AMATEUR RADIO STATION**, #0709-4, \$4.30. Complete construction of amateur radio station. Schematic and wiring diagrams and chassis layouts for Novice and General Class stations.

6. **COLOR TELEVISION: Principles and Servicing**, #5929-9, \$5.70. Receiver troubleshooting and servicing techniques. Charts listing trouble symptoms, causes, and remedies. Instructions for using the latest test instruments.

7. **HOW TO BUILD A LOW-COST LASER**, #5934-5, \$4.55. How to build a laser at home, from readily available parts, for approximately \$100! Includes a collection of laser experiments.

8. **BENCH-TESTED COMMUNICATIONS PROJECTS**, #0788-4, \$3.75. Telephone broadcaster, party line listening, canned light music, rollaway ham

shack, VHF extender, 6-meter solid-state transmitter, etc.

9. **HOW TO BUILD A WORKING DIGITAL COMPUTER**, #0748-5, \$5.45. Step-by-step instructions for building an inexpensive digital computer simulator. Includes parts lists, theory of operation, and fundamental programming techniques for solving simple problems.

10. **110 THYRISTOR PROJECTS USING SCR'S AND TRIACS**, #5096-8, \$4.30. Burglar, fire and water level alarms, power control devices for electric tools, and other useful projects built and fully evaluated by the author.

H **Hayden Book Company, Inc., 50 Essex St., Rochelle Park, N.J. 07662**

Please send the books I have circled on 15-day free examination. At the end of that time, I will remit payment, plus postage, or return the book(s) with no further obligation. (SAVE MONEY! Payment enclosed. Publisher pays all shipping and handling charges. Same 15-day return guarantee.)

Name _____

Address _____

City _____ State _____ Zip _____

Prices subject to change without notice.

75-42

MORE
COMPANIES
BUY
WIRE-WOUND
RESISTORS
FROM
RCL

THAN
FROM
ANYONE
ELSE
ON
EARTH

Write for
catalog



Call our hotline for prompt
service and delivery.

(603) 627-3831

AMF

RCL Electronics

195 McGregor St.

Manchester, N.H. 03102

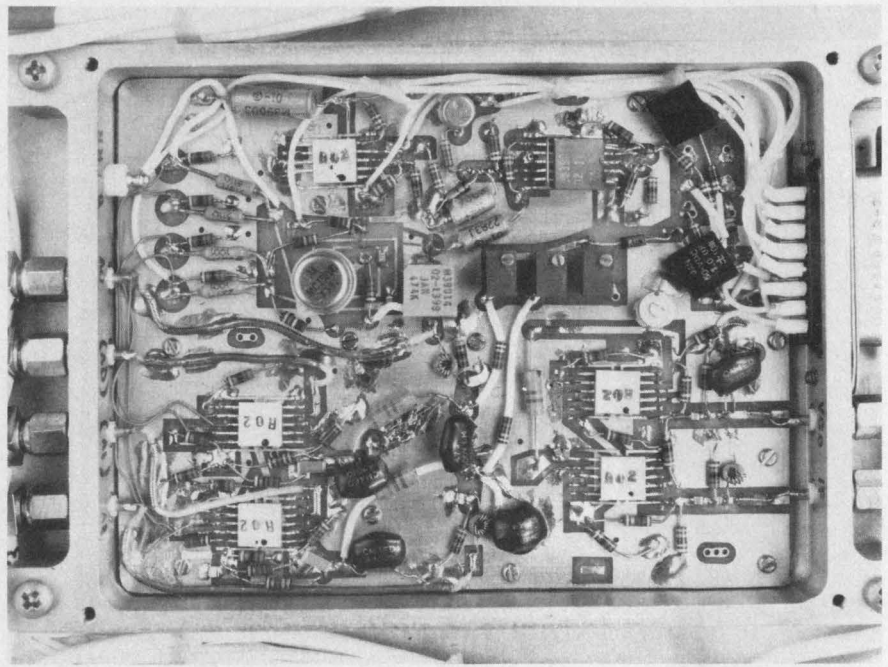

A 3 × 4-in. module contains a complete quadriphase demodulator, including the "IQ" loop, which provides carrier reconstruction. The compact unit employs 1-GHz bipolar-logic ICs developed by Motorola.

diodes and various RF filtering in hybrid and discrete designs.

But with the improved ICs, dramatic space savings result. For example, a complete QPSK demodulator comes on a module measuring just 3 × 4-in. (see photo). It contains only six of the new ICs and a standard op-amp IC. An earlier version required two modules, each 4 × 7 in. with about 15 standard ECL and hybrid circuits.

Performance benefits are also evident. "At room temperature," Ryan said in an interview, "both versions can have about the same performance. But the new ICs have a lower drift rate." So they are more stable over the operating temperature range.

Moreover the adaptive-equalizer design, which uses about 40 ICs on a 3 × 8-in. module, "wouldn't have been practical without the new ICs," Ryan added. Other techniques would have led to unacceptably large circuitry.

The new chips measure either 50 × 50 or 80 × 80 mils. The first offers two logic functions per chip, while the second represents a medium-scale integration.

A gate in the new family resembles the corresponding unit in conventional ECL. However, with the new family, called current-steering logic by Ryan, the following are offered:

- Bandwidth increases to 1 GHz.

- Interface levels are tailored to transmission-line systems.

- Outputs are changed from emitter-follower to open-collector types.

- Linear operating region is characterized.

Transistors play a key role in the bandwidth extension. They have a gain-bandwidth product of 3 to 4 GHz. More important, junction capacitances in all directions are less than 1/2 pF.

Input logic levels range from about -1/2 V to zero, compared with -0.7 to -1.8 V for standard ECL. Since one logic state has a zero potential, a resistor terminated to ground can be used for a direct connection. However, impedances of 68 Ω, rather than the common 50 Ω, are used to permit reduced power dissipation. With a 68-Ω load, rise time doesn't exceed 0.4 ns.

The linear properties of the essentially digital circuits have been obtained from an analysis of voltage characteristics. When biased at 1/4 V, the circuits permit linear operation with an input voltage up to 150 mV, pk-pk.

Among the limitations are output power and noise figure. An IC in the family can't deliver more than a few milliwatts. And typical noise figures of 15 dB preclude the family's use for, say, first-stage i-f gain. ■■

*New FIRE-PLUG™
connectors
meet UL 94V-0
flammability tests*

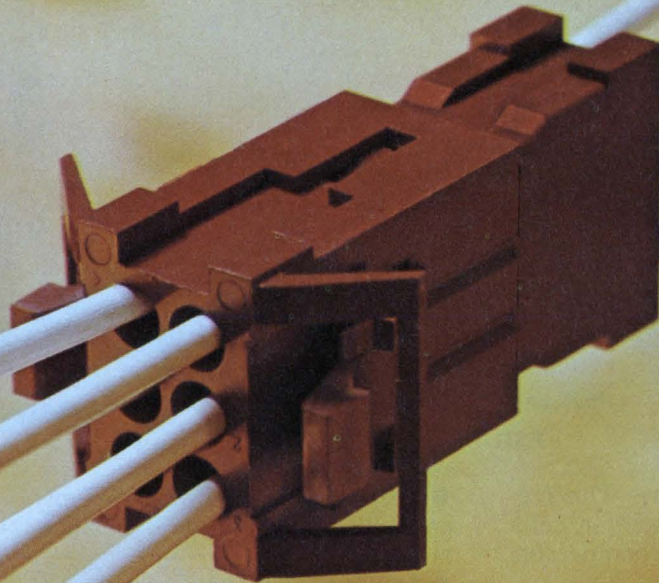

Amphenol's new FIRE-PLUG connector line is classified 94V-0 by Underwriters Laboratories. This is the most stringent test of plastic material flammability conducted by UL. Also listed by CSA.

And FIRE-PLUG exceeds UL's proposed upgraded requirements scheduled to go into effect on July 1, 1977. In time for you to upgrade your products now.

More than just a connector, the FIRE-PLUG connector line is a *total interconnection system* consisting of connector housings, contacts and termination equipment.

Costs no more than you're paying now.

FIRE-PLUG connectors cost no more than commercial connectors now sold under the less stringent UL 94V-2 rating.

Interchangeable with connectors you're using now.

FIRE-PLUG connectors are interchangeable, intermatable

and intermountable with the most popular types of commercial connectors.

Faster panel mounting saves time and labor.

FIRE-PLUG mounting latches flex easily so only fingertip pressure is required to push and lock the housing into a panel. Cable-to-cable styles also available.

ECONO-PLUG™ connectors save you even more money.

If your application requires only a UL 94V-2 rating, then the ECONO-PLUG connector line is your answer. Available in six colors for applications requiring color coding.

Both FIRE-PLUG and ECONO-PLUG connectors are available from Amphenol Industrial Distributors across the country. Write for new catalog FP-1 from Amphenol Industrial Division, 1830 So. 54th Avenue, Chicago, Illinois 60650.



Semi-automatic crimping machine.
Hand tools also available.

*When you can connect it
and forget it...that's quality.*

**BUNKER
RAMO**

AMPHENOL

Power Splitters/Combiners

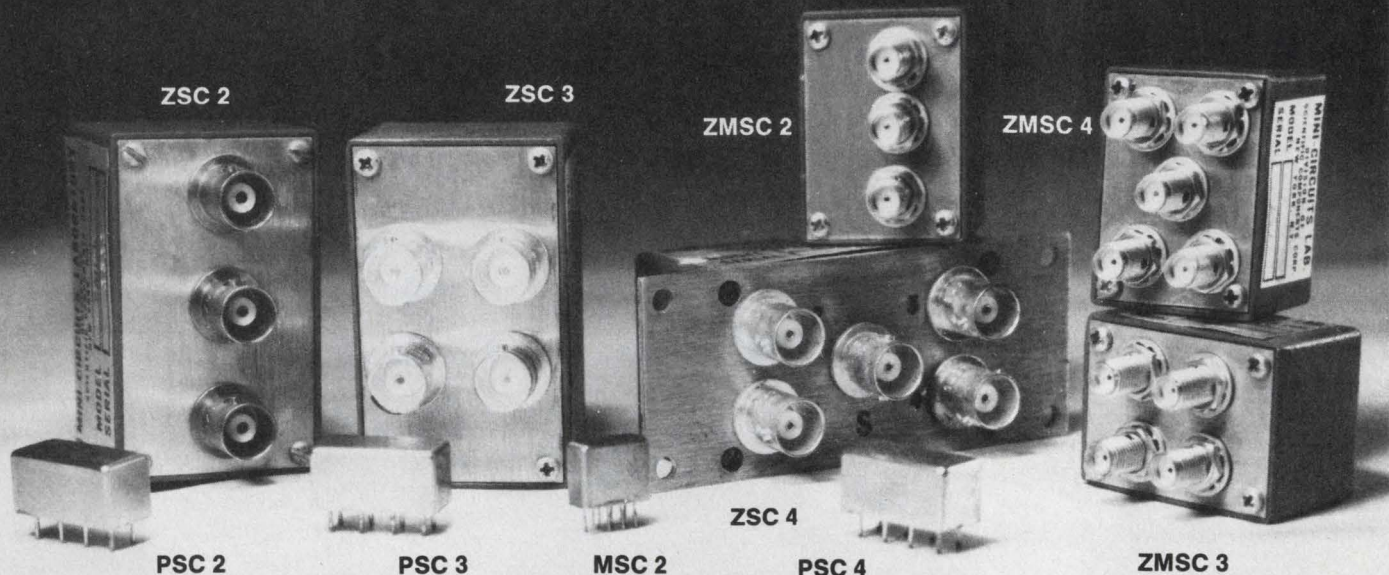

- **Broad Bandwidth** — The frequency range of any splitter/combiner is wider than any comparable competitive units.
- **High Isolation** — Typical; 40 dB @ 30 MHz — 30 dB @ 100 MHz.

- **Closely Matched Outputs**—Typical 0.05 dB amplitude unbalance at ports.
- **Low Insertion Loss** — Less than 0.5 dB over most of the bandwidth.
- **Small Board Area** — only 0.2" x 0.5" (0.1 sq. in.) P. C. Board area required for MSC series.

- **Price** — from 1/3 to 1/2 the price of competitive units (see below).
- **Delivery** — from stock — one week maximum.

TWO-WAY, THREE-WAY AND FOUR-WAY POWER SPLITTER/COMBINERS

Model No.	Freq. range (MHz)	Isolation between outputs (dB) typical	Insertion loss (dB) (typical)	Unbalance		Price (Quantity)
				φ (deg)	Amp. (dB)	
PSC 2-1 ZSC 2-1 ZMSC 2-1	0.1-400	25	0.4 above 3dB split	1	0.05	\$ 9.95 (6-49) \$24.95 (4-24) \$34.95 (4-24)
MSC 2-1	0.1-450	30	0.4 above 3dB split	1	0.05	\$15.95 (6-24)
PSC 2-2 ZSC 2-2 ZMSC 2-2	0.002-60	40	0.3 above 3dB split	1	0.05	\$19.95 (6-49) \$34.95 (4-24) \$44.95 (4-24)
*PSC 2-1-75 *ZSC 2-1-75	0.25-300	25	0.4 above 3dB split	1	0.05	\$ 9.95 (6-49) \$24.95 (4-24)
PSC 3-1 ZSC 3-1 ZMSC 3-1	1-200	40	0.4 above 4.8 split	2	0.05	\$19.95 (6-49) \$34.95 (4-24) \$44.95 (4-24)

Model No.	Freq. range (MHz)	Isolation between outputs (dB) typical	Insertion loss (dB) (typical)	Unbalance		Price (Quantity)
				φ (deg)	Amp. (dB)	
PSC 3-2 ZSC 3-2 ZMSC 3-2	0.01-30	40	0.25 above 4.8 split	2	0.1	\$29.95 (6-49) \$44.95 (4-24) \$54.95 (4-24)
PSC 4-1 ZSC 4-1 ZMSC 4-1	0.1-200	30	0.5 above 6dB split	2	0.1	\$24.95 (6-49) \$39.95 (4-24) \$49.95 (4-24)
ZSC 4-2 ZMSC 4-2	0.002-20	33	0.45 above 6dB split	2	0.1	\$64.95 (4-24) \$74.95 (4-24)
PSC 4-3 ZSC 4-3 ZMSC 4-3	0.25-250	30	0.5 above 6dB split	2	0.1	\$23.95 (6-49) \$38.95 (4-24) \$48.95 (4-24)
**PSCJ 2-1 **ZSCJ 2-1	1-200	35	0.6 above 3dB split	Phase deviation from 180° 2.5		\$19.95 (5-49) \$34.95 (5-49)

COMMON SPECIFICATIONS FOR ALL MODELS: Impedance all ports, 50 ohms, *Except 75 suffix denotes 75 ohms VSWR: 1.1-1.2 typical
 Nominal phase difference between output ports; °*Except J suffix denotes 180° Delivery from stock; One week max.

**OUR NEW ADDRESS IS: 837-843 Utica Avenue,
 Brooklyn, NY 11203 (212) 342-2500
 Int'l Telex 620156**

Foreign Sales Representatives: AUSTRALIA General Electronic Services, 99 Alexander Street, New South Wales, Australia 2065; ENGLAND Dale Electronics, Dale House, Wharf Road, Frimley Green, Camberley Surrey; FRANCE S. C. I. E. - D. I. M. E. S., 31 Rue George - Sand, 91120 Palaiseau, France; GERMANY, AUSTRIA, SWITZERLAND Industrial Electronics GMBH, Klüberstrasse 14, 6000 Frankfurt/Main, Germany; ISRAEL Vectorics, Ltd., 69 Gordon Street, Tel-Aviv, Israel; JAPAN Densho Kaisha, Ltd., Eguchi Building, 8-1 1 Chome Hamamatsucho Minato-ku, Tokyo; EASTERN CANADA B. D. Hummel, 2224 Maynard Avenue, Utica, NY 13502 (315) 736-7821; ITALY Microel Italia s. r. l. via M. Loria 50, 20144 Milano & via Senafte 27, 00199 Roma; NETHERLANDS, BELGIUM, LUXEMBURG: Coimex, Veldweg 11, Hattem, Holland.

US Distributors: NORTHERN CALIFORNIA Cain-White & Co., Foothill Office Center, 105 Fremont Avenue, Los Altos, CA 94022 (415) 948-6533; SOUTHERN CALIFORNIA, ARIZONA Crown Electronics, 11440 Collins Street, No. Hollywood, CA 91601 (213) 877-3550

For complete U.S. Rep listing and product line see MicroWaves' Product Data Directory

Washington Report

Great Debate on defense spending fizzles

The long-awaited Great Debate on defense spending for fiscal 1976 turned out to be a sputtering candle in the wind. To the chagrin of a small bloc of liberal Senators, the \$25-billion package presented by the Armed Services Committee sailed through the Senate by a resounding 77-6 vote. The House version, passed earlier, was even more generous, giving the Defense Dept. authority to obligate \$26.5-billion for hardware and R&D. The difference between the two bills—some \$500-million for a new aircraft and \$700-million for naval ships—will be ironed out in a conference.

Since the Mayaguez ship-rescue operation off Cambodia, Congress has indicated that if it is going to err in defense spending, it will err in favor of more rather than less funds. So a final authorization of around \$26-billion may emerge from the conference. Senators who had planned to cut defense funds and use the money for social programs had aimed for a figure closer to \$23-billion.

All major new weapons systems emerged unscathed. The next efforts by the liberal Senators will be directed at the upcoming appropriations bill, but their prospects for any major turnaround are slim this year. Instead, they are likely to challenge the "counterforce" concept now favored by the Pentagon. This is the Air Force plan that advocates strategic forces hitting enemy military targets rather than cities. If the Senators can prevent adoption of counterforce as the dominant strategic policy, they would find it easier to cut defense funds in coming years.

FCC eyes TV receiver standards

The Federal Communications Commission is planning to re-evaluate and possibly revise its uhf TV "taboo" table in order to get better use of the spectrum. The taboos, based on 1952 capabilities, now block or inhibit 18 potential channel assignments in an area for every one that's assigned. Each channel now takes up 108 MHz of spectrum.

With the advances receiver technology have made, the FCC says, a lot of the present 23-year-old restrictions are not valid. FCC is therefore asking industry and the public for suggestions. The result could be mandatory receiver standards and more uhf TV stations.

Defense Dept. challenged on noncompetitive contracts

The General Accounting Office doesn't think the Defense Dept.'s technical evaluations of fixed-price, noncompetitive proposals are adequate. The watchdog agency reviewed the evaluations of 40 noncompetitive pro-

posals and concluded that 40% weren't adequate.

The GAO looked at proposals totaling about \$132-million that were handled by 20 different defense agencies. It decided that evaluators hadn't adequately reviewed nearly \$24-million of contractors' proposed direct costs and that many evaluations didn't contain sufficient information to support recommendations.

The Defense Dept. doesn't agree that its system is at fault, but the GAO insists that adherence to uniform performance and reporting standards will improve technical evaluation of proposed costs and give greater insurance that prices negotiated in the absence of competition are fair and reasonable.

Equipment sales up 4.9% in 1974

Last year, electronic equipment sales reached \$35.4-billion, a 4.9 per cent increase over 1973, according to the Electronic Industries Association.

Sales of communications and industrial electronic products increased 14% to \$17.2-billion. Sales to the Federal Government, ranking second at \$11-billion, were up 2.3%. Consumer electronic product sales faltered, dropping 11% to \$6.2-billion. Foreign sales of U.S. produced electronic products were \$5.2-billion, topping imports of \$4.6-billion.

The EIA says that 49% of sales were to the communications and industrial market, 31.2% to the Government market and about 17% to the consumer market. Replacement components accounted for the remainder.

Capital Capsules: The Federal Communications Commission has created a new radio service—the Private Operational-Fixed Microwave Service—which will include all systems operating in frequencies above 952 MHz. In the past these systems were regulated under Safety and Special Radio Services. All existing microwave systems must comply with the new standards by Aug. 1, 1975. . . . The Consumer Product Safety Commission has announced acceptance of the offer of Underwriters' Laboratories of Chicago to develop a consumer product safety standard for television receivers. The commission will contribute \$54,895 to the project. UL will develop the standard with the help of representatives from trade associations, engineers and industry specialists. . . . The Electronic Industries Association is urging the U.S. International Trade Commission to give preferential importation treatment to certain solid-state circuits: discrete diodes and transistors, ICs and various assemblies of discrete semiconductors. The EIA says that while high technology tends to be U.S.-based, the use of offshore low-cost assembly labor is critical both for U.S. consumption and export to world markets. . . . The Air Force Avionics Laboratory at Wright-Patterson AFB, Ohio, is seeking sources for research and development of X-band power transistors, both GaAs FET and silicon bipolar, with the goal of establishing X-band power-transistor technology. The laboratory is also promoting advanced R&D in FET transistor processing and microwave IC amplifier design. . . . The House Science and Technology Committee has begun hearings on a bill that would create a national science policy and a White House science adviser. Reports are that President Ford will appoint an adviser if the legislation passes both houses of Congress, but that is probably months away.



For Precision Phase Measurement
the only logical choice
DRANETZ SERIES 305
for 7 logical
reasons...

- 1** HIGHEST ATTAINABLE ACCURACY.
 $\pm 0.03^\circ$ absolute, over wide rated level/frequency ranges.
- 2** HIGHEST CALIBRATION STABILITY.
 - Short-Term: $\pm 0.005^\circ$ repeatability
 - Long Term: 30-day drift, 0.05° max.
 - Temperature: $\pm 0.001^\circ/\text{C}$ max.
- 3** WIDEST FREQUENCY RANGE.
 2 Hz to 11 MHz, performance-optimized by plug-in modularity. Auto-tuned averager optimizes response speed.
- 4** WIDEST DYNAMIC RANGE.
 1 mV to 300 V, with autoranging and gain programming.
- 5** MOST VERSATILE PROGRAMMABILITY.
 Automatic or Remote (computer-compatible) programming of every range and function.
- 6** ABSOLUTE FREEDOM FROM AMBIGUITY
 Patented technique (U.S. Pat. #3,725,781) eliminates noise-triggering anomalies; exclusive double-zero-crossing averaging for waveform and duty-cycle independence.
- 7** GREATEST INTERFACE FLEXIBILITY.
 Choice of 9 different plug-ins and 3 mainframe options provide for virtually every application . . . developed over a decade of design evolution.

Send today for your free copy of this brand-new engineering monograph. Hundreds of diagrams, equations, graphs, charts, etc. on precision phase measurement.



DRANETZ

Liquid Crystal Displays: An Application Report

Design and function of liquid crystal displays are stimulating increased interest and expanding application of this versatile, digital readout. Although the LCD is a late comer in the display field, it is presenting a strong challenge to the other types, principally the light emitting diode — LED.

LCD advantages are greatly responsible for the fast development and lower cost of exciting new products. And for improved design of conventional equipment and machines. For example, simple sandwich construction of Hamlin's LCD fits limited space. Alphanumeric displays (transmissive and reflective) provide side-by-side mounting versatility. Light control film offers a choice of colored displays. There's no washout in high ambient light levels. Microwatt power requirements, few parts, good viewing angle, exceptional reliability over extended life period are more reasons for the switch to LCDs.

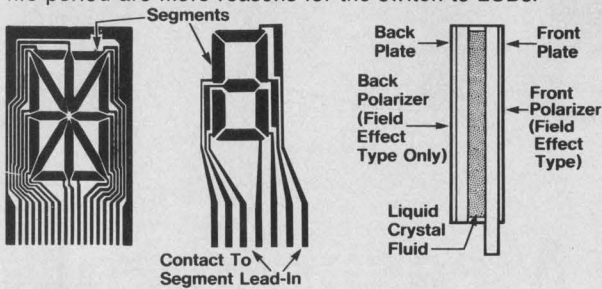

Flexibility of design permits LCDs to be scaled up or down to meet product needs. For example, Hamlin makes a display used in a ladies watch that measures only .450" x .575" (11.25 x 41.375 mm), but production facilities permitting, a display could be almost any size. Type of artwork used for creating the display design also provides an inexpensive way to customize with a logo, product illustration, etc.

A choice of lighting methods permits LCDs to match a wide range of applications. Because liquid crystal displays are not self-illuminating, ambient light must be used to best advantage, or the light source must be placed to cast light through or on the display. To meet viewing needs in relation to product design, Hamlin suggests a variety of lighting techniques:

Louwer backlighting with ambient light for transmissive displays utilizes a plastic film at the back of the displays which permits the angle, depth and color to be varied. It provides a dark background while the activated display appears a frosty white. It is suitable for battery powered calculators, desk clocks, portable instrumentation, etc.

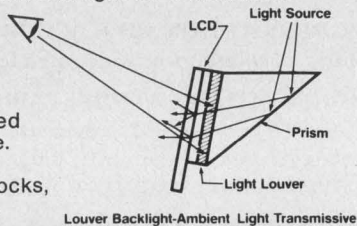

Cavity mount, employing a light source and reflector, achieves a high contrast white-on-dark display. Designed for transmissive displays, the light is hidden from the viewer. This arrangement is ideal for line cord operated instruments such as calculators.

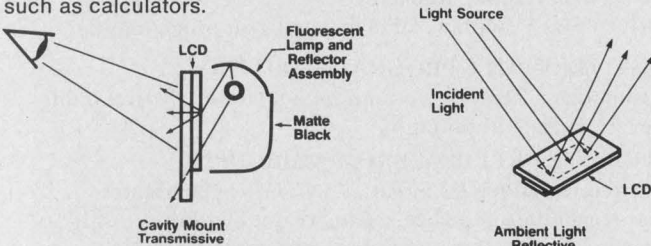

Ambient lighting (reflective displays) is the simplest of all arrangements, but the display should be mounted as closely as possible to the panel with minimum recess to receive maximum illumination. For good contrast, a dark background such as a matte black surface on the back plate should be used.

Edge lighting offers a low power, compact method for reflective displays. Flat pack arrangement permits the display to be viewed by ambient light by day, and edge lighting by night.

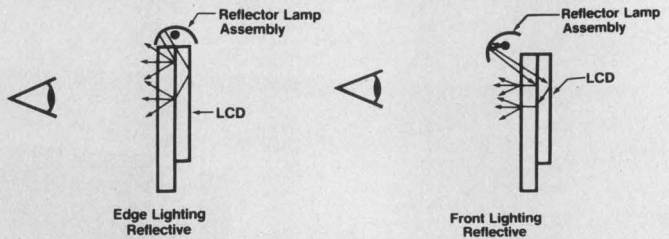

Front lighting (reflective design) uses incandescent lamps or a fluorescent (typically 3-watt). It provides the advantage of viewing with ambient light by day and artificial light at night.

Mounting techniques with large LCDs are applicable to most equipment designs. Two most common types are:

Panel Mounting requires a special bracket to hold the display in the panel. The panel can be sloped to place the display viewing surface perpendicular to the operator's line of sight, or a bezel can be used to attain the same effect. Type of display and lighting will, of course, determine the mounting.

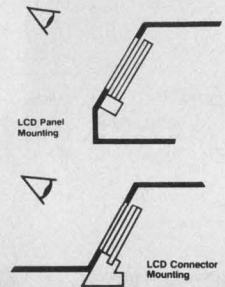

Connector Mounting is made with an edge board connector to hold the display and for making electrical hook up.

Determining viewing distance vs character size is a critical factor in adapting liquid crystal displays. Character height, width, spacing; segment width, separation between each and slope of characters are all to be considered. Examples illustrate viewing distance in relation to character height.

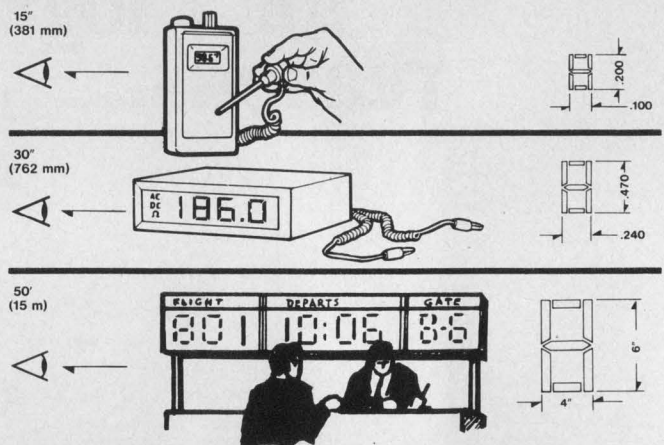

In application, liquid crystal displays meet the needs of an almost unlimited number of products — from watches to office equipment, flight instruments to appliances. In fact, where MOS and C/MOS compatibility, flexibility of design, low power requirements are factors, LCDs provide an efficient and practical solution.

Hamlin stocks several standard LCDs in both dynamic scattering and field effect types (transmissive and reflective) for immediate delivery. Special displays with virtually any image can be produced to order with surprisingly low preparation costs. And LCD's simplicity means lead time of just a few weeks. For detailed specifications and application data, write Hamlin, Inc., Dept. #614 Lake Mills, WI 53551, 414/648-2361. Evaluation samples are available at moderate cost.

HAMLIN
INCORPORATED

INFORMATION RETRIEVAL NUMBER 26

ELECTRONIC DESIGN 14, July 5, 1975

Listening with both ears

"We could do this," one of my editors told me the other day. So I said, "Yes, yes" and moved on to something else, leaving a problem unsolved. A few days later, he reminded me of the solution. And again, because I had other things on my mind, I brushed it aside.

Fortunately, I sort of woke up later and understood what he had been telling me. His suggestion improved an article in the magazine and saved us money—a good combination. But I almost missed it because I was hardly listening.

I'm convinced that I'm not the only one who doesn't listen sometimes. And I suspect that some of the consequences of not listening are drastic. I know one executive, Jack, who loaded up on capacitors right at the peak of the seller's market. He saw only one thing. Capacitors had been getting more expensive, almost by the week, and deliveries were stretching out. Though his engineers argued that these capacitors weren't very good, and that prices could not rise forever, Jack wouldn't listen. He could see only one part of the picture. Through his shrewd negotiations, he had convinced a vendor to sell him a huge supply of capacitors.

And then, WHAM! Capacitor prices started to tumble. 40-week deliveries started shrinking to four weeks. And Jack's instruments weren't selling so well so he wasn't using so many capacitors. He found himself with a three-year supply of not-so-good capacitors. Of course, he urged his engineers to use these capacitors rather than newer, better and less costly units because the huge inventory made his balance sheet look rotten. And when the engineers used them, the instruments weren't quite as good as competitive units so they didn't sell so well, which made his capacitor supply last still longer.

Unwilling to swallow his error, Jack tried to push these capacitors into other instruments, even if it called for redesign. And that made those instruments less competitive.

Of course, it's easy now to say that Jack shouldn't have bought those capacitors in the first place, though the situation certainly looked different then. But Jack didn't give himself a chance. He didn't listen. Then he compounded his error by forcing a one-shot mistake to multiply itself. When his engineers warned him of the consequences of forcing an old, not-so-good capacitor into new designs, he didn't listen. He was too busy worrying about other problems.

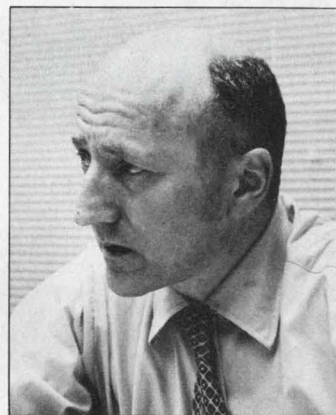

George Rostky

GEORGE ROSTKY
Editor-in-Chief

Consider all the ins and outs of your new circuit design. Then consider Curtis® Terminal Blocks.

Tangled, twisted, and loose wires can snarl up even the best circuit design. So don't tangle with trouble. Curtis offers 19 electronic and electrical terminal blocks with hundreds of model variations available to straighten out almost any wiring layout problem.

Here are just a few of the features offered----

- capacities ranging from 5 amps/300 volts to 250 amps/600 volts
- modular, channel-formed, closed-back, feed-thru and fully insulated feed-thru designs offered
- choice of tab, screw, clamp, PC pin or taper pin termination
- heavy duty lug and tubular, high pressure solderless types available for high current applications
- full mechanical thread system incorporated in many units

Specify Curtis electronic and electrical terminal blocks and you'll have the best line in the industry to work with. Specify anything less and you may be tangling with trouble.



CURTIS INDUSTRIES, INC.

8000 West Tower Avenue, Milwaukee, Wisconsin 53223
 Call (414) 354-1500 for the name of a representative or distributor near you.
 In Canada: A.C. Simmonds & Sons, LTD, Willowdale, Ontario.

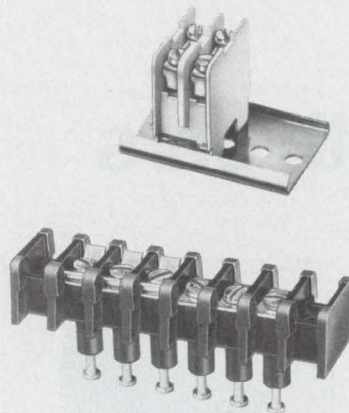

INFORMATION RETRIEVAL NUMBER 27

You'd probably expect a portable oscilloscope as rugged and reliable as this one to cost a lot.

You'd be wrong.

Introducing the B&K Model 1403 3" Solid-state oscilloscope. It's so compact, reliable, and inexpensive that it's the perfect scope for most on-the-line monitoring applications. Look at its specs: DC to 2MHz bandwidth at 20mV/cm. Recurrent sweep speeds from 10Hz to 100k Hz. New wide-angle CRT to reduce case depth to a minimum. Direct-deflection terminals for waveforms up to 150 MHz. Weighs only 8½ pounds. And has a smoked acrylic graticule for trace sharpness and easy reading. All the reliability and accuracy you need in a monitor scope—at a surprisingly low price.

Contact your distributor, or write Dynascan Corporation.

\$189⁰⁰

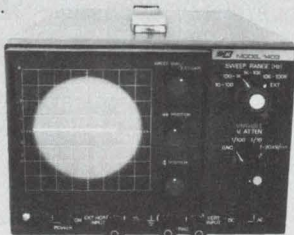

B&K Very good equipment at a very good price.
 Dynascan Corporation.
 1801 West Belle Plaine Avenue, Chicago, Illinois 60613

INFORMATION RETRIEVAL NUMBER 28

10MHz 5" scope with easier calibration and voltage measurement

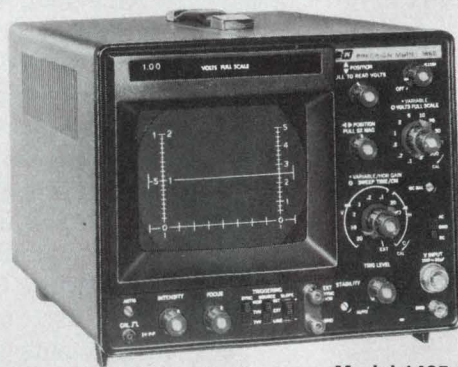

Model 1465 \$400

Here are some B&K extra touches. Besides DC-to-10MHz bandwidth, triggered sweep, automatic sync, 16.6mV/cm vertical sensitivity, DC-coupled amplifier and front-panel Vectorscope capability, Model 1465 also has 5X magnification to increase sweep speed to 0.2usec/cm for complex waveform analysis. And Cali-Brain®, which collapses horizontal sweep to let you measure instantaneous peak-to-peak voltage easily while simultaneously displaying the full-scale voltage range. Now in stock at your local distributor or write Dynascan.

B&K PRODUCTS OF **DYNASCAN**
 1801 W. Belle Plaine Ave.
 Chicago, IL 60613 • (312) 327-7270

INFORMATION RETRIEVAL NUMBER 29

ELECTRONIC DESIGN 14, July 5, 1975

HAYDEN BOOK COMPANY, INC.

50 Essex Street, Rochelle Park, New Jersey 07662



An Open Letter To Manufacturing Managers.

Are you putting off reliable and promising systems innovations because of the money involved? Or the time? Or maybe because of the painful "people problems" you can foresee?

You probably face these problems constantly because as systems technology expands, it demands radically new talents and skills from management.

Recently, professionals from industry, education and government met for the 10th annual symposium co-sponsored by Informatics and UCLA. Their goal? To bring *clarity* and *profitability* to today's new manufacturing methods—for *you*, the *manager*.

Now we have compiled the proceedings into a compact management handbook, called **MANUFACTURING MANAGEMENT SYSTEMS: New Challenges and Profit Opportunities**. As a manager, you couldn't ask for anything more.

This handbook is the symposium and *more*. We've cut away all the extras—the repetitions, the mumblers and the chit-chat—leaving you with the clear and uninterrupted essentials.

The result is an unparalleled, personalized handbook of guidelines, solutions and solid information from some of the nation's most successful industrial leaders.

You'll hear the vice-president in charge of technical affairs at Ford Motor Company tell how an American institution computerized its vast and complex production lines (and battled equally monstrous supplier foul-ups, record problems, etc. along the way).

An executive from a major R & D firm outlines what he has discovered to be the vital managerial skills and essentials for directing progressive operations.

One of Informatic's key men spells out some of the latest and most worthwhile computerized tools available to manufacturers.

The president of a manufacturing firm offers 16 pages of realistic guidelines for handling the sensitive problems of system implementation (without any of the current psycho-social jargon).

There's one corporation president whose share of this handbook is frankly titled "Making Sure You Really Get a Payoff From Your Manufacturing System." It amounts to nothing less than a proven master plan for doing just that.

There are ten sections in all, each one more helpful and informative than the next. Every page is sharp and direct, yet conversational, as if it were being spoken. For the manager, there's a perfect balance of technical information and the wisdom and common sense for using it.

You can now examine, read and use the handbook free, for 15 days, just by circling the information retrieval number shown below. At the end of that time, just send in a check for \$10.50, plus postage and handling, or return the book with no further obligation.

You won't run across many opportunities to hear this kind of straight talk. Try to imagine a symposium where you sit right up front and write down every single word because you know you can use it all.

P.S. Remember—it's easy to order. Just circle the *Information Retrieval No.* shown below!

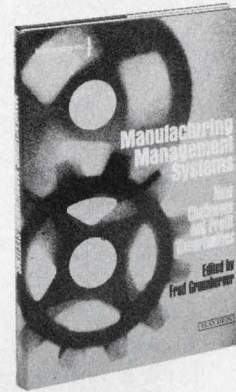

TO ORDER, CIRCLE 98

FOCUS

on Operational amplifiers

The art of glossing over or covering up the poor points of a product while exploiting the good may find its highest expression in the op-amp industry.

Op amps are admirably suited for this game because they have a confusing number of interdependent specs. All are generally related to one another as nonlinear functions of temperature and supply voltage, and in the fierce competition among semiconductor and module manufacturers, the bad specs tend to get buried.

For example, changing either the temperature or supply voltage, or both, affects such key op-amp performance characteristics as open-loop voltage gain, output-voltage swing, bandwidth, bias currents, offset voltages and slew rate. Tradeoffs are concealed by a variety of approaches.

Some manufacturers play a guessing game: "When is a maximum value not a maximum value?" Answer: When some listed maximums are guaranteed and others on the same sheet are simply design maximums. The task here is to figure out which is simply a rated value and which is the guaranteed spec—without phoning the manufacturer.

Check max and min values carefully

Suppliers of op amps keep the number of guaranteed specs for a unit to a minimum, unless such specs are demanded by a customer. Why? Because a guarantee for a parameter means that a hundred percent of the devices must be tested. And testing raises the price in the highly competitive op-amp market.

Another game that can easily drive designers up a wall is called "the salted sample." The supplier sends prototype samples with performance that is substantially above the norm. The design-



High accuracy op amps with FET inputs, the Analog Devices AD506, have a maximum offset of 0.1 mV, $10\mu\text{V}/^\circ\text{C}$, maximum drift and 5-pA maximum bias current.

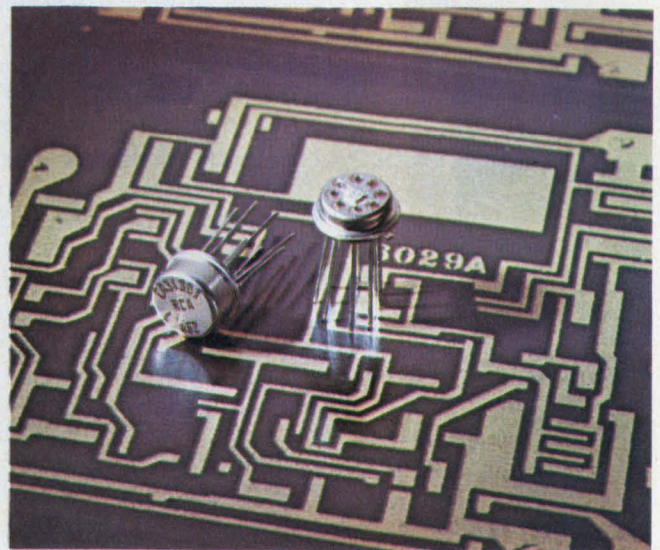

The first op amp to combine bipolar and CMOS on one chip, the RCA 3130, has a CMOS pair that is capable of swinging the output voltage to within 10 mV of either supply terminal.

Jim McDermott
Eastern Editor

er finds out who's won when only two out of 100 units in the production batch work in his final circuit.

One of the more deceptive practices is the inclusion of parameters in the min and max columns of a data sheet to imply that they are guaranteed.

The burden of proof is left to the op-amp buyer. It turns out that the specs selected for this treatment are usually the more difficult and costly ones to test. And, for the same reasons, they are seldom checked by the purchaser in his incoming inspection.

Examples of such parameters are long-term drift, temperature coefficients of offset voltage or current, and—with some manufacturers—all parameters at the extremes of the operating temperature range.

Watch out for omitted specs

Where specs are simply omitted in the data sheet, suspect the worst. A good rule of thumb to follow is that if a spec makes the device look good, it will be included. If it doesn't show up, *caveat emptor*.

In other cases the best you may get is simply a "typical" spec without limits. But "typical" specs seldom are typical. Most units fall into a gray area of plus or minus 30% around the typical curves.

In some cases the use of "typical" means that the manufacturer once made a prototype run of a device with those specs, and he believes he can do it again.

Specs defining parameter changes with temperature are vital. Yet in many cases, while operation at room temperature is guaranteed, the data sheets give no limits on what the device will do at temperature extremes.

In some cases the spec actually gives the operating junction temperature—not ambient—at 25 C. This spec may be useful for the designer of equipment that is to be used inside the cold compartment of a refrigerator or at the earth's polar regions. But for the vast majority of applications, the moment that current is applied to the device at room temperature, the junction temperature rises and the spec becomes meaningless.

What usually is not spelled out in bipolar specs is whether drift with temperature of the offset voltage gets better or is degraded when the amplifier is nulled. Some high-accuracy bipolar circuits—typically the more costly modular units—have a parabolic temperature curve that has a zero tempo at the zero-offset point. In these amplifiers the drift at null is guaranteed.

But in other bipolar op amps the correction of the dc voltage error may increase temperature sensitivity of these devices.

The null specs for FET input op amps are usually vague. Manufacturers want to overlook the fact that several input parameters can be degraded if the offset voltage is nulled.

FET bias currents are a problem

The problem with FET amplifier bias current is unique, in that while these currents are very small, they double every 10 C. For a temperature increase of 100 C this means the current increases more than 1000 times. On the other hand, bipolar bias currents typically decrease from 0.5 to 1% for every increase in degree centigrade.

Also, unlike bipolar circuits, with FET input amps the zero offset point is not the same as the zero drift point. Typical FET input amplifiers have nulled drifts of about $25 \mu\text{V}/^\circ\text{C}$ per mV offset. Then, for an amplifier that has a basic

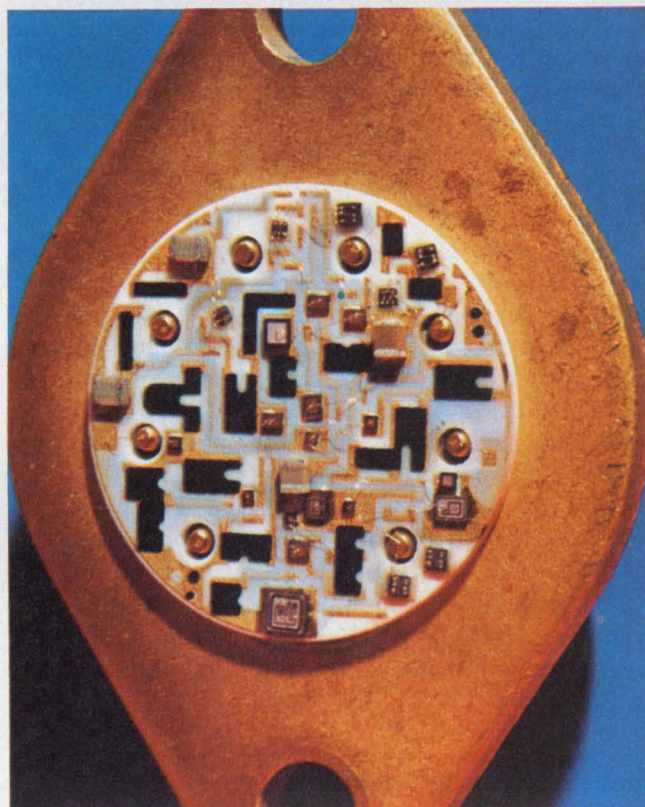

Hybrid technology makes possible this high-voltage op amp, the 3582J, by Burr-Brown. The device can provide 15 mA at ± 145 V ac into a 2-k Ω load, with a ± 150 -V-dc supply.

10 mV/ $^\circ\text{C}$ offset, nulling it can cause a drift of $125 \mu\text{V}/^\circ\text{C}$, which is added to the basic tempo of the unit.

One version of the spec numbers game reduces the maximum figure for bias current by splitting the difference between the currents in both inputs. Called the "average maximum," this value appears as a single number, but it is obtained by adding the currents in both legs and

dividing by two to give an in-between value.

Specified offset voltages and bias currents for monolithic op amps are often lower than they will be in your system. This is because the devices are computer-tested, with only a fraction of a second available to test each IC. The chip simply doesn't have time to warm up. Extrapolations are made by manufacturers, but these figures may not represent performance in real applications.

Another spec for monolithic ICs, noted for its absence, defines the effect of fairly short thermal transients on the offset voltage and bias currents. The ICs have high thermal conductivity and low thermal mass, and the chip readily conducts heat from its output stage back to the input. This thermal feedback introduces offset voltage changes that accompany load-current variations. In some cases the input voltage change may be sufficient to override the summing-junction signal and to cause infinite open-loop gain and instability.

A key, but controversial, specification is the speed with which the op amp can respond to a step input. Agreement among manufacturers on how to specify this is far from universal.

Op amp response depends on five characteristics: bandwidth, full-power response, slewing rate, overload recovery and settling time.

Bandwidth can be defined as the 3-dB-down point, the unity-gain crossover point or the gain-bandwidth product. It is frequently listed as the unity-gain figure. But if the amplifier requires frequency compensation, this figure can be altered. Thus the actual bandwidth at the operating gain may turn out to be different from that implied by the specs.

The full-power response—frequency response for full output power—depends upon how the manufacturer drew up the tests.

His spec may define only the highest sine-wave frequency that can drive the maximum load to peak rated output, ignoring the input signal variations.

Amp supplier sets distortion limits

The amount of distortion permitted depends upon the whim of the manufacturer. In the extreme—and least conservative—case, the waveform deteriorates to a triangular shape. In this case the amplifier is being overdriven at the frequency of test.

On the other hand, for a conservative spec of 2% allowable distortion, the maximum full-power frequency is reduced, which gives the appearance of poorer performance.

The maximum frequency of full-power response is governed by the amplifier's slew rate. As a rough rule, it's generally accepted that 100 kHz of full power response is equal to 6 V/ μ s

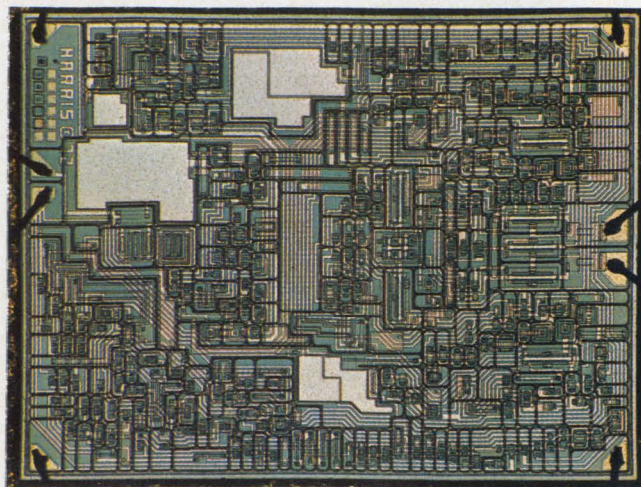

This monolithic chopper-stabilized amplifier, by Harris, has an offset voltage drift of only 0.2 μ V/ $^{\circ}$ C. Open loop gain is 5×10^8 , bandwidth is 3 MHz and slew rate is 2.5 V/ μ s.

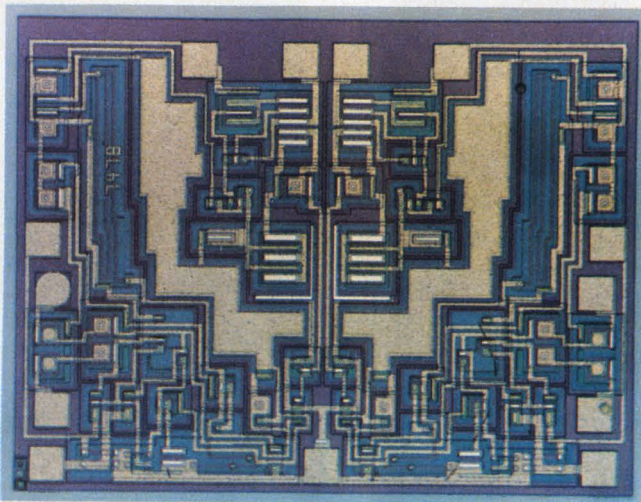

Dual high performance op amps on this chip, by Texas Instruments, are protected against shorts and against latchup. No external frequency compensation is needed.

of slew. This figure must be used with caution.

Slew rate is measured differently by different op-amp producers. One will measure the slope of the amplifier response to a large step input. Another will deliberately overdrive the amplifier to produce a triangular waveform and then specify the slope of the waveform as the slew.

Also, remember that measurement of the slew with the inverting op-amp configuration gives a different value than with the noninverting connection.

Unfortunately, how the manufacturer tested for slew rate doesn't usually appear on the data sheet.

The type of op-amp input—bipolar or FET—also makes a substantial difference in the slew rate. Use of a FET front end on an op amp provides a 30-to-1 or 40-to-1 increase in slew rate.

For op amps in which the bandwidth is speci-

fied as the unity-gain crossover frequency of the open-loop gain-magnitude response, the unity-gain frequency, f_c , is the maximum closed-loop bandwidth. However, this is useful only for small signals, typically below 100 mV, because of non-linear response and distortion for larger values.

For large-signal applications, the full-power response, f_p , is a more useful measure of speed, as it defines, with small distortion, the bandwidth for which the rated output can be developed. In general, f_p is 1/10th to 1/100th of f_c .

To permit fast settling, the open-loop response of the amplifier should approximate a single-pole response, which is characterized by a -6 dB/octave response slope.

Settling time has at least three definitions, depending apparently upon the capability of the op amp and the conservatism of the manufacturer.

The first definition specifies settling time as that period between the time the amplified voltage crosses the final value until it settles within a given error band.

The second definition says that settling time is the period in which the amplifier output settles within an error band, starting with the 10% rise point of the slew ramp.

The third definition (see figure) includes the following: (1) the initial propagation delay, (2) the time to slew near the final value plus recovery from the initial overshoot, and (3) the time to settle within the error band.

The true settling time cannot be predicted easily from open-loop specs, such as slew rate and small signal bandwidth. A step input, of course, falls in the large-signal category.

One widespread technique for masking the limitations of an op amp is to measure the settling time (or slew rate) using amplifier gains of 3 or 4, and sometimes much higher, instead of unity. This gives faster performance, but when this same amp is used at unity-gain, it displays distorted waveforms. Compensation networks can be used to overcome the problem, but they lower the amplifier's performance.

Settling time is usually specified under ideal conditions. But if the amplifier is loaded with the capacitance of long shielded input cables, a settling time of, say, 60 ns may increase to 1 μ s. Such a capacitance limitation is another parameter that is frequently omitted.

And, of course, op amp outputs can never settle within a given error band if output noise comparable to the error band is present.

In general, to ensure the accuracy of a unity-gain follower amplifier that must settle to within $\pm 0.01\%$, the gain should be greater than 10,000. For unity-gain inverters with the same settling requirements, the gain would have to be 20,000.

For voltage-follower applications, the common-

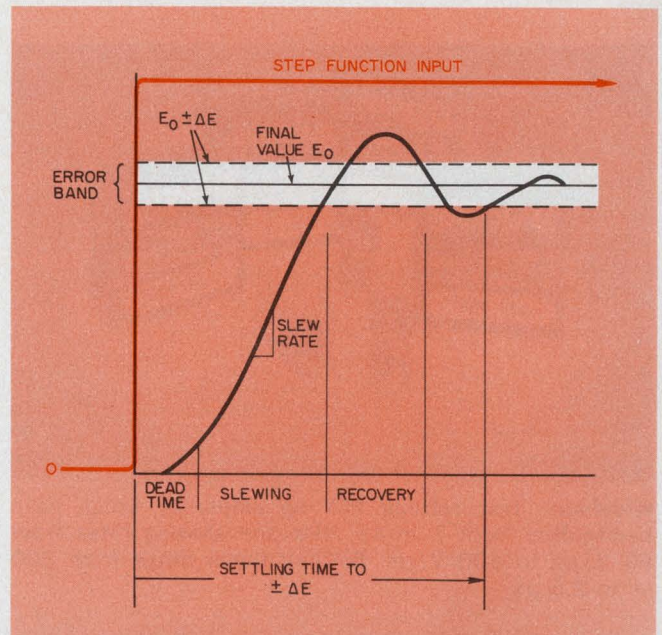

The most complete definition of settling time considers the dead time, slewing, recovery and settling of the output to within the tolerance of the error band.

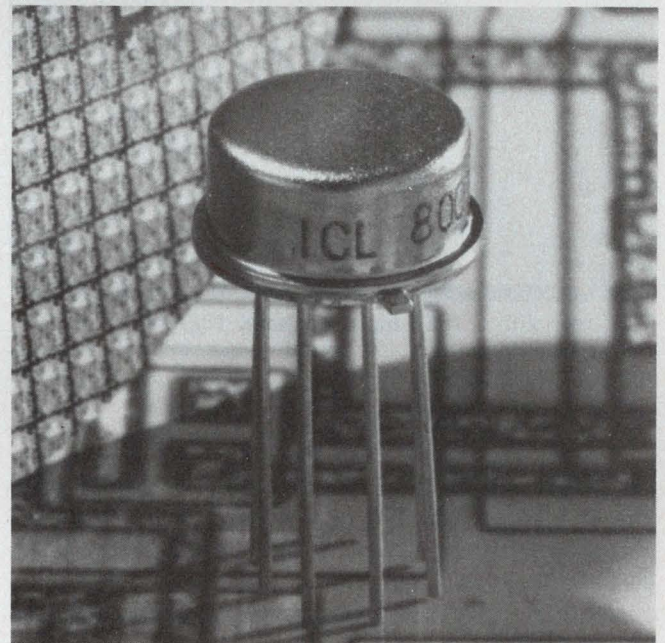

Very low input current of 1 pA max and low offset voltage of 2 mV max are features in this 8007 FET-input op amp by Intersil. Input impedance is 10^{12} ohms.

mode rejection ratio should be compatible with the desired gain accuracy.

Noise specs hard to compare

Input noise is generally specified for three spectral regions: a 1/f band from about 100 Hz down to 0.1 Hz, a plateau extending from 100 Hz to about 10 kHz, and a high-frequency region sloping off into the MHz area.

Unfortunately, noise is characterized on spec

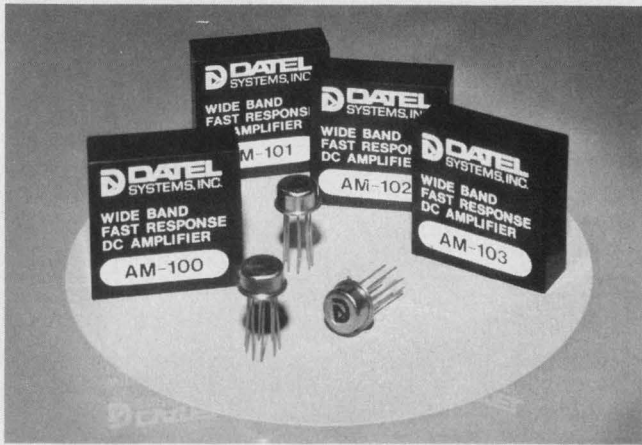

Wideband, fast settling FET op amps, by Datel, have bandwidths from 7 to 45 MHz and slewing rates from $60 \text{ V}/\mu\text{s}$ to $400 \text{ V}/\mu\text{s}$. Settling times range from 300 ns to $2.5 \mu\text{s}$.

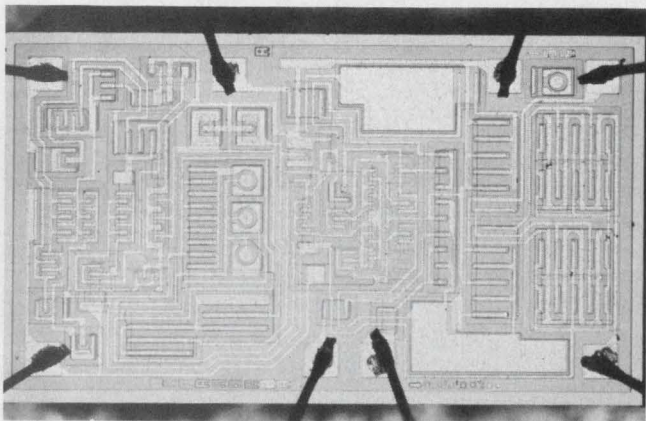
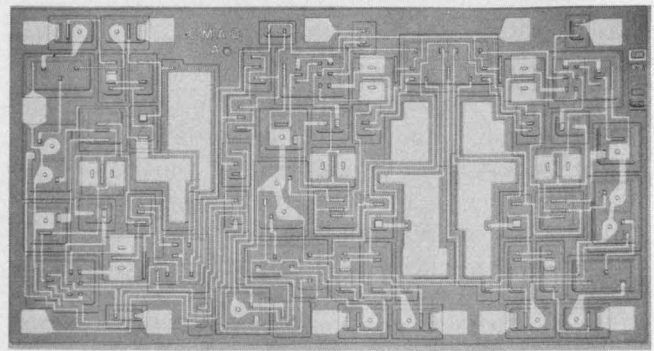

This monolithic JFET input op amp, National's LF 156, uses ion implantation to combine matched JFETs with bipolar transistors. It features very low noise and a low $1/f$ noise corner.

sheets in different ways for these regions. For the $1/f$ band, the noise is always peak to peak. For the higher regions, it may be spec'd as peak to peak or rms. Thus comparison of noise figures for different vendors, or in slightly different frequency bands, can prove difficult.

For example, to convert rms noise to peak-to-peak values, the time-honored 1.414 multiplier for a sine-wave function is useless. Instead the rms figure must be multiplied by 5 or 6, which statistically relates the peak to the rms values.

Rms noise is frequently specified at a single spot value, obtained by use of very-narrowband filter. In this case the manufacturer does not give values extending over a bandwidth. However, he may include a graph of "typical" noise performance.

The noise over any band of interest may, however, be obtained by multiplication of the spot noise, which is usually stated in $\text{nV}/\sqrt{\text{Hz}}$ rms, by the square root of the bandwidth chosen.

A new dual op amp designed for single-supply operation, Signetics' NE532, uses a Darlington input stage that can be driven slightly below ground (-0.3 V).

While strong op-amp industry competition has been responsible for much specsmanship, that same competition has also contributed to substantial improvements in op-amp technology and device performance.

The modular units remain the highest-priced, because they use high-quality discrete components that are carefully selected and matched for a particular amp. But modular op amps still provide the best performance for a combination of characteristics.

For example, Analog Device's 52 K is a low-noise, low-drift, nonchopper amplifier. It has a guaranteed low noise of $1.5 \mu\text{V}$ peak-to-peak max from 0.01 to 1 Hz, low voltage drift of $1 \mu\text{V}/^\circ\text{C}$ and an open-loop gain of better than 1 million.

Modular op amps also provide capabilities, like high isolation, that are unattainable with their hybrid and monolithic competitors. An example here is Burr-Brown's 3452 isolation amplifier, which provides up to 2000-V isolation between input and output. This is accomplished by use of a transformer-coupled modulation/demodulation stage that isolates the input from the output by $10^{12} \Omega$ in parallel with 16 pF of coupling capacitance. The Burr-Brown amplifier can be operated in the inverting, noninverting or differential amplifier configurations.

Hybrid op amps are fast approaching modules in performance in applications from high-input-impedance instrument amplifiers to high-voltage and high-current devices. As one example, Tele-dyne Philbrick's 103502 JFET op amp reduces bias currents to minuscule levels approaching those of a varactor amplifier—50 femtoamps (10^{-15} A) guaranteed at 25 C ambient—but with lower offset voltage, tempco, noise figure and cost.

A high-voltage hybrid by Burr-Brown—the 3582J—uses a $\pm 150\text{-V}$ supply, has an open loop gain of 800,000 and produces an output swing of $\pm 145 \text{ V}$ at 15 mA. The device also has internal thermal sensing to shut itself off automatically

when it overheats during operation.

National Semiconductor has produced a hybrid ultra-fast FET op-amp—the LH0032—with a slew rate of 500 V/ μ s and a bandwidth of 70 MHz. Typical settling times are given as 100 ns to approach within 1% of final value and 300 ns to settle to within 0.1% of that area. Output voltage swing is ± 13.5 V at 20 mA for a ± 18 -V supply.

Monolithic device performance has improved dramatically. The Harris HA-2900, the first chopper-stabilized monolithic op amp to be produced, has an open-loop gain of 5×10^8 , an offset voltage drift of 0.2 V/ $^{\circ}$ C and an offset current drift of 1 pA/PC. With bipolar transistors for the amplifiers and FETs for the chopper, the input resistance is typically 100 M Ω .

Several companies have been experimenting with new technologies that combine FETs of one sort or another with bipolar devices. Whereas Harris and Fairchild combine bipolar and PMOS on the chip, RCA is the first to integrate CMOS with bipolar transistors in its CA3130 Series op amp.

Gate-protected p-channel MOS FETs in the CA3130 provide an input impedance of typically 1.5×10^{12} Ω and an input current of 5 pA with 15 V across the device. The RCA device has bandwidth of 15 MHz at unity-gain crossover, an open-loop amplifier gain of 320,000 and a high slew rate of 10 V/ μ s. The device can operate off either a single 15-V or dual ± 8 -V supplies.

The output stage employs a CMOS transistor pair that is capable of swinging the output to within 10 mV of either supply terminal. The high output current of 20 mA is sufficient to operate sensitive relays.

Ion implant gives low-noise FET amp

National Semiconductor is now producing bipolar and JFET transistors on the same monolithic chip to improve noise performance figures. Heretofore, fabrication of a pair of JFETs having a matching comparable to that of a bipolar pair has been difficult, because the JFETs require control of the vertical implant dimensions to a tolerance 10 times tighter than that for the bipolars.

To get around this, National has adopted ion implantation to produce the JFETs. With this technique, an ultra-thin, precisely controlled, doped layer can be formed.

National's new LF series of monolithic amplifiers has ion-implanted JFETs on the chip with bipolars. The series includes the LF 156, now available in quantity. Typical input current is 30 pA. The offset voltage is 3 mV, and the temperature drift is 5 μ V/ $^{\circ}$ C. The input noise volt-

age is 15 nV/ $\sqrt{\text{Hz}}$ at 100 Hz.

The gain bandwidth of the LF 156 is 5 MHz, slew rate is 15 V/ μ s, and it settles rapidly to within 0.01% of the error band in 1.5 μ s. For driving capacitive loads, the LF 156 has a new type of output stage that can drive 10,000 pF without instability.

Supply current is low—only 5 mA. The amp takes ± 22 -V supplies for a military version and ± 18 V for commercial units.

The industry's standard op amp—the 741—is being constantly improved as a single device, as well as in doubles and in quad configurations. Teledyne Semiconductor has an 844 series termed "the super 741." With a high slew rate, high input impedance, low noise and a low price, it is designed for audio applications.

Motorola has a high-slew-rate, internally compensated op amp—the MC1741—that is equivalent to the standard 741 but has a 20 times higher slew rate and bandwidth. A slew rate of 10 V/ μ s is guaranteed for unity-gain operation. Minimum power bandwidth is 150 kHz, with 200 kHz given as typical. Dual and quad configurations of the 741 are available from Motorola as the MC1558 and the MC3403.

Single and dual versions of the 741 op amp are sealed in RCA's new Gold Chip package, a low-cost tri-metal process that completely moisture-proofs the IC. The RCA single op amp is the CA741G, and the dual version is the CA747G.

A programmable micropower triple op amp, the Siliconix L144, is the forerunner of a trend to "micropower" devices. It has an external programming feature to control the current, power dissipation and the input bias. It operates from supplies of ± 18 V to as low as ± 1.5 V, with supply currents controllable from 10 μ A to 1 mA. The unity-gain crossover of the individual amplifiers occurs at 600 kHz. Slew rates range from 0.03 V/ μ s with a source voltage of ± 1.5 V to 2 V/ μ s with a ± 15 -V source. ■■

Need more information?

The companies and products cited in this report have, of necessity, received only brief coverage. They've been selected for their illustrative qualities. Many companies not mentioned may offer similar products. Readers may consult the following manufacturers and ELECTRONIC DESIGN's Gold Book for further details about their products.

Adaptive Systems Inc., P.O. Box 1481, Pompano Beach, FL 33060. (305) 974-8354. (P. D. Craig). **Circle No. 401**
Advanced Micro Devices, 901 Thompson Pl., Sunnyvale, CA 94086. (408) 732-2400. (E. Turney). **Circle No. 402**

(continued on page 50)

OSCILLATORS

.001% STABILITY

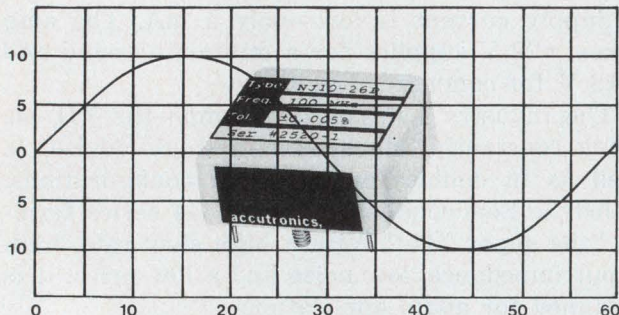

"AND MORE"

PARAMETER (1)	SERIES 110
Frequency Range	10 MHz / 250 MHz
Supply Voltage	+12 VDC
Distortion	<10%
Output Voltage	>.5 VRMS
Load	50 Ω
-55°C to +75°C (2)	±.005%
0 to +60°C (2)	±.001%
+15°C to +35°C (2)	±.0005%
Current Drain	<30 ma @ 10 MHz <60 ma @ 250 MHz
Size	1.5 x 1.5 x 1.5

STABILITY: Is one of the prime factors in crystal Oscillator selection. Perhaps your application doesn't dictate stabilities in the .001% range, but due to our standardization programs and volume purchases, we may be able to offer you extra stability at the same cost you may already be paying for far less stable units. We can even offer you less stable units if you desire. INTERESTED? Call Gerald DeWar at (312) 232-2600 today. He will be glad to discuss your particular requirement with you and send you our new catalog.

See Gold Book, Vol. 2 pg. 936-937

Please write or call for

NEW 1975 CATALOG

Our new catalog covers various types of oscillators: VCXO, LCVCO, RCVCO, high stability, computer clocks, high output power, Navy standard hardware modules and low current drain oscillators from 1 Hz to 250 MHz. We'll even send you three neat conversion charts (3) to hang on your wall and impress your friends.

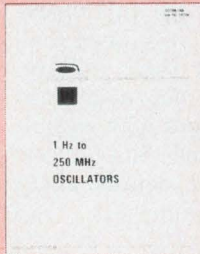

accutronics

A HAMMOND CORPORATION COMPANY

628 NORTH STREET • GENEVA, ILLINOIS 60134

INFORMATION RETRIEVAL NUMBER 31

(continued from page 49)

- Analog Devices, Inc., P.O. Box 280, Norwood, MA 02062. (617) 329-4700. (J. Corsi). **Circle No. 403**
- Analogic Corp., 39 Audubon Rd., Wakefield, MA 01880. (617) 246-0300. (G. Wilson). **Circle No. 404**
- Bailey Instruments Co., 516 Victor St., Saddle Brook, NJ 07662. (201) 845-7252. (R. J. Bailey). **Circle No. 405**
- Beckman Instruments, 2500 Harbor Blvd., Fullerton, CA 92634. (714) 871-4848. (R. E. Schmidt). **Circle No. 446**
- B&H Electronics Co., Box 490, Chester, NY 10918. (914) 783-4988. (B. Horowitz). **Circle No. 406**
- BLH Electronics Inc., 42 4th Ave., Waltham, MA 02154. (617) 890-6700. (G. D. Rummell). **Circle No. 407**
- Burr-Brown Research Corp., 6730 S. Tucson Blvd., Tucson, AZ 85734. (602) 294-1431. (G. Tobey). **Circle No. 408**
- Computer Labs, 1108 S. Chapman St., Greensboro, NC 27403. (919) 292-6427. (Don Brockman). **Circle No. 409**
- Cycon, Inc., 1080 E. Duane Ave., Sunnyvale, CA 94086. (408) 732-8311. (L. Wayne Peacock). **Circle No. 410**
- Datel Systems Inc., 1020 Turnpike St., Canton, MA 02021. (617) 828-8000. (J. Gallagher). **Circle No. 411**
- Dynamic Measurement, 6 Lowell Ave., Winchester, MA 01890. (617) 729-7870. (J. Gendreau). **Circle No. 412**
- Exar Integrated Systems, 16933 Milliken Ave., Irvine, CA 92705. (714) 546-7750. (W. Davidson). **Circle No. 413**
- Fairchild Semiconductor, 464 Ellis Ct., Mountain View, CA 94042. (415) 962-5011. (Al Tremain). **Circle No. 414**
- Function Modules Inc., 711 W. Seventeenth St., Costa Mesa, CA 92626. (714) 645-6001. (G. S. Osgood). **Circle No. 415**
- General Instrument Corp., 600 W. John St., Hicksville, NY 11802. (516) 733-3333. (Joseph LaFiandra). **Circle No. 416**
- Halex Inc., 3500 W. Torrance Blvd., Torrance, CA 90509. (213) 542-3555. (M. J. Bergquist). **Circle No. 417**
- Harris Semiconductor, P.O. Box 883, Melbourne, FL 32901. (305) 727-5407. (Frank Abreu). **Circle No. 418**
- Hybrid Systems Corp., 87A 2nd Ave., Burlington, MA 01803. (617) 272-1522. (C. Kramer). **Circle No. 419**
- ILC Data Device Corp., 105 Wilbur Pl., Bohemia, NY 11716. (516) 567-5600. (T. Berg). **Circle No. 420**
- Intech Inc., 1220 Coleman Ave., Santa Clara, CA 95050. (408) 244-0500. (B. Jumper). **Circle No. 421**
- Intersil Inc., 10900 Tantau Ave., Cupertino, CA 95014. (408) 257-5450. (J. L. Zabkar). **Circle No. 422**
- Intronics Inc., 57 Chapel St., Newton, MA 02158. (617) 332-7350. (A. G. Pfaelzer). **Circle No. 423**
- ITT Semiconductors, 3301 Electronics Way, West Palm Beach, FL 33407. (305) 842-2411. (D. R. Saban). **Circle No. 424**
- MS Kennedy Co., Pickard Dr., Syracuse, NY 13211. (315) 455-7077. (B. D. Lesjack). **Circle No. 425**
- Modular Devices Inc., 1385 Lakeland Ave., Bohemia, NY 11716. (516) 567-9620. (R. Greenstone). **Circle No. 426**
- Motorola Semiconductor Products Inc., 5005 E. McDowell Rd., Phoenix, AZ 85008. (602) 244-6900. (Steven Faulkner). **Circle No. 427**
- National Semiconductor Corp., 2900 Semiconductor Dr., Santa Clara, CA 95051. (408) 732-5000. (Chuck Signor). **Circle No. 428**
- Op Amp Labs, Inc., 172 S. Alta Vista Blvd., Los Angeles, CA 90036. (213) 934-3566. (B. Losmandy). **Circle No. 429**
- Optical Electronics Inc., Box 11140, Tucson, AZ 85734. (602) 624-8358. (S. Boyer). **Circle No. 430**
- Precision Monolithics, 1500 Space Park Dr., Santa Clara, CA 95050. (408) 246-9225. (Jerry Zis). **Circle No. 431**
- Raytheon Co., Semiconductor Div., 350 Ellis St., Mountain View, CA 94040. (415) 968-9211. (G. Selven). **Circle No. 432**
- RCA Solid State Div., Box 3200, Somerville, NJ 08876. (201) 722-3200. (Merle Hoover). **Circle No. 433**
- Signetics Corp., Sub. Corning Glass, 811 E. Arques Ave., Sunnyvale, CA 94086. (408) 739-7700. (John Mattis). **Circle No. 434**
- Silicon General, Inc., 7382 Bolsa Ave., Westminster, CA 92683. (714) 892-5531. (Q. T. Wyles). **Circle No. 435**
- Siliconix Inc., 2201 Laurelwood Rd., Santa Clara, CA 95054. (408) 246-8000. (L. Lynberg). **Circle No. 436**
- Solid State Electronics, 15321 Rayen St., Sepulveda, CA 91343. (213) 894-2271. (E. Y. Politi). **Circle No. 437**
- Soliton Devices, Inc., 8808 Balboa Ave., San Diego, CA 92123. (714) 278-8780. **Circle No. 438**
- Sprague Electric Co., 645 Marshall St., North Adams, MA 01247. (413) 664-4411. (C. G. Killen). **Circle No. 439**
- Teledyne Philbrick, Allied Dr. at Rte. 128, Dedham, MA 02026. (617) 329-1600. (Frank Goodenough). **Circle No. 440**
- Teledyne Semiconductor, 1300 Terra Bella Ave., Mountain View, CA 94040. (415) 968-9241. (H. W. Gebhardt). **Circle No. 441**
- Texas Instruments Inc., P.O. Box 5012, Mail Station 84, Dallas, TX 75222. (214) 238-2011. (Dale Pippinger). **Circle No. 442**
- Transitron Electronic Corp., 168 Albion St., Wakefield, MA 01880. (617) 245-4500. **Circle No. 443**
- Westamp Inc., 1542 15 St., Santa Monica, CA 90404. (213) 393-0401. (J. Manda). **Circle No. 444**
- Zeltex Inc., 940 Detroit Ave., Concord, CA 94518. (415) 686-6680. (R. Seinfeld). **Circle No. 445**

"Smart" but friendly!

The first signal generator to incorporate a microprocessor.

The Fluke 6010A is a remarkable new instrument—a smart but friendly (easy to use) general purpose signal generator. It's a versatile 7 digit, 10 Hz to 11 MHz instrument with performance comparable to instruments costing twice our \$2,495.*

The key to the 6010A is . . . automation.

The Fluke 6010A features free-form entry of frequency in Hz, kHz, or MHz. Stores and recalls up to ten preset frequencies, modulation and attenuator settings by pushing a single button . . . a unique capability.



This feature is particularly important in any kind of repetitive testing, where tediously punching in a 7-digit number exposes the operator to error. It also radically shortens the time required by the testing sequence.

The microprocessor plays a part in several other operations, including *automatic range selection* and *automatic justification* (the unit automatically justifies the entry on the bright, 7-digit LED readout to give the greatest possible resolution).

A sophisticated bench oscillator that's easy to use.

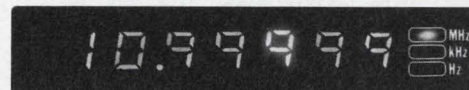

For all its sophistication, the 6010A works easier than any other instrument of its kind.

Continuous tuning is possible with Frequency Edit which consists of a large dual-concentric rotary knob.

The bright digit denotes the tuned decade. The bright digit can be "decremented" or incremented with complete wraparound and carryover.

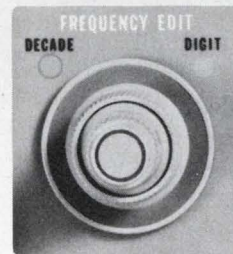

The 6010A is self-checking.

Spacewise, the unit measures only 5¼" x 8½" x 19", so it takes up minimum space on the work bench.

Interfaces directly with ASCII systems.

The 6010A fits easily into an auto-testing system, because expensive interfacing is not needed. The unit "handshakes" directly with most ASCII (IEC) systems; the microprocessor handles the interfacing problems.

Here's price/performance without peer. And, it is backed by Fluke's second-to-none reputation for engineering, reliability and service.

For data out today, dial our toll-free hotline: 800-426-0361.

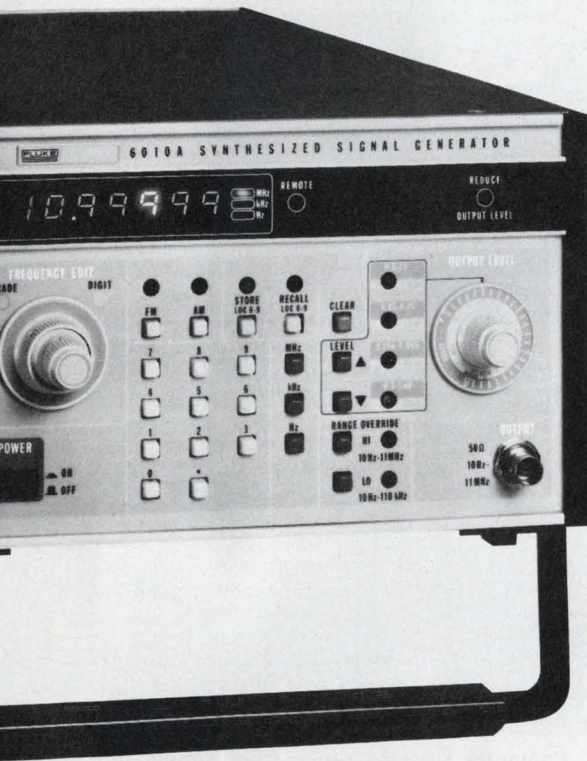

INTRODUCING THE 6010A SYNTHESIZED SIGNAL GENERATOR

John Fluke Mfg. Co., Inc., P.O. Box 43210, Mountlake Terrace, WA 98043

For a demo circle # 281. For literature only circle # 282

For information on the rest of the Fluke line, see EEM or the Gold Book.



*U.S.A. price

The mini's most important part may be its operating system, but many users neglect it. Here are tradeoffs to consider in evaluating today's minicomputers.

Of the three major parts of a computer system, the operating system (OS) may well be the most important—and the most neglected.

The two other parts of the system—the central processing unit and peripheral I/O devices—generally get close attention from the designer. The OS, which ties the CPU and peripherals together and enables the user's application programs to run smoothly, usually gets short shrift.

No single OS can do everything. Different computer applications call for optimizing different criteria. The user—and, of course, the OS designer—must answer these questions:

- Do I maximize throughput?
- Do I minimize interrupt-response latency?
- Do I reduce core overhead?
- Do I optimize the OS scheduler (executive) for conversational, batch or real-time programs?
- Do I optimize data structures for access time, or storage density?

Until recently the operating-system designer for minicomputer systems—and therefore also the user—had only a limited range of choices, because of limited memory capacity, a small command set and long cycle times. This situation is changing; now mini-mainframes break the traditional 64-k-byte memory limitation with systems that range to 256-k bytes and more.

For example, Interdata is shipping 32-bit minicomputer systems, called Megaminis, with the capacity to address up to one megabyte of memory directly.

In addition core memories, previously standardized at 1 μ s, are now available with 900, 800 or even 750-ns cycle times. And a few minicomputers offer solid-state MOS memories that cycle in less than 300 ns. Thus more memory space at higher speeds is available for OS use.

Instruction repertoires have also increased from the five or six memory-reference commands provided by the first primitive minis in the 1960s to more than 100 commands.

At the hardware level, minicomputers have

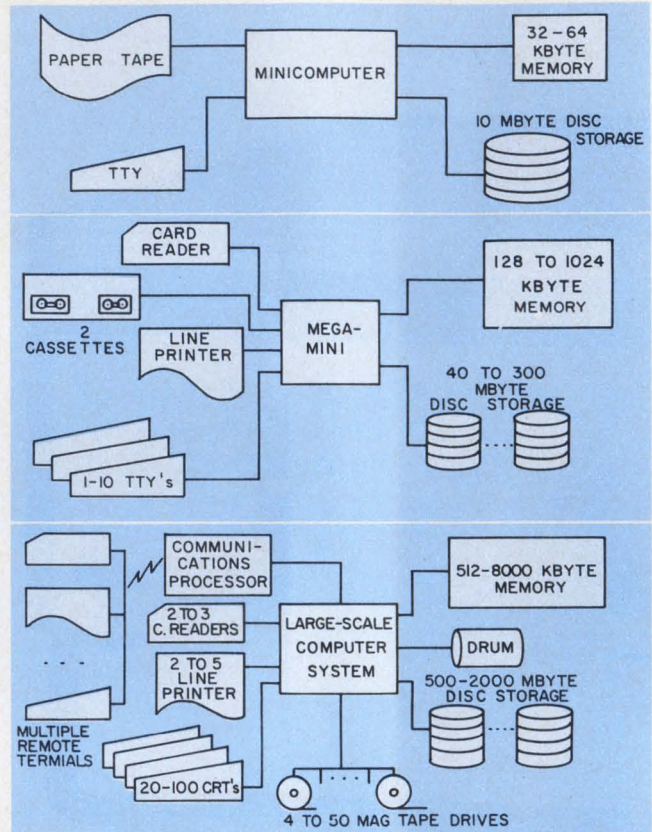

1. Computer systems range from simple minis to large scale mainframes. Newer minis, such as Interdata's Megamini, have less elaborate hardware than mainframe units and fill the gap between large scale processors and simple stand-alone configurations.

benefited from the introduction of new MSI and LSI chips. Where early minis processed only eight to 12 bits at a time in one or two working registers, modern units handle as many as 32 bits simultaneously. And 32 or more working registers are becoming commonplace.

One feature of some new minicomputers is of particular help to the OS designer. Their register sets are partitioned so the executive—the nucleus of the OS—can have exclusive control of one set of registers. This can substantially increase system efficiency in both memory and time.

But even with all this new processing power and freedom, today's OS designers can go wrong if they are not aware of the differences between

William C. M. Vaughan, Senior Systems Programmer, Interdata, Inc., 2 Crescent Pl., Oceanport, NJ 07757.

these new "superminis" and the large-frame computers.

'Superminis' are different

Though the new superminis handle as much, or more, memory and have the raw computing power of the bigger, more expensive machines, their OS design must take a different approach. Here are some reasons why:

- The typical large-scale computer uses a peripheral complement that is very different from the typical supermini's (Fig. 1).
- The task load of a large-scale system is usually more heavily I/O bound.
- Large systems generally have specialized hardware for faster bulk-file access; disc storage

OS scheduling disciplines

	Real-time	Batch	Time-sharing
Tasks	Part of an interacting system	Part of a serial job stream	Controlled by a user terminal
Task Activation	External events	Available resources	Time slice
Task Priority	Fixed	Flexible	Very flexible
I/O	High speed	High throughput	Fully buffered
Critical Parameter	Worst-case interrupt response time	System throughput	Average terminal response time
Typical Environment	Process control	Job shop	Multi-user system
Typical Language	FORTRAN	COBOL	BASIC

space is assumed to be virtually unlimited; therefore file manipulation features are provided that are beyond the new large mini's capability.

▪ Minicomputers, including the new supermini class, are usually oriented to real-time operation, while time-sharing is left to large-scale mainframes.

Adapting a large-scale OS to the new minis just won't work. The supermini needs an operating system tailored to its own capabilities. Factors in the selection of the OS include:

- Applications.
- Scheduling disciplines.
- Flexibility.
- Task coordination.

Most minicomputer applications fall into one of these categories:

▪ *Scientific computation.* Often written in FORTRAN, these applications tend to use large

memory partitions for array manipulation. They generally run hands-off, with the execution time generally noncritical. Programs may run for hours or days.

▪ *Remote-inquiry and response.* A conversational mode is generally used. The response time to terminal requests may be several seconds, and the applications often involve the manipulation of large data bases on disc and in memory. Many terminals must be accommodated over remote data links.

▪ *Data communications.* May include message switches and concentrators, and often require large data storage and normally high throughput. Extremely high reliability is needed.

▪ *Process-control and data acquisition.* Often very time critical, these applications are driven by external events. Often they cannot afford disc access time; thus much of the data must be maintained in memory.

▪ *In-house time-sharing.* Often used by systems builders for program development, this requires multilanguage capability, limited real-time response and substantial memory for user partitions.

Different schedulers for different users

Each application employs one of three scheduling disciplines—real-time, batch or time-sharing. Usually a single OS can support only one of these disciplines, because the optimization requirements vary too drastically. It is generally not possible—even on a supermini—to implement a scheduler that is optimal for all three.

Real-time scheduling must be highly responsive to external stimuli and operate on a fixed priority basis. Priority is determined by the task and, barring emergencies, is not changed by the computer system. For an interrupt-driven task, the worst-case response time—the elapsed time between an external event and the computer's response to the event—is a critical OS parameter. To optimize real-time scheduling, the OS should be designed to load the tasks as speedily as possible, minimize the time spent in an interrupt-inhibited state and schedule on an absolute priority basis. A given task should never prevent the execution of a task with higher priority.

On the other hand, in batch scheduling, where job streams enter the computer from either local or remote operators, priority scheduling is usually more flexible.

System throughput can sometimes be improved if a low-priority task is dispatched before a high-priority task. Often disc access-time-latency considerations dictate the priority assignment. The objective in a batch-oriented system is to optimize throughput rather than response time to

an individual job. For batch scheduling, the OS should emphasize the following:

- Efficient use of system resources through sophisticated spooling and de-spooling routines.
- Maximum time spent in the problem state. OS and waiting times should be minimum.
- Flexibility in scheduling to optimize throughput. Priority should take a back seat.

In time-sharing scheduling neither throughput nor priority is of prime importance. Instead, the response to stimuli from such a system's terminals must appear to be what a human operator would consider real-time—less than a second. Computer I/O wait periods are often long; thus the system should be able to direct the terminal to bulk storage for the waiting period.

Priorities are not fixed, but rather set by the scheduler. The governing criterion of OS design for a time-sharing system is to minimize the average response time for the set of all user tasks. However, the exact time is not a critical value as long as it is less than one second.

To optimize time-sharing scheduling, the OS should have these features:

- A full-scale swapping system, in which tasks stored in bulk storage contend for CPU time on an equal basis with tasks in memory.
- The ability to queue I/O or any other system request that requires a response. Waiting for access is necessary to allow program swapping to take place.
- Sophisticated user-oriented file-handling and utility services capabilities.
- A "fair" scheduler that ensures that no task ever waits too long to obtain access to the CPU. This is generally done by time-division multiplexing, or time-slicing, and by the dynamic adjustment of the priority of a program so that the longer the program waits, the higher its priority.

The three scheduling disciplines have different goals and characteristics. Absolute-priority scheduling for real-time operation conflicts with the flexible schedulers required for batch and time-sharing. Queued I/O for time-sharing conflicts with the direct-access, high-speed I/O required for real time, and even with spooled I/O in batch processing. Thus scheduling and resource allocation are truly optimal for only one of the disciplines.

In only a few cases can the disciplines be mixed without major difficulties. The real-time discipline is most flexible (see table). Though real-time jobs can't be properly run on either a batch or time-sharing system, it is possible to run batch and time-sharing jobs on a real-time system. The tradeoff commonly made forgoes "fair scheduling" for the time-sharing jobs, which is generally only a minor annoyance.

Systems that must support both real-time and time-sharing use often employ a time-slicing

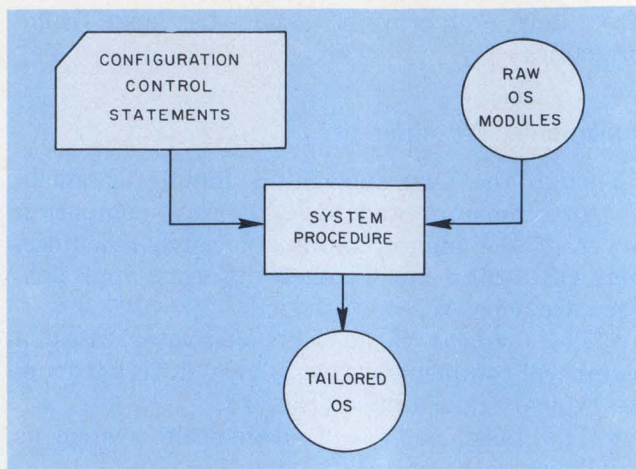

2. To start work with a supermini, the user must do a SYSGEN—in which selected operating system modules are joined to support the particular application.

scheduler for the time-sharing jobs, to ensure that no time-sharing job hogs the system. Of course, the extra load on the scheduler tends to degrade the system's real-time performance.

The OS is key to versatility

Classical minis are very often limited to use on dedicated systems because they haven't got enough memory to be more flexible. An OS that can support a variety of jobs can easily occupy 50-k bytes of memory—almost the entire allotment in a classical mini.

Supermini-class hardware, with its large memory capacity, is not limited in this way. But a supermini needs a well-designed OS to take advantage of this potential flexibility. File structures should be versatile enough to use in program development and still allow fast access for real-time programs. Enough communications features should be built into the OS to let programs talk to remote terminals, as well as to local teletypewriters or CRTs. Multiple-language processors like FORTRAN, BASIC and assembly-language should be supported. Users should be able to work in both conversational (hands-on) and batch (hands-off) modes.

However, a truly versatile OS will probably contain many more features than a single user is likely to want. To avoid saddling the user with the extra memory required to support unused features, a modular OS will allow selection of only the desired features.

A process called system generation, or SYSGEN, enables a user to select the items he desires in a properly modularized OS. With SYSGEN, he gets a complete package of the available OS modules and a procedure to make the selection. Each vendor has a different modular OS package and procedure. To help evaluate them consider these factors (Fig. 2):

- The procedure should be easy to use. Often the repeated application of SYSGEN must be performed before a final OS is selected.

- The more choices SYSGEN allows, the better. Beware of a setup where all you can do is change drivers (subroutines for controlling peripherals like card readers, printers, etc.).

- The SYSGEN procedure should have a configuration error-detection capability. An error detected during SYSGEN, is far easier to correct than after the OS is assembled and in use.

Another ingredient essential to a flexible OS is versatility in disc-file management. Data can be accessed either randomly, sequentially or in key-sorted order. No file management technique is best for all purposes. The OS should be able to support several different kinds of disc-file methods. Here are some of the most important:

- *Buffering and blocking.* OS control of data transfers to and from the file can use the memory to buffer the data and relieve the user from concern with buffer management. Part of efficient OS disc management is a blocking function that allows multiple records to be packed into a disc block, thereby saving disc access time and space on the disc. However, where fast access is of prime concern, unbuffered and unblocked disc access should also be allowed in at least one file.

- *Open-ended files.* Open-ended file capability is almost mandatory for program development. Assemblers and compilers can't predict how long scratch files need to be, but with open-ended files there is no need to specify a file length.

- *Random access.* A user should be able to retrieve a record by record number rather than having to read from the beginning of the file until he gets to the desired record.

- *Variable block size.* It is desirable to be able to vary disc-block size for some files. In many operating systems the size of the disc block is fixed, usually at 256, 512 or 1024 bytes, which may not be appropriate for all applications.

- *Programmed file handling.* User programs should be able to create, open and close files. Though this capability may seem obvious, some OS's require that this be done by the operator.

- *File protection.* Files should be secured from unauthorized access, especially in time-shared systems.

- *Dismountable volumes.* The OS should allow the read-in of a new disc directory to make a "removable" pack really removable.

Task coordination is critical

Most important is the ability of a minicomputer to coordinate its tasks. The OS in real-time systems, at a minimum, should allow a task to be loaded and started while another task is being executed.

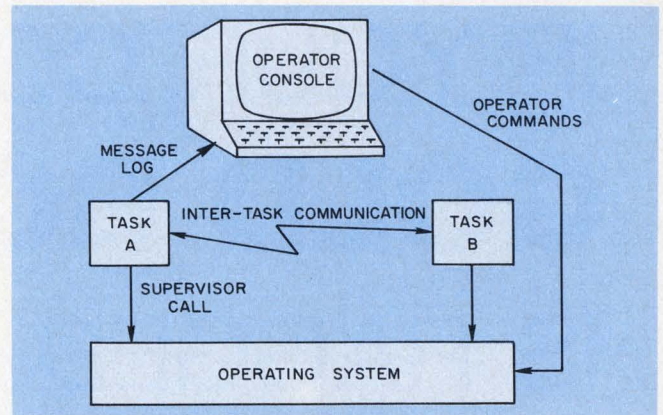

3. To operate successfully in real-time, individual tasks must communicate data with one another and possibly change the order of execution. Contact with the operating system to coordinate these activities is vital.

Other important coordinating capabilities for real-time systems include these:

- Transmission of messages between tasks.
- Interruption of tasks.
- Cancellation of a task or its removal from memory.

- Temporary suspension of a task.
- Connection of a device or file to a task.

Equally important for real-time and other applications is how well the tasks communicate with the OS (Fig. 3). Desirable features include:

- Transmission of messages to the console operator.

- Requests to the system for more memory or the release of memory.

- Decoding of commands and operands with OS routines.

- Acceptance of interrupts generated by external devices, other tasks, the system timer and the console operator. The task should be able to suspend its operation temporarily to deal with the event causing the interrupt and then resume where it left off. This action should not require that all system interrupts also be disabled.

A good set of guidelines for task-coordination functions is found in the Instrumentation Society of America (ISA) standards for real-time process control. Many vendor operating systems support some subset of these standards. Some systems, such as Interdata's OS/32-MT and DEC's RSX-11D, support the full set. These standards are actually extensions to the FORTRAN language rather than OS standards. However, implementation of the standards requires a lot of support from the OS.

The Purdue Workshop of ISA is a good source for information on file-manipulation techniques and OS standards.

If the OS choice is made wisely, the new superminicomputer system can provide greater power and flexibility than large-scale systems of the recent past. ■■

IF YOUR COPY OF THE
GOLD BOOK

IS RAGGED FROM USE
(and most of them are)

DON'T WORRY....

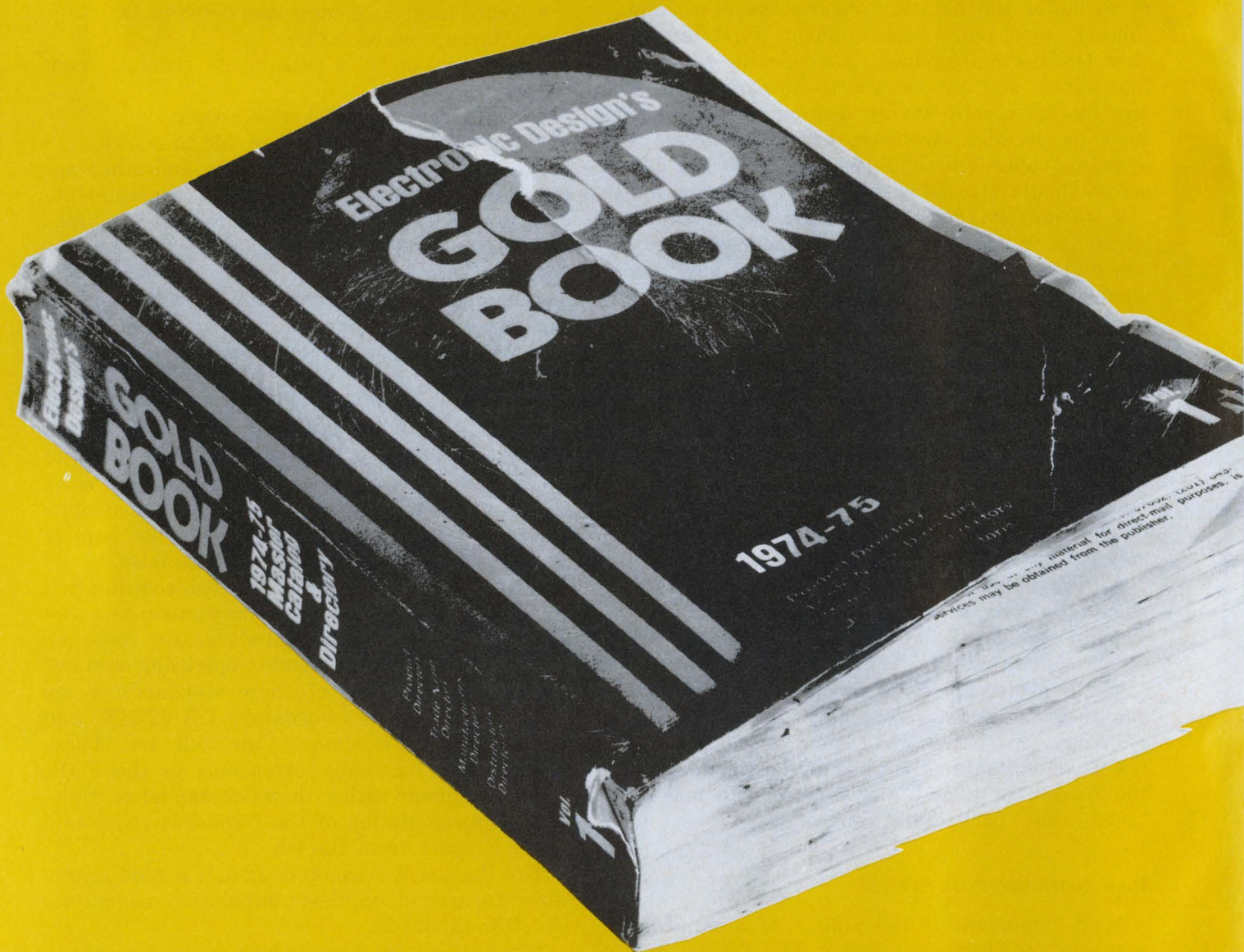

Electronic Design's **GOLD BOOK...**

**THERE'S AN
ALL NEW
1975-76
EDITION**

**COMING YOUR WAY SOON
WITH...**

***MORE* PRODUCT LISTINGS**

***MORE* CROSS REFERENCES**

***MORE* DETAILED COMPANY INFORMATION**

***MORE* SALES OUTLETS (REPS, SALES OFFICES
AND DISTRIBUTORS) LISTED FOR
MANUFACTURERS**

Engineers reach for the GOLD BOOK first because it contains by far the most complete, most detailed information for electronic product search that's ever been published anywhere in the world. And now there's an even better GOLD BOOK on the way. Companies have given us more data about themselves; provided more contact information. There are more product categories; more cross references; more trade names. So if your GOLD BOOK is falling apart from constant use . . . cheer up. It won't be long before the 1975-76 edition arrives. The GOLD BOOK is FREE to *Electronic Design's* qualified subscribers. Others may order copies at \$30 per set (domestic) or \$40 (elsewhere).

"THE ONE THAT'S USED FIRST"

How fast does your CRT write? You can get the photographic speed from the spec sheet, but the odds are the number will be fuzzy. Here's how to find out yourself.

When it comes to pinning down the photographic writing speed (PWS) of an oscilloscope, you might be better off measuring it yourself. Because there's no industry standard for PWS and because the measurement is influenced by many factors, the values on many spec sheets are fuzzy.

Thus scope manufacturers specify PWS as "minimum," "typical," "approximately," "estimated" and "up to." All these qualifiers are vague and are sure to make you unhappy when your scope and camera fall short in the numbers game. The "typical" number usually runs 1.5 to 2 times the "minimum"; consequently it will look good. The "up to" number represents the best to expect—but don't count on it.

Why is there no industry standard for PWS? Because the subjective nature of the results, plus unavoidable wide variations in film properties, can easily result in a 2-to-1 spread in the measurement. To measure the number under your own expected working conditions, start by defining PWS.

The importance of writing speed

Photographic writing speed is a figure of merit that roughly describes a scope/camera system's ability to photograph fast-moving traces. The figure expresses the maximum spot speed—usually in centimeters per microsecond or nano-second—that can be photographed satisfactorily. "Satisfactorily" means the trace shape and amplitude are discernible on the photo.

As the trace moves faster, the electron beam strikes each point on the phosphor coating for a shorter time and the trace becomes dimmer. Camera systems and scopes with a high PWS are therefore required to record signals with low repetition rates or to capture a fast single sweep.

Of course, what is clearly discernible to one person may not be to another. Trained observers using standardized techniques—and identical photographs—can interpret writing speeds for

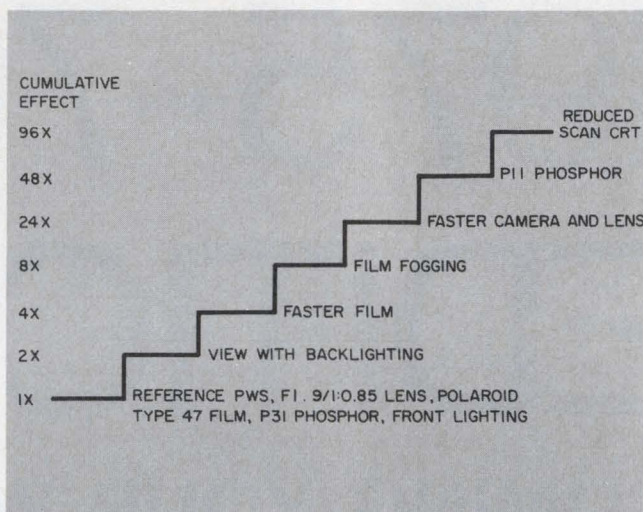

1. Speed can be increased up to about 100 times (cumulative) with various steps. Easiest methods include backlighting, film fogging and faster film.

the same scope/camera system with a variation of $\pm 30\%$.

Consider the many variables that affect the writing speed of a scope. They include the speed and magnification of the camera lens, the CRT phosphor, the film, the CRT beam current and spot size, the camera's optical arrangement and the development time of the film.

Information writing speed is yet another measure of a scope/camera system's ability to record a fast trace. It is a measure of the maximum number of spots of information per unit time that can be recorded and identified on a single trace. Thus the number is useful only for signals of small vertical amplitude and does not express PWS as it is typically found in instrument specs.

How much can you improve writing speed with practical techniques? The cumulative range of approximate improvement is shown in Fig. 1. Remember that less PWS is required as the amplitude of the signal is reduced. If an eightfold improvement or less is all you need, consider the easier methods first: backlighting, faster film and film fogging. For greater increases, a faster camera or even another CRT may be necessary.

Some traces of high frequency or fast rise times cannot be read with front illumination.

Murlan Kaufman, Manager, High-Frequency Lab Scopes, Tektronix, Inc., P.O. Box 500, Beaverton, OR 97005.

They need backlighted Polaroid film (Fig. 2). But Type 107 flatpack can't be backlighted.

The most widely used films for PWS measurements are Polaroid Types 47 and 410. Tektronix uses Type 47 as a standard for PWS.

You should be aware that the ASA speed system was developed for pictorial photography and should be considered only as a relative indicator of film speed for fast CRT recording. Film will vary from batch to batch and from roll to roll, so that PWS measurements with 410 (10,000 ASA) can vary as much as 50%. Type 47 or 107 (3000

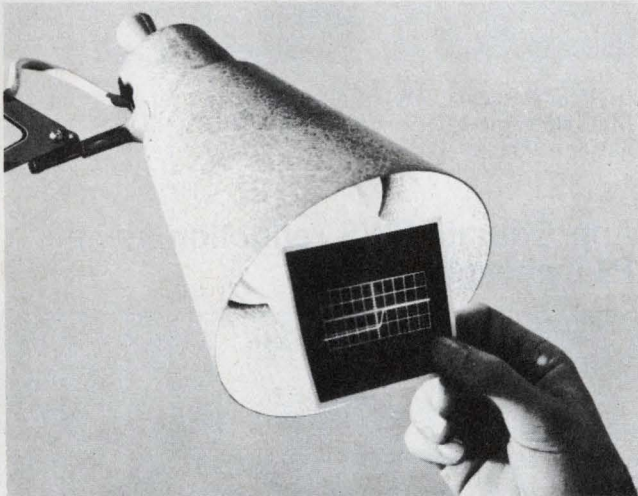

2. In backlighting, the developed film is illuminated from the rear and read by transmitted light, rather than reflected. Some film types can't be backlighted, however.

ASA) is more consistent, has better contrast and is less sensitive to environmental variations. However, 410 is approximately twice as fast as either 47 or 107 (Fig. 3).

You may use up several rolls of film before you get a satisfactory PWS measurement. And you might have to use film from different batches. Even the method of film storage is important. For example, opened film is subject to degradation from humidity.

A few seconds of exposure permits the film to gather the most light from the CRT for a single-shot trace. This is because of long-term, low-level light emitted by even high-speed phosphors, such as P11. For consistency, use a standard 5-s exposure and a 20-s development time for 107, 47 and 410 film.

When the scope/camera system works at the extremes of its energy-transfer capability, another useful way to provide more writing speed is through film fogging. This involves a slight additional exposure of the film on top of that of the actual measurement. This sensitizing process can be done before, during or after the trace exposure, and it can double writing speed.

Film can be fogged in a number of ways: (1) The camera can have a built-in fogger that

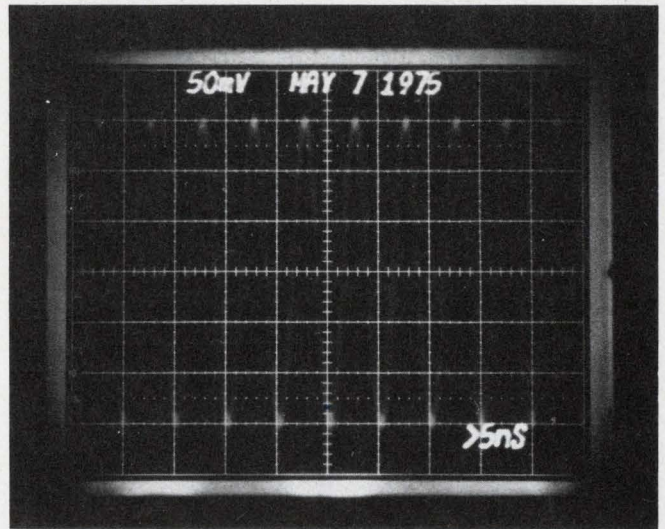

(a)

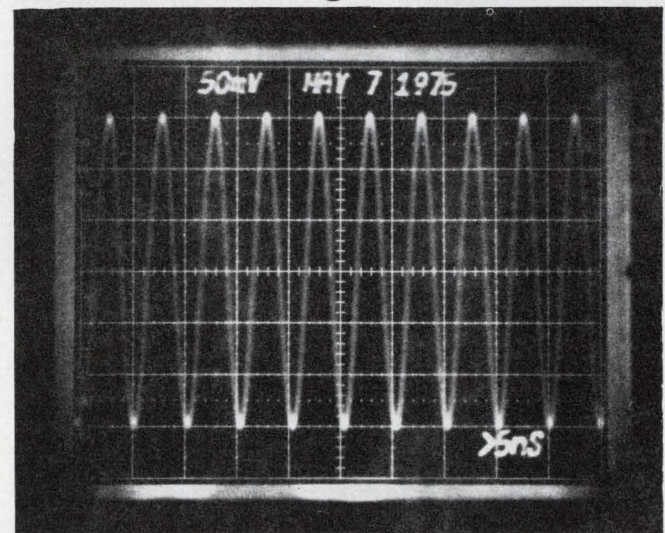

(b)

3. Film speed makes the difference in the production of clear photographs. With 3000 ASA film, a trace is just discernible (a). The same trace appears boldly when photographed with film of 10,000 ASA rating (b).

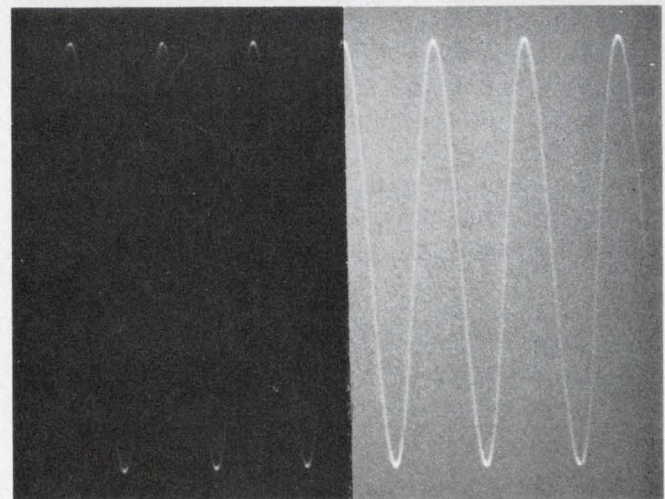

4. Two shots made under identical conditions show the effects of film fogging, that is, pre-exposure of the film. The left trace is hardly legible but appears clear and sharp after the film is fogged (right).

uniformly exposes the film to a predetermined light level; (2) The scope can provide background illumination such as a pulsed raster scan; (3) The film can be X-rayed, and (4) The development time of the film can be varied.

In all of these procedures you must experiment to achieve an increase in writing speed (Fig. 4). A word of caution: Though fogging is an aid to gaining additional speed, it sometimes decreases the resolution. And the slightly fogged background gives somewhat less contrast.

And while a pulsed readout and graticule don't contribute to writing speed, they add significant information to the photograph, and they do it in a repeatable way for ease in single-shot photography. At the completion of a single-shot event, the readout and graticule can be pulsed on to a predetermined level. Some scopes can provide pulsed fogging at this time, also to a predetermined and repeatable level.

The lens plays a key role

Since mechanical play or movement can affect focusing, the camera and its mount must be sturdy. Shutter variations are not a problem since, for single-shot photos, the camera is set to the timed or bulb setting. But the most important part of the camera is the lens.

The light-gathering power of a lens is determined by its aperture, magnification ratio and light transmission. As the magnification ratio decreases, the light-gathering power increases. At present a top-quality lens has an f/stop of 1.2 and a magnification ratio of 1:0.5. Fast lenses are usually coated to respond to the peak light wavelength of P11 phosphor, around 450 nanometers (nm).

It is important to follow the manufacturer's recommendation to obtain the optimum focus, since less than optimum can reduce the PWS. Note that the image at the center of the screen will have a greater PWS than the edge, because of lens falloff of up to 50%.

Selection of the right phosphor can make the difference between a discernible photograph or none at all. Of the many types available, the most commonly used are P11 and P31; P11 has the highest comparative writing speed for photography, and P31 represents a compromise between writing speed and visual brightness and persistence. Fig. 5 shows the relative sensitivity of various phosphors for 410 film. Note that the film is about twice as sensitive to the 450-nm wavelength of P11 as it is to the 530-nm wavelength of P31. Although the film is more sensitive to P2, the effective PWS of P2 is one quarter that of P11.

You can boost the PWS by reducing the scan area of the CRT. This allows the CRT spot size

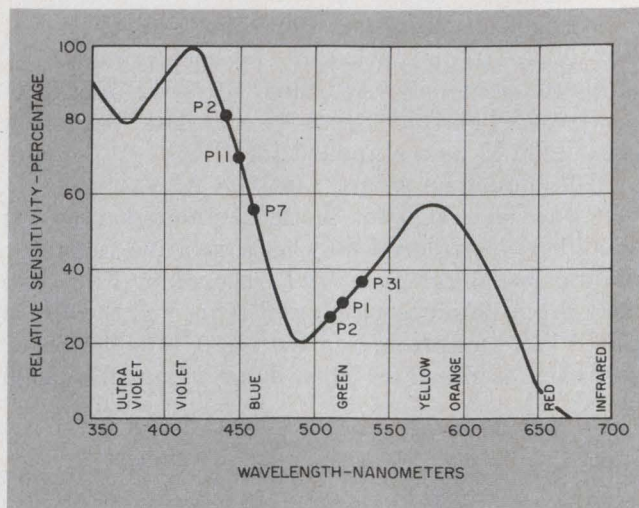

5. Relative sensitivity vs phosphor type for Polaroid 410 film. Note the difference in sensitivities for P11 at 450 nm and P31 at 530 nm.

Approximate PWS reduction using P11 phosphor

Light blue filter	15%
Neutral gray filter	60%
Metal-grid electromagnetic interference filter	72%
Clear plexiglass implosion shield	8%
Clear Lexan implosion shield	20%

to be reduced, which increases the spot density for a given beam current. Though smaller divisions are then used, the PWS is usually still given in cm/ns. If desired, the photograph may be enlarged with little loss in contrast. However, note that the PWS does not increase indefinitely as the scan area decreases.

Any filter or dirt between the CRT and camera lens will reduce the PWS. Static electricity attracts such a dirt film. Thus the CRT faceplate must be cleaned occasionally. The table shows typical losses for clean filters and for the implosion shield. Filters are most useful when repetitive signals are viewed in ambient light, and are normally removed for trace photography.

To yield a high writing speed, the CRT must be adjusted for the smallest and brightest spot. First, adjust the focus and astigmatism visually at full intensity with a low-repetition signal. With a scope having auto focus, you can use the scope's calibrator signal and a lower intensity setting to make these adjustments. Then increase the intensity to maximum for the single-shot exposure.

Tektronix uses a C51R camera, which accepts Polaroid 47 and 410 roll film. The lens is an f/1.2 with a 1:0.5 object-to-image ratio (magnification). The steps are as follows:

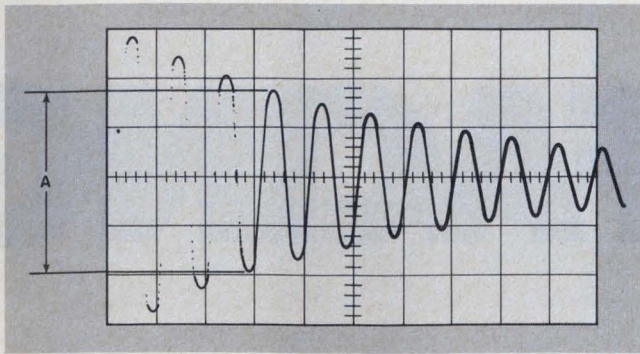

6. To avoid taking a series of exposures to find the writing speed, you can use a damped sinusoid and calculate the results from an equation.

- Remove any filters.
- Check camera focus with focus plate. A few experimental photos will give the best focus.
- Adjust focus astigmatism controls on the scope, using the X10 horizontal magnifier and with the intensity set for maximum.
- Allow five minutes for the phosphor to decay after you place the camera on the scope. This reduces the possibility of spurious fogging.
- Open the shutter, trigger the single-shot event. Fogging, if used, is triggered by the end of the single-shot sweep.
- Close the shutter after 5 s, remove the film and develop for exactly 20 s at 20 C or above.
- Read the photo and backlight if necessary. Repeat the process just described several times with sine waves of equal amplitude but increasing frequency. Use one cycle per division to make the horizontal-velocity component negligible. The frequency of the just discernible sine wave is then substituted into the following equation:

$$PWS = \pi Af (\text{sine wave}), \quad (1)$$

where PWS = photographic writing speed in cm/ μ s,

A = vertical peak-to-peak amplitude in cm,

f = frequency in MHz.

You can use a damped sine wave to measure the PWS without running a series of exposures. Eq. 1 is applied, where A is the peak-to-peak amplitude of the first discernible half wave (Fig. 6). Or use the equation

$$PWS = \frac{KA}{t_r} (\text{step}), \quad (2)$$

where PWS = photographic writing speed in cm/ μ s,

A = vertical amplitude, 0 to 100%, in cm,

t_r = rise time of signal, 10 to 90%, in μ s.

K = 0.8 for a linear ramp.

In this case, a step response is used to determine the writing speed. However, this method is the least reliable. ■■



IEE • ARGUS

64 CHARACTERS <.5" DEEP

Ideally suited for display of dynamic, randomly generated data, IEE-ARGUS' mere .47", ultra-slim profile requires but a fraction of the panel depth needed for conventional CRT's. Available in 64, 128 and 256-character configurations, its 5 x 7 dot matrix, .3" high characters provide the full spectrum of ASCII or EBCDIC alphanumeric and symbols in either soft green or neon orange for easy viewing. Built-in multiplex capabilities permit additional units for slaved operations at remote locations. Inherent in each unit are provisions for backspace, underline cursor to indicate the position of the next character to be displayed, and over-write capabilities for error correction and keyboard editing. Why not examine ARGUS' versatility, space economy and comparative low cost before investing in CRT's or other panel displays???

INFORMATION RETRIEVAL NUMBER 201

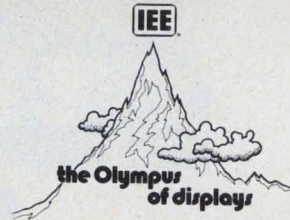

Industrial Electronic Engineers, Inc.

7740 Lemona Ave., Van Nuys, Calif. 91405
Phone: (213) 787-0311
TWX 910-495-1707

European Office: 6707 Schifferstadt, Eichendorff-Allee 19, Germany.



INFLATION FIGHTER

OEM's, fight today's rising costs with IEE•ELECTRA Subminiature Incandescent Lamps! Now available - AT NEW LOW PRICES - in sizes T-3/4 through T-1 3/4, including new 28 volt T-1, you may select from wire lead, screw base, bi-pin, midget & sub-midget flange, or midget groove terminations, according to your needs. Operating parameters range from 4 to 28 volts, and from .014 to .6 MSCP light output. All lamps feature seamless, tipless envelopes for clarity, and are handcrafted for precise filament location and superior performance. Controlled aging at rated voltages ensures filament stabilization and elimination of random failures. Prices start as low as \$0.12 each* for popular sizes. Non-standard & special lamps to your specifications available on order. CONTACT IEE TODAY FOR YOUR FREE COPY OF OUR NEW CATALOG AND BUYERS LAMP SELECTION HANDBOOK.

INTERFACING



Before.

Let's face it. Interfacing with CMOS used to be a hell of a job.

You had to have extra resistors, use external transistors, figure out more board space and find some place to inventory all those parts.

But now you can say goodbye to all that.

Now National has 14 heavenly interface devices that make everything easy as plucking a harp.

Here's a rundown:

TTL Buffers that translate +5 volt or higher CMOS levels to +5 volt TTL levels.
(74C 901, 902)

PMOS Buffers that translate PMOS or negative-going logic to CMOS or TTL levels.
(74C 903, 904)

Open Drain Buffers that translate low

WITH CMOS.



After.

level logic to higher levels with the use of pull up or pull down resistors. (74C 906, 907)

A Dual High Voltage Driver for interfacing with relays, solenoids, and other high current high voltage requirements. (74C 908, 918)

A Schmitt Trigger that translates inputs that exceed Vcc or are below ground and converts them to standard CMOS signals. (74C 914)

Driver Decoders that drive seven-segment displays directly. (74C 48 & CD4511)

Tri-State® Buffers for multiplexing and buss oriented systems. (80C 95, 97)

And Line Drivers for driving twisted pairs and single-ended lines. (88C 29, 30)

Available from your distributor. Or send for our brand new 250 page CMOS Handbook.

Hallelujah!

National

National Semiconductor Corp., 2900 Semiconductor Drive, Santa Clara, Calif. 95051; Scottsdale, Ariz. (602) 945-8473; Mountain View, Calif. (415) 961-4740; Sherman Oaks, Calif. (213) 783-8272; Tustin, Calif. (714) 832-8113; Miami, Fla. (305) 446-8309; Chicago, Ill. (312) 693-2660; Indianapolis, Ind. (317) 255-5822; Lenexa, Kan. (816) 358-8102; Glen Burnie, Md. (301) 760-5220; Burlington, Mass. (617) 273-1350; Farmington, Mich. (313) 477-0400; Minneapolis, Minn. (612) 888-4666; Englewood Cliffs, N.J. (201) 871-4410; Syracuse, N.Y. (315) 455-5858; Dayton, Ohio (513) 434-0097; Dallas, Tex. (214) 233-6801

INFORMATION RETRIEVAL NUMBER 35

Ze'ev Drori of Monolithic Memories Speaks On Coping With Engineers' Weaknesses

Before you can use engineers effectively, you have to hire them effectively. And that's not easy. First of all, you can't look for perfection. You can't find it. You must accept the fact that an engineer will have strong points and weak ones. So you have to supplement one person's weaknesses with another's strengths.

When I'm hiring, I look first at our whole organization. Then I interview as many guys as I can and try to get a picture of what's out there. If I find someone who can do the whole job, terrific. But that's not likely. Instead, I try to find the man or woman who's strong where we are weak. In fact, I may need several people to get the strength I need.

Now this is important. If you can't afford all these people, you should limit your objectives, and not try to do everything that suits your fancy. Any company, regardless of size, has a finite amount of energy in terms of manpower, physical resources, plant facilities—everything. A company that tries to do too many things will fail. It must develop the ability to focus its energy. You can't cheat by getting the all-purpose guy. He doesn't exist.

Once I get the man I need, I try to work on his weaknesses. Sometimes I fail. There are guys in

any company who just dig themselves into a hole. No matter how much we try to help them, it doesn't work. For example, there's one man who can design read-only memories. He's terrific at it. But he can't design any other circuit. Another can do the dc design beautifully, but he can't do the ac. He's terrible on ac. So what do you do? You get another guy who's fantastic at ac synthesis and analysis and put them together.

Getting the right people is just a beginning. You then have to treat them right. You have to tailor your approach to the man.

Engineering is a highly individualistic occupation and every individual in it is different. One individual may be too exuberant; you have to curb him a bit. Another is too timid and you have to boost him.

Remember that the design engineer works alone. He sits at his desk alone. If there's a design review at the end of his project, it's usually superficial. His boss isn't going to check every calculation he's made. When he works with somebody else, say, a mask designer, or processing engineer or project leader, it's on a one-to-one relationship. So the success of your project really depends on the individual engineer—and how he

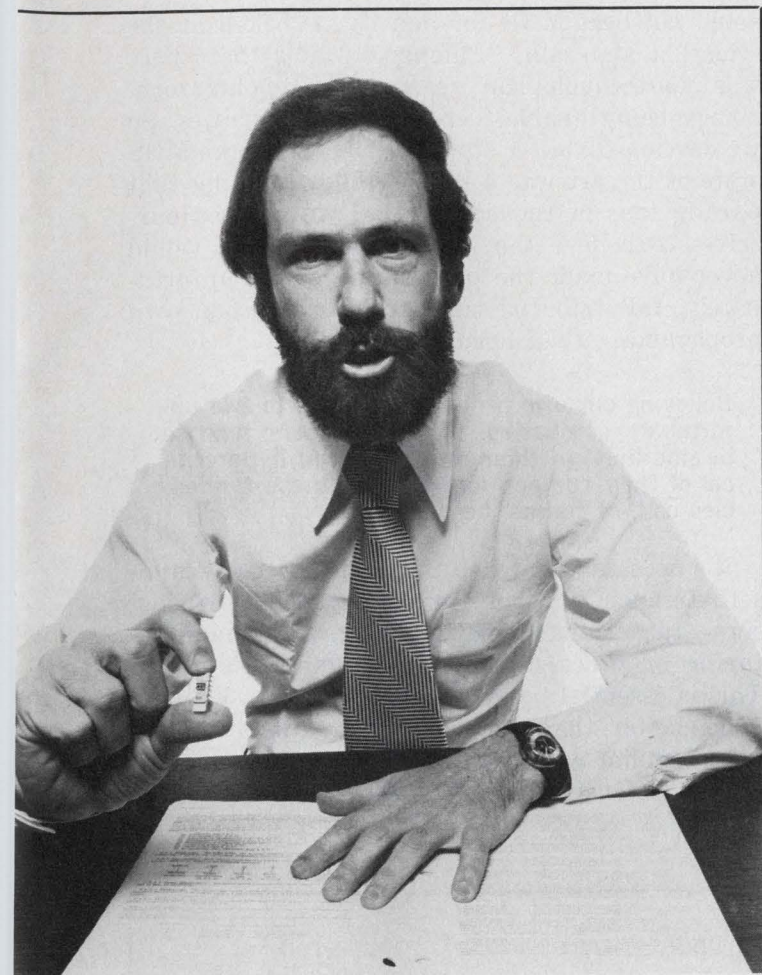

performs—not on a group.

It may look like a great idea to have two or three engineers working on a design because you'll get the best efforts of three minds rather than one. But in practice, I don't think this happens. In practice, the dominant engineer—the one with the strongest personality—wins out. Everybody designs what he's designing. So you're back to the individual. You must understand him.

That's not easy because engineering personalities are so extreme. You seldom find neutral, middle-of-the-road engineers. And because most engineers tend to be overoptimistic, you must subject them to a great deal of critical review.

One of the problems you run into is that engineers are quick to find fault with the work of others. If a product works, it's always the design engineer who's responsible for its success. If it doesn't work, it's someone else's fault. Manufacturing screwed up. Or the processing people don't know how to make the part.

If the engineer designs a chip with a yield of one per wafer, he might think it's a good design. "It works," he says. But maybe the part can't be manufactured because thresholds are marginal—a design problem.

If you have a fellow who tends to design in too

little margin, you should give him a well defined margin spec. But also try to learn why he skimmed on margin. He was probably chasing speed and he made the wrong tradeoff. The fellow is so obsessed with speed that he's designing the fastest part in the world, except for one problem. It doesn't work. So you tell this man to slow down a bit and improve the margin. The point is to learn the errors of each individual.

It's not easy to learn from design engineers because many are poor communicators.

Some engineers will plug away at a project and won't verbalize problems they're encountering. You tell them something and they won't challenge you. They come up with an idea to do something, or not to do something, and they can't express it clearly, so they just plug along with what they've been doing. They don't come out and say, "This won't work because . . ." They just sit in the lab and play with the thing rather than convey a strong feeling.

As a manager you must try to develop your engineers' ability to communicate. This is important because the engineer needs feedback during the design process. Regardless of his function, an engineer must interact with other engineers in, say, processing or manufacturing.

If you don't have the feedback, you run into trouble. The circuits guy, for example, might assume that his circuit is good because it's smaller, and if it's smaller, he'll get better yield from the wafer. So he ignores design rules set up by the processing people. You can dodge this kind of problem with improved communications.

The communication problem is very important because some engineers tend to run after the innovative and ignore the practical. So you must supply it for them. You have to define boundary conditions. This means that product conception, by and large, does not come from engineers. It comes from the outside world. It's a composite of the needs of many customers.

But this leads to another problem. Even when you find a need for a specific product, you may find that your engineers aren't ready to develop it. They may have become intimidated.

Take the PROM. We didn't invent the programmable read-only memory. Harris Semiconductor had one long before we did. But we thought the world needed a 1-k PROM with direct ROM compatibility and nobody had one. The standard at the time was a 1-k ROM in a 16-pin package.

I figured that if we could make a 16-pin PROM that was pin and performance compatible with the 16-pin ROM, we'd have the world on a string. I saw a market hole and I wanted to fill it. Intel was talking about an 18-pin PROM. But I felt

that "almost" pin compatible was not quite enough. "Almost" doesn't count. I decided that Harris *didn't* have it, Intel *almost* had it; if I could *really* get it, I'd be a winner.

So I threw the problem at one of my engineers and said, "Let's build a 16-pin compatible PROM." Several days later he said it couldn't be done. I knew it wasn't easy or the whole world would have done it. But I insisted that he show me why it couldn't be done. So he went through his analysis, point by point, and showed me. And as he was showing me why it couldn't be done, I saw exactly how to do it.

I guess he was intimidated by the fact that others had not designed a 16-pin, 1-k PROM. He probably reasoned that "if those brilliant engineers at our competitors don't know how to make it, how can I?" He dug a hole for himself and couldn't pull himself out because he was intimidated by a fine industry name.

Fortunately, when someone shows you exactly why something can't be done, it's often easy to find holes in his argument.

But look at another example of intimidation. Not long ago, it was axiomatic that bipolar ICs

could not beat MOS for density. I looked at the situation and said, "Baloney." I felt that there was no technological reason for bipolar technology being unable to match MOS densities. So we developed an 8-k bipolar ROM while the MOS state of the art was 4 k. We're now making that part in tens of thousands. Had we allowed ourselves to believe the industry axiom, we would never have made the part. Many of us, unfortunately, fall into the trap of believing our own propaganda. It's a herd instinct.

Believing our own propaganda leads to two unfortunate corollaries. Many engineers tend to be uncritical of their own work and hypercritical of their competition. Both of these tendencies can, of course, be disastrous.

It's necessary to teach the engineer to ask himself, frequently, what's wrong with his own design—rather than what's wrong with manufacturing or processing or the competitor's parts. This is essential because he can evaluate his own work better than somebody else can since he's most familiar with what he's done. And he doesn't feel so defensive against his own attacks as he

Who is Ze'ev Drori?

He started his engineering career lucky. Right after he took his BSEE from the Polytechnic Institute of Brooklyn in 1965, Ze'ev Drori took a position as junior engineer with IBM in Burlington, Vermont. His timing couldn't have been better. For IBM was just on the verge of making a major commitment to semiconductor memories and Drori was along from the start. His progress was dizzying and, within four years, he was Engineering Manager in Charge of Semiconductor Memories and Test Technology.

At this point, Drori, who has been described as a man unencumbered by modesty, decided that he ought to work for himself. He had great ideas, he says now, but he lacked about \$3 million. He realized that nobody would give him that kind of money since nobody knew him. And IBM, he points out, is not the place to get known. At IBM, he says, you don't deal with the outside world. He was in the Components Division, which sells to the Systems Division, which sells through IBM Marketing. This was terrific for IBM, but not for Drori, who felt he was in a closed society in Burlington.

So he decided to get exposure and, in 1969, there was no better place than Fairchild. Gene Blanchette was tantalized by the prospects for semi memories so he invited Drori to lead Fairchild's memories work. And there he gained the exposure he needed.

Some eight months later he left and, after a brief vacation in Hawaii, began to organize a memories operation for a major semiconductor operation. At the last minute, the company's attorney changed the conditions of the deal, so Drori decided to start all over again. "If you do it, do it right in the first place," says Drori.

By October 1970, despite the recession, he received the necessary financial backing and recruited his basic team. He deliberately avoided getting key people from the same company because he didn't want to proliferate any single company's hangups. He didn't want to duplicate the "Fairchild way" or the "National way" or the "TI way."

The company he formed, Monolithic Memories, has done very well. In its year ended September 1974, it had pretax income of more than \$3 million and total sales of more than \$20 million.

Drori attributes the company's success to its dedication to advanced-technology products that lend themselves to high-volume production.

Drori is now a 37-year-old bachelor. He had been married in Burlington where, he says, he couldn't stand the cold winters alone. So he followed the sun to California. Meanwhile, he spends his spare time skiing and playing tennis. He used to like flying, gliding and sky-jumping, but his hobbies are not permanent—a point to which several ladies will testify.

would against criticisms of others.

Criticizing the competition is an extension of failure to criticize yourself. You say that they can't deliver, or they can't make the part, or their part doesn't meet specs, etc. That's a copout and it's dangerous. It's easy to think that your competitor is out when he's merely down. Even if he can't deliver today, that doesn't mean he won't be able to deliver tomorrow.

And are you immune? Can you be certain that he'll never solve his problems? If you assume he's stupid, he may come up and hit you when you're least expecting it.

But if you give him credit—even more than he deserves—you'll be better prepared for what he may come up with. If you assume he can't make the product, and then he makes a better product than yours, you are in real trouble. So you must always give your engineers a healthy respect for their competitors.

You have to give your engineers respect for each other, too. This becomes particularly important when you elevate one of them to a management position. And here you must teach yourself that the manager you appoint is not necessarily going to be like you. You must realize that there isn't a single correct management style. A manager must adopt a management style that works with his own personality. He has to work within that framework. He has to learn, too, that he won't have 100% success in his decisions. He must simply hope that he'll be right more often than he's wrong and that his correct judgments will be more significant than the wrong ones.

You have to realize, too, that one manager can be extremely successful in dealing with an engineer under one set of circumstances. Under different circumstances, the same manager can be destructive with the very same engineer.

The most important thing you must teach your new managers is that they're not engineers any more. When a man switches from engineering to engineering management he must make the switch in fact—not just in title. Too many managers are so much in love with engineering that they can't let go, so they neglect their management duties.

Sometimes they're trying to retain the respect of their engineers by showing that they are still good engineers. That's a mistake. They must learn to command respect for the leadership they provide—not for their superior engineering. They have to demonstrate leadership without actually getting in to do the design.

They have to learn, too, that they mustn't look for love on the job; they mustn't try to please everybody. An engineer can hate your guts; but if you provide proper leadership he'll stick with you and you will both win the world. ■■

Need power supplies? Save!

FOR A LIMITED TIME*: A 10% DISCOUNT ON SMALL QUANTITY ORDERS of some of the most popular models for analog and digital applications... including the NEW PD Open Frame Dual Tracking Continuously Adjustable ± 12 to ± 15 Vdc @ 1A for only \$42.00 (1-9)

• **INPUT:** 105-125 Vac, 47-63 Hz • **REGULATION:** $\pm 0.05\%$ Line (105 to 125 Vac); $\pm 0.05\%$ LOAD (N.L. - F.L.) • **RIPPLE:** 2 mV p-p • **TRANSIENT RESPONSE:** Less than 50 μ sec for a 50% load change • **MAX. TRACKING ERROR:** 2% • **T.C.:** $\pm 0.015\%/^{\circ}\text{C}$ • **OPERATING TEMPERATURE:** 0 to 70 $^{\circ}\text{C}$ (derate load current linearly to 65% of F. L. above 50 $^{\circ}$) • **FEATURES:** Remote Load Sensing; Fold-Back Current Limiting Short Circuit Protection • **SIZE:** 4.25" W x 6.87" H x 2.0" D



Open Frame Modules

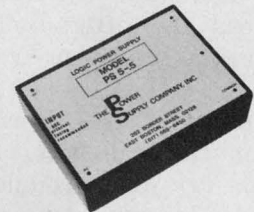

Encapsulated Modules

Our power supplies have been designed to be competitive and interchangeable with those of other manufacturers. All units are burned-in prior to shipment and carry a 2 year warranty.

OPEN FRAME MODELS

OUTPUT:	5Vdc @ 3A	6Vdc @ 2.5A	5Vdc @ 6A	6Vdc @ 5A	5Vdc @ 12A
DIMENSIONS:	4.0"W x 5.0"H x 1.88"D		4.88"W x 5.63"H x 2.50"D		4.88"W x 9.0"H x 2.75"D
PRICE (1-9):	\$27.00		\$45.00		\$79.00

• **INPUT:** 105-125 Vac, 47-63 Hz • **REGULATION:** $\pm 0.1\%$ Line ($\pm 10\%$); $\pm 0.1\%$ Load (N.L. - F.L.) • **RIPPLE:** 1 mV rms • **TRANSIENT RESPONSE:** Less than 50 μ sec for a 50% load change • **T.C.:** $\pm 0.02\%/^{\circ}\text{C}$ • **OPERATING TEMPERATURE:** 0 to 70 $^{\circ}\text{C}$ (derate load current linearly to 65% of F.L. above 40 $^{\circ}$) • **FEATURES:** Remote Load Sensing; Fold-Back Current Limiting Short Circuit Protection

ENCAPSULATED MODULES

SINGLE OUTPUT:	5Vdc @ 500mA	5Vdc @ 1A
REGULATION:	$\pm 0.05\%$ Line ($\pm 10\%$) and $\pm 0.05\%$ Load (N.L. - F.L.)	
DIMENSIONS:	2.5" x 3.5" x 0.875"H	2.5" x 3/5" x 1.25"H
PRICE (1-9):	\$48.00	\$59.00

DUAL OUTPUT:	± 12 Vdc @ 100mA	± 15 Vdc @ 50mA	± 15 Vdc @ 100mA	± 15 Vdc @ 200mA
REGULATION:	$\pm 0.01\%$ Line ($\pm 10\%$); $\pm 0.01\%$ Load (N.L. - F.L.)			
DIMENSIONS:	2.5" x 3/5" x 0.875"H			2.5 x 3.5 x 1.25"H
PRICE (1-9):	\$48.00	\$39.00	\$48.00	\$68.00

TRIPLE OUTPUT:	5Vdc @ 500 mA and ± 15 Vdc @ 100mA
REGULATION:	$\pm 0.05\%$ Line ($\pm 10\%$); $\pm 0.05\%$ Load (N.L. - F.L.)
DIMENSIONS:	2.5" x 3.5" x 1.25"H
PRICE (1-9):	\$79.00

• **INPUT:** 105-125 Vac, 50-400 Hz • **INPUT ISOLATION:** 500 megohms • **OUTPUT VOLTAGE TOLERANCE:** ± 100 mV • **RIPPLE:** 2mV p-p • **T.C.:** $\pm 0.01\%/^{\circ}\text{C}$ • **OPERATING TEMPERATURE:** -25 $^{\circ}\text{C}$ to +71 $^{\circ}\text{C}$ • **FEATURES:** Short Circuit Protection, Unique Thermal Design for Reliability

In addition to a broad range of standard supplies, we also make specials. Our engineers are intimate with the needs of customers in computer peripherals, process controls, instrumentation, etc.

P.S. don't forget...
we're

THE POWER
SUPPLY COMPANY, INC.

*AUGUST 31, 1975

262 BORDER ST., E. BOSTON, MASS. 02128 • 617-569-6450

Low-distortion modulator and carrier source made at low cost with single dual op amp

A simple test oscillator and amplitude modulator can be built with one IC for less than \$15. The modulator is linear and distortion-free, whereas the often-used clipping types distort either the peaks or valleys of the modulated envelope.

The circuit uses a programmable op amp in a nonconventional way. Modulating and carrier signals are direct-coupled and mixed in half of an HA-2735 programmable dual op amp without need for transformer coupling. The other half of the IC package operates as a Wien-bridge oscillator at the carrier frequency. Thus the circuit can be used as a compact test generator for troubleshooting AM systems with carrier frequencies to 2 MHz (Fig. 1).

The current flow out of pin 1 of A_1 and pin 13 of A_2 directly controls each op amp's cut-off frequency response. The oscillator circuit is statically programmed for maximum bandwidth. This allows the selection of a wide range of carrier frequencies. The change in cut-off frequency response of amplifier A_2 is directly translated into

a change in gain in the modulator circuit.

Amplifier A_1 operates as a Wien-bridge oscillator with a fixed, 147-k Ω resistor at pin 1. Amplitude control of the oscillator is achieved with 1N914 clamping diodes in the feedback network. If the output voltage tends to increase, the diodes offer more conductance, which lowers the gain. Resistor R_1 is adjusted to minimize distortion from nonlinear diode action. With the components in the diagram, the carrier frequency is approximately 700 kHz. This frequency can be changed by selection of different RC combinations in the Wien-bridge feedback circuit.

Amplifier A_2 's open-loop response is controlled by the modulating voltage applied to R_2 . The degree of modulation is directly proportional to the modulating voltage, but the output envelope is 180 degrees out of phase with the voltage. When sinusoidal modulation is applied to R_2 , the circuit gain varies from a maximum, A_H , to a minimum, A_L , as A_2 's frequency response to the carrier frequency, f_c , is modulated by the set current (Fig. 2).

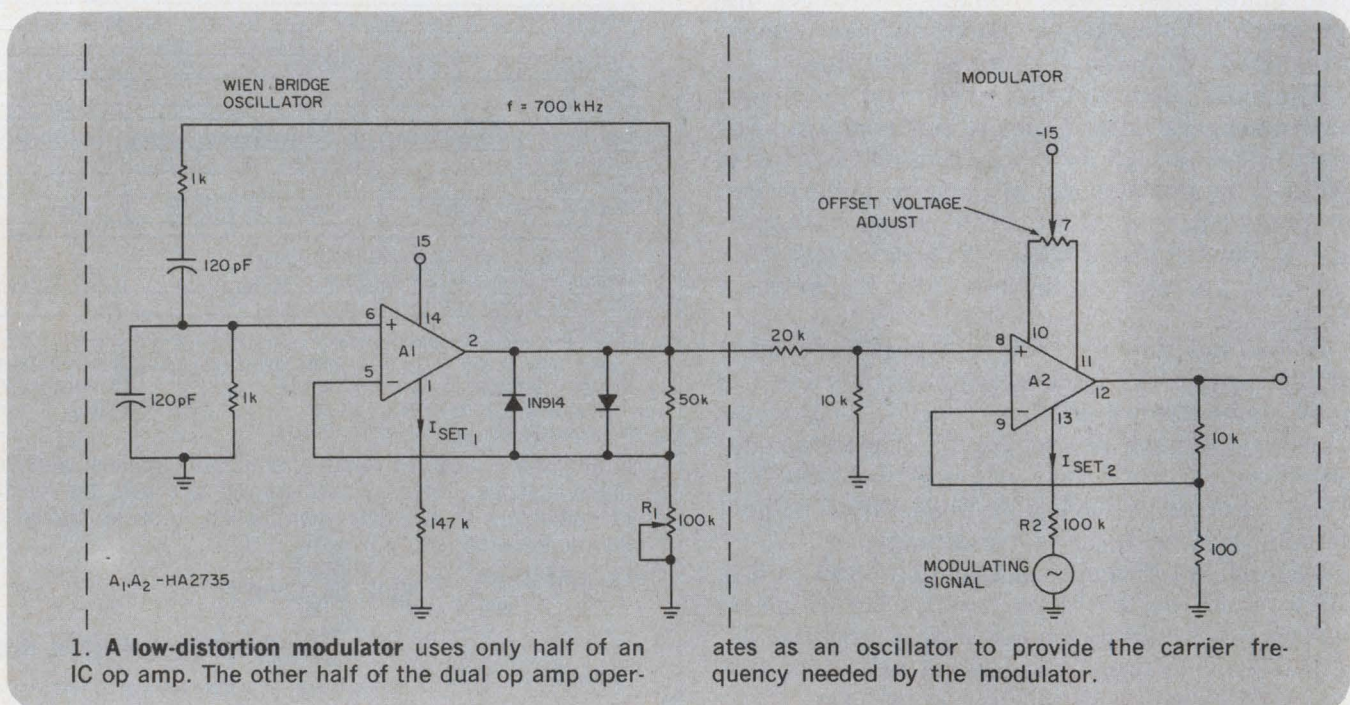

1. A low-distortion modulator uses only half of an IC op amp. The other half of the dual op amp oper-

ates as an oscillator to provide the carrier frequency needed by the modulator.

NEW BENCHTOP POWER ...FROM \$99



SEPARATE METERS FOR VOLTAGE AND CURRENT

These reliable, yet low-cost power supplies have the performance and features ideally suited for circuit development, component evaluation and other laboratory applications. Line and load regulation, $\pm 0.01\%$ or 2 mv. Ripple, 0.25 mv rms. All models have coarse and fine output voltage controls, and adjustable current limiting. Models K7S200 and K7S500 also have adjustable overvoltage protection. Dual and triple output models also available. Shipment from stock. Write for brochure.

OUTPUT VOLTAGE RANGE	OUTPUT CURRENT AMPS.	PRICE	MODEL
0-7	1.0	\$99	K7S100
0-7	2.0	135	K7S200
0-7	5.0	190	K7S500
0-18	0.6	99	K18S60
0-18	1.0	120	K18S100
0-32	0.35	99	K32S35
0-32	0.6	120	K32S60
0-50	0.35	120	K50S35



Corp., Easton, Pa. 18042. Telephone: (215) 258-5441.

INFORMATION RETRIEVAL NUMBER 37

IDEAS FOR DESIGN

The open-loop gain, A_H , must be less than the closed-loop gain to avoid clipping and distortion. It is necessary to close A_2 's loop to keep the amplifier from dc saturation. The quiescent gain, A_0 , can be adjusted with resistor, R_2 .

A 23-V peak-to-peak modulation signal yields 90% modulation; 10-V peak-to-peak yields 50%. For smaller signals, a positive offset voltage can

be added to the modulating signal to increase the degree of modulation.

Note, in the photographs, that output waveforms for 90% modulation are continuous, without crossover clipping, and the envelopes are essentially distortion-free.

Ernie Thibodeaux, Senior Applications Engineer, Harris Semiconductor, P.O. Box 883, Melbourne, FL 32901.
CIRCLE NO. 311

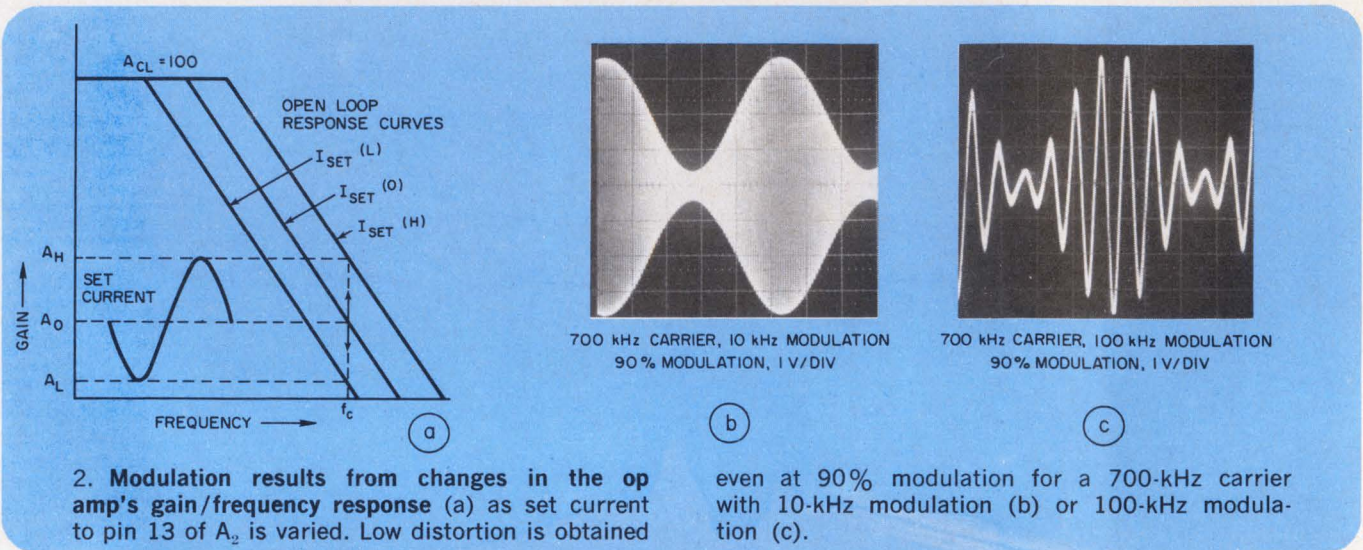

Digital circuit detects frequencies within adjustable difference band

A digital frequency comparator produces a logic-ONE output whenever two input pulse trains have frequencies that are within $1/T$ Hz of each other, regardless of their individual frequencies. Period T is determined by an adjustable one-shot. When the frequencies of digital inputs A and B differ by more than the reciprocal of the one-shot pulse width, a logic ZERO output results.

Flip-flop FF_1 mixes the two signals, and its output is a pulse train whose frequency is the difference of the two inputs. This pulse train triggers a 74123 retriggerable one-shot. As long as the output of FF_1 has a period that is smaller than the one-shot pulse width, the one-shot output remains high.

The output of FF_1 also clocks flip-flop FF_2 , which stores the logic level of the one-shot output before the one-shot triggers. Only when the two inputs are close in frequency—thus making the FF_1 output period longer than T —is the one-shot allowed to time out and a logic ONE clocked into the \bar{Q} output of FF_2 .

The one-shot circuit components shown set

$T = 1$ ms to detect frequency differences of less than 1 kHz. The one-shot period can be adjusted by the use of a variable resistor for R .

Ken Erickson, Senior Electronic Engineer, Dept. 4170, Interstate Electronics, 707 E. Vermont, Anaheim, CA 92805.
CIRCLE NO. 312

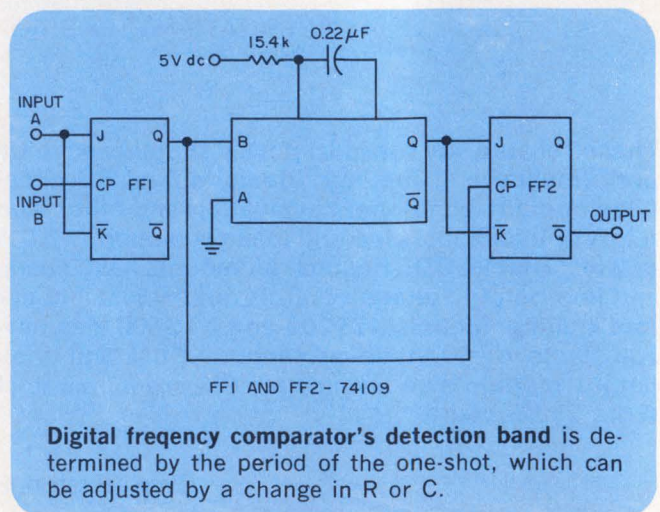

We've got it all together -quality, performance, price.

1220A:
\$750*

Bright 8 x 10 cm display for trouble-free viewing.

Internal graticule eliminates parallax error.

Small, crisp spot size shows sharp details of your signal.

Automatic switching from alternate to chop.

TV sync mode automatically locks on line or frame, depending on sweep speed selected.

2 mV/cm to 10 V/cm deflection factors allow both low level and general purpose measurements.

1222A:
\$895* gives you all the above plus:

Delay line shows leading edges and greatly simplifies digital timing measurements.

Auto/normal trigger selection for easy detection of signals with low repetition rates or fast, narrow pulses.

Sum and difference (A±B modes) give fast, accurate differential measurements for balance and symmetry checks.

X-Y operation through A and B channel amplifiers for simultaneous phase magnitude measurements.

One quick look tells you that these dual channel, 15 MHz scopes have just the features you need for making those difficult audio, video, and logic measurements. They give you big-scope capability—but at a budget price. For work in which it's important to see the leading edges of your signal, take a good look at our 1222A. At \$895*, it gives you all the benefits of its look-alike twin plus a delay line and more. For measurements that don't call for all the capability of the 1222A, the 1220A

at \$750* is a popular choice. And if you can do your job with a single-channel scope, HP can meet your needs with the 1221A; it's just \$695*.

Before you choose a scope, let us give you all the information you need for a price/performance comparison for your particular application. Just call your nearby HP field office. Or write for complete details. You'll be surprised at how much HP quality you can get in a low-cost scope.

*Domestic USA Price Only.



Sales and service from 172 offices in 65 countries
1501 Page Mill Road, Palo Alto, California 94304

FOR TECHNICAL INFORMATION 271

FOR IMMEDIATE APPLICATIONS ASSISTANCE 272

Constant period with variable duty cycle obtained from 555 timer with single control

By adding a few components to the astable configuration for the 555 timer, you can build a multivibrator with a constant timing period and a duty cycle that can be adjusted over an extremely wide range.

Separate paths must be provided for charging and discharging the timing capacitor (C in the figure). Transistors Q₁ and Q₂ are both turned on when the output of the 555 is high. At this time, C is being charged by the current through Q₁, resistor R_A and the portion of the potentiometer designated R_A'. When the voltage across C reaches the upper threshold level (2/3 V_{cc}) of the timer, the timer output switches low.

Capacitor C now begins discharging toward the lower threshold level (1/3 V_{cc}) through R_B', R_B, and the internal transistor of the 555. Upon reaching the lower threshold, the output switches high and the timing cycle starts again.

The time during which the output waveform is high is given by the formula

$$t_1 = 0.693 (R_A + R_{A'}) C,$$

and the output is low for

$$t_2 = 0.693 (R_{B'} + R_B) C.$$

The total period is then

$$T = 0.693 (R_A + R_{A'} + R_{B'} + R_B) C.$$

But since (R_A' + R_B') = R_P, then

$$T = (R_A + R_P + R_B) C.$$

The duty cycle can now be changed by variations in the potentiometer setting, but the total

period, T, remains constant. The duty cycle is determined by the equation

$$\text{duty cycle} = \frac{R_A + R_{A'}}{R_A + R_P + R_{B'}}.$$

The component values in the figure allow the duty cycle to be adjusted between 1 and 99%.

Robert W. Hilsher, Assistant Engineer, Dept. 487, Bendix Communications Div., E. Joppa Road, Baltimore MD 21204.

CIRCLE No. 313

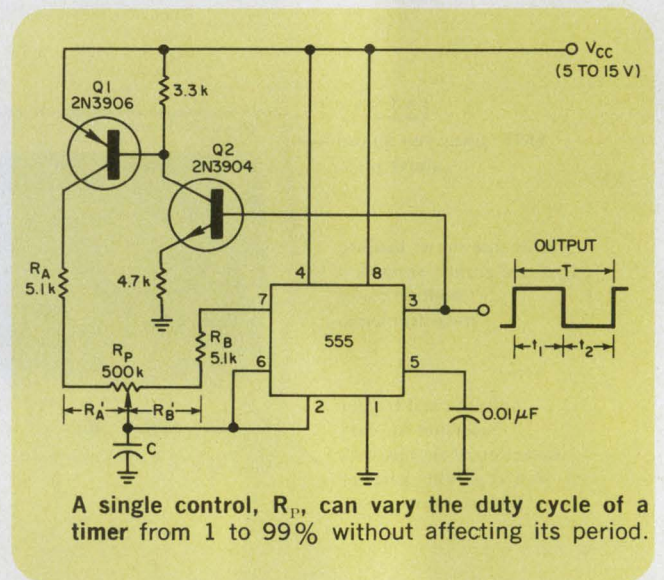

IFD Winner of March 1, 1975

Paul Berkowitz, Electronic Engineer, Vanguard Recording Society, 71 W. 23rd St., New York, NY 10010. His idea "Voltage-Controlled Music Oscillator Has Linear Control Properties" has been voted the Most Valuable of Issue Award.

Vote for the Best Idea in this issue by circling the number for your selection on the Information Retrieval Card at the back of this issue.

SEND US YOUR IDEAS FOR DESIGN. You may win a grand total of \$1050 (cash)! Here's how. Submit your IFD describing a new or important circuit or design technique, the clever use of a new component or test equipment, packaging tips, cost-saving ideas to our Ideas for Design editor. Ideas can only be considered for publication if they are submitted exclusively to ELECTRONIC DESIGN. You will receive \$20 for each published idea, \$30 more if it is voted best of issue by our readers. The best-of-issue winners become eligible for the Idea of the Year award of \$1000.

ELECTRONIC DESIGN cannot assume responsibility for circuits shown nor represent freedom from patent infringement.

MATSUSHITA'S ARROW-M INTRODUCES THE WORLD'S FINEST RELAYS.

Unique designs and superior manufacturing techniques produce relays of highest quality and reliability.

DL relays

Mercury film contacts feature non-position sensitivity, no bounce and chatter, low and stable contact resistance, and long life. Compact size and DIP terminals are ideal for high density pc board mounting.

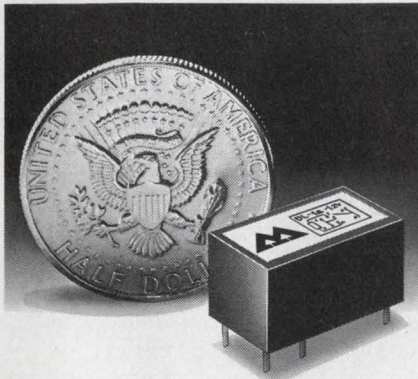

R relays

Sub-miniature form C reed relays are an innovation. No glass capsule is used. Bifurcated contacts, high speed and sensitivity, low operating power, both latching and non-latching functions, and a large capacity of 1 Amp/20WDC prove their reputation.

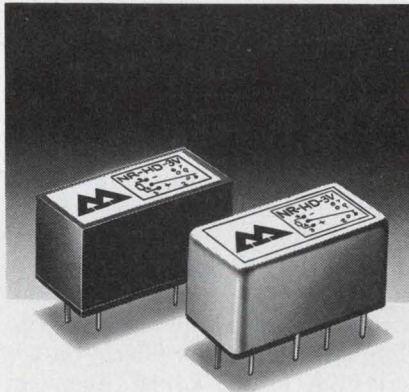

NF relays

Low profile relays of .402 inch height meet high density packaging design requirements. Unique molding technique, lift-off contact system, and twin contacts assure dependable application. Patented design absorbs chatter and bounce.

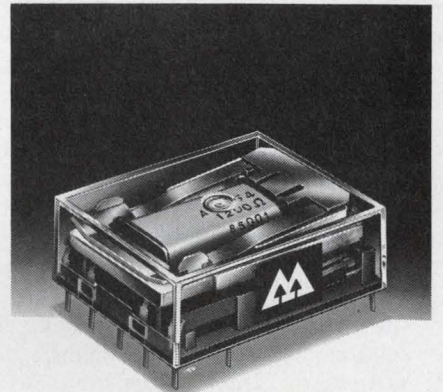

K relays

Miniature cradle relays assure highly reliable operation. Large magnetic force, lift-off contact mechanism plus screwless assembly and simultaneous molding techniques guarantee an excellent quality.

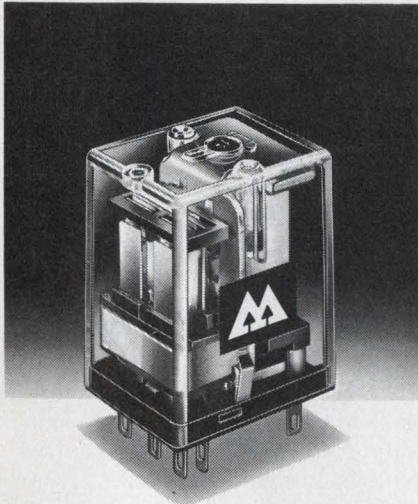

HC relays

Miniature power relays are available in form 1C(10A), 2C and 3C(7A) and 4C(5A), each at 240VAC. Arc barrier, contact debris well, gold-flashed AgCdO contacts, and one-piece molded contact blocks ensure long life and high reliability.

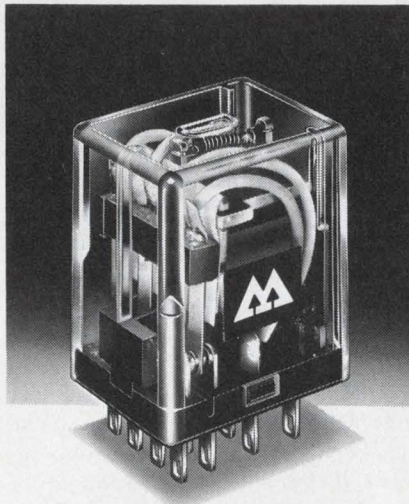

More information

Short-form catalog is available to provide you with specifications of Arrow-M relays. Call or write to Arrow-M or our nearest representative for catalogs and more information.

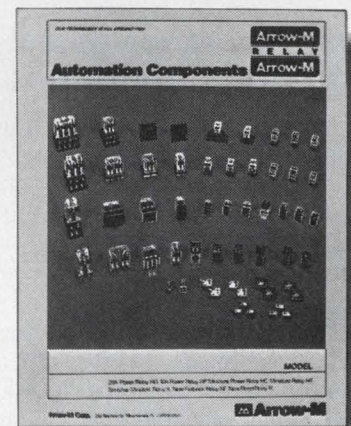

Arrow-M Corp. 250 Sheffield St.,
Mountainside, N.J. 07092
201-232-4260

Relays for advanced technology



Arrow-M

INFORMATION RETRIEVAL NUMBER 39

Liquid-crystal camera used in IR studies

A liquid-crystal camera that responds to infrared and hyperfrequency radiation has been developed by the Commissariat à l'Énergie Atomique in Fontenay-aux-Roses, France. The camera can be used for imagery as well as to estimate the power of incident rays.

The sensitive camera element is a 5×5 -cm screen mounted on a sheet of plastic, 3.5μ thick. A semitransparent metal deposit is sufficiently thick to ensure 50% ray absorption. A $20\text{-}\mu\text{m}$ coat of liquid cholesteric crystals is applied to the plastic sheet.

For visual observation, this coat

is continuously illuminated with white light or, for photography, with an electronic flash. The wavelength of the visible diffracted light depends on the coating temperature. The energy distribution of the incident beam thus appears in the form of a colored image.

The liquid-crystal screen is housed in a vacuum compartment, with the temperature regulated to eliminate convection effects on the screen. A heater adjusts the temperature—and hence the color of the screen—to obtain the best contrast. The heater also serves to calibrate the equipment.

action between two opposing acoustic waves, one longitudinal and one transverse. The correlation signal is carried by a propagating acoustic wave.

In the experimental setup, a 12-mm-long crystal of lead molybdate was used. A pulsed longitudinal wave at 230 MHz and a pulsed transverse wave at 53 MHz were launched from opposite ends of the crystal. Equal numbers of acoustic cycles were contained in the primary pulses. A transverse-wave transducer detected a triangular correlation signal at the difference frequency. All transducers used were of lithium niobate.

Rainfall data stored for display on color TV

Digital rainfall data transmitted by radar signals are stored in a new memory system and converted into a color code for display on a color television set. The system was designed by Jasmin Electronics Ltd. of Leicester, England, as part of an automated weather radar network for the British Meteorological Office.

Data can be logged or further processed by computer and are continually updated every 15 minutes. An ordinary tape recorder can be used as a backup store, and the recorded data can be displayed at any time.

The system can store up to nine small area pictures or one composite picture covering the entire country. Precipitation data, from light rain to thunderstorm with hail, can be held for two hours. Fifteen minutes is the normal interval between successive pictures.

The user can immediately view rainfall distribution in his selected area at any one of nine different selected times. Alternatively, the user can play back the nine pictures in sequence to give a picture of the weather developing both in and outside his area.

Photoconductor detects fast optical waveforms

A fast-response bulk photoconductor that can be used either to detect high-speed optical waveforms or as an optically gated switch has been developed at the Centre National d'Études des Télécommunications in France.

Chromium-doped gallium arsenide is the basic photoconductor material. This compound has low dark conductivity and a sufficiently short light-excited conductive lifetime to respond to fast-changing incident light.

To take advantage of the fast response, the detector is strip-line mounted with two ohmic contacts about 0.4 mm apart. Within the time resolution of the measuring equipment, no significant reflections occurred to interfere with the detection of fast pulses from a dye laser. The laser operated at $0.6 \mu\text{m}$ and had a pulse duration of 32 ps. The photoconductor im-

pulse response was about 85 ps, and the equivalent step response to an optical step input was estimated at 92 ps.

Coupling short optical pulses to this fast photoconductor provides an electrical switch with complete isolation of the gating signal.

Acoustic-wave device is nonpiezoelectric

A standing acoustic-wave device that uses nonpiezoelectric material has been developed at the Laboratoire d'Optoacoustoelectronique of the Centre Universitaire de Valenciennes in France.

A prime advantage that it has over piezoelectric acoustic-wave devices is that saturation does not occur, even over a wide dynamic range. And high efficiency is maintained over a wide range of input powers.

In the Centre Universitaire device, a correlation signal is generated by the nonlinear elastic inter-

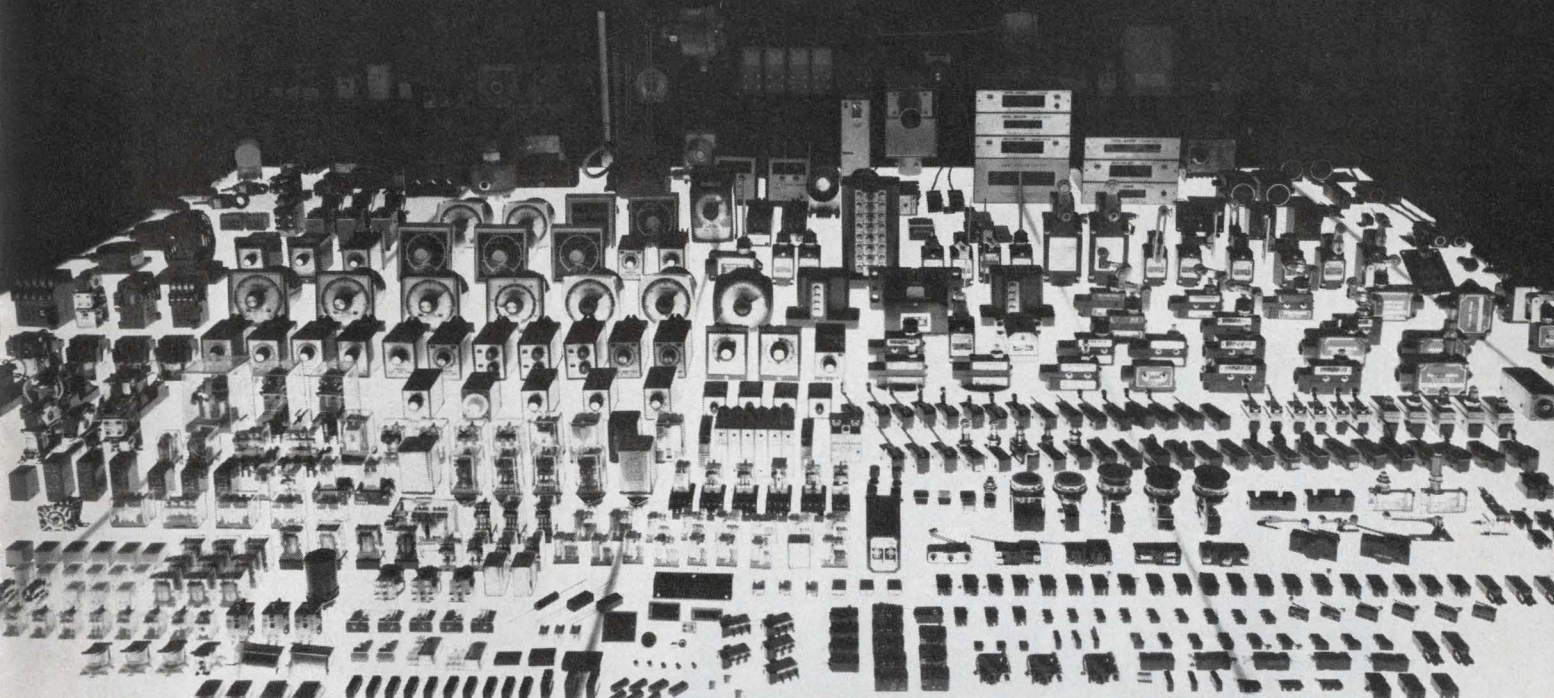

**Choose the one company
that makes all this...**

**and win
this calculator.**

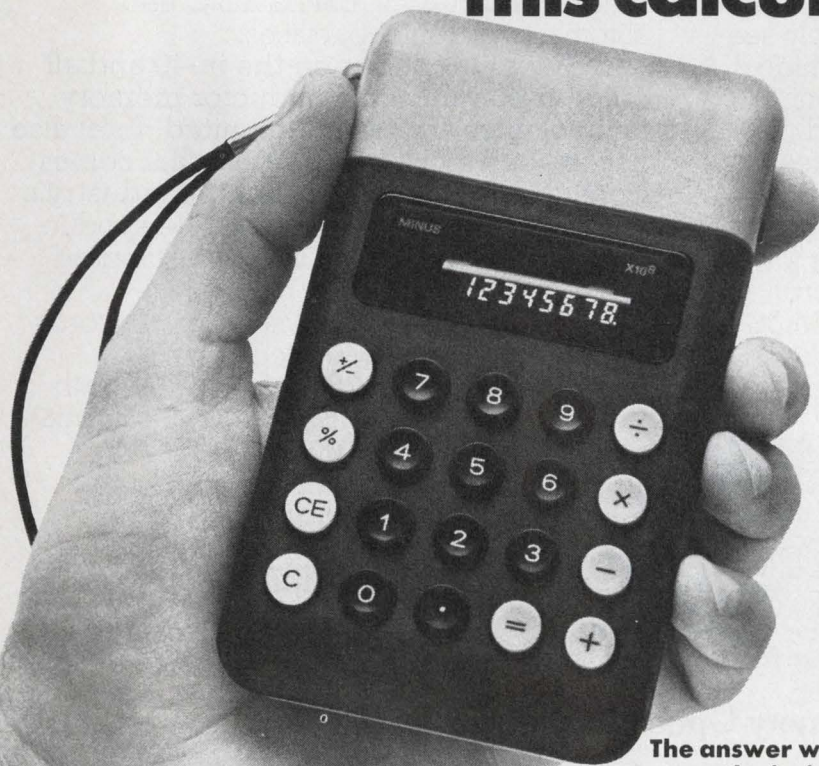

**The answer will
appear on the inside
cover of the August 7, 1975,
Electronics magazine.**

If you can guess* the name, and are among the first 500 to do so, we will send you a four-function calculator (retail value \$19.95) free. Hint: The company that made all the products in the photo also made the calculator.

Name the company in the coupon below that has this enormous breadth of line. If the coupon has been torn out, send your entry in any form to: Breadth of Line Contest, P.O. Box 4160, Merchandise Mart, Chicago, IL 60654. Calculators will be mailed to the winners—the first 500 correct entries, based on postmark—on August 1, 1975.

Breadth of Line Contest
P.O. Box 4160, Merchandise Mart,
Chicago, IL 60654

The company with this enormous breadth
of line is: _____

Name _____

Title _____

Company _____

Address _____

City _____ State _____ Zip _____

*Limit, one guess per entrant.

Void where prohibited by law or where taxed.

Employees of this company, of their advertising agency,
and of their sales representative organization are not eligible.

Now, 4 times the memory on the same size card.

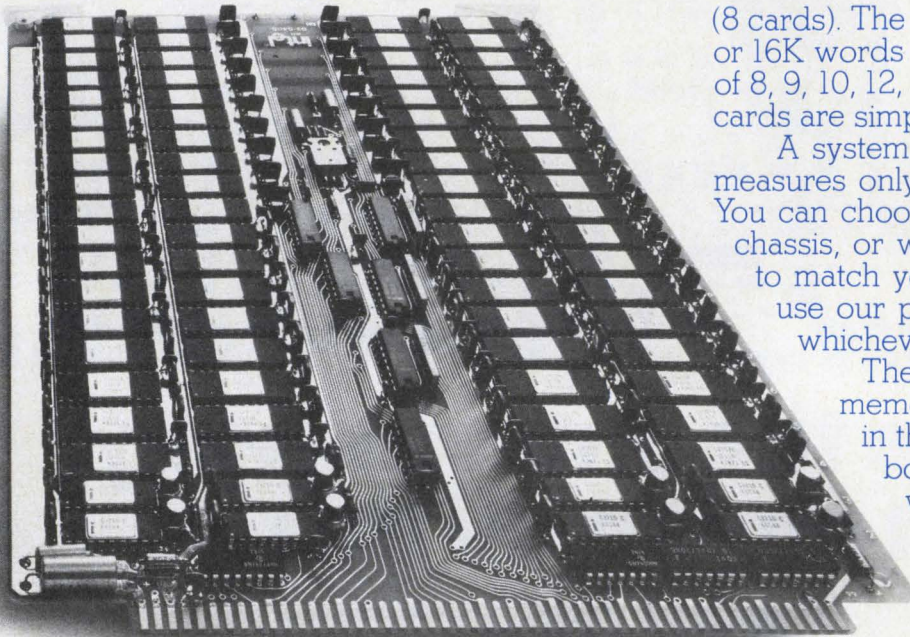

The most compact and most expandable low-cost memory system you'll probably see for years to come is Intel's in-40 dynamic RAM system. It's a true new generation design, available right now in standard models from 16K words to 256 kilobytes or in custom configurations with quick delivery.

Besides highest density, the in-40 assures you higher performance than previous low-cost systems, whether solid-state or core. Built with Intel's newest 4K n-channel MOS RAMs, the in-40 provides an access time of 350 ns, cycle time of 550 ns, low power dissipation and TTL compatibility with very solid margins. **One single in-40 memory board stores 16,384 18-bit words or 32,768 9-bit words.** One single control unit board runs any system up to 128 kilowords or 256 kilobytes

(8 cards). The standard options are 4K, 8K or 16K words per board and word lengths of 8, 9, 10, 12, 16 or 18 bits. For longer words, cards are simply combined.

A system expanded to 256 kilobytes measures only 8.175 x 10.5 x 5.0 inches. You can choose one of our standard card chassis, or we can make a custom chassis to match your requirements. You can use our power supplies or yours, whichever you prefer.

There probably never was a memory system as easy to expand in the field or in your factory. The boards are also interchangeable with our in-10 1103 systems — 10,000 of which have already been shipped. Just allow 0.5 inch for each board. The universal control unit provides byte control, module select, address register, optional data register and control and data I/O and automatic refresh capabilities.

But your options on the in-40 and all other important semiconductor memory technologies are really unlimited. Intel also has the customizing expertise that comes from doing work for most of the industry's leading OEM's. And our billion-bit production plant gives quick delivery on standard or custom designs.

Call us if you want to store more words on fewer cards at lower cost.

Intel Memory Systems, 1302 North Mathilda, Sunnyvale, California 94086 (408) 734-8102

Regional offices:
Boston (617) 861-1136;
Philadelphia (215) 542-9444;
Dayton (513) 836-2808;
Dallas (214) 661-8829;
Los Angeles (714) 835-9642.

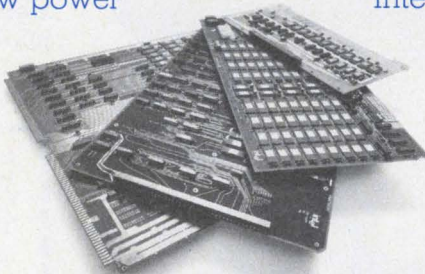

Memory Options Unlimited

intel memory systems

A DIVISION OF INTEL CORPORATION

INFORMATION RETRIEVAL NUMBER 41

Hand-held IR thermometer has digital and analog displays

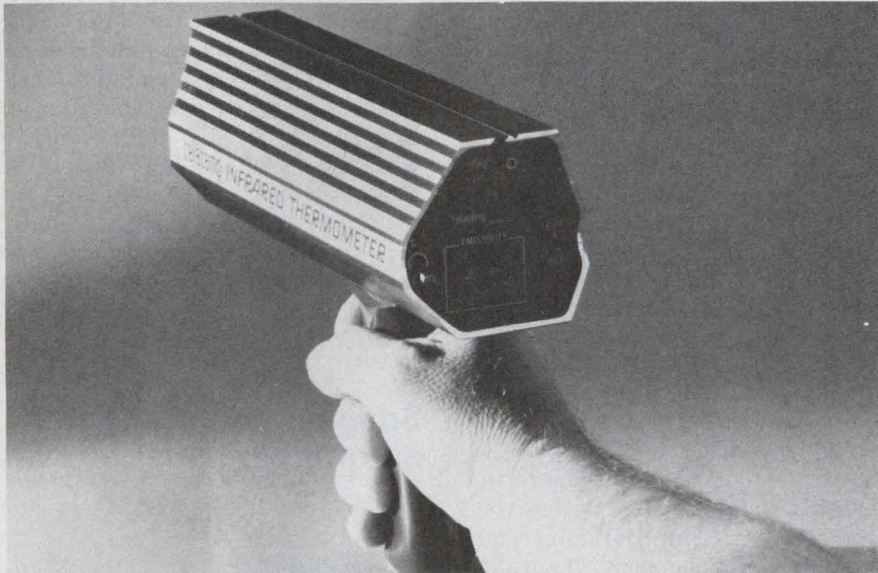

Telatemp Corp., 213 N. Pomona Ave., Box 5160, Fullerton, CA 92635. (714) 879-2901. \$1495; 30 days.

Telatemp's Darringer infrared thermometer is the first to offer both a digital readout and analog indication of temperature. The unit's three-digit display, with 1/3-in. LEDs, provides temperature readings to an accuracy of better than $\pm 0.5\%$. Analog indication is given by a "hot spot" indicator, which brightens proportionally to target temperature and responds within 0.05 s.

Temperature units and ranges are switch-selectable, giving the user a choice of readouts: 0 to 1000 F or 0 to 600 C. An optional peak hold feature retains the hottest measured temperature on the display until the hold switch is released.

A chopper-stabilized preamp eliminates zero drift, making pre-measurement calibration adjustments unnecessary. Thus the unit has no zero adjust control, while competing units require zero ad-

justment before each measurement.

The closest competing unit is the Heat-Spy from W. Wahl Corp. (12908 Panama St., Los Angeles, CA 90066). It sells for the same price as Darringer and is the only other hand-held digital-readout IR thermometer on the market.

Analog readout units are available at less than half the price of the Darringer. But these are accurate only to about $\pm 2\%$ full scale, and they have slower response times and more limited temperature ranges.

Wahl's Heat-Spy comes in a 0-to-600-F model and a 0-to-500-C model. It doesn't have an analog indicator, though there is an output jack for a strip-chart recorder. Its accuracy is the same as that of Telatemp's Darringer.

The Darringer is powered by four 1.25-V Ni-Cd rechargeable batteries. Provision is also made for ac line operation, and the unit may be operated while being charged.

The on-off switch is built into the handle to allow "pistol-grip" operation. In addition a two-digit

thumbwheel switch adjusts, with 1% accuracy, for the emissivity of the material being scanned. Other units allow potentiometer emissivity adjustments that are accurate to no better than 2 to 10%.

The focal distance, D, of the thermometer is factory-adjustable from 8 in. to infinity. Spot size is then less than D/20 at the instrument's focal plane. For example, at 3 ft the spot size is 1.8 in.

The unit operates over a temperature range of 35 to 120 F. It features electro-optical bore sighting and, at 1-3/4 lb, is the lightest on the market.

For Telatemp

CIRCLE NO. 302

For W. Wahl

CIRCLE NO. 303

50- Ω source sweeps, costs just \$350

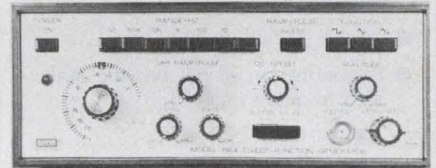

Dana Exact Electronics, 455 S.E. 2nd Ave., Hillsboro, OR 97123. (503) 648-6661. \$350; stock.

Model 196A sweep/function generator offers sine, triangle, square, pulse and sweep waveforms over a frequency range of 0.1 Hz to 1 MHz. Signal amplitudes of 20-V pk-pk open circuit or 10 V pk-pk into a 50- Ω load are available from a 50- Ω output. 70 dB of attenuation is provided in 20-dB fixed steps and 30-dB variable. The unit has an internal sweep generator to sweep the frequency of the main generator with a variable sweep width up to three decades (1000:1). The sweep rate is adjustable from 1 ms to 10 s.

CIRCLE NO. 305

Grayhill coded output switch modules stack up!

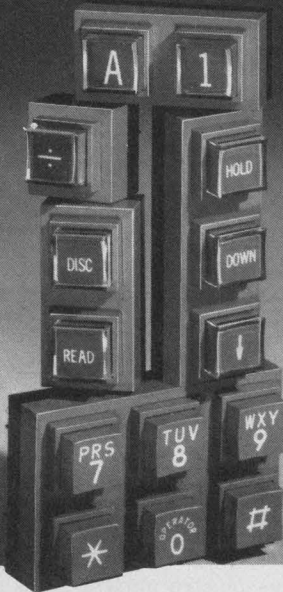

**new performance
standards...
1,500,000 cycles
with less than
10 milliseconds bounce**

- Self-generated logic...7 wire coding capability
- Can be stacked in any array
- Telephone array will provide standard frequency selection

This "second generation" of low-profile Grayhill pc mountable push-button switch modules passes exacting test for life and for bounce. Choose 6-, 3-, 2- and 1-button horizontal or vertical modules, to array in any format, including telephone key set, while maintaining constant center-to-center spacing! Circuitry available as SPST through 4 PST, normally open, or the poles can be internally shorted so several terminals connect when button is actuated. Choice of colors, with hot stamped or molded-in legends. For more information on these Series 82 modules, consult EEM or ask Grayhill for engineering data.



561 Hillgrove Avenue • LaGrange, Illinois 60525
(312) 354-1040

INSTRUMENTATION

Portable unit tests in-system 8008 chips

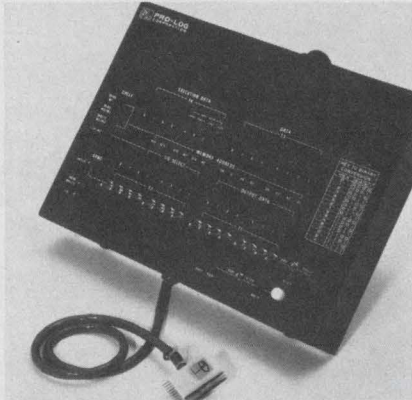

Pro-Log, 852 Airport Rd., Monterey, CA 93940. (408) 372-4593. \$550; stock.

A new portable analyzer for testing 8008 microprocessor chips, called the M-821, can be used with any system that uses the chip. The tester displays cycle data, chip status, and time-state data and allows a user to test systems in either a static, single-step or a dynamic-run mode. The M-821 interfaces to the system under test through an 18-pin DIP connector that clips onto the 8008. The tester operates from 115 V ac and automatically references the most positive supply voltage on the 8008. Weight of the analyzer is 4.5 lb.

CIRCLE NO. 306

Logic probe handles all logic families



Kurz-Kasch, Inc., P.O. Box 1246, Dayton, OH 45401. (513) 296-0330. \$237.

Multifamily PLP-550 logic probe is a programmable, all-solid-state, hand-sized probe that uses three lighted displays to indicate logic levels. The unit is compatible, through present logic thresholds, with all logic families. For a logic "1" threshold the red lamp will display. For a "0," the white lamp displays. For the deadband between these levels, there will be no display. A pulse capture feature displays pulses as fast as 10 ns.

CIRCLE NO. 307

1-MHz function gen sells for just \$89.95



Advanced Electronics, P.O. Box 63, Newton, MA 02161. (617) 969-5331. \$89.95; stock.

Model 10 function generator delivers three outputs: one TTL-compatible square wave, one triangle wave of 4 V pk-pk, and the third provides a switch-selectable square, sine or triangular-wave output with a 0 to 20 V pk-pk capability. The frequency range covers 1 Hz to 1 MHz with 200 ppm/°C stability; sine-wave distortion is less than 2% from 1 Hz to 100 kHz.

CIRCLE NO. 308

Snap-on counter/timer autoranges time interval

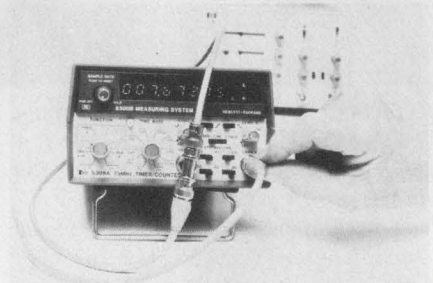

Hewlett-Packard, 1501 Page Mill Rd., Palo Alto, CA 94304. (415) 493-1501. \$450; 30 days.

A new 75-MHz electronic counter/timer, Model 5308A, is said to be the first to autorange when averaging time interval or when measuring frequency ratio. This is in addition to autoranging frequency and period-average measurements. The unit counts frequency, frequency ratio, period, period average and time interval; it scales and totalizes. Beyond those usual abilities, it offers subnanosecond time-interval averaging, and it autoranges to select the range that gives best resolution within a convenient measuring time, 0.11 to 1.1 s. 5308A is a new module in the HP 5300 snap-together measuring system.

CIRCLE NO. 309

MODULES & SUBASSEMBLIES

High-rel converters now standard products



Analog Devices, Rte. 1 Industrial Park, P.O. Box 280, Norwood, MA 02062. (617) 329-4700. From \$425 (1 to 9); stock.

High reliability modular converters are available as standard products. Two 12-bit digital-to-analog converters, a 12-bit analog-to-digital converter, and a sample-and-hold amplifier all operate over the full military -55 to +125 C temperature range. Microcircuits used are qualified to MIL-M-38510, Class B, processed to MIL-M-38510, Class B, or MIL-STD-883, Class B; discrete semiconductors are hermetically sealed and meet MIL-S-19500. The modules are inspected under a system which meets the requirements of MIL-I-45208. The testing for each module includes temperature cycling per MIL-STD-883, Method 1010, Condition B and a 168-hour burn-in under power at 125 C. The ADC1111 a/d converter completes a 12-bit word in 25 μ s. It contains its own clock and internal reference and requires only ± 15 V and +5 V dc power. The DAC1112 d/a converter settles to within $\pm 1/2$ LSB of final value in 8 μ s. It includes its own internal reference and output op amp. The SHA1114 s/h amplifier acquires an input signal to 0.01% in 500 ns or to 0.1% in 300 ns. The DAC1117 current output 12-bit d/a converter can drive the virtual ground summing junction of an external op amp. The converter settles to within $\pm 1/2$ LSB of final value within 7 μ s. It includes its own internal reference and internal feedback resistors, and requires ± 15 V and +5 V dc.

CIRCLE NO. 310



MARKED RF CHIP CAPACITORS

IN 40 STOCK DESIGN VALUES

40 MARKED POPULAR VALUES IMMEDIATELY AVAILABLE IN PROTOTYPE AND PRODUCTION QUANTITIES (BACKED BY A STOCK OF OVER ONE MILLION CHIPS IN THE DESIGN VALUES SHOWN BELOW):

DESIGN VALUE KIT B1 mini-cube® A trim kit (55 mil cube)			
QTY.	CASE	CAP. (pF)	TOL.
10	A	0.1	B
10	A	0.5	B
10	A	0.8	B
10	A	1.8	B
10	A	3.3	B
10	A	4.7	C
10	A	6.2	C
10	A	8.2	C
10	A	9.1	C
10	A	10.0	J

DESIGN VALUE KIT B2 mini-cube® A Tune Kit (55 mil cube)			
QTY.	CASE	CAP. (pF)	TOL.
10	A	12.0	J
10	A	15.0	J
10	A	18.0	J
10	A	22.0	J
10	A	27.0	J
10	A	33.0	J
10	A	47.0	J
10	A	62.0	J
10	A	82.0	J
10	A	100.0	M

mini-cube® is a registered trademark and MAXI-'Q'UBET™ is a proprietary trademark of ATC.

DESIGN VALUE KIT B3 MAXI-'Q'UBET™ B trim kit (110 mil cube)			
QTY.	CASE	CAP. (pF)	TOL.
10	B	1.6	C
10	B	1.8	C
10	B	2.4	C
10	B	4.7	C
10	B	5.6	C
10	B	6.2	C
10	B	7.5	C
10	B	8.2	K
10	B	10.0	K
10	B	12.0	K

DESIGN VALUE KIT B4 MAXI-'Q'UBET™ B Tune Kit (110 mil cube)			
QTY.	CASE	CAP. (pF)	TOL.
10	B	18.0	K
10	B	24.0	J
10	B	27.0	K
10	B	30.0	J
10	B	43.0	J
10	B	68.0	J
10	B	110.0	J
10	B	120.0	J
10	B	180.0	J
10	B	220.0	J

BUY ANY DESIGN VALUE KIT OF 100 ATC 100 LOW LOSS PORCELAIN CHIP CAPACITORS FOR \$77.00.

If you need further information on these Design Value Kits, just circle the number below.

To place your order, or for samples of other ATC Capacitors, call Ralph Wood at (516) 271-9600.

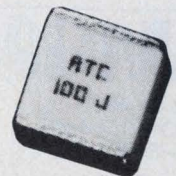

ACTUAL SIZE: 55 MIL CUBE

american technical ceramics
ONE NORDEN LANE, HUNTINGTON STATION, N.Y. 11746
(516) 271-9600 • TWX 510-226-6993

INFORMATION RETRIEVAL NUMBER 43

Over/under voltage sensor has wide range



Zenith Controls, 830 W. 40th St., Chicago, IL 60609. (312) 247-6400. \$55 (list).

The AR series voltage sensors are easily adjusted for both dropout and pickup points. A broad setting range enables the AR series sensors to be used as under or over voltage sensors. Specifications include the following: supply voltage, 120, 208/240 or 277 V single phase; supply frequency 50 to 400 Hz; pickup point, 50 to 125% adjustable; dropout point, 2 to 30% below pickup point; repeat accuracy, $\pm 0.5\%$ of voltage range; contact rating, spdt, 10 A, 240 V or 5 A, 480 V; and temperature range, 0 to 60 C. The sensor measures $3.25 \times 4.625 \times 3.375$ in. and weighs 1 lb.

CIRCLE NO. 320

Solid-state timers handle 1-A loads

Electronic Products Marketing, 1001 Vine St., Liverpool, NY 13088. (315) 457-9611. From \$7.95 (100 up); stock.

Many timing functions are possible with the Versa-timer. Options include interval timing, anti-short cycling for compressors, off delay and on/off recycling. The units are available with normally-on, normally-closed contacts and factory fixed or adjustable time delays. Timing ranges span 50 ms to 600 s with a $\pm 2\%$ repeat accuracy. The holding current is only 5 mA and the contacts can handle a max load of 1 A.

CIRCLE NO. 321

Synchro/BCD converter lets you set scaler

Computer Conversions Corp., 6 Dunton Ct., East Northport, NY 11731. (516) 261-3300. \$395; 4 wk.

A series of three or four decade, synchro-to-BCD converter modules provides a choice of scale factor. The units measure $2.6 \times 3.1 \times 0.82$ in. and are designed to be mounted on PC boards. They convert synchro or resolver inputs of 11.8 or 90 V, 400 Hz or 90 V, 60 Hz into three or four-decade BCD data that represent an angle with an accuracy of ± 6 or ± 30 minutes of arc. Unipolar and bipolar ($\pm 180^\circ$) models are available. Part No. SBC40 requires a 26 V or 115 V, 400 Hz ac reference input, +15 V dc at 40 mA and +5 V dc at 600 mA. Two operating temperature ranges are available: 0 to +70 C and -55 to +85 C.

CIRCLE NO. 322

Band-reject active filters have Q of 10

Frequency Devices, 25 Locust St., Haverhill, MA 01830. (617) 374-0761. \$57 (100-up); stock to 4 wk.

Two wide-notch band-reject active filters, the 783R3Q10-60 and the 783R3Q10-50, use a multipole design that gives a Q of 10, steep slopes (shape factor = 6) and a wide, -50 dB notch bandwidth (1.6% of f_0). The 783R3Q10-60 has center frequency of 60 Hz and the -50 a center frequency of 50 Hz.

CIRCLE NO. 323

Liquid level control uses 50-k Ω sensor

Curtis Industries, 8000 W. Tower Ave., Milwaukee, WI 53223. (414) 354-1500. \$17.55 (1 to 24).

The Model ELC liquid level control has a fixed operating setpoint sensitive to 50 k Ω . The control is designed primarily for use with liquid level sensing probes, but may be used with photocells, thermistors or any other resistance sensing transducer properly matched to the input impedance. Maximum direct-short probe current is limited to 10 mA at 24 V ac with the control consuming less than 3 W. The ELC liquid level control is intended for operation over a 0 to 60 C ambient temperature range and can tolerate supply voltage fluctuations up to $\pm 10\%$. Other features include barrier-type terminals that accept wire sizes up to No. 12 AWG and a plug-in dust-tight spdt in dpdt relay rated for 1/4 hp, 10 A at 120 V ac or 1/3 hp at 240 V ac. Enclosures conforming to NEMA 3 and NEMA 4 JIC are also available.

CIRCLE NO. 324



ANALOGY

FEED TRANSDUCER DATA FROM TOUGH ENVIRONMENTS TO REMOTE MINIS THROUGH THE FIRST CRISTAL CONTROLLED VOLTAGE-TO-FREQUENCY CONVERTER MODULES WITH TOTAL ISOLATION AND 15-BIT ADC PERFORMANCE. INTECH'S NEW A-841 HAS BUILT-IN OPTICAL ISOLATOR. A-842 DRIVES 2000 FT. OF CABLE THROUGH ITS PULSE TRANSFORMER, BOTH AT TTL LEVELS. WE ALSO SUPPLY BETTER ADC, DAC, SEH, OP AMP AND MATH MODULES AT PRICES THAT SAVE.

intech/FMI
282 BROKAW RD. SANTA CLARA,
CA 95050 (408) 244-0500

Miniature time delay unit has wide range

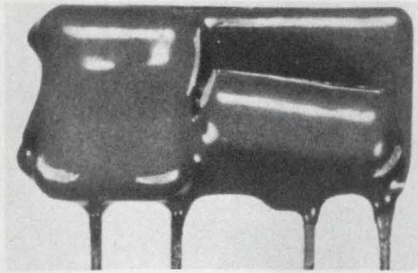

Instrumentation and Control Systems, 129 Laura Dr., Addison, IL 60101. (312) 543-6200. \$5 (large qty).

The Icsotimer, a miniature time delay, offers adjustable delays from 0.1 to 300 s. The hybrid network can switch standard relays and contactors. The timer has an accuracy of $\pm 2\%$. Input voltages available include 115 V ac, 24 V ac, 130 V dc and 24 V dc. The unit measures $1.1 \times 0.6 \times 0.3$ in. and has leads of #20 AWG solid, tin plated wire, 1 in. long.

CIRCLE NO. 325

Sample/hold amplifier made for high speed

National Semiconductor, 2900 Semiconductor Dr., Santa Clara, CA 95051. (408) 732-5000. From \$18.15 (100-up); stock.

The LH0053G, high speed hybrid sample-and-hold amplifier, can acquire a 20-V step signal in under $5 \mu\text{s}$. An internal, auxiliary, FET switch for a preset or reset function extends the sample-and-hold's usefulness in applications such as preset integrators. Operating features of the LH0053G include sample-accuracy nulling (which compensates for source impedance and feedback resistor tolerances), output dc offset adjust to zero and DTL/TTL-compatible FET gating. Only a single storage capacitor is needed. Some specifications include: sample accuracy, 0.2% max (may be nulled, however); drift rate, 30 mV/s max (6 mV/s typ.); aperture time, 25 ns max; analog input voltage range, ± 10 V min; and a short-circuit-proof output. The LH0053G is specified for -55 to $+125$ C operation, while the LH0053CG, industrial version, operates between -25 and $+85$ C; both types are housed in a hermetic, 12-lead, TO-8 metal can.

CIRCLE NO. 326

A BARGAIN IN SOLID-STATE IMAGING:

WHAT YOU GET:

You get a 3" x 3" circuit card which contains RETICON's RL-64P image sensor and all of the associated drive and video processing circuitry. A standard ribbon cable connects the unit to your power supply (+5V, -10V) and also carries the 0 to 2V video output. The RL-64P has 64 sensing elements on 2 mil centers in a standard ceramic DIP sealed with an optical quality quartz window. The device has an integrated on-chip driver and portions of the video processing circuitry. The RL-64P is a proven device in production for over three years.

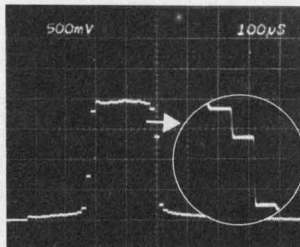
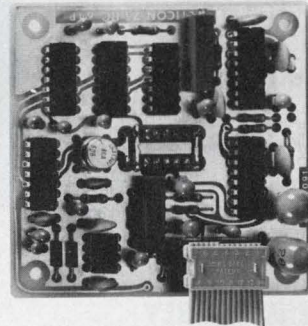
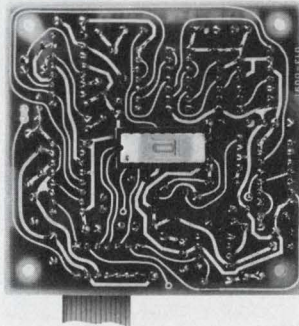

\$195
Single unit quantities

WHAT YOU SEE:

You see over 200:1 dynamic range (peak signal to peak noise) at 250 KHz. The photo shown is the actual output of a 30 mil front illuminated band imaged onto the array using 1:1 optics. The "box-car" type sampled-and-held output can be easily thresholded or A/D converted into multiple grey levels.

Applications in OCR, point-of-sale, industrial non-contact measurement and control are a natural for this unit.

Evaluate our technology with this complete imaging system. If you need higher resolution, we have an extensive line of image sensors with up to 1872 elements. We have over four years of experience in solid state image sensor and related circuit development. And there are over 70 salesmen and 15 distributors to serve you worldwide.

RETICON®

910 Benicia Avenue
Sunnyvale, California 94086
(408) 738-4266 • TWX: 910-339-9343

INFORMATION RETRIEVAL NUMBER 45

QUALITY IN VOLUME

When you achieve it, you can offer true competitive value. That's just what we're doing at USCC/Centralab for 1975. MONO-KAP™ radial, and MONO-GLASS axial monolithic ceramic capacitors are now available to volume users *from stock* to eight weeks. Our investment and "learning curves" last year guarantee competitive responsiveness — USCC will welcome your specials and non-stock orders. Here's an offer you haven't heard lately — your money is going to buy more at USCC. Cash in on the best values in monolithic ceramic capacitors.

DISCRETE ASSEMBLY

MONO-KAP™ radial-leaded epoxy coated capacitors are reliable performers; they're rugged enough to work in MIL environments. 4.7 pF to 10 Mfd., 50 to 200 WVDC in 4 dielectrics, including Z5U, in a variety of case sizes featuring meniscus control to 0.032 inches. Large quantity orders from stock.

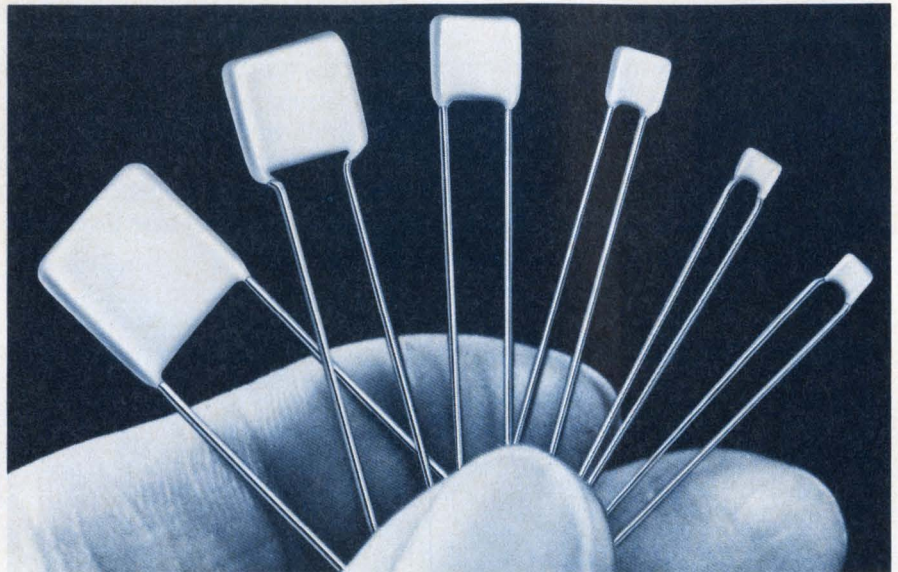

AUTOMATIC INSERTION

MONO-GLASS axials are glass encapsulated, designed for automatic PCB insertion; furnished reel-packed for high volume applications. They're available in 50 and 100 WVDC from 1pF to 1.0 Mfd.; four dielectrics: COG, X7R, Z5U and Y5V.

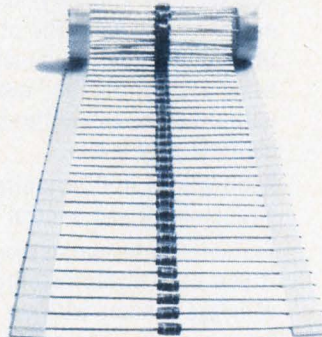

CUSTOM DESIGN

We're responsive to your design requirements; get USCC's new expanded 1975 catalog.



If you need a special, call (213) 843-4222 or your nearest overseas location for assistance or evaluation samples.

Remember. USCC/Centralab. Value.

FOR QUICK REFERENCE, SEE OUR PRODUCTS IN YOUR EEM, GOLD BOOK OR EBG PAGES.



USCC/Centralab

Electronics Division • Globe-Union Inc.

2151 North Lincoln Street • Burbank, California 91504
(213) 843-4222 • TWX: 910-498-2222



INFORMATION RETRIEVAL NUMBER 46

Switching supply achieves power density of 2.3 W/in.³

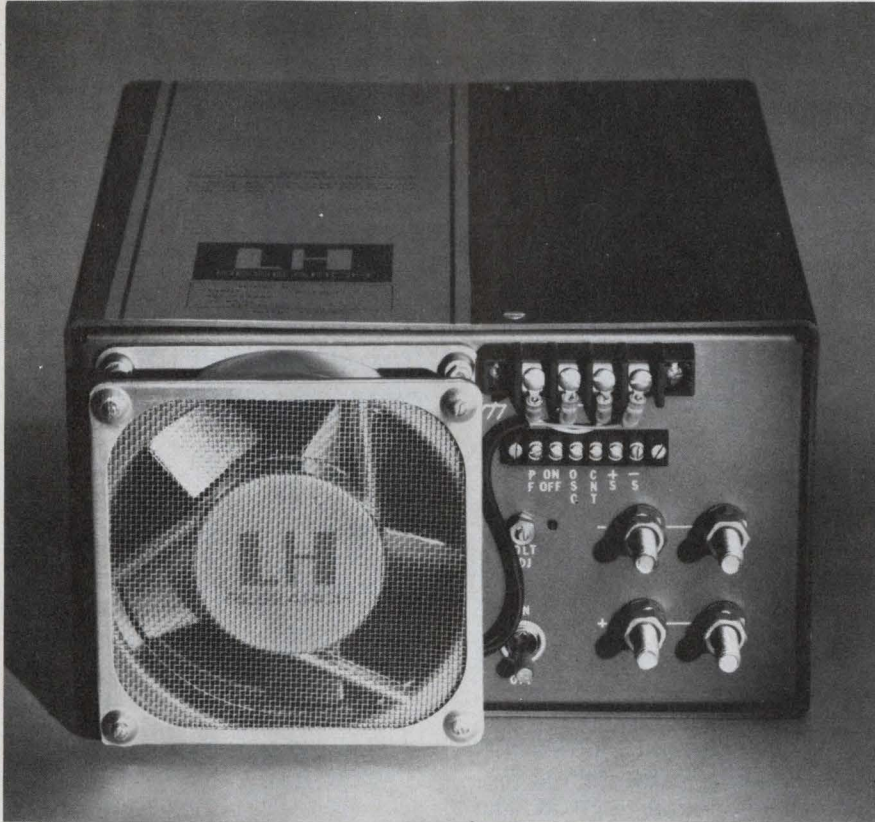

LH Research, 2052 S. Grand Ave., Santa Ana, CA 92705. (714) 546-5279. \$1295 (1-24); 8 weeks.

With more than twice the power density of most competing switching power supplies, a new unit from LH Research packs 1500 W into a package that weighs less than 20 lb. Its power density of about 2.3 W/in.³ allows the Model LH 800 to fit into a compact 5.25 × 9.5 × 13.0 in.

While most switching power supplies achieve efficiencies of 65 to 75%, the LH 800 achieves 80%. The reduced dissipation is one of the main contributors to the unit's small size.

Rated at 5 V and 300 A, the supply has a 50-mV pk-pk ripple and noise on the output. Line and load regulation are both 0.2%.

Response time of 200 μs and SCR soft-start circuitry combine to make the supply fast and well-protected. Additional protection is afforded by a thermal overload

switch, overvoltage automatic shutdown and a fold-back current limiter. With fold-back current limiting, the short-circuit current is held to about 10% of the rated output current. The output returns to normal when the overload is removed.

Full rating is maintained to 40 C, with derating to 60% at 71 C. A fan is built-in.

For uninterruptible operation, where switchover to batteries is needed in case of line failure, the LH 800 holds its regulated output for at least 20 ms after the removal of ac power.

Other features are EMI filtering and remote sensing, to compensate for up to 0.5-V drop in the power distribution cables.

Available as options are: three-phase input, power-failure detection, output inhibit, master-slave paralleling or straight paralleling of up to 10 units.

CIRCLE NO. 304

Triple-output lab unit fits in pocket

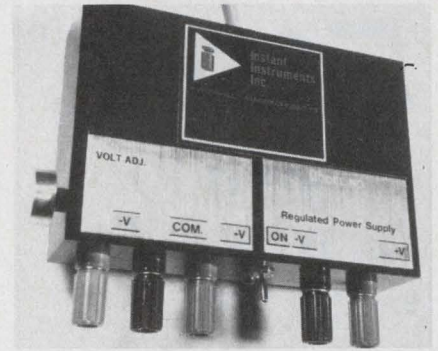

Instant Instruments, 306 River St., Haverhill, MA 01830. (617) 373-9260. \$96 to \$137.

Three new triple-output laboratory power supplies have been added to the company's pocket-sized series. One model includes a variable, dual ±9 to ±18 V dc at 100 mA and 5 V dc at 1-A output, while the two other models have preset ±15 V dc at 100-mA and 200-mA outputs for discrete and 5 V dc at 500-mA and 1-A outputs, respectively. General specs include 1% voltage accuracy, regulation 0.05% line, 0.01% load, ripple less than 1 mV rms.

CIRCLE NO. 327

Digital supply delivers dual outputs

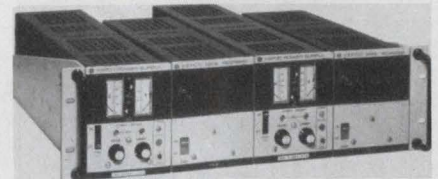

Kepeco, Inc., 131-38 Sanford Ave., Flushing, NY 11352. (212) 461-7000. \$3253; 45 days.

This dual, digitally programmed auto-crossover unit produces up to 100 W per section with a selection of 0 to 6, 0 to 15, 0 to 25, 0 to 36, 0 to 75 or 0 to 100 V fs. Digitally controlled in voltage, you get 12 bits of resolution and factor-of-10 scaling (the full 12 bits resolution spread over the lowest 10% of range). Current is also digitally controlled with 8 bits of resolution. Each section features a dual-range voltmeter and ammeter and an independent overvoltage crowbar, plus mode lights. Stabilization for 100% load variations is better than 0.005%. Ripple and noise are below 200 μV rms, 2 mV pk-pk.

CIRCLE NO. 328

about
5¢/yr.*
 buys a lot
 of reliability
 with
 Angstrom's
 new
 SAR,
 20 year
 end-of-life
 precision
 metal film
 resistors!

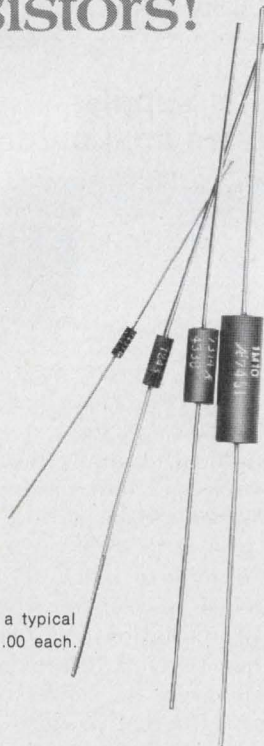

*Based on a typical cost of \$1.00 each.

angstrom precision, inc.
 one precision place
 hagerstown, maryland 21740
 telephone: 301-739-8722
 twx: 710-853-6834

DISCRETE SEMICONDUCTORS

**Optical detector has
 10⁻¹² W sensitivity**



Bell & Howell, 706 Bostwick Ave., Bridgeport, CT 06605. (203) 368-6751. From \$25; stock.

The Model 529 electro-optical detector consists of a silicon photo-detector and integrated signal processing electronics mounted in a hermetic TO-99 package. The sensor is available with either 0.8 mm² or 5 mm² detector elements. Sensitivity and bandwidth are programmable with two low value external resistors. The devices provide sensitivities to 10⁻¹² W and spectral responses of 0.35 to 1.12 microns.

CIRCLE NO. 329

**Mini rectifiers handle
 1 A at temp of 75 C**

General Instrument, 600 W. John St., Hicksville, N.Y. 11802. (516) 733-3000. From \$0.05 (50,000 up); 3 to 4 wk.

A line of diffused junction, glass passivated, miniature rectifiers meets or exceeds all electrical parameters of the 1N4001 through 1N4007 D041 plastic rectifiers. The mini rectifiers in the MG-4001 through MG4007 series are rated for 1 A at an ambient temperature of 75 C and have a peak surge rating of over 30 A. The devices cover the PRV range of 50 to 1000 V and have an operating temperature range of -65 to +175 C. All rectifiers in the new series exceed environmental standards of MIL-STD-19500/228.

CIRCLE NO. 330

**Tuning varactors have
 4.5:1 capacitive ratio**

MSI Electronics, 34-32 57th St., Woodside, NY 11377. (212) 672-6500. \$12 (100-up); stock to 2 wk.

The MV205D hyperabrupt tuning varactor features a minimum capacitance tuning ratio of 4.5:1 from 3-to-25-V bias. The capacitance at 25 V is 2 pF nominal and the Q is a minimum of 650 at 4 V and 50 MHz. The diodes have a 30-V breakdown rating, a series inductance of 0.8 nH, nominally, and a package capacitance of 0.15 pF. The MV205D is particularly useful in the uhf and low microwave frequency bands.

CIRCLE NO. 331

**Impatt diodes operate
 over 18 to 100 GHz**

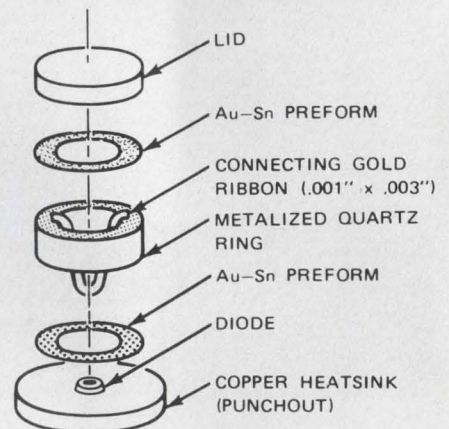

Hughes Electron Dynamics Div., 3100 W. Lomita Blvd., Torrance, CA 90509. (213) 534-2121. From \$50; 30 to 45 day.

A line of millimeter-wave Impatt diodes covers the frequency range from 18 to 100 GHz. The diodes include both single-drift models with minimum output from 5 to 300 mW, and experimental double-drift versions in a more limited range with minimum output of 300 mW CW and 5 W pulsed. Available configurations include the company's Minidisc ceramic package and quartz designs, both of which may be stud-mounted. Diodes supplied for operation below 40 GHz are packaged with a 50-mil diameter ceramic ring making up the Minidisc package. Diodes for operation above 40 GHz are packaged with a 30-mil diameter quartz ring, which is an integral part of the quartz package.

CIRCLE NO. 332

bottom line bargain

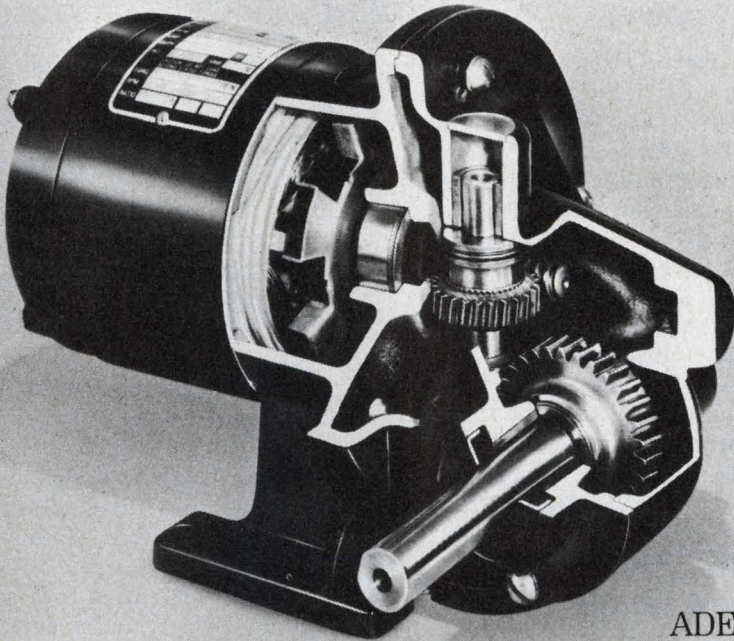

ADE (After Delivery Economies)
make Bodine a better fhp buy

BODINE
ELECTRIC
COMPANY

BODINE MOTORS
GEARMOTORS
SPEED CONTROLS

Bodine puts more into its fhp motor and drive system design to give you greater bottom line profit in the long run. We call it ADE (After Delivery Economies). You get fewer rejects from the start and less profit robbing service headaches when your product is in use. Motor to motor, lot to lot, Bodine's consistent quality pays big performance dividends.

If you're concerned about costs, profitability and tomorrow's repeat sales, take a close look at Bodine. You won't find a better fhp buy—1/2000 thru 1/4 Hp.

Bodine Electric Company, 2500 W. Bradley Place, Chicago, IL 60618. Phone: (312) 478-3515, Telex: 25-3646.

INFORMATION RETRIEVAL NUMBER 49

You don't have to buy a new car to get an electronic ignition.

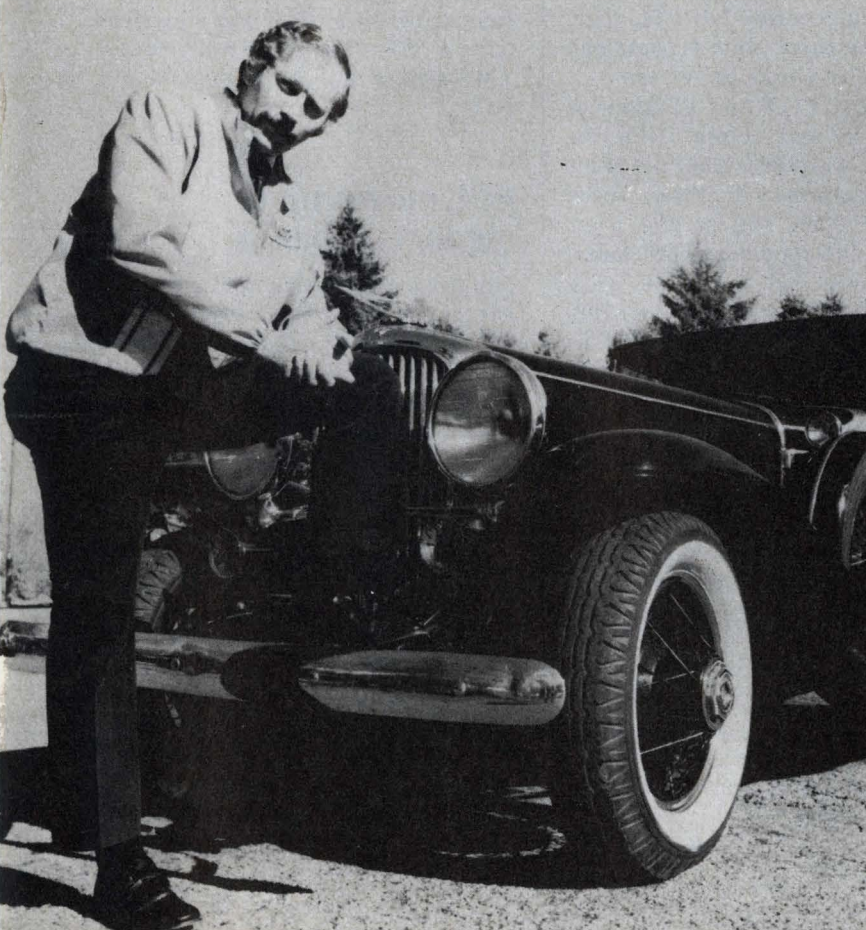

Most of you know the evaluation of automotive electrical systems . . . an evaluation characterized only occasionally by efficiency and performance. I know that, and that's why I use the Delta Mark Ten B CDI on all my cars, new and old. And believe me, you don't have to have a new car to appreciate the best electronic ignition available today. Study these features and you'll know what I mean.

1. Mark Ten and Mark Ten B Capacitive Discharge Ignition Systems are manufactured by Delta Products, Inc., a company with a conscience, and with a proven record of reliability both in product and in customer relations.
2. The Mark Ten CDI's really do save money by eliminating the need for 2 out of 3 tune-ups. Figure it out for yourself. The first tune-up or two saved pays for the unit, the rest is money in your pocket. No bunk!
3. Because the Mark Ten CDI's keep your car in better tune, you actually can save on expensive gasoline.
4. With a Mark Ten, spark plugs stay clean and last longer . . . fouling is virtually eliminated.



No matter what kind of car you drive, it too can use a Delta quality lift.

I want to know more about Mark Ten B CDI's. Send me complete no-nonsense information on how they can improve the performance of my car.

Name _____
Address _____
City _____ State _____ Zip _____



DELTA PRODUCTS, INC.

P.O. Box 1147, Dept. ED, Grand Junction, Colo. 81501
303-242-9000

Mark Ten B,
assembled \$64.95 ppd
Mark Ten B, kit . . . \$49.95 ppd

Standard Mark Ten,
assembled \$49.95 ppd
Deltakit® \$34.95 ppd

the facts about E.M.I. SHIELDING

Design information from Mag-Shield's
30 years experience in E.M.I. shielding.

HOW CAN I QUICKLY EVALUATE MY SHIELDING REQUIREMENTS?

Construct an experimental shield. Then conduct comparative attenuation measurements with our A.C. magnetic pick-up probe. Mag-Shield's new high sensitivity probe produces 60 millivolts/gauss output at 60 Hz when used with a standard AC/VTVM. The probe is precisely calibrated for direct field intensity measurements.

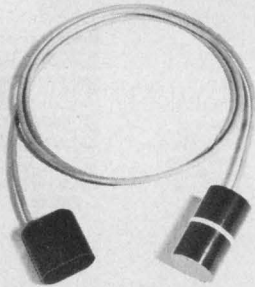

Mag-Shield's high sensitivity magnetic pick-up probe simplifies shield attenuation measurements.

HOW DO I SET UP THESE COM- PARATIVE MEASUREMENTS?

Use high permeability Co-Netic material or high saturation Netic material to construct the prototype shield. Next, measure the decrease in field intensity with the probe placed within the shield. A single layer shield will provide shielding efficiencies of approximately 40 db with Co-Netic material and 10-15 db with Netic material.

WHAT ABOUT SHIELDING E.M.I. FIELDS ABOVE 60HZ?

The frequency range of any Mag-Shield probe may be extended to 3 KHz by applying a simple calibration correction formula.

For further information, just circle the reader service number, or write Mag-Shield direct for brochure EP-102.

MAGNETIC SHIELD DIVISION



Perfection Mica Company
740 Thomas Drive
Bensenville, Illinois 60106
(312) 766-7800 TWX (910) 256-4815

INTEGRATED CIRCUITS

2102s boost speed and cut power

Advanced Micro Devices Inc., 901
Thompson Pl., Sunnyvale, CA
94086. (408) 732-2400. \$11.20 to
\$13.35 (100 up).

A trio of 2102-type memories—1024-bit n-channel static RAMs—offers speeds of 250 ns or power dissipation of only 175 mW. These ICs feature guaranteed dc standby mode that reduces power requirements. Called 9102s, the new circuits have input and output characteristics identical to TTL with guaranteed fanouts of two TTL loads.

CIRCLE NO. 333

1-k static RAMs form new family

Intel, 3065 Bowers Ave., Santa
Clara, CA 95051. (408) 246-7501.
\$7.45 to \$20.90 (100 up); stock.

A complete family of 256×4 -bit and 1024×1 -bit TTL-compatible static MOS RAMs are offered in the 2101, 2111, 2112 and 2102A series of silicon-gate n-channel memories. The new products expand the popular 2102 1-k static RAM series. All RAMs use a single 5-V supply, operate at TTL logic levels, have three-state outputs and don't require clocks or refresh.

The 2101, 2111 and 2112 series—in 22, 18 and 16-pin DIPs, respectively—provide 256×4 -bit configurations in three speed ranges: 500 ns, 650 ns and 1 μ s. These speeds represent both maximum access and minimum cycle times, which are identical in 2102-type RAMs, and are specified as worst-case over the 0-to-70-C temperature range. Typical power dissipation is 150 mW.

The 2102A series retains the standard 1-k configuration. It has 16 pins, separate input data and output data lines, and one-chip-enable input, as well as address and read/write control inputs. At present, five 1024×1 types are available: three industrial devices with worst-case speeds of 250, 300 and 450 ns from 0 to 70 C, and two military devices with worst-case speeds of 450 and 650 ns from -55 to +125 C.

CIRCLE NO. 334

4-k RAMs have 200-ns access

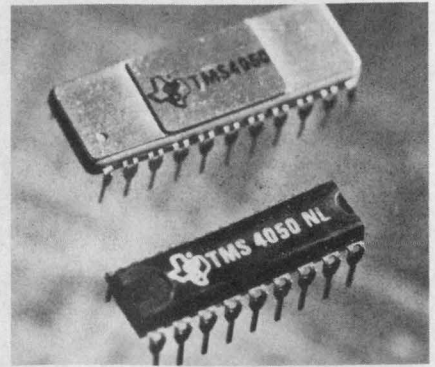

Texas Instruments, P.O. Box 5012,
Dallas, TX 75222. (214) 238-3741.
\$24.30 to \$30.69 (100-999).

Two 4096-bit NMOS dynamic RAMs—the TMS4050 and the TMS4060—feature a guaranteed maximum access time of 200 ns with maximum cycle time of 400 ns. The TMS4050 comes in a compact 18-pin DIP, which reportedly increases board density by 70 to 100% over existing 22-pin 4-k RAMs. To keep the number of pins down to 18, data input and output are multiplexed on a single terminal. However, a full 12-line address is provided. Also, a memory chip select has been eliminated by using the chip-enable clock and the R/W mode control to enable the RAM. The TMS4060 is an upgraded pin-compatible version of the manufacturer's previously introduced TMS4030, a 4-k RAM in a 22-pin DIP.

CIRCLE NO. 335

ECL moves up to gigahertz speeds

Motorola Semiconductor Products
Inc., P.O. Box 20924, Phoenix, AZ
85036. (602) 244-3464. \$39 to \$89
(100-999); stock.

The first of a series of gigahertz logic circuits are these: a divide-by-10 counter (MC1696) and a divide-by-4 counter (MC1699). Both are part of the company's MECL III family and have a typical toggle frequency of 1.2 GHz. The MC1696 is a bi-quinary decade counter that features BCD outputs as well as divide-by-10. The MC1699 counter is intended for digital TV tuners and for pre-scaler applications. Its clock input can accept capacitor-coupled sine-wave signals above 10 MHz.

CIRCLE NO. 336

8-bit NMOS processor comes on two chips

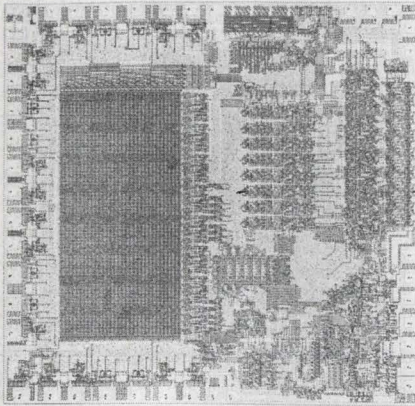

Fairchild Integrated Circuits Group, 464 Ellis St., Mountain View, CA 94042. (415) 962-3816. \$130 (1-9); 4 wks.

A two-chip, 8-bit n-channel MOS microprocessor system, called the F8, emphasizes I/O capabilities to maximize flexibility and minimize external parts requirements.

In the minimum system, a CPU and PSU (program storage unit) chip each provide two 8-bit bidirectional I/O ports, resulting in a total of 32 available I/O bits. This allows the two-chip system to accommodate directly virtually all common I/O devices. Four additional circuits being added to the basic chip set are a memory interface (MI), direct-memory access (DMA), communications interface (USART), and a 256 × 4-bit n-channel static RAM.

The basic two-chip F8 system—consisting of the 3850 CPU and the 3851 Program Storage Unit—contain 1024 × 8-bits of storage. The CPU chip communicates with other F8 circuits by means of an 8-bit bidirectional data bus, and has five control lines to set the state of other chips.

Contained in the CPU circuit are an arithmetic logic unit, an accumulator, a 512-bit scratch-pad memory, a status register, two 8-bit bidirectional I/O ports, clock circuits to control all chips in the system, an interrupt-control circuit, and a power-on detect circuit that disables the interrupt system and assures that processing starts from a unique address when power is first applied. The PSU chip serves principally for storage of programmed instructions.

CIRCLE NO. 337

THE POWER SUPPLY A MANAGEMENT TEAM COULD LOVE

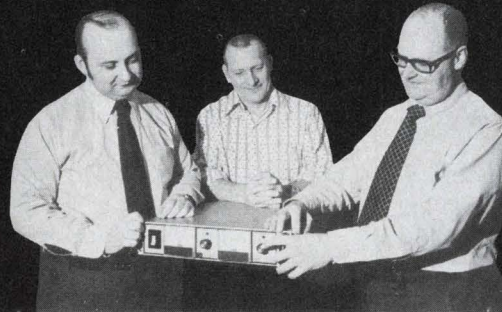

If you're an engineer, or in engineering management, you might find our new SCR Series Single Phase Input Power Supplies very attractive. They provide 800, 1600 or 2400 watts of power and precise 0.1% regulation in both voltage and current modes (for higher power ask about our three phase input SCR units). All offer the highest power output per mechanical volume in the industry.

Check these superior benefits:

- * High Efficiency
- * Remote Sensing
- * Remote Programming
- * Series or Parallel Operation
- * 5 Year Warranty
- * Rack or Bench Mount
- * Overvoltage Protected (optional)
- * Constant voltage or current with automatic crossover
- * Optional Input Voltages

For applications assistance and technical information, phone TOLL FREE (800) 631-4298

VOLTAGE	CURRENT	CV-rms RIPPLE	CC-rms RIPPLE	% EFF.	AC input I NOM.E.	PRICE \$
0-7.5	100	75 mv	1000 ma	63	13	650
	180	80 mv	1920 ma	65	26	850
	250	80 mv	2990 ma	66	20	1100
0-10	80	75 mv	600 ma	65	13	600
	150	80 mv	1200 ma	68	26	850
	210	80 mv	1680 ma	69	19	1100
0-20	40	60 mv	120 ma	67	13	600
	80	80 mv	320 ma	70	25	800
	120	80 mv	480 ma	73	18	1000
0-40	20	60 mv	30 ma	68	13	500
	40	100 mv	100 ma	75	24	750
	60*	100 mv	150 ma	80	18	900
0-60	13	70 mv	15 ma	70	13	500
	26	90 mv	39 ma	81	23	850
	40	90 mv	60 ma	81	18	1000
0-80	10	80 mv	10 ma	77	12	500
	20	120 mv	30 ma	83	21	850
	30**	100 mv	35 ma	82	18	1000
0-150	5	150 mv	5 ma	80	10	500
	10	200 mv	13 ma	87	20	850
	15	200 mv	20 ma	84	18	1000
0-300	3	250 mv	3 ma	85	6	550
	5	300 mv	5 ma	87	20	850
	8	300 mv	8 ma	85	17	1000
0-600	2	700 mv	2 ma	87	6	650
	3	700 mv	4 ma	88	20	850
	4	750 mv	5 ma	85	17	1100

*Specify Model No. SCR40-58
**Specify Model No. SCR80-28



ELECTRONIC MEASUREMENTS INC.

405 Essex Road, Neptune, N. J. 07753
Phone: (New Jersey) 201 - 922-9300 • (Toll-Free) 800 - 631-4298
Specialists in Power Conversion Equipment

Be an isolationist with Intronics' Isolation Amplifiers

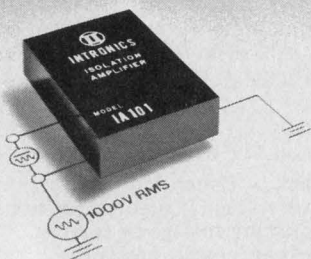

When you require extreme input/output isolation, Intronics' IA100 series isolation amplifiers can provide the best in safety and performance. These models offer up to 5000 volt isolation capacity with accuracies of $\pm 0.01\%$, operable over a wide temperature range. They're the sure way to transmit signals in the presence of very large common mode voltages for medical/biomedical, nuclear and industrial control applications where safety and reliability are paramount.

Intronics makes a broad line of signal processing modules to meet your specific requirements. For complete information send for our new catalog, or for immediate assistance call Rick Sakakeeny at (617) 332-7350.



57 Chapel Street, Newton, Massachusetts 02158 U.S.A.
(617) 332-7350, TWX 710-335-6835

Overseas call:
Brussels, Belgium (02) 513-73-84
Kent, England Maidstone 54224/6
Orsay, France 9077844
Munich, Germany 524181
Tel-Aviv, Israel (03) 415645
Cernusco, Italy 9041319
The Hague, Netherlands 678380
Wallisellen, Switzerland 01/8303161

DATA PROCESSING

Tape drive offers IBM-compatibility

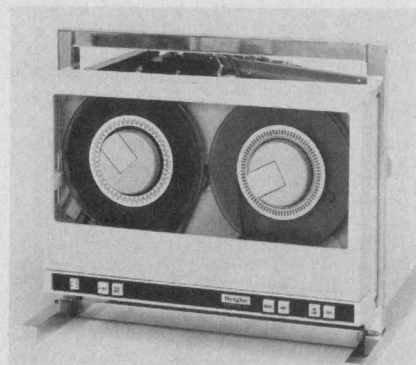

Bright Industries, 668 W. Maude Ave., Sunnyvale, CA 94086. (415) 321-2133. \$3375.

The Model 2630 tape-drive handles 8.5 in., IBM-compatible reels in either NRZI or phase-encoded formats at densities of 1600, 800, 556 or 200 bits/in. The vacuum-column 2630 operates at tape speeds of 12.5 to 37.5 in/s and has an industry-compatible interface. Field conversion from NRZI to phase-encoded formats is accomplished by replacing one circuit board.

CIRCLE NO. 338

Universal I/O system has intelligent cables

Computer Automation, 18651 Von Karman, Irvine, CA 92664. (714) 833-8830. See text.

A universal I/O interface system uses a computer in each interface to handle diverse peripherals and user-defined application devices. A single half-card—called an I/O Distributor—and a set of intelligent, computer-driven cables enable any member of the company's LSI computer family to communicate with up to eight parallel or serial devices. Each cable contains a PicoProcessor, a very fast, small processor micro-coded for the characteristics of the desired device. The Distributed I/O System transfers data concurrently on all channels directly to or from memory through direct memory channels. The I/O Distributor price is \$380 (single qty); intelligent cables are \$145 each. And volume discounts are available.

CIRCLE NO. 339

Slave disc-drives help reduce storage costs

Orbis Systems, 3303 Harbor Blvd., Costa Mesa, CA 92626. (714) 556-8450. 74M: \$695; 74S: \$595; stock.

The 74M/74S Master/Slave floppy disc family offers low-cost volume storage. A user can achieve 12.8 Mbits of data storage by interfacing one 74M and up to three 74S drives in a master/slave relationship. The 74M (Master Drive) is the direct interface to the users equipment in a star or daisy chain. It has a full capability unit including interface electronics. The 74S (Slave Drive) is less costly and contains minimal electronics. Up to three 74S units can be daisy chained onto a 74M. Both units are IBM compatible and offer an unformatted data capacity of 3.1 Mbits per disc, 250 bit/s data transfer rate and 6-ms access time (track-to-track).

CIRCLE NO. 340

Floppy disc system has multiple formats

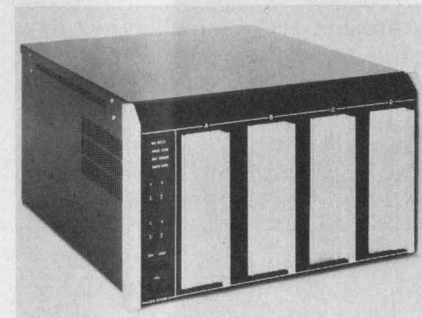

Advanced Electronics Design, 754 N. Pastoria St., Sunnyvale, CA 94068. (408) 733-3555. See text.

The AED 3100-P floppy disc system provides one to four IBM-compatible disc drives and all electronics in a single 10.5-in. cabinet. The programmable formatter, a system feature, permits each drive to read or write in different formats. For example one drive can contain a minicomputer operating system written in 256-word sectors while the other drives process IBM standard 64-word sectors. The formatter can also load the minicomputer bootstrap into memory from the floppy disc. Each disc can store 128,128 sixteen-bit words in IBM format. Access is 10 ms per track; data are transferred at the rate of 15 k-word/s.

CIRCLE NO. 341

The original

SAFER
PASTE
BRAZING
FLUX
for silver
soldering



Helps meet OSHA standards

FREE SAMPLE

Reusable 10, 36 and 60 lb. polyethylene pails



- Effective temperature range from 850°F. to 1600°F. For brazing, hard soldering and silver soldering ferrous and non-ferrous metals and alloys.
- Hot water removes excess flux or residues. Non-corrosive, won't burn operators' hands or skin. Conforms to AMS 3410 and O-F-499C specs.
- Eliminates occupational hazards inherent in acid type fluxes.
- Powerful, capillary action draws molten solder through long, tubular joints, forming leakproof joints... permits tolerances of .003" in joined parts.

SUPERIOR FLUX & MFG. CO.

653 Alpha Drive, Cleveland, Ohio 44143, Dept. ED
Phone: (216) 461-3315

No. 6-1

INFORMATION RETRIEVAL NUMBER 54

SOLID STATE RELAYS WITH SOMETHING EXTRA

From Elec-Trol, a complete line of 6, 10 and 25 Amp, AC and DC input Solid State Relays and custom designs to meet your needs. All feature: **Zero Crossover Switching** to eliminate RF noise and load current or voltage surges. **Photo Isolation between Input & Output** - 1500 VRMS **FET Input Current Limiter** on all DC models prevents relay closure by input transients & increases LED life. **Built-in Snubber Network in Output** prevents uncontrolled operation due to load-line transients. **IC Compatibility and Reverse Polarity Protection** on all DC models. Call or write for complete information today.

26477 N. Golden Valley Road • Saugus, Calif. 91350
(805) 252-8330 • (213) 788-7292 • TWX 910-336-1556

ELEC-TROL, INC.

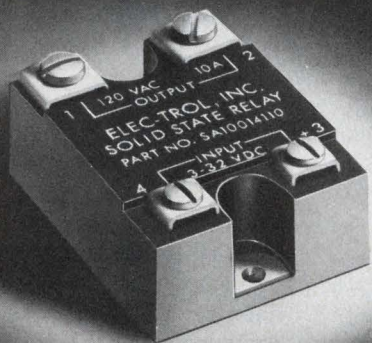

INFORMATION RETRIEVAL NUMBER 55

ELECTRONIC DESIGN 14, July 5, 1975

don't expect look-alikes
to perform-alike...

if it
doesn't
say
Globe
it isn't a

gel/cell[®]

write for information
on Gel/Cell
the first and most
experienced
maintenance free
rechargeable battery!



GLOBE BATTERY
DIVISION OF GLOBE-UNION INC

Gel/Cell Marketing
5757 N. Green Bay Avenue
Milwaukee, WI 53201 - (414) 228-2394

INFORMATION RETRIEVAL NUMBER 56

BIG POWER SUPPLIES



IN LITTLE PACKAGES

**AC-DC and DC-DC
miniaturized power converters
that deliver 3.9 watts
per cubic inch.**

- AC inputs: 115-220 VAC, 47-500 Hz.
- DC inputs: 12, 28, 48, 115 & 150 VDC.
- 1 to 6 isolated and regulated DC outputs from 4.2 to 300 VDC.
- Line and load regulation to 0.1%.
- Up to 800 watts per output.
- Efficiencies to 85%.
- Design-As-You-Order construction from standard sub-modules . . . over 1200 possible configurations.
- Completed converters provided in tested and encapsulated, conduction cooled packages in just days.

See for yourself how we've packed the power and performance in . . . request our actual size "little black box" punch out kit and catalog today!

Call us collect . . . ask for Jim Dunn.



ARNOLD MAGNETICS CORPORATION

11520 W. Jefferson Blvd.
Culver City, Ca. 90230 ● (213) 870-7014

PACKAGING & MATERIALS

Plastic boxes have two aluminum panels

*Vero Electronics, 171 Bridge Rd.,
Hauppauge, NY 11787. (516) 234-
0400. From \$9.*

Three sizes of plastic Veroboxes have clear anodized aluminum panels at front and rear. The boxes are available in three sizes from 1.6 × 8.1 × 5.5 to 4.3 × 8.1 × 5.5 in. and are molded in gray, high impact polystyrene. Top and bottom sections are held together by four screws entering through the base and concealed by plastic feet. Also, the bottom selections contain threaded inserts to use as PC board standoffs for horizontal card mounting, and molded-in card-guide slots for vertical PC board mounting.

CIRCLE NO. 342

Indicating paints tell temperature changes

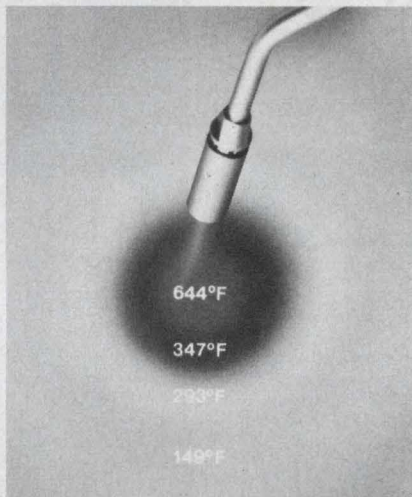

*Telatemp Corp., P.O. Box 5160,
Fullerton, CA 92635. (714) 879-
2901. \$12 per 20 g; stock.*

Thermocolor paints change color upon exposure to specific temperatures. The color change is distinct, clear and permanent. The user can determine temperature distribution without complex measuring instruments. Over 35 different formulations cover a range of 40 to 1350 C. Available paints offer two, three or four distinct color changes with just one application. Application may be made with a brush, spray gun or atomizer. Twenty grams of pigment is sufficient to cover an area of 3 ft².

CIRCLE NO. 343

Snap-in mounts for PCs snap apart to fit width

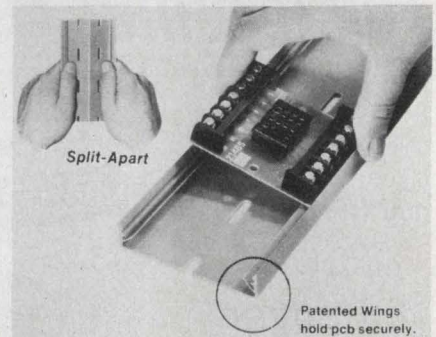

*Reed Devices Inc., 21 W. 183rd Hill
Ave., Glen Ellyn, IL 60137. (312)
858-2050. \$2.75 per 4 ft.*

Fast easy mounting of boards is provided by Snaptrack channel. It is now available in a new split-apart version—the 4TK2 series—for boards wider than 3-1/4 in. The channel, in lengths to 4 ft, can mount to panels with rivets, screws or double-faced tape. Simply snap them apart along a score line and mount the two halves to accommodate the width of the PC board.

CIRCLE NO. 344

Casting compound uses sand filler

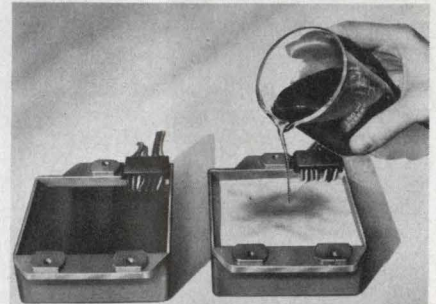

*Dexter Corp., 15051 E. Don Julian
Rd., City of Industry, CA 91749.
(213) 968-6511.*

Hysol casting compound ES0269 is formulated specifically for "sand-casting." Devices are filled with clean, dry sand and usually accompanied by vibration to ensure complete filling. After oven pre-heating, the epoxy system is poured into the warmed units, where it impregnates the sand and completely encapsulates the device circuitry. This modern version of an ancient technique is used to protect and insulate automotive solid-state ignition systems. Low exotherm and flexibility prevent damage to sensitive electronic components.

CIRCLE NO. 345

Card extender provides easy-access test clips

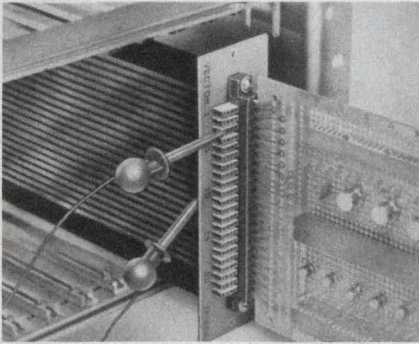

Vector Electronic Co., Inc., 12460 Gladstone Ave., Sylmar, CA 91342. (213) 365-9661. TP-1: \$17.59, TP-2: \$22.05 (unity qty); stock.

A new card extender and card-edge adapter unit allows convenient front-panel troubleshooting of cage-mounted circuit boards. Designed for boards with 22/44 edge contacts on 0.156-in. centers, the adapters, Models TP-1 and TP-2, provide four external test clips (Klip-Strips) for each receptacle contact. Signals may be inserted, jumpers installed, components added and measurements taken without probing the board directly.

CIRCLE NO. 346

Reversible fans pressurize or evacuate

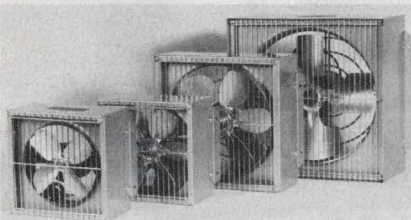

McLean Engineering Laboratories, P.O. Box 127, Princeton Junction, NJ 08550. (609) 799-0100.

This line of four mechanically reversible fans may be used to pressurize or evacuate electronic cabinets without mechanical changes or field modification. Installation options include vertical or horizontal and inside or outside the enclosure. Sizes are 4-1/2-in. deep by either 8-7/8, 12-1/8, or 15-1/8-in. square. Air deliveries are 275, 450, 725 or 1200 cfm. Motor speeds are 3100, 1650, 1600 or 1450 rpm. All units can be supplied with dust filter, guards and decorative air inlet grilles; all are UL approved.

CIRCLE NO. 347

Tool helps coax cable assembly or removal



Trompeter Electronics Inc., 8936 Comanche Ave., Chatsworth, CA 91311. (213) 882-1020. Stock.

A new tool helps in the instal-

lation or removal of coax cables that are terminated with most BNC, F or TPS connectors. It is particularly useful in areas of high cable density. The tool has a high impact plastic handle and comes in 6 and 12-in. lengths. BNC tools are designated RT1S (6 in.) and RT1L (12 in.); TPS are RT2S and RT2L; and F are RT3S and RT3L.

CIRCLE NO. 348

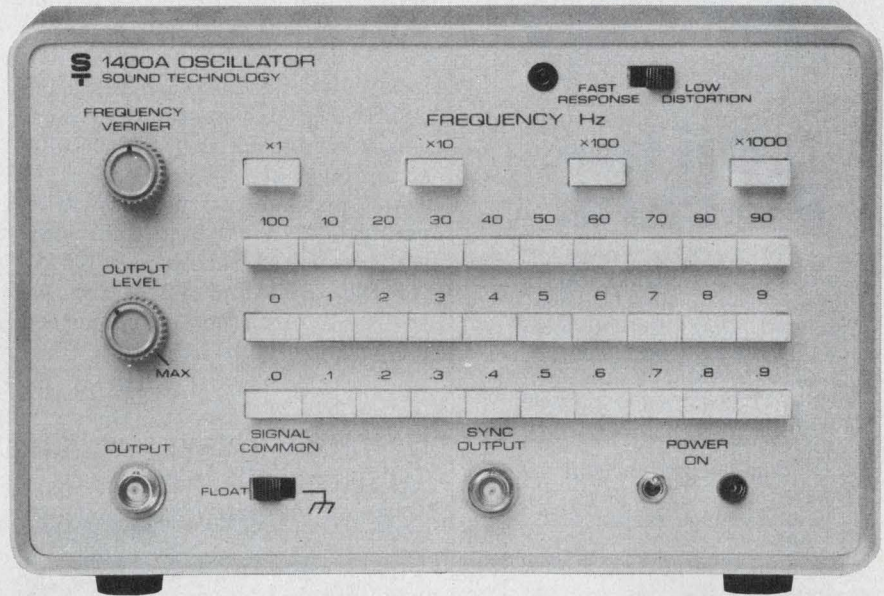

ULTRA-LOW DISTORTION OSCILLATOR

10 Hz-110 kHz: pushbutton tuned for high repeatability, 3-digit resolution. **FLOATING OUTPUT:** selectable by panel switch. **ULTRA-LOW DISTORTION:** typically .001% in audio range (see curve). **FAST SETTling:** settles to .001% distortion in 5 seconds. Faster alternate mode. **FREQUENCY RESPONSE:** flat within 0.2 dB. **PRICE:** only \$610.

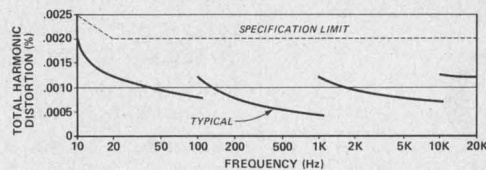

CALL NOW

Call Larry Maguire or Bob Andersen now for full information on this important new Model 1400A.

ST

SOUND TECHNOLOGY

1400 DELL AVENUE
CAMPBELL, CALIFORNIA 95008
(408) 378-6540

INFORMATION RETRIEVAL NUMBER 58

Regulated power where you NEED it

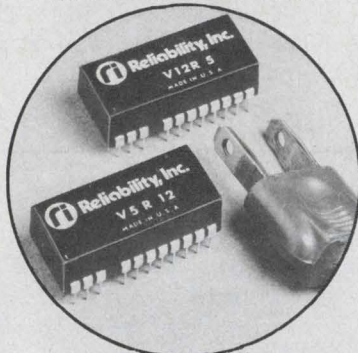

...On the PC card!

Have 5 or 12v DC, and need power for RAMs, ROMs, UARTs, OpAmps, line drivers? Use new regulated V-PAC* DC-DC power sources. Isolated, protected against shorts and thermal overload, use them for either positive or negative voltage.

DC inputs: 5 or 12v

DC outputs: 3 to 15v (see table)

Output voltage tolerance: $\pm 5\%$

Output ripple: 100 mv, P-P, max.

Line regulation: $\pm 0.2\%$

Load regulation: 150 mv, no load to full load

Operating temperature range: 0 to 70°C

Temperature coefficient: $\pm 3\text{mv}/^\circ\text{C}$

Package: 24 pin DIP. .6 X 1.25 X .4 inches

Price: \$33.25 in 1 to 9 quantities.

12v input Part type	5v input Part type	Output v DC	Output Ma
V12R 3	V5R 3	3	90
V12R 5	V5R 5	5	100
V12R 9	V5R 9	9	90
V12R 12	V5R 12	12	80
V12R 15	V5R 15	15	65



Reliability, Inc.

5325 Glenmont/Houston, Texas 77036
713-666-3261/TWX: 910-881-1739

Facilities in Nenagh, Ireland

*Trademark, Reliability, Inc.

Price subject to change without notice

COMPONENTS

SIP resistor networks feature low profile

Beckman Instruments Inc., 2500 Harbor Blvd., Fullerton, CA 92634. (714) 871-4848. \$0.65: 764-1; \$0.60: 764-3; stock.

Two new series of single in-line package (SIP) resistor networks feature a low profile (0.2-in. max) that provides direct package height compatibility with DIP ICs. Series 764-1 contains seven equal resistors with a common termination at pin 1; Series 764-3 contains four equal but isolated resistors. Each eight-pin SIP is available in standard values ranging from 22 Ω to 100 k Ω . Resistor tolerance is $\pm 2\%$ or $\pm 2\%$. Total package power dissipation rating is 1.5 W at 25 C. Individual resistor power rating is 0.175 W for the 764-1 and 0.2 W for the 764-3. Maximum recommended temperature is 125 C.

CIRCLE NO. 349

Hermetic relays switch 10-A resistive loads

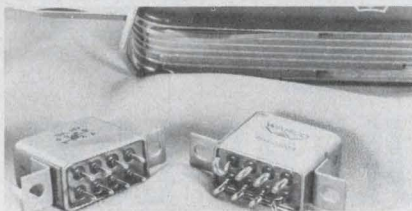

Westinghouse Air Brake Co., Pittsburgh, PA 15218. (412) 242-5000. \$8.50 (1000 up); 8 to 10 wks.

Four general-purpose DPDT rotary relays, designated Type 905, are hermetically sealed, weigh a maximum of 1.28 oz, measure slightly over 1 in. from top of case to bottom of insertion pins and are 0.525-in. wide and 1.718 in. between the outsides of the two mounting brackets. The relays are available in four coil voltages—6, 12, 26.5 and 48 V dc, and in six standard mounting styles. Solder and plug-in terminals are offered. Contact rating is 10-A resistive, 4-A inductive, 3-A motor or 2-A lamp load at 28 V dc. Operating and release time maximums are 10 ms. Life is 100,000 operations for resistive loads, but only 20,000 for rated inductive loads.

CIRCLE NO. 350

DIP switch handles 1 A in calculator use

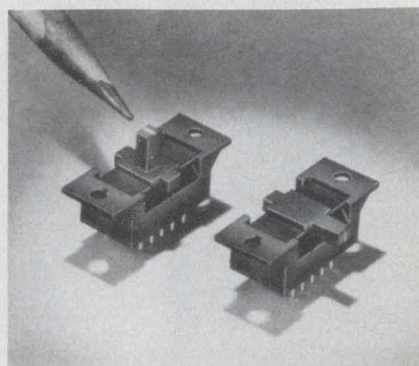

AMP Inc., Harrisburg, PA 17105. (717) 564-0101.

Designed for use in logic-level switching applications, such as desk calculators, this five-position DIP switch incorporates one normally open contact pair that closes and remains closed through four other normally closed switch positions. The switch body measures 0.75 L \times 0.44 W \times 0.38 H-in. with mounting holes on 0.937-in. centers. Lead spacing is the standard 0.1 \times 0.3-in. DIP pattern. At 12 V dc, the contact rating is 1 A nonswitching and 250 mA switching. Contact resistance is 100 m Ω maximum and dielectric withstanding voltage is 250 V ac. All contacts are phosphor bronze, plated gold over nickel, with an expected life of 100,000 crosspoint switchings. Vertical and right angle configurations are available.

CIRCLE NO. 351

Adjustable toroids use movable magnets

Nytronics, Orange St., Darlington, SC 29532. (803) 393-5421. From \$6.19 (100-up); 4 to 6 wk.

Tunable toroidal inductors permit stepless inductance adjustment over a $\pm 5\%$ range. The inductance of these Adjustoroids can be varied by turning a permanent magnet that is mounted in close proximity to the coil. Nominal inductance values of 0.01 to 12 Henries are available, $\pm 2\%$. The Adjustoroids are available in three cylindrical case sizes with diameters from 0.75 in. to 1.3125 in. and heights from 0.8125 to 1.1875 in., not including pin height. Custom units with hermetically sealed metal cases, tapped or multiple windings are also available.

CIRCLE NO. 352

Synchronous PM motor provides 10 oz-in.



Molon Motor & Coil Corp., 3737 Industrial Ave., Rolling Meadows, IL 60008. (312) 259-8700.

Model LMO 3000 permanent-magnet synchronous motors can be used either with 60 Hz at 300 rpm or 50 Hz at 250 rpm V. The units are reversible, capacitor types and provide a 10-oz-in. pull-out torque. Motors can be wound for input voltages that range from 6 to 240 V. Standard gear boxes can provide almost any desired rpm. The motor is also available as a stepper motor.

CIRCLE NO. 353

Terminal-strip barriers bend but don't break

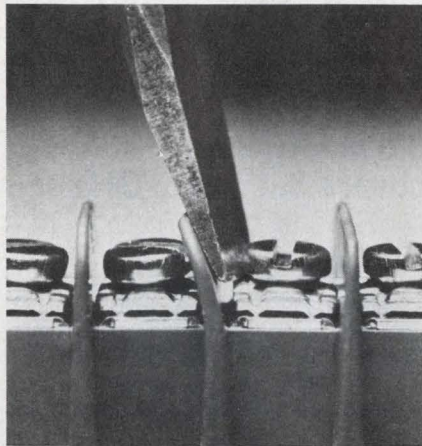

Vernitron Electrical Components, P.O. Box 10, Laconia, NH 03246. (603) 524-5101.

High-barrier resilient terminal strips, the new 72000 series, which can bend without breaking, are made of glass-filled thermoplastic materials with impact strength many times greater than phenolic. The terminals are rated at 20 A, 600 V and come in a single-row style with 1-to-26 terminals on 3/8-in. centers. Barrier strips have a minimum over-all height of 21/32 in.

CIRCLE NO. 354

MAG TAPE FOR NOVA

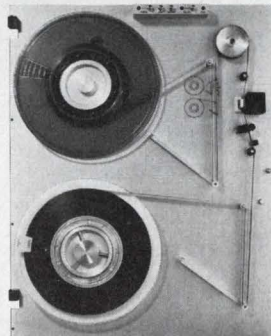

A great minicomputer deserves a great mag tape transport! Don't hang second-rate peripherals on your top-notch NOVA. Digi-Data offers you the finest quality tape-handling equipment available anywhere at any cost.

Phase-encoded, NRZI, or both together, and tape speeds to 45 ips. Prices start at \$4,750 for complete systems which are thoroughly checked out on our own NOVA's and supplied with diagnostic software.

Digi-Data also manufactures mag tape systems for D.E.C.'s PDP-11 and Hewlett-Packard's HP2100.

SEE THE REEL EXPERTS FOR YOUR MAG TAPE NEEDS NOW.



DIGI-DATA CORPORATION

8580 Dorsey Run Road, Jessup, Md. 20794 (301) 498-0200

Digi-Data Europe

Fluestrasse 632 5313 Klingnau Switzerland TELEX: 845-58555

INFORMATION RETRIEVAL NUMBER 61

Three Cheers for **FERRITES** from the Permag Team

1. With Permag supplying application-rated Indiana General Corp. Ferramics, you'll always get exactly what you need.
2. Complete fabricating facilities. Prototype quantities available. Plus engineering assistance, field testing.
3. Prompt 24-hour delivery. Extensive stock of ferrite parts at all locations. New catalog available. Yea Team!

FERRAMICS™ FROM PERMAG

Consult your Yellow Pages for address and telephone number of Permag near you.

Cable Address: MAGNETS NEWYORK

YOUR NO. 1 SOURCE FOR ALL MAGNETIC MATERIALS

PERMAG

ALL ACROSS THE COUNTRY

San Francisco Los Angeles Dallas Boston New York Chicago Toledo Atlanta

INFORMATION RETRIEVAL NUMBER 62

DIRECT FROM STOCK

**SINGLES
72⁰⁰**

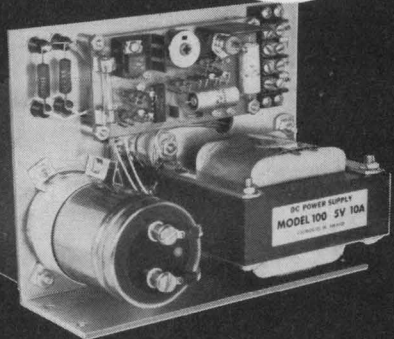

5V10A

**SINGLES AND DUALS
FULL RATING AT 71°C**

SPECIFICATIONS

Size: 7 x 5.5 x 5.5 overall
 Input: 105-125V, 47-420 Hz
 Output: Any DC voltage 3 to 30
 Regulation: Line — 0.005%
 Load — 0.05%
 Ripple: Less than 500 Microvolts
 Temp. Operative — 20 to +71°C
 Storage — 65 to +85°C
 Coefficient — 0.01%/°C Max.
 Current Limiting: Fixed Foldback Type
 Overvoltage: Optional

SINGLE OUTPUTS			DUAL OUTPUTS		
Model	Voltage	Amps	Model	Voltage	Amps
100-5	5.0	10.0	100-0505	5.0	5.0
				5.0	5.0
100-10	10.0	8.0	100-1212	12.0	3.5
				12.0	3.5
100-12	12.0	7.0	100-1515	15.0	3.0
				15.0	3.0
100-15	15.0	6.0	100-2424	24.0	2.0
				24.0	2.0
100-24	24.0	4.0	100-2828	28.0	2.0
				28.0	2.0

ORDERING INFORMATION

Quantity	Singles	With O.V.*	Duals	With O.V.*
1-9	\$72 ea	\$78 ea	\$85 ea	\$97 ea
10-14	68	73	81	91
25-49	62	67	73	83
50-99	57	61	67	76
100-	53	57	63	72

*O.V. = Overvoltage protection

CALL (714) 279-1414

Electrostatics, Inc.
 7718 CLAIREMONT MESA BLVD. • SAN DIEGO, CA 92111

MICROWAVES & LASERS

**4-to-8-GHz amps
use GaAs FETs**

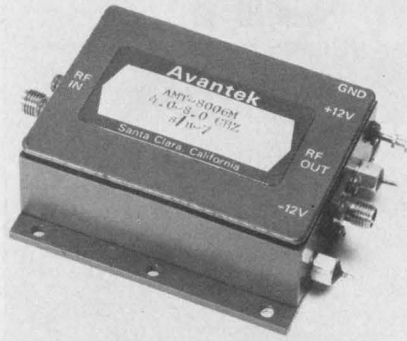

Avantek, Inc., 3175 Bowers Ave., Santa Clara, CA 95051. (408) 249-0700. 90-120 days.

The AMT-8000 series of GaAs-FET amplifiers features minimum-gain specs of 11 to 42 dB and gain flatness of 0.75 to 2.0 dB over the 4-to-8-GHz frequency range. Maximum noise figure is 8 to 9 dB. All units have an input and output VSWR of 2:1, and they list a +7-dBm output power for 1-dB gain compression. Also, typical intercept point for IM products is +20 dBm.

CIRCLE NO. 355

**Gunn osc has
high stability**

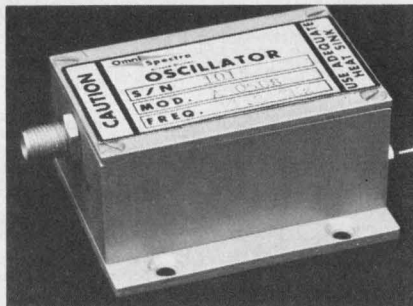

Omni Spectra, Inc., 1040 W. Alameda Dr., Tempe, AZ 85282. (602) 966-1471. \$425; 4-6 wks.

With an integral isolator and voltage regulator, the Model A3-0508 MIC Gunn oscillator guarantees the following: +17 dBm minimum output power and a 0.01% frequency stability over the temperature range of -55 to +110 C and with load pulling into all phases of a 2:1 VSWR. Operating over the 5-to-18-GHz range, the unit has a Gunn bias voltage of 15 V dc at 1 A minimum (including heater).

CIRCLE NO. 356

**Automatic osc permits
remote timing**

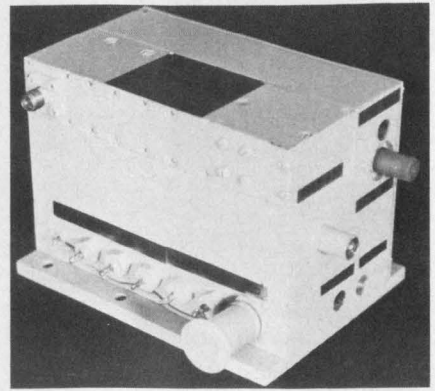

Solid State Technology, 3650 Charles St., Santa Clara, CA 95050. (408) 247-8620.

The SSXA series of automatic phase-locked oscillators provides remote tuning of output frequency by a simple change in the synthesizer input-reference frequency. Units are available in 3 to 10% bandwidths from 750 MHz to 18 GHz. Output power is 10 to 500 mW. FM noise is -90 dBc/kHz/10 kHz to 1 MHz typical. Harmonic rejection of output frequency is -30 to -50 dBc. Spurious rejection is greater than 60 dBc/kHz and AM noise is greater than -100 dBc/kHz.

CIRCLE NO. 357

**32-way divider
covers 3.4 to 4.2 GHz**

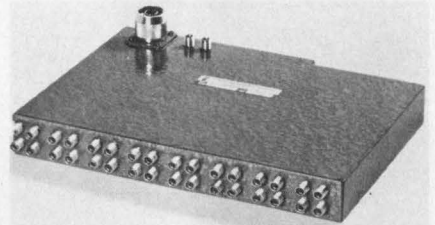

Sage Laboratories Inc., 3 Huron Dr., Natick, MA 01760. (617) 653-0844. \$1500; 60 days.

The FP279 series of 32-way power divider/combiners covers the 3.4-to-4.2-GHz range. Return loss is 19 dB minimum and insertion loss is 17.5 dB maximum. Output balance is ±0.5 dB. Isolation between outputs is 18 dB minimum. The input port connector is type N, and all output port connectors are type SMA. The Model FP279 measures 8 x 5.5 x 1 in.

CIRCLE NO. 358

Design Aids

SAMPLE

$$as^2 + bs + c \quad \text{*For HP-45, use any register.}$$

$$= a(s-r_1)(s-r_2)$$

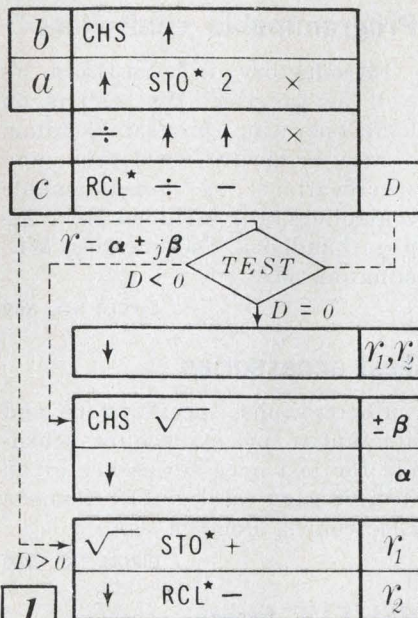

© fos-rch 1974

Program packages

Three programs are available that permit the HP-21, 35, 45 and 55 to compete with the HP-65 and solve problems that previously were reserved for large computers. Packages I, II or III, \$3.95 each with case. Package I is required for full use of Package II. Specify HP-21, 35, 45, or 55. FOS-RCH/Programs, 3120 Castle Oak Ave., Orlando, FL 32808.

INQUIRE DIRECT

Relay wall chart

A relay wall chart contains illustrations, specifications and a contact form arrangement diagram for 80 relays. Magnecraft.

CIRCLE NO. 359

Chip capacitors

Product performance, size, capacitance/voltage range and ordering information for both ceramic and tantalum chip capacitors are presented in a fold-out chart. Union Carbide.

CIRCLE NO. 360

Flat packs

Information on all-metal flat packages, an index showing suggested substrate sizes and availabilities of lids and preforms for each package is contained in a guide. Isotronics.

CIRCLE NO. 361

Surge suppressors

A surge suppressor cross-reference lists nearly 140 competitive

part numbers and the IR replacement units. International Rectifier, Semiconductor Div.

CIRCLE NO. 362

Meter-relay guide

Applications, specifications, photographs, model numbers and data sheet references for meter-relays, controllers and digital control meters are shown in a wall chart. LFE Corp.

CIRCLE NO. 363

Bright? Brighter? Brightest?
We'll help you
spot the difference.

There's one sure way to consistently and objectively measure light: the Spectra SpotMeter. The key is a high sensitivity, built-in photomultiplier tube and an internal, ultrastable calibrating source providing NBS-traceable light readings.

The unique optical system lets you measure luminance (brightness) as close as 2½" — or to infinity — without using supplementary lenses or other extras. What's more, it provides an unobstructed light measuring path free of mirrors, beamsplitters or fiber optics. The result? Zero polarization error. A full complement of optional accessories expands measurement capabilities over a wide range of lighting parameters.

For full data, write for brochure. Or call collect.

Spectra SpotMeter™

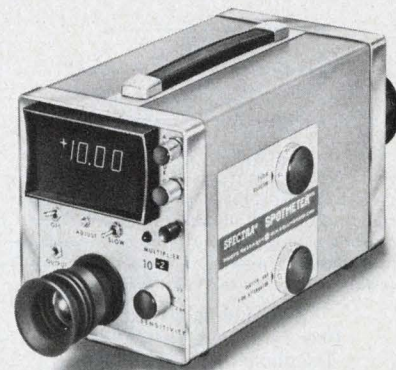

PHOTO RESEARCH
 A Division of Kollmorgen Corporation

3000 No. Hollywood Way, Burbank, CA 91505
 (213) 849-6017 • Telex 69-1427

The light measurement people

PULSE AMPS

C-COR

**Fast Rise Time
High Output
PULSE AMPLIFIERS
ARE the best.**

Performance is why!

FOR EXAMPLE:

MODEL	3310	3370-P	3374-P
Risetime	0.95 ns	0.6 ns	1.1 ns
Gain	30dB	20dB	20dB
Z In/Out	50/50 ohms	50/50 ohms	1m/50 ohms
Output	± 9 Vp into 50 ohms	± 3 Vp into 50 ohms	± 3 Vp into 50 ohms

For a complete amplifier catalog call, write, or wire:

C-COR
Electronics, Inc.

60 Decibel Road
State College, PA 16801
814-238-2461
TWX 510-691-1933

INFORMATION RETRIEVAL NUMBER 66

Circuit Savers



DC **95¢** 1000 pcs.

TRANSIENT SUPPRESSOR

SEE FURTHER INFORMATION ON OUR TECH-PACKS IN Electronic Design's GOLD BOOK

The TSD-1.5 Series are ideal for protection of long signal lines from damage from induced lightning etc. Reaction time is in nanoseconds.

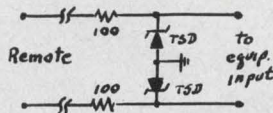

2 units (back to back) will protect sensitive components from a 5KV, 1ms duration transient. Clamp voltages from 5V to 200V. Call Mike Coyle for applications assistance. Full line of protection modules for every hi-lo voltage/current requirement. Write or call for Catalog 749.

279 Skidmore Road
Deer Park, New York 11729
Telephone: 516-586-5125

MCG Electronics

INFORMATION RETRIEVAL NUMBER 67

New Literature

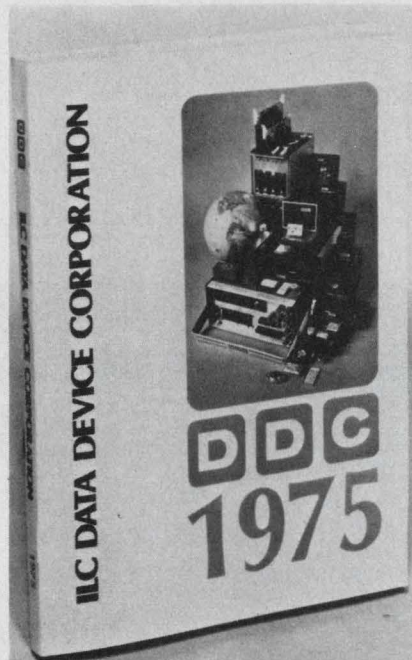

Data conversion guide

A 164-page data conversion products catalog includes application notes. Devices covered are a/d and d/a data conversion, video conversion, data conversion instrumentation and synchro converters. ILC Data Device, Bohemia, NY

CIRCLE NO. 364

Transducers

Pressure transducers and transducer-related instrumentation are featured in a 34-page catalog. Tyco Instrument Div., Lexington, MA

CIRCLE NO. 365

All-metal packages

All-metal packages, manufactured for the hybrid microcircuit industry, are covered in a fully indexed 128-page catalog. Isoelectronics, New Bedford, MA

CIRCLE NO. 366

Instrumentation

Ac and dc voltage and current standards, calibrators and precision sources are presented in a selection guide. Electronic Development, Boston, MA

CIRCLE NO. 367

Switchboard instruments

High-accuracy switchboard instruments are described in a 40-page, illustrated catalog. The catalog includes dimensional drawings, principles of operation, a glossary of technical terms and price information. General Electric, Schenectady, NY

CIRCLE NO. 368

Programmable controllers

Introductory information as well as practical discussions on logic operation, program loading, system hardware description and specifications of programmable controllers are included in a 28-page handbook. Datametrics, Wilmington, MA

CIRCLE NO. 369

Test accessories

Photographs, specifications and a quantity price discount schedule for test accessories are given in a 68-page catalog. ITT Pomona Electronics, Pomona, CA

CIRCLE NO. 370

RFI/EMC filters

Specifications for filters, rf filtered and shielded circuit-breaker panelboards, shielded enclosures and secure communications and signal line filters are presented in a 24-page handbook. Filtron, Chatsworth, CA

CIRCLE NO. 371

Small computers

"The Sensible Way to Use Computers" talks about using small computers to supplement or extend large, central computer systems. Data General, Southboro, MA

CIRCLE NO. 372

Linear integrated circuits

A 700-page data handbook, Linear Integrated Circuits, includes descriptions, specifications, graphs, charts, diagrams and selection and cross-reference indexes. For a free copy, write to Marketing Services Dept., National Semiconductor, 2900 Semiconductor Dr., Santa Clara, CA 95051

INQUIRE DIRECT

FOR PEOPLE WHO WANT TO READ ALL ABOUT IT!



We have nothing less than a fully illustrated, systematic, easy-to-use survey of the entire field of data management as it exists today. It covers it all, from A to Z, so it's for everybody. The programmer tightening up his files. The analyst working out a workable timesharing program. Top management needing industry-wide perspective on competitive system designs.

It's a rare publication that takes a unique "blueprint approach" to current know-how. Beginning with the single data item as the first building block in total system design. And progressing through specific techniques for data structures, streams, files . . . total hardware and operating system control . . . the latest advances in timesharing and multiprogramming . . . system modeling and simulation . . . complete

designs for various types of commercial accounting and document-oriented storage and retrieval systems. It all adds up to a vast and impressive "top to bottom" view.

And it does it all in fresh, jargon-free language, with scores of illustrations and diagrams for a rapid, visual grasp.

Whether you use it as an on-the-job manual, as a desk-top reference, or as a conference room companion with all the answers, it's an indispensable tool guaranteed to broaden your perspective and practical skill in a field that knows no limits to growth and progress. And generally give you the professional confidence that comes from knowing just about everything that's going on.

#5100-X, 6 x 9, 300 pages, cloth \$14.95

To Order:

Circle the **Information Retrieval Number** to order your 15-day free examination copy of **Data Management for On-Line Systems** by **David Lefkowitz**. At the end of that time please remit payment or return the book with no further obligation.



Hayden Book Company, Inc., 50 Essex Street, Rochelle Park, N. J. 07662

TO ORDER, CIRCLE 96



CONDUCTIVE CONNECTOR STRIPS

• Conductive and resilient elastomeric multiple connecting device • Standard contact spacing: 0.050" centers and 0.100" centers • Mounting holes are provided in carrier frames • Can be supplied with adhesive on sides for positioning and mounting • Applications include: Inter-connections of PC boards, liquid crystal displays and flat cable connections • Speeds assembly and reduces package volume.



EASTERN-DIVISION • 129 DERMODY ST. CRANFORD, N. J. 07016 (201) 272-5500
WESTERN-DIVISION • 427 OLIVE ST. SANTA BARBARA, CALIF. 93101 (805) 963-1867

INFORMATION RETRIEVAL NUMBER 69

ELECTRONIC ENCLOSURE

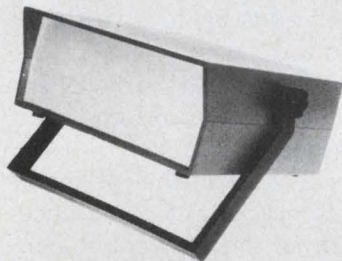

Approximate size:
3"H x 5"D x 7"W

Tracewell Enclosures are versatile, inexpensive, and adapt easily to a wide variety of stock or specialized applications.

The flat front panel readily accepts a wide range of digital panel meter sizes and can be easily punched and silkscreened. Both front and rear panels are 1/16 inch anodized aluminum; the exterior is 1/8 inch high-impact plastic.

Inside are molded-in vertical grooves for mounting printed circuit boards. The first four grooves are designed for many different style digital readouts. There are also molded-in standoffs for horizontal mounting. Several options including under-dash mounting bracket and height increase spacers are available.

TRACEWELL ENCLOSURES, INC.
200 Montrose Way Columbus, Ohio 43214

INFORMATION RETRIEVAL NUMBER 70

SUBSCRIBER SERVICE For prompt service include the addressed label when writing about your subscription.

CHANGE OF ADDRESS

city	company address	division/department	company	name	NEW ADDRESS
state				title	
zip					

If you're moving, please let us know six weeks before changing your address. If you have a question, place your magazine address label here and clip this form to your letter.

MAIL TO: ELECTRONIC DESIGN Circulation Dept. Hayden Publishing Co., Inc., 50 Essex Street, Rochelle Park, NJ 07662

NEW LITERATURE

Electrical insulation

Structural electrical insulation—radial spacer material, fiber boards, synthetic fiber-epoxy paper and flame retardant insulation boards—are listed in a folder. Rogers Corp., Rogers, CT

CIRCLE NO. 373

Power supply components

Typical schematics and suggested components for construction of low-cost, miniaturized, unregulated and regulated power supplies are provided in a bulletin. Microtran, Valley Stream, NY

CIRCLE NO. 374

Assembled instruments

High-performance assembled instruments, including oscilloscopes, frequency counters, digital multimeters, VOMs and VTMs, power supplies, generators and strip-chart recorders, are described in a catalog. Heath Co., Benton Harbor, MI

CIRCLE NO. 375

Ribbon cable newsletter

SPECTRA is published quarterly and includes design data, application notes and other articles of interest to ribbon cable users. Spectra Strip, Garden Grove, CA

CIRCLE NO. 376

Control transmitters

Four bulletins describe electronic transmitters for the process control industry. Each bulletin spotlights a single transmitter, giving descriptions, photographs, specifications, dimensional drawings and ordering information. Beckman Instruments, Process Instruments Div., Fullerton, CA

CIRCLE NO. 377

Image converters

Principles of operation, specifications and applications of 11, 17 and 25-mm single stage, electrostatically focused tubes are covered in a four-page brochure. ITT Electro-Optical Products, Roanoke, VA

CIRCLE NO. 378

Vendors Report

Annual and interim reports can provide much more than financial-position information. They often include the first public disclosure of new products, new techniques and new directions of our vendors and customers. Further, they often contain superb analyses of segments of industry that a company serves.

Selected companies with recent reports are listed here with their main electronic products or services. For a copy, circle the indicated number.

Cutler-Hammer. Electrical and electronic control components, systems and subsystems.

CIRCLE NO. 379

Data-Design Laboratories. Engineering services and engineered products.

CIRCLE NO. 380

Calcomp. Computer peripheral equipment.

CIRCLE NO. 381

AMP. Connectors, splices, flexible circuits, receptacles, flexible cable, tools and ties, switches and relays.

CIRCLE NO. 382

Beckman. Analytical and electronic instruments, precision electro-products and chemical products.

CIRCLE NO. 383

Computer Communications. Communications processors and terminals.

CIRCLE NO. 384

Tandy. Consumer electronics and electronic components.

CIRCLE NO. 385

Datatron. Test systems, editing systems, microelectronic testing laboratories and displays.

CIRCLE NO. 386

United Cable Television. Cable TV and common-carrier microwave facilities.

CIRCLE NO. 387

TeleMation. TV studio equipment.

CIRCLE NO. 388

17,568 design possibilities

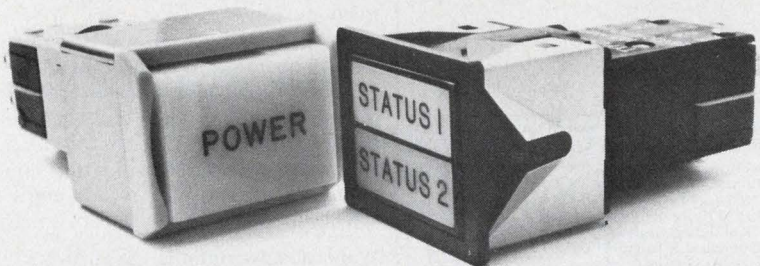

That's how many combinations you can have with Illuminated Products' new Series 700/800 Presslite switches. Nine vivid colors. With barriers or without. Black or light grey housings. Snap-in or hard mount versions. One or two lamps. Split or single legend. One or two poles. Single or double throw. Alternate or momentary action. All this in a 10.5 amp switch that's impossible to tease. Write or call: Illuminated Products Inc., 207 S. Helena St., P.O. Box 4011, Anaheim, CA 92803. (714) 535-6037.

ILLUMINATED PRODUCTS INC.

A Subsidiary of OAK Industries Inc.

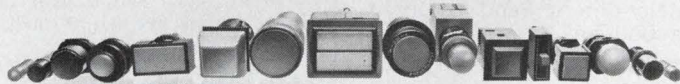

One innovation in a series.

INFORMATION RETRIEVAL NUMBER 71

Built to amplify, no matter what the impedance.



The DC-300A power amplifier drives low impedance loads at full rated power as long as needed. Dependable AC or DC power for servo motors or force transducers.

Rated power 150 watts per channel (600 watts balanced single channel) into 8 ohms. Maximum power

depends on exact load impedance and operation of thermal overload protection. Essentially flat frequency and phase response from DC to 20KHz. Not affected by shorted, mismatched or open loads. Will not self-destruct under any conditions of use.

Sounds expensive? For three years your total cost is the original list price of \$799.00. Crown guarantees that the DC-300A will work as specified during that time or we'll fix it free—and pay shipping costs.

Interested? Send for spec sheet.



CROWN INTERNATIONAL

Industrial Products Division
1718 W. Mishawaka Road, Elkhart, IN 46514

INFORMATION RETRIEVAL NUMBER 72

recruitment and classified ads

FREE ALARM CATALOG

Huge selection of burglar & fire systems, supplies. Motion detectors, infrared beams; controls, door switches, bells, sirens. 500 items, 99 pp. packed with technical details, notes.

(Outside U.S., send \$1.00.)



mountain west alarm
4215 n. 16th st., phoenix, az. 85016

CIRCLE NO. 203

STRETCH YOUR BUDGET!

Reconditioned Scopes, SS Power Supplies, Freq. Counters & Generators - Many others. Send for our: "Bargain Bulletin"

Lawrence Instruments, Sunbury PA

CIRCLE NO. 204

Help college help you.

Businesses like yours gave over \$340,000,000 to higher education last year.

It was good business to do so. Half of all college graduates who seek work go into business. The more graduates there are, and the better educated they are, the more college serves the business community.

Your money was vital to colleges. It relieved financial pressures, made planning more flexible, and contributed to the kind of basic and applied research that puts new knowledge and technology at the service of industry.

So that colleges can continue to help you, give to the college of your choice now. For information on ways to do it, please write on your letterhead to Council for Financial Aid to Education, Inc., 6 East 45th Street, New York, N.Y. 10017. Ask for the free booklet, "How Corporations Can Aid Colleges and Universities."



Council for Financial Aid to Education, Inc.

Advertising contributed for the public good.



Electronic Design

ELECTRONIC DESIGN's function is:

- To aid progress in the electronics manufacturing industry by promoting good design.
- To give the electronic design engineer concepts and ideas that make his job easier and more productive.
- To provide a central source of timely electronics information.
- To promote communication among members of the electronics engineering community.

Want a subscription? ELECTRONIC DESIGN is sent free to qualified engineers and engineering managers doing design work, supervising design or setting standards in the United States and Western Europe. For a free subscription, use the application form bound in the magazine. If none is included, write to us direct for an application form.

If you do not qualify, you may take out a paid subscription for \$30 a year in the U.S.A., \$40 a year elsewhere. Single copies are \$1.50 each.

If you change your address, send us an old mailing label and your new address; there is generally a postcard for this bound in the magazine. You will have to requalify to continue receiving ELECTRONIC DESIGN free.

The accuracy policy of ELECTRONIC DESIGN is:

- To make diligent efforts to ensure the accuracy of editorial matter.
- To publish prompt corrections whenever inaccuracies are brought to our attention. Corrections appear in "Across the Desk."
- To encourage our readers as responsible members of our business community to report to us misleading or fraudulent advertising.
- To refuse any advertisement deemed to be misleading or fraudulent.

Microfilm copies are available of complete volumes of ELECTRONIC DESIGN at \$19 per volume, beginning with Volume 1, 1952 through Volume 20. Reprints of individual articles may be obtained for \$3.00 each, prepaid (\$.50 for each additional copy of the same article) no matter how long the article. For further details and to place orders, contact the Customer Services Department, University Microfilms, 300 North Zeeb Road, Ann Arbor, Michigan 48106 telephone (313) 761-4700.

Want to contact us? If you have any comments or wish to submit a manuscript or article outline, address your correspondence to:

Editor
ELECTRONIC DESIGN
50 Essex Street
Rochelle Park, N.J. 07662

Double up, America.



Two can ride cheaper than one.

When people carpool, companies benefit directly, because, obviously, fewer cars will make less demand on the parking spaces in the company lot. And some companies have attributed an increase in punctuality to the fact that more and more of their employees were carpooling.

Find out how you can help organize carpools. For your "Double up Kit," write to Double up, U.S. Department of Transportation, P.O. Box 1813, Washington, D.C. 20013.



A Public Service of This Magazine & The Advertising Council



Electronic Design

Advertising Sales Staff

Tom W. Carr, Sales Director

Rochelle Park, NJ 07662

Robert W. Gascoigne

Daniel J. Rowland

(Recruitment, Quick Ads, Classified)

50 Essex Street

(201) 843-0550

TWX: 710-9990-5071

Philadelphia

Thomas P. Barth

50 Essex Street

Rochelle Park, NJ 07662

(201) 843-0550

Boston 02178

Gene Pritchard

P.O. Box 379

Belmont, MA 02178

(617) 489-2340

Chicago 60611

Thomas P. Kavooras

Berry Conner, Jr.

200 East Ontario

(312) 337-0588

Cleveland

Thomas P. Kavooras

(Chicago)

(312) 337-0588

Los Angeles 90045

Stanley I. Ehrenclou

Burt Underwood

8939 S. Sepulveda Boulevard

Suit 510

Los Angeles, CA

(213) 641-6544

San Francisco 94040

Robert A. Lukas

3579 Cambridge Lane

Mountain View, CA 94040

(415) 965-2636

London, Amsterdam, Tokyo, Seoul

John Ashcraft

12, Bear St.

Leicester Square

London WC2H 7AS England

Phone: 01-930-0525

W. J. M. Sanders

John Ashcraft & Co.

Herengracht 365

Amsterdam C., Holland

Phone: 020-24-09-08

Haruki Hirayama

Electronic Media Service

5th Floor, Lila Bldg.,

4-9-8 Roppongi

Minato-ku, Tokyo, Japan

Phone: 402-4556

Cable: Electronicmedia, Tokyo

Mr. O-kyu Park, President

Dongbo Int'l Corp.—

World Marketing

C.P.O. Box 4010

Seoul, Korea

Tel. 76-3910/3911

Cable: DONGBO SEOUL

Telex: EBKOREA K27286

Design Data from Manufacturers

Advertisements of booklets, brochures, catalogs and data sheets. To order use Reader-Service Card (Advertisement)



NEW PORTABLE MINI-UBIQUITOUS® NEVER FORGETS!

For on-site instant diagnosis of noise/vibration, 440A real-time universal frequency analyzer/averager/waveform recorder **always "remembers"** to write test conditions and readings on its CRT—a Polaroid photo preserves them: perfect for inexperienced personnel.

Detects closely-spaced frequencies with 400-point resolution; senses small signals over a 60 dB (1000:1) dynamic range (greater with averaging). All-digital design means precision without recalibration. Includes digital reading of both frequency and amplitude at cursor. On-line real-time display of instantaneous frequency spectra and changing average; viewing and plotting of input time signal. Plug-in modules for special/future jobs. Annotated photos, X-Y plots, or digital recordings.

For machine analysis: reads frequency directly in RPM and Hz; harmonics are automatically identified. **For noise reduction:** subtracts factory background noise from a machine noise spectrum; log frequency scales available. **For machine failure prediction:** signature analysis of rotating machines in terms of orders; direct readout of differences between present and past spectra. **For automatic systems:** digital input or output, remote control/sensing. **For transients:** transient waveform can be held, viewed and plotted before analysis; spectrum of transient is undistorted because of **true flat weighting**.

CIRCLE NO. 171

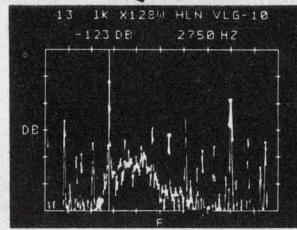

Nicolet Scientific Corporation (formerly Federal Scientific Corp.)

245 Livingston St., Northvale, N.J. 07647, 201-767-7100 TWX: 710 991 9619

Low-Noise High-Gain Pre amplification

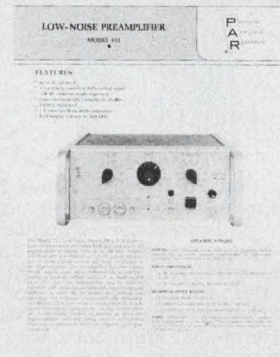

Complete specifications of a variable-bandwidth high-gain preamplifier are contained in the Model 113 data sheet, T-224. Included are typical noise figure contours illustrating the amplifier's exceptionally low noise, which is as low as .05 dB at mid frequencies with a 1 megohm source. Other illustrations include typical plots of the equivalent input noise and common mode rejection, which exceeds 100 dB at 60 Hz at all gain settings. The data contained in the specification sheet will be of interest to all engineers and researchers looking for a preamplifier with calibrated gain and rolloffs from dc to 300 kHz.

CIRCLE NO. 172

Princeton Applied Research Corporation

Box 2565, Princeton, New Jersey 08540 - (609) 452-2111

GIANT FREE CATALOG

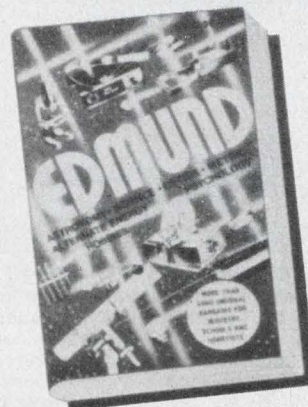

New 180-page catalog! Packed with 1,000's of hard-to-find buys in Optics, Science, Electronics. Loaded with optical, scientific, electronic equipment available from stock. Rare surplus buys. Many "one-of-a-kinds". Ingenious scientific tools. Components galore: lenses, prisms, wedges, mirrors, mounts, accessories. 100's of instruments: pollution test equipment, lasers, comparators, magnifiers, microscopes, projectors, telescopes, binoculars, photo attachments, alternate energy sources. Shop, save by mail! Request free Catalog "DA".

CIRCLE NO. 173

Edmund Scientific Co.

America's Largest Science-Optics-Electronics Mart

300 Edscorp Bldg., Barrington, New Jersey 08007 (609) 547-3488

ABP

BPA

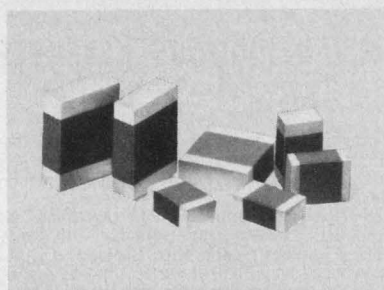

HIGH Q MULTILAYER CAPACITORS feature very high quality factors at microwave frequencies. Offered in three standard sizes: .050 x .040, .080 x .050, .125 x .095. Capacitance values from 0.1 pf to 1000 pf with close tolerance and voltages to 1000 VDCW. Johanson/Monolithic Dielectrics Div., Box 6456, Burbank, Ca. 91510, (213) 848-4465.

MULTILAYER CHIP CAPACITORS 601

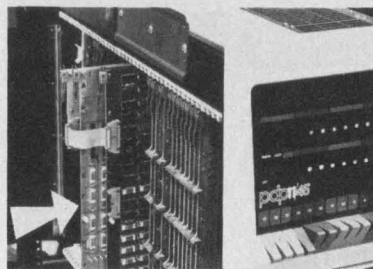

Cache Buffer for PDP 11/45. Model 4511 buffers entire 124k main core memory of PDP 11/45, achieving effective MOS speed of 450 nsecs, without 32k MOS limitation. Plug-compatible, bipolar technology, contained on 3 p.c. cards. Installs in minutes. Fabri-Tek, Inc. 5901 S. County Rd. 18, Mpls., MN 55436. (612) 935-8811.

CACHE BUFFERS 604

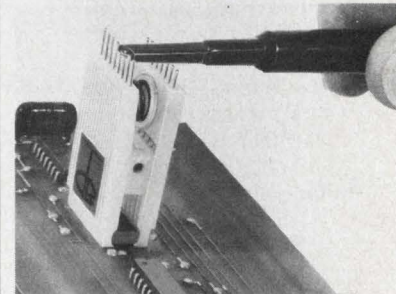

IC Test Clips: New Lower Prices. Eleven models of A P Test Clips provide full access to standard and LSI DIP leads . . . solve probe attachment problems . . . remove DIP's damage-free. Typical reduced prices: TC-14: \$5.25 TC-16: \$5.75. TC-24: \$13.85. Gold-plated contacts. Free catalog. A P Products Inc. Box 110-D, Painesville, OH 44077.

TEST CLIPS 607

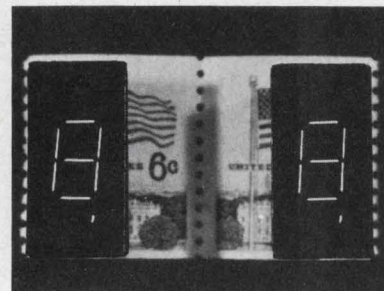

The Proven Incandescent Readout Standard 16 Pin DIP Flat Pack. All units 5 Volt 100,000 hrs. plus 3015F-BM 08ma/seg 700 ft/lam 3015F-BM10 10ma/seg 1700 ft/lam 3015F-BM15 15ma/seg 4500 ft/lam Field tested over 4 years in many applications. READOUTS, INC. P.O. Box 149, Del Mar, Ca. 92014 Tel. 714-755-2641 Telex 69-7992.

DISPLAY 602

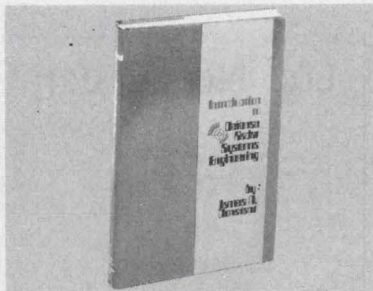

Introduction To Defense Radar Systems Engineering. Excellent introduction and practical reference to radar systems design and applications. #9194, 260 pp., \$22.95. Circle the Info Retrieval No. to order 15-day exam copy. When billed, remit or return book with no obligation. Hayden Book Co. 50 Essex St. Rochelle Park, N.J. 07662

RADAR SYSTEMS 605

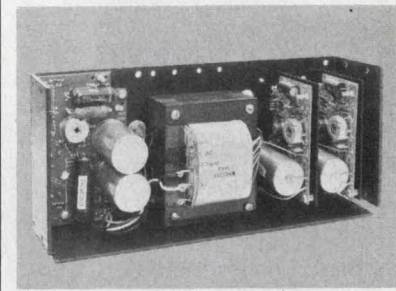

OPEN FRAME POWER SUPPLIES in single, dual or triple output feature IC control, copper shield in transformer, teflon wiring, and computer grade electrolytics. Options include 230 vac input, remote sense, and built-in OV protection. Dynage, Inc., 1331 Blue Hills Avenue, Bloomfield, Conn. 06002 203-243-0315

POWER SUPPLIES 608



NEW TOPAZ AC LINE REGULATORS FEATURE: • 98% efficiency • Small size and weight • Very low distortion • Wide input voltage range • Excellent response Prices start at \$245. Models from 500 VA to 24 kVA. Delivery from stock. TOPAZ ELECTRONICS, 3855 Ruffin Road, San Diego, CA. 92123

AC LINE REGULATORS 603

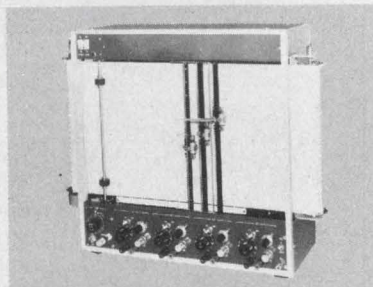

D-73BP Three pen X-Y, Y₂, Y₃ T Recorder features single X-axis common to 3 electrically independent Y axes. Use as a 3-channel recorder for accurate time correlation and greatly extended duration. Sensitivity: 2, 5, 10, 50, 100, 500mV, 1, 5, 10, 50 100V/full scale. Riken Denshi Co. Ltd. 5-5-2, Yutenji, Meguro-ku, Tokyo, Japan. tel (03) 711-6656.

RECORDER 606

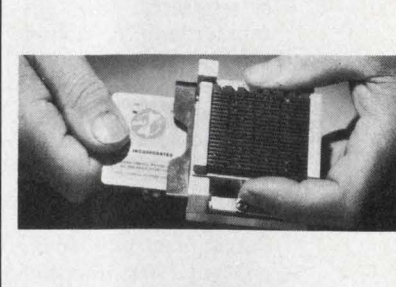

Where new high security starts, at low, lock-and-key prices. We introduce the AMP 130 Security Card Reader—a high reliability, low-cost first. It could revolutionize your thinking in large-volume access-control applications—hotels, motels, offices, computer peripherals. Or in timekeeping, personnel identification, factory-control equipment, etc. No external power, no complex mechanisms—operates with the insertion of a standard 2 1/8 x 3 3/8" punched card. Has a maximum capacity of 80 bits. Never needs adjustment or preventive maintenance. Compact, rugged, built to withstand a lot of user abuse. AMP Captron Division, Elizabethtown, Pa. 17022. (717) 367-1105.

SECURITY CARD READER 609

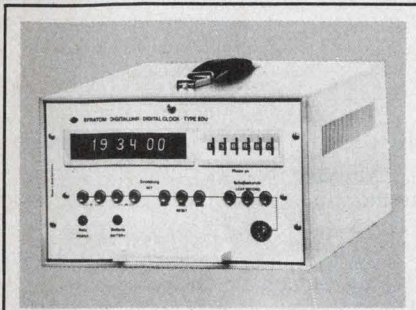

DIGITAL CLOCK EDU—High resolution timing unit for frequency standards e.g., our FRT. Accepts external sync. Displays hrs, min, secs, and leap sec. correction. Outputs BCD time data and IPPS timing ref. TTL. Time setting accuracy 500 nano-seconds. Efratom Cal., Inc., 3303 Harbor Blvd., El, Costa Mesa, CA 92626 (714-556-1620)

DIGITAL CLOCK

610

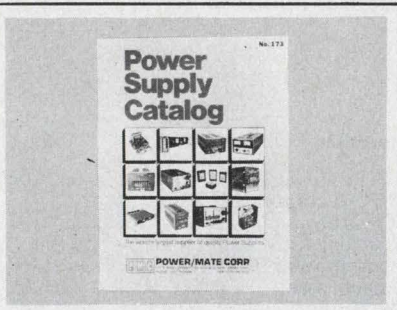

Free catalog of 34,500 power supplies from the worlds largest manufacturer of quality Power Supplies. New '74 catalog covers over 34,500 D.C. Power Supplies for every application. All units are UL approved, and meet most military and commercial specs for industrial and computer uses. Power Mate Corp. (201) 343-6294.

POWER SUPPLY

613

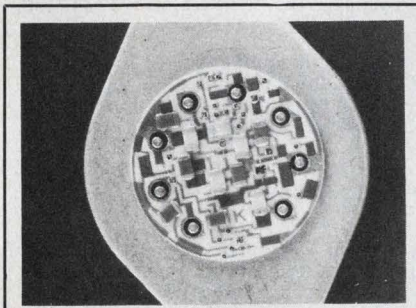

MSK MODEL 150. High Voltage—High Current Operation Amplifiers. 1 Amp Output Current. ± 20 Volt Output. Full Mil Temperature Range. Short Circuit Protected. TO-3 Package. Designed specifically for Synchro Applications. 100 pc. price \$58.00 ea. M.S. KENNEDY CORP. Syracuse, N.Y. (315) 455-7077

AMPLIFIERS

611

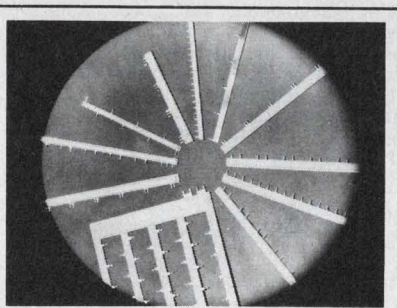

Mini/Bus® Evaluation Kit, \$25, in stock. Lets you try Rogers' low-cost, noise attenuating, high packaging density power distribution system for PC boards. Millions in use. Standard parts on 2 weeks delivery, or less! Customer parts 4 to 6 weeks delivery. Rogers Corporation, Chandler, Ariz. 85224. Phone (602) 963-4584

MINI BUS

614

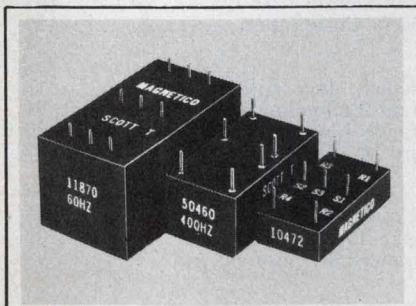

Scott T Transformer. 11870: 60HZ, 90v, L-L in. 1.1x2.1x1.1. 50460: 400HZ, 90v, L-L in. 7/8x1-5/8 x11/16. 50642: 400HZ, 11.8v, L-L in. 7/8x1-5/8-11/16. 10472: 400-HZ, 11.8v, L-L in. 3/4x1-1/2x3/8. All with 6v RMS sine & cosine output. MAGNETICO, INC., 182 Morris Ave, Holtsville, N.Y. 11742 516-654-1166.

TRANSFORMER

612

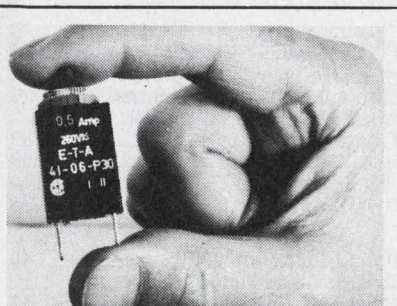

Overcurrent Protector, manual reset eliminates fuse replacement. Convenient panel mounting. 15 fractional ratings from 0.1 to 3 amp. Other models up to 400 amp. Trip-free and fool-proof, UL and CSA approved. High quality, low cost \$1.29 ea. in 1000 lots. E-T-A Products Co. of America, 7400 N. Croname Rd., Chicago, Ill. 60648. Tel: (312) 647-8303. Telex: 253780.

CIRCUIT BREAKER

615

Advertisers wishing to reserve Quick Ad units should note the following mechanical requirements: Specs—Supply glossy photo of product and approximately 40 words which will set no more than 10 lines of 34 characters each. AFTER SUBMISSION NO COPY CHANGES CAN BE ACCEPTED. Quick Ads cost only \$325 per insertion, less for frequency advertisers.

RATES:

1x
\$325

7x
\$300

13x
\$275

19x
\$270

26x
\$265

39x
\$260

52x
\$255

104x
\$250

A GOLD MINE OF INFORMATION & DATA

- **520** CATALOG PAGES ON ICs & SEMICONDUCTORS
- **300** CATALOG PAGES ON INSTRUMENTS
- **290** CATALOG PAGES ON POWER SUPPLIES
- **210** CATALOG PAGES ON WIRE & CONNECTOR PRODUCTS
- **150** CATALOG PAGES ON SWITCHES
- **2800** CATALOG PAGES ALL TOLD IN 52 PRODUCT CATEGORIES

Electronic Design's GOLD BOOK puts the entire electronics industry at your fingertips. Use it for product search, selection, specification and purchase. It's the most thorough industry master catalog & directory ever compiled.

When you need Information . . .

Electronic Design's

GOLD BOOK IS THE PLACE TO LOOK

Advertiser's Index

Advertiser	Page	Advertiser	Page
A P Products Inc.....	102	Intel Memory Systems.....	76
AMP, Incorporated, Capatron Division	102	Intronics Industries, Inc.....	88
Accutronics, A Hammond Corporation Company	50	Johanson Manufacturing Corp.....	7
Acopian Corp	69	Johanson/Monolithic Dielectrics Division	102
Advertising Council, The.....	100, 108	Kennedy Corporation, M. S.	103
Allen Bradley Co.....	12	MCG Electronics	96
American Technical Ceramics.....	79	Magnecraft Electric Company...Cover III	
Amphenol Industrial Division, Bunker-Ramo Corp.	35	Magneto, Inc.	103
Angstrom Precision, Inc.....	84	Microswitch, A Division of Honeywell	8, 9
Arnold Magnetics Corp.....	90	Mini-Circuits Laboratory, A Division of Scientific Components Corp.	2, 36
Arrow-M Corp.	73	Motorola Semiconductor Products, Inc.	17, 18, 19, 20
B & K Products of Dynascan.....	42	National Semiconductor Corporation	62, 63
Bodine Electric Company.....	85	Nichicon America Corporation.....	107
Bunker-Ramo Corp., Amphenon Industrial Division	35	Nicolet Scientific Corp.....	101
C-Cor Electronics, Inc.....	96	Omron Corporation of America	75
Control Data Corporation.....	11	Perfection Mica Company.....	86
Coors Porcelain Company.....	22	Permag	93
Crown International Industrial Products Division	99	Photo Research, A Division of Kollmorgen Corporation	95
Curtis Industries, Inc.....	42	Pomona Electronics, A Division of ITT	105
Cutler-Hammer, Specialty Products Division	14, 15	Power One, Inc.....	107
Delta Products, Inc.....	85	Power/Mate Corp.	103
Digi-Data Corporation	93	Power Supply Co., The.....	67
Dranetz Engineering Laboratories, Incorporated	39	Princeton Applied Research Corp.....	101
Dynage Inc.	102	RCA Solid State	Cover IV
Dynascan Corporation	42	RCL Electronics, Inc.....	34
EECO	Cover II	Readouts, Inc.	102
E-T-A Products Co. of America.....	103	Reliability, Inc.	92
Edmund Scientific Company.....	101	Reticon	81
Efratom California, Inc.....	103	Riken Denshi Co., Ltd.	102
Elec-Trol, Inc.	89	Rogers Corporation	103
*Electronic Design	16, 75	Siliconix, Incorporated	13
Electronic Measurements, Inc.....	87	Sound Technology	91
Electrostatics, Inc.	94	Sprague Electric Company	10
Fabri-Tek Inc.	102	Superior Flux Company.....	89
Fluke Mfg. Co., Inc., John.....	51	Tecknit	98
GTE Automatic Electric.....	16	Topaz Electronics	102
General Instrument Corporation, Rotating Memory Products.....	27	Tracewell Enclosures, Inc.	98
Globe-Union, Inc., Gel/Cell Division	89	USCC/Centralab Electronics Division, Globe-Union, Inc.....	82, *83
*Gold Book, The.....	12, 69	Vactec, Inc.	29
Gold Book, The.....	56, 57, 104	Wavetek Indiana Incorporated.....	1
Grayhill, Inc.	78	Woven Electronics	6
Hamlin, Incorporated	40		
Harris Semiconductor, A Division of Harris Corporation.....	31		
Hayden Book Co., Inc.	21, 33, 43, 97, 105		
Hewlett-Packard	71		
Hoffman Engineering Company.....	107		
Honywell Test Instruments Division	25		
Illuminated Products Inc.	99		
Industrial Electronic Engineers, Inc.	61		
Intech, Incorporated	80		
Intel Corporation	4, 5		

*Advertisers in non-U.S. edition.

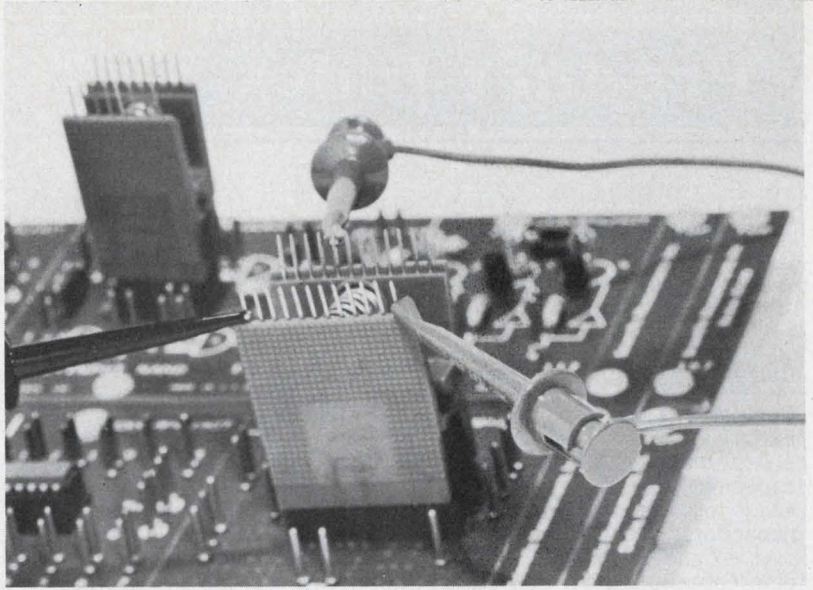
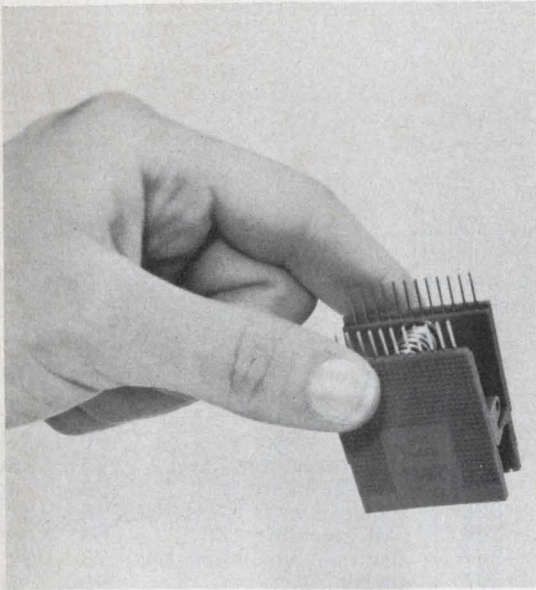

dip clip & 1/2

24-pin dual in-line packages can now be quickly and easily tested with the new Model 4124 24-lead Dip Clip. Test contacts are elevated for easy attach-

ment of test probes, and separated to greatly reduce the possibility of accidental shorting while testing live circuits.



POMONA ELECTRONICS

1500 East Ninth St., Pomona, California 91766 Tel: (714) 623-3463

A Division of ITT

INFORMATION RETRIEVAL NUMBER 75

Do you train or retrain employees? Consider these famous courses...

BASIC ELECTRICITY

By Van Valkenburgh, Nooger & Neville, Inc.

This simplified illustrated course is the civilian version of the Basic Electricity course used for years by the U.S. Navy and requires no previous background in electricity and little mathematics. The step-by-step approach covers basic concepts from electromagnetism to AC and DC circuits and motors. Frequently only one new concept is introduced on each page and it is amplified by at least one illustration per page. Each topical section concludes with helpful review pages. In five volumes, 624 pages.

- Paperbound set, #0033-2, \$18.40
- Combined Cloth Edition, #0039-1, \$16.70



HAYDEN BOOK COMPANY, INC., 50 Essex St., Rochelle Park, N.J. 07662

Please send me the book(s) checked above on 15-day free examination. At the end of that time, I will remit payment, plus postage, or return the book(s) with no further obligation. **Save Money!** Payment enclosed. Publisher will pay all shipping and handling charges—same 15-day guarantee.

BASIC ELECTRONICS

By Van Valkenburgh, Nooger & Neville, Inc.

Any trainee with a basic knowledge of electricity (equivalent to *Basic Electricity* study) can master the fundamentals of electronics with this progressive course. *Basic Electronics* explains all vital concepts in a logical, step-by-step sequence — from power supply elements and circuits through amplifiers, transmitters, receivers and transistors. In six volumes, 680 pages.

- Paperbound, #0048-0, \$22.15
- Combined Cloth Edition, #0049-9, \$19.50

Tests (and answers) for both courses are available for group and self-study applications.

Prices subject to change without notice.

Name _____
Firm _____
Address _____
City/State/Zip _____

Free!

Polyester Film Capacitor Catalogs

Request your choice of Polyester Film or Metallized Polyester Film catalogs today. For more than five decades the name Nichicon has been synonymous with outstanding quality and new developments in the international electronics field.

PRODUCTION ITEMS: Electrolytic Capacitors, Ceramic Capacitors, Film Capacitors, Oil Filled Capacitors—without P.C.B., Metallized Paper Capacitors, Wax Paper and Mica Capacitors, Hybrid IC's and P.T.C. Thermistors.

nichicon We help keep your world turned on.

NICHICON AMERICA CORPORATION
 Division of NICHICON CAPACITOR LTD., Kyoto, Japan
 6435 N. Proesel, Chicago, Ill. 60645 (312) 679-6530
 40 Orville Dr., Bohemia, N.Y. 11716 (516) 567-2994

INFORMATION RETRIEVAL NUMBER 78

NEW POWER FROM POWER-ONE

HIGH VOLTAGE

\$29.95
Single Quantities

Powers the new "self-scanning" gas discharge displays as well as conventional display devices. IC regulated performance and reliability in a popular open-frame package.

FEATURES: 115/230 VAC Input • $\pm .05\%$ Regulation • 10 mv Ripple • Foldback Overload Protection • 50 μ sec Response • IC Regulated • UL Recognized • 2 Hour Burn-in • 2 Year Warranty

MODELS: HB200 - .12, 175 - 210 VDC @ .12A
 HB250 - .10, 240 - 260 VDC @ .10A

For a catalog on our complete OEM power supply line, contact Power-One or your local factory representative.



531 Dawson Dr. Camarillo, Ca. 93010
 Phone: 805/484-2806 TWX: 910-336-1297

POWER-ONE, INC.

INFORMATION RETRIEVAL NUMBER 80

ELECTRONIC DESIGN 14, July 5, 1975

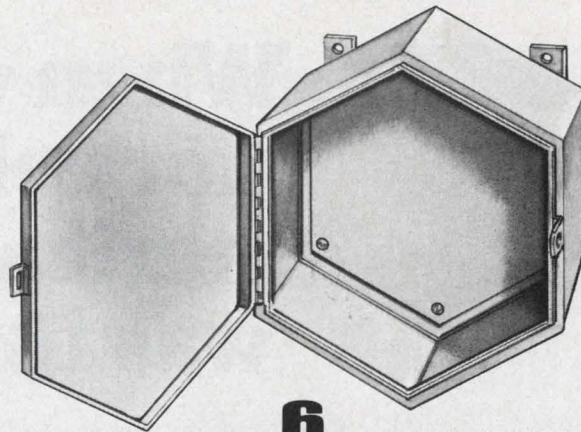

6 angles to consider in filling your enclosure needs:

1. You'll be looking for a company with real depth in know-how to carry out the details of your special requests. Hoffman has a large staff of knowledgeable engineers and years of manufacturing experience.
2. You want a supplier with a broad production capability. You'll find that at Hoffman. Our factory is equipped to produce over 1,700 standard products and hundreds of custom jobs on a continuing basis.
3. You'll want to deal with a company with a dedication to quality. Hoffman pays meticulous attention to quality and has gained a reputation for exceeding industry standards.
4. You'll want to deal with a reliable, financially stable company. Hoffman has a long record of serving industry needs and has become one of the major electrical enclosure manufacturers in the country.
5. You'll want a company that keeps up with industry requirements. Look to Hoffman, an innovator in new and improved products.
6. Helpful people are ready to respond to your needs at Hoffman. As a leader in the manufacture of electrical enclosures, we have a large staff of people with a broad range of experience related to your needs. We also have a nationwide network of distributors with local stocks.

After you've considered all the angles, give us a call at 612/421-2240.

Hoffman ELECTRICAL ENCLOSURES

HOFFMAN ENGINEERING COMPANY
 Division of Federal Cartridge Corporation
 ANOKA, MN 55303 DEPT. ED-552

INFORMATION RETRIEVAL NUMBER 79

When we called for volunteers American Business was first in line.



Not just last year. Or the year before. But American Business has been first in line to answer the United Way call for help every year. With corporate gifts, payroll deduction plans, executives volunteering for our campaigns.

Your response has been overwhelmingly impressive. And has left lasting impressions on the forgotten, the sick, the poor. The thousands cared for and served by our United Way community agencies. Thanks to you it's working.

**Thanks to you
it's working.
The United Way.**

©The United Way 1974.



A Public Service of This Magazine & The Advertising Council



Just How Broad is the MAGNECRAFT Stock Relay Line?

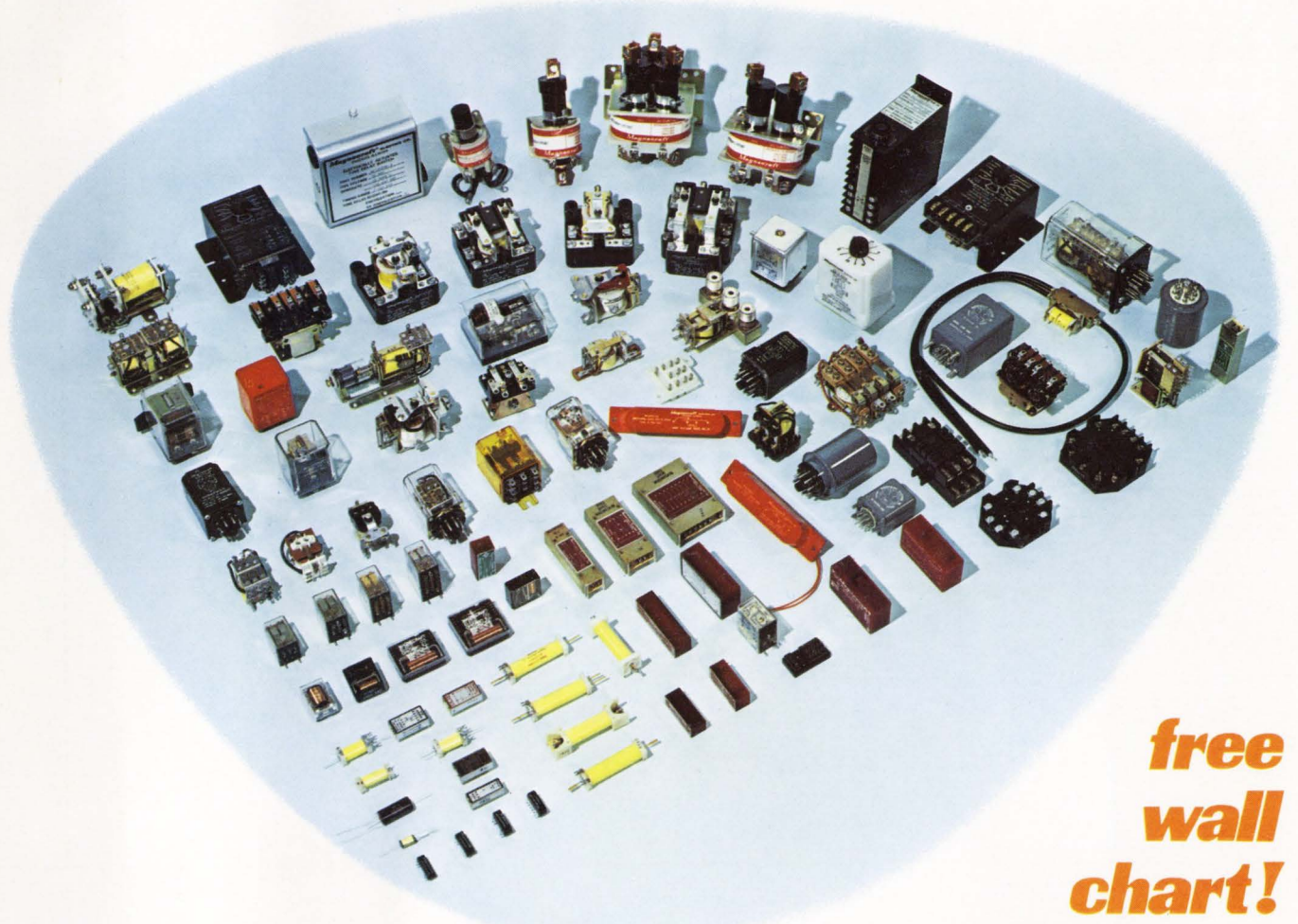

**free
wall
chart!**

Magnecraft's stock relay line consists of 1200 versions derived from 17 categories - - - - that is the largest and broadest line in the industry.

Oh? Did I read that correctly?

Yes, Magnecraft Electric provides 1200 relay versions in stock through our nationwide distributor network. Those 17 categories include; low profile, general purpose, power, mercury displacement, sensitive, coaxial, telephone type, air dashpot time delay, solid state, latching types, high voltage, mercury wetted reeds, dry reeds, and dip reed relays.

Magnecraft can offer you the design engineer, a quality product, local distributors, and the broadest relay line in the industry to choose from. If we don't have the relay in stock we will custom design a relay to meet your requirements.

Full color 22"x 34" relay specification chart.

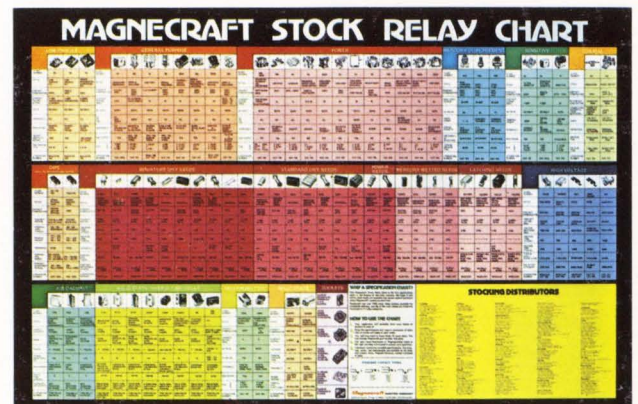

Magnecraft® ELECTRIC COMPANY

5575 NORTH LYNCH AVENUE • CHICAGO, ILLINOIS 60630 • 312 • 282 5500 • TWX 910 221 5221

What's new in solid state...

Leak-proof, torque-proof thyristors from RCA.

Now readily available: RCA thyristors with our no-strain solution to lead torque problems.

It's flexible-lead packaging, and it works this way. We attach long flexible leads to the cathode and gate terminals – and then completely embed those couplings plus the glass hermetic seal in epoxy. Device leads are solidly locked in position, so there can be no strain on the glass-to-metal seal. You have an extra barrier against dust, dirt, oil and moisture. Wiring into your equipment is much easier. And so is meeting UL and IEC creepage specs.

On short notice, you can have flexible-lead packaging on any RCA standard

commercial press fit thyristor, mounted either on a stud or TO-3 base, and in both isolated and non-isolated versions.

Many are available off the shelf: Triacs (10, 15, 30 and 40 amps; 200-600 volts), and SCRs (20-35 amps; 200-600 volts). For availability information and prices, contact your

local RCA Solid State distributor. Or RCA.

Write: RCA Solid State, Box 3200, Somerville, New Jersey 08876; Ste. Anne de Bellevue 810, Canada; Sunbury-on-Thames, U.K.; Fuji Bldg., Tokyo, Japan.

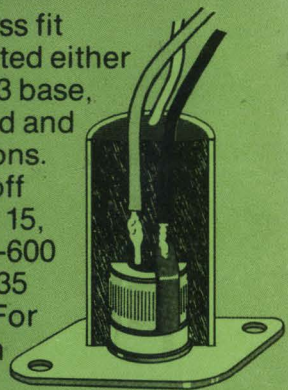

RCA

INFORMATION RETRIEVAL NUMBER 254

RCA. A powerhouse in thyristors.