



FIRE

GAS | WOOD | ELECTRIC | OUTDOOR

HEAT & GLO[®]



NO ONE
BUILDS
A BETTER
FIRE.

THE PURSUIT OF INNOVATION

Heat & Glo is fueled by innovation and driven to prove “No One Builds A Better Fire.” The brand was founded in 1975 in a small Minnesota garage by brothers Ron and Dan Shimek. In 1987, the brand introduced Direct Vent technology—forever changing the way fireplaces function.

Much has changed since its beginning. Yet much remains the same. Today, Heat & Glo continues on an endless pursuit; pushing the boundaries of where fire can go and how it can look.

DESIGN

Design is an integral part of form and function. With Heat & Glo, meticulous product development creates cutting-edge designs with creative applications. An expansive breadth of offerings is available. From traditional to ultramodern. With more than 40 models and countless styles.

INNOVATIVE TECHNOLOGY

Heat & Glo holds the most patents, honors and awards in the industry. The brand created fire from water, and also developed exclusive technologies like FireBrick® and IntelliFire™ Touch. Heat & Glo is always pushing the envelope with technology for today, and innovation for tomorrow.



FIREPLACE TABLE OF CONTENTS

TRADITIONAL GAS FIREPLACES	10
Premium.....	12
Mid-Range.....	22
Basic	32
MODERN GAS FIREPLACES	38
Premium.....	40
Mid-Range.....	60
Basic	64
GAS FIREPLACE INSERTS	70
Premium.....	72
Mid-Range.....	74
TRADITIONAL WOOD FIREPLACES	80
Premium.....	82
Mid-Range.....	86
Basic	88
ELECTRIC FIREPLACES	92
Premium.....	94
Mid-Range.....	98
Basic	100
INDOOR/OUTDOOR GAS FIREPLACES	104
Premium.....	106
OUTDOOR FIREPLACES	112
OUTDOOR GAS FIREPLACES	114
OUTDOOR WOOD FIREPLACES	120
OUTDOOR GAS FIREPIT	126

PREMIUM

A product series offering the finest features and options.

MID-RANGE

A product series offering enhanced consumer benefits with improved features and options.

BASIC

A product series offering essential consumer benefits.



✓ CAD DETAILS

✓ REVIT OBJECTS

✓ CSI SPECS

HEAT & GLO MAKES SPECIFYING SIMPLE

Have confidence in your plans by leveraging our array of design and specification tools including proprietary CAD drawings compatible with the latest AutoCAD software, and 3D Revit BIM objects and families. Heat & Glo also has complete 3-Part CSI/CSA fireplaces specifications for you to add instantly into section 10-31-00 of your construction documents.

DESIGN CONSIDERATIONS

The placement of the fireplace is critical to specifying the right fireplace for the right project.

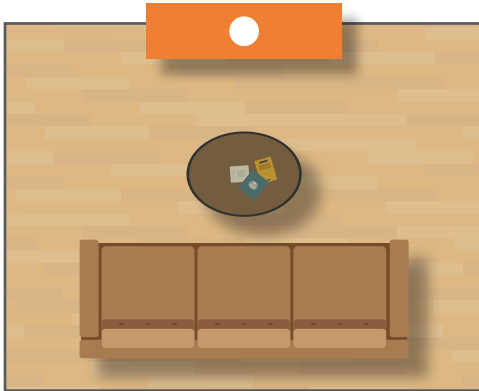

EXTERIOR WALL

A classic application that suits both traditional and contemporary fireplace models. These applications typically require the least complicated vent runs, but may require an exterior chase or bump out.

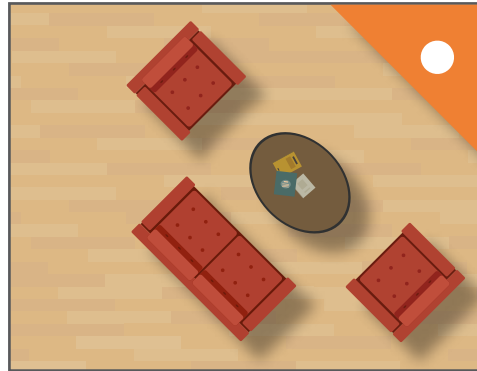

CORNER

Best used in floorplans with square footage to spare or where other architectural elements (i.e. windows) take precedence as a focal point. Traditional models or smaller modern linear units work best for these applications.

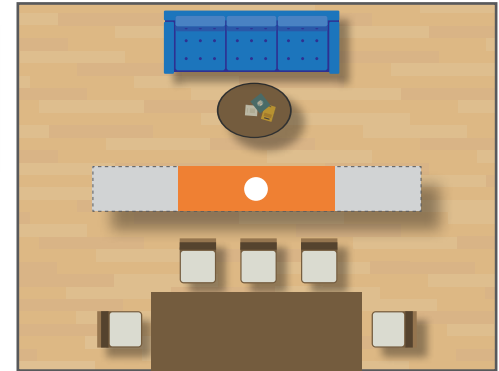

INTERIOR WALL / ISLAND

An interior island application is an innovative way to enhance a space. See-through models are highly desired for these types of design, particularly in open floor plans. These applications may require a power vent system and a more complex vent run.



Install Virtually Anywhere: Power Vent™ Technology

Fireplaces aren't just for exterior walls. A fan-powered accessory with slim venting can zigzag throughout your home – up, down, over or under – making it possible to install a gas fireplace virtually anywhere.



SPECIFICATION CHECK LIST

Planning is critical to ensure the model you are specifying will work with your construction plans. When specifying a fireplace model for your building, make sure to work with your local Hearth Expert to factor in the following factors:



FRAMING DIMENSIONS

For both the fireplace itself and for any vent pipes that must terminate through a wall.

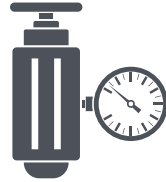

CONNECTION REQUIREMENTS

Make sure you understand where venting, gas and electrical connection points are on the model you're specifying.

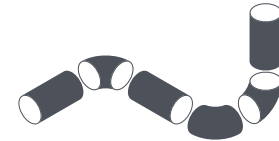

VENT RUN REQUIREMENTS

The maximum and minimum lengths required for vertical, horizontal and mixed vent runs may vary from model to model. Understanding these parameters early on is essential in deciding where best to place the fireplace in your plans.



CLEARANCES TO COMBUSTIBLES

For mantels, surround material and appliances above the fireplace.



EXTERIOR TERMINATION LOCATION

Know the distances needed from the termination cap to nearby fenestrations, overhangs, soffits and sidewalks.

KEY TECHNOLOGIES



DIRECT VENT TECHNOLOGY

Direct Vent fireplaces remove 100% of combustion exhaust and odors outside of the home. These sealed fireplaces provide optimal heat, conserve energy and ensure clean, safe indoor air quality.



POWER VENT™ TECHNOLOGY

A power vent is a fan-powered accessory allowing for longer more complicated vent runs – making it possible to install a gas fireplace virtually anywhere in a property.



WHISPERTONE™ TECHNOLOGY

Patent-pending system which allows airflow with minimal sound, the ability to horizontally terminate, and an automatic damper which stops air movement when the fireplace is off, thus preventing cold air infiltration into the home.



INTELLIFIRE™ IGNITION SYSTEMS

Advanced intermittent pilot ignition systems with memory settings and programmable RC300 or RC400 remote controls. IPI systems constantly monitors ignition, ensures safe functioning and conserves up to \$10/month in energy costs. Options include IntelliFire, IntelliFire Plus and IntelliFire Touch.



FIREBRICK® TECHNOLOGY

FireBrick is a patented, energy-saving ceramic material molded in a variety of masonry designs. FireBrick produces up to 25% more radiant heat than metal fireboxes – heating rooms faster and using less fuel. This increases efficiency and reduces heating costs.

PRODUCT FEATURES



BLACK GLASS



LED EMBER
BED



ANTI-REFLECTIVE
GLASS



LED ACCENT
LIGHTING



BLUETOOTH



HIGH-DEFINITION
LOGS

HEAT MANAGEMENT SOLUTIONS

Heat Management technologies allow end users to enjoy the fire in comfort and at the same time control the heat produced by their fireplace. Heat management solutions also give you more interior design flexibility, such as the location of the TV and what kind of wall materials can be installed. Heat & Glo offers the widest breadth of heat management solutions and technologies on the market.



HEAT ZONE TECHNOLOGY

Draw heat from the fireplace into another room of the home, up to 20 feet away. When a heat zone kit is run continuously, it will redirect up to 25% of the fireplace's heat to another area, thus reducing wall temperatures above the fireplace. Two heat zones run continuously will redirect up to 50% of the fireplace's heat.



HEAT OUT TECHNOLOGY

Draw heat from the fireplace and direct it outside, up to 25 feet away. When operating continuously on high, it can redirect up to 40% of the heat off the fireplace, also reducing wall temperatures above the fireplace.



PASSIVE HEAT SYSTEM/SMARTWALL TV KIT

Allows a TV to be mounted 12" above the fireplace without a mantel or shelf.



POWERFLOW™ HEAT MANAGEMENT TECHNOLOGY

Our exclusive PowerFlow Technology redirects the flow of heat, sending warmth where you want it, all while maintaining safe outer glass and a cool wall. End-users can quickly adjust heat distribution throughout the space, inside or outside the home – at the flip of a switch.



HEAT DUCT TECHNOLOGY

Brings the warmth from the fireplace to the rest of your home by redistributing heat from the fireplace via the furnace ductwork. When a heat duct kit is run continuously, it will redirect up to 25% of the fireplace's heat to another area, thus reducing wall temperatures above the fireplace. Two heat ducts run continuously will redirect up to 50% of the fireplace's heat.



TRADITIONAL GAS FIREPLACES



WHY A GAS FIREPLACE?

Gas fireplaces offer the most versatility of placement, model variety, and technology. A gas fireplace will not only add an unforgettable focal point to your space, but ambiance and comfort to the properties you're creating. Gas-burning fireplaces are clean and efficient. Building and design professionals should add at least one in entry-level new construction homes and a second or third fireplace when planning move-up or luxury/custom properties.

¹ 2016 Realtor.com Homebuyer & Realtor Research, "Fireplace is the #1 Must Have Home Feature"; 2016 Angie's List Homebuyer & Realtor Research, "Both indoor and outdoor fireplaces are one of the most sought after home features by both homebuyers and realtors"

² Marshall & Swift Residential Cost Handbook

³ 2013 NAHB "What Homebuyers Really Want"

#1

New homebuyers rank fireplaces as the **TOP MOST DESIRED DECORATIVE PRODUCTS** in a new home¹



A gas fireplace will add between **\$2,950-\$5,900** to a home's value²



Direct vent gas is the **PREFERRED TECHNOLOGY** in every green building program³



PHOENIX
TRUEVIEW GAS FIREPLACE

Designed with a large glass-free view and the authentic look of a traditional wood fireplace. Be captivated by the beautiful hand-painted logs, glowing LED ember bed and bold flames in a traditional brick or modern reflective black glass interior. Safely place a TV 12" above the opening with no mantel required. Set the mood with mild heat for year round enjoyment, and stream music or the sound of a crackling fire through Bluetooth® speakers for a truly immersive experience. Phoenix. The convenience of gas without the glass.

PHOENIX

INTERIOR PANELS



FADE-RESISTANT REFLECTIVE
BLACK GLASS INTERIOR PANELS



TRADITIONAL BRICK
INTERIOR PANELS



GLOWING LED EMBER BED

DOORS



BLACK GRAND VISTA
SCREEN DOORS

SPECIFICATIONS

MODEL	FRONT WIDTH (A)		HEIGHT (B)		DEPTH (C)		REAR WIDTH (D)		VIEWING AREA (E x F)	BTU/HR INPUT
	ACTUAL	FRAMING	ACTUAL	FRAMING	ACTUAL	FRAMING	ACTUAL	FRAMING		
PHOENIX42-IFT	50-3/8" [1280]	51-3/8" [1305]	74-1/8" [1883]	74-5/8" [1895]	28-1/2" [724]	28" [711]	34-5/8" [879]	51-3/8" [1305]	42" x 28-1/2" [1068 x 723]	65,000

TOP VIEW

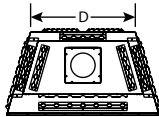

FRONT VIEW

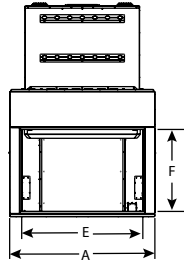

LEFT SIDE VIEW

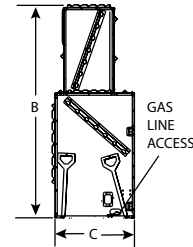

RIGHT SIDE VIEW

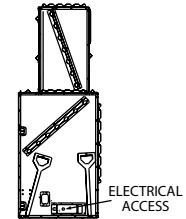

TECHNOLOGIES/FEATURES



BLUETOOTH



WHISPERTONE



INTELLIFIRE
TOUCH



36" 42" 50"

TRUE DIRECT VENT GAS FIREPLACE

The TRUE offers the most authentic masonry appearance available in a Direct Vent gas fireplace. The best fire, cleanest look and largest view available comes in three sizes with high definition logs, LED accent and ember lighting and reflection-free glass. It's an attractive, powerful fireside experience – a TRUE innovation in traditional style.

SPECIFICATIONS

MODEL	FRONT WIDTH (A)		BACK WIDTH (B)		HEIGHT (C)		DEPTH (D)		GLASS SIZE (E x F)	BTU/HOUR INPUT (NG)
	UNIT	FRAMING	UNIT	FRAMING	UNIT	FRAMING	UNIT	FRAMING		
TRUE-36	61 [1549]	59-1/2 [1511]	59-1/4 [1505]	59-1/2 [1511]	57-5/8 [1464]	56 [1422]	24 [610]	24 [610]	35-7/8 x 31-1/16 [911 x 789]	28,000 - 45,500
TRUE-42	67 [1702]	65-9/16 [1665]	65-5/16 [1659]	65-9/16 [1665]	62-5/8 [1591]	61 [1549]	24 [610]	24 [610]	41-7/8 x 36-1/16 [1064 x 916]	30,500 - 55,500
TRUE-50	75 [1905]	73-9/16 [1869]	73-5/16 [1862]	73-9/16 [1869]	66-5/8 [1692]	65 [1651]	24 [610]	24 [610]	49-7/8 x 40-1/16 [1267 x 1018]	36,000 - 65,000

TOP VIEW

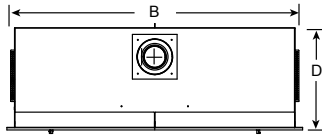

FRONT VIEW

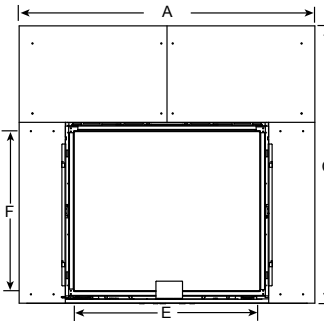

LEFT SIDE VIEW

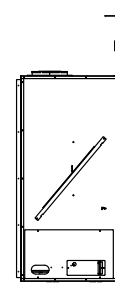

RIGHT SIDE VIEW

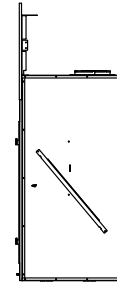

TECHNOLOGIES/FEATURES



BLACK GLASS



LED EMBER
BED



ANTI-REFLECTIVE
GLASS



LED ACCENT
LIGHTING



DIRECT VENT



HEAT-ZONE



POWER VENT



INTELLIFIRE
TOUCH

FRONTS



FIRESCREEN



FIRESCREEN ARCH

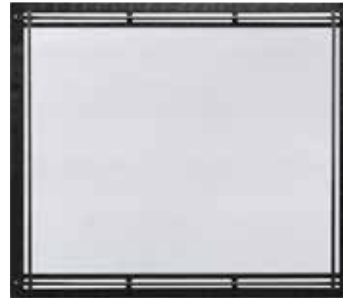

FORGE
Hand-crafted, hammered steel

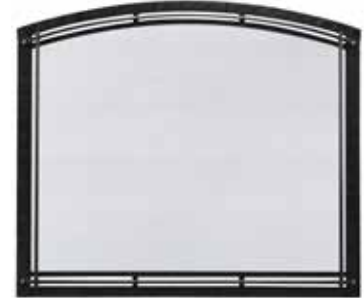

FORGE ARCH
Hand-crafted, hammered steel

FINISHES FOR FIRESCREEN AND FIRESCREEN ARCH

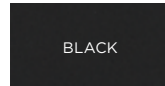

BLACK

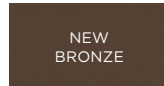

NEW
BRONZE



GRAPHITE

INTERIOR PANELS

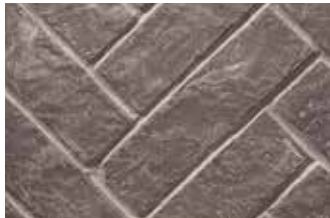

TRANQUIL GREIGE
HERRINGBONE



STRATFORD



FADE RESISTANT REFLECTIVE
BLACK GLASS





36" 42"

CERONA

DIRECT VENT GAS FIREPLACE

The Cerona is the only true-arched fireplace on the market. The arched elegance pairs well with robust flames and impressive efficiency. Patented, heat-radiating FireBrick® material and cantilevered corners provide the beauty of a custom-built masonry fireplace.

CERONA

FRONTS



CHATEAU



CHATEAU DELUXE



VALENCIA

FINISHES

Available for all fronts

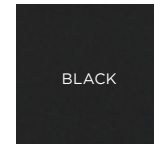

BLACK

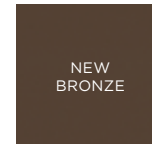

NEW
BRONZE



GRAPHITE

SPECIFICATIONS

MODEL	FRONT WIDTH (A)		BACK WIDTH (B)		HEIGHT (C)		DEPTH (D)		GLASS SIZE (E x F)	BTU/HR INPUT
	UNIT	FRAMING	UNIT	FRAMING	UNIT	FRAMING	UNIT	FRAMING		
CERONA-36	41-1/8 [1046]	42-1/8 [1070]	28-1/2 [724]	42-1/8 [1070]	49-7/8 [1268]	50-1/2 [1283]	21-3/4 [551]	22-1/4 [565]	30-1/4 X 23-1/2 [767 X 595]	25,000-37,500 (NG)
CERONA-42	48-1/8 [1223]	49-1/8 [1248]	35-3/8 [900]	49-1/8 [1248]	54 [1372]	54-1/2 [1384]	21-3/4 [551]	22-1/4 [565]	35-7/8 X 27-3/4 [912 X 704]	32,000-48,000 (NG)

TOP VIEW

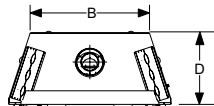

FRONT VIEW

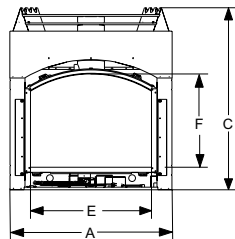

LEFT SIDE VIEW

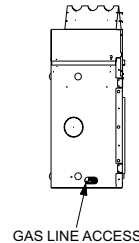

GAS LINE ACCESS

RIGHT SIDE VIEW

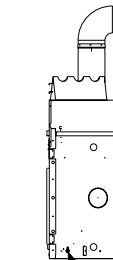

ELECTRICAL ACCESS

TECHNOLOGIES/FEATURES



INTELLIFIRE



DIRECT VENT



FIREBRICK



HEAT-ZONE



42"

ESCAPE SEE-THROUGH DIRECT VENT GAS FIREPLACE

Take comfort to the next level with the Escape model. Flames rise through intricate logs and are complemented by electric embers and accent lighting for a broad fire. Enjoy the Escape See-Through from two rooms, with arched or square front designs.

ESCAPE SEE-THROUGH

FRONT



FIRESCREEN



ARCHED FIRESCREEN



PRAIRIE RIDGE COMPANIONS

FINISHES

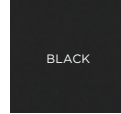

BLACK

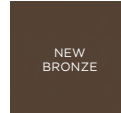

NEW BRONZE

INTERIOR PANELS

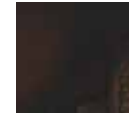

BLACK METAL



BLACK PORCELAIN



FADE-RESISTANT REFLECTIVE BLACK GLASS

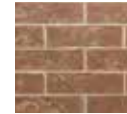

STRATFORD BRICK



STANDARD CORNER BRICK

SPECIFICATIONS

MODEL	FRONT WIDTH (A)		BACK WIDTH (B)		HEIGHT (C)		DEPTH (D)		GLASS SIZE (E x F)	BTU/HOUR INPUT
	UNIT	FRAMING	UNIT	FRAMING	UNIT	FRAMING	UNIT	FRAMING		
ESCAPE SEE-THROUGH (IFT)	59-15/16 [1522]	60-1/4 [1530]	59-15/16 [1524]	60-1/4 [1530]	46-3/8 [1178]	46-1/2 [1181]	30 [762]	30 [762]	39-7/16 x 35-1/8 [1002 X 892]	43,500 - 57,500

TOP VIEW

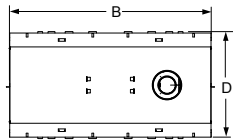

FRONT VIEW

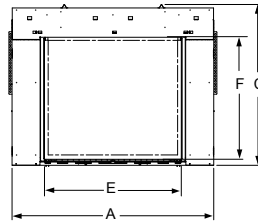

LEFT SIDE VIEW

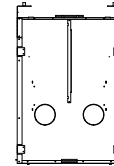

RIGHT SIDE VIEW

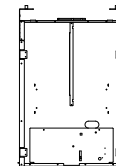

TECHNOLOGIES/FEATURES



INTELLIFIRE



INTELLIFIRE TOUCH



DIRECT VENT



POWER VENT



LED EMBER BED



BLACK GLASS



36" 42"

6000 & 8000 SERIES DIRECT VENT GAS FIREPLACE

The 6000 Series is the flagship of Heat & Glo. Three models are available (C, CL, CLX), offering different heating, features and aesthetics for different homebuyers. The 8000 Series provides all of the benefits of the 6000 Series in a larger size with greater heat output.

6000 & 8000 SERIES

SPECIFICATIONS

MODEL	FRONT WIDTH (A)		BACK WIDTH (B)		HEIGHT (C)		DEPTH (D)		GLASS SIZE (E x F)	BTU/HOUR INPUT (NG)
	UNIT	FRAMING	UNIT	FRAMING	UNIT	FRAMING	UNIT	FRAMING		
6000CLX, 6000CL, 6000C,	41 [1041]	42 [1067]	28-1/2 [724]	42 [1067]	39-7/8 [1013]	40-1/8 [1019]	21-1/2 [546]	22 [559]	32 x 21-1/2 [813 x 546]	CLX: 40,000 CL: 35,000 C: 30,000
8000CLX, 8000CL, 8000C,	48 [1219]	49 [1245]	35-1/2 [901]	49 [1245]	41-7/8 [1064]	42-1/8 [1070]	21-1/2 [546]	22 [559]	39 x 23-5/8 [991 x 600]	CLX: 45,000 CL: 40,000 C: 35,000

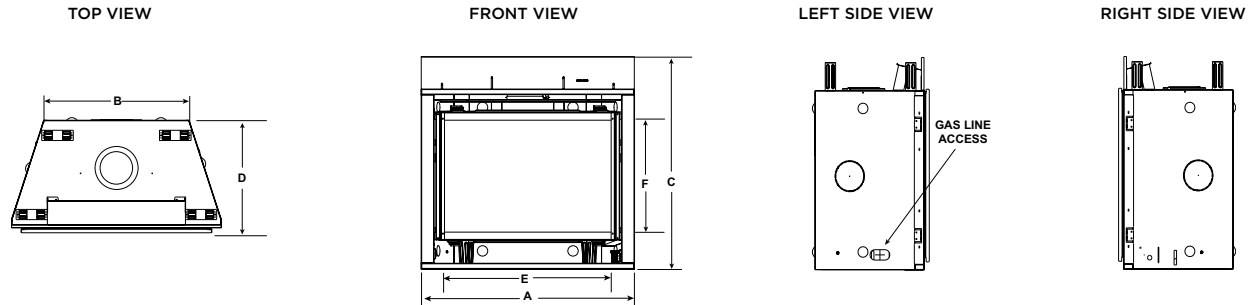

TECHNOLOGIES/FEATURES



6000 & 8000 SERIES

FRONTS



CHATEAU FORGE
Hand-crafted, hammered steel.



GALLERIA



CHATEAU



HALSTON



IRON AGE



ARCADIA



FOLIO



CLEAN FACE

FINISHES
Available for all
fronts except
chateau forge

BLACK

NEW
BRONZE

GRAPHITE

INTERIOR PANELS



BLACK METAL
(Standard on C models)



STRATFORD BRICK PANELS
(Standard on CL/CLX models;
optional on C models)



**FADE-RESISTANT REFLECTIVE
BLACK GLASS PANELS**
(Standard on CL/CLX;
optional on C models)





36"

MULTI-SIDED DIRECT VENT GAS FIREPLACES

Multi-Sided fireplaces present an opportunity to divide a space elegantly, act as a window between rooms or provide dramatic architectural elements. Pier, see-through and left- or right-corner models showcase fire in more ways. Create your own, unique hearth with a variety of sizes, styles and finishing options.

MULTI-SIDED

PIER SPECIFICATIONS

MODEL	SIDES WIDTH (A)		BACK WIDTH (B)		HEIGHT (C)		DEPTH (D)		GLASS SIZE (E x F)	BTU/HOUR INPUT
	UNIT	FRAMING	UNIT	FRAMING	UNIT	FRAMING	UNIT	FRAMING		
PIER-36TR (IFT) PIER-36TRB (IFT)	40-1/2 [1029]	40 [1016]	40-1/2 [1029]	40 [1016]	38 [965]	38-1/8 [968]	24 [610]	23 [584]	33 X 21-5/8 [838 X 549]	21,000 - 38,000

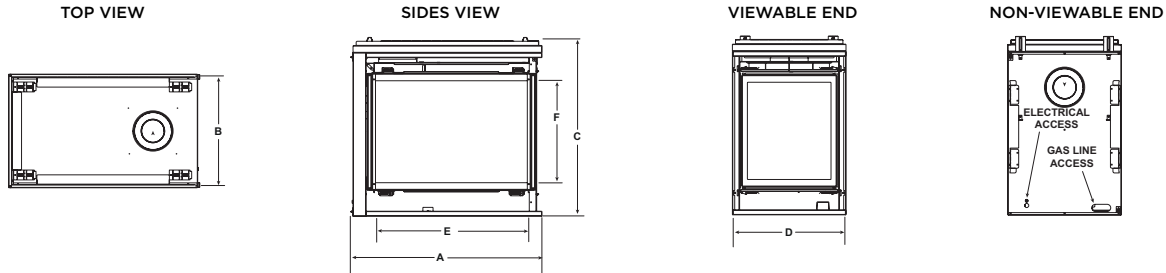

SEE-THROUGH SPECIFICATIONS

MODEL	SIDES WIDTH (A)		BACK WIDTH (B)		HEIGHT (C)		DEPTH (D)		GLASS SIZE (E x F)	BTU/HOUR INPUT
	UNIT	FRAMING	UNIT	FRAMING	UNIT	FRAMING	UNIT	FRAMING		
ST-36TR (IFT) ST-36TRB (IFT)	42-1/2 [1080]	43 [1092]	42-1/2 [1080]	43 [1092]	38 [965]	38-1/8 [968]	24 [610]	23 [584]	33 X 21-5/8 [838 X 549]	21,000 - 38,000

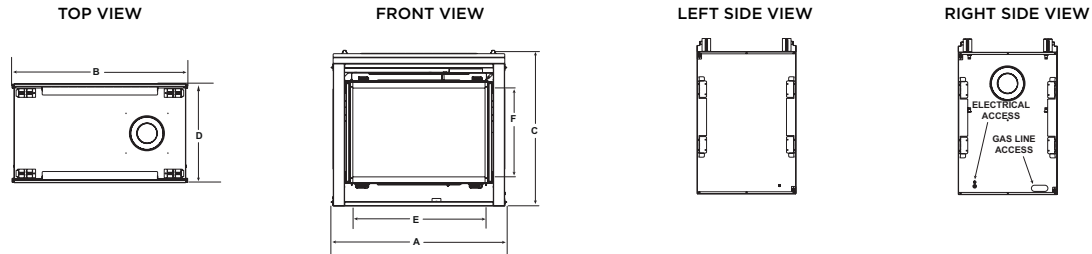

TECHNOLOGIES/FEATURES



INTELLIFIRE TOUCH



DIRECT VENT



POWER VENT



BLACK GLASS

MULTI-SIDED

FRONTS



ARCADIA
See-Through and Pier



CHATEAU
See-Through and Pier

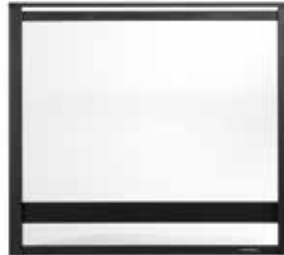

FOLIO
See-Through and Pier



GALLERIA
See-Through only

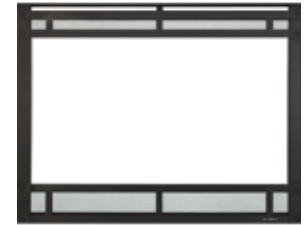

HALSTON
See-Through only

FINISHES Available for all fronts

BLACK

NEW
BRONZE

GRAPHITE

MEDIA



CRYSTAL GLASS



EBONY GLASS



COBALT GLASS



AMBER GLASS



SCARLET GLASS



ICED FOG GLASS



CAST STONES

INTERIOR PANELS



BLACK METAL



BLACK PORCELAIN



FADE-RESISTANT
BLACK GLASS



STRATFORD BRICK

MULTI-SIDED





36

CORNER DIRECT VENT GAS FIREPLACES

Add architectural interest to your space and enjoy the power of fire in creative new ways with this stunning two-sided gas fireplace. Upgrade any corner and warm up your space with class. Left- or right-facing gas fireplaces are an ideal way to add impact in tighter spaces.

LEFT/RIGHT CORNER

FRONT



FIRESCREEN
Available in black

INTERIOR PANEL



**STANDARD CORNER
BRICK PANELS**

SPECIFICATIONS

MODEL	FRONT WIDTH (A)		BACK WIDTH (B)		HEIGHT (C)		DEPTH (D)		GLASS SIZE (E x F)	BTU/HOUR INPUT
	UNIT	FRAMING	UNIT	FRAMING	UNIT	FRAMING	UNIT	FRAMING		
LCOR-36IN RCOR-36IN	40-1/2 [1029]	40 [1016]	40 -1/2 [1029]	40 [1016]	38 [965]	38-1/8 [968]	24-1/2 [622]	24 [610]	33 X 21-5/8 [838 X 549]	21,000 - 38,000

TOP VIEW

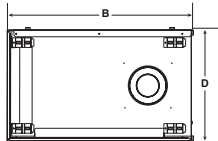

FRONT VIEW

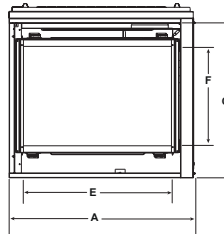

VIEWABLE END

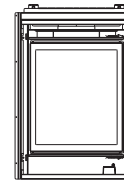

NON-VIEWABLE END

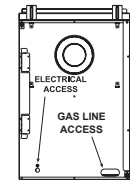

TECHNOLOGIES/FEATURES



**INTELLIFIRE
TOUCH**



DIRECT VENT



POWER VENT



28" 32" 36" 42"

SLIMLINE SERIES

DIRECT VENT GAS FIREPLACE

SlimLine fireplaces fit where others don't. Slender profiles make unique installations a reality. Bring your vision to life with multiple models, sizes and finishing options. The ideal combination of flame, glow and logs creates a fireside experience you never want to leave.

SLIMLINE SERIES

SPECIFICATIONS

MODEL	FRONT WIDTH		BACK WIDTH		HEIGHT		DEPTH		GLASS SIZE	BTU/HR INPUT (NG)
	ACTUAL	FRAMING	ACTUAL	FRAMING	ACTUAL	FRAMING	ACTUAL	FRAMING		
SL-3X	33 [838]	34 [864]	22-3/4 [578]	34 [864]	32-3/8 [822]	32-3/4 [852]	16-1/4 [413]	16-1/4 [413]	24-1/8 X 16 [613 x 406]	11,500-21,000
SL-5/5X	36 [913]	37 [940]	25-3/4 [653]	37 [940]	34-3/8 [873]	34-3/4 [882]	16-5/16 [415]	16-1/4 [413]	27-3/16 X 18-1/16 [691 x 459]	14,900-21,000 (5) 14,500-27,500 (5X)
SL-7/7X	41 [1041]	42 [1067]	30-3/4 [781]	42 [1067]	37-7/8 [962]	38-1/4 [972]	16-5/16 [415]	16-1/4 [413]	32-1/16 X 21-1/2 [814 x 546]	17,500-25,000 (7) 17,500-30,500 (7X)
SL-9/9X	48 [1218]	49 [1245]	37-3/4 [959]	49 [1245]	39-9/16 [1005]	40-1/4 [1022]	16-5/16 [415]	16-1/4 [413]	39-1/16 X 23-9/16 [992 x 599]	23,500-30,000 (9) 18,000-35,000 (9X)

TOP VIEW

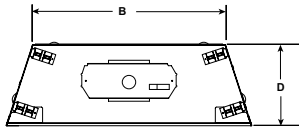

FRONT VIEW

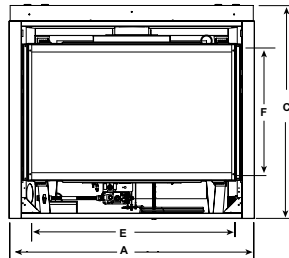

LEFT SIDE VIEW

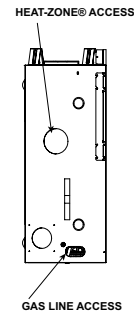

RIGHT SIDE VIEW

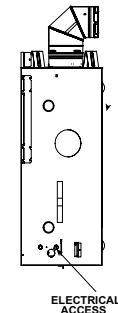

TECHNOLOGIES/FEATURES



INTELLIFIRE



DIRECT VENT



POWER VENT



LED EMBER
BED



BLACK GLASS



HEAT-ZONE



HEAT DUCT



HEAT OUT

SLIMLINE SERIES

FRONTS



CHATEAU FORGE
Handcrafted, hammered steel.
Not available for 3X.



ARCADIA
Black, new bronze or graphite.
Not available for 3X.



CLEAN FACE
Black, new bronze or graphite.
Not available for 3X.



CHATEAU
Available for all models in black,
new bronze or graphite.

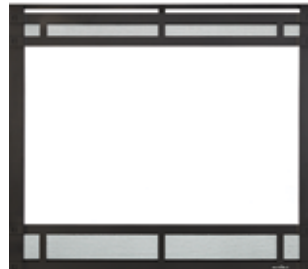

HALSTON
Available for all models in black,
new bronze or graphite.



FIRESCREEN
Available for all models in black.

FINISHES

BLACK

NEW
BRONZE

GRAPHITE

INTERIOR PANELS



STRATFORD BRICK PANELS
Included standard on X
collection models. Optional
upgrade for SL models.



**FADE-RESISTANT REFLECTIVE
BLACK GLASS PANELS**
Optional upgrade for all models.

MANTEL SYSTEMS

A variety of mantel systems can transform your space. Visit heatglo.com for more options and additional information on mantel systems, shelves and stone surrounds.



— SLIMLINE SERIES

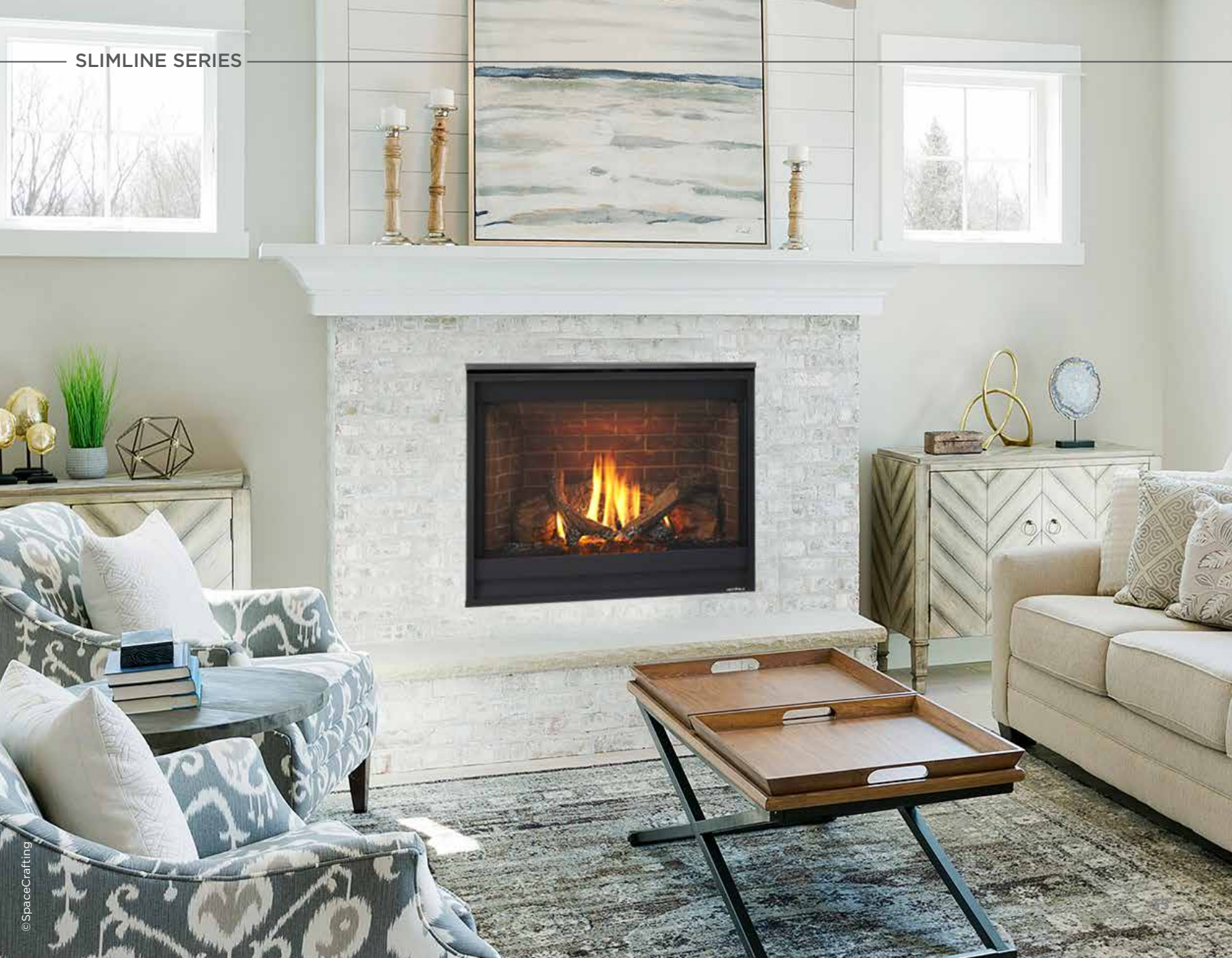



36" 42"

REVEAL

B-VENT GAS FIREPLACE

Recreate the timelessness of a wood-burning fire with the open-hearth Reveal. Match your mood and enjoy full, generous flames with the optional doors open or closed.

REVEAL

DOORS



NON-OPERABLE GLASS DOOR



OPERABLE BI-FOLD GLASS DOOR

SPECIFICATIONS

MODEL	FRONT WIDTH (A)		BACK WIDTH (B)		HEIGHT (C)		DEPTH (D)		VIEWING AREA (E x F)	BTU/HR INPUT
	UNIT	FRAMING	UNIT	FRAMING	UNIT	FRAMING	UNIT	FRAMING		
RBV4236	41 [1041]	42 [1067]	23-3/4 [603]	42 [1067]	39-1/2 [1003]	39-3/4 [1010]	21-1/2 [546]	22 [559]	36 x 21 [914 x 533]	40,000 (NG)
RBV4842	47 [1194]	48 [1219]	29-3/4 [756]	48 [1219]	39-1/2 [1003]	39-3/4 [1010]	21-1/2 [546]	22 [559]	42 x 21 [1067 x 533]	43,000 (NG)

TOP VIEW

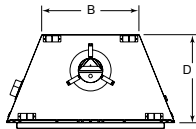

FRONT VIEW

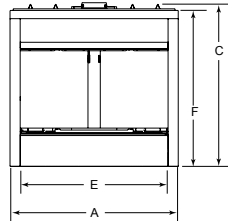

LEFT SIDE VIEW

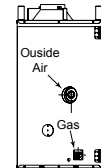

RIGHT SIDE VIEW

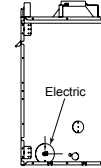

TECHNOLOGIES/FEATURES



INTELLIFIRE



MODERN GAS FIREPLACES



MODERN STYLE, TIMELESS APPEAL

The move to modern fireplaces is a trend that's here to stay. From sleek, modern linear fireplaces to unique models with dazzling features, our line of modern fireplaces will help you create an “impact wall” for your clients that will be the envy of the neighborhood. Make sure to specify a model that matches your project goals – select premium models for luxury properties and mid-range or basic models for move-up and entry-level homes.



LUXURY/PREMIUM

Perfect for mid-size to large rooms and commercial buildings. The combination of seamless, clean-finish options, very active flame, multi-colored LED lighting and standard accessories and heat-management technologies make these fireplaces one of a kind.



MID-RANGE

Works great for mid-size to large rooms. Comes standard with LED lighting, wireless control, and an active flame. Multiple customizable options to fit any type of room.



BASIC

Basic modern fireplaces are ideal for small to mid-size rooms. Calm flame, modest heat output, and optional accessories complement your décor.



Foundation Series
SINGLE-SIDED
DIRECT VENT GAS FIREPLACE

Even your most timeless setting comes alive with a Foundation Series single-sided luxury fireplace, where innovative appearance meets modern design.

FOUNDATION SERIES: SINGLE-SIDED

SPECIFICATIONS

MODEL	FRONT WIDTH (A)		BACK WIDTH (B)		HEIGHT (C)		DEPTH (D)		GLASS SIZE (E x F)
	ACTUAL	FRAMING	ACTUAL	FRAMING	ACTUAL	FRAMING	ACTUAL	FRAMING	
FDN-4-SS	53-3/4" [1,365]	55-3/4" [1,416]	53-3/4" [1,365]	55-3/4" [1,416]	50" [1,270]	56" [1,422]	24-1/32" [610]	25-1/32" [636]	50-3/16" x 24" [1,275 x 610]
FDN-5-SS	65-3/4" [1,670]	67-3/4" [1,721]	65-3/4" [1,670]	67-3/4" [1,721]	50" [1,270]	56" [1,422]	24-1/32" [610]	25-1/32" [636]	62-3/16" x 24" [1,580 x 610]
FDN-6-SS	77-3/4" [1,975]	79-3/4" [2,026]	77-3/4" [1,975]	79-3/4" [2,026]	50" [1,270]	56" [1,422]	24-1/32" [610]	25-1/32" [636]	74-3/16" x 24" [1,884 x 610]
FDN-7-SS	89-3/4" [2,280]	91-3/4" [2,330]	89-3/4" [2,280]	91-3/4" [2,330]	50" [1,270]	56" [1,422]	24-1/32" [610]	25-1/32" [636]	86-3/16" x 24" [2,189 x 610]

LEFT VIEW

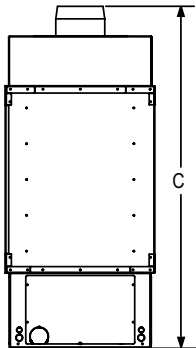

FRONT VIEW

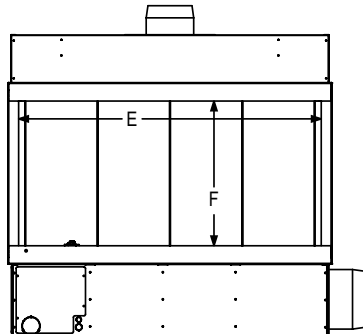

TOP VIEW

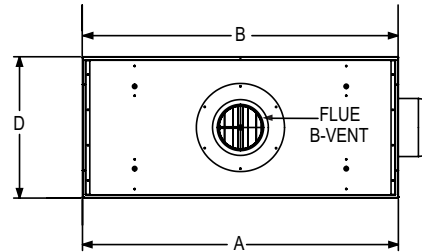

RIGHT VIEW

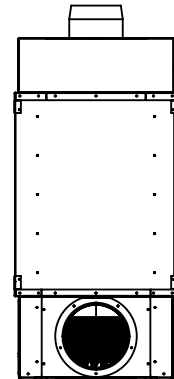



Foundation Series

SEE-THROUGH

DIRECT VENT GAS FIREPLACE

Add a spacious new dimension to your living space or gathering area with a Foundation Series luxury see-through fireplace. It's a captivating look that invites conversation.

FOUNDATION SERIES: SEE-THROUGH

SPECIFICATIONS

MODEL	FRONT WIDTH (A)		BACK WIDTH (B)		HEIGHT (C)		DEPTH (D)		GLASS SIZE (E x F)
	ACTUAL	FRAMING	ACTUAL	FRAMING	ACTUAL	FRAMING	ACTUAL	FRAMING	
FDN-4-ST	53-3/4" [1,365]	55-3/4" [1,416]	53-3/4" [1,365]	55-3/4" [1,416]	50" [1,270]	56" [1,422]	24" [610]	23" [584]	50-3/16" x 24" [1,275 x 610]
FDN-5-ST	65-3/4" [1,670]	67-3/4" [1,721]	65-3/4" [1,670]	67-3/4" [1,721]	50" [1,270]	56" [1,422]	24" [610]	23" [584]	62-3/16" x 24" [1,580 x 610]
FDN-6-ST	77-3/4" [1,975]	79-3/4" [2,026]	77-3/4" [1,975]	79-3/4" [2,026]	50" [1,270]	56" [1,422]	24" [610]	23" [584]	74-3/16" x 24" [1,884 x 610]
FDN-7-ST	89-3/4" [2,280]	91-3/4" [2,330]	89-3/4" [2,280]	91-3/4" [2,330]	50" [1,270]	56" [1,422]	24" [610]	23" [584]	86-3/16" x 24" [2,189 x 610]

LEFT VIEW

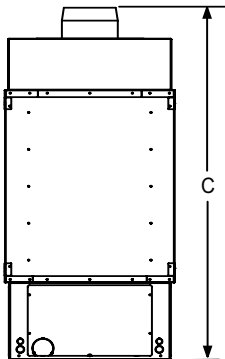

FRONT VIEW

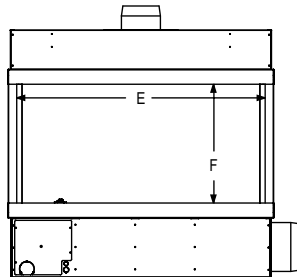

TOP VIEW

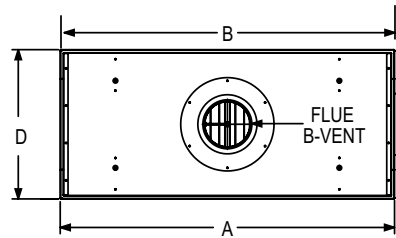

RIGHT VIEW

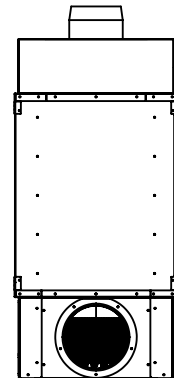



Foundation Series

PIER

DIRECT VENT GAS FIREPLACE

Let your distinctive spaces maintain their own character while you tastefully unite your overall design. A Foundations Series pier fireplace brings your interior together.

FOUNDATION SERIES: PIER

SPECIFICATIONS

MODEL	FRONT WIDTH (A)		BACK WIDTH (B)		HEIGHT (C)		DEPTH (D)		GLASS SIZE LONG SIDE (E x F)	GLASS SIZE SHORT SIDE (G x F)
	ACTUAL	FRAMING	ACTUAL	FRAMING	ACTUAL	FRAMING	ACTUAL	FRAMING		
FDN-4-PIER	53-3/4" [1,365]	54-3/4" [1,391]	53-3/4" [1,365]	54-3/4" [1,391]	50" [1,270]	56" [1,422]	24" [610]	23" [584]	50-13/16" x 24" [1,290 x 610]	24" x 24" [610 x 610]
FDN-5-PIER	65-3/4" [1,670]	66-3/4" [1,695]	65-3/4" [1,670]	66-3/4" [1,695]	50" [1,270]	56" [1,422]	24" [610]	23" [584]	62-13/16" x 24" [1,595 x 610]	24" x 24" [610 x 610]
FDN-6-PIER	77-3/4" [1,975]	78-3/4" [2,000]	77-3/4" [1,975]	78-3/4" [2,000]	50" [1,270]	56" [1,422]	24" [610]	23" [584]	74-13/16" x 24" [1,900 x 610]	24" x 24" [610 x 610]
FDN-7-PIER	89-3/4" [2,280]	90-3/4" [2,305]	89-3/4" [2,280]	90-3/4" [2,305]	50" [1,270]	56" [1,422]	24" [610]	23" [584]	86-13/16" x 24" [2,205 x 610]	24" x 24" [610 x 610]

LEFT VIEW

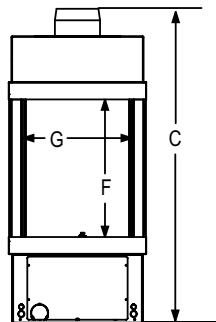

FRONT VIEW

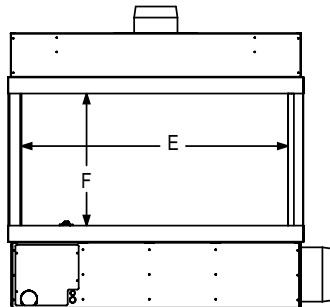

TOP VIEW

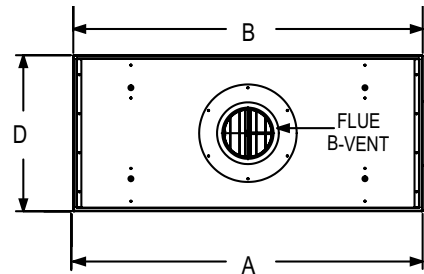

RIGHT VIEW

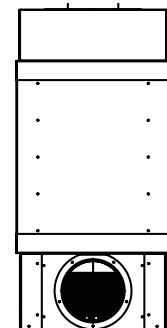



Foundation Series

BAY

DIRECT VENT GAS FIREPLACE

Trend-defining innovation embraces multi-sided visual enjoyment in a Foundation Series bay fireplace, where first glances become lasting looks – from every vantage point.

FOUNDATION SERIES: BAY

SPECIFICATIONS

MODEL	FRONT WIDTH (A)		BACK WIDTH (B)		HEIGHT (C)		DEPTH (D)		GLASS SIZE LONG SIDE (E x F)	GLASS SIZE SHORT SIDE (G x F)
	ACTUAL	FRAMING	ACTUAL	FRAMING	ACTUAL	FRAMING	ACTUAL	FRAMING		
FDN-4-BAY	53-3/4" [1,365]	52-3/4" [1,340]	53-3/4" [1,365]	52-3/4" [1,340]	50" [1,270]	56" [1,422]	24" [610]	25" [635]	53-5/8" x 24" [1,362 x 610]	24" x 24" [610 x 610]
FDN-5-BAY	65-3/4" [1,670]	64-3/4" [1,645]	65-3/4" [1,670]	64-3/4" [1,645]	50" [1,270]	56" [1,422]	24" [610]	25" [635]	65-5/8" x 24" [1,667 x 610]	24" x 24" [610 x 610]
FDN-6-BAY	77-3/4" [1,975]	76-3/4" [1,949]	77-3/4" [1,975]	76-3/4" [1,949]	50" [1,270]	56" [1,422]	24" [610]	25" [635]	77-5/8" x 24" [1,972 x 610]	24" x 24" [610 x 610]
FDN-7-BAY	89-3/4" [2,280]	88-3/4" [2,254]	89-3/4" [2,280]	88-3/4" [2,254]	50" [1,270]	56" [1,422]	24" [610]	25" [635]	89-5/8" x 24" [2,276 x 610]	24" x 24" [610 x 610]

LEFT VIEW

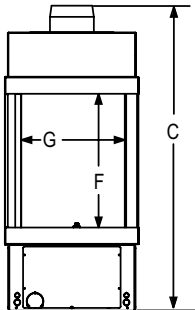

FRONT VIEW

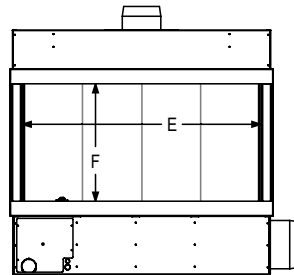

TOP VIEW

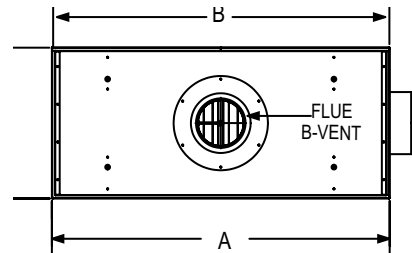

RIGHT VIEW

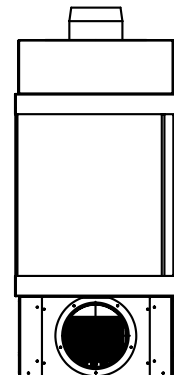

FOUNDATION SERIES: FEATURES & OPTIONS

GLASS MEDIA



CRYSTAL (STANDARD)



AMBER



CARIBBEAN BLUE



EBONY

REAL NATURAL STONES



HIGH POLISHED BLACK



POLISHED MIXED



POLISHED GOLD

DRIFTWOOD LOGS



REVERSIBLE MIRRORED INTERIOR PANELS



Enhanced infinite flame reflection or subtle infinite flame reflection

REMOTE CONTROL

Each Foundation Series fireplace comes standard with multi-colored chromotherapy LED lighting and remote control. Set and easily change the lights to different hues to match whatever mood or color scheme you'd like. Chromotherapy uses light in the form of color to balance energy in a person's body by enhancing relaxation or invigoration.



FOUNDATION SERIES: TECHNOLOGIES

The Foundation Series includes commercial grade valve and ignition system for your peace of mind. Flexible vent runs (up to 110', 11 elbows, 6' vertical drop) give you ultimate design versatility.



CO-LINEAR DIRECT VENT WITH POWERVENT SYSTEM

Co-linear design utilizing B-vent with choice of standard powervent or inline powervent exhaust system, which allows for installation flexibility.

MODEL	FLUE	OUTSIDE AIR
4"	8"	10"
5"	8"	10"
6"	10"	10"
7"	10"	10"



SAFE SURFACE GLASS

Patented SafeSurface™ double-pane glass in a proprietary cooling system that keeps heat away from outer glass surface with no safety screen needed.



MECHANICAL INTAKE DAMPER

Keeps cold air out; reversible collar allows air to come in from the side or bottom of fireplace.

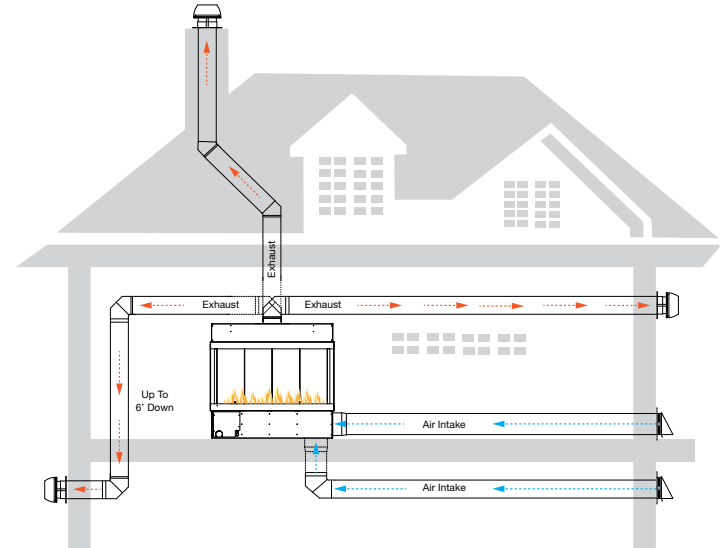

Foundation Series fireplaces vent off the top of the unit. Whether the desired cap location is a vertical or side wall application, you have up to 110 feet and 11 elbows to plan your vent run, allowing the fireplace to be right where you want it.



48" 60" 72"

PRIMO
DIRECT VENT GAS FIREPLACE

Warm up to our most luxurious fireplace yet. Where intricate modern styling meets innovative heating technology. Defying convention and designed for the spotlight. There's a reason we call it the PRIMO.

SPECIFICATIONS

MODEL	FRONT WIDTH (A)		BACK WIDTH (B)		HEIGHT (C)		DEPTH (D)		GLASS SIZE (E x F)	BTU/HOUR INPUT (NG)
	UNIT	FRAMING	UNIT	FRAMING	UNIT	FRAMING	UNIT	FRAMING ³		
PRIMO48, PRIMO48ST	59-1/2 [1511]	60-1/4 [1530]	59-1/2 [1511]	60-1/4 [1530]	30-9/16 [776]	42 [1067]	17-3/16 [437]	18-1/4 [464] ST: 17 [432]	47-1/2 x 12-1/2 [1207 x 318]	31,000 - 45,000
PRIMO60, PRIMO60ST	71-1/2 [1816]	72-1/4 [1835]	71-1/2 [1816]	72-1/4 [1835]	30-9/16 [776]	48 [1219]	17-3/16 [437]	18-1/4 [464] ST: 17 [432]	59-1/2 x 12-1/2 [1511 x 318]	38,000 - 55,000
PRIMO72, PRIMO72ST	83-1/2 [2121]	84-1/4 [2140]	83-1/2 [2121]	84-1/4 [2140]	30-9/16 [776]	48 [1219]	17-3/16 [437]	18-1/4 [464] ST: 17 [432]	71-1/2 x 12-1/2 [1861 x 318]	41,000 - 61,000

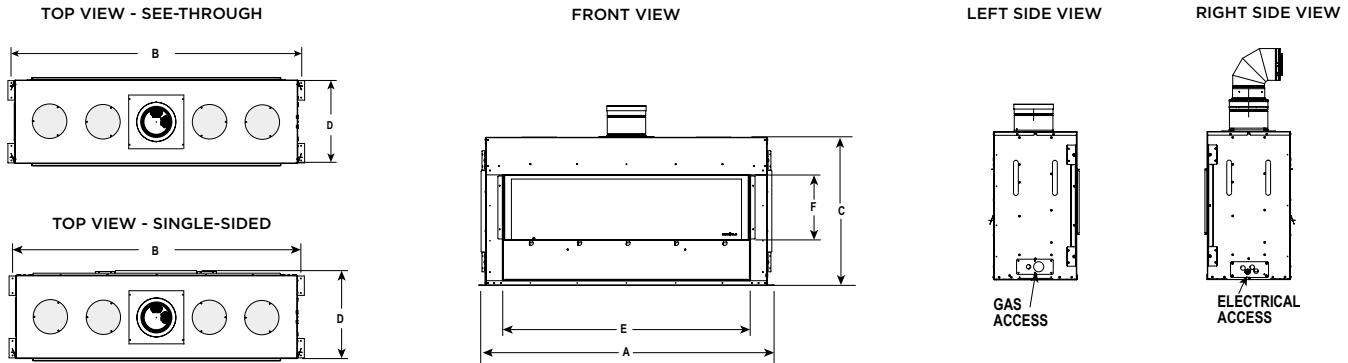

TECHNOLOGIES/FEATURES



PRIMO

SINGLE-SIDED



SEE-THROUGH



INTERIORS



CRYSTAL GLASS



EBONY GLASS



AMBER GLASS



COBALT GLASS



SCARLET GLASS



ICED FOG GLASS



DRIFTWOOD LOGS¹



RIVER ROCK STONES¹

THE DUNES MODERN WHITE LOGS BY ELISA CARLUCCI¹



The Dunes unveils a whole new view of fire. White logs transform the modern fireplace into a gallery of sculpture. The flames radiate glowing light and shadow on the sculptures creating a fireside experience unlike any other.

MULTI-COLORED LED LIGHTING



WHITE LIGHT



AQUA LIGHT



BLUE LIGHT



GREEN LIGHT



YELLOW LIGHT



RED LIGHT



MAGENTA LIGHT

¹: Requires glass media

PRIMO





36" 48" 60" 72"

MEZZO

DIRECT VENT GAS FIREPLACE

You've never experienced modern design like this. Clean. Discreet. Affordable luxury. In four sizes, with single-sided and see-through models. And a variety of finishing options. We spared nothing, to give you everything. It's modern design, redefined.

MEZZO

SPECIFICATIONS

MODEL	FRONT WIDTH (A)		BACK WIDTH (B)		HEIGHT (C)		DEPTH (D)		GLASS SIZE (E x F)	BTU/HOUR INPUT (NG)
	UNIT	FRAMING	UNIT	FRAMING	UNIT	FRAMING	UNIT	FRAMING		
MEZZO36, MEZZO36ST	46-3/16 [1173]	48-1/4 [1226]	46-3/16 [1173]	48-1/4 [1226]	41-3/4 [1060]	42 [1067]	17-1/8 [435]	18-1/4 [464] ST: 17 [432]	35-1/2 x 12-1/2 [908 x 318]	17,500 - 30,000
MEZZO48, MEZZO48ST	58 [1473]	60-1/4 [1530]	58 [1473]	60-1/4 [1530]	41-3/4 [1060]	42 [1067]	17-1/8 [435]	18-1/4 [464] ST: 17 [432]	47-1/2 x 12-1/2 [1207 x 318]	21,000 - 40,000
MEZZO60, MEZZO60ST	70 [1778]	72-1/4 [1835]	70 [1778]	72-1/4 [1835]	47-3/4 [1213]	48 [1219]	17-1/8 [435]	18-1/4 [464] ST: 17 [432]	59-1/2 x 12-1/2 [1511 x 318]	26,000 - 50,000
MEZZO72, MEZZO72ST	82 [2083]	84-1/4 [2140]	82 [2083]	84-1/4 [2140]	47-3/4 [1213]	48 [1219]	17-1/8 [435]	18-1/4 [464] ST: 17 [432]	71-1/2 x 12-1/2 [1861 x 318]	30,000 - 58,000

TOP VIEW - SINGLE-SIDED

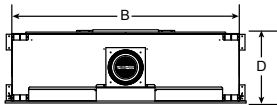

TOP VIEW - SEE-THROUGH

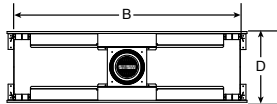

FRONT VIEW

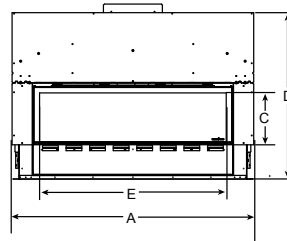

LEFT SIDE VIEW

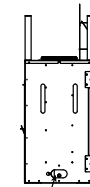

GAS ACCESS

RIGHT SIDE VIEW

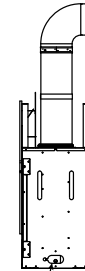

ELECTRICAL ACCESS

TECHNOLOGIES/FEATURES



BLACK GLASS



LED ACCENT LIGHTING



INTELLIFIRE PLUS



DIRECT VENT



HEAT-ZONE

MEZZO

SINGLE-SIDED



SEE-THROUGH



FRONTS



LOFT FORGE¹
Hammered steel



QUATTRO¹
Black or new bronze



CLEAN FACE TRIM
Black, new bronze or stainless steel

FINISHES

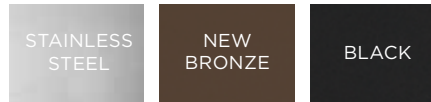

INTERIORS



CRYSTAL GLASS

EBONY GLASS

AMBER GLASS

COBALT GLASS

SCARLET GLASS

ICED FOG GLASS

NATURAL
LOGS²

DRIFTWOOD
LOGS²

RIVER ROCK
STONES²

1: Not available for 72-inch model. 2: Requires glass media





36" 42"

6000 & 8000 MODERN DIRECT VENT GAS FIREPLACES

These two models are a modern take on the flagship series of Heat & Glo. Sleek flames rise through crushed glass and multiply with a with fade-resistant reflective fluted black glass interior. It's a vivid and elegant fireside experience.

INTERIOR PANELS



FADE-RESISTANT FLUTED BLACK GLASS

INTERIOR MEDIA



CRYSTAL GLASS



EBONY GLASS



AMBER GLASS



COBALT GLASS

SPECIFICATIONS

MODEL	FRONT WIDTH		BACK WIDTH		HEIGHT		DEPTH		GLASS SIZE (E x F)	BTU/HOUR INPUT (NG)
	UNIT	FRAMING	UNIT	FRAMING	UNIT	FRAMING	UNIT	FRAMING		
6000 MODERN	41 [1041]	42 [1067]	28-1/2 [724]	42 [1067]	39-7/8 [1015]	40-1/8 [1019]	21-1/2 [546]	22 [559]	32 x 21-1/2 [813 x 546]	34,000
8000 MODERN	48 [1219]	49 [1245]	35-1/2 [901]	49 [1245]	41-7/8 [1064]	42-1/8 [1070]	21-1/2 [546]	22 [559]	39 x 23-5/8 [991 x 600]	35,500

TOP VIEW

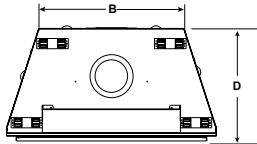

FRONT VIEW

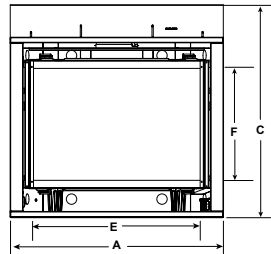

LEFT SIDE VIEW

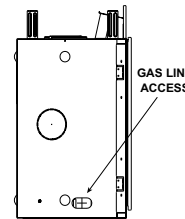

RIGHT SIDE VIEW

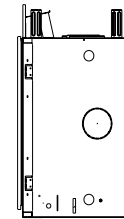

TECHNOLOGIES/FEATURES



INTELLIFIRE



DIRECT VENT



HEAT-ZONE



POWER VENT



LED ACCENT
LIGHTING



ANTI-REFLECTIVE
GLASS



32" 42"

COSMO

DIRECT VENT GAS FIREPLACE

COSMO gas fireplaces provide warmth, ambiance and chic contemporary detail. Two sizes with multiple finishing options deliver a bold design statement through a functional focal point.

SPECIFICATIONS

MODEL	FRONT WIDTH (A)		HEIGHT (B)		DEPTH (C)		REAR WIDTH (D)		GLASS SIZE (E x F)	BTU/HR INPUT
	ACTUAL	FRAMING	ACTUAL	FRAMING	ACTUAL	FRAMING	ACTUAL	FRAMING		
COSMO 32	36" [914]	37" [940]	38-1/16" [967]	36-1/2" [927]	17-3/4" [451]	17-3/4" [451]	25-3/4" [654]	37" [940]	27-1/4" x 15-1/4" [692 mm x 387]	19,000 [NG] 16,500 [LP]
COSMO 42	48" [1219]	49" [1245]	33-11/16" [856]	32-3/4" [832]	17-3/4" [451]	17-3/4" [451]	37-3/4" [959]	49" [1016]	39" x 15-1/4" [991 mm x 387]	25,250 [NG] 23,500 [LP]

TOP VIEW

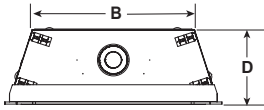

FRONT VIEW

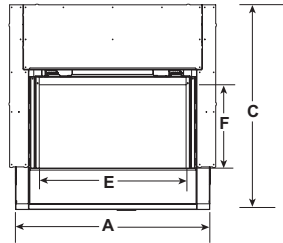

LEFT VIEW

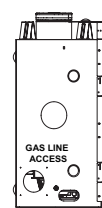

32" RIGHT VIEW

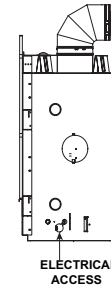

42" RIGHT VIEW

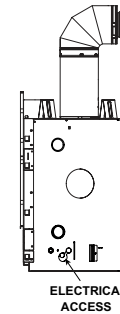

TECHNOLOGIES/FEATURES



BLACK GLASS



LED ACCENT LIGHTING



INTELLIFIRE TOUCH



SMARTWALL



HEAT-ZONE



HEAT DUCT



HEAT OUT

COSMO

FRONTS



MARTINI FRONT
Graphite, new bronze, fog gray, ebony (gloss finish)



CLEAN FACE TRIM
Graphite, new bronze, fog gray, ebony (gloss finish), stainless steel, black

FINISHES

BLACK	NEW BRONZE
FOG GRAY	GRAPHITE
EBONY (GLOSS FINISH) ¹	STAINLESS STEEL ¹

INTERIORS



FADE-RESISTANT REFLECTIVE BLACK GLASS INTERIOR PANELS



DRIFTWOOD LOGS



TRADITIONAL LOGS



LED ACCENT LIGHTING²



CRYSTAL GLASS



BLACK GLASS



AMBER GLASS



BLUE GLASS



BLACK GLASS BEADS



WHITE GLASS BEADS



CLEAR GLASS BEADS



RIVER ROCK

¹ Available for 42" only. ² White comes standard; available colors (green, red, dark blue, yellow, purple, light blue) must be set at installation.





32" 36"

SLIMLINE FUSION DIRECT VENT GAS FIREPLACE

You can personalize this unique member of the SlimLine Series with modern stones or glass, or traditional logs. Create a style uniquely yours – a fusion of modern and traditional elements.

SLIMLINE FUSION

SPECIFICATIONS

MODEL	FRONT WIDTH (A)		BACK WIDTH (B)		HEIGHT (C)		DEPTH (D)		GLASS SIZE (E x F)	BTU/HOUR INPUT
	UNIT	FRAMING	UNIT	FRAMING	UNIT	FRAMING	UNIT	FRAMING		
SL-5F	36 [914]	37 [940]	25-3/4 [654]	37 [940]	34-3/8 [873]	34-3/4 [883]	16-5/16 [414]	16-1/4 [413]	27-3/16 x 18-1/16 [691 x 459]	12,000-17,500 (NG) 13,500-17,000 (LP)
SL-7F	41 [1041]	42 [1067]	30-3/4 [781]	42 [1067]	37-7/8 [962]	38-1/4 [972]	16-5/16 [414]	16-1/4 [413]	32-1/16 x 21-1/2 [814 x 546]	16,500-24,000 (NG) 16,500-20,500 (LP)

TOP VIEW

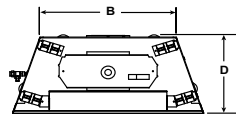

FRONT VIEW

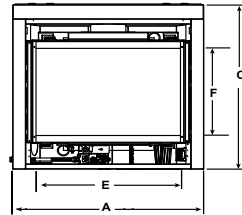

LEFT SIDE VIEW

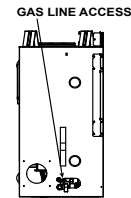

RIGHT SIDE VIEW

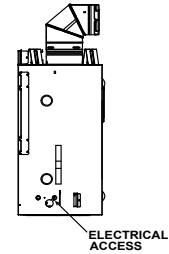

TECHNOLOGIES/FEATURES



BLACK GLASS



INTELLIFIRE



DIRECT VENT



HEAT-ZONE



HEAT DUCT



POWER VENT

SLIMLINE FUSION

FRONTS



FIRESCREEN
Available in black only



CLEAN FACE
Black, new bronze, graphite

FINISHES

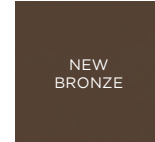
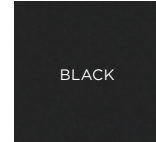

STANDARD LOGS OR OPTIONAL GLASS AND STONES



LOGS (STANDARD)



CRYSTAL GLASS



BLACK GLASS



AMBER GLASS



BLUE GLASS



WHITE GLASS BEADS



BLACK GLASS BEADS



CLEAR GLASS BEADS



CERAMIC FIBER
STONES





32"

METRO SERIES

DIRECT VENT GAS FIREPLACE

The METRO Series features a contemporary design and shallow footprint for unique installation areas, in both single-sided and see-through models. Highlight both contemporary and transitional décor with this compact, efficient option.

METRO SERIES

FRONT



MODERN

FINISHES

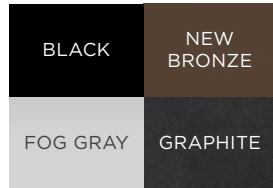

INTERIORS



CRYSTAL GLASS



BLACK GLASS



AMBER GLASS



BLUE GLASS

SPECIFICATIONS

MODEL	FRONT WIDTH (A)		BACK WIDTH (B)		HEIGHT (C)		DEPTH (D)		GLASS SIZE (E x F)	BTU/HOUR INPUT
	UNIT	FRAMING	UNIT	FRAMING	UNIT	FRAMING	UNIT	FRAMING		
METRO 32	36 [913]	37 [940]	25-3/4 [653]	37 [940]	34-3/8 [873]	43 [1092]	16-1/4 [413]	16-1/4 [413]	27-3/16 X 18-1/16 [691 X 459]	21,000
METRO SEE-THROUGH	37-5/8 [956]	38-1/8 [968]	37-5/8 [905]	38-1/8 [968]	41-1/4 [1048]	41-1/2 [1054]	16 [406]	15 [381]	27-3/16 X 18-1/16 [691 X 459]	16,000 - 22,000

METRO

TOP VIEW

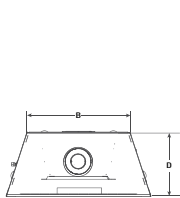

FRONT VIEW

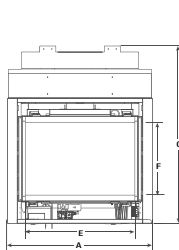

LEFT SIDE VIEW

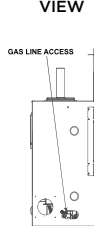

RIGHT SIDE VIEW

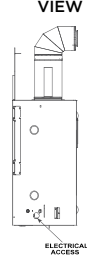

METRO SEE-THROUGH

TOP VIEW

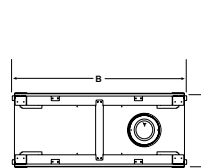

FRONT VIEW

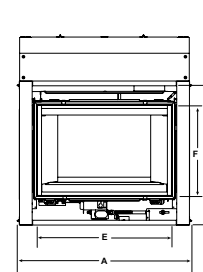

LEFT SIDE VIEW

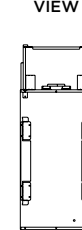

RIGHT SIDE VIEW

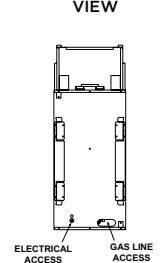

TECHNOLOGIES/FEATURES



INTELLIFIRE



DIRECT VENT



HEAT-ZONE



GAS FIREPLACE INSERTS

NO MESS. NO HASSLE.



BEFORE



AFTER

GAS INSERTS: AN INSTANT UPGRADE

Heat & Glo gas inserts provide an instant upgrade to any hearth, designed to fit directly into the existing masonry or manufactured wood-burning fireplace. Inserts instantly transform a drafty, dated fireplace into an easy, efficient and reliable heat source.



30" 35"

ESCAPE

DIRECT VENT GAS INSERT

The Escape revives an existing fireplace with impressive flames and high-efficiency heating. Exclusive FireBrick material provides authentic masonry appearances and greater heat output.

ESCAPE

FRONTS



CHATEAU FORGE
Hand-crafted, hammered steel



GALLERIA Black, new bronze or graphite



HALSTON Black, new bronze or graphite



IRON AGE Black, new bronze or graphite



FIRESCREEN Black, new bronze or graphite

FINISHES

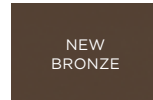
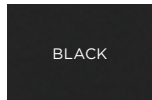
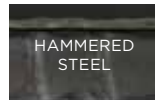

SPECIFICATIONS

MODEL	FRONT WIDTH (A)		BACK WIDTH (B)		HEIGHT (C)		DEPTH (D)		GLASS SIZE (E x F)	BTU/HOUR INPUT (NG)	CONVECTION BLOWER
	UNIT	MIN. FIREBOX OPENING	UNIT	MIN. FIREBOX OPENING	UNIT	MIN. FIREBOX OPENING	UNIT	MIN. FIREBOX OPENING			
ESCAPE-I35	34-5/8 [879]	35-1/8 [892]	25 [635]	25-1/2 [648]	24-3/8 [619]	24-5/8 [625]	17-7/8 [454]	18-1/8 [460]	31-3/8 x 19-7/8 [797 x 505]	20,000 - 40,000	120 CFM
ESCAPE-I30	30 [762]	30-1/2 [775]	21 [533]	21-1/2 [546]	22-3/8 [568]	22-5/8 [575]	16-3/8 [410]	16-5/8 [422]	26-11/16 x 17-7/8 [678 x 454]	17,000 - 36,000	120 CFM

TOP VIEW

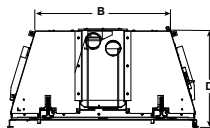

FRONT VIEW

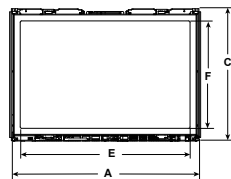

LEFT SIDE VIEW

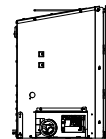

RIGHT SIDE VIEW

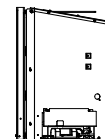

TECHNOLOGIES/FEATURES



INTELLIFIRE TOUCH



DIRECT VENT



FIREBRICK



25" 30" 35"

SUPREME DIRECT VENT GAS INSERTS

Transform a dated or drafty fireplace into a beautiful source of warmth. With additional features, these metal gas inserts provide efficient performance in smaller or larger hearth openings.

SUPREME

FRONTS



HALSTON ARCH Black, new bronze or graphite



IRON AGE Black, new bronze or graphite



FIRESCREEN Black, new bronze, graphite or gray



INSIDE FIT Black

FINISHES

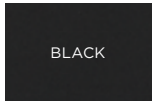

BLACK

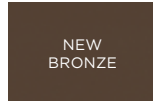

NEW
BRONZE

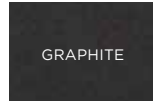

GRAPHITE

INTERIOR PANELS



BLACK METAL
(Standard)



STRATFORD
TEXTURED BRICK

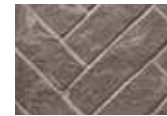

TRANQUIL GREIGE
HERRINGBONE
BRICK



REFLECTIVE
BLACK GLASS

SPECIFICATIONS

MODEL	FRONT WIDTH [A]		BACK WIDTH [B]		HEIGHT [C]		DEPTH [D]		GLASS SIZE [E X F]	BTU/HOUR INPUT (NG)	CONVECTION BLOWER
	UNIT	MIN FIREBOX OPENING	UNIT	MIN. OPEN	UNIT	MIN FIREBOX OPENING	UNIT	MIN FIREBOX OPENING			
SUPREME-125-IFT	26-1/8" [664mm]	26-5/8" [676mm]	14-5/8" [372mm]	15-1/8" [384mm]	17-1/16" [433mm]	17-5/16" [439mm]	14-1/2" [368mm]	15" [381mm]	22-1/2" X 12-7/16" [572mm X 316mm]	18,900-27,000	160 CFM
SUPREME-130-IFT	31-1/8" [791mm]	31-5/8" [803mm]	19-5/8" [499mm]	20-1/8" [511mm]	20-3/4" [527mm]	21" [533mm]	14-1/2" [368mm]	15" [381mm]	27-1/2" X 15-15/16" [699mm X 405mm]	22,890-32,700	160 CFM
SUPREME-135-IFT	36-1/8" [918mm]	36-5/8" [930mm]	24-5/8" [626mm]	25-1/8" [638mm]	24" [610mm]	24-1/4" [616mm]	14-1/2" [368mm]	15" [381mm]	32-1/2" X 19-3/8" [826mm X 492mm]	24,500-35,000	160 CFM

LEFT SIDE VIEW

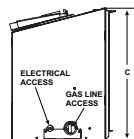

FRONT VIEW

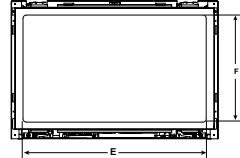

TOP VIEW

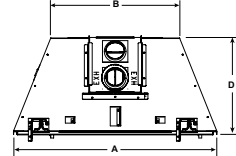

RIGHT SIDE VIEW

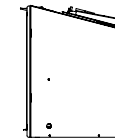

TECHNOLOGIES



**INTELLIFIRE
TOUCH**



DIRECT VENT



30" 35"

PROVIDENT DIRECT VENT GAS INSERT

Go from underused to unbelievable in as little as one day. Designed with value in mind, the Provident gas insert can turn your dated wood fireplace into a beautiful and efficient heat source without a major renovation.

PROVIDENT

FRONTS



FIRESCREEN Black, new bronze, graphite or gray



INSIDE FIT Black

FINISHES

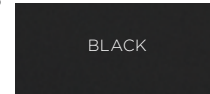

BLACK

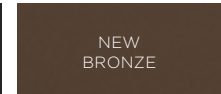

NEW
BRONZE

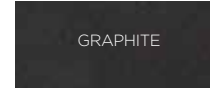

GRAPHITE



GRAY

INTERIOR PANELS



BLACK METAL
(Standard)



STRATFORD
TEXTURED BRICK

SPECIFICATIONS

MODEL	FRONT WIDTH [A]		BACK WIDTH [B]		HEIGHT [C]		DEPTH [D]		GLASS SIZE [E X F]	BTU/HOUR INPUT (NG)	CONVECTION BLOWER
	UNIT	MIN FIREBOX OPENING	UNIT	MIN. OPEN	UNIT	MIN FIREBOX OPENING	UNIT	MIN FIREBOX OPENING			
PROV-I30-IPI	31-1/8" [791mm]	31-5/8" [803mm]	19-5/8" [499mm]	20-1/8" [511mm]	20-3/4" [527mm]	21" [533mm]	14-1/2" [368mm]	15" [381mm]	27-1/2" X 15-15/16" [699mm X 405mm]	21,000-30,000	160 CFM
PROV-I35-IPI	36-1/8" [918mm]	36-5/8" [930mm]	24-5/8" [626mm]	25-1/8" [638mm]	24" [610mm]	24-1/4" [616mm]	14-1/2" [368mm]	15" [381mm]	32-1/2" X 19-3/8" [826mm X 492mm]	22,890-32,700	160 CFM

LEFT SIDE VIEW

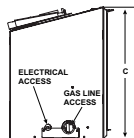

FRONT VIEW



TOP VIEW

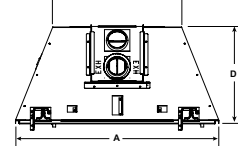

RIGHT SIDE VIEW

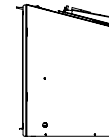

TECHNOLOGIES



INTELLIFIRE



DIRECT VENT



30" 35"

COSMO DIRECT VENT GAS INSERT

From modern to transitional design, the COSMO gas insert can transform an existing wood fireplace opening with a stunning fluted reflective black glass interior and dancing flames. Customize the interior with driftwood logs and river rock stones.

COSMO INSERT

FRONTS



HALSTON ARCH Black, new bronze or graphite



IRON AGE Black, new bronze or graphite



FIRESCREEN Black, new bronze, graphite or gray



INSIDE FIT Available in black.

FINISHES



CLEAR GLASS



EBONY GLASS



AMBER GLASS



COBALT GLASS



SCARLET GLASS



ICED FOG GLASS



CERAMIC RIVER ROCK STONES (Optional)



DRIFTWOOD LOGS (Optional)

SPECIFICATIONS

MODEL	FRONT WIDTH [A]		BACK WIDTH [B]		HEIGHT [C]		DEPTH [D]		GLASS SIZE [E X F]	BTU/HOUR INPUT (NG)	CONVECTION BLOWER
	UNIT	MIN FIREBOX OPENING	UNIT	MIN. OPEN	UNIT	MIN FIREBOX OPENING	UNIT	MIN FIREBOX OPENING			
COSMO-130-IFT	31-1/8" [791mm]	31-5/8" [803mm]	19-5/8" [499mm]	20-1/8" [511mm]	20-3/4" [527mm]	21" [533mm]	14-1/2" [368mm]	15" [381mm]	27-1/2" X 15-15/16" [699mm X 405mm]	19,600-28,000	160 CFM
COSMO-135-IFT	36-1/8" [918mm]	36-5/8" [930mm]	24-5/8" [626mm]	25-1/8" [638mm]	24" [610mm]	24-1/4" [616mm]	14-1/2" [368mm]	15" [381mm]	32-1/2" X 19-3/8" [826mm X 492mm]	21,000-30,000	160 CFM

LEFT SIDE VIEW

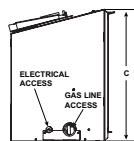

FRONT VIEW

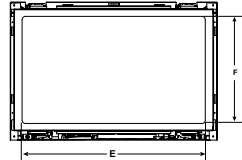

TOP VIEW

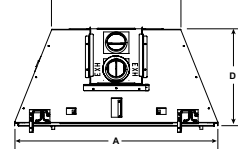

RIGHT SIDE VIEW

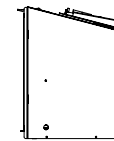

TECHNOLOGIES



INTELLIFIRE TOUCH



DIRECT VENT



TRADITIONAL WOOD FIREPLACES

WHY A WOOD FIREPLACE?

Heat & Glo wood burning fireplaces are a robust, reliable and budget-friendly alternative to true masonry fireplaces and are ideal for projects where the hearth is used seasonally or when end-users are seeking the hands-on experience of a wood-fueled appliance. It's important to understand local codes when specifying wood burning models, particularly when seeking to comply with EPA requirements and other state and city mandates.

Termination Requirements for Wood Burning Fireplaces

The quality of the fire depends on where you design—in the chimney and termination components for the specified wood-burning model. It's important to get with a local hearth installer early in the design process to ensure proper termination placement. Variables such as roof angle, prevailing wind location, and nearby overhangs, objects and openings may need to be taken into consideration.

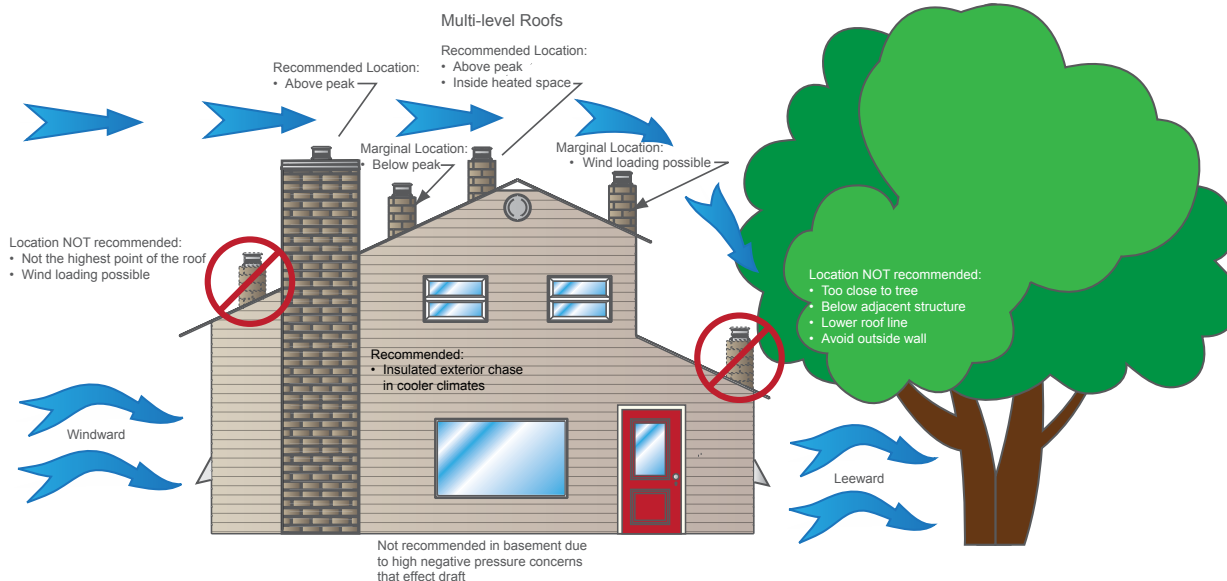



36" 42" 50"

RUTHERFORD WOOD FIREPLACE

The Rutherford Series offers robust performance and the appearance of a custom-built masonry fireplace – all at a fraction of the cost. Whether a crackle or a blaze, the Rutherford delivers a bold statement in your favorite room.

RUTHERFORD

INTERIORS



RUTHERFORD
TRADITIONAL



RUTHERFORD
HERRINGBONE

BI-FOLD GLASS DOORS



DOOR FINISHES

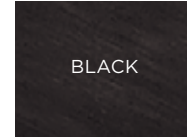

BLACK

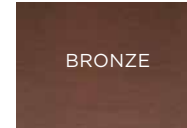

BRONZE

ANDIRONS

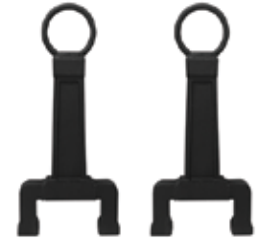

SPECIFICATIONS

MODEL	FRONT WIDTH		BACK WIDTH		HEIGHT		DEPTH		FIREBOX OPENING
	ACTUAL	FRAMING	ACTUAL	FRAMING	ACTUAL	FRAMING	ACTUAL	FRAMING	
RUTHERFORD-36	46-7/8 [1191]	47-7/8 [1216]	31-1/8 [790]	47-7/8 [1216]	74-1/8 [1883]	74-1/4 [1886]	27-1/2 [699]	28-1/2 [724]	36" x 38 [914 x 965]
RUTHERFORD-42	52-7/8 [1343]	53-7/8 [1368]	37-1/8 [943]	53-7/8 [1368]	74-1/8 [1883]	74-1/2 [1892]	27-1/2 [699]	28-1/2 [724]	42" x 38 [1067 x 965]
RUTHERFORD-50	60-7/8 [1546]	61-7/8 [1572]	45-1/8 [1146]	61-7/8 [1572]	74-1/8 [1883]	74-1/2 [1892]	27-1/2 [699]	28-1/2 [724]	50" x 38 [1270 x 965]

TOP VIEW

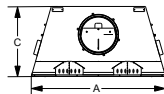

FRONT VIEW

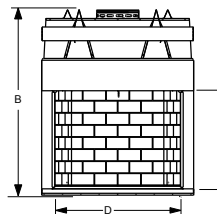

SIDE VIEW



RUTHERFORD-42
SIDE VIEW

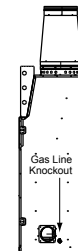



36"

NORTHSTAR
EPA-CERTIFIED WOOD FIREPLACE

The Northstar exceeds the strictest environmental standards in the nation so you can enjoy roaring fires even in areas where conventional wood-burning fireplaces are banned.

BI-FOLD GLASS DOORS

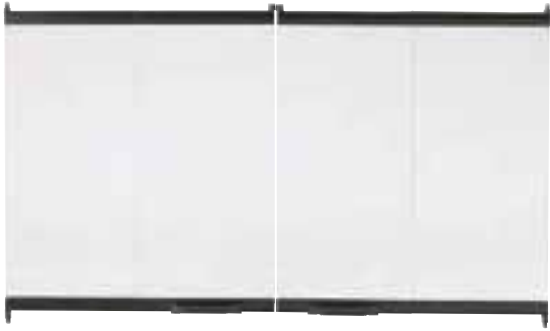

FINISHES

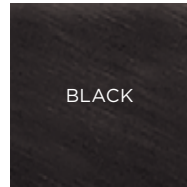

SPECIFICATIONS

MODEL	WIDTH (A)		HEIGHT (B)		DEPTH (C)		VIEWING AREA (D x E)
	ACTUAL	FRAMING	ACTUAL	FRAMING	ACTUAL	FRAMING	
NORTHSTAR	40 [1016]	42-1/2 [1080]	40-1/4 [1022]	44 [1118]	23 [584]	24 [610]	29-1/4 x 16-5/8 [743 x 422]

TOP VIEW

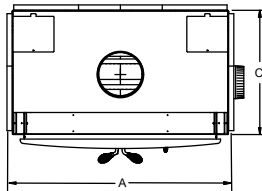

FRONT VIEW

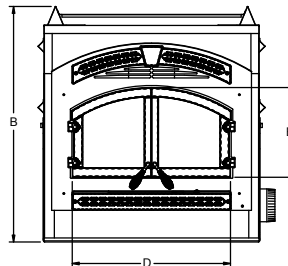

SIDE VIEW

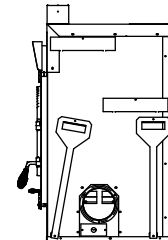



36" 42" 50"

EXCLAIM WOOD FIREPLACE

The Exclaim Series offers large viewing areas and attractive brick interiors, bringing warmth and ambiance into your favorite room.

EXCLAIM

DOORS

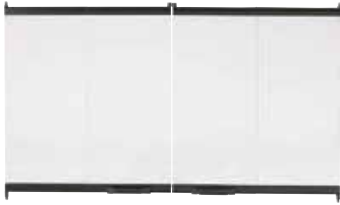

BI-FOLD GLASS DOORS
Black, stainless steel

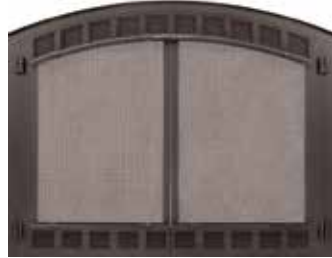

CONTOUR MESH DOORS
Black



GRAND VISTA MESH DOORS
Black, bronze

DOOR FINISHES

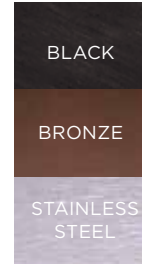

INTERIORS



TRADITIONAL

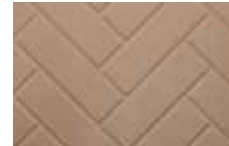

HERRINGBONE

SPECIFICATIONS

MODEL	WIDTH (A)		HEIGHT (B)		DEPTH (C)		VIEWING AREA (D x E)
	ACTUAL	FRAMING	ACTUAL	FRAMING	ACTUAL	FRAMING	
EXCLAIM-36	44-1/2 [1130]	45-1/2 [1156]	59-1/4 [1505]	59-3/4 [1518]	27-1/2 [699]	28 [711]	36 x 28-1/2 [914 x 724]
EXCLAIM-42	50-1/2 [1283]	51-1/2 [1308]	59-1/4 [1505]	59-3/4 [1518]	27-1/2 [699]	28-1/2 [724]	42 x 28-1/2 [1067 x 724]
EXCLAIM-50	60-5/8 [1540]	61-5/8 [1565]	70-1/2 [1791]	71 [1803]	29-1/2 [749]	30-1/2 [772]	50 x 33 [1270 x 838]

TOP VIEW

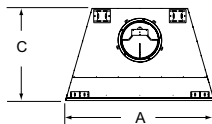

FRONT VIEW

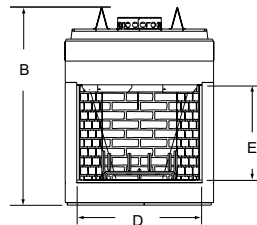

SIDE VIEW

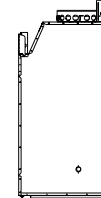



36" 42"

ENERGY MASTER WOOD FIREPLACE

The Energy Master Series delivers generous warmth and solid radiant heat from an insulated, heat-circulating fireplace.

ENERGY MASTER

DOORS



GASKETED GLASS DOORS
Black



GRAND VISTA MESH DOORS
Black, bronze

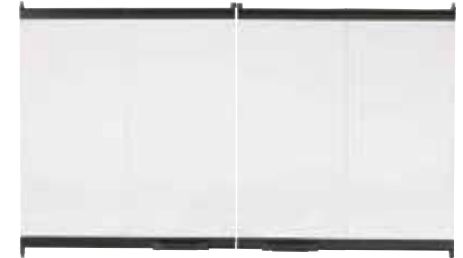

BI-FOLD GLASS DOORS
Black, stainless steel

DOOR FINISHES

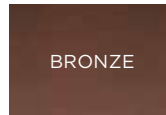
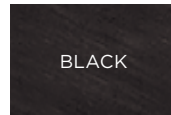

SPECIFICATIONS

MODEL	WIDTH (A)		HEIGHT (B)		DEPTH (C)		VIEWING AREA (D x E)
	ACTUAL	FRAMING	ACTUAL	FRAMING	ACTUAL	FRAMING	
ENERGY MASTER-415	42 [1067]	43 [1092]	41-3/8 [1051]	41-1/2 [1054]	22-3/4 [578]	23 [584]	36 x 23-3/8 [914 x 594]
ENERGY MASTER-485T	48 [1219]	49 [1245]	41-3/8 [1051]	41-1/2 [1054]	22-3/4 [578]	23 [584]	42 x 23-3/8 [1067 x 594]

TOP VIEW

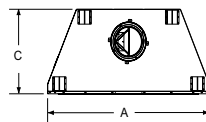

FRONT VIEW

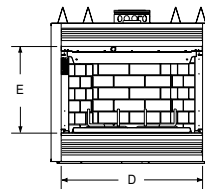

SIDE VIEW

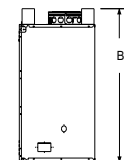



36" 42"

ROYAL HEARTH WOOD FIREPLACE

Enjoy blazing wood-burning fires with the Royal Hearth Series. An easy-to-operate damper, convenient ash lip and invisible smoke shield make staying comfortable even easier.

ROYAL HEARTH

BI-FOLD GLASS DOORS

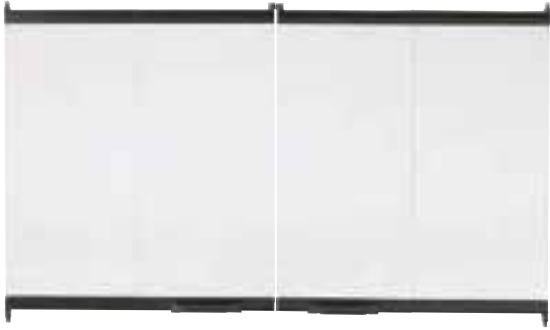

FINISHES

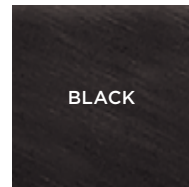

SPECIFICATIONS

MODEL	WIDTH (A)		HEIGHT (B)		DEPTH (C)		FIREBOX OPENING (D x E)
	ACTUAL	FRAMING	ACTUAL	FRAMING	ACTUAL	FRAMING	
ROYAL HEARTH 36"	41 [1041]	42 [1067]	39-1/2 [1003]	39-3/4 [1010]	21-3/8 [543]	21-1/2 [546]	36 x 21 [914 x 533]
ROYAL HEARTH 42"	47 [1194]	48 [1219]	39-1/2 [1003]	39-3/4 [1010]	21-3/8 [543]	21-1/2 [546]	42 x 21 [1067 x 533]

TOP VIEW

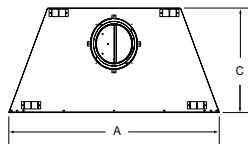

FRONT VIEW

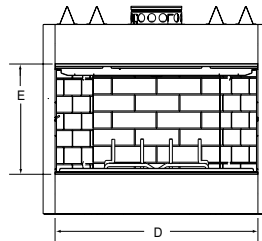

SIDE VIEW

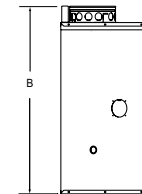



ELECTRIC FIREPLACES

WHY AN ELECTRIC FIREPLACE?

Electric fireplaces are an excellent option when no other fuel sources are available or when vent runs are exceeded. Available in both built-in and wall-mounted units, electric fireplaces will entice end-users with vibrant LED “flames”, unique design features like backlighting, and heat optional operation.



EASY AND ECONOMICAL

Electric fireplaces provide a unique focal point without expensive installation costs as they require no venting. At an entry price point and costing just pennies a day to operate, they are an ideal hearth solution to specify for any residential or commercial space. Ideal as a second or third fireplace, electric fireplaces can be installed in any room of a property.



HEAT OPTIONAL

The heat output of electric fireplaces can be adjusted or turned off altogether – an excellent solution for projects where the ambiance of a fire is desired without the supplemental warmth. Specify electric models when building in warm climates or for spaces that would benefit from a heat-optional function.



ENVIRONMENTALLY FRIENDLY

Electric fireplaces emit zero combustion by-products and are allowed in all national green building programs.



30" 36"

SIMPLIFIRE BUILT-IN ELECTRIC FIREPLACE

Adding the traditional look of a fireplace to your home has never been this easy. A detailed masonry-style interior, textured log set and four different flame intensity levels enhance the appeal of the SimpliFire Built-In electric fireplace series. Enjoy the ambiance – with or without the heat. Experience “Fire Made Simple.”

SIMPLIFIRE BUILT-IN

FRONTS



OPTIONAL FRONT

SPECIFICATIONS

MODEL	FRONT WIDTH (A)		REAR WIDTH (D)		HEIGHT (B)		DEPTH (C)		BTU/HR OUTPUT	
	ACTUAL	FRAMING	ACTUAL	FRAMING	ACTUAL	FRAMING	ACTUAL	FRAMING	120V	240V
SimpliFire Built-In 30	31" (787mm)	32" (813mm)	24" (610mm)	32" (813mm)	26-3/4" (679mm)	26-13/16" (681mm)	11" (279mm)	11-5/8" (295mm)	4,800	10,000
SimpliFire Built-In 36	37" (940mm)	38" (965mm)	30" (762mm)	38" (965mm)	31-7/32" (793mm)	31-7/32" (793mm)	11" (279mm)	11-5/8" (295mm)	4,800	10,000

TOP VIEW

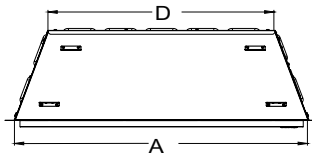

FRONT VIEW

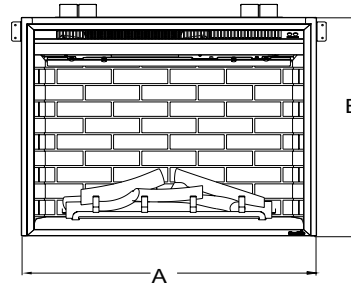

SIDE VIEW

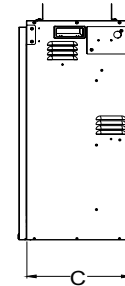



43" 55" 78"

SIMPLIFIRE SCION

CLEAN FACE LINEAR
ELECTRIC FIREPLACE

Enjoy warmth and coziness without the need for gas lines or venting. Modern design comes with no mesh screens or visible heat vents, a multitude of flame and ember bedlighting themes, and the ability to bring finishing materials right up to the edge of the fireplace for a flush look.

SIMPLIFIRE SCION

STANDARD MEDIA



DRIFTWOOD LOGS



CLEAR CRYSTALS

SPECIFICATIONS

MODEL	BTU OUTPUT	WIDTH (A)*		HEIGHT (B)		DEPTH (C)*		VIEWING AREA (D X E)
		UNIT	FRAMING	UNIT	FRAMING	UNIT	FRAMING	
43" Clean Face Linear SF-SC43-BK	5,000	44-1/2" [1130]	45" [1143]	23-7/8" [606]	24-1/4" [616]	7-5/8" [194]	7-5/8" [194]	41-1/2" x 15" [1054 x 381]
55" Clean Face Linear SF-SC55-BK	5,000	56-1/2" [1435]	57" [1448]	23-7/8" [606]	24-1/4" [616]	7-5/8" [194]	7-5/8" [194]	53-1/4" x 15" [1353 x 381]
78" Clean Face Linear SF-SC78-BK	5,000	80" [2032]	80-1/2" [2045]	23-7/8" [606]	24-1/4" [616]	7-5/8" [194]	7-5/8" [194]	76-7/8" x 15" [1953 x 381]

*Dimensions include louver projection on sides and top panels

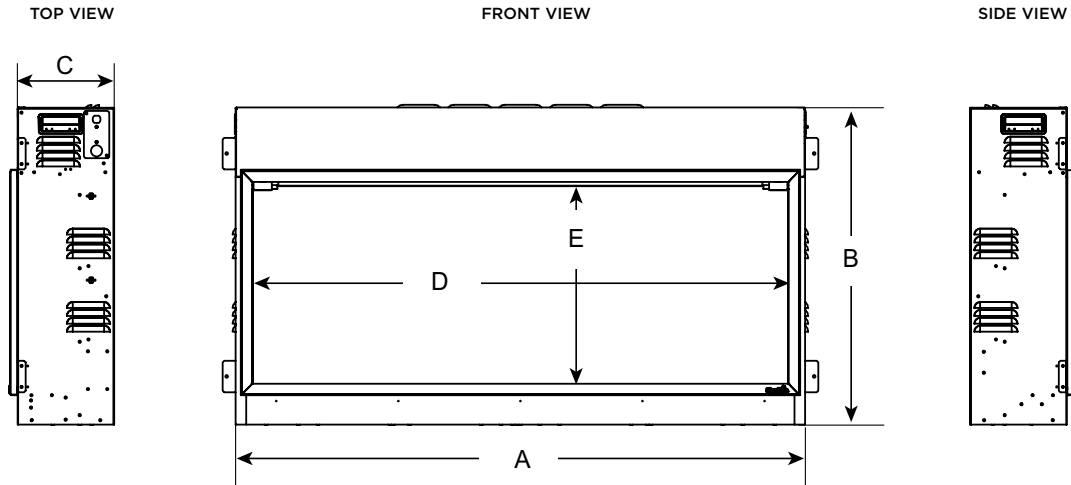



40" 48" 60" 84"

SIMPLIFIRE ALLUSION

RECESSED LINER
ELECTRIC FIREPLACE

The Allusion electric fireplace series embraces modern design by combining linear proportions with a multitude of flame and ember bed lighting themes. These fireplaces can be installed fully or partially recessed into the wall anywhere fireplaces can't go or a second or third option is desired, or hung on the wall for instant enjoyment.

SIMPLIFIRE ALLUSION

OPTIONAL MEDIA



DRIFTWOOD LOGS



CERAMIC STONES

SPECIFICATIONS

MODEL	BTU OUTPUT	WIDTH			HEIGHT			DEPTH		VIEWING AREA (F X G)
		FRONT (A)	BACK (B)	FRAMING	FRONT (C)	BACK (D)	FRAMING	UNIT (E)	FRAMING*	
40" Recessed Linear SF-ALL48-BK	5,000	40-1/2" [1029]	35" [889]	36" [914]	20-1/4" [515]	17-13/16" [453]	18-1/8" [461]	5-15/16" [151]	6" [152]	31-3/8" x 11-1/4" [797 x 285]
48" Recessed Linear SF-ALL48-BK	5,000	48-7/16" [1230]	42-13/16" [1088]	44-5/16" [1126]	20-1/4" [515]	17-13/16" [453]	18-1/8" [461]	5-15/16" [151]	6" [152]	39-3/8" x 11-1/4" [1000 x 285]
60" Recessed Linear SF-ALL60-BK	5,000	60-1/4" [1530]	54-5/8" [1388]	56-1/8" [1426]	20-1/4" [515]	17-13/16" [453]	18-1/8" [461]	5-15/16" [151]	6" [152]	51-3/16" x 11-1/4" [1300 x 285]
84" Recessed Linear SF-ALL48-BK	5,000	83-7/8" [2130]	78-1/4" [1988]	79-1/2" [2019]	20-1/4" [515]	17-13/16" [453]	18-1/8" [461]	5-15/16" [151]	6" [152]	74-7/8" x 11-1/4" [1902 x 285]

*Reflects fully recessed into a 6" interior wall. Framing may need to be adjusted when installing in an exterior wall requiring insulation. Refer to installation manual for details.

TOP VIEW

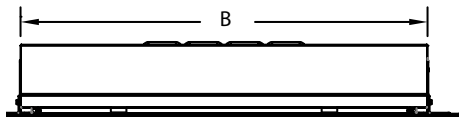

FRONT VIEW

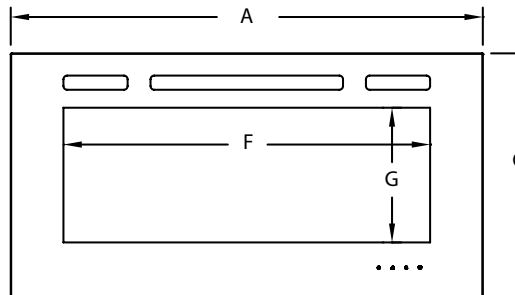

SIDE VIEW

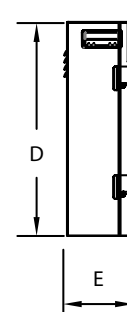



38" 58" 70" 94"

SIMPLIFIRE WALL-MOUNT ELECTRIC FIREPLACE

Create a distinct contemporary look. Four Wall-Mount electric fireplace models provide an instant upgrade to any space, with or without the heat. Simply hang these units on the wall and plug them in. Easily find the right size for your space: 38, 58, 70 and 94-inch models are available, all with standard multi-colored LED backlighting to accent any décor.

SIMPLIFIRE WALL-MOUNT

SPECIFICATIONS

MODEL	FRONT WIDTH (A)		REAR WIDTH (A)		HEIGHT (B)		DEPTH (C)		BTU/HR OUTPUT
	ACTUAL	FRAMING	ACTUAL	FRAMING	ACTUAL	FRAMING	ACTUAL	FRAMING	
SimpliFire Wall-Mount 38	37-3/4" (959mm)	N/A	34-3/4" (883mm)	N/A	17-3/4" (451mm) 20-3/4" w/stand (527mm)	N/A	4-3/4" (121mm)	N/A	4,800
SimpliFire Wall-Mount 58	58-1/4" (1480mm)	N/A	42-15/16" (1091mm)	N/A	26-3/8" (670mm)	N/A	5-7/8" (149mm)	N/A	4,800
SimpliFire Wall-Mount 70	70-1/4" (1784mm)	N/A	54-3/4" (1391mm)	N/A	26-3/8" (670mm)	N/A	5-7/8" (149mm)	N/A	4,800
SimpliFire Wall-Mount 94	93-11/16" (2380mm)	N/A	78-3/8" (1991mm)	N/A	26-3/8" (670mm)	N/A	5-7/8" (149mm)	N/A	4,800

FRONT VIEW

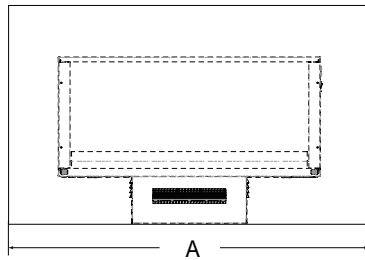

SIDE VIEW

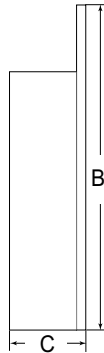



30"

SIMPLIFIRE INSERT ELECTRIC FIREPLACE INSERT

There has never been a more economical way to transform your drafty, dated fireplace into an efficient and attractive source of warmth. Firebox accent lighting, textured log set and multiple flame intensity levels enhance the allure. Best of all, enjoy the ambiance with or without the heat for year-round use. This is "Fire Made Simple."

SIMPLIFIRE INSERT

MULTI-FUNCTION REMOTE



AN INTUITIVE
MULTIFUNCTION REMOTE
CONTROL COMES
STANDARD

SPECIFICATIONS

MODEL	BTU OUTPUT	WIDTH			HEIGHT			DEPTH		VIEWING AREA (F X G)
		FRONT (A)	BACK (B)	FRAMING	FRONT (C)	BACK (D)	FRAMING	UNIT (E)	FRAMING*	
30" Fireplace Insert SF-INS30-BK	5,000	33-1/8" [841]	22-7/8" [581]	31" [787]	21-7/8" [556]	20-1/2" [521]	21-3/8" [543]	11-7/8" [302]	11-1/2" [292]	27" x 18-1/8" [686 x 460]

TOP VIEW

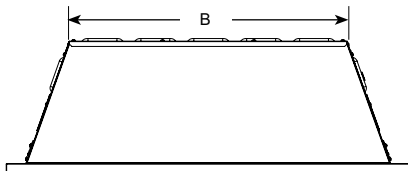

FRONT VIEW

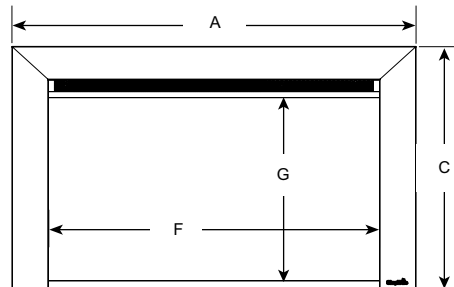

SIDE VIEW

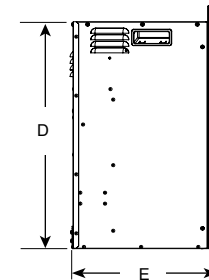



INDOOR/OUTDOOR GAS FIREPLACES



WHY AN INDOOR/OUTDOOR FIREPLACE?

Today's hearth technology allows for a vast array of architectural products designed to seamlessly blend inside and outside areas together. Indoor/Outdoor gas fireplaces are engineered for two sided applications, creating a beautiful portal to the outdoors while keeping your building envelope secure and thermally efficient. Flank with windows and glass and create a focal point with a view.



36"

TWILIGHT II

INDOOR/OUTDOOR GAS FIREPLACE

Add warmth and fireside views to two spaces with one fireplace. The Twilight II is the world's first see-through indoor/outdoor gas fireplace. Enjoy the fire all year long from either side. An advanced design and strong construction ensures an impressive and consistent performance.

TWILIGHT II

FRONTS/INTERIOR



FIRESCREEN



CONTEMPORARY

FRONT/EXTERIOR



FIRESCREEN

FINISHES



BLACK



FOG GRAY

(Contemporary front only)

SPECIFICATIONS

MODEL	FRONT WIDTH (A)		REAR WIDTH (B)		HEIGHT (C)		DEPTH (D)		GLASS SIZE (E x F)	BTU/HR INPUT
	ACTUAL	FRAMING	ACTUAL	FRAMING	ACTUAL	FRAMING	ACTUAL	FRAMING		
TWILIGHT II	43 [1091]	44 [1118]	43 [1091]	44 [1118]	46-7/8 [1191]	47-5/8 [1210]	24 [609]	23 [584]	35-5/8 x 21-1/2 [905 x 546]	38,000 (NG), 36,000 (LP)

TOP VIEW

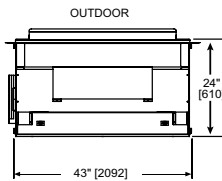

FRONT VIEW INDOOR

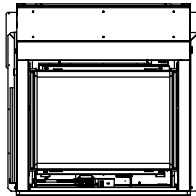

FRONT VIEW OUTDOOR

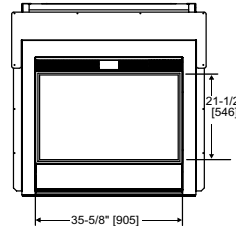

SIDE VIEW

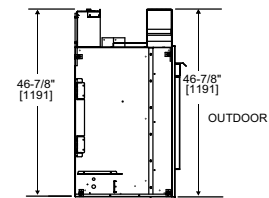

TECHNOLOGIES/FEATURES



INTELLIFIRE



DIRECT VENT



36"

TWILIGHT MODERN INDOOR/OUTDOOR GAS FIREPLACE

The Twilight Modern is an evolution of the industry's first indoor/outdoor see-through fireplace. This Direct Vent gas unit offers impressive fireside views whether relaxing inside or enjoying the outdoors. Bolster your favorite room and upgrade your outdoor living space. Let the Twilight deliver modern style, inside and out.

TWILIGHT MODERN

FRONTS/INTERIOR



FIRESCREEN



CONTEMPORARY

FRONT/EXTERIOR



FIRESCREEN

FINISHES



BLACK



FOG GRAY

(Contemporary front only)

INTERIORS



CRYSTAL GLASS



BLACK GLASS (INCLUDED)



AMBER GLASS

SPECIFICATIONS

MODEL	FRONT WIDTH (A)		REAR WIDTH (B)		HEIGHT (C)		DEPTH (D)		GLASS SIZE (E x F)	BTU/HR INPUT
	ACTUAL	FRAMING	ACTUAL	FRAMING	ACTUAL	FRAMING	ACTUAL	FRAMING		
TWILIGHT II	43 [1091]	44 [1118]	43 [1091]	44 [1118]	46-7/8 [1191]	47-5/8 [1210]	24 [609]	23 [584]	35-5/8 x 21-1/2 [905 x 546]	38,000 (NG), 36,000 (LP)

TOP VIEW

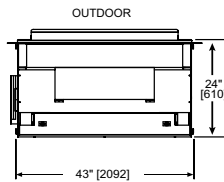

FRONT VIEW INDOOR

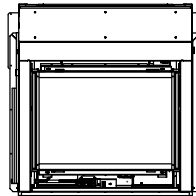

FRONT VIEW OUTDOOR

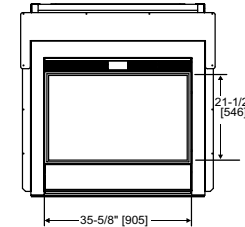

SIDE VIEW

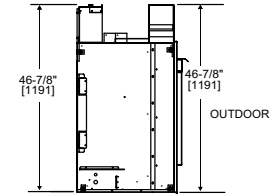

TECHNOLOGIES/FEATURES



INTELLIFIRE



DIRECT VENT



30'

FORTRESS

INDOOR/OUTDOOR GAS FIREPLACES

Seamlessly integrate your indoor and outdoor space with the Fortress see-through gas fireplace. The traditional style, expansive viewing area and authentic look fit perfectly in a variety of spaces. Non-reflective glass, accent lights and multiple interior brick options make this unique fireplace the ultimate in traditional luxury design. Enjoy the view both inside and out with the Fortress.

FORTRESS

INTERIORS



TRADITIONAL BRICK



HERRINGBONE BRICK



SPECIFICATIONS

MODEL	WIDTH (A)		HEIGHT (B)		DEPTH (C)		VIEWING AREA (D x E)	BTU/HR INPUT
	ACTUAL	FRAMING	ACTUAL	FRAMING	ACTUAL	FRAMING		
FORTRESS	49-3/8 [1254]	49-1/2 [1257]	44-3/8 [1154]	44-1/2 [1130]	25-5/8 [650]	23 [584]	36" x 30 [915 x 762]	56,000 (NG/LP)

TOP VIEW

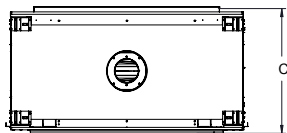

FRONT VIEW

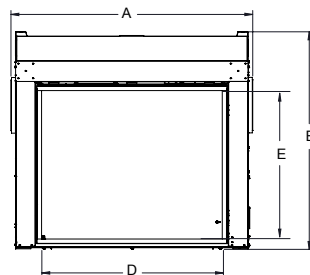

LEFT SIDE VIEW

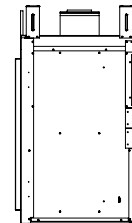

RIGHT SIDE VIEW

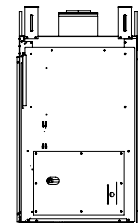

TECHNOLOGIES/FEATURES



INTELLIFIRE TOUCH



DIRECT VENT



BLACK GLASS



ANTI-REFLECTIVE GLASS



OUTDOOR FIREPLACES

WHY AN OUTDOOR FIREPLACE?

Adding a fireplace to your outdoor space design will extend its seasonality and deliver a vibrant feature for which your clients will clamor. Designed specifically to withstand the elements, outdoor fireplaces come in a variety of styles to suit the goals of your clients and end-users. Incorporate into your exterior building envelope or as an attractive free-standing island application.



Outdoor fireplaces are in the
TOP 10
most essential and desired
outdoor home features¹.

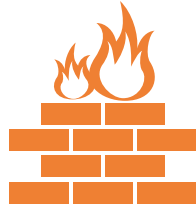

Fire features are the
MOST POPULAR
outdoor design element².



90%
of real estate agents
say an outdoor
fireplace increases a
home's value³.



70%
of design and build firms
report an increased demand
for outdoor living space⁴.

1: National Association Home Builders, "Housing Preferences of Homebuyers – The Boomer Generation & How They Compare to Other Homebuyers", Dec. 2016

2: Source: American Society of Landscape Architects 2016 Residential Landscape Architecture Trends Survey

3: Source: Houzz.com 2016 Landscaping Study

4: Source: American Institute of Architects



51'

LANAI OUTDOOR GAS FIREPLACE

Light up your landscape. The Lanai linear gas fireplace offers contemporary style, where end users feel confident enjoying the flames with proven technologies. The night comes alive with glowing flames and a colorful firebed.

LANAI

LED LIGHTING



WHITE



AQUA



BLUE



PURPLE



RED



YELLOW



GREEN

SAFETY SCREEN



SPECIFICATIONS

MODEL	WIDTH (A)		HEIGHT (B)		DEPTH (C)		VIEWING AREA (D x E)	BTU/ HR INPUT
	ACTUAL	FRAMING	ACTUAL	FRAMING	ACTUAL	FRAMING		
LANAI	57-1/4 [1454]	57-3/4 [1467]	36-3/8 [924]	39-1/2 [1003]	17-5/8 [448]	17-5/8 [448]	51 x 18 [1295 x 457]	55,000

FRONT VIEW

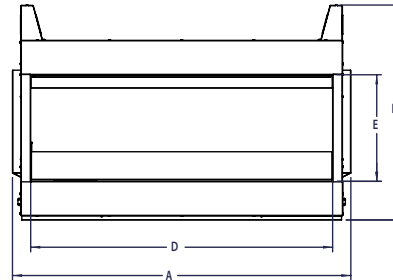

SIDE VIEW

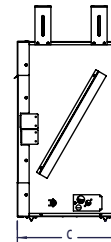

TECHNOLOGIES/FEATURES



INTELLIFIRE



LED EMBER
BED



36" 42"

COURTYARD OUTDOOR GAS FIREPLACE

The Courtyard outdoor gas fireplace is the perfect blend of artistry and function: traditional styling with ultra-realistic logs or contemporary glass, that ignites at the flip of a switch. Mesmerizing flames provide instant ambiance and relaxation. Cozy up with the Courtyard.

COURTYARD

INTERIORS



PREMIUM
HERRINGBONE



PREMIUM
TRADITIONAL



STANDARD
TRADITIONAL



STAINLESS STEEL

GLASS MEDIA



CRYSTAL GLASS



BLACK GLASS



AMBER GLASS



BLUE GLASS



RED GLASS

FRAMED MESH BARRIER

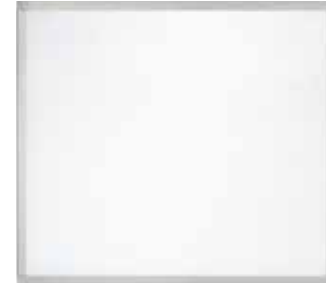

SPECIFICATIONS

MODEL	FRONT WIDTH (A)		HEIGHT (B)		DEPTH (C)		VIEWING AREA (D x E)	BTU/ HR INPUT
	ACTUAL	FRAMING	ACTUAL	FRAMING	ACTUAL	FRAMING		
COURTYARD-36"	41-3/4 [1060]	43-1/2 [1105]	44 [1118]	44-1/8 [1121]	18 [457]	18-1/8 [459]	36 x 30-3/4 [914 x 781]	40,000 (NG), 40,000 (LP)
COURTYARD-42"	47-3/4 [1213]	49-1/2 [1257]	44 [1118]	44-1/8 [1121]	18 [457]	18-1/8 [459]	42 x 30-3/4 [1067 x 781]	42,000 (NG), 42,000 (LP)

FRONT VIEW

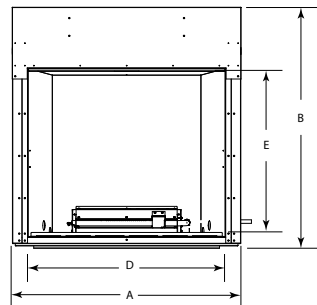

SIDE VIEW

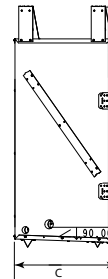

TECHNOLOGIES/FEATURES



INTELLIFIRE



HIGH-DEFINITION
LOGS



36" 42"

VILLA GAS OUTDOOR GAS FIREPLACE

The Villa Gas is a versatile outdoor gas fireplace at a value price. This compact unit can easily be installed on decks or patios. A stainless, steel surround withstands the elements, and complements an outdoor kitchen or contemporary living space.

VILLA GAS

DOORS



STAINLESS STEEL OPERABLE DOORS

INTERIOR



STANDARD TRADITIONAL

SPECIFICATIONS

MODEL	FRONT WIDTH (A)		HEIGHT (B)		DEPTH (C)		VIEWING AREA (D x E)	BTU/ HR INPUT
	ACTUAL	FRAMING	ACTUAL	FRAMING	ACTUAL	FRAMING		
VILLA GAS 36"	41 [1041]	42 [1067]	39-1/2 [1003]	39-3/4 [1010]	21-3/8 [544]	21-1/2 [546]	36 x 20-7/8 [914 x 532]	40,000 (NG) 40,000 (LP)
VILLA GAS 42"	47 [1194]	48 [1219]	39-1/2 [1003]	39-3/4 [1010]	21-3/8 [544]	21-1/2 [546]	42 x 20-7/8 [1067 x 532]	42,000 (NG) 42,000 (LP)

TOP VIEW

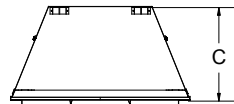

FRONT VIEW

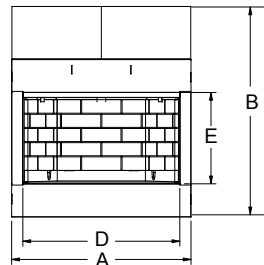

SIDE VIEW

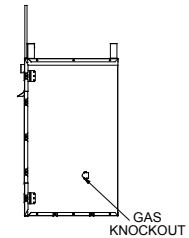



CASTLEWOOD
OUTDOOR WOOD FIREPLACE

The Castlewood turns any outdoor area into a welcoming and relaxing living space. A large, high opening provides a dramatic view from across the yard, and a textured brick interior offers masonry-style looks at a fraction of the cost.

CASTLEWOOD

INTERIOR STYLES



TRADITIONAL



HERRINGBONE

DOORS



CABINET DOORS

SPECIFICATIONS

MODEL	FRONT WIDTH (A)		BACK WIDTH (B)		HEIGHT (C)		DEPTH (D)		VIEWING AREA (E x F)
	ACTUAL	FRAMING	ACTUAL	FRAMING	ACTUAL	FRAMING	ACTUAL	FRAMING	
CASTLEWOOD-42"	52-7/8 [1343]	53-7/8 [1368]	37-1/8 [943]	40-1/8 [1019]	74-1/8 [1883]	74-1/2 [1892]	27-1/2 [699]	28-1/2 [724]	41-7/8 x 38 [1063 x 965]

TOP VIEW

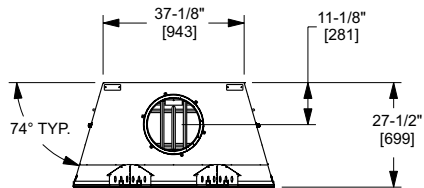

SIDE VIEW

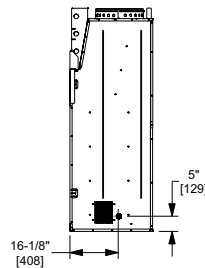

FRONT VIEW

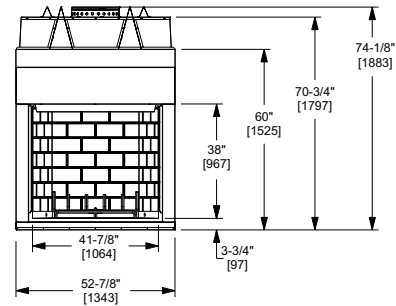

SIDE VIEW

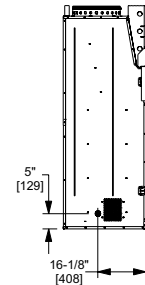



36" 42"

MONTANA OUTDOOR WOOD FIREPLACE

The Montana is the original outdoor fireplace that started it all. It's fashionably built to withstand adverse weather conditions and deliver solid performance – season after season, year after year.

MONTANA

INTERIOR STYLES



TRADITIONAL



HERRINGBONE

SPECIFICATIONS

MODEL	FRONT WIDTH		BACK WIDTH		HEIGHT		DEPTH		VIEWING AREA
	ACTUAL	FRAMING	ACTUAL	FRAMING	ACTUAL	FRAMING	ACTUAL	FRAMING	
Montana-36"	42" [1067]	43" [1091]	25" [635]	43" [1091]	42-1/4" [1073]	42-3/8" [1076]	23-1/4" [591]	24-1/8" [613]	36" x 23-1/2" [915 x 597]
Montana-42"	48" [1219]	49" [1246]	31" [787]	49" [1246]	42-1/4" [1073]	42-3/8" [1076]	23-1/4" [591]	24-1/8" [613]	42" x 23-1/2" [1067 x 597]

TOP VIEW

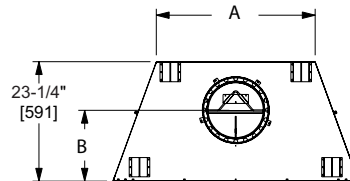

FRONT VIEW

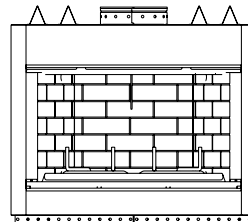

SIDE VIEW

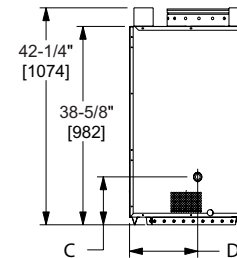



36" 42"

VILLAWOOD OUTDOOR WOOD FIREPLACE

The Villawood is a wood-burning fireplace at home in a variety of outdoor spaces. Upgrade your outdoor kitchen or enhance your living area with style and warmth. Attractive stainless steel, surround helps accent your décor.

VILLA WOOD

INTERIOR STYLES



TRADITIONAL



HERRINGBONE

SPECIFICATIONS

MODEL	FRONT WIDTH		BACK WIDTH		HEIGHT		DEPTH		VIEWING AREA
	ACTUAL	FRAMING	ACTUAL	FRAMING	ACTUAL	FRAMING	ACTUAL	FRAMING	
Villawood-36"	41" [1041]	42" [1067]	23-3/4" [603]	42" [1067]	39-1/2" [1003]	39-3/4" [1010]	21-3/8" [544]	21-1/2" [546]	36" x 20-7/8" [914 x 532]
Villawood-42"	47" [1194]	48" [1219]	29-3/4" [756]	48" [1219]	39-1/2" [1003]	39-3/4" [1010]	21-3/8" [544]	21-1/2" [546]	42" x 20-7/8" [1067 x 532]

TOP VIEW

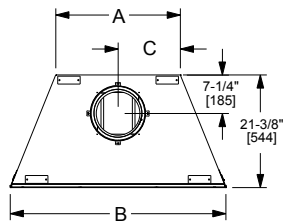

FRONT VIEW

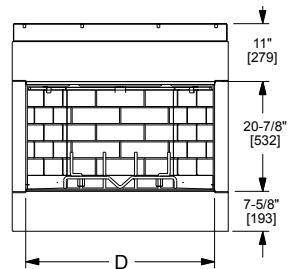

SIDE VIEW

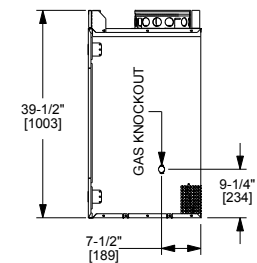



OUTDOOR GAS FIRE PIT



24" 48" 72" 96" 120"

PLAZA

LINEAR GAS FIRE PIT

The Plaza outdoor linear gas fire pit allows you to invite your neighbors to gather around the fire (2 or 4' lengths) or add a dramatic statement piece in your space (6, 8 or 10' lengths). Make this fire feature your own with endless finishing options to complete your outdoor oasis. With only a flick of a lighter, sit back and enjoy.

PLAZA

MEDIA



Crystal



Ebony



Cobalt



Amber



Lava Rock

SPECIFICATIONS

MODEL	LENGTH	WIDTH	DEPTH	VIEWING AREA	BTU/HR INPUT
PLAZA-24S	24 [610]	5-3/8 [137]	5-3/8 [137]	24 x 5-3/8 [613 x 137]	32,000

TOP VIEW

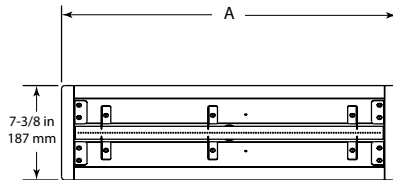

SIDE VIEW

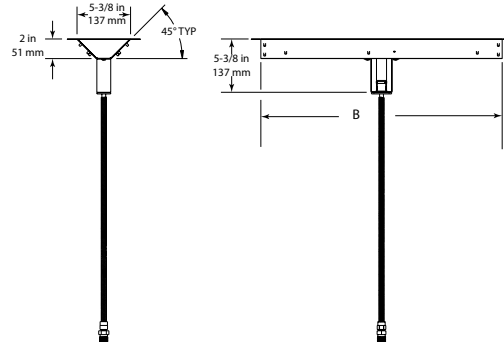

CLEARANCES

Appliance enclosure must be made entirely of non-combustible materials

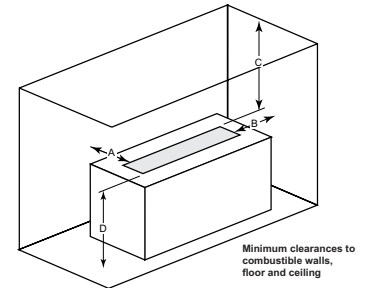
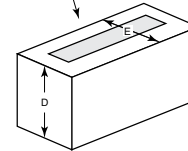





	Starter Kit	Starter +1 extension	Starter + 2 extensions	Starter + 3 extensions	Starter + 4 extensions
A	26 in (660 mm)	50 in (1270 mm)	74 in (1880 mm)	98 in (2489 mm)	122 in (3099 mm)
B	24 in (610 mm)	48 in (1219 mm)	72 in (1829 mm)	96 in (2438 mm)	120 in (3048 mm)

		A	B	C	D	E
ODPLAZA-L24S	in	17	17	45	8	8
	mm	432	432	1143	203	203

HEAT & GLO®

No one builds a better fire

 facebook.com/HeatandGlo
 twitter.com/HeatandGlo
 youtube.com/HeatandGlo
 instagram.com/HeatnGloFireplaces
 linkedin.com/company/Heat-n-Glo

Web:
heatnglo.com & pro.heatnglo.com

E-mail:
prohelpdesk@hearthnhome.com

HNG-1139U-0419