

You should have
all the

RIDER MANUALS

to use
in conjunction
with this book

Volume VII 1600 pages	\$10.00
Volume VI 1240 pages	\$ 7.50
Volume V 1200 pages	\$ 7.50
Volume IV 1060 pages	\$ 7.50
Volume III 1070 pages	\$ 7.50
Volume II 800 pages	\$ 6.50
Volume I 1000 pages	\$ 7.50

You can't go wrong
with a RIDER
Manual!



ALIGNING
PHILCO
RECEIVERS

ALIGNING PHILCO RECEIVERS

JOHN
F.
RIDER BY JOHN F. RIDER

ALIGNING PHILCO RECEIVERS

THIS collection of alignment instructions covers every Philco receiver from the earliest up to the latest 1937 model. . . . They are presented in a brand-new tabular form, which follows the logical procedure used when aligning a receiver.

Every trimmer is identified by a number in the tables and accompanying chassis layouts show exactly where every trimmer is located on the chassis.

Extra necessary information is given beneath the tables so that you have everything you need for aligning any Philco receiver.

The use of the tables in this book will speed up your work. . . . That means more sets through your shop and therefore greater profits.

**READ THE
INTRODUCTION**

It's Important!

ALIGNING
PHILCO
RECEIVERS

BY JOHN F. RIDER

**ALIGNING
PHILCO
RECEIVERS**

Other Books
by
JOHN F. RIDER

THE CATHODE-RAY TUBE AT WORK
SERVICING SUPERHETERODYNES
PRACTICAL TESTING SYSTEMS

SPECIALIZED AUTO RADIO MANUAL

Volume I
Volume II

PERPETUAL TROUBLE SHOOTER'S MANUAL

Volume I
Volume II
Volume III
Volume IV
Volume V
Volume VI
Volume VII

SERVICING RECEIVERS BY MEANS OF RESISTANCE
MEASUREMENT

AN HOUR A DAY WITH RIDER

on

AUTOMATIC VOLUME CONTROL

RESONANCE AND ALIGNMENT

D-C. VOLTAGE DISTRIBUTION IN RADIO RECEIVERS

ALTERNATING CURRENTS IN RADIO RECEIVERS

ALIGNING PHILCO RECEIVERS

by
JOHN F. RIDER

Author of
"Perpetual Trouble Shooter's Manual,"
"The Cathode-Ray Tube at Work,"
"An Hour A Day With Rider" Series,
and
Other Books for the Service Industry



Published by
JOHN F. RIDER, Publisher

1440 Broadway

New York City

Copyright, 1937, by
JOHN F. RIDER

Copyright, 1936, 1937, by
PHILCO RADIO AND TELEVISION CORPORATION
Philadelphia, Pa.

All rights reserved, including that of translation
into the Scandinavian and other foreign languages.

Certain of the material herein contained has been
copyrighted by the Philco Radio and Television
Corporation. Permission to reproduce this material
in this book has been granted to John F. Rider.

Printed in the United States of America

Dedicated to Janet
who is
approaching her fifth birthday

INDEX

<i>Model</i>	<i>Page</i>
3	1
4	2
5	3
6, 9, 12 (122), A, B	4
7, 8, 12 (121)	5
8—See Model 7	5
9—See Model 6	4
10 (121, 122), 800 (121), C (121, 122), D (121, 122), E (121, 122), H (121)	6
11 (121, 122), 700, J, Q, R	7
12 (121)—See Model 7	5
12 (122)—See Model 6	4
14 (121, 122, 123)	8
14 (221, 222)—See Model 91	86
15, 111, 112, 211, 212	9
16 (121, 122, 123)	10
16 (125, 126, 127)	11
17 (121, 122, 123)	12
18 (121-124), 503	13
19, 26, 27, 32, 89	14
20, 21, 50, 220	1
21—See Model 20	1
22, 22L, Phono—See Model 71	80
23, 23X, Phono—See Model 91	86
24 Phono—See Model 51	71
25 Phono—See Model 43	65
26 Phono—See Model 19	14
27 Phono—See Model 19	14
28	15
29, 29TX	16
30, 95, 96, 296	17
32—See Model 19	14
34, 34A	18
35, 36	19
36—See Model 35	19
37	20

<i>Model</i>	<i>Page</i>
37-9	21
37-10, 37-11 (121)	22
37-33	24
37-34	25
37-38	26
37-60	27
37-61	28
37-84	29
37-89	30
37-116	31
37-600	34
37-602	35
37-604	36
37-610 (121, 122)	37
37-611	38
37-620	39
37-623	41
37-624	41
37-630	42
37-640	43
37-641 (121)	45
37-643	46
37-650	48
37-660	50
37-665	52
37-670	54
37-675, (121, 122)	56
37-690	59
37-2620	62
38, 38A, (121, 122, 123)	63
39, 39A	64
40, 41, 42	17
41—See Model 40	17
42—See Model 40	17
43, 25	65
44, 504	66
45	67
46	17
47	68
48	69
49	70
50—See Model 20	1
51, 52, 24, 551	71
52—See Model 51	71
53	72
54	73

<i>Model</i>	<i>Page</i>
57, 58	74
58—See Model 57	74
59	75
60, 505	76
65	77
66	78
70 (Below Serial No. B22,000), 270, 370, 570	79
70 (Above Serial No. B22,000)—See Model 71	80
71, 22, 22L, 70 (Above Serial No. B22,000), 270, 370, 570	80
76, 77	77
77—See Model 76	77
80	81
81	82
82, 86, 87	77
84	83
86—See Model 82	77
87—See Model 82	77
89—See Model 19	14
90, 90A, (2-45)	84
90, 90A, (1-47)	84
90, 90A, (2-47)	85
91, 14 (221, 222), 23, 23X	86
95—See Model 30	17
96—See Model 30	17
97	87
111—See Model 15	9
112—See Model 15	9
116 (121, 122)	88
118 (121, 123), 507	89
144, 506	90
200	91
201, 509	92
211—See Model 15	9
212—See Model 15	9
220—See Model 20	1
270—See Model 70	79
296—See Model 30	17
370—See Model 70	79
470—See Model 4 Converter	2
and Model 70 Receiver	79
490—See Model 4 Converter	2
and Model 90 Receiver	84
503—See Model 18	13
504—See Model 44	66
505—See Model 60	76
506—See Model 144	90

<i>Model</i>	<i>Page</i>
507—See Model 118	89
509—See Model 201	92
511	94
551—See Model 51	71
570—See Model 70	79
600	95
602	96
604	97
610	98
611	99
620, 625, 630, 635	100
623, 623A	101
624	102
625—See Model 620	100
630 (Early and Late)—See Model 620	100
635—See Model 620	100
640, 650	103
641	104
642	105
643, 643A	106
645	107
650—See Model 640	103
651	108
655	109
660, 665	110
665—See Model 660	110
680	111
700—See Model 11	7
800 (121)—See Model 10	6
800 (122), 802, H (122)	113
802—See Model 800 (122)	113
805	114
806, 808, 809, T7, T8	115
808—See Model 806	115
809—See Model 806	115
810PA, 810PB	116
810PV	118
811PA, 811PB	120
811PV	119
816	122
817, 818	123
818, 818K—See Model 817	123
819, 819H	124
P-1417, G-1418, N-1418	125
G-1418—See Model P-1417	125
N-1418—See Model P-1417	125

<i>Model</i>	<i>Page</i>
P-1421, T10	126
P-1430, S-1431, N-1433, G-1436	127
S-1431—See Model P-1430	127
N-1433—See Model P-1430	127
G-1436—See Model P-1430	127
2620	128
A-PAD, PAL—See Model 6	4
B-PBD—See Model 6	4
C-SCD, NCD—See Model 10	6
C (122)—SCD—See Model 10	6
D-NDD, SDD, CDS—See Model 10	6
D (122)—NDD—See Model 10	6
E-MED—See Model 10	6
G (121)—CGD	129
G (122)—CGD; N-FND	130
H-HHD—See Model 10	6
H (122)—HHD, PHD—See Model 800 (122)	113
J-SJD, NJD—See Model 11	7
N-FND—See Model G (122)	130
Q-NQD, SQD—See Model 11	7
R-CRD, HRD—See Model 11	7
DPV	131
T2-CT2, HT2; T5-CT5, PT5	132
T3-MT3, RT3, ST3	133
T5-CT5, PT5—See Model T2	132
T6, FT6	134
T7, T8,-NT7, ST7, NTS—See Model 806	115
T9-FT9, FT9X; T11, T12, T14, T15	135
T10-CT10—See Model P-1421	126
T11*CT11, HT11X—See Model T9	135
T12-NT12X, NT12X2, ST12—See Model T9	135
T14-LT14X3, MT14X4, PT14, RT14X—See Model T9	135
T15-NT15, ST15—See Model T9	135

AUTHOR'S FOREWORD

THE arrangement of the alignment instructions in this book will be found to be a radical departure from the conventional form in which they are usually prepared. It is our belief that the tabular form can be more easily followed by the serviceman working at the bench and so will save him time.

We can not stress too strongly the fact that *the serviceman should read the Introduction before using the tables to align a single set*. The unique form of the instructions make it imperative that he do this, so that he will be able to use them to the greatest advantage.

We wish to take this opportunity of thanking those of the Philco Service and Engineering Divisions who so kindly cooperated with the author in collecting the servicing data used in this book.

JOHN F. RIDER.

INTRODUCTION

THIS book contains all the necessary information to enable you to align every Philco receiver quickly and accurately. In every case you will find that the location of all the compensating condensers is identified and that the frequencies at which the several adjustments are made are indicated in the accompanying text. These instructions have been prepared in collaboration with the Philco Engineering Department, and are therefore authentic and complete in every respect.

Tabular Arrangement

In looking through this book you will be impressed by the convenient arrangement of the alignment tables. We have a very definite reason for having arranged the data in this form. The alignment of a receiver is essentially a series of operations which must be performed in a certain sequence. You can see therefore that a tabular form is peculiarly adapted to indicate the operations to be performed. Thus for each adjustment it is necessary that the signal generator be connected to a certain section of the receiver. This may be the grid of the first detector tube, the antenna post, etc., and the particular signal generator connection which is called for is in every case indicated in the first column. The frequency setting of the signal generator is indicated in the second column, while the corresponding setting of the receiver dial is tabulated in the third column.

Not only must the receiver dial be adjusted to a certain position or dial reading, but it is also important that the wave-band switch be set at the correct position—broadcast, police, short-wave, etc. This data is contained in the fourth column, where the receiver has more than one band.

When the items mentioned above have been taken care of, the adjustment of the appropriate trimmer follows. The trimmer in question is identified in the next to the last column. Using the identification number which is listed in this column, reference to the accompanying layout will show the position of the trimmer on the chassis.

The last column indicates whether the adjustment is to be made for maximum or minimum output. Thus the notation "Max." in this column indicates adjustment for maximum output, while "Min." indicates that the adjustment must be made for minimum output.

Notes

In a number of cases the alignment procedure calls for instructions which cannot conveniently be included in the table. In these cases the pertinent information is indicated in the form of a footnote, which is identified either by the form "Note 1" or "550 k.c.¹"—to cite two particular examples. Both these types of representation indicate that reference is to be made at this point in the procedure to Note 1, contained at the bottom of the table.

The use of this tabular form effects an economy in the amount of time required for you to align a receiver by eliminating the need for continually referring back and forth to previous instructions especially in the alignment of multiband receivers. In this same connection, and for the same reasons, the simplicity of the arrangement makes for accuracy and goes far toward eliminating errors in alignment.

General Observations

It is not our intention in this book to explain the reason for every adjustment which is indicated. We take it for granted that you are familiar with the theory behind the operation of superheterodynes, with resonant circuits, and their behavior. Lack of space prevents us from tak-

ing up these things in detail here, but you will find these subjects adequately covered in two other books by the author, "Servicing Superheterodynes" and "An Hour a Day with Rider on Resonance and Alignment." We shall confine ourselves in this introduction to general observations, which are of extreme practical importance and are not to be neglected even when the theoretical aspects of alignment are understood.

Need for Alignment

When does a receiver need alignment? This is a question which is quite difficult to answer in some cases without actually carrying out the alignment first. As a general rule, however, this much can be said—that in entirely too many cases there is a tendency to blame poor operation of a receiver upon the alignment without first investigating other obvious defects.

In general, an incorrect alignment condition in a receiver causes low sensitivity, poor selectivity, and faulty dial calibration. Low sensitivity is a fault which can be caused by many other factors besides improper alignment. Therefore the fact that the sensitivity of a receiver is low is not sufficient in itself to throw suspicion upon the alignment. However, when a condition of low sensitivity is accompanied by poor selectivity and inaccurate dial calibration, then you can quite definitely be certain that realignment of the receiver is needed.

If, as often occurs in practice, an all-wave receiver shows normal sensitivity and operation on one or more bands, and fails to perform properly on the other bands, then the first step should be to check the adjustments common to that band only. That is, it is quite unnecessary to check the alignment of the i-f. amplifier, since the fact that the receiver performs properly on at least one band is direct evidence that the i-f. amplifier is doing its job.

So much for the observations on when alignment is called for. We brought up the discussion to emphasize the point that it is not wise to tamper with the alignment just because the receiver is not performing as it should. Remember that there are other reasons which can prevent a receiver from producing the peak performance of which it is capable.

Correct Equipment is Essential

The alignment of all the receivers, and all procedures given in these instructions, were based on the use of the Philco All-Wave Signal Generator (Model 088) and the Philco Combination Output Meter and Circuit Tester (Model 025). The combination of these two units (088 and 025) in a single case, is known as the Philco Model 099, which meets the necessary requirements equally well.

Through the use of the above equipment the serviceman can be assured that every adjustment necessary on any Philco receiver can be correctly made so as to restore 100% original performance.

There are very few tools which are necessary when aligning a receiver. A fiber hexagon socket wrench and a fiber screw driver are absolutely essential. The use of metallic tools is undesirable because of the increased capacity and losses which they introduce into the tuned circuit. Alignment tools of the proper type can be obtained from your nearest Philco distributor.

General Notes

Let us say that you are about to begin the alignment of a receiver. What are some of the precautions which you should take? In so far as it is possible for you to do so, you should make certain that the receiver is in normal operating condition; apart from its alignment. It is important that the tube shields be in place and that the r-f. and i-f. wiring be undisturbed after alignment is begun.

In the case of all-wave receivers it is of special importance that you allow the receiver to warm up for 15 or 20 minutes before beginning the alignment. This is to prevent oscillator drift from destroying the alignment. By waiting a period of time before beginning the alignment, you allow the oscillator circuits to reach a stable operating condition and thus avoid errors from this source.

Alignment Tool Reaction

In the course of aligning a receiver, you will observe that although a compensator is adjusted for maximum reading on the output meter, this reading falls as the alignment tool is removed. This occurs because the tool introduces a certain amount of capacity into the tuned circuit and consequently the circuit is detuned when the tool is removed. This is especially noticeable in the case of the oscillator adjustments on the short-wave bands.

Experience is of great assistance in overcoming this effect. You will find that if you adjust the trimmer for maximum output and then increase the adjustment slightly (clockwise) that the output will rise to its previous maximum value as the tool is withdrawn. If you do not obtain the correct adjustment the first time, you should repeat the adjustment until the output rises to approximately the same value when the tool is removed, that it had when you adjusted for maximum output with the tool on the trimmer.

Signal Generator Connection

The signal generator should be connected to the appropriate point in the receiver through a shielded wire. A suitable shielded lead is part of the equipment of the Philco Model 088 Signal Generator. It is very important that the shield be grounded to the receiver chassis and that in addition a good ground be used on the receiver chassis.

In some cases you will observe that the grid clip is not removed from the tube to which the signal generator lead is applied. In these cases the tables invariably call for the signal generator connection to be made through a condenser which generally has a capacity of .1 mfd. This condenser may be connected directly at the signal generator or at the tube, depending upon which point is more convenient.

In other cases the instructions call for the removal of the grid clip and the connection of the signal generator directly to the grid of the tube. In these cases it is very important that there be no blocking condenser used. The presence of a condenser in the output of the signal generator will leave the grid of the tube free, since no d-c. return path is provided for the grid. It is very important that you determine whether the output of your signal generator already contains a condenser. This can be done by measuring the resistance between the output and ground terminals of the signal generator. If this measurement shows that there is no d-c. path, you should connect a resistor, about 500 ohms in value, across these two terminals. This will provide the required d-c. path for those cases in which the grid clip is removed. Failure to provide this d-c. path may lead to improper alignment because of the instability created by leaving the grid of a tube free.

As a protective measure in aligning AC-DC or DC sets, there should always be a condenser in series with the signal generator.

Dummy Antenna

The correct alignment of the antenna tuned circuits calls for the use of a dummy antenna. As a general rule, this takes the form of a 100- or 200-mmfd. condenser, or a 400-ohm resistor. This condenser or resistor, constituting the dummy antenna, should be connected in series with the high side of the signal generator output *at the*

receiver antenna post. The correct value for the different models and the several wave bands is indicated in the alignment tables.

In the majority of the "37" Philco models a terminal panel is provided at the rear of the chassis for connection of the antenna (transmission line) and ground. This panel contains four terminals, numbered 1 to 4. The antenna lead from the signal generator should be connected to terminal No. 1 and the ground lead to No. 2. The metal connecting link on the terminal panel should be placed across terminals Nos. 2 and 3. Where the notes in the tabulated instructions call for connection to the "transmission line" terminals, make the connections as outlined above.

Unless otherwise specified in the alignment instructions, a 100-ohm resistor should be connected between the signal generator output and the set antenna terminal where using the latest type of Philco 088 signal generator.

Signal Strength

There are certain general practices which you should follow with regard to the strength of the signal which is used for alignment. As a general rule—unless otherwise stated in the instructions—you should make the input signal as weak as possible and at the same time strong enough to obtain a readable indication. This means that you will have to adjust the attenuator constantly during the course of the alignment so as to keep the output meter reading at about middle scale. Thus, as the set is brought into alignment, its sensitivity naturally increases and a smaller value of input signal is required. You should never attempt to prevent the output meter from going off scale by shifting to a higher output meter range, or by turning down the volume. Failure to observe this procedure will result in a poor alignment job.

The reason for keeping the signal input at a low level is to prevent the a.v.c. system from interfering with the

proper peaking of the tuned circuits. When the signal input is high enough so that the a.v.c. system tends to keep the output at a constant level, it becomes very difficult to peak the trimmers properly.

Output Meter

With but a few exceptions, all Philco receivers are aligned with the conventional type of output meter which is connected so as to measure the audio output of the receiver. For receivers which have but a single output stage it is convenient to connect the output meter from the plate terminal of the output tube to the cathode. It is, of course, assumed that the output meter contains a blocking condenser so as to prevent the d-c. plate voltage from burning out the meter. In the case of push-pull output stages, the meter can be connected in the same way if it is so desired. It is also possible to connect the output meter across the plates of the push-pull tubes. This latter type of connection does not subject the blocking condenser in the output meter to a high plate voltage. However it should not be used where one terminal on the output meter is grounded to the case because of possibility of shock.

It is important that the proper scale range be used on the output meter. For general purposes the 0-30 or 0-50 volt scale range is quite satisfactory. If the signal input is constantly adjusted so as to keep the meter at half scale setting, there will be no danger of the a.v.c. action introducing error as was previously explained.

I. F. Alignment

With these general ideas in mind, we can proceed to a consideration of the points which you should observe as the alignment procedure gets under way. As you know the first step in the alignment of a superheterodyne receiver is the alignment of the i-f. amplifier. The in-

structions given in the following pages are specific as to the manner in which the signal generator is to be connected. In most cases you will find it possible to drive a signal through the i-f. amplifier with the signal generator connected to the grid of the first detector. Where this is not possible, it is advisable to connect the signal generator lead to the grid of the first i-f. stage. After the trimmers for the last stage are aligned, you should shift the signal generator to the grid of the first detector and align the remaining i-f. trimmers. As a general rule, you should start the i-f. adjustments with the trimmer nearest the second detector and work towards the first detector. However, in some cases this order is not followed and in these cases you should carefully follow the procedure outlined for the specific model.

While the position of the tuning condenser and the waveband switch are not directly involved while the i-f. amplifier is being aligned, it is good practice to set the waveband switch to the broadcast band position and the dial to the low frequency end of the band in the neighborhood of 550 k.c. If instructions are given in the alignment tables—follow these instructions. Inability to drive a signal through the i-f. amplifier can often be traced to the short circuiting effect of the first detector tuned circuit. This effect is minimized by tuning the receiver to the low frequency end of the broadcast band. When the grid clip of the first detector is removed, the positions of the waveband switch and the tuning dial are of no importance.

Change of I. F. Peak

In certain localities it has been found advisable to align two and three-gang Philco receivers at some i-f. peak other than the one for which they were designed, i.e. 470 k.c. This change has been found necessary because of certain types of interference peculiar to these

localities, among which are Portland, Maine; Miami, Florida; New Haven, Connecticut; San Diego, California; the northern one third of Long Island; Newark; and Southern New Jersey.

When interference is experienced in any one of these places, it is advisable to realign the i-f. amplifier at 456 k.c., 465 k.c., or 480 k.c. The i-f. peak which is furthest away from the interference should be used. The wave trap should not be aligned at the i-f. peak, but preferably to give maximum attenuation of the interference.

Dial Alignment

Following the alignment of the intermediate-frequency amplifier, the next step is to check the relative position of the dial with respect to the condenser shaft. Instructions for the proper dial alignment vary considerably in the earlier Philco receivers, but in the later models, you will find that the proper dial alignment is secured by completely meshing the plates and setting the dial so that the glowing beam indicator falls on or between two index marks at the low frequency end of the broadcast scale.

In other models you will find that proper dial alignment is secured by inserting a thin gauge—generally .006" thick—between the stator and rotor plates and with the condenser shaft in this position adjusting the dial so that it reads say 1500 k.c. (the exact value is different for different receivers and is specified in the notes accompanying the alignment instructions). You should make it a practice to recheck the dial alignment after the set screws are finally tightened to insure against error due to possible movement of the shaft or dial while tightening the set screws.

In still other cases the final adjustment of the dial is made in the middle of the band at 1000 k.c. after the entire alignment of the receiver has been made; but unless otherwise stated the dial alignment operation should be carried out directly following the i-f. alignment. This

operation is very important and failure to carry it out (where it is necessary) will result in poor alignment and calibration.

Wave Trap Alignment

Following the alignment of the i-f. amplifier and the check on the dial alignment, the next operation is the adjustment of the wave trap. Of course not all receivers have a wave trap but when they have, the wave trap should be adjusted so as to prevent interaction between the wave trap and the r-f. adjustments. This is avoided by carrying out the wave trap adjustment before the r-f. adjustments. The initial adjustment of the wave trap is made with the signal generator connected to the antenna post of the receiver.

Unlike practically all other adjustments, the wave trap trimmer is adjusted for *minimum* output with the signal generator frequency set to the i-f. peak. In general it will not be necessary to change this adjustment again. However, if after the receiver is installed, interference in the neighborhood of the intermediate frequency is present, then you should readjust the wave trap trimmer slightly. This readjustment should be made while the receiver is connected to the antenna and tuned to the point on the dial where the interference is most pronounced. With the receiver in this condition and the volume control fully advanced, you should adjust the wave trap trimmer so as to minimize this noise. This is the proper adjustment even though the wave trap is resonated to a frequency slightly different from the intermediate frequency.

Oscillator Adjustments

By far the most important of the adjustments which follow are those located in the oscillator circuit. They

are of extreme importance because the frequency of the oscillator determines whether the beat frequency produced in the first detector is above, below, or exactly at the i-f. peak. Improper adjustment of the oscillator impairs the sensitivity, selectivity and the dial calibration to a marked extent. On the other hand, the other adjustments which are made at radio frequencies affect the performance to a much smaller degree. The dial calibration in particular is controlled almost entirely by the oscillator adjustment.

High Frequency End of Band

As a general rule the adjustment of the high-frequency oscillator trimmer is the first radio-frequency adjustment. This is carried out with the signal generator tuned to the high frequency end of the band—generally 1400 k.c. for the broadcast band. In general the receiver should be tuned to the same frequency at which the signal generator is set and an attempt should be made to pick up the signal. If the receiver is out of alignment appreciably, it will be impossible to pick up the signal at the correct point on the dial—but you will find that the signal comes in somewhere near the required point—perhaps as much as 100 k.c. on either side. If for example the signal generator is set at 1400 k.c. and the signal appears at 1300 k.c. on the receiver dial, then the high frequency oscillator trimmer should be turned clockwise slowly (increasing the capacity) until it is possible to hear the signal with the dial set at the proper frequency, which is 1400 k.c. in this example. You should now adjust the trimmer accurately for maximum output—both the signal generator and the dial reading exactly the same frequency. Following this adjustment the r-f. and antenna compensators (generally located on the top of the tuning condenser gang) are adjusted for maximum output.

Low Frequency Oscillator-Rocking

Just as the high frequency oscillator adjustment determines the performance of the receiver over the high frequency portion of the band, so the low frequency oscillator compensator determines the performance over the low frequency end of the band.

The procedure for making this adjustment is different from the usual manner in which the other compensating condensers in the receivers are adjusted, and is generally known as "rocking."

This rocking adjustment is carried out as follows: The receiver and signal generator are tuned to that point near the low frequency end of the band which is specified in the table of instructions. To make this discussion more definite and easier to follow, we shall assume that the operation is being carried out for the broadcast band, in which case the signal generator would be set at about 600 k.c. The next step is to tune the receiver so that the maximum output is obtained. In general, the dial reading will not be 600 k.c. but may be off by as much as 10 or more kilocycles on either side. That is the dial reading may be 590 k.c. or perhaps 610 k.c. Whatever the dial reading, however, the next step is to try to increase the output by adjusting the low frequency compensating condenser. After adjusting this for maximum output, rotate the dial of the receiver slightly in both directions and leave it in that position which gives the greatest output. Then readjust the compensating condenser for maximum output and following this, reset the dial for maximum output. You should continue this alternate readjustment of the low frequency compensating condenser and the dial position until readjustment no longer raises the output.

To put it very briefly, the purpose of this so called rocking adjustment, the need for which is indicated in this book by an asterisk (*), is to secure the best possible alignment by tuning the r-f. and detector circuits exactly

to the signal and at the same time making the oscillator frequency higher than the signal by the amount of the intermediate frequency.

In the case of some receivers, you will observe that a slightly different method is indicated for the adjustment of low frequency compensating condensers. This different method is called for because the selectivity of the r-f. tuned circuits is purposely lowered so as to prevent sideband cutting and permit high fidelity reception. In those cases where this procedure is called for, the instructions explain the method.

Image Check

The basic procedure for making the adjustments of the r-f. and oscillator compensating condensers is the same for the short-wave bands as for the broadcast bands. However, somewhat greater care must be exercised because of the possibility of error due to the image response of the receiver. This possibility of error arises since there are two settings of the oscillator frequency which will give the same output at the specific frequency at which the set is being aligned. In spite of the fact that two adjustments of the oscillator trimmer are possible, only one of these is correct and will produce good performance over the entire dial.

As you know, a superheterodyne receiver can operate with the oscillator frequency either above or below the intermediate frequency. For this reason as you decrease the capacity of the oscillator trimmer, starting from the maximum capacity position, you will in general encounter two peaks. The first of these peaks occurs when the oscillator frequency is less than the signal frequency by the amount of the i-f. peak. As the capacity is further decreased, the second peak occurs and this is the correct setting at which the oscillator frequency is higher than the signal frequency. This is the correct setting of the

oscillator compensating condenser for all the receivers listed in this book.

In some cases you will find that only the correct peak can be obtained. This means that the range of the trimmer capacity is not large enough to drop the oscillator frequency to the peak below the signal frequency.

On all the short-wave bands you should make the following check to guard against the possibility of oscillator misalignment. We shall illustrate the method for a specific case and the general procedure for checking the image response will then be clear. Suppose that the receiver is being aligned at 18 m.c. With the dial and signal generator set at 18 m.c., the oscillator trimmer is adjusted for maximum output. After this is done, the receiver is slowly detuned below 18 m.c. and at a dial reading of about 17.08 m.c. it should be possible to pick up the image response. For this condition the oscillator frequency is below the signal frequency by the amount of the i-f. peak, but the r-f. and detector circuits are detuned. For this reason you will find it necessary to raise the output of the signal generator in order to find the image.

In cases where the oscillator has been incorrectly aligned, it will be impossible to find any image response (that is to pick up the 18-m.c. signal) at a point lower in frequency than the signal. However in these cases you will find the image *above* the signal frequency instead of below. To continue with this same example, the image would be found by tuning the receiver to about 18.92 m.c. If the image is found above the signal frequency rather than below, it means that the oscillator has been aligned to the "greater capacity peak" instead of the "smaller capacity peak." Repeat the adjustment and this time set the oscillator trimmer to the correct peak so that the image response occurs below the signal frequency, as explained above.

The above figures have been given for an i-f. peak of 460 k.c. For any i-f. peak the image should be found at

a point below the signal frequency by an amount equal to twice the i-f. peak. Thus for an i-f. peak of 260 k.c. and a frequency of 18 m.c., the two image points are 18.520 and 17.480 m.c. The first of those points is the incorrect image point and indicates an error in adjustment to the wrong peak. When the image is found at the second point (17.480 m.c.), this indicates that the alignment has been made correctly and you can then proceed with the remaining r-f. adjustments.

Detector and R. F. Alignment

As far as the broadcast band and the lower frequency short-wave bands are concerned, the alignment of the detector and antenna tuned circuits does not present any particular problem and is made in the ordinary manner, as indicated in the instructions. However, for certain receivers, a modified procedure is indicated, which we shall now explain.

When an attempt is made to adjust the antenna and r-f. trimmers in the usual way, poor alignment occurs because of the interaction between the r-f. tuned circuits and the oscillator; that is, a change in the oscillator compensator affects the r-f. adjustments and makes it difficult to secure accurate alignment.

To get around this difficulty you will observe that the instructions call for placing a variable condenser having a capacity of about 350 mmf. and having a good vernier drive across the oscillator tuned circuit. The procedure is as follows: The receiver and signal generator are first tuned to the value indicated in the tables, which we shall assume to be 18 m.c. The oscillator trimmer is next adjusted to maximum output and the image check made, as we explained in the previous section. The next step is to connect the external variable condenser across the oscillator tuned circuit and to adjust this condenser so that a signal is again received. (You should be careful not to disturb the dial setting while the condenser is be-

ing connected and adjusted.) When this is done the oscillator is working at half of its normal operating frequency. In other words, the second harmonic, rather than the fundamental, of the oscillator mixes with the incoming signal. In this way the interaction between the several circuits is reduced so as to make possible an accurate adjustment of the r-f. and detector compensating condensers.

Wherever this method is necessary, the instructions are specific as to the procedure. We have brought up this point here because it is frequently used and it is desirable that you understand why this apparently complicated procedure is used. In this same connection, the external variable condenser must be connected across the *entire oscillator tuned circuit* for those models which employ a series condenser to accomplish electrical band spread. If the external variable condenser is connected across the oscillator section of the variable condenser for these models, it will be impossible to reduce the oscillator frequency to a sufficiently low value.

Magnetic Tuning Alignment

The Magnetic Tuning System employed in some Philco receivers is a system of automatic frequency control designed to make possible quick and accurate tuning and to compensate for the effects of oscillator drift. It is composed of two principal units; (1) the discriminator, which determines whether the set is mistuned and which provides control voltages whose magnitude and polarity indicate the extent and direction of the mistuning, and (2) the control circuit, which, in response to the control voltages, changes or shifts the oscillator frequency accordingly.

The control circuit does not present any problem from the point of view of alignment since there are no adjustments required. However, it is extremely important that the discriminator transformer be accurately aligned at

the intermediate frequency. As you will observe by glancing through the alignment instructions for any one of the receivers equipped with a Magnetic Tuning system, the receiver is first aligned in the usual manner *with the Magnetic Tuning switch in the off position*. This includes the complete i-f., oscillator, and r-f. adjustments and also the primary winding of the discriminator transformer, since this winding feeds the second detector. We repeat: *these adjustments must be made with the Magnetic Tuning switch in the "off" position*.

With these adjustments completed, it remains to adjust the secondary trimmer of the discriminator transformer. This is accomplished in the following manner: Couple the signal generator to the antenna of the receiver and set the frequency at 1000 k.c. *Tune in the signal very carefully for maximum output*. A strong value of input signal must be used. Without disturbing any of the settings, the Magnetic Tuning switch should be turned to the "on" position and the secondary trimmer of the discriminator transformer adjusted for maximum output.

When the Magnetic Tuning system is functioning properly, there will be no hiss or change in tone as the automatic tuning switch is shifted on and off. If there is a change in tone or a hiss, it indicates that a frequency shift has taken place, and the adjustment of the secondary discriminator trimmer should be repeated.

Regenerative Receivers

The alignment procedure for a number of regenerative receivers is described in this book. In this connection there are some general observations which are of interest.

For this type of receiver it is advisable to make the preliminary adjustment of the receiver with the regeneration control set near minimum, so that there is no tendency toward oscillation. When the complete adjustment of the receiver has been made with the regeneration control in this position, the regeneration control should be

advanced to the point where the receiver goes into oscillation as evidenced by a hissing or squealing sound. You should then back off this adjustment slightly and make certain that the receiver does not go into oscillation at any point in the band.

With the regeneration control in this position, the entire adjustment of the receiver should be repeated so as to secure the greatest possible sensitivity. The final adjustment of the regeneration control should in every case be made with the receiver connected to the antenna with which it is to be used. In general, the control should be backed off sufficiently so that there is no tendency toward oscillation at any point in the band. Unless extreme sensitivity is desired, the regeneration control should be backed off at least one turn beyond the point at which oscillation begins. This tolerance is necessary to prevent changes in circuit conditions due to temperature, humidity, etc., from throwing the receiver into oscillation. However, where the maximum sensitivity is necessary, the control will have to be left near the point of oscillation and may require more or less frequent re-adjustment.

Neutralizing Adjustments

As a general rule, the alignment operation should be carried out before the receiver is neutralized. Only a comparatively few receivers require this type of adjustment, but nevertheless it is in order to mention a few of the points which should be observed during this process. After the receiver is aligned, the last r-f. tube should be removed and replaced with a "dummy" tube—that is, a tube of the same type as the r-f. tube, but with an open filament or with one filament prong cut off. With this tube in the socket, the volume control at maximum, and the receiver tuned sharply to the signal, you should adjust the neutralizing condenser associated with the last r-f. stage until the output drops to a minimum value. It

will be necessary to raise the output of the signal generator in order to carry out this adjustment accurately.

The same process is then repeated for each of the remaining r-f. stages, working from the last r-f. stage to the antenna stage. If you find that it is necessary to change any of the neutralizing adjustments appreciably, then the alignment should be repeated because of the interaction between the alignment and the neutralization.

10-KC Filter Adjustment

A number of Philco receivers incorporate an audio filter which should be adjusted to cut off at 10 k.c. This filter will seldom require adjustment unless it has been tampered with.

In the event that adjustment proves to be necessary, it is best carried out with an audio oscillator, which should be set to generate a frequency of 10 k.c. The output of the audio signal generator should be connected across the audio volume control. With the output meter connected as usual, the 10 k.c. filter adjustment should be made for minimum output.

Where an audio oscillator is not available, the following procedure can be used to effect an adjustment. Connect the signal generator to the grid of the first detector through a .0001-mfd. condenser and set the frequency at the i-f. peak of the receiver. (The fidelity or selectivity switch for this adjustment should be in the "broad" position.) The next step is to tune in a local station and to adjust the output of the signal generator so that a beat (whistle) is obtained between the local station and the signal generator. Then adjust the receiver dial carefully so that zero beat is obtained.

The object of the next step is to obtain a 10 k.c. beat. This is done by advancing the setting of the signal generator by 10 k.c. That is, for example, if the i-f. peak is 260 k.c., then the signal generator should be advanced to 270 k.c. Having advanced the frequency of the signal

generator by this amount, a 10-k.c. whistle will be heard and the adjustment of the filter is completed when the compensating condenser across the 10-k.c. tuned circuit is adjusted so that the output is a minimum.

Repetition of Adjustments

As a general rule it will be quite unnecessary to go over the compensating condensers to a greater extent than that indicated in the instructions. The exception to this rule occurs when the receiver is initially very badly out of line. When this is the case, you will find that an appreciable change in the capacity of the trimmer condensers is necessary on the first adjustment. The final adjustment in these cases will be considerably improved if the entire alignment procedure is repeated.

In this same connection, the final adjustment of the i-f. amplifier can be made before the r-f. alignment is attempted. The only exception to this rule is in the case where a composite oscillator-detector circuit is used. In this case there is some interaction between the r-f. adjustments and the adjustment of the first i-f. transformer. For this type of receiver, the *final* adjustment of the i-f. amplifier should be made after a preliminary adjustment of the r-f. and oscillator circuits.



MODEL NO. 3

Signal Generator Connection	Signal Generator Frequency	Dial Position	Wave Band Switch Position	Trimmer Number	Output Signal
Ant. 1. 4	1000-1200 k.c.	Note 2	...	3rd ^s r.f.	Max.
"	"	"	...	2nd ^s r.f.	Max.
"	"	"	...	1st ^s r.f.	Max.

Note 1.—Through a 150 mmfd. condenser.

Note 2.—Tune sharply to signal before adjusting.

Note 3.—Mounted on tuning-condenser housing. Accessible with special fibre wrench through holes in bottom of receiver, after removing cover plate.

Note 4.—When the antenna-stage adjustment is made with the receiver installed in the car, the receiver must be connected to the car antenna in the usual manner. Connect the signal-generator output to a wire placed near the car antenna but not connected to it.

MODEL NO. 20, 21, 50, 220

Signal Generator Connection	Signal Generator Frequency	Dial Position	Trimmer Number	Output Signal
Ant.*	1400 k.c.	140	Det. ¹	Max.
"	"	"	R.F. ¹	Max.
"	"	"	Ant. ¹	Max.

* Connect a 200-mmfd. condenser between signal generator and antenna post of set, at the antenna post.

Note 1.—Mounted on right side of frame of tuning-condenser assembly and reached from rear and top of chassis.

MODEL NO. 4

Signal Generator Connection	Signal Generator Frequency	Dial Position	Wave Band Switch Position	Trimmer Number	Output Signal
Converter ¹ Ant.	3.5 m.c.	3.5 m.c.	3.5 m.c. band	7	Max. ²
"	1.6 m.c.	1.6 m.c.	"	14	Max.
"	7 m.c.	7 m.c.	7 m.c. band	6	Max.
"	3.5 m.c.	3.5 m.c.	"	13	Max.
"	18 m.c.	18 m.c.	18 m.c. band	5 ³	Max.
"	8.8 m.c.	8.8 m.c.	"	11 ⁴	Max.
"	1000 k.c.	17 ⁵	Min.

Note 1.—Connect converter to receiver in the usual manner. Set the receiver dial at 1000 k.c.

Note 2.—Output meter connected to receiver.

Note 3.—Turn all the way in. Then back off until *second* signal is heard. Adjust to maximum on this peak. This adjustment is critical.

Note 4.—On early production only. Later production used a fixed 1800 mmfd. condenser.

Note 5.—This wave-trap adjustment is made to eliminate interference from stations broadcasting at or near 1000 k.c.

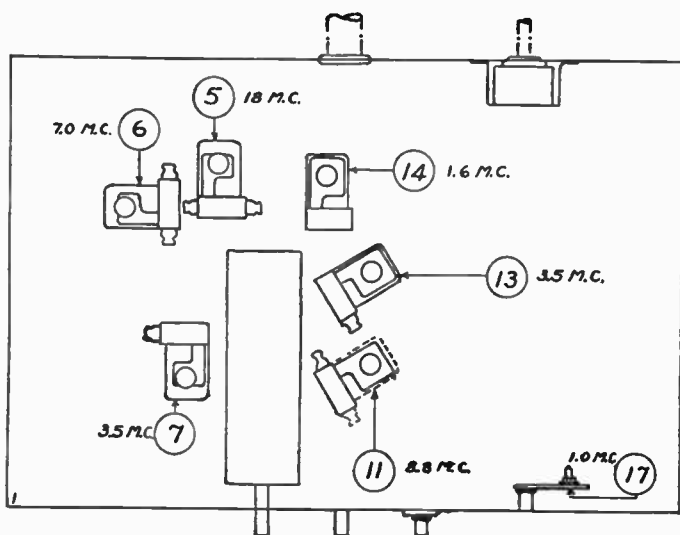

MODEL NO. 5

Signal Generator Connection	Signal Generator Frequency	Dial Position	Wave Band Switch Position	Trimmer Number	Output Signal
Remove grid clip from 6A7					
Control grid of 6A7 tube	460 k.c.	8 ¹	...
"	"	4	Max.
"	"	3	Max.
"	"	2	Max.
"	"	1	Max.
Connect grid clip to 6A7					
Ant. ^{2, 7}	1500 k.c.	Note 3	...	Osc. ⁴ section	Max.
"	1400 k.c.	1400 k.c. ⁵	...	Ant. ⁶ section	Max.
"	600 k.c.	600 k.c.	...	8	Max.
"	1400 k.c.	1400 k.c.	...	Ant. ⁶ section	Max.

Note 1.—Turn in until tight. Then "back off" one full turn. Leave at this setting until later adjustment.

Note 2.—Through a 150 mmfd. condenser.

Note 3.—Unmesh plates as wide as possible. Place piece of paper on stator plates and then turn rotor out until it just strikes paper. This gives the 1500 k.c. setting of the receiver dial.

Note 4.—Located on second section of tuning-condenser gang nearest drive mechanism.

Note 5.—Remove paper (mentioned in Note 3) from tuning condenser.

Note 6.—Located on tuning condenser section.

Note 7.—When the antenna-stage adjustment is made with the receiver installed in the car, the receiver must be connected to the car antenna in the usual manner. Connect the signal-generator output to a wire placed near the car antenna but not connected to it.

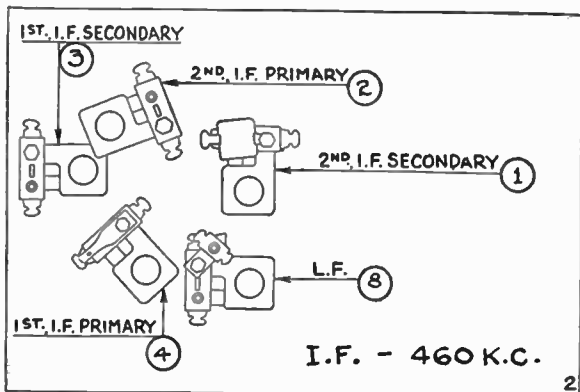

MODEL NOS. 6, 9, 12 (122), A, B

Signal Generator Connection	Signal Generator Frequency	Dial Position	Wave Band Switch Position	Trimmer Number	Output Signal
Remove grid clip from det.-osc. tube					
Control grid of det.-osc.	260 k.c.	2	Max.
"	"	4	Max.
"	"	3	Max.
Connect grid clip to det.-osc. tube					
Ant. ^{1, 4}	1400 k.c.	140	...	Third ² section	Max.
"	"	"	...	Second ³ section	Max.
"	"	"	...	First ³ section	Max.
"	700 k.c.	70	...	8	Max.*
"	1400 k.c.	140	...	Third ² section	Max.

Note 1.—Through a 150 mmfd. condenser.

Note 2.—Located on extreme left of tuning condenser.

Note 3.—Located on tuning condenser.

Note 4.—When the antenna-stage adjustment is made with the receiver installed in the car, the receiver must be connected to the car antenna in the usual manner. Connect the signal-generator output to a wire placed near the car antenna but not connected to it.

* While rocking.

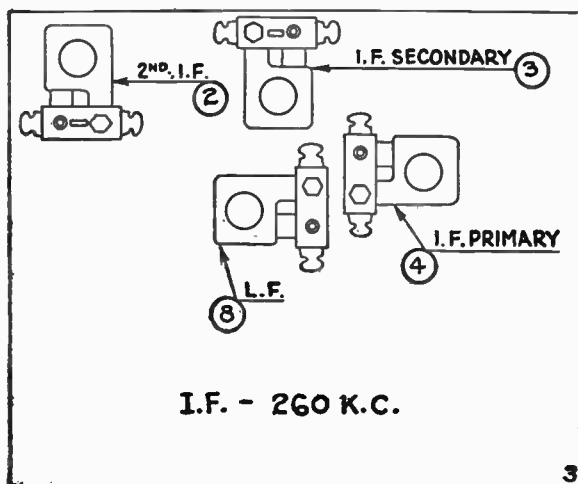

MODEL NOS. 7, 8, 12 (121)

Signal Generator Connection	Signal Generator Frequency	Dial Position	Wave Band Switch Position	Trimmer Number	Output Signal
Remove grid clip from det.-osc. tube					
Control grid of det.-osc. tube	175 k.c.	2	Max.
"	"	4	Max.
"	"	3	Max.
Connect grid clip to det.-osc. tube					
Ant. 1. ⁴	1400 k.c.	140	...	Third ² section	Max.
"	"	"	...	Second ³ section	Max.
"	"	"	...	First ³ section	Max.
"	700 k.c.	70	...	8 section	Max.*
"	1400 k.c.	140	...	Third ² section	Max.

Note 1.—Through a 150 mmfd. condenser.

Note 2.—Located on extreme left of tuning condenser.

Note 3.—Located on tuning condenser.

Note 4.—When the antenna-stage adjustment is made with the receiver installed in the car, the receiver must be connected to the car antenna in the usual manner. Connect the signal-generator output to a wire placed near the car antenna but not connected to it.

* While rocking.

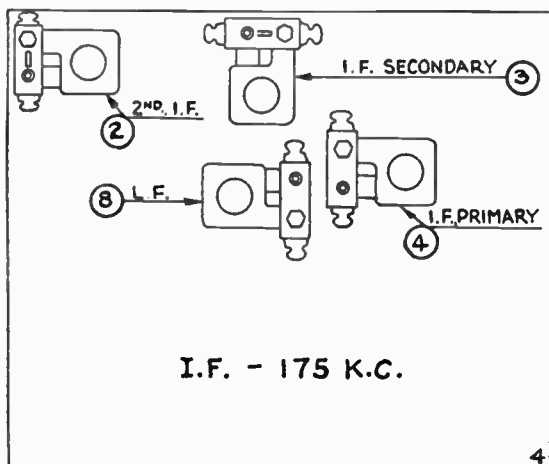

MODEL NOS. 10 (121, 122), 800 (121), C (121, 122), D (121, 122), E (121, 122), H (121)

Signal Generator Connection	Signal Generator Frequency	Dial Position	Wave Band Switch Position	Trimmer Number	Output Signal
Remove grid clip from det.-osc.					
Control grid of det.-osc.	260 k.c.	1 ¹	...
"	"	2 ²	Max.
"	"	1 ³	Max.
"	"	3 ¹	...
"	"	4 ²	Max.
"	"	3 ³	Max.
Connect grid clip to det.-osc.					
Ant. ^{4, 6}	1500 k.c.	Note 5	...	7	Max.
"	1400 k.c.	140	...	6	Max.
"	"	140	...	5	Max.
"	600 k.c.	60	...	8	Max.*
"	1400 k.c.	140	...	6	Max.
"	"	"	...	5	Max.

Note 1.—Screw adjustment. Turn all the way in.

Note 2.—Nut adjustment.

Note 3.—This is a critical adjustment. Note the maximum reading, then turn screw in again and slowly bring adjustment to this maximum reading. Do not pass this point. If you do, repeat the adjustment.

Note 4.—Through a 150 mmfd. condenser.

Note 5.—Using a piece of paper approximately .006" thick as a gauge between the heel of the rotor plates and the stator plates, turn the rotor plates until they strike against the paper. This is the correct adjustment for 1500 k.c.—150 on the dial scale.

Note 6.—When the antenna-stage adjustment is made with the receiver installed in the car, the receiver must be connected to the car antenna in the usual manner. Connect the signal-generator output to a wire placed near the car antenna but not connected to it.

* While rocking.

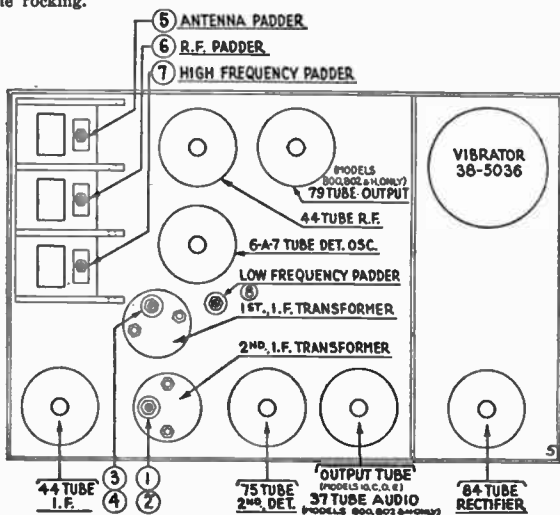

MODEL NOS. 11 (121, 122), 700, J, Q, R

Signal Generator Connection	Signal Generator Frequency	Dial Position	Wave Band Switch Position	Trimmer Number	Output Signal
Remove grid clip from det.-osc. tube					
Control grid of det.-osc. tube	260 k.c.	1 ¹	...
"	"	2 ²	Max.
"	"	1 ³	Max.
"	"	3 ¹	...
"	"	4 ²	Max.
"	"	3 ³	Max.
Connect grid clip to det.-osc. tube					
Ant. ^{4, 6}	1580 k.c.	Note 5	...	7	Max.
"	1400 k.c.	140	...	6	Max.
"	"	"	...	5	Max.

Note 1.—This is a screw adjustment. Turn all way in.

Note 2.—This is a nut adjustment.

Note 3.—This adjustment is critical. Note maximum reading obtainable and then turn the screw in again, just bringing it up to the maximum reading. Do not pass this point. If you do, repeat complete operation.

Note 4.—Through a 150 mmfd. condenser.

Note 5.—Using a piece of paper approximately .006" thick as a gauge between the heel of the rotor plates and the stator plates, turn the rotor plates until they strike against the paper. This is the correct adjustment for 1580 k.c.—158 on the dial scale.

Note 6.—When the antenna-stage adjustment is made with the receiver installed in the car, the receiver must be connected to the car antenna in the usual manner. Connect the signal-generator output to a wire placed near the car antenna but not connected to it.

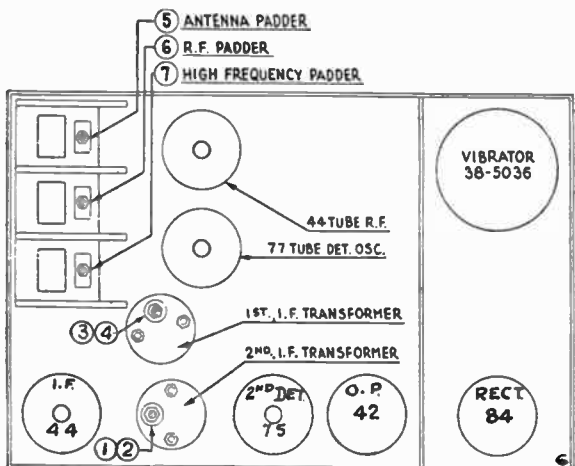

MODEL NO. 14 (121, 122, 123)

Signal Generator Connection	Signal Generator Frequency	Dial Position	Wave Band Switch Position	Trimmer Number	Output Signal
Disconnect grid clip from 6A7					
Control grid of 6A7	175 k.c.	55	Broadcast	1	Max.
"	"	"	"	2	Max.
"	"	"	"	3	Max.
"	"	"	"	4	Max.
Connect grid clip to 6A7					
Ant.**	1400 k.c.	140	"	Osc.H.F. ¹	Max.
"	"	"	"	Det. ¹	Max.
"	"	"	"	5	Max.
"	600 k.c.	60	"	6	Max.*
"	1400 k.c.	140	"	Osc.H.F. ¹	Max.

Note 1.—Located on tuning-condenser assembly and accessible from above.

* While rocking.

** Connect 200-mmf. condenser between signal generator and antenna post, at the antenna post.

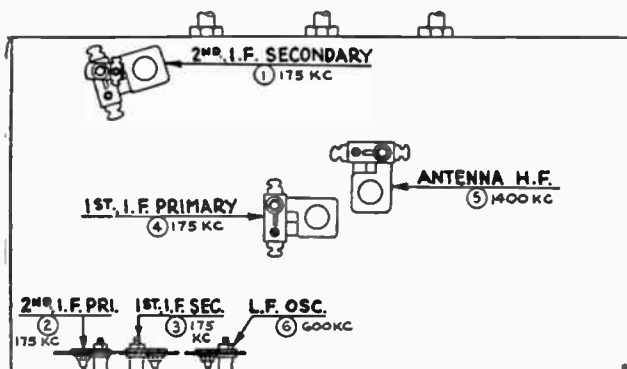

MODEL NOS. 15, 111, 112, 211, 212

Signal Generator Connection	Signal Generator Frequency	Dial Position	Wave Band Switch Position	Trimmer Number	Output Signal
Remove grid clip from 1st det.					
1st det.	175 k.c.	55	...	1	Max.
"	"	"	...	2	Max.
"	"	"	...	3	Max.
"	"	"	...	4	Max.
Connect grid clip to 1st det.					
Ant.**	1400 k.c.	140	...	5	Max.
"	"	"	...	6	Max.
"	"	"	...	7	Max.
"	"	"	...	8	Max.
"	600 k.c.	60	...	9	Max.*
"	1400 k.c.	140	...	5	Max.

* While rocking.

** Connect 200-mmf. condenser between signal generator and antenna post, at the antenna post.

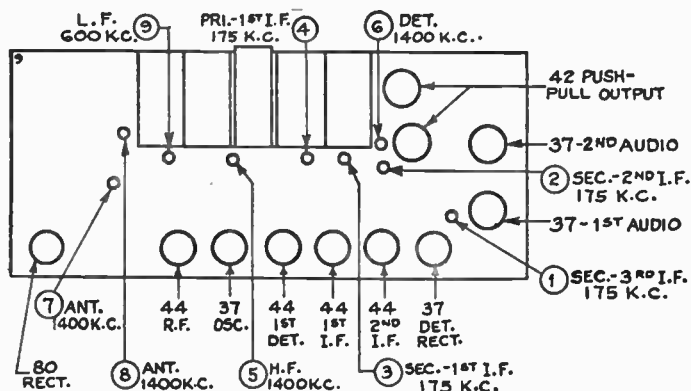

MODEL NO. 16 (121, 122, 123)

Signal Generator Connection	Signal Generator Frequency	Dial Position	Wave Band Switch Position	Trimmer Number	Output Signal
Remove grid clip from 1st det. tube					
Control grid of 1st det.	460 k.c.	520 k.c.	520-1500 k.c.	7	Max.
"	"	"	"	8	Max.
"	"	"	"	9	Max.
"	"	"	"	10	Max.
"	"	"	"	11	Max.
"	"	"	"	12	Max.
Connect grid clip to 1st det.					
Ant. ¹	460 k.c.	520 k.c.	520-1500 k.c.	13	Min.
"	11 m.c.	11 m.c.	5.8-12 m.c.	1	Max.
"	11 m.c.	22 m.c.	11-23 m.c.	..	Note 2
"	5.2 m.c.	5.2 m.c.	3.2-6.0 m.c.	2	Max.
"	3.5 m.c.	3.5 m.c.	1.5-4.0 m.c.	3	Max.
"	1.6 m.c.	1.6 m.c.	"	4	Max.
"	1400 k.c.	1400 k.c.	520-1500 k.c.	5	Max.
"	520 k.c.	520 k.c.	"	6	Max.

Note 1.—Use dummy antenna of 200-mmf. condenser in series on broadcast band and a 400-ohm carbon resistor on shortwave bands.

Note 2.—If signal is not heard within a reasonable distance (100 k.c.) on either side of the 22 m.c. point, slightly change previous 11 m.c. adjustment until signal is heard. This causes a slight error in the 11 m.c. setting. The error at the two points (11 m.c. and 22 m.c.) must be split in proportion to the frequencies. Do not mistake the image frequency of 22 m.c. which can be heard at approximately 21.1 m.c.

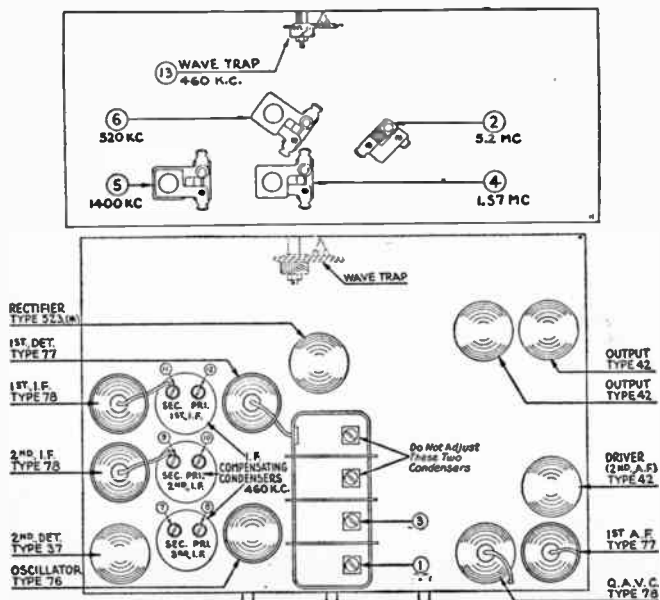

MODEL NO. 16 (125, 126, 127)

Signal Generator Connection	Signal Generator Frequency	Dial Position	Wave Band Switch Position	Trimmer Number	Output Signal
Remove grid clip from 1st det.					
Control grid of 1st det.	460 k.c.	550 k.c.	Range 1	1	Max.
"	"	"	"	2	Max.
"	"	"	"	3	Max.
"	"	"	"	4	Max.
"	"	"	"	5	Max.
"	"	"	"	6	Max.
"	"	"	"	7	Max.
Replace grid clip on 1st det.					
Ant.*	"	"	"	8	Min.
"	18 m.c.	18 m.c.	Range 4	9	Max.
"	"	"	"	10	Max.
"	"	"	"	11 ¹	Max.
"	7.2 m.c.	7.2 m.c.	Range 3	12	Max.
"	"	"	"	13	Max.
"	"	"	"	14 ²	Max.
"	3.5 m.c.	3.5 m.c.	Range 2	15	Max.
"	"	"	"	16	Max.
"	"	"	"	17	Max.
"	1500 k.c.	1.5 m.c.	"	18 ³	Max.
"	"	1500 k.c.	Range 1	19	Max.
"	"	"	"	20	Max.
"	"	"	"	21	Max.
"	600 k.c.	600 k.c.	"	22 ⁴	Max.

* Use 200-mmfd. condenser dummy antenna on broadcast band and 400-ohm carbon resistor on shortwave bands.

Note 1.—To insure proper adjustment, check image at 17.08 m.c. on dial.

Note 2.—Check dial calibration by tuning in 11.0 m.c. image near 10.08 on dial. If there is appreciable error at this point, readjust padder (12) for maximum output. Then return dial to 7.2 m.c. position, tuning for maximum output and then readjust padders (13) and (14).

Note 3.—Nut adjustment.

Note 4.—Screw adjustment.

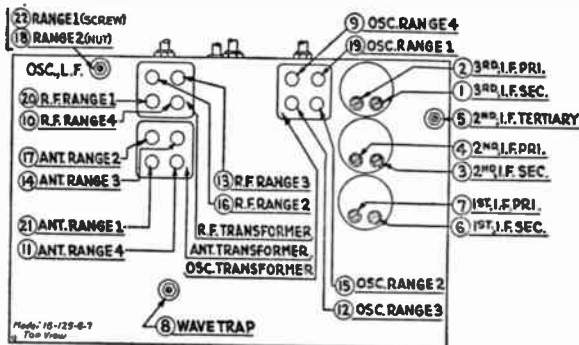

MODEL NO. 17 (121, 122, 123)

Signal Generator Connection	Signal Generator Frequency	Dial Position	Wave Band Switch Position	Trimmer Number	Output Signal
Remove grid clip from 6A7					
Control grid of 6A7 ¹	175 k.c.	55	Broadcast	1	Max.
"	"	"	"	2	Max.
"	"	"	"	3	Max.
"	"	"	"	4	Max.
"	"	"	"	5	Max.
Connect grid clip to 6A7					
Ant. ²	1400 k.c.	140	"	6	Max.
"	"	"	"	7	Max.
"	600 k.c.	60	"	8	Max.*
"	1400 k.c.	140	"	6	Max.
"	1600 k.c.	1.6	S.W.	10	Max.*

* While rocking.

Note 1.—Connect 0.1-mf. condenser between grid clip and ground.

Note 2.—Connect a 200-mmf. condenser between signal generator and antenna post of set, at the antenna post.

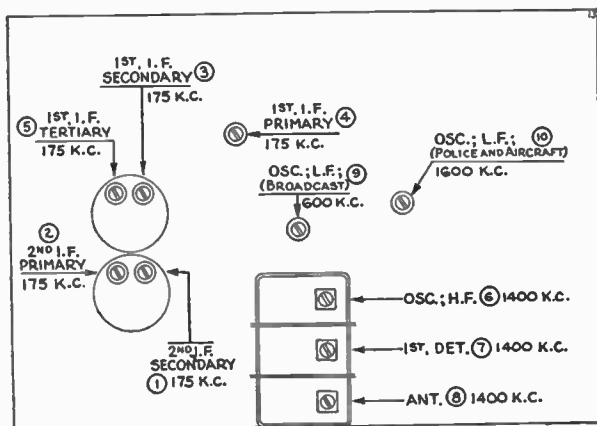

MODEL NOS. 18 (121-124), 503

Signal Generator Connection	Signal Generator Frequency	Dial Position	Wave Band Switch Position	Trimmer Number	Output Signal
Remove grid clip from 6A7					
Control grid of 6A7	260 k.c.	55	...	3	Max.
"	"	"	...	2	Max.
"	"	"	...	1	Max.
Connect grid clip to 6A7					
Ant.**	1500 k.c.	150	...	6	Max.
"	1400 k.c.	140	...	5	Max.
"	1400 k.c.	"	...	4	Max.
"	600 k.c.	60	...	7	Max.*
"	1500 k.c.	150	...	6	Max.

* While rocking.

** Connect a 200-mmf. condenser between signal generator and antenna post of set, at antenna post.

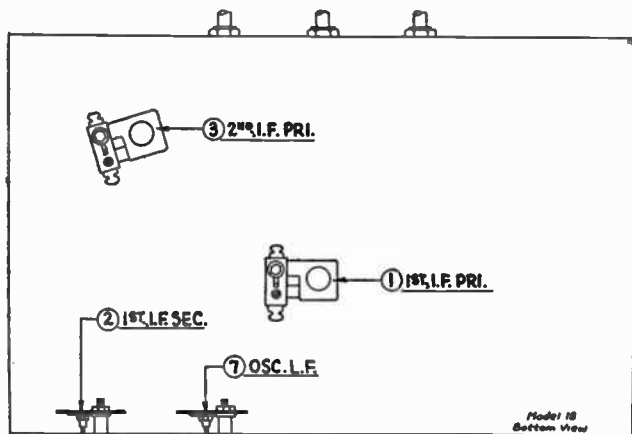
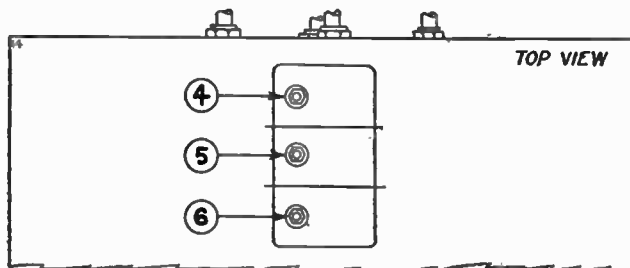

MODEL NOS. 19, 26, 27, 32, 89

Signal Generator Connection	Signal Generator Frequency	Dial Position	Trimmer Number	Output Signal
Remove grid clip from det.-osc.				
Control grid of det.-osc.	260 k.c.	55	1	Max.
"	"	"	2	Max.
"	"	"	3	Max.
Connect grid clip to det.-osc.				
Ant.**	1400 k.c.	140	4	Max.
"	"	"	5	Max.
"	"	"	6	Max.
"	650 k.c.	65	7	Max.*
"	1400 k.c.	140	4	Max.

* While rocking.

** Connect a 200-mmf. condenser between signal generator and antenna post of set, at antenna post.

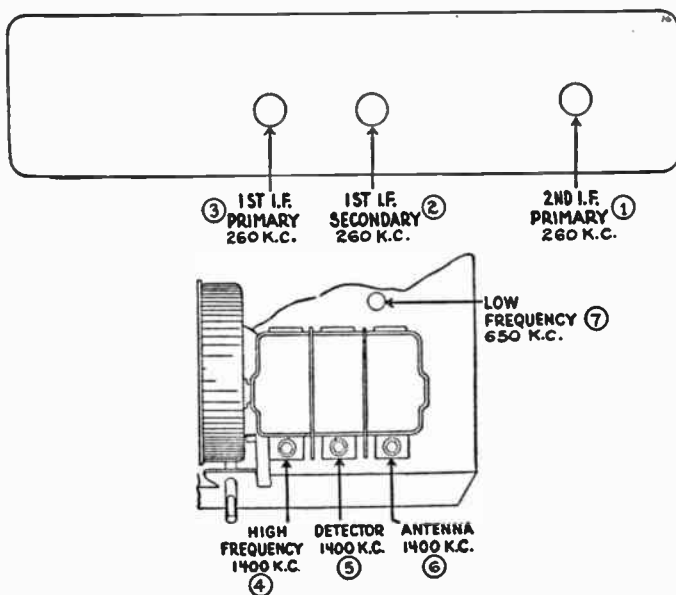

MODEL NO. 28

Signal Generator Connection	Signal Generator Frequency	Dial Position	Wave Band Switch Position	Trimmer Number	Output Signal
Remove grid clip from 6A7					
Control grid of 6A7	460 k.c.	600 k.c.	Broadcast	6 ¹	Max.
"	"	"	"	5 ²	Max.
"	"	"	"	4 ¹	Max.
"	"	"	"	3 ²	Max.
"	"	"	"	2 ¹	Max.
"	"	"	"	1 ²	Max.
Connect grid clip to 6A7					
Ant. ⁴	"	540 k.c.	"	7	Min.
"	1500 k.c.	1500 k.c.	"	8	Max.
"	"	"	"	9	Max.
"	600 k.c.	600 k.c.	"	10 ³	Max.

Note 1.—Nut adjustment.

Note 2.—Screw adjustment.

Note 3.—Accessible through hole from top of chassis.

Note 4.—Use a 200-mmf. condenser as dummy antenna for broadcast band and a 400-ohm carbon resistor on the shortwave band.

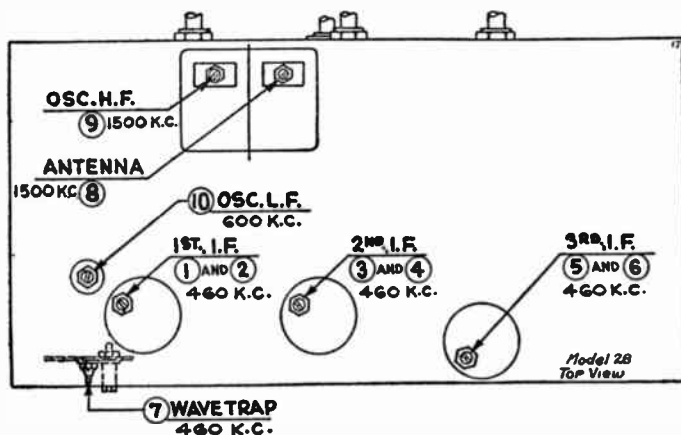

MODEL NOS. 29, 29TX

Signal Generator Connection	Signal Generator Frequency	Dial Position	Wave Band Switch Position	Trimmer Number	Output Signal
Remove grid clip from 6A7					
Control grid of 6A7	460 k.c.	600 k.c.	Broadcast	1 ¹	Max.
"	"	"	"	2 ²	Max.
"	"	"	"	3 ¹	Max.
"	"	"	"	4 ²	Max.
"	"	"	"	5 ¹	Max.
"	"	"	"	6 ²	Max.
Connect grid clip to 6A7					
Ant. ⁴	"	540 k.c.	"	7	Min.
"	1500 k.c.	1500 k.c.	"	8	Max.
"	"	"	"	9	Max.
"	600 k.c.	600 k.c.	"	10 ³	Max.

Note 1.—Nut adjustment.

Note 2.—Screw adjustment.

Note 3.—Accessible through hole from top of chassis.

Note 4.—Use a 200-mmf. condenser as dummy antenna on the broadcast wave-band and a 400-ohm carbon resistor on the shortwave band.

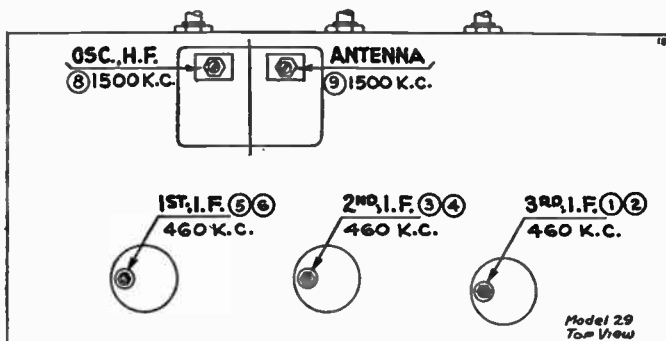
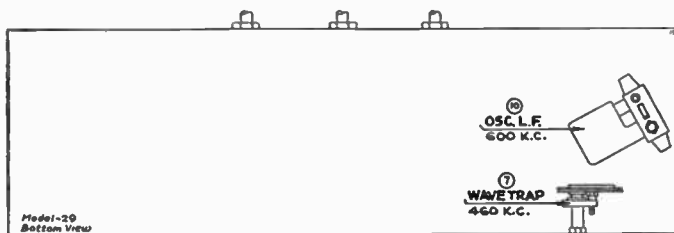

MODEL NOS. 30, 95, 96, 296

Signal Generator Connection	Signal Generator Frequency	Dial Position	Trimmer Number	Output Signal
Ant.*	1300 k.c.	130	Det. ¹	Max.
"	"	"	3rd ¹	Max.
"	"	"	R.F. 2nd ¹	Max.
"	"	"	R.F. Ant. ¹	Max.

Note 1.—Located on top of chassis, behind gang condenser and between r.f. coil shields.

* Connect a 200-mm.f. condenser between the signal generator and the antenna post of the set, at the antenna post.

MODEL NOS. 40, 41, 42

Signal Generator Connection	Signal Generator Frequency	Dial Position	Trimmer Number	Output Signal
Ant.*	1300 k.c.	130	Ant. ^{1, 2}	...
"	"	"	1st r.f. ²	Max.
"	"	"	Ant. ²	Max.

Note 1.—Turn all the way in so as to purposely unbalance the first stage and permit accurate alignment of the second stage.

Note 2.—Located at the right of the gang condenser in front of the 1st r.f. transformer—accessible from top of chassis.

* Connect a 200-mm.f. condenser between the signal generator and the antenna post of the set, at the antenna post.

MODEL NO. 46

Signal Generator Connection	Signal Generator Frequency	Dial Position	Wave Band Switch Position	Trimmer Number	Output Signal
Ant.*	1200-1400 k.c.	120-140	...	Det. ¹	Max.
"	"	"	...	R.F. ¹	Max.
"	"	"	...	Ant. ¹	Max.

* Connect a 200-mm.f. condenser between signal generator and antenna post of set, at the antenna post.

Note 1.—These trimmers are located on the sections of the variable-condenser gang. Adjust from above.

MODEL NOS. 34, 34A

Signal Generator Connection	Signal Generator Frequency	Dial Position	Wave Band Switch Position	Trimmer Number	Output Signal
Remove grid clip from 1C6					
Grid of 1C6	460 k.c.	520 k.c.	Broadcast	7	Max.
"	"	"	"	8	Max.
"	"	"	"	9	Max.
"	"	"	"	10	Max.
"	"	"	"	11	Max.
"	"	"	"	12	Max.
Connect grid clip to 1C6					
Ant.*	"	520 k.c.	"	13	Min.
"	20 m.c.	20 m.c.	Range 4	1	Max.
"	10.8 m.c.	10.8 m.c.	Range 3	2	Max.
"	3.5 m.c.	3.5 m.c.	Range 2	3 ¹	Max.
"	1500 k.c.	1.5 m.c.	"	4 ¹	Max.
"	1400 k.c.	1400 k.c.	Broadcast	5 ¹	Max.
"	520 k.c.	520 k.c.	"	6 ¹	Max.

Note 1.—Accessible from underneath chassis.

* Use a 200-mmf. condenser as dummy antenna on the broadcast waveband and a 400-ohm carbon resistor on the shortwave band.

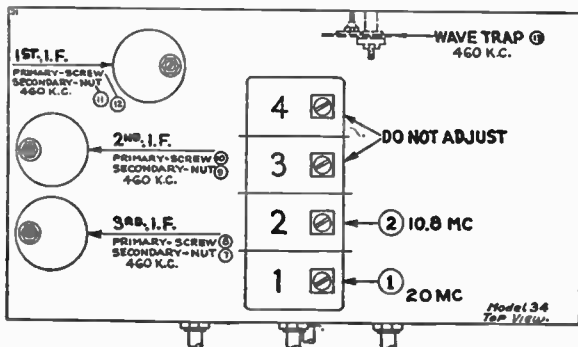
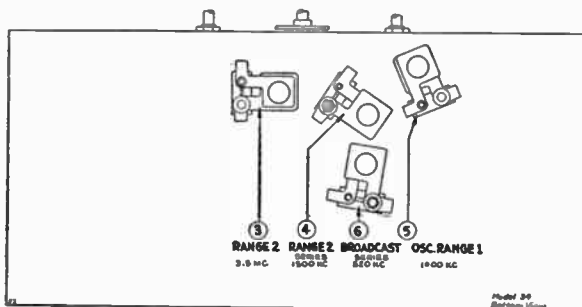

MODEL NOS. 35, 36

Signal Generator Connection	Signal Generator Frequency	Dial Position	Trimmer Number	Output Signal
Remove grid clip from 1st det.				
Control grid of 1st det.	260 k.c.	55	1 ¹	Max.
"	"	"	2 ¹	Max.
"	"	"	3 ¹	Max.
Connect grid clip to 1st det.				
Ant.*	1400 k.c.	140	4	Max.
"	"	"	5	Max.
"	"	"	6	Max.
"	600 k.c.	60	7 ²	Max.**
"	1400 k.c.	140	4	Max.

Note 1.—(1), (2), and (3) are accessible at rear of chassis.

Note 2.—(7) is accessible through hole from top of chassis.

* Connect a 200-mmf. condenser between signal generator and antenna post of set, at the antenna post.

** While rocking.

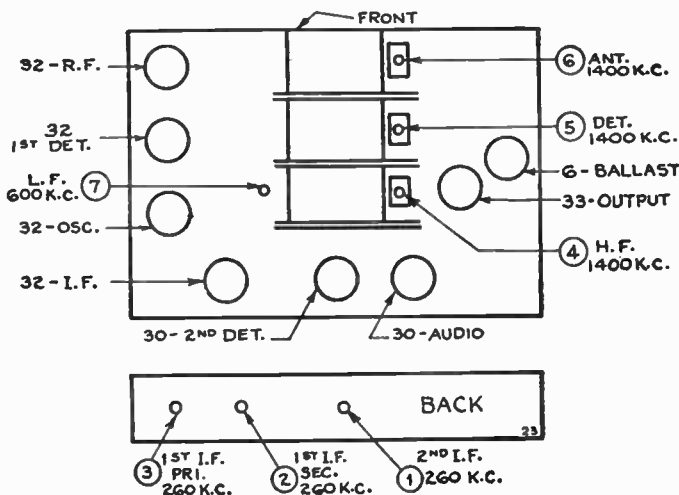

MODEL NO. 37

Signal Generator Connection	Signal Generator Frequency	Dial Position	Trimmer Number	Output Signal
Remove grid clip from 1st det.				
Control grid of 1st det.	175 k.c.	55	1	Max.
"	"	"	2	Max.
"	"	"	3	Max.
Connect grid clip to 1st det.				
Ant.*	1400 k.c.	140	4	Max.
"	"	"	5	Max.
"	"	"	6	Max.
"	600 k.c.	60	7	Max.**
"	1400 k.c.	140	4	Max.

* Connect a 200-mmf. condenser between the signal generator and the antenna post of the set, at the antenna post.

** While rocking.

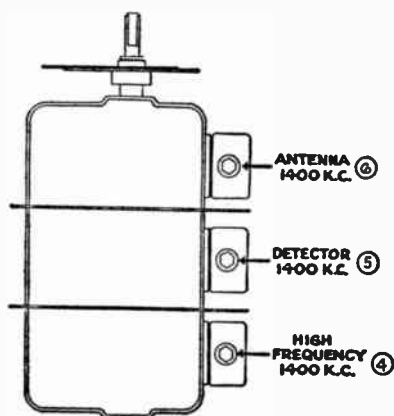
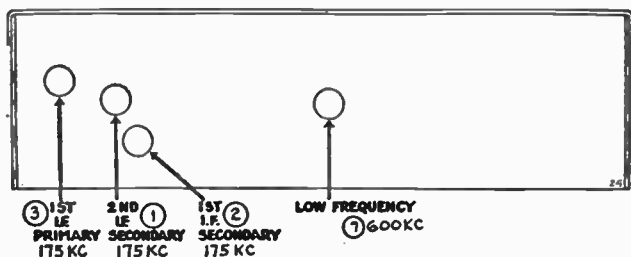

MODEL NO. 37-9

Signal Generator Connection	Signal Generator Frequency	Dial Position	Wave Band Switch Position	Trimmer Number	Output Signal
Control grid 1, 2 of 6A8G	470 k.c.	580 k.c.	Broadcast	54	Max.
"	"	"	"	53P	Max.
"	"	"	"	43S	Max.
"	"	"	"	43P	Max.
Ant. term. ³ #1	1600 k.c.	1600 k.c.	"	21	Max.
"	"	"	"	36B	Max.
"	"	"	"	36A	Max.
"	580 k.c.	580 k.c.	"	22	Max.*
"	1600 k.c.	1600 k.c.	"	21	Max.
"	1500 k.c.	1500 k.c.	"	36A	Max.
"	"	"	"	36B	Max.
"	6 m.c.	6 m.c.	Range 2 2.3-7.4 m.c.	21A	Max.
"	18 m.c.	18 m.c.	Range 3 7.35-22 m.c.	21B	Max.
"	"	17.06	"	Image check	
"	"	18 m.c.	"	10	Max.*
"	"	"	"	4	Max.
"	"	"	"	21B	Max.
"	1000 k.c.	1000 k.c. ⁴	Broadcast	53S	Max. ⁵

Note 1.—Through a .1 mfd. condenser.

Note 2.—Set controls as follows: Magnetic tuning—"off"; bass compensation—minimum.

Note 3.—Through a .1 mfd. condenser. Link terminals 2 and 3.

Note 4.—The receiver dial must be adjusted very accurately for maximum output.

Note 5.—The magnetic tuning control should be turned to the "on" position before adjusting trimmer 53S. When the adjustment is completed, there should be no change in tone or hiss, when the magnetic tuning control is switched "on" and "off." A change indicates a shift in frequency and means that the adjustment should be repeated.

* While rocking.

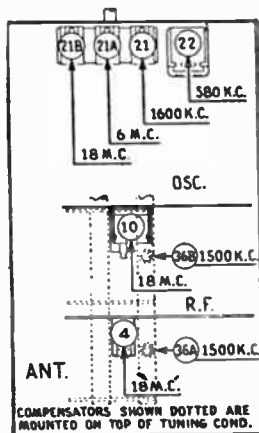
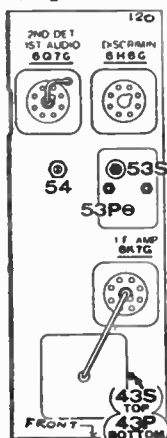

MODEL NOS. 37-10, 37-11

Signal Generator Connection	Signal Generator Frequency	Dial Position	Wave Band Switch Position	Trimmer Number	Output Signal
Control grid ^{1, 2} of 6K7G i.f.	470 k.c.	580 k.c.	Broadcast	59	Max.
"	"	"	"	48P	Max.
Control grid of 6A8G	"	"	"	54S	Max.
"	"	"	"	54P	Max.
Ant. term. ³ #1	18 m.c.	18 m.c.	Range 3 7.35-22 m.c.	24B	Max. ⁴
"	"	17.06 m.c.	"		Image check
"	"	18 m.c. ⁵	"	10B	Max.
"	"	"	"	2B	Max.
"	18 m.c. ⁶	"	"	24B	Max.
"	"	17.06 m.c.	"		Image check
"	7 m.c.	7 m.c.	Range 2 2.3-7.4 m.c.	24A	Max.
"	6 m.c.	6 m.c.	"	10A	Max.
"	"	"	"	2A	Max.
"	1600 k.c.	1600 k.c.	Broadcast	24	Max.
"	"	"	"	10	Max.
"	"	"	"	2	Max.
"	580 k.c.	580 k.c.	"	25	Max.*
"	1600 k.c.	1600 k.c.	"	24	Max.
"	1500 k.c.	1500 k.c.	"	10	Max.
"	"	"	"	2	Max.
"	1000 k.c.	1000 k.c. ⁷	"	48S	Note 8

Note 1.—To align the dial to track properly with the tuning condenser, proceed as follows: Loosen the shaft coupling set screws, turn the tuning condenser fully closed and the dial to the first index line. Now tighten the set screws, and rotate the dial until the 520 k.c. mark is midway between the index line and the glowing beam indicator. With the condenser in this position, loosen the set screws and turn the dial until the glowing beam indicator is centered on the index line. *Be careful that the tuning condenser is not disturbed while turning the dial.* Now retighten the set screws.

Note 2.—Through a .1 mfd. condenser. Controls as follows: Magnetic tuning—"off"; Bass compensation—minimum.

Note 3.—Through a .1 mfd. condenser. Link terminals 2 and 3.

Note 4.—The lower capacity setting should be used.

Note 5.—Connect a variable tuning condenser (Philco part No. 45-2325) from the oscillator compensator to ground. Tune the added condenser so that the second harmonic of the oscillator beats against the signal to produce maximum output. Then adjust 10B for maximum output.

Note 6.—Remove external variable condenser.

Note 7.—The receiver dial must be adjusted very carefully for maximum output.

Note 8.—The magnetic tuning control must be turned to the "on" position before adjusting trimmer 48S for maximum output. When the adjustment is completed there should be no change in tone or hiss when the magnetic tuning control is switched "on" and "off." A change indicates a shift in frequency and the adjustment should be repeated.

* While rocking.

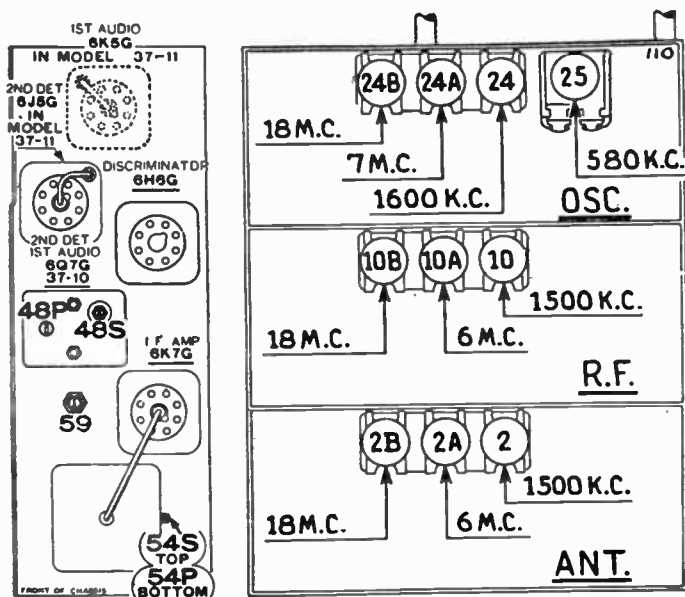

MODEL NO. 37-33

Signal Generator Connection	Signal Generator Frequency	Dial Position	Trimmer Number	Output Signal
Control ¹ grid of 1C7G	470 k.c.	550 k.c.	13S	Max.
"	"	"	13P	Max.
"	"	"	12S	Max.
"	"	"	12P	Max.
Ant. ²	1700 k.c.	Note 3	4B	Max.
"	"	"	4A	Max.
"	580 k.c.	580 k.c.	7	Max.*
"	1700 k.c.	Note 3	4B	Max.
"	"	"	4A	Max.
"	1500 k.c.	1500 k.c.	4A	Max.

Note 1.—Through a .1 mfd. condenser.

Note 2.—Connect signal generator direct to transmission line terminals.

Note 3.—Turn tuning condenser gang to minimum capacity position (clockwise), then place a .006" gauge horizontally between the rotor and stator plates (left side of tuning condenser facing front of chassis), and turn condenser until rotor and stator plates touch gauge. Then remove gauge without disturbing this setting of the plates and proceed to adjust (4A) and (4B). Follow this same procedure to readjust (4A) and (4B) after adjustment of (7) at 580 k.c.

* While rocking.

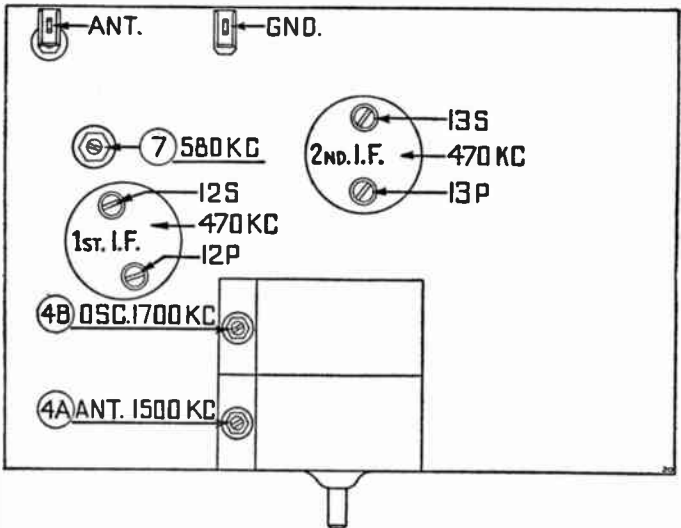

MODEL NO. 37-34

Signal Generator Connection	Signal Generator Frequency	Dial Position	Wave Band Switch Position	Trimmer Number	Output Signal
Grid of 1, 2 1D7G	470 k.c.	580 k.c.	...	18S	Max.
"	"	"	...	18P	Max.
"	"	"	...	17S	Max.
"	"	"	...	17P	Max.
Ant. ³	1600 k.c.	1600 k.c.	...	5A	Max.
"	"	"	...	5	Max.
"	580 k.c.	580 k.c.	...	12	Max.*
"	1600 k.c.	1600 k.c.	...	5A	Max.
"	1500 k.c.	1500 k.c.	...	5	Max.

Note 1.—Dial adjustment: Set the tuning condenser in the maximum capacity position. Loosen the set screw of dial hub and set dial with glowing indicator centered between the first and second index lines at the low frequency end of the scale.

Note 2.—Through a .1 mfd. condenser.

Note 3.—Through a 200 mmfd. condenser.

* While rocking.

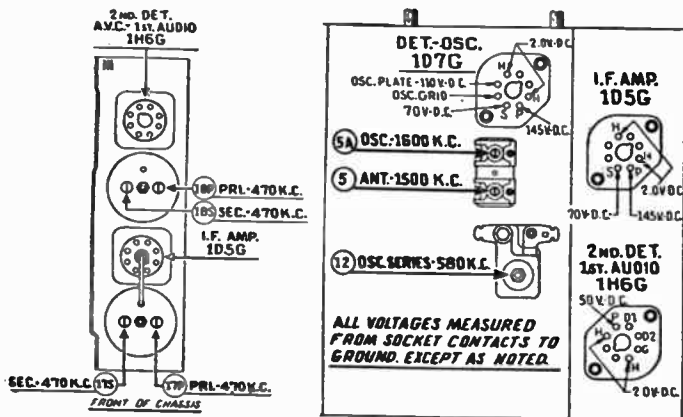

MODEL NO. 37-38

Signal Generator Connection	Signal Generator Frequency	Dial Position	Wave Band Switch Position	Trimmer Number	Output Signal
Control ^{1, 2} grid of 1C7G	470 k.c.	580 k.c.	Broadcast	28S	Max.
"	"	"	"	28P	Max.
"	"	"	"	15S	Max.
"	"	"	"	15P	Max.
Ant. ²	7.0 m.c.	7.0 m.c.	Short Wave	12	Max.
"	6.0 m.c.	6.0 m.c.	"	5A	Max.
"	1600 k.c.	1600 k.c.	Broadcast	14 ⁴	Max.
"	"	"	"	5	Max.
"	580 k.c.	580 k.c.	"	14A ⁵	Max.*
"	1600 k.c.	1600 k.c.	"	14 ⁴	Max.
"	1500 k.c.	1500 k.c.	"	5	Max.

Note 1.—Dial adjustment—Set tuning condenser at maximum capacity. Loosen set screw of dial hub and set dial so that the glowing indicator is centered between the first and second index lines at the low frequency end of the scale.

Note 2.—Connect signal generator direct to transmission line terminals.

Note 3.—Through a 200-mmfd. condenser.

Note 4.—Screw adjustment.

Note 5.—Nut adjustment.

* While rocking.

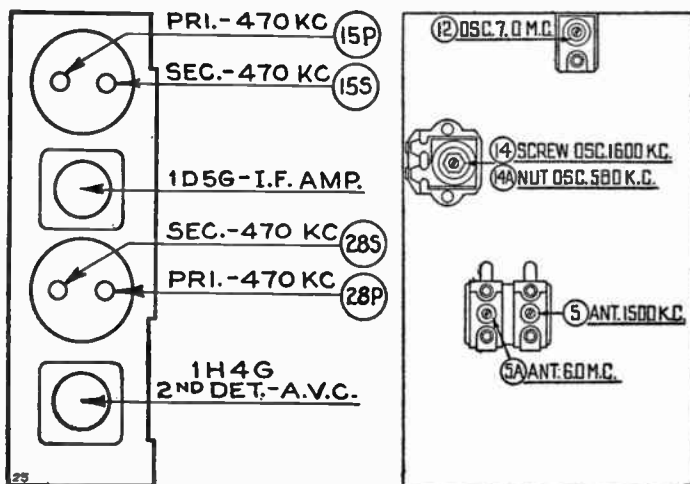

MODEL NO. 37-60

Signal Generator Connection	Signal Generator Frequency	Dial Position	Wave Band Switch Position	Trimmer Number	Output Signal
Grid of ^{1, 2} 6A8G	470 k.c.	600 k.c.	Broadcast	26A	Max.
"	"	"	"	26	Max.
"	"	"	"	14A	Max.
"	"	"	"	14	Max.
Ant. ³	7.0 m.c.	7.0 m.c.	Short Wave	7	Max.
"	6.0 m.c.	6.0 m.c.	"	3A	Max.
"	1600 k.c.	1600 k.c.	Broadcast	8	Max.
"	1500 k.c.	"	"	3	Max.
"	600 k.c.	600 k.c.	"	8A	Max.*
"	1600 k.c.	1600 k.c.	"	8	Max.
"	1500 k.c.	1500 k.c.	"	3	Max.

Note 1.—Set tuning condenser to maximum capacity position, by turning knob counter-clockwise. Loosen set screw of dial hub, and set dial, with glowing beam indicator centered between the last two index lines at the low-frequency end of broadcast scale. Retighten set screw.

Note 2.—Through .1 mfd. condenser.

Note 3.—Connect signal generator direct to transmission line terminals.

* While rocking.

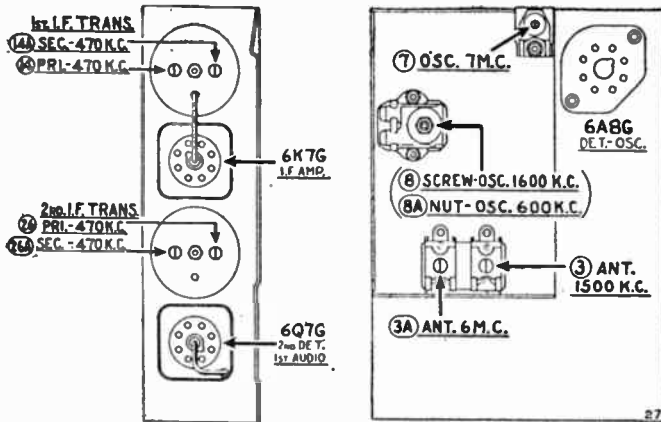

MODEL NO. 37-61

Signal Generator Connection	Signal Generator Frequency	Dial Position	Wave Band Switch Position	Trimmer Number	Output Signal
Grid of 6A8G ^{1, 2}	470 k.c.	600 k.c.	Broadcast	26A	Max.
"	"	"	"	26	Max.
"	"	"	"	14A	Max.
"	"	"	"	14	Max.
Ant. ³	18 m.c.	18 m.c.	Short Wave	7	Max.
"	"	18 m.c. ⁴	"	3A ⁵	Max.
"	"	18 m.c. ⁶	"	7	Note 7
"	1600 k.c.	1600 k.c.	Broadcast	8	Max.
"	"	"	"	3	Max.
"	600 k.c.	600 k.c.	"	8A	Max.*
"	1600 k.c.	1600 k.c.	"	8	Max.
"	1500 k.c.	1500 k.c.	"	3	Max.

Note 1.—Set tuning condenser to maximum capacity position, by turning knob counter-clockwise. Loosen set screw of dial hub, and set dial with glowing beam indicator centered between the last two index lines at low-frequency end of broadcast scale.

Note 2.—Through .1 mfd. condenser.

Note 3.—Connect signal generator direct to transmission line terminals.

Note 4.—To overcome detuning effect caused by adjustment of (7) in previous step, connect variable condenser (350 mmfd. with good vernier drive) across oscillator section of tuning condenser, tuning this so that second harmonic of receiver oscillator will beat against the signal from the signal generator.

Note 5.—This adjustment is made under the conditions described in Note 4 above.

Note 6.—Remove external condenser mentioned in Note 4.

Note 7.—Turn counter-clockwise from maximum capacity position until a second peak is reached—*adjust to maximum on this peak only*. Neglect first peak which is caused by image response.

* While rocking.

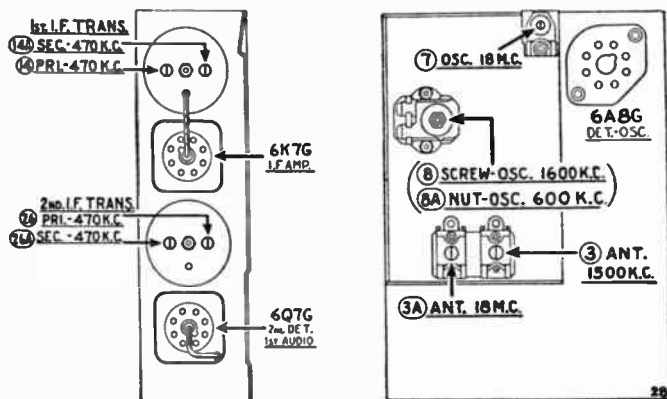

MODEL NO. 37-84

Signal Generator Connection	Signal Generator Frequency	Dial Position	Wave Band Switch Position	Trimmer Number	Output Signal
Grid of ¹ 6J7G	17	Note 2
"	470 k.c.	540 k.c.	...	11	Max.
"	"	"	...	15	Max.
"	"	"	...	17	Note 3
Ant. ⁴	1700 k.c.	Note 5	...	13	Max.
"	"	"	...	5	Max.
"	1400 k.c.	Note 6	...	5	Max.
"	1000 k.c.	Note 7	Max.

Note 1.—Through a .1 mfd. condenser.

Note 2.—Turn clockwise to maximum capacity position and then release 1¼ turns (counter-clockwise).

Note 3.—Turn clockwise until oscillation (hiss) is heard. Then turn counter-clockwise until hiss ceases—continue for ¼ turn more.

Note 4.—Through a 100-mmfd. condenser.

Note 5.—Turn gang condenser to minimum capacity position (extreme clockwise). Place .006" gauge between stator and rotor plates. Turn gang condenser counter-clockwise until stator and rotor plates touch gauge. Then remove gauge.

Note 6.—Tune gang condenser for maximum output.

Note 7.—Tune gang condenser for maximum output. Relocate pointer (if necessary) to indicate 1000 k.c. Dial indications will then be correct for all stations.

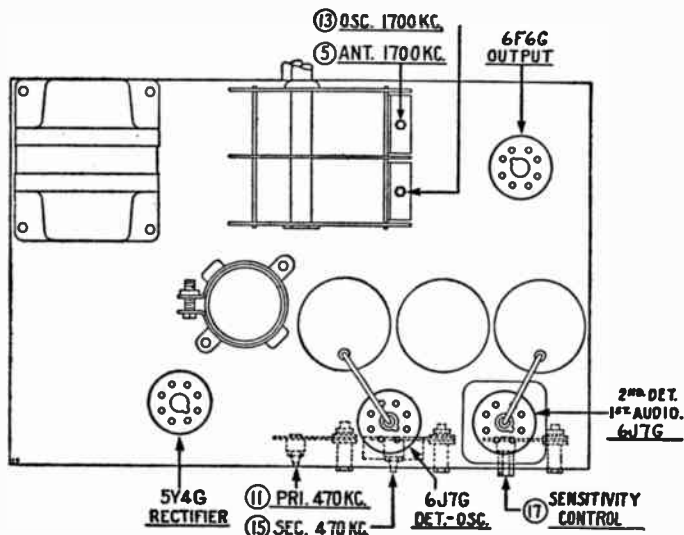

MODEL NO. 37-89

Signal Generator Connection	Signal Generator Frequency	Dial Position	Wave Band Switch Position	Trimmer Number	Output Signal
Grid of ^{1,2} 6A8G	470 k.c.	600 k.c.	Broadcast (left)	20S	Max.
"	"	"	"	20P	Max.
"	"	"	"	19S	Max.
"	"	"	"	19P	Max.
Ant. ³	1500 k.c.	1500 k.c.	"	12	Max.
"	"	"	"	10	Max.
"	"	"	"	2	Max.
"	600 k.c.	600 k.c.	"	12A	Max.*
"	1500 k.c.	1500 k.c.	"	12	Max.
"	"	"	"	10	Max.
"	"	"	"	2	Max. ⁴

Note 1.—To check dial adjustment, tuning-condensér gang is set at maximum-capacity position by turning control knob clockwise. Loosen set-screw of dial hub and set dial with glowing beam indicator centered between the first and second index lines at the low-frequency end of scale.

Note 2.—Through a .1 mfd. condenser.

Note 3.—Connect signal generator direct to transmission line terminals.

Note 4.—No adjustments are necessary for the short-wave band.

* While rocking.

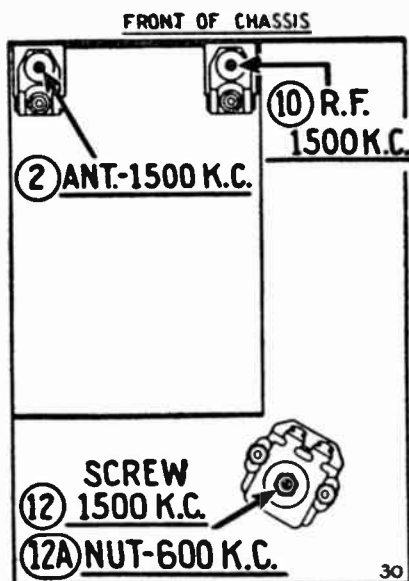
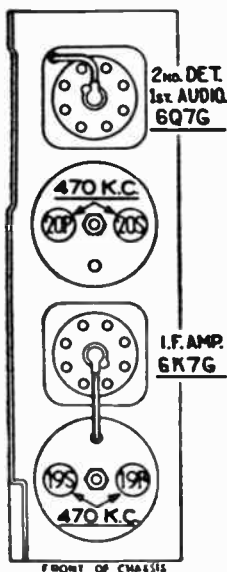

MODEL NO. 37-116 (121, 122)

Signal Generator Connection	Signal Generator Frequency	Dial Position	Wave Band Switch Position	Trimmer Number	Output Signal
Grid of 1, 2 6L7G	470 k.c.	580 k.c.	Range 1	64B	Max.
"	"	"	"	64A	Max.
"	"	"	"	64D	Max.
"	"	"	"	64C	Max.
"	"	"	"	71S	Max.
"	"	"	"	71P	Max.
"	Note 3	"	"	71S	Note 3
"	470 k.c.	580 k.c. ⁴	"	81P	Min.
Ant. ⁵	18 m.c.	18 m.c. ⁶	Range 5	43D	Note 7
"	"	18 m.c. ⁸	"	7D	Max.
"	"	"	"	25D	Max.
"	"	18 m.c. ⁹	"	43D	Note 7
"	12 m.c.	12 m.c.	"	43E	Max.
"	"	"	"	25E	Max.
"	"	"	"	7E	Max.
"	18 m.c.	18 m.c.	"	43D	Note 7
"	"	18 m.c. ⁸	"	7D	Max.
"	"	"	"	25D	Max.
"	"	18 m.c. ⁹	"	43D	Note 7
"	11.0 m.c.	11.0 m.c.	Range 4	43B	Max.
"	"	10.06 m.c.	"	Image check	
"	"	11.0 m.c. ¹⁰	"	7B	Max.
"	"	"	"	25B	Max.
"	"	11.0 m.c. ¹¹	"	43B	Max.
"	7.5 m.c.	7.5 m.c.	"	43C	Max.
"	"	"	"	25C	Max.
"	"	"	"	7C	Max.
"	11 m.c.	11 m.c.	"	43B	Max.
"	"	10.06 m.c.	"	Image check	
"	"	11 m.c. ¹⁰	"	7B	Max.
"	"	"	"	25B	Max.
"	"	11 m.c. ¹¹	"	43B	Max.
"	7.0 m.c.	7.0 m.c.	Range 3	43	Max.
"	"	"	"	25	Max.
"	"	"	"	7	Max.
"	5.0 m.c.	5.0 m.c.	"	43A	Max.
"	"	"	"	25A	Max.
"	"	"	"	7A	Max.
"	7.0 m.c.	7.0 m.c.	"	43	Max.
"	"	"	"	25	Max.
"	"	"	"	7	Max.
"	4.5 m.c.	4.5 m.c.	Range 2	42B	Max.
"	"	"	"	24A	Max.
"	"	"	"	6A	Max.
"	1.7 m.c.	1.7 m.c.	"	42C	Max.*

MODEL NO. 37-116 (121, 122) Cont.

Signal Generator Connection	Signal Generator Frequency	Dial Position	Wave Band Switch Position	Trimmer Number	Output Signal
Ant. ⁵	4.5 m.c.	4.5 m.c.	Range 2	42B	Max.
"	"	"	"	24A	Max.
"	"	"	"	6A	Max.
"	1500 k.c.	1500 k.c.	Range 1	42	Max.
"	"	"	"	24	Max.
"	"	"	"	6	Max.
"	580 k.c.	580 k.c.	"	42A	Max.*
"	1500 k.c.	1500 k.c.	"	42	Max.
"	1400 k.c.	1400 k.c.	"	24	Max.
"	"	"	"	6	Max.
"	1000 k.c.	Note 12	"	...	Max.
"	"	Note 13	"	81S	Max.
"	"	Note 14	"

Note 1.—The receiver should be allowed to heat for at least 15 minutes before adjusting the compensators.

Dial adjustment—Loosen set screws on shaft coupling of tuning condenser, and turn until plates are in maximum-capacity position. Set glowing beam indicator on *index line* at low-frequency end of the broadcast band and tighten set screws. Turn tuning-condenser control until indicator is on *first division from index line* and again loosen set screws on shaft coupling. Without disturbing position of variable condenser, turn dial until indicator is again on *index line*. Carefully tighten set-screws in this position. Set receiver volume control in maximum position. Turn fidelity-selectivity control clockwise and magnetic tuning control in "off" position (counter-clockwise).

Note 2.—Through .1 mfd. condenser.

Note 3.—Turn fidelity-selectivity control to the expanded position (counter-clockwise). Check i-f. curve for symmetry as follows: Slowly shift signal-generator dial between 460 k.c. and 480 k.c. As dial is turned, two peaks will be indicated on output meter—one at about 465 k.c. and the other at about 475 k.c. These peaks should both give the same deflection on the output meter. If they are unequal, adjust (71S) slightly to right or left—depending upon which peak gives the lower reading—until they are equal. Each time (71S) is set in another position, rotate signal-generator dial through 460 k.c. to 480 k.c. and note output-meter reading of each peak. If peaks become more equal when (71S) is turned to left, continue in this direction until they are equal. If they become more unequal, turn (71S) to right. Continue this adjustment in either direction until the peaks become equal.

Note 4.—Turn fidelity-selectivity control clockwise (selective position) and set signal generator to give highest output at this step.

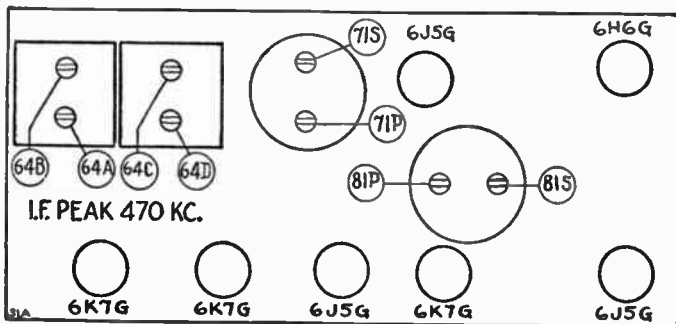

- Note 5.—Connect signal generator direct to transmission line terminals.
- Note 6.—Set magnetic-tuning control in "off" position and fidelity-selectivity control in extreme clockwise position.
- Note 7.—Turn screw clockwise to maximum-capacity position, then slowly turn counter-clockwise until a *second* peak is reached on output meter. First peak from maximum capacity is image response and receiver *must not* be adjusted at this point. On some receivers, only one peak will be found, therefore adjust (43D) on this peak. If above procedure is correctly followed, the image signal will be found at 17,060 m.c. by advancing signal-generator output and tuning receiver dial to this frequency mark on the scale.
- Note 8.—Connect variable condenser (Philco part #45-2325) across (43D) contact (first contact from left side of receiver, facing rear underside view of chassis) and ground. Tune this external condenser until second harmonic of receiver oscillator beats against signal from signal-generator, resulting in a maximum indication on output meter. Increase signal-generator output if necessary.
- Note 9.—Remove external variable condenser (Philco Part No. 45-2325) mentioned in note 8 before readjustment of (43D).
- Note 10.—Connect external variable condenser (Philco Part #45-2325) across (43B) contact (third contact from left side of receiver facing rear underside view of chassis) and ground. Tune this added condenser for maximum output before adjusting (7B) and (25B).
- Note 11.—Remove external variable condenser of note 10 before readjustment of (43B).
- Note 12.—Adjustment of magnetic control—Set fidelity-selectivity control in "selective" position (clockwise) and magnetic tuning control in "off" (out) position. Then adjust receiver tuning condenser for maximum output as accurately as possible—setting signal generator to give highest output.
- Note 13.—Turn magnetic-tuning control to "on" position (clockwise) before adjusting (81S).
- Note 14.—To check adjustment—Turn magnetic tuning control to "off"; when this is done, there should be no change in tone of receiver signal. If either a change of tone or a hiss develops, it indicates a shift in frequency and the adjustment must be made again.

* While rocking.

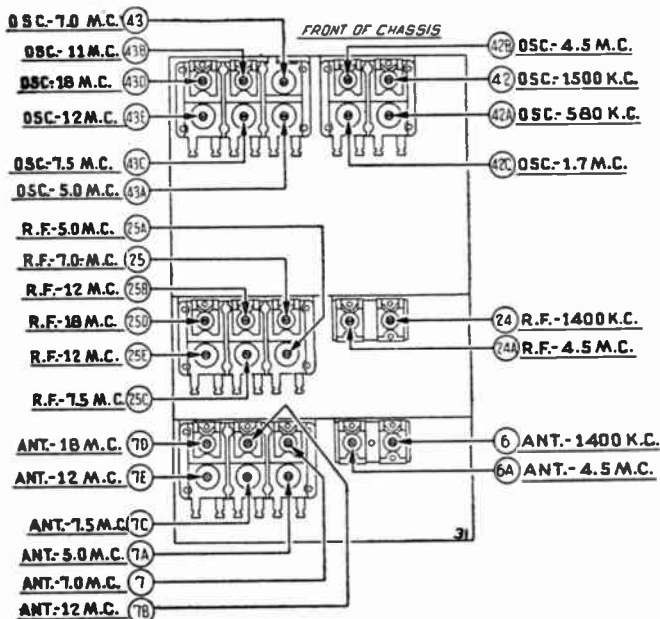

MODEL NO. 37-600

Signal Generator Connection	Signal Generator Frequency	Dial Position	Wave Band Switch Position	Trimmer Number	Output Signal
Control ¹ grid of 6A8G	470 k.c.	600 k.c.	...	23	Note 2
"	"	"	...	18	Max.
"	"	"	...	20	Max.
"	"	"	...	23	Note 3
Ant. ⁴	1800 k.c.	Note 5	...	6	Max.
"	"	"	...	5	Max.
"	600 k.c.	600 k.c.	...	16	Max.*
"	1800 k.c.	Note 5	...	6	Max.
"	1400 k.c.	1400 k.c.	...	5	Max.
"	1000 k.c.	Note 6	Max.

Note 1.—Through .1 mfd. condenser.

Note 2.—Turn to maximum capacity position (clockwise). Then turn counter clockwise $1\frac{1}{2}$ turns.

Note 3.—Turn clockwise until a hiss (oscillation) is heard—Then turn counter clockwise until hiss ceases and continue for $\frac{1}{4}$ turn more.

Note 4.—Through 100 mmfd. condenser.

Note 5.—Turn variable-condenser gang all the way out of mesh. Place .008" gauge between stator and rotor plates. Turn rotor plates until gauge touches both stator and rotor plates. Then remove gauge.

Note 6.—After installing chassis in cabinet, tune the variable-condenser gang for maximum output and set pointer to read 1000 k.c. This operation will correct the dial calibration.

* While rocking.

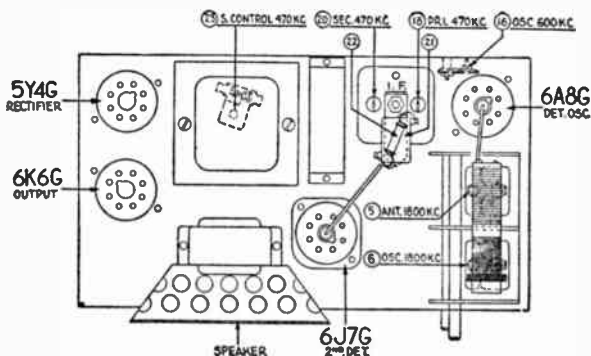

MODEL NO. 37-602

Signal Generator Connection	Signal Generator Frequency	Dial Position	Wave Band Switch Position	Trimmer Number	Output Signal
Control grid ¹ of 6K7G	470 k.c.	550 k.c.	...	27	Max.
"	"	"	...	29	Max.
Control grid ² of 6A8G	"	"	...	21	Max.
"	"	"	...	23	Max.
Ant. ³	1800 k.c.	Note 4	...	6A	Max.
"	"	"	...	3	Max.
"	600 k.c.	600 k.c.	...	8	Max.*
"	1800 k.c.	Note 4	...	6A	Max.
"	1400 k.c.	1400 k.c.	...	3	Max.
"	1000 k.c.	Note 5	Max.

Note 1, 2.—Through .1 mfd. condenser.

Note 3.—Through 100 mmfd. condenser.

Note 4.—Turn gang condenser counter clockwise to minimum-capacity position and place .006" gauge between stator and rotor plates. Turn gang condenser clockwise until stator and rotor plates both touch gauge. Then remove gauge.

Note 5.—After installing chassis in cabinet, tune the variable-condenser gang for maximum output and set dial pointer to read 1000 k.c. This operation corrects the dial calibration.

* While rocking.

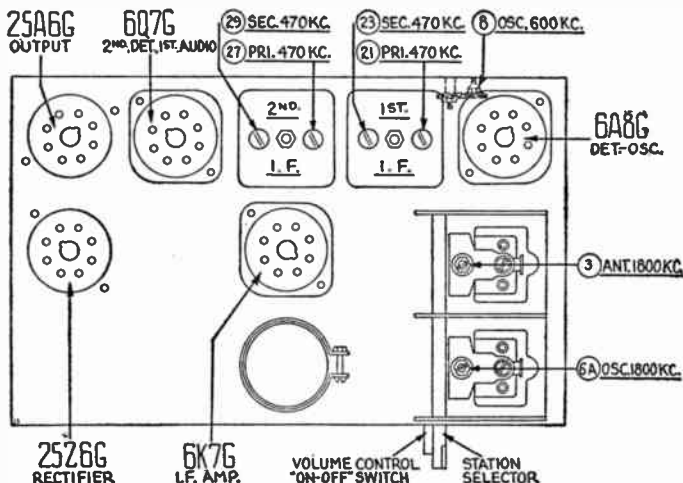

MODEL NO. 37-604

Signal Generator Connection	Signal Generator Frequency	Dial Position	Wave Band Switch Position	Trimmer Number	Output Signal
Control grid ^{1, 2} of 6K7G	470 k.c.	550 k.c.	Broadcast	24A	Max.
"	"	"	"	24	Max.
Control grid ² of 6A8G	"	"	"	18A	Max.
"	"	"	"	18	Max.
Ant. ³	18 m.c.	18 m.c.	Short Wave	3C	Max.
"	"	18 m.c. ⁴	"	3A	Max.
"	"	18 m.c. ⁵	"	3C	Note 6
"	18 m.c. ⁷	17.060 m.c.	"	Image check	
"	6 m.c.	6 m.c.	"	6A	Max.*
"	18 m.c.	18 m.c. ⁴	"	3A	Max.
"	"	18 m.c. ⁵	"	3C	Note 6
"	18 m.c. ⁷	17.060 m.c.	"	Image check	
"	1600 k.c.	1600 k.c.	Broadcast	3B	Max.
"	"	"	"	3	Max.
"	600 k.c.	600 k.c.	"	6	Max.*
"	1600 k.c.	1600 k.c.	"	3B	Max.
"	"	"	"	3	Max.
"	1400 k.c.	1400 k.c.	"	3	Max.

Note 1.—Dial adjustment—Turn tuning condenser counter clockwise to extreme maximum-capacity end. Loosen set screw of dial hub, then turn dial until glowing beam indicator is centered on the first index line of dial scale and retighten set screw.

Note 2.—Through .1 mfd. condenser.

Note 3.—Connect signal generator direct to transmission line terminals.

Note 4.—Connect vernier-drive variable condenser of about 350 mmfd. across oscillator section of receiver variable condenser (bottom section). Tune until second harmonic of receiver oscillator beats against signal from signal-generator. 3A is adjusted under these conditions.

Note 5.—Remove external variable condenser mentioned in Note 4 above.

Note 6.—Turn to maximum-capacity position, and then turn counter clockwise until a second peak is reached. Adjust to maximum on this peak only. Do not use first peak which is caused by image response.

Note 7.—Increase signal-generator output to a value great enough to clearly indicate the image signal at this step.

* While rocking.

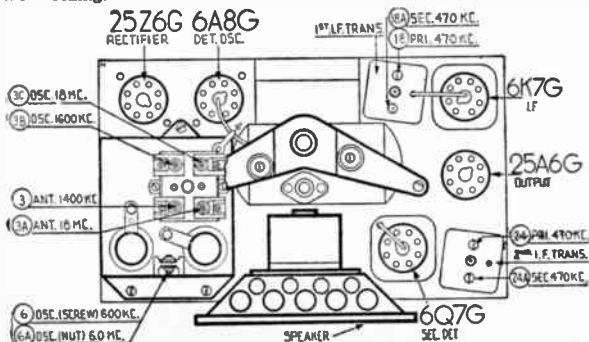

MODEL NO. 37-610 (121, 122)

Signal Generator Connection	Signal Generator Frequency	Dial Position	Wave Band Switch Position	Trimmer Number	Output Signal
Control ^{1, 2} grid of 6A8G	470 k.c.	550 k.c.	Range 1 (broadcast)	29	Max.
"	"	"	"	28	Max.
"	"	"	"	26	Max.
"	"	"	"	25	Max.
Ant. ³	18.0 m.c.	18.0 m.c.	Range 3	19	Max.
"	"	"	"	6	Max.
"	"	18.0 m.c. ⁴	"	6	Max.
"	"	18.0 m.c. ⁵	"	19 ⁶	Max.
"	7.0 m.c.	7.0 m.c.	Range 2	15	Max.
"	6.0 m.c.	6.0 m.c.	"	5	Max.
"	800 k.c.	1600 k.c.	Range 1	14	Max.
"	"	"	"	4	Max.
"	600 k.c.	600 k.c.	"	13	Max.*
"	800 k.c.	1600 k.c.	"	14	Max.
"	"	"	"	4	Max.
"	750 k.c.	1500 k.c.	"	4	Max.

Note 1.—Dial adjustment. Turn variable-condenser gang to maximum capacity. Loosen set screw of dial hub and turn dial until glowing-beam indicator is centered between index lines on dial scale. Then retighten set screw.

Note 2.—Through .1 mfd. condenser.

Note 3.—Connect signal generator direct to transmission line terminals.

Note 4.—Connect vernier-drive variable condenser, 350 mmfd., across oscillator section of receiver condenser gang. Tune this condenser so that second harmonic of receiver oscillator will beat against signal from signal-generator. (8) is adjusted on this beat.

Note 5.—Remove external variable-condenser mentioned in note 4 above.

Note 6.—Turn to maximum capacity (clockwise)—then back-off (counter clockwise) until a second peak is reached. Adjust to maximum on this peak only. Do not use first peak (caused by image-frequency signal).

* While rocking.

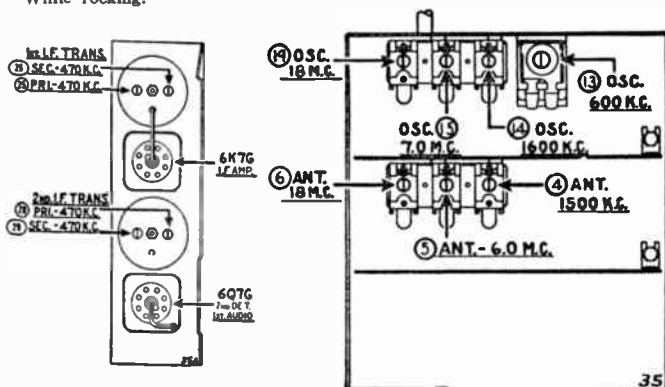

MODEL NO. 37-611

Signal Generator Connection	Signal Generator Frequency	Dial Position	Wave Band Switch Position	Trimmer Number	Output Signal
Control ^{1, 2} grid of 6A8G	470 k.c.	550 k.c.	Range 1 (broadcast)	23S	Max.
"	"	"	"	23P	Max.
"	"	"	"	20S	Max.
"	"	"	"	20P	Max.
Ant. ³	18 m.c.	18 m.c.	Range 3	9B	Note 4
"	18 m.c. ⁵	17.06 m.c.	"	Image check	
"	18 m.c.	18 m.c. ⁶	"	5B	Max.
"	"	18 m.c. ⁷	"	9B	Note 4
"	18 m.c. ⁵	17.06 m.c.	"	Image check	
"	7.0 m.c.	7.0 m.c.	Range 2	9A	Max.
"	6.0 m.c.	6.0 m.c.	"	5A	Max.
"	1600 k.c.	1600 k.c.	Range 1	9	Max.
"	"	"	"	5	Max.
"	600 k.c.	600 k.c.	"	10	Max.*
"	1600 k.c.	1600 k.c.	"	9	Max.
"	1500 k.c.	1500 k.c.	"	5	Max.

Note 1.—Dial adjustment—Turn variable condenser to maximum-capacity position. Loosen set screw of dial hub and turn dial until glowing beam indicator is centered between index lines on dial scale. Then retighten set screw.

Note 2.—Through .1 mfd. condenser.

Note 3.—Connect signal generator direct to transmission line terminals.

Note 4.—Turn clockwise to maximum-capacity position, then slowly turn back until a second peak is reached. Adjust to maximum on this peak only. Do not use first peak which is caused by image response.

Note 5.—Increase signal-generator output to a value great enough to clearly indicate the image at this step.

Note 6.—Connect a vernier drive variable condenser (about 350 mmfd.) across oscillator section of receiver variable condenser gang. Tune from maximum capacity point until second harmonic of receiver oscillator beats against signal-generator. Adjust (5B) under these conditions.

Note 7.—Remove external variable condenser mentioned in note 6.

* While rocking.

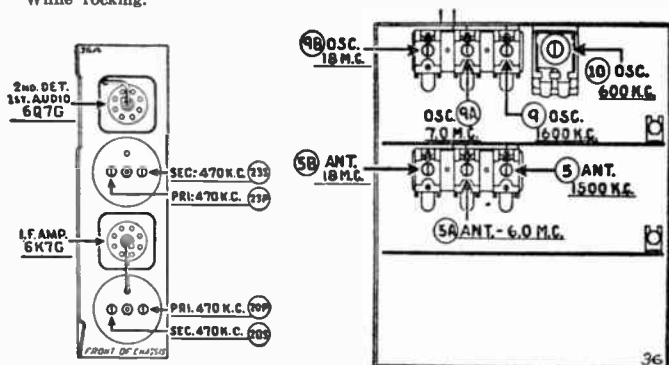

MODEL NO. 37-620

Signal Generator Connection	Signal Generator Frequency	Dial Position	Wave Band Switch Position	Trimmer Number	Output Signal
Control grid ^{1, 2} of 6A8G	470 k.c.	550 k.c.	Range 1 (broadcast)	37A	Max.
"	"	"	"	37	Max.
"	"	"	"	31A	Max.
"	"	"	"	31	Max.
Ant. ³	18 m.c.	18 m.c.	Range 3	23B	Max.
"	"	"	"	8B	Max.
"	"	"	"	4B	Max.
"	"	18 m.c. ⁴	"	4B	Max.
"	"	"	"	8B	Max.
"	"	18 m.c. ⁵	"	23B	Note 6

(Continued on page 40)

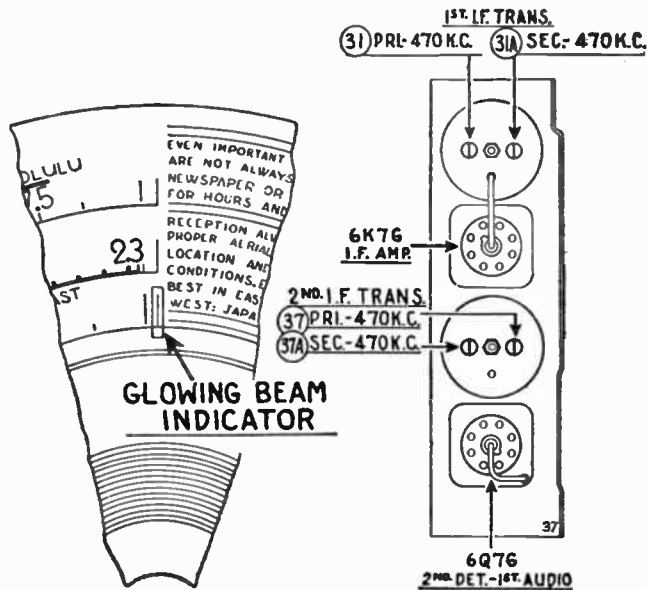

MODEL NO. 37-620 Cont.

Signal Generator Connection	Signal Generator Frequency	Dial Position	Wave Band Switch Position	Trimmer Number	Output Signal
Ant. ^s	7.0 m.c.	7.0 m.c.	Range 2	23A	Max.
"	6.0 m.c.	6.0 m.c.	"	8A	Max.
"	"	"	"	4A	Max.
"	1600 k.c.	1600 k.c.	Range 1	23	Max.
"	"	"	"	8	Max.
"	"	"	"	4	Max.
"	600 k.c.	600 k.c.	"	21	Max.*
"	1600 k.c.	1600 k.c.	"	23	Max.
"	"	"	"	8	Max.
"	"	"	"	4	Max.
"	1500 k.c.	1500 k.c.	"	4	Max.
"	"	"	"	8	Max.

Note 1.—Dial adjustment—Turn variable condenser gang to maximum-capacity position. Loosen set screw of dial hub and turn dial until glowing beam indicator is centered on first index line of dial scale. Then retighten set screw.

Note 2.—Through .1 mfd. condenser.

Note 3.—Connect signal generator direct to transmission line terminals.

Note 4.—Connect vernier-drive variable condenser (about 350 mmfd.) across oscillator section of tuning condenser gang. Tune so that second harmonic of receiver oscillator will beat against signal from signal-generator. Adjust (4B) and (8B) under these conditions.

Note 5.—Remove external variable condenser mentioned in note 4 above.

Note 6.—Turn clockwise to maximum-capacity position, then back off counter clockwise until a second peak is reached on output meter. Adjust to maximum on this peak only. Do not use first peak which is caused by image response.

* While rocking.

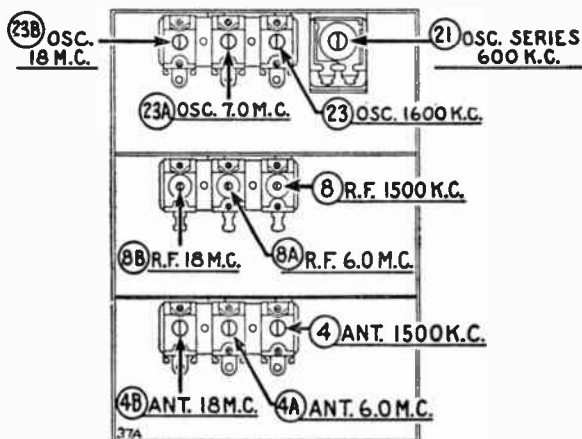

MODEL NOS. 37-623, 37-624

Signal Generator Connection	Signal Generator Frequency	Dial Position	Wave Band Switch Position	Trimmer Number	Output Signal
Control grid ^{1, 2} of 1C7G	470 k.c.	550 k.c.	Range 1 (broadcast)	30S	Max.
"	"	"	"	30P	Max.
"	"	"	"	28S	Max.
"	"	"	"	28P	Max.
Ant. ³	20 m.c.	20 m.c.	Range 3	20B	Note 4
"	20 m.c. ⁵	19.060 m.c.	"	Image	check
"	20 m.c.	20 m.c. ⁶	"	4B	Max.
"	"	"	"	16B	Max.
"	"	20 m.c. ⁷	"	20B	Note 4
"	20 m.c. ⁵	19.060 m.c.	"	Image	check
"	7.0 m.c.	7.0 m.c.	Range 2	20A	Max.
"	6.0 m.c.	6.0 m.c.	"	4A	Max.
"	"	"	"	16A	Max.
"	1600 k.c.	1600 k.c.	Range 1	20	Max.
"	"	"	"	4	Max.
"	"	"	"	16	Max.
"	580 k.c.	580 k.c.	"	19	Max.*
"	1600 k.c.	1600 k.c.	"	20	Max.
"	1500 k.c.	1500 k.c.	"	4	Max.
"	"	"	"	16	Max.

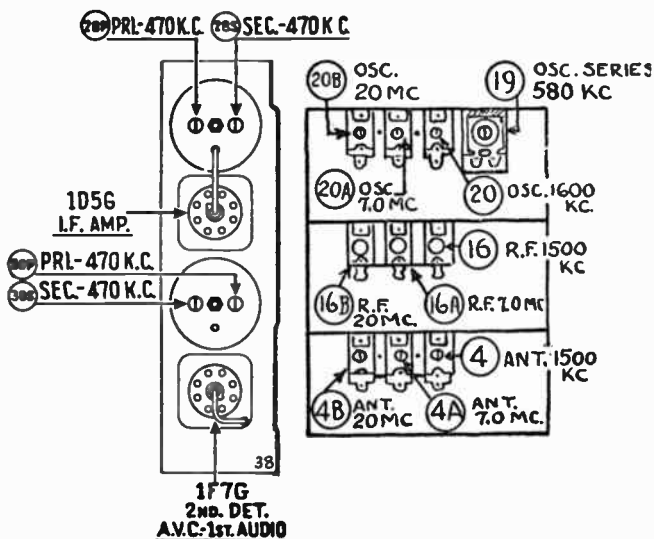

Note 1.—Dial adjustment—Turn variable condenser to maximum-capacity position. Loosen set screw of dial hub and turn dial until glowing beam indicator is centered between first and second index lines at low-frequency end of broadcast scale. Then retighten set screw.

Note 2.—Through .1 mfd. condenser.

Note 3.—Connect signal generator direct to transmission line terminals.

Note 4.—Turn clockwise to maximum-capacity position, then slowly turn back until a second peak is reached on the output meter. Adjust to maximum on this peak only. Do not use first peak which is caused by image response. On some receivers, only one peak will be observed—use this peak.

Note 5.—Advance signal-generator output to a value great enough to clearly indicate the image signal at this step.

Note 6.—Connect a variable condenser (Philco Part 245-2325) across oscillator compensator (20B) contact (first contact from left side of receiver facing rear underside of chassis) and ground. Tune this condenser so that second harmonic of receiver oscillator beats against the signal from the signal-generator giving a maximum indication on the output meter. It may be necessary to increase signal-generator output to get a readable indication. Adjust (4B) and (16B) under these conditions.

Note 7.—Remove variable condenser mentioned in note 6 above.

* While rocking.

MODEL NO. 37-630

Signal Generator Connection	Signal Generator Frequency	Dial Position	Wave Band Switch Position	Trimmer Number	Output Signal
Control grid ^{1, 2} of 6A8G	470 k.c.	550 k.c.	Range 1	37A	Max.
"	"	"	"	37	Max.
"	"	"	"	31A	Max.
"	"	"	"	31	Max.
Ant. ³	18 m.c.	18 m.c.	Range 3	23B	Max.
"	"	"	"	8B	Max.
"	"	"	"	4B	Max.
"	"	18 m.c. ⁴	"	4B	Max.
"	"	"	"	8B	Max.
"	"	18 m.c. ⁵	"	23B	Note 6
"	7.0 m.c.	7.0 m.c.	Range 2	23A	Max.
"	6.0 m.c.	6.0 m.c.	"	8A	Max.
"	"	"	"	4A	Max.
"	1600 k.c.	1600 k.c.	Range 1	23	Max.
"	"	"	"	8	Max.
"	"	"	"	4	Max.
"	600 k.c.	600 k.c.	"	21	Max.*
"	1600 k.c.	1600 k.c.	"	23	Max.
"	"	"	"	8	Max.
"	"	"	"	4	Max.
"	1500 k.c.	1500 k.c.	"	4	Max.
"	"	"	"	8	Max.

Note 1.—Dial adjustment—turn variable condenser to maximum-capacity position. Loosen set screw of dial hub and turn dial until glowing beam indicator is centered on first index line of dial scale. Then retighten set screw. (See illustration page 39)

Note 2.—Through .1 mfd. condenser.

- Note 3.—Connect signal-generator direct to transmission line terminals.
 Note 4.—Connect a vernier-drive variable-condenser (about 350 mmfd.) across oscillator section of tuning-condenser gang. Tune so that second harmonic of receiver oscillator will beat against signal from signal-generator. Adjust (4B) and (8B) under these conditions.
 Note 5.—Remove external variable condenser mentioned in note 4 above.
 Note 6.—Turn clockwise to maximum-capacity position, then back off counter clockwise until a second peak is reached on output meter. Adjust to maximum on this peak only. Do not use first peak which is caused by image response.

* While rocking.

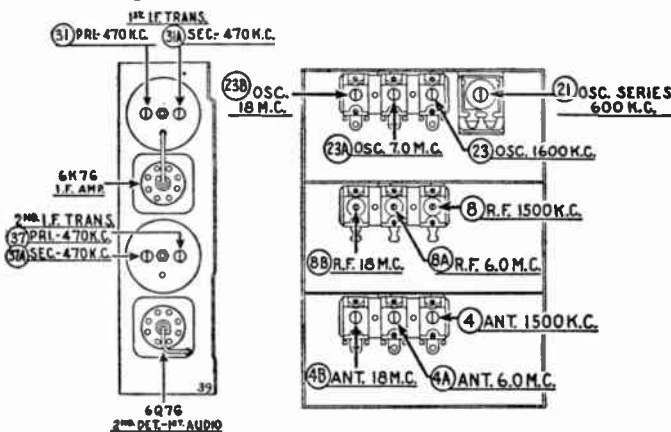

MODEL NO. 37-640

Signal Generator Connection	Signal Generator Frequency	Dial Position	Wave Band Switch Position	Trimmer Number	Output Signal
Control grid 1, 2 of 6A8G	470 k.c.	550 k.c.	Range 1 (broadcast)	34S	Max.
"	"	"	"	34P	Max.
"	"	"	"	33S	Max.
"	"	"	"	33P	Max.

(Continued on page 44)

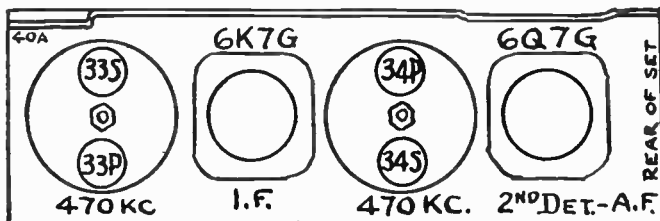

MODEL NO. 37-640 Con't.

Signal Generator Connection	Signal Generator Frequency	Dial Position	Wave Band Switch Position	Trimmer Number	Output Signal
Ant. ³	18 m.c.	18 m.c.	Range 3	23B	Max.
"	"	"	"	8B	Max.
"	"	"	"	4B	Max.
"	"	18 m.c. ⁴	"	4B	Max.
"	"	"	"	8B	Max.
"	"	18 m.c. ⁵	"	23B	Note 6
"	7.0 m.c.	7.0 m.c.	Range 2	23A	Max.
"	6.0 m.c.	6.0 m.c.	"	8A	Max.
"	"	"	"	4A	Max.
"	1600 k.c.	1600 k.c.	Range 1	23	Max.
"	"	"	"	8	Max.
"	"	"	"	4	Max.
"	600 k.c.	600 k.c.	"	21	Max.*
"	1600 k.c.	1600 k.c.	"	23	Max.
"	"	"	"	8	Max.
"	"	"	"	4	Max.
"	1500 k.c.	1500 k.c.	"	4	Max.
"	"	"	"	8	Max.

Note 1.—Dial adjustment. Turn variable condenser to maximum-capacity position. Loosen set screw of dial hub and turn dial until glowing beam indicator is centered on first index line of dial scale. Then retighten set screw.

Note 2.—Through .1 mfd. condenser.

Note 3.—Connect signal-generator direct to transmission line terminals.

Note 4.—Connect vernier-drive variable condenser (about 350 mmfd.) across oscillator section of tuning condenser. Tune so that second harmonic of receiver oscillator will beat against signal from signal-generator. Adjust (4B) and (8B) under these conditions.

Note 5.—Remove external variable condenser mentioned in note 4 above.

Note 6.—Turn clockwise to maximum-capacity position, then back off counter clockwise until a second peak is reached on output meter. Adjust to maximum on this peak only. Do not use first peak which is caused by image response.

* While rocking.

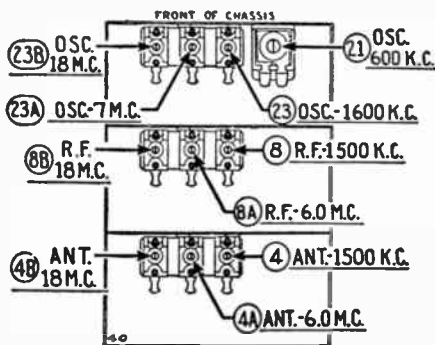

MODEL NO. 37-641 (121)

Signal Generator Connection	Signal Generator Frequency	Dial Position	Wave Band Switch Position	Trimmer Number	Output Signal
Control grid ¹ of 6A8G	470 k.c.	580 k.c.	Broadcast	38P	Max.
"	"	"	"	38S	Max
"	"	"	"	35P	Max
"	"	"	"	35S	Max
Ant. term. ² #1	18 m.c.	18 m.c.	Range 3	18B	Max. ³
"	"	17.06 m.c.	7.35-22 m.c.	"	Image check
"	"	18 m.c. ⁴	"	11B	Max.
"	"	"	"	2B	Max.
"	18 m.c. ⁵	"	"	18B	Max.
"	7 m.c.	7 m.c.	Range 2	18A	Max.
"	"	"	2.3-7.4 m.c.	"	"
"	6 m.c.	6 m.c.	"	11A	Max.
"	"	"	"	2A	Max.
"	1600 k.c.	1600 k.c.	Broadcast	18	Max.
"	"	"	"	11	Max.
"	"	"	"	2	Max.
"	580 k.c.	580 k.c.	"	20	Max.*
"	1600 k.c.	1600 k.c.	"	18	Max.
"	1500 k.c.	1500 k.c.	"	11	Max.
"	"	"	"	2	Max.

Note 1.—Through a .1 mfd. condenser.

Note 2.—Through a .1 mfd. condenser. Link terminals 2 and 3 together.

Note 3.—Use lower capacity peak.

Note 4.—Connect an external variable condenser (Philco Part No. 45-2325) from the oscillator compensator (18B) to ground. Tune the added condenser from the minimum capacity position until the second harmonic of the oscillator beats against the signal to produce maximum output.

Note 5.—Remove the external variable condenser.

* While rocking.

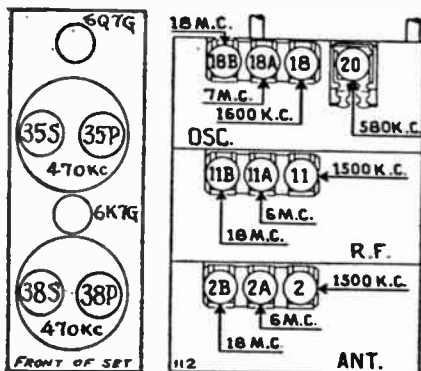

MODEL NO. 37-643

Signal Generator Connection	Signal Generator Frequency	Dial Position	Wave Band Switch Position	Trimmer Number	Output Signal
Control grid ^{1, 2} of 1C7G	470 k.c.	580 k.c.	Broadcast	34S	Max.
"	"	"	"	34P	Max.
"	"	"	"	33S	Max.
"	"	"	"	33P	Max.
Ant. term. ³ #1	18 m.c.	18 m.c.	Range 4 11.5-18.2 m.c.	25A	Max. ⁴
"	18 m.c.	17.06 m.c.	"		Image check
"	18 m.c. ⁵	18 m.c.	"	6A	Max.
"	"	"	"	16A	Max.
"	12 m.c. ⁶	12 m.c.	"	25B	Max.
"	"	"	"	16B	Max.
"	"	"	"	6B	Max.
"	18 m.c.	18 m.c.	"	25A	Max.
"	18 m.c. ⁵	"	"	6A	Max.
"	"	"	"	16A	Max.
"	11 m.c. ⁶	11 m.c.	Range 3 7.35-11.6 m.c.	25	Max.
"	11 m.c.	10.06 m.c.	"		Image check
"	11 m.c. ⁷	11 m.c.	"	16	Max.
"	"	"	"	6	Max.
"	11 m.c. ⁶	"	"	25	Max.
"	4.5 m.c.	4.5 m.c.	Range 2 4.7-7.4 m.c.	22B	Max.
"	"	"	"		
"	"	"	"	15A	Max.
"	"	"	"	5A	Max.
"	1.7 m.c.	1.7 m.c.	"	22C	Max.
"	4.5 m.c.	4.5 m.c.	"	22B	Max.
"	"	"	"	15A	Max.
"	"	"	"	5A	Max.
"	1500 k.c.	1500 k.c.	Broadcast	22	Max.
"	"	"	"	15	Max.
"	"	"	"	5	Max.
"	580 k.c.	580 k.c.	"	22A	Max.*
"	1500 k.c.	1500 k.c.	"	22	Max.
"	1400 k.c.	1400 k.c.	"	15	Max.
"	"	"	"	5	Max.

* While rocking.

Note 1.—Dial alignment: Rotate the tuning control to the extreme counter-clockwise position (maximum capacity). Loosen the set screw of the dial hub, then turn dial until glowing beam indicator is centered on the second index line of dial scale. Now tighten the dial hub set screw in this position.

Note 2.—Through a .1 mfd. condenser.

Note 3.—Through a .1 mfd. condenser. Link antenna terminals 2 and 3 together.

Note 4.—Use the lower capacity peak.

Note 5.—Connect a variable tuning condenser (Philco Part No. 45-2325) from the oscillator compensator to ground. (First lug from left side of r.f. unit.)

Note 6.—Remove the external variable condenser.

Note 7.—Connect the same external variable tuning condenser from the oscillator compensator to ground (third lug from left side of r.f. unit).

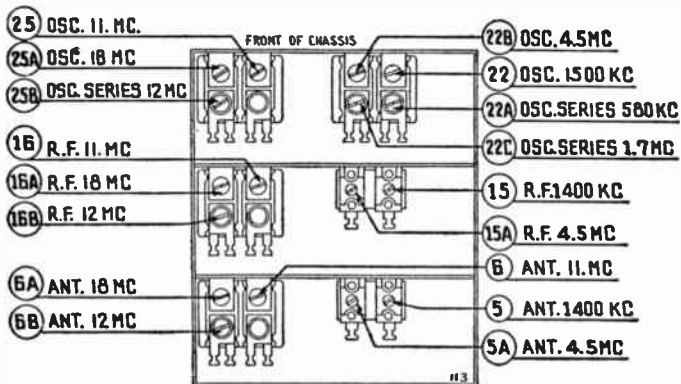
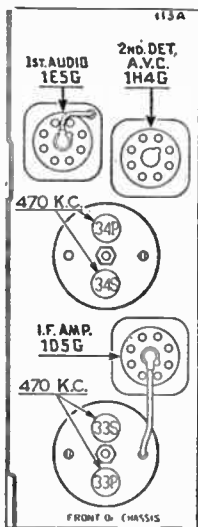
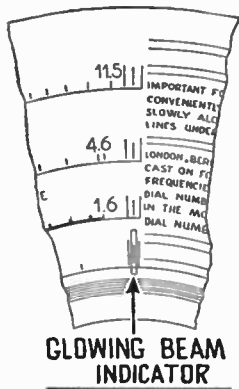

MODEL NO. 37-650

Signal Generator Connection	Signal Generator Frequency	Dial Position	Wave Band Switch Position	Trimmer Number	Output Signal
Control grid ^{1, 2} of 6A8G	470 k.c.	550 k.c.	Range 1	28S	Max.
"	"	"	"	28P	Max.
"	"	"	"	26S	Max.
"	"	"	"	26P	Max.
Ant. ³	18 m.c.	18.0 m.c.	Range 3	16D	Note 4
"	18 m.c. ⁵	17.060 m.c.	"	Image check	
"	18 m.c.	18.0 m.c. ⁶	"	4C	Max.
"	"	"	"	10C	Max.
"	"	18.0 m.c. ⁷	"	16D	Note 4
"	12 m.c.	12 m.c.	"	16E	Max.
"	"	"	"	10D	Max.
"	"	"	"	4D	Max.
"	18 m.c.	18.0 m.c.	"	16D	Note 4
"	"	18.0 m.c. ⁶	"	4C	Max.
"	"	"	"	10C	Max.
"	"	18.0 m.c. ⁷	"	16D	Note 4
"	18 m.c. ⁵	17.060 m.c.	"	Image check	
"	11 m.c.	11.0 m.c.	Range 2	16B	Note 4
"	11 m.c. ⁵	10.06 m.c.	"	Image check	
"	11 m.c.	11.0 m.c. ⁸	"	10A	Max.
"	"	"	"	4A	Max.
"	"	11.0 m.c. ⁹	"	16B	Note 4
"	6 m.c.	6 m.c.	"	16C	Max.
"	"	"	"	10B	Max.
"	"	"	"	4B	Max.
"	11 m.c.	11.0 m.c.	"	16B	Note 4
"	"	11.0 m.c. ⁸	"	10A	Max.
"	"	"	"	4A	Max.
"	"	11.0 m.c. ⁹	"	16B	Note 4
"	"	10.06 m.c.	"	Image check	
"	1600 k.c.	1600 k.c.	Range 1	16	Max.
"	"	"	"	10	Max.
"	"	"	"	4	Max.
"	580 k.c.	580 k.c.	"	16A	Max.
"	1600 k.c.	1600 k.c.	"	16	Max.
"	1500 k.c.	1500 k.c.	"	10	Max.
"	"	"	"	4	Max.

Note 1.—Dial calibration. Turn variable condenser gang to maximum-capacity position. Loosen set screw of dial hub and turn dial until glowing beam indicator is centered on second index line of dial scale. Then retighten set screw.

Note 2.—Through .1 mfd. condenser.

Note 3.—Connect signal generator direct to transmission line terminals.

Note 4.—Turn clockwise to maximum-capacity position, then slowly turn counter clockwise until a second peak is indicated on output meter. Adjust to maximum on this peak. Do not use first peak which is caused by image response.

Note 5.—Advance signal-generator output at this step to value high enough to give clear indication on output-meter.

Note 6.—Connect vernier-drive variable condenser (about 350 mmfd.) across oscillator compensator (16D) contact (first contact from left side of receiver, facing rear underside view of chassis) and ground. Tune so

that second harmonic of receiver oscillator beats against signal from signal-generator to give indication on output meter. Increase signal-generator output if necessary. Adjust (4C) and (10C) under these conditions.

Note 7.—Remove external variable-condenser mentioned in note 6 above.

Note 8.—Connect external variable condenser (same as in note 6) from (16B) contact (third contact from left side of receiver, facing rear underside view of chassis) and ground. Tune this condenser as in Note 6 and follow same procedure to adjust (10A) and (4A).

Note 9.—Remove external variable condenser mentioned in note 8 above.

* While rocking.

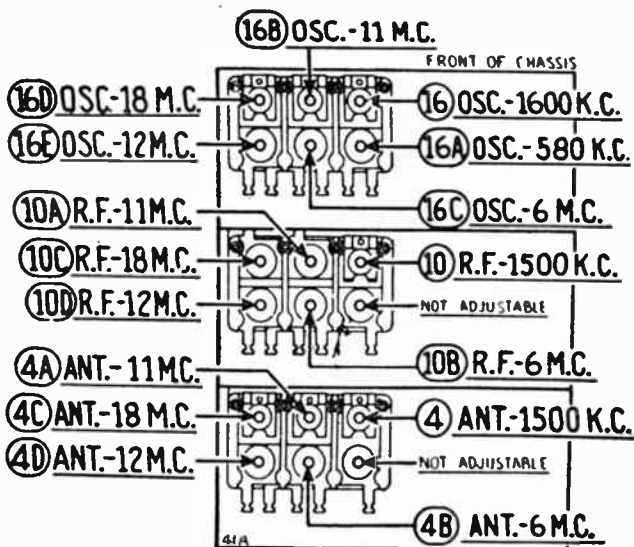
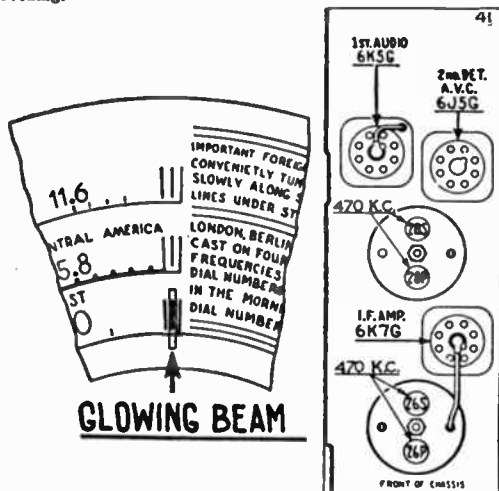

MODEL NO. 37-660

Signal Generator Connection	Signal Generator Frequency	Dial Position	Wave Band Switch Position	Trimmer Number	Output Signal
Control grid ^{1, 2} of 6A8G	470 k.c.	580 k.c.	Range 1 (broadcast)	47S	Max.
"	"	"	"	47P	Max.
"	"	"	"	32S	Max.
"	"	"	"	32P	Max.
Ant. ³	18 m.c.	18 m.c.	Range 4	31B	Note 4
"	"	17.06 m.c.	"	Image	check
"	"	18 m.c. ⁵	"	6B	Max.
"	"	"	"	17B	Max.
"	"	18 m.c. ⁶	"	31B	Note 4
"	12 m.c.	12 m.c.	"	31C	Max.
"	"	"	"	17C	Max.
"	"	"	"	6C	Max.
"	18 m.c.	18 m.c.	"	31B	Note 4
"	"	18 m.c. ⁵	"	6B	Max.
"	"	"	"	17B	Max.
"	"	18 m.c. ⁶	"	31B	Note 4
"	"	17.06 m.c.	"	Image	check
"	11 m.c.	11 m.c.	Range 3	31	Note 4
"	"	10.06 m.c.	"	Image	check
"	"	11 m.c. ⁷	"	17	Max.
"	"	"	"	6	Max.
"	"	11 m.c. ⁶	Range 3	31	Note 4
"	7.5 m.c.	7.5 m.c.	"	31A	Max.
"	"	"	"	17A	Max.
"	"	"	"	6A	Max.
"	11 m.c.	11 m.c.	"	31	Note 4
"	"	11 m.c. ⁷	"	17	Max.
"	"	"	"	6	Max.
"	"	11 m.c. ⁶	"	31	Note 4
"	"	10.06 m.c.	"	Image	check
"	7.0 m.c.	7.0 m.c.	Range 2	30B	Max.
"	"	"	"	16A	Max.
"	"	"	"	5A	Max.
"	2.5 m.c.	2.5 m.c.	"	30C	Max.*
"	7.0 m.c.	7.0 m.c.	"	30B	Max.
"	6.0 m.c.	6.0 m.c.	"	16A	Max.
"	"	"	"	5A	Max.
"	1600 k.c.	1600 k.c.	Range 1	30	Max.
"	"	"	"	16	Max.
"	"	"	"	5	Max.
"	580 k.c.	580 k.c.	"	30A	Max.*
"	1600 k.c.	1600 k.c.	"	30	Max.
"	1500 k.c.	1500 k.c.	"	16	Max.
"	"	"	"	5	Max.

Note 1.—Dial calibration. Turn variable condenser gang to maximum-capacity position. Loosen set screw of dial hub and turn dial until glowing beam indicator is centered between first and second index lines of dial scale. Then retighten set screw.

Note 2.—Through .1 mfd. condenser.

Note 3.—Connect signal generator direct to transmission line terminals.

Note 4.—Turn clockwise to maximum capacity position, then slowly turn counter clockwise until a second peak is indicated on output meter. Adjust to maximum on this peak. Do not use first peak which is caused by image response. If only one peak can be observed on some receivers, adjust on that peak.

Note 5.—Connect vernier-drive variable condenser (about 350 mmfd.) across oscillator compensator (31B) contact (first contact from left side of receiver, facing rear underside view of chassis) and ground. Tune the external condenser so that second harmonic of receiver oscillator beats against signal from signal-generator. Adjust (6B) and (17B) under these conditions.

Note 6.—Remove external variable condenser.

Note 7.—Connect external variable-condenser (same as in Note 5) from (31) contact (third contact from left side of receiver, facing rear underside view of chassis) and ground. Tune this condenser as in Note 5 and follow same procedure to adjust (17) and (6).

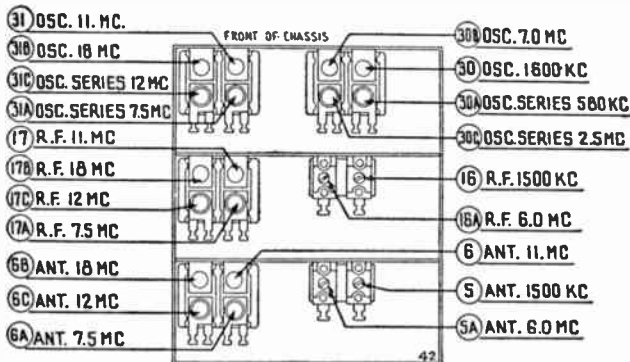
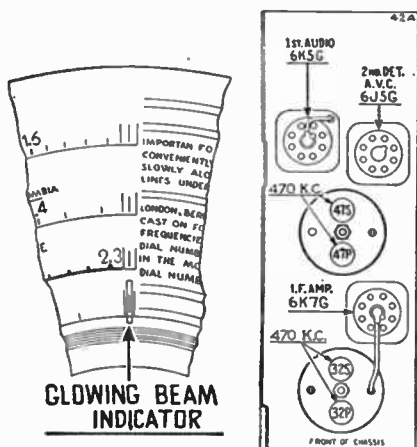

MODEL NO. 37-665

Signal Generator Connection	Signal Generator Frequency	Dial Position	Wave Band Switch Position	Trimmer Number	Output Signal
Control grid ^{1, 2} of 6A8G	470 k.c.	580 k.c.	Broadcast	39P	Max.
"	"	"	"	39S	Max.
"	"	"	"	40P	Max.
"	"	"	"	40S	Max.
Ant. term. ³ #1	13 m.c.	39 m.c.	Range 4 28-42 m.c.	23	Max. ⁴
"	"	38.06 m.c.	"		Image check
"	"	39 m.c.	"	9	Max.*
"	"	26 m.c.	"	23A	Max.
"	"	"	"	9A	Max.
"	"	39 m.c.	"	23	Max. ⁴
"	"	"	"	9	Max.*
"	18 m.c.	18 m.c.	Range 3 7.35-22 m.c.	23B	Max.
"	"	17.06 m.c.	"		Image check
"	18 m.c. ⁵	18 m.c.	"	9B	Max.
"	"	"	"	4B	Max.
"	7 m.c.	7 m.c.	Range 2 2.3-7.4 m.c.	29	Max.
"	"	"	"	18A	Max.
"	"	"	"	4A	Max.
"	2.35 m.c.	2.35 m.c.	"	29A	Max.
"	7 m.c.	7 m.c.	"	29	Max.
"	6 m.c.	6 m.c.	"	18A	Max.
"	"	"	"	4A	Max.
"	1600 k.c.	1600 k.c.	Broadcast	29B	Max.
"	"	"	"	18	Max.
"	"	"	"	4	Max.
"	580 k.c.	580 k.c.	"	29C	Max.*
"	1600 k.c.	1600 k.c.	"	29B	Max.
"	1500 k.c.	1500 k.c.	"	18	Max.
"	"	"	"	4	Max.

Note 1.—Dial calibration: Rotate the tuning control to the extreme counter-clockwise position (maximum capacity). Loosen the set screw of the dial hub, then turn the dial until the glowing indicator is centered on the middle index line of dial scale. Now tighten the set screw in this position.

Note 2.—Through a .1 mfd. condenser.

Note 3.—Link terminals 2 and 3 together.

Note 4.—Use the lower capacity peak.

Note 5.—Connect an external variable condenser (Philco Part No. 43-2325) from the oscillator compensator (23B) to ground. Tune the added condenser from the maximum capacity position until the second harmonic of the oscillator beats against the signal to produce maximum output.

Note 6.—Remove the external variable condenser.

* While rocking.

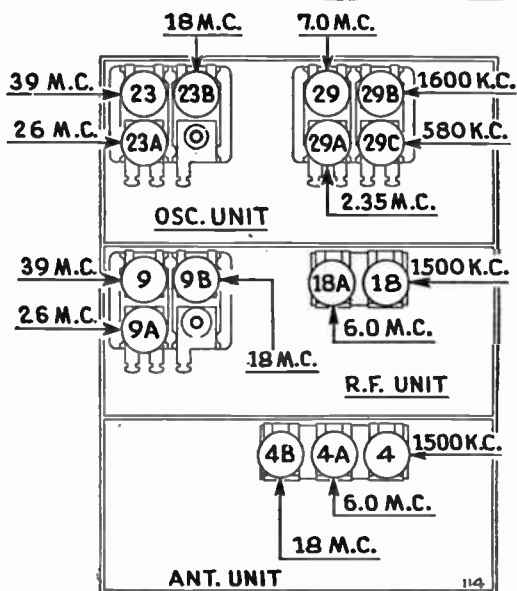
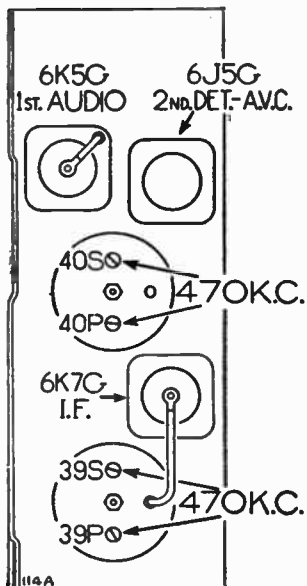
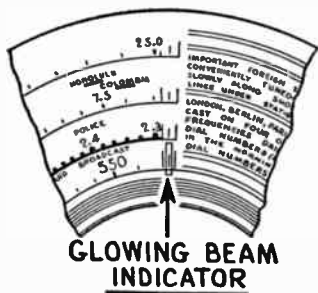

MODEL NO. 37-670

Signal Generator Connection	Signal Generator Frequency	Dial Position	Wave Band Switch Position	Trimmer Number	Output Signal
Control grid ^{1, 2} of 6A8G	470 k.c.	580 k.c.	Range 1 (broadcast)	42S	Max.
"	"	"	"	42P	Max.
"	"	"	"	41S	Max.
"	"	"	"	41P	Max.
Ant. ³	18 m.c.	18 m.c.	Range 5	29D	Note 4
"	"	17.06 m.c.	"	Image check	
"	"	18 m.c. ⁵	"	7D	Max.
"	"	"	"	19D	Max.
"	"	18 m.c. ⁶	"	29D	Note 4
"	12 m.c.	12 m.c.	"	29E	Max.
"	"	"	"	19E	Max.
"	"	"	"	7E	Max.
"	18 m.c.	18 m.c.	"	29D	Note 4
"	"	18 m.c. ⁵	"	7D	Max.
"	"	"	"	19D	Max.
"	"	18 m.c. ⁶	"	29D	Note 4
"	"	17.06 m.c.	"	Image check	
"	11 m.c.	11 m.c.	Range 4	29B	Note 4
"	"	10.06 m.c.	"	Image check	
"	"	11 m.c. ⁷	"	19B	Max.
"	"	"	"	7B	Max.
"	"	11 m.c. ⁶	"	29B	Max.
"	7.5 m.c.	7.5 m.c.	"	29C	Max.
"	"	"	"	19C	Max.
"	"	"	"	7C	Max.
"	11 m.c.	11 m.c.	"	29B	Note 4
"	"	11 m.c. ⁷	"	19C	Max.
"	"	"	"	7C	Max.
"	"	11 m.c. ⁶	"	29B	Note 4
"	"	10.06 m.c.	"	Image check	
"	7.0 m.c.	7.0 m.c.	Range 3	29	Max.
"	"	"	"	19	Max.
"	"	"	"	7	Max.
"	5.0 m.c.	5.0 m.c.	"	29A	Max.
"	"	"	"	19A	Max.
"	"	"	"	7A	Max.
"	7.0 m.c.	7.0 m.c.	"	29	Max.
"	"	"	"	19	Max.
"	"	"	"	7	Max.
"	4.5 m.c.	4.5 m.c.	Range 2	27B	Max.
"	"	"	"	18A	Max.
"	"	"	"	6A	Max.
"	1.7 m.c.	1.7 m.c.	"	27C	Max.*
"	4.5 m.c.	4.5 m.c.	"	27B	Max.
"	"	"	"	18A	Max.
"	"	"	"	6A	Max.
"	1500 k.c.	1500 k.c.	Range 1	27	Max.
"	"	"	"	18	Max.
"	"	"	"	6	Max.
"	580 k.c.	580 k.c.	"	27A	Max.*
"	1500 k.c.	1500 k.c.	"	27	Max.
"	1400 k.c.	1400 k.c.	"	18	Max.
"	"	"	"	6	Max.

Note 1.—Dial calibration. Turn variable condenser gang to maximum-capacity position. Loosen set screw of dial hub and turn dial until glowing beam indicator is centered on second index line of dial scale. Then retighten set screw.

Note 2.—Through .1 mfd. condenser.

Note 3.—Connect signal generator direct to transmission line terminals.

Note 4.—Turn clockwise to maximum capacity position, then slowly turn counter clockwise until a second peak is indicated on output meter. Adjust to maximum on this peak. Do not use first peak which is caused by image response. If only one peak can be observed on some receivers, adjust on that peak.

Note 5.—Connect a variable condenser (about 350 mmfd. such as Philco Part 245-2325) across oscillator compensator (29D) contact (first contact from left side of receiver, facing rear underside of chassis) and ground. Tune the external condenser so that second harmonic of receiver oscillator beats against signal from signal generator. Adjust (7D) and (19D) under these conditions.

Note 6.—Remove external variable condenser.

Note 7.—Connect external variable condenser (same as in note 5) from oscillator compensator (29B) (third contact from left side of receiver) to ground. Tune this condenser as in note 5 and follow same procedure to adjust (19B) and (7B).

* While rocking.

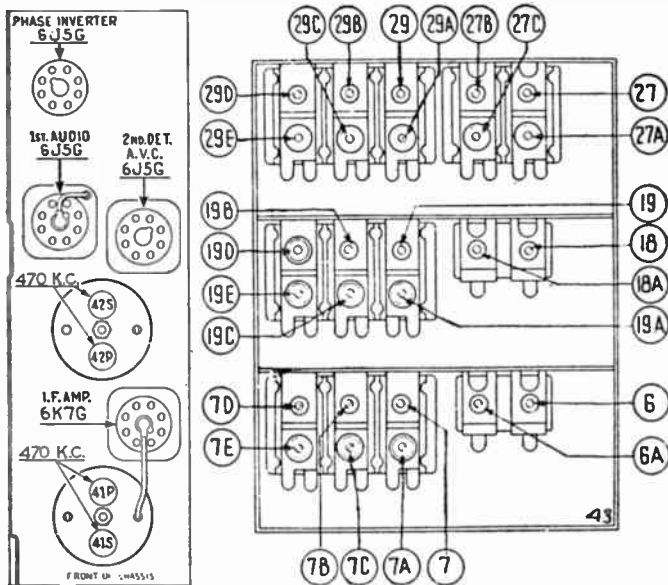

MODEL NO. 37-675 (121, 122)

Signal Generator Connection	Signal Generator Frequency	Dial Position	Wave Band Switch Position	Trimmer Number	Output Signal
Control grid ^{1,2} of 2nd i.f. 6K7G	470 k.c.	580 k.c.	Range 1 Broadcast	84P	Max.
Control grid ² of 1st i.f. 6K7G	"	"	"	69T	Note 3
"	"	"	"	68	Max.
"	"	"	"	69S	Max.
"	"	"	"	69T	Max.
Control grid ² of 6L7G	"	"	"	64P	Max.
"	"	"	"	64S	Max.
Ant. ⁴	18 m.c.	18 m.c. ⁵	Range 5	44D	Note 6
"	"	17.06 m.c.	"	Image check	
"	"	18 m.c. ⁷	"	7D	Max.
"	"	"	"	25D	Max.
"	"	18 m.c. ⁸	"	44D	Note 6
"	12 m.c.	12 m.c.	"	44E	Max.
"	"	"	"	25E	Max.
"	"	"	"	7E	Max.
"	18 m.c.	18 m.c.	"	44D	Note 6
"	"	18 m.c. ⁷	"	7D	Max.
"	"	"	"	25D	Max.
"	"	18 m.c. ⁸	"	44D	Note 6
"	"	17.06 m.c.	"	Image check	
"	11.0 m.c.	11.0 m.c.	Range 4	44B	Max.
"	"	10.06 m.c.	"	Image check	
"	"	11.0 m.c. ⁹	"	7B	Max.
"	"	"	"	25B	Max.
"	"	11.0 m.c. ⁸	"	44B	Max.
"	7.5 m.c.	7.5 m.c.	"	44C	Max.
"	"	"	"	25C	Max.
"	"	"	"	7C	Max.
"	11.0 m.c.	11.0 m.c.	"	44B	Max.
"	"	10.06 m.c.	"	Image check	
"	"	11.0 m.c. ⁹	"	7B	Max.
"	"	"	"	25B	Max.
"	"	11.0 m.c. ⁸	"	44B	Max.

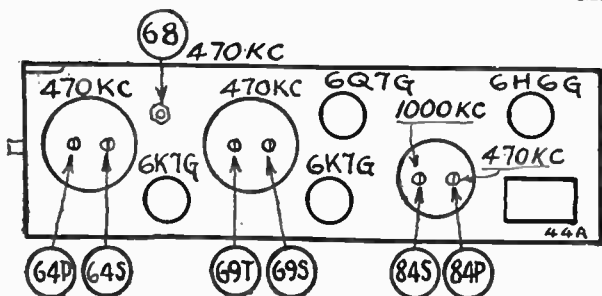

MODEL 37-675 (121, 122) Cont.

Signal Generator Connection	Signal Generator Frequency	Dial Position	Wave Band Switch Position	Trimmer Number	Output Signal
Ant. ⁴	7.0 m.c.	7.0 m.c.	Range 3	44	Max.
"	"	"	"	25	Max.
"	"	"	"	7	Max.
"	5.0 m.c.	5.0 m.c.	"	44A	Max.
"	"	"	"	25A	Max.
"	"	"	"	7A	Max.
"	7.0 m.c.	7.0 m.c.	"	44	Max.
"	"	"	"	25	Max.
"	"	"	"	7	Max.
"	4.5 m.c.	4.5 m.c.	Range 2	42B	Max.
"	"	"	"	24A	Max.
"	"	"	"	6A	Max.
"	1.7 m.c.	1.7 m.c.	"	42C	Max.*
"	4.5 m.c.	4.5 m.c.	"	42B	Max.
"	"	"	"	24A	Max.
"	"	"	"	6A	Max.
"	1500 k.c.	1500 k.c.	Range 1	42	Max.
"	"	"	"	24	Max.
"	"	"	"	6	Max.
"	580 k.c.	580 k.c.	"	42A	Max.*
"	1500 k.c.	1500 k.c.	"	42	Max.
"	1400 k.c.	1400 k.c.	"	24	Max.
"	"	"	"	6	Max.
"	1000 k.c.	Note 10	"	84S	Max. ¹¹
"	"	Note 12	"

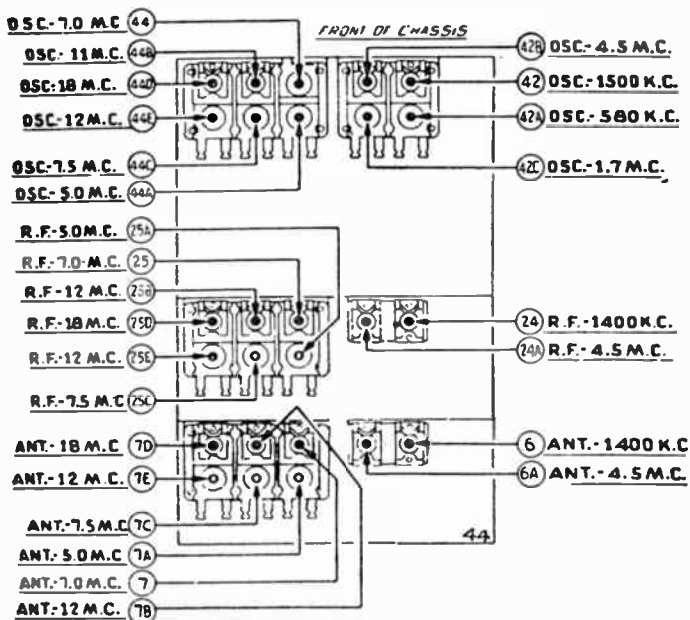

- Note 1.—Allow the receiver to heat for at least 15 minutes before adjusting compensators. Dial scale adjustment: Loosen set screws on shaft coupling of tuning condenser, and turn until plates are in maximum-capacity position. Set glowing beam indicator on index line at low-frequency end of broadcast band, and tighten set screws. Turn tuning-condenser control until indicator is on first division from index line, and again loosen set screws on shaft-coupling. Without disturbing position of variable-condenser plates, turn dial until indicator is again on index line and retighten set screws in this position. Set receiver volume control at maximum position; tone control counter clockwise; magnetic-tuning switch "off" (counter clockwise); bass-compensation switch on first tap from "off" position.
- Note 2.—Through .1 mfd. condenser.
- Note 3.—Turn clockwise until tight before adjusting (68) and (69S).
- Note 4.—Connect signal generator direct to transmission line terminals.
- Note 5.—Set magnetic-tuning control in the "off" position.
- Note 6.—Turn clockwise to maximum-capacity position, then slowly counter clockwise until output meter indicates a second peak. Adjust to maximum on this peak. Do not use first peak (due to image-frequency response). If only one peak can be observed on some receivers, adjust on that peak.
- Note 7.—Connect a variable condenser (such as Philco Part #45 2325) across oscillator compensator 44D contact (first contact from side of receiver, facing rear underside view of chassis) and ground. Tune this condenser until second harmonic of receiver oscillator beats against the signal from the signal-generator to give a maximum indication on the output meter. Adjust (7D) and (25D) under these conditions.
- Note 8.—Remove external variable condenser.
- Note 9.—Connect external variable-condenser (same as in Note 7) across oscillator-compensator (44B) contact (third contact from left side of receiver, facing rear underside view of chassis) and ground. Tune this condenser as in Note 7, and follow same procedure to adjust (7B) and (25B).
- Note 10.—Set magnetic-tuning switch in "off" position. For adjustment of magnetic-tuning control, carefully tune receiver at 1000 k.c. for maximum indication on output meter. Adjust signal-generator output to a high level.
- Note 11.—Turn magnetic-tuning control to "on" position (clockwise) before adjusting (84S).
- Note 12.—To check adjustment, turn magnetic-tuning control to "off." When this is done, there should be no change in tone of the receiver signal. If either a change of tone, or a hiss develops, it indicates a frequency shift and readjustment is necessary.
- * While rocking.

MODEL NO. 37-690

Signal Generator Connection	Signal Generator Frequency	Dial Position	Wave Band Switch Position	Trimmer Number	Output Signal
Control grid of 2nd i.f.	470 k.c.	580 k.c. ¹	Range 1 Broadcast	94S	Max.
"	"	"	"	94P	Max.
Control grid of 1st i.f.	"	"	"	85S	Max.
"	"	"	"	85P	Max.
"	"	"	"	81S	Max.
"	"	"	"	81P	Max.
Control grid of 1st det.	"	"	"	73S	Max.
"	"	"	"	73P	Max.
"	"	"	"	94S	Max.
"	"	"	"	94P	Max.
"	Note 2, 3	580 k.c.	"	94P	Note 3
"	470 k.c.	580 k.c. ⁴	"	119P	Min.
Ant. ⁵	1500 k.c.	1500 k.c.	"	35	Max.
"	"	"	"	51	Max.
"	"	"	"	2	Max.
"	580 k.c.	580 k.c.	"	35A	Max.*
"	1500 k.c.	1500 k.c.	"	35	Max.
"	1400 k.c.	1400 k.c.	"	51	Max.
"	"	"	"	2	Max.
"	7.0 m.c.	7.0 m.c.	Range 3	28	Max.
"	5.0 m.c.	5.0 m.c.	"	28A	Max.
"	7.0 m.c.	7.0 m.c.	"	28	Max.
"	"	"	"	15	Max.
"	"	"	"	5	Max.
"	5.0 m.c.	5.0 m.c.	"	28A	Max.
"	"	"	"	15A	Max.
"	"	"	"	5A	Max.
"	7.0 m.c.	7.0 m.c.	"	28	Max.
"	"	"	"	15	Max.
"	"	"	"	5	Max.

(Continued on page 60)

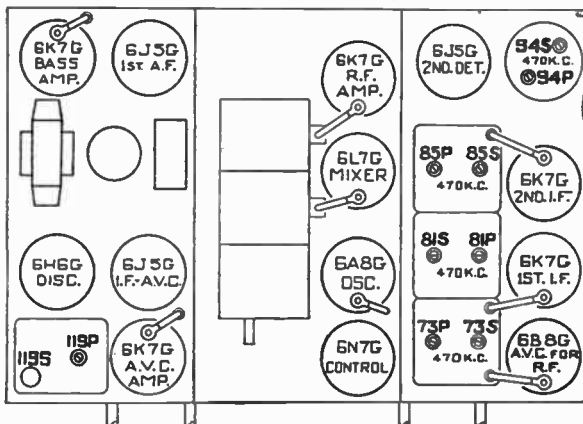

MODEL NO. 37-690 Cont.

Signal Generator Connection	Signal Generator Frequency	Dial Position	Wave Band Switch Position	Trimmer Number	Output Signal
Ant. ⁵	11.0 m.c.	11.0 m.c.	Range 4	28B	Max.
"	7.5 m.c.	7.5 m.c.	"	28C	Max.
"	11.0 m.c.	11.0 m.c.	"	28B	Max.
"	"	11.0 m.c. ⁶	"	15B	Max.
"	"	"	"	5B	Max.
"	7.5 m.c.	7.5 m.c. ⁷	"	28C	Max.
"	"	"	"	15C	Max.
"	"	"	"	5C	Max.
"	11.0 m.c.	11.0 m.c. ⁸	"	15B	Max.
"	"	"	"	5B	Max.
"	4.5 m.c.	4.5 m.c. ⁷	Range 2	35B	Max.
"	"	"	"	51A	Max.
"	"	"	"	2A	Max.
"	1.7 m.c.	1.7 m.c.	"	35C	Max.*
"	4.5 m.c.	4.5 m.c.	"	35B	Max.
"	"	"	"	51A	Max.
"	"	"	"	2A	Max.
"	18.0 m.c.	18.0 m.c.	Range 5	28D	Note 8
"	"	17.06 m.c.	"	Image	check
"	12.0 m.c.	12.0 m.c.	"	28E	Max.
"	18.0 m.c.	18.0 m.c.	"	28D	Max.
"	"	18.0 m.c. ⁹	"	15D	Max.
"	"	"	"	5D	Max.
"	12.0 m.c.	12.0 m.c. ⁷	"	28E	Max.
"	"	"	"	15E	Max.
"	"	"	"	5E	Max.
"	18.0 m.c.	18.0 m.c.	"	28D	Note 8
"	"	17.06 m.c.	"	Image	check
"	"	18.0 m.c. ⁹	"	15D	Max.
"	"	"	"	5D	Max. ⁷
"	Note 10	Note 11	Range 1	119S	Max. ¹²
Note 13	10,000 cycles	Min.

Note 1.—Adjust hum control for minimum hum with volume control counter clockwise. Then set selectivity-fidelity control clockwise; bass-amplifier control at minimum (counter clockwise), volume control full clockwise; magnetic-tuning control "off."

Note 2.—Set fidelity-control in expanded position.

Note 3.—Definite peak indications (on output meter) will appear when signal-generator output passes through 465 k.c. and 475 k.c. If both are not the same, slight readjustment of (94P) will equalize them.

Note 4.—Turn fidelity-selectivity control clockwise (selective position).

Note 5.—Connect signal generator direct to transmission line terminals.

Note 6.—Connect a variable-condenser (such as Philco 345-2325) from oscillator compensator (28B) (third contact from left, rear underside view of r.f. unit) and ground. Tune this condenser until second harmonic of receiver oscillator beats against signal from signal-generator to give maximum indication on output meter. Adjust (15B) and (5B) under these conditions.

Note 7.—Remove external variable condenser.

- Note 8.—Turn clockwise to maximum-capacity position, then slowly counter clockwise until output meter indicates a second peak. Adjust to maximum on this peak. Do not use first peak (caused by image response).
- Note 9.—Connect external variable condenser (same as in note 6) across oscillator compensator (28D) (first contact from left, rear underside view of r.f. unit) and ground. Tune this condenser as in Note 6, and follow same procedure to adjust (15D) and (5D).
- Note 10.—Set signal-generator output to any frequency in the broadcast band and tune receiver accurately to this same frequency.
- Note 11.—Set magnetic-tuning control to "on" position (clockwise) before adjusting (119S).
- Note 12.—To check adjustment, turn magnetic-tuning control "off" and "on." There should be no change in tone of received signal. If change of tone or hiss develops, it indicates frequency shift, and readjustment is necessary.
- Note 13.—Reset 10 k.c. filter adjustment only if tampered with or parts are changed. Use an accurately calibrated audio oscillator. Connect the high side of the audio oscillator to the variable tap on the volume control and adjust the compensator for minimum output.

* While rocking.

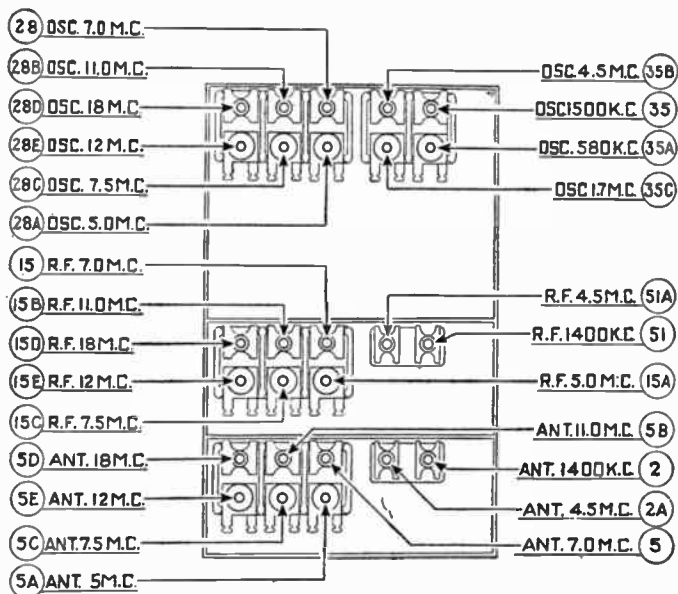

MODEL NO. 37-2620

Signal Generator Connection	Signal Generator Frequency	Dial Position	Wave Band Switch Position	Trimmer Number	Output Signal
Control grid ¹ of 6A8G	470 k.c.	580 k.c.	Broadcast	37A	Max.
"	"	"	"	37	Max.
"	"	"	"	31A	Max.
"	"	"	"	31	Max.
Ant. term. ² #1	18 m.c.	18 m.c.	Range 3 5.7-18 m.c.	23B	Max. ³
"	"	17.06 m.c.	"	Image check	
"	18 m.c. ⁴	18 m.c.	"	8B	Max.
"	"	"	"	4B	Max.
"	18 m.c. ⁵	"	"	23B	Max.
"	1600 k.c.	1600 k.c.	Broadcast	23A	Max.
"	"	"	"	8A	Max.
"	"	"	"	4A	Max.
"	580 k.c.	580 k.c.	"	25	Max.*
"	1600 k.c.	1600 k.c.	"	23A	Max.
"	"	"	"	8A	Max.
"	"	"	"	4A	Max.
"	1500 k.c.	1500 k.c.	"	8A	Max.
"	"	"	"	4A	Max.
Ant. term. ⁶ #1	300 k.c.	300 k.c.	Range 1 150-350 k.c.	23	Max.
"	"	"	"	8	Max.
"	"	"	"	4	Max.
"	160 k.c.	160 k.c.	"	21	Max.*
"	300 k.c.	300 k.c.	"	23	Max.
"	"	"	"	8	Max.
"	"	"	"	4	Max.
"	160 k.c.	160 k.c.	"	21	Max.*
"	300 k.c.	300 k.c.	"	23	Max.
"	"	"	"	8	Max.
"	"	"	"	4	Max.

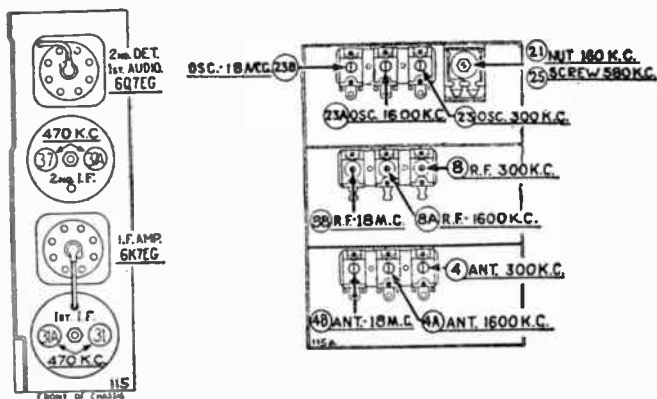

Note 1.—Through a .1 mfd. condenser.

Note 2.—Link terminals 2 and 3 together.

Note 3.—Use lower capacity peak.

Note 4.—Connect an external variable condenser. (Philco Part No. 45-2325) from the oscillator compensator to ground (First contact from left rear underside view of r.f. unit). Tune the added condenser from the minimum capacity position until the second harmonic of the oscillator beats against the signal to produce maximum output.

Note 5.—Remove the external variable condenser.

Note 6.—Through a 250 mmfd. condenser.

* While rocking.

MODEL NOS. 38, 38A, (121, 122, 123)

Signal Generator Connection	Signal Generator Frequency	Dial Position	Wave Band Switch Position	Trimmer Number	Output Signal
Remove grid clip from det.-osc.					
Control grid of det.-osc.	460 k.c.	55	Broadcast (left)	4	Max.
"	"	"	"	3	Max.
"	"	"	"	2	Max.
"	"	"	"	1	Max.
Connect grid clip to det.-osc.					
Ant. ²	1500 k.c.	150	"	6	Max.
"	"	"	"	5	Max.
"	600 k.c.	60	"	7	Max.
"	2000 k.c.	2.0	Police (right)	8 ¹	Max.
"	1500 k.c.	1.5	"	9 ¹	Max.

Note 1.—(8) and (9) are reached through holes from top of chassis gang.

Note 2.—Connect a 200-mmfd. condenser between the signal generator and the antenna post of set, at the antenna post.

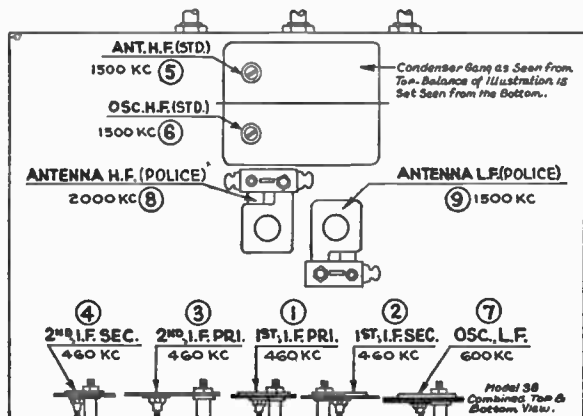

MODEL NOS. 39, 39A

Signal Generator Connection	Signal Generator Frequency	Dial Position	Wave Band Switch Position	Trimmer Number	Output Signal
Remove grid clip from 1C6					
Control grid of 1C6	460 k.c.	55	Broadcast (left)	4 ¹	Max.
"	"	"	"	3 ²	Max.
"	"	"	"	2 ¹	Max.
"	"	"	"	1 ²	Max.
Connect grid clip to 1C6					
Ant.*	"	"	"	5	Min.
"	1500 k.c.	150	"	7	Max.
"	"	"	"	6	Max.
"	600 k.c.	60	"	8	Max.
"	15 m.c.	15 m.c.	Short wave (right)	9 ²	Max.
"	7 m.c.	7 m.c.	"	10	Max.

Note 1.—Nut adjustment.

Note 2.—Screw adjustment.

Note 3.—Reached from underneath chassis.

* Use a 200-mmf. condenser as dummy antenna for broadcast band and a 400-ohm carbon resistor for the shortwave band.

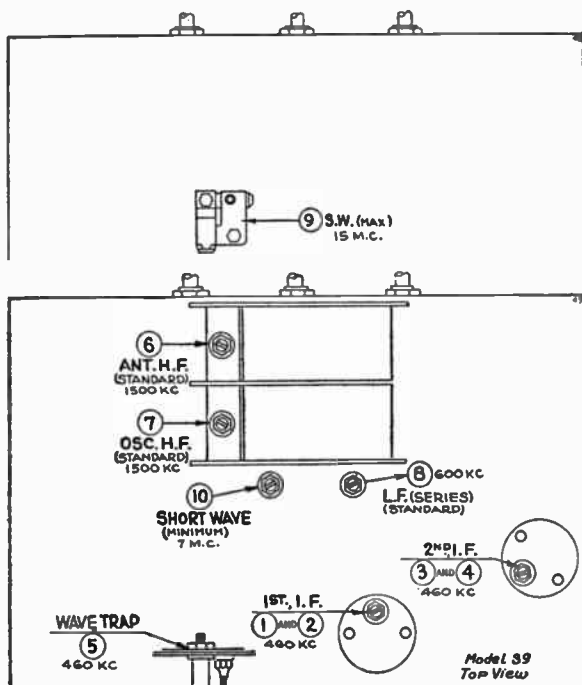

MODEL NOS. 43, 25

Signal Generator Connection	Signal Generator Frequency	Dial Position	Wave Band Switch Position	Trimmer Number	Output Signal
Remove grid clip from 1st det.					
Control grid of 1st det.	460 k.c.	550 k.c.	Broadcast	1	Max.
"	"	"	"	2	Max.
"	"	"	"	3	Max.
"	"	"	"	4	Max.
"	"	"	"	5	Max.
"	"	"	"	6	Max.
Connect grid clip to 1st det.					
Ant.*	"	"	"	7	Min.
"	700 k.c.	700 k.c.	"	8	Max.
"	1400 k.c.	1400 k.c.	"	9	Max.
"	"	1400 k.c.	Short Wave	10	Max.

* Use a 200-mmf. condenser as dummy antenna on broadcast band and a 400-ohm carbon resistor on shortwave band.

Note: Never attempt readjustment of other compensating condensers in shortwave range. These are of special construction and will never require such readjustment.

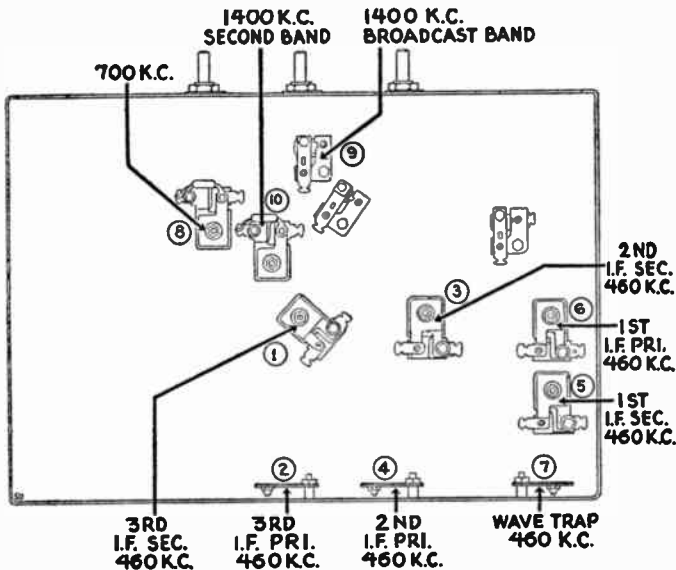

MODEL NOS. 44, 504

Signal Generator Connection	Signal Generator Frequency	Dial Position	Wave Band Switch Position	Trimmer Number	Output Signal
Remove grid clip from 6A7					
Control grid of 6A7	460 k.c.	520 k.c.	Range 1	7 ¹	Max.
"	"	"	"	8 ²	Max.
"	"	"	"	9 ¹	Max.
"	"	"	"	10 ²	Max.
"	"	"	"	11	Max.
"	"	"	"	12	Max.
Connect grid clip to 6A7					
Ant.*	"	"	"	13	Min.
"	20 m.c.	20 m.c.	Range 4	1	Max.
"	10.8 m.c.	10.8 m.c.	Range 3	2	Max.
"	3.6 m.c.	3.6 m.c.	Range 2	3	Max.
"	1500 k.c.	1.5 m.c.	"	4	Max.
"	1400 k.c.	1400 k.c.	Range 1	5	Max.
"	520 k.c.	520 k.c.	"	6	Max.

* Use a 200-mmf. condenser as dummy antenna on broadcast band and a 400-ohm carbon resistor on shortwave band.

Note 1.—Nut adjustment.

Note 2.—Screw adjustment.

Caution: The two trimmers on the rear sections of the tuning condenser gang are correctly adjusted and sealed at the factory. Do not change this adjustment.

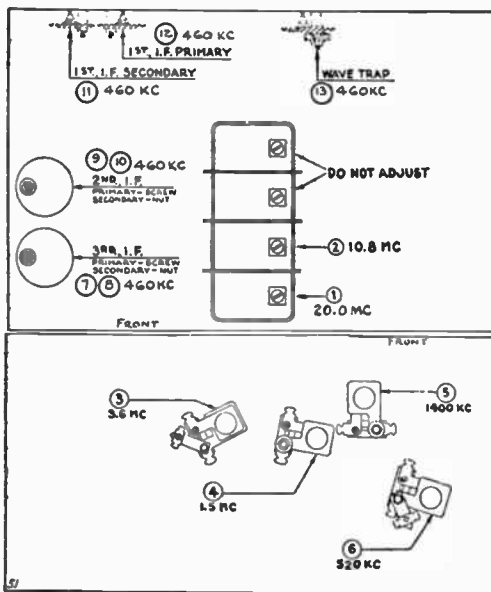

MODEL NO. 45

Signal Generator Connection	Signal Generator Frequency	Dial Position	Wave Band Switch Position	Trimmer Number	Output Signal
Remove grid clip from 6A7					
Control grid of 6A7	460 k.c.	540 k.c.	Broadcast (left)	1 ¹	Max.
"	"	"	"	2 ²	Max.
"	"	"	"	3 ¹	Max.
"	"	"	"	4 ²	Max.
"	"	"	"	5 ¹	Max.
"	"	"	"	6 ²	Max.
Connect grid clip to 6A7					
Ant.*	"	540 k.c.	"	7	Min.
"	1500 k.c.	1500 k.c.	"	8	Max.
"	"	"	"	9	Max.
"	600 k.c.	600 k.c.	"	10 ³	Max.

* Use a 200-mmf. condenser as dummy antenna on broadcast band and a 400-ohm resistor on the shortwave band.

Note 1.—Nut adjustment.

Note 2.—Screw adjustment.

Note 3.—(10) is reached through hole from top of chassis, between the two electrolytic condensers (left hand end of chassis when facing rear).

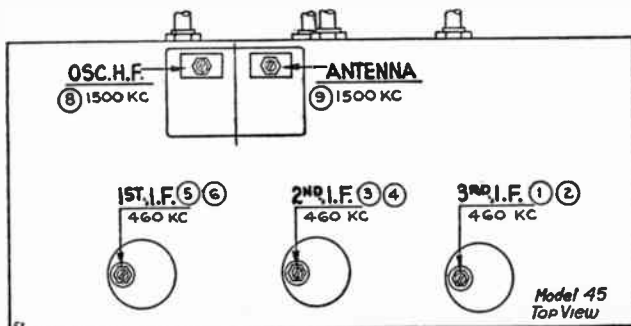
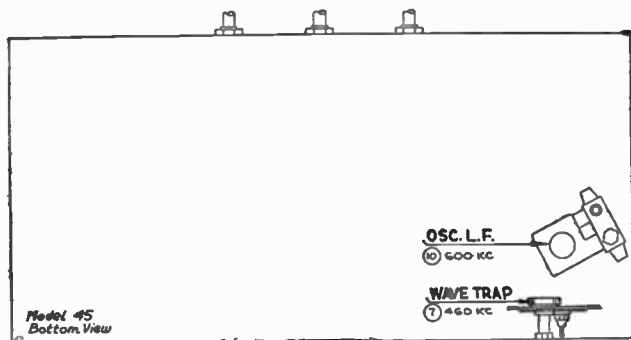

MODEL NO. 47

Signal Generator Connection	Signal Generator Frequency	Dial Position	Wave Band Switch Position	Trimmer Number	Output Signal
Remove grid clip from det.-osc.					
Control grid of det.-osc.	260 k.c.	60	...	1 ¹	Max.
"	"	"	...	2 ¹	Max.
"	"	"	...	3 ¹	Max.
"	"	"	...	4 ¹	Max.
Connect grid clip to det.-osc.					
Ant.*	1400 k.c.	140	...	5	Max.
"	"	"	...	6	Max.
"	"	"	...	7	Max.
"	600 k.c.	60	...	8 ²	Max.**
"	1400 k.c.	140	...	5	Max.

Note 1.—Accessible through holes in rear of chassis.

Note 2.—Accessible through hole from top of chassis.

* Connect a 200-mmf. condenser between signal generator and antenna post of set, at the antenna post.

** Adjust while rocking.

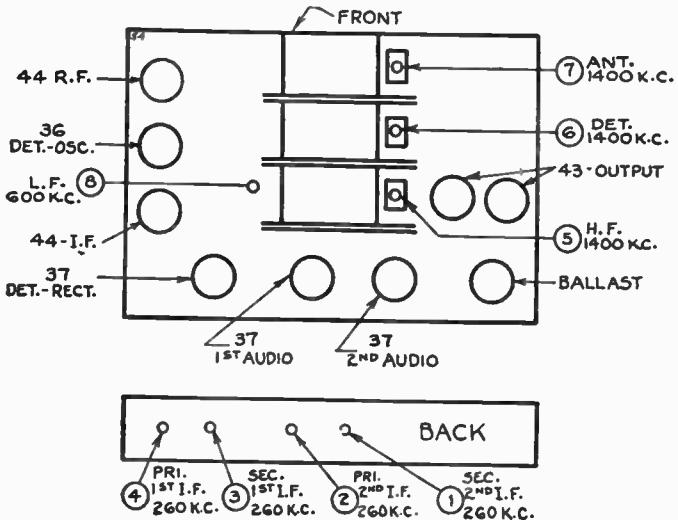

MODEL NO. 48

Signal Generator Connection	Signal Generator Frequency	Dial Position	Trimmer Number	Output Signal
Remove grid clip from det.-osc.				
Control grid of det.-osc.	175 k.c.	60	1	Max.
"	"	"	2	Max.
"	"	"	3	Max.
Connect grid clip to det.-osc.				
Ant.*	1400 k.c.	140	4	Max.
"	"	"	5	Max.
"	"	"	6	Max.
"	600 k.c.	60	7	Max.
"	1400 k.c.	140	4	Max.

* Connect a 200-mmf. condenser between signal generator and antenna post of set, at the antenna post.

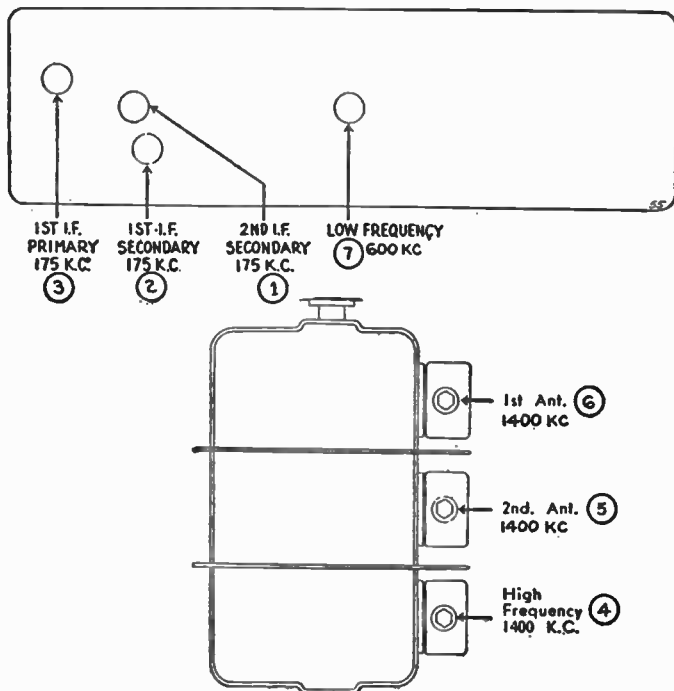

MODEL NO. 49

Signal Generator Connection	Signal Generator Frequency	Dial Position	Wave Band Switch Position	Trimmer Number	Output Signal
Remove grid clip from 6A7					
Control grid of 6A7	260 k.c.	55	Broadcast (Left)	4	Max.
"	"	"	"	3	Max.
"	"	"	"	2	Max.
"	"	"	"	1	Max.
Connect grid clip to 6A7					
Ant.*	1500 k.c.	150	"	5	Max.
"	"	"	"	6	Max.
"	"	"	"	7	Max.
"	600	60	"	8 ¹	Max.
"	11 m.c.	11 m.c.	Short Wave (right)	9 ¹	Max.
"	"	"	"	10 ²	Max.

Note 1.—Located and accessible underneath chassis.

Note 2.—Accessible through hole from top of chassis.

* Use a 200-mmf. condenser dummy antenna for broadcast band and a 400-ohm carbon resistor for shortwave band.

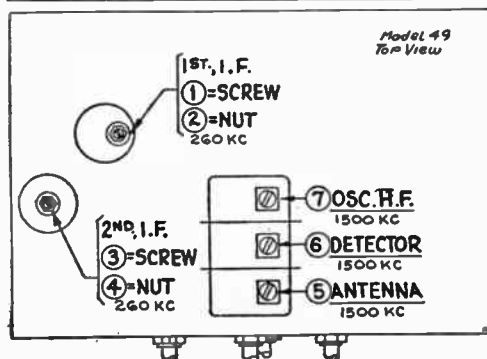
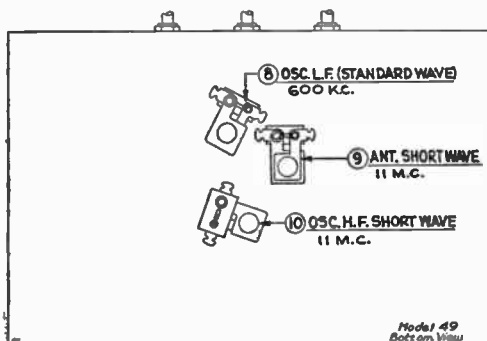

MODEL NOS. 51, 52, 551, 24

Signal Generator Connection	Signal Generator Frequency	Dial Position	Trimmer Number	Output Signal
Remove grid clip from det.-osc.				
Control grid of det.-osc.	175 k.c.	55	1 ¹	Max.
"	"	"	2 ¹	Max.
"	"	"	3 ¹	Max.
Connect grid clip to det.-osc.				
Ant.*	1400 k.c.	140	4	Max.
"	"	"	5	Max.
"	"	"	6	Max.
"	600 k.c.	60	7 ¹	Max.**
"	1400 k.c.	140	4	Max.

Note 1.—Accessible through holes in rear of chassis.

* Connect a 200-mmf. condenser between signal generator and antenna post of set, at the antenna post.

** While rocking.

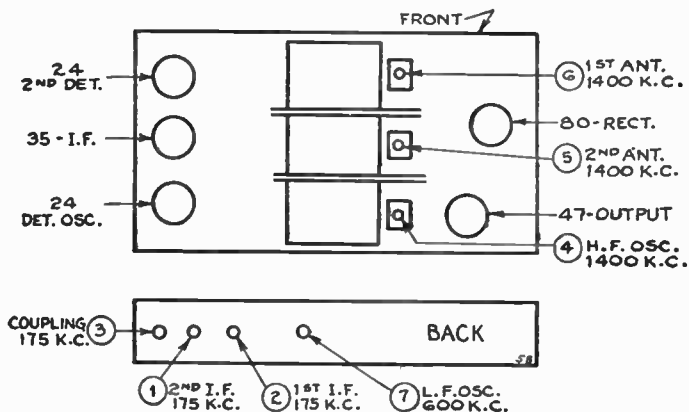

MODEL NO. 53

Signal Generator Connection	Signal Generator Frequency	Dial Position	Trimmer Number	Output Signal
Remove grid clip from det.-osc.				
Control grid of det.osc.	460 k.c.	55	1	Max.
"	"	"	2	Max.
Connect grid clip to det.-osc.				
Note 1	1400 k.c.	140	3	Max.
"	600 k.c.	60	4	Max.
"	1400 k.c.	140	3	Max.
"	"	"	5	Max.
"	"	"	6	Note 2

Note 1.—Connect receiver to antenna and ground in the usual manner. Connect the signal generator to a wire which is placed near the antenna lead but not connected to it. This procedure is for the purpose of obtaining maximum sensitivity from the receiver.

Note 2.—Turn to right as far as possible without causing an oscillation or squeal. Check for oscillation at all points in band. If set oscillates at any point in the band, back off (6) until squeal disappears.

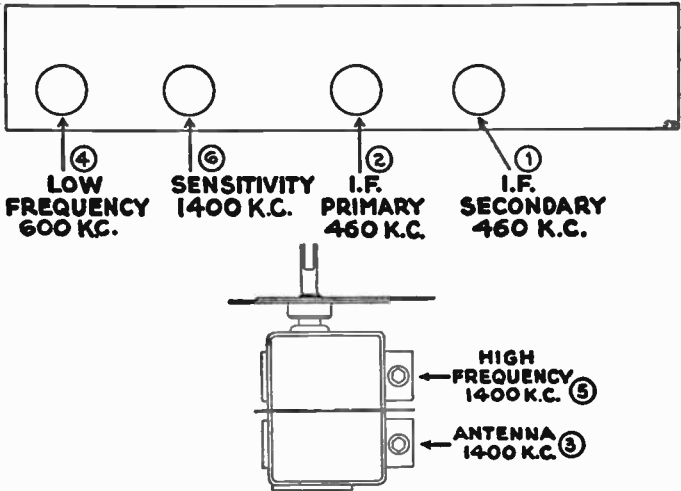

MODEL NO. 54

Signal Generator Connection	Signal Generator Frequency	Dial Position	Wave Band Switch Position	Trimmer Number	Output Signal
Remove grid clip from 6A7					
Control grid of 6A7	460 k.c.	55	Broadcast	1	Max.
"	"	"	"	2	Max.
"	"	"	"	3	Max.
"	"	"	"	4	Max.
Connect grid clip to 6A7					
Ant.*	1400 k.c.	140	"	5 ¹	Max.
"	"	"	"	6 ¹	Max.
"	600 k.c.	60	"	7 ²	Max.**
"	1400 k.c.	140	"	5 ¹	Max.

Note 1.—Padders (5) and (6) are accessible through the top grille of cabinet.
 Note 2.—Padder (7) is accessible from rear of cabinet.

* Use a 100-mmf. condenser as dummy antenna.

** While rocking.

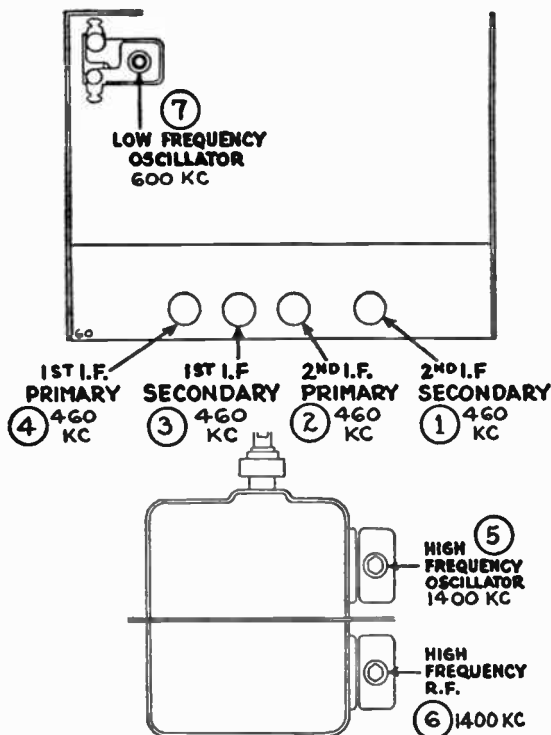

MODEL NOS. 57, 58

Signal Generator Connection	Signal Generator Frequency	Dial Position	Trimmer Number	Output Signal
Remove grid clip from det.-osc.				
Control grid of det.-osc.	460 k.c.	55	1	Max.
"	"	"	2	Max.
Connect grid clip to det.-osc.				
Ant.*	1400 k.c.	140	3	Max.
"	"	"	4	Max.
"	600 k.c.	60	5	Max.*
"	1400 k.c.	140	3	Max.
"	"	"	6	Note 1
"	460 k.c.	"	1	Max.
"	"	"	2	Max.
"	1400 k.c.	"	6	Note 1

Note 1.—Turn fibre screw in clockwise direction until receiver goes into oscillation, giving a squeal when various stations are passed with the station selector. Then turn screw counter-clockwise until the "swishing" sound just ceases. Continue to turn in the same direction about $\frac{1}{4}$ revolution beyond this point. Tune to different stations over the dial, noting if squeal is present at any point. If so, turn screw further counter-clockwise until squeal ceases. For best average operation, this screw should be turned back from $\frac{1}{2}$ to 1 turn, except where extreme selectivity is required. When the 2nd det. tube is replaced, this adjustment should be repeated.

* Use a 100-mmf. condenser as dummy antenna.

** While rocking.

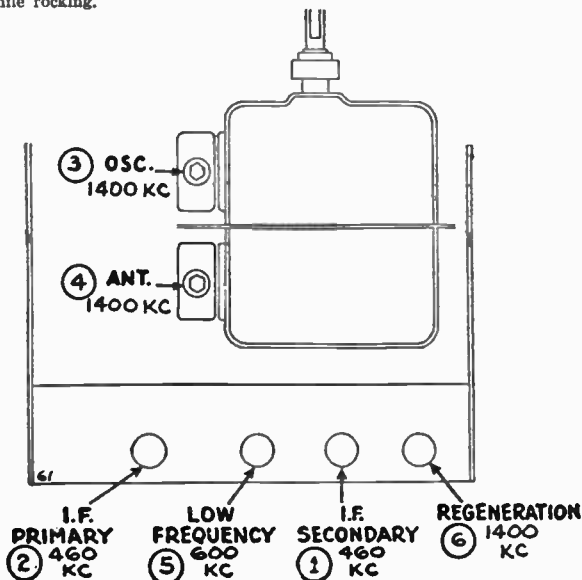

MODEL NO. 59

Signal Generator Connection	Signal Generator Frequency	Dial Position	Trimmer Number	Output Signal
Remove grid clip from det.-osc.				
Control grid of det.-osc.	460 k.c.	60	2	Max.
"	"	"	1	Max.
Connect grid clip to det.-osc.				
Ant.*	1400 k.c.	Note 1	3 ²	Max.
"	"	"	4 ²	Max.
Note 3	Note 3	Note 3	5	Note 4

* Use a 100-mmf. condenser as dummy antenna.

Note 1.—Remove chassis from cabinet (removing base-plate, knobs, pointer, etc.). Turn variable condenser until rotor plates barely mesh with stationary plates.

Note 2.—These trimmers are located on the tuning-condenser gang. Be sure to replace dial-pointer exactly as it was removed.

Note 3.—Connect antenna to receiver and tune in a signal near 1300 k.c.

Note 4.—Turn fibre hex-head screw clockwise until set oscillates or squeals. Then turn back $\frac{1}{4}$ revolution until squealing stops. Tune in other stations on different points along the scale, noting if squeal is present. If so, turn back slightly until all squealing ceases. Readjust this condenser whenever the det.-osc. tube is changed.

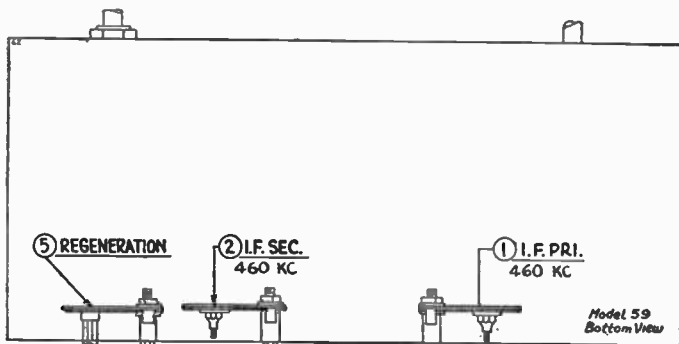

MODEL NOS. 60, 505

Signal Generator Connection	Signal Generator Frequency	Dial Position	Wave Band Switch Position	Trimmer Number	Output Signal
Remove grid clip from 6A7					
Control grid of 6A7	460 k.c.	55	Broadcast	1	Max.
"	"	"	"	2	Max.
"	"	"	"	3	Max.
Connect grid clip to 6A7					
Ant.*	"	"	"	Wave ¹ Trap	Min.
"	1400 k.c.	140	"	H.F. Osc. ²	Max.
"	"	"	"	Ant. ²	Max.
"	600 k.c.	60	"	4	Max.**
"	1400 k.c.	140	"	H.F. Osc.	Max.
"	Note 3	Low-freq. end	Police	5	Max.

Note 1.—Wave trap in series with antenna was not used on early production.

Note 2.—H.F. osc. and ant. trimmers are located on tuning-condenser frame—the ant. trimmer is nearest front of chassis.

Note 3.—Set signal generator frequency to same as point on dial chosen near low frequency end. Adjustment of (5) will correct the dial calibration.

* Connect a 200-mmf. condenser between signal generator and antenna post of set, at the antenna post.

** While rocking.

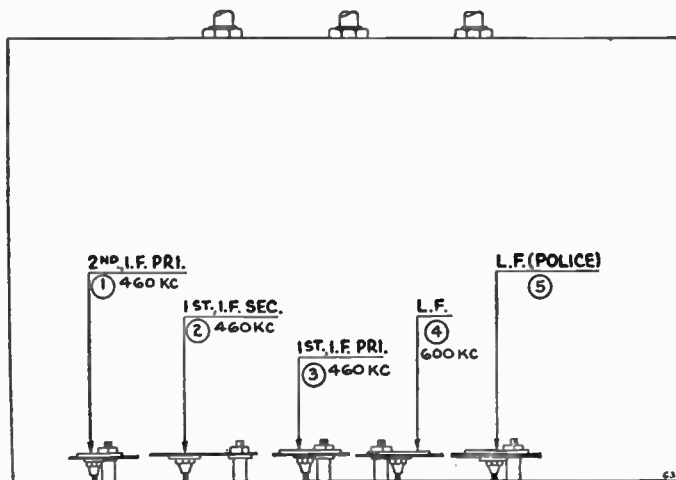

MODEL NO. 65

Signal Generator Connection	Signal Generator Frequency	Dial Position	Wave Band Switch Position	Trimmer Number	Output Signal
Ant.*	1400 k.c.	140 ¹	...	Ant. ²	Note 3
"	"	"	...	R.F. ²	Max.
"	"	"	...	Ant. ²	Max.

Note 1.—Tune for maximum output.

Note 2.—Located on inside back of tuning-condenser gang—accessible through opening in back of frame.

Note 3.—Turn trimmer all-in to purposely upset alignment.

* Connect a 200-mmf. condenser between signal generator and antenna post of set, at the antenna post.

MODEL NOS. 76, 77

Signal Generator Connection	Signal Generator Frequency	Dial Position	Wave Band Switch Position	Trimmer Number	Output Signal
Ant.*	1400 k.c.	140 ¹	...	Ant. ²	Note 3
"	"	"	...	R.F. ²	Max.
"	"	"	...	Ant. ²	Max.

* Connect a 200-mmf. condenser between the signal generator and the antenna post of set, at the antenna post.

Note 1.—Tune for maximum output.

Note 2.—Located behind the right-hand end of gang-condenser assembly and accessible from top of chassis.

Note 3.—Turn all the way in to upset alignment.

CAUTION: Do not attempt to adjust the other two trimmers located on 3rd r.f. and det. coils. These are set at factory with special signal-generator equipment and sealed.

MODEL NOS. 82, 86, 87

Signal Generator Connection	Signal Generator Frequency	Dial Position	Wave Band Switch Position	Trimmer Number	Output Signal
Ant.*	1300 k.c.	Note 1	...	Det. ²	Max.
"	"	"	...	R.F. ²	Max.
"	"	"	...	R.F. ²	Max.
"	"	"	Note 3	3rd R.F. ⁴	Min.
"	"	"	"	neut.	
"	"	"	"	2nd R.F. ⁴	Min.
"	"	"	"	neut.	
"	"	"	"	1st R.F. ⁴	Min.
				neut.	

* Connect a 200-mmf. condenser between the signal generator and the antenna post of set, at the antenna post.

Note 1.—Advance volume control and tune sharply for maximum output.

Note 2.—Located in front of the tuning-condenser gang.

Note 3.—Use "dummy" 226 tube—1 filament prong cut-off.

Note 4.—Neutralizing condensers are in back of condenser gang. These adjustments are critical—use extreme care, and have volume control on full.

MODEL NO. 66

Signal Generator Connection	Signal Generator Frequency	Dial Position	Wave Band Switch Position	Trimmer Number	Output Signal
Remove grid clip from 6A7					
Control grid of 6A7	460 k.c.	55	Broadcast (left)	4	Max.
"	"	"	"	3	Max.
"	"	"	"	2	Max.
"	"	"	"	1	Max.
Connect grid clip to 6A7					
Ant.*	"	"	"	5	Min.
"	1700 k.c.	170	"	7	Max.
"	"	"	"	6	Max.
"	600 k.c.	60	"	8 ¹	Max.

* Use a 200-mmf. condenser as dummy antenna for broadcast band and a 400-ohm carbon resistor for shortwave band.
 Note 1.—Accessible from underneath chassis.

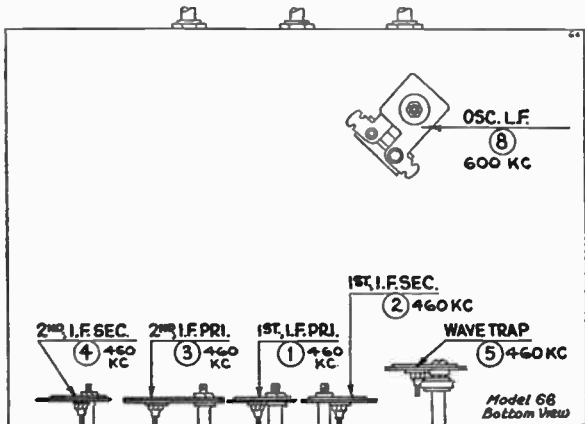
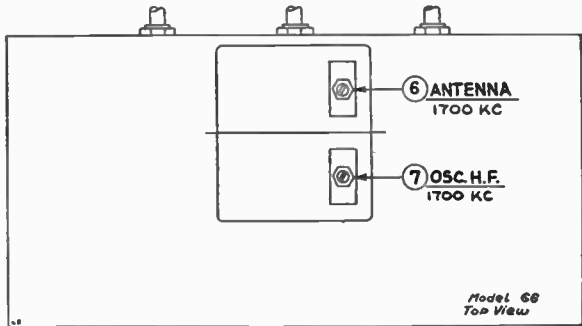

MODEL NOS. 70 (below ser. #B22,000), 270, 370, 570

Signal Generator Connection	Signal Generator Frequency	Dial Position	Wave Band Switch Position	Trimmer Number	Output Signal
Remove grid clip from 1st det.					
Control grid of 1st det.	260 k.c.	55	...	1	Max.
"	"	"	...	2	Max.
"	"	"	...	3	Max.
Connect grid clip to 1st det.					
Ant.*	1400 k.c.	140	...	4	Max.
"	"	"	...	5	Max.
"	"	"	...	6	Max.
"	600 k.c.	60	...	7	Max.**
"	1400 k.c.	140	...	4	Max.

* Connect a 200-mm.f. condenser between signal generator and antenna post of set, at the antenna post.

** While rocking.

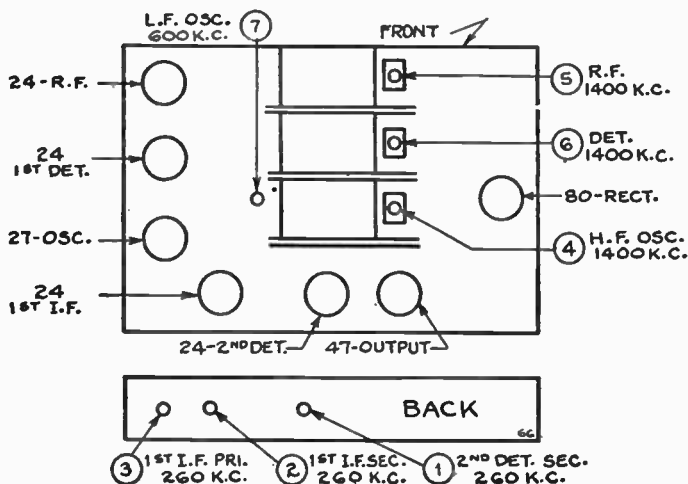

**MODEL NOS. 71, 70 (above serial #B22,000), 270,
370, 570, 22, 22L**

Signal Generator Connection	Signal Generator Frequency	Dial Position	Wave Band Switch Position	Trimmer Number	Output Signal
Remove grid clip from det.-osc.					
Control grid of det.-osc.	260 k.c.	55	...	1	Max.
"	"	"	...	2	Max.
"	"	"	...	3	Max.
"	"	"	...	4	Max.
Connect grid clip to det.-osc.					
Ant.	1400 k.c.	140	...	5	Max.
"	"	"	...	6	Max.
"	"	"	...	7	Max.
"	600 k.c.	60	...	8	Max.**
"	1400 k.c.	140	...	5	Max.

* Connect a 200-mmf. condenser between signal generator and antenna post of set, at the antenna post.

** While rocking.

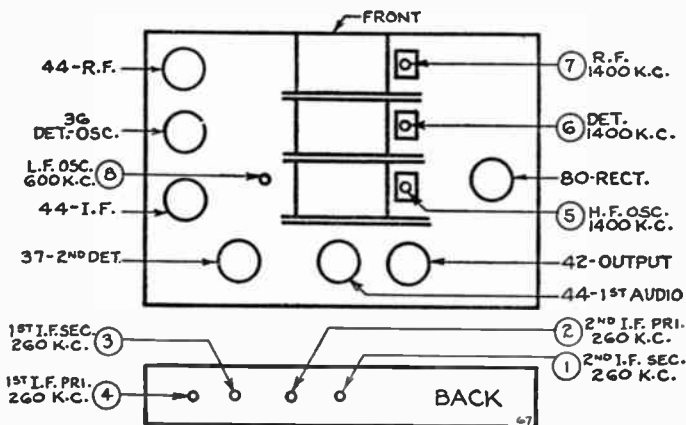

MODEL NO. 80

Signal Generator Connection	Signal Generator Frequency	Dial Position	Wave Band Switch Position	Trimmer Number	Output Signal
Remove grid clip from det.-osc.					
Control grid of det.-osc.	460 k.c.	55	...	1	Max.
"	"	"	...	2	Max.
Connect grid clip to det.-osc.					
Ant.*	1400 k.c.	140	...	3	Max.
"	"	"	...	4	Max.
"	600 k.c.	60	...	5	Max.**
"	1400 k.c.	140	...	3	Max.
Note 1	Note 1	Note 1	...	6	Note 1

* Use a 100-mmf. condenser as dummy antenna.

** While rocking.

Note 1.—Connect antenna to receiver. Tune in station, first at about 130 and adjust (6) to a point just before squealing starts. Tune in stations along other points on dial. If squealing is present at any point readjust (6) slightly until there is none at any point along dial. This adjustment may have to be changed if set is moved to different location or if antenna length or 2nd det. tube is changed.

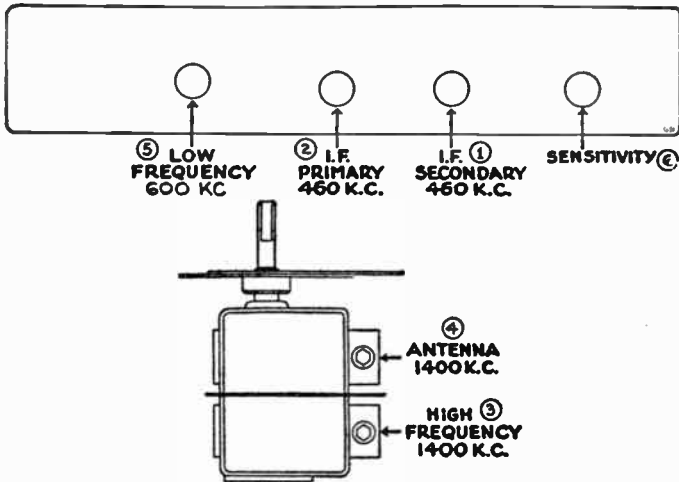

MODEL NO. 81

Signal Generator Connection	Signal Generator Frequency	Dial Position	Wave Band Switch Position	Trimmer Number	Output Signal
Remove grid clip from det.-osc.					
Control grid of det.-osc.	460 k.c.	55	Broadcast	1	Max.
"	"	"	"	2	Max.
Connect grid clip to det.-osc.					
Ant.*	1400 k.c.	140	"	3	Max.
"	"	"	"	4	Max.
"	600 k.c.	60	"	5	Max.**
"	1400 k.c.	140	"	3	Max.
"	2400 k.c.	2400 k.c.	Police	6	Max.
"	1700 k.c.	1700 k.c.	"	7	Max.
Note 1	Note 1	Note 1	Broadcast	8	Note 1

* Use a 100-mmf. condenser as dummy antenna.

** While rocking.

Note 1.—Connect antenna to receiver. Tune in station, first at about 130 and adjust (8) to a point just before squealing starts. Tune in stations along other points on dial. If squealing is still present, back off (8) slightly until there is none at any point along dial. This adjustment may have to be changed if antenna length or 2nd det. tube are changed.

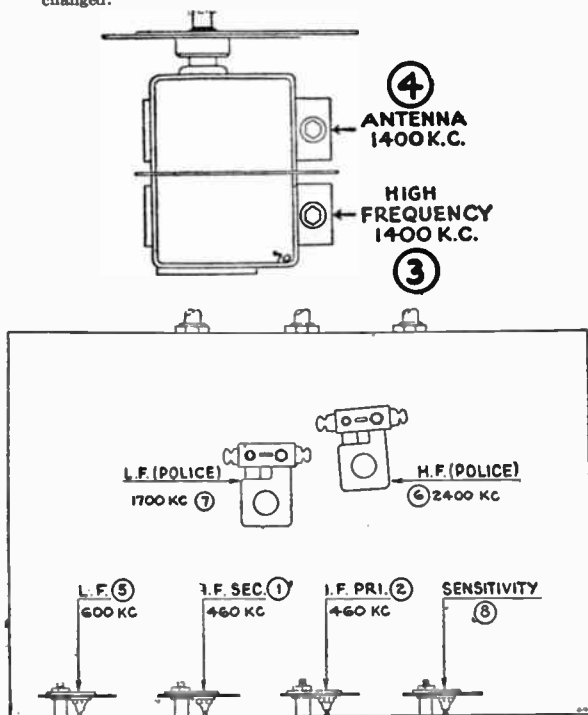

MODEL NO. 84

Signal Generator Connection	Signal Generator Frequency	Dial Position	Wave Band Switch Position	Trimmer Number	Output Signal
Remove grid clip from det.-osc.					
Control grid of det.-osc.	460 k.c.	60	...	2	Max.
"	"	"	...	1	Max.
Connect grid clip to det.-osc.					
Ant.*	1500 k.c.	150	...	3	Note 1
"	600 k.c.	60	...	3	Note 2
"	1400 k.c.	140	...	4	Max.
"	"	"	...	5	Max.

* Use a 100-mm.f. condenser as dummy antenna.

Note 1.—Turn fibre nut clockwise until squealing starts. Then turn back $\frac{1}{2}$ turn to left.

Note 2.—If squealing is present, turn nut back half-turn from squealing point.

Note 3.—The final adjustment of (3) should be made with the receiver connected to the antenna. Adjust (3) so that the receiver does not squeal at any point in the band.

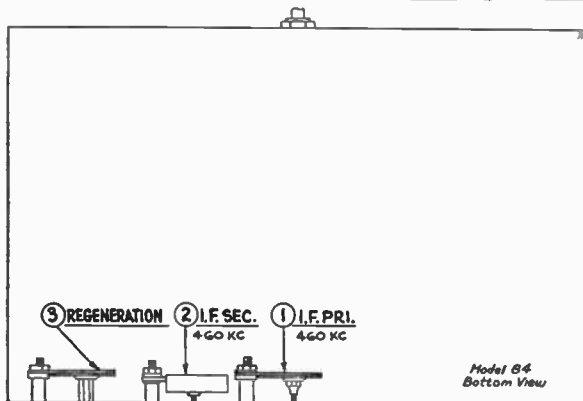
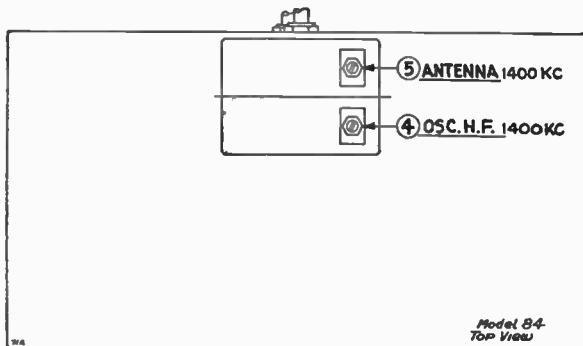

MODEL NOS. 90, 90A, (with 2-45), (with 1-47)

Signal Generator Connection	Signal Generator Frequency	Dial Position	Wave Band Switch Position	Trimmer Number	Output Signal
Remove grid clip from 1st det.					
Control grid of 1st det.	Note 1	55	...	1	Max.
"	"	"	...	2	Max.
"	"	"	...	3	Max.
Connect grid clip to 1st det.					
Ant.*	1400 k.c.	140	...	5	Max.
"	"	"	...	4	Max.
"	"	"	...	6	Max.
"	"	"	...	7	Max.
"	600 k.c.	60	...	8	Max.**
"	1400 k.c.	140	...	5	Max.

* Connect a 200-mmf. condenser between signal generator and antenna post of set, at the antenna post.

** While rocking.

Note 1.—175 k.c. for models with two 45s and 260 k.c. for models with one 47.

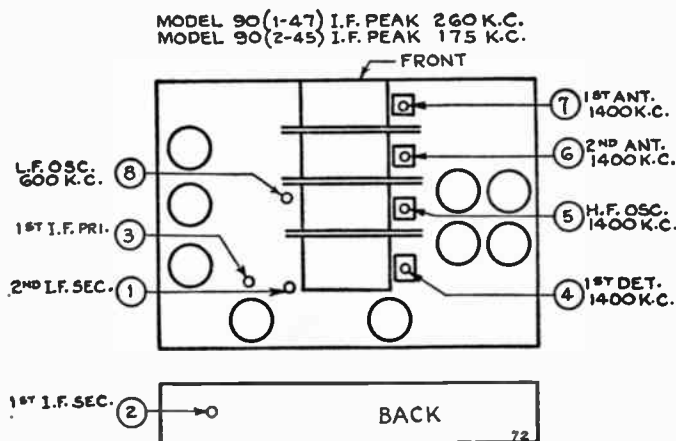

MODEL NOS. 90, 90A (with 2-47)

Signal Generator Connection	Signal Generator Frequency	Dial Position	Wave Band Switch Position	Trimmer Number	Output Signal
Remove grid clip from det.-osc.					
Control grid of det.-osc.	260 k.c.	55	..	1	Max.
"	"	"	...	2	Max.
"	"	"	...	3	Max.
"	"	"	...	4	Max.
Connect grid clip to det.-osc.					
Ant.*	1400 k.c.	140	...	5	Max.
"	"	"	...	6	Max.
"	"	"	...	7	Max.
"	600 k.c.	60	...	8	Max.**
"	1400 k.c.	140	...	5	Max.

* Connect a 200-mmf. condenser between signal generator and antenna post of set, at the antenna post.

** While rocking.

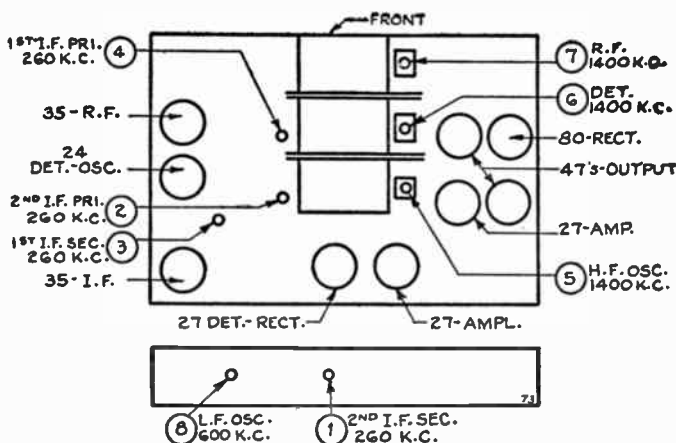

MODEL NOS. 91, 14 (221, 222), 23, 23X

Signal Generator Connection	Signal Generator Frequency	Dial Position	Wave Band Switch Position	Trimmer Number	Output Signal
Remove grid clip from det.-osc. tube					
Control grid of det.-osc. tube	260 k.c.	55	Broadcast	1	Max.
"	"	"	"	2	Max.
"	"	"	"	3	Max.
"	"	"	"	4	Max.
Connect grid clip to det.-osc. tube					
Ant.*	1400 k.c.	140	"	5	Max.
"	"	"	"	6	Max.
"	"	"	"	7	Max.
"	600 k.c.	60	"	8	Max.**
"	1400 k.c.	140	"	5	Max.

* Connect a 200-mmf. condenser between signal generator and antenna post of set, at the antenna post.

** While rocking.

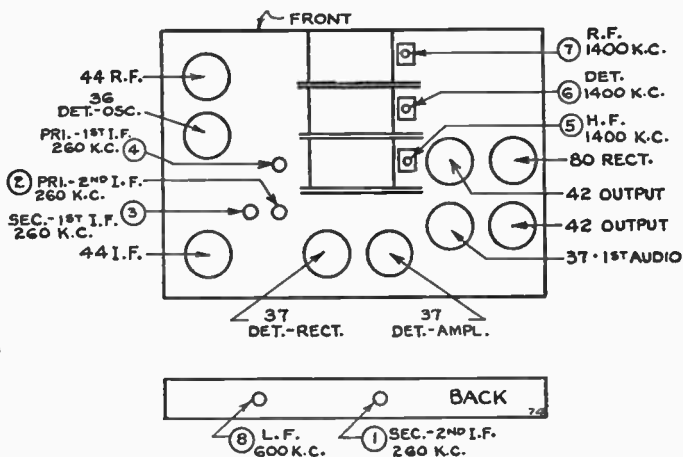

MODEL NO. 97

Signal Generator Connection	Signal Generator Frequency	Dial Position	Wave Band Switch Position	Trimmer Number	Output Signal
Remove grid clip from 6A7					
Control grid of 6A7	460 k.c.	550 k.c.	Range 1 (left)	39	Max.
"	"	"	"	37	Max.
"	"	"	"	34	Max.
"	"	"	"	32	Max.
Connect grid clip to 6A7					
Ant.*	"	"	"	2	Min.
"	18.0 m.c.	18.0 m.c.	Range 3 (right)	21	Max.
"	"	"	"	14	Max.
"	"	"	"	6	Max.
"	3600 k.c.	3.6 m.c.	Range 2 (center)	22	Max.
"	"	"	"	15	Max.
"	"	"	"	5	Max.
"	1800 k.c.	1.8 m.c.	"	23	Max.
"	1600 k.c.	1600 k.c.	Range 1 (left)	24	Max.
"	"	"	"	16	Max.
"	"	"	"	4	Max.
"	600 k.c.	600 k.c.	"	25	Max.

* Use a 200-mmf. condenser dummy antenna for broadcast band and a 400-ohm carbon resistor for the shortwave band.

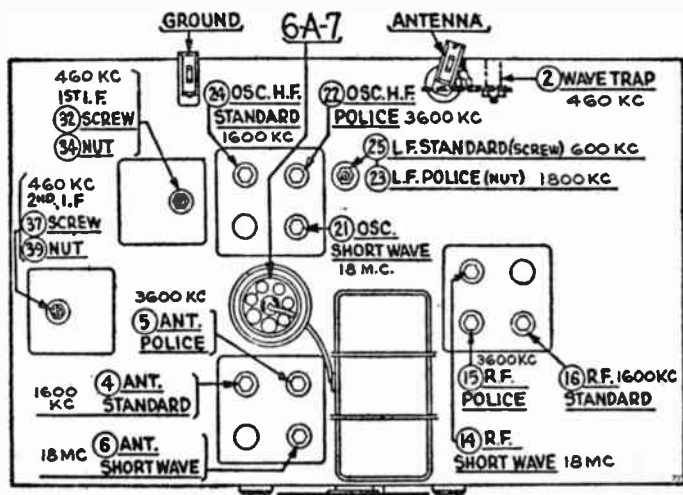

MODEL NO. 116 (121, 122)

Signal Generator Connection	Signal Generator Frequency	Dial Position	Wave Band Switch Position	Trimmer Number	Output Signal
Remove grid clip from 1st det.					
Control grid of 1st det.	460 k.c.	55	Range 2	54 ¹	...
"	"	"	"	59	Max.
"	"	"	"	57	Max.
"	"	"	"	53	Max.
"	"	"	"	51	Max.
"	"	"	"	50	Max.
"	"	"	"	48	Max.
"	"	"	"	54	Max.
Connect grid clip to 1st det.					
Ant.*	"	"	"	1	Min.
"	18.0 m.c.	18.0 m.c.	Range 5	28	Max.
"	"	"	"	9	Max.
"	"	"	"	18	Max.
"	9.5 m.c.	9.5 m.c.	Range 4	29	Max.
"	"	"	"	10	Max.
"	"	"	"	19	Max.
"	4.0 m.c.	4.0 m.c.	Range 3	30	Max.
"	"	"	"	11	Max.
"	"	"	"	20	Max.
"	1600 k.c.	1.6 m.c.	"	30A	Max.
"	1500 k.c.	1500 k.c.	Range 2	31	Max.
"	"	"	"	12	Max.
"	"	"	"	21	Max.
"	600 k.c.	600 k.c.	"	31A	Max.
"	340 k.c.	340 k.c.	Range 1	32	Max.
"	175 k.c.	175 k.c.	"	32A	Max.

* Use a 200-mmf. condenser dummy antenna on broadcast band and a 400-ohm resistor on the shortwave band.
 Note 1.—Turn all the way down.

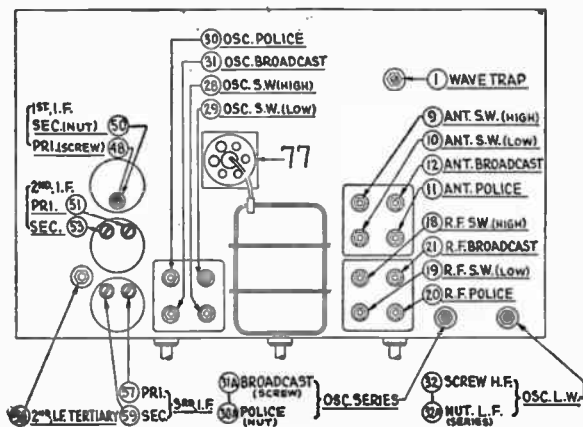

MODEL NOS. 118 (121, 123), 507

Signal Generator Connection	Signal Generator Frequency	Dial Position	Wave Band Switch Position	Trimmer Number	Output Signal
Remove grid clip from 6A7					
Control grid of 6A7	260 k.c.	55	Broadcast (left)	4 ¹	Max.
"	"	"	"	3 ²	Max.
"	"	"	"	2 ¹	Max.
"	"	"	"	1 ²	Max.
Connect grid clip to 6A7					
Ant.*	"	"	"	5	Min.
"	1500 k.c.	150	"	6	Max.
"	"	"	"	7	Max.
"	"	"	"	8	Max.
"	600 k.c.	60	"	9	Max.
"	11 m.c.	11 m.c. Short Wave	(right)	10	Max.
"	"	"	"	11	Max.

* Use a 200-mmf. condenser dummy antenna on broadcast band and a 400-ohm carbon resistor on shortwave band.

Note 1.—Nut adjustment.

Note 2.—Screw adjustment.

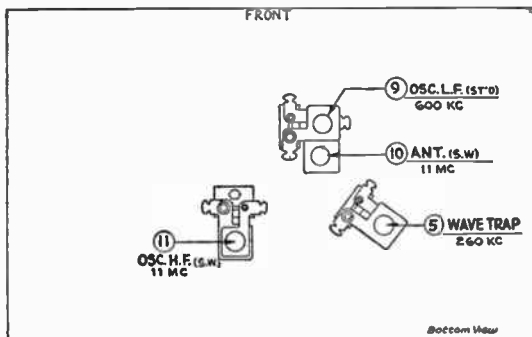
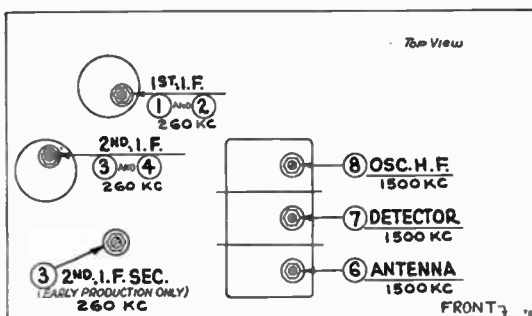

MODEL NOS. 144, 506

Signal Generator Connection	Signal Generator Frequency	Dial Position	Wave Band Switch Position	Trimmer Number	Output Signal
Remove grid clip from 6A7					
Control grid of 6A7	460 k.c.	520 k.c.	Range 1	7 ¹	Max.
"	"	"	"	8 ²	Max.
"	"	"	"	9 ¹	Max.
"	"	"	"	10 ²	Max.
"	"	"	"	11 ¹	Max.
"	"	"	"	12 ²	Max.
Connect grid clip to 6A7					
Ant.*	"	"	"	13	Min.
"	20.0 m.c.	20.0 m.c.	Range 4	1	Max.
"	11.0 m.c.	11.0 m.c.	Range 3	2	Max.
"	3.5 m.c.	3.5 m.c.	Range 2	3	Max.
"	1500 k.c.	1.5 m.c.	"	4	Max.
"	1400 k.c.	1400 k.c.	Range 1	5	Max.
"	520 k.c.	520 k.c.	"	6	Max.

Do not attempt to adjust the two end trimmers shown on top-view. These have been adjusted and sealed at the factory.

* Use a 200-mmf. condenser dummy antenna on broadcast band and a 400-ohm carbon resistor on the shortwave band.

Note 1.—Nut adjustment.

Note 2.—Screw adjustment.

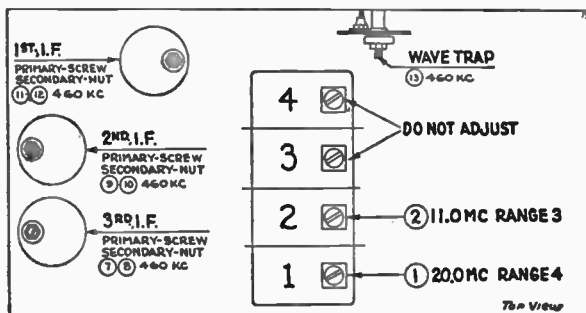
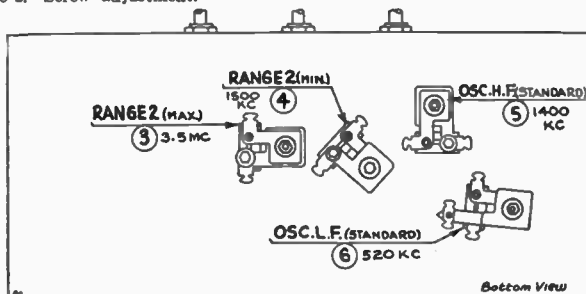

MODEL NO. 200

Signal Generator Connection	Signal Generator Frequency	Dial Position	Wave Band Switch Position	Trimmer Number	Output Signal
Remove grid clip from 6A7					
Control grid of 6A7	175 k.c. ¹	550 k.c.	Note 2	1	Min. ³
"	"	"	...	2	Min.
"	"	"	...	3	Min.
"	"	"	...	4	Min.
"	"	"	...	5	Min.
"	"	"	...	6	Min.
"	"	"	Note 4	5	Min.
"	"	"	Note 5	6	Min.
"	"	"	Note 6	7	Max.
"	"	"	...	8	Max.
"	Note 7	"	...	6	Note 7
Connect grid clip to 6A7					
Ant.*	1500 k.c. ⁸	1500 k.c.	Note 9	9	Min.
"	"	"	...	10	Min.
"	"	"	...	11	Note 10
"	"	"	...	12	Min.
"	"	"	...	11 ¹¹	Min.
"	600 k.c.	600 k.c.	...	13 ¹²	Min.
"	"	"	...	14	Note 13
Note 14	10 k.c.	15	Min.

* Connect a 200-mmf. condenser between signal generator and antenna post of set, at the antenna post.

Note 1.—Adjust signal-generator to give an *unmodulated* output, which should be regulated to give a reading of about two volts on the voltmeter scale (see note 3) during the first six i-f. adjustments.

Note 2.—Turn fidelity-selectivity control all the way to the left.

Note 3.—The usual output meter cannot be used with an unmodulated signal. Use indirect indication through a.v.c. system (for all adjustments unless otherwise noted) by connecting a high-resistance voltmeter (scale 0-5 or 0-10 volts) across the r.f. cathode resistor. This method will give *minimum scale reading for maximum receiver output*, and vice-versa. The voltmeter will indicate about 3 volts bias when no signal is applied to the antenna and will decrease upon application of signal.

Note 4.—Connect 250-mmfd. condenser from plate of second i-f. tube to ground. This increases voltmeter reading to about 2.5 volts.

Note 5.—Remove the 250 mmfd. condenser (note 4). Do not touch the grid padder (5) again.

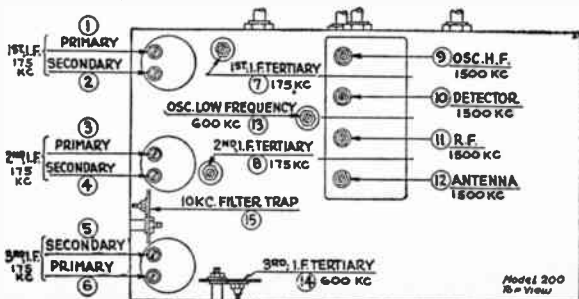

- Note 6.—Turn fidelity-selectivity control all the way to the right.
- Note 7.—When varying the frequency of signal-generator, two definite dips will appear in the voltmeter reading—one at 167 k.c. and the other at 182 k.c., indicating peaks in the tuning curve. The amplitude of both peaks should be equal (same voltage reading at each frequency). Variations can be corrected by *slight* readjustments of trimmer (6). If peak at 167 k.c. is higher than that at 182 k.c. turn (6) out (decrease capacity), and vice-versa.
- Note 8.—Regulate signal generator output to maintain voltmeter reading of 2 volts during adjustment of (9) and (10).
- Note 9.—Turn fidelity-selectivity control all the way to the left.
- Note 10.—Turn "in" until voltmeter reads 2.5 volts.
- Note 11.—After this adjustment, do not touch trimmer (12) again.
- Note 12.—Since the r.f. tuning is broad, there will be considerable range on dial that gives same output when (13) is adjusted for maximum receiver output. Adjust trimmer (13) at the middle of this range as follows: Start with the usual 2 volt reading, and slowly turn receiver dial toward low-frequency end, while at the same time readjusting (13) for maximum receiver output, until a point is reached where voltmeter indicates 2.5 volts. Carefully note dial reading at this point. Follow same procedure while turning the receiver dial in the opposite direction until voltmeter again indicates 2.5 volts. Set the dial in the exact center between these two points for the final adjustment of trimmer (13).
- Note 13.—Adjust (14) to give *minimum width* on shadow-tuning meter of the receiver.
- Note 14.—The accurate adjustment of the 10 k.c. audio filter requires a calibrated audio oscillator. Connect the low side of the audio oscillator to ground and the high side to the variable tap on the receiver volume control.

MODEL NOS. 201, 509

Signal Generator Connection	Signal Generator Frequency	Dial Position	Wave Band Switch Position	Trimmer Number	Output Signal
Remove grid clip from 6A7					
Control grid of 6A7	260 k.c. ¹	550 k.c.	Broadcast ² (left)	1	Min. ³
"	"	"	"	2	Min.
"	"	"	"	3	Min.
"	"	"	"	4	Min.
"	"	"	"	5 ⁴	Min.
"	"	"	"	6 ⁵	Min.
"	260 k.c. ⁶	"	"	7	Note 7
"	260 k.c. ^{8, 9}	"	"	8	Max.
"	"	"	"	9	Max.
"	Note 10	"	"	8	Note 10
Connect grid clip to 6A7					
Ant.	260 k.c. ¹¹	"	"	10	Max.
Ant. ¹²	1500 k.c.	1500 k.c.	"	11	Min.
"	"	"	"	12	Min.
"	"	"	"	13	Min.
"	600 k.c.	600 k.c.	"	14	Min.*
Ant. ¹³	11.0 m.c.	11.0 m.c.	Short Wave (right)	15 ¹⁴	Max. ¹⁵
"	"	10.48 m.c.	"		Image check
"	"	11.0 m.c.	"	16	Max.
Note 16	10 k.c.	17	Min.

- Note 1.—Adjust signal generator to give an unmodulated output, which should be regulated to give a reading of about two volts on the voltmeter scale (see note 3) during the first four i-f. adjustments.
- Note 2.—Turn fidelity-selectivity control all the way to the left.
- Note 3.—The usual output meter cannot be used with an unmodulated signal. Use indirect indication through a.v.c. system (for all adjustments unless otherwise noted) by connecting a high-resistance d.c. voltmeter (scale 0-5 or 0-10 volts) across the r.f. cathode resistor. This method will give *minimum scale reading* for maximum receiver output, and vice-versa. The voltmeter will indicate about 3.5 volts bias when no signal is applied to the antenna and will decrease upon application of signal.
- Note 4.—Connect 500 mmfd. condenser from plate of second i-f. tube to ground.
- Note 5.—Remove 500 mmfd. condenser (note 4) from plate of second i-f. tube and connect across the third i-f. secondary. Remove this condenser after adjustment is completed.
- Note 6.—Set signal-generator for maximum output.
- Note 7.—Adjust (7) to give *minimum width* on shadow-tuning meter of receiver.
- Note 8.—Set signal-generator output to give reading of 2 volts on voltmeter.
- Note 9.—Turn fidelity-selectivity control all the way to the right.
- Note 10.—When varying signal-generator frequency through 253 k.c. and 267 k.c., a definite peak on the voltmeter should be noted for each. If these two readings are not the same, they can be equalized by slight readjustment of (8).
- Note 11.—Turn fidelity-selectivity control all the way to the left.
- Note 12.—Through 250 mmfd. condenser.
- Note 13.—Through 400 ohm resistance.
- Note 14.—Remove voltmeter from r.f. cathode resistor and connect regular output meter to plates of output tubes in the usual manner for adjustment of (15), (16) and (17).
- Note 15.—Use "lower capacity peak" for adjustment of (15) to maximum indication on output meter. Neglect "higher-capacity peak."
- Note 16.—The accurate adjustment of the 10 k.c. audio filter (17) requires a calibrated audio oscillator. Connect the low side of the audio oscillator to ground and the high side to the variable tap on the receiver volume control.
- * While rocking.

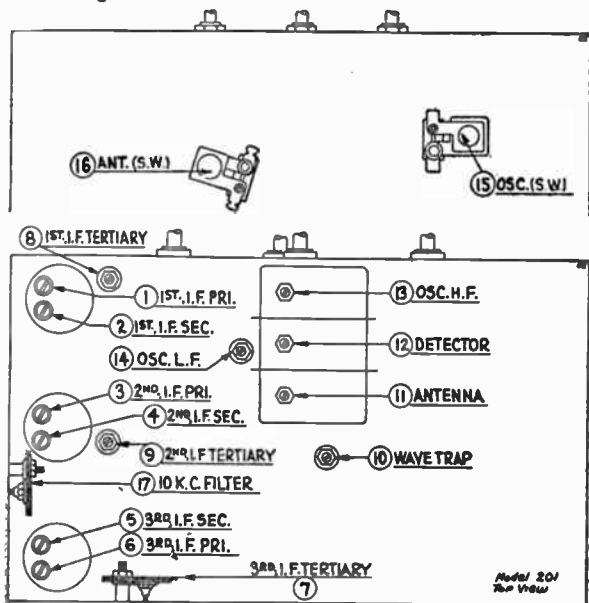

MODEL NO. 511

Signal Generator Connection	Signal Generator Frequency	Dial Position	Wave Band Switch Position	Trimmer Number	Output Signal
Ant.*	1300 k.c.	Note 1	...	1	Max.
"	"	"	...	2	Max.
"	"	"	...	3	Max.
"	"	"	...	4 ²	Min.
"	"	"	...	5 ²	Min.
"	"	"	...	6 ²	Min.

* Connect a 200-mmf. condenser between signal generator and antenna post of set, at the antenna post.

Note 1.—Leave volume control full on. Tune sharply for maximum output.

Note 2.—Use a dummy 226 tube (one filament prong cut off) in the stage being neutralized. Neutralizing adjustments are critical and must be accurately made.

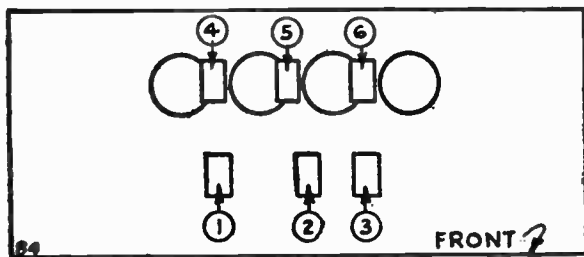

MODEL NO. 600

Signal Generator Connection	Signal Generator Frequency	Dial Position	Wave Band Switch Position	Trimmer Number	Output Signal
Remove grid clip from 6A7					
Control grid of 6A7	460 k.c.	550 k.c.	...	23	Note 1
"	"	"	...	18	Max.
"	"	"	...	20	Max.
"	"	"	...	23	Note 2
Connect grid clip to 6A7					
Ant.*	1800 k.c.	Note 3	...	5	Max.
"	"	"	...	6	Max.
"	600 k.c.	600 k.c.	...	16	Max.

* Use a 100-mmf. condenser as dummy antenna.

Note 1.—Adjust to about $1\frac{1}{2}$ turns counter clockwise from "tight" position.

Note 2.—Turn clockwise until a hiss (oscillation) is heard. Then turn counter clockwise until hiss ceases and continue for $\frac{1}{4}$ turn more.

Note 3.—Turn variable-condenser gang all the way out of mesh. Place .006" gauge between stator and rotor plates. Turn rotor plates until gauge touches both stator and rotor plates. Reset dial pointer (if necessary) to read 1800 k.c. at this step. Then remove gauge.

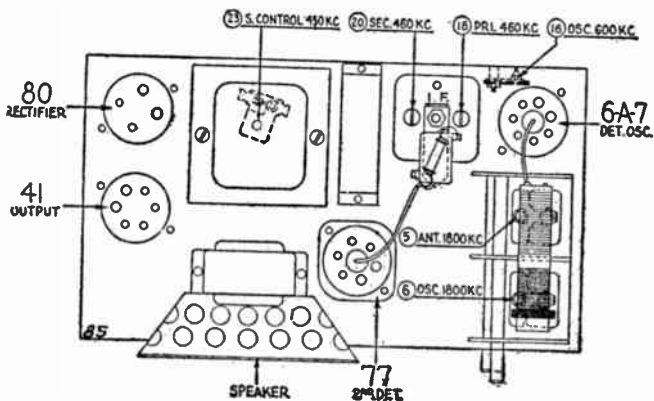

MODEL NO. 602

Signal Generator Connection	Signal Generator Frequency	Dial Position	Wave Band Switch Position	Trimmer Number	Output Signal
Control grid ¹ of i.f.	460 k.c.	550 k.c.	...	28	Max.
"	"	"	...	29	Max.
Control grid ¹ of 6A7	"	"	...	21	Max.
"	"	"	...	23	Max.
Ant.*	"	"	...	Wave trap	Min.
"	1800 k.c.	Note 2	...	4A	Max.
"	"	"	...	6A	Max.
"	600 k.c.	600 k.c.	...	8	Max.

* Use a 100-mmf. condenser as dummy antenna.

Note 1.—Through .00025 mfd. condenser.

Note 2.—Place .006" gauge between stator and rotor plates (after turning condenser gang to minimum capacity position). Then turn condenser gang until stator and rotor plates both touch the gauge. Reset dial pointer (if necessary) to read 1800 k.c. at this step. Remove gauge.

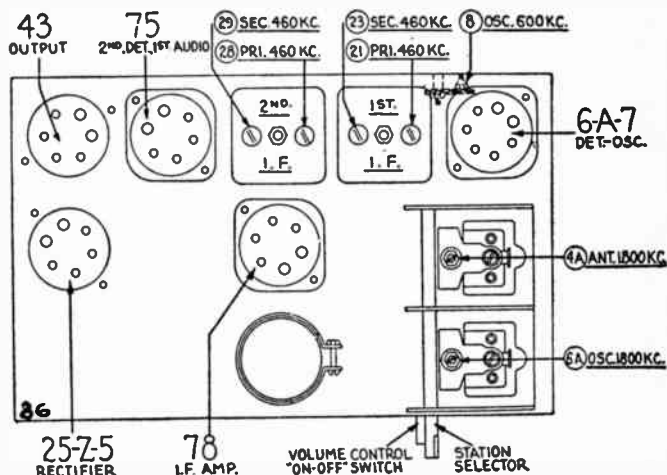

MODEL NO. 604

Signal Generator Connection	Signal Generator Frequency	Dial Position	Wave Band Switch Position	Trimmer Number	Output Signal
Control grid ¹ of i.f.	460 k.c.	550 k.c.	Broadcast (left)	33	Max.
"	"	"	"	35	Max.
Control grid of 6A7	"	"	"	23	Max.
"	"	"	"	25	Max.
Ant.*	"	"	"	2	Min.
"	18 m.c.	18 m.c. ²	Short Wave (right)	17	Max.
"	"	18 m.c. ³	"	9	Max.
"	18 m.c. ⁴	17.1 m.c.	"	Image check	
"	6.0 m.c.	6.0 m.c.	"	11	Max.
"	18.0 m.c.	18.0 m.c.	"	9	Max.
"	1600 k.c.	1600 k.c.	Broadcast (left)	8	Max.
"	"	"	"	16	Max.
"	1400 k.c.	1400 k.c.	"	16	Max.
"	580 k.c.	580 k.c.	"	10	Max.

* Use a 200-mmf. condenser dummy antenna for broadcast band and a 400-ohm carbon resistor for shortwave band.

Note 1.—Through .00025 mfd. condenser.

Note 2.—Connect variable condenser (about .00025 mfd.) across oscillator section of receiver variable-condenser gang, and tune external condenser so that the second harmonic of the receiver oscillator beats with the 18 m.c. signal from the signal-generator. Adjust (17) under these conditions.

Note 3.—Disconnect condenser mentioned in note 2 above.

Note 4.—Increase signal-generator output to check for image signal.

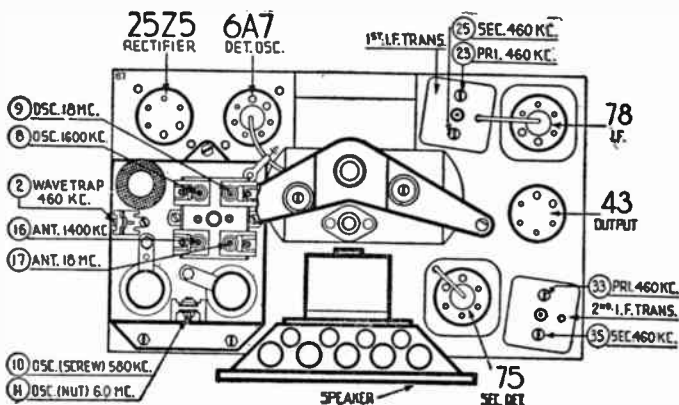

MODEL NO. 610

Signal Generator Connection	Signal Generator Frequency	Dial Position	Wave Band Switch Position	Trimmer Number	Output Signal
Remove grid clip from 6A7					
Control grid of 6A7	460 k.c.	550 k.c.	Broadcast (left)	26	Max.
"	"	"	"	28	Max.
"	"	"	"	20	Max.
"	"	"	"	22	Max.
Connect grid clip to 6A7					
Ant.*	"	"	"	1	Min.
"	1600 k.c.	1600 k.c.	"	11	Max.
"	"	"	"	5	Max.
"	600 k.c.	600 k.c.	"	10 ¹	Max.
"	18.0 m.c.	18.0 m.c.	Short Wave (right)	12	Max.
"	"	"	"	6	Max.
"	7.2 m.c.	7.2 m.c.	"	13 ²	Max.

* Use a 200-mmf. condenser dummy antenna on broadcast band and a 400-ohm carbon resistor on shortwave band.

Note 1.—Screw adjustment.

Note 2.—Nut adjustment.

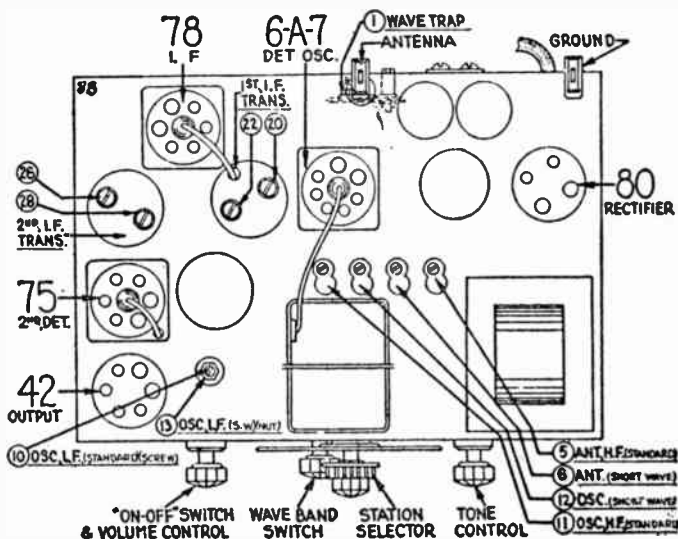

MODEL NO. 611

Signal Generator Connection	Signal Generator Frequency	Dial Position	Wave Band Switch Position	Trimmer Number	Output Signal
Remove grid clip from 6A7					
Control grid of 6A7	460 k.c.	550 k.c.	Broadcast	29	Max.
"	"	"	"	31	Max.
"	"	"	"	23	Max.
"	"	"	"	25	Max.
Connect grid clip to 6A7					
Ant.*	"	"	"	1	Min.
"	1500 k.c.	1500 k.c.	"	13	Max.
"	"	"	"	7	Max.
"	600 k.c.	600 k.c.	"	12	Max.
"	18.0 m.c.	18.0 m.c.	Short Wave	14	Max.
"	"	"	"	8	Max.
"	6.0 m.c.	6.0 m.c.	"	15	Max.

* Use a 200-mmf. condenser as dummy antenna for broadcast band and a 400-ohm carbon resistor for shortwave bands.

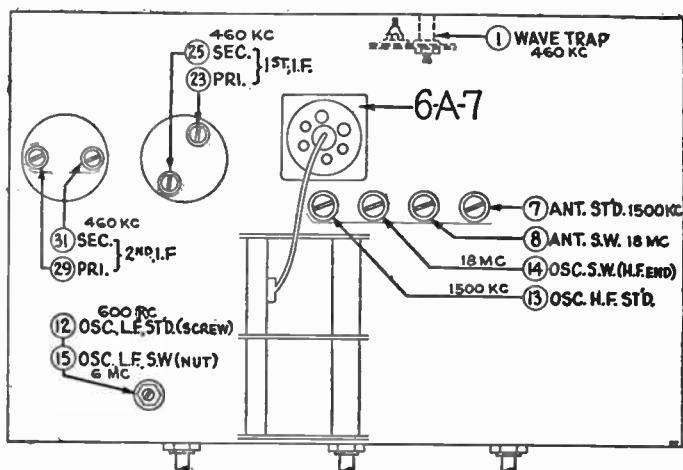

MODEL NOS. 620, 625, 630, 635

Signal Generator Connection	Signal Generator Frequency	Dial Position	Wave Band Switch Position	Trimmer Number	Output Signal
Remove grid clip from 6A7					
Control grid of 6A7	460 k.c.	550 k.c.	Range 1 (left)	36 ¹	Max.
"	"	"	"	38 ²	Max.
"	"	"	"	31 ¹	Max.
"	"	"	"	33 ²	Max.
Connect grid clip to 6A7					
Ant.*	460 k.c.	550 k.c.	"	Note 3	Min.
"	1700 k.c.	1700 k.c.	"	14	Max.
"	"	"	"	6	Max.
"	"	"	"	10	Max.
"	600 k.c.	600 k.c.	"	17 ¹	Max.
"	3.6 m.c.	3.6 m.c.	Range 2 (center)	13	Max.
"	"	"	"	5	Max.
"	"	"	"	9	Max.
"	1800 k.c.	1.8 m.c.	"	16 ²	Max.
"	18.0 m.c.	18.0 m.c.	Range 3 (right)	15	Max.
"	"	"	"	4	Max.
"	"	"	"	8	Max.

* Use a 200-mmf. condenser dummy antenna on broadcast band and a 400-ohm carbon resistor on the shortwave band.

Note 1.—Screw adjustment.

Note 2.—Nut adjustment.

Note 3.—Wave trap adjustment—accessible through hole in rear of chassis near antenna terminal.

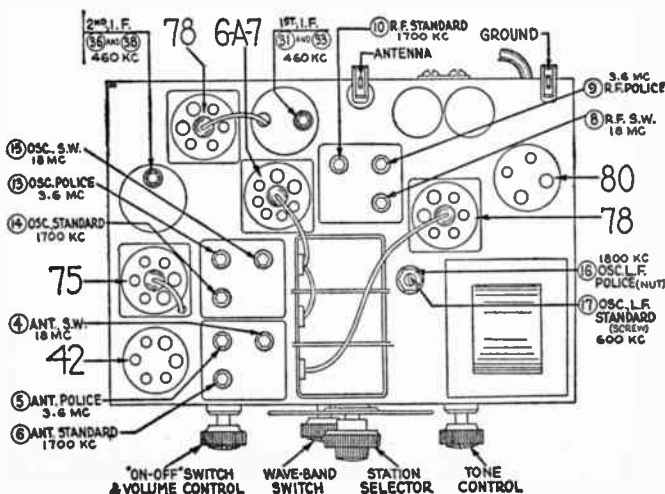

MODEL NOS. 623, 623A

Signal Generator Connection	Signal Generator Frequency	Dial Position	Wave Band Switch Position	Trimmer Number	Output Signal
Remove grid clip from 1C6					
Control grid of 1C6	460 k.c.	550 k.c.	Broadcast	27	Max.
"	"	"	"	29	Max.
"	"	"	"	22	Max.
"	"	"	"	24	Max.
Connect grid clip to 1C6					
Ant.*	"	"	"	1	Min.
"	1500 k.c.	1500 k.c.	"	13	Max.
"	"	"	"	6	Max.
"	600 k.c.	600 k.c.	"	11 ¹	Max.
"	18.0 m.c.	18.0 m.c.	Short Wave	12	Max.
"	"	"	"	7	Max.
"	6.0 m.c.	6.0 m.c.	"	14 ²	Max.

* Use a 200-mmf. condenser as dummy antenna on broadcast band and a 400-ohm carbon resistor on shortwave bands.

Note 1.—Screw adjustment.

Note 2.—Nut adjustment.

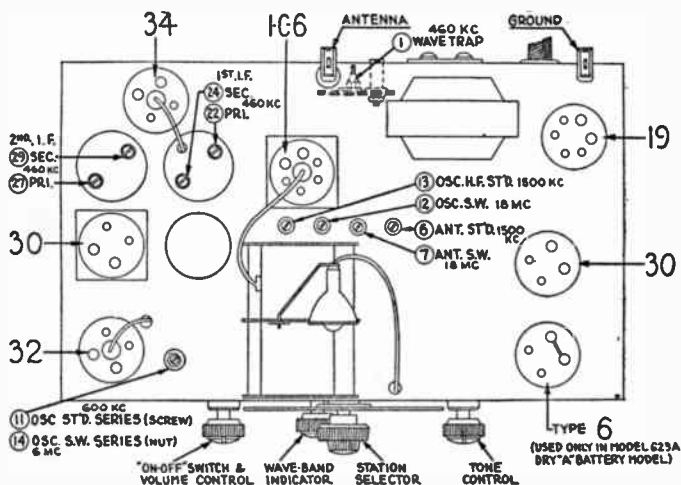

MODEL NO. 624

Signal Generator Connection	Signal Generator Frequency	Dial Position	Wave Band Switch Position	Trimmer Number	Output Signal
Control grid of i.f.	460 k.c.	55 ¹	Range 3 (left)	27	Max.
"	"	"	"	29	Max.
Remove grid clip from 1C6					
Control grid of 1C6	"	"	"	24	Max.
"	"	"	"	26	Max.
Connect grid clip to 1C6					
Ant.*	"	"	"	1	Min.
"	18 m.c.	18 m.c. ²	Range 1 (right)	6	Max.
"	"	18 m.c. ³	"	16	Max.
"	18 m.c. ⁴	17.1 m.c.	"	Image check	
"	6.0 m.c.	6.0 m.c.	"	17	Max.
"	18 m.c.	18 m.c.	"	16	Max.
"	1500 k.c.	150	Range 3 (left)	14	Max.
"	"	"	"	5	Max.
"	600 k.c.	60	"	19	Max.

* Use a 200-mmf. condenser dummy antenna for broadcast band and a 400-ohm carbon resistor for shortwave band.

Note 1.—Advance receiver volume control to just below the point at which oscillator hiss becomes noticeable.

Note 2.—Connect variable condenser (about .00025 mfd.) across oscillator section of gang condenser (front section). Tune this condenser so that the second harmonic of the oscillator beats against the signal from the signal generator. Adjust (6) under these conditions.

Note 3.—Remove variable condenser mentioned in note 2 above.

Note 4.—Advance signal-generator output to level sufficiently high to give clear indication on output meter at this step.

Note 5.—No adjustments are necessary for the alignment of Range 2.

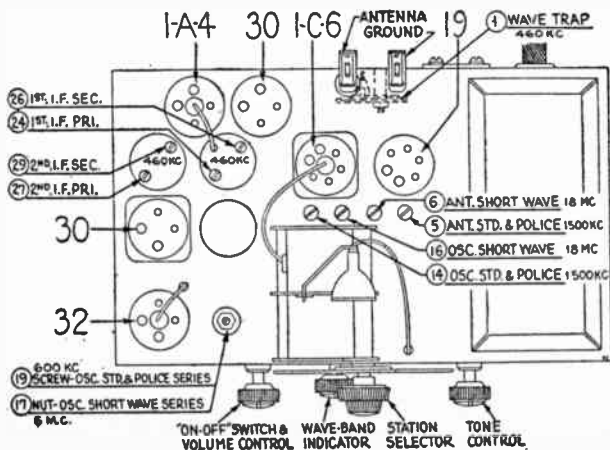

MODEL NOS. 640, 650

Signal Generator Connection	Signal Generator Frequency	Dial Position	Wave Band Switch Position	Trimmer Number	Output Signal
Remove grid clip from 6A7					
Control grid of 6A7	460 k.c.	550 k.c.	Range 2	46	Max.
"	"	"	"	48	Max.
"	"	"	"	38	Max.
"	"	"	"	40	Max.
Connect grid clip to 6A7					
Ant.*	"	"	"	1	Min.
"	18.0 m.c.	18.0 m.c.	Range 4	23	Max.
"	"	"	"	15	Max.
"	"	"	"	7	Max.
"	6.0 m.c.	6.0 m.c.	"	28 ¹	Max.
"	1500 k.c.	1500 k.c.	Range 2	25	Max.
"	"	"	"	13	Max.
"	"	"	"	5	Max.
"	600 k.c.	600 k.c.	"	27 ²	Max.
"	2400 k.c.	2.4 m.c.	Range 3	4	Max.
"	"	"	"	14	Max.
"	350 k.c.	350 k.c.	Range 1	24	Max.
"	"	"	"	12	Max.
"	"	"	"	6	Max.
"	170 k.c.	170 k.c.	"	26 ³	Max.

* Use a 200-mmf. condenser as dummy antenna on broadcast band and a 400-ohm carbon resistor on shortwave band.

Note 1.—Accessible from underneath chassis near middle-front.

Note 2.—Nut adjustment.

Note 3.—Screw adjustment.

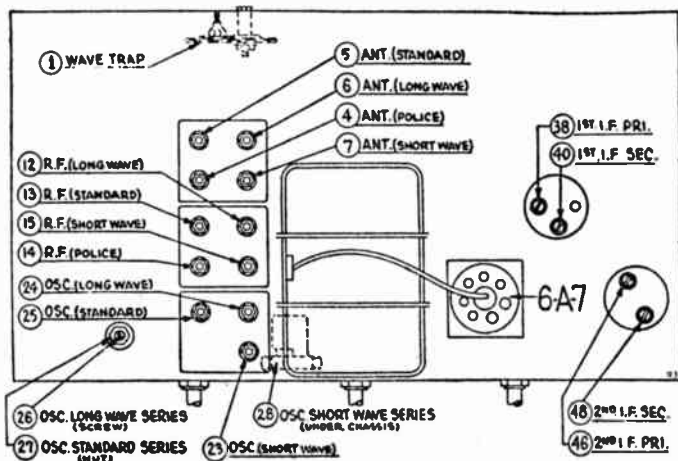

MODEL NO. 641

Signal Generator Connection	Signal Generator Frequency	Dial Position	Wave Band Switch Position	Trimmer Number	Output Signal
Remove grid clip from i.f.					
Control grid of i.f.	460 k.c.	550 k.c.	Range 1	38	Max.
"	"	"	"	40	Max.
Connect grid clip to i.f. and remove grid clip from 6A7					
Control grid of 6A7	"	"	"	32	Max.
"	"	"	"	34	Max.
Connect grid clip to 6A7					
Ant.*	"	"	"	Wave trap	Min.
"	18.0 m.c.	18.0 m.c. ¹	Range 3	4	Max.
"	"	"	"	15	Max.
"	"	18.0 m.c. ²	"	23	Max.
"	6.0 m.c.	6.0 m.c.	"	17	Max.
"	18.0 m.c.	18.0 m.c.	"	23	Max.
"	1400 k.c.	1400 k.c.	Range 1	5	Max.
"	"	"	"	14	Max.
"	"	"	"	18	Max.
"	580 k.c.	580 k.c.	"	19	Max.
"	1400 k.c.	1400 k.c.	"	18	Max.
"	2400 k.c.	2400 k.c.	Range 2	6	Max.
"	"	"	"	13	Max.

* Use a 200-mmf. condenser as dummy antenna for broadcast band and a 400-ohm carbon resistor for shortwave bands.

Note 1.—Connect a variable condenser across the oscillator section of the receiver tuning condenser gang. Tune this variable condenser for maximum indication on output meter. Then adjust (4) and (15).

Note 2.—Remove variable condenser mentioned in note 1 above.

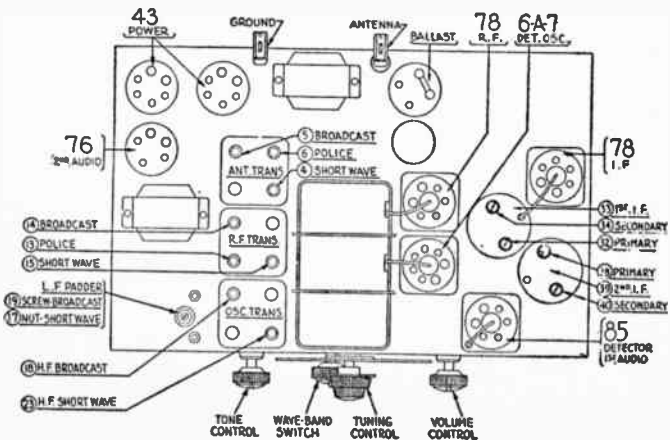

MODEL NO. 642

Signal Generator Connection	Signal Generator Frequency	Dial Position	Wave Band Switch Position	Trimmer Number	Output Signal
Remove grid clip from 6F7					
Control grid of 6F7	460 k.c.	600 k.c. ¹	Range 1 (broadcast)	55	Max.
"	"	"	"	57	Max.
Connect grid clip to 6F7 and remove grid clip from 6A7					
Control grid of 6A7	"	"	"	34	Max.
"	"	"	"	36	Max.
Connect grid clip to 6A7					
Ant.	"	"	"	Note 2	Min.
Remove grid clip from 78 r.f.					
Control grid of 78 r.f.	18.0 m.c.	18.0 m.c.	Range 3	10 ³	...
"	"	"	"	14	Max.
"	6.0 m.c.	6.0 m.c.	"	10	Max.
Connect grid clip to 78 r.f.					
Ant.*	18.0 m.c.	18.0 m.c.	"	6	Max.
"	18.0 m.c. ⁴	17.1 m.c.	"	Image check	
"	5.5 m.c.	5.5 m.c.	Range 2	5	Max.
"	"	"	"	9	Max.
"	"	"	"	13	Max.
"	1800 k.c.	1800 k.c.	"	16	Max.
"	5.5 m.c.	5.5 m.c.	"	13	Max.
"	1500 k.c.	1500 k.c.	Range 1	4	Max.
"	"	"	"	8	Max.
"	"	"	"	12	Max.
"	580 k.c.	580 k.c.	"	17	Max.
"	1500 k.c.	1500 k.c.	"	12	Max.

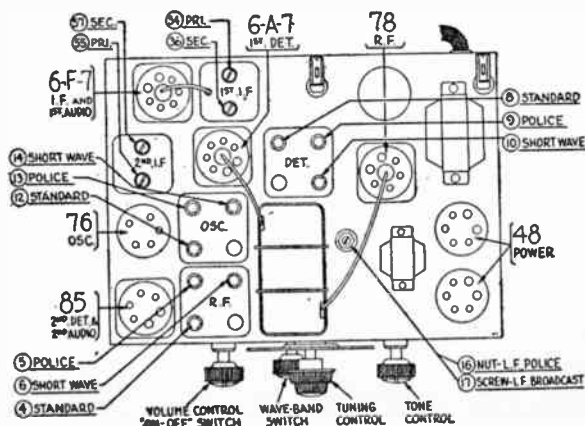

- Use a 200-mmf. condenser as dummy antenna on broadcast band and a 400-ohm carbon resistor on shortwave band.
- Note 1.—Adjust receiver volume control to near maximum position—just before the point at which oscillator hiss becomes noticeable.
- Note 2.—Connect external variable condenser across oscillator section of receiver tuning condenser. Tune the external condenser so that second harmonic of receiver oscillator will beat against signal from signal-generator. Adjust (20) and (8) under these conditions.
- Note 3.—Remove external variable condenser mentioned in note 2 above.
- Note 4.—Advance signal-generator output to level high enough to give a clear indication on output meter at this step.
- Note 5.—Accessible from underneath chassis (near middle-front).

MODEL NO. 645

Signal Generator Connection	Signal Generator Frequency	Dial Position	Wave Band Switch Position	Trimmer Number	Output Signal
Control grid ¹ of 78 i.f.	460 k.c.	55	Range 3	31	Max.
"	"	"	"	33	Max.
Control grid of 6A7	"	"	"	26	Max.
"	"	"	"	28	Max.
Ant.*	"	"	"	2	Min.
"	18.0 m.c.	18.0 m.c. ²	Range 1	5	Max.
"	"	"	"	13	Max.
"	"	18.0 m.c. ³	"	20	Max.
"	18.0 m.c. ⁴	17.1 m.c.	"	Image check	
"	6.0 m.c.	6.0 m.c.	"	22	Max.
"	18.0 m.c.	18.0 m.c.	"	20	Max.
"	5500 k.c.	5.5 m.c.	Range 2	19	Max.
"	"	"	"	4	Max.
"	"	"	"	12	Max.
"	1800 k.c.	1.8 m.c.	"	23	Max.
"	1500 k.c.	150	Range 3	18	Max.
"	"	"	"	3	Max.
"	"	"	"	11	Max.
"	600 k.c.	60	"	24	Max.

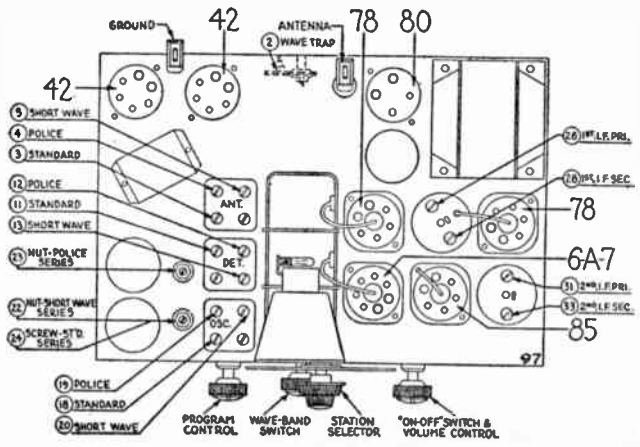

* Use a 200-mmf. condenser in series as dummy antenna for broadcast band and a 400-ohm carbon resistor on the shortwave band.

Note 1.—Through .001 mfd. condenser.

Note 2.—Connect external variable condenser (about .00025 mfd.) across oscillator section of receiver tuning condenser (front section). Tune the external condenser so that second harmonic of receiver oscillator will beat against the signal from signal-generator. Adjust (5) and (13) under these conditions.

Note 3.—Disconnect external variable condenser mentioned in note 2 above.

Note 4.—Advance signal-generator output to level high enough to give a clear indication on output meter at this step.

MODEL NO. 651

Signal Generator Connection	Signal Generator Frequency	Dial Position	Wave Band Switch Position	Trimmer Number	Output Signal
Control grid ¹ of 78 i.f.	460 k.c.	55	Range 3 (left)	58	Max.
“	“	“	“	60	Max.
Control grid ¹ of 6A7	“	“	“	54	Max.
“	“	“	“	56	Max.
Ant.*	“	“	“	5	Min.
“	18 m.c.	18 m.c. ²	Range 1 (right)	6	Max.
“	“	“	“	13	Max.
“	“	18 m.c. ³	“	18	Max.
“	“	17.1 m.c.	“	Image check	
“	6.0 m.c.	6.0 m.c.	“	21	Max.
“	18 m.c.	18 m.c.	“	18	Max.
“	5500 k.c.	5.5 m.c.	Range 2 (center)	7	Max.
“	“	“	“	12	Max.
“	“	“	“	17	Max.
“	1800 k.c.	1.8 m.c.	“	20	Max.
“	1500 k.c.	150	Range 3	16	Max.
“	“	“	“	11	Max.
“	“	“	“	8	Max.
“	580 k.c.	58	“	19	Max.

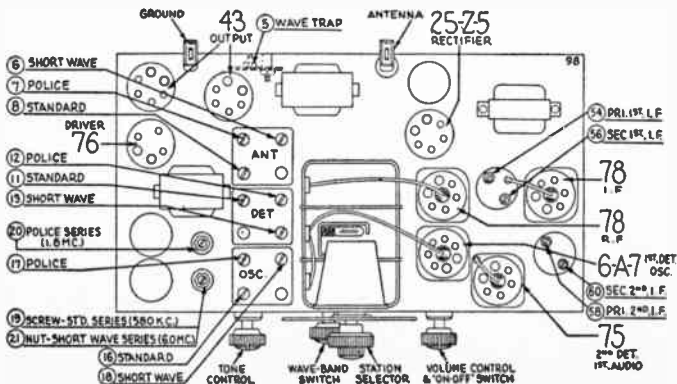

* Use a 200-mmf. condenser in series as a dummy antenna on broadcast band and a 400-ohm carbon resistor on the shortwave band.

Note 1.—Through .001 mfd. condenser.

Note 2.—Connect a variable condenser (about .00025 mfd.) across oscillator (front) section of receiver tuning-condenser gang. Tune the external condenser so that second harmonic of receiver oscillator beats against signal from signal-generator. Adjust (6) and (13) under these conditions.

Note 3.—Remove external variable condenser mentioned in Note 2 above.

MODEL NO. 655

Signal Generator Connection	Signal Generator Frequency	Dial Position	Wave Band Switch Position	Trimmer Number	Output Signal
Control grid ¹ of 78 i.f.	460 k.c.	55	Range 3 (left)	29	Max.
"	"	"	"	31	Max.
Control grid ¹ of 6A7	"	"	"	24	Max.
"	"	"	"	26	Max.
Ant.*	"	"	"	2	Min.
"	18 m.c.	18 m.c. ²	Range 1 (right)	6	Max.
"	"	"	"	13	Max.
"	"	18 m.c. ³	"	19	Max.
"	"	17.1 m.c.	"	Image check	
"	6.0 m.c.	6.0 m.c.	"	20	Max.
"	18.0 m.c.	18.0 m.c.	"	19	Max.
"	5500 k.c.	5.5 m.c.	Range 2	18	Max.
"	"	"	"	5	Max.
"	"	"	"	12	Max.
"	1800 k.c.	1.8 m.c.	"	21	Max.
"	1500 k.c.	150	Range 3	17	Max.
"	"	"	"	4	Max.
"	"	"	"	11	Max.
"	600 k.c.	60	"	22	Max.

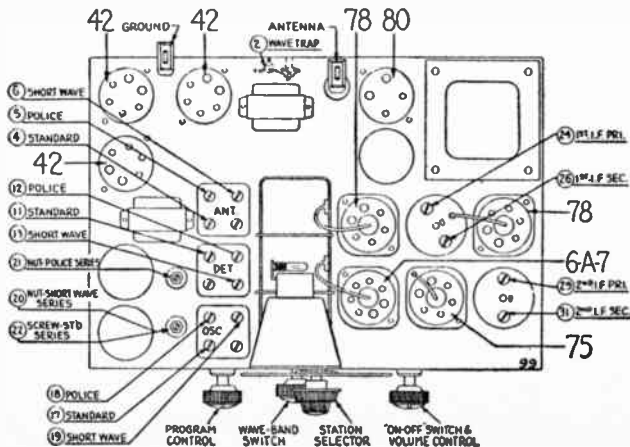

* Use a 200-mmf. condenser in series as dummy antenna for broadcast band and a 400-ohm carbon resistor for shortwave band.

Note 1.—Through .001 mfd. condenser.

Note 2.—Connect variable condenser (about .00025 mfd.) across oscillator (front) section of receiver tuning-condenser gang. Tune the external condenser so that second harmonic of receiver oscillator beats against signal from signal-generator. Adjust (6) and (13) under these conditions.

Note 3.—Remove external variable condenser mentioned in note 2 above.

MODEL NOS. 660, 665

Signal Generator Connection	Signal Generator Frequency	Dial Position	Wave Band Switch Position	Trimmer Number	Output Signal
Remove grid clip from 1st det.					
Control grid of 1st det.	460 k.c.	60	Broadcast ¹	51 ²	...
"	"	"	"	57	Max.
"	"	"	"	55	Max.
"	"	"	"	52	Max.
"	"	"	"	49	Max.
"	"	"	"	42	Max.
"	"	"	"	40	Max.
"	"	"	"	51	Max.
Connect grid clip to 1st det.					
Ant.*	"	"	"	24	Min.
"	18 m.c.	18.0 m.c.	Short Wave ³	21	Max.
"	"	"	"	13	Max.
"	"	"	"	7	Max.
"	4.5 m.c.	4.5 m.c.	Police ⁴	29	Max.
"	"	"	"	12	Max.
"	"	"	"	6	Max.
"	1800 k.c.	1.8 m.c.	"	18	Max.
"	1500 k.c.	1500 k.c.	Broadcast ¹	27	Max.
"	"	"	"	10	Max.
"	"	"	"	4	Max.
"	600 k.c.	600 k.c.	"	16	Max.
"	340 k.c.	340 k.c.	Long Wave ⁵	28	Max.
"	"	"	"	11	Max.
"	"	"	"	5	Max.
"	175 k.c.	175 k.c.	"	17	Max.

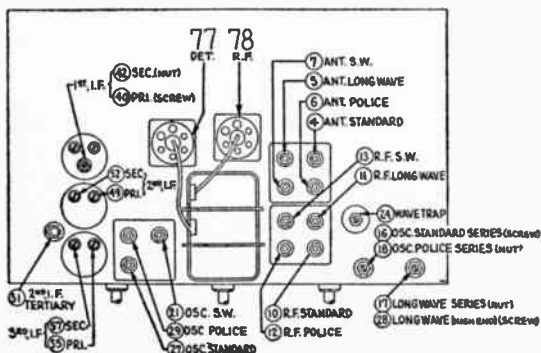

* Use a 200-mmf. condenser in series as dummy antenna for broadcast band and a 400-ohm carbon resistor for shortwave band.

Note 1.—Second position from left.

Note 2.—Turn all the way down before adjusting other i-f. compensators.

Note 3.—Extreme right position.

Note 4.—Third position from left.

Note 5.—Extreme left position.

MODEL NO. 680

Signal Generator Connection	Signal Generator Frequency	Dial Position	Wave Band Switch Position	Trimmer Number	Output Signal
Control grid of 2nd i.f.	460 k.c.	Note 1	Note 2	133	Note 3
"	"	550 k.c.	Broadcast	136	Max.
"	"	"	"	128	Max.
"	"	"	"	131	Max.
"	"	"	"	133	Min.
Control grid of 1st i.f.	"	"	"	96	Max.
"	"	"	"	94	Max.
Control grid of 1st det.	"	"	"	89	Max.
"	"	"	"	87	Max.
Ant. ⁵	"	"	"	133	Note 4
Control grid of 1st det.	Note 6	"	"	1	Min.
Ant. ⁷	18 m.c.	18 m.c.	Range 1 ⁸	56	Max.
"	"	17.1 m.c.	"	Image check	
"	"	18 m.c. ⁹	"	9	Max.
"	"	"	"	38	Max.
"	8 m.c.	8 m.c. ¹⁰	"	42	Max.
"	18 m.c.	18 m.c.	"	56	Max.
"	6 m.c.	6 m.c.	Range 2	8	Max.
"	"	"	"	37	Max.
"	"	"	"	55	Max.
"	2.4 m.c.	2.4 m.c.	"	44	Max.
"	6 m.c.	6 m.c.	"	55	Max.
"	1500 k.c.	1500 k.c.	Range 3	7	Max.
"	"	"	"	26	Max.
"	"	"	"	36	Max.
"	"	"	"	54	Max.
Ant. ¹¹	580 k.c.	580 k.c.	"	46	Max.
"	340 k.c.	340 k.c.	Range 4	6	Max.
"	"	"	"	35	Max.
"	"	"	"	51	Max.
"	175 k.c.	175 k.c.	"	48	Max.
"	340 k.c.	340 k.c.	"	51	Max.
"	580 k.c.	580 k.c.	Range 3	46	Max.
"	1500 k.c.	1500 k.c.	"	54	Max.
"	"	"	"	36	Max.
Note 12	10,000 cycles	153	Min.

- Note 1.—Glowing arrow should be between the two vertical lines at extreme left of the low-frequency calibration with the plates fully meshed.
- Note 2.—Turn bass control off (to left) and fidelity control to selective position (left). Adjust hum control for minimum hum and volume control to maximum (right).
- Note 3.—Turn four turns to left.
- Note 4.—Turn down volume control and increase signal-generator output level—for this step only—until shadow meter width decreases to one-half. Adjust (133) for minimum shadow meter width.
- Note 5.—Through 200-mmfd. condenser.
- Note 6.—Turn fidelity-selectivity control to extreme right for this step. Definite peaks (on output-meter indication) appear when signal-generator output passes through 452 k.c. and 468 k.c. Both should be equal. If 452 k.c. peak is higher, turn (131) out (decrease capacity), and vice-versa.
- Note 7.—Through 400-ohm carbon resistor.
- Note 8.—Turn fidelity control back to extreme left.
- Note 9.—Connect variable condenser (about 250 mmfd.) across oscillator section (second from front) of variable condenser gang. Turn this condenser until 18 m.c. signal gives indication on output meter. Adjust (9) and (38) on this setting.
- Note 10.—Remove external variable condenser (mentioned in Note 9 above).
- Note 11.—Remove 400-ohm resistor from antenna lead (mentioned in note 7 above).
- Note 12.—Reset 10 k.c. filter adjustment only if tampered with or parts are changed. Use an accurately calibrated audio oscillator. Connect the high side of the audio oscillator to the variable tap on the volume control and adjust (153) for maximum output.

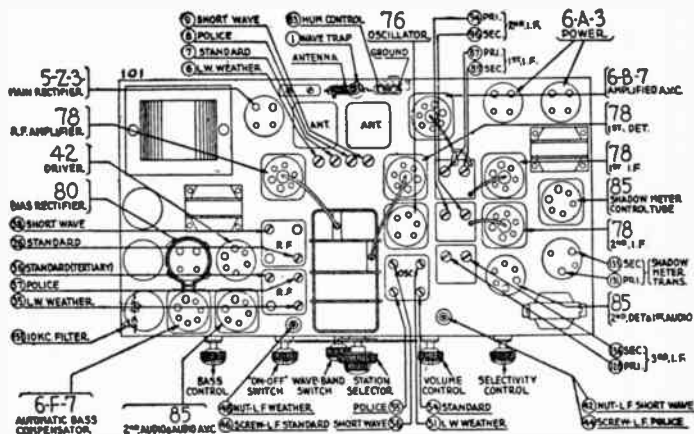

MODEL NOS. 800 (122), 802, H (122)

Signal Generator Connection	Signal Generator Frequency	Dial Position	Wave Band Switch Position	Trimmer Number	Output Signal
Remove grid clip from det.-osc. tube					
Control grid of det.-osc. tube	260 k.c.	Note 1	...	1 ²	Max.
"	"	2 ³	Max.
"	"	3 ²	Max.
"	"	4 ³	Max.
Connect grid clip to det.-osc. tube					
Ant. 4, 6	1500 k.c.	Note 5	...	7	Max.
"	1400 k.c.	140	...	6	Max.
"	"	"	...	5	Max.
"	600 k.c.	60	...	8	Max.*
"	1400 k.c.	140	...	6	Max.
"	"	"	...	5	Max.

Note 1.—*PHXD only*—Set sensitivity switch to "distance" position and tone control to "brilliant."

Note 2.—This is a screw adjustment.

Note 3.—This is a nut adjustment.

Note 4.—Through a 150 mmfd. condenser.

Note 5.—Using a piece of paper approximately .006" thick as a gauge between the heel of the rotor plates and the stator plates, turn the rotor plates until they strike the paper. This gives the correct adjustment for 1500 k.c.—150 on the dial scale.

Note 6.—When the antenna-stage adjustment is made with the receiver installed in the car, the receiver must be connected to the car antenna in the usual manner. Connect the signal-generator output to a wire placed near the car antenna but not connected to it.

* While rocking.

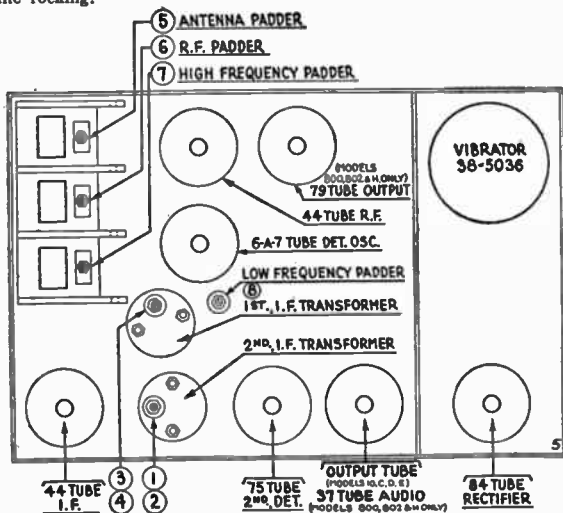

MODEL NO. 805

Signal Generator Connection	Signal Generator Frequency	Dial Position	Wave Band Switch Position	Trimmer Number	Output Signal
Remove grid clip from det.-osc. tube					
Control grid of det.-osc. tube	260 k.c.	1 ¹	Max.
"	"	2 ²	Max.
"	"	3 ¹	Max.
"	"	4 ²	Max.
Connect grid clip to det.-osc. tube					
Ant. ^{3, 5}	1600 k.c.	Note 4	...	7	Max.
"	1400 k.c.	140	...	6	Max.
"	"	"	...	5	Max.
"	600 k.c.	60	...	8	Max.*
"	1400 k.c.	140	...	6	Max.
"	"	"	...	5	Max.

Note 1.—This is a screw adjustment.

Note 2.—This is a nut adjustment.

Note 3.—Through a 150 mmfd. condenser.

Note 4.—Turn the tuning condenser plates wide open. This gives the correct adjustment for 1600 k.c.—160 on the dial scale.

Note 5.—When the antenna-stage adjustment is made with the receiver installed in the car, the receiver must be connected to the car antenna in the usual manner. Connect the signal-generator output to a wire placed near the car antenna but not connected to it.

* While rocking.

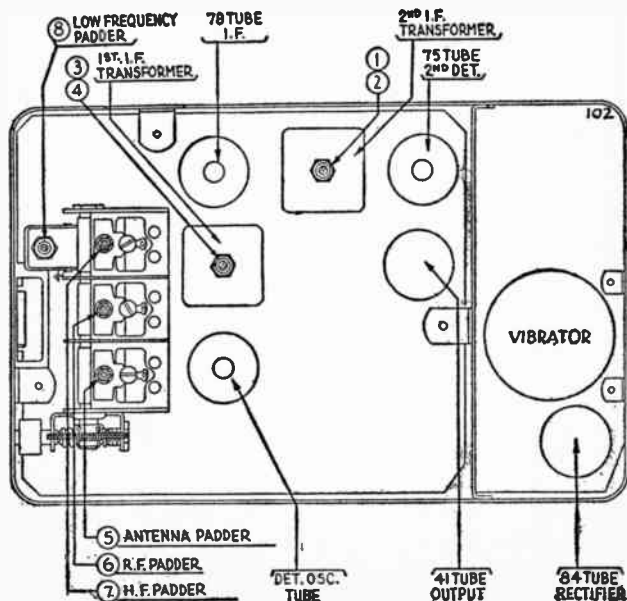

MODEL NOS. 806, 808, 809, T7, T8

Signal Generator Connection	Signal Generator Frequency	Dial Position	Wave Band Switch Position	Trimmer Number	Output Signal
Remove grid clip from det.-osc. tube					
Control grid of det.-osc. tube	260 k.c.	1 ¹	Max.
"	"	2 ²	Max.
"	"	3 ¹	Max.
"	"	4 ²	Max.
Connect grid clip to det.-osc. tube					
Ant. ^{3, 5}	1800 k.c.	Note 4	...	7	Max.
"	1400 k.c.	140	...	6	Max.
"	"	"	...	5	Max.
"	600 k.c.	60	...	8	Max.*
"	1400 k.c.	140	...	6	Max.
"	"	"	...	5	Max.

Note 1.—This is a screw adjustment.

Note 2.—This is a nut adjustment.

Note 3.—Through a 150 mmfd. condenser.

Note 4.—Turn the tuning condenser plates wide open. This gives the correct adjustment for 1800 k.c.—160 on the dial scale.

Note 5.—When the antenna-stage adjustment is made with the receiver installed in the car, the receiver must be connected to the car antenna in the usual manner. Connect the signal-generator output to a wire placed near the car antenna but not connected to it.

* While rocking.

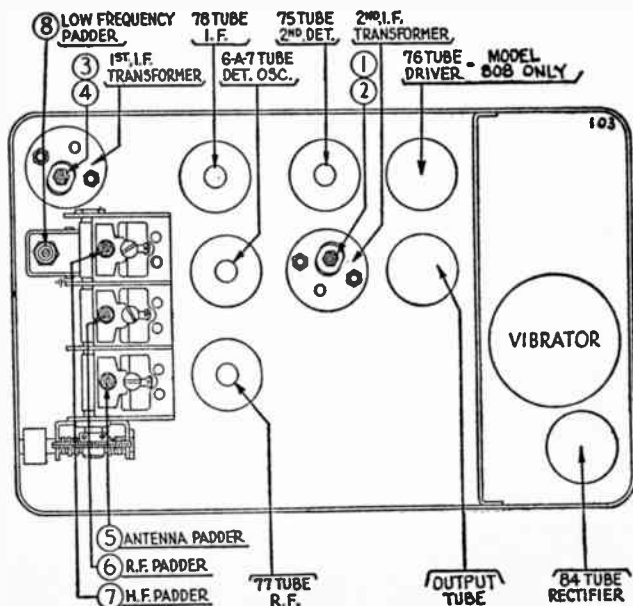

MODEL NOS. 810 PA—810 PB

Signal Generator Connection	Signal Generator Frequency	Dial Position	Wave Band Switch Position	Trimmer Number	Output Signal
Remove grid clip from i.f. tube					
Control grid of i.f. tube	Note 1	Note 2	...	24 ³	Max.
"	"	"	...	26 ⁴	Max.
Connect grid clip to i.f. tube and remove grid clip from det.-osc. tube					
Control grid of det.-osc. tube	Note 1	Note 2	...	19 ³	Max.
"	"	"	...	21 ⁵	Max.
"	"	"	...	24	Max.
"	"	"	...	26	Max.
"	"	"	...	19	Max.
"	"	"	...	21	Max.
Ant. ⁶	Note 6	Note 7	...	6 ⁸	Max.
"	"	"	...	10 ⁸	Max.
"	"	"	...	17 ^{9, 11}	Max.
"	"	"	...	13 ^{10, 11}	Max.
Note 12	...	"	...	6	Max.
"	...	"	...	10	Max.
"	...	"	...	13 ¹⁰	Max.
"	...	"	...	17 ⁹	Max.
"	...	"	...	24	Max.
"	...	"	...	26	Max.
"	...	"	...	19	Max.
"	...	"	...	21	Max.

Caution: Do not open crystal holder. If it has been opened, crystal and plates should be carefully cleaned with carbon tetrachloride, and afterward must not be touched by the fingers. Use clean cloth for handling.

Note 1.—The intermediate frequency is the difference between the frequency of the receiver crystal and the transmitter frequency.

	Range of Receiver	Crystal Frequency	Crystal Part No.
Model 810-P A	1565-1665 k.c.	1875 k.c.	45-2101
	1660-1760 k.c.	1970 k.c.	45-2102
Model 810-P B	2100-2200 k.c.	2410 k.c.	45-2103
	2200-2300 k.c.	2510 k.c.	45-2104
	2300-2400 k.c.	2610 k.c.	45-2105
	2400-2500 k.c.	2710 k.c.	45-2106

Adjust signal-generator output level to give low indication on output meter. Signal should not be strong enough to operate receiver automatic volume control.

- Note 2.—Allow receiver to “warm-up” before adjustment, and readjust after it has operated for several hours. Turn receiver “Q” switch to “off.”
- Note 3.—Screw adjustment.
- Note 4.—Nut adjustment.
- Note 5.—Through 200 mmfd. condenser.
- Note 6.—Signal-generator frequency same as transmitter frequency.
- Note 7.—Unlock the variable-condenser gang by adjusting its two set screws, and tune it to the input frequency. If crystal-oscillator circuit does not function, loosen (13) on the oscillator section of the tuning condenser and (17). The receiver-oscillator output can be increased, if necessary, by adjusting (13) for the higher frequencies and (17) for the lower frequencies.
- Note 8.—If (6) or (10) are too loose after the adjustment, back out the tuning-condenser slightly—if too tight, turn the tuning-condenser in slightly. Then readjust (6) and (10).
- Note 9.—On Model 810 PA (lower frequency band).
- Note 10.—For Model 810 PB (higher frequency band).
- Note 11.—This adjustment will not give a sharp peak, but it is possible to adjust for maximum output. Then back off adjusting nut $\frac{1}{2}$ turn.
- Note 12.—Recheck using a test tone from the police transmitter, connected to the antenna lead through a 200 mmfd. condenser.

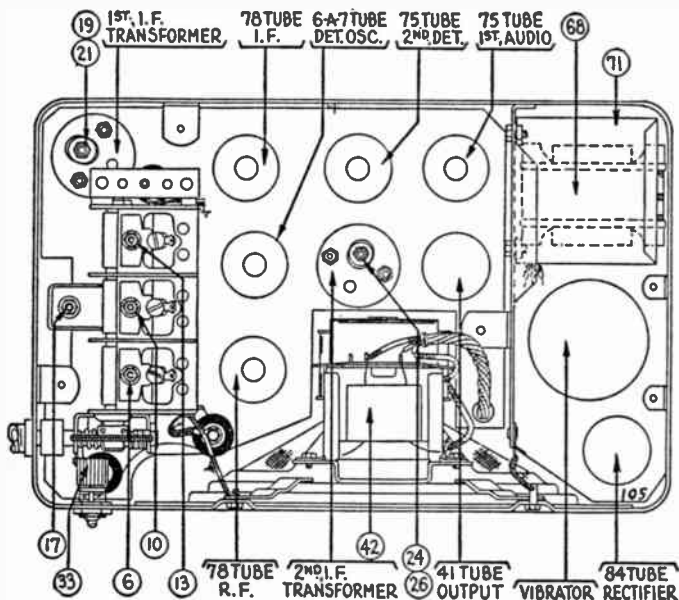

MODEL NO. 810 PV

Signal Generator Connection	Signal Generator Frequency	Dial Position	Wave Band Switch Position	Trimmer Number	Output Signal
Remove grid clip from i.f. tube					
Control grid of i.f. tube	260 k.c. ¹	Note 2	...	24 ³	Max.
"	"	"	...	26 ⁴	Max.
Connect grid clip to i.f. tube and remove grid clip from 6A7					
Control grid of 6A7	"	"	...	19 ⁵	Max.
"	"	"	...	21 ⁴	Max.
Control grid of r.f. tube	2600 k.c.	Note 5	...	10	Max.
"	"	"	...	13	Max.
"	1600 k.c.	1600 k.c.	...	17	Max.*
"	2600 k.c.	Note 5	...	13	Max.
Ant. ⁶	"	"	...	6	Max.

Note 1.—Adjust signal-generator output level to give low indication on output meter. Signal should not be strong enough to operate receiver automatic volume control.

Note 2.—Set receiver "Q" switch to "off."

Note 3.—Screw adjustment.

Note 4.—Nut adjustment.

Note 5.—Turn tuning-condenser gang to minimum-capacity position, using a strip of bond paper as a gauge between the stator and the heel of the rotor plates. This gives the correct setting for 2600 k.c.—2.6 on the dial scale.

Note 6.—Through a 200 mmfd. condenser.

* While rocking.

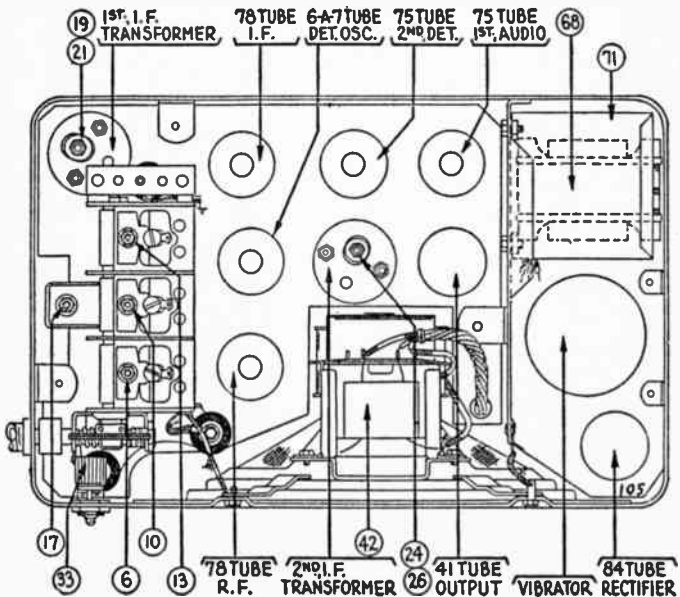

MODEL NO. 811 PV

Signal Generator Connection	Signal Generator Frequency	Dial Position	Wave Band Switch Position	Trimmer Number	Output Signal
Control grid ¹ of i.f. tube	260 k.c. ²	Note 3	...	22	Max.
"	"	"	...	24	Max.
Control grid ¹ of det.-osc. tube	"	"	...	19	Max.
"	"	"	...	21	Max.
Control grid ¹ of r.f. tube	2600 k.c.	Note 4	...	10	Max.
"	"	"	...	13	Max.
"	1600 k.c.	1600 k.c.	...	17	Max.*
"	2600 k.c.	Note 4	...	13	Max.
Ant. ⁵	"	"	...	6	Max.

Note 1.—Through .1 mfd. condenser.

Note 2.—Adjust signal-generator output level to give low indication on output meter. Signal should not be strong enough to operate receiver automatic-volume control.

Note 3.—Set receiver "Q" switch to "off."

Note 4.—Turn tuning-condenser gang to minimum capacity position, using a strip of bond paper as a gauge between stator and heel of rotor plates. This gives the true setting for 2600 k.c.—2.6 on the dial scale.

Note 5.—Through 200 mmfd. condenser.

IMPORTANT: All adjustments should be repeated after the receiver has been operated at 8 volts for about 8 hours.

* While rocking.

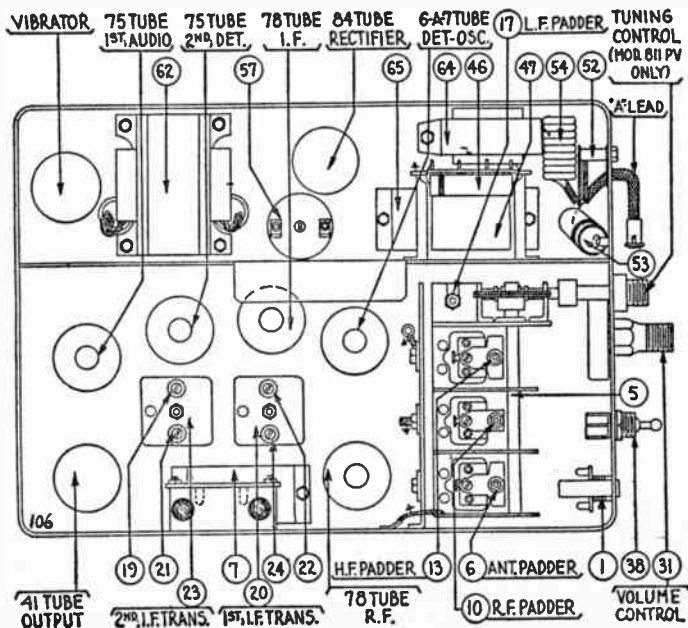

MODEL NOS. 811 PA—811 PB

Signal Generator Connection	Signal Generator Frequency	Dial Position	Wave Band Switch Position	Trimmer Number	Output Signal
Control grid ¹ of i.f. tube	Note 2	Note 3	...	22	Max.
"	"	"	...	24	Max.
Control grid ¹ of det.-osc. tube	"	"	...	19	Max.
"	"	"	...	21	Max.
"	"	"	...	22	Max.
"	"	"	...	24	Max.
"	"	"	...	19	Max.
"	"	"	...	21	Max.
Ant. ⁴	Note 5	Note 6	...	6 ⁷	Max.
"	"	"	...	10 ⁷	Max.
"	"	"	...	17 ^{8, 10}	Max.
"	"	"	...	13 ^{9, 10}	Max.
Note 11	...	"	...	6	Max.
"	...	"	...	10	Max.
"	...	"	...	13 ⁹	Max.
"	...	"	...	17 ⁸	Max.
"	...	"	...	22	Max.
"	...	"	...	24	Max.
"	...	"	...	19	Max.
"	...	"	...	21	Max.

IMPORTANT: These adjustments should be repeated after the receiver has been operated at 8 volts for about 8 hours.

CAUTION: Do not open crystal holder. If it has been opened, crystal and plates should be carefully cleaned with carbon tetrachloride and must not be touched by the fingers afterwards. Use clean cloth for handling.

Note 1.—Through .1 mfd. condenser.

Note 2.—The intermediate frequency is the difference between the frequency of the receiver crystal and the transmitter frequency.

	Range of Receiver	Crystal Frequency	Crystal Part No.
Model 811 PA	1630-1634-1642-1650-1658-1666 k.c.	1908 k.c.	45-2194
	1674-1682-1690-1698-1706-1712 k.c.	1953 k.c.	45-2195
Model 811 PB	2382-2390-2398-2406-2414 k.c.	2658 k.c.	45-2196
	2422-2430-2442-2450 k.c.	2696 k.c.	45-2197
	2458-2466-2474-2482-2490 k.c.	2734 k.c.	45-2198

Adjust signal-generator output level to give low indication on output meter. Signal should not be strong enough to operate receiver automatic-volume control.

Note 3.—Allow receiver to warm-up before adjusting. Turn receiver "Q" switch to "off."

Note 4.—Through 200 mmfd. condenser.

Note 5.—Signal-generator frequency same as transmitter frequency.

Note 6.—Unlock variable-condenser gang by adjusting its two set screws and tune it to the input frequency. If crystal oscillator circuit does not function, loosen (13) on oscillator section of tuning condenser gang and (17). Receiver-oscillator output can be increased, if necessary, by adjusting (13) for the higher frequencies and (17) for the lower frequencies.

Note 7.—If (6) or (10) are too loose after the adjustment, back out tuning-condenser slightly—if too tight, turn tuning-condenser in slightly. Then readjust (6) and (10).

Note 8.—On Model 811 PA (lower frequency band).

Note 9.—On Model 811 PB (higher frequency band).

Note 10.—This adjustment will not give a sharp peak, but it is possible to adjust for maximum output. Then back off adjusting nut $\frac{1}{2}$ turn.

Note 11.—Recheck using a test tone from the police transmitter, connected to the antenna lead through a 200 mmfd. condenser.

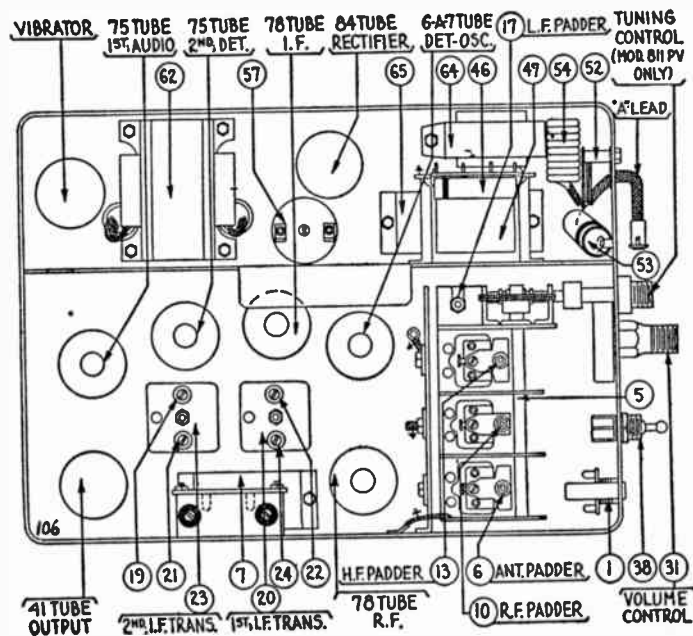

MODEL NO. 816

Signal Generator Connection	Signal Generator Frequency	Dial Position	Wave Band Switch Position	Trimmer Number	Output Signal
Control grid ¹ of i.f. tube	260 k.c.	1	Max.
"	"	2	Max.
Control grid ¹ of det.-osc. tube	"	3	Max.
"	"	4	Max.
Control grid ¹ of r.f. tube	1550 k.c.	Note 2	...	7	Max.
"	"	"	...	6	Max.
"	580 k.c.	58	...	8	Max.*
"	1550 k.c.	155	...	7	Max.
Ant. ^{3, 4}	580 k.c.	58	...	9	Max.
"	1400 k.c.	140	...	6	Max.
"	"	"	...	5	Max.

Note 1.—Through a .1 mfd. condenser. Do not remove the grid clip.

Note 2.—Turn tuning-condenser plates out of mesh as far as they will go. This adjustment gives the true setting for 1550 k.c.—155 on the dial scale.

Note 3.—Connect the signal-generator lead to the antenna cable assembly (made up of Part No. L 1915 loom, 1-27-7133 terminal and 40 inches of 16 strand #30 wire) through a 200 mmfd. condenser. Place the connector plug in the antenna socket on the receiver. Plug the cable into the antenna socket.

Note 4.—When the antenna stage adjustment is made with the receiver installed in the car, the receiver antenna lead must be connected to the car antenna in the usual manner. The signal-generator output lead should be connected to a wire placed near the car antenna but not connected to it.

* While rocking.

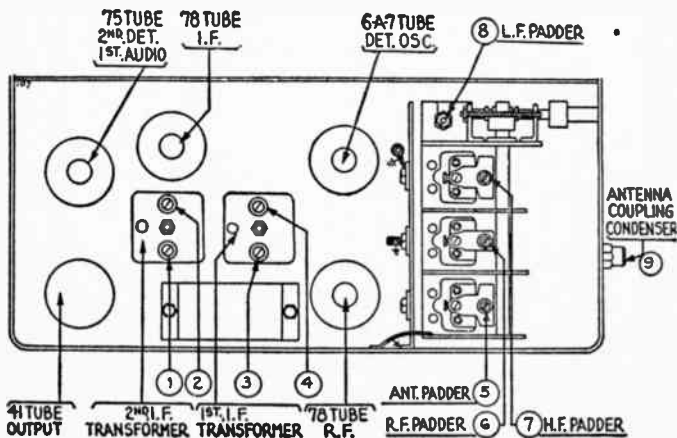

MODEL NOS. 817, 818

Signal Generator Connection	Signal Generator Frequency	Dial Position	Wave Band Switch Position	Trimmer Number	Output Signal
Control grid ¹ of i.f. tube	260 k.c.	1	Max.
“	“	2	Max.
Control grid ¹ of det-osc. tube	“	3	Max.
“	“	4	Max.
Control grid ¹ of r.f. tube	1550 k.c.	Note 2	...	7	Max.
“	“	“	...	6	Max.
“	580 k.c.	58	...	8	Max.*
“	1550 k.c.	155	...	7	Max.
Ant. ^{3, 4}	580 k.c.	58	...	9	Max.
“	1400 k.c.	140	...	6	Max.
“	“	“	...	5	Max.

Note 1.—Through a .1 mfd. condenser. Do not remove the grid clip.

Note 2.—Turn tuning-condenser plates out of mesh as far as they will go. This adjustment gives the true setting for 1550 k.c.—155 on the dial scale.

Note 3.—Connect the signal-generator lead to the antenna cable assembly (made up of Part No. L 1915 loom, 1-27-7133 terminal and 40 inches of 16 strand #30 wire) through a 200 mmfd. condenser. Place the connector plug in the antenna socket on the receiver. Plug the cable into the antenna socket.

Note 4.—When the antenna stage adjustment is made with the receiver installed in the car, the receiver antenna lead must be connected to the car antenna in the usual manner. The signal-generator output lead should be connected to a wire placed near the car antenna but not connected to it.

* While rocking.

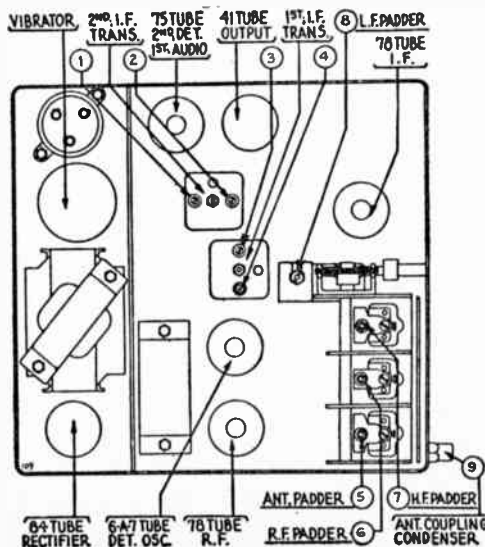

MODEL NOS. 819, 819H

Signal Generator Connection	Signal Generator Frequency	Dial Position	Wave Band Switch Position	Trimmer Number	Output Signal
Control grid ¹ of i.f. tube	260 k.c.	1	Max.
"	"	2	Max.
Control grid ¹ of det-osc. tube	"	3	Max.
"	"	4	Max.
Control grid ¹ of r.f. tube	1550 k.c.	Note 2	...	7	Max.
"	"	"	...	6	Max.
"	580 k.c.	58	...	8	Max.*
"	1550 k.c.	155	...	7	Max.
Ant. ^{3, 4}	580 k.c.	58	...	9	Max.
"	1400 k.c.	140	...	6	Max.
"	"	"	...	5	Max.

Note 1.—Through a .1 mfd. condenser. Do not remove the grid clip.

Note 2.—Turn tuning-condenser plates out of mesh as far as they will go. This adjustment gives the true setting for 1550 k.c.—155 on the dial scale.

Note 3.—Connect the signal-generator lead to the antenna cable assembly (made up of Part No. L 1915 loom, 1-27-7133 terminal and 40 inches of 16 strand #30 wire) through a 200 mmfd. condenser. Place the connector plug in the antenna socket on the receiver. Plug the cable into the antenna socket.

Note 4.—When the antenna stage adjustment is made with the receiver installed in the car, the receiver antenna lead must be connected to the car antenna in the usual manner. The signal-generator output lead should be connected to a wire placed near the car antenna but not connected to it.

* While rocking.

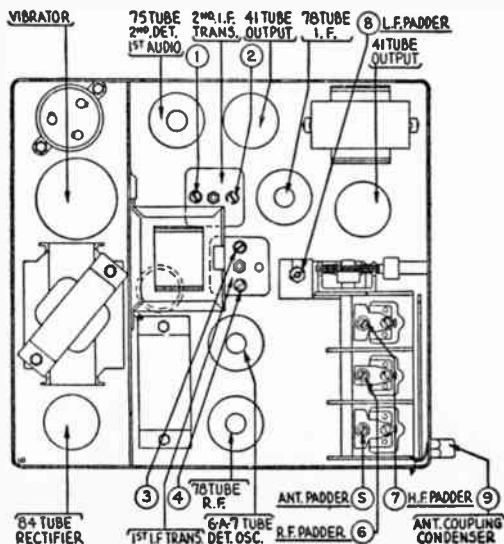

MODEL NOS. P-1417, G-1418, N-1418

Signal Generator Connection	Signal Generator Frequency	Dial Position	Wave Band Switch Position	Trimmer Number	Output Signal
Control grid ¹ of i.f. tube	260 k.c.	1	Max.
"	"	2	Max.
Control grid ¹ of det.-osc. tube	"	3	Max.
"	"	4	Max.
"	"	1	Max.
"	"	2	Max.
Control grid of r.f. tube	1550 k.c.	Note 2	...	7	Max.
"	"	"	...	6	Max.
"	600 k.c.	60	...	8	Max.*
"	1550 k.c.	155	...	7	Max.
Ant. ^{3, 4}	600 k.c.	60	...	9	Max.
"	1400 k.c.	140	...	6	Max.
"	"	"	...	5	Max.

Note 1.—Through a .1 mfd. condenser.

Note 2.—Turn the tuning-condenser plates out of mesh as far as they will go. This adjustment gives the true setting for 1550 k.c.—155 on the dial scale.

Note 3.—For *G-1418* and *N-1418*: Connect the signal-generator lead to the antenna cable assembly (made up of Part No. 38-7295 cable) through a 155 mmfd. condenser. Plug the cable into the antenna receptacle on the bottom of the receiver.

For *P-1417*: Connect the signal-generator to the antenna through a 280 mmfd. condenser. This value must be used.

Note 4.—When the antenna-stage adjustment is made with the receiver installed in the car, the receiver antenna lead must be connected to the car antenna in the usual manner. Connect the signal-generator output lead to a wire placed near the car antenna but not connected to it.

* While rocking.

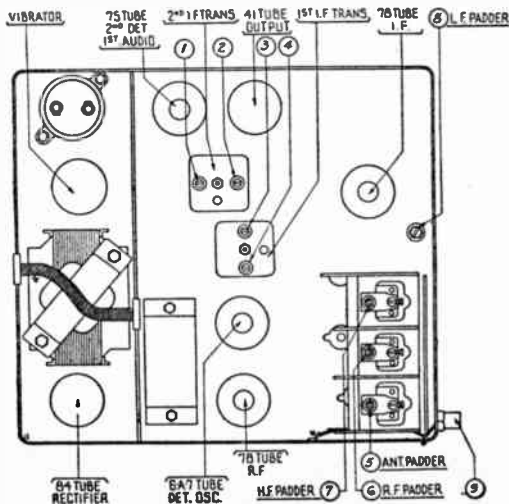

MODEL NOS. P-1421, T10

Signal Generator Connection	Signal Generator Frequency	Dial Position	Wave Band Switch Position	Trimmer Number	Output Signal
Control grid ¹ of i.f. tube	260 k.c.	1	Max.
"	"	2	Max.
Control ¹ grid of det.-osc. tube	"	3	Max.
"	"	4	Max.
"	"	1	Max.
"	"	2	Max.
Control ¹ grid of r.f. tube	1550 k.c.	Note 2	...	7	Max.
"	"	"	...	6	Max.
"	600 k.c.	60	...	8	Max.*
"	1550 k.c.	155	...	7	Max.
Ant. ^{3, 4}	1400 k.c.	140	...	6	Max.
"	"	"	...	5	Max.

Note 1.—Through a .1 mfd. condenser.

Note 2.—Turn the tuning-condenser plates out of mesh. Insert a strip of paper about .008" thick as a gauge between the heel of the rotor plates and the stator plates; then turn the rotor plates until they strike against this paper strip. This adjustment gives the true setting for 1550 k.c.—155 on dial scale.

Note 3.—For P-1421: through a 280 mmfd. condenser. For T10: through a 2100 mmfd. condenser.

Note 4.—When the antenna-stage adjustment is made with the receiver installed in the car, the receiver antenna lead must be connected to the car antenna in the usual manner. Connect the signal-generator output lead to a wire placed near the car antenna, but not connected to it.

* While rocking.

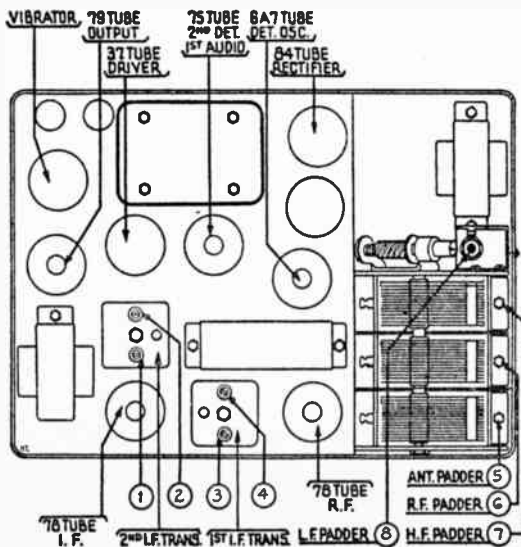

MODEL NOS. P-1430, S-1431, N-1433, G-1436

Signal Generator Connection	Signal Generator Frequency	Dial Position	Wave Band Switch Position	Trimmer Number	Output Signal
Control grid ¹ of i.f. tube	260 k.c.	1	Max.
"	"	2	Max.
Control grid ¹ of det.-osc. tube	"	3	Max.
"	"	4	Max.
"	"	1	Max.
"	"	2	Max.
Control grid ¹ of r.f. tube	1550 k.c.	Note 2	...	7	Max.
"	"	"	...	6	Max.
"	600 k.c.	60	...	8	Max.*
"	1550 k.c.	155	...	7	Max.
Ant. ^{3, 4}	1400 k.c.	140	...	6	Max.
"	"	"	...	5	Max.

Note 1.—Through a .1 mfd. condenser.

Note 2.—Turn the tuning-condenser plates out of mesh. Insert a strip of paper about .006" thick as a gauge between the heel of the rotor plates and the stator plates; then turn the rotor plates until they strike against this paper strip. This adjustment gives the true setting for 1550 k.c.—155 on the dial scale.

Note 3.—For P-1430: Through a 280 mmfd. condenser. This value must be used.

For S-1431 and N-1433: Connect the signal-generator lead to the antenna cable Part No. L-2520 through a 64 mmfd. condenser. Plug the cable into the roof-antenna connector on the end of the receiver.

For G-1436: Connect the signal-generator lead to the antenna cable Part No. 38-7295 through a 1650 mmfd. condenser. Plug the cable into the antenna-lead connector on the end of receiver.

Note 4.—When the antenna-stage adjustment is made with the receiver installed in the car, the receiver antenna lead must be connected to the car antenna in the usual manner. Connect the signal-generator output-lead to a wire placed near the car antenna but not connected to it.

* While rocking.

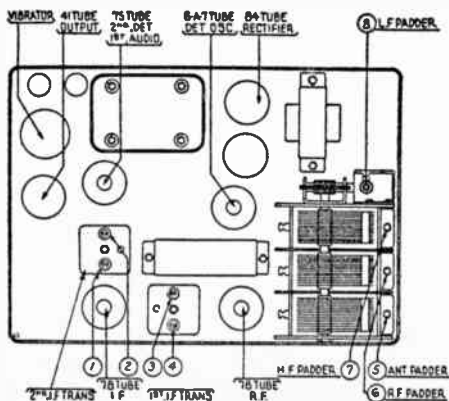

MODEL NO. 2620

Signal Generator Connection	Signal Generator Frequency	Dial Position	Wave Band Switch Position	Trimmer Number	Output Signal
Remove grid clip from i.f.					
Control grid of i.f.	460 k.c.	550 k.c.	Range 2 (left)	48	Max.
"	"	"	"	50	Max.
Connect grid clip to i.f. and disconnect grid clip from 6A7					
Control grid of 6A7	"	"	"	39	Max.
"	"	"	"	41	Max.
Connect grid clip to 6A7					
Ant.*	"	"	"	1	Min.
"	18.0 m.c.	18.0 m.c. ²	Range 3 (right)	22	Max.
"	"	"	"	28	Max.
"	"	18.0 m.c. ³	"	8	Max.
"	"	17.1 m.c.	"	Image	check
"	1500 k.c.	1500 k.c.	Range 2 (left)	11	Max.
"	"	"	"	21	Max.
"	"	"	"	26	Max.
"	580 k.c.	580 k.c.	"	7	Max.
"	1500 k.c.	1500 k.c.	"	11	Max.
"	350 k.c.	350 k.c.	Range 1 (center)	10	Max.
"	"	"	"	20	Max.
"	"	"	"	27	Max.
"	170 k.c.	170 k.c.	"	6	Max.

* Use a 200-mmf. condenser in series as dummy antenna for broadcast band and a 400-ohm carbon resistor for shortwave band.

Note 1.—Set tone control to counter clockwise position.

Note 2.—Connect an external variable condenser across oscillator section of receiver tuning condenser gang and tune this external condenser to give maximum indication on output meter.

Note 3.—Remove external variable condenser mentioned in note 2 above.

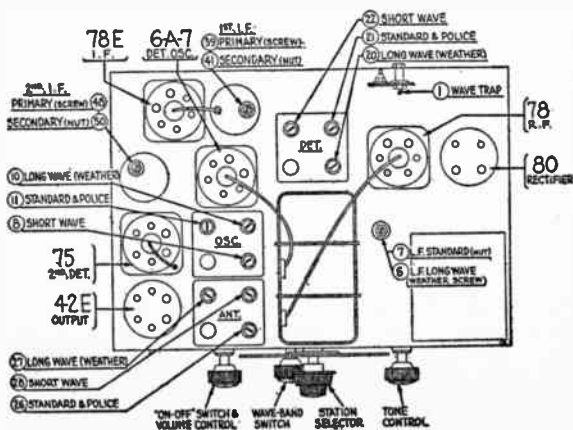

MODEL NO. G (121)

Signal Generator Connection	Signal Generator Frequency	Dial Position	Wave Band Switch Position	Trimmer Number	Output Signal
Remove grid clip from det.-osc. tube					
Control grid of det.-osc. tube	260 k.c.	1 ¹	...
"	"	2 ²	Max.
"	"	1 ³	Max.
"	"	3 ¹	...
"	"	4 ²	Max.
"	"	3 ³	Max.
Connect grid clip to det.-osc. tube					
Ant. ^{4, 6}	1500 k.c.	Note 5	...	7	Max.
"	1400 k.c.	140	...	6	Max.
"	"	"	...	5	Max.
"	600 k.c.	60	...	8	Max.*
"	1400 k.c.	140	...	6	Max.
"	"	"	...	5	Max.

Note 1.—Screw adjustment. Turn all the way in.

Note 2.—Nut adjustment.

Note 3.—This is a critical adjustment. Note the maximum reading, then turn screw in again and slowly bring adjustment to this maximum reading. Do not pass this point. If you do, repeat the adjustment.

Note 4.—Through a 150 mmfd. condenser.

Note 5.—Using a piece of paper approximately .006" thick as a gauge between the heel of the rotor plates and the stator plates, turn the rotor plates until they strike the papers. This is the correct adjustment for 1500 k.c.—150 on the dial scale.

Note 6.—When the antenna stage adjustment is made with the receiver installed in the car, the receiver must be connected to the car antenna in the usual manner. Connect the signal-generator output to a wire placed near the car antenna but not connected to it.

* While rocking.

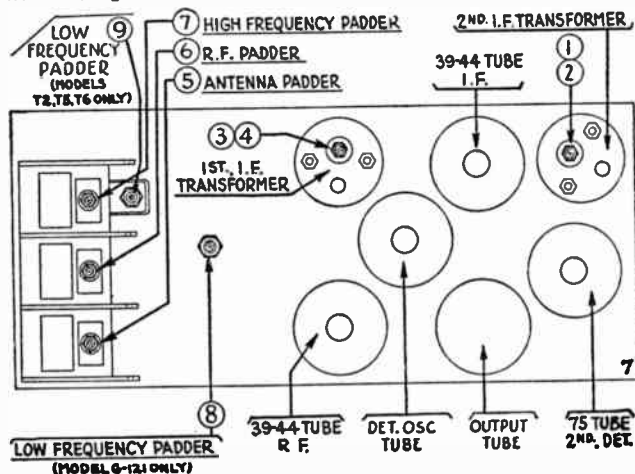

MODEL NOS. G (122), N

Signal Generator Connection	Signal Generator Frequency	Dial Position	Wave Band Switch Position	Trimmer Number	Output Signal
Remove grid clip from det.-osc. tube					
Control grid of det.-osc. tube	260 k.c.	1 ¹	...
"	"	2 ²	Max.
"	"	1 ³	Max.
"	"	3 ¹	...
"	"	4 ²	Max.
"	"	3 ³	Max.
Connect grid clip to det.-osc. tube					
Ant. ^{4, 6}	1580 k.c.	Note 5	...	7	Max.
"	1400 k.c.	140	...	6	Max.
"	"	"	...	5	Max.

Note 1.—This is screw adjustment. Turn all way in.

Note 2.—This is a nut adjustment.

Note 3.—This adjustment is critical. Note maximum reading obtainable and then turn the screw in again, just bringing it up to the maximum reading. Do not pass this point. If you do, repeat complete operation.

Note 4.—Through a 150 mmfd. condenser.

Note 5.—Using a piece of paper approximately .006" thick as a gauge between the heel of the rotor plates and the stator plates, turn the rotor plates until they strike against the paper. This is the correct adjustment for 1580 k.c.—158 on the dial scale.

Note 6.—When the antenna-stage adjustment is made with the receiver installed in the car, the receiver must be connected to the car antenna in the usual manner. Connect the signal-generator output to a wire placed near the car antenna but not connected to it.

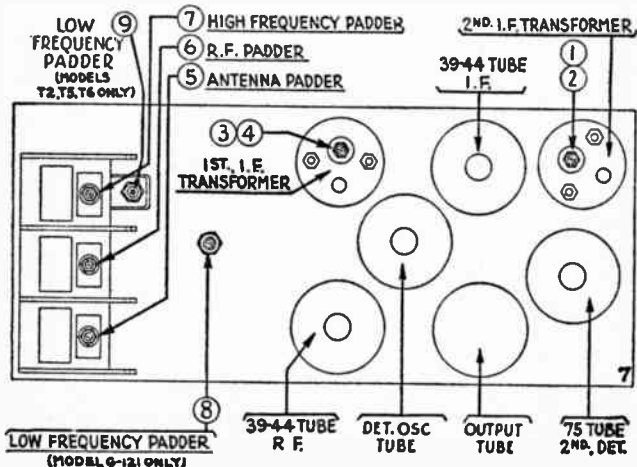

MODEL NOS. T2, T5

Signal Generator Connection	Signal Generator Frequency	Dial Position	Wave Band Switch Position	Trimmer Number	Output Signal
Remove grid clip from det.-osc. tube Control grid of det.-osc. tube	260 k.c.	1 ¹	Max.
"	"	2 ²	Max.
"	"	3 ¹	Max.
"	"	4 ²	Max.
Connect grid clip to det.-osc. tube					
Ant. ^{3, 5}	1600 k.c.	Note 4	...	7	Max.
"	1400 k.c.	140	...	6	Max.
"	"	"	...	5	Max.
"	600 k.c.	60	...	9	Max.*
"	1400 k.c.	140	...	6	Max.
"	"	"	...	5	Max.

Note 1.—This is a screw adjustment.

Note 2.—This is a nut adjustment.

Note 3.—Through a 150 mmfd. condenser.

Note 4.—Turn the tuning condenser plates wide open. This gives the correct adjustment for 1600 k.c.—160 on the dial scale.

Note 5.—When the antenna-stage adjustment is made with the receiver installed in the car, the receiver must be connected to the car antenna in the usual manner. Connect the signal-generator output to a wire placed near the car antenna but not connected to it.

* While rocking.

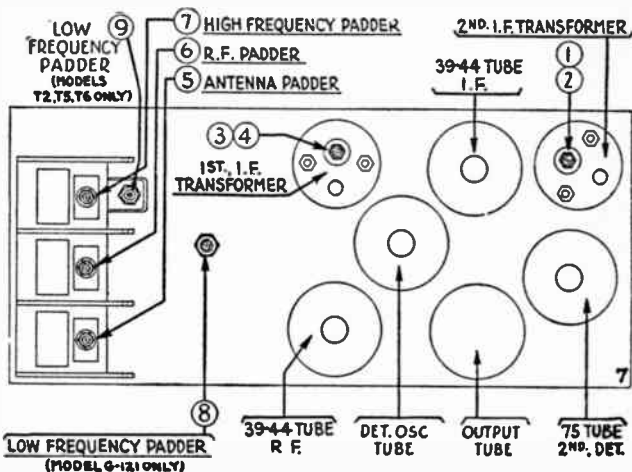

MODEL NO. T3

Signal Generator Connection	Signal Generator Frequency	Dial Position	Wave Band Switch Position	Trimmer Number	Output Signal
Remove grid clip from det.-osc. tube					
Control grid of det.-osc. tube	260 k.c.	1 ¹	Max.
"	"	2 ²	Max.
"	"	3 ¹	Max.
"	"	4 ²	Max.
Connect grid clip to det.-osc. tube					
Ant. ^{3, 5}	1600 k.c.	Note 4	...	7	Max.
"	1400 k.c.	140	...	6	Max.
"	"	"	...	5	Max.
"	600 k.c.	60	...	8	Max.*
"	1400 k.c.	140	...	6	Max.
"	"	"	...	5	Max.

Note 1.—This is a screw adjustment.

Note 2.—This is a nut adjustment.

Note 3.—Through a 150 mmfd. condenser.

Note 4.—Turn the tuning condenser plates wide open. This gives the correct adjustment for 1600 k.c.—160 on the dial scale.

Note 5.—When the antenna-stage adjustment is made with the receiver installed in the car, the receiver must be connected to the car antenna in the usual manner. Connect the signal-generator output to a wire placed near the car antenna but not connected to it.

* While rocking.

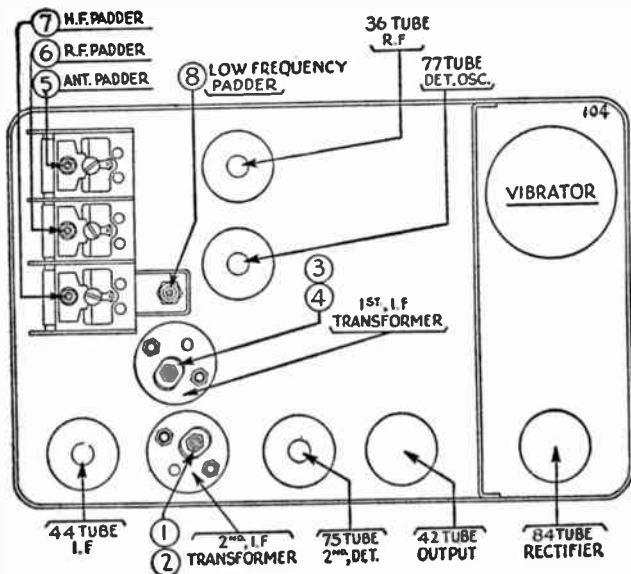

MODEL NOS. T6, FT6

Signal Generator Connection	Signal Generator Frequency	Dial Position	Wave Band Switch Position	Trimmer Number	Output Signal
Remove grid clip from det.-osc. tube					
Control grid of r.f. tube	260 k.c.	1 ¹	...
"	"	2 ²	Max.
"	"	1 ³	Max.
"	"	3 ¹	...
"	"	4 ²	Max.
"	"	3 ³	Max.
Connect grid clip to det.-osc. tube					
Ant. ^{4, 6}	1600 k.c.	Note 5	...	7	Max.
"	1400 k.c.	140	...	6	Max.
"	"	"	...	5	Max.
"	600 k.c.	60	...	9	Max.*
"	1600 k.c.	160	...	7	Max.
"	1400 k.c.	140	...	6	Max.
"	"	"	...	5	Max.

Note 1.—Screw adjustment. Turn all the way in.

Note 2.—Nut adjustment.

Note 3.—This is a critical adjustment. Note the maximum reading, then turn the screw in again and slowly bring the adjustment to this maximum reading. Do not pass this point. If you do, repeat the adjustment.

Note 4.—Through a 150 mmfd. condenser.

Note 5.—Turn the tuning-condenser plates wide open. This adjustment gives the true setting for 1600 k.c.—160 on the dial scale.

Note 6.—When the antenna-stage adjustment is made with the receiver installed in the car, the receiver must be connected to the car antenna in the usual manner. Connect the signal-generator output to a wire placed near the car antenna but not connected to it.

* While rocking.

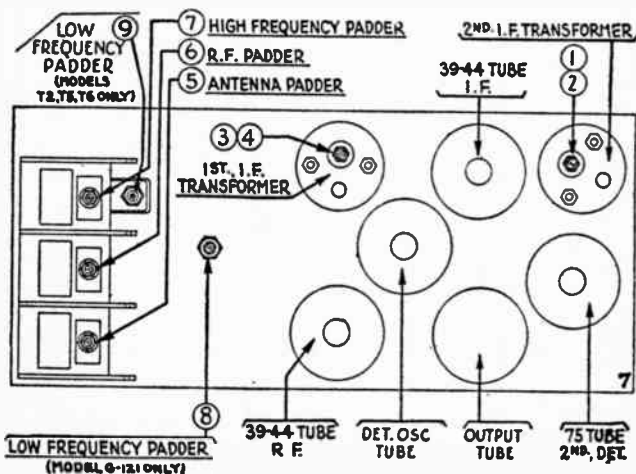

MODEL NOS. T9, T11, T12, T14, T15

Signal Generator Connection	Signal Generator Frequency	Dial Position	Wave Band Switch Position	Trimmer Number	Output Signal
Control grid ¹ of i.f. tube	260 k.c.	Note 2	...	1	Max.
"	"	2	Max.
Control grid ¹ of det.-osc. tube	"	3	Max.
"	"	4	Max.
Control grid ¹ of r.f. tube	1600 k.c.	Note 3	...	7	Max.
"	"	"	...	6	Max.
"	580 k.c.	58	...	8	Max.*
"	1600 k.c.	160	...	7	Max.
Ant. ^{4, 5}	1400 k.c.	140	...	6	Max.
"	"	"	...	5	Max.

Note 1.—Through a .1 mfd. condenser.

Note 2.—For T12, T14: Set the sensitivity switch to the "distance" position and the tone control to the "brilliant" position.

Note 3.—Turn the tuning-condenser plates out of mesh as far as they will go. This adjustment gives the true setting for 1600 k.c.—160 on the dial scale.

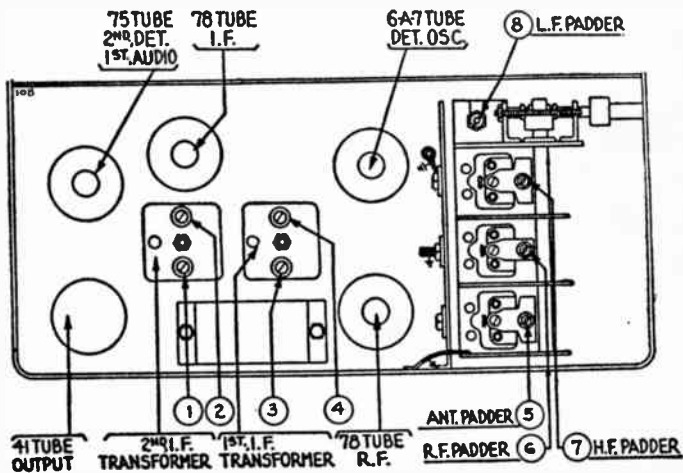

Note 4.—*For T9:* Through a 125 mmfd. condenser.

For T11: Connect the signal-generator lead to the antenna cable assembly (made up of Part No. L 1915 loom and 40 inches of 16 strand #30 wire) through a 110 mmfd. condenser. Plug the cable into the antenna socket marked "Fabric Top."

For NT12X and ST12: Connect the signal-generator lead to the antenna cable assembly (made up of Part No. L 1915 loom, 1-27-7133 terminal and 40 inches of 16 strand #30 wire) through a 200 mmfd. condenser. Plug the cable into the antenna socket.

For NT12X2: Connect the signal-generator lead to the antenna lead, using a 1250 mmfd. condenser and a 50 ohm non-inductive resistor as a dummy antenna. Plug the antenna lead into the antenna socket.

For T14: Connect the signal-generator lead to the antenna lead, using a 230 mmfd. condenser in series between the two leads and the .1 mfd. condenser.

For LT14X3: Connect the signal-generator lead to the antenna cable assembly (made up of Part No. L 1963 loom, 1-27-7133 terminal and 64 inches of 16 strand #30 wire) through a 530 mmfd. condenser. Plug the cable into the antenna socket.

For T16: Connect the signal-generator lead to the antenna cable assembly (made up of Part No. L 1915 loom, 1-27-7133 terminal and 40 inches of 16 strand #30 wire) through a 200 mmfd. condenser. Plug the cable into the antenna socket.

Note 5.—When the antenna-stage adjustment is made with the receiver installed in the car, the receiver antenna lead must be connected to the car antenna in the usual manner. The signal-generator output-lead should be connected to a wire placed near the car antenna but not connected to it.

* While rocking.

