

Altivar Process ATV900

Variable Speed Drives

Programming Manual

05/2019



The information provided in this documentation contains general descriptions and/or technical characteristics of the performance of the products contained herein. This documentation is not intended as a substitute for and is not to be used for determining suitability or reliability of these products for specific user applications. It is the duty of any such user or integrator to perform the appropriate and complete risk analysis, evaluation and testing of the products with respect to the relevant specific application or use thereof. Neither Schneider Electric nor any of its affiliates or subsidiaries shall be responsible or liable for misuse of the information contained herein. If you have any suggestions for improvements or amendments or have found errors in this publication, please notify us.

You agree not to reproduce, other than for your own personal, noncommercial use, all or part of this document on any medium whatsoever without permission of Schneider Electric, given in writing. You also agree not to establish any hypertext links to this document or its content. Schneider Electric does not grant any right or license for the personal and noncommercial use of the document or its content, except for a non-exclusive license to consult it on an "as is" basis, at your own risk. All other rights are reserved.

All pertinent state, regional, and local safety regulations must be observed when installing and using this product. For reasons of safety and to help ensure compliance with documented system data, only the manufacturer should perform repairs to components.

When devices are used for applications with technical safety requirements, the relevant instructions must be followed.

Failure to use Schneider Electric software or approved software with our hardware products may result in injury, harm, or improper operating results.

Failure to observe this information can result in injury or equipment damage.

© 2019 Schneider Electric. All rights reserved.

Table of Contents



	Safety Information	15
	About the Book	21
Part I	Introduction	25
Chapter 1	Setup	27
	Initial Steps	28
	Steps for Setting-Up the Drive	30
	Software Enhancements	32
Chapter 2	Overview	35
	Factory Configuration	36
	Application Functions	37
	Basic Functions	40
	Graphic Display Terminal	41
	Multipoint Screen	45
	Structure of the Parameter Table	47
	Finding a Parameter in This Document	48
Chapter 3	Cyber Security	49
	Cyber Security	49
Part II	Programming	51
Chapter 4	[Simply start] 5 Y 5 -	53
	[Simply start] 5 , П - Menu	54
	[My menu] П Y П П - Menu	61
	[Modified parameters] L П d - Menu	61
Chapter 5	[Dashboard] d 5 H -	63
	[System] d 5 t - Menu	64
	[Dashboard] d 5 H - Menu	65
	[kWh Counters] K W C - menu	65
	[Dashboard] d 5 H - Menu	67
Chapter 6	[Diagnostics] d , R -	69
6.1	[Diag. data]	70
	[Diag. data] d d t - Menu	71
	[Service message] 5 E r - Menu	72
	[Other State] 5 5 t - Menu	73
	[Diagnostics] d R u - Menu	74
	[Identification] o , d - Menu	74
6.2	[Error history] P F H - Menu	75
	[Error history] P F H - Menu	75
6.3	[Warnings] R L r - Menu	78
	[Actual warnings] R L r d - Menu	79
	[Warning group 1 definition] R 1 C - Menu	79
	[Warning group 2 definition] R 2 C - Menu	79
	[Warning group 3 definition] R 3 C - Menu	79
	[Warning group 4 definition] R 4 C - Menu	79
	[Warning group 5 definition] R 5 C - Menu	80
	[Warnings] R L r - Menu	80
Chapter 7	[Display] П o n -	81
7.1	[Energy parameters]	82
	[Elec Ener Input Counter] E L i - Menu	83
	[Elec Ener Output Counter] E L o - Menu	85
	[Mechanical energy] П E C - Menu	87
	[Energy saving] E 5 R - Menu	88

7.2	[Application parameters]	89
	[Application parameters] <i>APP</i> - Menu	89
7.3	[Pump parameters]	90
	[Variable speed pump] <i>PPP</i> - Menu	90
7.4	[M/S parameters]	91
	[M/S Local Display] <i>MSL</i> - Menu	92
	[M/S System Display] <i>MSR</i> - Menu	94
7.5	[Motor parameters]	96
	[Motor parameters] <i>MPM</i> - Menu	96
7.6	[Drive parameters]	98
	[Drive parameters] <i>MPD</i> - Menu	98
7.7	[Thermal monitoring]	102
	[Thermal Monitoring] <i>MPM</i> - Menu	102
7.8	[PID display]	103
	[PID display] <i>MPID</i> - Menu	103
7.9	[Counter management]	104
	[Counter Management] <i>MPM</i> - Menu	104
7.10	[Other state]	107
	[Other state] <i>MSL</i> - Menu	107
7.11	[I/O map]	108
	[Digital Input Map] <i>MDI</i> - Menu	109
	[AI1] <i>MDI1</i> - Menu	110
	[AI2] <i>MDI2</i> - Menu	112
	[AI3] <i>MDI3</i> - Menu	113
	[AI4] <i>MDI4</i> - Menu	114
	[AI5] <i>MDI5</i> - Menu	115
	[Analog inputs image] <i>MDI</i> - Menu	116
	[Digital output map] <i>MDO</i> - Menu	116
	[AQ1] <i>MDO1</i> - Menu	117
	[AQ2] <i>MDO2</i> - Menu	121
	[PTO Frequency] <i>MDO</i> - Menu	123
	[DI7 frequency measured] <i>MDI7</i> - Menu	125
	[DI8 frequency measured] <i>MDI8</i> - Menu	127
	[Freq. signal image] <i>MDI</i> - Menu	128
	[Cabinet Digital Input Map] <i>MDI</i> - Menu	129
	[Cabinet Digital Output Map] <i>MDO</i> - Menu	129
7.12	[Communication map]	130
	[Communication map] <i>MDI</i> - Menu	131
	[Modbus network diag] <i>MDI</i> - Menu	134
	[Com. scanner input map] <i>MDI</i> - Menu	135
	[Com scan output map] <i>MDO</i> - Menu	136
	[Modbus HMI Diag] <i>MDI</i> - Menu	137
	[Ethernet Emb Diag] <i>MDI</i> - Menu	138
	[DeviceNet Diag] <i>MDI</i> - Menu	139
	[Profibus Diag] <i>MDI</i> - Menu	140
	[PROFINET Diag] <i>MDI</i> - Menu	142
	[EtherCAT Module Diag] <i>MDI</i> - Menu	144
	[Powerlink Diag] <i>MDI</i> - Menu	145
	[Command word image] <i>MDI</i> - Menu	146
	[Freq. ref. word map] <i>MDI</i> - Menu	147
	[CANopen map] <i>MDI</i> - Menu	148
	[PDO1 image] <i>MDI1</i> - Menu	149
	[PDO2 image] <i>MDI2</i> - Menu	151
	[PDO3 image] <i>MDI3</i> - Menu	152
	[CANopen map] <i>MDI</i> - Menu	153

7.13	[Data logging]	154
	[Distributed logging] <i>dL o</i> - Menu	155
	[Log dstrb prm select] <i>L d P</i> - Menu	156
	[Distributed logging] <i>dL o</i> - Menu	157
7.14	[Braking Unit Option]	158
	[Braking Unit Option] <i>b u o</i> - Menu	158
Chapter 8	[Complete settings] <i>C S t</i> -	159
8.1	[Macro configuration]	161
	[Macro configuration] <i>Π C r</i> - Menu	161
8.2	[Motor parameters] <i>Π P A</i> - Menu	162
	[Motor parameters] <i>Π P A</i> - Menu	163
	[Data] <i>Π t d</i> - Menu	166
	[Angle test setting] <i>A S A</i> - Menu	175
	[Motor tune] <i>Π t u</i> - Menu	177
	[Motor monitoring] <i>Π o P</i> - Menu	184
	[Thermal monitoring] <i>t P P</i> - Menu	185
	[Motor monitoring] <i>Π o P</i> - Menu	194
	[Motor control] <i>d r C</i> - Menu	197
	[Fluxing by DI] <i>F L i</i> - Menu	202
	[Spd Loop Optimization] <i>Π C L</i> - Menu	204
	[Motor control] <i>d r C</i> - Menu	214
	[Switching frequency] <i>S w F</i> - Menu	217
	[Input Filter] <i>d C r</i> - Menu	219
8.3	[Define system units]	220
	[Define system units] <i>S u C</i> - Menu	220
8.4	[Command and Reference] <i>C r P</i> - Menu	222
	[Command and Reference] <i>C r P</i> - Menu	222
8.5	[Pump functions] - [PID controller]	236
	[PID controller] <i>P i d</i> - Overview	237
	[PID Feedback] <i>F d b</i> - Menu	241
	[PID Reference] <i>r F</i> - Menu	247
	[PID preset references] <i>P r i</i> - Menu	250
	[PID Reference] <i>r F</i> - Menu	252
	[Settings] <i>S t</i> - Menu	253
8.6	[Pump functions] - [Sleep/wakeup]	256
	[Sleep/Wakeup] <i>S P w</i> - Overview	257
	[Sleep menu] <i>S L P</i> - Menu	259
	[Boost] <i>S b t</i> - Menu	261
	[Wake up menu] <i>w K P</i> - Menu	262
8.7	[Pump functions] - [Feedback monitoring]	263
	[Feedback monitoring] <i>F K Π</i> - Menu	263
8.8	[Pump functions] - [ENA System]	265
	[ENA System] <i>E n A</i> - Menu	265
8.9	[Pump functions] - [Backspin Control]	267
	[Backspin Control] <i>b S C C</i> - Menu	267
8.10	[Pump monitoring] - [Pumpcycle monitoring]	270
	[Pumpcycle monitoring] <i>C S P</i> - Menu	270
8.11	[Pump monitoring] - [Thermal monitoring]	272
	[Thermal monitoring] <i>t P P</i> - Menu	272
8.12	[Master/Slave]	273
	MultiDrive Link Mechanism	274
	[M/S System Architecture] <i>Π S A</i> - Menu	276
	[Speed Ref AI1 Config.] <i>Π S r 1</i> - Menu	279
	[Speed Ref AI2 Config.] <i>Π S r 2</i> - Menu	280
	[Speed Ref AI3 Config.] <i>Π S r 3</i> - Menu	281

	[Speed Ref AI4 Config.] П 5 r 4 - Menu	282
	[Speed Ref AI5 Config.] П 5 r 5 - Menu	283
	[M/S System Architecture] П 5 A - Menu	284
	[Torque Ref AI1 Config.] П 5 r 1 - Menu	285
	[Torque Ref AI2 Config.] П 5 r 2 - Menu	286
	[Torque Ref AI3 Config.] П 5 r 3 - Menu	287
	[Torque Ref AI4 Config.] П 5 r 4 - Menu	288
	[Torque Ref AI5 Config.] П 5 r 5 - Menu	289
	[M/S System Architecture] П 5 A - Menu	290
	[Speed Ref AQ1 Config.] П 5 П 1 - Menu	291
	[Speed Ref AQ2 Config.] П 5 П 2 - Menu	292
	[M/S System Architecture] П 5 A - Menu	293
	[Torque Ref AQ1 Config.] П 5 П 1 - Menu	293
	[Torque Ref AQ2 Config.] П 5 П 2 - Menu	294
	[M/S System Architecture] П 5 A - Menu	295
	[M/S Control] П 5 E - Menu	297
	[M/S Torque Control] П 5 9 - Menu	299
	[M/S Control] П 5 E - Menu	303
	[M/S Filters] П 5 F - Menu	304
	[Load Sharing M/S] П 5 b - Menu	307
	[M/S Control] П 5 E - Menu	310
8.13	[Backlash compensation]	312
	[Backlash compensation] б 5 9 П - Menu	312
8.14	[Hoisting Functions]	322
	[Brake logic control] б Л C - Menu	323
	[High speed hoisting] H 5 H - Menu	341
	[Load Sharing] Л д 5 - Menu	348
	[Rope Slack Handling] 5 д r - Menu	350
8.15	[Hoisting monitoring]	351
	[Dynamic load detect.] д Л д - Menu	351
8.16	[Conveyor Functions]	353
	[Load Sharing] Л д 5 - Menu	353
8.17	[Generic functions] - [Speed limits]	356
	[Speed limits] 5 Л П - Menu	356
8.18	[Generic functions] - [Ramp]	358
	[Ramp] r A П P - Menu	358
8.19	[Generic functions] - [Ramp switching]	362
	[Ramp switching] r P E - Menu	362
8.20	[Generic functions] - [Stop configuration]	364
	[Stop configuration] 5 E E - Menu	364
8.21	[Generic functions] - [Auto DC injection]	369
	[Auto DC injection] A д C - Menu	369
8.22	[Generic functions] - [Ref. operations]	372
	[Ref. operations] o A i - Menu	372
8.23	[Generic functions] - [Preset speeds]	374
	[Preset speeds] P 5 5 - Menu	374
8.24	[Generic functions] - [+/- speed]	378
	[+/- speed] u P d - Menu	378
8.25	[Generic functions] - [+/- speed around ref]	381
	[+/- speed around ref] 5 r E - Menu	381
8.26	[Generic functions] - [Jump frequency]	384
	[Jump frequency] J u F - Menu	384

8.27	[Generic functions] - [PID controller]	385
	[PID controller] <i>P i d</i> - Overview	386
	[PID Feedback] <i>F d b</i> - Menu	390
	[PID Reference] <i>r F</i> - Menu	396
	[PID preset references] <i>P r i</i> - Menu	399
	[PID Reference] <i>r F</i> - Menu	401
	[Settings] <i>S t</i> - Menu	402
8.28	[Generic functions] - [Feedback mon.]	405
	[Feedback monitoring] <i>F K n</i> - Menu	405
8.29	[Generic functions] - [Threshold reached]	406
	[Threshold reached] <i>t H r E</i> - Menu	406
8.30	[Generic functions] - [Mains contactor command]	409
	[Mains contactor command] <i>L L C</i> - Menu	409
8.31	[Generic functions] - [Output contactor cmd]	412
	[Output contactor cmd] <i>o C C</i> - Menu	412
8.32	[Generic functions] - [Reverse disable]	415
	[Reverse disable] <i>r E i n</i> - Menu	415
8.33	[Generic functions] - [Torque limitation]	416
	[Torque limitation] <i>t o L</i> - Menu	416
8.34	[Generic functions] - [2nd current limit.]	420
	[2nd current limit.] <i>C L i</i> - Menu	420
8.35	[Generic functions] - [Jog]	422
	[Jog] <i>J o G</i> - Menu	422
8.36	[Generic functions] - [High Speed Switching]	424
	[High Speed Switching] <i>C H S</i> - Menu	424
8.37	[Generic functions] - [Memo reference frequency]	426
	[Memo reference frequency] <i>S P n</i> - Menu	426
8.38	[Generic functions] - [Brake logic control]	427
	[Brake logic control] <i>b L C</i> - Menu	427
8.39	[Generic functions] - [Limit switches]	428
	[Limit switches] <i>L S t</i> - Menu	428
8.40	[Generic functions] - [Positioning by sensors]	430
	[Positioning by sensors] <i>L P o</i>	430
8.41	[Generic functions] - [Torque control]	438
	[Torque control] <i>t o r</i> - Menu	438
8.42	[Generic functions] - [Parameters switching]	445
	[Parameters switching] <i>n L P</i> - Menu	446
	[Set 1] <i>P S 1</i> - Menu	450
	[Set 2] <i>P S 2</i> - Menu	450
	[Set 3] <i>P S 3</i> - Menu	450
8.43	[Generic functions] - [Stop after speed timeout]	451
	[Stop after speed timeout] <i>P r S P</i> - Menu	451
8.44	[Generic functions] - [Active Front End]	453
	[Active Front End] <i>A F E</i> - Menu	453
8.45	[Generic functions] - [Bus Ref Link]	454
	[Bus Ref Link] <i>d b S</i> -	454
8.46	[Generic functions] - [DC bus supply]	456
	[DC bus supply] <i>d C o</i> - Menu	456
8.47	[Generic functions] - [Multimotors config]	458
	[Multimotors config] <i>n n C</i> - Menu	458
8.48	[Generic Functions] [External Weight Measurement]	462
	[External weight meas.] <i>E L n</i> - Menu	462

8.49	[Generic monitoring]	465
	[Process underload] <i>u L d</i> - Menu	466
	[Process overload] <i>o L d</i> - Menu	468
	[Stall monitoring] <i>S t P r</i> - Menu	470
	[Thermal monitoring] <i>t P P</i> - Menu	470
	[Frequency meter] <i>F q F</i> - Menu	471
8.50	[Input/Output] - [I/O assignment]	473
	[DI1 assignment] <i>L 1 A</i> - Menu	474
	[DI2 assignment] <i>L 2 A</i> - Menu	474
	[DI3 assignment] <i>L 3 A</i> - Menu	474
	[DI4 assignment] <i>L 4 A</i> - Menu	475
	[DI5 assignment] <i>L 5 A</i> - Menu	475
	[DI6 assignment] <i>L 6 A</i> - Menu	475
	[DI7 assignment] <i>L 7 A</i> - Menu	476
	[DI8 assignment] <i>L B A</i> - Menu	476
	[DI11 assignment] <i>L 1 1 A</i> - Menu	476
	[DI12 assignment] <i>L 1 2 A</i> - Menu	477
	[DI13 assignment] <i>L 1 3 A</i> - Menu	477
	[DI14 assignment] <i>L 1 4 A</i> - Menu	477
	[DI15 assignment] <i>L 1 5 A</i> - Menu	478
	[DI16 assignment] <i>L 1 6 A</i> - Menu	478
	[DI7 Pulse Input Assign] <i>P , 7 A</i> - Menu	479
	[DI8 Pulse Input Assign] <i>P , B A</i> - Menu	480
	[Encoder Pulse Assign] <i>P t G A</i> - Menu	480
	[AI1 assignment] <i>A , 1 A</i> - Menu	480
	[AI2 assignment] <i>A , 2 A</i> - Menu	481
	[AI3 assignment] <i>A , 3 A</i> - Menu	481
	[AI4 assignment] <i>A , 4 A</i> - Menu	481
	[AI5 assignment] <i>A , 5 A</i> - Menu	481
	[AIV1 assignment] <i>A V 1 A</i> - Menu	482
	[DI50 Assignment] <i>d 5 0 A</i> - Menu	482
	[DI51 Assignment] <i>d 5 1 A</i> - Menu	482
	[DI52 Assignment] <i>d 5 2 A</i> - Menu	483
	[DI53 Assignment] <i>d 5 3 A</i> - Menu	484
	[DI54 Assignment] <i>d 5 4 A</i> - Menu	484
	[DI55 Assignment] <i>d 5 5 A</i> - Menu	484
	[DI56 Assignment] <i>d 5 6 A</i> - Menu	485
	[DI57 Assignment] <i>d 5 7 A</i> - Menu	485
	[DI58 Assignment] <i>d 5 B A</i> - Menu	485
	[DI59 Assignment] <i>d 5 9 A</i> - Menu	486
8.51	[Input/Output] - [DI/DQ]	487
	[DI1 Configuration] <i>d , 1</i> - Menu	488
	[DI2 Configuration] <i>d , 2</i> - Menu	488
	[DI3 Configuration] <i>d , 3</i> - Menu	489
	[DI4 Configuration] <i>d , 4</i> - Menu	489
	[DI5 Configuration] <i>d , 5</i> - Menu	490
	[DI6 Configuration] <i>d , 6</i> - Menu	490
	[DI7 Configuration] <i>d , 7</i> - Menu	491
	[DI8 Configuration] <i>d , B</i> - Menu	491
	[DI11 Configuration] <i>d , 1 1</i> - Menu	492
	[DI12 Configuration] <i>d , 1 2</i> - Menu	492
	[DI13 Configuration] <i>d , 1 3</i> - Menu	493
	[DI14 Configuration] <i>d , 1 4</i> - Menu	493
	[DI15 Configuration] <i>d , 1 5</i> - Menu	494
	[DI16 Configuration] <i>d , 1 6</i> - Menu	494

	[DI7 Pulse Config] <i>P A , 7</i> - Menu	495
	[DI8 Pulse Config] <i>P A , 8</i> - Menu	497
	[Encoder Config] <i>P G</i> - Menu	498
	[DQ1 Configuration] <i>d o 1</i> - Menu	499
	[DQ11 Configuration] <i>d o 1 1</i> - Menu	500
	[DQ12 Configuration] <i>d o 1 2</i> - Menu	501
	[DI50 Configuration] <i>d , 5 0</i> - Menu	502
	[DI51 Configuration] <i>d , 5 1</i> - Menu	502
	[DI52 Configuration] <i>d , 5 2</i> - Menu	503
	[DI53 Configuration] <i>d , 5 3</i> - Menu	504
	[DI54 Configuration] <i>d , 5 4</i> - Menu	505
	[DI55 Configuration] <i>d , 5 5</i> - Menu	505
	[DI56 Configuration] <i>d , 5 6</i> - Menu	506
	[DI57 Configuration] <i>d , 5 7</i> - Menu	506
	[DI58 Configuration] <i>d , 5 8</i> - Menu	507
	[DI59 Configuration] <i>d , 5 9</i> - Menu	507
8.52	[Input/Output] - [Analog I/O]	508
	[AI1 configuration] <i>A , 1</i> - Menu	509
	[AI2 configuration] <i>A , 2</i> - Menu	511
	[AI3 configuration] <i>A , 3</i> - Menu	512
	[AI4 configuration] <i>A , 4</i> - Menu	513
	[AI5 configuration] <i>A , 5</i> - Menu	514
	[AQ1 configuration] <i>A o 1</i> - Menu	515
	[AQ2 configuration] <i>A o 2</i> - Menu	519
	[PTO configuration] <i>P E o</i> - Menu	521
	[Virtual AI1] <i>A V 1</i> - Menu	523
8.53	[Input/Output] - [Relay]	524
	[R1 configuration] <i>r 1</i> - Menu	525
	[R2 configuration] <i>r 2</i> - Menu	527
	[R3 configuration] <i>r 3</i> - Menu	528
	[R4 configuration] <i>r 4</i> - Menu	528
	[R5 configuration] <i>r 5</i> - Menu	529
	[R6 configuration] <i>r 6</i> - Menu	529
	[R60 configuration] <i>r 6 0</i> - Menu	530
	[R61 configuration] <i>r 6 1</i> - Menu	530
	[R62 configuration] <i>r 6 2</i> - Menu	531
	[R63 configuration] <i>r 6 3</i> - Menu	531
	[R64 configuration] <i>r 6 4</i> - Menu	532
	[R65 configuration] <i>r 6 5</i> - Menu	532
	[R66 configuration] <i>r 6 6</i> - Menu	533
	[Input/Output] <i>, o</i> - Menu	534
8.54	[Encoder configuration]	536
	[Encoder configuration] <i>, E n</i> - Menu	536
8.55	[Error/Warning handling]	543
	[Auto fault reset] <i>A E r</i> - Menu	544
	[Fault reset] <i>r 5 E</i> - Menu	545
	[Catch on the fly] <i>F L r</i> - Menu	547
	[Error detection disable] <i>, n H</i> - Menu	549
	[External error] <i>E E F</i> - Menu	552
	[Output phase loss] <i>o P L</i> - Menu	553
	[Input phase loss] <i>, P L</i> - Menu	554
	[4-20mA loss] <i>L F L</i> - Menu	555
	[Fallback speed] <i>L F F</i> - Menu	556
	[Fieldbus monitoring] <i>C L L</i> - Menu	557
	[Embedded Modbus TCP] <i>E n E C</i> - Menu	558

	[Communication module] <i>C o P o</i> - Menu	559
	[Undervoltage handling] <i>u S b</i> - Menu	561
	[Ground Fault] <i>G r F L</i> - Menu	563
	[Motor thermal monit] <i>t H t</i> - Menu	564
	[Encoder monitoring] <i>S d d</i> - Menu	566
	[Braking Resistor monit] <i>b r P</i> - Menu	567
	[Torque or i lim. detect] <i>t , d</i> - Menu	568
	[Drive overload monit] <i>o b r</i> - Menu	569
	[Warn grp 1 definition] <i>A 1 C</i> - Menu	570
	[Warn grp 2 definition] <i>A 2 C</i> - Menu	570
	[Warn grp 3 definition] <i>A 3 C</i> - Menu	570
	[Warn grp 4 definition] <i>A 4 C</i> - Menu	570
	[Warn grp 5 definition] <i>A 5 C</i> - Menu	570
	[Error/Warning Handling] <i>C S W P</i> - menu	571
8.56	[Maintenance]	572
	[Diagnostics] <i>d R u</i> - Menu	573
	[Drive warranty mgnt] <i>d W P R</i> - Menu	574
	[Customer event 1] <i>C E 1</i> - Menu	575
	[Customer event 2] <i>C E 2</i> - Menu	576
	[Customer event 3] <i>C E 3</i> - Menu	576
	[Customer event 4] <i>C E 4</i> - Menu	577
	[Customer event 5] <i>C E 5</i> - Menu	577
	[Customer events] <i>C u E V</i> - Menu	578
	[Fan management] <i>F R P R</i> - Menu	579
	[Maintenance] <i>C S P R</i> - Menu	580
8.57	[Cabinet I/O Function] <i>C R b F</i> -	581
	[Monitoring circuit A] <i>C P C A</i> - Menu	582
	[Monitoring circuit B] <i>C P C b</i> - Menu	583
	[Monitoring circuit C] <i>C P C C</i> - Menu	584
	[Monitoring circuit D] <i>C P C d</i> - Menu	584
	[Cabinet circuit A] <i>C C P A</i> - Menu	585
	[Cabinet circuit B] <i>C C P b</i> - Menu	585
	[Cabinet circuit C] <i>C C P C</i> - Menu	586
	[Motor winding A] <i>C t , A</i> - Menu	586
	[Motor winding B] <i>C t , b</i> - Menu	587
	[Motor bearing A] <i>C t , C</i> - Menu	587
	[Motor bearing B] <i>C t , d</i> - Menu	588
	[Circuit breaker] <i>C C b</i> - Menu	588
	[Cabinet I/O functions] <i>C R b F</i> - menu	590
Chapter 9	[Communication] <i>C o P</i> -	591
	[Modbus Fieldbus] <i>P d 1</i> - Menu	592
	[Com. scanner input] <i>, C 5</i> - Menu	594
	[Com. scanner output] <i>o C 5</i> - Menu	595
	[Modbus HMI] <i>P d 2</i> - Menu	596
	[Embd Eth Config] <i>E t E</i> - Menu	597
	[Fast Device Replacement] <i>F d r</i> - Menu	598
	[CANopen] <i>C n o</i> - Menu	599
	[DeviceNet] <i>d n C</i> - Menu	599
	[Profibus] <i>P b C</i> - Menu	599
	[Profinet] <i>P n C</i> - Menu	599
	[EtherCAT Module] <i>E t C</i> - Menu	600
	[Powerlink] <i>E P L</i> - Menu	600

Chapter 10	[File management] <i>F П Е</i> -	601
	[Transfer config file] <i>Е С F</i> - Menu	602
	[Factory settings] <i>F C S</i> - Menu	602
	[Parameter group list] <i>F P Y</i> - Menu	603
	[Factory settings] <i>F C S</i> - Menu	604
	[Pre-settings] <i>P P E S</i> - Menu	605
	[Firmware update diag] <i>F W U d</i> - Menu	606
	[Identification] <i>И , d</i> - Menu	607
	[Package version] <i>P F V</i> - Menu	608
	[Firmware update] <i>F W U P</i> - Menu	608
Chapter 11	[My preferences] <i>П У P</i> -	609
11.1	[Language]	610
	[Language] <i>L H G</i> - Menu	610
11.2	[Password]	611
	[Password] <i>C o d</i> - Menu	611
11.3	[Parameter access]	613
	[Restricted channels] <i>P C d</i> - Menu	614
	[Restricted param] <i>P P R</i> - Menu	614
	[Visibility] <i>V , S</i> - Menu	614
11.4	[Customization]	615
	[My menu config.] <i>П У C</i> - Menu	616
	[Display screen type] <i>П S C</i> - Menu	616
	[Param. Bar Select] <i>P b S</i> - Menu	616
	[Customer parameters] <i>C Y P</i> - Menu	617
	[Service message] <i>S E r</i> - Menu	617
11.5	[Date & Time settings]	618
	[Date/time settings] <i>r t C</i> - Menu	618
11.6	[Access level]	619
	[Access level] <i>L H C</i> - Menu	619
11.7	[Webserver]	620
	[Webserver] <i>w b S</i> - Menu	620
11.8	[Functions key mgnt]	621
	[Functions key mgnt] <i>F K G</i> - Menu	621
11.9	[LCD settings]	622
	[LCD settings] <i>C H L</i> - Menu	622
11.10	[Stop and go]	623
	[Stop and go] <i>S t G</i> - Menu	623
11.11	[QR code]	625
	[QR code] <i>q r C</i> - Menu	625
11.12	[QR code] - [My link 1]	626
	[My link 1] <i>П У L 1</i> - Menu	626
11.13	[QR code] - [My link 2]	627
	[My link 2] <i>П У L 2</i> - Menu	627
11.14	[QR code] - [My link 3]	628
	[My link 3] <i>П У L 3</i> - Menu	628
11.15	[QR code] - [My link 4]	629
	[My link 4] <i>П У L 4</i> - Menu	629
11.16	[Pairing password]	630
	[Pairing password] <i>P P ,</i>	630
Part III	Maintenance and diagnostics	631
Chapter 12	Maintenance	633
	Maintenance	633
Chapter 13	Diagnostics and Troubleshooting	635
13.1	Warning Codes	636
	Warning Codes	636

13.2 Error Codes	639
Overview	643
[AFE Modulation Rate Error] <i>A C F 1</i>	644
[AFE Current Control Error] <i>A C F 2</i>	644
[Load slipping] <i>A n F</i>	645
[Angle error] <i>A S F</i>	645
[Brake Control] <i>b L F</i>	646
[Brake Resistor ovid] <i>b o F</i>	646
[Brake Feedback] <i>b r F</i>	647
[Backlash Error] <i>b S 9 F</i>	647
[DB unit sh. circuit] <i>b u F</i>	648
[DB unit op. circuit] <i>b u F o</i>	648
[BUO Overheat error] <i>b u H F</i>	649
[BUO Overcurrent error] <i>b u o C</i>	649
[Circuit Breaker Error] <i>C b F</i>	650
[CabinetCircuit A Error] <i>C F A</i>	650
[CabinetCircuit B Error] <i>C F b</i>	651
[CabinetCircuit C Error] <i>C F C</i>	651
[Incorrect Configuration] <i>C F F</i>	652
[Invalid Configuration] <i>C F ,</i>	652
[Conf Transfer Error] <i>C F , 2</i>	653
[Pre-settings Transfer Error] <i>C F , 3</i>	653
[Empty Configuration] <i>C F , 4</i>	654
[Cabinet Overheat Error] <i>C H F</i>	654
[Fieldbus Com Interrupt] <i>C n F</i>	655
[CANopen Com Interrupt] <i>C o F</i>	655
[Precharge Capacitor] <i>C r F 1</i>	656
[AFE contactor fdbk error] <i>C r F 3</i>	656
[Channel Switch Error] <i>C S F</i>	657
[Dynamic Load Error] <i>d L F</i>	657
[DC Bus Ripple Error] <i>d C r E</i>	658
[Encoder Coupling] <i>E C F</i>	658
[EEPROM Control] <i>E E F 1</i>	659
[EEPROM Power] <i>E E F 2</i>	659
[Encoder] <i>E n F</i>	660
[External Error] <i>E P F 1</i>	660
[Fieldbus Error] <i>E P F 2</i>	661
[Embd Eth Com Interrupt] <i>E t H F</i>	661
[Out Contact Closed Error] <i>F C F 1</i>	662
[Out Contact Opened Error] <i>F C F 2</i>	662
[FDR 1 Error] <i>F d r 1</i>	663
[FDR 2 Error] <i>F d r 2</i>	663
[Firmware Update Error] <i>F w E r</i>	664
[Boards Compatibility] <i>H C F</i>	664
[Egy Saving Exit Error] <i>, d L F</i>	665
[MonitorCircuit A Error] <i>, F A</i>	665
[MonitorCircuit B Error] <i>, F b</i>	666
[MonitorCircuit C Error] <i>, F C</i>	666
[MonitorCircuit D Error] <i>, F d</i>	667
[Input Overheating] <i>, H F</i>	667
[Internal Link Error] <i>, L F</i>	668
[Internal Error 0] <i>, n F 0</i>	668
[Internal Error 1] <i>, n F 1</i>	668
[Internal Error 2] <i>, n F 2</i>	669
[Internal Error 3] <i>, n F 3</i>	669

[Internal Error 4] <i>i n F 4</i>	669
[Internal Error 6] <i>i n F 6</i>	670
[Internal Error 7] <i>i n F 7</i>	670
[Internal Error 8] <i>i n F B</i>	670
[Internal Error 9] <i>i n F 9</i>	671
[Internal Error 10] <i>i n F A</i>	671
[Internal Error 11] <i>i n F b</i>	671
[Internal Error 12] <i>i n F C</i>	672
[Internal Error 13] <i>i n F d</i>	672
[Internal Error 14] <i>i n F E</i>	672
[Internal Error 15] <i>i n F F</i>	673
[Internal Error 16] <i>i n F G</i>	673
[Internal Error 17] <i>i n F H</i>	673
[Internal Error 18] <i>i n F i</i>	674
[Internal Error 19] <i>i n F J</i>	674
[Internal Error 20] <i>i n F K</i>	674
[Internal Error 21] <i>i n F L</i>	675
[Internal Error 22] <i>i n F Π</i>	675
[Internal Error 23] <i>i n F n</i>	675
[Internal Error 25] <i>i n F P</i>	676
[Internal Error 27] <i>i n F r</i>	676
[Internal Error 28] <i>i n F S</i>	676
[Internal Error 29] <i>i n F t</i>	677
[Internal Error 30] <i>i n F u</i>	677
[Internal Error 31] <i>i n F V</i>	677
[Internal Error 32] <i>i n F W</i>	678
[Input Contactor] <i>L C F</i>	678
[AI1 4-20mA loss] <i>L F F 1</i>	679
[AI3 4-20mA loss] <i>L F F 3</i>	679
[AI4 4-20mA loss] <i>L F F 4</i>	680
[AI5 4-20mA loss] <i>L F F 5</i>	680
[AFE Bus Ref Error] <i>Π d F</i>	681
[Load Mvt Error] <i>Π d C F</i>	681
[MultiDrive Link Error] <i>Π d L F</i>	682
[Mains Freq Out Of Range] <i>Π F F</i>	682
[M/S Device Error] <i>Π 5 d F</i>	683
[DC Bus Overvoltage] <i>o b F</i>	683
[AFE Bus unbalancing] <i>o b F 2</i>	684
[Overcurrent] <i>o C F</i>	684
[Drive Overheating] <i>o H F</i>	685
[Process Overload] <i>o L C</i>	685
[Motor Overload] <i>o L F</i>	686
[Single Output Phase Loss] <i>o P F 1</i>	686
[Output Phase Loss] <i>o P F 2</i>	687
[Supply Mains Overvoltage] <i>o 5 F</i>	687
[Cab I/O 24V Error] <i>P 2 4 C</i>	688
[PumpCycle Start Error] <i>P C P F</i>	688
[PID Feedback Error] <i>P F Π F</i>	689
[Program Loading Error] <i>P G L F</i>	689
[Program Running Error] <i>P G r F</i>	690
[Input phase loss] <i>P H F</i>	690
[Rotation Angle Monit] <i>r R d F</i>	691
[Safety Function Error] <i>S R F F</i>	691
[Motor short circuit] <i>S C F 1</i>	692
[Ground Short Circuit] <i>S C F 3</i>	692

	[IGBT Short Circuit] 5 C F 4	693
	[Motor Short Circuit] 5 C F 5	693
	[AFE ShortCircuit error] 5 C F 6	694
	[Modbus Com Interruption] 5 L F 1	694
	[PC Com Interruption] 5 L F 2	695
	[HMI Com Interruption] 5 L F 3	695
	[Motor Overspeed] 5 o F	696
	[Encoder Feedback Loss] 5 P F	696
	[Torque timeout] 5 r F	697
	[Torque Limitation Error] 5 S F	697
	[Motor Stall Error] 5 t F	698
	[AI1 Thermal Sensor Error] t 1 C F	698
	[AI3 Thermal Sensor Error] t 3 C F	699
	[AI4 Thermal Sensor Error] t 4 C F	699
	[AI5 Thermal Sensor Error] t 5 C F	700
	[Encoder Th Sensor Error] t E C F	700
	[MotorWinding A Error] t F A	701
	[MotorWinding B Error] t F b	701
	[MotorBearing A Error] t F C	702
	[MotorBearing B Error] t F d	702
	[AI1 Th Level Error] t H 1 F	703
	[AI3 Th Level Error] t H 3 F	703
	[AI4 Th Level Error] t H 4 F	704
	[AI5 Th Level Error] t H 5 F	704
	[Encoder Th Detected Error] t H E F	705
	[IGBT Overheating] t J F	705
	[AFE IGBT over-heat error] t J F 2	706
	[Drive Overload] t L o F	706
	[Autotuning Error] t n F	707
	[Process Underload] u L F	707
	[AFE Mains Undervoltage] u r F	708
	[Supply Mains UnderV] u S F	708
13.3	FAQ	709
	FAQ	709
Glossary	711



Important Information

NOTICE

Read these instructions carefully, and look at the equipment to become familiar with the device before trying to install, operate, service, or maintain it. The following special messages may appear throughout this documentation or on the equipment to warn of potential hazards or to call attention to information that clarifies or simplifies a procedure.



The addition of this symbol to a “Danger” or “Warning” safety label indicates that an electrical hazard exists which will result in personal injury if the instructions are not followed.



This is the safety alert symbol. It is used to alert you to potential personal injury hazards. Obey all safety messages that follow this symbol to avoid possible injury or death.

DANGER

DANGER indicates a hazardous situation which, if not avoided, **will result in** death or serious injury.

WARNING

WARNING indicates a hazardous situation which, if not avoided, **could result in** death or serious injury.

CAUTION

CAUTION indicates a hazardous situation which, if not avoided, **could result in** minor or moderate injury.

NOTICE

NOTICE is used to address practices not related to physical injury.

PLEASE NOTE

Electrical equipment should be installed, operated, serviced, and maintained only by qualified personnel. No responsibility is assumed by Schneider Electric for any consequences arising out of the use of this material.

A qualified person is one who has skills and knowledge related to the construction and operation of electrical equipment and its installation, and has received safety training to recognize and avoid the hazards involved.

Qualification Of Personnel

Only appropriately trained persons who are familiar with and understand the contents of this manual and all other pertinent product documentation are authorized to work on and with this product. In addition, these persons must have received safety training to recognize and avoid hazards involved. These persons must have sufficient technical training, knowledge and experience and be able to foresee and detect potential hazards that may be caused by using the product, by changing the settings and by the mechanical, electrical and electronic equipment of the entire system in which the product is used. All persons working on and with the product must be fully familiar with all applicable standards, directives, and accident prevention regulations when performing such work.

Intended Use

This product is a drive for three-phase synchronous, asynchronous motors and intended for industrial use according to this manual. The product may only be used in compliance with all applicable safety standard and local regulations and directives, the specified requirements and the technical data. The product must be installed outside the hazardous ATEX zone. Prior to using the product, you must perform a risk assessment in view of the planned application. Based on the results, the appropriate safety measures must be implemented. Since the product is used as a component in an entire system, you must ensure the safety of persons by means of the design of this entire system (for example, machine design). Any use other than the use explicitly permitted is prohibited and can result in hazards.

Product Related Information

Read and understand these instructions before performing any procedure with this drive.

 **DANGER**

HAZARD OF ELECTRIC SHOCK, EXPLOSION OR ARC FLASH

- Only appropriately trained persons who are familiar with and understand the contents of this manual and all other pertinent product documentation and who have received safety training to recognize and avoid hazards involved are authorized to work on and with this drive system. Installation, adjustment, repair and maintenance must be performed by qualified personnel.
- The system integrator is responsible for compliance with all local and national electrical code requirements as well as all other applicable regulations with respect to grounding of all equipment.
- Many components of the product, including the printed circuit boards, operate with mains voltage.
- Only use properly rated, electrically insulated tools and measuring equipment.
- Do not touch unshielded components or terminals with voltage present.
- Motors can generate voltage when the shaft is rotated. Prior to performing any type of work on the drive system, block the motor shaft to prevent rotation.
- AC voltage can couple voltage to unused conductors in the motor cable. Insulate both ends of unused conductors of the motor cable.
- Do not short across the DC bus terminals or the DC bus capacitors or the braking resistor terminals.
- Before performing work on the drive system:
 - Disconnect all power, including external control power that may be present. Take into account that the circuit breaker or main switch does not de-energize all circuits.
 - Place a **Do Not Turn On** label on all power switches related to the drive system.
 - Lock all power switches in the open position.
 - Wait 15 minutes to allow the DC bus capacitors to discharge.
 - Follow the instructions given in the chapter "Verifying the Absence of Voltage" in the installation manual of the product.
- Before applying voltage to the drive system:
 - Verify that the work has been completed and that the entire installation cannot cause hazards.
 - If the mains input terminals and the motor output terminals have been grounded and short-circuited, remove the ground and the short circuits on the mains input terminals and the motor output terminals.
 - Verify proper grounding of all equipment.
 - Verify that all protective equipment such as covers, doors, grids is installed and/or closed.

Failure to follow these instructions will result in death or serious injury.

Damaged products or accessories may cause electric shock or unanticipated equipment operation.

 **DANGER**

ELECTRIC SHOCK OR UNANTICIPATED EQUIPMENT OPERATION

Do not use damaged products or accessories.

Failure to follow these instructions will result in death or serious injury.

Contact your local Schneider Electric sales office if you detect any damage whatsoever.

This equipment has been designed to operate outside of any hazardous location. Only install this equipment in zones known to be free of a hazardous atmosphere.

DANGER

POTENTIAL FOR EXPLOSION

Install and use this equipment in non-hazardous locations only.

Failure to follow these instructions will result in death or serious injury.

Your application consists of a whole range of different interrelated mechanical, electrical, and electronic components, the drive being just one part of the application. The drive by itself is neither intended to nor capable of providing the entire functionality to meet all safety-related requirements that apply to your application. Depending on the application and the corresponding risk assessment to be conducted by you, a whole variety of additional equipment is required such as, but not limited to, external encoders, external brakes, external monitoring devices, guards, etc.

As a designer/manufacture of machines, you must be familiar with and observe all standards that apply to your machine. You must conduct a risk assessment and determine the appropriate Performance Level (PL) and/or Safety Integrity Level (SIL) and design and build your machine in compliance with all applicable standards. In doing so, you must consider the interrelation of all components of the machine. In addition, you must provide instructions for use that enable the user of your machine to perform any type of work on and with the machine such as operation and maintenance in a safe manner.

The present document assumes that you are fully aware of all normative standards and requirements that apply to your application. Since the drive cannot provide all safety-related functionality for your entire application, you must ensure that the required Performance Level and/or Safety Integrity Level is reached by installing all necessary additional equipment.

WARNING

INSUFFICIENT PERFORMANCE LEVEL/SAFETY INTEGRITY LEVEL AND/OR UNINTENDED EQUIPMENT OPERATION

- Conduct a risk assessment according to EN ISO 12100 and all other standards that apply to your application.
- Use redundant components and/or control paths for all critical control functions identified in your risk assessment.
- If moving loads can result in hazards, for example, slipping or falling loads, operate the drive in closed loop mode.
- Verify that the service life of all individual components used in your application is sufficient for the intended service life of your overall application.
- Perform extensive commissioning tests for all potential error situations to verify the effectiveness of the safety-related functions and monitoring functions implemented, for example, but not limited to, speed monitoring by means of encoders, short circuit monitoring for all connected equipment, correct operation of brakes and guards.
- Perform extensive commissioning tests for all potential error situations to verify that the load can be brought to a safe stop under all conditions.

Failure to follow these instructions can result in death, serious injury, or equipment damage.

A specific application note [NHA80973](#) is available on hoisting machines and can be downloaded on [se.com](#).

Drive systems may perform unexpected movements because of incorrect wiring, incorrect settings, incorrect data or other errors.

WARNING

UNANTICIPATED EQUIPMENT OPERATION

- Carefully install the wiring in accordance with the EMC requirements.
- Do not operate the product with unknown or unsuitable settings or data.
- Perform a comprehensive commissioning test.

Failure to follow these instructions can result in death, serious injury, or equipment damage.

WARNING

LOSS OF CONTROL

- The designer of any control scheme must consider the potential failure modes of control paths and, for critical control functions, provide a means to achieve a safe state during and after a path failure. Examples of critical control functions are emergency stop, overtravel stop, power outage and restart.
- Separate or redundant control paths must be provided for critical control functions.
- System control paths may include communication links. Consideration must be given to the implications of unanticipated transmission delays or failures of the link.
- Observe all accident prevention regulations and local safety guidelines (1).
- Each implementation of the product must be individually and thoroughly tested for proper operation before being placed into service.

Failure to follow these instructions can result in death, serious injury, or equipment damage.

(1) For USA: Additional information, refer to NEMA ICS 1.1 (latest edition), Safety Guidelines for the Application, Installation, and Maintenance of Solid State Control and to NEMA ICS 7.1 (latest edition), Safety Standards for Construction and Guide for Selection, Installation and Operation of Adjustable-Speed Drive Systems.

The temperature of the products described in this manual may exceed 80 °C (176 °F) during operation.

WARNING

HOT SURFACES

- Ensure that any contact with hot surfaces is avoided.
- Do not allow flammable or heat-sensitive parts in the immediate vicinity of hot surfaces.
- Verify that the product has sufficiently cooled down before handling it.
- Verify that the heat dissipation is sufficient by performing a test run under maximum load conditions.

Failure to follow these instructions can result in death, serious injury, or equipment damage.

Machines, controllers, and related equipment are usually integrated into networks. Unauthorized persons and malware may gain access to the machine as well as to other devices on the network/fieldbus of the machine and connected networks via insufficiently secure access to software and networks.

 WARNING

UNAUTHORIZED ACCESS TO THE MACHINE VIA SOFTWARE AND NETWORKS

- In your hazard and risk analysis, consider all hazards that result from access to and operation on the network/fieldbus and develop an appropriate cyber security concept.
- Verify that the hardware infrastructure and the software infrastructure into which the machine is integrated as well as all organizational measures and rules covering access to this infrastructure consider the results of the hazard and risk analysis and are implemented according to best practices and standards covering IT security and cyber security (such as: ISO/IEC 27000 series, Common Criteria for Information Technology Security Evaluation, ISO/ IEC 15408, IEC 62351, ISA/IEC 62443, NIST Cybersecurity Framework, Information Security Forum - Standard of Good Practice for Information Security).
- Verify the effectiveness of your IT security and cyber security systems using appropriate, proven methods.

Failure to follow these instructions can result in death, serious injury, or equipment damage.

 WARNING

LOSS OF CONTROL

Perform a comprehensive commissioning test to verify that communication monitoring properly detects communication interruptions

Failure to follow these instructions can result in death, serious injury, or equipment damage.

NOTICE

DESTRUCTION DUE TO INCORRECT MAINS VOLTAGE

Before switching on and configuring the product, verify that it is approved for the mains voltage.

Failure to follow these instructions can result in equipment damage.

About the Book



At a Glance

Document Scope

The purpose of this document is to:

- help you to set up the drive,
- show you how to program the drive,
- show you the different menus, modes, and parameters,
- help you in maintenance and diagnostics.

Validity Note

Original instructions and information given in this manual have been written in English (before optional translation).

This documentation is valid for Altivar Process ATV900 drives except for ATV991 and ATV992 drive systems. Refer to the related documents.

The technical characteristics of the devices described in the present document also appear online. To access the information online:

Step	Action
1	Go to the Schneider Electric home page www.schneider-electric.com .
2	In the Search box type the reference of a product or the name of a product range. <ul style="list-style-type: none">• Do not include blank spaces in the reference or product range.• To get information on grouping similar modules, use asterisks (*).
3	If you entered a reference, go to the Product Datasheets search results and click on the reference that interests you. If you entered the name of a product range, go to the Product Ranges search results and click on the product range that interests you.
4	If more than one reference appears in the Products search results, click on the reference that interests you.
5	Depending on the size of your screen, you may need to scroll down to see the datasheet.
6	To save or print a datasheet as a .pdf file, click Download XXX product datasheet .

The characteristics that are presented in the present document should be the same as those characteristics that appear online. In line with our policy of constant improvement, we may revise content over time to improve clarity and accuracy. If you see a difference between the document and online information, use the online information as your reference.

Related Documents

Use your tablet or your PC to quickly access detailed and comprehensive information on all our products on www.schneider-electric.com.

The internet site provides the information you need for products and solutions:

- The whole catalog for detailed characteristics and selection guides,
- The CAD files to help design your installation, available in over 20 different file formats,
- All software and firmware to maintain your installation up to date,
- A large quantity of White Papers, Environment documents, Application solutions, Specifications... to gain a better understanding of our electrical systems and equipment or automation,
- And finally all the User Guides related to your drive, listed below:

Title of Documentation	Catalog Number
Catalog: Variable speed drives Altivar Process ATV900	DIA2ED2150601EN (English), DIA2ED2150601FR (French)

Title of Documentation	Catalog Number
ATV900 Getting Started - Video	FAQ FA364431 (English) 
ATV930, ATV950 Getting Started	NHA61578 (English), NHA61579 (French), NHA61580 (German), NHA61581 (Spanish), NHA61724 (Italian), NHA61582 (Chinese), NHA61578PT (Portuguese), NHA61578TR (Turkish)
ATV900 Getting Started Annex (SCCR)	NHA61583 (English)
ATV930, ATV950 Installation manual	NHA80932 (English), NHA80933 (French), NHA80934 (German), NHA80935 (Spanish), NHA80936 (Italian), NHA80937 (Chinese), NHA80932PT (Portuguese), NHA80932TR (Turkish)
ATV600F, ATV900F Installation Instruction sheet	NVE57369 (English)
ATV900 Programming manual	NHA80757 (English), NHA80758 (French), NHA80759 (German), NHA80760 (Spanish), NHA80761 (Italian), NHA80762 (Chinese), NHA80757PT (Portuguese), NHA80757TR (Turkish)
ATV900 Embedded Modbus Serial Link manual	NHA80939 (English)
ATV900 Embedded Ethernet manual	NHA80940 (English)
ATV900 PROFIBUS DP manual (VW3A3607)	NHA80941 (English)
ATV900 DeviceNet manual (VW3A3609)	NHA80942 (English)
ATV900 PROFINET manual (VW3A3627)	NHA80943 (English)
ATV900 CANopen manual (VW3A3608, 618, 628)	NHA80945 (English)
ATV900 EtherCAT manual (VW3A3601)	NHA80946 (English)
ATV900 POWERLINK manual (VW3A3619)	PHA99693 (English)
ATV900 Communication Parameters addresses	NHA80944 (English)
ATV900 Embedded Safety Function manual	NHA80947 (English)
ATV900 Safety Module Manual (VW3A3802) Upcoming commercialization	NVE64209 (English), NVE64210 (French), NVE64211 (German), NVE64212 (Spanish), NVE64213 (Italian), NVE64214 (Chinese)
Drive Systems ATV960 handbook	NHA37115 (English), NHA37114 (German)
Drive Systems ATV980 handbook	NHA37117 (English), NHA37116 (German)
Drive Systems ATV990 handbook Multidrive Systems	NHA37145 (English), NHA37143 (German)
ATV991, ATV992 Supply units, Programming manual	QGH33275 (English)
Drive Systems Installation manual	NHA37118 (German), NHA37119 (English), NHA37121 (French), NHA37122 (Spanish), NHA37123 (Italian), NHA37124 (Dutch), NHA37126 (Polish), NHA37127 (Portuguese), NHA37129 (Turkish), NHA37130 (Chinese)
SoMove: FDT	SoMove_FDT (English, French, German, Spanish, Italian, Chinese)
ATV900: DTM	ATV9xx DTM Library EN (English - to be installed first), ATV9xx DTM Lang FR (French), ATV9xx DTM Lang DE (German), ATV9xx DTM Lang SP (Spanish), ATV9xx DTM Lang IT (Italian), ATV9xx DTM Lang CN (Chinese)
ATV61-71 to ATV600-900 Migration Manual	EAV64336 (English)
Altivar Application Note for Hoisting (coming soon)	NHA80973 (English)

You can download these technical publications and other technical information from our website at www.schneider-electric.com/en/download

Terminology

The technical terms, terminology, and the corresponding descriptions in this manual normally use the terms or definitions in the relevant standards.

In the area of drive systems this includes, but is not limited to, terms such as **error, error message, failure, fault, fault reset, protection, safe state, safety function, warning, warning message**, and so on.

Among others, these standards include:

- IEC 61800 series: Adjustable speed electrical power drive systems
- IEC 61508 Ed.2 series: Functional safety of electrical/electronic/programmable electronic safety-related
- EN 954-1 Safety of machinery - Safety related parts of control systems
- ISO 13849-1 & 2 Safety of machinery - Safety related parts of control systems
- IEC 61158 series: Industrial communication networks - Fieldbus specifications
- IEC 61784 series: Industrial communication networks - Profiles
- IEC 60204-1: Safety of machinery - Electrical equipment of machines – Part 1: General requirements

In addition, the term **zone of operation** is used in conjunction with the description of specific hazards, and is defined as it is for a **hazard zone** or **danger zone** in the EC Machinery Directive (2006/42/EC) and in ISO 12100-1.

Contact Us

Select your country on:

www.schneider-electric.com/contact

Schneider Electric Industries SAS

Head Office

35, rue Joseph Monier

92500 Rueil-Malmaison

France

Part I

Introduction

What Is in This Part?

This part contains the following chapters:

Chapter	Chapter Name	Page
1	Setup	27
2	Overview	35
3	Cyber Security	49

Chapter 1

Setup

What Is in This Chapter?

This chapter contains the following topics:

Topic	Page
Initial Steps	28
Steps for Setting-Up the Drive	30
Software Enhancements	32

Initial Steps

Before Powering up the Drive

⚠ WARNING
UNANTICIPATED EQUIPMENT OPERATION
Before switching on the device, verify that no unintended signals can be applied to the digital inputs that could cause unintended movements.
Failure to follow these instructions can result in death, serious injury, or equipment damage.

If the drive was not connected to mains for an extended period of time, the capacitors must be restored to their full performance before the motor is started.

NOTICE
REDUCED CAPACITOR PERFORMANCE
<ul style="list-style-type: none"> ● Apply mains voltage to the drive for one hour before starting the motor if the drive has not been connected to mains for the following periods of time: <ul style="list-style-type: none"> ○ 12 months at a maximum storage temperature of +50°C (+122°F) ○ 24 months at a maximum storage temperature of +45°C (+113°F) ○ 36 months at a maximum storage temperature of +40°C (+104°F) ● Verify that no Run command can be applied before the period of one hour has elapsed. ● Verify the date of manufacture if the drive is commissioned for the first time and run the specified procedure if the date of manufacture is more than 12 months in the past.
Failure to follow these instructions can result in equipment damage.

If the specified procedure cannot be performed without a Run command because of internal mains contactor control, perform this procedure with the power stage enabled, but the motor being at standstill so that there is no appreciable mains current in the capacitors.

Mains Contactor

NOTICE
RISK OF DAMAGE TO THE DRIVE
Do not switch on the drive at intervals of less than 60 s.
Failure to follow these instructions can result in equipment damage.

Using a Motor with a Lower Rating or Dispensing with a Motor Altogether

In factory settings, the motor output phase loss detection is active: [OutPhaseLoss Assign] \square *PL* is set to [OPF Error Triggered] *Y E 5*. For details, refer to the parameter description (*see page 553*). For commissioning tests or maintenance phase, the drive could be connected to a small motor power size and thus trigger an error [Output Phase Loss] \square *PF 2* or [Single output phase loss] \square *PF 1* when a Run command is applied. For that purpose, the function can be disabled by setting [OutPhaseLossAssign] \square *PL* to [Function Inactive] \square *0*.

Set also [Motor control type] *L E E* to [SVC V] *V V L* in [Motor parameters] *Π P A* -. For details, refer to the parameter description.

NOTICE
MOTOR OVERHEATING
Install external thermal monitoring equipment under the following conditions: <ul style="list-style-type: none"> ● If a motor with a nominal current of less than 20% of the nominal current of the drive is connected. ● If you use the function Motor Switching.
Failure to follow these instructions can result in equipment damage.

  **DANGER****HAZARD OF ELECTRIC SHOCK, EXPLOSION OR ARC FLASH**

If output phase monitoring is disabled, phase loss and, by implication, accidental disconnection of cables, are not detected.

- Verify that the setting of this parameter does not result in unsafe conditions.

Failure to follow these instructions will result in death or serious injury.

Steps for Setting-Up the Drive

1 INSTALLATION

Refer to the installation manual.

2 Switch On the drive without active run command.

3 Configure:

- The nominal frequency of the motor [**Motor Standard**] *b F r* if this is not 50 Hz.
- The motor parameters including [**Motor Th Current**] *i L H* in the [**Motor parameters**] *Π P R* - menu, only if the factory configuration of the drive is not suitable.
- The application functions in the [**Complete settings**] *Γ s L* - menu, only if the factory configuration of the drive is not suitable.

4 In the [**Simply start**] *Σ Y S* - menu, adjust the following parameters:

- [**Acceleration**] *Α C C* and [**Deceleration**] *Δ E C*
- [**Low speed**] *L S P* and [**High Speed**] *H S P*

5 Start the drive.



Drive systems may perform unexpected movements because of incorrect wiring, incorrect settings, incorrect data or other errors.

⚠ WARNING

UNANTICIPATED EQUIPMENT OPERATION

- Carefully install the wiring in accordance with the EMC requirements.
- Do not operate the product with unknown or unsuitable settings or data.
- Perform a comprehensive commissioning test.

Failure to follow these instructions can result in death, serious injury, or equipment damage.

Tips

Use the **[Config. Source] F C 5** , parameter (*see page 602*) to restore the factory settings at any time.

NOTE: The following operations must be performed for optimum drive performance in terms of accuracy and response time:

- Enter the values indicated on the motor nameplate in the **[Motor parameters] P P R** - menu.
- Perform autotuning with the motor cold and connected using the **[Autotuning] E u n** parameter.

Software Enhancements

Overview

Since the ATV900 was first launched, it has benefited from the addition of several new functions.

The software version has been updated to V2.2. Although this documentation relates to version V2.2, it can still be used with earlier versions.

Enhancements Made to Version V2.2 in Comparison to V2.1

In the **[Motor parameters]** *MPA* - menu, the **[DC Bus Ripple]** *dCr* - menu is available, including its related parameters.

Improvements on **[Brake logic control]** *bLc* - function, refer to the new parameters **[BRH b5]** *brH5*, **[Load Maintain Time]** *ndFE* and **[Load Mtn Remain Time]** *ntbF*.

Enhancements Made to Version V2.1 in Comparison to V1.9

Improvements on **[Brake logic control]** *bLc* - function. Parameters linked to brake relay feedback have been added and **[BRH b4]** *brH4* function can be used to trigger an error.

Improvement of the function **[Stop and go]** *SEG* - with a time parameter.

[Output Contactor Cmd] *oCC* - and **[External Weight Meas.]** *PE5* - functions are now available.

Improvement of the password protection to limit the access to the menus.

Enhancements Made to Version V1.9 in Comparison to V1.8

Improvements and new functionalities on **[Brake logic control]** *bLc* - functions can be found in their related menus. New parameters are available and the calculation of the **[AUTO]** *AUTO* setting values have been updated.

The virtual analog input type is now settable with **[AIV1 type]** *AV1E* parameters.

Support of bidirectional scaled analog inputs, see **[Aix range]** *AixL* parameters.

[Input phase loss] *PHF* is cleared as soon as its cause has been removed.

Enhancements Made to Version V1.8 in Comparison to V1.6

Support of VW3A3619 POWERLINK fieldbus module.

In the **[Motor control]** *drc* - menu, "Output Voltage Management and Overmodulation" function is added.

A new possible behavior is added for the STOP/RESET key, see **[Stop Key Enable]** *P5E* parameter.

Enhancements Made to Version V1.6 in Comparison to V1.3

Firmware evolution to support Altivar Process Modular offer.

In the **[Complete settings]** *CSL* - menu, the **[Encoder configuration]** *EN* - has been updated with complementary informations.

In the **[Catch on Fly]** *FLr* - menu, a new selection has been added to allow the function to be active after stop types different than freewheel.

In the **[Input/Output] - [DI/DQ]** menu, the **[Encoder Config]** *PG* - menu is available, including its related parameters.

From this new version, the selection of **[Never]** *SEP* on **[Fan Mode]** *FFN* has no effect.

Enhancements Made to Version V1.3 in Comparison to V1.2

In the **[Complete settings]** *CSL* - menu, the **[Encoder configuration]** *EN* - has been updated with parameters and affectations added to support the HTL encoder module.

Enhancements Made to Version V1.2 in Comparison to V1.1

In the **[Complete settings] C 5 E** - menu, the **[Master/Slave] M 5 H** - menu has been updated with parameters added to use Master/Slave function with MultiDrive Link mechanism.

In the **[Complete settings] C 5 E** - menu, the **[Backlash compensation] B 5 9 H** - menu is available, including its related parameters.

In the **[Pump functions] P F E** - menu, the **[Backspin Control] B 5 C C** - menu is available, including its related parameters.

Chapter 2

Overview

What Is in This Chapter?

This chapter contains the following topics:

Topic	Page
Factory Configuration	36
Application Functions	37
Basic Functions	40
Graphic Display Terminal	41
Multipoint Screen	45
Structure of the Parameter Table	47
Finding a Parameter in This Document	48

Factory Configuration

Factory Settings

The drive is factory-set for common operating conditions:

- Display: drive ready [**Pre-Ramp Ref Freq**] *F r H* when motor is ready to run and motor frequency when motor is running.
- The DI3 and DI5 to DI8 digital inputs, AI2 and AI3 analog inputs, R2 and R3 relays are unassigned.
- Stop mode when error detected: freewheel.

This table presents the basic parameters of the drive and their factory setting values:

Code	Name	Factory setting values
<i>b F r</i>	[Motor Standard]	[50Hz IEC] <i>5 0</i>
<i>t t t</i>	[2/3-Wire Control]	[2-Wire Control] <i>t t</i> : 2-wire control
<i>t t t</i>	[Motor control type]	[SVC V] <i>v v t</i> : voltage vector control
<i>A t t</i>	[Acceleration]	3.0 s
<i>d e t</i>	[Deceleration]	3.0 s
<i>L S P</i>	[Low Speed]	0.0 Hz
<i>H S P</i>	[High Speed]	50.0 Hz
<i>i t H</i>	[Motor Th Current]	Nominal motor current (value depending on drive rating)
<i>F r d</i>	[Forward]	[DI1] <i>d i 1</i> : Digital input DI1
<i>r r S</i>	[Reverse]	[DI2] <i>d i 2</i> : Digital input DI2
<i>F r 1</i>	[Ref Freq 1 Config]	[AI1] <i>A i 1</i> : Analog input AI1
<i>r 1</i>	[R1 Assignment]	[Operating State Fault] <i>F L t</i> : the contact opens when the drive has detected error or when the drive has been switched off
<i>b r A</i>	[Dec.Ramp Adapt]	[Yes] <i>y e s</i> : function active (automatic adaptation of deceleration ramp)
<i>A t r</i>	[Auto Fault Reset]	[No] <i>n o</i> : function inactive
<i>S t t</i>	[Type of stop]	[On Ramp] <i>r n P</i> : on ramp
<i>A a 1</i>	[AQ1 assignment]	[Motor Frequency] <i>a F r</i> : Motor frequency
<i>A a 2</i>	[AQ2 assignment]	[Motor Current] <i>a t r</i> : Motor current
<i>r S F</i>	[Fault Reset Assign]	[DI4] <i>d i 4</i> : Digital input DI4

NOTE: If you want to restore the drive presets to their factory values, set [**Config. Source**] *F t 5* , to [**Macro Config**] *i n 1* .

Verify whether the above values are compatible with the application and modify them if required.

Application Functions

Introduction

The following tables show the combinations of functions and applications in order to guide your selection.

The functions in these tables relate to the following applications:

- Mining, Mineral and Metal (MMM):
 - Long belt conveyor
 - Long-distance heavy conveying
 - Crusher
 - Grinding mills
 - Vibro feeders
- Hoisting:
 - Special cranes (Gantry cranes - Grab cranes)
 - Ship loaders
- Food & Beverage:
 - Mixers
 - Centrifuges machines
 - Hot rotary dryers
- O&G:
 - PCP (Progressive Cavity Pump)
 - ESP (Electrically Submersible Pump)
 - Rod pump

Each application has its own special features, and the combinations listed here are not mandatory or exhaustive.

 WARNING
UNANTICIPATED EQUIPMENT OPERATION
Multiple functions can be assigned to and simultaneously activated via a single input.
<ul style="list-style-type: none"> ● Verify that assigning multiple functions to a single input does not result in unsafe conditions.
Failure to follow these instructions can result in death, serious injury, or equipment damage.

Combinations of Functions and Applications

Function	MMM		O&G			F&B	Process
	Conveyor	Hoisting	Pump Jack or Road pump	PCP control	ESP control	High inertia	
ENA system <i>(see page 265)</i>			✓				
Brake sequence <i>(see page 323)</i>	✓	✓					
Boost for conical motors <i>(see page 200)</i>	✓	✓					
Limit switch management <i>(see page 428)</i>	✓						
Torque regulation	✓						✓
Positioning / Autostop on distance <i>(see page 430)</i>	✓						
Positioning value for PLC <i>(see page 542)</i>	✓	✓					
Load sharing <i>(see page 348)</i>	✓	✓				✓	✓
Master/Slave management <i>(see page 276)</i>	✓	✓				✓	✓
Master/Slave on rigid coupling <i>(see page 297)</i>	✓	✓				✓	

Function	MMM		O&G			F&B	Process
	Conveyor	Hoisting	Pump Jack or Road pump	PCP control	ESP control	High inertia	
Master/Slave on elastic coupling <i>(see page 297)</i>	✓	✓					
Backspin sequence for PCP pumps <i>(see page 267)</i>				✓			
Braking balance <i>(see page 361)</i>		✓				✓	✓
DC Bus charge option <i>(see page 456)</i>						✓	✓
High-speed hoisting <i>(see page 341)</i>		✓					
Commutation high speed <i>(see page 424)</i>		✓					

Combination of Functions and Monitoring Functions

Function	MMM		O&G			F&B	Process
	Conveyor	Hoisting	Pump Jack or Road pump	PCP control	ESP control	High inertia	
External error <i>(see page 552)</i>	✓	✓	✓	✓	✓	✓	
Catch on the fly <i>(see page 547)</i>	✓		✓	✓	✓	✓	
Motor Overspeed <i>(see page 696)</i>		✓		✓	✓		✓
Torque limitation <i>(see page 416)</i>	✓						
Encoder check <i>(see page 536)</i>	✓	✓					✓
Reverse disable <i>(see page 228)</i>			✓	✓	✓	✓	✓
Thermal monitoring of the braking resistor <i>(see page 567)</i>	✓	✓				✓	
Under load detection <i>(see page 466)</i>	✓			✓	✓		
Fast stop <i>(see page 365)</i>	✓	✓				✓	
Dynamic load detection <i>(see page 351)</i>	✓					✓	✓
Mechanical resonance rejection <i>(see page 210)</i>		✓					
Stall monitoring <i>(see page 470)</i>	✓					✓	✓
Load slipping monitoring <i>(see page 566)</i>		✓					
Rope slack and anti rope slack detection <i>(see page 345)</i>		✓					

Combination of Functions and Configuration management

Function	MMM		O&G			F&B	Process
	Conveyor	Hoisting	Pump Jack or Road pump	PCP control	ESP control	High inertia	
Motor switching (see page 458)	✓	✓					
Configuration switching (see page 458)	✓	✓					
Parameter switching (see page 445)	✓						
Current threshold function (see page 406)	✓	✓	✓	✓	✓	✓	✓
Torque threshold reached (see page 407)	✓	✓				✓	✓
Frequency threshold reached (see page 407)	✓	✓	✓	✓	✓	✓	✓
Thermal state reached (see page 407)	✓	✓	✓	✓	✓	✓	✓
Automatic fault reset (see page 544)	✓						
Surge voltage on motor (see page 218)				✓	✓		
Parameter customization (see page 615)	✓		✓		✓		✓
Pulse input configuration (see page 495)	✓	✓	✓			✓	
Dual rating (see page 163)			✓				✓

Basic Functions

Drive Ventilation

If **[Fan mode] F F Π** is set to:

- **[Standard] S E d** , the operation of the fan is enabled when the motor is running. According to drive rating, this could be the only available setting.
- **[Always] r u n**, the fan is always activated.
- **[Economy] E C σ** , the fan is activated only if necessary, according to the internal thermal state of the drive.
- **[Never] S E P** , If the software version is:
 - up to V1.6 (excluded), the fan of the drive is disabled.
 - V1.6 or higher, this selection has no effect. The operation of the fan is enabled when the motor is running.

NOTICE

OVERHEATING

Verify that the ambient temperature does not exceed 40 °C (104° F) if the fan is disabled.

Failure to follow these instructions can result in equipment damage.

Fan speed and **[Fan Operation Time] F P b t** are monitored values:

- An abnormal low speed of the fan triggers a warning **[Fan Feedback Warning] F F $d R$** .
- As soon as **[Fan Operation Time] F P b t** reach the predefined value of 45,000 hours, a warning **[Fan Counter Warning] F C $t R$** is triggered.

[Fan Operation Time] F P b t counter can be set to 0 by using the **[Time Counter Reset] r P r** parameter.

Graphic Display Terminal

Description of the Graphic Display Terminal (VW3A1111)

This Graphic Display Terminal is a local control unit which can be either plugged on the drive or mounted on the door of the wall-mounted or floor-standing enclosure. It has a cable with connectors, which is connected to the drive front Modbus serial link. The Graphic Display Terminal embeds a real time clock used for the time stamping of logged data and all other functions which require time information.

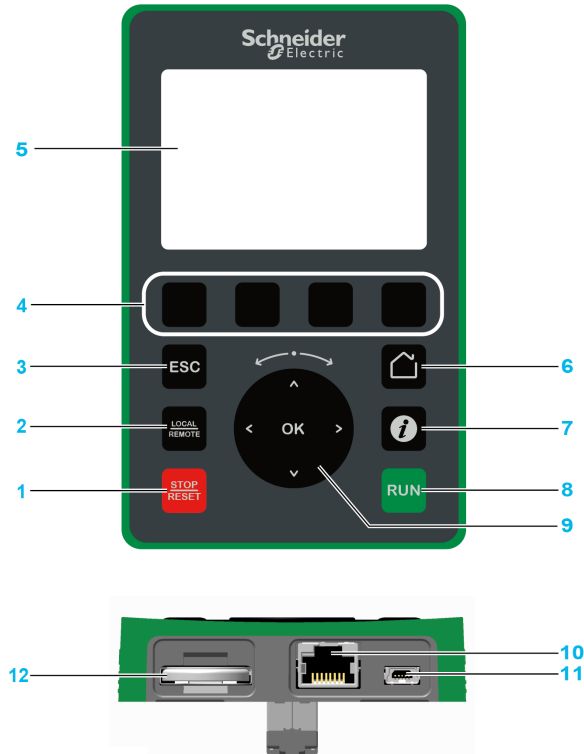

- 1 **STOP / RESET:** Stop command / apply a Fault Reset.
- 2 **LOCAL / REMOTE:** used to switch between local and remote control of the drive.
- 3 **ESC:** used to quit a menu/parameter or remove the currently displayed value in order to revert to the previous value retained in the memory
- 4 **F1 to F4:** function keys used to access drive id, QR code, quick view, and submenus. Simultaneous press of F1 and F4 keys generates a screenshot file in the Graphic Display Terminal internal memory.
- 5 **Graphic display.**
- 6 **Home:** used to access directly at the home page.
- 7 **Information:** used to have more information about menus, submenus, and parameters. The selected parameter or menu code is displayed on the first line of the information page.
- 8 **RUN:** executes the function assuming it has been configured.
- 9 **Touch wheel / OK:** used to save the current value or access the selected menu/parameter. The touch wheel is used to scroll fast into the menus. Up/down arrows are used for precise selections, right/left arrows are used to select digits when setting a numerical value of a parameter.
- 10 **RJ45 Modbus serial port:** used to connect the Graphic Display Terminal to the drive in remote control.
- 11 **MiniB USB port:** used to connect the Graphic Display Terminal to a computer.
- 12 **Battery** (10 years service life. Type: CR2032). The battery positive pole points to the front face of the Graphic Display Terminal.

NOTE: Keys 1, 8 and 9 can be used to control the drive if control via the Graphic Display Terminal is activated. To activate the keys on the Graphic Display Terminal, you first need to set **[Ref Freq 1 Config] F r 1** to **[Ref.Freq-Rmt.Term] L C C**.

Description of the Graphic Display

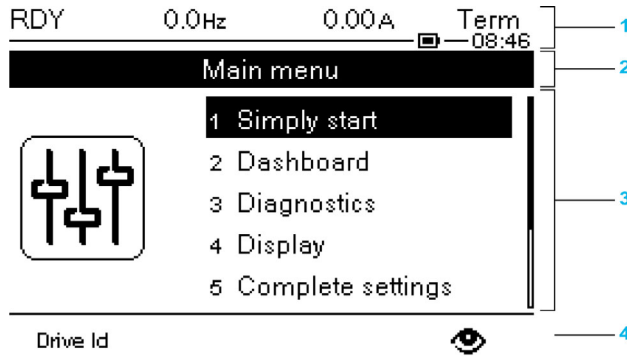

- 1 Display line: its content can be configured
- 2 Menu line: indicates the name of the current menu or submenu
- 3 Menus, submenus, parameters, values, bar charts, and so on, are displayed in drop-down window format on a maximum of five lines. The line or value selected by the navigation button is displayed in reverse video
- 4 Section displaying tabs (1 to 4 by menu), these tabs can be accessed using F1 to F4 keys

NOTE: The numbers in front of the menus and submenus in the graphic display terminal are different from chapters numbers in the programming manual.

Display line details:

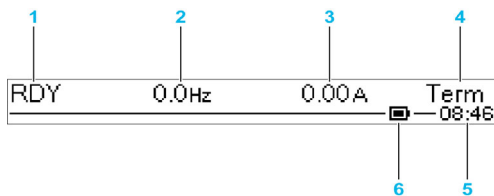

Key	
1	[Drive State] H Π , 5
2	Customer defined
3	Customer defined
4	Active control channel <ul style="list-style-type: none"> ● TERM: terminals ● HMI: Graphic Display Terminal ● MDB: integrated Modbus serial ● CAN: CANopen® ● NET: fieldbus module ● ETH: integrated Ethernet ● PWS: DTM based commissioning software
5	Present time
6	Battery level

Description of the Product Front LEDs

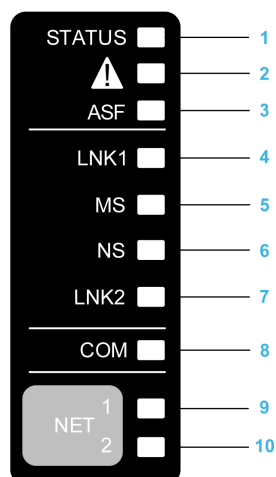

Following table provides the details of the drive status LEDs:

Item	LED	Color & status	Description
1	STATUS	OFF	Indicates that the drive is powered off
		Green flashing	Indicates that the drive is not running, ready to start
		Green blinking	Indicates that the drive is in transitory status (acceleration, deceleration, and so on)
		Green on	Indicates that the drive is running
		Yellow on	Device Visual identification function when using SoMove or the device DTM
2	Warning/Error	Red flashing	Indicates that the drive detected warning
		Red on	Indicates that the drive detected error
3	ASF	Yellow on	Indicates that the safety function is activated

Following table provides the details of the embedded Ethernet LEDs:

Item	LED	Color & status	Description
4	LNK1	OFF	No link.
		Green/Yellow flashing	Power on testing.
		Green on	Link established at 100 Mbit/s.
		Green flashing	Link established at 10 Mbit/s.
		Yellow flashing	Fieldbus activity at 100 Mbit/s.
		Yellow on	Fieldbus activity at 10 Mbit/s.
5	MS	OFF	No power is supplied to the device.
		Green/Red flashing	Power up testing.
		Green on	The device is operating correctly.
		Green flashing	The device has not been configured.
		Red flashing	The device has detected a recoverable minor detected error.
		Red on	The device has detected a non-recoverable major detected error.
6	NS	OFF	The device does not have an IP address or powered off.
		Green/Red flashing	Power on testing.
		Green on	A connection is established to control the command word.
		Green flashing	Device has a valid IP, but no command word connection.
		Red flashing	Duplicated IP.
		Red on	An established connection to control the command word is closes or timed out.

Item	LED	Color & status	Description
7	LNK2	OFF	No link.
		Green/Yellow flashing	Power on testing.
		Green on	Link established at 100 Mbit/s.
		Green flashing	Link established at 10 Mbit/s.
		Yellow flashing	Fieldbus activity at 100 Mbit/s.
		Yellow on	Fieldbus activity at 10 Mbit/s.

Following table provides the details of the embedded Modbus serial LEDs:

Item	LED	Color & status	Description
8	COM	Yellow flashing	Indicates embedded Modbus serial activity

Following table provides the details of the fieldbus module LEDs:

Item	LED	Color & status	Description
9	NET 1	Green/Red	for details, refer to the fieldbus manual (see related documents)
10	NET 2	Green/Red	for details, refer to the fieldbus manual (see related documents)

Graphic Display Terminal Connected to a Computer

<i>NOTICE</i>
<p>INOPERATIVE PERIPHERAL EQUIPMENT</p> <p>Do not connect equipment to the RJ45 port and to the USB port of the Graphic Display Terminal at the same time.</p> <p>Failure to follow these instructions can result in equipment damage.</p>

The Graphic Display Terminal is recognized as a USB storage device named SE_VW3A1111 while plugged on a computer.

This allows to access the saved drive configurations (`DRVCONF` folder) and the Graphic Display Terminal screenshots (`PRTSCR` folder).

Screenshots can be stored by a simultaneous press on `F1` and `F4` function keys

How To Update Language Files on the Graphic Display Terminal?



The Graphic Display Terminal (VW3A1111) language files can be updated:

- Download the latest version of language files here: [Languages Drives VW3A1111](#)
- Unzip the file and follow the instructions of the ReadMe text file.

Multipoint Screen

Overview

Generally, a Graphic Display Terminal is connected to only one drive. However, communication is possible between a Graphic Display Terminal and several Altivar drives (ATV340, ATV600, and ATV900) connected on the same Modbus serial fieldbus via the RJ45 port (HMI or Modbus serial). In such a case, the multipoint mode is automatically applied on the Graphic Display Terminal.

The multipoint mode allows you to:

- Have an overview of all the drives connected on the fieldbus (drive state and two selected parameters).
- Access to all the menus of each drive connected on the fieldbus.
- Command a stop on all the connected drives with the STOP/RESET key (irrespective of the present screen displayed). The type of stop can be individually configured on each drive with the parameter **[Stop Key Enable] P 5 L** in the menu **[Command and Reference] C r P** - (see page 222).

Apart the Stop function linked to the STOP/RESET key, the multipoint mode does not allow to apply a Fault Reset and command the drive via the Graphic Display Terminal: in multipoint mode, the Run key and the Local/Remote key are deactivated.

Prerequisites

To use the multipoint mode:

- The Graphic Display Terminal software version must be equal to or higher than V1.2IE48.
- For each drive, the command channel and the reference channel must be set in advance to a value different from **[Ref.Freq-Rmt.Term] L C C** (see page 222).
- The address of each drive must be configured in advance to different values by setting the parameter **[Modbus Address] A d d** in the **[Modbus Fieldbus] P d I** - (see page 592).
- If the connection to the drive is done via the HMI RJ45 port, the parameter settings in **[Modbus HMI] P d 2** - must be compliant with the Graphic Display Terminal usage (see page 596).
- If the connection to the drive is done via the Modbus serial RJ45 port, the parameter settings in **[Modbus Fieldbus] P d I** - must be compliant with the Graphic Display Terminal usage (see page 592).

Example of Installation Topology

The following figure gives a topology example using three drives and one Graphic Display Terminal (VW3A1111) linked to one Modbus splitter block (LU9GC3):



Screens for Multipoint Mode

The following figure gives the browsing between the different screens linked to the multipoint mode:

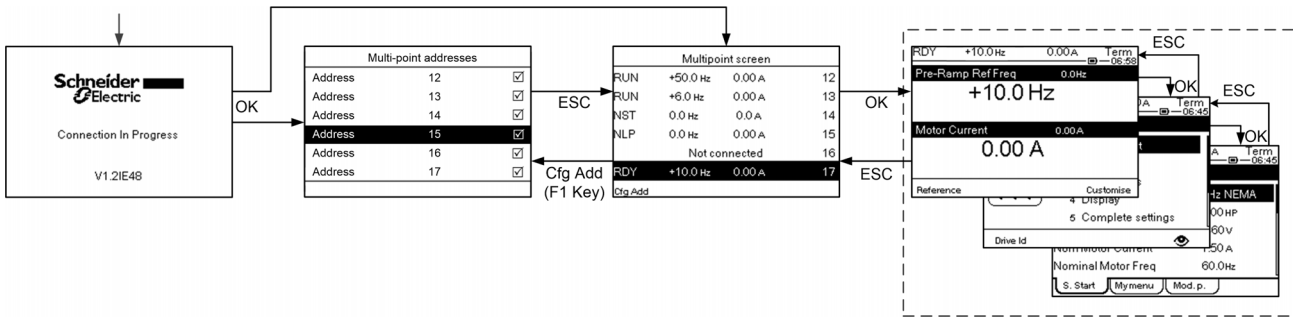

On the fieldbus common with the Graphic Display Terminal, if two or more drives are powered on, you access to the **[connection in progress]** screen. If there is no address selected by the Graphic Display Terminal or no recognized address, the Graphic Display Terminal is locked on this screen. Press OK key to access to the **[Multi-point Addresses]** screen. Otherwise, if there are addresses-selected and one of them have been recognized by the Graphic Display Terminal, the screen switches automatically to **[Multipoint screen]**.

The **[Multi-point Addresses]** screen allows to select, by pressing OK key, the addresses of the drives you want to connect with. Up to 32 addresses can be selected (address setting range: 1...247). When all the addresses have been selected, press ESC key to access to the **[Multipoint screen]**.

NOTE: To help to prevent a low refresh rate of the Graphic Display Terminal screen, do not select addresses that are not corresponding to drive addresses.

On the **[Multipoint screen]**, the touch wheel is used to navigate between the drive overviews. Access to the menus of the selected drive by pressing OK key. Return to the **[Multipoint screen]** by pressing ESC key.



NOTE: To access the **[Multi-point Addresses]** screen from the **[Multipoint screen]**, press F1 key.

If a drive triggers an error, the Graphic Display Terminal goes automatically to the **[Multipoint screen]** on the overview of the latest drive who has triggered an error.

The two parameters given in the drive overview can be modified individually on each drive in **[Param. Bar Select] [PbS-]** menu (see page 616).

Structure of the Parameter Table

General Legend

Pictogram	Description
	These parameters only appear if the corresponding function has been selected in another menu. When the parameters can also be accessed and adjusted from within the configuration menu for the corresponding function, their description is detailed in these menus, on the pages indicated, to aid programming.
	Setting of this parameter can be done during operation or when stopped. NOTE: It is advisable to stop the motor before modifying any of the settings.
	To modify the assignment of the parameter, reinforced validation is required.

Parameter Presentation

Below is an example of a parameter presentation:

[Sample Menu] *C o d E - Menu*

Access

Parameters described below can be accessed by:

[Path] → [Sub-path]

About this menu

Description of the menu or function

[Parameter1] *C o d E 1*

Description of the parameter

Example of a table with a setting range:

Setting ()	Description
0.0... 10,000.0	Setting range Factory setting: 50.0

[Parameter2] *C o d E 2*

Description of the parameter

Example of a table with a list of choices:

Setting ()	Code / Value	Description
[50 Hz IEC]	5 0	IEC Factory setting
[60 Hz NEMA]	6 0	NEMA

Finding a Parameter in This Document

With the Graphic Display Terminal

Select the required parameter and press .

The parameter code is displayed at the top of the information window.

Example: **[Acceleration]** code is *R C C*.

With the Manual

It is possible to use either the parameter name or the parameter code to search in the manual the page giving details of the selected parameter.

Difference Between Menu and Parameter

A dash after menu and submenu codes is used to differentiate menu commands from parameter codes.

Example:

Level	Name	Code
Menu	[Ramp]	<i>r R P P -</i>
Parameter	[Acceleration]	<i>R C C</i>

Chapter 3

Cyber Security

Cyber Security

Introduction

Cyber Security is a branch of network administration that addresses attacks on or by computer systems and through computer networks that can result in accidental or intentional disruptions.

The objective of Cyber Security is to help provide increased levels of protection for information and physical assets from theft, corruption, misuse, or accidents while maintaining access for their intended users.

No single Cyber Security approach is adequate. Schneider Electric recommends a defense-in-depth approach. Conceived by the **National Security Agency** (NSA), this approach layers the network with security features, appliances, and processes.

The basic components of this approach are:

- Risk assessment
- A security plan built on the results of the risk assessment
- A multi-phase training campaign
- Physical separation of the industrial networks from enterprise networks using a demilitarized zone (DMZ) and the use of firewalls and routing to establish other security zones
- System access control
- Device hardening
- Network monitoring and maintenance

This chapter defines the elements that help you configure a system that is less susceptible to cyber attacks.

For detailed information on the defense-in-depth approach, refer to the TVDA: [How Can I Reduce Vulnerability to Cyber Attacks in the Control Room \(STN V2\)](#) on the Schneider Electric website.

To submit a Cyber Security question, report security issues, or get the latest news from Schneider Electric, visit the Schneider Electric website.

Password Management

The system is secured thanks to several passwords:

- Drive password (*see page 611*) must contain six characters (blanks are allowed)
- Webserver password (*see page 620*) must contain:
 - A total of eight characters
 - At least one upper-case letter
 - At least one lower-case letter
 - At least one special character (for example, @, #, \$)
 - No blank character

NOTE: After five unsuccessful login attempts, the access must be reactivated by the administrator.

Schneider Electric recommends to:

- Modify the password every 90 days
- Use a dedicated password (not related to your personal password)

NOTE: No responsibility is assumed by Schneider Electric for any consequences if anyone hacks your product password and if you use the same password for personal usage.

Backing-up and Restoring the Software Configuration

To protect your data, Schneider Electric recommends backing-up the device configuration and keeping your backup file in a safe place. The backup is available in the device DTM, using "load from device" and "store to device" functions.

Remote Access to the Drive

When remote access is used between a device and the drive, ensure your network is secure (VPN, Firewall...).

Machines, controllers, and related equipment are usually integrated into networks. Unauthorized persons and malware may gain access to the machine as well as to other devices on the network/fieldbus of the machine and connected networks via insufficiently secure access to software and networks.

⚠ WARNING
UNAUTHORIZED ACCESS TO THE MACHINE VIA SOFTWARE AND NETWORKS
<ul style="list-style-type: none">● In your hazard and risk analysis, consider all hazards that result from access to and operation on the network/fieldbus and develop an appropriate cyber security concept.● Verify that the hardware infrastructure and the software infrastructure into which the machine is integrated as well as all organizational measures and rules covering access to this infrastructure consider the results of the hazard and risk analysis and are implemented according to best practices and standards covering IT security and cyber security (such as: ISO/IEC 27000 series, Common Criteria for Information Technology Security Evaluation, ISO/IEC 15408, IEC 62351, ISA/IEC 62443, NIST Cybersecurity Framework, Information Security Forum - Standard of Good Practice for Information Security).● Verify the effectiveness of your IT security and cyber security systems using appropriate, proven methods.
Failure to follow these instructions can result in death, serious injury, or equipment damage.

Data Flow Restriction

To secure the access to the drive and limit the data flow, the use of a firewall device is required.

ConneXium Tofino Firewall Product

The ConneXium TCSEFEA Tofino Firewall is a security appliance that provides levels of protection against cyber threats for industrial networks, automation systems, SCADA systems, and process control systems.

This Firewall is designed to permit or deny communications between devices connected to the external network connection of the Firewall and the protected devices connected to the internal network connection.

The Firewall can restrict network traffic based on user defined rules that would permit only authorized devices, communication types and services.

The Firewall includes built-in security modules and an off-line configuration tool for creating secure zones within an industrial automation environment.

Control Command Restriction

To prevent unauthorized use of the command of the drive, it is possible to grant access to a limited number of IP address using the IP master parameter.

The parameter IP Master defines which device can command with the device. This parameter is available in the device DTM.

Deactivation of unused functions

To avoid unauthorized access, it is advisable to deactivate unused functions.

Example: WebServer, Fast Device Replacement ...

Part II

Programming

What Is in This Part?

This part contains the following chapters:

Chapter	Chapter Name	Page
4	[Simply start] <i>SY5</i> -	53
5	[Dashboard] <i>dSH</i> -	63
6	[Diagnostics] <i>d i R</i> -	69
7	[Display] <i>Π ο η</i> -	81
8	[Complete settings] <i>LSL</i> -	159
9	[Communication] <i>COΠ</i> -	591
10	[File management] <i>FΠL</i> -	601
11	[My preferences] <i>ΠYP</i> -	609

Chapter 4

[Simply start] 5 4 5 -

Introduction



[Simply start] 5 4 5 - menu contains 3 tabs for quick access to mains features:

- Simply Start tab which gives a quick access to basic parameters to set.
- My Menu tab which is a user-defined menu for quick access to specific parameters.
- Modified Parameters tab which gives a quick access to the 10 last modified parameters.

What Is in This Chapter?

This chapter contains the following topics:

Topic	Page
[Simply start] 5 , П - Menu	54
[My menu] П 4 П П - Menu	61
[Modified parameters] L П П - Menu	61

[Simply start] 5 , 7 - Menu

Access

[Simply start] → [Simply start]

About This Menu

⚠ WARNING

LOSS OF CONTROL

- Fully read and understand the manual of the connected motor.
- Verify that all motor parameters are correctly set by referring to the nameplate and the manual of the connected motor.

Failure to follow these instructions can result in death, serious injury, or equipment damage.

This menu provides a quick access to the basic parameters to set.

[Motor Standard] b F r ★

Motor standard.

This parameter can be accessed if [Motor control type] C E E is not set to:

- [Sync. mot.] 5 Y n, or
- [Sync.CL.] F 5 Y, or
- [SYN_U VC] 5 Y n u, or
- [Rel. Mot.] 5 r V C.

This parameter modifies the presets of the following parameters:

- [High Speed] H 5 P
- [Motor Freq Thd] F E d
- [Nom Motor Voltage] u n 5
- [Nominal Motor Freq] F r 5
- [Max Frequency] E F r

NOTE: The factory setting value is changed to [60 Hz NEMA] 6 0 for ATV930●●●S6● catalog numbers.

Setting	Code / Value	Description
[50 Hz IEC]	5 0	IEC Factory setting
[60 Hz NEMA]	6 0	NEMA

[Nominal motor power] n P r ★

Nominal motor power.

This parameter can be accessed if:

- [Motor control type] C E E is not set to:
 - [Sync. mot.] 5 Y n, or
 - [Sync.CL.] F 5 Y, or
 - [SYN_U VC] 5 Y n u, or
 - [Rel. Mot.] 5 r V C, and
- [Motor param choice] n P C is set to [Mot Power] n P r.

Rated motor power given on the nameplate, in kW if [Motor Standard] b F r is set to [50Hz IEC] 5 0, in HP if [Motor Standard] b F r is set to [60Hz NEMA] 6 0.

Setting	Description
According to drive rating	Setting range Factory setting: according to the drive rating

[Nom Motor Voltage] u_n 5 ★

Nominal motor voltage.

This parameter can be accessed if **[Motor control type] CEE** is not set to:

- **[Sync. mot.] SYn** , or
- **[Sync.CL.] $F5Y$** , or
- **[SYN_U VC] $SYnu$** , or
- **[Rel. Mot.] $SRVL$** .

Rated motor voltage given on the nameplate.

Setting	Description
100.0...690.0 Vac	Setting range Factory setting: according to drive rating and [Motor Standard] BFr

[Nom Motor Current] in Cr ★

Rated motor current given on the nameplate.

This parameter can be accessed if **[Motor control type] CEE** is not set to:

- **[Sync. mot.] SYn** , or
- **[Sync.CL.] $F5Y$** , or
- **[SYN_U VC] $SYnu$** , or
- **[Rel. Mot.] $SRVL$** .

Setting	Description
0.25...1.5 In ⁽¹⁾	Setting range Factory setting: according to drive rating and [Motor Standard] BFr
(1) Corresponding to the rated drive current indicated in the installation manual and on the drive nameplate.	

[Nominal Motor Freq] F_r 5 ★

Nominal motor frequency.

This parameter can be accessed if **[Motor control type] CEE** is not set to:

- **[Sync. mot.] SYn** , or
- **[Sync.CL.] $F5Y$** , or
- **[SYN_U VC] $SYnu$** , or
- **[Rel. Mot.] $SRVL$** .

The factory setting is 50 Hz, or preset to 60 Hz if **[Motor Standard] BFr** is set to 60 Hz.

Setting	Description
10.0...599.0 Hz	Setting range Factory setting: 50.0 Hz

[Nominal Motor Speed] n 5 P ★

Nominal motor speed.

This parameter can be accessed if [Motor control type] C E E is not set to:

- [Sync. mot.] 5 Y n, or
- [Sync.CL.] F 5 Y, or
- [SYN_U VC] 5 Y n u, or
- [Rel. Mot.] 5 r V C.

If the nameplate indicates the synchronous speed and the slip in Hz or as a %, use one of the formulas to calculate the rated speed:

- Nominal speed = Synchronous speed x $\frac{100 - \text{slip as a \%}}{100}$
- Nominal speed = Synchronous speed x $\frac{60 - \text{slip in Hz}}{60}$ (60 Hz motors)
- Nominal speed = Synchronous speed x $\frac{50 - \text{slip in Hz}}{50}$ (50 Hz motors).

Setting	Description
0...65,535 rpm	Setting range Factory setting: according to drive rating

[Motor 1 Cosinus Phi] C o 5 ★

Nominal motor cosinus Phi.

This parameter can be accessed if:

- [Motor control type] C E E is not set to:
 - [Sync. mot.] 5 Y n, or
 - [Sync.CL.] F 5 Y, or
 - [SYN_U VC] 5 Y n u, or
 - [Rel. Mot.] 5 r V C, and
- [Motor param choice] P P C is set to [Mot Cosinus] C o 5.

Setting	Description
0.50...1.00	Setting range Factory setting: according to the drive rating

[2/3-Wire Control] $\exists \text{ } \mathcal{L}$

2-wire or 3-wire control.

⚠ WARNING

UNANTICIPATED EQUIPMENT OPERATION

If this parameter is changed, the parameters [Reverse Assign] $r \text{ } r \text{ } 5$ and [2-wire type] $\exists \text{ } \mathcal{L}$ and the assignments of the digital inputs are reset to the factory setting.

Verify that this change is compatible with the type of wiring used.

Failure to follow these instructions can result in death, serious injury, or equipment damage.

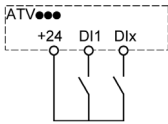
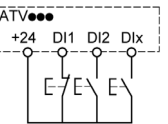
Setting	Code / Value	Description
[2-Wire Control]	$\exists \text{ } \mathcal{L}$	<p>2-wire control (level commands): This is the input state (0 or 1) or edge (0 to 1 or 1 to 0), which controls running or stopping.</p> <p>Example of source wiring:</p>  <p>D11 Forward Dlx Reverse</p> <p>Factory setting</p>
[3-Wire Control]	$\exists \text{ } \mathcal{L}$	<p>3-wire control (pulse commands) [3 wire]: A forward or reverse pulse is sufficient to command starting, a stop pulse is sufficient to command stopping.</p> <p>Example of source wiring:</p>  <p>D11 Stop D12 Forward Dlx Reverse</p>

[Max Frequency] $\exists \text{ } F \text{ } r$

Maximum output frequency.

The factory setting is 60 Hz, or preset to 72 Hz if [Motor Standard] $b \text{ } F \text{ } r$ is set to 60 Hz.

Setting	Description
10.0...599.0 Hz ⁽¹⁾	Setting range Factory setting: 60 Hz
(1) The maximum of the range is $10 * [\text{Nominal Motor Freq}] F \text{ } r \text{ } 5$ for an asynchronous law or $10 * [\text{Sync Nominal Freq}] F \text{ } r \text{ } 5 \text{ } 5$ for a synchronous law.	

[Autotuning] *t u n* 

⚠ WARNING

UNEXPECTED MOVEMENT

Autotuning moves the motor in order to tune the control loops.

- Only start the system if there are no persons or obstructions in the zone of operation.

Failure to follow these instructions can result in death, serious injury, or equipment damage.

During autotuning, noise development and oscillations of the system are normal.

If [Autotuning Type] *t u n t* is set to [Standard] *S t d*, during autotuning, the motor makes small movements.

If [Autotuning Type] *t u n t* is set to [Rotation] *r o t*, during autotuning, the motor runs at half of its nominal frequency.

In any case, the motor has to be stopped before performing a tune operation. Verify that the application does not make the motor turn during the tune operation.

The tune operation optimizes:

- The motor performances at low speed.
- The estimation of the motor torque.

Autotuning is only performed if no stop command has been activated. If a “freewheel stop” or “fast stop” function has been assigned to a digital input, this input must be set to 1 (active at 0).

Autotuning takes priority over any run or prefluxing commands, which will be taken into account after the autotuning sequence.

If autotuning has detected error, the drive always displays [No action] *n o* and, depending on the configuration of [Tuning Error Resp] *t n l*, may switch to [Autotuning] *t u n* detected error mode.

Autotuning may last for several seconds. Do not interrupt the process. Wait for the Graphic Display Terminal to change to [No action] *n o*.

NOTE: The motor thermal state has a significant influence on the tuning result. Always perform a motor tuning with the motor stopped and cold. Verify that the application does not have the motor operate during a tuning operation.

To redo a motor tuning, wait that it is stopped and cold. Set first [Autotuning] *t u n* to [Erase Autotuning] *C L r*, then redo the motor tuning.

The use of the motor tuning without doing a [Erase Autotuning] *C L r* first is used to get the thermal state estimation of the motor.

The cable length has an influence on the tune result. If the wiring is modified, it is necessary to redo the tune operation.

Setting ()	Code / Value	Description
[No action]	<i>n o</i>	Autotuning not in progress Factory setting
[Apply Autotuning]	<i>Y E S</i>	Autotuning is performed immediately if possible, then the parameter automatically changes to [No action] <i>n o</i> . If the drive state does not allow the tune operation immediately, the parameter changes to [No action] <i>n o</i> and the operation must be done again.
[Erase Autotuning]	<i>C L r</i>	The motor parameters measured by the autotuning function are reset. The default motor parameter values are used to control the motor. [Autotuning Status] <i>t u S</i> is set to [Not done] <i>t R b</i> .

[Autotuning Status] *t u 5*

Autotuning status.

(for information only, cannot be modified)

This parameter is not saved at drive power off. It shows the autotuning status since last power-on.

Setting ()	Code / Value	Description
[Not done]	<i>t R b</i>	Autotune is not done Factory setting
[Pending]	<i>P E n d</i>	Autotune has been requested but not yet performed
[In Progress]	<i>P r o G</i>	Autotune is in progress
[Error]	<i>F R i L</i>	Autotune has detected an error
[Autotuning Done]	<i>d o n E</i>	The motor parameters measured by the autotuning function are used to control the motor

[Tune Selection] *5 t u n* ★

Tune selection.

Setting ()	Code / Value	Description
[Default]	<i>t R b</i>	The default motor parameter values are used to control the motor Factory setting
[Measure]	<i>M E A S</i>	The values measured by the autotuning function are used to control the motor
[Custom]	<i>C u 5</i>	The values manually set are used to control the motor

[Motor Th Current] *i t H*

Motor thermal monitoring current to be set to the rated current indicated on the nameplate.

Setting ()	Description
0.12...1.1 In ⁽¹⁾	Setting range Factory setting: According to drive rating
(1) Corresponding to the rated drive current indicated in the installation manual and on the drive nameplate.	

[Acceleration] *A C C*

Time to accelerate from 0 to the [Nominal Motor Freq] *F r 5*. To have a repeatability in the ramps, the value of this parameter must be set according to the possibility of the application.

Setting ()	Description
0.0...6,000.0 s ⁽¹⁾	Setting range Factory setting: 3.0 s
(1) Range 0.01 to 99.99 s or 0.1 to 999.9 s or 1...6,000 s according to [Ramp increment] <i>i n r</i> .	

[Deceleration] *d E C*

Time to decelerate from the [Nominal Motor Freq] *F r 5* to 0. To have a repeatability in the ramps, the value of this parameter must be set according to the possibility of the application.

Setting ()	Description
0.0...6,000.0 s ⁽¹⁾	Setting range Factory setting: 3.0 s
(1) Range 0.01 to 99.99 s or 0.1 to 999.9 s or 1...6,000 s according to [Ramp increment] <i>i n r</i> .	

[Low Speed] *L S P*

Low speed.

Motor frequency at minimum reference, can be set between 0 and **[High Speed] *H S P***.

Setting ()	Description
0.0... [High Speed] <i>H S P</i> Hz	Setting range Factory setting: 0.0 Hz

[High Speed] *H S P*

High speed.

Motor frequency at maximum reference, can be set between **[Low Speed] *L S P*** and **[Max Frequency] *L F r***. The factory setting changes to 60 Hz if **[Motor Standard] *b F r*** is set to **[60Hz NEMA] *B D***.

Setting ()	Description
0.0... [Max Frequency] <i>L F r</i> Hz	Setting range Factory setting: 50.0 Hz

[My menu] ПУПн - Menu

Access

[Simply start] → [My menu]

About This Menu

This menu contains the parameters selected in the [My menu config.] ПУС - Menu.

NOTE: This menu is empty by default.

[Modified parameters] L ПД - Menu

Access

[Simply start] → [Modified parameters]

About This Menu

This menu gives a quick access to the 10 last modified parameters (or the full list in the DTM)

Chapter 5

[Dashboard] d 5 H -

Introduction



[Dashboard] d 5 H - menu contains tabs for quick access to system and display features:

- System tab to configure the main system parameters.
- Energy tab which provides a complete access for instantaneous power counters and energy reports by means of graphics on the Graphic Display Terminal.

What Is in This Chapter?

This chapter contains the following topics:

Topic	Page
[System] d 5 L - Menu	64
[Dashboard] d 5 H - Menu	65
[kWh Counters] K W L - menu	65
[Dashboard] d 5 H - Menu	67

[System] d S t - Menu

Access

[Dashboard] → [System]

[Pre-Ramp Ref Freq] F r H

Frequency reference before ramp (signed value).

Actual frequency reference linked to the motor regardless of which channel for reference value has been selected. This parameter is in read-only mode.

Setting	Description
-[High Speed] H S P...[High Speed] H S P Hz	Setting range Factory setting: –

[Drive State] H n , S

Drive state.

Setting	Code / Value	Description
[Autotuning]	t u n	Autotuning
[In DC inject.]	d C b	DC Injection
[Ready]	r d y	Drive ready
[Freewheel]	n S t	Freewheel stop control
[Running]	r u n	Motor in steady state or run command present and zero reference
[Accelerating]	A C C	Acceleration
[Decelerating]	d E C	Deceleration
[Current limitation]	C L i	In current limitation
[Fast stop]	F S t	Fast stop
[No Mains Voltage]	n L P	Control is powered on but the DC bus is not loaded
[control.stop]	C t L	Controlled stop
[Dec. adapt.]	a b r	Adapted deceleration
[Output cut]	S o C	Stand by output cut
[Undervoltage Warning]	u S A	Undervoltage warning
["Operating State "Fault""]	F L t	Product has detected an error
[DCP Flashing Mode]	d C P	DCP flashing mode
[STO Active]	S t o	Safe Torque Off active
[Energy Saving]	i d L E	Idle stop and go mode
[Firmware Update]	F W u P	Firmware update
[Angle test]	A S A	Angle setting
[AFE Mains Undervoltage]	u r A	Displayed if the voltage applied on the Active Front End power brick exceeds the [Mains Voltage] u r E S, the drive stops on [Freewheel Stop] n S t.

[Motor Current] L C r

Motor current.

Setting	Description
According to drive rating	Setting range Factory setting: –

[Motor speed] S P d

Motor speed in rpm.

This parameter displays the estimated rotor speed without motor slip.

Setting	Description
0...65,535 rpm	Setting range Factory setting: –

[Motor Therm state] t H r

Motor thermal state.

The nominal motor thermal state is 100%, the **[Motor Overload] o L F** threshold is set to 118%.

Setting	Description
0...200%	Setting range Factory setting: –

[Dashboard] d S H - Menu**Access**

[Dashboard]

[Trq/Spd] C t S

Displays the torque versus speed curve.

[kWh Counters] K w C - menu**Access**

[Dashboard] → [kWh Counters]

About This Menu

This menu presents many energy objects available for instantaneous data and kW consumption reports. It offers the possibility to display logged data with graphics by pressing the F4 function key.

[Elc Energy Cons] o C 4 ★

Electrical energy consumed by the motor in TWh.

This parameter can be accessed if **[Elc energy cons(TWh)] o C 4** is not set to 0.

Setting	Description
0...999 TWh	Setting range Factory setting: Read Only

[Elc Energy Cons] o C 3 ★

Electrical energy consumed by the motor in GWh.

Setting	Description
0...999 GWh	Setting range Factory setting: Read Only

[Elc Energy Cons] o C 2 ★

Electrical energy consumed by the motor in MWh.

Setting	Description
0...999 MWh	Setting range Factory setting: Read Only

[Elc Energy Cons]    ★

Electrical energy consumed by the motor in kWh.

Setting	Description
0...999 kWh	Setting range Factory setting: Read Only

[Elc Energy Cons]    ★

Electrical energy consumed by the motor in Wh.

Setting	Description
0...999 Wh	Setting range Factory setting: Read Only

[Acv Elc Out Pwr Estm] *E P r W*

Active electrical output power estimation.

Setting	Description
-32,767...32,767	Setting range Value in kW or HP according to [Motor Standard] <i>b F r</i> setting Factory setting: Read Only

[Elc Egy Today]   

Electrical energy consumed today by the motor in kWh.

Setting	Description
0...4,294,967,295 kWh	Setting range in kWh Factory setting: Read Only

[Elc Egy Yesterday]   

Electrical energy consumed yesterday by the motor in kWh.

Setting	Description
0...4,294,967,295 kWh	Setting range in kWh Factory setting: Read Only

[Dashboard] *d S H* - Menu

Access

[Dashboard]

About This Menu

Using **F4** function key on the Graphic Display Terminal, it is possible to select one of the following view for the **[Energy]** tab.

[Instant kW Trend] *C V I*

Displays the instantaneous electrical energy curve at the drive output.

[Daily kWh Report] *H S d*

Displays the daily energy histogram.

[Weekly kWh Report] *H S W*

Displays the weekly energy histogram.

[Monthly kWh Report] *H S M*

Displays the monthly energy histogram.

[Yearly kWh Report] *H S Y*

Displays the yearly energy histogram.

Chapter 6

[Diagnostics] *d , R -*

Introduction



[Diagnostics] *d , R -* menu presents drive and application data useful when diagnostics is required.

What Is in This Chapter?

This chapter contains the following sections:

Section	Topic	Page
6.1	[Diag. data]	70
6.2	[Error history] <i>P F H -</i> Menu	75
6.3	[Warnings] <i>R L r -</i> Menu	78

Section 6.1

[Diag. data]

What Is in This Section?

This section contains the following topics:

Topic	Page
[Diag. data] <i>d d t</i> - Menu	71
[Service message] <i>S E r</i> - Menu	72
[Other State] <i>S S t</i> - Menu	73
[Diagnostics] <i>d R u</i> - Menu	74
[Identification] <i>a i d</i> - Menu	74

[Diag. data] d d E - Menu**Access**

[Diagnostics] → [Diag. data]

About This Menu

This menu presents the actual warning and detected error in addition to drive data.

[Last Warning] L R L r

Last warning which occurred.

The list of warning codes is available in the chapter "Diagnostics and Troubleshooting" (*see page 636*).

[Last Error] L F E

Last error which occurred.

The list of error codes is available in the chapter "Diagnostics and Troubleshooting" (*see page 639*).

[Identification Error] i n F E ★

Identification Error (inF6).

This parameter can be accessed if **[Last Error] L F E** is **[Identification Error] i n F E**.

Setting	Description
0...12 (value in Hex.)	Value = 0x00 : No error detected Value = 0x01 : No response of the option module Value = 0x02 : Signature reception timeout Value = 0x03 : ACK reception timeout Value = 0x04 : Signature length Value = 0x05 : CheckSum Value = 0x06 : Unknown state Value = 0x07 : UART receive Value = 0x08 : Unknown protocol version Value = 0x09 : Unknown module type Value = 0x0A : More than 5 unsuccessful tries Value = 0x0B : Unknown module type Value = 0x0C : Option module not supported by the slot Value = 0x0D : Same option module in more than one slot Value = 0x0E : O1SV not received Value = 0x0F : O1SV option module software version not compatible Value = 0x10 : reserved Value = 0x11 : reserved Value = 0x12 : Control terminal module not present or not recognized Factory setting: –

[Internal Error 19] i n F J ★

Encoder module error code.

This parameter can be accessed if **[Last Error] L F E** is **[Internal Error 19] i n F J**.

Setting	Description
0...65,535	Setting Range Factory setting: –

[Encoder Fdbck Error] E n C E ★

Encoder feedback error code.

This parameter can be accessed if **[Last Error] L F E** is **[Encoder Feedback Loss] 5 P F**.

Setting	Description
0...65,535	Setting range Encoder error Id 1: Encoder power supply overcurrent 10: AB encoder: A-line disconnected 11: AB encoder: B-line disconnected 12: AB encoder: tracking error 13: AB encoder: spike error 20: Resolver: LOS error 21: Resolver: DOS error 22: Resolver: LOT error 30: SinCos: loss of signal 31: SinCos: loss of signal 32: SinCos: tracking error 33: SinCos: spike error 40: Hiperface: timeout while waiting for response and retry exceeded 41: Hiperface: encoder type is not known and can not be read from encoder EEPROM 42: Hiperface: Hiperface command GetAbsolutePosition error 43: Hiperface: checksum error detected and retry exceeded 50: Endat: communication error 51: Endat: encoder not connected 52...56: Endat: error reading EnDat21 parameter 57: Endat: encoder does not support EnDat22 58: Endat: runtime compensation procedure 59: Endat: runtime compensation procedure 60: Endat: error in cyclic communication Factory setting: –

[Nb Of Start] n S Π

Number of motor starts (resettable).

Setting	Description
0...4,294,967,295	Setting range Factory setting: 0

[Motor Run Time] r E H H

Motor run time.

Run elapsed time display (resettable) in 0.1 hours (length of time the motor has been switched on).

Setting	Description
0.0...429,496,729.5 h	Setting range Factory setting: _

[Service message] 5 E r - Menu

Access

[Diagnostics] → [Diag. data] → [Service message]

About This Menu

This menu presents the service messages.

This is a user-defined service message configured in **[My preferences] Π Y P → [Customization] C U S → [Service messages] 5 E r**.

[Other State] 5 5 Ɛ - Menu**Access**

[Diagnostics] → [Diag. data] → [Other State]

About This Menu

List of secondary states.

List

[Sleep Active] *5 L ƞ*
 [Sleep Boost active] *5 L P b*
 [Set 1 active] *Ɛ F P 1*
 [Set 2 active] *Ɛ F P 2*
 [Set 3 active] *Ɛ F P 3*
 [Automatic restart] *R u Ɛ o*
 [DC Bus Charged] *d b L*
 [Fast stop Active] *F 5 Ɛ*
 [Fallback Frequency] *F r F*
 [Speed Maintained] *r L 5*
 [Type of stop] *5 Ɛ Ɛ*
 [Encoder Config] *, Ɛ Ɛ*
 [In braking] *b r 5*
 [Backspin Active] *b 5 Ɛ*
 [DC Bus Ripple Warn] *d Ɛ r W*
 [Ref Freq Warning] *5 r R*
 [Forward] *ƞ F r d*
 [Reverse] *ƞ r r 5*
 [In motor fluxing] *F L X*
 [Autotuning] *Ɛ u ƞ*

[Diagnostics] *d I A* - Menu

Access

[Diagnostics] → [Diag. data] → [Diagnostics]

About This Menu

This menu allows to make simple test sequences for diagnostics.

[FAN Diagnostics] *F n t*

Diagnostics of internal fan(s).

This will start a test sequence.

NOTE:

Fan diagnostics of internal fan(s) will be not-successful if the DC bus is not fully charged. This will be the case:

- on separate control (e.g. the control block is only supplied on 24V), or
- if the drive is in **[Energy saving]** *i d L E* mode (e.g. Stop and go function is active).

[HMI LED Diagnostics] *H L t*

Diagnostics of product LED(s).

This will start a test sequence.

[IGBT Diag w motor] *i w t*

Diagnostics of product IGBT(s).

This will start a test sequence with the connected motor (open circuit/short-circuit).

[IGBT Diag w/o motor] *i w o t*

Diagnostics of product IGBT(s).

This will start a test sequence without the motor (short-circuit).

[Identification] *i d* - Menu

Access

[Diagnostics] → [Diag. data] → [Identification]

About This Menu

This is a read-only menu that cannot be configured. It enables the following information to be displayed:

- Drive reference, power rating, and voltage
- Drive software version
- Drive serial number
- Type of option modules present, with their software version
- Graphic Display Terminal type and version

Section 6.2

[Error history] P F H - Menu

[Error history] P F H - Menu

Access

[Diagnostics] → [Error history]

About This Menu

This menu shows the 15 last detected errors (*d P I* to *d P F*).

Pressing OK key on the selected error code in the Error history list displays the drive data recorded when the error has been detected.

NOTE: Same content for [Last Error 1] *d P I* to [Last Error F] *d P F*.

[Last Error 1] *d P I*

Last error 1.

Identical to [Last Error] *L F E* (see page 71).

[Drive State] *H S I*

HMI status.

Identical to [Drive State] *H Π , S* (see page 64).

[Last Error 1 Status] *E P I*

Status of last error 1.

DRIVECOM status register (same as [ETA state word] *E E H*).

[ETI state word] *, P I*

ETI state word.

ETI status register (see the communication parameter file).

[Cmd word] *Π P I*

Cmd word.

Command register (same as [Cmd word] *Π d*).

[Motor current] *L C P I*

Motor current (same as [Motor Current] *L C r*).

Setting	Description
0...2*In ⁽¹⁾	Setting range Factory setting: _
(1) Corresponding to the rated drive current indicated in the installation manual and on the drive nameplate.	

[Output frequency] *r F P I*

Output frequency (same as [Output frequency] *r F r*).

Setting	Description
-3,276.7...3,276.7 Hz	Setting range Factory setting: _

[Elapsed Time] r t P I

Elapsed time.

Setting	Description
0...65,535 h	Setting range Factory setting: _

[DC bus voltage] u L P I

DC bus voltage (same as [DC bus voltage] u L P I).

Setting	Description
0...6,553.5 Vdc	Setting range: [No meas.] - - - - is displayed if no value is measured. Factory setting: _

[Motor therm state] t H P I

Motor thermal state (same as [Motor Therm state] t H r).

Setting	Description
0...200%	Setting range Factory setting: _

[Command Channel] d C C I

Command channel (same as [Command channel] C P d C).

Setting	Code / Value	Description
[Terminals]	t E r	Terminal block
[Ref. Freq-Rmt.Term]	L C C	Graphic Display Terminal
[Modbus]	P d b	Modbus serial
[CANopen]	C A n	CANopen
[Com. Module]	n E t	Fieldbus module
[Ethernet Module]	E t h	Embedded Ethernet
[PC tool]	P W 5	DTM based commissioning software

[Ref Freq Channel] d r C I

Channel for reference frequency (same as [Ref Freq Channel] r F C C).

Identical to [Command channel] d C C I (see page 76).

[Motor Torque] o t P I

Estimated motor torque value (same as [Motor Torque] o t r).

NOTE: The displayed value is always positive in motor mode and negative in generator mode whatever the direction.

Setting	Description
-300...300%	Setting range Factory setting: _

[Drive Thermal State] t d P I

Measured drive thermal state (same as [Drive Therm State] t H d).

Setting	Description
0...200%	Setting range Factory setting: _

[IGBT Junction Temp] t_{JP}

Estimated junction temperature value.

Setting	Description
0...255°C	Setting range Factory setting: _

[Switching Frequency] SFr

Switching frequency applied (related to **[Switching Frequency] SFr**).

Setting	Description
0...65,535 Hz	Setting range Factory setting: _

[Power Brick Error ID] bP_i

Power Brick error ID

The value displayed is the bit number of the brick with actual error, starting with number 1 on the right side.

Setting	Description
0...255	Setting range Factory setting: _

[AFE Power brick error ID] bF_i

Active Front End brick error ID

The value displayed is the bit number of the brick with actual error, starting with number 1 on the right side.

Setting	Description
0...65535	Setting range Factory setting: _

[Last Error 2] dP_2 to [Last Error F] dPF

Last error 2... Last error F

Identical to **[Last Error1] dP_1** (*see page 75*).

Section 6.3

[Warnings] *ALr* - Menu

What Is in This Section?

This section contains the following topics:

Topic	Page
[Actual warnings] <i>ALrd</i> - Menu	79
[Warning group 1 definition] <i>ALC</i> - Menu	79
[Warning group 2 definition] <i>ALC</i> - Menu	79
[Warning group 3 definition] <i>ALC</i> - Menu	79
[Warning group 4 definition] <i>ALC</i> - Menu	79
[Warning group 5 definition] <i>ALC</i> - Menu	80
[Warnings] <i>ALr</i> - Menu	80

[Actual warnings] *A L r d* - Menu

Access

[Diagnostics] → [Warnings] → [Actual warnings]

About This Menu

List of current warnings.

If a warning is active, ✓ and  appears on the Graphic Display Terminal.

List of Available Warnings

The list of warning codes is available in the chapter "Diagnostics and Troubleshooting" (*see page 636*).

[Warning group 1 definition] *A 1 C* - Menu

Access

[Diagnostics] → [Warnings] → [Warning group 1 definition]

About This Menu

The following submenus group the warnings into 1 to 5 groups, each of which can be assigned to a relay or a digital output for remote signaling.

When one or a number of warnings selected in a group occurs, this warning group is activated.

List of Warnings

The list of warning codes is available in the chapter "Diagnostics and Troubleshooting" (*see page 636*).

[Warning group 2 definition] *A 2 C* - Menu

Access

[Diagnostics] → [Warnings] → [Warning group 2 definition]

About This Menu

Identical to [Warning group 1 definition] *A 1 C* (*see page 79*)

[Warning group 3 definition] *A 3 C* - Menu

Access

[Diagnostics] → [Warnings] → [Warning group 3 definition]

About This Menu

Identical to [Warning group 1 definition] *A 1 C* (*see page 79*)

[Warning group 4 definition] *A 4 C* - Menu

Access

[Diagnostics] → [Warnings] → [Warning group 4 definition]

About This Menu

Identical to [Warning group 1 definition] *A 1 C* (*see page 79*)

[Warning group 5 definition] *R 5 C* - Menu

Access

[Diagnostics] → [Warnings] → [Warning group 5 definition]

About This Menu

Identical to [Warning group 1 definition] *R 1 C* (*see page 79*)

[Warnings] *R L r* - Menu

Access

[Diagnostics] → [Warnings]

About This Menu

This menu presents the warning history (30 past warnings).

[Warning History] *R L H*

Identical to [Last warning] *L R L r* (*see page 71*).

Chapter 7

[Display] Π ο η -

Introduction



[Display] Π ο η - menu shows monitoring data related to the drive and the application.

It offers an application-oriented display in terms of energy, cost, cycle, efficiency, ...

This is available with customized units and graphics view.

What Is in This Chapter?

This chapter contains the following sections:

Section	Topic	Page
7.1	[Energy parameters]	82
7.2	[Application parameters]	89
7.3	[Pump parameters]	90
7.4	[M/S parameters]	91
7.5	[Motor parameters]	96
7.6	[Drive parameters]	98
7.7	[Thermal monitoring]	102
7.8	[PID display]	103
7.9	[Counter management]	104
7.10	[Other state]	107
7.11	[I/O map]	108
7.12	[Communication map]	130
7.13	[Data logging]	154
7.14	[Braking Unit Option]	158

Section 7.1

[Energy parameters]

What Is in This Section?

This section contains the following topics:

Topic	Page
[Elec Ener Input Counter] <i>E L I</i> - Menu	83
[Elec Ener Output Counter] <i>E L O</i> - Menu	85
[Mechanical energy] <i>M E C</i> - Menu	87
[Energy saving] <i>E S R</i> - Menu	88

[Elec Ener Input Counter] *E L* , - Menu

Access

[Display] → [Energy parameters] → [Elec Ener Input Counter]

About This Menu

This menu presents the input electrical energy data.

NOTE: On Altivar Process range, except for ATV980 and ATV9B0 products, the power and energy parameters are estimated based on the output current of the drive. For ATV980 and ATV9B0 products, the power and energy parameters are measured.

[Active Input Power] *P r W*

Active electrical input power.

Setting	Description
According to the drive rating	Setting range in kW if [Motor Standard] <i>b F r</i> is set to [50Hz IEC] <i>5 D</i> or in HP if [Motor Standard] <i>b F r</i> is set to [60Hz NEMA] <i>6 D</i> Factory setting: _

[Input Reactive Power] *q r W*

Reactive electrical input power.

This parameter can be accessed on ATV980 and ATV9B0

Setting	Description
According to the drive rating	Setting range in kW if [Motor Standard] <i>b F r</i> is set to [50Hz IEC] <i>5 D</i> or in HP if [Motor Standard] <i>b F r</i> is set to [60Hz NEMA] <i>6 D</i> Factory setting: _

[Input Power Factor] *P w F*

Mains input power factor.

This parameter can be accessed on ATV980 and ATV9B0

Setting	Description
According to the drive rating	Setting range displayed as a percentage Factory setting: _

[Real Input Energy] *E 4* ★

Input electrical power consumed (TWh).

This parameter can be accessed if [Real Input Energy] *E 4* is not set to 0.

Setting	Description
-999...999 TWh	Setting range Factory setting: _

[Real Input Energy] *E 3* ★

Input electrical power consumed (GWh).

Setting	Description
-999...999 GWh	Setting range Factory setting: _

[Real Input Energy] , E 2 ★

Input electrical power consumed (MWh).

Setting	Description
-999...999 MWh	Setting range Factory setting: _

[Real Input Energy] , E 1 ★

Input electrical power consumed (kWh).

Setting	Description
-999...999 kWh	Setting range Factory setting: _

[Real Input Energy] , E 0 ★

Input electrical power consumed (Wh).

Setting	Description
-999...999 Wh	Setting range Factory setting: _

[Elec Ener Output Counter] *E L 0* - Menu

Access

[Display] → [Dashboard Energy] → [Energy parameters] → [Elec Ener Output Counter]

About This Menu

This menu presents the output electrical energy data.

[Acv Elc out pwr estm] *E P r W*

Active electrical output power estimation.

Setting	Description
According to the drive rating	Setting range in kW if [Motor Standard] <i>b F r</i> is set to [50Hz IEC] <i>5 D</i> or in HP if [Motor Standard] <i>b F r</i> is set to [60Hz NEMA] <i>6 D</i> Factory setting: _

[Real Consumption] *0 E 4* ★

Electrical energy consumed (TWh).

This parameter can be accessed if [Real Consumption] *0 E 4* is not set to 0.

Setting	Description
-999...999 TWh	Setting range Factory setting: _

[Real Consumption] *0 E 3*

Electrical energy consumed (GWh).

Setting	Description
-999...999 GWh	Setting range Factory setting: _

[Real Consumption] *0 E 2*

Electrical energy consumed (MWh).

Setting	Description
-999...999 MWh	Setting range Factory setting: _

[Real Consumption] *0 E 1*

Electrical energy consumed (kWh).

Setting	Description
-999...999 kWh	Setting range Factory setting: _

[Real Consumption] *0 E 0*

Electrical energy consumed (Wh).

Setting	Description
-999...999 Wh	Setting range Factory setting: _

[Elc Egy Today] $\alpha C E$

Electrical energy consumed today by the motor (kWh).

Setting	Description
0...4,294,967,295 kWh	Setting range Factory setting: _

[Elc Egy Yesterday] $\alpha C Y$

Electrical energy consumed yesterday by the motor (kWh).

Setting	Description
0...4,294,967,295 kWh	Setting range Factory setting: _

[Over-Consumption Thd] $P C R H$

Power level for over-consumption.

Setting	Description
[Under-Consumption Thd] $P C R L$...200.0%	Setting range Factory setting: 0.0%

[Under-Consumption Thd] $P C R L$

Power level for under-consumption.

Maximum value = $P C R H$ if $P C R H \leq 100\%$.

Setting	Description
0.0...100.0% or [Over-Consumption Thd] $P C R H$ if $P C R L \leq 100\%$	Setting range Factory setting: 0.0%

[Over/Under-Cons Delay] $P C R E$

Over/under-consumption detection time.

Setting	Description
0...60 min	Setting range Factory setting: 1 min

[Peak Output Power] $\Pi \alpha E P$

Peak output power.

Setting	Description
According to the drive rating	Setting range Factory setting: _

[Mechanical energy] $\Pi E C$ - Menu

Access

[Display] → [Dashboard Energy] → [Energy parameters] → [Mechanical energy]

About This Menu

This menu presents the output mechanical energy data.

[Power Estim Value] $\alpha P r W$

Motor shaft power estimation.

Setting	Description
According to the drive rating	Setting range in kW if [Motor Standard] $b F r$ is set to [50Hz IEC] $5 D$ or in HP if [Motor Standard] $b F r$ is set to [60Hz NEMA] $6 D$ Factory setting: _

[Motor Consumption] $\Pi E 4$ ★

Energy consumption (TWh).

This parameter can be accessed if [Motor Consumption] $\Pi E 4$ is not set to 0.

Setting	Description
0...999 TWh	Setting range Factory setting: _

[Motor Consumption] $\Pi E 3$ ★

Energy consumption (GWh).

Setting	Description
0...999 GWh	Setting range Factory setting: _

[Motor Consumption] $\Pi E 2$ ★

Energy consumption (MWh).

Setting	Description
0...999 MWh	Setting range Factory setting: _

[Motor Consumption] $\Pi E 1$ ★

Energy consumption (kWh).

Setting	Description
0...999 kWh	Setting range Factory setting: _

[Motor Consumption] $\Pi E 0$ ★

Energy consumption (Wh).

Setting	Description
0...999 Wh	Setting range Factory setting: _

[Energy saving] *E S R* - Menu

Access

[Display] → [Dashboard Energy] → [Energy parameters] → [Energy saving]

About This Menu

This menu presents the comparison in term of cost, energy, CO₂ between solutions with and without drive.

[Reference Power] *P r E F*

Reference Power without drive

Setting	Description
0.00...655.35 kW	Setting range in kW if [Motor Standard] <i>b F r</i> is set to [50Hz IEC] <i>S D</i> or in HP if [Motor Standard] <i>b F r</i> is set to [60Hz NEMA] <i>S D</i> . Factory setting: 0.00 kW

[kWh Cost] *E C S L*

Cost of the kWh.

Setting	Description
0.00...655.35 \$	Setting range in € if [Motor Standard] <i>b F r</i> is set to [50 Hz IEC] <i>S D</i> or in \$ if [Motor Standard] <i>b F r</i> is set to [60Hz NEMA] <i>S D</i> . Factory setting: _

[CO2 Ratio] *E C o 2*

Quantity of CO₂ by kWh.

Setting	Description
0.000...65.535 kg/kWh	Setting range Factory setting: 0.000 kg/kWh

[Energy Saved] *E S R V*

Energy saved with the drive solution.

Setting	Description
0...4,294,967,295 kWh	Setting range Factory setting: _

[Money Saved] *C R S H*

Cost saved with the drive solution.

Setting	Description
0.00...42,949,672 \$	Setting range in € if [Motor Standard] <i>b F r</i> is set to [50 Hz IEC] <i>S D</i> or in \$ if [Motor Standard] <i>b F r</i> is set to [60 Hz NEMA] <i>S D</i> . Factory setting: _

[Co2 Saved] *C o 2 S*

CO₂ saved with the drive solution.

Setting	Description
0.0...429,496,729.5 t	Setting range Factory setting: _

Section 7.2

[Application parameters]

[Application parameters] *APP* - Menu

Access

[Display] → [Application parameters]

About This Menu

This menu displays information related to the application.

[Application State] *APP5*

Application state.

This parameter indicates the drive application state.

Setting	Code / Value	Description
[Running]	<i>r u n</i>	No application function in progress; the drive is running
[Stop]	<i>S t o p</i>	No application function in progress; the drive is not running
[Local Mode Active]	<i>L o c a l</i>	Forced local mode activated
[Channel 2 Active]	<i>o v e r</i>	Override speed control mode activated
[Manual Mode Active]	<i>M a n u</i>	Motor running; manual PID mode is active
[PID Active]	<i>A u t o</i>	Motor running; auto PID mode is active
[Boost In progress]	<i>b o o s t</i>	The boost is in progress
[Sleep Active]	<i>S L E E P</i>	The sleep is active
[BL In Progress]	<i>b 9 5</i>	Backlash sequence is in progress

Section 7.3

[Pump parameters]

[Variable speed pump] *Π P P* - Menu

Access

[Display] → [Pump parameters] → [Variable speed pump]

About This Menu

This menu shows the pump-related parameters.

[Motor Run Time] *r t H H*

Motor run time.

Run elapsed time display (resettable) in 0.1 hours (length of time the motor has been switched on).

Setting	Description
0.0...429,496,729.5 h	Setting range Factory setting: _

[Motor Mechanical speed] *S P d Π*

Motor mechanical speed.

This parameter displays the estimated rotor speed with motor slip.

Setting	Description
0...65,535 rpm	Setting range Factory setting: _

[Nb Of Start] *r S Π*

Number of motor starts (resettable).

Setting	Description
0...4,294,967,295	Setting range Factory setting: _

[Acv Elc Out Pwr Estm] *E P r W*

Active electrical output power estimation.

Setting	Description
-327.67...327.67 kW	Setting range in kW if [Motor Standard] <i>b F r</i> is set to [50 Hz IEC] <i>S D</i> or in HP if [Motor Standard] <i>b F r</i> is set to [60 Hz NEMA] <i>S D</i> Factory setting: _

Section 7.4

[M/S parameters]

About this Menu

This menu can be accessed if [M/S Comm Mode] $\Pi 5 \text{ C } \Pi$ is not set to [No] $\Pi \alpha$.

What Is in This Section?

This section contains the following topics:

Topic	Page
[M/S Local Display] $\Pi 5 \alpha$ - Menu	92
[M/S System Display] $\Pi 5 \text{ r}$ - Menu	94

[M/S Local Display] П 5 0 - Menu

Access

[Display] → [M/S parameters] → [M/S Local Display]

About This Menu

This menu present the master slave local display related parameters.

This menu can be accessed if [M/S Comm Mode] П 5 0 П is not set to [No] 0 0.

[M/S Status] П 5 5

M/S function status.

Setting	Code / Value	Description
[None]	0 0 0 E	Not configured
[M/S Local Control]	0 P 0 E	M/S local control
[M/S Not Ready]	0 r d Y	M/S not ready
[M/S Ready]	r E R d Y	M/S ready
[M/S Running]	r u n	M/S running
[M/S Warning]	P L R r П	M/S warning

[M/S Master Speed Ref] П 5 П 5 ★

M/S Master speed reference.

This parameter can be accessed if [M/S Comm Mode] П 5 0 П is not set to [No] 0 0.

Setting	Description
-599.0...599.0 Hz	Setting range Factory setting: _

[M/S Master Torq Ref] P П E r ★

M/S Master torque reference.

This parameter can be accessed if [M/S Comm Mode] П 5 0 П is not set to [No] 0 0.

Setting	Description
-32,767...32,767 Nm	Setting range. Factory setting: _

[M/S Local Speed Ref] П 5 5 r ★

M/S Local speed reference.

This parameter can be accessed if:

- [M/S Comm Mode] П 5 0 П is not set to [No] 0 0, and
- [M/S Device Role] П 5 d E is set to [Slave] 5 L R V E.

Setting	Description
-599.0...599 Hz	Setting range Factory setting: _

[M/S Local Torq Ref] F t o r ★

M/S Local torque reference.

This parameter can be accessed if:

- [M/S Comm Mode] *Π 5 C Π* is not set to [No] *η α*, and
- [M/S Device Role] *Π 5 d t* is set to [Slave] *5 L R V E*.

Setting	Description
-32,767...32,767 Nm	Setting range. Factory setting: _

[Motor Frequency] r F r

Motor frequency.

This parameter displays the estimated rotor frequency without motor slip.

Setting	Description
-3,276.7...3,276.7 Hz	Setting range Factory setting: 0.0 Hz

[Motor Torque (Nm)] o t q n

Motor torque.

Output torque value.

NOTE: The displayed value is always positive in motor and negative in generator mode whatever the direction.

Setting	Description
-32,767...32,767 Nm	Setting range. Factory setting: _

[M/S System Display] *Π 5 r* - Menu

Access

[Display] → [M/S parameters] → [M/S System Display]

About This Menu

This menu present the master slave system related parameters.

This menu can be accessed if [M/S Comm Mode] *Π 5 C Π* is set to [MultiDrive Link] *Π d L*.

[M/S Local Speed Ref] *Π 5 S r* ★

M/S output speed reference.

This parameter can be accessed if:

- [M/S Comm Mode] *Π 5 C Π* is not set to [No] *Π a*, and
- [M/S Device ID] *Π 5 i d* is set to [Slave] *5 L A V E*.

Setting	Description
-599.0...599 Hz	Setting range Factory setting: _

[M/S Local Torq Ref] *F t o r* ★

M/S output torque reference.

This parameter can be accessed if:

- [M/S Comm Mode] *Π 5 C Π* is not set to [No] *Π a*, and
- [M/S Device ID] *Π 5 i d* is set to [Slave] *5 L A V E*.

Setting	Description
-32,767...32,767 Nm	Setting range. Factory setting: _

[M/S Device Selection] *Π 5 d n*

M/S device selection.

This parameter allows to select the device parameters to be displayed.

Setting	Code / Value	Description
[Master]	<i>Π 5 E E r</i>	Master Factory setting
[Slave 1]	<i>5 L V 1</i>	Slave 1
[Slave 2]	<i>5 L V 2</i>	Slave 2
[Slave 3]	<i>5 L V 3</i>	Slave 3
[Slave 4]	<i>5 L V 4</i>	Slave 4
[Slave 5]	<i>5 L V 5</i>	Slave 5
[Slave 6]	<i>5 L V 6</i>	Slave 6
[Slave 7]	<i>5 L V 7</i>	Slave 7
[Slave 8]	<i>5 L V 8</i>	Slave 8
[Slave 9]	<i>5 L V 9</i>	Slave 9
[Slave 10]	<i>5 L V 10</i>	Slave 10

[M/S Device Status] P 5 d 5

M/S device status.

Status of the device selected using **[M/S Device Selection] P 5 d n**.

Setting	Code / Value	Description
[None]	<i>n o n E</i>	Not configured
[M/S Not Ready]	<i>n r d Y</i>	M/S not ready
[M/S Ready]	<i>r E A d Y</i>	M/S ready
[M/S Running]	<i>r u n</i>	M/S running
[M/S Warning]	<i>R L A r n</i>	M/S warning

[M/S Device Speed Ref] P 5 X 5

M/S device speed reference.

Displays the local speed reference value of the device selected using **[M/S Device Selection] P 5 d n**.

Setting	Description
-599.0...599 Hz	Setting range Factory setting: _

[M/S Device Torq Ref] F X L

M/S device torque reference.

Displays the local torque reference value of the device selected using **[M/S Device Selection] P 5 d n**.

Setting	Description
-32,767...32,767 Nm	Setting range. Factory setting: _

Section 7.5

[Motor parameters]

[Motor parameters] $\Pi \Pi \square$ - Menu

Access

[Display] → [Motor parameters]

About This Menu

This menu shows the motor-related parameters.

[Motor Speed] SPd

Motor speed.

This parameter displays the estimated rotor speed without motor slip.

Setting	Description
0...65,535 rpm	Setting range Factory setting:-

[Signed Mech Speed] $SPdI$

Signed motor mechanical speed.

Setting	Description
-100,000...100,000 rpm	Setting range Factory setting:-

[Motor Voltage] $\mu \square P$

Motor voltage.

Setting	Description
0...65,535 V	Setting range Factory setting:-

[Motor Power] $\square P r$

Motor power.

Output power in % (100% = nominal motor mechanical power).

Setting	Description
-300...300%	Setting range Factory setting: -

[Nom Motor Torque] $t \eta \eta$

Computed nominal motor torque in Nm (+/- 2% tolerance).

Setting	Description
0.01...65,535 Nm	Setting range. Factory setting: -

[Motor Torque] $\alpha \text{ t r}$

Motor torque.

Output torque value (100% = **[Nom Motor Torque] t q n**).

NOTE: The displayed value is always positive in motor mode and negative in generator mode whatever the direction.

Setting	Description
-300.0... 300.0%	Setting range Factory setting: –

[Motor Torque (Nm)] $\alpha \text{ t q n}$

Motor torque (Nm).

Output torque value.

NOTE: The displayed value is always positive in motor mode and negative in generator mode whatever the direction.

Setting	Description
-32,767 Nm...32,767 Nm	Setting range. Factory setting: –

[Motor Current] L C r

Motor current.

Setting	Description
0.00...65,535 A	Setting range according to drive ratings Factory setting: –

[Motor Therm state] t H r

Motor thermal state.

The normal motor thermal state is 100%, the **[Motor Overload] $\alpha \text{ L F}$** is set to 118%.

Setting	Description
0...200%	Setting range Factory setting: –

Section 7.6

[Drive parameters]

[Drive parameters] ΠP , - Menu

Access

[Display] → [Drive parameters]

About This Menu

This menu shows the drive-related parameters.

[AIV1 Image input] $\# V I$

AIV1 Image input.

This parameter is read-only. It enables to display the speed reference applied to the motor via the fieldbus channel.

Setting	Description
-10,000...10,000 ⁽¹⁾	Setting range Factory setting: –
1): range according to [AIV1 Type] $\# V I E$.	

[Pre-Ramp Ref Freq] $F r H$

Frequency reference before ramp.

This parameter is read-only. It enables to display the reference frequency applied to the motor, regardless of which channel for reference value has been selected.

Setting	Description
-599.0...599.0 Hz	Setting range Factory setting: 0 Hz

[Ref Frequency] $L F r$

Reference frequency.

This parameter only appears if the function has been enabled. It is used to change the reference frequency from the remote control. OK does not have to be pressed to enable a change of reference.

Setting ()	Description
-599.0...599.0 Hz	Setting range Factory setting: –

[Torque ref.] $L E r$ ★

Torque reference.

This parameter only appears if the function has been enabled. It is used to change the torque reference value from the remote control. OK does not have to be pressed to enable a change of reference value.

This parameter can be accessed if:

- [Trq/spd switching] $E S S$ is not set to [Not Assigned] $n o$, and
- [Torque ref. channel] $E r I$ is set to [Ref. Freq-Rmt.Term] $L E E$.

Setting ()	Description
-300.0...300.0%	Setting range Factory setting: –

[Torque reference] $t r r$ ★

Torque reference.

This parameter can be accessed if:

- **[M/S Device Role] $n s d t$** is set to **[Slave] $s l r v e$** , and
- **[M/S Control Type] $n s c t$** is set to:
 - **[Torque Direct] $t r q d$** , or
 - **[Torque Reverse] $t r q r$** , or
 - **[Torque Custom] $t r q c$** .

Setting ()	Description
-3,276.7...3,276.7 %	Setting range Factory setting: –

[Motor Frequency] $r f r$

Motor frequency.

This parameter displays the estimated rotor frequency without motor slip.

Setting	Description
-3,276.7...3,276.7 Hz	Setting range Factory setting: 0.0 Hz

[Stator Frequency] $s f q$ ★

Stator frequency.

This parameter can be accessed if **[Access Level] $l a c$** is set to **[Expert] $e p r$**

Setting ()	Description
[No Freq Applied] $n o$...599.0 Hz	Setting range Factory setting: –

[Rotor Frequency] $r f q$ ★

Rotor frequency.

This parameter displays the estimated rotor frequency with motor slip.

This parameter can be accessed if **[Access Level] $l a c$** is set to **[Expert] $e p r$**

Setting ()	Description
[No Freq Applied] $n o$...599.0 Hz	Setting range Factory setting: –

[Measured output fr.] $n n f$ ★

Measured output frequency.

This parameter can be accessed only if the encoder module has been inserted, and the available selections will depend on the type of encoder module used.

Setting ()	Description
-3,276.7...3,276.7 Hz	Setting range Factory setting: –

[Multiplying Coeff.] $\Pi F r$ ★

Multiplying coefficient.

This parameter can be accessed if **[Ref Freq - Multiply] $\Pi A 2, \Pi A 3$** has been assigned.

Setting ()	Description
0...100%	Setting range Factory setting: –

[Measured Freq] $F 9 5$ ★

Pulse input measured frequency.

This parameter can be accessed if **[Frequency meter] $F 9 F$** is not set to **[Not Configured] $n o$** .

Setting ()	Description
0...30 KHz	Setting range Factory setting: –

[Mains Voltage] $\mu L n$

Mains voltage based on AC bus measurement, motor running or stopped.

Setting	Description
1.0...6,553.5 Vac	Setting range: [no meas.] - - - is displayed if no value is measured. Factory setting: –

[Mains Voltage phase 1-2] $\mu L 1$

Mains voltage phase 1-2 measurement.

This parameter cannot be accessed on ATV930C22N4...C31N4.

Setting	Description
-3,276.7...3,276.7 Vac	Setting range Factory setting: –

[Mains Voltage phase 2-3] $\mu L 2$

Mains voltage phase 2-3 measurement.

This parameter cannot be accessed on ATV930C22N4...C31N4.

Setting	Description
-3,276.7...3,276.7 Vac	Setting range Factory setting: –

[Mains Voltage phase 3-1] $\mu L 3$

Mains voltage phase 3-1 measurement

This parameter cannot be accessed on ATV930C22N4...C31N4.

Setting	Description
-3,276.7...3,276.7 Vac	Setting range Factory setting: –

[Mains Current] *i L n*

Actual mains current (effective value of the fundamental mode).

Accuracy: 2% (related to drive nominal current).

This parameter can be accessed on ATV980 and ATV9B0.

Setting	Description
According to drive rating	Setting range Factory setting: –

[Mains Frequency] *F H C*

Actual mains frequency.

This parameter can be accessed on ATV980 and ATV9B0.

Setting	Description
0.0...999.9 Hz	Setting range Factory setting: –

[DC Bus Voltage] *V b u 5*

DC bus voltage.

Setting	Description
0...6,553.5 Vdc	Setting range Factory setting: –

[Drive Therm State] *t H d*

Drive thermal state.

The normal drive thermal state is 100%, the **[Motor Overload] *o L F*** is set to 118%.

Setting	Description
0...200%	Setting range Factory setting: –

[Used Param. Set] *C F P 5* ★

Used parameter set.

Configuration parameter status (can be accessed if parameter switching function has been enabled).

Setting	Code / Value	Description
[None]	<i>n o</i>	Not assigned
[Set N°1]	<i>C F P 1</i>	Parameter set 1 active
[Set N°2]	<i>C F P 2</i>	Parameter set 2 active
[Set N°3]	<i>C F P 3</i>	Parameter set 3 active

[Config. active] *C n F 5*

Active configuration.

Setting	Code / Value	Description
[In progress]	<i>n o</i>	Transitory state
[Config. No.0]	<i>C n F 0</i>	Configuration 0 active
[Config. No.1]	<i>C n F 1</i>	Configuration 1 active
[Config. No.2]	<i>C n F 2</i>	Configuration 2 active
[Config 3 active]	<i>C n F 3</i>	Configuration 3 active

Section 7.7

[Thermal monitoring]

[Thermal Monitoring] $\mathcal{E} P \Pi$ - Menu

Access

[Display] → [Thermal Monitoring]

About This Menu

The content of this menu can be accessed if the thermal monitoring function has been activated.

Wiring

Refer to the wiring (*see page 185*) of the [Thermal monitoring] $\mathcal{E} P P$ - menu.

[AI1 Th Value] $\mathcal{E} H IV$ ★

AI1 thermal value.

Setting	Description
-15...200°C	Setting range Factory setting: –

[AI3 Th Value] $\mathcal{E} H \exists V$ ★

AI3 thermal value.

Identical to [AI1 Th Value] $\mathcal{E} H IV$.

[AI4 Th Value] $\mathcal{E} H \forall V$ ★

AI4 thermal value.

Identical to [AI1 Th Value] $\mathcal{E} H IV$.

This parameter can be accessed if VW3A3203 I/O extension module has been inserted.

[AI5 Th Value] $\mathcal{E} H \exists V$ ★

AI5 thermal value.

Identical to [AI1 Th Value] $\mathcal{E} H IV$.

This parameter can be accessed if VW3A3203 I/O extension module has been inserted.

[Enc Th Value] $\mathcal{E} h E V$

Encoder thermal sensor value

Setting	Description
-15...200°C	Setting range Factory setting: –

Section 7.8

[PID display]

[PID display] P, L - Menu

Access

[Display] → [PID display]

About This Menu

NOTE: This function cannot be used with some other functions.

Following parameters can be accessed if [PID feedback Assign] P, F is not set to [Not Configured] n, o .

[Internal PID ref] r, P, \star

Internal PID reference.

Setting 	Description
0...32,767	Setting range Factory setting: 150

[PID Reference] r, P, L, \star

PID setpoint value.

Setting	Description
0...65,535	Setting range Factory setting: 0

[PID feedback] r, P, F, \star

PID feedback value.

Setting	Description
0...65,535	Setting range Factory setting: 0

[PID Error] r, P, E, \star

PID error value.

Setting	Description
-32,767...32,767	Setting range Factory setting: -

[PID Output] r, P, o, \star

PID output value.

Setting	Description
[PID Min Output] P, o, L ...[PID Max Output] P, o, h	Setting range Factory setting: _

Section 7.9

[Counter management]

[Counter Management] *E L E* - Menu

Access

[Display] → [Counter Management]

About This Menu

This menu shows the drive and motor-related counters.

[Motor Run Time] *r E H H*

Motor run time.

Run elapsed time display (resettable) in 0.1 hours (length of time the motor has been switched on).

Setting	Description
0.0...429,496,729.5 h	Setting range Factory setting: _

[Power-on Time] *P E H H*

Power-on time (resettable) or counter can be set to 0 by using the [Time Counter Reset] *r P r* parameter.

Setting	Description
0.0...429,496,729.5 h	Setting range Factory setting: _

[Fan Operation Time] *F P B E*

Fan operation time.

As soon as [Fan Operation Time] *F P B E* reach the predefined value of 45,000 hours, a warning [Fan Counter Warning] *F C E A* is triggered.

[Fan Operation Time] *F P B E* counter can be set to 0 by using the [Time Counter Reset] *r P r* parameter.

Setting	Description
0...500,000 h	Setting range Factory setting: Read Only

[Nb Of Start] *r S A*

Number of motor starts (resettable) or counter can be set to 0 by using the [Time Counter Reset] *r P r* parameter.

Setting	Description
0...4,294,967,295	Setting range Factory setting: _

[Cabinet Fan Opt Time] F C L

Cabinet Fan operation time

If **[Cabinet Fan Oper Time] F C L** has reached the predefined value of 30,000 hours, a warning **[Cabinet Fan Counter Warn] F C C R** is triggered.

This parameter can be accessed on ATV960 or ATV980.

Setting	Description
0...500,000 h	Setting range Factory setting: Read Only

[AFE Run Time] b r H H

AFE Run Time

This parameter can be accessed on ATV980 and ATV9B0.

Setting	Description
0.0...429,496,729.5 h	Setting range Factory setting: _

[AFE Power-On Time] b P H H

AFE brick power on elapsed time

This parameter can be accessed on ATV980 and ATV9B0.

Setting	Description
0.0...429,496,729.5 h	Setting range Factory setting: _

[AFE Fan Operation Time] F b R L

AFE Fan Operation Time

If **[AFE Fan Operation Time] F b R L** has reached the predefined value of 45,000 hours, a warning **[AFE Fan Counter Warn] F C b R** is triggered.

This parameter can be accessed on ATV980 and ATV9B0.

Setting	Description
0...50,000 h	Setting range Factory setting: _

[AFE Nb of starts] b n S R

AFE number of starts

This parameter can be accessed on ATV980 and ATV9B0.

Setting	Description
0...4,294,967,295	Setting range Factory setting: _

[DBR Run Time] r r H H

Braking resistor run time

Setting	Description
0.0...429,496,729.5 h	Setting range Factory setting: _

[BUO Fan Operation Time] F b b t

Braking unit fan operation time

Setting	Description
0...500,000 h	Setting range Factory setting: _

[BUO Power-on time] r P H H

Braking unit Power-on time

Setting	Description
0.0...429,496,729.5 h	Setting range Factory setting: _

[Time Counter Reset] r P r

Time counter reset.

Setting ()	Code / Value	Description
[No]	n o	No Factory setting
[Run Time Reset]	r t H	Run time reset
[Power ON Time Reset]	P t H	Power ON time reset
[Reset Fan Counter]	F t H	Reset fan counter
[Clear NSM]	n S Π	Clear number of motor starts
[Clear AFE Fan]	F b A t	Clear AFE Fan operation time ⁽¹⁾
[Clear Cabinet Fan]	F C t	Clear cabinet fan operation time NOTE: This selection can be accessed on ATV960, ATV980, and ATV993.
[Clear AFE Power ON Time]	b P t h	Clear AFE power ON time ⁽¹⁾
[Clear BRTH]	b r t h	Clear AFE run time ⁽¹⁾
[Clear AFE Nb. start]	b n S A	Clear AFE brick number of start ⁽¹⁾
[Clear BUO Run Time]	r r t H	Clear Braking Unit run time.
[Clear BUO Power On Time]	r P t H	Clear Braking Unit Power-on time.
[Clear BUO Fan Time]	F b b t	Clear Braking Unit fan operation time.
1 This selection can be accessed on ATV980 and ATV9B0.		

Section 7.10

[Other state]

[Other state] 5 5 t - Menu

Access

[Display] → [Other state]

About This Menu

List of secondary states.

List

[Sleep Active] *S L Π*
 [Sleep Boost active] *S L P b*
 [Set 1 active] *C F P 1*
 [Set 2 active] *C F P 2*
 [Set 3 active] *C F P 3*
 [Automatic restart] *R u t a*
 [DC Bus Charged] *d b L*
 [Fast stop Active] *F S t*
 [Fallback Frequency] *F r F*
 [Speed Maintained] *r L S*
 [Type of stop] *S t t*
 [Encoder Config] *i C C*
 [In braking] *b r S*
 [Backspin Active] *b S C*
 [DC Bus Ripple Warn] *d C r W*
 [Ref Freq Warning] *S r R*
 [Forward] *Π F r d*
 [Reverse] *Π r r S*
 [In motor fluxing] *F L X*
 [Autotuning] *t u n*

Section 7.11

[I/O map]

What Is in This Section?

This section contains the following topics:

Topic	Page
[Digital Input Map] L , R - Menu	109
[AI1] R , 1 C - Menu	110
[AI2] R , 2 C - Menu	112
[AI3] R , 3 C - Menu	113
[AI4] R , 4 C - Menu	114
[AI5] R , 5 C - Menu	115
[Analog inputs image] R , R - Menu	116
[Digital output map] L ◻ R - Menu	116
[AQ1] R ◻ 1 C - Menu	117
[AQ2] R ◻ 2 C - Menu	121
[PTO Frequency] P L ◻ C - Menu	123
[DI7 frequency measured] P F C 7 - Menu	125
[DI8 frequency measured] P F C B - Menu	127
[Freq. signal image] F 5 , - Menu	128
[Cabinet Digital Input Map] L , C R - Menu	129
[Cabinet Digital Output Map] L ◻ C R - Menu	129

[Digital Input Map] L, R - Menu

Access

[Display] → [I/O map] → [Digital Input Map]

About This Menu

This menu presents the state and assignment of digital inputs.

Read-only parameters, cannot be configured.

If no functions have been assigned, **[Not assigned]** is displayed. Use the touch wheel to scroll through the functions.

[A11] *R* , *IC* - Menu

Access

[Display] → [I/O map] → [Analog inputs image] → [A11]

[A11] *R* , *IC*

Physical value A11.

A11 customer image: value of analog input 1.

Setting	Description
-32,767...32,767	Setting range Factory setting: –

NOTE: The parameters [A11 Assignment] *R* , *IR*, [A11 min value] *L* , *L* , [A11 max value] *L* , *H* and [A11 filter] *R* , *IF* can be accessed on the Graphic Display Terminal by pressing the **OK** key on the [A11] *R* , *IC* parameter.

[A11 Assignment] *R* , *IR*

Analog input A11 functions assignment.

Read-only parameter, cannot be configured. It displays all the functions associated with input A11 in order to verify, for example, for compatibility problems.

If no functions have been assigned, [No] *no* is displayed.

Setting	Code / Value	Description
[No]	<i>no</i>	Not assigned
[Torque Ref Offset]	<i>t r o</i>	Torque offset source
[Torque Ref Ratio]	<i>t r r</i>	Torque ratio source
[Ref Freq Channel 1]	<i>f r 1</i>	Reference frequency channel 1 Factory Setting
[Ref Freq Channel 2]	<i>f r 2</i>	Reference frequency channel 2
[Ref Frequency 2 Summing]	<i>s r 2</i>	Reference frequency 2 summing
[PID Feedback]	<i>p , f</i>	PI controller feedback
[Torque limitation]	<i>t r r</i>	Torque limitation: activation by an analog value
[Torque limitation 2]	<i>t r r 2</i>	Torque limitation: activation by an analog value
[Subtract Ref Freq 2]	<i>d r 2</i>	Subtract reference frequency 2
[Manual PID Ref.]	<i>p , n</i>	Manual speed reference of the PID controller (auto-man)
[PID Ref Frequency]	<i>f p ,</i>	PID reference frequency
[Ref Frequency 3 Summing]	<i>s r 3</i>	Reference frequency 3 summing
[Ref Frequency 1B]	<i>f r 1 b</i>	Reference frequency 1B
[Subtract Ref Freq 3]	<i>d r 3</i>	Subtract reference frequency 3
[Forced local]	<i>f l o c</i>	Forced local reference source1
[Ref Frequency 2 multiplier]	<i>m r 2</i>	Reference frequency 2 multiplier
[Ref Frequency 3 multiplier]	<i>m r 3</i>	Reference frequency 3 multiplier
[Torque reference]	<i>t r 1</i>	Torque regulation: torque set point 1
[Torque reference 2]	<i>t r 2</i>	Torque regulation: torque set point 2

Setting	Code / Value	Description
[External Feed Forward]	<i>E F F</i>	External feed-forward
[M/S Speed Ref In]	<i>Π S S</i>	Master Slave: speed input
[M/S Trq Ref In]	<i>Π S T</i>	Master Slave: torque input
[Weight input]	<i>P E S</i>	External weight sensor input

[AI1 min value] *U, L* ★

AI1 minimum value.

AI1 voltage scaling parameter of 0%.

This parameter can be accessed if [AI1 Type] *R, I E* is set to [Voltage] *I D U*.

Setting	Description
0.0...10.0 Vdc	Setting range Factory setting: 0.0 Vdc

[AI1 max value] *U, H* ★

AI1 maximum value.

AI1 voltage scaling parameter of 100%.

This parameter can be accessed if [AI1 Type] *R, I E* is set to [Voltage] *I D U*.

Setting	Description
0.0...10.0 Vdc	Setting range Factory setting: 10.0 Vdc

[AI1 min. value] *C, L* ★

AI1 minimum value.

AI1 current scaling parameter of 0%.

This parameter can be accessed if [AI1 Type] *R, I E* is set to [Current] *D R*.

Setting	Description
0.0...20.0 mA	Setting range Factory setting: 0.0 mA

[AI1 max. value] *C, H* ★

AI1 maximum value.

AI1 current scaling parameter of 100%.

This parameter can be accessed if [AI1 Type] *R, I E* is set to [Current] *D R*.

Setting	Description
0.0...20.0 mA	Setting range Factory setting: 20.0 mA

[AI1 filter] *R, I F*

AI1 filter.

Interference filtering.

Setting 	Description
0.00...10.00 s	Setting range Factory setting: 0.00 s

[AI2] *R* , *2 C* - Menu

Access

[Drive menu] → [Display] → [I/O map] → [Analog inputs image] → [AI2]

[AI2] *R* , *2 C*

Physical value AI2.

AI2 customer image: value of analog input 2.

Identical to [AI1] *R* , *1 C* (*see page 110*).

[AI2 Assignment] *R* , *2 R*

Configuration of AI2.

Identical to [AI1 Assignment] *R* , *1 R* (*see page 110*).

[AI2 min value] *u* , *L 2* ★

AI2 minimum value.

AI2 voltage scaling parameter of 0%.

This parameter can be accessed if [AI2 Type] *R* , *2 E* is set to [Voltage] *1 0 u*.

Identical to [AI1 min value] *u* , *L 1* (*see page 111*).

[AI2 max value] *u* , *H 2* ★

AI2 maximum value.

AI2 voltage scaling parameter of 100%.

This parameter can be accessed if [AI2 Type] *R* , *2 E* is set to [Voltage] *1 0 u*.

Identical to [AI1 max value] *u* , *H 1* (*see page 111*).

[AI2 filter] *R* , *2 F*

AI2 filter.

Interference filtering.

Identical to [AI1 filter] *R* , *1 F* (*see page 111*).

[AI3] *R* , *3* *C* - Menu

Access

[Display] → [I/O map] → [Analog inputs image] → [AI3]

[AI3] *R* , *3* *C*

Physical value AI3.

AI3 customer image: value of analog input 3.

Identical to [AI1] *R* , *1* *C* (*see page 110*).

[AI3 Assignment] *R* , *3* *A*

Configuration of AI3.

Identical to [AI1 Assignment] *R* , *1* *A* (*see page 110*).

[AI3 min value] *u* , *L* *3* ★

AI3 voltage scaling parameter of 0%.

This parameter can be accessed if [AI3 Type] *R* , *3* *E* is set to [Voltage] *1* *0* *u*.

Identical to [AI1 min value] *u* , *L* *1* (*see page 111*).

[AI3 max value] *u* , *H* *3* ★

AI3 voltage scaling parameter of 100%.

This parameter can be accessed if [AI3 Type] *R* , *3* *E* is set to [Voltage] *1* *0* *u*.

Identical to [AI1 max value] *u* , *H* *1* (*see page 111*).

[AI3 min. value] *C* *r* *L* *3* ★

This parameter can be accessed if [AI3 Type] *R* , *3* *E* is set to [Current] *0* *A*.

Identical to [AI1 min. value] *C* *r* *L* *1* (*see page 111*).

[AI3 max. value] *C* *r* *H* *3* ★

AI3 current scaling parameter of 100%.

This parameter can be accessed if [AI3 Type] *R* , *3* *E* is set to [Current] *0* *A*.

Identical to [AI1 max. value] *C* *r* *H* *1* (*see page 111*).

[AI3 Filter] *R* , *3* *F*

AI3 filter.

Interference filtering.

Identical to [AI1 filter] *R* , *1* *F* (*see page 111*).

[AI4] R , 4 C - Menu

Access

[Display] → [I/O map] → [Analog inputs image] → [AI4]

About This Menu

This menu can be accessed if VW3A3203 I/O extension module has been inserted.

[AI4] R , 4 C

Physical value AI4.

AI4 customer image: value of analog input 4.

Identical to [AI1] R , 1 C (see page 110).

[AI4 Assignment] R , 4 R

AI4 functions assignment. If no functions have been assigned, [No] n o is displayed.

Identical to [AI1 Assignment] R , 1 R (see page 110).

[AI4 min value] u , L 4 ★

AI4 minimum value.

AI4 voltage scaling parameter of 0%.

This parameter can be accessed if [AI4 Type] R , 4 E is set to [Voltage] I D u .

Identical to [AI1 min value] u , L 1 (see page 111).

[AI4 max value] u , H 4 ★

AI4 maximum value.

AI4 voltage scaling parameter of 100%.

This parameter can be accessed if [AI4 Type] R , 4 E is set to [Voltage] I D u .

Identical to [AI1 max value] u , H 1 (see page 111).

[AI4 min. value] C r L 4 ★

AI4 minimum value.

AI4 current scaling parameter of 0%.

This parameter can be accessed if [AI4 Type] R , 4 E is set to [Current] D R .

Identical to [AI1 min. value] C r L 1 (see page 111).

[AI4 max. value] C r H 4 ★

AI4 maximum value.

AI4 current scaling parameter of 100%.

This parameter can be accessed if [AI4 Type] R , 4 E is set to [Current] D R .

Identical to [AI1 max. value] C r H 1 (see page 111).

[AI4 filter] R , 4 F

AI4 filter.

Interference filtering.

Identical to [AI1 filter] R , 1 F (see page 111).

[AI5] *A* , *S* *C* - Menu

Access

[Display] → [I/O map] → [Analog inputs image] → [AI5]

About This Menu

This menu can be accessed if VW3A3203 I/O extension module has been inserted.

[AI5] *A* , *S* *C*

AI5 customer image: value of analog input 5.

Identical to [AI1] *A* , *I* *C* (*see page 110*).

[AI5 Assignment] *A* , *S* *A*

AI5 functions assignment. If no functions have been assigned, [No] *n* *a* is displayed.

Identical to [AI1 Assignment] *A* , *I* *A* (*see page 110*).

[AI5 min value] *v* , *L* *S* ★

AI5 voltage scaling parameter of 0%.

This parameter can be accessed if [AI5 Type] *A* , *S* *E* is set to [Voltage] *I* *D* *v*.

Identical to [AI1 min value] *v* , *L* *I* (*see page 111*).

[AI5 max value] *v* , *H* *S* ★

AI5 voltage scaling parameter of 100%.

This parameter can be accessed if [AI5 Type] *A* , *S* *E* is set to [Voltage] *I* *D* *v*.

Identical to [AI1 max value] *v* , *H* *I* (*see page 111*).

[AI5 min. value] *C* , *r* *L* *S* ★

AI5 current scaling parameter of 0%.

This parameter can be accessed if [AI5 Type] *A* , *S* *E* is set to [Current] *D* *A*.

Identical to [AI1 min. value] *C* , *r* *L* *I* (*see page 111*).

[AI5 max. value] *C* , *r* *H* *S* ★

AI5 current scaling parameter of 100%.

This parameter can be accessed if [AI5 Type] *A* , *S* *E* is set to [Current] *D* *A*.

Identical to [AI1 max. value] *C* , *r* *H* *I* (*see page 111*).

[AI5 filter] *A* , *S* *F*

AI5 filter.

Interference filtering.

Identical to [AI1 filter] *A* , *I* *F* (*see page 111*).

[Analog inputs image] *A I A* - Menu

Access

[Display] → [I/O map] → [Analog inputs image]

[Enc Resistor Value] *E H E r* ★

Encoder thermal resistor value.

This parameter can be accessed if:

- An encoder option module has been inserted, and
- [Enc Therm Sensor Type] *E H E t* is not set to [None] *n o n E*.

Setting	Description
-32,767...32,767	Setting range Factory setting: _

[Digital output map] *L O A* - Menu

Access

[Display] → [I/O map] → [Digital output map]

About This Menu

DQ assignment.

R1, R2, R3 assignment.

R4, R5, R6 assignment if VW3A3204 relay output option module has been inserted.

DQ11, DQ12 assignment if VW3A3203 I/O extension module has been inserted.

On the Graphic Display Terminal, click the digital output to see the assignment.

Read-only parameters, cannot be configured.

It displays the function which is assigned to a digital output. If no function has been assigned, [Not assigned] *n o* is displayed.

It allows to verify the delay, active state, and holding time set for the digital output. Possible values are identical as those in the configuration menu.

[AQ1] $\# \square I C$ - Menu

Access

[Display] → [I/O map] → [Analog outputs image] → [AQ1]

Minimum and Maximum Output Values

The minimum output value, in volts, corresponds to the lower limit of the assigned parameter and the maximum value corresponds to its upper limit. The minimum value may be greater than the maximum value.

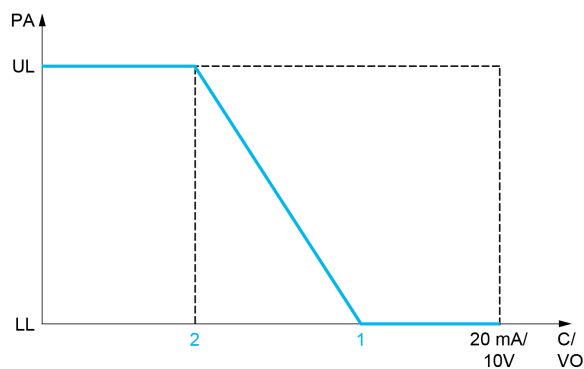
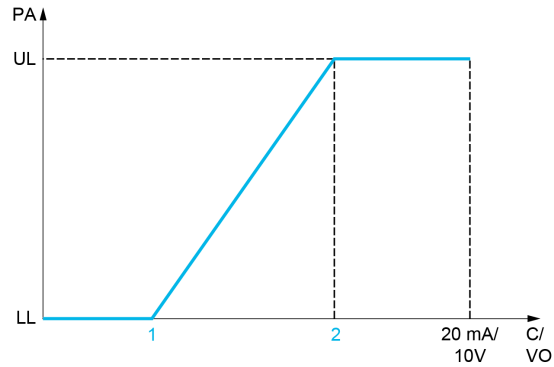

PA Parameter assigned
 C / VO Current or voltage output
 UL Upper limit
 LL Low limit
 1 [Min Output] $\# \square L X$ or $\square \square L X$
 2 [Max Output] $\# \square H X$ or $\square \square H X$

Scaling of the Assigned Parameter

The scale of the assigned parameter can be adapted in accordance with requirements by modifying the values of the lower and upper limits with two parameters for each analogic output.

These parameters are given in %. 100% corresponds to the total variation range of the configured parameter, so: 100% = upper limit - lower limit.

For example, [Sign. torque] $5 L 9$ which varies between -3 and $+3$ times the rated torque, 100% corresponds to 6 times the rated torque.

- The [Scaling AQx min] $\# 5 L X$ parameter modifies the lower limit: new value = lower limit + (range x $\# 5 L X$). The value 0% (factory setting) does not modify the lower limit.
- The [Scaling AQx max] $\# 5 H X$ parameter modifies the upper limit: new value = lower limit + (range x $\# 5 L X$). The value 100% (factory setting) does not modify the upper limit.
- [Scaling AQx min] $\# 5 L X$ must always be lower than [Scaling AQx max] $\# 5 H X$.

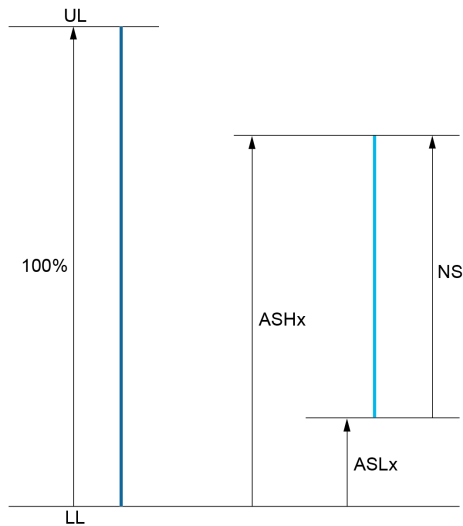

UL Upper limit of the assigned parameter
LL Lower limit of the assigned parameter
NS New scale
ASHx Scaling max
ASLx Scaling min

Application Example

The value of the motor current at the AQ1 output is to be transferred with 0...20 mA, range 2 In motor, In motor being the equivalent of a 0.8 In drive.

- The **[Motor Current] o C r** parameter varies from 0 to 2 times the rated drive current.
- **[Scaling AQ1 min] # 5 L 1** must not modify the lower limit, which therefore remains at its factory setting of 0%.
- **[Scaling AQ1 max] # 5 H 1** must modify the upper limit by 0.5x the rated motor torque, or 100 - 100/5 = 80% (new value = lower limit + (range x ASH1)).

[AQ1] # o 1 C

AQ1 customer image: value of analogic output 1.

Setting ()	Description
-32,767...32,767	Setting range Factory setting: Read only

[AQ1 assignment] # o 1

AQ1 assignment.

Setting	Code / Value	Description
[Not Configured]	n o	Not assigned
[Motor Current]	o C r	Current in the motor, from 0 to 2 In (In = rated drive current indicated in the Installation manual and on the drive nameplate)
[Motor Frequency]	o F r	Output frequency, from 0 to [Max Frequency] t F r Factory Setting
[Ramp out.]	o r P	From 0 to [Max Frequency] t F r
[Motor torq.]	t r 9	Motor torque, from 0 to 3 times the rated motor torque
[Sign. torque]	5 t 9	Signed motor torque, between -3 and +3 times the rated motor torque. The + sign corresponds to the motor mode and the - sign to the generator mode (braking).
[sign ramp]	o r 5	Signed ramp output, between - [Max Frequency] t F r and + [Max Frequency] t F r
[PID ref.]	o P 5	PID controller reference between [Min PID reference] P , P 1 and [Max PID reference] P , P 2

Setting	Code / Value	Description
[PID feedbk]	$\alpha P F$	PID controller feedback between [Min PID feedback] P_{F1} and [Max PID feedback] P_{F2}
[PID error]	$\alpha P E$	PID controller detected error between -5% and +5% of [Max PID feedback] $P_{F2} - [\text{Min PID feedback}] P_{F1}$
[PID output]	$\alpha P I$	PID controller output between [Low speed] LSP and [High speed] HSP
[Motor power]	$\alpha P r$	Motor power, between 0 and 2.5 times [Nominal Motor Power] $n P r$
[Mot thermal]	$t H r$	Motor thermal state, from 0 to 200% of the rated thermal state
[Drv thermal]	$t H d$	Drive thermal state, from 0 to 200% of the rated thermal state
[Torque 4Q]	$t r 4 q$	Signed motor torque, between -3 and +3 times the rated motor torque. The + and - signs correspond to the physical direction of the torque, regardless of mode (motor or generator)
[Measured Motor Freq]	$\alpha F r r$	Measured motor frequency
[Sig. o/p frq.]	$\alpha F 5$	Signed output frequency, between -[Max Frequency] $t F r$ and +[Max Frequency] $t F r$
[Mot therm2]	$t H r 2$	Motor thermal 2 state
[Mot therm3]	$t H r 3$	Motor thermal 3 state
[Mot therm4]	$t H r 4$	Motor thermal 4 state
[Unsigned Trq Ref]	$u t r$	Unsigned torque reference
[Signed Trq Ref]	$S t r$	Signed torque reference
[Torque lim.]	$t 9 L$	Torque limit
[Motor volt.]	$u o P$	Voltage applied to the motor, between 0 and [Nom Motor Voltage] $u n 5$
[M/S Out Speed Reference]	$n 5 5 o$	Master / slave output speed reference
[M/S Out Torque Reference]	$n 5 t o$	Master / slave output torque reference

[AQ1 Min Output] $u o L I \star$

AQ1 minimum output.

This parameter can be accessed if [AQ1 Type] $R o I t$ is set to [Voltage] $I O u$.

Setting	Description
0.0...10.0 Vdc	Setting range Factory setting: 0.0 Vdc

[AQ1 max Output] $u o H I \star$

AQ1 maximum output.

This parameter can be accessed if [AQ1 Type] $R o I t$ is set to [Voltage] $I O u$.

Setting	Description
0.0...10.0 Vdc	Setting range Factory setting: 10.0 Vdc

[AQ1 min output] $R o L I \star$

AQ1 minimum output.

This parameter can be accessed if [AQ1 Type] $R o I t$ is set to [Current] $O R$.

Setting	Description
0.0...20.0 mA	Setting range Factory setting: 0.0 mA

[AQ1 max output] # 0 H I ★

AQ1 maximum output.

This parameter can be accessed if **[AQ1 Type] # 0 I E** is set to **[Current] 0 #**.

Setting	Description
0.0...20.0 mA	Setting range Factory setting: 20.0 mA

[Scaling AQ1 min] # 5 L I

Scaling of the lower limit of the assigned parameter, as a percentage of the maximum possible variation.

Setting	Description
0.0...100.0%	Setting range Factory setting: 0.0%

[Scaling AQ1 max] # 5 H I

Scaling of the upper limit of the assigned parameter, as a percentage of the maximum possible variation.

Setting	Description
0.0...100.0%	Setting range Factory setting: 100.0%

[AQ1 Filter] # 0 I F

Interference filtering.

Setting	Description
0.00...10.00 s	Setting range Factory setting: 0.00 s

[AQ2] $\#02C$ - Menu**Access**

[Display] → [I/O Map] → [Analog outputs image] → [AQ2]

[AQ2] $\#02C$

AQ2 customer image: value of analog output 2.

Identical to [AQ1] $\#01C$ (see page 118).**[AQ2 Assignment] $\#02$**

AQ2 assignment.

Setting	Code / Value	Description
[Not Configured]	$n0$	Not assigned
[Motor Current]	$0Cr$	Current in the motor, from 0 to 2 In (In = rated drive current indicated in the Installation manual and on the drive nameplate) Factory Setting
[Motor Frequency]	$0Fr$	Output frequency, from 0 to [Max Frequency] EFr
[Ramp out.]	$0rP$	From 0 to [Max Frequency] EFr
[Motor torq.]	$t r 9$	Motor torque, from 0 to 3 times the rated motor torque
[Sign. torque]	$5 t 9$	Signed motor torque, between -3 and +3 times the rated motor torque. The + sign corresponds to the motor mode and the - sign to the generator mode (braking).
[sign ramp]	$0 r 5$	Signed ramp output, between -[Max Frequency] EFr and +[Max Frequency] EFr
[PID ref.]	$0 P 5$	PID controller reference between [Min PID reference] $P, P 1$ and [Max PID reference] $P, P 2$
[PID feebk]	$0 P F$	PID controller feedback between [Min PID feedback] $P, F 1$ and [Max PID feedback] $P, F 2$
[PID error]	$0 P E$	PID controller detected error between -5% and +5% of [Max PID feedback] $P, F 2$ - [Min PID feedback] $P, F 1$
[PID output]	$0 P ,$	PID controller output between [Low speed] $L 5 P$ and [High speed] $H 5 P$
[Motor power]	$0 P r$	Motor power, between 0 and 2.5 times [Nominal Motor Power] $n P r$
[Mot thermal]	$t H r$	Motor thermal state, from 0 to 200% of the rated thermal state
[Drv thermal]	$t H d$	Drive thermal state, from 0 to 200% of the rated thermal state
[Torque 4Q]	$t r 4 9$	Signed motor torque, between -3 and +3 times the rated motor torque. The + and - signs correspond to the physical direction of the torque, regardless of mode (motor or generator)
[Measured Motor Freq]	$0 F r r$	Measured motor frequency
[Sig. o/p frq.]	$0 F 5$	Signed output frequency, between -[Max Frequency] EFr and +[Max Frequency] EFr
[Mot therm2]	$t H r 2$	Motor thermal 2 state
[Mot therm3]	$t H r 3$	Motor thermal 3 state
[Mot therm4]	$t H r 4$	Motor thermal 4 state
[Unsigned Trq Ref]	$u t r$	Unsigned torque reference
[Signed Trq Ref]	$5 t r$	Signed torque reference
[Torque lim.]	$t 9 L$	Torque limit
[Motor volt.]	$u o P$	Voltage applied to the motor, between 0 and [Nom Motor Voltage] $u n 5$
[M/S Out Speed Reference]	$\pi 5 5 o$	Master / slave output speed reference
[M/S Out Torque Reference]	$\pi 5 t o$	Master / slave output torque reference
[AI Virtual 1]	$R , V 1$	Virtual analog input 1

[AQ2 Min Output] UOLZ★

AQ2 minimum output.

This parameter can be accessed if **[AQ2 Type] ROZE** is set to **[Voltage] IDU**.

Identical to **[AQ1 min Output] UOL I** (*see page 119*).

[AQ2 Max Output] UOHZ★

AQ2 maximum output.

This parameter can be accessed if **[AQ2 Type] ROZE** is set to **[Voltage] IDU**.

Identical to **[AQ1 max Output] UOH I** (*see page 119*).

[AQ2 Min Output] ROLZ★

AQ2 minimum output.

This parameter can be accessed if **[AQ2 Type] ROZE** is set to **[Current] DR**.

Identical to **[AQ1 Min Output] ROL I** (*see page 291*).

[AQ2 Max Output] ROHZ★

AQ2 maximum output.

This parameter can be accessed if **[AQ2 Type] ROZE** is set to **[Current] DR**.

Identical to **[AQ1 Max Output] ROH I** (*see page 291*).

[Scaling AQ2 min] R5LZ

Scaling of the lower limit of the assigned parameter, as a % of the maximum possible variation.

Identical to **[Scaling AQ2 min] R5L I** (*see page 120*).

[Scaling AQ2 max] R5HZ

Scaling of the upper limit of the assigned parameter, as a % of the maximum possible variation.

Identical to **[Scaling AQ1 max] R5H I** (*see page 120*).

[AQ2 Filter] ROZF

Interference filtering.

Identical to **[AQ1 Filter] ROIF** (*see page 120*).

[PTO Frequency] P t o C - Menu

Access

[Display] → [I/O Map] → [Analog outputs image] → [PTO Frequency]

[PTO Frequency] P t o C

Pulse train output frequency value.

Setting	Description
0.00...655.35 kHz	Setting range Factory setting: Read only

[PTO Assign] P t o a

Pulse train output assignment.

Setting	Code / Value	Description
[Not Configured]	n o	Not assigned
[Motor Current]	a C r	Current in the motor, from 0 to 2 In (In = rated drive current indicated in the Installation manual and on the drive nameplate)
[Motor Frequency]	a F r	Output frequency, from 0 to [Max Frequency] t F r Factory Setting
[Ramp out.]	a r P	From 0 to [Max Frequency] t F r
[Motor torq.]	t r 9	Motor torque, from 0 to 3 times the rated motor torque
[Sign. torque]	5 t 9	Signed motor torque, between -3 and +3 times the rated motor torque. The + sign corresponds to the motor mode and the - sign to the generator mode (braking).
[sign ramp]	a r 5	Signed ramp output, between -[Max Frequency] t F r and +[Max Frequency] t F r
[PID ref.]	a P 5	PID controller reference between [Min PID reference] P , P 1 and [Max PID reference] P , P 2
[PID feebk]	a P F	PID controller feedback between [Min PID feedback] P , F 1 and [Max PID feedback] P , F 2
[PID error]	a P E	PID controller detected error between -5% and +5% of [Max PID feedback] P , F 2 - [Min PID feedback] P , F 1
[PID output]	a P ,	PID controller output between [Low speed] L 5 P and [High speed] H 5 P
[Motor power]	a P r	Motor power, between 0 and 2.5 times [Nominal Motor Power] n P r
[Mot thermal]	t H r	Motor thermal state, from 0 to 200% of the rated thermal state
[Drv thermal]	t H d	Drive thermal state, from 0 to 200% of the rated thermal state
[Torque 4Q]	t r 4 9	Signed motor torque, between -3 and +3 times the rated motor torque. The + and - signs correspond to the physical direction of the torque, regardless of mode (motor or generator)
[Measured Motor Freq]	a F r r	Measured motor frequency
[Sig. o/p freq.]	a F 5	Signed output frequency, between -[Max Frequency] t F r and +[Max Frequency] t F r
[Mot therm2]	t H r 2	Motor thermal 2 state
[Mot therm3]	t H r 3	Motor thermal 3 state
[Mot therm4]	t H r 4	Motor thermal 4 state
[Unsigned Trq Ref]	u t r	Unsigned torque reference
[Signed Trq Ref]	5 t r	Signed torque reference
[Torque lim.]	t 9 L	Torque limit
[Motor volt.]	u o P	Voltage applied to the motor, between 0 and [Nom Motor Voltage] u n 5
[M/S Out Speed Reference]	n 5 5 a	Master / slave output speed reference
[M/S Out Torque Reference]	n 5 t a	Master / slave output torque reference

[PTO Max Output Freq] P L o H ★

Pulse train output maximum output frequency.

This parameter can be accessed if **[PTO Assign] P L o** is not set to **[Not configured] n o**.

Setting	Description
1.00...30.00 kHz	Setting range Factory setting: 4.00 kHz

[DI7 frequency measured] P F C 7 - Menu

Access

[Display] → [I/O map] → [Freq. signal image] → [DI7 frequency measured]

About This Menu

Following parameters can be accessed on the Graphic Display Terminal by pressing the OK key on the [DI7 Frequency Measured] P F C 7 parameter.

[DI7 Frequency Measured] P F C 7

Filtered customer pulse input frequency reference.

Setting	Description
0...4,294,967,295	Setting range Factory setting: Read only

[DI7 Pulse Input Assign] P , 7 A

DI7 pulse input assignment.

It displays all the functions associated with the pulse input in order to verify, for example, for compatibility problems.

If no functions have been assigned, [No] n o is displayed.

Setting	Code / Value	Description
[No]	n o	Not assigned
[Torque Ref Offset]	t r o	Torque offset source
[Torque Ref Ratio]	t r r	Torque ratio source
[Ref Frequency 1]	F r 1	Reference frequency 1
[Ref Frequency 2]	F r 2	Reference frequency 2
[Ref Frequency 2 Summing]	S R 2	Reference frequency 2 summing
[PID Feedback]	P , F	PI controller feedback
[Torque limitation]	t r r	Torque limitation: activation by an analog value
[Torque limitation 2]	t r r 2	Torque limitation: activation by an analog value
[Subtract Ref Freq 2]	d r 2	Subtract reference frequency 2
[Manual PID Ref.]	P , n	Manual speed reference of the PID controller (auto-man)
[PID Ref Frequency]	F P ,	PID reference frequency
[Ref Frequency 3 Summing]	S R 3	Reference frequency 3 summing
[Ref Frequency 1B]	F r 1 b	Reference frequency 1B
[Subtract Ref Freq 3]	d r 3	Subtract reference frequency 3
[Forced local]	F L o C	Forced local reference source1
[Ref Frequency 2 multiplier]	n r 2	Reference frequency 2 multiplier
[Ref Frequency 3 multiplier]	n r 3	Reference frequency 3 multiplier
[Torque reference]	t r 1	Torque regulation: torque set point 1
[Torque reference 2]	t r 2	Torque regulation: torque set point 2
[Frequency Meter]	F q F	Frequency meter function activation

Setting	Code / Value	Description
[External Feed Forward]	<i>E E F F</i>	External feed-forward
[M/S Speed Ref In]	<i>M S S I</i>	M/S Master speed reference input
[M/S Trq Ref In]	<i>M S T I</i>	M/S Master torque reference input
[Weight input]	<i>P E S</i>	External weight sensor input

[DI7 PulseInput Low Freq] *P I L 7*

Di7 pulse input low frequency.

Pulse input scaling parameter of 0% in Hz x 10 unit.

Setting	Description
0.00...30,000.00 Hz	Setting range Factory setting: 0 Hz

[DI7 PulseInput High Freq] *P I H 7*

Di7 pulse input high frequency.

Pulse input scaling parameter of 100% in Hz x 10 unit.

Setting	Description
0.00...30.00 kHz	Setting range Factory setting: 30.00 kHz

[DI7 Frequency Filter] *P F I 7*

Interference filtering pulse input cut-off time of the low-filter.

Setting	Description
0...1,000 ms	Setting range Factory setting: 0 ms

[DI8 frequency measured] *P F C B* - Menu

Access

[Display] → [I/O map] → [Freq. signal image] → [DI8 frequency measured]

About This Menu

Following parameters can be accessed on the Graphic Display Terminal by pressing the OK key on the [DI8 Frequency Measured] *P F C B* parameter.

[DI8 Frequency Measured] *P F C B*

Filtered customer pulse input frequency reference.

Identical to [DI7 frequency measured] *P F C 7* (*see page 125*).

[DI8 Pulse Input Assign] *P , B A*

DI8 pulse input assignment.

Identical to [DI7 Pulse Input Assign] *P , 7 A* (*see page 125*).

[DI8 PulseInput Low Freq] *P , L B*

DI8 pulse input low frequency.

Identical to [DI7 PulseInput Low Freq] *P , L 7* (*see page 126*).

[DI8 PulseInput High Freq] *P , H B*

DI8 pulse input high frequency.

Identical to [DI7 PulseInput High Freq] *P , H 7* (*see page 126*).

[DI8 Frequency Filter] *P F , B*

Interference filtering pulse input cut-off time of the low-filter.

Identical to [DI7 Frequency Filter] *P F , 7* (*see page 126*).

[Freq. signal image] F 5 , - Menu**Access**

[Display] → [I/O map] → [Freq. signal image]

[Encoder Pulse Freq] E C F r

Encoder pulse frequency.

This parameter can be accessed if:

- an encoder module has been inserted, and
- **[Encoder usage] E n u** is set to **[Speed Reference] P G r**, and
- **[Reference Type] P G R** is set to **[Frequency Generator] P L G**

Setting	Description
-21,474,836.47...21,474,836.47_kHz	Setting range Factory setting: Read only

[Encoder Frequency] E , F C

Encoder frequency.

This parameter can be accessed if:

- an encoder module has been inserted, and
- **[Encoder usage] E n u** is set to **[Speed Reference] P G r**, and
- **[Reference Type] P G R** is set to **[Frequency Generator] P L G**

Setting	Description
-21,474,836.47...21,474,836.47_kHz	Setting range Factory setting: Read only

[Cabinet Digital Input Map] L I C A - Menu

Access

[Display] → [I/O Map] → [Cabinet Digital Input Map]

These parameters can be accessed on ATV960 or ATV980, equipped with cabinet IO, and if **[Access Level]** L A C is set to **[Expert]** E P r .

About This Menu

This menu presents the state and assignment of cabinet digital inputs.

Read-only parameters cannot be configured.

It is used to visualize the state of the cabinet digital inputs

It displays all the functions that are assigned to a cabinet digital input, in order to verify for multiple assignments.

If no functions have been assigned, **[Not assigned]** n o is displayed. Use the touch wheel to scroll through the functions.

[Cabinet Digital Output Map] L O C A - Menu

Access

[Display] → [I/O Map] → [Cabinet Digital Output Map]

These parameters can be accessed on ATV960 or ATV980, equipped with cabinet IO, and if **[Access Level]** L A C is set to **[Expert]** E P r .

About This Menu

This menu presents the state and assignment of cabinet digital outputs.

Read-only parameters cannot be configured.

It displays the function which is assigned to a cabinet digital output. If no function has been assigned, **[Not assigned]** n o is displayed.

It allows verifying the delay, active state, and holding time set for the cabinet digital outputs. Possible values are identical as those in the configuration menu.

Section 7.12

[Communication map]

What Is in This Section?

This section contains the following topics:

Topic	Page
[Communication map] <i>C N N</i> - Menu	131
[Modbus network diag] <i>M n d</i> - Menu	134
[Com. scanner input map] <i>i S R</i> - Menu	135
[Com scan output map] <i>o S R</i> - Menu	136
[Modbus HMI Diag] <i>M d H</i> - Menu	137
[Ethernet Emb Diag] <i>M P E</i> - Menu	138
[DeviceNet Diag] <i>d V n</i> - Menu	139
[Profibus Diag] <i>P r b</i> - Menu	140
[PROFINET Diag] <i>P r n</i> - Menu	142
[EtherCAT Module Diag] <i>E t d</i> - Menu	144
[Powerlink Diag] <i>P w L</i> - Menu	145
[Command word image] <i>C w i</i> - Menu	146
[Freq. ref. word map] <i>r w i</i> - Menu	147
[CANopen map] <i>C n n</i> - Menu	148
[PDO1 image] <i>P o 1</i> - Menu	149
[PDO2 image] <i>P o 2</i> - Menu	151
[PDO3 image] <i>P o 3</i> - Menu	152
[CANopen map] <i>C n n</i> - Menu	153

[Communication map] $\mathcal{L} \mathcal{P} \mathcal{P}$ - Menu

Access

[Display] → [Communication map]

[Command Channel] $\mathcal{L} \mathcal{P} \mathcal{L} \mathcal{L}$

Command channel.

Setting	Code / Value	Description
[Terminals]	$\mathcal{L} \mathcal{E} \mathcal{r}$	Terminal block source Factory Setting
[Ref.Freq-Rmt.Term]	$\mathcal{L} \mathcal{L} \mathcal{L}$	Command via Graphic Display Terminal
[Ref. Freq-Modbus]	$\mathcal{P} \mathcal{d} \mathcal{b}$	Command via Modbus
[Ref. Freq-CANopen]	$\mathcal{L} \mathcal{P} \mathcal{n}$	Command via CANopen if a CANopen module has been inserted
[Ref. Freq-Com. Module]	$\mathcal{n} \mathcal{E} \mathcal{L}$	Command via fieldbus module if a fieldbus module has been inserted
[Embedded Ethernet]	$\mathcal{E} \mathcal{L} \mathcal{H}$	Command via Embedded Ethernet

[Cmd Register] $\mathcal{L} \mathcal{P} \mathcal{L}$

Command register.

[Control Mode] $\mathcal{L} \mathcal{H} \mathcal{L} \mathcal{F}$ is not set to [I/O profile] $\mathcal{I} \mathcal{O}$

Possible values in CiA402 profile, separate, or not separate mode:

Bit	Description, Value
0	Set to 1: "Switch on"/Contactor command
1	Set to 0: "Disable voltage"/Authorization to supply AC power
2	Set to 0: "Quick stop"
3	Set to 1: "Enable operation"/Run command
4 to 6	Reserved (= 0)
7	"Fault reset" acknowledgment active on 0 to 1 rising edge
8	Set to 1: Halt stop according to the [Type Of Stop] $\mathcal{S} \mathcal{L} \mathcal{L}$ parameter without leaving the operation enabled state
9 and 10	Reserved (= 0)
11 to 15	Can be assigned to commands

Possible values in the I/O profile. On state command [2-Wire Control] $\mathcal{L} \mathcal{L}$:

Bit	Description, Value
0	Forward (on state) command: 0: No forward command 1: Forward command NOTE: The assignment of bit 0 cannot be modified. It corresponds to the assignment of the terminals. It can be switched. Bit 0 $\mathcal{L} \mathcal{L} \mathcal{O} \mathcal{O}$ is only active if the channel of this control word is active.
1 to 15	Can be assigned to commands

Possible values in the I/O profile. On edge command [3-Wire Control] $\mathcal{L} \mathcal{L}$:

Bit	Description, Value
0	Stop (run authorization): 0: Stop 1: Run is authorized on a forward or reverse command
1	Forward (on 0 to 1 rising edge) command
2 to 15	Can be assigned to commands
NOTE: The assignment of bits 0 and 1 cannot be modified. It corresponds to the assignment of the terminals. It can be switched. Bits 0 $\mathcal{L} \mathcal{L} \mathcal{O} \mathcal{O}$ and 1 $\mathcal{L} \mathcal{L} \mathcal{O} \mathcal{I}$ are only active if the channel of this control word is active.	

[Ref Freq Channel] r F C C

Channel of reference frequency.

Identical to **[Command Channel] C P D C** (see page 131)

[Pre-Ramp Ref Freq] F r H

Frequency reference before ramp.

This parameter is read-only. It enables to display the reference frequency applied to the motor, regardless of which channel for reference value has been selected.

Setting	Description
-599.0...599.0 Hz	Setting range Factory setting: 0 Hz

[CIA402 State Reg] E L H

CIA402 State Register.

Possible values in CiA402 profile, separate, or not separate mode:

Bit	Description, Value
0	"Ready to switch on", awaiting power section line supply
1	"Switched on", ready
2	"Operation enabled", running
3	Operating detected error state: 0: Inactive 1: Active
4	"Voltage enabled", power section line supply present: 0: Power section line supply unavailable 1: Power section line supply present NOTE: When the drive is powered by the power section only, this bit is always at 1.
5	Quick stop
6	"Switched on disabled", power section line supply locked
7	Warning: 0: No warning 1: Warning
8	Reserved (= 0)
9	Remote: command or reference via the network 0: Command or reference via the Graphic Display Terminal 1: Command or reference via the network
10	Targets reference reached: 0: The reference is not reached 1: The reference has been reached NOTE: When the drive is in speed mode, this is the speed reference.
11	"Internal limit active", reference outside limits: 0: The reference is within the limits 1: The reference is not within the limits NOTE: When the drive is in speed mode, the limits are defined by the [Low speed] L S P and [High speed] H S P parameters.
12	Reserved
13	Reserved
14	"Stop key", STOP via stop key: 0: STOP key not pressed 1: Stop triggered by the STOP key on the Graphic Display Terminal
15	"Direction", direction of rotation: 0: Forward rotation at output 1: Reverse rotation at output
NOTE: The combination of bits 0, 1, 2, 4, 5 and 6 defines the state in the DSP 402 state chart (see the communication manuals).	

Possible values in the I/O profile:

Bit	Description, Value
0	Reserved (= 0 or 1)
1	Ready: 0: Not ready 1: Ready
2	Running: 0: The drive does not start if a reference other than zero is applied 1: Running, if a reference other than zero is applied, the drive can start
3	Operating detected error state: 0: Inactive 1: Active
4	Power section line supply present: 0: Power section line supply unavailable 1: Power section line supply present
5	Reserved (= 1)
6	Reserved (= 0 or 1)
7	Warning 0: No warning 1: Warning
8	Reserved (= 0)
9	Command via a network: 0: Command via the terminals or the Graphic Display Terminal 1: Command via a network
10	Reference reached: 0: The reference is not reached 1: The reference has been reached
11	Reference outside limits: 0: The reference is within the limits 1: The reference is not within the limits NOTE: When the drive is in speed mode, the limits are defined by LSP and HSP parameters.
12	Reserved (= 0)
13	Reserved (= 0)
14	Stop via STOP key: 0: STOP key not pressed 1: Stop triggered by the STOP key on the Graphic Display Terminal
15	Direction of rotation: 0: Forward rotation at output 1: Reverse rotation at output
NOTE: The value is identical in the CiA402 profile and the I/O profile. In the I/O profile, the description of the values is simplified and does not refer to the CiA402 (Drivecom) state chart.	

[Modbus network diag] П n d - Menu**Access**

[Display] → [Communication map] → [Modbus network diag]

About This Menu

Used for the Modbus serial communication port at the bottom of the control block. Refer to the Modbus serial embedded communication manual for a complete description.

[COM LED] П d b l

View of the Modbus communication LED.

[Mdb Frame Nb] П l c t

Modbus network frames counter: number of processed frames.

Setting	Description
0...65,535	Setting range Factory setting: Read only

[Mb NET CRC errors] П l e c

Modbus network CRC error countered: number of CRC errors

Setting	Description
0...65,535	Setting range Factory setting: Read only

[Com. scanner input map] , 5 H - Menu

Access

[Display] → [Communication map] → [Modbus network diag] → [Com. scanner input map]

About This Menu

Used for CANopen® and Modbus network.

[Com Scan In1 val.] [n p 1](#)

Com scanner input 1 value. Value of the first input word.

Setting	Description
0...65,535	Setting range Factory setting: Read only

[Com Scan In2 val.] [n p 2](#)

Com scanner input 2 value. Value of the second input word.

Identical to [\[Com Scan In1 val.\] \[n p 1\]\(#\)](#) ([see page 135](#)).

[Com Scan In3 val.] [n p 3](#)

Com scanner input 3 value. Value of the third input word.

Identical to [\[Com Scan In1 val.\] \[n p 1\]\(#\)](#) ([see page 135](#)).

[Com Scan In4 val.] [n p 4](#)

Com scanner input 4 value. Value of the fourth input word.

Identical to [\[Com Scan In1 val.\] \[n p 1\]\(#\)](#) ([see page 135](#)).

[Com Scan In5 val.] [n p 5](#)

Com scanner input 5 value. Value of the fifth input word.

Identical to [\[Com Scan In1 val.\] \[n p 1\]\(#\)](#) ([see page 135](#)).

[Com Scan In6 val.] [n p 6](#)

Com scanner input 6 value. Value of the sixth input word.

Identical to [\[Com Scan In1 val.\] \[n p 1\]\(#\)](#) ([see page 135](#)).

[Com Scan In7 val.] [n p 7](#)

Com scanner input 7 value. Value of the seventh input word.

Identical to [\[Com Scan In1 val.\] \[n p 1\]\(#\)](#) ([see page 135](#)).

[Com Scan In8 val.] [n p 8](#)

Com scanner input 8 value. Value of the eighth input word.

Identical to [\[Com Scan In1 val.\] \[n p 1\]\(#\)](#) ([see page 135](#)).

[Com scan output map] ▢ 5 H - Menu

Access

[Display] → [Communication map] → [Com scan output map]

About This Menu

Used for CANopen® and Modbus networks.

[Com Scan Out1 val.] n L 1

Com scanner output 1 value. Value of the first output word.

Setting (↺)	Description
0...65,535	Setting range Factory setting: Read only

[Com Scan Out2 val.] n L 2

Com scanner output 2 value. Value of the second output word.

Identical to [Com Scan Out1 val.] n L 1 (*see page 136*).

[Com Scan Out3 val.] n L 3

Com scanner output 3 value. Value of the third output word.

Identical to [Com Scan Out1 val.] n L 1 (*see page 136*).

[Com Scan Out4 val.] n L 4

Com scanner output 4 value. Value of the fourth output word.

Identical to [Com Scan Out1 val.] n L 1 (*see page 136*).

[Com Scan Out5 val.] n L 5

Com scanner output 5 value. Value of the fifth output word.

Identical to [Com Scan Out1 val.] n L 1 (*see page 136*).

[Com Scan Out6 val.] n L 6

Com scanner output 6 value. Value of the sixth output word.

Identical to [Com Scan Out1 val.] n L 1 (*see page 136*).

[Com Scan Out7 val.] n L 7

Com scanner output 7 value. Value of the seventh output word.

Identical to [Com Scan Out1 val.] n L 1 (*see page 136*).

[Com Scan Out8 val.] n L 8

Com scanner output 8 value. Value of the eighth output word.

Identical to [Com Scan Out1 val.] n L 1 (*see page 136*).

[Modbus HMI Diag] ПДН - Menu

Access

[Display] → [Communication map] → [Modbus HMI Diag]

About This Menu

Used for the Modbus serial communication port at the front of the control block (used by the Graphic Display Terminal)

[COM LED] ПДБЭ

View of the Modbus HMI communication LED.

[Mdb NET frames] ПЭЦЕ

Terminal Modbus 2: number of processed frames.

Setting ()	Description
0...65,535	Setting range Factory setting: Read only

[Mdb NET CRC errors] ПЭЕЕ

Terminal Modbus 2: number of CRC errors.

Setting ()	Description
0...65,535	Setting range Factory setting: Read only

[Ethernet Emb Diag] *Π P E* - Menu

Access

[Display] → [Communication map] → [Ethernet Emb Diag]

About This Menu

Refer to the Modbus TCP Ethernet-IP communication manual for a complete description.

[MAC @] *Π P C E*

MAC address of the embedded Ethernet adapter.
Read-only parameter.
The address format is XX-XX-XX-XX-XX-XX.

[ETH emb Rx frames] *E r X E*

Ethernet embedded Rx frames counter.

Setting ()	Description
0...4,294,967,295	Setting range Factory setting: Read only

[ETH emb Tx frames] *E t X E*

Ethernet embedded Tx frames counter.

Setting ()	Description
0...4,294,967,295	Setting range Factory setting: Read only

[ETH emb error frames] *E E r E*

Ethernet embedded error frames counter.

Setting ()	Description
0...4,294,967,295	Setting range Factory setting: Read only

[Ethernet Rate Data] *R r d E* ★

Actual data rate.

Setting ()	Code / Value	Description
[Auto]	<i>A u t o</i>	Automatic
[10M. full]	<i>1 0 F</i>	10 Mega bytes full-duplex
[10M. half]	<i>1 0 H</i>	10 Mega bytes half-duplex
[100M. full]	<i>1 0 0 F</i>	100 Mega bytes full-duplex
[100M. half]	<i>1 0 0 H</i>	100 Mega bytes half-duplex

[DeviceNet Diag] *d V n* - Menu**Access**

[Display] → [Communication map] → [DeviceNet Diag]

About This Menu

Following parameters can be accessed if DeviceNet module (VW3A3609) has been inserted.

[Data rate used] *b d r u* ★

Data rate used by the fieldbus module.

Setting	Code / Value	Description
[Automatic]	<i>A u t o</i>	Automatic detection Factory setting
[125 Kbps]	<i>1 2 5 K</i>	125,000 Bauds
[250 Kbps]	<i>2 5 0 K</i>	250,000 Bauds
[500 Kbps]	<i>5 0 0 K</i>	500,000 Bauds

[Fieldbus Error] *E P F 2*

External detected error from fieldbus module.

Setting	Description
0...1	0: No Error 1: Profile error, verify the settings on [Command and Reference] <i>C r P</i> - menu.

[Fieldbus Com Interrupt] *C n F*

Fieldbus module communication interruption. Refer to the related fieldbus manual.

Setting	Description
0...65,535	0: No error 1: Error triggered by network 2: Duplicated MAC ID 3: FIFO Rx error 4: FIFO Tx error 5: CAN overrun 6: Transmission error 7: Bus off 8: IO timeout 9: Acknowledge error 10: DeviceNet network reset 11: IO connection deleted 12: No network power 13: IOC error

[Profibus Diag] *P r b* - Menu

Access

[Display] → [Communication] → [Profibus Diag]

About This Menu

Following parameters can be accessible if Profibus DP module (VW3A3607) has been inserted.

[Data rate used] *b d r u* ★

Data rate used by the fieldbus module.

Setting (↵)	Code / Value	Description
[Automatic]	<i>R u t o</i>	Automatic detection Factory setting
[9.6 Kbps]	<i>9 K 6</i>	9,600 Bauds
[19.2 Kbps]	<i>1 9 K 2</i>	19,200 Bauds
[93.75 Kbps]	<i>9 3 K 7</i>	93,750 Bauds
[187.5 Kbps]	<i>1 8 7 K</i>	187,500 Bauds
[500 Kbps]	<i>5 0 0 K</i>	500,000 Bauds
[1.5 Mbps]	<i>1 7 5</i>	1.5 MBauds
[3 Mbps]	<i>3 7</i>	3 MBauds
[6 Mbps]	<i>6 7</i>	6 MBauds
[12 Mbps]	<i>1 2 7</i>	12 MBauds

[PPO profile used] *P r F L* ★

PPO profile in use.

Setting (↵)	Code / Value	Description
[Not configured]	<i>u n C G</i>	Not configured
[1]	<i>1</i>	PROFIdrive
[100]	<i>1 0 0</i>	Device specific
[101]	<i>1 0 1</i>	Device specific
[102]	<i>1 0 2</i>	Device specific
[106]	<i>1 0 6</i>	Device specific
[107]	<i>1 0 7</i>	Device specific

[DP Master Active] *d P M A* ★

Active master: 1 or 2.

Setting (↵)	Code / Value	Description
[MCL1]	<i>1</i>	Master 1 Factory setting
[MCL2]	<i>2</i>	Master 2

[Fieldbus Error] *E P F 2*

External detected error from fieldbus module.

[Fieldbus Com Interrupt] C n F

Fieldbus module communication interruption. Refer to the related fieldbus manual.

Setting 	Description
0...65,535	0: No error 1: Network timeout for received requests 2: Identification error between the module and the master 3: Master in clear mode 4: Master class 2 timeout

[InternCom Error1] , L F I

Option module communication interruption. Refer to the related fieldbus manual.

Setting 	Description
0...65,535	Setting range Factory setting: Read only

[PROFINET Diag] *P r n* - Menu

Access

[Display] → [Communication map] → [PROFINET Diag]

About This Menu

Following parameters are accessible if PROFINET® module (VW3A3627) has been inserted.

[MAC @] *n r c*

MAC address of the PROFINET module.
read-only parameter.
The address format is XX-XX-XX-XX-XX-XX.

[PPO profile used] *P r F L* ★

PPO profile in use.

Setting ()	Code / Value	Description
[Not configured]	<i>u n C C</i>	Not configured
[1]	<i>1</i>	PROFIdrive
[100]	<i>1 0 0</i>	Device specific
[101]	<i>1 0 1</i>	Device specific
[102]	<i>1 0 2</i>	Device specific
[106]	<i>1 0 6</i>	Device specific
[107]	<i>1 0 7</i>	Device specific

[iPar Status] *, P r E* ★

PROFINET: IPAR service status.

Setting ()	Code / Value	Description
[Idle State]	<i>, d L E</i>	Idle state
[Init]	<i>, n i t</i>	Initialization
[Configuration]	<i>C o n F</i>	Configuration
[Ready]	<i>r d y</i>	Ready
[Operational]	<i>o P E</i>	Operational
[Not Configured]	<i>u C F C</i>	Not configured
[Unrecoverable Error]	<i>u r E C</i>	Unrecoverable detected error

[iPar Error Code] *, P r d* ★

IPar detected error code.

Setting ()	Description
0...5	Setting range Factory setting: Read only

[DP Master Active] d P n A ★

Active master: 1 or 2.

Setting (↻)	Code / Value	Description
[MCL1]	1	Master 1 Factory setting
[MCL2]	2	Master 2

[Fieldbus Error] E P F 2

External detected error from fieldbus module.

Setting	Description
0...13	0: No Error 9: Duplicate IP 10: No IP address 12: IPAR unconfigured 13: IPAR file unrecognized

[Fieldbus Com Interrupt] L n F

Fieldbus module communication interruption.

Setting (↻)	Description
0...65,535	0: No error 1: Network timeout 2: Network overload 3: Ethernet carrier loss 17: IOC scanner error

[InternCom Error1] , L F I

Option module communication interruption.

Setting (↻)	Description
0...65,535	Setting range Factory setting: Read only

[EtherCAT Module Diag] *E E d* - Menu

Access

[Display] → [Communication map] → [EtherCAT Module Diag]

About This Menu

Following parameters can be accessed if EtherCAT module (VW3A3601) has been inserted.

[External Error] *E P F 2*

External detected error from fieldbus module.

[Fieldbus Com Interrupt] *C n F*

Fieldbus module communication interruption.

Setting ()	Description
0...65,535	Setting range Factory setting: _

[InternCom Error1] *, L F 1*

Internal communication interruption 1.

Setting ()	Description
0...65,535	Setting range Factory setting: _

[Powerlink Diag] P W L - Menu

Access

[Display] → [Communication map] → [Powerlink Diag]

About This Menu

Following parameters can be access if Powerlink module (VW3A3619) has been inserted. Refer to the Powerlink communication manual for a complete description.

This menu contains read-only parameters.

[Mac @]] P A C

MAC address of the POWERLINK module.

The address format is XX-XX-XX-XX-XX-XX

[Fieldbus Error]] E P F 2

External detected error from fieldbus module.

[Fieldbus Com Interrupt]] C n F

Fieldbus module communication interruption. Refer to the related fieldbus manual.

Setting	Description
0...65,535	0: No network interruption 1: Unspecified interruption 17: Lost of link (2 ports) 23: Invalid Sync Manager configuration 25: No valid outputs 27: Sync Manager watchdog (1 port) 29: Invalid Sync Manager out configuration 30: Invalid Sync Manager in configuration 31: Invalid watchdog configuration 36: Invalid input mapping 37: Invalid output mapping 38: Inconsistent settings 43: No valid inputs and outputs 44: Sync error 80: EE no access 81: EE error 96: 0x60

[InternCom Error1]] L F I

Option module communication interruption.

Setting ()	Description
0...65,535	Setting range Factory setting: Read-only

[Command word image] [\[W \]](#) - Menu

Access

[Display] → [Communication map] → [Command word image]

About This Menu

Command word image.

[Modbus Cmd] [\[1 \]](#)

Command word image built with Modbus port source.
Identical to [CMD Register] [\[1 \]](#) ([see page 131](#)).

[CANopen Cmd] [\[2 \]](#)

Command word image built with CANopen® port source.
Identical to [CMD Register] [\[1 \]](#) ([see page 131](#)).

[COM. Module Cmd.] [\[3 \]](#)

Command word image built with fieldbus module source.
Identical to [CMD Register] [\[1 \]](#) ([see page 131](#)).

[Ethernet Embd cmd.] [\[5 \]](#)

Command word image built with Ethernet embedded source.
Identical to [CMD Register] [\[1 \]](#) ([see page 131](#)).

[Freq. ref. word map] *r W 1* - Menu

Access

[Display] → [Communication map] → [Freq. ref. word map]

About This Menu

Frequency reference image.

[Modbus Ref Freq] *L F r 1*

Frequency reference image built with Modbus port source (LFR_MDB).

Setting 	Description
-32,767...32,767 Hz	Setting range Factory setting: 0.0 Hz

[CAN Ref Freq] *L F r 2*

Frequency reference image built with CANopen® port source (LFR_CAN).

Setting 	Description
-32,767...32,767 Hz	Setting range Factory setting: 0.0 Hz

[Com Module Ref Freq] *L F r 3*

Frequency reference image built with fieldbus module source (LFR_COM).

Setting 	Description
-32,767...32,767 Hz	Setting range Factory setting: 0.0 Hz

[Ethernet Emdb Ref Freq] *L F r 5*

Embedded Ethernet reference frequency.

Setting 	Description
-32,767...32,767 Hz	Setting range Factory setting: 0.0 Hz

[CANopen map] *C n Π* - Menu

Access

[Display] → [Communication map] → [CANopen map]

About This Menu

This menu is visible if a CANopen fieldbus module is present. Refer to the CANopen communication module manual.

[RUN LED] *C o n*

Bitfield: view of the CANopen® Run LED status.

[ERR LED] *C A n E*

Bitfield: view of the CANopen® error LED status.

[PDO1 image] P 0 1 - Menu

Access

[Display] → [Communication map] → [CANopen map] → [PDO1 image]

About This Menu

View of the Receive PDO1 and Transmit PDO1.

[Receive PDO1-1] r P 1 1 ★

First frame of the receive PDO1.

Setting	Description
0...65,535	Setting range Factory setting: Read only

[Receive PDO1-2] r P 1 2 ★

Second frame of the receive PDO1.

Setting	Description
0...65,535	Setting range Factory setting: Read only

[Receive PDO1-3] r P 1 3 ★

Third frame of the receive PDO1.

Setting	Description
0...65,535	Setting range Factory setting: Read only

[Receive PDO1-4] r P 1 4 ★

Fourth frame of the receive PDO1.

Setting	Description
0...65,535	Setting range Factory setting: Read only

[Transmit PDO1-1] t P 1 1 ★

First frame of the transmit PDO1.

Setting	Description
0...65,535	Setting range Factory setting: Read only

[Transmit PDO1-2] t P 1 2 ★

Second frame of the transmit PDO1.

Setting	Description
0...65,535	Setting range Factory setting: Read only

[Transmit PDO1-3] *LP 13* ★

Third frame of the transmit PDO1.

Setting	Description
0...65,535	Setting range Factory setting: Read only

[Transmit PDO1-4] *LP 14* ★

Fourth frame of the transmit PDO1.

Setting	Description
0...65,535	Setting range Factory setting: Read only

[PDO2 image] P 0 2 - Menu

Access

[Display] → [Communication map] → [CANopen map] → [PDO2 image]

About This Menu

View of the RPDO2 and TPDO2: same structure as [PDO1 image] P 0 1 - (*see page 149*).

[Receive PDO2-1] r P 2 1 ★

First frame of the receive PDO2.

[Receive PDO2-2] r P 2 2 ★

Second frame of the receive PDO2.

[Receive PDO2-3] r P 2 3 ★

Third frame of the receive PDO2.

[Receive PDO2-4] r P 2 4 ★

Fourth frame of the receive PDO2.

[Transmit PDO2-1] t P 2 1 ★

First frame of the transmit PDO2.

[Transmit PDO2-2] t P 2 2 ★

Second frame of the transmit PDO2.

[Transmit PDO2-3] t P 2 3 ★

Third frame of the transmit PDO2.

[Transmit PDO2-4] t P 2 4 ★

Fourth frame of the transmit PDO2.

[PDO3 image] P 0 3 - Menu

Access

[Display] → [Communication map] → [CANopen map] → [PDO3 image]

About This Menu

View of the RPDO3 and TPDO3.

[Receive PDO3-1] r P 3 1 ★

First frame of the receive PDO3.

Setting ()	Description
0...65,535	Setting range Factory setting: Read only

[Receive PDO3-2] r P 3 2 ★

Second frame of the receive PDO3.

Identical settings as in **[Receive PDO3-1] r P 3 1**.

[Receive PDO3-3] r P 3 3 ★

Third frame of the receive PDO3.

Identical settings as in **[Receive PDO3-1] r P 3 1**.

[Receive PDO3-4] r P 3 4 ★

Fourth frame of the receive PDO3.

Identical settings as in **[Receive PDO3-1] r P 3 1**.

[Transmit PDO3-1] t P 3 1 ★

First frame of the transmit PDO3.

Setting ()	Description
0...65,535	Setting range Factory setting: Read only

[Transmit PDO3-2] t P 3 2 ★

Second frame of the transmit PDO3.

Identical settings as in **[Transmit PDO3-1] t P 3 1**.

[Transmit PDO3-3] t P 3 3 ★

Third frame of the transmit PDO3.

Identical settings as in **[Transmit PDO3-1] t P 3 1**.

[Transmit PDO3-4] t P 3 4 ★

Fourth frame of the transmit PDO3.

Identical settings as in **[Transmit PDO3-1] t P 3 1**.

[CANopen map] *Ⓛ Ⓝ Ⓜ* - Menu

Access

[Display] → [Communication map] → [CANopen map]

About This Menu

CANopen® image.

[CANopen NMT state] *Ⓝ Ⓜ Ⓛ Ⓢ*

Drive NMT state of the CANopen® slave.

Settings	Code / Value	Description
[Boot]	<i>b o o t</i>	Bootup
[Stopped]	<i>S t o p</i>	Stopped
[Operation]	<i>o p e</i>	Operational
[Pre-op]	<i>P o p e</i>	Pre-Operational

[Number of TX PDO] *Ⓝ b t P*

Number of transmit PDO.

Setting (Ⓢ)	Description
0...65,535	Setting range Factory setting: Read only

[Number of RX PDO] *Ⓝ b r P*

Number of receive PDO.

Setting (Ⓢ)	Description
0...65,535	Setting range Factory setting: Read only

[CANopen Error] *E r r o*

Error registry CANopen®.

Setting	Description
0...5	Setting range Factory setting: Read only

[RX Error Counter] *r E C I*

Number of receive error counter (not saved at power off).

Setting	Description
0...65,535	Setting range Factory setting: Read only

[TX Error Counter] *t E C I*

Number of transmit errors countered (not saved at power off).

Setting	Description
0...65,535	Setting range Factory setting: Read only

Section 7.13

[Data logging]

What Is in This Section?

This section contains the following topics:

Topic	Page
[Distributed logging] <i>dL a</i> - Menu	155
[Log dstrb prm select] <i>L dP</i> - Menu	156
[Distributed logging] <i>dL a</i> - Menu	157

[Distributed logging] *d L o* - Menu

Access

[Display] → [Data logging] → [Distributed logging]

About This Menu

This menu is used to store data following specific parameters.

The distributed logging function allows to log up to four parameter distributions at the same time. Each parameter storage is synchronized with the same sample time.

The result of this function gives the possibility to extract a bar graph with 10 bars (every 10% of the defined maximum value) to visualize the distribution for each of the four selected parameters.

NOTE: Any modification of the data logging function configuration will clear the data previously stored.

This function aims at extracting samples of data to store them. When available, these samples can be uploaded by other tools (SoMove and/or Webserver). Data logging meets the need to record and store data over time.

The drive can store the following data:

Type of [Data logging]	Description	[Data logging] storage: Automatic/Manual	Access
Drive identification	Drive identification data	Automatic, in [Dashboard] <i>d S H</i> - menu	SoMove Webserver
Even warning logging	Warning logging	Automatic, in [Dashboard] <i>d S H</i> - menu	SoMove Webserver
Even error logging	Error logging	Automatic, in [Dashboard] <i>d S H</i> - menu	SoMove Webserver
Distribution logging	4 Distribution data	Manual	Webserver
Energy logging	1 Energy logging data	Automatic, in [Dashboard] <i>d S H</i> - menu	SoMove Webserver

Activation

To activate [Distributed logging] *d L o* - :

- Select 1 to 4 data to store with [Log dstrb prm select] *L d P* -
- Set [Log Distrib State] *L d E n* to [Start] *S t A r t*

The logging starts as soon as the motor is running.

To stop logging, set [Log Distrib State] *L d E n* to [Stop] *S t o P*.

[Log Distrib State] *L d E n*

Logging distribution state.

Setting ()	Code / Value	Description
[Stop]	<i>S t o P</i>	Distribution logging disabled Factory setting
[Start]	<i>S t A r t</i>	Distribution logs only when the motor is started
[Always]	<i>A L W A Y S</i>	Distribution logs all the time
[Reset]	<i>r E S E t</i>	Distribution logging reset (configuration, data)
[Clear]	<i>C L E A r</i>	Clear distribution data
[Error]	<i>E r r o r</i>	An error has been detected during distribution logging

[Log dstrb prm select] L d P - Menu**Access**

[Display] → [Data logging] → [Distributed logging] → [Log dstrb prm select]

About This Menu

This menu allows you to select up to 4 parameters for data logging. The peak value for each parameter is also stored.

[Log Distrib. Data 1] L d d 1

Logging distribution data 1.

Setting ()	Code / Value	Description
[Distrib. Log. Disable]	n o	Distribution logging disable Factory setting
[Motor Frequency]	r F r	Motor frequency
[Motor Current]	L C r	Motor current
[Motor Speed]	S P d	Motor speed
[Motor Voltage]	u o P	Motor voltage
[Motor Mech. Power]	o P r W	Motor mechanical power
[Input Elec. Power]	i P r W	Input electrical power
[Output Elec. Power]	E P r W	Output electrical power
[Motor Torque]	o t r	Motor torque
[Mains Voltage]	u L n	Mains voltage
[DC BUS Voltage]	V b u S	DC BUS voltage
[AI1 Th Value]	t H 1 V	Thermal sensor AI1
[AI3 Th Value]	t H 3 V	Thermal sensor AI3
[AI4 Th Value]	t H 4 V	Thermal sensor AI4
[AI5 Th Value]	t H 5 V	Thermal sensor AI5
[Drive Thermal State]	t H d	Drive thermal state
[Motor Therm State]	t H r	Motor thermal state
[Mains Current]	i L n	Main estimated current
[Input Reactive Power]	i q r W	Re-active Electrical input power estimation
[Input Power factor]	P W F	Main power factor
[DBR Thermal State]	t H b	Braking thermal stat

[Log Distrib. Data 2] L d d 2

Logging distribution data 2.

Identical to [Log Distrib. Data 1] L d d 1 (see page 156).

[Log Distrib. Data 3] L d d 3

Logging distribution data 3.

Identical to [Log Distrib. Data 1] L d d 1 (see page 156).

[Log Distrib. Data 4] L d d 4

Logging distribution data 4.

Identical to [Log Distrib. Data 1] L d d 1 (see page 156).

[Distributed logging] *d L o* - Menu

Access

[Display] → [Data logging] → [Distributed logging]

About This Menu

NOTE: If a log data exceeds the user defined maximum values for log distribution data, this value will not be stored in the log distribution.

[Log Distrib Slp Time] *L d S t*

Logging distribution sample time.

Setting ()	Code / Value	Description
[200 ms]	<i>2 0 0 0 5</i>	200 ms
[1 second]	<i>1 5</i>	1 s Factory setting
[2 second]	<i>2 5</i>	2 s
[5 second]	<i>5 5</i>	5 s

[Dist Max Val 1] *L d 1*

Maximum value of the log distribution data 1.

Setting ()	Description
10...65,535	Setting range Factory setting: Read only

[Dist Max Val 2] *L d 2*

Maximum value of the log distribution data 2.

Setting ()	Description
10...65,535	Setting range Factory setting: Read only

[Dist Max Val 3] *L d 3*

Maximum value of the log distribution data 3.

Setting ()	Description
10...65,535	Setting range Factory setting: Read only

[Dist Max Val 4] *L d 4*

Maximum value of the log distribution data 4.

Setting ()	Description
10...65,535	Setting range Factory setting: Read only

Section 7.14

[Braking Unit Option]

[Braking Unit Option] *b u o* - Menu

Access

[Display] → [Braking Unit Option]

About This Menu

This menu can be accessed if a Braking Unit Option has been configured.

[DBR thermal state] *t H b*

Braking Resistor thermal state

Setting	Description
0...118%	Setting range Factory setting: Read only

[Braking Resistor Energy] *b r E C*

Braking resistor energy counter

Setting	Description
0...4,294,967,295 kWh	Setting range Factory setting: Read only

[DBR Run Time] *r r H H*

Braking resistor run time

Setting	Description
0.0...429,496,729.5 h	Setting range Factory setting: Read only

[BUO Fan Operation Time] *F b b t*

Braking unit fan operation time

Setting	Description
0...500,000 h	Setting range Factory setting: Read only

[BUO Power-on time] *r P H H*

Braking unit Power-on time

Setting	Description
0.0...429,496,729.5 h	Setting range Factory setting: Read only

Chapter 8

[Complete settings] *C 5 E* -

Introduction



[Complete settings] *C 5 E* - menu presents all the settings related to drive functions for:

- Motor and drive configuration
- Application functions
- Monitoring functions

What Is in This Chapter?

This chapter contains the following sections:

Section	Topic	Page
8.1	[Macro configuration]	161
8.2	[Motor parameters] <i>PPR</i> - Menu	162
8.3	[Define system units]	220
8.4	[Command and Reference] <i>CP</i> - Menu	222
8.5	[Pump functions] - [PID controller]	236
8.6	[Pump functions] - [Sleep/wakeup]	256
8.7	[Pump functions] - [Feedback monitoring]	263
8.8	[Pump functions] - [ENA System]	265
8.9	[Pump functions] - [Backspin Control]	267
8.10	[Pump monitoring] - [Pumpcycle monitoring]	270
8.11	[Pump monitoring] - [Thermal monitoring]	272
8.12	[Master/Slave]	273
8.13	[Backlash compensation]	312
8.14	[Hoisting Functions]	322
8.15	[Hoisting monitoring]	351
8.16	[Conveyor Functions]	353
8.17	[Generic functions] - [Speed limits]	356
8.18	[Generic functions] - [Ramp]	358
8.19	[Generic functions] - [Ramp switching]	362
8.20	[Generic functions] - [Stop configuration]	364
8.21	[Generic functions] - [Auto DC injection]	369
8.22	[Generic functions] - [Ref. operations]	372
8.23	[Generic functions] - [Preset speeds]	374
8.24	[Generic functions] - [+/- speed]	378
8.25	[Generic functions] - [+/- speed around ref]	381
8.26	[Generic functions] - [Jump frequency]	384
8.27	[Generic functions] - [PID controller]	385
8.28	[Generic functions] - [Feedback mon.]	405
8.29	[Generic functions] - [Threshold reached]	406
8.30	[Generic functions] - [Mains contactor command]	409
8.31	[Generic functions] - [Output contactor cmd]	412
8.32	[Generic functions] - [Reverse disable]	415
8.33	[Generic functions] - [Torque limitation]	416
8.34	[Generic functions] - [2nd current limit.]	420
8.35	[Generic functions] - [Jog]	422
8.36	[Generic functions] - [High Speed Switching]	424

Section	Topic	Page
8.37	[Generic functions] - [Memo reference frequency]	426
8.38	[Generic functions] - [Brake logic control]	427
8.39	[Generic functions] - [Limit switches]	428
8.40	[Generic functions] - [Positioning by sensors]	430
8.41	[Generic functions] - [Torque control]	438
8.42	[Generic functions] - [Parameters switching]	445
8.43	[Generic functions] - [Stop after speed timeout]	451
8.44	[Generic functions] - [Active Front End]	453
8.45	[Generic functions] - [Bus Ref Link]	454
8.46	[Generic functions] - [DC bus supply]	456
8.47	[Generic functions] - [Multimotors config]	458
8.48	[Generic Functions] [External Weight Measurement]	462
8.49	[Generic monitoring]	465
8.50	[Input/Output] - [I/O assignment]	473
8.51	[Input/Output] - [DI/DQ]	487
8.52	[Input/Output] - [Analog I/O]	508
8.53	[Input/Output] - [Relay]	524
8.54	[Encoder configuration]	536
8.55	[Error/Warning handling]	543
8.56	[Maintenance]	572
8.57	[Cabinet I/O Function] <i>L R B F</i> -	581

Section 8.1

[Macro configuration]

[Macro configuration] ПЦГ - Menu

Access

[Complete settings] → [Macro configuration]

About This Menu

This menu allows to select an application type in order to display only the parameters and menus useful for the selected application.

The application type selection should be done prior to the application settings.

Menu	[Generic Pump Control] ГППП	[Hoisting] H o S t	[Conveyor] C o n v	[All Applications] R L L
[Pump functions] П F t -	X			X
[Pump monitoring] П P t -	X			X
[Hoisting functions] H F t -		X		X
[Hoisting monitoring] H П n -		X		X
[Conveyor functions] C F t -			X	X

[Application Selection] АПП t

Application selection.

 WARNING
UNANTICIPATED EQUIPMENT OPERATION
If this parameter is changed, the functions that are active with the current configuration are disabled and the assignments of the inputs used in these functions are reset to the factory setting.
Verify that this change is compatible with the type of wiring used.
Failure to follow these instructions can result in death, serious injury, or equipment damage.

Setting	Code / Value	Description
[Generic Pump Control]	Г П П П	Generic pump control application
[Hoisting]	H o S t	Hoisting control application
[Conveyor]	C o n v	Conveyor control application
[All Applications]	R L L	All Applications Factory setting

Section 8.2

[Motor parameters] П P R - Menu

What Is in This Section?

This section contains the following topics:

Topic	Page
[Motor parameters] П P R - Menu	163
[Data] П E d - Menu	166
[Angle test setting] P 5 P - Menu	175
[Motor tune] П E u - Menu	177
[Motor monitoring] П o P - Menu	184
[Thermal monitoring] E P P - Menu	185
[Motor monitoring] П o P - Menu	194
[Motor control] d r C - Menu	197
[Fluxing by DI] F L , - Menu	202
[Spd Loop Optimization] П C L - Menu	204
[Motor control] d r C - Menu	214
[Switching frequency] S W F - Menu	217
[Input Filter] d C r - Menu	219

[Motor parameters] П P A - Menu

Access

[Complete settings] → [Motor parameters]

About This Menu

For an application where less than 120% of overload is required

- Power rating of the drive could be equal to power rating of the motor
- Normal rating should be used

For an application where more that 120% of overload is required (up to 150%)

- Power rating of the drive should be greater than power rating of the motor
- High rating could be used to pre-adjust motor nameplate parameter

If high rating is selected, drive current limitation is extended to 1.5. In and maximum values of motor parameters linked to current and/or power are reduced. When switching from one to another selection, all the related parameters are set to their factory setting values.

In any case, the maximum current of the drive does not change. Setting the drive to high rating mode decreases the nominal values for the motor parameters. It means that for the same motor, an oversized drive is required in high rating mode.

ATV900 Motor Control Types

ATV900 drive embeds 8 motor control types which covers all the use cases depending of the application.

The following table shows the Motor Control types selection depending of the application needs:

Control	Motor Type	[Motor Control Type] C L E selection	Description
Opened-Loop	Asynchronous motor	[SVC V] V V C	Voltage vector control law with slip compensation
		[U/F VC 5pts] u F 5	5 points U/F vector control law
		[Energy Sav.] n L d	Energy saving control law
	Synchronous motor	[Sync. mot.] 5 Y n	Permanent magnet control law
		[SYN_U VC] 5 Y n u	Permanent magnet control law for variable torque applications
Reluctant motor	[Rel. Mot.] 5 r V C	Reluctant motor control law	
Closed-Loop ¹	Asynchronous motor	[FVC] F V C	Current vector control law
	Synchronous motor	[Sync.CL] F 5 Y	Permanent magnet control law

(1) For these applications, an encoder must be present and configured.

Parameters List for Asynchronous Motors

The following table shows the minimum parameters list that needs to be configured for asynchronous motors depending of [Motor Control Type] C L E selection:

NOTE: After setting these parameters, it is recommended to perform an [Autotuning] E u n to optimize the performances.

Parameters	[SVC V] V V C	[FVC] F V C	[U/F VC 5pts] u F 5	[Energy Sav.] n L d
[Motor Standard] b F r	✓	✓	✓	✓
[Nominal Motor Power] n P r	✓	✓	✓	✓
[Nom Motor Voltage] u n 5	✓	✓	✓	✓
[Nom Motor Current] n C r	✓	✓	✓	✓

(1) Encoder settings depend of the encoder used on the application. (see page 536)

Parameters	[SVC V] V V L	[FVC] F V L	[U/F VC 5pts] u F 5	[Energy Sav.] n L d
[Nominal Motor Freq] F r 5	✓	✓	✓	✓
[Nominal Motor Speed] n 5 P	✓	✓	✓	✓
[Encoder Type] u E L P		✓ (1)		
[Encoder supply volt.] u E L V		✓ (1)		
[Encoder usage] E n u		✓ (1)		

(1) Encoder settings depend of the encoder used on the application. (see page 536)

Parameters List for Synchronous or Reluctant Motors

The following table shows the minimum parameters list that needs to be configured for synchronous or reluctant motors depending of [Motor Control Type] L L L selection:

NOTE: After setting these parameters, it is recommended to perform an [Autotuning] L u n to optimize the performances

Parameters	[Sync. mot.] 5 Y n	[Sync.CL] F 5 Y	[SYN_U VC] 5 Y n u	[Rel. Mot.] 5 r V L
[Sync Nominal I] n L r 5	✓	✓	✓	✓
[Nom SyncMotor] Speed n 5 P 5	✓	✓	✓	✓
[Nom Motor torque] t 9 5	✓	✓	✓	✓
[Pole pairs] P P n 5	✓	✓	✓	✓
A[n]gle setting type] R 5 L	✓	✓	✓	✓
[Encoder Type] u E L P		✓ (1)		
[Encoder supply volt.] u E L V		✓ (1)		
[Encoder usage] E n u		✓ (1)		
[Autotuning Type] L u n t				✓ (2)

(1) Encoder settings depend of the encoder used on the application. (see page 536)
 (2) [Autotuning Type] L u n t can be changed to optimize the performances with Reluctant motors.

[Dual Rating] d r t

Dual rating state.

Setting	Code / Value	Description
[Normal Duty]	n o r P R L	Normal rating, drive current limitation is 1.2 In Factory setting
[Heavy Duty]	H i G H	High rating, drive current limitation is 1.5 In

[Motor Control Type] L L L

Motor control type.

NOTE: Select the motor control type before entering parameter values.

Setting	Code / Value	Description
[SVC V]	V V L	Voltage vector control: Open-loop voltage flux vector control with automatic slip compensation according to the load. It supports operation with a number of motors connected in parallel on the same drive (if motors are identical). Factory setting
[FVC]	F V L	Current vector control closed loop: Closed-loop current flux vector control for motors with encoder sensor; this option can be selected if an encoder module has been inserted. NOTE: Verify the encoder (see page 536) before selecting [FVC] F V L.

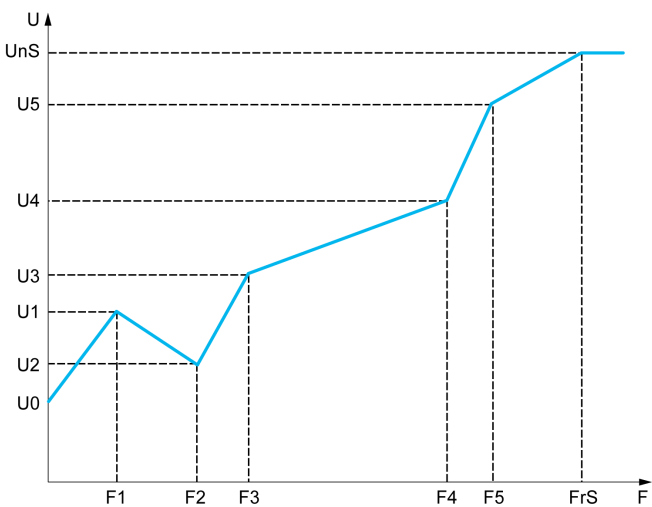
Setting	Code / Value	Description
[U/F VC 5pts]	$\mu F 5$	<p>5-segment V/F profile:</p>  <p>The profile is defined by the values of parameters $u n S$, $F r S$, $u 1$ to $u 5$ and $F 1$ to $F 5$. $F r S > F 5 > F 4 > F 3 > F 2 > F 1$</p> <p>NOTE: U0 is the result of an internal calculation based on motor parameters and multiplied by $\mu F r$ (%). U0 can be adjusted by modifying $\mu F r$ value.</p>
[Sync. mot.]	$S Y n$	Open-loop synchronous motors: Motor control type specific for permanent magnet synchronous motors.
[Energy Sav.]	$n L d$	Specific motor control type optimized for energy saving. This motor control type automatically reduces the drive output current according to the motor load. This automatic current level adaptation allows energy saving for periods when load is kept to a minimum and preserves the drive performance up to full load.
[Sync.CL]	$F 5 Y$	Closed-loop synchronous motor: For permanent magnet synchronous motors, with encoder. This selection is only possible if an encoder module has been inserted. NOTE: Verify the encoder (see page 536) before selecting [Sync.CL] $F 5 Y$.
[SYN_U VC]	$S Y n \mu$	Open-loop synchronous motor: Motor control type specific for permanent magnet synchronous motors. This motor control type is used for variable torque applications.
[Rel. Mot.]	$S r V c$	Synchronous Reluctant Motor: Motor control type for reluctance motors. This motor control type is used for variable torque applications. If the maximum output current of the drive is not equal or greater than the motor current, this will lead to a lack of torque performances. [Stall Monitoring] $S t P C$ function helps to prevent a motor overload by monitoring the motor current and the speed rise time.

[Data] *Π Ε δ* - Menu

Access

[Complete settings] → [Motor parameters] → [Motor data] → [Data]

About This Menu

For synchronous motor parameters. Dedicated parameters can be accessed if [Motor control type] *Λ Ε Ε* is set to:

- [Sync. mot.] *Σ Υ η*, or
- [Sync.CL.] *Φ Σ Υ*, or
- [SYN_U VC] *Σ Υ η υ*, or
- [Rel. Mot.] *Σ ρ V ε*.

⚠ WARNING

LOSS OF CONTROL

- Fully read and understand the manual of the connected motor.
- Verify that all motor parameters are correctly set by referring to the nameplate and the manual of the connected motor.

Failure to follow these instructions can result in death, serious injury, or equipment damage.

This table presents the steps to follow to set and optimize the motor data:

Step	Action
1	Enter the motor nameplate
2	Perform the [Autotuning] <i>Ε υ η</i> operation
3	Adjust [Syn. EMF constant] <i>PH 5</i> to optimize the behavior: <ul style="list-style-type: none"> • Start the motor at minimal stable frequency available on the machine (at minimum load). • Check and note the [% error EMF sync] <i>ρ d R E</i> value: <ul style="list-style-type: none"> ○ If the [% error EMF sync] <i>ρ d R E</i> value is lower than 0%, then [Syn. EMF constant] <i>PH 5</i> may be increased. ○ If the [% error EMF sync] <i>ρ d R E</i> value is upper than 0%, then [Syn. EMF constant] <i>PH 5</i> may be reduced. [% error EMF sync] <i>ρ d R E</i> value should be closed to 0%. • Stop the motor for modify [Syn. EMF constant] <i>PH 5</i> in accordance with the value of the [% error EMF sync] <i>ρ d R E</i> (previously noted).

[Motor Standard] *β F ρ* ★

Motor standard.

This parameter modifies the presets of the following parameters:

- [High Speed] *H 5 P*
- [Motor Freq Thd] *F Ε δ*
- [Nom Motor Voltage] *υ η 5*
- [Nominal Motor Freq] *F ρ 5*
- [Max Frequency] *ε F ρ*

NOTE: The factory setting value is changed to [60 Hz NEMA] for ATV930●●●S6● catalog numbers.

This parameter can be accessed if [Motor control type] *Λ Ε Ε* is not set to:

- [Sync. mot.] *Σ Υ η*, or
- [Sync.CL.] *Φ Σ Υ*, or
- [SYN_U VC] *Σ Υ η υ*, or
- [Rel. Mot.] *Σ ρ V ε*.

Setting	Code / Value	Description
[50 Hz IEC]	<i>5 0</i>	IEC Factory setting
[60 Hz NEMA]	<i>6 0</i>	NEMA

[Nominal Motor Power] nPr ★

Nominal motor power.

This parameter can be accessed if **[Motor control type] CEE** is not set to:

- **[Sync. mot.] SYn** , or
- **[Sync.CL.] $F5Y$** , or
- **[SYN_U VC] $SYnu$** , or
- **[Rel. Mot.] SVc** .

Rated motor power given on the nameplate, in kW if **[Motor Standard] BFr** is set to **[50Hz IEC] SD** , in HP if **[Motor Standard] BFr** is set to **[60Hz NEMA] ED** .

Setting	Description
According to drive rating	– Factory setting: according to the drive rating

[Nom Motor Voltage] $un5$ ★

Nominal motor voltage.

This parameter can be accessed if **[Motor control type] CEE** is not set to:

- **[Sync. mot.] SYn** , or
- **[Sync.CL.] $F5Y$** , or
- **[SYN_U VC] $SYnu$** , or
- **[Rel. Mot.] SVc** .

Rated motor voltage given on the nameplate.

Setting	Description
100...690 Vac	Setting range Factory setting: according to drive rating and [Motor Standard] BFr

[Nom Motor Current] nCr ★

Rated motor current given on the nameplate.

This parameter can be accessed if **[Motor control type] CEE** is not set to:

- **[Sync. mot.] SYn** , or
- **[Sync.CL.] $F5Y$** , or
- **[SYN_U VC] $SYnu$** , or
- **[Rel. Mot.] SVc** .

Setting	Description
0.25...1.5 I_n ⁽¹⁾	Setting range Factory setting: according to drive rating and [Motor Standard] BFr
(1) Corresponding to the rated drive current indicated in the installation manual and on the drive nameplate.	

[Nominal Motor Freq] $Fr5$ ★

Nominal motor frequency.

This parameter can be accessed if **[Motor control type] CEE** is not set to:

- **[Sync. mot.] SYn** , or
- **[Sync.CL.] $F5Y$** , or
- **[SYN_U VC] $SYnu$** , or
- **[Rel. Mot.] SVc** .

The factory setting is 50 Hz, or preset to 60 Hz if **[Motor Standard] BFr** is set to 60 Hz.

Setting	Description
10.0...599.0 Hz	Setting range Factory setting: 50 Hz

[Nominal Motor Speed] $n S P$ ★

Nominal motor speed.

This parameter can be accessed if **[Motor control type] $C E E$** is not set to:

- **[Sync. mot.] $S Y n$** , or
- **[Sync.CL.] $F S Y$** , or
- **[SYN_U VC] $S Y n u$** , or
- **[Rel. Mot.] $S r V c$** .

If the nameplate indicates the synchronous speed and the slip in Hz or as a %, use any 1 of the formulas to calculate the rated speed:

- Nominal speed = Synchronous speed x $\frac{100 - \text{slip as a \%}}{100}$
- Nominal speed = Synchronous speed x $\frac{60 - \text{slip in Hz}}{60}$ (60 Hz motors)
- Nominal speed = Synchronous speed x $\frac{50 - \text{slip in Hz}}{50}$ (50 Hz motors).

Setting	Description
0...65,535 rpm	Setting range Factory setting: according to drive rating

[Motor Param Choice] $n P C$ ★

Motor parameter choice.

This parameter can be accessed if **[Motor control type] $C E E$** is not set to:

- **[Sync. mot.] $S Y n$** , or
- **[Sync.CL.] $F S Y$** , or
- **[SYN_U VC] $S Y n u$** , or
- **[Rel. Mot.] $S r V c$** .

Setting	Code / Value	Description
[Mot Power]	$n P r$	Motor power Factory setting
[Mot Cosinus]	$C o S$	Motor cosinus

[Motor 1 Cosinus Phi] $C o S$ ★

Nominal motor cosinus Phi.

This parameter can be accessed if:

- **[Motor param choice] $n P C$** is set to **[Mot Cosinus] $C o S$** , and if
- **[Motor control type] $C E E$** is not set to:
 - **[Sync. mot.] $S Y n$** , or
 - **[Sync.CL.] $F S Y$** , or
 - **[SYN_U VC] $S Y n u$** , or
 - **[Rel. Mot.] $S r V c$** .

Setting	Description
0.50...1.00	Setting range Factory setting: according to the drive rating

[Nominal motor slip] n_{5L} ★

Motor nominal slip, calculated by the drive.

This is a read-only parameter.

To modify the nominal motor slip, modify the **[Rated motor speed] n_{5P}** .

This parameter can be accessed if:

- **[Access Level] LAC** is set to **[Expert] EPR** , and if
- **[Motor control type] CEE** is not set to:
 - **[Sync. mot.] SYN** , or
 - **[Sync.CL.] $F5Y$** , or
 - **[SYN_UVC] $SYNU$** , or
 - **[Rel. Mot.] $SRVC$** .

Setting	Description
0...6553.5 Hz	Setting range Factory setting: _

[AsyncMotor R Stator] r_{5R} ★

Asynchronous motor stator resistance.

This parameter can be accessed if:

- **[Access Level] LAC** is set to **[Expert] EPR** , and if
- **[Motor control type] CEE** is not set to:
 - **[Sync. mot.] SYN** , or
 - **[Sync.CL.] $F5Y$** , or
 - **[SYN_UVC] $SYNU$** , or
 - **[Rel. Mot.] $SRVC$** .

The factory setting is replaced by the result of the autotuning operation if it has been performed.

Setting	Description
0...65,535 mOhm	Setting range Factory setting: 0 mOhm

[Magnetizing Current] i_{dR} ★

Magnetizing current.

This parameter can be accessed if:

- **[Access Level] LAC** is set to **[Expert] EPR** , and if
- **[Motor control type] CEE** is not set to:
 - **[Sync. mot.] SYN** , or
 - **[Sync.CL.] $F5Y$** , or
 - **[SYN_UVC] $SYNU$** , or
 - **[Rel. Mot.] $SRVC$** .

Setting	Description
0...6,553.5 A	Setting range Factory setting: 0 A

[AsyncMotor Lf Induct] L F A ★

Asynchronous motor leakage inductance.

This parameter can be accessed if:

- **[Access Level] L A C** is set to **[Expert] E P r**, and if
- **[Motor control type] C E E** is not set to:
 - **[Sync. mot.] S Y n**, or
 - **[Sync.CL.] F S Y**, or
 - **[SYN_U VC] S Y n u**, or
 - **[Rel. Mot.] S r V c**.

The factory setting is replaced by the result of the autotuning operation if it has been performed.

Setting	Description
0...655.35 mH	Setting range Factory setting: 0 mH

[Rotor Time Const] L r A ★

Rotor time constant.

This parameter can be accessed if:

- **[Access Level] L A C** is set to **[Expert] E P r**, and if
- **[Motor control type] C E E** is not set to:
 - **[Sync. mot.] S Y n**, or
 - **[Sync.CL.] F S Y**, or
 - **[SYN_U VC] S Y n u**, or
 - **[Rel. Mot.] S r V c**.

Setting	Description
0...65,535 ms	Setting range Factory setting: 0 ms

[Sync Nominal I] n C r S ★

Sync motor nominal current.

This parameter can be accessed if **[Motor control type] C E E** is set to:

- **[Sync. mot.] S Y n**, or
- **[Sync.CL.] F S Y**, or
- **[SYN_U VC] S Y n u**, or
- **[Rel. Mot.] S r V c**.

Setting	Description
0.25...1.5 I _n ⁽¹⁾	Setting range Factory setting: according to the drive rating.
(1) Corresponding to the rated drive current indicated in the installation manual and on the drive nameplate.	

[Nom SyncMotor Speed] n S P S ★

Nominal synchronous motor speed.

This parameter can be accessed if **[Motor control type] C E E** is set to:

- **[Sync. mot.] S Y n**, or
- **[Sync.CL.] F S Y**, or
- **[SYN_U VC] S Y n u**, or
- **[Rel. Mot.] S r V c**.

Setting	Description
0...48,000 rpm	Setting range Factory setting: according to the drive rating.

[Nom Motor torque] $L 9 5$ ★

Nominal motor torque

This parameter can be accessed if **[Motor control type] $C E E$** is set to:

- **[Sync. mot.] $S Y n$** , or
- **[Sync.CL.] $F S Y$** , or
- **[SYN_U VC] $S Y n u$** , or
- **[Rel. Mot.] $S r V c$** .

Setting	Description
0.1...6,553.5 Nm	Setting range. Factory setting: according to the drive rating.

[Pole pairs] $P P n 5$ ★

Pole pairs.

This parameter can be accessed if **[Motor control type] $C E E$** is set to:

- **[Sync. mot.] $S Y n$** , or
- **[Sync.CL.] $F S Y$** , or
- **[SYN_U VC] $S Y n u$** , or
- **[Rel. Mot.] $S r V c$** .

Setting	Description
1...50	Setting range Factory setting: according to the drive rating.

[Angle setting type] $P 5 E$ ★

Automatic angle setting type.

This parameter can be accessed if **[Motor control type] $C E E$** is set to:

- **[Sync. mot.] $S Y n$** , or
- **[Sync.CL.] $F S Y$** , or
- **[SYN_U VC] $S Y n u$** , or
- **[Rel. Mot.] $S r V c$** .

[PSI align] $P 5 i$ and **[PSIO align] $P 5 i o$** are working for all types of synchronous motors. **[SPM align] $S P n A$** and **[IPM align] $i P n A$** increase performances depending on the type of synchronous motor.

[Rotational Current Injection] $r C i$, may be used where **[PSI align] $P 5 i$** and **[PSIO align] $P 5 i o$** do not give expected performances.

Setting	Code / Value	Description
[IPM align]	$i P n A$	Alignment for IPM motor. Alignment mode for Interior-buried Permanent Magnet motor (usually, this kind of motor has a high saliency level). It uses high frequency injection, which is less noisy than standard alignment mode.
[SPM align]	$S P n A$	Alignment for SPM motor. Mode for Surface-mounted Permanent Magnet motor (usually, this kind of motor has a medium or low saliency level). It uses high frequency injection, which is less noisy than standard alignment mode.
[PSI align]	$P 5 i$	Pulse signal injection. Standard alignment mode, without rotor motion The angle measurement is realized by monitoring the stator current response to a pulse signal injection over a wide range of frequencies
[PSIO align]	$P 5 i o$	Pulse signal injection - optimized. Optimized alignment mode, without rotor motion Same operation as [PSI align] $P 5 i$, is performed over an optimized range of frequencies The measurement time is reduced after the first run order or tune operation, even if the drive has been turned off Factory setting

Setting	Code / Value	Description
[Rotational Current Injection]	r C i	Rotational current injection. Alignment mode with rotor motion. This alignment mode realizes the mechanical alignment of the rotor and the stator; it requires up to 4 s. The motor needs to be stopped and without resistive torque. NOTE: This setting is recommended when a sinus filter is used on the application. NOTE: For synchronous reluctance motor, it is recommended to use this setting.
[No align]	n a	No alignment

[Syn. EMF constant] P H 5 ★

Synchronous motor EMF constant

This parameter can be accessed if [Motor control type] C E E is set to:

- [Sync. mot.] 5 Y n, or
- [Sync.CL.] F 5 Y, or
- [SYN_U VC] 5 Y n u.

P H 5 adjustment allows you to reduce the current in operation without load.

Setting	Description
0...6,553.5 mV/rpm	Setting range Factory setting: 0 mV/rpm

[SyncMotor Stator R] r 5 R 5 ★

Calculated synchronous motor stator R.

Cold state stator resistance (per winding). The factory setting is replaced by the result of the tuning operation if it has been performed.

This parameter can be accessed if:

- [Access Level] L R C is set to [Expert] E P r, and if
- [Motor control type] C E E is set to:
 - [Sync. mot.] 5 Y n, or
 - [Sync.CL.] F 5 Y, or
 - [SYN_U VC] 5 Y n u, or
 - [Rel. Mot.] 5 r V c.

You can enter the value if you know it.

Setting (°)	Description
0...65,535 mOhm	Setting range Factory setting: 0 mOhm

[Autotune L d-axis] L d 5 ★

Autotune L d-axis.

Axis "d" stator inductance in mH (per phase).

This parameter can be accessed if:

- [Access Level] L R C is set to [Expert] E P r, and if
- [Motor control type] C E E is set to:
 - [Sync. mot.] 5 Y n, or
 - [Sync.CL.] F 5 Y, or
 - [SYN_U VC] 5 Y n u, or
 - [Rel. Mot.] 5 r V c.

On motors with smooth poles [Autotune L d-axis] L d 5 = [Autotune L q-axis] L q 5 = Stator inductance L.

The factory setting is replaced by the result of the autotuning operation if it has been performed.

Setting	Description
0...655.35 mH	Setting range Factory setting: 0

[Autotune L q-axis] L 9 5 ★

Autotune L q-axis.

Axis "q" stator inductance in mH (per phase).

This parameter can be accessed if:

- **[Access Level] L A C** is set to **[Expert] E P r**, and if
- **[Motor control type] C E E** is set to:
 - **[Sync. mot.] S Y n**, or
 - **[Sync.CL.] F S Y**, or
 - **[SYN_U VC] S Y n u**, or
 - **[Rel. Mot.] S r V c**.

On motors with smooth poles **[Autotune L d-axis] L d 5** = **[Autotune L q-axis] L 9 5** = Stator inductance L.

The factory setting is replaced by the result of the autotuning operation if it has been performed.

Setting	Description
0...655.35 mH	Setting range Factory setting: 0

[Sync Nominal Freq] F r 5 5 ★

Synchronous motor nominal frequency.

Nominal motor frequency for synchronous motor in Hz unit. Automatically updated according to **[Nom SyncMotor Speed] n 5 P 5** and **[Pole pairs] P P n 5** data.

This parameter can be accessed if:

- **[Access Level] L A C** is set to **[Expert] E P r**, and if
- **[Motor control type] C E E** is set to:
 - **[Sync. mot.] S Y n**, or
 - **[Sync.CL.] F S Y**, or
 - **[SYN_U VC] S Y n u**, or
 - **[Rel. Mot.] S r V c**.

Setting (°)	Description
10.0...599.0 Hz	Setting range Factory setting: $n 5 P 5 \times P P n 5 / 60$

[PSI Align Curr Max] n C r ★

Maximum current of PSI alignment.

Current level in % of **[Sync Nominal I] n C r 5** for **[PSI align] P 5**, and **[PSI Oalign] P 5**, α angle shift measurement modes. This parameter has an impact on the inductor measurement.

This parameter can be accessed if:

- **[Access Level] L A C** is set to **[Expert] E P r**, and if
- **[Motor control type] C E E** is set to:
 - **[Sync. mot.] S Y n**, or
 - **[Sync.CL.] F S Y**, or
 - **[SYN_U VC] S Y n u**, or
 - **[Rel. Mot.] S r V c**.

This current must be equal to or higher than the maximum current level of the application; otherwise an instability may occur.

If **[PSI Align Curr Max] n C r** is set to **[AUTO] R u t o**, **[PSI Align Curr Max] n C r** is adapted by the drive according to the motor data settings.

Setting	Description
[AUTO] R u t o ...300%	Setting range Factory setting: [AUTO] R u t o

NOTE: In case of instability, **[PSI Align Curr Max] n C r** should be increased by steps up to obtain the requested performances.

[Current Filter Time] *C r t F* ★

Filter time of the current.

This parameter can be accessed if **[Access Level] *L A C*** is set to **[Expert] *E P r***.

Setting	Description
[AUTO] <i>A u t o</i> ...100.0 ms	Setting range Factory setting: [AUTO] <i>A u t o</i>

[Currents Filter] *C r F A* ★

Internal currents filter time.

This parameter can be accessed if **[Access Level] *L A C*** is set to **[Expert] *E P r***.

Setting (°)	Description
0.0...100.0 ms	Setting range Factory setting: According to drive rating

[% error EMF sync] *r d A E* ★

Ratio D-axis current.

This parameter can be accessed if **[Motor control type] *C t t*** is set to:

- **[Sync. mot.] *S Y n***, or
- **[Sync.CL.] *F S Y***, or
- **[SYN_U VC] *S Y n u***.

Use **[% error EMF sync] *r d A E*** to adjust **[Syn. EMF constant] *P H 5***, **[% error EMF sync] *r d A E*** should be closed to 0%.

If the **[% error EMF sync] *r d A E*** value is:

- Lower than 0%: **[Syn. EMF constant] *P H 5*** may be increased.
- Upper than 0%: **[Syn. EMF constant] *P H 5*** may be reduced.

For the all steps to follow to optimize the synchronous motor settings (*see page 166*).

Setting	Description
0.0...6,553.5%	Setting range Factory setting: –

[Angle test setting] *P5A* - Menu

Access

[Complete settings] → [Motor parameters] → [Motor data] → [Angle test setting]

About This Menu

For synchronous motor parameters.

This menu can be accessed if [Motor control type] *CLL* is set to:

- [Sync.CL.] *F5Y*.

And if an encoder option module has been inserted.

[Angle setting type] *P5L* ★

Auto angle setting type.

This parameter can be accessed if [Motor Control Type] *CLL* is set to:

- [Sync. mot.] *SYn*, or
- [Sync.CL] *F5Y*, or
- [SYN_UVC] *SYnU*, or
- [Rel. Mot.] *SVL*.

[PSI align] *P5i*, and [PSIO align] *P5io* are working for all types of synchronous motors. [SPM align] *SPnA* and [IPM align] *iPnA* increase performances depending on the type of synchronous motor.

[Rotational Current Injection] *rLi*, may be used where [PSI align] *P5i*, and [PSIO align] *P5io* do not give expected performances.

Setting	Code / Value	Description
[IPM align]	<i>iPnA</i>	Alignment for IPM motor. Alignment mode for Interior-buried Permanent Magnet motor (usually, this kind of motor has a high saliency level). It uses high frequency injection, which is less noisy than standard alignment mode.
[SPM align]	<i>SPnA</i>	Alignment for SPM motor. Mode for Surface-mounted Permanent Magnet motor (usually, this kind of motor has a medium or low saliency level). It uses high frequency injection, which is less noisy than standard alignment mode.
[PSI align]	<i>P5i</i>	Pulse signal injection. Standard alignment mode, without rotor motion The angle measurement is realized by monitoring the stator current response to a pulse signal injection over a wide range of frequencies
[PSIO align]	<i>P5io</i>	Pulse signal injection - optimized. Optimized alignment mode, without rotor motion Same operation as [PSI align] <i>P5i</i> , is performed over an optimized range of frequencies The measurement time is reduced after the first run order or tune operation, even if the drive has been turned off Factory setting
[Rotational Current Injection]	<i>rLi</i>	Rotational current injection. Alignment mode with rotor motion. This alignment mode realizes the mechanical alignment of the rotor and the stator; it requires up to 4 s. The motor needs to be stopped and without resistive torque. NOTE: This setting is recommended when a sinus filter is used on the application. NOTE: For synchronous reluctant motor, it is recommended to use this setting.
[No align]	<i>nA</i>	No alignment

[Angle auto-test] # 5 #

Angle setting.

Setting	Code / Value	Description
[No]	n o	Auto angle setting is not done Factory setting
[Yes]	y e s	Auto angle setting is requested.
[Done]	d o n e	Auto angle setting is done.

[Angle Test Assign] # 5 L

Auto angle setting activation by logic signal.

Setting	Code / Value	Description
[Not Assigned]	n o	Not assigned Factory setting
[DI1]...[DI8]	L , I ... L , B	Digital input DI1...DI8
[DI11]...[DI16]	L , I I ... L , I B	Digital input DI11...DI16 if VW3A3203 I/O extension module has been inserted
[CD00]...[CD10]	C d 0 0 ... C d 1 0	Virtual digital input CMD.0...CMD.10 in [I/O profile] , o configuration
[CD11]...[CD15]	C d 1 1 ... C d 1 5	Virtual digital input CMD.11...CMD.15 regardless of configuration
[C101]...[C110]	C 1 0 1 ... C 1 1 0	Virtual digital input CMD1.01...CMD1.10 with integrated Modbus Serial in [I/O profile] , o configuration
[C111]...[C115]	C 1 1 1 ... C 1 1 5	Virtual digital input CMD1.11...CMD1.15 with integrated Modbus Serial regardless of configuration
[C201]...[C210]	C 2 0 1 ... C 2 1 0	Virtual digital input CMD2.01...CMD2.10 with CANopen® fieldbus module in [I/O profile] , o configuration
[C211]...[C215]	C 2 1 1 ... C 2 1 5	Virtual digital input CMD2.11...CMD2.15 with CANopen® fieldbus module regardless of configuration
[C301]...[C310]	C 3 0 1 ... C 3 1 0	Virtual digital input CMD3.01...CMD3.10 with a fieldbus module in [I/O profile] , o configuration
[C311]...[C315]	C 3 1 1 ... C 3 1 5	Virtual digital input CMD3.11...CMD3.15 with a fieldbus module regardless of configuration
[C501]...[C510]	C 5 0 1 ... C 5 1 0	Virtual digital input CMD5.01...CMD5.10 with integrated Ethernet in [I/O profile] , o configuration
[C511]...[C515]	C 5 1 1 ... C 5 1 5	Virtual digital input CMD5.11...CMD5.15 with integrated Ethernet regardless of configuration

NOTE: If a **line contactor** function has been configured, the contactor closes during measurement.

[Angle setting Mode] # 6 #

Automatic auto angle setting activation.

Setting	Code / Value	Description
[No]	n o	Automatic auto angle setting is not activated
[Run Command]	R u n c o m m a n d	Auto angle setting launched at run command if the drive is not aligned state. Factory setting

[Angle offset value] # 5 V

Auto angle setting value.

Phase-shift angle between the motor and the encoder. 8192 corresponds to 360°.

Setting	Description
[No]...8192	Automatic auto angle setting value Factory setting: [No] n o

[Angle setting status] *A S E S*

Auto angle setting status.

Setting	Code / Value	Description
[Not done]	<i>E R b</i>	Angle setting value is not defined Factory setting
[Pending]	<i>P E n d</i>	Angle setting is in waiting state
[In progress]	<i>P r o G</i>	Angle setting function is in progress
[Error]	<i>F R , L</i>	Angle Setting function failed
[Done]	<i>d o n E</i>	Angle function is OK
[Custom Value]	<i>C u S</i>	The phase-shift angle value has been entered by the user via the display terminal or serial Link

[Motor tune] *M T u - Menu***Access**

[Complete settings] → [Motor parameters] → [Motor data] → [Motor tune]

[Autotuning] *A u n* **⚠ WARNING****UNEXPECTED MOVEMENT**

Autotuning moves the motor in order to tune the control loops.

- Only start the system if there are no persons or obstructions in the zone of operation.

Failure to follow these instructions can result in death, serious injury, or equipment damage.

During autotuning, noise development and oscillations of the system are normal.

If [Autotuning Type] *A u n t* is set to [Standard] *S e d*, during autotuning, the motor makes small movements.

If [Autotuning Type] *A u n t* is set to [Rotation] *r o t*, during autotuning, the motor runs at half of its nominal frequency.

In any case, the motor has to be stopped before performing a tune operation. Verify that the application does not make the motor turn during the tune operation.

If [Motor control type] *C t t* is set to [Rel. Mot.] *S r v C*, the drive operates the mechanical alignment of the motor ([Angle setting type] *A S E* set to [Rotational Current Injection] *r C i*) prior to start the autotuning.

The tune operation optimizes:

- The motor performances at low speed.
- The estimation of the motor torque.
- The accuracy of the estimation of the process values in sensorless operation and monitoring.

Autotuning is only performed if no stop command has been activated. If a “freewheel stop” or “fast stop” function has been assigned to a digital input, this input must be set to 1 (active at 0).

Autotuning takes priority over any run or prefluxing commands, which will be taken into account after the autotuning sequence.

If autotuning has detected an error, the drive always displays [No action] *n o* and, depending on the configuration of [Tuning Error Resp] *t e n L*, may switch to [Autotuning] *A u n* detected error mode.

Autotuning may last for several seconds. Do not interrupt the process. Wait for the Graphic Display Terminal to change to [No action] *n o*.

NOTE: The motor thermal state has a significant influence on the tuning result. Always perform a motor tuning with the motor stopped and cold. Verify that the application does not have the motor operate during a tuning operation.

To redo a motor tuning, wait that it is stopped and cold. Set first [Autotuning] *A u n* to [Erase Autotuning] *C L r*, then redo the motor tuning.

The use of the motor autotuning without doing a **[Erase Autotuning]** *CLr* first is used to get the thermal state estimation of the motor.

The cable length has an influence on the tune result. If the wiring is modified, it is necessary to redo the tune operation.

Setting ()	Code / Value	Description
[No action]	<i>no</i>	Autotuning not in progress Factory setting
[Apply Autotuning]	<i>YES</i>	Autotuning is performed immediately if possible, then the parameter automatically changes to [No action] <i>no</i> . If the drive state does not allow the tune operation immediately, the parameter changes to [No] <i>no</i> and the operation must be done again.
[Erase Autotuning]	<i>CLr</i>	The motor parameters measured by the autotuning function are reset. The default motor parameter values are used to control the motor. [Autotuning Status] <i>ETS</i> is set to [Not done] <i>TRb</i> .

[Autotuning Status] *ETS*

Autotuning status.

This parameter is not saved at drive power-off. It shows the autotuning status since the last power-on (for information only, cannot be modified).

Setting ()	Code / Value	Description
[Not done]	<i>TRb</i>	The autotuning is not done Factory setting
[Pending]	<i>PEND</i>	The autotuning has been requested but not yet performed
[In Progress]	<i>PROG</i>	The autotuning is in progress
[Error]	<i>FRIL</i>	The autotuning has detected an error
[Done]	<i>done</i>	The motor parameters measured by the autotuning function are used to control the motor

[Auto tuning usage] *ETNU* ★

Auto tune usage.

This parameter shows the way used to modify the motor parameters according to its estimated thermal state.

This parameter can be accessed if **[Access Level]** *LRl* is set to **[Expert]** *EP r*.

Setting ()	Code / Value	Description
[No]	<i>no</i>	No thermal state estimation Factory setting
[Therm Mot]	<i>EN</i>	Statoric thermal state estimation based on nominal current and current consumed by the motor.

[Tuning Error Resp] *ENL* ★

Response to autotune error.

This parameter can be accessed if **[Access Level]** *LRl* is set to **[Expert]** *EP r*.

Setting	Code / Value	Description
[Ignore]	<i>no</i>	Detected error ignored
[Freewheel Stop]	<i>YES</i>	Freewheel stop Factory setting

[Autotuning Assign] E U L ★

Autotuning input assignment.

The autotuning is performed when the assigned input or bit changes to 1.

This parameter can be accessed if **[Access Level] L H C** is set to **[Expert] E P r**.

NOTE: The autotuning causes the motor to start up.

Setting	Code / Value	Description
[Not Assigned]	n o	Not assigned Factory setting
[DI1]...[DI8]	L , I ... L , B	Digital input DI1...DI8
[DI11]...[DI16]	L , I I ... L , I B	Digital input DI11...DI16 if VW3A3203 I/O extension module has been inserted
[CD00]...[CD10]	C d 0 0 ... C d 1 0	Virtual digital input CMD.0...CMD.10 in [I/O profile] , o configuration
[CD11]...[CD15]	C d 1 1 ... C d 1 5	Virtual digital input CMD.11...CMD.15 regardless of configuration
[C101]...[C110]	C 1 0 1 ... C 1 1 0	Virtual digital input CMD1.01...CMD1.10 with integrated Modbus Serial in [I/O profile] , o configuration
[C111]...[C115]	C 1 1 1 ... C 1 1 5	Virtual digital input CMD1.11...CMD1.15 with integrated Modbus Serial regardless of configuration
[C201]...[C210]	C 2 0 1 ... C 2 1 0	Virtual digital input CMD2.01...CMD2.10 with CANopen® fieldbus module in [I/O profile] , o configuration
[C211]...[C215]	C 2 1 1 ... C 2 1 5	Virtual digital input CMD2.11...CMD2.15 with CANopen® fieldbus module regardless of configuration
[C301]...[C310]	C 3 0 1 ... C 3 1 0	Virtual digital input CMD3.01...CMD3.10 with a fieldbus module in [I/O profile] , o configuration
[C311]...[C315]	C 3 1 1 ... C 3 1 5	Virtual digital input CMD3.11...CMD3.15 with a fieldbus module regardless of configuration
[C501]...[C510]	C 5 0 1 ... C 5 1 0	Virtual digital input CMD5.01...CMD5.10 with integrated Ethernet in [I/O profile] , o configuration
[C511]...[C515]	C 5 1 1 ... C 5 1 5	Virtual digital input CMD5.11...CMD5.15 with integrated Ethernet regardless of configuration

[Autotuning Type] E U n t ★

Autotuning type.

This parameter can be accessed if:

- **[Access Level] L H C** is set to **[Expert] E P r**, and
- **[Motor control type] C t t** is set to **[Rel. Mot.] S r v C**.

Setting ()	Code / Value	Description
[Standard]	S t d	Standard autotune Factory setting
[Rotation]	r o t	Autotune in rotation. This selection can be used for: <ul style="list-style-type: none"> • Optimization of energy saving • Application with low inertia • Application that requires high motor control performances. With this selection, less than 30% of resistive load must be present on the application to optimize the autotuning result. During the autotune sequence, the motor will be started to half of its nominal frequency during maximum 45 seconds.

[Automatic autotune] *AUT* ★ 

Automatic autotune.

⚠ WARNING
UNEXPECTED MOVEMENT
If this function is activated, autotuning is performed each time the drive is switched on.
<ul style="list-style-type: none"> • Verify that activating this function does not result in unsafe conditions.
Failure to follow these instructions can result in death, serious injury, or equipment damage.

The motor must be stopped when switching on the drive.

This parameter can be accessed if [Access Level] *LAC* is set to [Expert] *EP*.

Setting ()	Code / Value	Description
[No]	<i>no</i>	Function deactivated Factory setting
[Yes]	<i>YES</i>	A tuning is automatically done at each power-up

[Tune Selection] *SEUN* ★

Tune selection.

Setting ()	Code / Value	Description
[Default]	<i>fab</i>	The default motor parameter values are used to control the motor Factory setting
[Measure]	<i>NEAS</i>	The values measured by the autotuning function are used to control the motor
[Custom]	<i>cus</i>	The values manually set are used to control the motor

[Saliency mot. state] *SNST* ★

Information on synchronous motor saliency.

This parameter can be accessed if :

- [Access Level] *LAC* is set to [Expert] *EP*, and
- [Tune Selection] *SEUN* is set to [Measure] *NEAS*, and
- [Motor control type] *CLT* is set to:
 - [Sync. mot.] *SYN*, or
 - [Sync.CL.] *FSY*, or
 - [SYN_UVC] *SYNU*, or
 - [Rel. Mot.] *SRV*.

This parameter helps to optimization of motor control performances for synchronous motors.

Setting	Code / Value	Description
[No]	<i>no</i>	Tune not done
[Low salient]	<i>LLS</i>	[Low saliency level. Recommended configuration: [Angle setting type] <i>AST</i> = [PSI align] <i>PSI</i> , or [PSIO align] <i>PSIO</i> and [HF inj. activation] <i>HFI</i> = [No] <i>no</i>
[Med salient]	<i>MLS</i>	Medium saliency level. [Angle setting type] <i>AST</i> = [SPM align] <i>SPM</i> and [HF inj. activation] <i>HFI</i> = [Yes] <i>YES</i> can be used to improve performances
[High salient]	<i>HLS</i>	High saliency level. [Angle setting type] <i>AST</i> = [IPM align] <i>IPM</i> and [HF inj. activation] <i>HFI</i> = [Yes] <i>YES</i> can be used to improve performances.

[Autotuning Lvl Of Current] $\tau C r$ ★

Tune current ratio.

This parameter can be accessed if **[Access Level] $L A C$** is set to **[Expert] $E P r$** .

This parameter shows the level of current applied to the motor during auto tuning, in percent of the drive nominal current.

This parameter has an impact on the inductor measurement.

Setting	Description
[Auto] $A u t o$...300%	Factory setting: [Auto] $A u t o$

[Angle setting type] $A S t$ ★

Automatic angle setting type.

This parameter can be accessed if **[Motor control type] $C t t$** is set to:

- **[Sync. mot.] $S Y n$** , or
- **[Sync.CL.] $F S Y$** , or
- **[SYN_U VC] $S Y n u$** , or
- **[Rel. Mot.] $S r V C$** .

[PSI align] $P S i$, and **[PSIO align] $P S i o$** are working for all types of synchronous motors. **[SPM align] $S P n A$** and **[IPM align] $i P n A$** increase performances depending on the type of synchronous motor.

[Rotational Current Injection] $r C i$, may be used where **[PSI align] $P S i$** , and **[PSIO align] $P S i o$** do not give expected performances.

Setting	Code / Value	Description
[IPM align]	$i P n A$	Alignment for IPM motor. Alignment mode for Interior-buried Permanent Magnet motor (usually, this kind of motor has a high saliency level). It uses high frequency injection, which is less noisy than standard alignment mode.
[SPM align]	$S P n A$	Alignment for SPM motor. Mode for Surface-mounted Permanent Magnet motor (usually, this kind of motor has a medium or low saliency level). It uses high frequency injection, which is less noisy than standard alignment mode.
[PSI align]	$P S i$	Pulse signal injection. Standard alignment mode, without rotor motion The angle measurement is realized by monitoring the stator current response to a pulse signal injection over a wide range of frequencies
[PSIO align]	$P S i o$	Pulse signal injection - optimized. Optimized alignment mode, without rotor motion Same operation as [PSI align] $P S i$, is performed over an optimized range of frequencies The measurement time is reduced after the first run order or tune operation, even if the drive has been turned off Factory setting
[Rotational Current Injection]	$r C i$	Rotational current injection. Alignment mode with rotor motion. This alignment mode realizes the mechanical alignment of the rotor and the stator; it requires up to 4 s. The motor needs to be stopped and without resistive torque. NOTE: This setting is recommended when a sinus filter is used on the application. NOTE: For synchronous reluctant motor, it is recommended to use this setting.
[No align]	$n o$	No alignment

[PSI Align Curr Max] $\pi C r$ ★

Maximum current of PSI alignment.

Current level in % of [Sync Nominal I] $n C r 5$ for [PSI align] $P 5$, and [PSI Oalign] $P 5$, α angle shift measurement modes. This parameter has an impact on the inductor measurement.

This parameter can be accessed if:

- [Access Level] $L A C$ is set to [Expert] $E P r$, and if
- [Motor control type] $C E E$ is set to:
 - [Sync. mot.] $S Y n$, or
 - [Sync.CL.] $F S Y$, or
 - [SYN_U VC] $S Y n u$, or
 - [Rel. Mot.] $S r V c$.

This current must be equal to or higher than the maximum current level of the application; otherwise an instability may occur.

If [PSI Align Curr Max] $\pi C r$ is set to [AUTO] $A u t o$, [PSI Align Curr Max] $\pi C r$ is adapted by the drive according to the motor data settings.

Setting	Description
[AUTO] $A u t o$...300%	Setting range Factory setting: [AUTO] $A u t o$

[Rotational Current Level] $r C L$ ★

Rotational current level.

This parameter can be accessed if [Angle setting type] $A S E$ is set to [Rotational Current Injection] $r C i$.

The current level should be set according to the torque required during the alignment operation.

Setting	Description
10...300%	Setting range, as a percentage of the nominal motor current Factory setting: 75%

[Rotational Torque Current] $r E C$ ★

Rotational torque current.

This parameter can be accessed if:

- [Access Level] $L A C$ is set to [Expert] $E P r$, and if
- [Angle setting type] $A S E$ is set to [Rotational Current Injection] $r C i$, and if
- [Motor control type] $C E E$ is not set to:
 - [Sync. mot.] $S Y n$, or
 - [Sync.CL.] $F S Y$, or
 - [SYN_U VC] $S Y n u$.

Setting	Description
0...300%	Setting range Factory setting: 0%

[RCI Max Freq] r C 5 P ★

RCI maximum output frequency.

This parameter can be accessed if:

- **[Access Level] L A C** is set to **[Expert] E P r**, and if
- **[Angle setting type] A S E** is set to **[Rotational Current Injection] r C i**, and if
- **[Motor control type] C E E** is not set to:
 - **[Sync. mot.] S Y n**, or
 - **[Sync.CL.] F S Y**, or
 - **[SYN_U VC] S Y n u**.

Setting	Description
[AUTO] A u t o ...599.0 Hz	Setting range Factory setting: [AUTO] A u t o

[RCI Round Nb] r C r P ★

RCI round number.

This parameter can be accessed if:

- **[Access Level] L A C** is set to **[Expert] E P r**, and if
- **[Angle setting type] A S E** is set to **[Rotational Current Injection] r C i**, and if
- **[Motor control type] C E E** is not set to:
 - **[Sync. mot.] S Y n**, or
 - **[SYN_U VC] S Y n u**.

Setting	Description
[AUTO] A u t o ...32767	Setting range Factory setting: [AUTO] A u t o

[RCI With Transformer] r C i r ★

RCI alignment with transformer.

This parameter can be accessed if:

- **[Access Level] L A C** is set to **[Expert] E P r**, and if
 - **[Angle setting type] A S E** is set to **[Rotational Current Injection] r C i**
- **[Motor control type] C E E** is set to:
 - **[Sync. mot.] S Y n**, or
 - **[SYN_U VC] S Y n u**, or
 - **[Sync.CL.] F S Y**, or
 - **[Rel. Mot.] S r V C**.

Setting	Code / Value	Description
[No]	n o	Function inactive Factory setting
[Yes]	Y E S	Function active

[Motor monitoring] $\Pi \square P$ - Menu**Access**

[Complete settings] → [Motor parameters] → [Motor monitoring]

[Motor Th Current] $, \text{L H}$

Motor thermal monitoring current to be set to the rated current indicated on the nameplate.

Setting ()	Description
0.2...1.5 In ⁽¹⁾	Setting range Factory setting: According to drive rating
(1) Corresponding to the rated drive current indicated in the installation manual and on the drive nameplate.	

[Motor Thermal Mode] L H L

Motor thermal monitoring mode.

NOTE: An error is detected when the thermal state reaches 118% of the rated state and reactivation occurs when the state falls back below 100%.

Setting	Code / Value	Description
[No]	$n \square$	No thermal monitoring
[Self cooled]	$F \text{L L}$	Self ventilated motor Factory setting
[Force-cool]	$F \text{L L}$	Fan-cooled motor

[MotorTemp ErrorResp] $\square \text{L L}$

Overload error response.

Setting	Code / Value	Description
[Ignore]	$n \square$	Detected error ignored
[Freewheel Stop]	$Y \text{E S}$	Free wheel Factory setting

[Thermal monitoring] *É P P* - Menu

Access

[Complete settings] → [Motor parameters] → [Motor monitoring] → [Thermal monitoring]

About This Menu

The thermal monitoring function helps to prevent against high temperature by monitoring the real temperature by the drive.

PTC, PT100, PT1000, and KTY84 thermal probes are supported by this function.

The function gives the possibility to manage 2 levels of monitoring:

- A Warning level: the drive triggers an event without stopping the application.
- An Error level: the drive triggers an event and stops the application.

The thermal probe is monitored for the following detected error:

- Overheating
- Probe break (loss of signal)
- Probe short-circuit

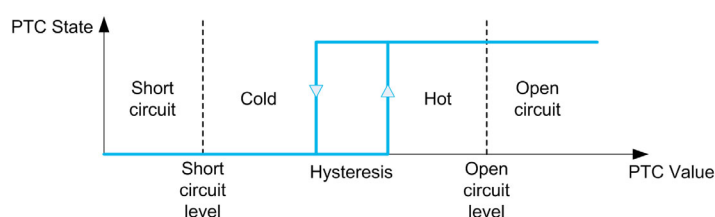

NOTE: AI1, AI3, AI4, AI5 and dedicated input of encoder modules can be configured for thermal monitoring.

Activation

[Alx Th Monitoring] *É H X 5* allows you to activate the thermal monitoring on the related analog input:

- [No] *no*: the function is disabled
- [Yes] *YE 5*: the thermal monitoring is enabled on the related Alx.

Type of Thermal Probe Selection

[Alx Type] *É X É* allows you to select the type of thermal sensor(s) connected on the related analog input:

- [No] *no*: no sensor
- [PTC Management] *É É É*: one to six PTC (in serial) is used
- [KTY] *É É É*: 1 KTY84 is used
- [PT100] *É É É*: 1 PT100 connected with two wires is used
- [PT1000] *É É É*: 1 PT1000 connected with two wires is used
- [PT100 in 3 wires] *É É É É*: 1 PT100 connected with three wires is used (AI4 & AI5 only)
- [PT1000 in 3 wires] *É É É É*: 1 PT1000 connected with three wires is used (AI4 & AI5 only)
- [3 PT100 in 3 wires] *É É É É É*: 3 PT100 connected with three wires is used (AI4 & AI5 only)
- [3 PT1000 in 3 wires] *É É É É É*: 3 PT1000 connected with three wires is used (AI4 & AI5 only)

2-wire thermal probes are supported on analog input 2 to analog input 5.

Wiring for PT100 and PT1000 Probes

For 2-wire probes, the following wirings are possible:

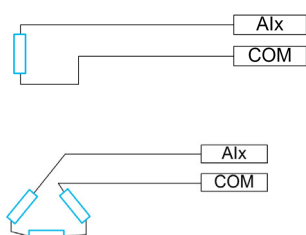

[AI1 Th Monitoring] E H I S

Activation of the thermal monitoring on AI1.

Setting	Code / Value	Description
[No]	n o	No Factory setting
[Yes]	Y E S	Yes

[AI1 Type] R , I E ★

AI1 assignment.

This parameter can be accessed if **[AI1 Th Monitoring] E H I S** is not set to **[No] n o**.

Setting	Code / Value	Description
[Voltage]	I D u	0-10 Vdc Factory setting
[Current]	D R	0-20 mA

[AI1 Th Error Resp] E H I b ★

Thermal monitoring response to a detected error for AI1.

This parameter can be accessed if **[AI1 Type] R , I E** is not set to

- **[Voltage] I D u**, or
- **[Current] D R**.

Setting	Code / Value	Description
[Ignore]	n o	Detected error ignored
[Freewheel Stop]	Y E S	Freewheel stop
[Per STT]	S E E	Stop according to [Type of stop] S E E parameter but without an error triggered after stop
[Fallback Speed]	L F F	Change to fallback speed, maintained as long as the detected error persists and the command has not been removed ⁽¹⁾
[Ramp stop]	r P P	Stop on ramp Factory setting

1 Because, in this case, the detected error does not trigger a stop, it is recommended to assign a relay or logic output to its indication.

[AI1 Th Error Level] E H I F ★

Error detection level for AI1.

This parameter can be accessed if **[AI1 Type] R , I E** is not set to:

- **[Voltage] I D u**, or
- **[Current] D R**, or
- **[PTC Management] P E C**.

Setting (°)	Description
-15.0...200.0°C	Setting range Factory setting: 110.0°C

[AI1 Th Warn Level] E H I R ★

Warning level for AI1.

This parameter can be accessed if **[AI1 Type] R , I E** is not set to:

- **[Voltage] I D U**, or
- **[Current] D R**, or
- **[PTC Management] P E L**.

Setting ()	Description
-15.0...200.0°C	Setting range Factory setting: 90.0°C

[AI1 Th Value] E H I V ★

AI1 thermal value.

This parameter can be accessed if **[AI1 Type] R , I E** is not set to:

- **[Voltage] I D U**, or
- **[Current] D R**, or
- **[PTC Management] P E L**.

Setting	Description
-15.0...200.0°C	Setting range Factory setting: _

[AI3 Th Monitoring] E H E S

Activation of the thermal monitoring on AI3.

Setting	Code / Value	Description
[No]	n o	No Factory setting
[YES]	y e s	Yes

[AI3 Type] R , E E ★

AI3 assignment.

This parameter can be accessed if **[AI3 Th Monitoring] E H E S** is not set to **[No] n o**.

Identical to **[AI1 Type] R , I E** (*see page 186*) with factory setting: **[Current] D R**.

[AI3 Th Error Resp] E H E B ★

Thermal monitoring response to a detected error for AI3.

This parameter can be accessed if **[AI3 Type] R , E E** is not set to:

- **[Voltage] I D U**, or
- **[Current] D R**, or

Setting	Code / Value	Description
[Ignore]	n o	Detected error ignored
[Freewheel Stop]	y e s	Freewheel stop
[Per STT]	s e t	Stop according to [Type of stop] S E E parameter but without an error triggered after stop
[Fallback Speed]	L F F	Change to fallback speed, maintained as long as the detected error persists and the command has not been removed ⁽¹⁾
[Ramp stop]	r a m p	Stop on ramp Factory setting

1 Because, in this case, the detected error does not trigger a stop, it is recommended to assign a relay or logic output to its indication.

[AI3 Th Error Level] E H 3 F ★

Error detection level for AI3.

This parameter can be accessed if [AI3 Type] R , 3 E is not set to:

- [Voltage] I D u , or
- [Current] D R , or
- [PTC Management] P E C .

Setting ()	Description
-15.0...200.0°C	Setting range Factory setting: 110.0°C

[AI3 Th Warn Level] E H 3 R ★

Warning level for AI3.

This parameter can be accessed if [AI3 Type] R , 3 E is not set to:

- [Voltage] I D u , or
- [Current] D R , or
- [PTC Management] P E C .

Setting ()	Description
-15.0...200.0°C	Setting range Factory setting: 90.0°C

[AI3 Th Value] E H 3 V ★

AI3 thermal value.

This parameter can be accessed if [AI3 Type] R , 3 E is not set to:

- [Voltage] I D u , or
- [Current] D R , or
- [PTC Management] P E C .

Setting	Description
-15.0...200.0°C	Setting range Factory setting: _

[AI4 Th Monitoring] E H 4 5 ★

Activation of the thermal monitoring on AI4.

This parameter can be accessed if VW3A3203 I/O extension module has been inserted.

Setting	Code / Value	Description
[No]	n o	No Factory setting
[YES]	y e s	Yes

[AI4 Type] R , 4 E ★

AI4 assignment.

This parameter can be accessed if [AI4 Th Monitoring] E H 4 5 is not set to [No] n o .

Setting	Code / Value	Description
[Voltage]	I D u	0-10 Vdc
[Current]	D R	0-20 mA Factory setting
[Voltage +/-]	n I D u	-10/+10 Vdc

[AI4 Th Error Resp] E H 4 B ★

Thermal monitoring response to a detected error for AI4.

This parameter can be accessed if **[AI4 Type] R , 4 E** is not set to

- **[Voltage] I D U**, or
- **[Current] D R**.

Setting	Code / Value	Description
[Ignore]	<i>n o</i>	Detected error ignored
[Freewheel Stop]	<i>Y E S</i>	Freewheel stop
[Per STT]	<i>S E E</i>	Stop according to [Type of stop] S E E parameter but without an error triggered after stop
[Fallback Speed]	<i>L F F</i>	Change to fallback speed, maintained as long as the detected error persists and the command has not been removed ⁽¹⁾
[Ramp stop]	<i>r P P</i>	Stop on ramp Factory setting

1 Because, in this case, the detected error does not trigger a stop, it is recommended to assign a relay or logic output to its indication.

[AI4 Th Error Level] E H 4 F ★

Error detection level for AI4.

This parameter can be accessed if **[AI4 Type] R , 4 E** is not set to:

- **[Voltage] I D U**, or
- **[Current] D R**, or
- **[PTC Management] P E C**.

Setting (°)	Description
-15.0...200.0°C	Setting range Factory setting: 110.0°C

[AI4 Th Warn Level] E H 4 R ★

Warning level for AI4.

This parameter can be accessed if **[AI4 Type] R , 4 E** is not set to:

- **[Voltage] I D U**, or
- **[Current] D R**, or
- **[PTC Management] P E C**.

Setting (°)	Description
-15.0...200.0°C	Setting range Factory setting: 90.0°C

[AI4 Th Value] E H 4 V ★

AI4 thermal value.

This parameter can be accessed if **[AI4 Type] R , 4 E** is not set to:

- **[Voltage] I D U**, or
- **[Current] D R**, or
- **[PTC Management] P E C**.

Setting	Description
-15.0...200.0°C	Setting range Factory setting: _

[AI5 Th Monitoring] 𐀀 𐀁 𐀂 𐀃 ★

Activation of the thermal monitoring on AI5.
 This parameter can be accessed if VW3A3203 I/O extension module has been inserted.

Setting	Code / Value	Description
[No]	𐀁 𐀂	No Factory setting
[YES]	𐀃 𐀄 𐀅	Yes

[AI5 Type] 𐀆 , 𐀇 𐀈 ★

AI5 assignment.
 This parameter can be accessed if **[AI5 Th Monitoring] 𐀀 𐀁 𐀂 𐀃** is not set to **[No] 𐀁 𐀂**.
 Identical to **[AI4 Type] 𐀆 , 𐀇 𐀈** (see page 188).

[AI5 Th Error Resp] 𐀉 𐀊 𐀋 𐀌 ★

Thermal monitoring response to a detected error for AI5.
 This parameter can be accessed if **[AI5 Type] 𐀆 , 𐀇 𐀈** is not set to

- **[Voltage] 𐀍 𐀎 𐀏**, or
- **[Current] 𐀐 𐀑**.

Setting	Code / Value	Description
[Ignore]	𐀁 𐀂	Detected error ignored
[Freewheel Stop]	𐀃 𐀄 𐀅	Freewheel stop
[Per STT]	𐀆 𐀇 𐀈	Stop according to [Type of stop] 𐀉 𐀊 𐀋 parameter but without an error triggered after stop
[Fallback Speed]	𐀌 𐀍 𐀎	Change to fallback speed, maintained as long as the detected error persists and the command has not been removed ⁽¹⁾
[Ramp stop]	𐀏 𐀐 𐀑	Stop on ramp Factory setting

1 Because, in this case, the detected error does not trigger a stop, it is recommended to assign a relay or logic output to its indication.

[AI5 Th Error Level] 𐀒 𐀓 𐀔 𐀕 ★

Error detection level for AI5.
 This parameter can be accessed if **[AI5 Type] 𐀆 , 𐀇 𐀈** is not set to:

- **[Voltage] 𐀍 𐀎 𐀏**, or
- **[Current] 𐀐 𐀑**, or
- **[PTC Management] 𐀒 𐀓 𐀔**.

Setting (°)	Description
-15.0...200.0°C	Setting range Factory setting: 110.0°C

[AI5 Th Warn Level] L H S R ★

Warning level for AI5.

This parameter can be accessed if **[AI5 Type] R , S L** is not set to:

- **[Voltage] I D U**, or
- **[Current] D R**, or
- **[PTC Management] P L L**.

Setting ()	Description
-15.0...200.0°C	Setting range Factory setting: 90.0°C

[AI5 Th Value] L H S V ★

AI5 thermal value.

This parameter can be accessed if **[AI5 Type] R , S L** is not set to:

- **[Voltage] I D U**, or
- **[Current] D R**, or
- **[PTC Management] P L L**.

Setting	Description
-15.0...200.0°C	Setting range Factory setting: _

[Enc Therm Sensor Type] L H E L ★

Encoder thermal sensor type.

This parameter can be accessed if an encoder module different from a HTL encoder has been inserted.

Settings	Code/Value	Description
[None]	<i>n o n E</i>	None Factory settings
[PTC]	<i>P L L</i>	PTC
[PT100]	<i>I P L 2</i>	PT100
[PT1000]	<i>I P L 3</i>	PT1000
[KTY]	<i>K L Y</i>	KTY
[Klixon]	<i>K L , X</i>	Klixon

[Enc Th ErrorResp] L H E b ★

Thermal monitoring response to a detected error for the encoder module input.

This parameter can be accessed if:

- An encoder module has been inserted, and
- **[Enc Therm Sensor Type] L H E L** is not set to **[None] n o n E**.

Setting	Code / Value	Description
[Ignore]	<i>n o</i>	External detected error ignored
[Freewheel Stop]	<i>Y E 5</i>	Freewheel stop
[Per STT]	<i>S L L</i>	Stop according to configuration of [Type of stop] S L L (<i>see page 364</i>), without tripping. In this case, the detected error relay does not open and the drive is ready to restart as soon as the detected error disappears, according to the restart conditions of the active command channel (for example, according to [2/3-wire control] L C L and [2-wire type] L C L (<i>see page 233</i>) if control is via the terminals). Configuring a warning for this detected error is recommended (assigned to a digital output, for example) in order to indicate the cause of the stop.

(1) Because, in this case, the detected error does not trigger a stop, it is advisable to assign a relay or digital output to its indication.

Setting	Code / Value	Description
[Fallback speed]	L F F	Change to fallback speed, maintained as long as the detected error persists and the run command has not been removed ⁽¹⁾
[Speed maintained]	r L 5	The drive maintains the speed being applied when the detected error occurred, as long as the detected error is active and the run command has not been removed ⁽¹⁾
[Ramp stop]	r P P	Stop on ramp Factory setting
[Fast stop]	F 5 t	Fast stop
[DC Injection]	d C i	DC injection stop. This type of stop cannot be used with some other functions

(1) Because, in this case, the detected error does not trigger a stop, it is advisable to assign a relay or digital output to its indication.

[Enc Th Error Level] L H E F ★

Thermal error level for encoder.

This parameter can be accessed if:

- An encoder module has been inserted, and
- [Enc Therm Sensor Type] L H E t is not set to:
 - [None] n o n E, or
 - [PTC] P t C.

Setting	Description
-15.0...200.0°C	Setting range Factory setting: 110.0°C

[Enc Th Warn Level] L H E A ★

Thermal warning level for encoder.

This parameter can be accessed if:

- An encoder module has been inserted, and
- [Enc Therm Sensor Type] L H E t is not set to:
 - [None] n o n E, or
 - [PTC] P t C.

Setting	Description
-15.0...200.0°C	Setting range Factory setting: 90.0°C

[Enc Th Value] L H E V ★

Encoder thermal value.

This parameter can be accessed if:

- An encoder module has been inserted, and
- [Enc Therm Sensor Type] L H E t is not set to:
 - [None] n o n E, or
 - [PTC] P t C.

Setting	Description
-15.0...200.0°C	Setting range Factory setting: _

[Fallback Speed] L F F

Fallback speed.

Setting	Description
0.0...599.0 Hz	Setting range Factory setting: 0.0 Hz

[Motor monitoring] $\Pi \square P$ - Menu

Access

[Complete settings] → [Motor parameters] → [Motor monitoring]

About This Menu

The thermal monitoring function helps to prevent the motor from overheating by an estimation of the thermal state of the motor.

[Current Limitation] ζL , ★

Internal current limit.

<i>NOTICE</i>
<p>OVERHEATING</p> <ul style="list-style-type: none"> Verify that the motor is properly rated for the maximum current to be applied to the motor. Verify that the parameter [Current Limitation] ζL is set to a value lower or equal to the value shown in this table. Consider the duty cycle of the motor and all factors of your application including derating requirements in determining the current limit. <p>Failure to follow these instructions can result in equipment damage.</p>

NOTE: If the setting is less than 0.25. In, the drive may lock in **[OutPhaseLoss Assign] $\square P L$** if this has been enabled. If it is less than the no-load motor current, the motor cannot run.

Setting (°)	Description
0...1.5 In ⁽¹⁾	Setting range Factory setting: 1.2 In ⁽¹⁾
(1) Corresponding to the rated drive current indicated in the installation manual and on the drive nameplate.	

[Attenuation Time] $S \square P$ ★

Attenuation time.

This parameter can be accessed if **[Motor surge limit.] $S V L$** is not set to **[No] $n \square$** .

The value of the **[Volt surge limit. opt] $S \square P$** parameter corresponds to the attenuation time of the cable used. It is defined to help to prevent the superimposition of voltage wave reflections resulting from long cable lengths. It limits over-voltages to twice the DC bus rated voltage.

As surge voltage depends on many parameters such as types of cable, different motor powers in parallel, different cable lengths in parallel, and so on, it is recommend the use of an oscilloscope to check the over-voltage values obtained at the motor terminals.

For long cable lengths, an output of the filter or a dV/dt filter must be used.

To retain the overall drive performance, do not increase the SOP value unnecessarily.

Setting	Code / Value	Description
[6 μs]	5	6 μs
[8 μs]	8	8 μs Factory setting
[10 μs]	10	10 μs

[Sinus Filter Activation] $\square F$, ★

Sinus filter activation.

This parameter can be accessed if **[Motor control type]** $\square E E$ is not set to:

- **[Sync. mot.]** $5 Y n$, or
- **[Sync.CL.]** $F 5 Y$, or
- **[SYN_U VC]** $5 Y n u$, or
- **[Rel. Mot.]** $5 r V \square$.

NOTICE**DAMAGE TO THE SINUS FILTER**

Do not set the maximum output frequency **[Max frequency]** $\square F r$ to a value greater than 100 Hz on system with a sinus filter.

Failure to follow these instructions can result in equipment damage.

Setting	Code / Value	Description
[No]	$n \square$	No sinus filter Factory setting
[Yes]	$Y E 5$	Use of a sinus filter to limit over-voltages on the motor and reduce the ground detected error leakage current or in case of applications with Step-Up transformer.

[Output Short Circuit Test] $5 E r E$

Output short circuit test configuration.

The drive outputs are tested at every power-up irrespective of the configuration of this parameter. If this parameter is set to **[Yes]** $Y E 5$, the test is also done every time a run command is applied. These tests cause a slight delay (a few ms). In the event of an error, the drive locks.

The *drive output short-circuit (terminals U-V-W)*: SCF error can be detected.

The factory setting value is changed to **[Yes]** $Y E 5$ depending on the catalog numbers.

Setting	Code / Value	Description
[No]	$n \square$	Not test at run command Factory setting
[Yes]	$Y E 5$	Output short circuit test at each run command

[Motor Therm Thd] $E E d$

Motor thermal threshold for **[Motor Thermal Thd]** $E 5 H$ warning activation.

Setting (°)	Description
0...118%	Setting range Factory setting: 100%

[Motor2 therm. level] $E E d 2$

Motor 2 thermal level for **[Motor2 Thermal Thd]** $E 5 2$ warning activation.

Setting (°)	Description
0...118%	Setting range Factory setting: 100%

[Motor3 therm. level] *ⓧ ⓧ ⓧ ⓧ*

Motor 3 thermal level for **[Motor3 Thermal Thd]** *ⓧ ⓧ ⓧ* warning activation.

Setting (ⓧ)	Description
0...118%	Setting range Factory setting: 100%

[Motor4 therm. level] *ⓧ ⓧ ⓧ ⓧ*

Motor 4 thermal level for **[Motor4 Thermal Thd]** *ⓧ ⓧ ⓧ* warning activation.

Setting (ⓧ)	Description
0...118%	Setting range Factory setting: 100%

[Motor control] *d r C* - Menu

Access

[Complete settings] → [Motor parameters] → [Motor control]

About This Menu

This menu shows the motor control related parameters.

[IR compensation] *u F r*

This parameter is used to optimize torque at low speed, or to adapt to special cases (for example: for motors connected in parallel, decrease [IR compensation] *u F r*). If there is insufficient torque at low speed, increase [IR compensation] *u F r*. A too high value can avoid the motor to start (locking) or change the current limiting mode.

Setting (°)	Description
0...200%	Setting range Factory setting: 100%

[Slip compensation] *S L P* ★

Slip compensation.

This parameter can be accessed if [Motor control type] *C E E* is set to:

- [SVC V] *V V C*, or
- [U/F VC 5pts] *u F 5*, or
- [Energy Sav.] *n L d*.

The speeds given on motor nameplates are not necessarily exact.

If the slip setting is lower than the actual slip, the motor is not rotating at the correct speed in steady state, but at a lower speed than the reference.

If the slip setting is higher than the actual slip, the motor is overcompensated and the speed is unstable.

Setting (°)	Description
0...300%	Setting range Factory setting: 100%

[U1] *u 1* ★

Voltage point 1 on 5 points V/F.

This parameter can be accessed if [Motor Control Type] *C E E* is set to [V/F 5pts] *u F 5*.

Setting (°)	Description
0...800 Vac	Setting range according to rating Factory setting: 0 Vac

[U2] *u 2* ★

Voltage point 2 on 5 points V/F.

V/F profile setting.

This parameter can be accessed if [Motor Control Type] *C E E* is set to [V/F 5pts] *u F 5*.

Setting (°)	Description
0...800 Vac	Setting range according to rating Factory setting: 0 Vac

[U3] ⌵ 3 ★

Voltage point 3 on 5 points V/F.

V/F profile setting.

This parameter can be accessed if [Motor Control Type] C E E is set to [V/F 5pts] ⌵ F 5.

Setting (⌵)	Description
0...800 Vac	Setting range according to rating Factory setting: 0 Vac

[U4] ⌵ 4 ★

Voltage point on 4 points V/F.

V/F profile setting.

This parameter can be accessed if [Motor Control Type] C E E is set to [V/F 5pts] ⌵ F 5.

Setting (⌵)	Description
0...800 Vac	Setting range according to rating Factory setting: 0 Vac

[U5] ⌵ 5 ★

Voltage point 5 on 5 points V/F.

V/F profile setting.

This parameter can be accessed if [Motor Control Type] C E E is set to [V/F 5pts] ⌵ F 5.

Setting (⌵)	Description
0...800 Vac	Setting range according to rating Factory setting: 0 Vac

[F1] F 1 ★

Frequency point 1 on 5 points V/F.

V/F profile setting.

This parameter can be accessed if [Motor Control Type] C E E is set to [V/F 5pts] ⌵ F 5.

Setting (⌵)	Description
0.0...599.0 Hz	Setting range Factory setting: 0.0 Hz

[F2] F 2 ★

Frequency point 2 on 5 points V/F.

V/F profile setting.

This parameter can be accessed if [Motor Control Type] C E E is set to [V/F 5pts] ⌵ F 5.

Setting (⌵)	Description
0.0...599.0 Hz	Setting range Factory setting: 0.0 Hz

[F3] F 3 ★

Frequency point 3 on 5 points V/F.

V/F profile setting.

This parameter can be accessed if **[Motor Control Type] C L L** is set to **[V/F 5pts] U F 5**.

Setting ()	Description
0.0...599.0 Hz	Setting range Factory setting: 0.0 Hz

[F4] F 4 ★

Frequency point 4 on 5 points V/F.

V/F profile setting.

This parameter can be accessed if **[Motor Control Type] C L L** is set to **[V/F 5pts] U F 5**.

Setting ()	Description
0.0...599.0 Hz	Setting range Factory setting: 0.0 Hz

[F5] F 5 ★

Frequency point 5 on 5 points V/F.

V/F profile setting.

This parameter can be accessed if **[Motor Control Type] C L L** is set to **[V/F 5pts] U F 5**.

Setting ()	Description
0.0...599.0 Hz	Setting range Factory setting: 0.0 Hz

[Output Ph Rotation] P H r

Output phase rotation.

Modifying this parameter operates as an inversion of 2 of the three motor phases. This results in changing the direction of rotation of the motor.

Setting	Code / Value	Description
[ABC]	<i>A b C</i>	Standard rotation Factory setting
[ACB]	<i>A C b</i>	Opposite rotation

[Inertia Factor] S P G U ★

Inertia factor

This parameter can be accessed if:

- **[Access Level] L H C** is set to **[Expert] E P r**, and
- **[Motor Control Type] C L L** is set to:
 - **[U/F VC 5pts] U F 5**, or
 - **[SYN_U VC] S Y n U**.

Setting ()	Description
1...1,000%	Setting range Factory setting: 40%

[Boost Activation] $b o A$ ★

Boost activation.

This parameter can be accessed if **[Access Level] $L A C$** is set to **[Expert] $E P r$** .

Setting	Code / Value	Description
[Inactive]	$n o$	No boost
[Dynamic]	$d y n A$	Dynamic boost, the magnetizing current value is modified according to the motor load. Factory setting NOTE: Drive manages itself the value [Magnetizing Current] $i d R$ to optimize the performances. NOTE: This selection can't be accessed if [Motor Control Type] $C t E$ is set to [Sync. mot.] $S y n$, [Sync.CL] $F S Y$, [Rel. Mot.] $S r V C$ or [SYN_U VC] $S Y n u$.
[Static]	$S t A t$	Static boost, the magnetizing current value follows the profile whatever the motor load NOTE: With this selection the [Boost] $b o o$ and [Freq Boost] $F R b$ are taken into account. NOTE: This selection can be used for conical motor with [Boost] $b o o$ sets to a negative value.
[Constant]	$C S t E$	Constant boost, the magnetizing current is maintained in case of change of direction of the motor. An additional parameter is available to handle the deceleration and stop phase. $C S t E$ can be accessed if [Motor Control Type] $C t E$ is set to [Sync. mot.] $S y n$, [Sync.CL] $F S Y$, [Rel. Mot.] $S r V C$ or [SYN_U VC] $S Y n u$. NOTE: With this selection only [Boost] $b o o$ is taken into account.
[Conical Motor]	$C n o t$	Conical boost, can be accessed if [Motor Control Type] $C t E$ is not set to [Sync. mot.] $S y n$, [Sync.CL] $F S Y$, [Rel. Mot.] $S r V C$ and [SYN_U VC] $S Y n u$. NOTE: With this selection, it is possible to adjust the [Boost] $b o o$ for acceleration and [Boost On Deceleration] $b o o 2$ for deceleration.

[Boost] $b o o$ ★

Value at 0 Hz: % of nominal magnetizing current (taken into account if different from 0).

A too high value of **[Boost] $b o o$** can result in a magnetic saturation of the motor, which leads to a torque reduction.

This parameter can be accessed if:

- **[Access Level] $L A C$** is set to **[Expert] $E P r$** , and
- **[Boost Activation] $b o A$** is not set to **[Inactive] $n o$** .

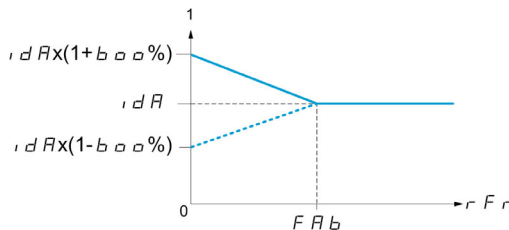

NOTE: For synchronous motors, it is recommended to set this value to optimize control at low speed.

Setting	Description
-100...100%	Setting range If [Boost Activation] $b o A$ is set to [Dynamic] $d y n A$, [Boost] $b o o$ is set to 25%. Factory setting: 0%

[Boost On Deceleration] b_{od} ★

Value in % of nominal magnetizing current (taken into account if different from 0).

This parameter is used during deceleration phase to quickly reduce the magnetizing current at stop phase.

This parameter can be accessed if:

- **[Access Level] L_{AC}** is set to **[Expert] E_{Pr}** , and
- **[Boost Activation] b_{oA}** is set to **[Conical Motor] $C_{P_{oE}}$** .

Setting	Description
-100...0%	Setting range Factory setting: -25%

[Freq Boost] F_{Ab} ★

Value at 0 Hz: speed threshold to reach nominal magnetizing current.

This parameter can be accessed if:

- **[Access Level] L_{AC}** is set to **[Expert] E_{Pr}** , and
- **[Boost Activation] b_{oA}** is not set to **[NO] n_{o}** , and
- **[Boost Activation] b_{oA}** is not set to **[Constant] C_{SE}** .

Setting	Description
0.0...599.0 Hz	Setting range If [Boost Activation] b_{oA} is set to [Dynamic] d_{YnA} , [Freq Boost] F_{Ab} is set to 30.0 Hz. Factory setting: 0.0 Hz

NOTE: For synchronous motors, it is recommended to set this value to optimize control at low speed.

[Braking level] V_{br}

Braking transistor command level.

Setting (°)	Description
335...1130 V	Setting range Factory setting: According to drive rating voltage

[Fluxing by DI] *F L ,* - Menu

Access

[Complete settings] → [Motor parameters] → [Motor control] → [Fluxing by DI]

About This Menu

Configure the fluxing by digital input.

[Motor fluxing] *F L u* ★

Motor fluxing configure

⚡ ⚠ DANGER
HAZARD OF ELECTRIC SHOCK, EXPLOSION, OR ARC FLASH
If the parameter [Motor fluxing] <i>F L u</i> is set to [Continuous] <i>F c t</i> , fluxing is always active, even if the motor does not run.
<ul style="list-style-type: none"> Verify that using this setting does not result in unsafe conditions.
Failure to follow these instructions will result in death or serious injury.

NOTICE
OVERHEATING
Verify that the connected motor is properly rated for the flux current to be applied.
Failure to follow these instructions can result in equipment damage.

In order to obtain rapid high torque on startup, magnetic flux needs to already have been established in the motor.

In [Continuous] *F c t* mode, the drive automatically builds up flux when it is powered up.

in [Not continuous] *F n c* mode, fluxing occurs when the motor starts up.

The flux current is greater than [Nom Motor Current] *n c r* (configured rated motor current) when the flux is established and is the adjusted to the motor magnetizing current.

If [Motor control type] *c t t* is set to [Sync. mot.] *5 y n*, the [Motor fluxing] *F L u* parameter causes the alignment of the motor and not the fluxing.

If [Brake assignment] *b l c* is not [No] *n o*, the [Motor fluxing] *F L u* parameter has no effect.

Setting ()	Code / Value	Description
[Not continuous]	<i>F n c</i>	Non-continuous mode
[Continuous]	<i>F c t</i>	Continuous mode This option is not possible if [Auto DC Injection] <i>A d c</i> (see page 369) is [Yes] <i>y e s</i> or if [Type of stop] <i>5 t t</i> (see page 364) is [Freewheel] <i>n 5 t</i>
[No]	<i>F n o</i>	Function inactive Factory setting

[Fluxing assignment] *F L ,* ★

Fluxing input assignment

NOTICE
OVERHEATING
Verify that the connected motor is properly rated for the flux current to be applied.
Failure to follow these instructions can result in equipment damage.

Assignment is only possible if [Motor fluxing] *F L u* is set to [Not continuous] *F n c*.

If a DI or a bit is assigned to the motor fluxing command, flux is built up when the assigned input or bit is at 1.

If a DI or a bit has not been assigned, or if the assigned DI or bit is at 0 when a run command is sent, fluxing occurs when the motor starts.

Setting	Code / Value	Description
[Not Assigned]	n a	Not assigned Factory setting
[DI1]...[DI8]	L , I...L , B	Digital input DI1...DI8
[DI11]...[DI16]	L , I I...L , I B	Digital input DI11...DI16 if VW3A3203 I/O extension module has been inserted
[CD00]...[CD10]	C d 0 0...C d 1 0	Virtual digital input CMD.0...CMD.10 in [I/O profile] , a configuration
[CD11]...[CD15]	C d 1 1...C d 1 5	Virtual digital input CMD.11...CMD.15 regardless of configuration
[C101]...[C110]	C 1 0 1...C 1 1 0	Virtual digital input CMD1.01...CMD1.10 with integrated Modbus Serial in [I/O profile] , a configuration
[C111]...[C115]	C 1 1 1...C 1 1 5	Virtual digital input CMD1.11...CMD1.15 with integrated Modbus Serial regardless of configuration
[C201]...[C210]	C 2 0 1...C 2 1 0	Virtual digital input CMD2.01...CMD2.10 with CANopen® fieldbus module in [I/O profile] , a configuration
[C211]...[C215]	C 2 1 1...C 2 1 5	Virtual digital input CMD2.11...CMD2.15 with CANopen® fieldbus module regardless of configuration
[C301]...[C310]	C 3 0 1...C 3 1 0	Virtual digital input CMD3.01...CMD3.10 with a fieldbus module in [I/O profile] , a configuration
[C311]...[C315]	C 3 1 1...C 3 1 5	Virtual digital input CMD3.11...CMD3.15 with a fieldbus module regardless of configuration
[C501]...[C510]	C 5 0 1...C 5 1 0	Virtual digital input CMD5.01...CMD5.10 with integrated Ethernet in [I/O profile] , a configuration
[C511]...[C515]	C 5 1 1...C 5 1 5	Virtual digital input CMD5.11...CMD5.15 with integrated Ethernet regardless of configuration

[Angle setting type] P 5 L ★

Automatic angle setting type.

This parameter can be accessed if **[Motor Control Type]** C L L is set to:

- **[Sync. mot.]** 5 4 n, or
- **[Sync.CL]** F 5 4, or
- **[SYN_U VC]** 5 4 n u, or
- **[Rel. Mot.]** 5 r v C.

[PSI align] P 5 , and **[PSIO align]** P 5 , a are working for all types of synchronous motors. **[SPM align]** 5 P n A and **[IPM align]** , P n A increase performances depending on the type of synchronous motor.

[Rotational Current Injection] r C , may be used where **[PSI align]** P 5 , and **[PSIO align]** P 5 , a do not give expected performances.

Setting	Code / Value	Description
[IPM align]	, P n A	Alignment for IPM motor. Alignment mode for Interior-buried Permanent Magnet motor (usually, this kind of motor has a high saliency level). It uses high frequency injection, which is less noisy than standard alignment mode.
[SPM align]	5 P n A	Alignment for SPM motor. Mode for Surface-mounted Permanent Magnet motor (usually, this kind of motor has a medium or low saliency level). It uses high frequency injection, which is less noisy than standard alignment mode.
[PSI align]	P 5 ,	Pulse signal injection. Standard alignment mode, without rotor motion The angle measurement is realized by monitoring the stator current response to a pulse signal injection over a wide range of frequencies

Setting	Code / Value	Description
[PSIO align]	P 5 1 0	Pulse signal injection - optimized. Optimized alignment mode, without rotor motion Same operation as [PSI align] P 5 , is performed over an optimized range of frequencies The measurement time is reduced after the first run order or tune operation, even if the drive has been turned off Factory setting
[Rotational Current Injection]	r C 1	Rotational current injection. Alignment mode with rotor motion. This alignment mode realizes the mechanical alignment of the rotor and the stator; it requires up to 4 s. The motor needs to be stopped and without resistive torque. NOTE: This setting is recommended when a sinus filter is used on the application. NOTE: For synchronous reluctance motor, it is recommended to use this setting.
[No align]	n 0	No alignment

[Spd Loop Optimization] P C L - Menu

Access

[Complete settings] → [Motor parameters] → [Motor control] → [Spd Loop Optimization]

About This Menu

This procedure can be done if [Motor control type] C E E is not set to [U/F VC 5pts] u F 5 or [SYN_U VC] S Y n u .

Recommended Procedure for Setting the High-Performance Speed Loop

Step	Action
1	Enter the motor parameters. If you subsequently modify one of these, you have to perform this whole procedure again.
2	The value of the inertia being driven must be entered in the [Application Inertia] J A P L parameter. <i>(see page 210)</i> NOTE: If a motor parameter is modified, the estimated inertia is recalculated and updated (parameters [Estim. app. inertia] J E 5 E and [Inertia Mult. Coef.] J P u L . [Application Inertia] J A P L returns to its default value according to the new value of [Estim. app. inertia] J E 5 E .
3	Check the speed loop response time by first setting [Feed forward] F F P to 0 (see graphs on next page).
4	If necessary, adjust the bandwidth and stability using parameters [FreqLoop Stab] S E R and [FreqLoopGain] F L G <i>(see page 207)</i> .
5	To optimize ramp following, increase the feedforward parameter [[Feed forward] F F P as indicated on the next page until the best result is obtained.
6	The feedforward term bandwidth can be adjusted if necessary (as shown on the next page) to further improve the ramp following or to filter the noise on the speed reference.

High-Performance speed Loop - Setting the [Feed forward] FFP Parameter

This is used to adjust the level of dynamic torque feedforward required for accelerating and decelerating the inertia. The effect of this parameter on ramp following is illustrated below. Increasing the value of FFP allows the ramp to be followed more closely. However, if the value is too high, overspeed occurs. The optimum setting is obtained when the speed follows the ramp precisely; this depends on the accuracy of the [Application Inertia] J_{APP} parameter, (see page 210) and the [Encoder filter value] FF_r parameter setting (see page 210)

FFP settings

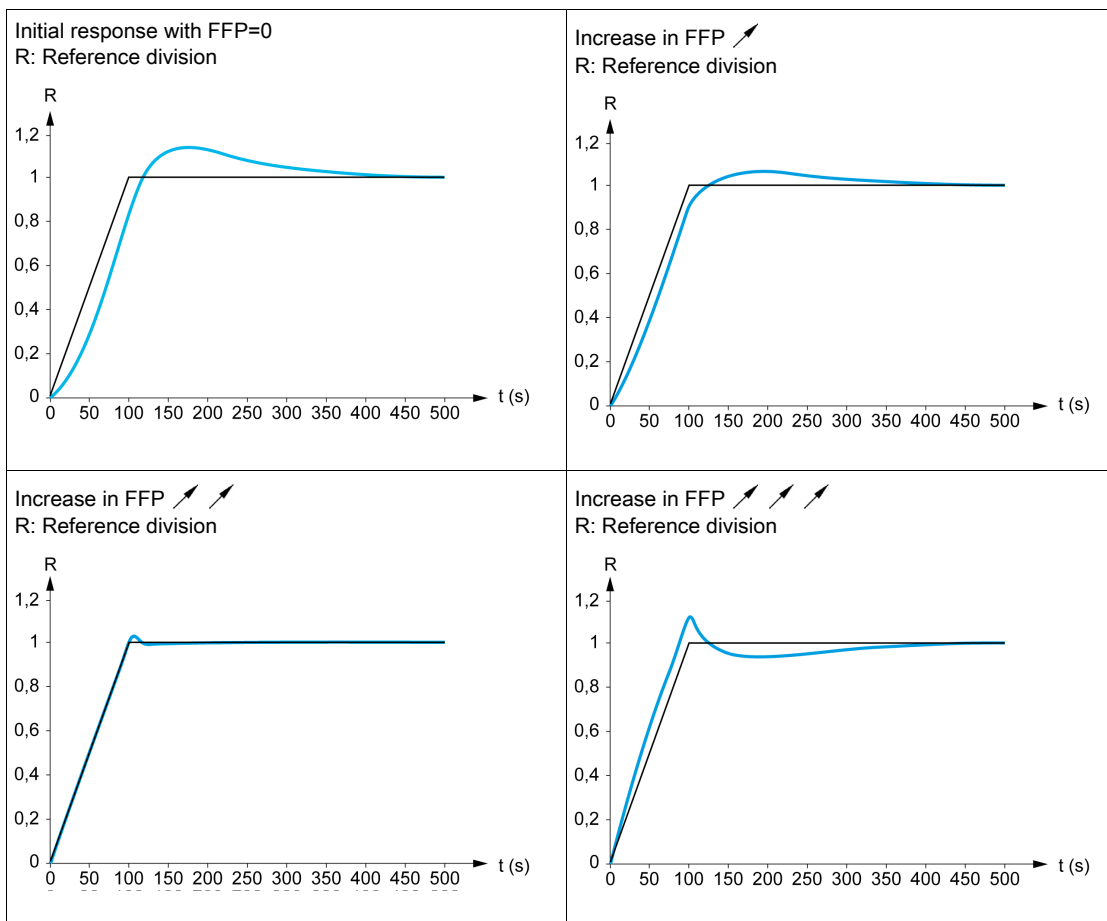

High-Performance Speed Loop - Setting the [FeedFwd Bandwidth] *FFV* Parameter

This is used to adjust the bandwidth of the dynamic torque feedforward term. The effect of this parameter on ramp following is illustrated below. Decreasing the value of *FFV* reduces the effect of noise on the speed reference (torque ripple). However, too great a decrease in relation to the ramp settings (on short ramps) causes a delay, and ramp following is adversely affected. Increasing the value of *FFV* allows the ramp to be followed more closely, but also heightens noise sensitivity. The optimum setting is obtained by reaching the best compromise between ramp following and the existing noise sensitivity.

FFV settings

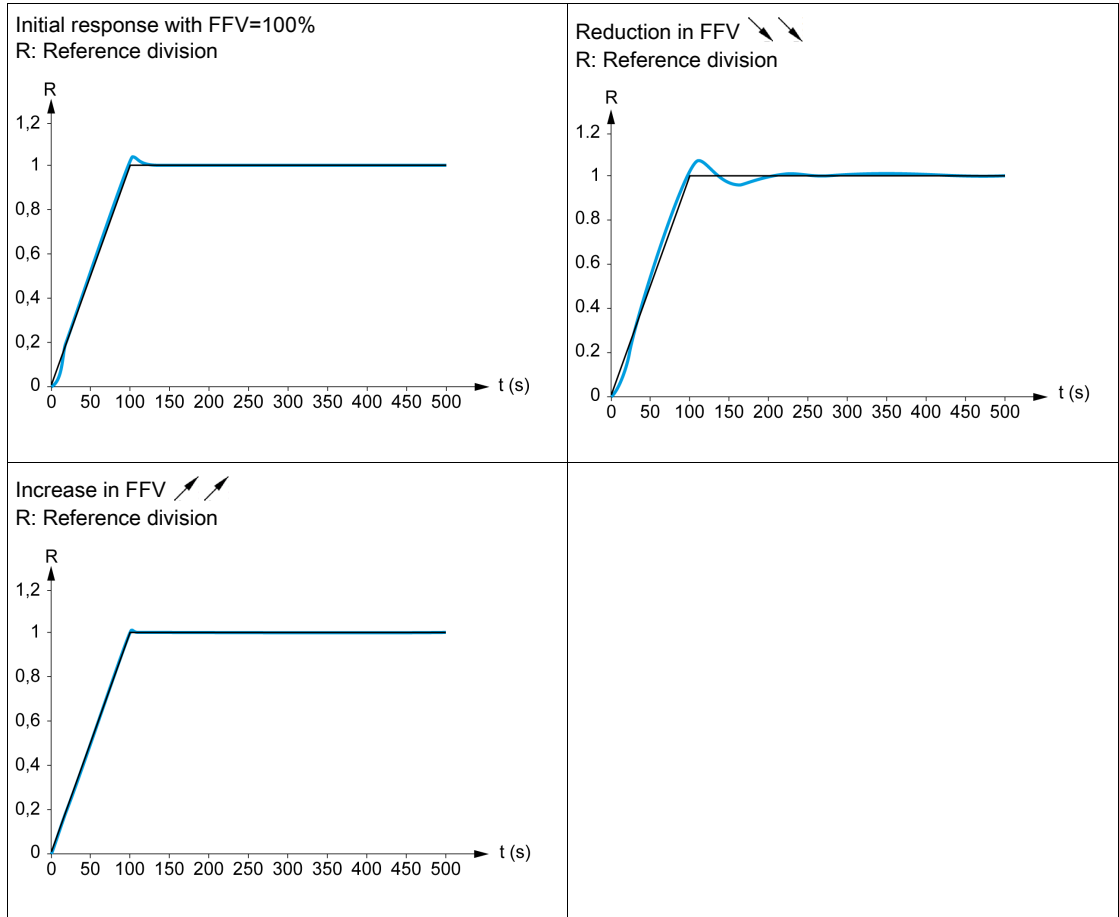

[Speed loop type] *SL* ★

Speed loop type.

This parameter can be accessed if [Motor control type] *LEL* is not set to:

- [U/F VC 5pts] *UF5*, or
- [SYN_U VC] *SYNU*.

Setting	Code / Value	Description
[Standard]	<i>SLD</i>	Standard speed loop Factory setting
[High Perf]	<i>HPF</i>	High-performance speed loop. It is advised to deactivate [Dec.Ramp Adapt] <i>brA</i> = [No] <i>na</i>

[Speed prop. gain] *SPG* ★

Speed loop proportional gain.

This parameter can be accessed if:

- **[Speed loop type] *SSL*** is set to **[Standard] *Std***, and
- **[Motor control type] *CLL*** is not set to:
 - **[U/F VC 5pts] *UF5***, or
 - **[SYN_U VC] *SynU***.

Setting (°)	Description
0...1,000%	Setting range Factory setting: 40%

[Speed time integral] *StI* ★

Speed loop integral time constant.

This parameter can be accessed if:

- **[Speed loop type] *SSL*** is set to **[Standard] *Std***, and
- **[Motor control type] *CLL*** is not set to:
 - **[U/F VC 5pts] *UF5***, or
 - **[SYN_U VC] *SynU***.

Setting (°)	Description
1...65,535 ms	Setting range Factory setting: According to the drive rating.

[K speed loop filter] *SFC*

Speed filter coefficient (0(IP) to 1(PI)).

Setting (°)	Description
0...100	Setting range Factory setting: 65

[Spd est. filter time] *FFH* ★

Filter time of the estimated speed.

This parameter can be accessed if **[Access Level] *LAC*** is set to **[Expert] *Exp***.

Setting (°)	Description
0.0...100.0 ms	Setting range Factory setting: According to the drive rating

[FreqLoop Stab] *SLA* ★

Frequency loop stability (Speed loop damping factor).

This parameter can be accessed if:

- **[Speed loop type] *SSL*** is set to **[High Perf] *HPP***, and
- **[Motor control type] *CLL*** is not set to:
 - **[U/F VC 5pts] *UF5***, or
 - **[SYN_U VC] *SynU***.

Stability: Used to adapt the return to steady state after a speed transient, according to the dynamics of the machine. Gradually increase the stability to increase control loop attenuation and thus reduce any overspeed.

Setting (°)	Description
0...100%	Setting range Factory setting: 20%

[FreqLoopGain] F L G ★

Frequency loop gain (Speed loop bandwidth).

This parameter can be accessed if:

- [Speed loop type] S S L is set to [High Perf] H P F , and
- [Motor control type] C E E is not set to:
 - [U/F VC 5pts] u F 5 , or
 - [SYN_U VC] S Y n u .

Used to adapt the response of the machine speed transients according to the dynamics. For machines with high resistive torque, high inertia of fast cycles, increase the gain gradually.

Setting (↔)	Description
0...100%	Setting range Factory setting: 20%

[Feed forward] F F P ★

Feed-Forward term activation and setting.

This parameter can be accessed if:

- [Speed loop type] S S L is set to [High Perf] H P F , and
- [Motor control type] C E E is not set to:
 - [U/F VC 5pts] u F 5 , or
 - [SYN_U VC] S Y n u .

Percentages of the high-performance regulator feedforward term. 100% corresponds to the term calculated using the value of [Application Inertia] J A P L .

Setting (↔)	Description
0...200%	Setting range Factory setting: 0%

[FeedFwd Bandwidth] F F V ★

Bandwidth of the filter of feed-forward term.

This parameter can be accessed if:

- [Speed loop type] S S L is set to [High Perf] H P F , and
- [Motor control type] C E E is not set to:
 - [U/F VC 5pts] u F 5 , or
 - [SYN_U VC] S Y n u .

Bandwidths of the high-performance speed loop feedforward term, as a percentage of the predefined value.

Setting (↔)	Description
20...500%	Setting range Factory setting: 100%

[External FeedFwd Assign] E E F F ★

External feed-forward mode

Setting	Code / Value	Description
[No]	n o	Analog input is not assigned Factory setting
[AI1]...[AI3]	A , 1... A , 3	Analog input AI1...AI3
[AI4]...[AI5]	A , 4... A , 5	Analog input AI4...AI5 if VW3A3203 I/O extension module has been inserted
[Ref.Freq-Rmt.Term]	L C C	Reference Frequency via remote terminal
[Ref. Freq-Modbus]	M d b	Reference frequency via Modbus

Setting	Code / Value	Description
[Ref. Freq-CANopen]	<i>C R n</i>	Reference frequency via CANopen if a CANopen module has been inserted
[Ref. Freq-Com. Module]	<i>n E t</i>	Reference frequency via fieldbus module if a fieldbus module has been inserted
[Embedded Ethernet]	<i>E t H</i>	Embedded Ethernet
[DI7 PulseInput]...[DI8 PulseInput]	<i>P , 7... P , 8</i>	Digital input DI7...DI8 used as pulse input
[Encoder]	<i>P G</i>	Encoder reference if an encoder module has been inserted.

[Inertia Mult. Coef.] *J P u L* ★

Scaling factor for inertia displays.

This parameter can be accessed if:

- [Speed loop type] *S S L* is set to [High Perf] *H P F*, and
- [Motor control type] *C t t* is not set to:
 - [U/F VC 5pts] *u F 5*, or
 - [SYN_U VC] *S Y n u*.

Increment for [Application Inertia] *J A P L* and [Estim. app. inertia] *J E S t* parameters, calculated by the drive, in read-only mode: 0.1 gm², 1 gm², 10 gm², 100 gm², 1000 gm².

Setting	Description
0.0...6553.5 gm ²	Setting range Factory setting: 0.0 gm ²

[Estim. app. inertia] *J E S t* ★

Estimated application inertia.

This parameter can be accessed if:

- [Speed loop type] *S S L* is set to [High Perf] *H P F*, and
- [Motor control type] *C t t* is not set to:
 - [U/F VC 5pts] *u F 5*, or
 - [SYN_U VC] *S Y n u*.

The inertia being driven is estimated by the drive according to the motor parameters, in read-only mode. Speed loop default settings are determined by the drive from this inertia.

Increment given by [Inertia Mult. Coef.] *J P u L*: - 0.1 gm², 1 gm², 10 gm², 100 gm² or 1000 gm².

Setting	Description
1...9,999 kg.m ²	Setting range Factory setting: -

[App. Inertia Coef.] *J A C o* ★

Adjustable application inertia ratio.

This parameter can be accessed if:

- [Speed loop type] *S S L* is set to [High Perf] *H P F*, and
- [Motor control type] *C t t* is not set to:
 - [U/F VC 5pts] *u F 5*, or
 - [SYN_U VC] *S Y n u*.

Coefficient which fixes the ratio between [Estim. app. inertia] *J E S t* and [Application Inertia] *J A P L* parameters.

[Application Inertia] *J A P L* = [Estim. app. inertia] *J E S t* × [App. Inertia Coef.] *J A C o*.

Setting	Description
0.10...100.00	Setting range Factory setting: 1

[Application Inertia] J A P L ★

Adjustable application inertia.

This parameter can be accessed if:

- [Speed loop type] S S L is set to [High Perf] H P F , and
- [Motor control type] C E E is not set to:
 - [U/F VC 5pts] U F 5 , or
 - [SYN_U VC] S Y n u .

Adjustable application inertia used by the drive to optimize speed loop settings).

Increment given by [Inertia Mult. Coef.] J n u L : 0.1 gm², 1 gm², 10 gm², 100 gm² or 1000 gm².

NOTE: If a motor parameter is modified, the estimated inertia is recalculated and updated (parameters [Estim. app. inertia] J E S E and [Inertia Mult. Coef.] J n u L). [Application Inertia] J A P L is also returned to its default value according to the new value of [Estim. app. inertia] J E S E .

Setting	Description
0.00...655.35 kgm ²	Setting range Factory setting: -

[Encoder filter activ.] F F A ★

Encoder feedback filter activation.

This parameter can be accessed if an encoder module is present.

This parameter can be accessed if [Encoder usage] E n u is set to [No] n o .

Setting	Code / Value	Description
[No]	n o	Filter deactivated Factory setting
[Yes]	Y E 5	Filter activated

[Encoder filter value] F F r ★

Encoder feedback filter value.

This parameter can be accessed if:

- [Access Level] L A C is set to [Expert] E P r , and
- [Encoder filter activ.] F F A is set to [Yes] Y E 5 .

Setting	Description
0.0...40.0 ms	Setting range Factory setting: according to encoder rating

[Notch Filter Activation] n F A ★

Notch filter activation.

This parameter activates the notch filter function. Two independent notch filters can be configured.

The notch filter central frequency should be set at or slightly higher than the mechanical resonance frequency. The main task is to identify as precise as possible the resonance frequency.

NOTE: Vibrations may occurs at frequencies higher than the mechanical resonance frequency, depending on the settings of the speed loop and motor parameters. It is important to identify the real mechanical resonance frequency.

Perform the following actions for the commissioning:

1. Set the motor data
2. Set the application data
3. Set the speed loop settings
4. In case of vibrations, set the Notch filter settings as described bellow
5. If the performances are not OK, restart from step 3

This parameter can be accessed if:

- an encoder module is present
- [Access Level] *L A C* is set to [Expert] *E P r*, and
- [Speed loop type] *S S L* is set to [High Perf] *H P F*.

Setting ()	Code / Value	Description
[First]	<i>1 5 t</i>	Notch filter 1 enabled
[2nd]	<i>2 n d</i>	Notch filter 2 enabled
[All]	<i>A L L</i>	Notch filters 1 and 2 enabled
[No]	<i>n o</i>	No notch filter enabled Factory setting

Notch filter settings

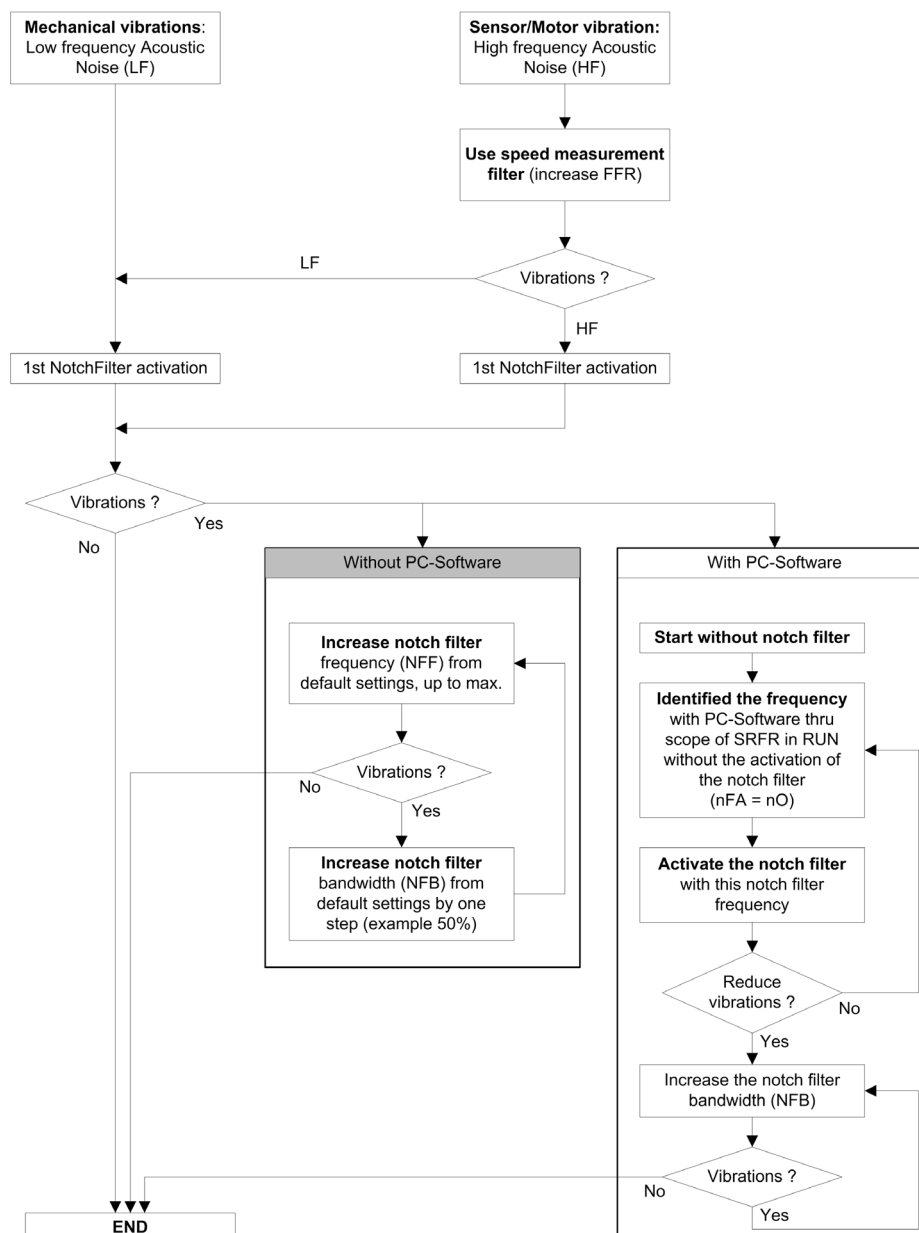

[Notch Filter Freq 1] *n F F 1* ★

Notch filter 1 central frequency.

This parameter can be accessed if:

- **[Access Level] *L A C*** is set to **[Expert] *E P r***, and
- **[Speed loop type] *S S L*** is set to **[High Perf] *H P F***, and
- **[Notch Filter Activation] *n F A*** is set to:
 - **[First] *I S t***, or
 - **[All] *A L L***.

Setting	Description
10.0...150.0 Hz	Setting range Factory setting: 15.0 Hz

[Notch Filter Bdw 1] *n F b 1* ★

Notch filter 1 bandwidth.

This parameter can be accessed if:

- **[Access Level] *L A C*** is set to **[Expert] *E P r***, and
- **[Speed loop type] *S S L*** is set to **[High Perf] *H P F***, and
- **[Notch Filter Activation] *n F A*** is set to:
 - **[First] *I S t***, or
 - **[All] *A L L***.

This parameter defines the bandwidth of the notch filter 1. Filter with higher bandwidth provides better stability margin when the load resonant frequency changes (with trolley position or load).

NOTE: Rising the bandwidth can interfere with the expect drive dynamic (reducing the dynamic of the speed loop).

Setting	Description
10...400%	Setting range Factory setting: 100%

[Notch Filter Depth 1] *n F d 1* ★

Notch filter 1 depth.

This parameter can be accessed if:

- **[Access Level] *L A C*** is set to **[Expert] *E P r***, and
- **[Speed loop type] *S S L*** is set to **[High Perf] *H P F***, and
- **[Notch Filter Activation] *n F A*** is set to:
 - **[First] *I S t***, or
 - **[All] *A L L***.

This parameter defines the gain of the notch filter 1 at the central frequency. When NFD1=100%, no filter is applied.

Setting	Description
0...99%	Setting range Factory setting: 10%

[Notch Filter Freq 2] $n F F 2$ ★

Notch filter 2 central frequency.

This parameter can be accessed if:

- **[Access Level] $L A C$** is set to **[Expert] $E P r$** , and
- **[Speed loop type] $S S L$** is set to **[High Perf] $H P F$** , and
- **[Notch Filter Activation] $n F A$** is set to:
 - **[Second] $2 n d$** , or
 - **[All] $A L L$** .

Setting	Description
10.0...150.0 Hz	Setting range Factory setting: 85.0 Hz

[Notch Filter Bdw 2] $n F b 2$ ★

Notch filter 2 bandwidth.

This parameter can be accessed if:

- **[Access Level] $L A C$** is set to **[Expert] $E P r$** , and
- **[Speed loop type] $S S L$** is set to **[High Perf] $H P F$** , and
- **[Notch Filter Activation] $n F A$** is set to:
 - **[Second] $2 n d$** , or
 - **[All] $A L L$** .

This parameter defines the bandwidth of the notch filter 2. Filter with higher bandwidth provides better stability margin when the load resonant frequency changes (with trolley position or load).

NOTE: Rising the bandwidth can interfere with the expect drive dynamic (reducing the dynamic of the speed loop).

Setting	Description
10...400%	Setting range Factory setting: 100%

[Notch Filter Depth 2] $n F d 2$ ★

Notch filter 2 depth.

This parameter can be accessed if:

- **[Access Level] $L A C$** is set to **[Expert] $E P r$** , and
- **[Speed loop type] $S S L$** is set to **[High Perf] $H P F$** , and
- **[Notch Filter Activation] $n F A$** is set to:
 - **[Second] $2 n d$** , or
 - **[All] $A L L$** .

This parameter defines the gain of the notch filter 2 at the central frequency. When $n F d 2 = 100\%$, no filter is applied.

Setting	Description
0...99%	Setting range Factory setting: 25%

[Motor control] *d r C* - Menu

Access

[Complete settings] → [Motor parameters] → [Motor control]

About This Menu

This menu shows the motor control related parameters.

[HF inj. activation] *H F i*

Activation of HF injection.

This parameter can be accessed if:

- [Access Level] *L A C* is set to [Expert] *E P r*, and
- [Motor control type] *C L t* is not set to:
 - [Sync. mot.] *S Y n*, or
 - [Sync.CL.] *F S Y*, or
 - [SYN_U VC] *S Y n u*, or
 - [Rel. Mot.] *S r V c*.

Setting	Code / Value	Description
[No]	<i>n o</i>	HF injection inactive Factory setting
[Yes]	<i>Y E S</i>	HF injection active

[HF injection freq.] *F r i*

Frequency of the HF injection signal.

This parameter can be accessed if:

- [Access Level] *L A C* is set to [Expert] *E P r*, and
- [HF inj. activation] *H F i* is set to [yes] *Y E S*.

Setting	Description
250...1000 Hz	Setting range Factory setting: 500 Hz

[HF pll bandwidth] *S P b*

Bandwidth of the HF PLL.

This parameter can be accessed if:

- [Access Level] *L A C* is set to [Expert] *E P r*, and
- [HF inj. activation] *H F i* is set to [yes] *Y E S*.

Setting	Description
0...400%	Setting range Factory setting: 100%

[Current Level Align] *i L r*

Current level of the HF alignment.

This parameter can be accessed if:

- [Access Level] *L A C* is set to [Expert] *E P r*, and
- [HF inj. activation] *H F i* is set to [yes] *Y E S*.

Setting	Description
0...200%	Setting range Factory setting: 50%

[Boost level align.] S_{IP}

Boost level for IPMA alignment.

This parameter can be accessed if **[Access Level]** L_{ACL} is set to **[Expert]** E_{PER} .

Setting	Description
0...200%	Setting range Factory setting: 100%

[Angle error Comp.] P_{ECL}

Angle position error compensation.

This parameter can be accessed if:

- **[Access Level]** L_{ACL} is set to **[Expert]** E_{PER} , and
- **[HF inj. activation]** H_{F_i} is set to **[yes]** Y_{E5} .

Setting	Description
0...500%	Setting range Factory setting: 0%

About Output Voltage Management and Overmodulation**[Overmodul. Activation]** $\sigma_{V_{PIA}}$

Overmodulation activation.

This parameter can be accessed if **[Access Level]** L_{ACL} is set to **[Expert]** E_{PER} .

The purpose of the overmodulation is to:

- compensate the voltage loss in DC bus when the drive is loaded.
- increase the maximum possible voltage to reduce current consumption at high motor voltage and limit thermal effect on the motor.

In factory settings, the motor supplied by the intermediate of the drive has:

- a common output voltage mode not null depending on the DC bus supply.
- No overmodulation (**[Overmodul. Activation]** $\sigma_{V_{PIA}}$ is set to **[No]** n_{σ}): sinusoidal phase to phase voltage.
- output voltage limited to the maximum possible value depending on DC bus supply which depends on the main power supply.

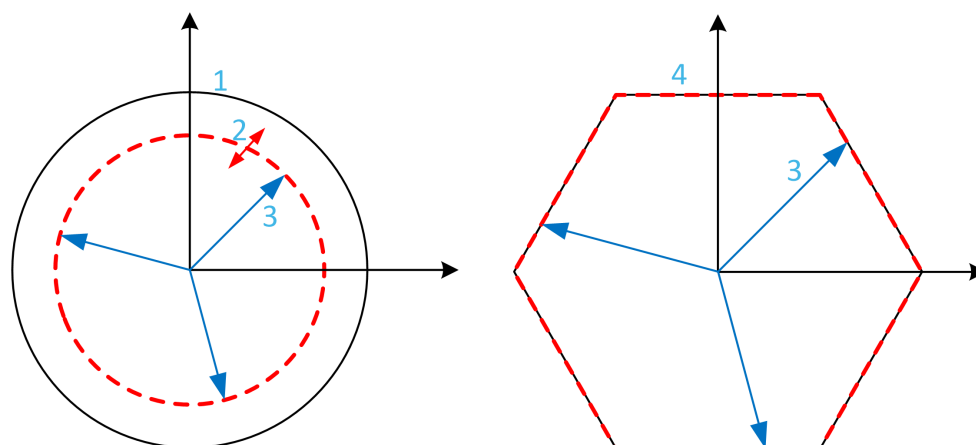

- 1 Maximum possible value of Output voltage limitation (default value)
- 2 V_{Lim} with numeric value under the maximum limitation
- 3 Output voltage
- 4 Output voltage limitation with full overmodulation (hexagon form)

Setting	Code / Value	Description
[Default]	<i>d E F F u L L</i>	Overmodulation is not configured By default, the Output voltage limitation describes a circle with at maximum radius depending of DC bus voltage. The radius can be reduced to a lower value by setting a numerical value to [Output voltage limitation] V L , Π . Factory setting
[Full]	<i>F u L L</i>	Overmodulation is active and full. The output voltage limitation describes a regular hexagon depending of DC bus voltage. The phase to phase voltages are not sinusoidal.

[Output voltage limitation] V L , Π

Output voltage limitation.

This parameter can be accessed if **[Access Level] L A C** is set to **[Expert] E P r**.

The purpose of this parameter is to modify the output voltage limitation to a lower value than the maximum default value.

The unit of the numerical value of this parameter is in phase to phase rms voltage.

This parameter cannot be set to a numerical value if **[Overmodul. Activation] o V Π A** is set to **[FULL] F u L L**.

Setting	Code / Value	Description
[Default]	<i>d E F F u L L</i>	Default value of Output Voltage limitation. The Output Voltage limitation is at the maximum capability of the DC bus voltage depending on [Overmodul. Activation] o V Π A setting. Factory setting
0...9999 V		Setting range of the output limitation voltage. Set a value lower than the corresponding [Default] d E F F u L L value to reduce the maximum output voltage limitation. If the numerical value is higher than the corresponding [Default] d E F F u L L value, this corresponding value is considered.

[Switching frequency] 5WF - Menu

Access

[Complete settings] → [Motor parameters] → [Switching frequency]

[Switching frequency] 5F_r

Drive switching frequency.

Adjustment range: The maximum value is limited to 4 kHz if [Motor surge limit.] 5VL parameter is configured.

If [Sinus Filter Activation] 5F_s is set to [Yes] 5E5, the minimum value is 2 kHz and the maximum value is limited to 6 kHz or 8 kHz according to drive rating.

NOTE: In the event of excessive temperature rise, the drive automatically reduces the switching frequency and reset it once the temperature returns to normal.

In case of high-speed motor, it is advised to increase the PWM frequency [Switching frequency] 5F_r at 8, 12 kHz or 16 kHz

Setting ()	Description
2...8 or 16 kHz according to drive rating	Setting range Factory setting: 4.0 kHz or 2.5 kHz according to the drive rating

[Noise Reduction] nr_d

Motor noise reduction.

Random frequency modulation helps to prevent any resonance, which may occur at a fixed frequency.

Setting	Code / Value	Description
[No]	no	Fixed frequency Factory setting
[Yes]	5E5	Frequency with random modulation

[Switch Freq Type] 5FL★

Switching frequency type.

This parameter can be accessed if [Access Level] LAL is set to [Expert] EPr.

The motor switching frequency is modified (reduced) when the internal temperature of the drive is too high.

Setting ()	Code / Value	Description
[SFR type 1]	HF1	Heating loss optimization Allows the system to adapt the switching frequency according to the motor frequency. This setting optimizes the heating loss of the drive in order to improve the drive efficiency. Factory setting
[SFR type 2]	HF2	Allows the system to keep a constant chosen switching frequency [Switching frequency] 5F _r whatever the motor frequency [Output frequency] rFr. With this setting, the motor noise is kept as low as possible by a high switching frequency. In the event of overheating, the drive automatically decreases the switching frequency. It is restored to its original value when the temperature returns to normal.

[Motor Surge Limit.] 5 V L

Surge voltage limitation.

This parameter is forced to **[No]** *n o* if **[Sinus Filter Activation] o F i** is set to **[Yes]** *y e s*.

This function limits motor over-voltages and is useful in the following applications:

- NEMA motors
- Old or poor quality motors
- Spindle motors
- Rewound motors

This parameter can remain set to **[No]** *n o* for 230/400 Vac motors used at 230 Vac, or if the length of cable between the drive and the motor does not exceed:

- 4 m with unshielded cables
- 10 m with shielded cables

NOTE: When **[Motor Surge Limit.] 5 V L** is set to **[Yes]** *y e s*, the maximum switching frequency **[Switching freq.] 5 F r** is modified.

Setting	Code / Value	Description
[No]	<i>n o</i>	Function inactive Factory setting
[Yes]	<i>y e s</i>	Function active

[Attenuation Time] 5 o P ★

Attenuation time.

This parameter can be accessed if **[Motor surge limit.] 5 V L** is not set to **[No]** *n o*. The value of the **[Attenuation Time] 5 o P** parameter corresponds to the attenuation time of the cable used. It is defined to help to prevent the superimposition of voltage wave reflections resulting from long cable lengths. It limits over-voltages to twice the DC bus rated voltage. As surge voltage depends on many parameters such as types of cable, different motor powers in parallel, different cable lengths in parallel, and so on, It is recommended to use an oscilloscope to check the over-voltage values obtained at the motor terminals. If the higher value of **[Attenuation Time] 5 o P** is not enough according to the cable lengths, an output filter or a dV/dt filter must be used.

To retain the overall drive performance, do not increase the **5 o P** value unnecessarily.

Setting	Code / Value	Description
[6 μs]	<i>6</i>	6 μs
[8 μs]	<i>8</i>	8 μs Factory setting
[10 μs]	<i>10</i>	10 μs

[Input Filter] *d C r* - Menu

Access

[Complete settings] → [Motor parameters] → [Input Filter]

About This Menu

This menu cannot be accessed on ATV980 and ATV9B0.

This function monitors the ripple on the DC bus by detecting instabilities. It is not used to detect input phase loss.

On the DC bus, if the oscillation frequencies are inconsistent with those observed on the mains supply, and if the amplitude is inconsistent with the drive capability (such as the DC bus capacitors), the drive triggers **[DC Bus Ripple Warn] *d C r W*** warning.

Depending on the setting of **[DC Bus Ripple Config] *d C r C***, if **[DC Bus Ripple Warn] *d C r W*** warning is persistent during an amount of time set by an internal fixed value, **[DC Bus Ripple Error] *d C r E*** error is triggered.

[Input Filter] *, F ,*

Use of an input filter.

This parameter is forced to **[No] *n o*** if:

- **[Motor Control Type] *C t t*** is not set to **[U/F VC 5pts] *u F 5***, or
- **[U1] *u 1*** or ... or **[U5] *u 5*** is configured, or
- **[F1] *F 1*** or ... or **[F5] *F 5*** is configured.

Setting	Code / Value	Description
[No]	<i>n o</i>	No input filter used. Factory setting
[Yes]	<i>Y E 5</i>	Motor control performance is adjusted to consider the use of an input filter in order to help to prevent ripple on the DC bus.

[DC Bus Ripple Config] *d C r C*

Configuration of the DC bus ripple monitoring.

This parameter is preset to **[Error] *F L t***, if **[Input Filter] *, F ,*** is set to **[Yes] *Y E 5***.

Setting	Code / Value	Description
[Ignore]	<i>n o</i>	DC bus ripple monitoring function is inactive. This selection can't be accessed if [Input Filter] <i>, F ,</i> is set to [Yes] <i>Y E 5</i> . Factory setting
[Warning]	<i>W A r n</i>	DC bus ripple monitoring function is enabled. In case of DC bus ripple, the drive triggers [DC Bus Ripple Warn] <i>d C r W</i> warning.
[Error]	<i>F L t</i>	The DC bus ripple monitoring function is fully enabled. The drive triggers [DC Bus Ripple Error] <i>d C r E</i> error if [DC Bus Ripple Warn] <i>d C r W</i> warning is persistent.

Section 8.3

[Define system units]

[Define system units] 5 2 C - Menu

Access

[Complete settings] → [Define system units]

About This Menu

In order to be easy to configure, commission, operate, and maintain, the drive uses the application units.

The physicals that are concerned by application units are:

- Temperature values
- Currency values

NOTE: Some other default system units are automatically deduced from configurable system units or from other parameters.

System unit applies by default to all communication parameters and HMI (Graphic Display Terminal, Web server, DTM-based software).

When a system unit is changed, there is no rescaling of values. Numerical values are kept, but the meaning of these values is not the same:

- After a change, the behavior of the product will not change (the system stays numerically the same).
- If new values are written through communication or through HMI in new unit, then the behavior is impacted. In that case, all parameters should be reconfigured according to the new selected unit.
- In order to avoid issues due to a modification of system unit parameters, system units should be modified only during the installation of the product and before the commissioning of the functions.

The precision of the physical values is selected at the same time as the unit.

By default, values are signed.

Default range of values are:

16 bits values	32 bits values
-32,768...32,767	-2,147,483,648...2,147,483,648

[Temperature unit] 5 2 E P

Default system application unit used for temperature.

Available temperature units:

Unit	Symbol	Conversion
Celsius Degree	°C	-
Fahrenheit Degree	°F	TF = 9/5*Tc+32

Setting	Code / Value	Description
[0.1°C]	<i>0 1 C</i>	0.1 °C Factory setting
[0.1°F]	<i>0 1 F</i>	0.1 °F

[Currency unit list] 5 2 C U

Default system application unit used for currency.

Setting	Code / Value	Description
[EURO]	<i>E u r o</i>	Euro Factory setting
[\$]	<i>d o L L A r</i>	Dollar
[£]	<i>P o u n d</i>	Pound

Setting	Code / Value	Description
[Krone]	<i>K r</i>	Krone
[Renminbi]	<i>r Π b</i>	Renminbi
[Other]	<i>o t H E r</i>	Other

Section 8.4

[Command and Reference] C r P - Menu

[Command and Reference] C r P - Menu

Access

[Complete settings] → [Command and Reference]

Command and Reference Channels Parameter Can Be Accessed

Run commands (forward, reverse, stop, and so on) and references can be sent using the following channels:

Command	Reference
Terminals: Digital inputs DI	Terminals: Analog inputs AI, pulse input
Graphic Display Terminal	Graphic Display Terminal
Integrated Modbus	Integrated Modbus
CANopen®	CANopen
Fieldbus module	Fieldbus module
–	+/- speed via the Graphic Display Terminal
Integrated Ethernet	Integrated Ethernet

NOTE: The stop keys on the Graphic Display Terminal can be programmed as non-priority keys. A stop key can only have priority if the **[Stop Key Enable] P 5 L** parameter menu is set to **[Stop Key Priority] Y E 5** or **[Stop Key Priority All] R L L**.

The behavior of the drive can be adapted according to requirements:

- **[Not separ.] 5 , 7:** Command and reference are sent via the same channel.
- **[Separate] 5 E P:** Command and reference may be sent via different channels. In these configurations, control via the communication bus is performed in accordance with the DRIVECOM standard with only 5 freely assignable bits (see communication parameter manual). The application functions cannot be accessed via the communication interface.
- **[I/O profile] , 0:** The command and the reference can come from different channels. This configuration both simplify and extends use via the communication interface. Commands may be sent via the digital inputs on the terminals or via the communication bus. When commands are sent via a bus, they are available on a word, which acts as virtual terminals containing only digital inputs. Application functions can be assigned to the bits in this word. More than one function can be assigned to the same bit.

NOTE: Stop commands from the Graphic Display Terminal remain active even if the terminals are not the active command channel.

Reference Channel for [Not separ.] 5, 7, [Separate] SEP and [I/O profile] 10 Configurations, PID Not Configured

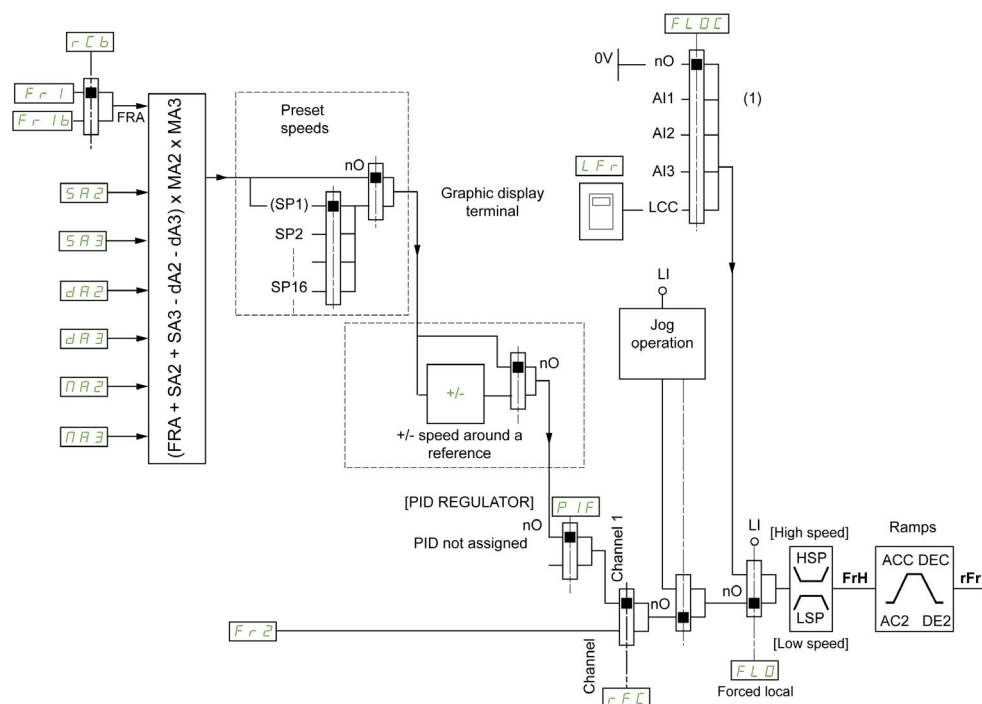

(1) Note: Forced local is not active in [I/O].

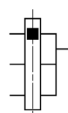

The black square represents the factory setting assignment.

Fr 1: terminals (including I/O extension module), Graphic Display Terminal, integrated Modbus, CANopen®, embedded Ethernet, DI7 PulseInput, DI8 PulseInput.

Fr 1b, for SEP and 10: terminals (including I/O extension module), Graphic Display Terminal, integrated Modbus, CANopen®, embedded Ethernet, DI7 PulseInput, DI8 PulseInput.

Fr 1b, for 5, 7: terminals (including I/O extension module), DI7 PulseInput, DI8 PulseInput.

SA2, SA3, dA2, dA3, PA2, PA3: terminals (including I/O extension module), Graphic Display Terminal, integrated Modbus, CANopen®, embedded Ethernet, DI7 PulseInput, DI8 PulseInput, and AI Virtual 1.

Fr 2: terminals (including I/O extension module), Graphic Display Terminal, integrated Modbus, CANopen®, embedded Ethernet, and Ref Freq via DI..

Reference Channel for [Not separ.] 5, 7, [Separate] SEP and [I/O profile] 10 Configurations, PID Configured with PID References at the Terminals

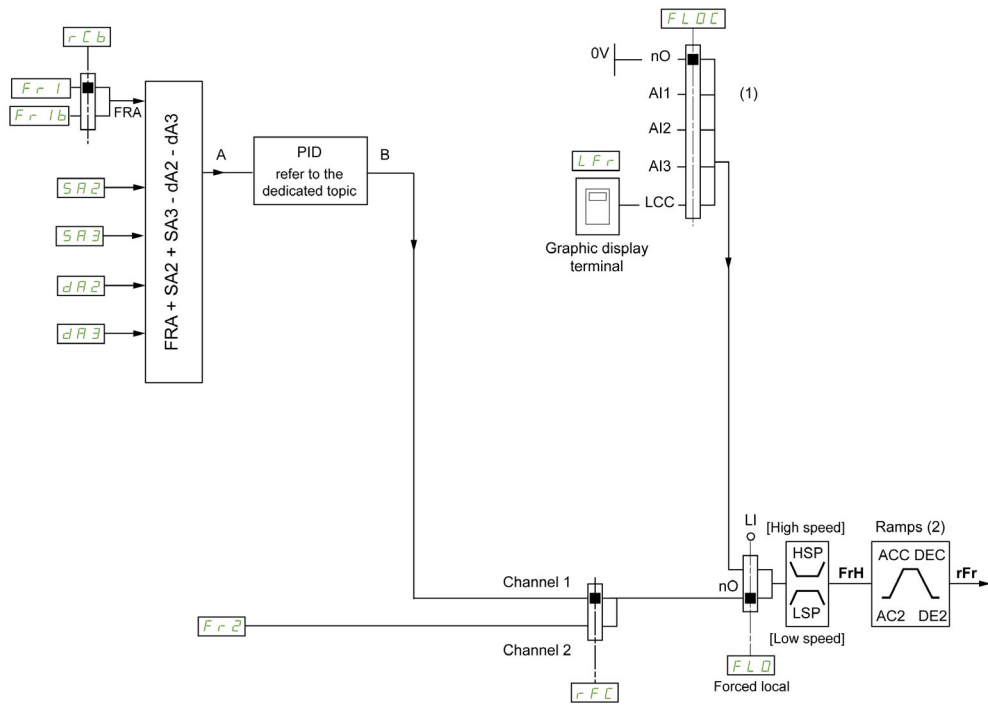

- (1) **Note:** Forced local is not active in [I/O profile].
- (2) Ramps not active if the PID function is active in automatic mode.

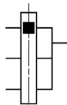

The black square represents the factory setting assignment.

Fr 1: terminals (including I/O extension module), Graphic Display Terminal, integrated Modbus, CANopen®, embedded Ethernet, DI7 PulseInput, DI8 PulseInput.

Fr 1b, for **SEP** and **10**: terminals (including I/O extension module), Graphic Display Terminal, integrated Modbus, CANopen®, embedded Ethernet, DI7 PulseInput, DI8 PulseInput.

Fr 1b, for **5, 7**: terminals (including I/O extension module), DI7 PulseInput, DI8 PulseInput.

SA2, SA3, dA2, dA3: terminals (including I/O extension module), Graphic Display Terminal, integrated Modbus, CANopen®, embedded Ethernet, DI7 PulseInput, DI8 PulseInput.

Fr 2: terminals (including I/O extension module), Graphic Display Terminal, integrated Modbus, CANopen®, embedded Ethernet, and Ref Freq via DI..

Command Channel for [Not separ.] 5, 7 configuration

Reference and command, not separate.

The command channel is determined by the reference channel. The parameters **Fr 1**, **Fr 2**, **rFc**, **FL0** and **FL0C** are common to reference and command.

Example: If the reference is **Fr 1 = R, I** (analog input at the terminals), control is via DI (digital input at the terminals).

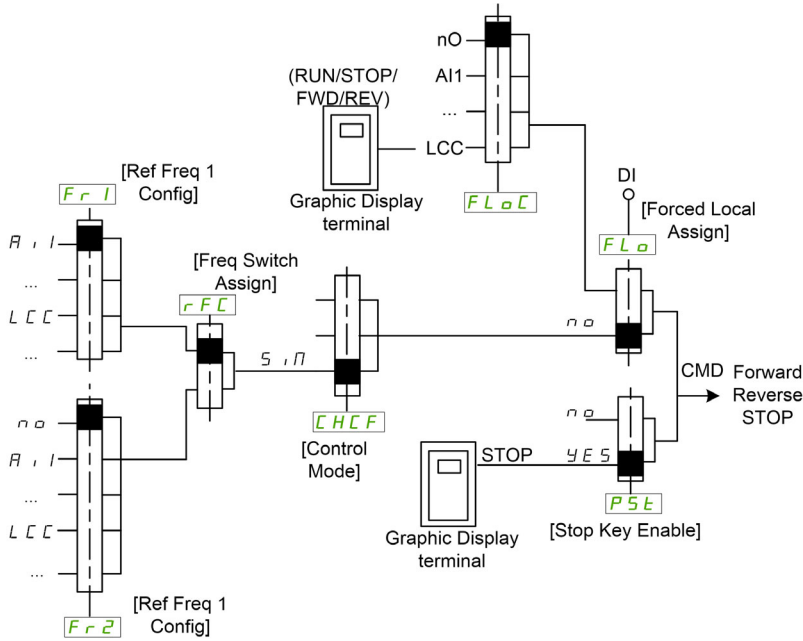

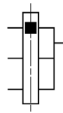
 The black square represents the factory setting assignment.

Command Channel for [Separate] SEP configuration

Separated Reference and command.

The parameters FLo and FLoC are common to reference and command.

Example: If the reference is in forced local mode via AI1 (analog input at the terminals), command in forced local mode is via DI (digital input at the terminals).

The command channels Cd1 and Cd2 are independent of the reference channels Fr1, Fr1b and Fr2.

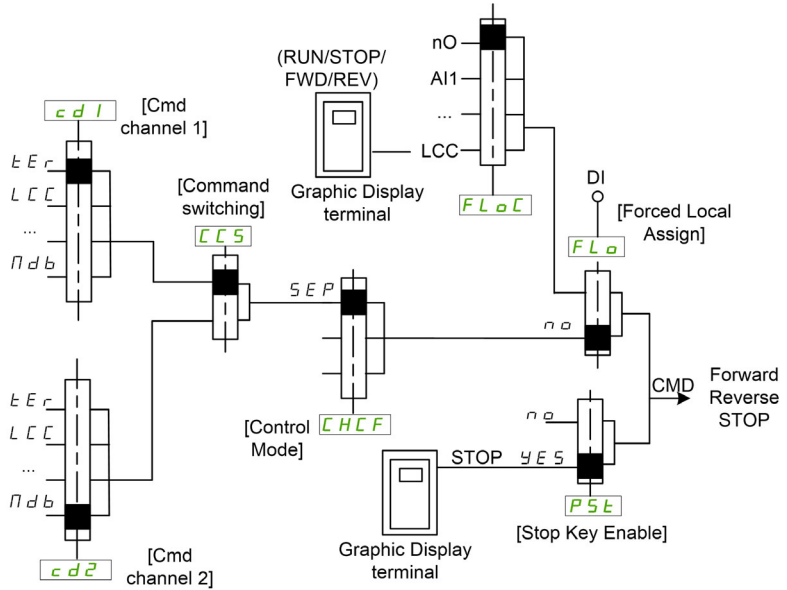

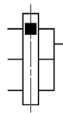
 The black square represents the factory setting assignment, except for [Control Mode] CHCF.

[Cmd channel 1] *C d 1* and [Cmd channel 2] *C d 2*: Terminals, graphic display terminal, HMI Panel, integrated Modbus, integrated CANopen®, communication card

Command Channel for I/O profile *i o* configuration

Separated Reference and command, as in [Separate] *5 E P* configuration.

The command channels *C d 1* and *C d 2* are independent of the reference channels *F r 1*, *F r 1 b* and *FR2*.

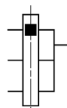
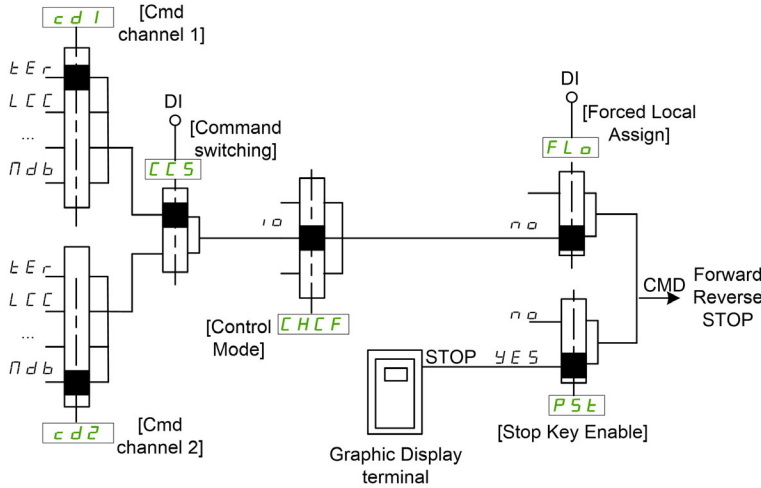

The black square represents the factory setting assignment, except for [Control Mode] *C H C F*.

[Cmd channel 1] *C d 1* and [Cmd channel 2] *C d 2*: Terminals, graphic display terminal, HMI Panel, integrated Modbus, integrated CANopen®, communication card.

A command or an action can be assigned:

- To a fixed channel by selecting a Digital input (Dix) or a Cxxx bit:
 - By selecting, for example, LI3, this action will be triggered by the digital input DI3 regardless of which command channel is switched.
 - By selecting, for example, C214, this action will be triggered by integrated CANopen® with bit 14 regardless of which command channel is switched.
- To a switchable channel by selecting a CDxx bit:
 - By selecting, for example, Cd11, this action will be triggered by: LI12 if the terminals channel is active, C111 if the integrated Modbus channel is active, C211 if the integrated CANopen® channel is active, C311 if the communication card channel is active, C511 if the Ethernet channel is active.

If the active channel is the graphic display terminal, the functions and commands assigned to CDxx switchable internal bits are inactive.

NOTE: Several CDxx does not have equivalent digital inputs and can only be used for switching between 2 networks.

[Ref Freq 1 Config] *F r 1*

Configuration reference frequency 1.

Setting	Code / Value	Description
[Not Configured]	<i>n o</i>	Not assigned
[AI1]	<i>R i 1</i>	Analog input AI1 Factory Setting
[AI2]...[AI3]	<i>R i 2...R i 3</i>	Analog input AI2...AI3
[AI Virtual 1]	<i>R i V 1</i>	Virtual analogic input 1

Setting	Code / Value	Description
[AI4]...[AI5]	<i>A 4...A 5</i>	Analog input AI4...AI5 if VW3A3203 I/O extension module has been inserted
[Ref.Freq-Rmt.Term]	<i>L C C</i>	Reference Frequency via remote terminal
[Ref. Freq-Modbus]	<i>Π d b</i>	Reference frequency via Modbus
[Ref. Freq-CANopen]	<i>C A n</i>	Reference frequency via CANopen if a CANopen module has been inserted
[Ref. Freq-Com. Module]	<i>n E t</i>	Reference frequency via fieldbus module if a fieldbus module has been inserted
[Embedded Ethernet]	<i>E t H</i>	Embedded Ethernet
[DI7 PulseInput]...[DI8 PulseInput]	<i>P 7...P 8</i>	Digital input DI7...DI8 used as pulse input
[Encoder]	<i>P G</i>	Encoder reference if an encoder module has been inserted.

[Ref.1B channel] *F r 1 b*

Configuration reference frequency 1B.

Identical to **[Ref Freq 1 Config] *F r 1*** (see above) with factory setting: **[Not Configured] *n o***.

[Ref 1B switching] *r c b*

⚠ WARNING

UNANTICIPATED EQUIPMENT OPERATION

This parameter can cause unintended movements, for example an inversion of the direction of the rotation of the motor, a sudden acceleration or a stop.

- Verify that the setting of this parameter does not cause unintended movements.
- Verify that the setting of this parameter does not result in unsafe conditions.

Failure to follow these instructions can result in death, serious injury, or equipment damage.

Select switching (1 to 1B).

- If the assigned input or bit is at *D*, **[Ref Freq 1 Config] *F r 1*** is active.
- If the assigned input or bit is at *I*, **[Ref.1B channel] *F r 1 b*** is active.

[Ref 1B switching] *r c b* is forced to **[Ref Freq Channel 1] *F r 1*** if **[Control Mode] *C H C F*** is set to **[Not separ.] *S , Π*** with **[Ref Freq 1 Config] *F r 1*** assigned via the terminals (analog inputs, pulse input).

NOTE: Activating this function from an other active command channel will also activate the monitoring of this new channel.

Setting	Code / Value	Description
[Ref Freq Channel 1]	<i>F r 1</i>	Reference channel = channel 1 (for RCB)
[Ref.1B channel]	<i>F r 1 b</i>	Reference channel = channel 1b (for RCB)
[DI1]...[DI8]	<i>L 1...L 8</i>	Digital input DI1...DI8
[DI11]...[DI16]	<i>L 11...L 16</i>	Digital input DI11...DI16 if VW3A3203 I/O extension module has been inserted
[CD00]...[CD10]	<i>C d 00...C d 10</i>	Virtual digital input CMD.0...CMD.10 in [I/O profile] <i>i o</i> configuration
[CD11]...[CD15]	<i>C d 11...C d 15</i>	Virtual digital input CMD.11...CMD.15 regardless of configuration
[C101]...[C110]	<i>C 101...C 110</i>	Virtual digital input CMD1.01...CMD1.10 with integrated Modbus Serial in [I/O profile] <i>i o</i> configuration
[C111]...[C115]	<i>C 111...C 115</i>	Virtual digital input CMD1.11...CMD1.15 with integrated Modbus Serial regardless of configuration
[C201]...[C210]	<i>C 201...C 210</i>	Virtual digital input CMD2.01...CMD2.10 with CANopen® fieldbus module in [I/O profile] <i>i o</i> configuration
[C211]...[C215]	<i>C 211...C 215</i>	Virtual digital input CMD2.11...CMD2.15 with CANopen® fieldbus module regardless of configuration

Setting	Code / Value	Description
[C301]...[C310]	C 3 0 1...C 3 1 0	Virtual digital input CMD3.01...CMD3.10 with a fieldbus module in [I/O profile] , o configuration
[C311]...[C315]	C 3 1 1...C 3 1 5	Virtual digital input CMD3.11...CMD3.15 with a fieldbus module regardless of configuration
[C501]...[C510]	C 5 0 1...C 5 1 0	Virtual digital input CMD5.01...CMD5.10 with integrated Ethernet in [I/O profile] , o configuration
[C511]...[C515]	C 5 1 1...C 5 1 5	Virtual digital input CMD5.11...CMD5.15 with integrated Ethernet regardless of configuration

[Reverse Disable] r , n

Reverse directions disable.

Lock of movement in reverse direction does not apply to direction requests sent by digital inputs.

Reverse direction requests sent by digital inputs are taken into account.

Reverse direction requests sent by the Graphic Display Terminal or sent by the line are not taken into account.

Any reverse speed reference originating from the PID, summing input, and so on, is interpreted as a zero reference (0 Hz).

Setting	Code / Value	Description
[No]	n o	No Factory Setting
[Yes]	y e s	Yes

[Control Mode] C H C F 

Mixed mode configuration.

⚠ WARNING
UNANTICIPATED EQUIPMENT OPERATION
Disabling [I/O profile] , o resets the drive to the factory settings.
<ul style="list-style-type: none"> • Verify that restoring the factory settings is compatible with the type of wiring used.
Failure to follow these instructions can result in death, serious injury, or equipment damage.

Setting	Code / Value	Description
[Not separ.]	S , n	Reference and command, not separate Factory Setting
[Separate]	S E P	Separate reference and command. This assignment cannot be accessed in [I/O profile] , o
[I/O profile]	, o	I/O profile

[Command Switching] C C S ★

⚠ WARNING
UNANTICIPATED EQUIPMENT OPERATION
This parameter can cause unintended movements, for example an inversion of the direction of the rotation of the motor, a sudden acceleration or a stop.
<ul style="list-style-type: none"> • Verify that the setting of this parameter does not cause unintended movements. • Verify that the setting of this parameter does not result in unsafe conditions.
Failure to follow these instructions can result in death, serious injury, or equipment damage.

Control channel switch.

This parameter can be accessed if **[Control Mode] C H C F** is set to **[Separate] S E P** or to **[I/O profile] , a**.
If the assigned input or bit is at 0, channel **[Cmd channel 1] C d 1** is active. If the assigned input or bit is at 1, channel **[Cmd channel 2] C d 2** is active.

NOTE: Activating this function from an other active command channel will also activate the monitoring of this new channel.

Setting	Code / Value	Description
[Command channel 1]	<i>C d 1</i>	Command channel = channel 1 (for CCS) Factory setting
[Command channel 2]	<i>C d 2</i>	Command channel = channel 2 (for CCS)
[DI1]...[DI8]	<i>L , I ... L , B</i>	Digital input DI1...DI8
[DI11]...[DI16]	<i>L , I I ... L , I B</i>	Digital input DI11...DI16 if VW3A3203 I/O extension module has been inserted
[C101]...[C110]	<i>C I D I ... C I I D</i>	Virtual digital input CMD1.01...CMD1.10 with integrated Modbus Serial in [I/O profile] , a configuration
[C111]...[C115]	<i>C I I I ... C I I S</i>	Virtual digital input CMD1.11...CMD1.15 with integrated Modbus Serial regardless of configuration
[C201]...[C210]	<i>C 2 D I ... C 2 I D</i>	Virtual digital input CMD2.01...CMD2.10 with CANopen® fieldbus module in [I/O profile] , a configuration
[C211]...[C215]	<i>C 2 I I ... C 2 I S</i>	Virtual digital input CMD2.11...CMD2.15 with CANopen® fieldbus module regardless of configuration
[C301]...[C310]	<i>C 3 D I ... C 3 I D</i>	Virtual digital input CMD3.01...CMD3.10 with a fieldbus module in [I/O profile] , a configuration
[C311]...[C315]	<i>C 3 I I ... C 3 I S</i>	Virtual digital input CMD3.11...CMD3.15 with a fieldbus module regardless of configuration
[C501]...[C510]	<i>C 5 D I ... C 5 I D</i>	Virtual digital input CMD5.01...CMD5.10 with integrated Ethernet in [I/O profile] , a configuration
[C511]...[C515]	<i>C 5 I I ... C 5 I S</i>	Virtual digital input CMD5.11...CMD5.15 with integrated Ethernet regardless of configuration

[Cmd channel 1] C d 1 ★

Command channel 1 assignment.

This parameter can be accessed if **[Control Mode] C H C F** is set to **[Separate] S E P** or **[I/O profile] , a**.

Setting	Code / Value	Description
[Terminals]	<i>t E r</i>	Terminal block source Factory Setting
[Ref.Freq-Rmt.Term]	<i>L C C</i>	Command via Graphic Display Terminal
[Ref. Freq-Modbus]	<i>M d b</i>	Command via Modbus
[Ref. Freq-CANopen]	<i>C A n</i>	Command via CANopen if a CANopen module has been inserted
[Ref. Freq-Com. Module]	<i>n E t</i>	Command via fieldbus module if a fieldbus module has been inserted
[Embedded Ethernet]	<i>E t H</i>	Command via Embedded Ethernet

[Cmd channel 2] C d 2 ★

Command channel 2 assignment.

This parameter can be accessed if **[Control Mode] C H C F** is set to **[Separate] S E P** or **[I/O profile] , a**.

Identical to **[Cmd channel 1] C d 1** with factory setting **[Ref. Freq-Modbus] M d b**.

[Freq Switch Assign] *r F C*

⚠ WARNING

UNANTICIPATED EQUIPMENT OPERATION

This parameter can cause unintended movements, for example an inversion of the direction of the rotation of the motor, a sudden acceleration or a stop.

- Verify that the setting of this parameter does not cause unintended movements.
- Verify that the setting of this parameter does not result in unsafe conditions.

Failure to follow these instructions can result in death, serious injury, or equipment damage.

frequency switching assignment.

If the assigned input or bit is at 0, channel [Ref Freq Channel 1] *r F C 1* is active.

If the assigned input or bit is at 1, channel [Ref Freq Channel 2] *r F C 2* is active.

NOTE: Activating this function from an other active command channel will also activate the monitoring of this new channel.

Setting	Code / Value	Description
[Ref Freq Channel 1]	<i>r F C 1</i>	Reference channel = channel 1 (for RFC)
[Ref Freq Channel 2]	<i>r F C 2</i>	Reference channel = channel 2 (for RFC)
[DI1]...[DI8]	<i>L 1...L 8</i>	Digital input DI1...DI8
[DI11]...[DI16]	<i>L 11...L 16</i>	Digital input DI11...DI16 if VW3A3203 I/O extension module has been inserted
[CD00]...[CD10]	<i>C d 0 0...C d 1 0</i>	Virtual digital input CMD.0...CMD.10 in [I/O profile] <i>r o</i> configuration
[CD11]...[CD15]	<i>C d 1 1...C d 1 5</i>	Virtual digital input CMD.11...CMD.15 regardless of configuration
[C101]...[C110]	<i>C 1 0 1...C 1 1 0</i>	Virtual digital input CMD1.01...CMD1.10 with integrated Modbus Serial in [I/O profile] <i>r o</i> configuration
[C111]...[C115]	<i>C 1 1 1...C 1 1 5</i>	Virtual digital input CMD1.11...CMD1.15 with integrated Modbus Serial regardless of configuration
[C201]...[C210]	<i>C 2 0 1...C 2 1 0</i>	Virtual digital input CMD2.01...CMD2.10 with CANopen® fieldbus module in [I/O profile] <i>r o</i> configuration
[C211]...[C215]	<i>C 2 1 1...C 2 1 5</i>	Virtual digital input CMD2.11...CMD2.15 with CANopen® fieldbus module regardless of configuration
[C301]...[C310]	<i>C 3 0 1...C 3 1 0</i>	Virtual digital input CMD3.01...CMD3.10 with a fieldbus module in [I/O profile] <i>r o</i> configuration
[C311]...[C315]	<i>C 3 1 1...C 3 1 5</i>	Virtual digital input CMD3.11...CMD3.15 with a fieldbus module regardless of configuration
[C501]...[C510]	<i>C 5 0 1...C 5 1 0</i>	Virtual digital input CMD5.01...CMD5.10 with integrated Ethernet in [I/O profile] <i>r o</i> configuration
[C511]...[C515]	<i>C 5 1 1...C 5 1 5</i>	Virtual digital input CMD5.11...CMD5.15 with integrated Ethernet regardless of configuration

[Ref Freq 2 Config] *r F C 2*

Configuration reference frequency 2.

Setting	Code / Value	Description
[Not Configured]	<i>r o</i>	Not assigned. If [Control Mode] <i>C H C F</i> is set to [Not separ.] <i>S 1</i> , the command is at the terminals with a zero reference. If [Control Mode] <i>C H C F</i> is set to [Separate] <i>S E P</i> or [I/O profile] <i>r o</i> , the reference is zero. Factory Setting
[AI1]...[AI3]	<i>R 1...R 3</i>	Analog input AI1...AI3
[AI4]...[AI5]	<i>R 4...R 5</i>	Analog input AI4...AI5 if VW3A3203 I/O extension module has been inserted
[AI Virtual 1]	<i>R v 1</i>	Virtual analogic input 1

Setting	Code / Value	Description
[Ref Frequency via DI]	$\omega P d t$	+/- speed command assigned to DIx
[Ref.Freq-Rmt.Term]	$L C C$	Reference frequency via Graphic Display Terminal
[Ref. Freq-Modbus]	$\Pi d b$	Reference frequency via Modbus
[Ref. Freq-CANopen]	$C R n$	Reference frequency via CANopen if a CANopen module has been inserted
[Ref. Freq-Com. Module]	$n E t$	Reference frequency via fieldbus module if a fieldbus module has been inserted
[Embedded Ethernet]	$E t h$	Integrated Ethernet
[DI7 PulseInput]...[DI8 PulseInput]	$P , 7 \dots P , 8$	Digital input DI7...DI8 used as pulse input
[Encoder]	$P G$	Encoder reference if an encoder module has been inserted.

[Copy Ch1-Ch2] $C \square P$ 

Copy channel 1 reference frequency to channel 2.

WARNING

UNANTICIPATED EQUIPMENT OPERATION

This parameter can cause unintended movements, for example an inversion of the direction of the rotation of the motor, a sudden acceleration or a stop.

- Verify that the setting of this parameter does not cause unintended movements.
- Verify that the setting of this parameter does not result in unsafe conditions.

Failure to follow these instructions can result in death, serious injury, or equipment damage.

Can be used to copy the current reference and/or the command with switching in order to avoid speed surges, for example.

If [Control Mode] $C H C F$ (see page 228) is set to [Not separ.] S , Π or [Separate] $S E P$, copying is possible only from channel 1 to channel 2.

If [Control Mode] $C H C F$ is set to [I/O profile] $\square \square$, copying is possible in both directions. A reference or a command cannot be copied to a channel on the terminals. The reference copied is [Pre-Ramp Ref Freq] $F r H$ (before ramp) unless the destination channel reference is set via +/- speed. In this case, the reference copied is [Output frequency] $r F r$ (after ramp).

Setting	Code / Value	Description
[No]	$n \square$	No copy Factory Setting
[Reference Frequency]	$S P$	Copy reference
[Command]	$C d$	Copy command
[Cmd + Ref Frequency]	$R L L$	Copy reference and command

As the Graphic Display Terminal may be selected as the command and/or reference channel, its action modes can be configured.

Comments:

- The Graphic Display Terminal command/reference is only active if the command and/or reference channels from the terminal are active except for BMP with Local/ Remote key (command via the Graphic Display Terminal), which takes priority over these channels. Press Local/ Remote key again to revert control to the selected channel.
- Command and reference via the Graphic Display Terminal are impossible if the latter is connected to more than one drive.

- The preset PID reference functions can only be accessed if **[Control Mode] C H C F** is set to **[Not separ.] S , P** or **[Separate] S E P**.
- The command via the Graphic Display Terminal can be accessed regardless of the **[Control Mode] C H C F**.

[Forced Local Freq] F L o C

Forced local reference source assignment.

Setting	Code / Value	Description
[Not Configured]	n o	Not assigned (control via the terminals with zero reference) Factory Setting
[AI1]...[AI3]	R , 1...R , 3	Analog input AI1...AI3
[AI4]...[AI5]	R , 4...R , 5	Analog input AI4...AI5 if VW3A3203 I/O extension module has been inserted
[Ref.Freq-Rmt.Term]	L C C	Graphic Display Terminal
[DI7 PulseInput]...[DI8 PulseInput]	P , 7...P , 8	Digital input DI7...DI8 used as pulse input
[Encoder]	P G	Encoder reference if an encoder module has been inserted.

[Time-out Forc. Local] F L o t ★

Time for channel confirmation after forced local.

This parameter can be accessed if **[Forced Local Assign] F L o** is not set to **[No] n o**.

Setting ()	Description
0.1...30.0 s	Setting range Factory setting: 10.0 s

[Forced Local Assign] F L o

Forced local assignment.

Forced local mode is active when the input is at state 1.

[Forced Local Assign] F L o is forced to **[No] n o** if **[Control Mode] C H C F** is set to **[I/O profile] , o**.

Setting	Code / Value	Description
[Not Assigned]	n o	Not assigned Factory setting
[DI1]...[DI8]	L , 1...L , 8	Digital input DI1...DI8
[DI11]...[DI16]	L , 11...L , 16	Digital input DI11...DI16 if VW3A3203 I/O extension module has been inserted

[Reverse Assign] r r S

Reverse assignment.

Setting	Code / Value	Description
[Not Assigned]	n o	Not assigned Factory setting
[DI1]...[DI8]	L , 1...L , 8	Digital input DI1...DI8
[DI11]...[DI16]	L , 11...L , 16	Digital input DI11...DI16 if VW3A3203 I/O extension module has been inserted
[CD00]...[CD10]	C d 00...C d 10	Virtual digital input CMD.0...CMD.10 in [I/O profile] , o configuration
[CD11]...[CD15]	C d 11...C d 15	Virtual digital input CMD.11...CMD.15 regardless of configuration
[C101]...[C110]	C 101...C 110	Virtual digital input CMD1.01...CMD1.10 with integrated Modbus Serial in [I/O profile] , o configuration

Setting	Code / Value	Description
[C111]...[C115]	C 1 1 1 ... C 1 1 5	Virtual digital input CMD1.11...CMD1.15 with integrated Modbus Serial regardless of configuration
[C201]...[C210]	C 2 0 1 ... C 2 1 0	Virtual digital input CMD2.01...CMD2.10 with CANopen® fieldbus module in [I/O profile] configuration
[C211]...[C215]	C 2 1 1 ... C 2 1 5	Virtual digital input CMD2.11...CMD2.15 with CANopen® fieldbus module regardless of configuration
[C301]...[C310]	C 3 0 1 ... C 3 1 0	Virtual digital input CMD3.01...CMD3.10 with a fieldbus module in [I/O profile] configuration
[C311]...[C315]	C 3 1 1 ... C 3 1 5	Virtual digital input CMD3.11...CMD3.15 with a fieldbus module regardless of configuration
[C501]...[C510]	C 5 0 1 ... C 5 1 0	Virtual digital input CMD5.01...CMD5.10 with integrated Ethernet in [I/O profile] configuration
[C511]...[C515]	C 5 1 1 ... C 5 1 5	Virtual digital input CMD5.11...CMD5.15 with integrated Ethernet regardless of configuration

[2/3-wire control] 2 2 2 

2-wire or 3-wire control.

WARNING

UNANTICIPATED EQUIPMENT OPERATION

If this parameter is changed, the parameters **[Reverse Assign]** r r 5 and **[2-wire type]** 2 2 2 and the assignments of the digital inputs are reset to the factory setting.

Verify that this change is compatible with the type of wiring used.

Failure to follow these instructions can result in death, serious injury, or equipment damage.

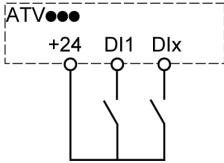
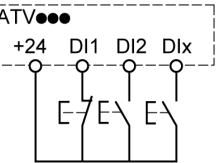
Setting	Code / Value	Description
[2-Wire Control]	2 2	<p>2-wire control (level commands): This is the input state (0 or 1) or edge (0 to 1 or 1 to 0), which controls running or stopping.</p> <p>Example of source wiring:</p>  <p>DI1 Forward DIx Reverse</p> <p>Factory setting</p>
[3-Wire Control]	3 2	<p>3-wire control (pulse commands) [3 wire]: A forward or reverse pulse is sufficient to command starting, a stop pulse is sufficient to command stopping.</p> <p>Example of source wiring:</p>  <p>DI1 Stop DI2 Forward DIx Reverse</p>

[2-wire type] LCL ★ 

Type of 2-wire control.

This parameter can be accessed if [2/3-wire control] LCL is set to [2-Wire Control] $2C$.

⚠ WARNING
UNANTICIPATED EQUIPMENT OPERATION
Verify that the parameter setting is compatible with the type of wiring used. Failure to follow these instructions can result in death, serious injury, or equipment damage.

Setting	Code / Value	Description
[Level]	LEL	State 0 or 1 is taken into account for run (1) or stop (0)
[Transition]	Ern	A change of state (transition or edge) is necessary to initiate operation in order to avoid accidental restarts after a break in the supply mains Factory setting
[Level With Fwd Priority]	PFa	State 0 or 1 is taken into account for run or stop, but the "forward" input takes priority over the "reverse" input

[Stop Key Enable] $P5L$ 

STOP/RESET key enable.

Setting this function to na disables the STOP key of the Display Terminal if the setting of the parameter [Command Channel] $CndC$ is not [Ref. Freq-Rmt.Term] LCL .

⚠ WARNING
LOSS OF CONTROL
Only set this parameter to na if you have implemented appropriate alternative stop functions. Failure to follow these instructions can result in death, serious injury, or equipment damage.

If 2-wire control by level is active (parameter [2/3-Wire Control] LCL set to [2-Wire Control] $2C$ and parameter [2-wire type] LCL set to [Level] LEL or [Level With Fwd Priority] PFa) and the parameter $P5L$ set to [Stop Key Priority All] is set to [Stop Key Priority All] ALL , the motor starts if the STOP/RESET key of the Display Terminal is pressed while a run command is active.

⚠ WARNING
UNANTICIPATED EQUIPMENT OPERATION
Only set the parameter [Stop Key Enable] $P5L$ to [Stop Key Priority All] ALL in 2-wire control by level after having verified that this setting cannot result in unsafe conditions. Failure to follow these instructions can result in death, serious injury, or equipment damage.

Irrespective of the configuration of [Stop Key Enable] $P5L$, if the active command channel is the Graphic Display Terminal, the STOP/RESET key performs:

- in run, a stop according to the [Type of stop] $5LE$,
- in "Operating State Fault", a fault reset command.

The following table gives the behavior of the function when the Graphic Display Terminal is not the active command channel:

Setting	Code / Value	Description
[Stop Key No Priority]	na	Disables the STOP/RESET key on the Graphic Display Terminal.
NOTE: The Fault Reset function is disabled in Multipoint mode (<i>see page 45</i>).		

Setting	Code / Value	Description
[Stop Key Priority]	<i>5 E 5</i>	Gives priority to the STOP/RESET key on the Graphic Display Terminal. Only the stop function is enabled. The stop is performed in freewheel. Factory Setting
[Stop Key Priority All]	<i>A L L</i>	Gives priority to the STOP/RESET key on the Graphic Display Terminal. The fault reset function and the stop function are enabled. The stop is performed depending on [Type of Stop] <i>5 E 5</i> setting value.
NOTE: The Fault Reset function is disabled in Multipoint mode (<i>see page 45</i>).		

[HMI cmd.] *b n P*

HMI command.

Setting	Code / Value	Description
[Stop]	<i>5 E a P</i>	Stops the drive (although the controlled direction of operation and reference of the previous channel are copied (to be taken into account on the next RUN command))
[Bumpless]	<i>b u n P</i>	Does not stop the drive (the controlled direction of operation and the reference of the previous channel are copied)
[Disabled]	<i>d i 5</i>	Disabled Factory Setting

Section 8.5

[Pump functions] - [PID controller]

What Is in This Section?

This section contains the following topics:

Topic	Page
[PID controller] <i>P i d</i> - Overview	237
[PID Feedback] <i>F d b</i> - Menu	241
[PID Reference] <i>r F</i> - Menu	247
[PID preset references] <i>P r i</i> - Menu	250
[PID Reference] <i>r F</i> - Menu	252
[Settings] <i>S t</i> - Menu	253

[PID controller] P_{id} - Overview

About This Menu

NOTE: This function cannot be used with some other functions.

Block Diagram

The function is activated by assigning an analog input to the PID feedback (measurement).

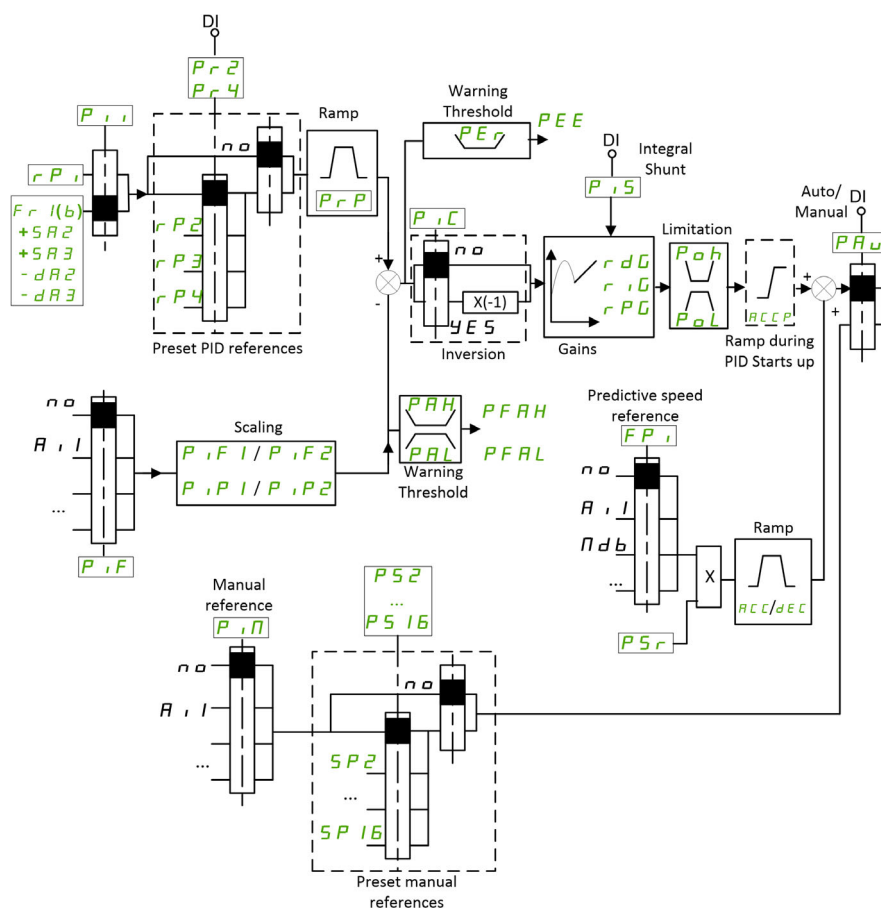

The PID feedback needs to be assigned to one of the analog inputs A11 to A15 or a pulse input, according to whether any I/O extension module has been inserted.

The PID reference needs to be assigned to the following parameters:

- Preset references via digital inputs ([Ref PID Preset 2] $rP2$, [Ref PID Preset 3] $rP3$, [Ref PID Preset 4] $rP4$).
- In accordance with the configuration of [Intern PID Ref] P_{i1} :
 - [Internal PID ref] $rP1$, or
 - Reference A [Ref Freq 1 Config] F_{r1} or [Ref.1B channel] F_{r1b} .

Combination Table for Preset PID References:

DI (Pr 4)	DI (Pr 2)	Pr 2 = no	Reference
0	0		r P 1, or F r I (b)
0	1		r P 2
1	0		r P 3
1	1		r P 4

A predictive speed reference can be used to initialize the speed on restarting the process.

Scaling of feedback and references:

- **[Min PID feedback] P , F 1, [Max PID feedback] P , F 2** parameters can be used to scale the PID feedback (sensor range). This scale must be maintained for all other parameters.
- **[Min PID Process] P , P 1, [Max PID Process] P , P 2** parameters can be used to scale the adjustment range, for example the reference. **Check that the adjustment range remains within the sensor range.**

The maximum value of the scaling parameters is 32,767. To facilitate the installation, it is recommended to use values as close as possible to this maximum level, while retaining powers of 10 in relation to the actual values. The scaling is without unit if **[Type of control] E o C E** is set to **[NA] n R**, in % if set to **[OTHER] o E H E r**.

Example

Adjustment of the volume in a tank, 6...15 m³.

- Probe used 4-20 mA, 4.5 m³ for 4 mA and 20 m³ for 20 mA, with the result that **P , F 1 = 4,500** and **P , F 2 = 20,000**.
- Adjustment range 6 to 15 m³, with the result that **P , P 1 = 6,000** (min. reference) and **P , P 2 = 15,000** (max. reference).
- Example references:
 - **r P 1** (internal reference) = 9,500
 - **r P 2** (preset reference) = 6,500
 - **r P 3** (preset reference) = 8,000
 - **r P 4** (preset reference) = 11,200

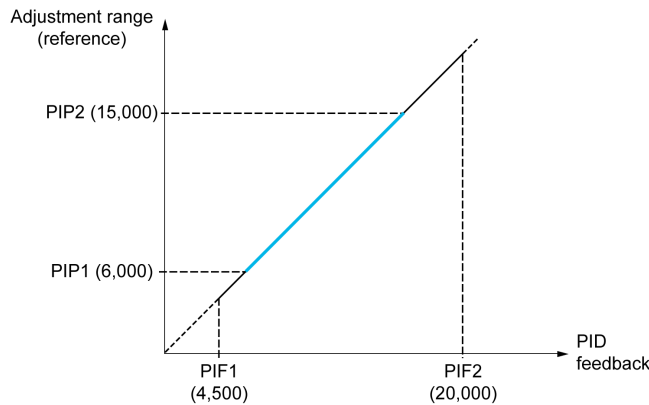

Other parameters:

- Reversal of the direction of correction **[PID Inversion] P , C**. If **[PID Inversion] P , C** is set to **[No] n o**, the speed of the motor increases when the detected error is positive (for example pressure control with a compressor). If **[PID Inversion] P , C** is set to **[Yes] Y E S**, the speed of the motor decreases when the detected error is positive (for example temperature control using a cooling fan).
- The integral gain may be short-circuited by a digital input.
- A warning on the **[PID feedback Assign] P , F** may be configured.
- A warning on the **[PID error] r P E** may be configured.

"Manual - Automatic" Operation with PID

This function combines the PID controller, the preset speeds, and a manual reference. Depending on the state of the digital input, the speed reference is given by the preset speeds or by a manual reference input via the PID function.

Manual PID reference **[Manual PID reference]** P_{PI} :

- Analog inputs AI1 to AI5
- Pulse inputs

Predictive speed reference **[Predictive Speed Ref]** F_{PI} :

- **[AI1]** A_{PI1} : analog input
- **[AI2]** A_{PI2} : analog input
- **[AI3]** A_{PI3} : analog input
- **[AI4]** A_{PI4} : analog input if VW3A3203 I/O extension module has been inserted
- **[AI5]** A_{PI5} : analog input if VW3A3203 I/O extension module has been inserted
- **[DI7 PulseInput]** P_{PI7} : pulse input
- **[DI8 PulseInput]** P_{PI8} : pulse input
- **[Ref.Freq-Rmt.Term]** L_{PI} : Graphic Display Terminal
- **[Modbus]** M_{PI} : integrated Modbus
- **[CANopen]** C_{PI} : CANopen® (if inserted)
- **[Com. Module]** E_{PI} : fieldbus option module (if inserted)
- **[Embedded Ethernet]** E_{PIH} : integrated Ethernet

Setting Up the PID Controller

1. Configuration in PID mode.

Refer to the Block Diagram (*see page 237*).

2. Perform a test in factory settings mode.

To optimize the drive, adjust **[PID Prop.Gain]** r_{PI} or **[PID Intgl.Gain]** r_{PII} gradually and independently, and observe the effect on the PID feedback in relation to the reference.

3. If the factory settings are unstable or the reference is incorrect.

Step	Action
1	Perform a test with a speed reference in Manual mode (without PID controller) and with the drive on load for the speed range of the system: <ul style="list-style-type: none"> • In steady state, the speed must be stable and comply with the reference, and the PID feedback signal must be stable. • In transient state, the speed must follow the ramp and stabilize quickly, and the PID feedback must follow the speed. If not, see the settings for the drive and/or sensor signal and wiring.
2	Switch to PID mode.
3	Set [PID ramp] r_{PIr} to the minimum permitted by the mechanism without triggering an [DC Bus Overvoltage] o_{bF} .
4	Set the integral gain [PID Intgl.Gain] r_{PII} to minimum.
5	Leave the derivative gain [PID derivative gain] r_{PIDG} at 0.
6	Observe the PID feedback and the reference.
7	Switch the drive ON/OFF a number of times or vary the load or reference rapidly a number of times.
8	Set the proportional gain [PID Prop.Gain] r_{PIr} in order to ascertain the compromise between response time and stability in transient phases (slight overshoot and 1 to 2 oscillations before stabilizing).
9	If the reference varies from the preset value in steady state, gradually increase the integral gain [PID Intgl.Gain] r_{PII} , reduce the proportional gain [PID Prop.Gain] r_{PIr} in the event of instability (pump applications), find a compromise between response time and static precision (see diagram).
10	Lastly, the derivative gain may permit the overshoot to be reduced and the response time to be improved, although this is more difficult to obtain a compromise in terms of stability, as it depends on 3 gains.
11	Perform in-production tests over the whole reference range.

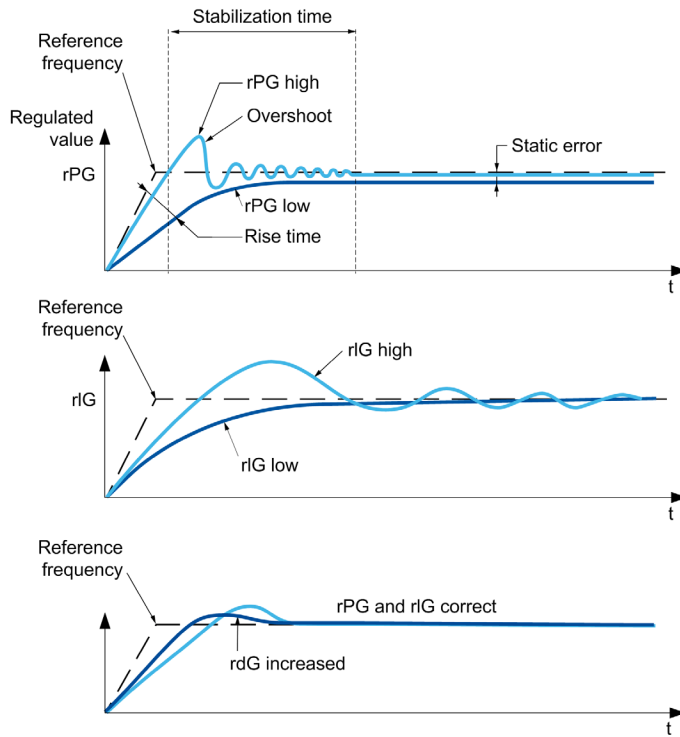

The oscillation frequency depends on the system kinematics:

Parameter	Rise time	Overshoot	Stabilization time	Static error
rPG +	--	+	=	-
rIG +	-	++	+	--
rdG +	=	-	-	=

[PID Feedback] *F d b* - Menu

Access

[Complete settings] → [Pump functions] → [PID controller] → [PID Feedback]

About This Menu

NOTE: This function cannot be used with some other functions.

[Type of Control] *t o C t*

Type of control for the PID = unit choice.

Setting	Code / Value	Description
[nA]	<i>n A</i>	(without unit) Factory setting
[Other]	<i>o t H E r</i>	Other control and unit (%)

[PID feedback Assign] *P , F*

PID controller feedback.

Setting	Code / Value	Description
[No]	<i>n o</i>	Not assigned Factory setting
[AI1]...[AI3]	<i>A , 1...A , 3</i>	Analog input AI1...AI3
[AI4]...[AI5]	<i>A , 4...A , 5</i>	Analog input AI4...AI5 if VW3A3203 I/O extension module has been inserted
[AI Virtual 1]...[AI Virtual 3]	<i>A , V 1...A , V 3</i>	Virtual analogic input 1...3
[DI7 PulseInput]...[DI8 PulseInput]	<i>P , 7...P , 8</i>	Digital input DI7...DI8 used as pulse input
[Encoder]	<i>P G</i>	Encoder reference if an encoder module has been inserted.

[AI1 Type] *A , I t* ★

Configuration of analog input AI1.

This parameter can be accessed if [PID feedback Assign] *P , F* is set to [AI1] *A , I*.

Setting	Code / Value	Description
[Voltage]	<i>I D v</i>	0-10 Vdc Factory setting
[Current]	<i>D A</i>	0-20 mA

[AI1 min value] *v , L I* ★

AI1 voltage scaling parameter of 0%.

This parameter can be accessed if:

- [PID feedback Assign] *P , F* is set to [AI1] *A , I*, and
- [AI1 Type] *A , I t* is set to [Voltage] *I D v*.

Setting	Description
0.0...10.0 Vdc	Setting range Factory setting: 0.0 Vdc

[AI1 max value] μ , H / ★

AI1 voltage scaling parameter of 100%.

This parameter can be accessed if:

- [PID feedback Assign] P, F is set to [AI1] R, I , and
- [AI1 Type] R, I, E is set to [Voltage] I, μ .

Setting	Description
0.0...10.0 Vdc	Setting range Factory setting: 10.0 Vdc

[AI1 min. value] $\epsilon, r, L / ★$

AI1 current scaling parameter of 0%.

This parameter can be accessed if:

- [PID feedback Assign] P, F is set to [AI1] R, I , and
- [AI1 Type] R, I, E is set to [Current] \square, R .

Setting	Description
0.0...20.0 mA	Setting range Factory setting: 0.0 mA

[AI1 max. value] $\epsilon, r, H / ★$

AI1 current scaling parameter of 100%.

This parameter can be accessed if:

- [PID feedback Assign] P, F is set to [AI1] R, I , and
- [AI1 Type] R, I, E is set to [Current] \square, R .

Setting	Description
0.0...20.0 mA	Setting range Factory setting: 20.0 mA

[AI1 range] $R, I, L / ★$

AI1 scaling selection.

This parameter can be accessed if:

- [PID feedback Assign] P, F is set to [AI1] $R, I, 2, 1$, and
- [AI1 Type] R, I, E is set to [Current] \square, R .

This parameter is forced to [0-100%] $P, \square, 5$ if:

- [AI1 Type] R, I, E is no set to [Current] \square, R , or
- [AI1 min. value] ϵ, r, L, I is lower than 3.0 mA.

Setting	Code / Value	Description
[0-100%]	$P, \square, 5$	Unidirectional: AI1 current scaling is 0% up to 100%. Factory setting
[-/+100%]	$P, \square, 5, n, E, G$	Bidirectional: AI1 current scaling is -100% up to 100%. [AI1 min. value] ϵ, r, L, I corresponds to -100%. [AI1 max. value] ϵ, r, H, I corresponds to 100%.

[AI2 Type] $R, I, 2, E / ★$

Configuration of analog input AI2.

This parameter can be accessed if [PID feedback Assign] P, F is set to [AI2] $R, I, 2$.

Setting	Code / Value	Description
[Voltage]	I, \square, μ	0-10 Vdc
[Voltage +/-]	n, I, \square, μ	-10/+10 Vdc Factory setting

[AI2 min value] U , L 2 ★

AI2 voltage scaling parameter of 0%.

This parameter can be accessed if:

- **[PID feedback Assign] P , F** is set to **[AI2] R , 2**, and
- **[AI2 Type] R , 2 E** is set to **[Voltage] I 0 U**.

Identical to **[AI1 min value] U , L 1** (*see page 241*).

[AI2 max value] U , H 2 ★

AI2 voltage scaling parameter of 100%.

This parameter can be accessed if:

- **[PID feedback Assign] P , F** is set to **[AI2] R , 2**, and
- **[AI2 Type] R , 2 E** is set to **[Voltage] I 0 U**.

Identical to **[AI1 max value] U , H 1** (*see page 242*).

[AI3 Type] R , 3 E ★

Configuration of analog input AI3.

This parameter can be accessed if **[PID feedback Assign] P , F** is set to **[AI3] R , 3**.

Identical to **[AI1 Type] R , 1 E** with factory setting: **[Current] 0 R** (*see page 242*).

[AI3 min value] U , L 3 ★

AI3 voltage scaling parameter of 0%.

This parameter can be accessed if:

- **[PID feedback Assign] P , F** is set to **[AI3] R , 3**, and
- **[AI3 Type] R , 3 E** is set to **[Voltage] I 0 U**.

Identical to **[AI1 min value] U , L 1** (*see page 241*).

[AI3 max value] U , H 3 ★

AI3 voltage scaling parameter of 100%.

This parameter can be accessed if:

- **[PID feedback Assign] P , F** is set to **[AI3] R , 3**, and
- **[AI3 Type] R , 3 E** is set to **[Voltage] I 0 U**.

Identical to **[AI1 max value] U , H 1** (*see page 242*).

[AI3 min. value] C r L 3 ★

AI3 current scaling parameter of 0%.

This parameter can be accessed if:

- **[PID feedback Assign] P , F** is set to **[AI3] R , 3**, and
- **[AI3 Type] R , 3 E** is set to **[Current] 0 R**.

Identical to **[AI1 min. value] C r L 1** (*see page 242*).

[AI3 max. value] C r H 3 ★

AI3 current scaling parameter of 100%.

This parameter can be accessed if:

- **[PID feedback Assign] P , F** is set to **[AI3] R , 3**, and
- **[AI3 Type] R , 3 E** is set to **[Current] 0 R**.

Identical to **[AI1 max. value] C r H 1** (*see page 242*).

[AI3 range] R , 3 L

AI3 scaling selection.

This parameter can be accessed if :

- **[PID feedback Assign] P , F** is set to **[AI3] R , 3**, and
- **[AI3 Type] R , 3 E** is set to **[Current] D R**.

Identical to **[AI1 range] R , 1 L**.

[AI4 Type] R , 4 E ★

Configuration of analog input AI4.

This parameter can be accessed if:

- VW3A3203 I/O extension module has been inserted, and
- **[PID feedback Assign] P , F** is set to **[AI4] R , 4**.

Setting	Code / Value	Description
[Voltage]	1 D u	0-10 Vdc
[Current]	D R	0-20 mA Factory setting
[Voltage +/-]	n 1 D u	-10/+10 Vdc

[AI4 min value] u , L 4 ★

AI4 voltage scaling parameter of 0%.

This parameter can be accessed if:

- **[PID feedback Assign] P , F** is set to **[AI4] R , 4**, and
- **[AI4 Type] R , 4 E** is set to **[Voltage] 1 D u**.

Identical to **[AI1 min value] u , L 1** (*see page 241*).

[AI4 max value] u , H 4 ★

AI4 voltage scaling parameter of 100%.

This parameter can be accessed if:

- **[PID feedback Assign] P , F** is set to **[AI4] R , 4**, and
- **[AI4 Type] R , 4 E** is set to **[Voltage] 1 D u**.

Identical to **[AI1 max value] u , H 1** (*see page 242*).

[AI4 min. value] C r L 4 ★

AI4 current scaling parameter of 0%.

This parameter can be accessed if:

- **[PID feedback Assign] P , F** is set to **[AI4] R , 4**, and
- **[AI4 Type] R , 4 E** is set to **[Current] D R**.

Identical to **[AI1 min. value] C r L 1** (*see page 242*).

[AI4 max. value] C r H 4 ★

AI4 current scaling parameter of 100%.

This parameter can be accessed if:

- **[PID feedback Assign] P , F** is set to **[AI4] R , 4**, and
- **[AI4 Type] R , 4 E** is not set to **[Current] D R**.

Identical to **[AI1 max. value] C r H 1** (*see page 242*).

[AI4 range] R , 4 L

AI4 scaling selection.

This parameter can be accessed if :

- **[PID feedback Assign] P , F** is set to **[AI4] R , 4**, and
- **[AI4 Type] R , 4 E** is set to **[Current] D R**.

Identical to **[AI1 range] R , 1 L**.

[AI5 Type] R , 5 E ★

Configuration of analog input AI5.

This parameter can be accessed if:

- VW3A3203 I/O extension module has been inserted, and
- **[PID feedback Assign] P , F** is set to **[AI5] R , 5**.

Identical to **[AI4 Type] R , 4 E** (*see page 244*).

[AI5 min value] U , L 5 ★

AI5 voltage scaling parameter of 0%.

This parameter can be accessed if:

- **[PID feedback Assign] P , F** is set to **[AI5] R , 5**, and
- **[AI5 Type] R , 5 E** is set to **[Voltage] I D U**.

Identical to **[AI1 min value] U , L 1** (*see page 241*).

[AI5 max value] U , H 5 ★

AI5 voltage scaling parameter of 100%.

This parameter can be accessed if:

- **[PID feedback Assign] P , F** is set to **[AI5] R , 5**, and
- **[AI5 Type] R , 5 E** is set to **[Voltage] I D U**.

Identical to **[AI1 max value] U , H 1** (*see page 242*).

[AI5 min. value] C r L 5 ★

AI5 current scaling parameter of 0%.

This parameter can be accessed if:

- **[PID feedback Assign] P , F** is set to **[AI5] R , 5**, and
- **[AI5 Type] R , 5 E** is set to **[Current] D R**.

Identical to **[AI1 min. value] C r L 1** (*see page 242*).

[AI5 max. value] C r H 5 ★

AI5 current scaling parameter of 100%.

This parameter can be accessed if:

- **[PID feedback Assign] P , F** is set to **[AI5] R , 5**, and
- **[AI5 Type] R , 5 E** is set to **[Current] D R**.

Identical to **[AI1 max. value] C r H 1** (*see page 242*).

[AI5 range] R , 5 L

AI5 scaling selection.

This parameter can be accessed if :

- **[PID feedback Assign] P , F** is set to **[AI5] R , 5**, and
- **[AI5 Type] R , 5 E** is set to **[Current] D R**.

Identical to **[AI1 range] R , 1 L**.

[Min PID feedback] P , F 1 ★

Minimum PID feedback.

This parameter can be accessed if **[PID feedback Assign] P , F** is not set to **[No] n o**.

Setting ()	Description
0... [Max PID feedback] P , F 2	Setting range Factory setting: 100

[Max PID feedback] P , F 2 ★

Maximum PID feedback.

This parameter can be accessed if **[PID feedback Assign] P , F** is not set to **[No] n o**.

Setting ()	Description
[Min PID feedback] P , F 1 ...32,767	Setting range Factory setting: 1,000

[PID feedback] r P F ★

Value for PID feedback, display only.

This parameter can be accessed if **[PID feedback Assign] P , F** is not set to **[No] n o**.

Setting	Description
0...65,535	Setting range Factory setting: _

[Min Fbk Warning] P A L ★

Minimum feedback level warning.

This parameter can be accessed if **[PID feedback Assign] P , F** is not set to **[No] n o**. **[PID Low Fdbck Warning] P F A L** warning is active if the value of the PID feedback is lower than the value configured in **[Min Fbk Warning] P A L**.

Setting ()	Description
0...65,535	Setting range Factory setting: 100

[Max Fbk Warning] P A H ★

Maximum feedback level warning.

This parameter can be accessed if **[PID feedback Assign] P , F** is not set to **[No] n o**. **[PID High Fdbck Warning] P F A H** warning is active if the value of the PID feedback is greater than the value configured in **[Max Fbk Warning] P A H**.

Setting ()	Description
0...65,535	Setting range Factory setting: 1,000

[PID Reference] $r F$ - Menu

Access

[Complete settings] → [Pump functions] → [PID controller] → [PID Reference]

About This Menu

NOTE: This function cannot be used with some other functions.

[Intern PID Ref] $r P$, $r I$ ★

Internal PID controller reference.

This parameter can be accessed if [PID feedback Assign] $r P$, $r F$ is not set to [Not Configured] $n o$.

Setting	Code / Value	Description
[No]	$n o$	The PID controller reference is given by [Ref Freq 1 Config] $r F$, $r I$ or [Ref.1B channel] $r F$, $r I b$ with summing/subtraction/multiplication functions. Refer to the block diagram (<i>see page 237</i>). Factory setting
[Yes]	$y e s$	The PID controller reference is internal via [Internal PID ref] $r P$, $r I$.

[Ref Freq 1 Config] $r F$, $r I$ ★

Configuration reference frequency 1.

This parameter can be accessed if:

- [PID feedback Assign] $r P$, $r F$ is not set to [Not Configured] $n o$, and
- [Intern PID Ref] $r P$, $r I$ is set to [No] $n o$.

Setting	Code / Value	Description
[Not Configured]	$n o$	Not assigned
[AI1]	$r A$, $r I$	Analog input AI1 Factory Setting
[AI2]...[AI3]	$r A$, $r 2$... $r A$, $r 3$	Analog input AI2...AI3
[AI Virtual 1]	$r A$, $r V$, $r I$	Virtual analogic input 1
[AI4]...[AI5]	$r A$, $r 4$... $r A$, $r 5$	Analog input AI4...AI5 if VW3A3203 I/O extension module has been inserted
[Ref.Freq-Rmt.Term]	$r L$, $r C$, $r C$	Reference Frequency via remote terminal
[Ref. Freq-Modbus]	$r M$, $r d$, $r b$	Reference frequency via Modbus
[Ref. Freq-CANopen]	$r C$, $r A$, $r n$	Reference frequency via CANopen if a CANopen module has been inserted
[Ref. Freq-Com. Module]	$r n$, $r E$, $r t$	Reference frequency via fieldbus module if a fieldbus module has been inserted
[Embedded Ethernet]	$r E$, $r t$, $r H$	Embedded Ethernet
[DI7 PulseInput]...[DI8 PulseInput]	$r P$, $r 7$... $r P$, $r 8$	Digital input DI7...DI8 used as pulse input
[Encoder]	$r P$, $r C$	Encoder reference if an encoder module has been inserted.

[Min PID reference] $r P$, $r P$, $r I$ ★

Minimum PID reference.

This parameter can be accessed if [PID feedback Assign] $r P$, $r F$ is not set to [Not Configured] $n o$.

Setting ()	Description
[Min PID feedback] $r P$, $r F$, $r I$...[Max PID reference] $r P$, $r P$, $r 2$	Setting range Factory setting: 150

[Max PID reference] P , P 2 ★

Maximum PID reference.

This parameter can be accessed if **[PID feedback Assign] P , F** is not set to **[Not Configured] n o**.

Setting ()	Description
[Min PID reference] P , P 1...[Max PID feedback] P , F 2	Setting range Factory setting: 900

[Internal PID ref] r P , ★

Internal PID controller reference.

This parameter can be accessed if:

- **[PID feedback Assign] P , F** is not set to **[Not Configured] n o**, and
- **[Intern PID Ref] P , r** is set to **[Yes] y e s**.

Setting ()	Description
[Min PID reference] P , P 1...[Max PID reference] P , P 2	Setting range Factory setting: 150

[Auto/Manual assign.] P R u ★

Auto/Manual select input.

This parameter can be accessed if **[PID feedback Assign] P , F** is not set to **[Not Configured] n o**.

Setting	Code / Value	Description
[Not Assigned]	n o	Not assigned Factory setting
[DI1]...[DI8]	L , 1...L , 8	Digital input DI1...DI8
[DI11]...[DI16]	L , 11...L , 16	Digital input DI11...DI16 if VW3A3203 I/O extension module has been inserted
[CD00]...[CD10]	C d 0 0...C d 1 0	Virtual digital input CMD.0...CMD.10 in [I/O profile] , o configuration
[CD11]...[CD15]	C d 1 1...C d 1 5	Virtual digital input CMD.11...CMD.15 regardless of configuration
[C101]...[C110]	C 1 0 1...C 1 1 0	Virtual digital input CMD1.01...CMD1.10 with integrated Modbus Serial in [I/O profile] , o configuration
[C111]...[C115]	C 1 1 1...C 1 1 5	Virtual digital input CMD1.11...CMD1.15 with integrated Modbus Serial regardless of configuration
[C201]...[C210]	C 2 0 1...C 2 1 0	Virtual digital input CMD2.01...CMD2.10 with CANopen® fieldbus module in [I/O profile] , o configuration
[C211]...[C215]	C 2 1 1...C 2 1 5	Virtual digital input CMD2.11...CMD2.15 with CANopen® fieldbus module regardless of configuration
[C301]...[C310]	C 3 0 1...C 3 1 0	Virtual digital input CMD3.01...CMD3.10 with a fieldbus module in [I/O profile] , o configuration
[C311]...[C315]	C 3 1 1...C 3 1 5	Virtual digital input CMD3.11...CMD3.15 with a fieldbus module regardless of configuration
[C501]...[C510]	C 5 0 1...C 5 1 0	Virtual digital input CMD5.01...CMD5.10 with integrated Ethernet in [I/O profile] , o configuration
[C511]...[C515]	C 5 1 1...C 5 1 5	Virtual digital input CMD5.11...CMD5.15 with integrated Ethernet regardless of configuration

[Manual PID Reference] P , n ★

Manual PID reference.

Reference input in manual mode.

This parameter can be accessed if:

- **[PID feedback Assign] P , F** is not set to **[Not Configured] n o**, and
- **[Auto/Manual assign.] P A u** is not set to **[No] n o**.

The preset speeds are active on the manual reference if they have been configured.

Setting	Code / Value	Description
[No]	n o	Not assigned Factory setting
[AI1]...[AI3]	A , 1...A , 3	Analog input AI1...AI3
[AI4]...[AI5]	A , 4...A , 5	Analog input AI4...AI5 if VW3A3203 I/O extension module has been inserted
[DI7 PulseInput]...[DI8 PulseInput]	P , 7...P , 8	Digital input DI7...DI8 used as pulse input
[Encoder]	P G	Encoder reference if an encoder module has been inserted.

[PID preset references] P r , - Menu

Access

[Complete settings] → [Pump functions] → [PID controller] → [PID Reference] → [PID preset references]

About This Menu

The function can be accessed if [PID feedback Assign] P , F is assigned.

[2 PID Preset Assign] P r 2

2 PID preset assignment.

If the assigned input or bit is at 0, the function is inactive.

If the assigned input or bit is at 1, the function is active.

Setting	Code / Value	Description
[Not Assigned]	n o	Not assigned Factory setting
[DI1]...[DI8]	L , I...L , B	Digital input DI1...DI8
[DI11]...[DI16]	L , I I...L , I B	Digital input DI11...DI16 if VW3A3203 I/O extension module has been inserted
[CD00]...[CD10]	C d 0 0...C d 1 0	Virtual digital input CMD.0...CMD.10 in [I/O profile] , o configuration
[CD11]...[CD15]	C d 1 1...C d 1 5	Virtual digital input CMD.11...CMD.15 regardless of configuration
[C101]...[C110]	C 1 0 1...C 1 1 0	Virtual digital input CMD1.01...CMD1.10 with integrated Modbus Serial in [I/O profile] , o configuration
[C111]...[C115]	C 1 1 1...C 1 1 5	Virtual digital input CMD1.11...CMD1.15 with integrated Modbus Serial regardless of configuration
[C201]...[C210]	C 2 0 1...C 2 1 0	Virtual digital input CMD2.01...CMD2.10 with CANopen® fieldbus module in [I/O profile] , o configuration
[C211]...[C215]	C 2 1 1...C 2 1 5	Virtual digital input CMD2.11...CMD2.15 with CANopen® fieldbus module regardless of configuration
[C301]...[C310]	C 3 0 1...C 3 1 0	Virtual digital input CMD3.01...CMD3.10 with a fieldbus module in [I/O profile] , o configuration
[C311]...[C315]	C 3 1 1...C 3 1 5	Virtual digital input CMD3.11...CMD3.15 with a fieldbus module regardless of configuration
[C501]...[C510]	C 5 0 1...C 5 1 0	Virtual digital input CMD5.01...CMD5.10 with integrated Ethernet in [I/O profile] , o configuration
[C511]...[C515]	C 5 1 1...C 5 1 5	Virtual digital input CMD5.11...CMD5.15 with integrated Ethernet regardless of configuration

[4 PID Preset Assign] P r 4

4 PID preset assignment.

Identical to [2 PID Preset Assign] P r 2 (see page 250).

Verify that [2 PID Preset Assign] P r 2 has been assigned before assigning this function.

[Ref PID Preset 2] r P 2 ★

Second PID preset reference.

This parameter can be accessed only if [2 PID Preset Assign] P r 2 is assigned.

Setting ()	Description
[Min PID reference] P , P 1...[Max PID reference] P , P 2	Setting range Factory setting: 300

[Ref PID Preset 3] r_{P3} ★

Third PID preset reference.

This parameter can be accessed only if **[4 preset PID ref.] r_{P4}** is assigned.

Setting ()	Description
[Min PID reference] r_{P1} ... [Max PID reference] r_{P2}	Setting range Factory setting: 600

[Ref PID Preset 4] r_{P4} ★

Fourth PID preset reference.

This parameter can be accessed only if **[2 preset PID ref.] r_{P2}** and **[4 preset PID ref.] r_{P4}** are assigned.

Setting ()	Description
[Min PID reference] r_{P1} ... [Max PID reference] r_{P2}	Setting range Factory setting: 900

[PID Reference] *r F* - Menu

Access

[Complete settings] → [Pump functions] → [PID controller] → [PID Reference]

[Predictive Speed Ref] *F P* , ★

Predictive speed reference.

This parameter can be accessed if:

- [Access Level] *L R C* is set to [Expert] *E P r*.
- [PID feedback] *P , F* is not set to [No] *n o*

Setting	Code / Value	Description
[Not Configured]	<i>n o</i>	Not assigned Factory setting
[AI1]...[AI3]	<i>R , 1...R , 3</i>	Analog input AI1...AI3
[AI4]...[AI5]	<i>R , 4...R , 5</i>	Analog input AI4...AI5 if VW3A3203 I/O extension module has been inserted
[Ref. Freq-Rmt.Term]	<i>L C C</i>	Reference frequency via remote terminal
[Ref. Freq-Modbus]	<i>M d b</i>	Reference frequency via Modbus
[Ref. Freq-CANopen]	<i>C R n</i>	Reference frequency via CANopen
[Ref. Freq-Com. Module]	<i>n E t</i>	Reference frequency via communication module
[Embedded Ethernet]	<i>E t H</i>	Embedded Ethernet
[DI7 PulseInput]...[DI8 PulseInput]	<i>P , 7...P , 8</i>	Digital input DI7...DI8 used as pulse input
[Encoder]	<i>P G</i>	Encoder reference if an encoder module has been inserted.

[Speed Input %] *P S r* ★

PID speed input % reference.

- This parameter can be accessed if [Access Level] *L R C* is set to [Expert] *E P r*, and
- [Predictive Speed Ref] *F P* , is not set to [Not Configured] *n o*.

Setting (°)	Description
1...100%	Setting range Factory setting: 100%

[Settings] 5 L - Menu

Access

[Complete settings] → [Pump functions] → [PID controller] → [Settings]

About This Menu

Following parameters can be accessed if [PID Feedback] P, F is not set to [Not Configured] $n o$.

NOTE: This function cannot be used with some other functions.

[PID Prop.Gain] $r P G$ ★

Proportional gain.

Setting ()	Description
0.01...100.00	Setting range Factory setting: 1.00

[PI Intgl.Gain] r , G ★

Integral gain.

Setting ()	Description
0.01...100.00	Setting range Factory setting: 1.00

[PID derivative gain] $r d G$ ★

Derivative gain.

Setting ()	Description
0.00...100.00	Setting range Factory setting: 0.00

[PID ramp] $P r P$ ★

PID acceleration/deceleration ramp, defined to go from [Min PID reference] $P, P 1$ to [Max PID reference] $P, P 2$ and conversely.

Setting ()	Description
0.0...99.9 s	Setting range Factory setting: 0.0 s

[PID Inversion] P, I ★

PID inversion.

Setting	Code / Value	Description
[No]	$n o$	No Factory setting
[Yes]	$Y E S$	Yes

[PID Min Output] $P o L$ ★

PID controller minimum output in Hz.

Setting ()	Description
-599.0...599.0 Hz	Setting range Factory setting: 0.0 Hz

[PID Max Output] P_oH ★

PID controller maximum output in Hz.

Setting ()	Description
0.0...599.0 Hz	Setting range Factory setting: 60.0 Hz

[PID Error Warning] P_Er ★

PID error warning. **[PID Error Warning] P_EE** is active if the value of PID error is greater than the value configured in **[PID Error Warning] P_Er**.

Setting ()	Description
0...65,535	Setting range Factory setting: 100

[PID Integral OFF] P_iS ★

Integral shunt.

If the assigned input or bit is at 0, the function is inactive (the PID integral is enabled).

If the assigned input or bit is at 1, the function is active (the PID integral is disabled).

Setting	Code / Value	Description
[Not Assigned]	n a	Not assigned Factory setting
[DI1]...[DI8]	L , I ... L , B	Digital input DI1...DI8
[DI11]...[DI16]	L , I I ... L , I B	Digital input DI11...DI16 if VW3A3203 I/O extension module has been inserted
[CD00]...[CD10]	C d 0 0 ... C d 1 0	Virtual digital input CMD.0...CMD.10 in [I/O profile] , a configuration
[CD11]...[CD15]	C d 1 1 ... C d 1 5	Virtual digital input CMD.11...CMD.15 regardless of configuration
[C101]...[C110]	C 1 0 1 ... C 1 1 0	Virtual digital input CMD1.01...CMD1.10 with integrated Modbus Serial in [I/O profile] , a configuration
[C111]...[C115]	C 1 1 1 ... C 1 1 5	Virtual digital input CMD1.11...CMD1.15 with integrated Modbus Serial regardless of configuration
[C201]...[C210]	C 2 0 1 ... C 2 1 0	Virtual digital input CMD2.01...CMD2.10 with CANopen® fieldbus module in [I/O profile] , a configuration
[C211]...[C215]	C 2 1 1 ... C 2 1 5	Virtual digital input CMD2.11...CMD2.15 with CANopen® fieldbus module regardless of configuration
[C301]...[C310]	C 3 0 1 ... C 3 1 0	Virtual digital input CMD3.01...CMD3.10 with a fieldbus module in [I/O profile] , a configuration
[C311]...[C315]	C 3 1 1 ... C 3 1 5	Virtual digital input CMD3.11...CMD3.15 with a fieldbus module regardless of configuration
[C501]...[C510]	C 5 0 1 ... C 5 1 0	Virtual digital input CMD5.01...CMD5.10 with integrated Ethernet in [I/O profile] , a configuration
[C511]...[C515]	C 5 1 1 ... C 5 1 5	Virtual digital input CMD5.11...CMD5.15 with integrated Ethernet regardless of configuration

[PID acceleration time] ACCP ★

PID: acceleration during start-up.

PID start ramp can be applied before starting the PID controller to allow reaching quickly the PID reference without increasing PID gains. If configured, the **[Start Accel Ramp] ACCS** is applied up to **[Low Speed] LSP** instead of **[PID acceleration time] ACCP**.

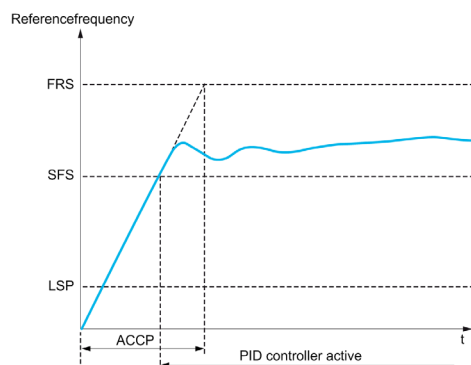

Setting (s)	Description
0.01...99,99 s ⁽¹⁾	Setting range Factory setting: 5.00 s
1	Range 0.01 to 99.99 s or 0.1 to 999.9 s or 1...6,000 s according to [Ramp increment] IR .

[PID Start Ref Freq] SFS ★

PID: speed reference for start-up.

Setting (Hz)	Description
0.0...599.0 Hz	Setting range If [PID Start Ref Freq] SFS is lower than [Low speed] LSP , this function has no effect. Factory setting: 0.0 Hz

Section 8.6

[Pump functions] - [Sleep/wakeup]

What Is in This Section?

This section contains the following topics:

Topic	Page
[Sleep/Wakeup] <i>S P W</i> - Overview	257
[Sleep menu] <i>S L P</i> - Menu	259
[Boost] <i>S b E</i> - Menu	261
[Wake up menu] <i>W K P</i> - Menu	262

[Sleep/Wakeup] S P W - Overview

About This Menu

Following parameters can be accessed if [PID feedback Assign] P , F is not set to [Not Configured] n o .

⚠ WARNING

UNANTICIPATED EQUIPMENT OPERATION

Verify that activating this function does not result in unsafe conditions.

Failure to follow these instructions can result in death, serious injury, or equipment damage.

The purpose of the "Sleep / Wake-Up" function is to stop the motor in process standstill situations.

It allows you to save energy and helps to prevent premature aging of some equipment that cannot run for a long time at low speed because the greasing or cooling depends on the machine speed.

Depending on user-defined wakeup conditions, the motor is restarted automatically.

Sleep/Wake-Up in PID Control Mode

When the drive is used in PID control, one of the following conditions is used to switch the application to the sleep state:

- Sleep on low speed.
- Sleep on low motor power.
- Sleep on external condition (using drive input).

The drive is in "PID control mode" when PID is active. Typically when:

- PID is configured, and
- Channel 1 is selected, and
- PID is in automatic mode.

When the drive is in a sleep state, a wake-up condition is used to restart the application:

- Wake-up on PID Feedback level
- Wake-up on PID Error level

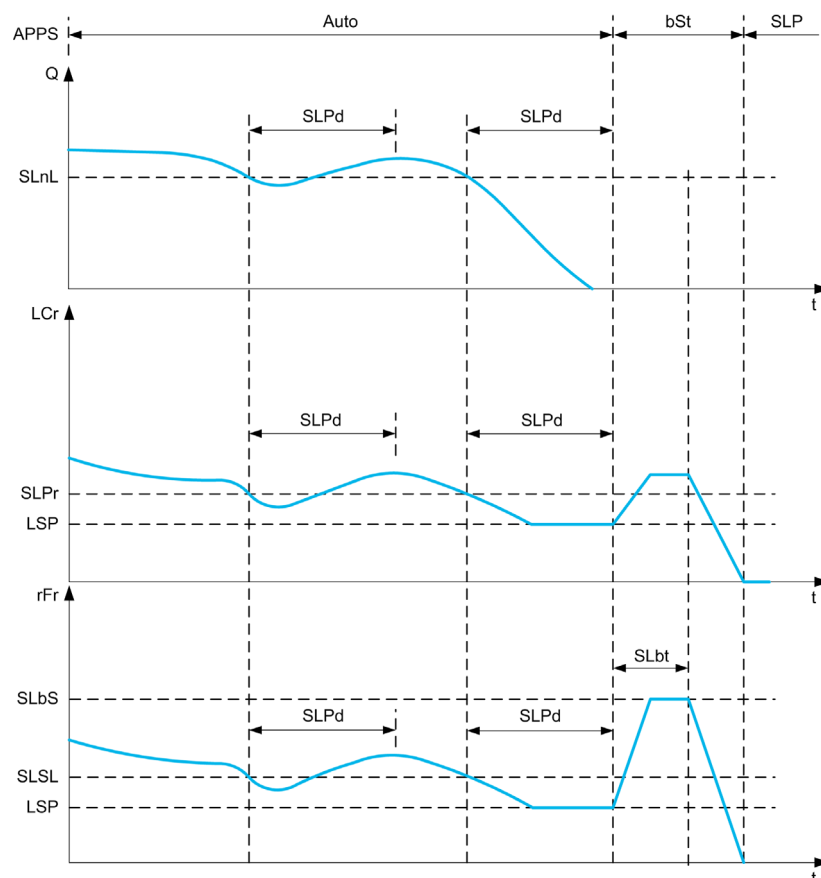

Sleep Conditions in PID Control Mode

If there is no valid wake-up condition, then the system switches to the sleep mode after one of the configured sleep conditions remains longer than **[Sleep Delay] 5 L P d**.

The sleep detection mode is selected by configuring **[Sleep Detect Mode] 5 L P n**. Then the system switches to sleep mode if the selected condition is met:

Configuration	Condition
5 W sleep on switch or external condition	The switch input becomes active
5 P d sleep on speed	The output frequency is below the sleep speed
P W r sleep on power level	The output power is below the sleep power
a r multiple conditions	At least 1 of the configured condition to enter in sleep mode is met

Wake-Up Conditions in PID Control Mode

The system wakes up according to **[Wake Up Mode] w u P n** configuration:

- On PID Feedback level
- On PID Error level.

If **[Feedback] F b K** is selected, then the system wakes up and goes back in PID control mode:

- When PID feedback drops below configured **[Wake Up Process Level] w u P F** if PID is configured in Direct mode, (**[PID Inversion] P i C** is set to **n o**).
- When PID feedback raises above configured **[Wake Up Process Level] w u P F**, if PID is configured in Reverse mode (**[PID Inversion] P i C** is set to **y e s**).

If **[Error] E r r** is selected, then the system wakes up and goes back in PID control mode:

- When PID feedback drops below (**[PID reference] r P C** - **[Wake Up Process Error] w u P E**), if PID is configured in Direct mode (**[PID Inversion] P i C** is set to **n o**).
- When PID feedback raises above (**[PID reference] r P C** + **[Wake Up Process Error] w u P E**), if PID is configured in Reverse mode (**[PID Inversion] P i C** is set to **y e s**).

Boosting Phase in PID Control Mode

When entering the sleep mode, the motor accelerates to **[Sleep Boost Speed] 5 L b S** during **[Sleep Boost Time] 5 L b t** and then stops.

If **[Sleep Boost Time] 5 L b t** is set to 0, then the boost phase is ignored.

Initial State in PID Control Mode

Just after the system starts in automatic mode (a run order appears while in automatic mode - channel 1 already selected and PID auto):

- If a wake-up condition is met, the drive goes in PID control mode (PID started).
- If a wake-up condition is not met, the drive goes in sleep mode (PID stays stopped and motor is kept halted), and Boosting phase is ignored.

When the control is switched to automatic mode while the motor is running (switch to channel 1 or switch to PID auto mode for example), the drive stays in running state and switches to PID automatic mode.

Configuration of Sleep External Condition (Usage of a No Flow Switch for Example)

Sleep switch allows you to select the source of sleep external condition:

- **n o**: no input selected for the sleep external condition.
- **d i X**: the sleep external condition (switch for example) is connected to DIx (the assignment is also possible on a control bit in I/O profile).

[Sleep menu] *S L P* - Menu**Access**

[Complete settings] → [Pump functions] → [Sleep/Wakeup] → [Sleep menu]

[Sleep Detect Mode] *S L P N*

Sleep detection mode.

Setting	Code / Value	Description
[No]	<i>n o</i>	Not configured Factory setting
[Switch]	<i>S W</i>	System enters in sleep mode on switch condition
[Speed]	<i>S P d</i>	System enters in sleep mode on speed condition
[Power]	<i>P W r</i>	System enters in sleep mode on power condition
[Multiple]	<i>o r</i>	System enters in sleep mode on multiple-OR condition

[Sleep Switch Assign] *S L P W*

Sleep switch assignment.

This parameter can be accessed if [Sleep Detect Mode] *S L P N* is set to:

- [Switch] *S W*, or
- [Multiple] *o r*.

Select an external condition to enter in sleep mode.

Setting	Code / Value	Description
[Not Assigned]	<i>n o</i>	Not assigned Factory setting
[DI1]...[DI8]	<i>L , I ... L , B</i>	Digital input DI1...DI8
[DI11]...[DI16]	<i>L , I I ... L , I B</i>	Digital input DI11...DI16 if VW3A3203 I/O extension module has been inserted
[CD00]...[CD10]	<i>C d 0 0 ... C d 1 0</i>	Virtual digital input CMD.0...CMD.10 in [I/O profile] , <i>o</i> configuration
[CD11]...[CD15]	<i>C d 1 1 ... C d 1 5</i>	Virtual digital input CMD.11...CMD.15 regardless of configuration
[C101]...[C110]	<i>C 1 0 1 ... C 1 1 0</i>	Virtual digital input CMD1.01...CMD1.10 with integrated Modbus Serial in [I/O profile] , <i>o</i> configuration
[C111]...[C115]	<i>C 1 1 1 ... C 1 1 5</i>	Virtual digital input CMD1.11...CMD1.15 with integrated Modbus Serial regardless of configuration
[C201]...[C210]	<i>C 2 0 1 ... C 2 1 0</i>	Virtual digital input CMD2.01...CMD2.10 with CANopen® fieldbus module in [I/O profile] , <i>o</i> configuration
[C211]...[C215]	<i>C 2 1 1 ... C 2 1 5</i>	Virtual digital input CMD2.11...CMD2.15 with CANopen® fieldbus module regardless of configuration
[C301]...[C310]	<i>C 3 0 1 ... C 3 1 0</i>	Virtual digital input CMD3.01...CMD3.10 with a fieldbus module in [I/O profile] , <i>o</i> configuration
[C311]...[C315]	<i>C 3 1 1 ... C 3 1 5</i>	Virtual digital input CMD3.11...CMD3.15 with a fieldbus module regardless of configuration
[C501]...[C510]	<i>C 5 0 1 ... C 5 1 0</i>	Virtual digital input CMD5.01...CMD5.10 with integrated Ethernet in [I/O profile] , <i>o</i> configuration
[C511]...[C515]	<i>C 5 1 1 ... C 5 1 5</i>	Virtual digital input CMD5.11...CMD5.15 with integrated Ethernet regardless of configuration
[DI52 (High level)]... [DI59 (High level)]	<i>d 5 2 H ... d 5 9 H</i>	Cabinet high level digital inputs NOTE: This selection can be accessed on ATV960, ATV980 equipped with Cabinet IO.

[Sleep Min Speed] 5 L 5 L ★

Sleep speed level.

Speed level under which the system should enter the sleep mode.

This parameter can be accessed if **[Sleep Detect Mode] 5 L P Π** is set to:

- **[Speed] 5 P d**, or
- **[Multiple] a r**.

Setting ()	Description
0...599.0 Hz	Setting range Factory setting: [No] n a

[Sleep Power Level] 5 L P r ★

Sleep power level.

Power level under which the system should enter the sleep mode.

This parameter can be accessed if **[Sleep Detect Mode] 5 L P Π** is set to:

- **[Power] P W r**, or
- **[Multiple] a r**.

Setting ()	Description
0...[Nominal Motor Power] n P r	Setting range Factory setting: [No] n a

[Sleep Delay] 5 L P d ★

Sleep delay.

This parameter can be accessed if **[Sleep Detect Mode] 5 L P Π** is not set to **[Not Configured] n a**.

Setting ()	Description
0...3,600 s	Setting range Factory setting: 20 s

[Boost] 5 b t - Menu**Access**

[Complete settings] → [Pump functions] → [Sleep/wakeup] → [Sleep menu] → [Boost]

About This Menu

Following parameters can be accessed if [Sleep Detect Mode] 5 L P Π is not set to [No] n o.

[Sleep Boost Speed] 5 L b 5 ★

Sleep boost speed.

Setting ()	Description
0...599.0 Hz	Setting range Factory setting: n o

[Sleep Boost Time] 5 L b t ★

Sleep boost time.

Setting ()	Description
0...3,600 s	Setting range Factory setting: n o

[Wake up menu] WK P - Menu**Access**

[Complete settings] → [Pump functions] → [Sleep/wakeup] → [Wake up menu]

About This Menu

This menu can be accessed if [Sleep Detect Mode] SL P Π is not set to [Not Configured] n o.

[Wake Up Mode] W U P Π ★

Wake-up mode.

Setting	Code / Value	Description
[Feedback]	F b K	Wake-up on PID feedback level Factory setting
[Error]	E r r	Wake-up on PID error level

[Wake Up Process Level] W U P F ★

Wake-up process value level.

This parameter can be accessed if [Wake Up Mode] W U P Π is set to [Feedback] F b K .

Setting ()	Description
[Min PID feedback] P , F 1...[Max PID feedback] P , F 2	Setting range Factory setting: 0

[Wake Up Process Error] W U P E ★

Wake-up process value error level.

This parameter can be accessed if [Wake Up Mode] W U P Π is set to [Error] E r r .

Setting ()	Description
0...[Max PID feedback] P , F 2	Setting range Factory setting: 0,0 Hz

Section 8.7

[Pump functions] - [Feedback monitoring]

[Feedback monitoring] *P F Π* - Menu

Access

[Complete settings] → [Pump functions] → [Feedback monitoring]

About This Menu

The function is typically used to detect cases where the installation capability is exceeded or where the installation is not operating properly:

- Fire hydrant opened.
- Pump start-up with open discharge valve.
- Mechanical breakdown of pipes.
- Water leakage.

When the drive is running at high speed, this function monitors the PID feedback in order to detect if it is out of a given range around the setpoint during a configurable time.

By using a warning or a detected error, this function also indicates that:

- The capability of the installation is exceeded
- The proper control could not be ensured
- Something is wrong on the installation.

This menu can be accessed if [PID feedback Assign] *P , F* is not set to [Not Configured] *n o*.

This graphic presents the PID feedback monitoring:

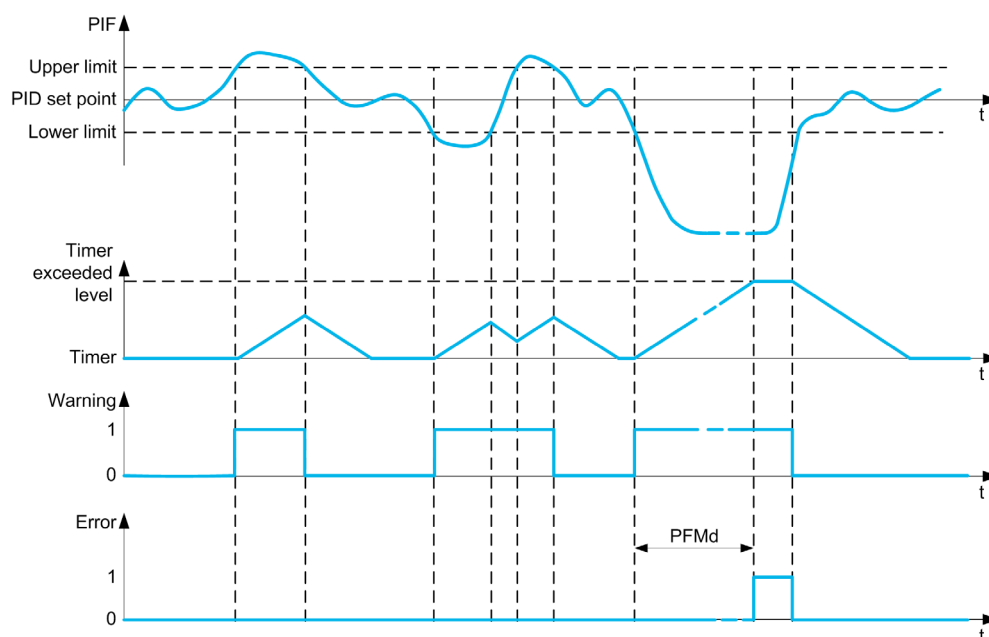

[PID Fdbk Monitoring] *P F Π Π*

PID feedback monitoring mode.

Parameter used to activate the function.

Setting	Code / Value	Description
[No]	<i>n o</i>	No Factory setting
[Yes]	<i>y e s</i>	Yes

[PID Fdbk Range] P F Π r ★

PID feedback monitoring range.

Range within which the PID feedback value is supposed to stay in normal situation.

This parameter can be accessed if **[PID Fdbk Monitoring] P F Π Π** is not set to **[No] n o**.

Setting (C)	Description
0...100%	Setting range Factory setting: 3%

[PID Fdbk Error Delay] P F Π d ★

PID feedback monitoring delay.

Delay to trig an error after detection of an anomaly.

This parameter can be accessed if **[PID Fdbk Monitoring] P F Π Π** is not set to **[No] n o**.

Setting (C)	Description
0...3,600 s	Setting range Factory setting: 10 s

[PID Fdbk Error Resp] P F Π b ★

PID feedback monitoring response to a detected error.

Define how the drive reacts when a feedback monitoring error occurs.

This parameter can be accessed if **[PID Fdbk Monitoring] P F Π Π** is not set to **[No] n o**.

Setting	Code / Value	Description
[Ignore]	n o	Detected error ignored
[Freewheel Stop]	Y E S	Freewheel stop
[Per STT]	S E E	Stop according to [Type of stop] S E E parameter but without an error triggered after stop
[Ramp stop]	r Π P	Stop on ramp Factory setting

Section 8.8

[Pump functions] - [ENA System]

[ENA System] E n A - Menu

Access

[Complete settings] → [Pump functions] → [ENA System]

About This Menu

ENA System is a control profile designed for rotating machines with unbalanced load. It is used primarily for oil pumps.

The operating principle applied:

- Allows operation without a braking resistor.
- Reduces mechanical stress on the rod.
- Reduces line current fluctuations.
- Reduces energy consumption by improving the electric power/current ratio.

[ENA activation] E n A ★

ENA function activation.

This parameter can be accessed if [Motor control type] C L E is set to [SVC V] V V C.

Setting ()	Code / Value	Description
[No]	n o	Not activated Factory setting
[Yes]	y e s	Activated

[ENA prop gain] G P E ★

ENA proportional gain.

This parameter can be accessed if [ENA activation] E n A is not set to [No] n o.

This setting is used to achieve a compromise between the reduced energy consumption (and/or line current fluctuations) and the mechanical stress to which the rod is subject. Energy is saved by reducing current fluctuations and increasing the current while retaining the same average speed.

Setting ()	Description
1...9999	Setting range Factory setting: 250

[ENA integral gain] G I E ★

ENA integral gain.

This parameter can be accessed if [ENA activation] E n A is not set to [No] n o.

This setting is used to smooth the DC bus voltage.

Start up the machine with a low integral and proportional gain (proportional 25% and integral 10%) in order to avoid an overvoltage trip in the absence of a braking resistor. See if these settings are suitable.

Recommended adjustments to be made during operation:

- To eliminate the braking resistor and, therefore, the increase in the DC bus voltage:
 - Display the machine speed on the Graphic Display Terminal.
 - Reduce the integral gain value until the machine speed drops
 - When this point is reached, increase the integral gain until the machine speed stabilizes.
 - Use the Graphic Display Terminal or an oscilloscope to check that the DC bus voltage is stable.
- To save energy:

Reduce the proportional gain (gradually) may increase energy savings by reducing the maximum value of the line current, but it will increase speed variations and, therefore, mechanical stress.
 The aim is to identify settings that will enable energy to be saved and minimize mechanical stress.
 When reducing the proportional gain, it may be necessary to readjust the integral gain in order to avoid an overvoltage trip.

NOTE: Once the adjustments are complete, check that the pump starts up correctly. If the ENA integral gain setting is too low, this may lead to insufficient torque on startup.

Setting ()	Description
0...9999	Setting range Factory setting: 100

[Reduction ratio] r RP ★

Reduction ratio in ENA system.

This parameter can be accessed if **[ENA activation] E n A** is not set to **[No] n o**.

This setting corresponds to the motor speed ahead of gearbox/speed after gearbox ratio.

This parameter is used to display the average speed in Hz and the machine speed in customer units (e.g., in strokes per minute) on the Graphic Display Terminal.

In order to be displayed on the Graphic Display Terminal, these values must be selected in the **[Display] P o n** - menu.

Adjustment recommendations for prevention of tripping on an **[Motor Overspeed] 5 o F** error, **[ENA System]** authorizes overspeed, which can trigger an **[Motor Overspeed] 5 o F** error.

To avoid this occurring, it is advisable to increase the value of the following parameters slightly:

- **[Max Frequency] E F r**
- **[Overspd. pulse thd.] F q A**, if the "frequency meter" function is configured

Setting ()	Description
10.0...999.9	Setting range Factory setting: 10.0

Section 8.9

[Pump functions] - [Backspin Control]

[Backspin Control] b 5 C C - Menu

Access

[Complete settings] → [Pump functions] → [Backspin Control]

About This Menu

This menu provides the capability to control backspin of a Progressing Cavity Pump (PCP).

This function avoids a shutdown of the drive in case of loss of the main supply. It is done using a DC bus voltage regulation to store enough energy to control the motor.

NOTICE

DAMAGE TO THE EQUIPMENT

A braking resistor must be used if [BS Activation] b 5 C C is enabled.

Failure to follow these instructions can result in equipment damage.

Functional diagram

This diagram shows the Mains Phase Loss Backspin Control sequence

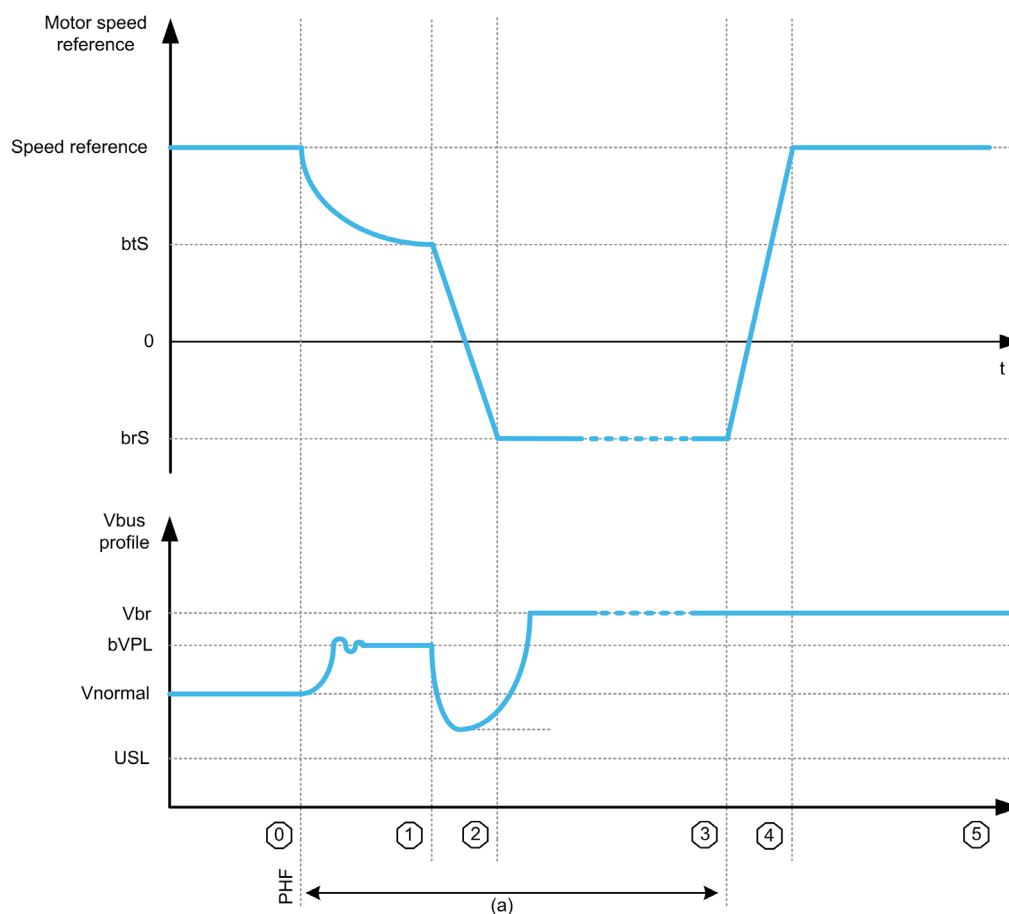

(a) Correspond to backspin function

State description

Sequence	Name	Description
0	Normal operation	Normal operation, drive is running at positive speed.
1	Backspin preparation	Mains phase loss is detected. The load torque resulting from the fluid column weighting on pump is still present. The lower limit of the energy control is set to a configured threshold [Deceleration Vbus Ref] b V P L , resulting to a rising [DC Bus Voltage] V b u 5 to this threshold (the regulation will adapt the torque to store energy).
2	Zero speed crossing	During this phase the following steps happens: <ul style="list-style-type: none"> Deceleration from [Reverse Speed Trigger] b t 5 to [BS DCBus Reg Freq Thd] b r 5, to cross the zero speed area. [DC Bus Voltage] V b u 5 drops due to losses in the system without incoming energy (near zero speed area). Energy gathered during phase 1 is spent to avoid drive shutdown.
3	Backspin speed control	During this phase, the drive regulates the speed according to [BS DCBus Reg Freq Thd] b r 5 . The [DC Bus Voltage] V b u 5 will rise to [Braking level] V b r due to the regenerative load. This energy will be dissipated by the braking resistor.
4	Acceleration	Mains supply is back, drive accelerates to normal operation speed.
5	Normal operation	Normal operation, drive is running at positive speed.

[BS Activation] b 5 C C

Backspin activation.

Mains phase loss PCP backspin will start on mains phase loss

Setting	Code / Value	Description
[Not Assigned]	n a	Not assigned Factory setting
[Yes]	Y E 5	Yes
[DI1]...[DI8]	L , I ... L , B	Digital input DI1...DI8
[DI11]...[DI16]	L , I I ... L , I B	Digital input DI11...DI16 if VW3A3203 I/O extension module has been inserted
[CD00]...[CD10]	C d 0 0 ... C d 1 0	Virtual digital input CMD.0...CMD.10 in [I/O profile] , a configuration
[CD11]...[CD15]	C d 1 1 ... C d 1 5	Virtual digital input CMD.11...CMD.15 regardless of configuration
[C101]...[C110]	C 1 0 1 ... C 1 1 0	Virtual digital input CMD1.01...CMD1.10 with integrated Modbus Serial in [I/O profile] , a configuration
[C111]...[C115]	C 1 1 1 ... C 1 1 5	Virtual digital input CMD1.11...CMD1.15 with integrated Modbus Serial regardless of configuration
[C201]...[C210]	C 2 0 1 ... C 2 1 0	Virtual digital input CMD2.01...CMD2.10 with CANopen® fieldbus module in [I/O profile] , a configuration
[C211]...[C215]	C 2 1 1 ... C 2 1 5	Virtual digital input CMD2.11...CMD2.15 with CANopen® fieldbus module regardless of configuration
[C301]...[C310]	C 3 0 1 ... C 3 1 0	Virtual digital input CMD3.01...CMD3.10 with a fieldbus module in [I/O profile] , a configuration
[C311]...[C315]	C 3 1 1 ... C 3 1 5	Virtual digital input CMD3.11...CMD3.15 with a fieldbus module regardless of configuration
[C501]...[C510]	C 5 0 1 ... C 5 1 0	Virtual digital input CMD5.01...CMD5.10 with integrated Ethernet in [I/O profile] , a configuration
[C511]...[C515]	C 5 1 1 ... C 5 1 5	Virtual digital input CMD5.11...CMD5.15 with integrated Ethernet regardless of configuration

[Deceleration Vbus Ref] b V P L ★

Vbus Reference for deceleration phase.

This parameter cannot be accessed if **[BS Activation] b 5 C C** is not set to **[Not Assigned] n a**.

Setting (°)	Description
100...1127 V	Setting range Factory setting: according to the drive rating

[BS DCBus Reg Freq Thd] b r 5 ★

Reference frequency during zero speed crossing phase.

This parameter cannot be accessed if [BS Activation] b 5 C C is not set to [Not Assigned] n o .

Setting (°)	Description
-599.0...599.0 Hz	Setting range Factory setting: -10.0 Hz

[Reverse Speed Trigger] b t 5 ★

Speed threshold triggering zero speed crossing phase.

This parameter cannot be accessed if [BS Activation] b 5 C C is not set to [Not Assigned] n o .

NOTE: This parameter must be adjusted according to the application. If a too high value is set, the drive can not store enough energy to allow the zero speed crossing sequence.

Setting (°)	Description
-599.0...599.0 Hz	Setting range Factory setting: 10.0 Hz

[Reverse Deceleration] b Z C d ★

Deceleration value during zero speed crossing phase.

This parameter cannot be accessed if [BS Activation] b 5 C C is not set to [Not Assigned] n o .

Setting (°)	Description
0.0...999.9 s ⁽¹⁾	Setting range Factory setting: 3.0 s
1	Range 0.00 to 99.99 s or 0 to 9999 s according to [Ramp increment] i n r .

Section 8.10

[Pump monitoring] - [Pumpcycle monitoring]

[Pumpcycle monitoring] *PCP* - Menu

Access

[Complete settings] → [Pump monitoring] → [Pumpcycle monitoring]

About This Menu

The purpose of this function is to monitor the number of start sequences during a configured time window in order to prevent from an unwanted aging of the system and to detect any abnormal operation.

An internal counter counts the number of pump start sequences. Each time the pump is started, the counter is incremented. It is decreased by one every time window corresponding to one start.

If the counter reaches the maximum number allowed **[PumpCycle MaxStarts] *PCPn***, a warning **[Pump Cycle warning] *PCPn*** is triggered.

If a start command occurs while the detected warning is active, an error **[PumpCycle Start Error] *PCPF*** is triggered. The application follows the **[PumpCycleError Resp] *PCPB*** defined behavior.

Restarting the pump is allowed as soon as the counter decreases under the maximum number of starts allowed, if the detected error has been cleared.

The function is based on the sliding time window in which the pump start commands are counted.

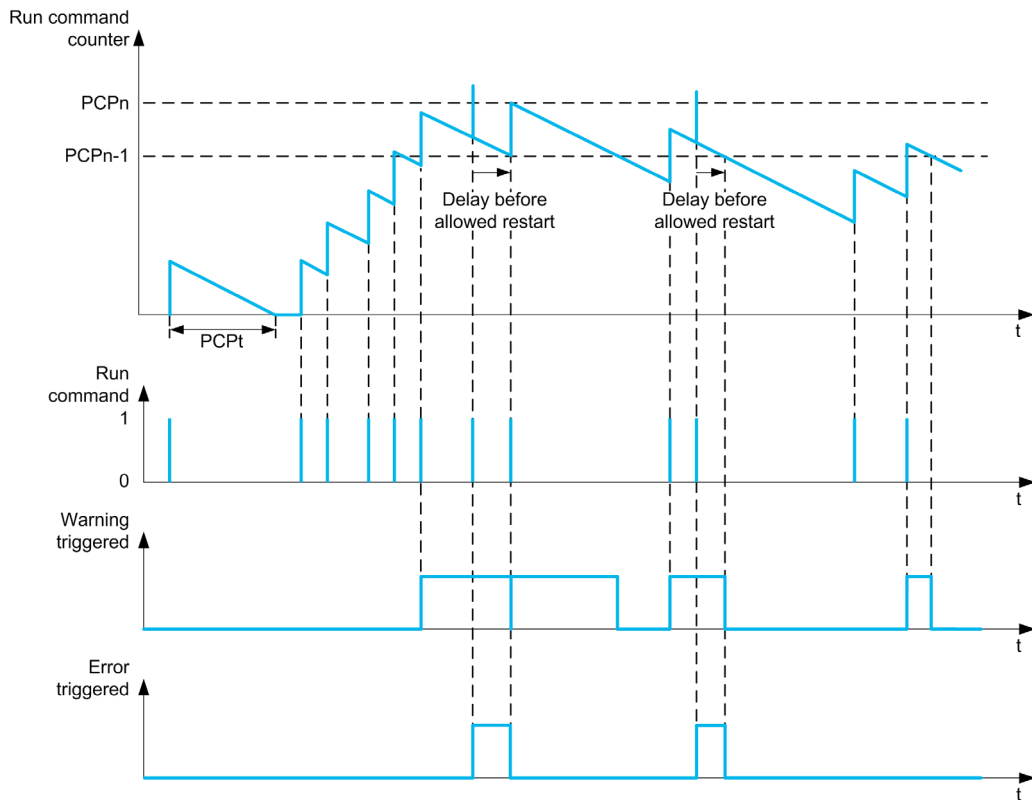

If **[PumpCycle Monitoring] *PCPN*** is set to **[Mode 1] *nor***, the function is activated without power Off time management.

If **[PumpCycle Monitoring] *PCPN*** is set to **[Mode 2] *rel***, the function is activated with power Off time management. This requires a time clock source such as the Graphic Display Terminal plugged at power On of the drive, or a Time server configured over Ethernet.

[PumpCycle Monitoring] P C P Π

Pumpcycle monitoring mode.

Setting	Code / Value	Description
[No]	n o	Cyclic monitoring disabled Factory setting
[Mode 1]	n o r Π	Cyclic monitoring without power off time management
[Mode 2]	r t C	Cyclic monitoring with power off time management

[PumpCycle MaxStarts] P C P n ★

Maximum number of events to trip.

This parameter can be accessed if [PumpCycle Monitoring] P C P Π is not set to [No] n o.

Setting (C)	Description
1...99	Setting range Factory setting: 6

[PumpCycle Timeframe] P C P t ★

Window time.

This parameter can be accessed if P C P Π is not set to [Inactive] n o.

Setting (C)	Description
0...3,600 min	Setting range Factory setting: 60 min

[PumpCycleError Resp] P C P b ★

Pumpcycle monitoring response to a detected error.

This parameter can be accessed if P C P Π is not set to [Inactive] n o.

Setting	Code / Value	Description
[Ignore]	n o	Detected error ignored
[Freewheel Stop]	y E 5	Freewheel stop
1 Because, in this case, the detected error does not trigger a stop, it is recommended to assign a relay or logic output to its indication.		

[Fallback Speed] L F F ★

Fallback speed.

This parameter can be accessed if P C P Π is not set to [Inactive] n o.

Setting	Description
0.0...599.0 Hz	Setting range Factory setting: 0.0 Hz

Section 8.11

[Pump monitoring] - [Thermal monitoring]

[Thermal monitoring] *E P P* - Menu

Access

[Complete settings] → [Pump monitoring] → [Thermal monitoring]

About This Menu

Identical to [Thermal monitoring] *E P P* - Menu (*see page 185*).

Section 8.12

[Master/Slave]

What Is in This Section?

This section contains the following topics:

Topic	Page
MultiDrive Link Mechanism	274
[M/S System Architecture] П 5 А - Menu	276
[Speed Ref AI1 Config.] П 5 r 1 - Menu	279
[Speed Ref AI2 Config.] П 5 r 2 - Menu	280
[Speed Ref AI3 Config.] П 5 r 3 - Menu	281
[Speed Ref AI4 Config.] П 5 r 4 - Menu	282
[Speed Ref AI5 Config.] П 5 r 5 - Menu	283
[M/S System Architecture] П 5 А - Menu	284
[Torque Ref AI1 Config.] П 5 r 1 - Menu	285
[Torque Ref AI2 Config.] П 5 r 2 - Menu	286
[Torque Ref AI3 Config.] П 5 r 3 - Menu	287
[Torque Ref AI4 Config.] П 5 r 4 - Menu	288
[Torque Ref AI5 Config.] П 5 r 5 - Menu	289
[M/S System Architecture] П 5 А - Menu	290
[Speed Ref AQ1 Config.] П 5 П 1 - Menu	291
[Speed Ref AQ2 Config.] П 5 П 2 - Menu	292
[M/S System Architecture] П 5 А - Menu	293
[Torque Ref AQ1 Config.] П 5 П 1 - Menu	293
[Torque Ref AQ2 Config.] П 5 П 2 - Menu	294
[M/S System Architecture] П 5 А - Menu	295
[M/S Control] П 5 5 - Menu	297
[M/S Torque Control] П 5 9 - Menu	299
[M/S Control] П 5 5 - Menu	303
[M/S Filters] П 5 F - Menu	304
[Load Sharing M/S] П 5 б - Menu	307
[M/S Control] П 5 5 - Menu	310

MultiDrive Link Mechanism

Introduction

MultiDrive Link function allows direct communication between a drives group. This communication is done through an Ethernet link between each drives. Some drive functions can be configured with the MultiDrive Link.

Topology

MultiDrive Link function is an Ethernet based protocol.

It can be used in following topologies:

- Daisy chain
- Star
- Redundant ring with RSTP

More information about topologies is available in ATV900 Embedded Ethernet Manual.

MultiDrive Link Properties

MultiDrive Link Group:

A MultiDrive Link group can be composed of:

- Master, which is mandatory.
- Up to 10 Slaves.

Only 1 master must be present in a MultiDrive Link group.

Each drive, acting as slave, must have its own slave identification.

Data Exchange Principle:

Each drive of the MultiDrive Link group sends data to all the drives of its group.

These data are sorted in data groups which are specifics for each application used in combination.

These data are sent using UDP frames with multicast IP addressing.

Network Configuration

The MultiDrive Link function uses the following network resources:

- IP address: 239.192.152.143
- UDP ports: 6700 and 6732
- Non routed networks

If the MultiDrive Link function is used over an Ethernet network, it is mandatory to take into account these resources for its configuration.

Only one MultiDrive Link group can be used on a same Ethernet network.

Drive Configuration

Each drive used on a MultiDrive Link group must have an IP address.

This IP address can be set manually or assigned by a DHCP server.

MultiDrive Link Communication Monitoring

A permanent monitoring of the communication is performed by each drive of the MultiDrive Link Group to avoid:

- Execution of the same command
- Corruption of data on the MultiDrive Link group

Duplicate Slave ID:

The following table shows how the function reacts in case of duplicate slave ID detection:

If a Duplicate Slave ID is...	Then...
Detected at the same time in the MultiDrive Link group	It is not possible to identify the valid drive. In this case, both drives: <ul style="list-style-type: none"> ● are considered invalid ● are unavailable on the MultiDrive Link group ● don't send data on the MultiDrive Link group
Detected and already one drive with this Slave ID is running	The existing drive is considered valid. The duplicate drive: <ul style="list-style-type: none"> ● is considered invalid ● is not available on the MultiDrive Link group ● don't send data on the MultiDrive Link group NOTE: There is no effect on the application in this case.

Intruder:

A drive is considered as intruder of a MultiDrive Link group if its Slave ID is not consistent with the number of slaves declared on Master configuration.

If the drive Slave ID is not consistent with the configuration then it:

- Considers itself as invalid
- Don't send data on the MultiDrive Link group
- Don't accept data from the MultiDrive Link group

[M/S System Architecture] $\Pi 5 A$ - Menu

Access

[Complete settings] → [Master/Slave] → [M/S System Architecture]

About This Menu

This menu allows the user to configure its Master/Slave architecture.

Master/Slave architecture configuration: allows configuring the communication mode between the Master and Slaves. Which drive is the Master and which ones are the Slaves. It also allows to assign speed and torque reference values.

Master/Slave error response: allows configuring how the Master or Slaves react if an error is detected (Master not present, Slave not ready or communication link error).

The following diagram shows the Master/Slave related parameters depending on their configuration:

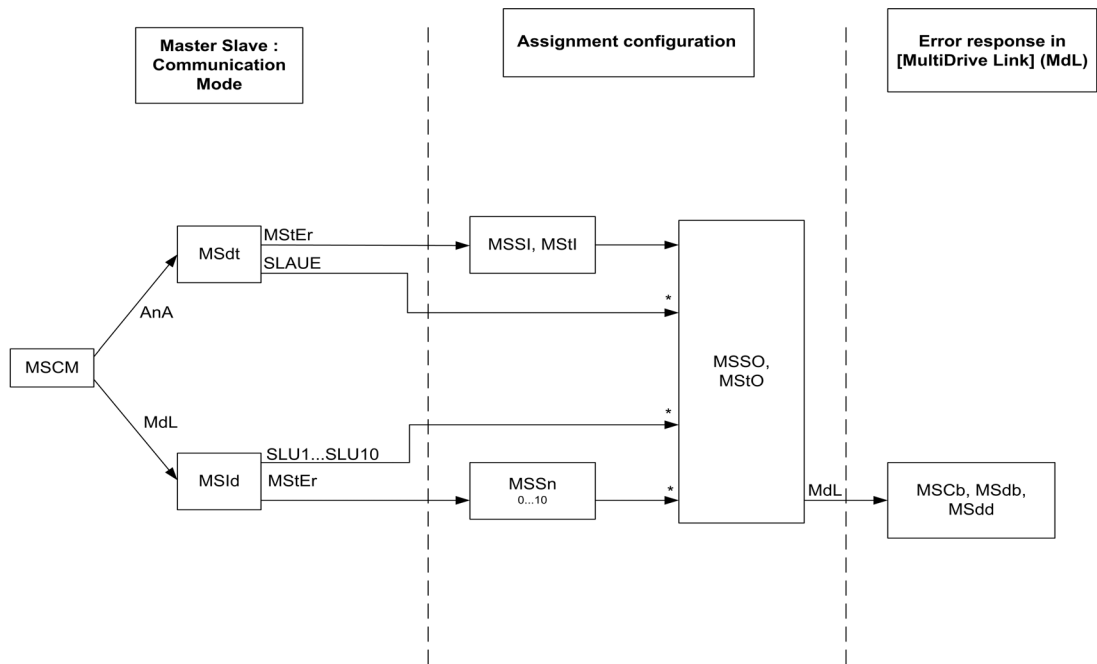

* [Access Level] LRC is set to [Expert] EP_r

The following table shows the visibility of the parameters in [Analog] ANA or in [MultiDrive Link] ΠdL mode:

[M/S Comm Mode] $\Pi 5 C \Pi$ M/S communication mode	Analog		MultiDrive Link	
[M/S Device ID] $\Pi 5 d$: Master or Slave ID selection	-	-	Master	Slave 1 to Slave 10
[M/S Device Role] $\Pi 5 d E$: Master or Slave selection	Master	Slave	-	-
[M/S Number of Slaves] $\Pi 5 5 n$: M/S number of slaves	-	-	0 to 10	-
[M/S Speed Ref In Assign] $\Pi 5 5 i$: M/S Master speed reference input assignment	-	Analog Input	-	-
[M/S Trq Ref In Assign] $\Pi 5 E i$: M/S Master torque reference input assignment	-	Analog Input	-	-
[M/S Speed Ref Out Assign] $\Pi 5 5 o$: M/S speed reference output assignment	Analog Output	Analog Output*	Analog Output*	Analog Output*
[M/S Trq Ref Out Assign] $\Pi 5 E o$: M/S torque reference output assignment	Analog Output	Analog Output*	Analog Output*	Analog Output*
[M/S Local Mode Assign] $\Pi 5 d i$: M/S local mode input assignment	-	-	Digital Input	Digital Input
* Parameters that can be accessed if [Access Level] LRC is set to [Expert] EP_r				

[M/S Comm Mode] <i>Π 5 C Π</i> M/S communication mode	Analog		MultiDrive Link	
[M/S Comm ErrorResp] <i>Π 5 C b</i> : M/S Response to communication error	-	-	Error Response	Error Response
[M/S Device ErrorResp] <i>Π 5 d b</i> : M/S Response to device error	-	-	Error Response	Error Response
[M/S Device Error Delay] <i>Π 5 d d</i> : M/S device error delay	-	-	Error Delay	Error Delay
* Parameters that can be accessed if [Access Level] <i>L R C</i> is set to [Expert] <i>E P r</i>				

NOTE: Master/Slave function can be configured only if [Motor Control Type] *C E E* is set to [SVC V] *V V C* or [FVC] *F V C* or [Sync. mot.] *S Y n* or [Sync.CL] *F 5 Y*.

NOTE: When a drive acts as a slave, [Low Speed] *L 5 P* and [High Speed] *H 5 P* must be configured same as master.

NOTE: The drive must be restart to apply the Master/Slave configuration.

[M/S Comm Mode] *Π 5 C Π* ★

Master / Slave communication mode.

Activate Master Slave and select communication mode to exchange data between drives involved in the Master Slave architecture.

Setting	Code / Value	Description
[No]	<i>n o</i>	Master/Slave is not configured. Factory setting
[MultiDrive Link]	<i>Π d L</i>	Master/Slave is configured using MultiDrive Link
[Analog]	<i>R n R</i>	Master/Slave is configured using Analog I/Os. It is recommended to wire a digital output of the slave assigned to [Operating State Fault] <i>F L E</i> to a digital input of the master set to [Ext Error assign] <i>E E F</i> , with this setting, an error on the slave drive generates a stop to the master. NOTE: If it is required, a digital output of the slaves assigned to [Operating State Fault] <i>F L E</i> can be wired to a digital input of the master sets to [Ext Error assign] <i>E E F</i> in order to stop the master if an error is detected on a slave drive.

[M/S Device ID] *Π 5 i d* ★

Master / Slave ID selection.

This parameter selects the Drive identification number for the Master Slave application.

This parameter can be accessed if [M/S Comm Mode] *Π 5 C Π* is set to [MultiDrive Link] *Π d L*

Setting	Code / Value	Description
[Master]	<i>Π 5 E E r</i>	Master Factory setting NOTE: Be sure that autotune has been done before selecting a drive as master. Otherwise, use the [M/S Local Mode Assign] <i>Π 5 d i</i> input to disable temporary the Master/Slave function and perform autotune.
[Slave1]...[Slave10]]	<i>5 L V 1... 5 L V 1 0</i>	Slave ID

[M/S Device Role] П5дЕ★

Master / Slave selection.

Select if the drive is the master or a slave.

This parameter can be accessed if [M/S Comm Mode] П5СП is set to [Analog] PnA

Setting	Code / Value	Description
[Master]	МСТЕР	The Drive is configured as the Master Drive. (it provides the speed and torque reference value to Slaves). Factory setting
[Slave]	СЛАВЕ	The Drive is configured as a Slave Drive. (it uses the speed and torque reference value from the Master).

[M/S Number of Slaves] П55n★

Master / Slave number of slaves.

Total number of slaves in the Master Slave architecture. The maximum number of slaves is 10 in multi-drive link architecture. In Analog architecture the maximum number of slaves depends on Analog I/O capabilities.

This parameter can be accessed if:

- [M/S Comm Mode] П5СП is set to [MultiDrive Link] ПдЛ, and
- [M/S Device ID] П5,д is set to [Master] МСТЕР.

Setting	Description
0...10	Setting range Factory setting: 0

[M/S Speed Ref In Assign] П55,★

Master / Slave speed reference input assignment.

This parameter can be accessed if:

- [M/S Comm Mode] П5СП is set to [Analog] PnA, and
- [M/S Device Role] П5дЕ is set to [Slave] СЛАВЕ.

Setting	Code / Value	Description
[No]	NO	Analog input is not configured Factory setting
[AI1]...[AI3]	P,1...P,3	Analog input AI1...AI3
[AI4]...[AI5]	P,4...P,5	Analog input AI4...AI5 if VW3A3203 I/O extension module has been inserted

[Speed Ref AI1 Config.] *Π 5 ρ 1* - Menu

Access

[Complete settings] → [Master/Slave] → [M/S System Architecture] → [Speed Ref AI1 Config.]

About This Menu

This menu can be accessed if:

- [M/S Device Role] *Π 5 δ ε* is set to [Slave] *5 L R V E*, and
- [M/S Speed Ref In Assign] *Π 5 5*, is set to [AI1] *R 1 E*.

[AI1 Type] *R 1 E*

Configuration of analog input AI1.

Setting	Code / Value	Description
[Voltage]	<i>1 0 μ</i>	0-10 Vdc Factory setting
[Current]	<i>0 R</i>	0-20 mA

[AI1 min value] *μ 1 L 1* ★

AI1 voltage scaling parameter of 0%.

This parameter can be accessed if [AI1 Type] *R 1 E* is set to [Voltage] *1 0 μ*.

Setting	Description
0.0...10.0 Vdc	Setting range Factory setting: 0.0 Vdc

[AI1 max value] *μ 1 H 1* ★

AI1 voltage scaling parameter of 100%.

This parameter can be accessed if [AI1 Type] *R 1 E* is set to [Voltage] *1 0 μ*.

Setting	Description
0.0...10.0 Vdc	Setting range Factory setting: 10.0 Vdc

[AI1 min. value] *ε ρ L 1* ★

AI1 current scaling parameter of 0%.

This parameter can be accessed if [AI1 Type] *R 1 E* is set to [Current] *0 R*.

Setting	Description
0.0...20.0 mA	Setting range Factory setting: 0.0 mA

[AI1 max. value] *ε ρ H 1* ★

AI1 current scaling parameter of 100%.

This parameter can be accessed if [AI1 Type] *R 1 E* is set to [Current] *0 R*.

Setting	Description
0.0...20.0 mA	Setting range Factory setting: 20.0 mA

[Speed Ref AI2 Config.] $\pi 5 r 2$ - Menu

Access

[Complete settings] → [Master/Slave] → [M/S System Architecture] → [Speed Ref AI2 Config.]

About This Menu

This menu can be accessed if:

- [M/S Device Role] $\pi 5 d E$ is set to [Slave] $5 L A V E$, and
- [M/S Speed Ref In Assign] $\pi 5 5$ is set to [AI2] $A I 2$.

[AI2 Type] $A I 2 E$

Configuration of analog input AI2.

Setting	Code / Value	Description
[Voltage]	$1 0 u$	0-10 Vdc
[Voltage +/-]	$n 1 0 u$	-10/+10 Vdc Factory setting

[AI2 min value] $u , L 2$ ★

AI2 voltage scaling parameter of 0%.

This parameter can be accessed if [AI2 Type] $A I 2 E$ is set to:

- [Voltage] $1 0 u$, or
- [Voltage+/-] $n 1 0 u$.

Identical to [AI1 min value] $u , L 1$ (*see page 279*).

[AI2 max value] $u , H 2$ ★

AI2 voltage scaling parameter of 100%.

This parameter can be accessed if [AI2 Type] $A I 2 E$ is set to:

- [Voltage] $1 0 u$, or
- [Voltage+/-] $n 1 0 u$.

Identical to [AI1 max value] $u , H 1$ (*see page 279*).

[Speed Ref AI3 Config.] П 5 r Э - Menu

Access

[Complete settings] → [Master/Slave] → [M/S System Architecture] → [Speed Ref AI3 Config.]

About This Menu

This menu can be accessed if:

- [M/S Device Role] П 5 d E is set to [Slave] 5 L A V E, and
- [M/S Speed Ref In Assign] П 5 5 is set to [AI3] A, Э.

[AI3 Type] A, Э E

Configuration of analog input AI3.

Identical to [AI2 Type] A, 2 E (*see page 280*) with factory setting: [Current] 0 A.

[AI3 min value] u, L Э ★

AI3 voltage scaling parameter of 0%.

Identical to [AI1 min value] u, L I (*see page 279*).

This parameter can be accessed if [AI3 Type] A, Э E is set to [Voltage] 1 0 u.

[AI3 max value] u, H Э ★

AI3 voltage scaling parameter of 100%.

Identical to [AI1 max value] u, H I (*see page 279*).

This parameter can be accessed if [AI3 Type] A, Э E is set to [Voltage] 1 0 u.

[AI3 min. value] C r L Э ★

AI3 current scaling parameter of 0%.

Identical to [AI1 min. value] C r L I (*see page 279*).

This parameter can be accessed if [AI3 Type] A, Э E is set to [Current] 0 A.

[AI3 max. value] C r H Э ★

AI3 current scaling parameter of 100%.

Identical to [AI1 max. value] C r H I (*see page 279*).

This parameter can be accessed if [AI3 Type] A, Э E is set to [Current] 0 A.

[Speed Ref AI4 Config.] П 5 r 4 - Menu

Access

[Complete settings] → [Master/Slave] → [M/S System Architecture] → [Speed Ref AI4 Config.]

About This Menu

This menu can be accessed if:

- [M/S Device Role] П 5 d E is set to [Slave] 5 L R V E , and
- [M/S Speed Ref In Assign] П 5 5 , is set to [AI4] R , 4 .

[AI4 Type] R , 4 E ★

Configuration of analog input AI4.

This parameter can be accessed if VW3A3203 I/O extension module has been inserted.

Setting	Code / Value	Description
[Voltage]	1 0 u	0-10 Vdc
[Current]	0 R	0-20 mA Factory setting
[Voltage +/-]	n 1 0 u	-10/+10 Vdc

[AI4 min value] u , L 4 ★

AI4 voltage scaling parameter of 0%.

This parameter can be accessed if [AI4 Type] R , 4 E is set to:

- [Voltage] 1 0 u , or
- [Voltage+/-] n 1 0 u .

Identical to [AI1 min value] u , L 1 (see page 279).

[AI4 max value] u , H 4 ★

AI4 voltage scaling parameter of 100%.

This parameter can be accessed if [AI4 Type] R , 4 E is set to:

- [Voltage] 1 0 u , or
- [Voltage+/-] n 1 0 u .

Identical to [AI1 max value] u , H 1 (see page 279).

[AI4 min. value] C r L 4 ★

AI4 current scaling parameter of 0%.

This parameter can be accessed if [AI4 Type] R , 4 E is set to [Current] 0 R .

Identical to [AI1 min. value] C r L 1 (see page 279).

[AI4 max. value] C r H 4 ★

AI4 current scaling parameter of 100%.

This parameter can be accessed if [AI4 Type] R , 4 E is set to [Current] 0 R .

Identical to [AI1 max. value] C r H 1 (see page 279).

[Speed Ref AI5 Config.] П 5 r 5 - Menu

Access

[Complete settings] → [Master/Slave] → [M/S System Architecture] → [Speed Ref AI5 Config.]

About This Menu

This menu can be accessed if:

- [M/S Device Role] П 5 d E is set to [Slave] 5 L A V E , and
- [M/S Speed Ref In Assign] П 5 5 , is set to [AI5] A , 5 .

[AI5 Type] A , 5 E ★

Configuration of analog input AI5.

This parameter can be accessed if VW3A3203 I/O extension module has been inserted.

Identical to [AI4 Type] A , 4 E . (see page 282)

[AI5 min value] u , L 5 ★

AI5 voltage scaling parameter of 0%.

This parameter can be accessed if [AI5 Type] A , 5 E is set to:

- [Voltage] I 0 u , or
- [Voltage+/-] n I 0 u .

Identical to [AI1 min value] u , L 1 (see page 279).

[AI5 max value] u , H 5 ★

AI5 voltage scaling parameter of 100%.

This parameter can be accessed if [AI5 Type] A , 5 E is set to:

- [Voltage] I 0 u , or
- [Voltage+/-] n I 0 u .

Identical to [AI1 max value] u , H 1 (see page 279).

[AI5 min. value] C r L 5 ★

AI5 current scaling parameter of 0%.

This parameter can be accessed if [AI5 Type] A , 5 E is set to [Current] 0 A .

Identical to [AI1 min. value] C r L 1 (see page 279).

[AI5 max. value] C r H 5 ★

AI5 current scaling parameter of 100%.

This parameter can be accessed if [AI5 Type] A , 5 E is set to [Current] 0 A .

Identical to [AI1 max. value] C r H 1 (see page 279).

[M/S System Architecture] П 5 А - Menu**Access**

[Complete settings] → [Master/Slave] → [M/S System Architecture]

[M/S Trq Ref In Assign] П 5 Е , ★

Master / Slave torque reference input assignment.

This parameter can be accessed if:

- [M/S Comm Mode] П 5 С П is set to [Analog] А н А
- [M/S Device Role] П 5 д Е is set to [Slave] S L A V E
- [M/S Control Type] П 5 С Е is set to [Torque Direct] Е r 9 d, [Torque Reverse] Е r 9 r or [Torque Custom] Е r 9 C .

Setting	Code / Value	Description
[No]	н 0	Analog input is not configured Factory setting
[AI1]...[AI3]	А , 1...А , 3	Analog input AI1...AI3
[AI4]...[AI5]	А , 4...А , 5	Analog input AI4...AI5 if VW3A3203 I/O extension module has been inserted

[Torque Ref AI1 Config.] *Π Ε ρ Ι* - Menu

Access

[Complete settings] → [Master/Slave] → [M/S System Architecture] → [Torque Ref AI1 Config.]

About This Menu

This menu can be accessed if:

- [M/S Device Role] *Π Σ Δ Ε* is set to [Slave] *Σ Λ Ρ Η Ε*, and
- [M/S Trq Ref In Assign] *Π Σ Ε*, is set to [AI1] *Ρ Ι Ε*.

[AI1 Type] *Ρ Ι Ε*

Configuration of analog input AI1.

Setting	Code / Value	Description
[Voltage]	<i>Ι Δ υ</i>	0-10 Vdc Factory setting
[Current]	<i>Δ Ρ</i>	0-20 mA

[AI1 min value] *υ , Λ Ι ★*

AI1 voltage scaling parameter of 0%.

This parameter can be accessed if [AI1 Type] *Ρ Ι Ε* is set to [Voltage] *Ι Δ υ*.

Setting	Description
0.0...10.0 Vdc	Setting range Factory setting: 0.0 Vdc

[AI1 max value] *υ , Η Ι ★*

AI1 voltage scaling parameter of 100%.

This parameter can be accessed if [AI1 Type] *Ρ Ι Ε* is set to [Voltage] *Ι Δ υ*.

Setting	Description
0.0...10.0 Vdc	Setting range Factory setting: 10.0 Vdc

[AI1 min. value] *Ε ρ Λ Ι ★*

AI1 current scaling parameter of 0%.

This parameter can be accessed if [AI1 Type] *Ρ Ι Ε* is set to [Current] *Δ Ρ*.

Setting	Description
0.0...20.0 mA	Setting range Factory setting: 0.0 mA

[AI1 max. value] *Ε ρ Η Ι ★*

AI1 current scaling parameter of 100%.

This parameter can be accessed if [AI1 Type] *Ρ Ι Ε* is set to [Current] *Δ Ρ*.

Setting	Description
0.0...20.0 mA	Setting range Factory setting: 20.0 mA

[Torque Ref AI2 Config.] $\pi \epsilon r \rho$ - Menu

Access

[Complete settings] → [Master/Slave] → [M/S System Architecture] → [Torque Ref AI2 Config.]

About This Menu

This menu can be accessed if:

- [M/S Device Role] $\pi \delta d \epsilon$ is set to [Slave] $S L A V E$, and
- [M/S Trq Ref In Assign] $\pi \delta \epsilon$ is set to [AI2] $A I 2$.

[AI2 Type] $A I 2 \epsilon$

Configuration of analog input AI2.

Setting	Code / Value	Description
[Voltage]	100	0-10 Vdc
[Voltage +/-]	$n 100$	-10/+10 Vdc Factory setting

[AI2 min value] $\mu , L \rho$ ★

AI2 voltage scaling parameter of 0%.

This parameter can be accessed if [AI2 Type] $A I 2 \epsilon$ is set to:

- [Voltage] 100 , or
- [Voltage+/-] $n 100$.

Identical to [AI1 min value] $\mu , L I$ (see page 285).

[AI2 max value] $\mu , H \rho$ ★

AI2 voltage scaling parameter of 100%.

This parameter can be accessed if [AI2 Type] $A I 2 \epsilon$ is set to:

- [Voltage] 100 , or
- [Voltage+/-] $n 100$.

Identical to [AI1 max value] $\mu , H I$ (see page 285).

[Torque Ref AI3 Config.] П L r Э - Menu

Access

[Complete settings] → [Master/Slave] → [M/S System Architecture] → [Torque Ref AI3 Config.]

About This Menu

This menu can be accessed if:

- [M/S Device Role] П S d E is set to [Slave] S L R V E, and
- [M/S Trq Ref In Assign] П S E, is set to [AI3] R, Э.

[AI3 Type] R, Э E

Configuration of analog input AI3.

Identical to [AI2 Type] R, Э E (see page 280) with factory setting: [Current] П R.

[AI3 min value] П, L Э ★

AI3 voltage scaling parameter of 0%.

Identical to [AI1 min value] П, L I (see page 285).

This parameter can be accessed if [AI3 Type] R, Э E is set to [Voltage] П R.

[AI3 max value] П, H Э ★

AI3 voltage scaling parameter of 100%.

Identical to [AI1 max value] П, H I (see page 285).

This parameter can be accessed if [AI3 Type] R, Э E is set to [Voltage] П R.

[AI3 min. value] C r L Э ★

AI3 current scaling parameter of 0%.

Identical to [AI1 min. value] C r L I (see page 285).

This parameter can be accessed if [AI3 Type] R, Э E is set to [Current] П R.

[AI3 max. value] C r H Э ★

AI3 current scaling parameter of 100%.

Identical to [AI1 max. value] C r H I (see page 285).

This parameter can be accessed if [AI3 Type] R, Э E is set to [Current] П R.

[Torque Ref AI4 Config.] П E r 4 - Menu

Access

[Complete settings] → [Master/Slave] → [M/S System Architecture] → [Torque Ref AI4 Config.]

About This Menu

This menu can be accessed if:

- [M/S Device Role] П S d E is set to [Slave] S L A V E , and
- [M/S Trq Ref In Assign] П S E , is set to [AI4] A , 4 .

[AI4 Type] A , 4 E ★

Configuration of analog input AI4.

This parameter can be accessed if VW3A3203 I/O extension module has been inserted.

Setting	Code / Value	Description
[Voltage]	1 0 u	0-10 Vdc
[Current]	0 A	0-20 mA Factory setting
[Voltage +/-]	n 1 0 u	-10/+10 Vdc

[AI4 min value] u , L 4 ★

AI4 voltage scaling parameter of 0%.

This parameter can be accessed if [AI2 Type] A , 2 E is set to:

- [Voltage] 1 0 u , or
- [Voltage+/-] n 1 0 u .

Identical to [AI1 min value] u , L 1 (see page 285).

[AI4 max value] u , H 4 ★

AI4 voltage scaling parameter of 100%.

This parameter can be accessed if [AI2 Type] A , 2 E is set to:

- [Voltage] 1 0 u , or
- [Voltage+/-] n 1 0 u .

Identical to [AI1 max value] u , H 1 (see page 285).

[AI4 min. value] C r L 4 ★

AI4 current scaling parameter of 0%.

This parameter can be accessed if [AI4 Type] A , 4 E is set to [Current] 0 A .

Identical to [AI1 min. value] C r L 1 (see page 285).

[AI4 max. value] C r H 4 ★

AI4 current scaling parameter of 100%.

This parameter can be accessed if [AI4 Type] A , 4 E is set to [Current] 0 A .

Identical to [AI1 max. value] C r H 1 (see page 285).

[Torque Ref AI5 Config.] $\Pi E r 5$ - Menu

Access

[Complete settings] → [Master/Slave] → [M/S System Architecture] → [Torque Ref AI5 Config.]

About This Menu

This menu can be accessed if:

- [M/S Device Role] $\Pi 5 d E$ is set to [Slave] $5 L A V E$, and
- [M/S Trq Ref In Assign] $\Pi 5 E$ is set to [AI5] $A, 5$.

[AI5 Type] $A, 5 E$ ★

Configuration of analog input AI5.

This parameter can be accessed if VW3A3203 I/O extension module has been inserted.

Identical to [AI4 Type] $A, 4 E$. (see page 282)

[AI5 min value] $u, L 5$ ★

AI5 voltage scaling parameter of 0%.

This parameter can be accessed if [AI2 Type] $A, 2 E$ is set to:

- [Voltage] $10 u$, or
- [Voltage+/-] $n 10 u$.

Identical to [AI1 min value] $u, L 1$ (see page 285).

[AI5 max value] $u, H 5$ ★

AI5 voltage scaling parameter of 100%.

This parameter can be accessed if [AI2 Type] $A, 2 E$ is set to:

- [Voltage] $10 u$, or
- [Voltage+/-] $n 10 u$.

Identical to [AI1 max value] $u, H 1$ (see page 285).

[AI5 min. value] $C r L 5$ ★

AI5 current scaling parameter of 0%.

This parameter can be accessed if [AI5 Type] $A, 5 E$ is set to [Current] $0 A$.

Identical to [AI1 min. value] $C r L 1$ (see page 285).

[AI5 max. value] $C r H 5$ ★

AI5 current scaling parameter of 100%.

This parameter can be accessed if [AI5 Type] $A, 5 E$ is set to [Current] $0 A$.

Identical to [AI1 max. value] $C r H 1$ (see page 285).

[M/S System Architecture] 050 - Menu**Access**

[Complete settings] → [Master/Slave] → [M/S System Architecture]

[M/S Speed Ref Out Assign] 055 ★

Master / Slave output speed reference.

Analog output selected for speed reference for the Master Drive.

This parameter can be accessed if [M/S Comm Mode] 050 is not set to [No] 00.

Setting	Code / Value	Description
[No]	00	Analog output for speed reference is not configured. Factory setting
[AQ1 assignment]	01	Analog Output for speed reference is configured to 01.
[AQ2 assignment]	02	Analog Output for speed reference is configured to 02.
In order to monitor the loss of signal, it is recommended to use a 4-20mA link between the master and the slave and to configure the monitoring function in the [4-20 mA loss] LFL - menu.		

NOTE: To allow configuration, outputs default configuration must be unconfigured.

[Speed Ref AQ1 Config.] Π 5 Π I - Menu

Access

[Complete settings] → [Master/Slave] → [M/S System Architecture] → [Speed Ref AQ1 Config.]

About This Menu

This menu can be accessed if [M/S Speed Ref Out Assign] Π 5 5 α is set to [AQ1 assignment] R α I.

[AQ1 Type] R α I ϵ

AQ1 type.

Setting	Code / Value	Description
[Voltage]	I Π μ	0-10 Vdc Factory setting
[Current]	Π R	0-20 mA

[AQ1 min output] R α L I ★

AQ1 current scaling parameter of 0%.

This parameter can be accessed if [AQ1 Type] R α I ϵ is set to [Current] Π R.

Setting	Description
0.0...20.0 mA	Setting range Factory setting: 0.0 mA

[AQ1 max output] R α H I ★

AQ1 current scaling parameter of 100%.

This parameter can be accessed if [AQ1 Type] R α I ϵ is set to [Current] Π R.

Setting	Description
0.0...20.0 mA	Setting range Factory setting: 20.0 mA

[AQ1 min Output] μ α L I ★

AQ1 voltage scaling parameter of 0%.

This parameter can be accessed if [AQ1 Type] R α I ϵ is set to [Voltage] I Π μ .

Setting	Description
0.0...10.0 Vdc	Setting range Factory setting: 0.0 Vdc

[AQ1 max Output] μ α H I ★

AQ1 voltage scaling parameter of 100%.

This parameter can be accessed if [AQ1 Type] R α I ϵ is set to [Voltage] I Π μ .

Setting	Description
0.0...10.0 Vdc	Setting range Factory setting: 10.0 Vdc

[Speed Ref AQ2 Config.] 1512 - Menu

Access

[Complete settings] → [Master/Slave] → [M/S System Architecture] → [Speed Ref AQ2 Config.]

About This Menu

This menu can be accessed if [M/S Speed Ref Out Assign] 1550 is set to [AQ2 assignment] 102.

[AQ2 Type] 102E

AQ2 type.

Setting	Code / Value	Description
[Voltage]	100	0-10 Vdc
[Current]	00	0-20 mA Factory setting

[AQ2 min output] 10L2★

AQ2 current scaling parameter of 0%.

This parameter can be accessed if [AQ2 Type] 102E is set to [Current] 00.

Identical to [AQ1 min output] 10L1 (see page 291).

[AQ2 max output] 10H2★

AQ2 current scaling parameter of 100%.

This parameter can be accessed if [AQ2 Type] 102E is set to [Current] 00.

Identical to [AQ1 max output] 10H1 (see page 291).

[AQ2 min Output] 10L2★

AQ2 voltage scaling parameter of 0%.

This parameter can be accessed if [AQ2 Type] 102E is set to [Voltage] 100.

Identical to [AQ1 min Output] 10L1 (see page 291).

[AQ2 max Output] 10H2★

AQ2 voltage scaling parameter of 100%.

This parameter can be accessed if [AQ2 Type] 102E is set to [Voltage] 100.

Identical to [AQ1 max Output] 10H1 (see page 291).

[M/S System Architecture] $\Pi 5 R$ - Menu

Access

[Complete settings] → [Master/Slave] → [M/S System Architecture]

[M/S Trq Ref Out Assign] $\Pi 5 L \square$ ★

Master / Slave output torque reference.

Analog output selected for torque reference for the Master Drive.

Setting	Code / Value	Description
[No]	$n \square$	Analog output for torque reference is not configured. Factory setting
[AQ1 assignment]	$R \square 1$	Analog Output for speed reference is configured to $R \square 1$.
[AQ2 assignment]	$R \square 2$	Analog Output for speed reference is configured to $R \square 2$.
In order to monitor the loss of signal, it is recommended to use a 4-20mA link between the master and the slave and to configure the monitoring function in the [4-20 mA loss] $L F L$ - menu.		

NOTE: To allow configuration, outputs default configuration must be unconfigured.

[Torque Ref AQ1 Config.] $\Pi E \Pi 1$ - Menu

Access

[Complete settings] → [Master/Slave] → [M/S System Architecture] → [Torque Ref AQ1 Config.]

About This Menu

This menu can be accessed if [M/S Trq Ref Out Assign] $\Pi 5 5 \square$ is set to [AQ1 assignment] $R \square 1$.

[AQ1 Type] $R \square 1 E$

AQ1 type.

Setting	Code / Value	Description
[Voltage]	$1 \square \square$	0-10 Vdc Factory setting
[Current]	$\square R$	0-20 mA

[AQ1 min output] $R \square L 1$ ★

AQ1 current scaling parameter of 0%.

This parameter can be accessed if [AQ1 Type] $R \square 1 E$ is set to [Current] $\square R$.

Setting	Description
0.0...20.0 mA	Setting range Factory setting: 0.0 mA

[AQ1 max output] $R \square H 1$ ★

AQ1 current scaling parameter of 100%.

This parameter can be accessed if [AQ1 Type] $R \square 1 E$ is set to [Current] $\square R$.

Setting	Description
0.0...20.0 mA	Setting range Factory setting: 20.0 mA

[AQ1 min Output] $\mu \square L \mid \star$

AQ1 voltage scaling parameter of 0%.

This parameter can be accessed if **[AQ1 Type] $R \square I \varepsilon$** is set to **[Voltage] $\mid \square \mu$** .

Setting	Description
0.0...10.0 Vdc	Setting range Factory setting: 0.0 Vdc

[AQ1 max Output] $\mu \square H \mid \star$

AQ1 voltage scaling parameter of 100%.

This parameter can be accessed if **[AQ1 Type] $R \square I \varepsilon$** is set to **[Voltage] $\mid \square \mu$** .

Setting	Description
0.0...10.0 Vdc	Setting range Factory setting: 10.0 Vdc

[Torque Ref AQ2 Config.] $\Pi \varepsilon \Pi \varepsilon - \text{Menu}$

Access

[Complete settings] → [Master/Slave] → [M/S System Architecture] → [Torque Ref AQ2 Config.]

About This Menu

This menu can be accessed if **[M/S Trq Ref Out Assign] $\Pi 5 5 \square$** is set to **[AQ2 assignment] $R \square \varepsilon$** .

[AQ2 Type] $R \square \varepsilon \varepsilon$

AQ2 type.

Setting	Code / Value	Description
[Voltage]	$\mid \square \mu$	0-10 Vdc
[Current]	$\square R$	0-20 mA Factory setting

[AQ2 min output] $R \square L \varepsilon \star$

AQ2 current scaling parameter of 0%.

This parameter can be accessed if **[AQ2 Type] $R \square \varepsilon \varepsilon$** is set to **[Current] $\square R$** .

Identical to **[AQ1 min output] $R \square L \mid$** (*see page 293*).

[AQ2 max output] $R \square H \varepsilon \star$

AQ2 current scaling parameter of 100%.

This parameter can be accessed if **[AQ2 Type] $R \square \varepsilon \varepsilon$** is set to **[Current] $\square R$** .

Identical to **[AQ1 max output] $R \square H \mid$** (*see page 293*).

[AQ2 min Output] $\mu \square L \varepsilon \star$

AQ2 voltage scaling parameter of 0%.

This parameter can be accessed if **[AQ2 Type] $R \square \varepsilon \varepsilon$** is set to **[Voltage] $\mid \square \mu$** .

Identical to **[AQ1 min Output] $\mu \square L \mid$** (*see page 294*).

[AQ2 max Output] $\mu \square H \varepsilon \star$

AQ2 voltage scaling parameter of 100%.

This parameter can be accessed if **[AQ2 Type] $R \square \varepsilon \varepsilon$** is set to **[Voltage] $\mid \square \mu$** .

Identical to **[AQ1 max Output] $\mu \square H \mid$** (*see page 294*).

[M/S System Architecture] П 5 А - Menu

Access

[Complete settings] → [Master/Slave] → [M/S System Architecture]

[M/S Local Mode Assign] П 5 д , ★

Master / Slave local mode assignment.

Digital input used to switch between Master/Slave automatic operation and local control mode (for example in maintenance mode).

This parameter can be accessed if [M/S Comm Mode] П 5 С П is not set to [No] н о .

NOTE: It is recommended to use this mode when system is stopped and, if possible, motor mechanically disconnected.

Setting	Code / Value	Description
[Not Assigned]	н о	Not assigned Factory setting
[DI1]...[DI8]	L , I...L , B	Digital input DI1...DI8
[DI11]...[DI16]	L , I I...L , I B	Digital input DI11...DI16 if VW3A3203 I/O extension module has been inserted

[MDL Comm Timeout] П Л Е о ★

MultiDrive Link communication timeout.

This parameter can be accessed if [M/S Comm Mode] П 5 С П is set to [MultiDrive Link] П д Л .

Setting	Description
0.01...10.00 s	Setting range Factory setting: 0.05 s

[M/S Comm ErrorResp] П 5 С б ★

Master / Slave response to a communication error.

Define how will react the drive when a multi-drive link communication error is detected.

This parameter can be accessed if [M/S Comm Mode] П 5 С П is set to [MultiDrive Link] П д Л .

Setting	Code / Value	Description
[Freewheel Stop]	У Е 5	Freewheel stop Factory setting
[Per STT]	5 Е Е	Stop according to [Type of stop] 5 Е Е parameter but without an error triggered after stop
[Ramp stop]	р П П	Stop on ramp
[Fast stop]	Ф 5 Е	Fast stop

NOTE: If the master is in [Ramp stop] р П П the slave has to be set to [Freewheel Stop] У Е 5 .

[M/S Device ErrorResp] П 5 д б ★

Master / Slave response to device error.

Define how will react the Drive when a device is lost

This parameter can be accessed if [M/S Comm Mode] П 5 С П set to [MultiDrive Link] П д Л .

Setting	Code / Value	Description
[Freewheel Stop]	У Е 5	Freewheel stop Factory setting
1	Because, in this case, the detected error does not trigger a stop, it is recommended to assign a relay or logic output to its indication.	

Setting	Code / Value	Description
[Per STT]	S E E	Stop according to [Type of stop] S E E parameter but without an error triggered after stop
[Fallback Speed]	L F F	Change to fallback speed, maintained as long as the detected error persists and the run command has not been removed ⁽¹⁾
[Spd maintained]	r L S	Speed maintained as long as the detected error persists and the run command has not been removed ⁽¹⁾
[Ramp stop]	r P P	Stop on ramp
[Fast stop]	F S E	Fast stop
1 Because, in this case, the detected error does not trigger a stop, it is recommended to assign a relay or logic output to its indication.		

NOTE: If the master is in [Ramp stop] r P P the slave has to be set to [Freewheel Stop] Y E S, [Speed maintained] r L S and [Fallback Speed] L F F are not available for slave drives.

[M/S Device Error Delay] P S d d ★

Master / Slave device error delay.

Monitoring delay before the system is ready. If one of the drives in the system is not ready after this delay, a [M/S Device Error] P S d F is triggered.

This parameter can be accessed if [M/S Comm Mode] P S C P is set to [MultiDrive Link] P d L .

Setting	Description
0...60 s	Setting range Factory setting: n o wait infinite time

[Fallback Speed] L F F ★

Fallback speed.

This parameter can be accessed if the error response parameter is set to [Fallback Speed] L F F .

Setting	Description
0.0...599.0 Hz	Setting range Factory setting: 0.0 Hz

[M/S Control] 15E - Menu

Access

[Complete settings] → [Master/Slave] → [M/S Control]

About This Menu

This menu is used to configure the type of control used in Master/Slave.

This function can be accessed if [M/S Comm Mode] 15C1 is not set to [No] 100.

Master/Slave Mechanical Coupling

The Master / Slave mechanical coupling type allow selecting two types of coupling:

- [Rigid] 15G1d coupling means that the rotor speed of each motor is forced to be the same by the application. This choice is typically used for coupling such as gearbox, toothed belt and when the elasticity is closed to '0'.
- In the [Elastic] 15E1E coupling, the motors rotors are not the same, due to elasticity or slip in the coupling. This type of coupling is use for example for overhead conveyor (using a tension system), long belt.

Selecting the [Elastic] 15E1E coupling give access to same parameters a [Rigid] 15G1d coupling plus:

- [M/S Filters] 15F -
- [Load Sharing M/S] 15b -
- [M/S Out Torque Ref Select] 150E -

Configuring parameters in the [Elastic] 15E1E coupling and then selecting [Rigid] 15G1d coupling will disable the [Elastic] 15E1E configured parameters. Conversely, switching from [Rigid] 15G1d coupling to [Elastic] 15E1E coupling has not effect on the [Rigid] 15G1d coupling parameters.

Master/Slave Control Type

The Master / Slave control type allow selecting which type of control will be applied on slave and direction of slave related to direction of Master:

- [Speed Direct] 15Pdd: Slave follows speed reference of Master in same direction.
- [Speed Reverse] 15Pdr: Slave follows speed reference of Master in reverse direction. Typically for face to face motors.
- [Torque Direct] 15r9d: Slave follows torque reference of Master in same direction.
- [Torque Reverse] 15r9r: Slave follows torque reference of Master in reverse direction. Typically for face to face motors.
- [Torque Custom] 15r9C: Slave follows torque reference of Master around speed reference. Direction of speed can be adjusted with [Speed Ref Direction] 155d and direction of torque with [Torque ref. sign] 155d.

Allows to apply a torque ratio or a torque ramp in case of application needs.

The following table shows the possible cases between [Speed Ref Direction] 155d and [Torque ref. sign] 155d when [M/S Control Type] 15C1E is set to [Torque Custom] 15r9C:

[Speed Ref Direction] 155d	[Torque ref. sign] 155d	[M/S Control Type] 15C1E
Inactive	Inactive	Slave runs in same direction as Master (speed and torque)
Inactive	Active	Slave runs in same direction as Master but apply opposite torque
Active	Inactive	Slave runs in reverse direction of Master and applies opposite torque
Active	Active	Slave runs in reverse direction of Master for speed and torque.

Stop Configuration

The slaves have different stop behavior depending of their configuration and master stop type.

When the master stops in freewheel:

- If **[M/S Control Type] *MSCE*** is set to **[Speed Direct] *SPdd*** or **[Speed Reverse] *SPdr***, the slaves stop following its **[Type of stop] *SEt*** configuration.
- If **[M/S Control Type] *MSCE*** is set to **[Torque Direct] *TrQd*** or **[Torque Reverse] *TrQr*** or **[Torque Custom] *TrQc***, the slaves stop following **[Torque control stop] *TSSt*** or **[Type of stop] *SEt***, depending of the priority between them.

Example: If **[Torque control stop] *TSSt*** is set to **[Freewheel Stop] *nSt*** and **[Type of stop] *SEt*** is set to **[On Ramp] *rPP***, the slaves will stop in freewheel.

When the master stops on ramp:

- If **[M/S Control Type] *MSCE*** is set to **[Speed Direct] *SPdd*** or **[Speed Reverse] *SPdr***, the slaves stop following the master ramp in speed control.
- If **[M/S Control Type] *MSCE*** is set to **[Torque Direct] *TrQd*** or **[Torque Reverse] *TrQr*** or **[Torque Custom] *TrQc***, the slaves stop following the master ramp in torque control.

Brake management

Brake sequence is managed only by the Master.

The Master manages its brake according to its brake sequence, in **[MultiDrive Link] *MDL*** or **[Analog] *ANA***. Optionally, the Master can manage the brakes of the slaves by the same brake command. The release and engage times of brakes in the application have to be the same.

Brake sequence is managed by the Master and Slaves.

In **[MultiDrive Link] *MDL*** brakes can be managed on each Drive. The synchronization of the release and engage times are managed by the Master through the **[MultiDrive Link] *MDL***.

[M/S Coupling Type] *MSNC*

Master / Slave mechanical coupling type.

Setting	Code / Value	Description
[Rigid]	<i>rGid</i>	Rigid coupling Factory setting
[Elastic]	<i>ELASt</i>	Elastic coupling

[M/S Control Type] *MSCE* ★

Master / Slave control type.

This parameter can be accessed if **[M/S Device Role] *MSdE*** is set to **[Slave] *SLAVE*** or **[M/S Device ID] *MSid*** is set to **[Slave 1]to[Slave 10]**.

Setting	Code / Value	Description
[Torque Direct]	<i>TrQd</i>	Torque direct control Factory setting
[Torque Reverse]	<i>TrQr</i>	Torque reverse control
[Torque Custom]	<i>TrQc</i>	Torque custom control Allow to apply a torque ratio a torque ramp in case of different motors
[Speed Direct]	<i>SPdd</i>	Speed direct control Is not a available if [M/S Coupling Type] <i>MSNC</i> is set to [Rigid] <i>rGid</i>
[Speed Reverse]	<i>SPdr</i>	Speed reverse control Is not a available if [M/S Coupling Type] <i>MSNC</i> is set to [Rigid] <i>rGid</i>

[M/S Torque Control] 759 - Menu

Access

[Complete settings] → [Master/Slave] → [M/S Control] → [M/S Torque Control]

About This Menu

This menu can be accessed if:

- [M/S Device Role] 75d is set to [Slave] 5L R V E or [M/S Device ID] 75 , d is set to [Slave1] to [Slave10], and
- [M/S Control Type] 75c is set to:
 - [Torque Direct] 6r 9d, or
 - [Torque Reverse] 6r 9r, or
 - [Torque Custom] 6r 9c.

[Speed Ref Direction] 55d ★

Speed reference direction.

Assignment for sign inversion of reference speed value coming from the master.

This parameter can be accessed if:

- [M/S Comm Mode] 75c 7 is not set to [No] n o, and
- [M/S Control Type] 75c is set to [Torque Custom] 6r 9c.

Setting	Code / Value	Description
[Not Assigned]	n o	Not assigned Factory setting
[Yes]	Y E 5	Yes
[DI1]...[DI8]	L , 1...L , 8	Digital input DI1...DI8
[DI11]...[DI16]	L , 11...L , 16	Digital input DI11...DI16 if VW3A3203 I/O extension module has been inserted
[CD00]...[CD10]	C d 0 0...C d 1 0	Virtual digital input CMD.0...CMD.10 in [I/O profile] , o configuration
[CD11]...[CD15]	C d 1 1...C d 1 5	Virtual digital input CMD.11...CMD.15 regardless of configuration
[C101]...[C110]	C 1 0 1...C 1 1 0	Virtual digital input CMD1.01...CMD1.10 with integrated Modbus Serial in [I/O profile] , o configuration
[C111]...[C115]	C 1 1 1...C 1 1 5	Virtual digital input CMD1.11...CMD1.15 with integrated Modbus Serial regardless of configuration
[C201]...[C210]	C 2 0 1...C 2 1 0	Virtual digital input CMD2.01...CMD2.10 with CANopen® fieldbus module in [I/O profile] , o configuration
[C211]...[C215]	C 2 1 1...C 2 1 5	Virtual digital input CMD2.11...CMD2.15 with CANopen® fieldbus module regardless of configuration
[C301]...[C310]	C 3 0 1...C 3 1 0	Virtual digital input CMD3.01...CMD3.10 with a fieldbus module in [I/O profile] , o configuration
[C311]...[C315]	C 3 1 1...C 3 1 5	Virtual digital input CMD3.11...CMD3.15 with a fieldbus module regardless of configuration
[C501]...[C510]	C 5 0 1...C 5 1 0	Virtual digital input CMD5.01...CMD5.10 with integrated Ethernet in [I/O profile] , o configuration
[C511]...[C515]	C 5 1 1...C 5 1 5	Virtual digital input CMD5.11...CMD5.15 with integrated Ethernet regardless of configuration

[Torque ref. sign] 65d ★

Assignment for the inversion of the sign of the reference for the torque regulation function.

This parameter can be accessed if:

- [M/S Comm Mode] 75c 7 is not set to [No] n o, and
- [M/S Control Type] 75c is set to [Torque Custom] 6r 9c.

Identical to [Speed Ref Direction] 55d.

[Torque ratio] $\tau r \tau$ ★

Torque ratio.

This parameter is used in case of using a slave motor with a different nominal torque than the master motor, or to unbalance torque between master and slave.

This parameter applies a factor in % on the torque reference received from the master.

This parameter can be accessed if:

- **[M/S Comm Mode] $\pi 5 \zeta \pi$** is not set to **[No] $n \sigma$** , and
- **[M/S Control Type] $\pi 5 \zeta \tau$** is set to **[Torque Custom] $\tau r \varrho \zeta$** .

Setting (°)	Description
0.0...1000.0%	Coefficient applied to [Torque ref. channel] $\tau r 1$ or [Torque ref. 2 channel] $\tau r 2$ Factory setting: 100.0%

[Torque Ref Offset] $\tau \varrho \sigma P$ ★

Torques reference offset.

This parameter is used to scale the torque reference value.

This parameter applies an offset in % on the torque reference.

This parameter can be accessed if:

- **[M/S Comm Mode] $\pi 5 \zeta \pi$** is not set to **[No] $n \sigma$** , and
- **[M/S Control Type] $\pi 5 \zeta \tau$** is set to **[Torque Custom] $\tau r \varrho \zeta$** .

Setting (°)	Description
-1000.0...1000.0%	Setting range Factory setting: 0.0%

[Torque ramp time] $\tau r P$ ★

Torque ramp time.

This parameter can be accessed if:

- **[M/S Comm Mode] $\pi 5 \zeta \pi$** is not set to **[No] $n \sigma$** , and
- **[M/S Control Type] $\pi 5 \zeta \tau$** is set to **[Torque Custom] $\tau r \varrho \zeta$** .

Setting (°)	Description
0.0...99.99 s	Rise and fall time for a variation of 100% of the rated torque Factory setting: 3.00 s

[Torque control stop] $\tau 5 \tau$

Torque control stop type.

Setting	Code / Value	Description
[Speed]	$5 P d$	Speed regulation stop, in accordance with the type of stop configuration
[Freewheel Stop]	$n 5 \tau$	Factory setting: Freewheel stop
[Spin]	$5 P n$	Zero torque stop, but maintaining the flux in the motor (only in closed loop)

[Spin time] SPt ★

Torque regulation: spin time.

Spin time following stop in order to remain ready to restart quickly.

This parameter specifies the time the motor is maintained fluxed after the zero speed is attained.

This parameter can be accessed if **[Torque control stop] $t5t$** is set to **[Spin] SPn** .

Setting (°)	Description
0.0...3600.0 s	Setting range Factory setting: 1.0 s

[Positive deadband] dbP

Torque regulation positive dead band.

The torque control is effective in an area defined by **[Positive deadband] dbP** and **[Negative deadband] dbn** around the speed reference value.

Outside of this area, the drive switch automatically in speed control to make speed returns inside the torque control area.

Value added algebraically to the speed reference.

Example for **[Positive deadband] dbP** = 10:

- If reference = + 50 Hz: + 50 + 10 = 60 Hz
- If reference = - 50 Hz: - 50 + 10 = - 40 Hz

Setting (°)	Description
0.0...2 x [Max Frequency] tFr	Setting range Factory setting: 10.0 Hz

[Negative deadband] dbn

Torque regulation negative dead band.

The torque control is effective in an area defined by **[Positive deadband] dbP** and **[Negative deadband] dbn** around the speed reference value.

Outside of this area, the drive switch automatically in speed control to make speed returns inside the torque control area.

Value subtracted algebraically from the speed reference.

Example for **[Negative deadband] dbn** = 10:

- If reference = + 50 Hz: + 50 - 10 = 40 Hz
- If reference = - 50 Hz: - 50 - 10 = - 60 Hz

Setting (°)	Description
0.0...2 x [Max Frequency] tFr	Setting range Factory setting: 10.0 Hz

[Torque ctrl time out] rtt □

Torque control time-out.

Time following automatic exit of torque control mode in the event of an error or a warning has been triggered.

Setting	Description
0.0...999.9 s	Setting range Factory setting: 60 s

[Torque Ctrl ErrorResp] L E 9

Response to torque control error.

Response of drive once time **[Torque ctrl time out] r E 9** has elapsed.

Setting	Code / Value	Description
[Warning]	<i>R L r Π</i>	Warning is triggered on timeout Factory setting
[Error]	<i>F L E</i>	An error is triggered with freewheel stop

[Low Torque] L E 9

Low torque threshold limit.

Torque applied on slave will be limited between **[Low Torque] L E 9** and **[High Torque] H E 9** (expressed in % of nominal torque).

This parameter cannot be higher than **[High Torque] H E 9**.

Setting (◀)	Description
-300.0... [High Torque] H E 9	Setting range Factory setting: -300.0%

[High Torque] H E 9

High torque threshold limit.

This parameter cannot be lower than **[Low Torque] L E 9**.

Setting (▶)	Description
[Low Torque] L E 9 ...300.0%	Setting range Factory setting: 300.0%

[M/S Control] П 5 Ё - Menu

Access

[Complete settings] → [Master/Slave] → [M/S Control]

About This Menu

This menu can be accessed if [M/S Comm Mode] П 5 Ё П is not set to [No] п о.

[Torque Filter] Ё r F ★

This function provides a filter on the torque reference for Slaves Drives to deal with dynamic control constraints (such as a communication delays). Select if the filtering on the input torque reference is present or not.

This parameter can be accessed if:

- [M/S Device Role] П 5 d Ё is set to [Slave] 5 L R V E or [M/S Device ID] П 5 , d is set to [Slave1] to [Slave10], and
- [M/S Control Type] П 5 Ё Ё is set to:
 - [Torque Direct] Ё r 9 d, or
 - [Torque Reverse] Ё r 9 r, or
 - [Torque Custom] Ё r 9 Ё.

Setting	Code / Value	Description
[No]	п о	Input torque reference filtering is disabled Factory setting
[Yes]	9 E 5	Input torque reference filtering is enabled

[Torque Filter Bandwidth] Ё r W ★

Defines the bandwidth of the filter in Hertz.

This parameter can be accessed if:

- [Torque Filter] Ё r F is set to [Yes] 9 E 5, and
- [M/S Control Type] П 5 Ё Ё is set to:
 - [Torque Direct] Ё r 9 d, or
 - [Torque Reverse] Ё r 9 r, or
 - [Torque Custom] Ё r 9 Ё.

Setting	Description
1...1000 Hz	Setting range Factory setting: 20 Hz.

[M/S Filters] $\Pi 5 F$ - Menu

Access

[Complete settings] → [Master/Slave] → [M/S Control] → [M/S Filters]

About This Menu

This menu can be accessed if [M/S Coupling Type] $\Pi 5 \Pi C$ is set to [Elastic] $E L R 5 E$ and [Access Level] $L R C$ is set to [Expert] $E P r$.

Master control speed and Slave is torque controlled. This feature allows configuring the transfer function between Master and Slave according to the dynamic of the coupling (elastic).

The advanced filter can be set independently on Master or/and Slaves to compensate the elasticity of the coupling:

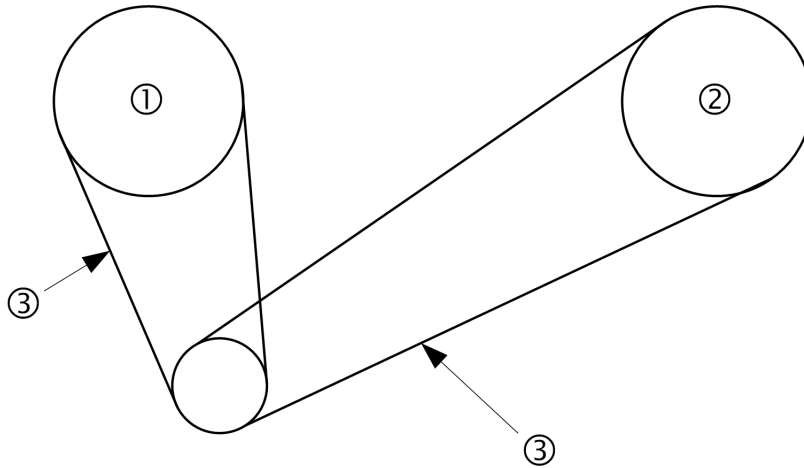

- 1 Master
- 2 Slave
- 3 Advanced filter can be set for this elastic coupling

[M/S Advanced Filter] $\Pi 5 F E$

Master / Slave advanced filter activation.

Setting	Code / Value	Description
[No]	$n o$	Advanced filtering disable Factory setting
[Yes]	$y e s$	Advanced filtering enable

[M/S Advanced Filter Freq] $\Pi 5 F F$ ★

Defines the frequency of the filter in Hz.

Influence of the [M/S Advanced Filter Freq] $\Pi 5 F F$ Parameter

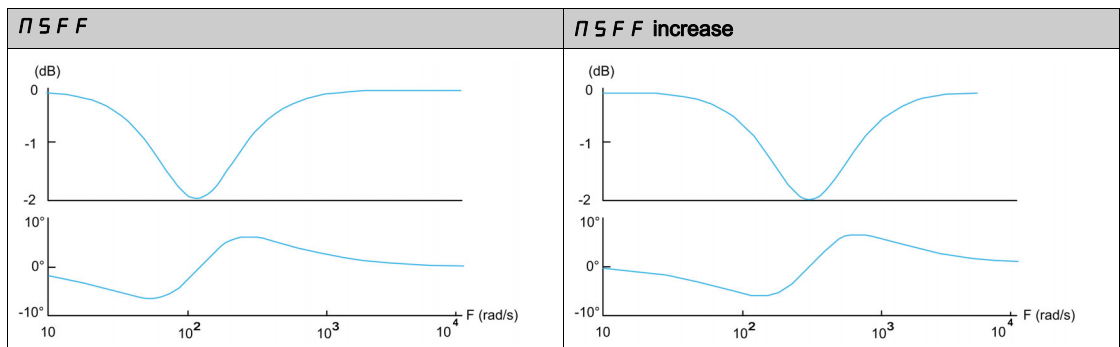

This parameter can be accessed if [M/S Advanced Filter] $\Pi 5 F E$ is not set to [No] $n o$.

Setting	Description
10.0...150 Hz	Setting range Factory setting: 15.0 Hz

[M/S Advanced Filter Bdw] π S F b ★

Defines the bandwidth. Means the width of the stop-band of the filter in % of the filter frequency.

Influence of the [M/S Advanced Filter Bdw] π S F b Parameter

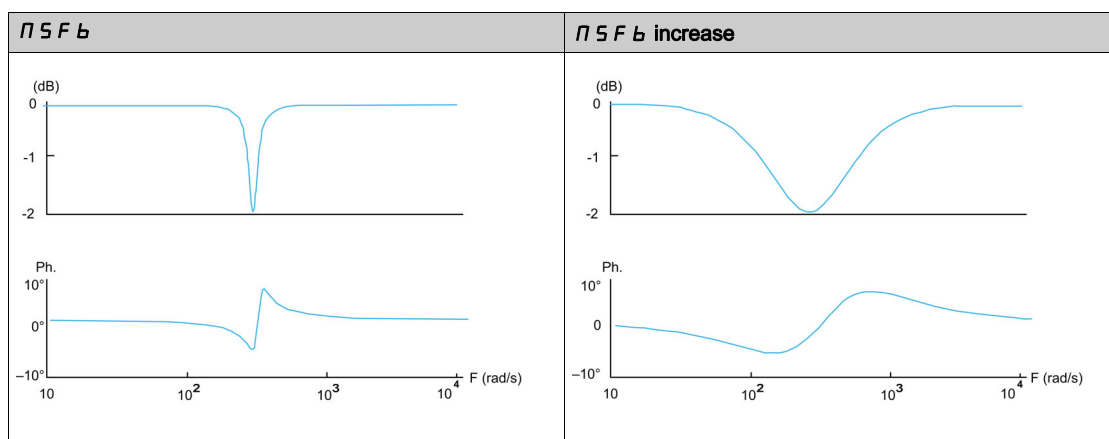

This parameter can be accessed if [M/S Advanced Filter] π S F E is not set to [No] n a.

Setting	Description
10...400%	Setting range Factory setting: 100%

[M/S Advanced Filter Depth] π S F d ★

Defines the attenuation level at the filter frequency.

Influence of the [M/S Advanced Filter Depth] π S F d Parameter

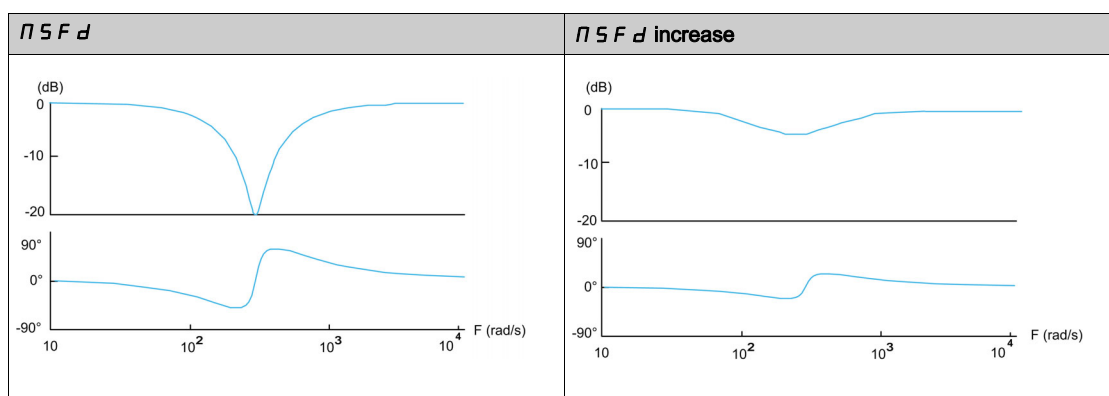

This parameter can be accessed if [M/S Advanced Filter] π S F E is not set to [No] n a.

Setting	Description
0...99%	Setting range Factory setting: 10%

[M/S Advanced Filter Gain] $\Pi 5 F G$ ★

Defines the gain of the filter. 100% means a unitary gain.

Influence of the **[M/S Advanced Filter Gain] $\Pi 5 F G$** Parameter

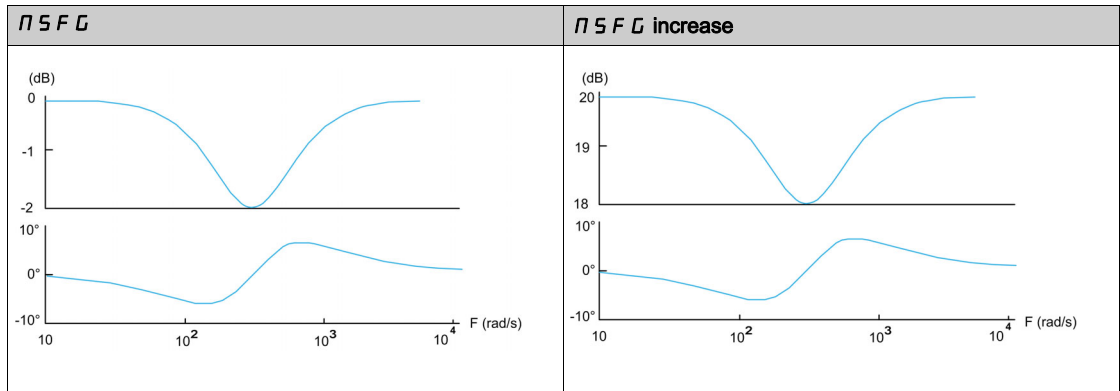

This parameter can be accessed if **[M/S Advanced Filter] $\Pi 5 F E$** is not set to **[No] $n o$** .

Setting	Description
0...1000%	Setting range Factory setting: 100%

[M/S Advanced Filter Coeff] $\Pi 5 F C$ ★

Master / Slave advanced filter coefficient.

Influence of the **[M/S Advanced Filter Coeff] $\Pi 5 F C$** Parameter

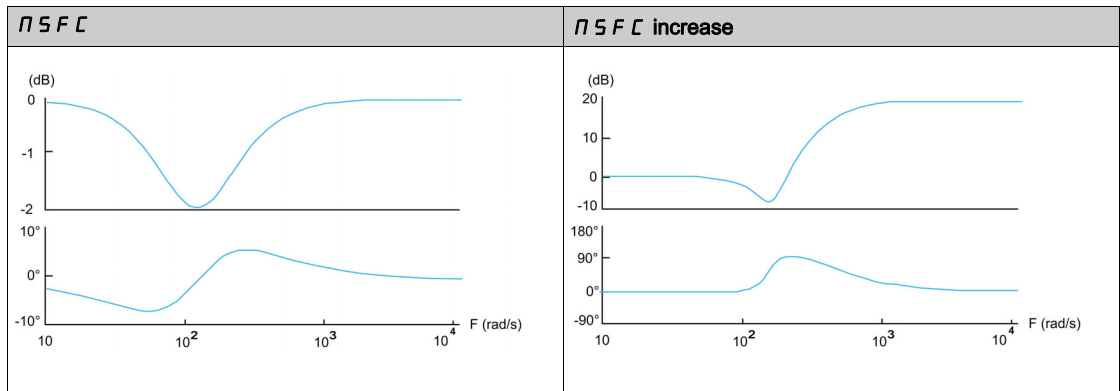

This parameter can be accessed if **[M/S Advanced Filter] $\Pi 5 F E$** is not set to **[No] $n o$** .

Setting	Description
0...1000%	Setting range Factory setting: 100%

[Load Sharing M/S] $\pi 5 b$ - Menu

Access

[Complete settings] → [Master/Slave] → [M/S Control] → [Load Sharing M/S]

About This Menu

This menu can be accessed if:

- [M/S Coupling Type] $\pi 5 \pi C$ is set to [Elastic] $E L R S E$, and
- [M/S Device Role] $\pi 5 d E$ or [M/S Device ID] $\pi 5 , d$ is set to [Master] $\pi 5 E E r$.

Or if:

- [M/S Device Role] $\pi 5 d E$ is set to [Slave] $S L A V E$ or [M/S Device ID] $\pi 5 , d$ is set to [Slave1] to [Slave10], and
- [M/S Control Type] $\pi 5 C E$ is set to:
 - [Speed Direct] $S P d d$, or
 - [Speed Reverse] $S P d r$.

Load sharing, Parameters That can be Accessed at Expert Level

Principle:

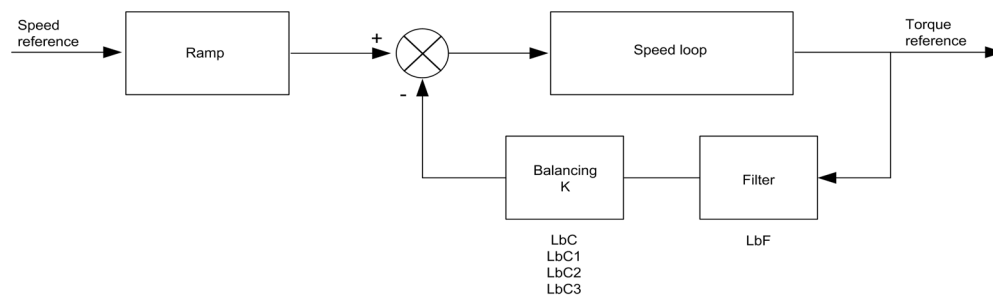

The load sharing factor K is determined by the torque and speed, with two factors K1 and K2 ($K = K1 \times K2$).

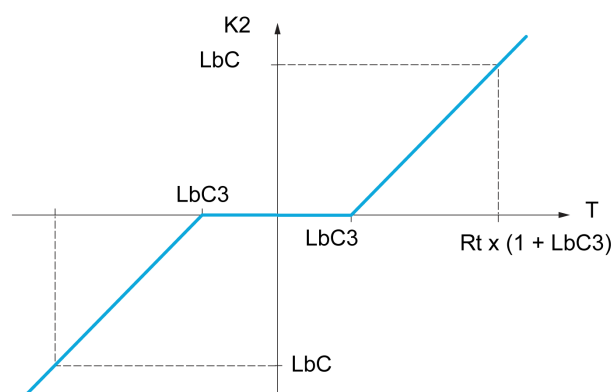
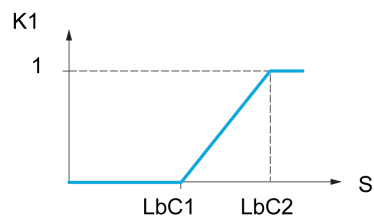

S Speed
T Torque
Rt Rated torque

[Load sharing] L b A

Load balancing configuration.

When 2 motors are connected mechanically and therefore at the same speed, and each is controlled by a drive, this function can be used to improve torque distribution between the two motors. To do this, it varies the speed based on the torque.

Setting	Code / Value	Description
[No]	n o	Function inactive Factory setting
[Yes]	y e s	Function active

[Load correction] L b C ★

Nominal speed load balance correction.

This parameter can be accessed if **[Load sharing] L b A** is not set to **[No] n o**.

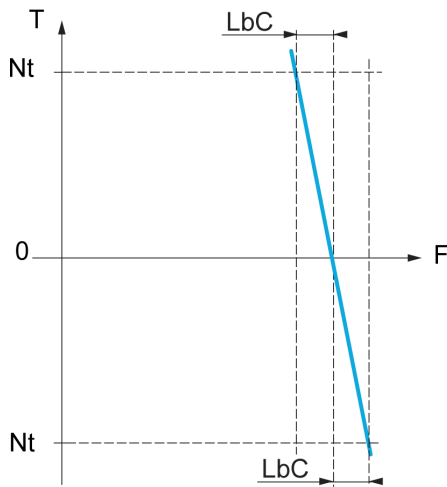

T Torque
Nt Nominal torque
F Frequency

Setting	Description
0.0...1000.0 Hz	Setting range Factory setting: 0.0 Hz

[Correction min spd] L b C / ★

Low Speed for torque decreasing function speed reference.

Minimum speed for load correction in Hz. Below this threshold, no corrections are made. Used to prevent correction at very low speed if this would hamper rotation of the motor.

This parameter can be accessed if:

- **[Access Level] L A C** is set to **[Expert] E P r**, and
- **[Load sharing] L b A** is not set to **[No] n o**.

Setting	Description
0.0...999.9 Hz	Setting range Factory setting: 0.0 Hz

[Correction max spd] L b C 2 ★

High speed for torque decreasing function speed reference.

Speed threshold in Hz above which maximum load correction is applied.

This parameter can be accessed if:

- **[Access Level] L A C** is set to **[Expert] E P r**, and
- **[Load sharing] L b R** is not set to **[No] n o**.

Setting	Description
L b C 1...1000.0 Hz	Setting range Factory setting: 0.0 Hz

[Torque offset] L b C 3 ★

Torque offset for torque correction.

Minimum torque for load correction as a % of the rated torque. Below this threshold, no corrections are made. Used to avoid torque instabilities when the torque direction is not constant.

This parameter can be accessed if:

- **[Access Level] L A C** is set to **[Expert] E P r**, and
- **[Load sharing] L b R** is not set to **[No] n o**.

Setting	Description
0...300%	Setting range Factory setting: 0%

[Sharing filter] L b F ★

Time constant filter.

This parameter can be accessed if:

- **[Access Level] L A C** is set to **[Expert] E P r**, and
- **[Load sharing] L b R** is not set to **[No] n o**.

Setting	Description
100...20,000 ms	Setting range Factory setting: 100 ms

[M/S Balance Trq Ref Sel] n 5 , b ★

Master / Slave load balancing torque reference selection.

This parameter can be accessed if **[Load sharing] L b R** is not set to **[No] n o**.

If **[M/S Advanced Filter] n 5 F E** is set to **[No] n o**, this parameter have no effect.

Setting	Code / Value	Description
[Not Applied]	n o	Not applied
[Before Advanced Filter]	b F , L E	Before advanced filter Factory setting
[After Advanced Filter]	A F , L E	After filter

[M/S Control] П 5 Ё - Menu

Access

[Complete settings] → [Master/Slave] → [M/S Control]

About This Menu

This function can be accessed if [M/S Comm Mode] П 5 Ь П is not set to [No] n o .

The following diagram shows the influence of reference entries and selections in the Master/Slave structure:

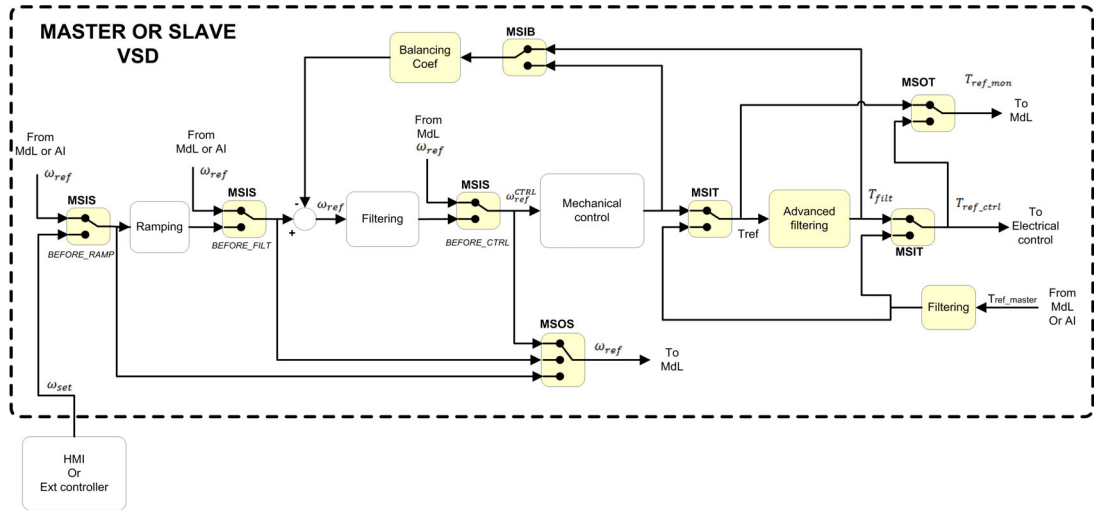

[M/S Torque Ref Entry] П 5 , Ё ★

Master / Slave torque reference entry in control chain.

This parameter can be accessed if:

- [M/S Advanced Filter] П 5 F E is not set to [No] n o .
- [M/S Coupling Type] П 5 П Ь is set to [Elastic] E L R 5 Ё , and
- [M/S Device Role] П 5 d Ё is set to [Slave] S L R V E or [M/S Device ID] П 5 , d is set to [Slave 1] to [Slave 10].

Setting	Code / Value	Description
[Not Applied]	n o	Not applied
[Before Advanced Filter]	b F , L Ё	Before advanced filter Factory setting
[After Advanced Filter]	R F , L Ё	After advanced filter

[M/S Out Torque Ref Select] П 5 o Ё ★

Master / Slave output torque reference selection.

Select the input routing of balancing feature.

This parameter can be accessed if:

- [M/S Coupling Type] П 5 П Ь is set to [Elastic] E L R 5 Ё , and
- [M/S Advanced Filter] П 5 F E is not set to [No] n o .

Identical to [M/S Torque Ref Entry] П 5 , Ё .

[M/S Speed Ref Entry] 15, 5 ★

Master / Slave speed reference entry in control chain.

Select the routing of the new speed reference input.

This parameter can be accessed if **[M/S Device Role] 15 d t** is set to **[Slave] 5 L R V E** or **[M/S Device ID] 15, d** is set to **[Slave 1]** to **[Slave 10]**.

Setting	Code / Value	Description
[Not Applied]	<i>n o</i>	Not applied
[Before Ramp]	<i>b r P P</i>	The input speed reference is before the ramp input in the control scheme Factory setting
[After Ramp]	<i>R r P P</i>	The input speed reference is after the ramp input in the control scheme
[Before Control Loop]	<i>b C t r L</i>	The input speed reference is before the control input in the control scheme

[M/S Out Speed Ref Select] 15 a 5

Master / Slave output speed reference selection.

Identical to **[M/S Speed Ref Entry] 15, 5**.

Section 8.13

[Backlash compensation]

[Backlash compensation] б 5 9 7 - Menu

Access

[Complete settings] → [Backlash compensation]

About This Menu

This menu presents:

- The backlash compensation sequence.
- The backlash compensation sequence dedicated to the Master/Slave on rigid coupling.

The purpose of this menu is to provide a dedicated sequence to compensate backlashes in order to reduce the wear gears by limiting the torque at the moment of the impact:

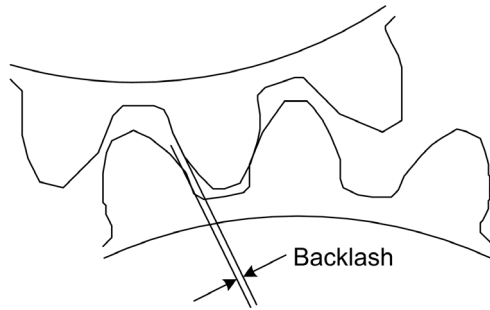

This menu is dedicated to non driving loads (horizontal movement) without brakes. It is available either in torque control or speed control.

Backlash Sequence

The purpose of the backlash sequence is to regulate speed startup under a torque limitation allowing motion until the backlash is fully compensated. The load torque will become greater than the torque limitation and stop the movement. Then the run can proceed starting from applied limitation torque.

There are three different use cases:

- Backlash sequence at startup only (UC-1)
- Stop at direction change (UC-2)
- Regulate 0Hz speed at direction change (UC-3)

Those use cases depends on the control mode:

	Torque control	Speed control
Open loop	(UC-1) (UC-2)	(UC-1) (UC-2)
Closed loop	(UC-1) (UC-3)	(UC-1) (UC-3)

Backlash sequence at startup only (UC-1)

The backlash sequence is configured only during starts of the drive and become transparent once it is in run:

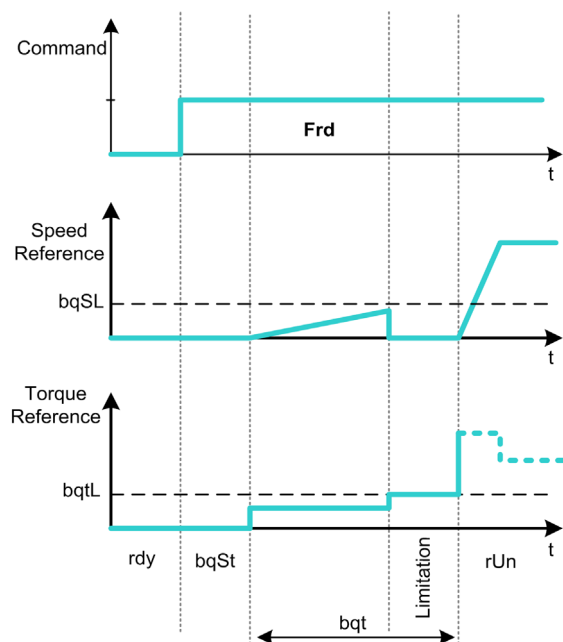

Stop at direction change (UC-2)

The drive stops when the direction of the movement changes and the drive will start if the run order is still present. Then do a backlash sequence according to its new direction:

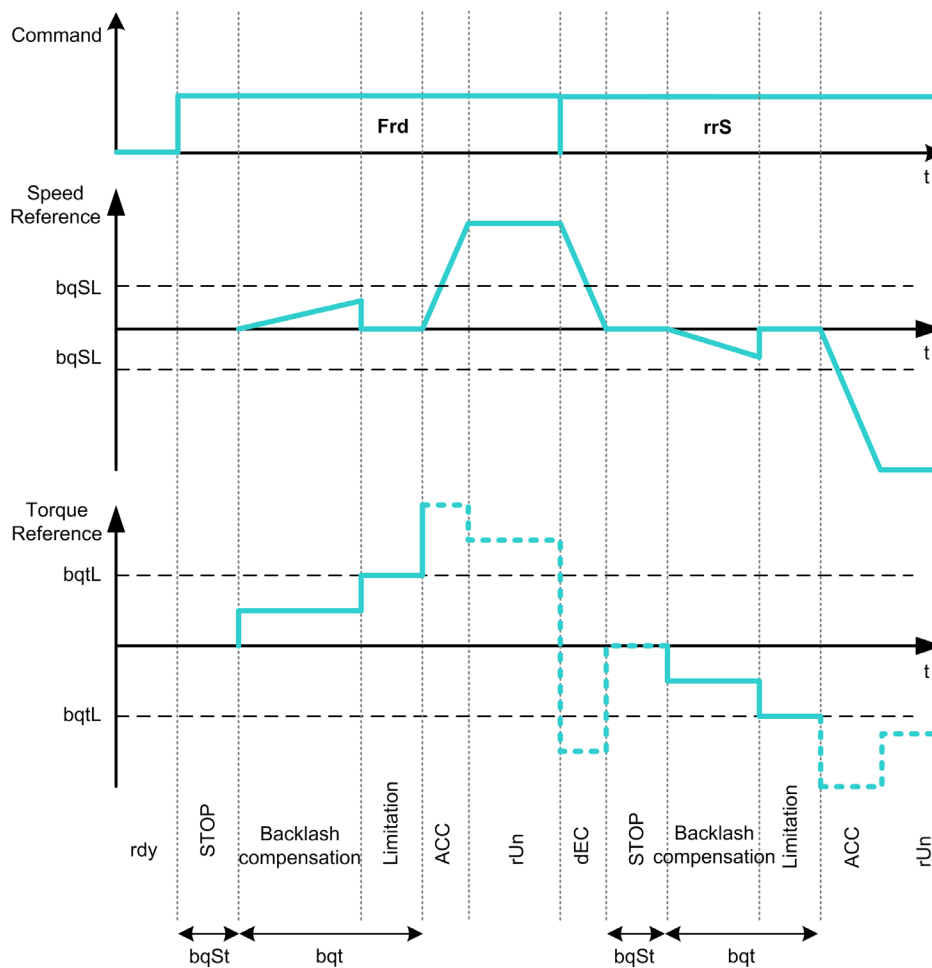

Regulate 0Hz speed at direction change (UC-3)

On a changing direction the drive will regulate the 0Hz speed and proceed to the backlash sequence according to the new direction of movement to come back in run at the end of the sequence:

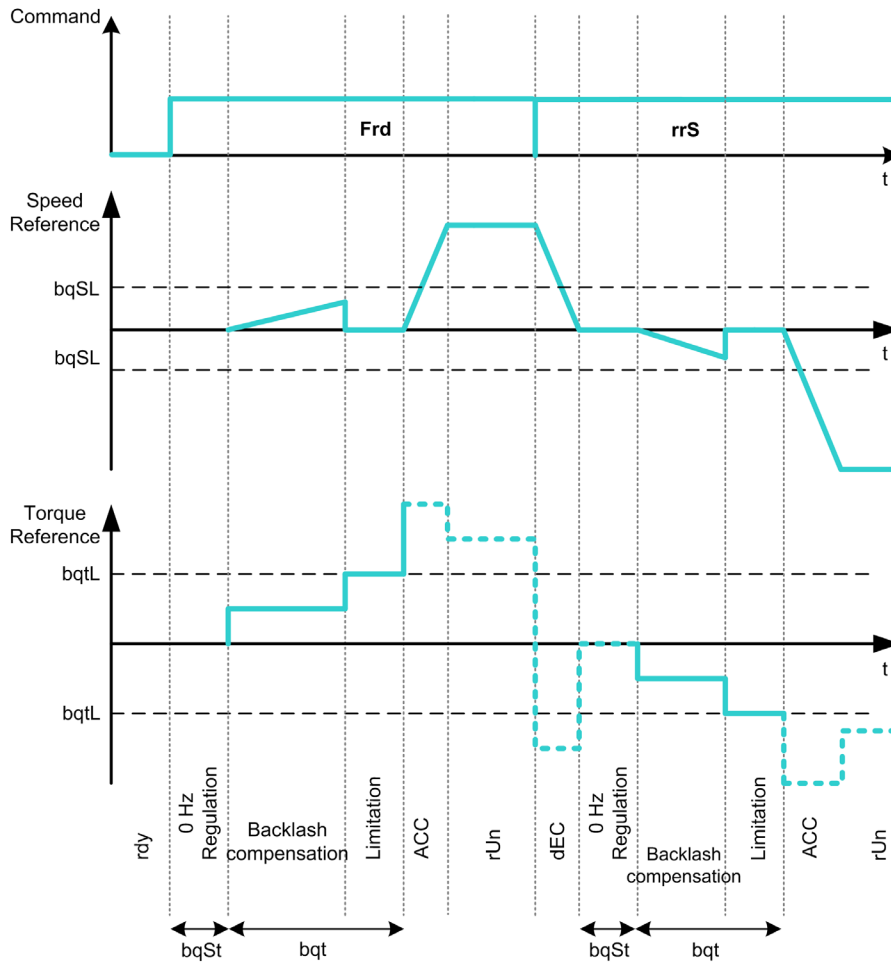

Backlash Sequence Dedicated to the Master/Slave on Rigid Coupling

The purpose of this menu is to provide backlash compensation dedicated to Master/Slave architectures in a rigid coupling context. The goal is to limit the impact torque on toothed wheels in order to reduce the wear.

There are four different Multiple Drive backlash compensation sequences strategies:

- Direct sequential slave backlash compensation (1)
- Direct simultaneous slave backlash compensation (2)
- Controlled sequential slave backlash compensation (3)
- Controlled simultaneous slave backlash compensation (4)

The following diagram shows how to configure the different compensation sequences strategies:

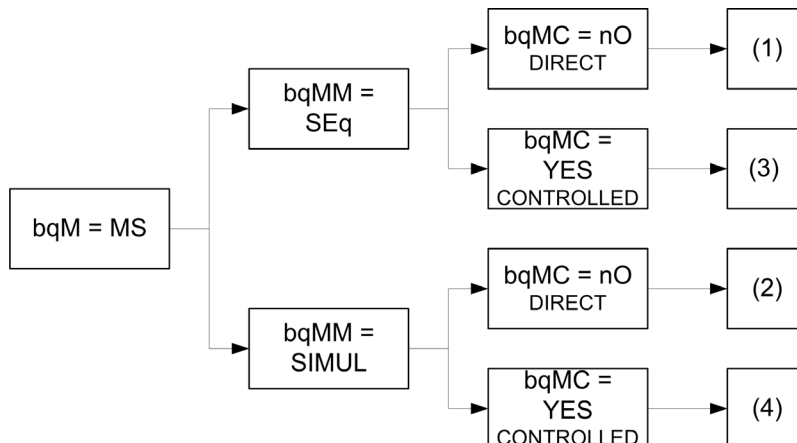

Direct sequential slave backlash compensation (1)

Each Slave will compensate its backlash by switching in speed control. Doing its sequence one at the time assuming that the settings allow compensating the backlash angle in the configured time. At the end, the master launches its own backlash sequence, meanwhile the Master stays in stop (open loop) or regulating 0Hz speed (closed loop):

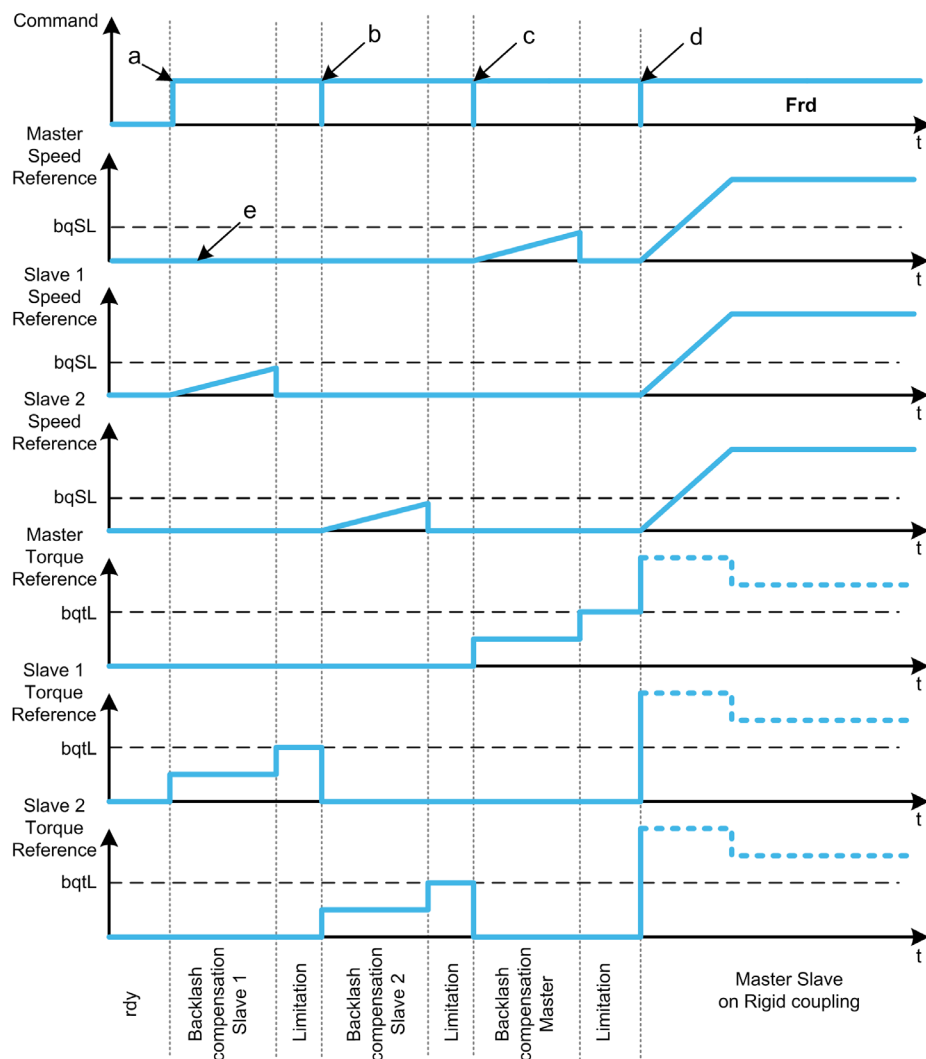

- a** Slave 1 starts
- b** Slave 2 starts, Slave 1 stops
- c** Slave 2 stops
- d** All slaves run start
- e** 0Hz regulation or stop

Direct simultaneous slave backlash compensation (2)

All slaves will compensate their backlashes angle simultaneously assuming that the tuning allows compensating the backlash angle in the configured time. Meanwhile the Master stays in stop (open loop) or regulating 0Hz speed (closed loop):

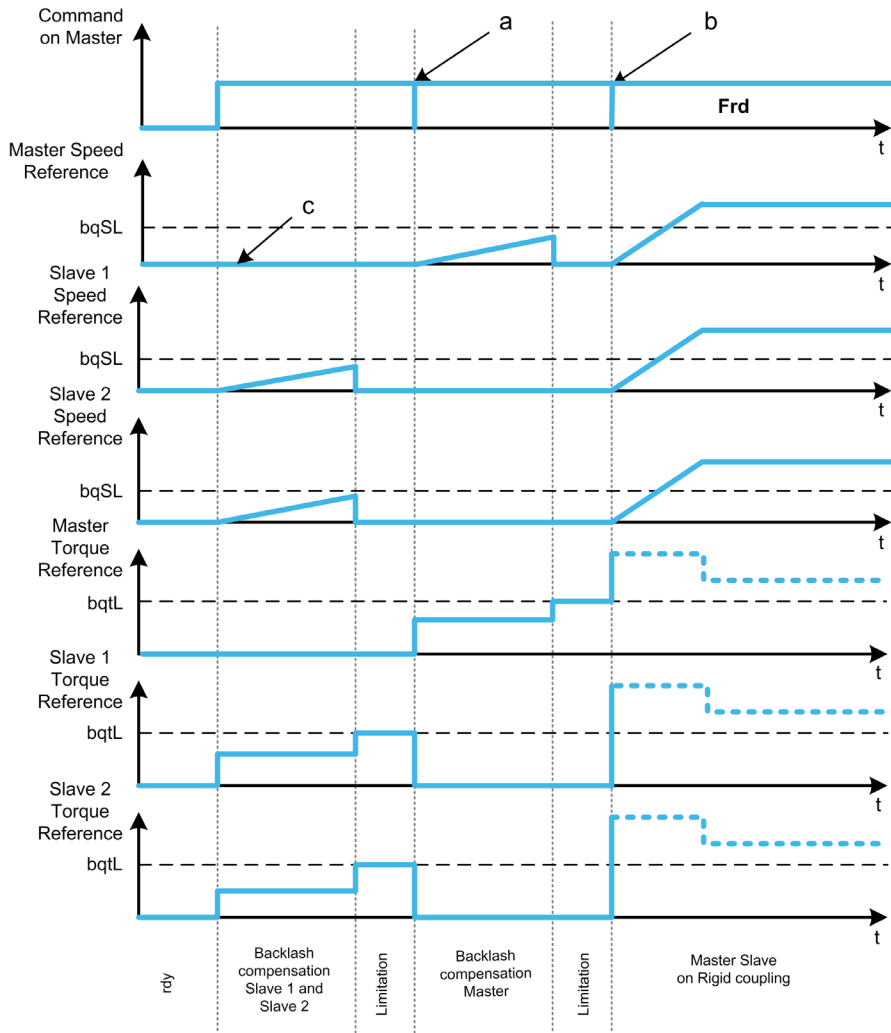

- a** All slaves stop
- b** All slaves start
- c** 0Hz regulation or stop

Controlled sequential slave backlash compensation (3)

All Slaves will compensate their backlashes angle one at the time. When it is done they notify to the Master. Meanwhile the Master stays in stop (open loop) or regulating 0Hz speed (closed loop). Then starts compensating its backlash and go in run as soon as the last Slave has compensated its backlash:

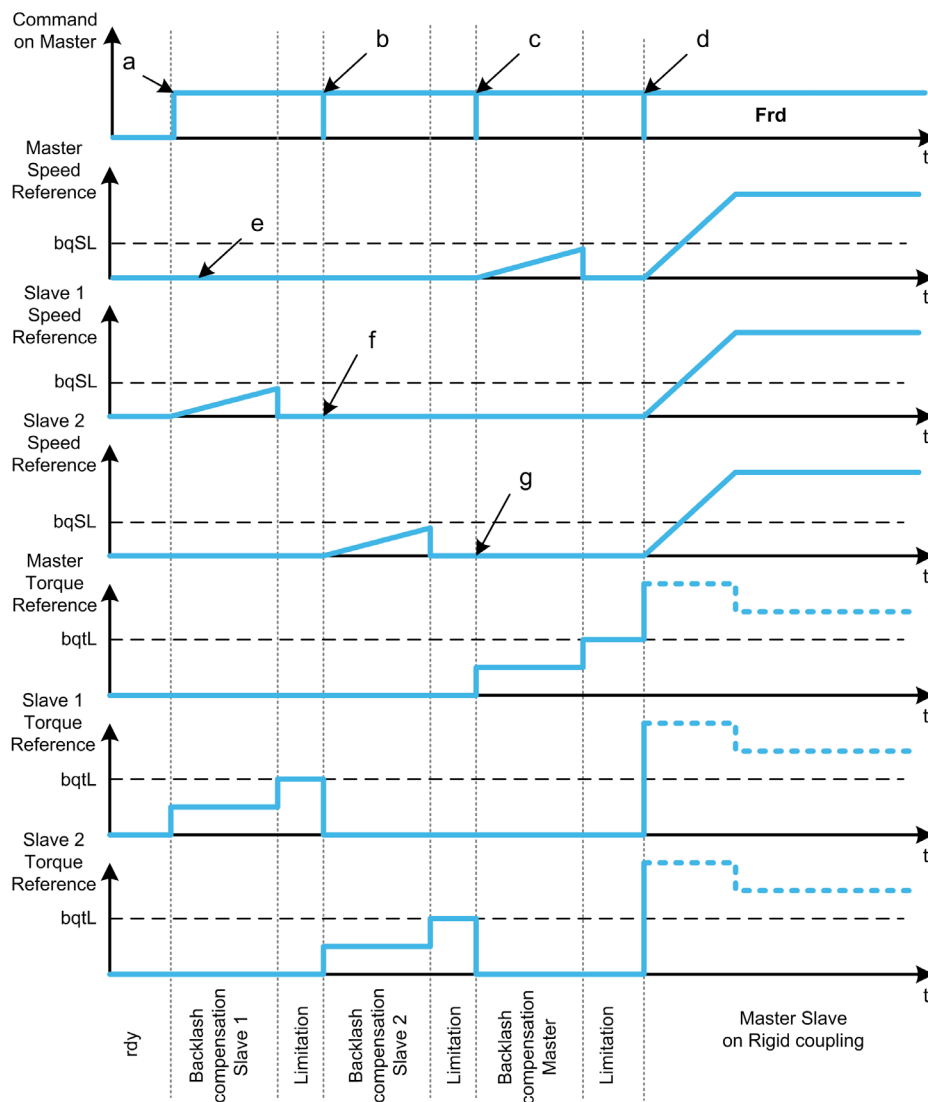

- a** Slave 1 starts
- b** Slave 2 starts, Slave 1 stops
- c** Slave 2 stops
- d** All slaves start
- e** 0Hz regulation or stop
- f** Slave 1 feedback
- g** Slave 2 feedback

Controlled simultaneous slave backlash compensation (4)

All Slaves will compensate their backlashes angle simultaneously broadcasting to the Master when it is done. Meanwhile the Master drive stays in stop (open loop) or regulating 0Hz speed (closed loop). Then starts compensating its backlash and go in run as soon as the last Slave has compensated its backlash:

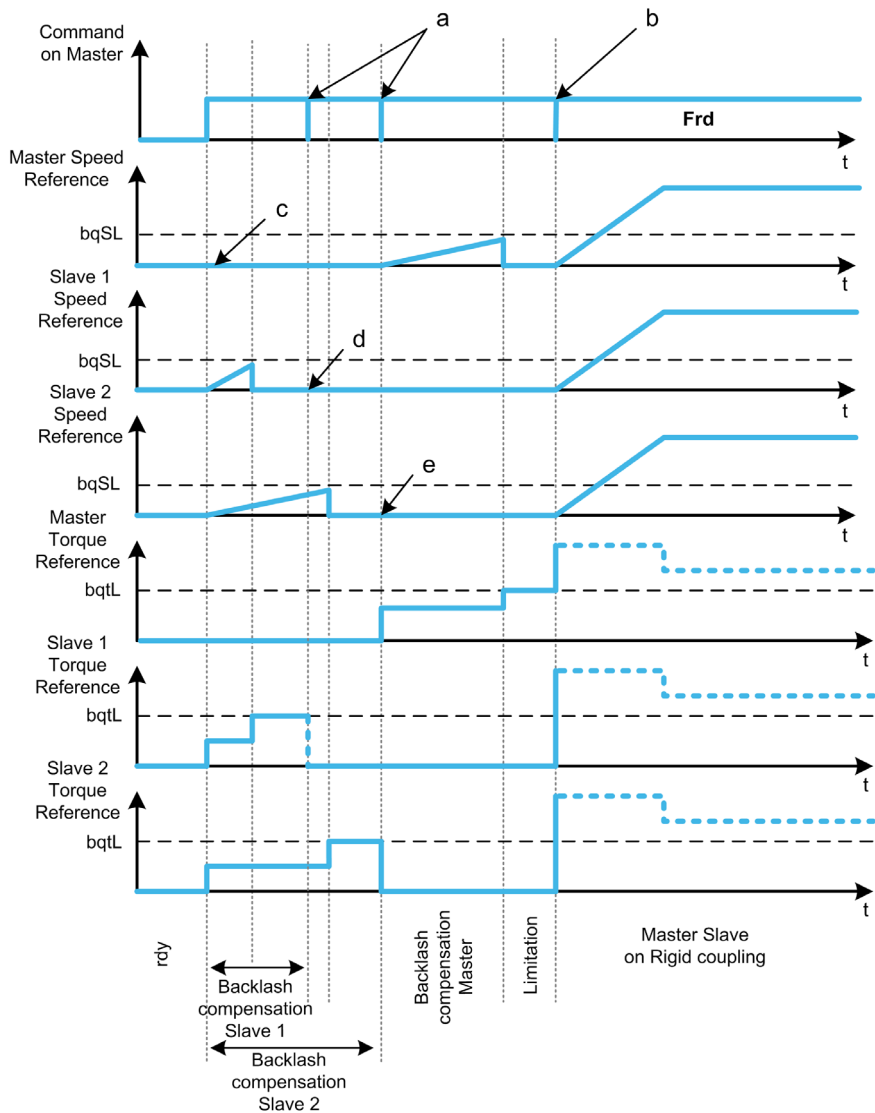

- a** Stop orders when feedback is done
- b** All slaves start
- c** 0Hz regulation or stop
- d** Slave 1 feedback
- e** Slave 2 feedback

[BL Mode] б 9 П

Backlash mode.

Setting	Code / Value	Description
[Not Configured]	no	Backlash compensation not configured Factory setting
[On Start]	Start	Backlash compensation is performed on each Drive start (run order appears or halt disappear)
[On Start + Dir Change]	StartDir	Backlash compensation is performed on each Drive start (run order appears or halt disappear) and on each direction change
[On Master Request]	MS	Backlash compensation managed through Master/Slave function.

[BL Type] б 9 П П ★

Backlash type.

This parameter can be accessed if:

- [BL Mode] б 9 П is not set to [Not Configured] no, and
- [M/S Comm Mode] П 5 С П is set to [MultiDrive Link] П Д Л, and
- [M/S Device Role] П 5 Д Е is set to [Master] П 5 Е Е r.

Setting	Code / Value	Description
[Sequential]	Seq	Each slave will do its sequence one by one Factory setting
[Simultaneous]	Simul	Backlash compensation is performed on each Drive start (run order appears or halt disappear)

[BL Slave Fdbck] б 9 П С ★

Backlash on slave(s) feedback.

This parameter can be accessed if:

- [BL Mode] б 9 П is not set to [Not Configured] no, and
- [M/S Comm Mode] П 5 С П is set to [MultiDrive Link] П Д Л, and
- [M/S Device Role] П 5 Д Е is set to [Master] П 5 Е Е r, and
- [Access Level] Л А С is set to [Expert] Е P r.

Setting	Code / Value	Description
[No]	no	Master does not take into account the slaves feedback
[Yes]	Yes	Master takes into account the slaves feedback Factory setting

[BL Time] б 9 П Е ★

Backlash time.

This parameter can be accessed if:

- [BL Mode] б 9 П is not set to [Not Configured] no, and
- [M/S Comm Mode] П 5 С П is set to [MultiDrive Link] П Д Л, and
- [M/S Device Role] П 5 Д Е is set to [Master] П 5 Е Е r, and
- [Access Level] Л А С is set to [Expert] Е P r, and
- [BL Slave Fdbck] б 9 П С is set to [No] no.

Setting ()	Description
0.1...100.0 s	Setting range Factory setting: 0.5 s

[BL Ref Freq] b 95 L ★

Backlash reference frequency.

This parameter can be accessed if **[BL Mode] b 97** is not set to **[Not Configured] n o**.

Setting ()	Description
0.0...599.0 Hz	Setting range Factory setting: 1% of [Nominal Motor Freq] F r 5 or [Sync Nominal Freq] F r 5 5 depending on [Motor control type] C k k .

[BL Acceleration] b 9A ★

Backlash acceleration.

Backlash Acceleration ramp value.

This parameter can be accessed if **[BL Mode] b 97** is not set to **[Not Configured] n o**.

Setting ()	Description
0.01...999.90 s ⁽¹⁾	Setting range Factory setting: 10.00 s
(1) Range 0.01 to 99.99 s or 0.1 to 999.9 s or 1 to 9,999 according to [Ramp increment] i n r	

[BL Trq Lim Value] b 9t L ★

Backlash torque limitation value.

This parameter can be accessed if **[BL Mode] b 97** is not set to **[Not Configured] n o**.

Setting ()	Description
0.0...100.0%	Setting range Factory setting: 5.0%

[BL Monit Delay] b 9t ★

Backlash torque limitation monitoring delay.

Delay from beginning of backlash speed ramp and check of torque limitation.

This parameter can be accessed if **[BL Mode] b 97** is not set to **[Not Configured] n o**.

Setting ()	Description
0.1...100.0 s	Setting range Factory setting: 0.5 s

NOTE: To adjust this parameter, the time needed by Angle test function must be considered.

[BL Start Delay] b 95 t ★

Backlash start delay.

Time spent in stop or standstill before backlash sequence.

This parameter can be accessed if **[BL Mode] b 97** is not set to **[Not Configured] n o**.

Setting ()	Description
0.0...100.0 s	Setting range Factory setting: 0.0 s

[BL Timeout] b 9 F d ★

Backlash timeout.

This parameter can be accessed if **[BL Mode] b 9 7** is not set to **[Not Configured] n o**.

Setting 	Description
0.0...100.0 s	Setting range Factory setting: 5.0 s ([BL Monit Delay] b 9 L x10)

[BL ErrorResp] b 9 F b ★

Backlash compensation error response.

This parameter can be accessed if **[BL Mode] b 9 7** is not set to **[Not Configured] n o**.

Setting	Code / Value	Description
[Ignore]	n o	Detected error ignored
[Freewheel Stop]	Y E 5	Freewheel stop Factory setting

Section 8.14

[Hoisting Functions]

What Is in This Section?

This section contains the following topics:

Topic	Page
[Brake logic control] <i>b L C</i> - Menu	323
[High speed hoisting] <i>H S H</i> - Menu	341
[Load Sharing] <i>L d S</i> - Menu	348
[Rope Slack Handling] <i>S d r</i> - Menu	350

[Brake logic control] *b L C* - Menu

Access

[Complete settings] → [Hoisting Functions] → [Brake logic control]

About This Menu

NOTE: This function cannot be used with some other functions.

Used to control one or several electromagnetic brake(s) via a single output of the drive, for horizontal and vertical hoisting applications, and for unbalanced machines.

For vertical movements, the objective is to maintain motor torque in the lifting direction during the release and the application of the brake, in order to hold the load. Start smoothly when the brake is released and stop smoothly when the brake is applied.

For horizontal movements, the objective is to synchronize during the beginning of the movement the release of the brake with the built-up of torque and during stopping the application of the brake with the zero speed, in order to help prevent jerking.

Instructions for Brake Logic Control for a Vertical Hoisting Application

 WARNING
<p>INSUFFICIENT PERFORMANCE LEVEL/SAFETY INTEGRITY LEVEL AND/OR UNINTENDED EQUIPMENT OPERATION</p> <ul style="list-style-type: none"> • Conduct a risk assessment according to EN ISO 12100 and all other standards that apply to your application. • Use redundant components and/or control paths for all critical control functions identified in your risk assessment. • If moving loads can result in hazards, for example, slipping or falling loads, operate the drive in closed loop mode. • Verify that the service life of all individual components used in your application is sufficient for the intended service life of your overall application. • Perform extensive commissioning tests for all potential error situations to verify the effectiveness of the safety-related functions and monitoring functions implemented, for example, but not limited to, speed monitoring by means of encoders, short circuit monitoring for all connected equipment, correct operation of brakes and guards. • Perform extensive commissioning tests for all potential error situations to verify that the load can be brought to a safe stop under all conditions. <p>Failure to follow these instructions can result in death, serious injury, or equipment damage.</p>

Take into account all information provided in the application note [NHA80973](#) for hoisting machines that can be downloaded on [se.com](#).

When the drive transitions to operating state Fault, the mains contactor and the brake contactor must be deenergized.

 WARNING
<p>UNANTICIPATED EQUIPMENT OPERATION</p> <ul style="list-style-type: none"> • Assign [Operating state fault] <i>F L E</i> to output relay R1. • Connect the coil of the mains contactor to output relay R1. • Connect the brake contactor downstream of the mains contactor. <p>Failure to follow these instructions can result in death, serious injury, or equipment damage.</p>

Step	Action
1	Assign [Brake assignment] <i>b L C</i> . It activates the function and the assigned output controls the command to release/apply the brake.
2	Verify [Movement type] <i>b 5 E</i> is set to [Hoisting] <i>V E r</i> .

Step	Action
3	[Brake Release Pulse] b r P : YES. Ensure that the direction of rotation FW corresponds to lifting the load. For applications in which the load being lowered is very different from the load being lifted, set [Brake Release Pulse] b r P = [2 IBR] 2 r (e.g., ascent always with a load and descent always without a load).
4	Assign [Brake contact] b c , to handle the brake contact feedback and/or [Brake Relay Fdbk] b r , to handle the brake contactor feedback. If necessary, adjust [brake fdbk filter] F b c , and/or [brake Rly Fdbk Filter] F b r .
5	Brake release current [Brk Release Current] b r and [Brake release I Rev] r d if [Brake Release Pulse] b r P = [2 IBR] 2 r : adjust the brake release current to the rated current indicated on the motor. During testing, adjust the brake release current in order to hold the load smoothly.
6	Acceleration time: for hoisting applications it is advisable to set the acceleration ramps to more than 0.5 seconds. Ensure that the drive does not exceed the current limit. The same recommendation applies for deceleration. Reminder: for a hoisting movement, a braking resistor should be used.
7	[Brake Release time] b r t : set according to the type of brake. It is the time required for the mechanical brake to release. This parameter must consider the maximum value of [brake fdbk filter] F b c , and [brake Rly Fdbk Filter] F b r .
8	[Brake release freq] b r , in open-loop mode only: Leave in [Auto] A u t o , adjust if necessary.
9	[Brake engage freq] b e n : leave in [Auto] , adjust if necessary.
10	[Brake engage time] b e t : set according to the type of brake. It is the time required for the mechanical brake to engage. This parameter must consider the maximum value of [brake fdbk filter] F b c , and [brake Rly Fdbk Filter] F b r .

Instructions for Brake Logic Control for an Horizontal Hoisting Application

 WARNING
<p>INSUFFICIENT PERFORMANCE LEVEL/SAFETY INTEGRITY LEVEL AND/OR UNINTENDED EQUIPMENT OPERATION</p> <ul style="list-style-type: none"> ● Conduct a risk assessment according to EN ISO 12100 and all other standards that apply to your application. ● Use redundant components and/or control paths for all critical control functions identified in your risk assessment. ● If moving loads can result in hazards, for example, slipping or falling loads, operate the drive in closed loop mode. ● Verify that the service life of all individual components used in your application is sufficient for the intended service life of your overall application. ● Perform extensive commissioning tests for all potential error situations to verify the effectiveness of the safety-related functions and monitoring functions implemented, for example, but not limited to, speed monitoring by means of encoders, short circuit monitoring for all connected equipment, correct operation of brakes and guards. ● Perform extensive commissioning tests for all potential error situations to verify that the load can be brought to a safe stop under all conditions. <p>Failure to follow these instructions can result in death, serious injury, or equipment damage.</p>

Take into account all information provided in the application note [NHA80973](#) for hoisting machines that can be downloaded on [se.com](#).

When the drive transitions to operating state Fault, the mains contactor and the brake contactor must be deenergized.

⚠ WARNING

UNANTICIPATED EQUIPMENT OPERATION

- Assign **[Operating state fault] F L E** to output relay R1.
- Connect the coil of the mains contactor to output relay R1.
- Connect the brake contactor downstream of the mains contactor.

Failure to follow these instructions can result in death, serious injury, or equipment damage.

Step	Action
1	Assign [Brake assignment] b L C . It activates the function and the assigned output controls the command to release/apply the brake.
2	Set [Movement type] b S E to [Traveling] H o r .
3	[Brake Release Pulse] b i P : no
4	Assign [Brake contact] b C i to handle the brake contact feedback and/or [Brake Relay Fdbk] b r i to handle the brake contactor feedback. If necessary, adjust [brake fdbk filter] F b C i , and/or [brake Rly Fdbk Filter] F b r i .
5	[Brk Release Current] i b r : set to 0 .
6	[Brake Release time] b r E : set according to the type of brake. It is the time required for the mechanical brake to release. This parameter must consider the maximum value of [brake fdbk filter] F b C i , and [brake Rly Fdbk Filter] F b r i .
7	[Brake engage freq] b E n , in open-loop mode only: leave in [Auto] A u t o , adjust if necessary.
8	[Brake engage time] b E E : set according to the type of brake. It is the time required for the mechanical brake to engage. This parameter must consider the maximum value of [brake fdbk filter] F b C i , and [brake Rly Fdbk Filter] F b r i .

Horizontal Movement in Open-Loop Mode

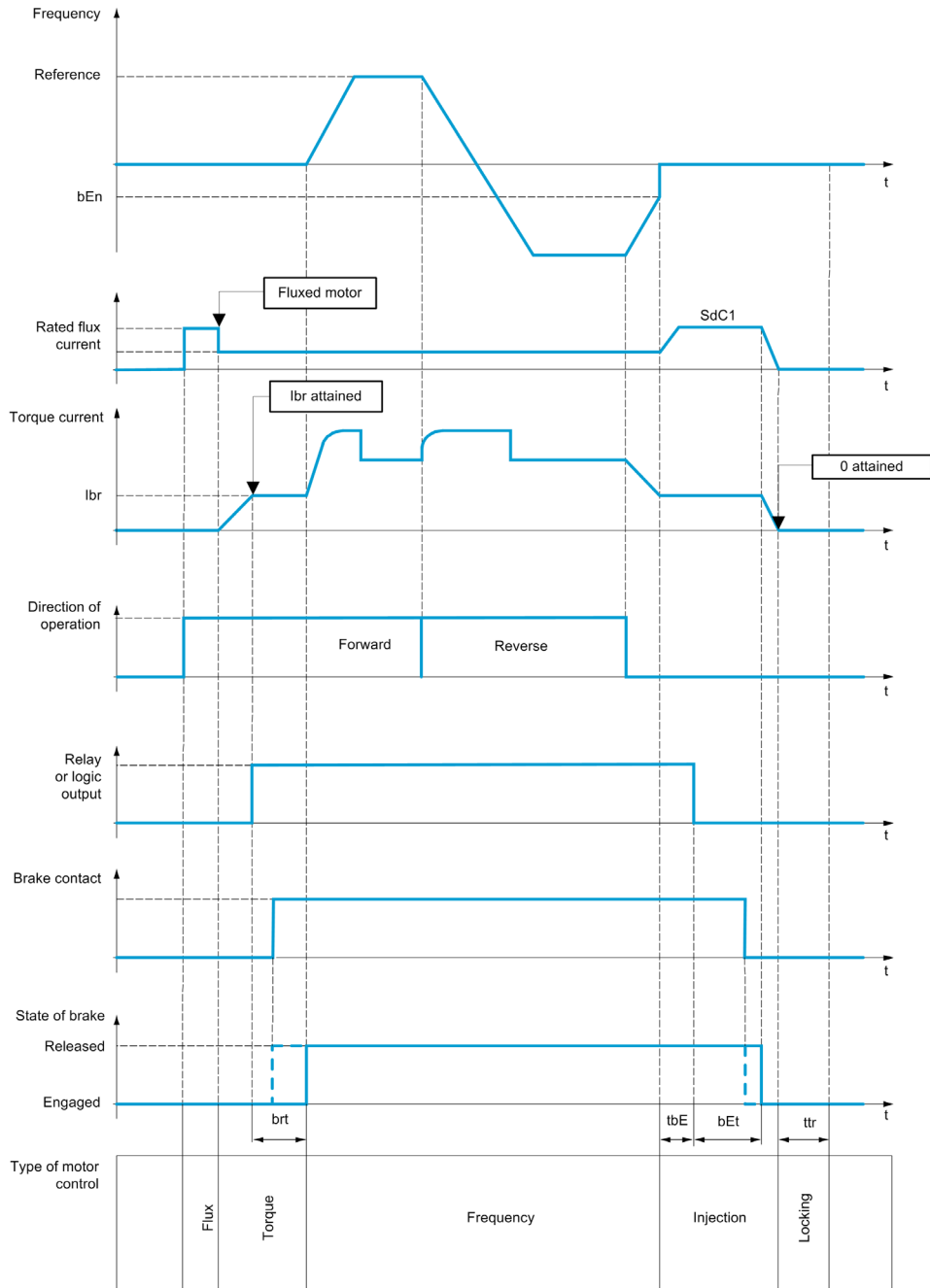

Vertical Movement in Open-Loop Mode

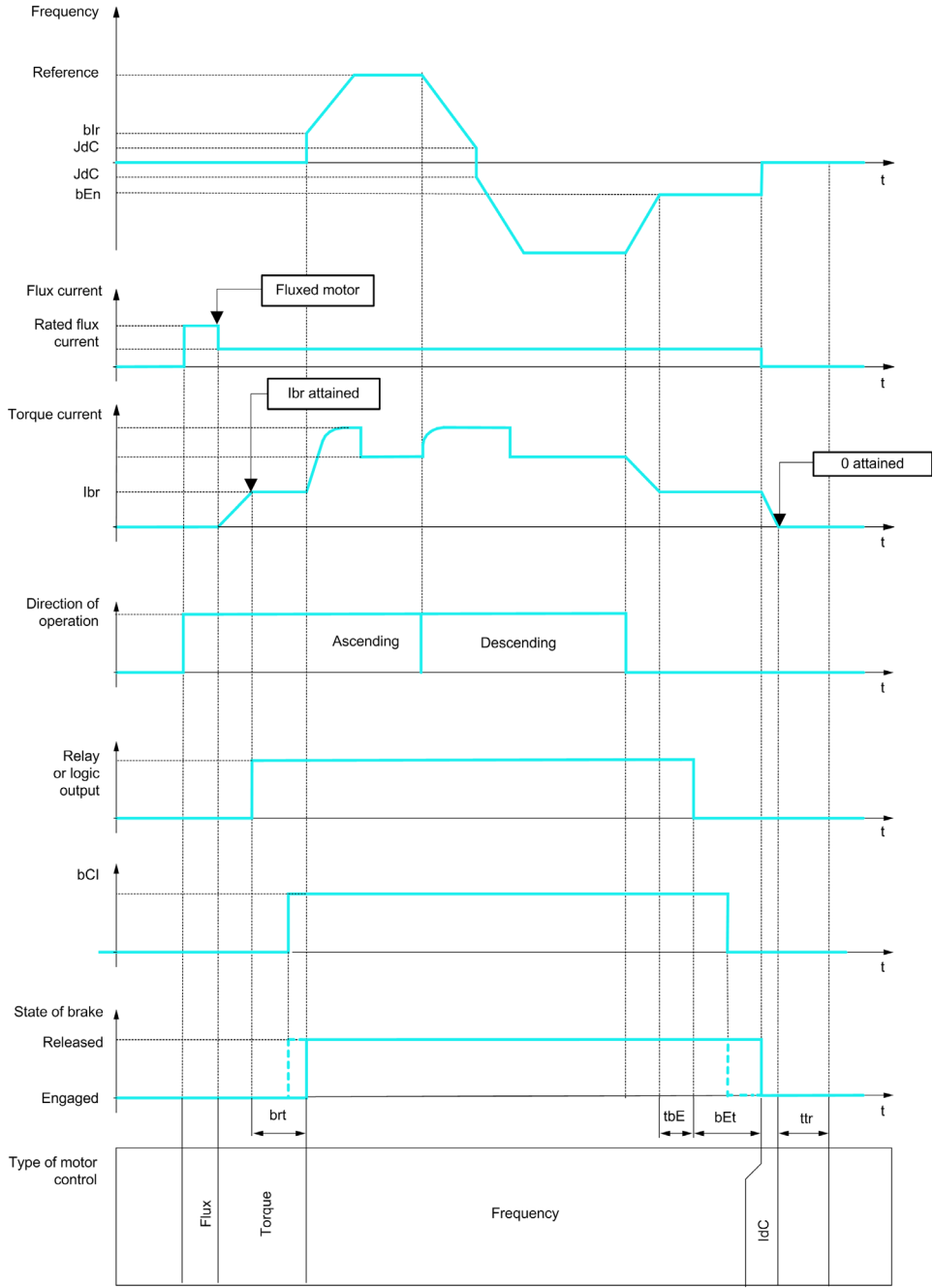

Frd = Up
rrS = Down

Vertical or Horizontal Movement in Closed-Loop Mode

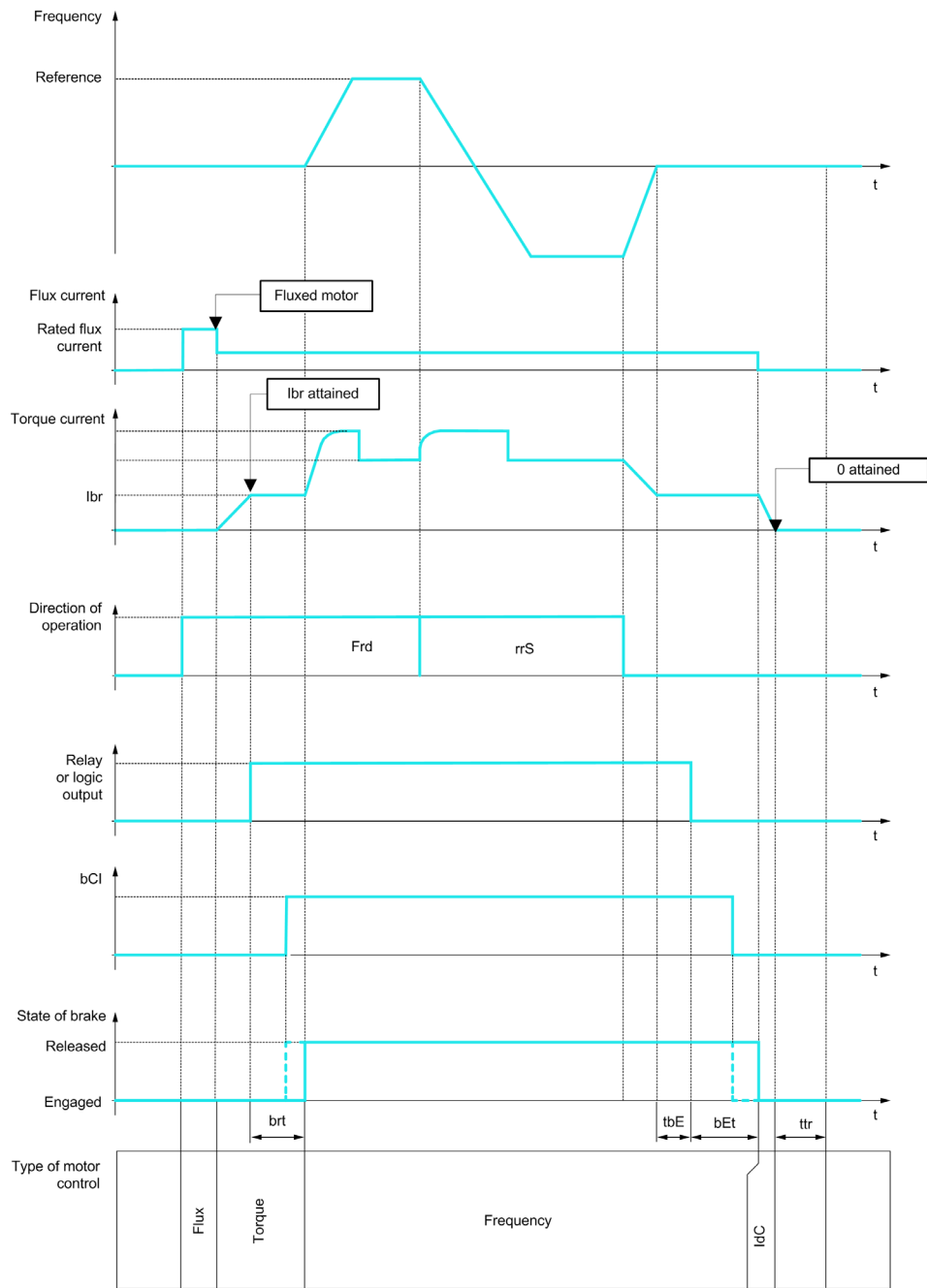

Vertical movement
 Frd = Up
 rrS = Down

Behavior at run command

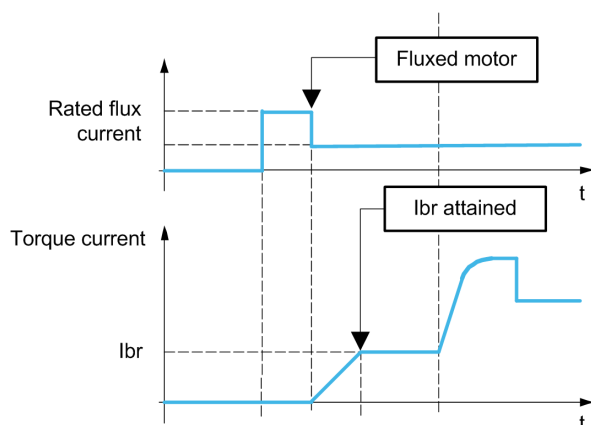

When run command is given, the drive over-fluxes the motor during a short time in order to generate a sufficient motor torque. The level of the torque is set with the parameter **[Brk Release Current]** i_{br} . This torque is required to maintain the load during the release of the brake and before starting speed control.

The parameter **[Rotor Time Const]** t_{rA} is the time needed by the motor to be fluxed. This parameter is computed by the drive using the values of the parameters **[Nom Motor Current]** n_{Cr} , **[Motor 1 Cosinus Phi]** $c_{\phi 5}$, **[Nom Motor Voltage]** u_{n5} and **[Nominal Motor Speed]** n_{5P} which have to be set properly according to the motor specification.

Before releasing the brake, by the means of the relay output R2 set with the parameter **[Brake assignment]** b_{LC} , the drive verifies the two following conditions:

- The fluxing current is stable.
- The torque set point is reached.

If one of the both conditions is not fulfilled, the drive does not release the brake and triggers the error **[Brake Control]** b_{LF} .

This error can be triggered, for example, if one phase of the motor is not properly connected to the motor output of the drive.

[Brake assignment] b_{LC}

Brake function assignment.

[Brake assignment] b_{LC} is forced to **[No]** n_0 if :

- **[Motor control type]** c_{tE} is set to **[U/F VC 5pts]** u_{F5} , **[SYN_U VC]** 5_{YNu} , **[Sync. mot.]** 5_{Yn} , **[Rel. Mot.]** 5_{rVc} .
- **[DC Injection Assign]** d_{CI} is not set to **[Not Assigned]** n_0
- **[Catch On Fly]** f_{Lr} is not set to **[No]** n_0
- **[Jog Assign]** j_{oG} is not set to **[Not Assigned]** n_0
- **[PID feedback]** p_{iF} is not set to **[Not Configured]** n_0
- **[OutPhaseLoss Assign]** o_{PL} is set to **[No Error Triggered]** o_{AC}
- **[BL mode]** $b_{q\pi}$ is not set to **[Not configured]** n_0

Setting	Code / Value	Description
[No]	n_0	Not assigned Factory setting
[R2]...[R3]	$r_2...r_3$	Relay output R2...R3
[R4]...[R6]	$r_4...r_6$	Relay output R4...R6 if VW3A3204 relay output option module has been inserted
[DQ1 Digital Output]	d_{o1}	Digital output DQ1
[DQ11 Digital Output]...[DQ12 Digital Output]	$d_{o11}...d_{o12}$	Digital output DQ11...DQ12 if VW3A3203 I/O extension module has been inserted

Setting	Code / Value	Description
[R61]...[R66]	r 6 1...r 6 6	Relay R61 ...R66 NOTE: This selection can be accessed on ATV960, ATV980 equipped with Cabinet IO.

[Movement type] b 5 5 ★

Brake sequence type.

This parameter can be accessed if **[Brake assignment] b L C** is not set to **[No] n o**.

This parameter is forced to **[Hoisting] V E r** if **[Weight sensor Assign] P E 5** is assigned.

Setting	Code / Value	Description
[Traveling]	H o r	Resistive-load movement (translational motion of overhead crane, for example).
[Hoisting]	V E r	Driving-load movement (hoisting winch, for example). Factory setting

[Brake contact] b C , ★

Brake contact input.

This parameter can be accessed if **[Brake assignment] b L C** is not set to **[No] n o**.

If the brake has a monitoring contact (closed for released brake).

Setting	Code / Value	Description
[Not Assigned]	n o	Not assigned Factory setting
[DI1]...[DI8]	L , 1...L , 8	Digital input DI1...DI8
[DI11]...[DI16]	L , 1 1...L , 1 6	Digital input DI11...DI16 if VW3A3203 I/O extension module has been inserted
[CD00]...[CD10]	C d 0 0...C d 1 0	Virtual digital input CMD.0...CMD.10 in [I/O profile] , o configuration
[CD11]...[CD15]	C d 1 1...C d 1 5	Virtual digital input CMD.11...CMD.15 regardless of configuration
[C101]...[C110]	C 1 0 1...C 1 1 0	Virtual digital input CMD1.01...CMD1.10 with integrated Modbus Serial in [I/O profile] , o configuration
[C111]...[C115]	C 1 1 1...C 1 1 5	Virtual digital input CMD1.11...CMD1.15 with integrated Modbus Serial regardless of configuration
[C201]...[C210]	C 2 0 1...C 2 1 0	Virtual digital input CMD2.01...CMD2.10 with CANopen® fieldbus module in [I/O profile] , o configuration
[C211]...[C215]	C 2 1 1...C 2 1 5	Virtual digital input CMD2.11...CMD2.15 with CANopen® fieldbus module regardless of configuration
[C301]...[C310]	C 3 0 1...C 3 1 0	Virtual digital input CMD3.01...CMD3.10 with a fieldbus module in [I/O profile] , o configuration
[C311]...[C315]	C 3 1 1...C 3 1 5	Virtual digital input CMD3.11...CMD3.15 with a fieldbus module regardless of configuration
[C501]...[C510]	C 5 0 1...C 5 1 0	Virtual digital input CMD5.01...CMD5.10 with integrated Ethernet in [I/O profile] , o configuration
[C511]...[C515]	C 5 1 1...C 5 1 5	Virtual digital input CMD5.11...CMD5.15 with integrated Ethernet regardless of configuration

[Brake Fdbk Filter] F b C , ★

Brake feedback filter.

The parameter can be accessed if **[Brake contact] b C ,** is not set to **[No] n o**.

Setting ()	Description
0...5000 ms	Setting range Factory setting: 100 ms

[Brake Relay Fdbk] *b r i*

Brake relay feedback input. (also known as brake contactor feedback input)

The parameter can be accessed if **[Brake assignment] *b L C*** is not set to **[No] *n o***.

Identical to **[Brake contact] *b C i***.

[Brake Rly Fdbk Filter] *F b r i*

Brake relay feedback filter. (also known as brake contactor feedback filter)

The parameter can be accessed if **[Brake Relay Fdbk] *b r i*** is not set to **[No] *n o***.

Setting (°)	Description
0...1000 ms	Setting range Factory setting: 100 ms

[Brake Release Pulse] *b , P* ★

Brake release pulse.

This parameter can be accessed if:

- **[Brake assignment] *b L C*** is not set to **[No] *n o***, and
- **[Weight Sensor Assign] *P E S*** is set to **[Not configured] *n o***.

Setting (°)	Code / Value	Description
[No]	<i>n o</i>	The motor torque is given in the required operating direction, at current [Brk Release Current] <i>i b r</i> . Factory setting: if [Movement type] <i>b S t</i> = [Traveling] <i>H o r</i>
[Yes]	<i>Y E S</i>	The motor torque is always Forward (check that this direction corresponds to ascending), at current [Brk Release Current] <i>i b r</i> . Factory setting: if [Movement type] <i>b S t</i> = [Hoisting] <i>V E r</i>
[2 IBR]	<i>2 i b r</i>	The torque is in required direction, at current [Brk Release Current] <i>i b r</i> Forward and [Brake release I Rev] <i>i r d</i> for Reverse, for certain specific applications.

[Brk Release Current] *i b r* ★

Brake release current level.

This parameter can be accessed if:

- **[Brake assignment] *b L C*** is not set to **[No] *n o***, and
- **[Weight Sensor Assign] *P E S*** is set to **[Not configured] *n o***.

Setting (°)	Description
0...1.1 <i>I_n</i> ⁽¹⁾	Setting range Factory setting: [Nom Motor Current] <i>n C r</i>
(1) In corresponds to the rated drive current indicated in the Installation Manual and on the drive nameplate.	

[Brake release I Rev] *i r d*

Brake release current level for going down.

This parameter can be accessed if:

- **[Brake assignment] *b L C*** is not set to **[No] *n o***, and
- **[Brake Release Pulse] *b , P*** is set to **[2 IBR] *2 i b r***, and
- **[Weight Sensor Assign] *P E S*** is set to **[Not configured] *n o***.

Setting (°)	Description
0...1.1 <i>I_n</i> ⁽¹⁾	Setting range Factory setting: 0
(1) In corresponds to the rated drive current indicated in the Installation Manual and on the drive nameplate.	

[Brake Release time] *b r t* ★

Brake release time.

The parameter can be accessed if **[Brake assignment] *b l c*** is not set to **[No] *n o***

Setting ()	Description
0.0...5.00 s	Setting range Factory setting: 0.50 s
NOTE: The minimum value considered internally by the drive is the maximum of [Brake Fdbk Filter] <i>f b c</i> , and [Brake Rly Fdbk Filter] <i>f b r i</i> .	

[Brake release freq] *b i r* ★

Brake release frequency.

The parameter can be accessed if **[Motor control type] *c t t*** is not **[FVC] *f v c*** or **[Sync.CL] *f s y*** and if **[Movement type] *b s t*** is set to **[Hoisting] *v e r*** .

Setting ()	Code / Value	Description
[Auto]	<i>R u t o</i>	The drive takes a value based on the rated slip of the motor, calculated using the drive parameters
0.0...10.0 Hz		Manual control Factory setting: <ul style="list-style-type: none"> • 0 if [Movement type] <i>b s t</i> is set to [Traveling] <i>h o r</i> or [Hoisting] <i>v e r</i> and in closed loop. • [Auto] <i>R u t o</i> if [Movement type] <i>b s t</i> is set to [Hoisting] <i>v e r</i> and in open loop

[Brake engage frequency] *b e n* ★

Brake engage frequency threshold.

The parameter can be accessed if **[Motor control type] *c t t*** is not set to **[FVC] *f v c*** or **[Sync.CL] *f s y*** and if **[Brake assignment] *b l c*** is not set to **[No] *n o*** .

Setting ()	Code / Value	Description
[Auto]	<i>R u t o</i>	The drive takes a value based on the rated slip of the motor, calculated using the drive parameters
0.0...10.0 Hz		Manual control Factory setting: <ul style="list-style-type: none"> • 0 in closed loop. • [Auto] <i>R u t o</i> in open loop

[Brake engage at 0] *b e c d* ★

Brake engage delay when 0 speed is attained with a reference frequency = 0 Hz.

This parameter can be accessed if **[Motor control type] *c t t*** is set to:

- **[FVC] *f v c*** , or
- **[Sync.CL] *f s y*** .

This parameter can be used to adjust the brake engage delay once zero speed has been reached.

Setting	Code / Value	Description
[No]	<i>n o</i>	Brake does not engage while zero speed is maintained. Factory setting
0.0...30.0 s		Brake engage delay once zero speed is reached. NOTE: The brake engagement type depends on [BRH b6] <i>b r h b</i> setting value.

[Brake engage delay] b E E ★

Temporization at brake engage frequency.

The parameter can be accessed if **[Brake assignment] b L C** is not set to **[No] n o**.

Time delay before request to engage brake. To delay brake engagement, if you wish the brake to be engaged when the drive comes to a complete stop.

Setting (°)	Description
0.00...5.00 s	Factory setting: 0.00 s

[Brake engage time] b E E ★

Brake engage time.

The parameter can be accessed if **[Brake assignment] b L C** is not set to **[No] n o**.

Setting (°)	Description
0.00...5.00 s	Factory setting: 0.50 s
NOTE: The minimum value considered internally by the drive is the maximum of [Brake Fdbk Filter] F b C i and [Brake Rly Fdbk Filter] F b r i .	

[Auto DC inj Level 1] S d C I ★

Auto DC injection level 1.

NOTICE**OVERHEATING AND DAMAGE TO THE MOTOR**

Verify that the connected motor is properly rated for the DC injection current to be applied in terms of amount and time in order to avoid overheating and damage to the motor.

Failure to follow these instructions can result in equipment damage.

This parameter can be accessed if:

- **[Movement Type] b S E** is set to **[Traveling] H o r**, and
- **[Motor control type] C E E** is not set to **[FVC] F V C** or **[Sync.CL] F S Y**.

Setting (°)	Description
0...1.1 In ⁽¹⁾	Setting range Factory setting: 0.7 In ⁽¹⁾
(1) In corresponds to the rated drive current indicated in the Installation Manual and on the drive nameplate.	

[Engage at reversal] b E d ★

Brake engage at speed inversion.

Can be used to select whether or not the brake engages on transition to zero speed when the operating direction is reversed.

The parameter can be accessed if **[Brake assignment] b L C** is not set to **[No] n o**.

Setting (°)	Code / Value	Description
[No]	n o	The brake does not engage Factory setting
[Yes]	Y E S	The brake engages

[Jump at reversal] J d C ★

Brake: Jump frequency at direction change.

This parameter can be accessed if

- **[Motor control type] C E E** is not set to:
 - **[FVC] F V C**, or
 - **[Sync.CL] F 5 Y**, and
- **[Movement type] b 5 E** is set to **[Hoisting] V E r**.

When the reference direction is reversed, this parameter can be used to avoid loss of torque (and consequential release of load) on transition to zero speed. Parameter is not applicable if **[Engage at reversal] b E d** is set to **[Yes] Y E 5**.

Setting ()	Code / Value	Description
[Auto]	<i>R u t o</i>	The drive takes a value based on the rated slip of the motor, calculated using the drive parameters
0.0...10.0Hz		Manual control Factory setting: <ul style="list-style-type: none"> • 0 if [Movement type] b 5 E is set to [Traveling] H o r or [Hoisting] V E r and in closed loop. • [Auto] R u t o if [Movement type] b 5 E is set to [Hoisting] V E r and in open loop

[Time to restart] t E r ★

Brake time to restart.

Time between the end of a brake sequence and the start of the next brake release sequence.

The parameter can be accessed if **[Brake assignment] b L C** is not set to **[No] n o**.

Setting ()	Description
0.00...15.00 s	Factory setting: 0.00 s

[BRH b0] b r H D ★

Selection of the brake restart sequence if a run command is repeated while the brake is engaging.

This parameter can be accessed if **[Brake assignment] b L C** is not set to **[No] n o** and if **[Access Level] L A C** is set to **[Expert] E P r**.

Use in open-loop and closed-loop mode

A run command may be requested during the brake engagement phase. Whether or not the brake release sequence is executed depends on the value selected for **[BRH b0] b r H D**.

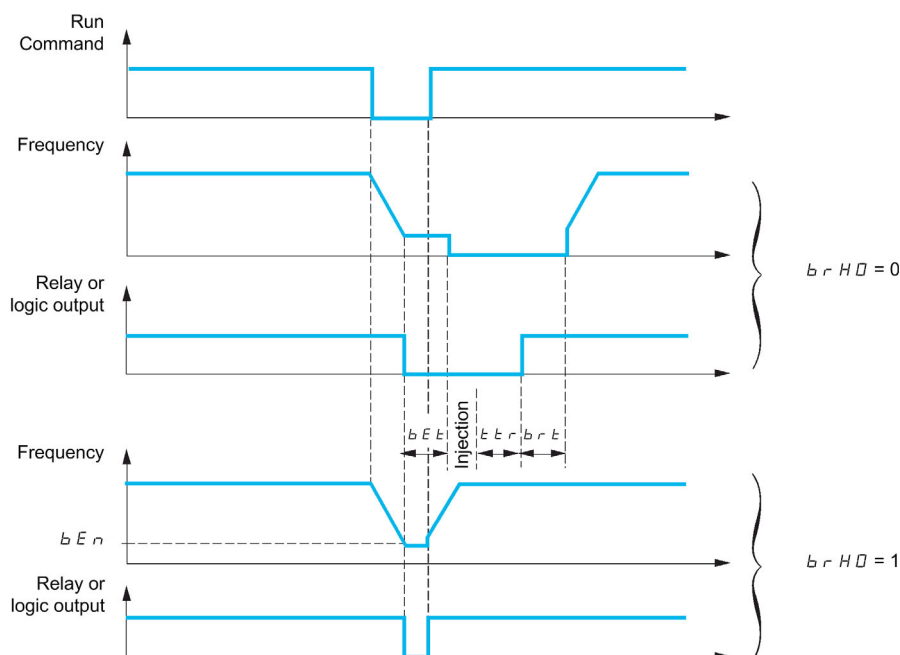

NOTE:

- if a run command is requested during the [Time to restart] $t E r$ phase, the complete brake control sequence is initialized.
- If a run command is requested with [Engage at reversal] $b E d$ active, the complete brake control sequence is initialized.

Setting	Code / Value	Description
[0]	0	The engage/release sequence is executed in full. Factory setting
[1]	1	During the brake engagement phase, if the run command is request: <ul style="list-style-type: none"> • Before the end of [Brake engage delay] $t b E$, the run command is considered immediately, • During [Brake engage time] $b E t$ phase, the run command is considered with the handling of [Brake release time] $b r t$ time before the restart; • After [Brake engage time] $b E t$ phase, the brake logic sequence is completed in full.

[BRH b1] $b_r H I$ ★

Deactivation of the brake contact in steady state error.

This parameter can be accessed if [Brake assignment] $b L C$ is not set to [No] $n o$ and if [Access Level] $L A C$ is set to [Expert] $E P r$.

Setting	Code / Value	Description
[0]	0	The brake contact in steady state error is active (error is triggered if the contact is open during operation). [Brake Feedback] $b r F$ is monitored in all operating phases Factory setting
[1]	1	The brake contact in steady state error is inactive. [Brake Feedback] $b r F$ is only monitored during the brake release and engage phases.

[BRH b2] brH2 ★

Taking the brake contact into account for the brake control sequence.

This parameter can be accessed if **[Brake assignment] bLC** is not set to **[No] no** and if **[Access Level] LAC** is set to **[Expert] EPr**.

If a digit input is assigned to the brake contact.

- **[BRH b2] brH2 = [0] 0**: During the brake release sequence, the reference is enabled at the end of the time **[Brake Release time] brt**. During the brake engage sequence, the current changes to **0** according to the ramp **[Current ramp time] brr** at the end of the **[Brake engage time] bet**.
- **[BRH b2] brH2 = [1] 1**: When the brake is released, the reference is enabled when the **[brake contact] bC**, digit input changes to **1**. When the brake is engaged, the current changes to **0** according to the ramp **[Current ramp time] brr** when the **[brake contact] bC**, digit input changes to **0**.

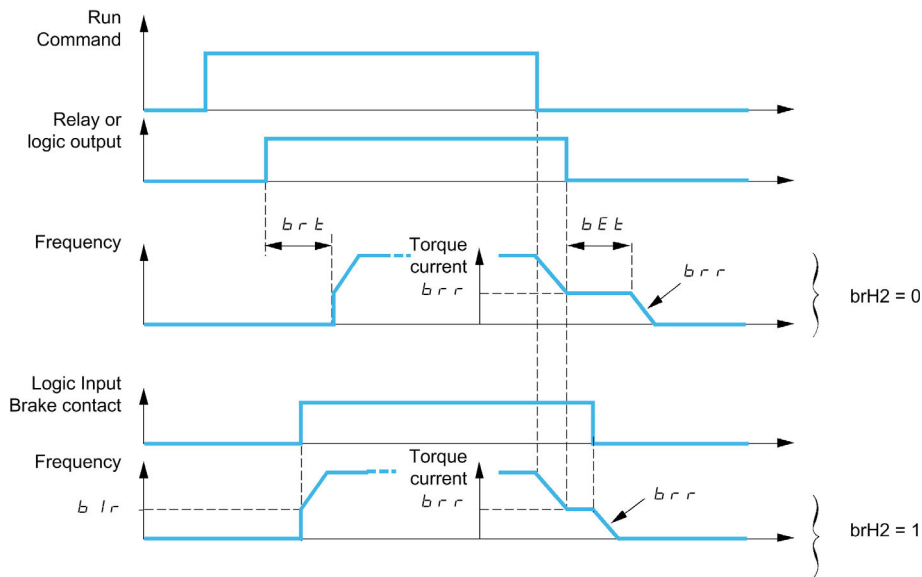

Setting	Code / Value	Description
[0]	0	The engage/release sequence is executed in full. Factory setting
[1]	1	The brake is released immediately.

[BRH b3] brH3 ★

In closed-loop mode only. Management of the absence of **[Brake contact] bC**, and/or **[Brake Relay Fdbk] br**, response, if it is assigned.

⚠ WARNING

FALLING LOAD

- Only set **[BRH b3] brH3** to [1] (1) if your application monitors the associated warning **[Brk cont. al] bCR**, for example, by assigning the warning **bCR** to an output.
- If the warning **bCR** is triggered, the following action must be taken by the user.
 - Move the load to a safe position.
 - Power off the drive.
 - Identify and remove the cause of the warning.
 - Verify correct operation of all electrical and mechanical components of the brake before resuming regular operation.

Failure to follow these instructions can result in death, serious injury, or equipment damage.

This parameter can be accessed if **[Brake assignment] bLC** is not set to **[No] no** and if **[Access Level] LAC** is set to **[Expert] EPr**.

Setting	Code / Value	Description
[0]	0	During the brake engage sequence, the brake contact and brake contactor (relay) feedback must be open before the end of [Brake engage time] b E t , otherwise the drive locks in a [Brake Feedback] b r F brake contact error. Factory setting
[1]	1	During the brake engage sequence, the brake contact and brake contactor (relay) feedback must be open before the end of [Brake engage time] b E t , otherwise a [Brake Contact Warn] b C A is triggered and zero speed is maintained. If this setting is used, behavior of the drive depends on the setting of [BRH b5] b r H 5 . Refer to the description of [BRH b5] b r H 5 for appropriate settings depending on your needs.

[BRH b4] b r H 4 ★

⚠ WARNING

FALLING LOAD

- Only set the parameter **[BRH_b4] b r H 4** to **[1] 1** if your application monitors the associated warning **b S A**, for example, by assigning the warning **b S A** to an output.
- If the warning **b S A** is triggered, the following action must be taken by the user.
 - a. Move the load to a safe position.
 - b. Power off the drive.
 - c. Identify and remove the cause of the warning.
 - d. Verify correct operation of all electrical and mechanical components of the brake before resuming regular operation.

Failure to follow these instructions can result in death, serious injury, or equipment damage.

In closed-loop mode only. Out of the brake sequence (after **[Time to restart] t E r** time) and depending **[BRH b4] b r H 4** setting, triggering of an error or activation of the speed loop at zero if a movement, for which no command has been given, occurs (measurement of a speed greater than a fixed minimum threshold determined by **[BRH_b4_freq] b F d t**).

This parameter can be accessed if **[Access Level] L A C** is set to **[Expert] E P r**.

Setting	Code / Value	Description
[0]	0	If a movement occurs for which no command has been given, [Load Mvt Error] n d C F error is triggered. Factory setting Note: <ul style="list-style-type: none"> • If this setting is used, behavior of the drive depends on the setting of [BRH_b4_freq] b F d t. Refer to the description of [BRH_b4_freq] b F d t for appropriate settings depending on your needs. • This behavior is irrespective of the command profile and available in all drive operating state except 2- Switch on disabled, 7- Fault Reaction Active and 8 - Fault states.
[1]	1	If a movement occurs for which no command has been given, the drive switches to zero speed regulation, with no brake release command, and a [Load Mvt Warn] b S A warning is triggered. NOTE: If this setting is used, behavior of the drive depends on the setting of [BRH_b4_freq] b F d t and [BRH b5] b r H 5 . Refer to the description of these parameters for appropriate settings depending on your needs.

[BRH b5] b r H 5 ★

This parameter can be accessed if **[Brake assignment] b L C** is not set to **[No] no** and if **[Access Level] L A C** is set to **[Expert] E P r**.

The setting of this parameter impacts the operating states of the drive within load movement is monitored, and the priority of the zero speed maintain compared to some events. It is linked to the parameters **[BRH b3] b r H 3** and **[BRH b4] b r H 4**.

Irrespective of the setting, the zero speed maintain has no priority compared to:

- A new run command in order to control the drive and move the load,
- An active STO,
- A lock of the drive with the function linked to the parameter **[drive lock] L E 5**.
- A stop command coming from a channel other than the active command channel if **[BRH b5] b r H 5** is set to **[0] 0** (see the table below).
- A triggered error if **[BRH b5] b r H 5** is set to **[0] 0** (see the table below).

If one of this event occurs, the zero speed maintain is interrupted.

Setting	Code / Value	Description
[0]	0	<p>Load movement is monitored only in the following drive operating states:</p> <ul style="list-style-type: none"> ● CIA402 command profile: 5-Operation Enabled, 6-Quick Stop Active. ● Other command profiles (Graphic Display Terminal, I/O, etc): 3-Ready to switch on, 4-Switched-on, 5-Operation enabled. <p>For example, when the product is controlled under Cia402 profile:</p> <ul style="list-style-type: none"> ● In Freewheel stop (NST) or in Operating State Fault (FLT), the load movement detection is not monitored. ● If the drive is stopped by a halt command (bit 8 of the command word CMD), the drive remains in operation enabled then, the load movement detection is monitored. <p>The zero speed maintain has no priority compared to a triggered error and a stop command coming from a channel other than the active command channel.</p> <p>Factory setting</p>
[1]	1	<p>Irrespective of the command profile, in all drive operating state except 7- Fault Reaction Active and 8 - Fault states, the load movement monitoring function is active.</p> <p>The zero speed maintain has priority compared to an error that can be disabled (see [ErrorDetect Disabled] i n H (see page 549)).</p>

[BRH b6] b r H 6 ★

This parameter can be accessed if **[Access Level] L A C** is set to **[Expert] E P r**.

Selection of the brake engage type if **[Brake engage at 0] b E C d** is set to a numeric value.

Setting	Code / Value	Description
[0]	0	<p>The brake is closed (including the handling of [Brake Engage Time] b E t) and the zero speed is still maintained. Then:</p> <ul style="list-style-type: none"> ● If a reference frequency other than zero is requested, the command to release the brake is sent following torque application with the handling of [Brake Release Time] b r t. ● If a stop command (external to the drive) is requested, the brake engage sequence is completed. <p>Factory setting</p> <p>NOTE: the stop command is only considered after [Brake Engage Time] b E t.</p>
[1]	1	<p>After the delay set by [Brake engage at 0] b E C d, A stop command is executed by the drive, the brake engage sequence is fully executed.</p>

[Current ramp time] b r r ★

Brake current ramp.

The parameter can be accessed if **[Brake assignment] b L C** is not set to **[No] n o**.

Torque current ramp time (increase and decrease) for a current variation equal to **[Brk Release Current] i b r**.

Setting (°)	Description
0.00...5.00 s	Factory setting: 0.00 s

[BRH_b4_freq] b F t d ★

BRH_b4 frequency threshold detection.

This parameter represents the detection threshold for **[BRH b4] b r h 4**. The required value depends on the response of the mechanical installation.

If the value of the parameter **[BRH_b4_freq] b F t d** is too low, this may lead to unwanted triggering of load movement monitoring.

If the value of the parameter **[BRH_b4_freq] b F t d** is too high, the load movement monitoring may not trigger when required.

⚠ WARNING

LOSS OF CONTROL

Verify that the setting of this parameter is suitable for the application by performing comprehensive commissioning tests for all load conditions and all potential error conditions.

Failure to follow these instructions can result in death, serious injury, or equipment damage.

Setting **[BRH_b4_freq] b F t d** to **[NO] n o** disables load movement monitoring. Unintended movements and falling of the load are not detected with this setting.

⚠ WARNING

FALLING LOAD

Verify that the setting of this parameter does not result in unsafe conditions.

Failure to follow these instructions can result in death, serious injury, or equipment damage.

This parameter can be accessed if

- **[Brake assignment] b L C** is not set to **[No] n o** and,
- **[Motor Control Type] C t t** is set to **[FVC] F v C** or **[Sync.CL] F 5 y**.

Setting (°)	Code / Value	Description
[No]	n o	The load movement monitoring function is disabled.
0.1...10 Hz		Setting range Factory setting: 10% of [Nominal Motor Freq] F r 5 or [Sync Nominal Freq] F r 5 5 depending on [Motor control type] C t t .

[Load Maintain Time] П d F t

Load maintain time before error.

When zero speed maintain is activated, **[Load Mvt Error] П d C F** error is triggered at the end of this duration.

If zero speed maintain is active, the remaining time before triggering the error is displayed with the parameter **[Load Mtn Remain Time] П t b F**. If a new run command is applied, the load movement monitoring function is temporary inactive and the remaining time **[Load Mtn Remain Time] П t b F** is frozen.

Reset of **[Load Mtn Remain Time] П t b F** requires a power cycle or a product restart.

This parameter can be accessed if:

- **[BRH b5] b r H 5** is set to **[1] 1** and,
- **[Motor Control Type] C t t** is set to **[FVC] F V C** or **[Sync.CL] F 5 Y**.

Setting (°)	Code / Value	Description
[No]	n o	Time before error is deactivated. Factory setting
1...60 min		Setting range

[Load Mtn Remain Time] П t b F

Load maintain remaining time before error.

Read-only parameter.

This parameter can be accessed if **[Load Maintain Time] П d F t** is not set to **[No] n o**.

Setting	Description
0...3,600 s	Setting range Factory setting: -

[High speed hoisting] H 5 H - Menu

Access

[Complete settings] → [Hoisting Functions] → [High speed hoisting]

About This Menu

NOTE: This function cannot be used with some other functions.

This function can be used to optimize the cycle times for hoisting movements for zero or lightweight loads. It authorizes operation at "constant power" in order to reach a speed greater than the rated speed without exceeding the rated motor current.

The speed remains limited by the [High speed] H 5 P.

The function acts on the speed reference pedestal and not on the reference itself.

Principle

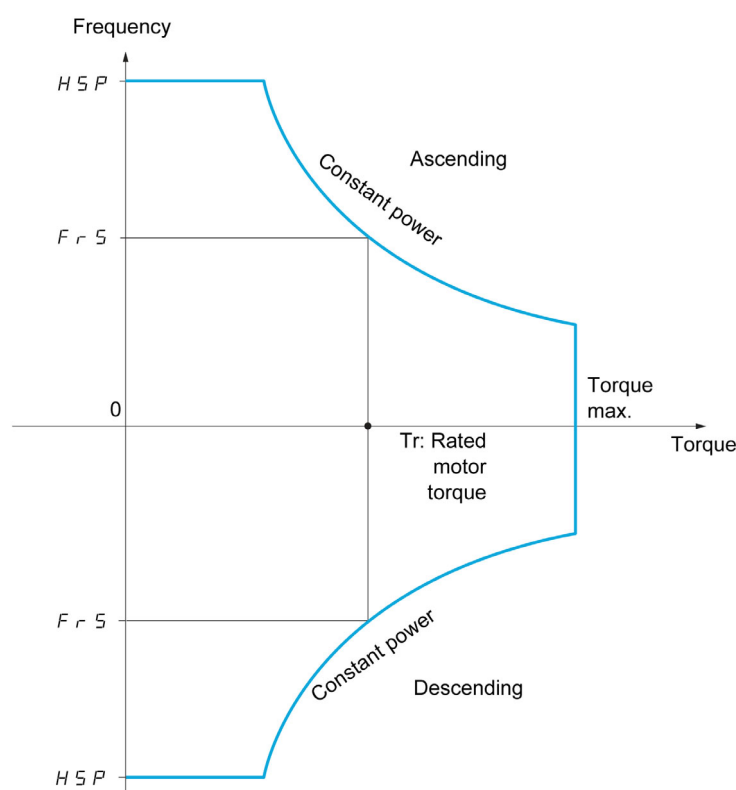

There are two possible operating modes:

- Speed reference mode: the maximum permissible speed is calculated by the drive during a speed step that is set so that the drive can measure the load.
- Current limitation mode: the maximum permissible speed is the speed that supports current limitation in motor mode, in the "ascending" direction only. For the "descending" direction, operation is in Speed reference mode.

Speed Reference Mode

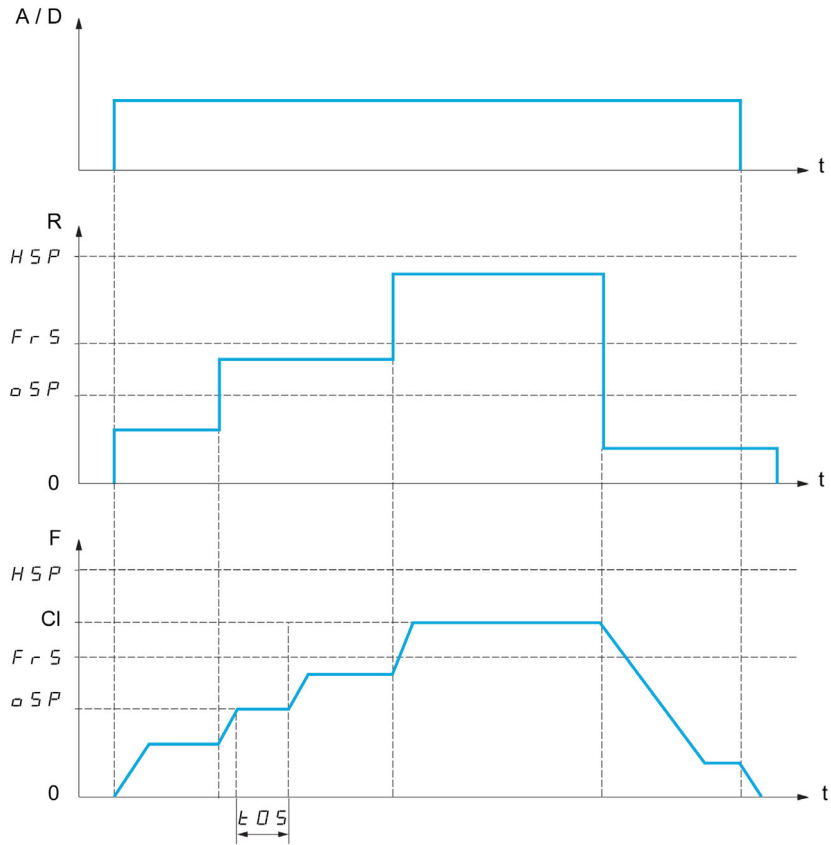

- A / D** Ascend or descend command
- R** Reference
- F** Frequency
- Cl** Calculated limit
- oSP** Adjustable speed step for load measurement
- tOS** Load measuring time

2 parameters are used to reduce the speed calculated by the drive, for ascending and descending.

Current Limiting Mode

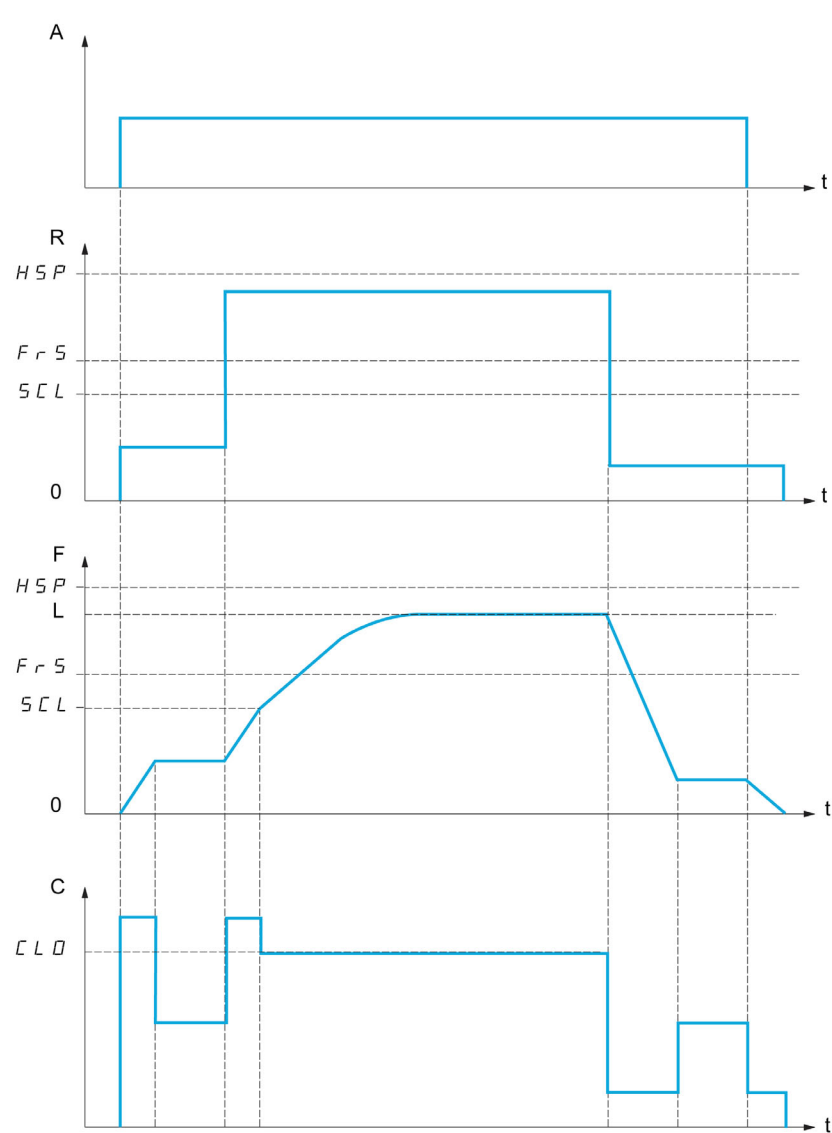

- A** Ascend command
- R** Reference
- F** Frequency
- L** Limit imposed by current limitation
- C** Current
- SCL** Adjustable speed threshold, above which current limitation is active
- CLO** Current limitation for high-speed function

NOTE: The speed reached for a specific current will be lower in case of network undervoltage in comparison with nominal network voltage.

Working at Constant Torque up to 87Hz

Depending of the motor isolation class, it is possible to supply motor with a voltage greater than one specified for its coupling.

For example, a 230/400 Vac motor wired and coupled (in delta) to work at 230 Vac / 50 Hz can be supplied at 400 V to work with constant torque up to 87 Hz.

Some motors have information on nameplate to work at 400 Vac / 87 Hz

To allow the high speed hoisting function working at 87 Hz, the following parameters must be configured as follows:

Step	Action
1	Configure [Max Frequency] E F r to 87 Hz.
2	Configure [High Speed] H 5 P to 87 Hz.
3	Configure [Nom Motor Current] n C r with the nominal current for delta coupling written on motor nameplate.
4	Configure [Nominal Motor Freq] F r 5 to 87 Hz.
5	Configure [Nom Motor Voltage] u n 5 with the result of following formula: $UNS_{87Hz} = UNS_{50Hz} \times \frac{FRS_{87Hz}}{FRS_{50Hz}}$
6	Configure [Nominal Motor Speed] n 5 P with the result of following formula: $NSP_{87Hz} = \frac{60}{n_p} \times 87 - \left(\frac{60}{n_p} \times 50 - NSP_{50Hz} \right)$ NOTE: With N_p : $n_p = \frac{FRS_{50Hz} \times 60}{NSP_{50Hz}}$ with $n_p \in \mathbb{N}$
7	Configure [Nominal motor power] n P r with the result of following formula: $NPR_{87Hz} = NPR_{50Hz} \times \frac{n_p NSP_{87Hz} + 30 FRS_{87Hz}}{n_p NSP_{50Hz} + 30 FRS_{50Hz}}$ NOTE: With N_p : $n_p = \frac{FRS_{50Hz} \times 60}{NSP_{50Hz}}$ with $n_p \in \mathbb{N}$
8	Perform an autotuning of the motor by setting [Autotuning] E u n to value [Yes] Y E 5 .

Rope Slack

The Rope slack function can be used to help to prevent starting up at high speed when a load has been set down ready for lifting but the rope is still slack (as illustrated below).

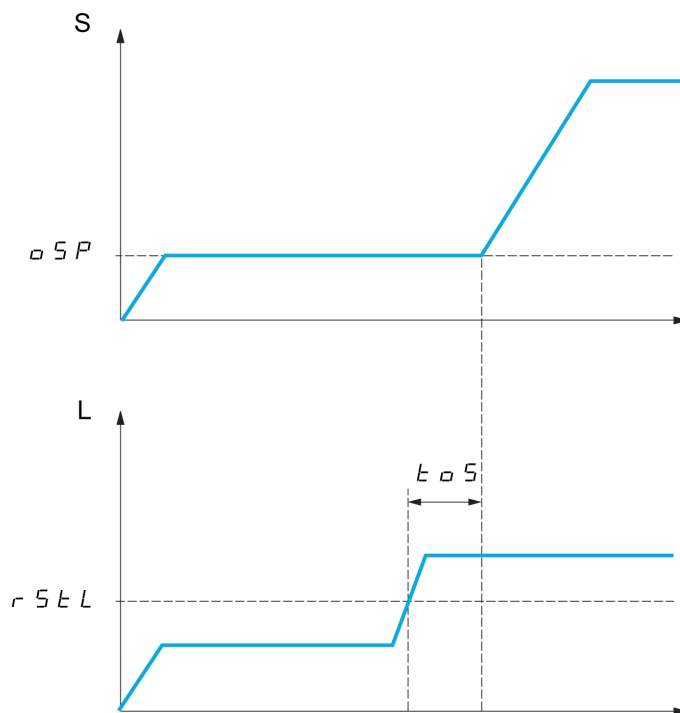
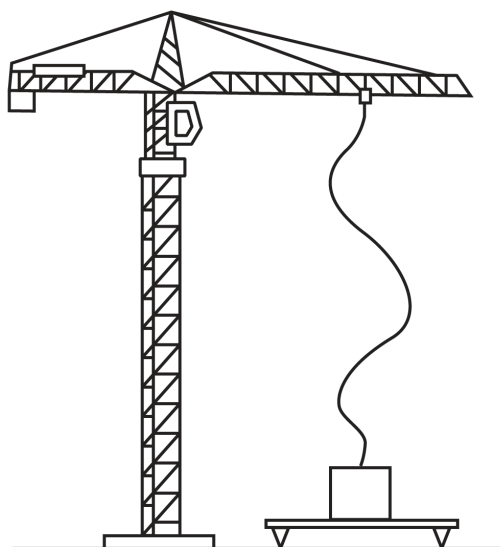

S Speed
L Load

The speed step (OSP parameters) is used to measure the load. The effective measurement cycle will not be triggered until the load reaches the adjustable threshold **[Rope slack trq level] r 5 t L**, which corresponds to the weight of the hook.

A digital output or a relay can be assigned to the indication of the Rope slack state in the **[Input/Output] i - a -** menu.

NOTE: The speed reached for a specific current will be lower in case of network undervoltage in comparison with nominal network voltage.

[High speed hoisting] H 5 a

High Speed Optimized activation function.

Setting	Code / Value	Description
[No]	n a	Function inactive Factory setting
[Reference Frequency]	5 5 a	Speed reference mode
[Current Limit]	L 5 a	Current limitation mode

[Motor speed coeff.] C a F ★

Coefficient Optimize Forward (motor quadrant).

This parameter can be accessed if **[High speed hoisting] H 5 a** is set to **[Speed ref] 5 5 a**.

Setting ()	Description
0...100%	Setting range Factory setting: 100%

[Gen. speed coeff] C o r ★

Coefficient Optimize Reverse (generator quadrant).

This parameter can be accessed if **[High speed hoisting] H 5 o** is not set to **[No] n o**.

Setting (°)	Description
0...100%	Setting range Factory setting: 50%

[Load measuring tm.] t o 5 ★

Torque measuring time.

This parameter can be accessed if **[High speed hoisting] H 5 o** is not set to **[No] n o**.

Setting (°)	Description
0.10...65.00 s	Setting range Factory setting: 0.50 s

[Measurement spd] o 5 P ★

Optimize Speed.

This parameter can be accessed if **[High speed hoisting] H 5 o** is not set to **[No] n o**.

Setting (°)	Description
0.0...599.0 Hz	Setting range Factory setting: 40 Hz

[High speed I Limit] C L o ★

Current Limitation Optimize.

This parameter can be accessed if **[High speed hoisting] H 5 o** is set to **[I Limit] C 5 o**.

NOTE: If the setting is less than 0.25 I_n, the drive may lock in **[Output Phase Loss] o P L** error if this has been enabled.

Setting (°)	Description
0...1.1 I _n ⁽¹⁾	Setting range Factory setting: I _n ⁽¹⁾
(1) I _n corresponds to the rated drive current indicated in the Installation Manual and on the drive nameplate.	

[I Limit. frequency] 5 C L ★

Frequency threshold, above which the high-speed limitation current is active.

This parameter can be accessed if **[High speed hoisting] H 5 o** is set to **[I Limit] C 5 o**.

Setting (°)	Description
0.0...599.0 Hz	Setting range Factory setting: 40.0 Hz

[Rope slack config.] r 5 d ★

Load measurement feedback.

This parameter can be accessed if **[High speed hoisting] H 5 a** is not set to **[No] n a**.

Setting	Code / Value	Description
[No]	<i>n a</i>	Function inactive Factory setting
[Weight Estimation]	<i>d r i</i>	Measurement of the load by estimating the torque generated by the drive
[Ext Weight Sensor]	<i>P E 5</i>	Measurement of the load using a weight sensor. It can only be assigned if [Ext Weight Sensor] P E 5 is not set to [Not configured] n a .

[Rope slack trq level] r 5 t L ★

Adjustment threshold corresponding to a load weighing slightly less than the hook when off-load, as a % of the rated load.

This parameter can be accessed if **[Rope slack config.] r 5 d** has been assigned.

Setting ()	Description
0...100%	Setting range Factory setting: 0%

[Load Sharing] L d 5 - Menu

Access

[Complete settings] → [Hoisting Functions] → [Load Sharing]

About This Menu

Principle:

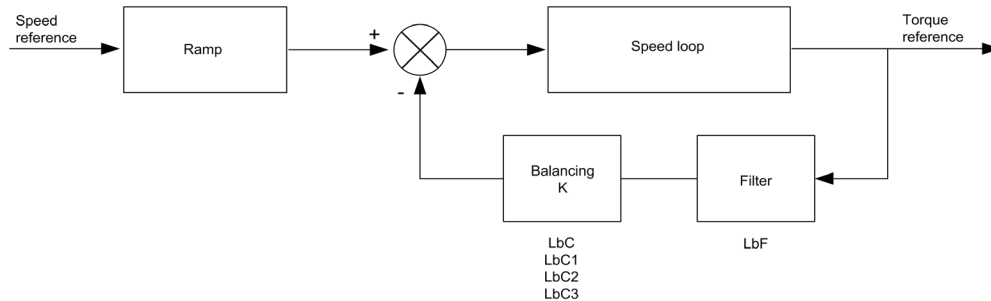

The load sharing factor K is determined by the torque and speed, with two factors K1 and K2 ($K = K1 \times K2$).

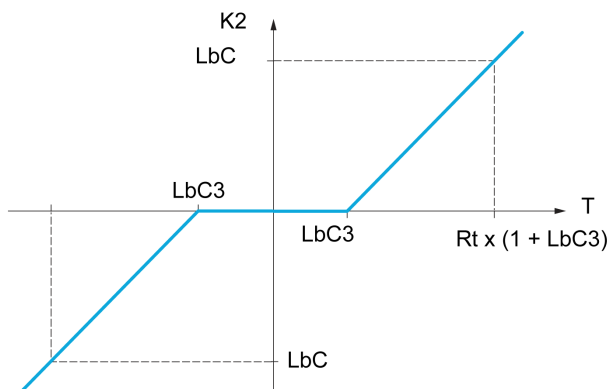
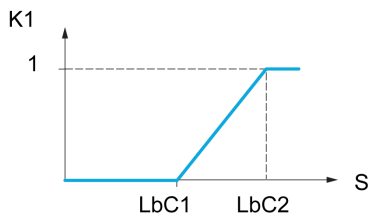

S Speed
T Torque
Rt Rated torque

[Load sharing] L b F

Load balancing configuration

When 2 motors are connected mechanically and therefore at the same speed, and each is controlled by a drive, this function can be used to improve torque distribution between the two motors. To do this, it varies the speed based on the torque.

This parameter can only be accessed if [Motor control type] C L E is set to [SVC V] V V L or [FVC] F V L or [Sync. mot]. 5 Y n or [Sync.CL] F 5 Y.

Setting	Code / Value	Description
[No]	n 0	Function inactive Factory setting
[Yes]	Y E 5	Function active

[Load correction] L b C

Nominal speed load balance correction.

This parameter can be accessed if **[Load sharing] L b A** is set to **[Yes] Y E 5**.

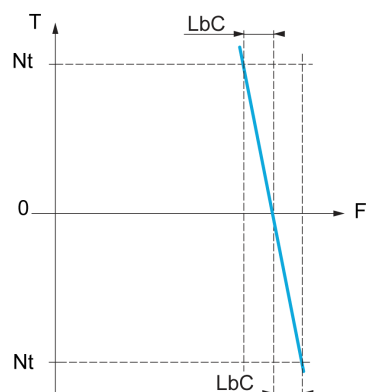

T Torque
t Nominal torque
F Frequency

Setting	Description
0...1000.0 Hz	Setting range Factory setting: 0.0 Hz

[Correction min spd] L b C 1

Low Speed for torque decreasing function speed reference

Minimum speed for load correction in Hz. Below this threshold, no corrections are made. Used to prevent correction at very low speed if this would hamper rotation of the motor.

This parameter can be accessed if **[Access Level] L A C** is set to **[Expert] E P r** and if **[Load sharing] L b A = [Yes] Y E 5**

Setting	Description
0...999.9 Hz	Setting range Factory setting: 0.0 Hz

[Correction max spd] L b C 2

High speed for torque decreasing function speed reference.

Speed threshold in Hz above which maximum load correction is applied.

This parameter can be accessed if **[Access Level] L A C** is set to **[Expert] E P r** and if **[Load sharing] L b A = [Yes] Y E 5**

Setting	Description
L b C 1 Hz at 1000.0 Hz	Setting range Factory setting: 0 Hz

[Torque offset] L b C 3

Torque offset for torque correction.

Minimum torque for load correction as a % of the rated torque. Below this threshold, no corrections are made. Used to avoid torque instabilities when the torque direction is not constant.

This parameter can be accessed if **[Access Level] L A C** is set to **[Expert] E P r** and if **[Load sharing] L b A = [Yes] Y E 5**

Setting	Description
0...300%	Setting range Factory setting: 0%

[Sharing filter] L b F

Time constant filter.

This parameter can be accessed if **[Load sharing] L b A = [Yes] Y E S** and if **[Access Level] L A C** is set to **[Expert] E P r**. Used in the event of flexible mechanical coupling in order to avoid instabilities.

Setting	Description
100...20000 ms	Setting range Factory setting: 100 ms

[Rope Slack Handling] S d r - Menu

Access

[Complete settings] → [Hoisting Functions] → [Rope Slack Handling]

About This Menu

This menu can be accessed if **[High speed hoisting] H S a** is not set to **[No] n a**.

[Rope slack config.] r S d ★

Load measurement feedback.

Setting	Code / Value	Description
[No]	n a	Function not active Factory setting
[Weight Estimation]	d r i	Drive motor torque estimation
[Ext Weight Sensor]	P E S	Measurement of the load using a weight sensor. It can only be assigned if [Ext Weight Sensor] P E S is not set to [Not configured] n a .

[Rope slack trq level] r S t L ★

Torque level for rope slack detection.

This parameter can be accessed if **[Rope slack config.] r S d** is not set to **[No] n a**.

Setting	Description
0...100%	Setting range Factory setting: 0%

Section 8.15

[Hoisting monitoring]

[Dynamic load detect.] *d L d* - Menu

Access

[Complete settings] → [Hoisting monitoring] → [Dynamic load detect.]

About This Menu

This detection is only possible with the high-speed hoisting function. It can be used to detect if an obstacle has been reached, triggering a sudden (upward) increase or (downward) decrease in the load.

Load variation detection triggers a **[Dynamic Load Error]** *d L F*. The **[Dyn. load Mgt.]** *d L b* parameter can be used to configure the response of the drive in the event of this detected error.

Load variation detection can also be assigned to a relay or a digital output.

There are two possible detection modes, depending on the configuration of high-speed hoisting:

- Speed reference mode
[High speed hoisting] *H S a* is set to **[Speed ref]** *S S a*.
 Torque variation detection.
 During high-speed operation, the load is compared to that measured during the speed step. The permissible load variation and its duration can be configured. If exceeded, an error is triggered.
- Current limitation mode
[High speed hoisting] *H S a* is set to **[Current Limit]** *C S a*. On ascend, during high-speed operation, an increase in load will result in a drop in speed. Even if high-speed operation has been activated, if the motor frequency drops below the **[I Limit Frequency]** *S C L* threshold, an error is triggered. The detection is realized only for a positive variation of the load and only in the high-speed area (area upper to **[I Limit Frequency]** *S C L*). On descend, operation takes the form of speed reference mode.

[Dynamic load time] *t L d*

Activation of load variation detection and adjustment of time delay for taking load variation detected an error **[Dynamic Load Error]** *d L F* into account.

Setting	Code / Value	Description
[No]	<i>n a</i>	No load variation detection Factory setting
0.00...10.00 s		Adjustment of the time delay for taking detected an error into account.

[Dyn. load threshold] *d L d*

Adjustment of the trip threshold for load variation detection, as a % of the load measured during the speed step.

Setting (°)	Description
1...100%	Setting range Factory setting: 100%

[Dyn. load Mgt.] *d L b*

Drive response in the event of a load variation detected error.

Setting	Code / Value	Description
[Ignore]	<i>n a</i>	Detected error ignored
[Freewheel Stop]	<i>Y E 5</i>	Freewheel stop Factory setting
1		Because, in this case, the detected error does not trigger a stop, it is recommended to assign a relay or logic output to its indication.

Setting	Code / Value	Description
[Per STT]	<i>S L L</i>	Stop according to [Type of stop] <i>S L L</i> parameter but without an error triggered after stop
[Fallback Speed]	<i>L F F</i>	Change to fallback speed, maintained as long as the detected error persists and the run command has not been removed ⁽¹⁾
[Spd maintained]	<i>r L S</i>	Speed maintained as long as the detected error persists and the run command has not been removed ⁽¹⁾
[Ramp stop]	<i>r P P</i>	Stop on ramp
[Fast stop]	<i>F S L</i>	Fast stop
1 Because, in this case, the detected error does not trigger a stop, it is recommended to assign a relay or logic output to its indication.		

Section 8.16 [Conveyor Functions]

[Load Sharing] L d 5 - Menu

Access

[Complete settings] → [Conveyor Functions] → [Load Sharing]

About This Menu

Principle:

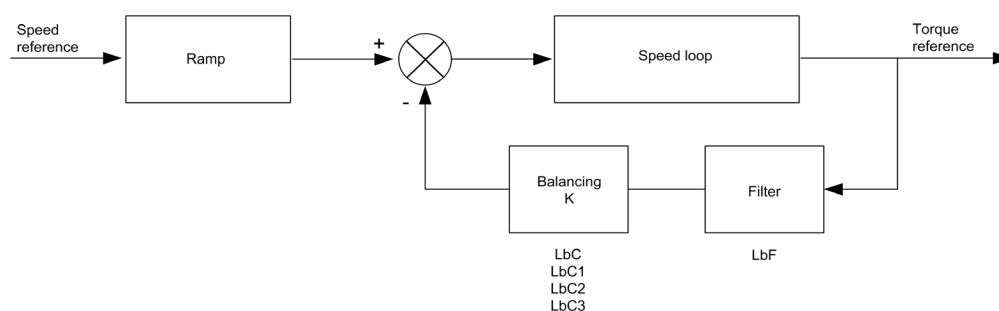

The load sharing factor K is determined by the torque and speed, with two factors K1 and K2 ($K = K1 \times K2$).

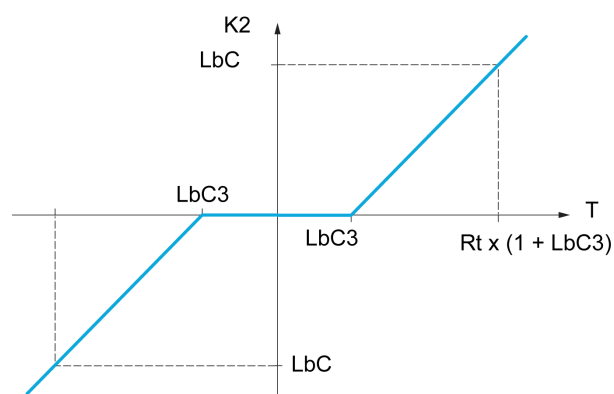
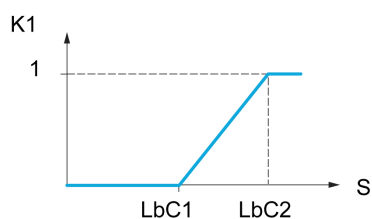

S Speed
T Torque
Rt Rated torque

[Load sharing] L b A ★

Load balancing configuration.

When 2 motors are connected mechanically and therefore at the same speed, and each is controlled by a drive, this function can be used to improve torque distribution between the two motors. To do this, it varies the speed based on the torque.

This parameters can be accessed if **[Motor control type] C E E** is set to:

- **[Sync. mot.] S Y n**, or
- **[Sync.CL.] F S Y**, or
- **[SVC V] V V C**, or
- **[FVC] F V C**.

Setting	Code / Value	Description
[No]	n o	Function inactive Factory setting
[Yes]	y e s	Function active

[Load correction] L b C ★

Nominal speed load balance correction.

This parameter can be accessed if **[Load sharing] L b A** is not set to **[No] n o**.

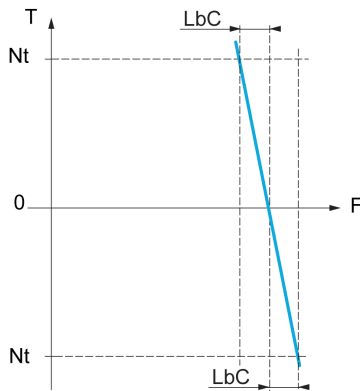

T Torque
Nt Nonimal torque
F Frequency

Setting	Description
0...1000.0 Hz	Setting range Factory setting: 0.0 Hz

[Correction min spd] L b C I ★

Low Speed for torque decreasing function speed reference.

Minimum speed for load correction in Hz. Below this threshold, no corrections are made. Used to prevent correction at very low speed if this would hamper rotation of the motor.

This parameter can be accessed if:

- **[Access Level] L A C** is set to **[Expert] E P r**, and
- **[Load sharing] L b A** is not set to **[No] n o**.

Setting	Description
0...999.9 Hz	Setting range Factory setting: 0.0 Hz

[Correction max spd] L b C 2 ★

High speed for torque decreasing function speed reference.

Speed threshold in Hz above which maximum load correction is applied.

This parameter can be accessed if:

- **[Access Level] L A C** is set to **[Expert] E P r**, and
- **[Load sharing] L b R** is not set to **[No] n o**.

Setting	Description
L b C 1 +0.1 Hz at 1000.0 Hz	Setting range Factory setting: 0.1 Hz

[Torque offset] L b C 3 ★

Torque offset for torque correction.

Minimum torque for load correction as a % of the rated torque. Below this threshold, no corrections are made. Used to avoid torque instabilities when the torque direction is not constant.

This parameter can be accessed if:

- **[Access Level] L A C** is set to **[Expert] E P r**, and
- **[Load sharing] L b R** is not set to **[No] n o**.

Setting	Description
0...300%	Setting range Factory setting: 0%

[Sharing filter] L b F ★

Time constant filter.

This parameter can be accessed if:

- **[Access Level] L A C** is set to **[Expert] E P r**, and
- **[Load sharing] L b R** is not set to **[No] n o**.

Setting	Description
100...20,000 ms	Setting range Factory setting: 100 ms

Section 8.17

[Generic functions] - [Speed limits]

[Speed limits] 5 L 7 - Menu

Access

[Complete settings] → [Generic functions] → [Speed limits]

[Low Speed] L 5 P

Motor frequency at low speed.

Setting ()	Description
0.0...599.0 Hz	Setting range Factory setting: 0 Hz

[High Speed] H 5 P

Motor frequency at high speed.

Setting ()	Description
0.0...599.0 Hz	Setting range Factory setting: 50.0 Hz

[Ref Freq Template] b 5 P

Low speed management (template).

This parameter defines how the speed reference is taken into account, for analog inputs and pulse input only. In the case of the PID controller, this is the PID output reference.

The limits are set by the [Low speed] L 5 P and [High speed] H 5 P parameters.

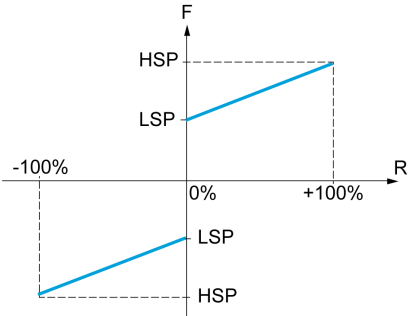
Setting ()	Code / Value	Description
[Standard]	b 5 d	 <p>F Frequency R Reference</p> <p>At reference = 0, the frequency = [Low speed] L 5 P Factory setting</p>

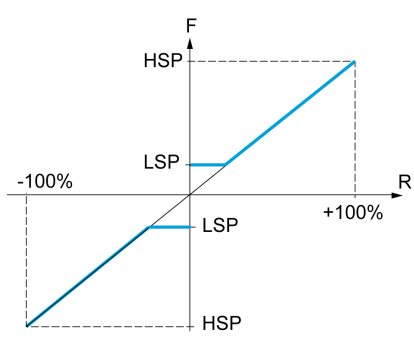
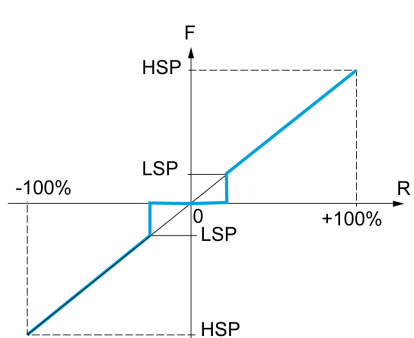
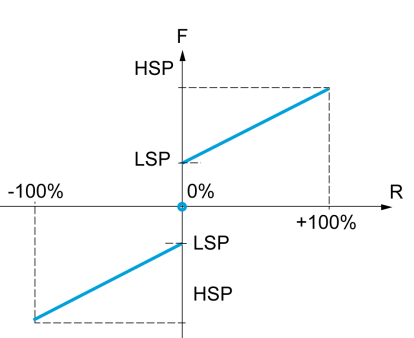
Setting (C)	Code / Value	Description
[Pedestal]	<i>b l 5</i>	 <p>F Frequency R Reference</p> <p>At reference = 0 to [Low speed] L 5 P, the frequency = [Low speed] L 5 P</p>
[Deadband]	<i>b n 5</i>	 <p>F Frequency R Reference</p> <p>At reference = 0 to L 5 P the frequency = 0</p>
[Deadband at 0%]	<i>b n 5 0</i>	 <p>F Frequency R Reference</p> <p>This operation is the same as [Standard] b 5 d, except that in the following cases at zero reference, the frequency = 0: The signal is less than [Min value], which is greater than 0 (example: 1 Vdc on a 2–10 Vdc input). The signal is greater than [Min value], which is greater than [Max value] (example: 11 Vdc on a 10–0 Vdc input). If the input range is configured as “bidirectional”, the operation remains identical to [Standard] b 5 d.</p>

Section 8.18

[Generic functions] - [Ramp]

[Ramp] *r A P P* - Menu

Access

[Complete settings] → [Generic functions] → [Ramp]

[Ramp Type] *r P t*

Type of ramp.

Setting	Code / Value	Description
[Linear]	<i>L i n</i>	Linear ramp Factory setting
[S-Ramp]	<i>S</i>	S ramp
[U-Ramp]	<i>u</i>	U ramp
[Customized]	<i>C u s</i>	Customer ramp

[Ramp increment] *i n r*

This parameter is valid for [Acceleration] *A C C*, [Deceleration] *d E C*, [Acceleration 2] *A C 2* and [Deceleration 2] *d E 2*.

Setting ()	Code / Value	Description
[0.01]	<i>0.0 1</i>	Ramp up to 99.99 seconds
[0.1]	<i>0. 1</i>	Ramp up to 999.9 seconds Factory setting
[1]	<i>1</i>	Ramp up to 6,000 seconds

[Acceleration] *A C C*

Time to accelerate from 0 to the [Nominal Motor Freq] *F r 5*.

To have repeatability in ramps, the value of this parameter must be set according to the possibility of the application.

Setting ()	Description
0.00...6,000.00 s ⁽¹⁾	Setting range Factory setting: 3.00 s
(1) Range 0.01 to 99.99 s or 0.1 to 999.9 s or 1 to 6,000 according to [Ramp increment] <i>i n r</i>	

[Deceleration] *d E C*

Time to decelerate from the [Nominal Motor Freq] *F r 5* to 0.

To have repeatability in ramps, the value of this parameter must be set according to the possibility of the application.

Setting ()	Description
0.00...6,000.00 s ⁽¹⁾	Setting range Factory setting: 3.00 s
(1) Range 0.01 to 99.99 s or 0.1 to 999.9 s or 1 to 6,000 according to [Ramp increment] <i>i n r</i>	

[Begin Acc round] $\bar{L} \bar{R} 1$ ★

Rounding of start of acceleration ramp as a percentage of the **[Acceleration] $\bar{R} \bar{L} \bar{L}$** or **[Acceleration 2] $\bar{R} \bar{L} \bar{Z}$** ramp time.

Can be set from 0 to 100%.

This parameter can be accessed if the **[Ramp type] $r P \bar{L}$** is set to **[Customized] $\bar{L} \cup \bar{S}$** .

Setting (°)	Description
0...100%	Setting range Factory setting: 10%

[End Acc round] $\bar{L} \bar{R} \bar{Z}$ ★

Rounding of end of acceleration ramp as a percentage of the **[Acceleration] $\bar{R} \bar{L} \bar{L}$** or **[Acceleration 2] $\bar{R} \bar{L} \bar{Z}$** ramp time.

Can be set between 0 and (100% - **[Begin Acc round] $\bar{L} \bar{R} 1$**).

This parameter can be accessed if the **[Ramp type] $r P \bar{L}$** is set to **[Customized] $\bar{L} \cup \bar{S}$** .

Setting (°)	Description
0...100%	Setting range Factory setting: 10%

[Begin Dec round] $\bar{L} \bar{R} \bar{E}$ ★

Rounding of start of deceleration ramp as a percentage of the **[Deceleration] $\bar{d} \bar{E} \bar{L}$** or **[Deceleration 2] $\bar{d} \bar{E} \bar{Z}$** ramp time.

Can be set from 0 to 100%.

This parameter can be accessed if the **[Ramp type] $r P \bar{L}$** is set to **[Customized] $\bar{L} \cup \bar{S}$** .

Setting (°)	Description
0...100%	Setting range Factory setting: 10%

[End Dec round] $\bar{L} \bar{R} \bar{E}$ ★

Rounding of end of deceleration ramp as a percentage of the **[Deceleration] $\bar{d} \bar{E} \bar{L}$** or **[Deceleration 2] $\bar{d} \bar{E} \bar{Z}$** ramp time.

Can be set between 0 and (100% - **[Begin Dec round] $\bar{L} \bar{R} \bar{E}$**).

This parameter can be accessed if the **[Ramp type] $r P \bar{L}$** is **[Customized] $\bar{L} \cup \bar{S}$** .

Setting (°)	Description
0...100%	Setting range Factory setting: 10%

[Dec.Ramp Adapt] brA

Deceleration ramp adaptation.

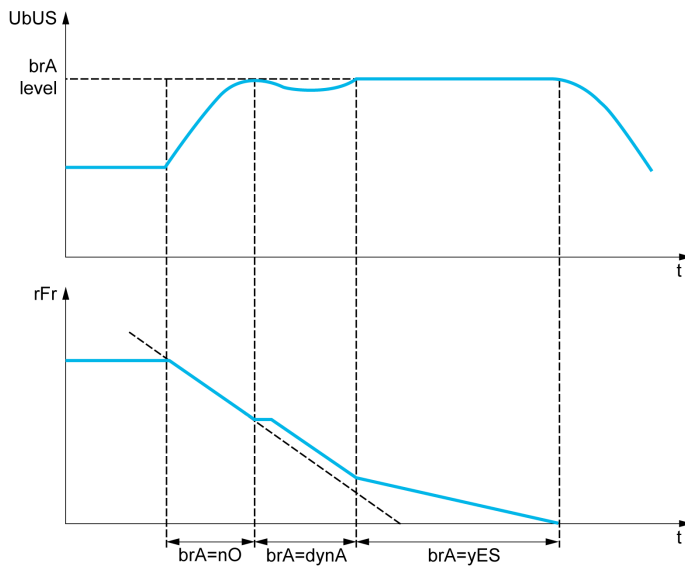

Activating this function automatically adapts the deceleration ramp, if this has been set at a too low value according to the inertia of the load, which can cause an overvoltage detected error.

The function is incompatible with applications requiring:

- Positioning on a ramp

NOTE:

The factory setting value of the parameter is changed to **[No] no** if:

- **[ENA activation] ENA** is set to **[Yes] YES**, or
- **[DC Bus Source Type] dCBS** is set to **[Supply Unit AFE] SAAF** or **[Drive with AFE] PCELH**.

NOTE: During generator mode with ATV9B0...Q6, if **[Dec.Ramp Adapt] brA** is equal to **[Yes] YES**, the drive may remain in current limitation state to stabilize the DC bus voltage.

Setting	Code / Value	Description
[No]	no	Function inactive. NOTE: [Dec.Ramp Adapt] brA if forced to [No] no if: <ul style="list-style-type: none"> • [Brake assignment] bLC is configured, or • [Braking balance] bBA is set to [Yes], or • [Motor control type] CLT is set to [Rel. Mot.] SRVL and [Dec.Ramp Adapt] brA was set to [High Torque] dYnA.
[Yes]	YES	Function active, for applications that do not require strong deceleration Factory setting
[High Torque]	dYnA	Addition of a constant current flow component. The [High Torque] dYnA selection appears depending on the rating of the drive and [Motor control type] CLT . It enables stronger deceleration to be obtained than with [Yes] YES . Use comparative testing to determine your selection. When [Dec.Ramp Adapt] brA is configured on [High Torque] dYnA , the dynamic performances for braking are improved by the addition of a current flow component. The aim is to increase the iron loss and magnetic energy stored in the motor.

[Braking balance] b b A

Braking balance

This parameter is used to balance the braking power between drives linked through the DC bus.

Setting ()	Code / Value	Description
[No]	n o	Function inactive. Factory setting
[Yes]	y e 5	Function active.

[Braking Resistor] b r C

Braking resistor connected.

NOTE: The factory setting value of the parameter is changed to [Yes] y e 5 if [Brake assignment] b L C is configured.

Setting	Code / Value	Description
[No]	n o	Function inactive Factory setting NOTE: With this selection [DB unit op. circuit] b u F o error can't be triggered.
[Yes]	y e 5	Function active NOTE: This parameter is forced to [Yes] y e 5 if: <ul style="list-style-type: none"> • [Dec.Ramp Adapt] b r A is set to [No] n o, and • [DC Bus Source Type] d c b 5 is set to [Not configured] n o, [Drive with AFE] n c e l h or [Drive with REC] n c p e.

Section 8.19

[Generic functions] - [Ramp switching]

[Ramp switching] *r P 4* - Menu

Access

[Complete settings] → [Generic functions] → [Ramp switching]

[Ramp 2 Thd] *F r 4*

Ramp 2 frequency threshold

The second ramp is switched if the value of [Ramp 2 Thd] *F r 4* is not 0 (0 deactivates the function) and the output frequency is greater than [Ramp 2 Thd] *F r 4*.

Threshold ramp switching can be combined with [Ramp Switch Assign] *r P 5* switching as follows:

DI or Bit	Frequency	Ramp
0	< <i>F r 4</i>	<i>R C C, d E C</i>
0	> <i>F r 4</i>	<i>R C 2, d E 2</i>
1	< <i>F r 4</i>	<i>R C 2, d E 2</i>
1	> <i>F r 4</i>	<i>R C 2, d E 2</i>

Setting ()	Description
0.0...599.0 Hz	Setting range Factory setting: 0.0 Hz

[Ramp Switch Assign] *r P 5*

Ramp switching.

Setting	Code / Value	Description
[Not Assigned]	<i>n a</i>	Not assigned Factory setting
[DI1]...[DI8]	<i>L 1 1...L 1 B</i>	Digital input DI1...DI8
[DI11]...[DI16]	<i>L 1 1 1...L 1 1 B</i>	Digital input DI11...DI16 if VW3A3203 I/O extension module has been inserted
[CD00]...[CD10]	<i>C d 0 0...C d 1 0</i>	Virtual digital input CMD.0...CMD.10 in [I/O profile] <i>i a</i> configuration
[CD11]...[CD15]	<i>C d 1 1...C d 1 5</i>	Virtual digital input CMD.11...CMD.15 regardless of configuration
[C101]...[C110]	<i>C 1 0 1...C 1 1 0</i>	Virtual digital input CMD1.01...CMD1.10 with integrated Modbus Serial in [I/O profile] <i>i a</i> configuration
[C111]...[C115]	<i>C 1 1 1...C 1 1 5</i>	Virtual digital input CMD1.11...CMD1.15 with integrated Modbus Serial regardless of configuration
[C201]...[C210]	<i>C 2 0 1...C 2 1 0</i>	Virtual digital input CMD2.01...CMD2.10 with CANopen® fieldbus module in [I/O profile] <i>i a</i> configuration
[C211]...[C215]	<i>C 2 1 1...C 2 1 5</i>	Virtual digital input CMD2.11...CMD2.15 with CANopen® fieldbus module regardless of configuration
[C301]...[C310]	<i>C 3 0 1...C 3 1 0</i>	Virtual digital input CMD3.01...CMD3.10 with a fieldbus module in [I/O profile] <i>i a</i> configuration
[C311]...[C315]	<i>C 3 1 1...C 3 1 5</i>	Virtual digital input CMD3.11...CMD3.15 with a fieldbus module regardless of configuration
[C501]...[C510]	<i>C 5 0 1...C 5 1 0</i>	Virtual digital input CMD5.01...CMD5.10 with integrated Ethernet in [I/O profile] <i>i a</i> configuration
[C511]...[C515]	<i>C 5 1 1...C 5 1 5</i>	Virtual digital input CMD5.11...CMD5.15 with integrated Ethernet regardless of configuration

[Acceleration 2] $r P 2$ ★

Acceleration 2 ramp time.

Time to accelerate from 0 to the **[Nominal Motor Freq] $F r 5$** . To have repeatability in ramps, the value of this parameter must be set according to the possibility of the application.

This parameter can be accessed if **[Ramp 2 Thd] $F r 4$** is greater than 0 or if **[Ramp Switch Assign] $r P 5$** is assigned.

Setting ()	Description
0.0...6,000 s ⁽¹⁾	Setting range Factory setting: 5.0 s
(1) Range 0.01 to 99.99 s or 0.1 to 999.9 s or 1...6,000 s according to [Ramp increment] $i n r$.	

[Deceleration 2] $d E 2$ ★

Time to decelerate from the **[Nominal Motor Freq] $F r 5$** to 0. To have repeatability in ramps, the value of this parameter must be set according to the possibility of the application.

This parameter can be accessed if:

- **[Ramp 2 Thd] $F r 4$** is greater than 0, or
- **[Ramp Switch Assign] $r P 5$** is assigned.

Setting ()	Description
0.0...6,000 s ⁽¹⁾	Setting range Factory setting: 5.0 s
(1) Range 0.01 to 99.99 s or 0.1 to 999.9 s or 1...6,000 s according to [Ramp increment] $i n r$.	

Section 8.20

[Generic functions] - [Stop configuration]

[Stop configuration] 5 4 4 - Menu

Access

[Complete settings] → [Generic functions] → [Stop configuration]

About This Menu

NOTE: This function cannot be used with some other functions.

[Type of stop] 5 4 4

Normal stop mode.

Stop mode on disappearance of the run command or appearance of a stop command.

Setting	Code / Value	Description
[On Ramp]	r P P	Stop on ramp, if [Brake assignment] b L C or [Low speed time out] L L S are configured, or if [Motor fluxing] F L u is set to [Continuous] F C E only a [On Ramp] r P P is possible. Factory setting
[Fast stop]	F S E	Fast stop
[Freewheel]	n S E	Freewheel stop
[DC injection]	d C i	DC injection stop. Available if [Motor control type] C E E is not set to: <ul style="list-style-type: none"> • [Sync. mot.] S Y n, or • [Sync.CL.] F S Y, or • [SYN_U VC] S Y n u, or • [Rel. Mot] S r V C

[Freewheel stop ass.] n S E

Freewheel stop.

The stop is activated when the input or the bit changes to 0. If the input returns to state 1 and the run command is still active, the motor will only restart if [2/3-wire control] E C C is set to [2-Wire Control] P C and if [2-wire type] E C E is set to [Level] L E L or [Fwd priority] P F a. If not, a new run command must be sent.

Setting	Code / Value	Description
[Not Assigned]	n a	Not assigned Factory setting
[CD00]...[CD10]	C d 0 0 ... C d 1 0	Virtual digital input CMD.0...CMD.10 in [I/O profile] i a configuration
[CD11]...[CD15]	C d 1 1 ... C d 1 5	Virtual digital input CMD.11...CMD.15 regardless of configuration
[C101]...[C110]	C 1 0 1 ... C 1 1 0	Virtual digital input CMD1.01...CMD1.10 with integrated Modbus Serial in [I/O profile] i a configuration
[C111]...[C115]	C 1 1 1 ... C 1 1 5	Virtual digital input CMD1.11...CMD1.15 with integrated Modbus Serial regardless of configuration
[C201]...[C210]	C 2 0 1 ... C 2 1 0	Virtual digital input CMD2.01...CMD2.10 with CANopen® fieldbus module in [I/O profile] i a configuration
[C211]...[C215]	C 2 1 1 ... C 2 1 5	Virtual digital input CMD2.11...CMD2.15 with CANopen® fieldbus module regardless of configuration
[C301]...[C310]	C 3 0 1 ... C 3 1 0	Virtual digital input CMD3.01...CMD3.10 with a fieldbus module in [I/O profile] i a configuration
[C311]...[C315]	C 3 1 1 ... C 3 1 5	Virtual digital input CMD3.11...CMD3.15 with a fieldbus module regardless of configuration

Setting	Code / Value	Description
[C501]...[C510]	C 5 0 1 ... C 5 1 0	Virtual digital input CMD5.01...CMD5.10 with integrated Ethernet in [I/O profile] configuration
[C511]...[C515]	C 5 1 1 ... C 5 1 5	Virtual digital input CMD5.11...CMD5.15 with integrated Ethernet regardless of configuration
[DI1 (Low level)]...[DI8 (Low level)]	L 1 L ... L 8 L	Digital input DI1...DI8 used at low level
[DI11 (Low level)]...[DI16 (Low level)]	L 1 1 L ... L 1 6 L	Digital input DI11...DI16 used at low level if VW3A3203 I/O extension module has been inserted
[DI52 (Low level)]...[DI59 (Low level)]	d 5 2 L ... d 5 9 L	Cabinet low level assignment digital inputs NOTE: This selection can be accessed on ATV960, ATV980 equipped with Cabinet IO.

[Freewheel stop Thd] F F L ★

Freewheel stop threshold.

Speed threshold below which the motor switches to freewheel stop.

This parameter supports switching from a ramp stop or a fast stop to a freewheel stop below a low speed threshold.

This parameter can be accessed if:

- **[Type of stop] S L L** is set to **[Fast stop] F S L** or **[On Ramp] r P P**, and
- **[Auto DC Injection] R d L** is configured, and
- **[Brake Assignment] b L L** is not configured.

Setting (°)	Description
0.2...599.0 Hz	Setting range Factory setting: 0.2 Hz

[Fast stop Assign] F S L

Fast stop.

The stop is activated when the input changes to 0 or the bit changes to 1 (bit in **[I/O profile]** configuration at 0).

If the input returns to state 1 and the run command is still active, the motor will only restart if **[2/3-wire control] L L L** is set to **[2-Wire Control] 2 L** and if **[2-wire type] L L L** is set to **[Level] L E L** or **[Fwd priority] P F 0**.

If not, a new run command must be sent.

NOTE: This function cannot be used with some other functions.

Setting	Code / Value	Description
[Not Assigned]	n 0	Not assigned Factory setting
[CD00]...[CD10]	C d 0 0 ... C d 1 0	Virtual digital input CMD.0...CMD.10 in [I/O profile] configuration
[CD11]...[CD15]	C d 1 1 ... C d 1 5	Virtual digital input CMD.11...CMD.15 regardless of configuration
[C101]...[C110]	C 1 0 1 ... C 1 1 0	Virtual digital input CMD1.01...CMD1.10 with integrated Modbus Serial in [I/O profile] configuration
[C111]...[C115]	C 1 1 1 ... C 1 1 5	Virtual digital input CMD1.11...CMD1.15 with integrated Modbus Serial regardless of configuration
[C201]...[C210]	C 2 0 1 ... C 2 1 0	Virtual digital input CMD2.01...CMD2.10 with CANopen® fieldbus module in [I/O profile] configuration
[C211]...[C215]	C 2 1 1 ... C 2 1 5	Virtual digital input CMD2.11...CMD2.15 with CANopen® fieldbus module regardless of configuration
[C301]...[C310]	C 3 0 1 ... C 3 1 0	Virtual digital input CMD3.01...CMD3.10 with a fieldbus module in [I/O profile] configuration
[C311]...[C315]	C 3 1 1 ... C 3 1 5	Virtual digital input CMD3.11...CMD3.15 with a fieldbus module regardless of configuration

Setting	Code / Value	Description
[C501]...[C510]	C 5 0 1 ... C 5 1 0	Virtual digital input CMD5.01...CMD5.10 with integrated Ethernet in [I/O profile] , 0 configuration
[C511]...[C515]	C 5 1 1 ... C 5 1 5	Virtual digital input CMD5.11...CMD5.15 with integrated Ethernet regardless of configuration
[DI1 (Low level)]...[DI8 (Low level)]	L 1 L ... L 8 L	Digital input DI1...DI8 used at low level
[DI11 (Low level)]...[DI16 (Low level)]	L 1 1 L ... L 1 6 L	Digital input DI11...DI16 used at low level if VW3A3203 I/O extension module has been inserted
[DI52 (Low level)]...[DI59 (Low level)]	d 5 2 L ... d 5 9 L	Cabinet low level assignment digital inputs NOTE: This selection can be accessed on ATV960, ATV980 equipped with Cabinet IO.

[Ramp Divider] d C F ★

Fast Stop deceleration ramp reduction coefficient.

The ramp that is enabled ([Deceleration] d E C or [Deceleration 2] d E 2) is then divided by this coefficient when stop requests are sent.

Value 0 corresponds to a minimum ramp time.

Setting ()	Description
0...10	Setting range Factory setting: 4

[DC Injection Assign] d C ,

DC injection brake assignment.

⚠ WARNING
UNINTENDED MOVEMENT
<ul style="list-style-type: none"> ● Do not use DC injection to generate holding torque when the motor is at a standstill. ● Use a holding brake to keep the motor in the standstill position. <p>Failure to follow these instructions can result in death, serious injury, or equipment damage.</p>

This parameter can be accessed if:

- Brake assignment] b L C is set to [No] n 0, or
- Motor control type] C E E is not set to [Sync. mot.] 5 Y n or [Sync.CL] F 5 Y or [Rel. Mot.] 5 r V C or [SYN_U VC] 5 Y n u.

DC injection braking is initiated when the assigned input or bit changes to state 1.

If the input returns to state 0 and the run command is still active, the motor will only restart if [2/3-wire control] E C C is set to [2-Wire Control] 2 C and if [2-wire type] E C E is set to [Level] L E L or [Fwd priority] P F 0. If not, a new run command must be sent.

NOTE: This function cannot be used with some other functions.

Setting	Code / Value	Description
[Not Assigned]	n 0	Not assigned Factory setting
[DI1]...[DI8]	L , 1 ... L , 8	Digital input DI1...DI8
[DI11]...[DI16]	L , 1 1 ... L , 1 6	Digital input DI11...DI16 if VW3A3203 I/O extension module has been inserted
[CD00]...[CD10]	C d 0 0 ... C d 1 0	Virtual digital input CMD.0...CMD.10 in [I/O profile] , 0 configuration
[CD11]...[CD15]	C d 1 1 ... C d 1 5	Virtual digital input CMD.11...CMD.15 regardless of configuration
[C101]...[C110]	C 1 0 1 ... C 1 1 0	Virtual digital input CMD1.01...CMD1.10 with integrated Modbus Serial in [I/O profile] , 0 configuration

Setting	Code / Value	Description
[C111]...[C115]	C 1 1 1 ... C 1 1 5	Virtual digital input CMD1.11...CMD1.15 with integrated Modbus Serial regardless of configuration
[C201]...[C210]	C 2 0 1 ... C 2 1 0	Virtual digital input CMD2.01...CMD2.10 with CANopen® fieldbus module in [I/O profile] configuration
[C211]...[C215]	C 2 1 1 ... C 2 1 5	Virtual digital input CMD2.11...CMD2.15 with CANopen® fieldbus module regardless of configuration
[C301]...[C310]	C 3 0 1 ... C 3 1 0	Virtual digital input CMD3.01...CMD3.10 with a fieldbus module in [I/O profile] configuration
[C311]...[C315]	C 3 1 1 ... C 3 1 5	Virtual digital input CMD3.11...CMD3.15 with a fieldbus module regardless of configuration
[C501]...[C510]	C 5 0 1 ... C 5 1 0	Virtual digital input CMD5.01...CMD5.10 with integrated Ethernet in [I/O profile] configuration
[C511]...[C515]	C 5 1 1 ... C 5 1 5	Virtual digital input CMD5.11...CMD5.15 with integrated Ethernet regardless of configuration

[DC inject. level 1] *i_{dc1}* ★

DC injection current.

NOTICE

OVERHEATING AND DAMAGE TO THE MOTOR

Verify that the connected motor is properly rated for the DC injection current to be applied in terms of amount and time in order to avoid overheating and damage to the motor.

Failure to follow these instructions can result in equipment damage.

Level of DC injection braking current activated via digital input or selected as stop mode.

This parameter can be accessed if:

- **[Type of stop] S t t** is set to **[DC injection] *i_{dc1}***, or
- **[DC.Brake DI] *i_{dc1}*** is not set to **[No] n o**.

Setting (°)	Description
0.1...1.41 In ⁽¹⁾	Setting range This setting is independent of the [Auto DC Injection] <i>f_{dc}</i> - function. Factory setting: 0.7 In ⁽¹⁾
(1) In corresponds to the rated drive current indicated in the Installation Manual and on the drive nameplate.	

[DC injection time 1] *t_{dc1}* ★

DC injection time 1.

NOTICE

OVERHEATING AND DAMAGE TO THE MOTOR

Verify that the connected motor is properly rated for the DC injection current to be applied in terms of amount and time in order to avoid overheating and damage to the motor.

Failure to follow these instructions can result in equipment damage.

Maximum current injection time **[DC inject. level 1] *i_{dc1}***. After this time, the injection current becomes **[DC inject. level 2] *i_{dc2}***.

This parameter can be accessed if:

- **[Type of stop] S t t** is set to **[DC injection] *i_{dc1}***, or
- **[DC.Brake DI] *i_{dc1}*** is not set to **[No] n o**.

Setting ()	Description
0.1...30 s	Setting range This setting is independent of the [Auto DC Injection] $R d C$ - function. Factory setting: 0.5 s

[DC inject. level 2] $i d C 2$ ★

DC injection current 2.

NOTICE
OVERHEATING AND DAMAGE TO THE MOTOR Verify that the connected motor is properly rated for the DC injection current to be applied in terms of amount and time in order to avoid overheating and damage to the motor. Failure to follow these instructions can result in equipment damage.

Injection current activated by digital input or selected as stop mode once period [DC injection time 1] $t d i$ has elapsed.

This parameter can be accessed if:

- [Type of stop] $S t E$ is set to [DC injection] $d C i$, or
- [DC Injection Assign] $d C i$ is not set to [No] $n o$.

Setting ()	Description
0.1 In ⁽¹⁾ ...[DC inject. level 1] $i d C$	Setting range This setting is independent of the [Auto DC Injection] $R d C$ - function. Factory setting: 0.5 In ⁽¹⁾
(1) In corresponds to the rated drive current indicated in the Installation Manual and on the drive nameplate.	

[DC Inj Time 2] $t d C 2$ ★

2nd DC injection time.

NOTICE
OVERHEATING AND DAMAGE TO THE MOTOR Verify that the connected motor is properly rated for the DC injection current to be applied in terms of amount and time in order to avoid overheating and damage to the motor. Failure to follow these instructions can result in equipment damage.

Maximum injection time [DC inject. level 2] $i d C 2$ for injection, selected as stop mode only.

This parameter can be accessed if [Type of stop] $S t E$ is set to [DC injection] $d C i$.

Setting ()	Description
0.1...30 s	Setting range This setting is independent of the [Auto DC Injection] $R d C$ - function. Factory setting: 0.5 s

[SwitchOnDisable Stp] $d o t d$

Disable operation stop mode.

Setting	Code / Value	Description
[Freewheel Stop]	$n S t$	The drive stops in freewheel when switching from the operating state Operation enabled to the operating state Switched on.
[Ramp Stop]	$r P P$	The drive stops on ramp when switching from the operating state Operation enabled to the operating state Switched on. Factory setting

Section 8.21

[Generic functions] - [Auto DC injection]

[Auto DC injection] *A d C* - Menu

Access

[Complete settings] → [Generic functions] → [Auto DC injection]

About This Menu

This menu presents the automatic injection of motor current function. This is used to hold the rotor of the motor at the end of the deceleration ramp.

[Auto DC Injection] *A d C*

Automatic DC Injection.

 **DANGER**

HAZARD OF ELECTRIC SHOCK, EXPLOSION, OR ARC FLASH

If the parameter [Auto DC Injection] *A d C* is set to [Continuous] *C E*, DC injection is always active, even if the motor does not run.

- Verify that using this setting does not result in unsafe conditions.

Failure to follow these instructions will result in death or serious injury.

 **WARNING**

UNINTENDED MOVEMENT

- Do not use DC injection to generate holding torque when the motor is at a standstill.
- Use a holding brake to keep the motor in the standstill position.

Failure to follow these instructions can result in death, serious injury, or equipment damage.

Automatic current injection on stopping (at the end of the ramp).

NOTE: There is an interlock between this function and [Motor fluxing] *F L U*. If [Motor fluxing] *F L U* is set to [Continuous] *F C E*, [Auto DC Injection] *A d C* must be [No] *n o*.

[Auto DC Injection] *A d C* is forced to [No] *n o* when [Brake assignment] *b L C* is not set to [No] *n o*. This parameter gives rise to the injection of current even if a run command has not been sent.

Setting ()	Code / Value	Description
[No]	<i>n o</i>	No injection Factory setting
[Yes]	<i>Y E S</i>	Adjustable injection time
[Continuous]	<i>C E</i>	Continuous standstill injection

[Auto DC inj Level 1] 5 d C 1 ★

Auto DC injection level 1.

NOTICE
<p>OVERHEATING AND DAMAGE TO THE MOTOR</p> <p>Verify that the connected motor is properly rated for the DC injection current to be applied in terms of amount and time in order to avoid overheating and damage to the motor.</p> <p>Failure to follow these instructions can result in equipment damage.</p>

Level of standstill DC injection current.

This parameter can be accessed if:

- [Auto DC Injection] *A d C* is not set to [No] *n o*, and
- [Motor control type] *C t t* is not set to [FVC] *F v C* or [Sync.CL] *F s Y*.

Setting ()	Description
0...1.1 In ⁽¹⁾	Setting range Factory setting: 0.7 In ⁽¹⁾
⁽¹⁾ In corresponds to the rated drive current indicated in the Installation Manual and on the drive nameplate.	

[Auto DC Inj Time 1] t d C 1 ★

Auto DC injection time 1.

NOTICE
<p>OVERHEATING AND DAMAGE TO THE MOTOR</p> <p>Verify that the connected motor is properly rated for the DC injection current to be applied in terms of amount and time in order to avoid overheating and damage to the motor.</p> <p>Failure to follow these instructions can result in equipment damage.</p>

This parameter can be accessed if [Auto DC Injection] *A d C* is not set to [No] *n o*.

This time corresponds to the zero speed maintenance time, if [Motor control type] *C t t* is set to:

- [Sync. mot.] *S Y n*, or
- [Sync.CL.] *F s Y*, or
- [SYN_U VC] *S Y n u*, or
- [Rel. Mot] *S r v C*

Setting ()	Description
0.1...30.0 s	Setting range Factory setting: 0.5 s

[Auto DC inj Level 2] 5 d C 2 ★

Auto DC injection level 2.

NOTICE
<p>OVERHEATING AND DAMAGE TO THE MOTOR</p> <p>Verify that the connected motor is properly rated for the DC injection current to be applied in terms of amount and time in order to avoid overheating and damage to the motor.</p> <p>Failure to follow these instructions can result in equipment damage.</p>

Second level of standstill DC injection current.

This parameter can be accessed if:

- [Auto DC Injection] *PdC* is not set to [No] *nD*, and
- Motor control type] *LLE* is not set to [FVC] *FVL* or [Sync.CL] *FSY*

Setting ()	Description
0...1.1 In ⁽¹⁾	Setting range Factory setting: 0.5 In ⁽¹⁾
(1) In corresponds to the rated drive current indicated in the Installation Manual and on the drive nameplate.	

[Auto DC Inj Time 2] *EdC2* ★

Auto DC injection time 2.

NOTICE
<p>OVERHEATING AND DAMAGE TO THE MOTOR</p> <p>Verify that the connected motor is properly rated for the DC injection current to be applied in terms of amount and time in order to avoid overheating and damage to the motor.</p> <p>Failure to follow these instructions can result in equipment damage.</p>

Second standstill injection time.

This parameter can be accessed if:

- [Auto DC Injection] *PdC* is set to [Yes] *YES*, and
- [Motor control type] *LLE* is not set to [FVC] *FVL* or [Sync.CL] *FSY*.

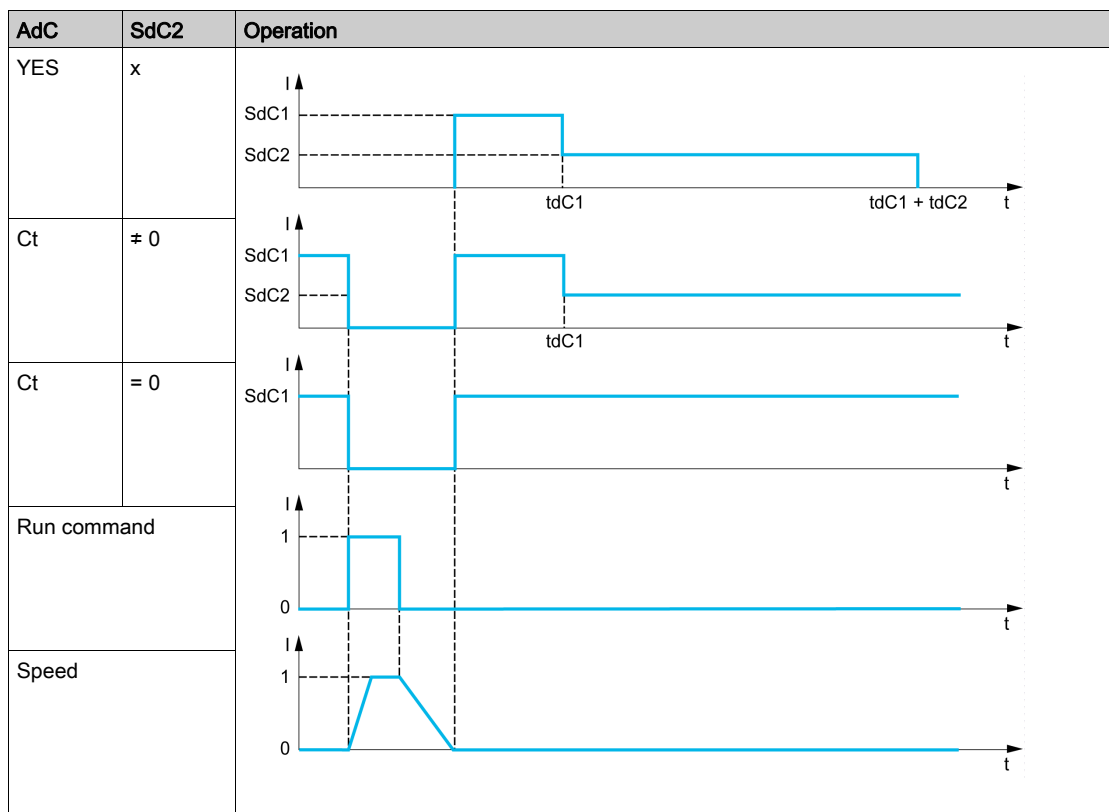

Setting ()	Description
0.0...30.0 s	Setting range Factory setting: 0.0 s

Section 8.22

[Generic functions] - [Ref. operations]

[Ref. operations] \square \mathcal{R} \mathcal{I} - Menu

Access

[Complete settings] → [Generic functions] → [Ref. operations]

About This Menu

Summing input / subtraction input / multiplier

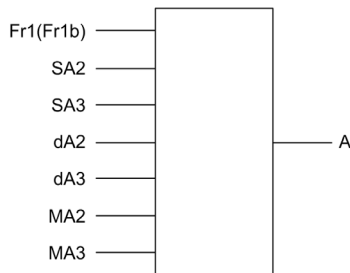

$$A = (\text{Fr1 or Fr1b} + \text{SA2} + \text{SA3} - \text{dA2} - \text{dA3}) \times \text{MA2} \times \text{MA3}$$

NOTE:

- If $\mathcal{S}\mathcal{R}\mathcal{2}$, $\mathcal{S}\mathcal{R}\mathcal{3}$, $\mathcal{d}\mathcal{R}\mathcal{2}$, $\mathcal{d}\mathcal{R}\mathcal{3}$ are not assigned, they are set to 0.
- If $\mathcal{M}\mathcal{R}\mathcal{2}$, $\mathcal{M}\mathcal{R}\mathcal{3}$ are not assigned, they are set to 1.
- A is limited by the minimum $\mathcal{L}\mathcal{S}\mathcal{P}$ and maximum $\mathcal{H}\mathcal{S}\mathcal{P}$ parameters.
- For a multiplication, the signal on $\mathcal{M}\mathcal{R}\mathcal{2}$ or $\mathcal{M}\mathcal{R}\mathcal{3}$ is interpreted as a %. 100% corresponds to the maximum value of the corresponding input. If $\mathcal{M}\mathcal{R}\mathcal{2}$ or $\mathcal{M}\mathcal{R}\mathcal{3}$ is sent via the communication bus or Graphic Display Terminal, an $\mathcal{M}\mathcal{F}\mathcal{r}$ multiplication variable must be sent via the bus or Graphic Display Terminal.
- Reversal of the direction of operation in the event of a negative result can be blocked (see [Reverse Disable] \mathcal{r} \mathcal{I} \mathcal{n}).

[Summing Input 2] $\mathcal{S}\mathcal{R}\mathcal{2}$

Summing input 2.

Selection of a reference to be added to [Ref Freq 1 Config] $\mathcal{F}\mathcal{r}$ \mathcal{I} or [Ref.1B channel] $\mathcal{F}\mathcal{r}$ $\mathcal{I}\mathcal{b}$.

Setting	Code / Value	Description
[Not Configured]	$\mathcal{n}\mathcal{o}$	Not assigned Factory Setting
[AI1]	\mathcal{R} \mathcal{I} \mathcal{I}	Analog input AI1
[AI2]...[AI3]	\mathcal{R} \mathcal{I} $\mathcal{2}$... \mathcal{R} \mathcal{I} $\mathcal{3}$	Analog input AI2...AI3
[AI4]...[AI5]	\mathcal{R} \mathcal{I} $\mathcal{4}$... \mathcal{R} \mathcal{I} $\mathcal{5}$	Analog input AI4...AI5 if VW3A3203 I/O extension module has been inserted
[Ref. Freq- Rmt. Term]	\mathcal{L} \mathcal{L} \mathcal{L}	Reference Frequency via remote terminal
[Ref. Freq-Modbus]	\mathcal{M} \mathcal{d} \mathcal{b}	Reference frequency via Modbus
[Ref. Freq-CANopen]	\mathcal{C} \mathcal{R} \mathcal{n}	Reference frequency via CANopen if a CANopen module has been inserted
[Ref. Freq-Com. Module]	\mathcal{n} \mathcal{E} \mathcal{E}	Reference frequency via fieldbus module if a fieldbus module has been inserted
[Embedded Ethernet]	\mathcal{E} \mathcal{E} \mathcal{H}	Embedded Ethernet
[AI Virtual 1]	\mathcal{R} \mathcal{I} \mathcal{V} \mathcal{I}	Virtual analogic input 1
[DI7 PulseInput]...[DI8 PulseInput]	\mathcal{P} \mathcal{I} $\mathcal{7}$... \mathcal{P} \mathcal{I} $\mathcal{8}$	Digital input DI7...DI8 used as pulse input
[Encoder]	\mathcal{P} \mathcal{E}	Encoder reference if an encoder module has been inserted.

[Summing Input 3] 5 A 3

Summing input 3.

Selection of a reference to be added to **[Ref Freq 1 Config]** *F r 1* or **[Ref.1B channel]** *F r 1 b*.

Identical to **[Summing Input 2] 5 A 2**

[Subtract Ref Freq 2] 4 A 2

Subtract reference frequency 2.

Selection of a reference to be subtracted from **[Ref Freq 1 Config]** *F r 1* or **[Ref.1B channel]** *F r 1 b*.

Identical to **[Summing Input 2] 5 A 2**

[Subtract Ref Freq 3] 4 A 3

Subtract reference frequency 3.

Selection of a reference to be subtracted from **[Ref Freq 1 Config]** *F r 1* or **[Ref.1B channel]** *F r 1 b*.

Identical to **[Summing Input 2] 5 A 2**.

[Ref Freq 2 Multiply] 1 A 2

Reference frequency 2 multiply (in % of the source range).

Selection of a multiplier reference **[Ref Freq 1 Config]** *F r 1* or **[Ref.1B channel]** *F r 1 b*.

Identical to **[Summing Input 2] 5 A 2**.

[Ref Freq 3 Multiply] 1 A 3

Reference frequency 3 multiply (in % of the source range).

Selection of a multiplier reference **[Ref Freq 1 Config]** *F r 1* or **[Ref.1B channel]** *F r 1 b*.

Identical to **[Summing Input 2] 5 A 2**.

Section 8.23

[Generic functions] - [Preset speeds]

[Preset speeds] P 5 5 - Menu

Access

[Complete settings] → [Generic functions] → [Preset speeds]

About This Menu

NOTE: This function cannot be used with some other functions.

Combination Table for Preset Speed Inputs

2, 4, 8 or 16 speeds can be preset, requiring 1, 2, 3 or 4 digital inputs respectively.

It is necessary to configure:

- 2 and 4 speeds in order to obtain 4 speeds.
- 2, 4 and 8 speeds in order to obtain 8 speeds.
- 2, 4, 8 and 16 speeds in order to obtain 16 speeds.

16 Preset Freq (PS16)	8 Preset Freq (PS8)	4 Preset Freq (PS4)	2 Preset Freq (PS2)	Speed Reference
0	0	0	0	Reference 1 ⁽¹⁾
0	0	0	1	SP2
0	0	1	0	SP3
0	0	1	1	SP4
0	1	0	0	SP5
0	1	0	1	SP6
0	1	1	0	SP7
0	1	1	1	SP8
1	0	0	0	SP9
1	0	0	1	SP10
1	0	1	0	SP11
1	0	1	1	SP12
1	1	0	0	SP13
1	1	0	1	SP14
1	1	1	0	SP15
1	1	1	1	SP16

(1) Reference 1 = 5 P 1, refer to diagram (see page 222)

[2 Preset Freq] P 5 2

2 preset freq assignment.

Setting	Code / Value	Description
[Not Assigned]	n a	Not assigned Factory setting
[DI1]...[DI8]	L , I ... L , B	Digital input DI1...DI8
[DI11]...[DI16]	L , I I ... L , I B	Digital input DI11...DI16 if VW3A3203 I/O extension module has been inserted
[CD00]...[CD10]	C d 0 0 ... C d 1 0	Virtual digital input CMD.0...CMD.10 in [I/O profile] , a configuration
[CD11]...[CD15]	C d 1 1 ... C d 1 5	Virtual digital input CMD.11...CMD.15 regardless of configuration

Setting	Code / Value	Description
[C101]...[C110]	C 1 0 1...C 1 1 0	Virtual digital input CMD1.01...CMD1.10 with integrated Modbus Serial in [I/O profile] , o configuration
[C111]...[C115]	C 1 1 1...C 1 1 5	Virtual digital input CMD1.11...CMD1.15 with integrated Modbus Serial regardless of configuration
[C201]...[C210]	C 2 0 1...C 2 1 0	Virtual digital input CMD2.01...CMD2.10 with CANopen® fieldbus module in [I/O profile] , o configuration
[C211]...[C215]	C 2 1 1...C 2 1 5	Virtual digital input CMD2.11...CMD2.15 with CANopen® fieldbus module regardless of configuration
[C301]...[C310]	C 3 0 1...C 3 1 0	Virtual digital input CMD3.01...CMD3.10 with a fieldbus module in [I/O profile] , o configuration
[C311]...[C315]	C 3 1 1...C 3 1 5	Virtual digital input CMD3.11...CMD3.15 with a fieldbus module regardless of configuration
[C501]...[C510]	C 5 0 1...C 5 1 0	Virtual digital input CMD5.01...CMD5.10 with integrated Ethernet in [I/O profile] , o configuration
[C511]...[C515]	C 5 1 1...C 5 1 5	Virtual digital input CMD5.11...CMD5.15 with integrated Ethernet regardless of configuration

[4 Preset Freq] P 5 4

4 preset freq assignment.

Identical to **[2 Preset Freq] P 5 2**

To obtain 4 speeds, you must also configure 2 speeds.

[8 Preset Freq] P 5 B

8 preset freq assignment.

Identical to **[2 Preset Freq] P 5 2**

To obtain 8 speeds, you must also configure 2 and 4 speeds.

[16 Preset Freq] P 5 16

16 preset freq assignment.

Identical to **[2 Preset Freq] P 5 2**

To obtain 16 speeds, you must also configure 2, 4 and 8 speeds.

[Preset speed 2] 5 P 2 ★

Preset speed 2. See the combination table for preset speed inputs (*see page 374*).

Setting ()	Description
0.0...599.0 Hz	Setting range Factory setting: 10.0 Hz

[Preset speed 3] 5 P 3 ★

Preset speed 3. See the combination table for preset speed inputs (*see page 374*).

Setting ()	Description
0.0...599.0 Hz	Setting range Factory setting: 15.0 Hz

[Preset speed 4] 5 P 4 ★

Preset speed 4. See the combination table for preset speed inputs (*see page 374*).

Setting ()	Description
0.0...599.0 Hz	Setting range Factory setting: 20.0 Hz

[Preset speed 5] 5 P 5 ★

Preset speed 5. See the combination table for preset speed inputs (*see page 374*).

Setting ()	Description
0.0...599.0 Hz	Setting range Factory setting: 25.0 Hz

[Preset speed 6] 5 P 6 ★

Preset speed 6. See the combination table for preset speed inputs (*see page 374*).

Setting ()	Description
0.0...599.0 Hz	Setting range Factory setting: 30.0 Hz

[Preset speed 7] 5 P 7 ★

Preset speed 7. See the combination table for preset speed inputs (*see page 374*).

Setting ()	Description
0.0...599.0 Hz	Setting range Factory setting: 35.0 Hz

[Preset speed 8] 5 P 8 ★

Preset speed 8. See the combination table for preset speed inputs (*see page 374*).

Setting ()	Description
0.0...599.0 Hz	Setting range Factory setting: 40.0 Hz

[Preset speed 9] 5 P 9 ★

Preset speed 9. See the combination table for preset speed inputs (*see page 374*).

Setting ()	Description
0.0...599.0 Hz	Setting range Factory setting: 45.0 Hz

[Preset speed 10] 5 P 10 ★

Preset speed 10. See the combination table for preset speed inputs (*see page 374*).

Setting ()	Description
0.0...599.0 Hz	Setting range Factory setting: 50.0 Hz

[Preset speed 11] 5 P 11 ★

Preset speed 11. See the combination table for preset speed inputs (*see page 374*).

Setting ()	Description
0.0...599.0 Hz	Setting range Factory setting: 55.0 Hz

[Preset speed 12] 5 P 12 ★

Preset speed 12. See the combination table for preset speed inputs (*see page 374*).

Setting ()	Description
0.0...599.0 Hz	Setting range Factory setting: 60.0 Hz

[Preset speed 13] 5 P 13 ★

Preset speed 13. See the combination table for preset speed inputs (*see page 374*).

Setting ()	Description
0.0...599.0 Hz	Setting range Factory setting: 70.0 Hz

[Preset speed 14] 5 P 14 ★

Preset speed 14. See the combination table for preset speed inputs (*see page 374*).

Setting ()	Description
0.0...599.0 Hz	Setting range Factory setting: 80.0 Hz

[Preset speed 15] 5 P 15 ★

Preset speed 15 See the combination table for preset speed inputs (*see page 374*).

Setting ()	Description
0.0...599.0 Hz	Setting range Factory setting: 90.0 Hz

[Preset speed 16] 5 P 16 ★

Preset speed 16. See the combination table for preset speed inputs (*see page 374*).

Setting ()	Description
0.0...599.0 Hz	Setting range Factory setting: 100.0 Hz

Section 8.24

[Generic functions] - [+/- speed]

[+/- speed] *u P d* - Menu

Access

[Complete settings] → [Generic functions] → [+/- speed]

About This Menu

This function can be accessed if reference channel [Ref Freq 2 Config] *F r 2* is set to [Ref Frequency via DI] *u P d t*

NOTE: This function cannot be used with some other functions.

2 types of operations are available:

- **Use of single action keys:** 2 digital inputs are required in addition to the operating directions. The input assigned to the “+ speed” command increases the speed, the input assigned to the “– speed” command decreases the speed.
- **Use of double action keys:** Only one digital input assigned to “+ speed” is required.

+/- speed with double-press buttons:

Description: 1 button pressed twice (2 steps) for each direction of rotation. A contact closes each time the button is pressed.

Setting	Released (– Speed)	First Press (Speed Maintained)	Second Press (Faster)
Forward button	–	a	a and b
Reverse button	–	c	c and d

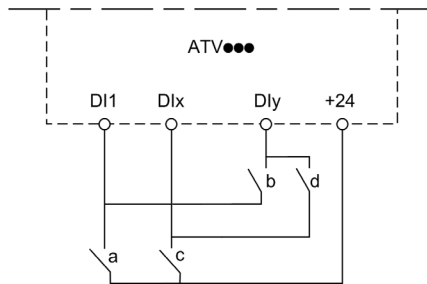

DI1 Forward
DIx Reverse
DIy + speed

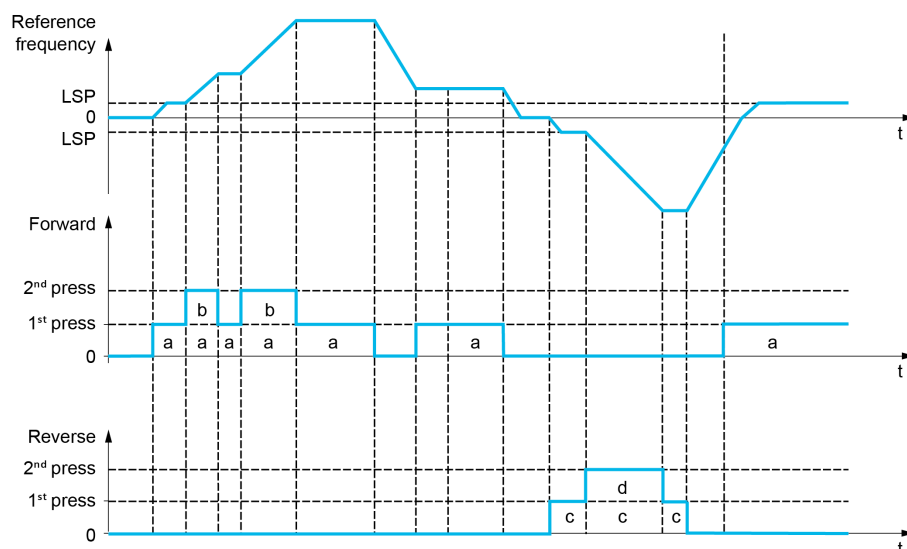

Do not use this +/- speed type with a 3-wire control.

Whichever type of operation is selected, the max. speed is set by **[High speed] H 5 P**.

NOTE: If the reference is switched via **[Freq Switch Assign] r F C** from any reference channel to another reference channel with "+/- speed", the value of reference **[Motor Frequency] r F r** (after ramp) may be copied at the same time in accordance with the **[Copy Ch1-Ch2] C 0 P** parameter.

This helps to prevent the speed from being incorrectly reset to zero when switching takes place.

[+ Speed Assign] u 5 P

Increase speed input assignment.

Function active if the assigned input or bit is at 1.

Setting	Code / Value	Description
[Not Assigned]	n 0	Not assigned Factory setting
[DI1]...[DI8]	L , 1...L , 8	Digital input DI1...DI8
[DI11]...[DI16]	L , 11...L , 16	Digital input DI11...DI16 if VW3A3203 I/O extension module has been inserted
[CD00]...[CD10]	C d 0 0...C d 1 0	Virtual digital input CMD.0...CMD.10 in [I/O profile] , 0 configuration
[CD11]...[CD15]	C d 1 1...C d 1 5	Virtual digital input CMD.11...CMD.15 regardless of configuration
[C101]...[C110]	C 1 0 1...C 1 1 0	Virtual digital input CMD1.01...CMD1.10 with integrated Modbus Serial in [I/O profile] , 0 configuration
[C111]...[C115]	C 1 1 1...C 1 1 5	Virtual digital input CMD1.11...CMD1.15 with integrated Modbus Serial regardless of configuration
[C201]...[C210]	C 2 0 1...C 2 1 0	Virtual digital input CMD2.01...CMD2.10 with CANopen® fieldbus module in [I/O profile] , 0 configuration
[C211]...[C215]	C 2 1 1...C 2 1 5	Virtual digital input CMD2.11...CMD2.15 with CANopen® fieldbus module regardless of configuration
[C301]...[C310]	C 3 0 1...C 3 1 0	Virtual digital input CMD3.01...CMD3.10 with a fieldbus module in [I/O profile] , 0 configuration
[C311]...[C315]	C 3 1 1...C 3 1 5	Virtual digital input CMD3.11...CMD3.15 with a fieldbus module regardless of configuration
[C501]...[C510]	C 5 0 1...C 5 1 0	Virtual digital input CMD5.01...CMD5.10 with integrated Ethernet in [I/O profile] , 0 configuration
[C511]...[C515]	C 5 1 1...C 5 1 5	Virtual digital input CMD5.11...CMD5.15 with integrated Ethernet regardless of configuration

[- Speed Assign] d 5 P

Down speed input assignment. See the assignment conditions.

Parameter settings identical to **[+ Speed Assign] u 5 P**.

Function active if the assigned input or bit is at 1.

[Ref Frequency Save] 5 E r ★

Reference frequency saves. This parameter can be accessed if **[+ Speed Assign] u 5 P** is not set to **[Not Assigned] n o** or **[- Speed Assign] d 5 P** is not set to **[Not Assigned] n o**.

Associated with the "+/- speed" function, this parameter can be used to save the reference:

- When the run commands disappear (saved to RAM).
- When the supply mains or the run commands disappear (saved to EEPROM).

Therefore, next time the drive starts up, the speed reference is the last reference frequency saved.

Setting	Code / Value	Description
[No save]	n o	Not saved Factory setting
[Save to RAM]	r R P	+/- speed with saving of the reference frequency in RAM
[Save to EEprom]	E E P	+/- speed with saving of the reference frequency in EEPROM

[+/- Speed Reference] 5 r E

+/- Speed Reference selection.

This parameter can be accessed if **[+ Speed Assign] u 5 P** is not set to **[Not Assigned] n o** or **[- Speed Assign] d 5 P** is not set to **[Not Assigned] n o**.

This parameter can be used to select the type of +/- speed reference value.

Setting	Code / Value	Description
[Motor Speed]	n o	Frequency reference from motor frequency. Factory setting
[Reference Speed]	Y E 5	Frequency reference from the reference frequency.

Section 8.25

[Generic functions] - [+/- speed around ref]

[+/- speed around ref] 5 r E - Menu

Access

[Complete settings] → [Generic functions] → [+/- speed around ref]

About This Menu

The function can be accessed for reference channel [Ref Freq 1 Config] $F r 1$.

NOTE: This function cannot be used with some other functions.

The reference is given by [Ref Freq 1 Config] $F r 1$ or [Ref.1B channel] $F r 1 b$ with summing/subtraction/multiplication functions and preset speeds if relevant (see the diagram below).

For improved clarity, it calls this reference A. The action of the +speed and –speed keys can be set as a % of this reference A. On stopping, the reference (A +/- speed) is not saved, so the drive restarts with reference A+ only.

The maximum total reference is limited by [High Speed] $H S P$ and the minimum reference by [Low Speed] $L S P$.

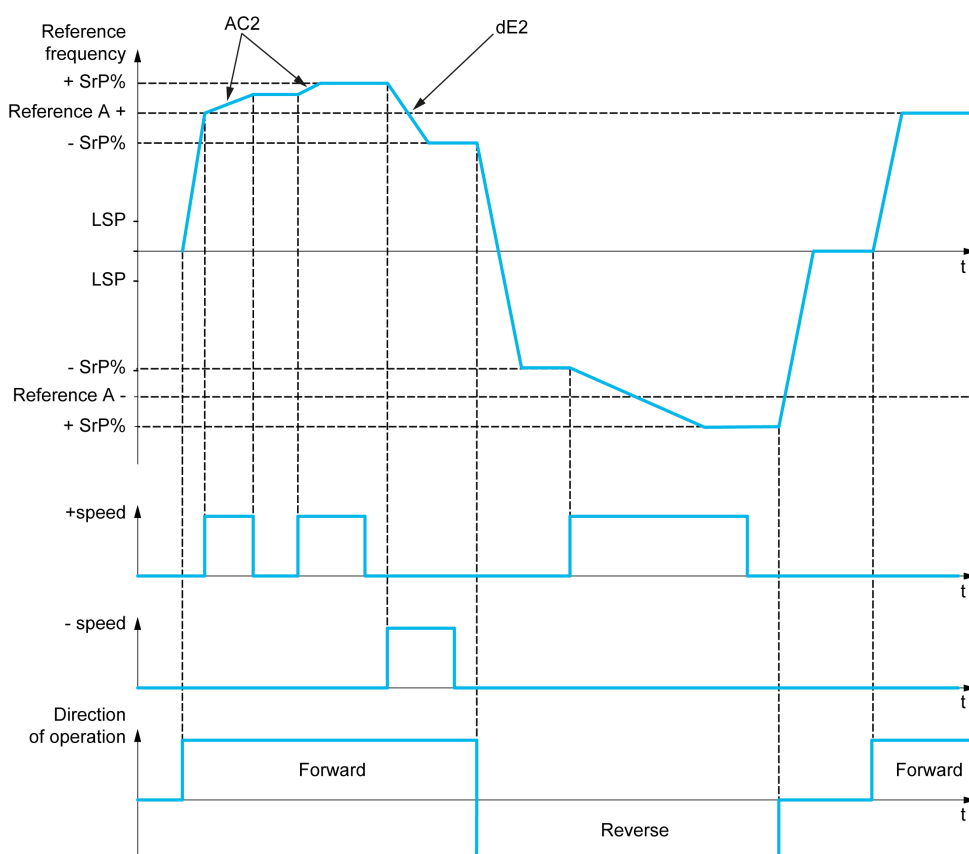

[+ Speed Assign] 5 r

Upper speed assignment.

Setting	Code / Value	Description
[Not Assigned]	$n o$	Not assigned Factory setting
[D11]...[D18]	$L 1 / \dots L 1 B$	Digital input DI1...DI8

Setting	Code / Value	Description
[DI11]...[DI16]	L , I I...L , I B	Digital input DI11...DI16 if VW3A3203 I/O extension module has been inserted
[CD00]...[CD10]	C d 0 0...C d 1 0	Virtual digital input CMD.0...CMD.10 in [I/O profile] , 0 configuration
[CD11]...[CD15]	C d I I...C d I B	Virtual digital input CMD.11...CMD.15 regardless of configuration
[C101]...[C110]	C 1 0 1...C 1 1 0	Virtual digital input CMD1.01...CMD1.10 with integrated Modbus Serial in [I/O profile] , 0 configuration
[C111]...[C115]	C I I I...C I I B	Virtual digital input CMD1.11...CMD1.15 with integrated Modbus Serial regardless of configuration
[C201]...[C210]	C 2 0 1...C 2 1 0	Virtual digital input CMD2.01...CMD2.10 with CANopen® fieldbus module in [I/O profile] , 0 configuration
[C211]...[C215]	C 2 I I...C 2 I B	Virtual digital input CMD2.11...CMD2.15 with CANopen® fieldbus module regardless of configuration
[C301]...[C310]	C 3 0 1...C 3 1 0	Virtual digital input CMD3.01...CMD3.10 with a fieldbus module in [I/O profile] , 0 configuration
[C311]...[C315]	C 3 I I...C 3 I B	Virtual digital input CMD3.11...CMD3.15 with a fieldbus module regardless of configuration
[C501]...[C510]	C 5 0 1...C 5 1 0	Virtual digital input CMD5.01...CMD5.10 with integrated Ethernet in [I/O profile] , 0 configuration
[C511]...[C515]	C 5 I I...C 5 I B	Virtual digital input CMD5.11...CMD5.15 with integrated Ethernet regardless of configuration

[- Speed Assign] d 5 ,

Down speed assignment. See the assignment conditions.

Function active if the assigned input or bit is at 1.

Setting	Code / Value	Description
[Not Assigned]	n 0	Not assigned Factory setting
[DI1]...[DI8]	L , I...L , B	Digital input DI1...DI8
[DI11]...[DI16]	L , I I...L , I B	Digital input DI11...DI16 if VW3A3203 I/O extension module has been inserted
[CD00]...[CD10]	C d 0 0...C d 1 0	Virtual digital input CMD.0...CMD.10 in [I/O profile] , 0 configuration
[CD11]...[CD15]	C d I I...C d I B	Virtual digital input CMD.11...CMD.15 regardless of configuration
[C101]...[C110]	C 1 0 1...C 1 1 0	Virtual digital input CMD1.01...CMD1.10 with integrated Modbus Serial in [I/O profile] , 0 configuration
[C111]...[C115]	C I I I...C I I B	Virtual digital input CMD1.11...CMD1.15 with integrated Modbus Serial regardless of configuration
[C201]...[C210]	C 2 0 1...C 2 1 0	Virtual digital input CMD2.01...CMD2.10 with CANopen® fieldbus module in [I/O profile] , 0 configuration
[C211]...[C215]	C 2 I I...C 2 I B	Virtual digital input CMD2.11...CMD2.15 with CANopen® fieldbus module regardless of configuration
[C301]...[C310]	C 3 0 1...C 3 1 0	Virtual digital input CMD3.01...CMD3.10 with a fieldbus module in [I/O profile] , 0 configuration
[C311]...[C315]	C 3 I I...C 3 I B	Virtual digital input CMD3.11...CMD3.15 with a fieldbus module regardless of configuration
[C501]...[C510]	C 5 0 1...C 5 1 0	Virtual digital input CMD5.01...CMD5.10 with integrated Ethernet in [I/O profile] , 0 configuration
[C511]...[C515]	C 5 I I...C 5 I B	Virtual digital input CMD5.11...CMD5.15 with integrated Ethernet regardless of configuration

[+/-Speed limitation] 5 r P ★

Up/Down speed limit.

This parameter limits the variation range with +/- speed as a % of the reference. The ramps used in this function are **[Acceleration 2] AC 2** and **[Deceleration 2] dE 2**.

This parameter can be accessed if **[+ Speed Assign] u 5** or **[- Speed Assign] d 5** is not set to **[No] n o**.

Setting (°)	Description
0...50%	Setting range Factory setting: 10%

[Acceleration 2] AC 2 ★

Acceleration 2 ramp time.

Time to accelerate from 0 to the **[Nominal Motor Freq] F r 5**. To have repeatability in ramps, the value of this parameter must be set according to the possibility of the application.

This parameter can be accessed if **[+ Speed Assign] u 5** or **[- Speed Assign] d 5** is not set to **[No] n o**.

Setting (°)	Description
0.00...6,000 s ⁽¹⁾	Setting range Factory setting: 5.00 s
(1) Range 0.01 to 99.99 s or 0.1 to 999.9 s or 1...6,000 s according to [Ramp increment] i n r .	

[Deceleration 2] dE 2 ★

Deceleration 2.

Time to decelerate from the **[Nominal Motor Freq] F r 5** to 0. To have repeatability in ramps, the value of this parameter must be set according to the possibility of the application.

This parameter can be accessed if **[+ Speed Assign] u 5** or **[- Speed Assign] d 5** is not set to **[No] n o**.

Setting (°)	Description
0.00...6,000 s ⁽¹⁾	Setting range Factory setting: 5.00 s
(1) Range 0.01 to 99.99 s or 0.1 to 999.9 s or 1...6,000 s according to [Ramp increment] i n r .	

Section 8.26

[Generic functions] - [Jump frequency]

[Jump frequency] *JLF* - Menu

Access

[Complete settings] → [Generic functions] → [Jump frequency]

About This Menu

This function helps to prevent prolonged operation within an adjustable range around the regulated frequency.

This function can be used to help to prevent a speed, which could cause resonance, being reached. Setting the function to 0 renders it inactive.

[Skip Frequency] *JPF*

Jump frequency.

Setting ()	Description
0.0...599.0 Hz	Setting range Factory setting: 0.0 Hz

[Skip Frequency 2] *JF2*

Jump frequency 2.

Setting ()	Description
0.0...599.0 Hz	Setting range Factory setting: 0.0 Hz

[3rd Skip Frequency] *JF3*

Jump frequency 3.

Setting ()	Description
0.0...599.0 Hz	Setting range Factory setting: 0.0 Hz

[Skip.Freq.Hysteresis] *JFH* ★

Jump frequency bandwidth.

This parameter can be accessed if at least one skip frequency *JPF*, *JF2*, or *JF3* is different from 0.

Skip frequency range: between $JPF - JFH$ and $JPF + JFH$ for example.

This adjustment is common to the 3 frequencies *JPF*, *JF2*, *JF3*.

Setting ()	Description
0.1...10.0 Hz	Setting range Factory setting: 1.0 Hz

Section 8.27

[Generic functions] - [PID controller]

What Is in This Section?

This section contains the following topics:

Topic	Page
[PID controller] <i>P i d</i> - Overview	386
[PID Feedback] <i>F d b</i> - Menu	390
[PID Reference] <i>r F</i> - Menu	396
[PID preset references] <i>P r i</i> - Menu	399
[PID Reference] <i>r F</i> - Menu	401
[Settings] <i>S t</i> - Menu	402

[PID controller] P, d - Overview

About This Menu

NOTE: This function cannot be used with some other functions.

Block Diagram

The function is activated by assigning an analog input to the PID feedback (measurement).

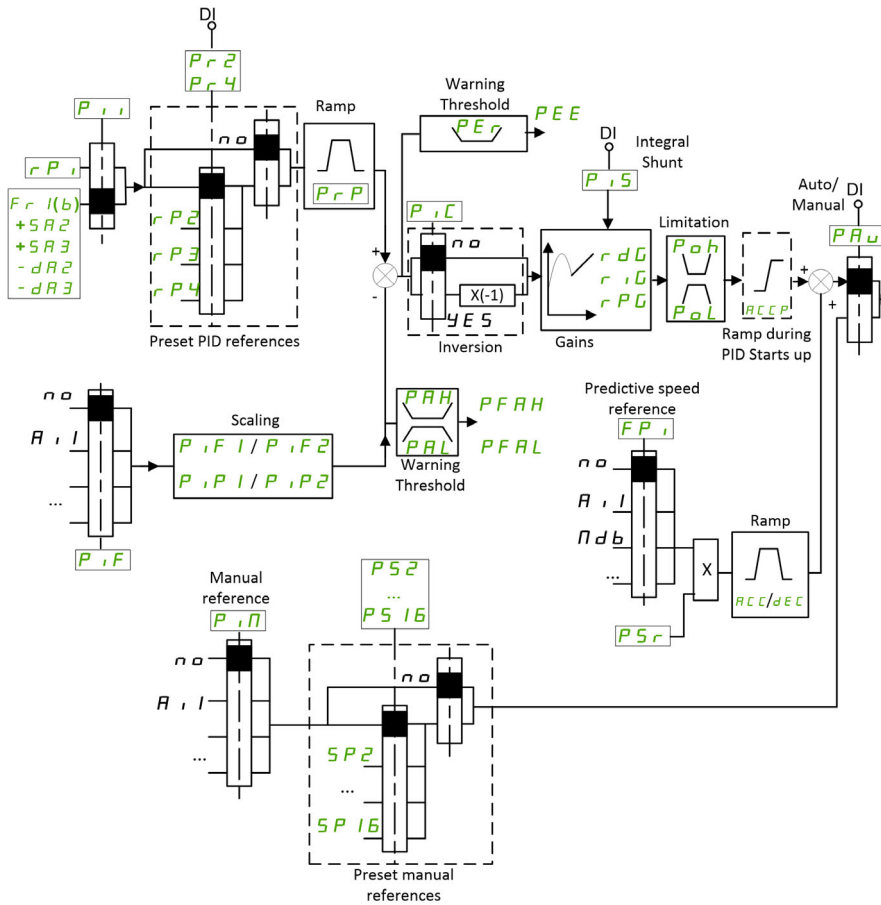

The PID feedback needs to be assigned to one of the analog inputs AI1 to AI5 or a pulse input, according to whether any I/O extension module has been inserted.

The PID reference needs to be assigned to the following parameters:

- Preset references via digital inputs ([Ref PID Preset 2] $rP2$, [Ref PID Preset 3] $rP3$, [Ref PID Preset 4] $rP4$).
- In accordance with the configuration of [Intern PID Ref] $P1i$:
 - [Internal PID ref] rPi , or
 - Reference A [Ref Freq 1 Config] $Fr1$ or [Ref.1B channel] $Fr1b$.

Combination Table for Preset PID References:

DI (P r 4)	DI (P r 2)	P r 2 = n o	Reference
			r P 1 or F r 1 b
0	0		r P 1 or F r 1 b
0	1		r P 2
1	0		r P 3
1	1		r P 4

A predictive speed reference can be used to initialize the speed on restarting the process.

Scaling of feedback and references:

- **[Min PID feedback] P , F 1**, **[Max PID feedback] P , F 2** parameters can be used to scale the PID feedback (sensor range). **This scale MUST be maintained for all other parameters.**
- **[Min PID Process] P , P 1**, **[Max PID Process] P , P 2** parameters can be used to scale the adjustment range, for example the reference. **Check that the adjustment range remains within the sensor range.**

The maximum value of the scaling parameters is 32,767. To facilitate the installation, it is recommended to use values as close as possible to this maximum level, while retaining powers of 10 in relation to the actual values. The scaling is without unit if **[Type of control] t o C t** is set to **[NA] n R**, in % if set to **[OTHER] o t H E r**.

Example

Adjustment of the volume in a tank, 6...15 m³.

- Probe used 4-20 mA, 4.5 m³ for 4 mA and 20 m³ for 20 mA, with the result that **P , F 1 = 4,500** and **P , F 2 = 20,000**.
- Adjustment range 6 to 15 m³, with the result that **P , P 1 = 6,000** (min. reference) and **P , P 2 = 15,000** (max. reference).
- Example references:
 - r P 1 (internal reference) = 9,500
 - r P 2 (preset reference) = 6,500
 - r P 3 (preset reference) = 8,000
 - r P 4 (preset reference) = 11,200

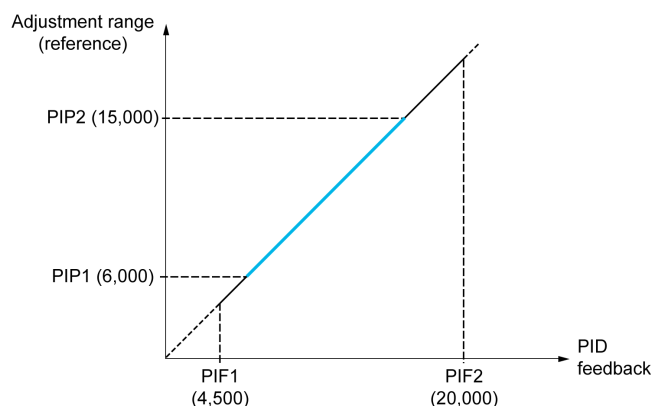

Other parameters:

- Reversal of the direction of correction **[PID Inversion] P , C**. If **[PID Inversion] P , C** is set to **[No] n o**, the speed of the motor increases when the detected error is positive (for example pressure control with a compressor). If **[PID Inversion] P , C** is set to **[Yes] Y E S**, the speed of the motor decreases when the detected error is positive (for example temperature control using a cooling fan).
- The integral gain may be short-circuited by a digital input.
- A warning on the **[PID feedback] P , F** may be configured.
- A warning on the **[PID error] r P E** may be configured.

"Manual - Automatic" Operation with PID

This function combines the PID controller, the preset speeds, and a manual reference. Depending on the state of the digital input, the speed reference is given by the preset speeds or by a manual reference input via the PID function.

Manual PID reference **[Manual PID reference] P , Π**:

- Analog inputs AI1 to AI5
- Pulse inputs

Predictive speed reference **[Predictive Speed Ref] F P , :**

- **[AI1] A , 1**: analog input
- **[AI2] A , 2**: analog input
- **[AI3] A , 3**: analog input
- **[AI4] A , 4**: analog input if VW3A3203 I/O extension module has been inserted
- **[AI5] A , 5**: analog input if VW3A3203 I/O extension module has been inserted
- **[DI7 PulseInput] P , 7**: pulse input
- **[DI8 PulseInput] P , 8**: pulse input
- **[Ref.Freq-Rmt.Term] L C C**: Graphic Display Terminal
- **[Modbus] Π d b**: integrated Modbus
- **[CANopen] C A n**: CANopen® (if inserted)
- **[Com. Module] n E E**: fieldbus option module (if inserted)
- **[Embedded Ethernet] E E H**: integrated Ethernet

Setting Up the PID Controller

1. Configuration in PID mode.

Refer to the Block Diagram (see page 386).

2. Perform a test in factory settings mode.

To optimize the drive, adjust **[PID Prop.Gain] r P G** or **[PID Intgl.Gain] r , G** gradually and independently, and observe the effect on the PID feedback in relation to the reference.

3. If the factory settings are unstable or the reference is incorrect.

Step	Action
1	Perform a test with a speed reference in manual mode (without PID controller) and with the drive on load for the speed range of the system: <ul style="list-style-type: none"> • In steady state, the speed must be stable and comply with the reference, and the PID feedback signal must be stable. • In transient state, the speed must follow the ramp and stabilize quickly, and the PID feedback must follow the speed. If not, see the settings for the drive and/or sensor signal and wiring.
2	Switch to PID mode.
3	Set [PID ramp] P r P to the minimum permitted by the mechanism without triggering an [DC Bus Overvoltage] o b F .
4	Set the integral gain [PID Intgl.Gain] r , G to minimum.
5	Leave the derivative gain [PID derivative gain] r d G at 0.
6	Observe the PID feedback and the reference.
7	Switch the drive ON/OFF a number of times or vary the load or reference rapidly a number of times.
8	Set the proportional gain [PID Prop.Gain] r P G in order to ascertain the compromise between response time and stability in transient phases (slight overshoot and 1 to 2 oscillations before stabilizing).
9	If the reference varies from the preset value in steady state, gradually increase the integral gain [PID Intgl.Gain] r , G , reduce the proportional gain [PID Prop.Gain] r P G in the event of instability (pump applications), find a compromise between response time and static precision (see diagram).
10	Lastly, the derivative gain may permit the overshoot to be reduced and the response time to be improved, although this is more difficult to obtain a compromise in terms of stability, as it depends on 3 gains.
11	Perform in-production tests over the whole reference range.

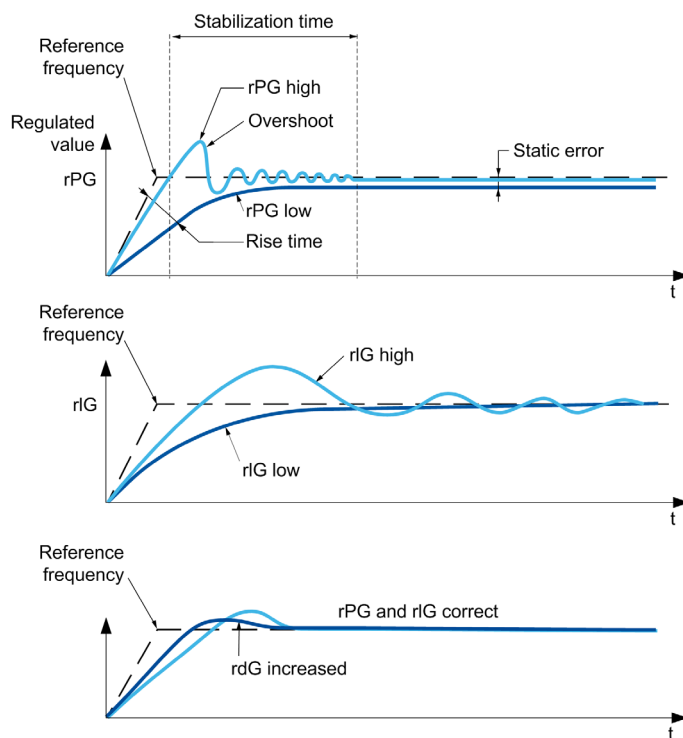

The oscillation frequency depends on the system kinematics:

Parameter	Rise time	Overshoot	Stabilization time	Static error
rPG +	--	+	=	-
rIG +	-	++	+	--
rdG +	=	-	-	=

[PID Feedback] F d b - Menu

Access

[Complete settings] → [Generic functions] → [PID controller] → [Feedback]

About This Menu

NOTE: This function cannot be used with some other functions.

[Type of Control] t o c t

Type of control for the PID = unit choice.

Setting	Code / Value	Description
[nA]	n A	No units Factory setting
[Other]	o t h e r	Other control and unit (%)

[PID Feedback] P , F

PID controller feedback.

Setting	Code / Value	Description
[No]	n o	Not assigned Factory setting
[AI1]...[AI3]	A , 1...A , 3	Analog input AI1...AI3
[AI4]...[AI5]	A , 4...A , 5	Analog input AI4...AI5 if VW3A3203 I/O extension module has been inserted
[AI Virtual 1]	A , V 1	Virtual analogic input 1
[DI7 PulseInput]...[DI8 PulseInput]	P , 7...P , 8	Digital input DI7...DI8 used as pulse input
[Encoder]	P G	Encoder reference if an encoder module has been inserted.

[AI1 Type] A , I t ★

Configuration of analog input AI1.

This parameter can be accessed if [PID Feedback] P , F is set to [AI1] A , I .

Setting	Code / Value	Description
[Voltage]	I 0 v	0-10 Vdc Factory setting
[Current]	0 A	0-20 mA

[AI1 min value] v , L I ★

AI1 voltage scaling parameter of 0%.

This parameter can be accessed if:

- [PID Feedback] P , F is set to [AI1] A , I , and
- [AI1 Type] A , I t is set to [Voltage] I 0 v .

Setting	Description
0.0...10.0 Vdc	Setting range Factory setting: 0.0 Vdc

[AI1 max value] \cup, H, I ★

AI1 voltage scaling parameter of 100%.

This parameter can be accessed if:

- **[PID Feedback] P, F** is set to **[AI1] R, I** , and
- **[AI1 Type] $R, I E$** is set to **[Voltage] $I D \cup$** .

Setting	Description
0.0...10.0 Vdc	Setting range Factory setting: 10.0 Vdc

[AI1 min. value] C, r, L, I ★

AI1 current scaling parameter of 0%.

This parameter can be accessed if:

- **[PID Feedback] P, F** is set to **[AI1] R, I** , and
- **[AI1 Type] $R, I E$** is set to **[Current] $D R$** .

Setting	Description
0.0...20.0 mA	Setting range Factory setting: 0.0 mA

[AI1 max. value] C, r, H, I ★

AI1 current scaling parameter of 100%.

This parameter can be accessed if:

- **[PID Feedback] P, F** is set to **[AI1] R, I** , and
- **[AI Type] $R, I E$** is set to **[Current] $D R$** .

Setting	Description
0.0...20.0 mA	Setting range Factory setting: 20.0 mA

[AI1 range] R, I, L ★

AI1 scaling selection.

This parameter can be accessed if:

- **[PID Feedback] P, F** is set to **[AI1] R, I** , and
- **[AI1 Type] $R, I E$** is set to **[Current] $D R$**

This parameter is forced to **[0-100%] $P \circ S$** if:

- **[AI1 Type] $R, I E$** is not set to **[Current] $D R$** , or
- **[AI1 min. value] C, r, L, I** is lower than 3.0 mA.

Setting	Code / Value	Description
[0-100%]	$P \circ S$	Unidirectional: AI1 current scaling is 0% up to 100%. Factory setting
[-/+100%]	$P \circ S n E G$	Bidirectional: AI1 current scaling is -100% up to 100%. [AI1 min. value] C, r, L, I corresponds to -100%. [AI1 max. value] C, r, H, I corresponds to 100%.

[AI2 Type] $R, I, 2 E$ ★

Configuration of analog input AI2.

This parameter can be accessed if **[PID Feedback] P, F** is set to **[AI2] $R, I, 2$**

Setting	Code / Value	Description
[Voltage]	$I D \cup$	0-10 Vdc
[Voltage +/-]	$n I D \cup$	-10/+10 Vdc Factory setting

[AI2 min value] μ , L 2 ★

AI2 voltage scaling parameter of 0%.

This parameter can be accessed if:

- **[PID Feedback] P, F** is set to **[AI2] R, 2**, and
- **[AI2 Type] R, 2 E** is set to **[Voltage] I 0 μ** .

Identical to **[AI1 min value] μ , L 1** (see page 390).

[AI2 max value] μ , H 2 ★

AI2 voltage scaling parameter of 100%.

This parameter can be accessed if:

- **[PID Feedback] P, F** is set to **[AI2] R, 2**, and
- **[AI2 Type] R, 2 E** is set to **[Voltage] I 0 μ** .

Identical to **[AI1 max value] μ , H 1** (see page 391).

[AI3 Type] R, 3 E ★

Configuration of analog input AI3.

This parameter can be accessed if **[PID Feedback] P, F** is set to **[AI3] R, 3**.

Identical to **[AI2 Type] R, 2 E** (see page 391) with factory setting: **[Current] 0 R**.

[AI3 min value] μ , L 3 ★

AI3 voltage scaling parameter of 0%.

This parameter can be accessed if:

- **[PID Feedback] P, F** is set to **[AI3] R, 3**, and
- **[AI3 Type] R, 3 E** is set to **[Voltage] I 0 μ** .

Identical to **[AI1 min value] μ , L 1** (see page 390).

[AI3 max value] μ , H 3 ★

AI3 voltage scaling parameter of 100%.

This parameter can be accessed if:

- **[PID Feedback] P, F** is set to **[AI3] R, 3**, and
- **[AI3 Type] R, 3 E** is set to **[Voltage] I 0 μ** .

Identical to **[AI1 max value] μ , H 1** (see page 391).

[AI3 min. value] C r L 3 ★

AI3 current scaling parameter of 0%.

This parameter can be accessed if:

- **[PID Feedback] P, F** is set to **[AI3] R, 3**, and
- **[AI3 Type] R, 3 E** is set to **[Current] 0 R**.

Identical to **[AI1 min. value] C r L 1** (see page 391).

[AI3 max. value] C r H 3 ★

AI3 current scaling parameter of 100%.

This parameter can be accessed if:

- **[PID Feedback] P, F** is set to **[AI3] R, 3**, and
- **[AI3 Type] R, 3 E** is set to **[Current] 0 R**.

Identical to **[AI1 max. value] C r H 1** (see page 391).

[AI3 range] R , 3 L ★

AI3 scaling selection.

This parameter can be accessed if:

- **[PID Feedback] P , F** is set to **[AI3] R , 3**, and
- **[AI3 Type] R , 3 E** is set to **[Current] 0 R**

Identical to **[AI1 range] R , 1 L** (see page 391).

[AI4 Type] R , 4 E ★

Configuration of analog input AI4.

This parameter can be accessed if:

- VW3A3203 I/O extension module has been inserted, and
- **[PID Feedback] P , F** is set to **[AI4] R , 4**.

Setting	Code / Value	Description
[Voltage]	1 0 u	0-10 Vdc
[Current]	0 R	0-20 mA Factory setting
[Voltage +/-]	n 1 0 u	-10/+10 Vdc

[AI4 min value] u , L 4 ★

AI4 voltage scaling parameter of 0%.

This parameter can be accessed if:

- **[PID Feedback] P , F** is set to **[AI4] R , 4**, and
- **[AI4 Type] R , 4 E** is set to **[Voltage] 1 0 u**.

Identical to **[AI1 min value] u , L 1** (see page 390).

[AI4 max value] u , H 4 ★

AI4 voltage scaling parameter of 100%.

This parameter can be accessed if:

- **[PID Feedback] P , F** is set to **[AI4] R , 4**, and
- **[AI4 Type] R , 4 E** is set to **[Voltage] 1 0 u**.

Identical to **[AI1 max value] u , H 1** (see page 391).

[AI4 min. value] C r L 4 ★

AI4 current scaling parameter of 0%.

This parameter can be accessed if:

- **[PID Feedback] P , F** is set to **[AI4] R , 4**, and
- **[AI4 Type] R , 4 E** is set to **[Current] 0 R**.

Identical to **[AI1 min. value] C r L 1** (see page 391).

[AI4 max. value] C r H 4 ★

AI4 current scaling parameter of 100%.

This parameter can be accessed if:

- **[PID Feedback] P , F** is set to **[AI4] R , 4**, and
- **[AI4 Type] R , 4 E** is set to **[Current] 0 R**.

Identical to **[AI1 max. value] C r H 1** (see page 391).

[AI4 range] R , 4 L ★

AI4 scaling selection.

This parameter can be accessed if:

- [PID Feedback] P , F is set to [AI4] R , 4 , and
- [AI4 Type] R , 4 E is set to [Current] D R

Identical to [AI1 range] R , 1 L (see page 391).

[AI5 Type] R , 5 E ★

Configuration of analog input AI5.

This parameter can be accessed if:

- VW3A3203 I/O extension module has been inserted, and
- [PID Feedback] P , F is set to [AI5] R , 5 .

Identical to [AI4 Type] R , 4 E .

[AI5 min value] L , 5 ★

AI5 voltage scaling parameter of 0%.

This parameter can be accessed if:

- [PID Feedback] P , F is set to [AI5] R , 5 , and
- [AI4 Type] R , 5 E is set to [Voltage] I D L .

Identical to [AI1 min value] L , 1 (see page 390).

[AI5 max value] L , 5 H ★

AI5 voltage scaling parameter of 100%.

This parameter can be accessed if:

- [PID Feedback] P , F is set to [AI5] R , 5 , and
- [AI4 Type] R , 5 E is set to [Voltage] I D L .

Identical to [AI1 max value] L , 1 (see page 391).

[AI5 min. value] L , 5 ★

AI5 current scaling parameter of 0%.

This parameter can be accessed if:

- [PID Feedback] P , F is set to [AI5] R , 5 , and
- [AI5 Type] R , 5 E is set to [Current] D R .

Identical to [AI1 min. value] L , 1 (see page 391).

[AI5 max. value] L , 5 H ★

AI5 current scaling parameter of 100%.

This parameter can be accessed if:

- [PID Feedback] P , F is set to [AI5] R , 5 , and
- [AI5 Type] R , 5 E is set to [Current] D R .

Identical to [AI1 max. value] L , 1 (see page 391).

[AI5 range] R , 5 L ★

AI5 scaling selection.

This parameter can be accessed if:

- [PID Feedback] P , F is set to [AI5] R , 5 , and
- [AI5 Type] R , 5 E is set to [Current] D R

Identical to [AI1 range] R , 1 L (see page 391).

[Min PID feedback] P , F I ★

Minimum PID feedback.

This parameter can be accessed if **[PID Feedback] P , F** is not set to **[Not Configured] n a**.

Setting ()	Description
0... [Max PID feedback] P , F 2	Setting range Factory setting: 100

[Max PID feedback] P , F 2 ★

Maximum PID feedback.

This parameter can be accessed if **[PID Feedback] P , F** is not set to **[Not Configured] n a**.

Setting ()	Description
[Min PID feedback] P , F I ...32,767	Setting range Factory setting: 1,000

[PID feedback] r P F ★

Value for PID feedback, display only.

This parameter can be accessed if **[PID Feedback] P , F** is not set to **[Not Configured] n a**.

Setting	Description
0...65,535	Setting range Factory setting: 0

[Min Fbk Warning] P F L ★

Minimum feedback level warning (for **[PID Low Fdbck Warn] P F F L** warning).

This parameter can be accessed if **[PID Feedback] P , F** is not set to **[Not Configured] n a**.

Setting ()	Description
0...65,535	Setting range Factory setting: 100

[Max Fbk Warning] P F H ★

Maximum feedback level warning (for **[PID High Fdbck Warn] P F F H** warning).

This parameter can be accessed if **[PID Feedback] P , F** is not set to **[Not Configured] n a**.

Setting ()	Description
0...65,535	Setting range Factory setting: 1,000

[PID Reference] *r F* - Menu

Access

[Complete settings] → [Generic functions] → [PID controller] → [PID Reference]

About This Menu

NOTE: This function cannot be used with some other functions.

[Intern PID Ref] *P , i* ★

Internal PID reference.

This parameter can be accessed if [PID Feedback] *P , F* is not set to [Not Configured] *n o*.

Setting	Code / Value	Description
[No]	<i>n o</i>	The PID controller reference is given by [Ref Freq 1 Config] <i>F r 1</i> or [Ref.1B channel] <i>F r 1 b</i> with summing/subtraction/multiplication functions. Refer to the block diagram (<i>see page 237</i>). Factory setting
[Yes]	<i>Y E S</i>	The PID controller reference is internal via [Internal PID ref] <i>r P i</i> .

[Ref Freq 1 Config] *F r 1* ★

Configuration reference frequency 1.

This parameter can be accessed if:

- [PID Feedback] *P , F* is not set to [Not Configured] *n o*, and
- [Intern PID Ref] *P , i* is set to [No] *n o*.

Setting	Code / Value	Description
[Not Configured]	<i>n o</i>	Not assigned
[AI1]	<i>A i 1</i>	Analog input AI1 Factory Setting
[AI2]...[AI3]	<i>A i 2...A i 3</i>	Analog input AI2...AI3
[AI Virtual 1]	<i>A i V 1</i>	Virtual analogic input 1
[AI4]...[AI5]	<i>A i 4...A i 5</i>	Analog input AI4...AI5 if VW3A3203 I/O extension module has been inserted
[Ref.Freq-Rmt.Term]	<i>L C C</i>	Reference Frequency via remote terminal
[Ref. Freq-Modbus]	<i>M d b</i>	Reference frequency via Modbus
[Ref. Freq-CANopen]	<i>C A n</i>	Reference frequency via CANopen if a CANopen module has been inserted
[Ref. Freq-Com. Module]	<i>n E t</i>	Reference frequency via fieldbus module if a fieldbus module has been inserted
[Embedded Ethernet]	<i>E t H</i>	Embedded Ethernet
[DI7 PulseInput]...[DI8 PulseInput]	<i>P , 7...P , 8</i>	Digital input DI7...DI8 used as pulse input
[Encoder]	<i>P G</i>	Encoder reference if an encoder module has been inserted.

[Min PID reference] *P , P I* ★

Minimum PID reference.

This parameter can be accessed if [PID Feedback] *P , F* is not set to [Not Configured] *n o*.

Setting ()	Description
[Min PID feedback] <i>P , F I</i> ...[Max PID reference] <i>P , P 2</i>	Setting range Factory setting: 150

[Max PID reference] P , P 2 ★

Maximum PID reference.

This parameter can be accessed if **[PID Feedback] P , F** is not set to **[Not Configured] n o**.

Setting ()	Description
[Min PID reference] P , P 1...[Max PID feedback] P , F 2	Setting range Factory setting: 900

[Internal PID ref] r P , ★

Internal PID reference.

This parameter can be accessed if:

- **[PID Feedback] P , F** is not set to **[Not Configured] n o**, and
- **[Intern PID Ref] P , r** is set to **[Yes] Y E 5**.

Setting ()	Description
[Min PID reference] P , P 1...[Max PID reference] P , P 2	Setting range Factory setting: 150

[Auto/Manual assign.] P A u ★

Auto/Manual select input.

This parameter can be accessed if **[PID Feedback] P , F** is not set to **[Not Configured] n o**.

Setting	Code / Value	Description
[Not Assigned]	n o	Not assigned Factory setting
[DI1]...[DI8]	L , I...L , B	Digital input DI1...DI8
[DI11]...[DI16]	L , I I...L , I B	Digital input DI11...DI16 if VW3A3203 I/O extension module has been inserted
[CD00]...[CD10]	C d 0 0...C d 1 0	Virtual digital input CMD.0...CMD.10 in [I/O profile] , o configuration
[CD11]...[CD15]	C d 1 1...C d 1 5	Virtual digital input CMD.11...CMD.15 regardless of configuration
[C101]...[C110]	C 1 0 1...C 1 1 0	Virtual digital input CMD1.01...CMD1.10 with integrated Modbus Serial in [I/O profile] , o configuration
[C111]...[C115]	C 1 1 1...C 1 1 5	Virtual digital input CMD1.11...CMD1.15 with integrated Modbus Serial regardless of configuration
[C201]...[C210]	C 2 0 1...C 2 1 0	Virtual digital input CMD2.01...CMD2.10 with CANopen® fieldbus module in [I/O profile] , o configuration
[C211]...[C215]	C 2 1 1...C 2 1 5	Virtual digital input CMD2.11...CMD2.15 with CANopen® fieldbus module regardless of configuration
[C301]...[C310]	C 3 0 1...C 3 1 0	Virtual digital input CMD3.01...CMD3.10 with a fieldbus module in [I/O profile] , o configuration
[C311]...[C315]	C 3 1 1...C 3 1 5	Virtual digital input CMD3.11...CMD3.15 with a fieldbus module regardless of configuration
[C501]...[C510]	C 5 0 1...C 5 1 0	Virtual digital input CMD5.01...CMD5.10 with integrated Ethernet in [I/O profile] , o configuration
[C511]...[C515]	C 5 1 1...C 5 1 5	Virtual digital input CMD5.11...CMD5.15 with integrated Ethernet regardless of configuration

[Manual PID Reference] P , n ★

Manual PID reference.

Reference input in manual mode.

This parameter can be accessed if:

- **[PID Feedback] P , F** is not set to **[Not Configured] n o**, and
- **[Auto/Manual assign.] P A u** is not set to **[No] n o**.

The preset speeds are active on the manual reference if they have been configured.

Setting	Code / Value	Description
[No]	<i>n o</i>	Not assigned Factory setting
[AI1]...[AI3]	<i>R , 1...R , 3</i>	Analog input AI1...AI3
[AI4]...[AI5]	<i>R , 4...R , 5</i>	Analog input AI4...AI5 if VW3A3203 I/O extension module has been inserted
[Ref.Freq-Rmt.Term]	<i>L C C</i>	Display terminal source
[Ref. Freq-Modbus]	<i>M d b</i>	Reference frequency via Modbus
[Ref. Freq-CANopen]	<i>C A n</i>	Reference frequency via CANopen
[Ref. Freq-Com. Module]	<i>n E E</i>	Reference frequency via Com Module
[Embedded Ethernet]	<i>E E H</i>	Embedded Ethernet source
[DI7 PulseInput]...[DI8 PulseInput]	<i>P , 7...P , 8</i>	Digital input DI7...DI8 used as pulse input
[Encoder]	<i>P G</i>	Encoder reference if an encoder module has been inserted.

[PID preset references] P_r - Menu

Access

[Complete settings] → [Generic functions] → [PID controller] → [Reference frequency] → [PID preset references]

About This Menu

The function can be accessed if [PID feedback Assign] $P_r F$ is assigned.

[2 PID Preset Assign] $P_r 2$

2 PID Preset assignment.

If the assigned input or bit is at 0, the function is inactive.

If the assigned input or bit is at 1, the function is active.

Setting	Code / Value	Description
[Not Assigned]	$n \emptyset$	Not assigned Factory setting
[DI1]...[DI8]	$L, I \dots L, B$	Digital input DI1...DI8
[DI11]...[DI16]	$L, I \dots L, 16$	Digital input DI11...DI16 if VW3A3203 I/O extension module has been inserted
[CD00]...[CD10]	$C \emptyset \emptyset \emptyset \dots C \emptyset 10$	Virtual digital input CMD.0...CMD.10 in [I/O profile] \emptyset configuration
[CD11]...[CD15]	$C \emptyset 11 \dots C \emptyset 15$	Virtual digital input CMD.11...CMD.15 regardless of configuration
[C101]...[C110]	$C 10 1 \dots C 1 10$	Virtual digital input CMD1.01...CMD1.10 with integrated Modbus Serial in [I/O profile] \emptyset configuration
[C111]...[C115]	$C 1 1 1 \dots C 1 1 5$	Virtual digital input CMD1.11...CMD1.15 with integrated Modbus Serial regardless of configuration
[C201]...[C210]	$C 2 0 1 \dots C 2 10$	Virtual digital input CMD2.01...CMD2.10 with CANopen® fieldbus module in [I/O profile] \emptyset configuration
[C211]...[C215]	$C 2 1 1 \dots C 2 1 5$	Virtual digital input CMD2.11...CMD2.15 with CANopen® fieldbus module regardless of configuration
[C301]...[C310]	$C 3 0 1 \dots C 3 10$	Virtual digital input CMD3.01...CMD3.10 with a fieldbus module in [I/O profile] \emptyset configuration
[C311]...[C315]	$C 3 1 1 \dots C 3 1 5$	Virtual digital input CMD3.11...CMD3.15 with a fieldbus module regardless of configuration
[C501]...[C510]	$C 5 0 1 \dots C 5 10$	Virtual digital input CMD5.01...CMD5.10 with integrated Ethernet in [I/O profile] \emptyset configuration
[C511]...[C515]	$C 5 1 1 \dots C 5 1 5$	Virtual digital input CMD5.11...CMD5.15 with integrated Ethernet regardless of configuration

[4 PID Preset Assign] $P_r 4$

4 PID Preset assignment.

Identical to [2 PID Preset Assign] $P_r 2$ (see page 399).

Verify that [2 PID Preset Assign] $P_r 2$ has been assigned before assigning this function.

[Ref PID Preset 2] $r P 2$ ★

Second PID preset reference.

This parameter can be accessed only if [2 PID Preset Assign] $P_r 2$ is assigned.

Setting ()	Description
[Min PID reference] $P_r P 1$...[Max PID reference] $P_r P 2$	Setting range Factory setting: 300

[Ref PID Preset 3] *r P 3* ★

Third PID preset reference.

This parameter can be accessed only if **[4 PID Preset Assign] *P r 4*** is assigned.

Setting ()	Description
[Min PID reference] <i>P , P 1</i>...[Max PID reference] <i>P , P 2</i>	Setting range Factory setting: 600

[Ref PID Preset 4] *r P 4* ★

Fourth PID preset reference.

This parameter can be accessed only if **[4 PID Preset Assign] *P r 4*** and **[2 PID Preset Assign] *P r 2*** are assigned.

Setting ()	Description
[Min PID reference] <i>P , P 1</i>...[Max PID reference] <i>P , P 2</i>	Setting range Factory setting: 900

[PID Reference] *r F* - Menu**Access**

[Complete settings] → [Generic functions] → [PID controller] → [PID Reference]

[Predictive Speed Ref] *F P* , ★

Predictive speed reference.

This parameter can be accessed if [Access Level] *L R C* is set to [Expert] *E P r*.

Setting	Code / Value	Description
[No]	<i>n o</i>	Not assigned Factory setting
[AI1]...[AI3]	<i>A , 1...A , 3</i>	Analog input AI1...AI3
[AI4]...[AI5]	<i>A , 4...A , 5</i>	Analog input AI4...AI5 if VW3A3203 I/O extension module has been inserted
[Ref. Freq- Rmt.Term]	<i>L C C</i>	Reference frequency via remote terminal
[Ref. Freq- Modbus]	<i>M d b</i>	Reference frequency via Modbus
[Ref. Freq- CANopen]	<i>C A n</i>	Reference frequency via CANopen
[Ref. Freq-Com. Module]	<i>n E t</i>	Reference frequency via communication module
[Embedded Ethernet]	<i>E t H</i>	Embedded Ethernet
[DI7 PulseInput]...[DI8 PulseInput]	<i>P , 7...P , 8</i>	Digital input DI7...DI8 used as pulse input
[Encoder]	<i>P G</i>	Encoder reference if an encoder module has been inserted.

[Speed Input %] *P S r* ★

PID speed input % reference.

This parameter can be accessed if [Access Level] *L R C* is set to [Expert] *E P r*.

Setting ()	Description
1...100%	Setting range Factory setting: 100%

[Settings] 5 L - Menu

Access

[Complete settings] → [Generic functions] → [PID controller] → [Settings]

About This Menu

Following parameters can be accessed if [PID Feedback] P, F is not set to [Not Configured] $n o$.

NOTE: This function cannot be used with some other functions.

[PID Prop.Gain] $r P G$ ★

PID proportional gain.

Setting ()	Description
0.01...100.00	Setting range Factory setting: 1.00

[PI Intgl.Gain] r , G ★

Integral gain.

Setting ()	Description
0.01...100.00	Setting range Factory setting: 1.00

[PID derivative gain] $r d G$ ★

Derivative gain.

Setting ()	Description
0.00...100.00	Setting range Factory setting: 0.00

[PID ramp] $P r P$ ★

PID acceleration/deceleration ramp, defined to go from [Min PID reference] $P, P 1$ to [Max PID reference] $P, P 2$ and conversely.

Setting ()	Description
0.0...99.9 s	Setting range Factory setting: 0.0 s

[PID Inversion] P , C ★

PID inversion.

Setting	Code / Value	Description
[No]	$n o$	No Factory setting
[Yes]	$Y E S$	Yes

[PID Min Output] $P o L$ ★

PID controller minimum output in Hz.

Setting ()	Description
-599.0...599.0 Hz	Setting range Factory setting: 0.0 Hz

[PID Max Output] P_oH ★

PID controller maximum output in Hz.

Setting ()	Description
0.0...599.0 Hz	Setting range Factory setting: 60.0 Hz

[PID Error Warning] PEr ★

PID error warning.

Setting ()	Description
0...65,535	Setting range Factory setting: 100

[PID Integral OFF] P_iS ★

Integral shunt.

If the assigned input or bit is at 0, the function is inactive (the PID integral is enabled).

If the assigned input or bit is at 1, the function is active (the PID integral is disabled).

Setting	Code / Value	Description
[Not Assigned]	n a	Not assigned Factory setting
[DI1]...[DI8]	L , I ... L , B	Digital input DI1...DI8
[DI11]...[DI16]	L , I I ... L , I B	Digital input DI11...DI16 if VW3A3203 I/O extension module has been inserted
[CD00]...[CD10]	C d 0 0 ... C d 1 0	Virtual digital input CMD.0...CMD.10 in [I/O profile] , a configuration
[CD11]...[CD15]	C d 1 1 ... C d 1 5	Virtual digital input CMD.11...CMD.15 regardless of configuration
[C101]...[C110]	C 1 0 1 ... C 1 1 0	Virtual digital input CMD1.01...CMD1.10 with integrated Modbus Serial in [I/O profile] , a configuration
[C111]...[C115]	C 1 1 1 ... C 1 1 5	Virtual digital input CMD1.11...CMD1.15 with integrated Modbus Serial regardless of configuration
[C201]...[C210]	C 2 0 1 ... C 2 1 0	Virtual digital input CMD2.01...CMD2.10 with CANopen® fieldbus module in [I/O profile] , a configuration
[C211]...[C215]	C 2 1 1 ... C 2 1 5	Virtual digital input CMD2.11...CMD2.15 with CANopen® fieldbus module regardless of configuration
[C301]...[C310]	C 3 0 1 ... C 3 1 0	Virtual digital input CMD3.01...CMD3.10 with a fieldbus module in [I/O profile] , a configuration
[C311]...[C315]	C 3 1 1 ... C 3 1 5	Virtual digital input CMD3.11...CMD3.15 with a fieldbus module regardless of configuration
[C501]...[C510]	C 5 0 1 ... C 5 1 0	Virtual digital input CMD5.01...CMD5.10 with integrated Ethernet in [I/O profile] , a configuration
[C511]...[C515]	C 5 1 1 ... C 5 1 5	Virtual digital input CMD5.11...CMD5.15 with integrated Ethernet regardless of configuration

[PID acceleration time] ACCP ★

PID: acceleration during start-up.

PID start ramp can be applied before starting the PID controller to allow reaching quickly the PID reference without increasing PID gains.

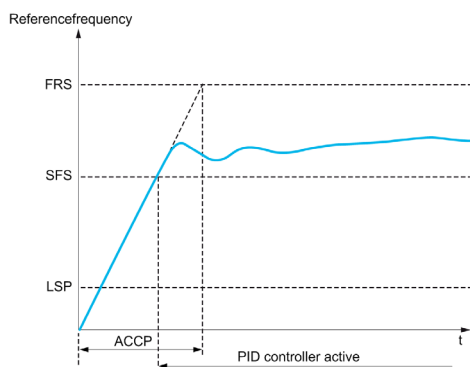

Setting ()	Description
0.01...99,99 s	Setting range Factory setting: 5.00 s
(1) Range 0.01 to 99.99 s or 0.1 to 999.9 s or 1 to 6,000 according to [Ramp increment] <i>inc</i>	

[PID Start Ref Freq] SF5 ★

PID start reference frequency.

Setting ()	Description
0.0...599.0 Hz	Setting range If [PID Start Ref Freq] SF5 is lower than [Low speed] L5P, this function has no effect. Factory setting: 0.0 Hz

Section 8.28

[Generic functions] - [Feedback mon.]

[Feedback monitoring] F K Π - Menu

Access

[Complete settings] → [Generic functions] → [Feedback monitoring]

About This Menu

Identical to [Feedback monitoring] F K Π - Menu (*see page 263*).

Section 8.29

[Generic functions] - [Threshold reached]

[Threshold reached] *L H F E* - Menu

Access

[Complete settings] → [Generic functions] → [Threshold reached]

[Low I Threshold] *L L d L*

Current low threshold value (for [Low Current Reached] *L L H L* warning).

Setting ()	Description
0...65,535 A	Setting range Factory setting: 0 A

[High Current Thd] *L L d*

Current high threshold value (for [Current Thd Reached] *L L H* warning).

Setting ()	Description
0...65,535 A	Setting range Factory setting: Drive nominal current

[Low Freq. Threshold] *F L d L*

Motor low frequency threshold (for [Mot Freq Low Thd] *F L H L* warning).

Setting ()	Description
0.0...599.0 Hz	Setting range Factory setting: 0.0 Hz

[Motor Freq Thd] *F L d*

Motor frequency threshold (for [Mot Freq High Thd] *F L H* warning).

Setting ()	Description
0.0...599.0 Hz	Setting range Factory setting: 50.0 Hz

[2 Freq. Threshold] *F 2 d L*

Motor low frequency second threshold (for [Mot Freq Low Thd 2] *F 2 H L* warning).

Setting ()	Description
0.0...599.0 Hz	Setting range Factory setting: 0.0 Hz

[Freq. threshold 2] *F 2 d*

Motor frequency threshold 2 (for [Mot Freq High Thd 2] *F 2 H* warning).

Setting ()	Description
0.0...599.0 Hz	Setting range Factory setting: 50.0 Hz

[Motor Thermal Thd] *Ⓛ Ⓛ Ⓜ*

Motor thermal state threshold (for **[Motor Therm Thd reached] *Ⓛ Ⓜ Ⓜ*** warning).

Setting (Ⓜ)	Description
0...118%	Setting range Factory setting: 100%

[Motor2 therm. level] *Ⓛ Ⓛ Ⓜ Ⓜ*

Motor 2 thermal state threshold (for **[Mot2 Therm Thd reached] *Ⓛ Ⓜ Ⓜ*** warning).

Setting (Ⓜ)	Description
0...118%	Setting range Factory setting: 100%

[Motor3 therm. level] *Ⓛ Ⓛ Ⓜ Ⓜ*

Motor 3 thermal state threshold (for **[Mot3 Therm Thd reached] *Ⓛ Ⓜ Ⓜ*** warning).

Setting (Ⓜ)	Description
0...118%	Setting range Factory setting: 100%

[Motor4 therm. level] *Ⓛ Ⓛ Ⓜ Ⓜ*

Motor 4 thermal state threshold (for **[Mot4 Therm Thd reached] *Ⓛ Ⓜ Ⓜ*** warning).

Setting (Ⓜ)	Description
0...118%	Setting range Factory setting: 100%

[Reference high Thd] *Ⓛ Ⓛ Ⓜ*

Reference frequency high threshold (for **[Ref Freq High Thd reached] *Ⓛ Ⓜ Ⓜ*** warning).

Setting (Ⓜ)	Description
0.0...599.0 Hz	Setting range Factory setting: 0.0 Hz

[Reference low Thd] *Ⓛ Ⓛ Ⓜ Ⓜ*

Reference frequency low threshold (for **[Ref Freq Low Thd reached] *Ⓛ Ⓜ Ⓜ*** warning).

Setting (Ⓜ)	Description
0.0...599.0 Hz	Setting range Factory setting: 0.0 Hz

[High torque thd.] *Ⓛ Ⓛ Ⓜ*

High torque threshold (for **[High Torque Warning] *Ⓛ Ⓜ Ⓜ*** warning).

Setting (Ⓜ)	Description
-300...300%	Setting range Factory setting: 100%

[Low torque thd.] *L L L*

Low torque threshold (for **[Low Torque Warning]** *L L R* warning).

Setting (°)	Description
-300...300%	Setting range Factory setting: 50%

Section 8.30

[Generic functions] - [Mains contactor command]

[Mains contactor command] L L C - Menu

Access

[Complete settings] → [Generic functions] → [Mains contactor command]

About This Menu

The line contactor closes every time a run command (forward or reverse) is sent and opens after every stop, as soon as the drive is locked. For example, if the stop mode is stop on ramp, the contactor opens when the motor reaches zero speed.

NOTE: The drive control power supply must be provided via an external 24 Vdc source.

NOTICE

DAMAGE TO THE DRIVE

Do not use this function at intervals of less than 60 s.

Failure to follow these instructions can result in equipment damage.

Example circuit (24 Vdc power supply):

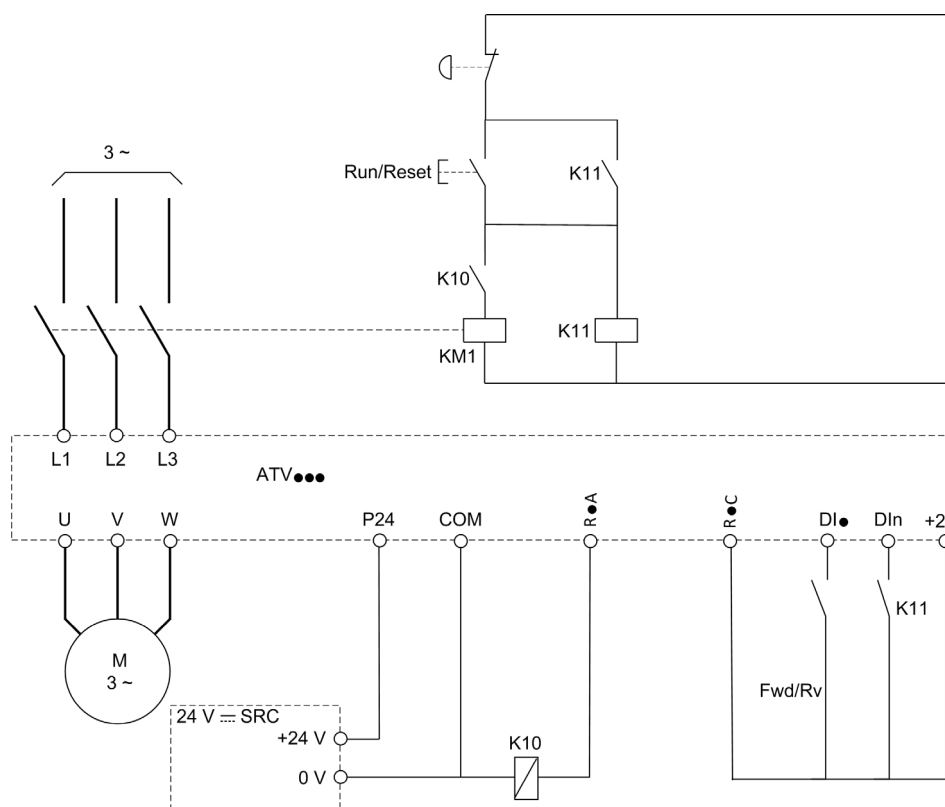

DI• = Run command [Forward] *F r d* or [Reverse] *r r 5*

R•A/R•C = [Mains Contactor] *L L C*

DI• = [Drive Lock] *L E 5*

NOTE: The Run/Reset key must be pressed once the emergency stop key has been released.

[Mains Contactor] L L C

Mains contactor control.

Setting	Code / Value	Description
[No]	<i>n 0</i>	Not assigned Factory setting
[R2]...[R3]	<i>r 2...r 3</i>	Relay output R2...R3
[R4]...[R6]	<i>r 4...r 6</i>	Relay output R4...R6 if VW3A3204 relay output option module has been inserted
[DQ1 Digital Output]	<i>d 0 1</i>	Digital output DQ1
[DQ11 Digital Output]...[DQ12 Digital Output]	<i>d 0 1 1...d 0 1 2</i>	Digital output DQ11...DQ12 if VW3A3203 I/O extension module has been inserted
[R61]...[R66]	<i>r 6 1...r 6 6</i>	Relay R61 ...R66 NOTE: This selection can be accessed on ATV960, ATV980 equipped with Cabinet IO.

[Drive Lock] L E 5 ★

Drive lock assignment.

This parameter can be accessed if **[Mains Contactor] L L C** is not set to **[No] n 0**.

The drive locks when the assigned input or bit changes to 0.

Setting	Code / Value	Description
[Not Assigned]	<i>n 0</i>	Not assigned Factory setting
[CD00]...[CD10]	<i>C d 0 0...C d 1 0</i>	Virtual digital input CMD.0...CMD.10 in [I/O profile] , 0 configuration
[CD11]...[CD15]	<i>C d 1 1...C d 1 5</i>	Virtual digital input CMD.11...CMD.15 regardless of configuration
[C101]...[C110]	<i>C 1 0 1...C 1 1 0</i>	Virtual digital input CMD1.01...CMD1.10 with integrated Modbus Serial in [I/O profile] , 0 configuration
[C111]...[C115]	<i>C 1 1 1...C 1 1 5</i>	Virtual digital input CMD1.11...CMD1.15 with integrated Modbus Serial regardless of configuration
[C201]...[C210]	<i>C 2 0 1...C 2 1 0</i>	Virtual digital input CMD2.01...CMD2.10 with CANopen® fieldbus module in [I/O profile] , 0 configuration
[C211]...[C215]	<i>C 2 1 1...C 2 1 5</i>	Virtual digital input CMD2.11...CMD2.15 with CANopen® fieldbus module regardless of configuration
[C301]...[C310]	<i>C 3 0 1...C 3 1 0</i>	Virtual digital input CMD3.01...CMD3.10 with a fieldbus module in [I/O profile] , 0 configuration
[C311]...[C315]	<i>C 3 1 1...C 3 1 5</i>	Virtual digital input CMD3.11...CMD3.15 with a fieldbus module regardless of configuration
[C501]...[C510]	<i>C 5 0 1...C 5 1 0</i>	Virtual digital input CMD5.01...CMD5.10 with integrated Ethernet in [I/O profile] , 0 configuration
[C511]...[C515]	<i>C 5 1 1...C 5 1 5</i>	Virtual digital input CMD5.11...CMD5.15 with integrated Ethernet regardless of configuration
[DI1 (Low level)]...[DI8 (Low level)]	<i>L 1 L ...L 8 L</i>	Digital input DI1...DI8 used at low level
[DI11 (Low level)]...[DI16 (Low level)]	<i>L 1 1 L ...L 1 6 L</i>	Digital input DI11...DI16 used at low level if VW3A3203 I/O extension module has been inserted
[DI52 (Low level)]...[DI59 (Low level)]	<i>d 5 2 L ...d 5 9 L</i>	Cabinet low level assignment digital inputs NOTE: This selection can be accessed on ATV960, ATV980 equipped with Cabinet IO.

[Mains V. time out] L C L

Monitoring time for closing of line contactor.

Setting	Description
1...999 s	Setting range Factory setting: 5 s

Section 8.31

[Generic functions] - [Output contactor cmd]

[Output contactor cmd] ▢ ▢ ▢ - Menu

Access

[Complete settings] → [Generic functions] → [Output contactor cmd]

About This Menu

This function allows the drive to control and/or monitor a contactor installed between the drive and the motor.

The control of the output contactor by the drive is activated by assigning [Out. contactor Assign] ▢ ▢ ▢. A request to close the contactor is done when a run command is activated. A request to open the contactor is done when no current is applied to the motor.

The monitoring of the output contactor by the drive is activated by assigning the feedback to [Output contact. Fdbk] ▢ ▢ ▢. In the event of an inconsistency, the drive triggers:

- [Out Contact Opened Error] ▢ ▢ ▢ error, if the [Output contact. Fdbk] ▢ ▢ ▢ is not closed before the end of [Delay to motor run] ▢ ▢ ▢ or if the [Output contact. Fdbk] ▢ ▢ ▢ opens if the motor is running.
- [Out Contact Closed Error] ▢ ▢ ▢ error, if [Output contact. Fdbk] ▢ ▢ ▢ is not opened before the end of [Delay to open con.] ▢ ▢ ▢ or if the [Output contact. Fdbk] ▢ ▢ ▢ closes if the motor is stopped.

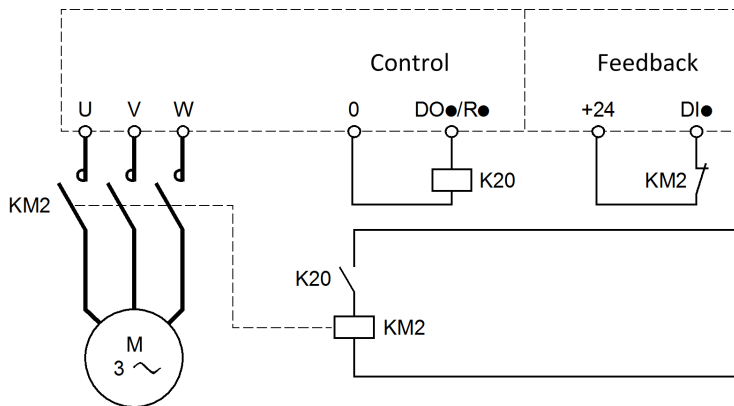

NOTE:

- [Out Contact Opened Error] ▢ ▢ ▢ error can be cleared by a transition from 1 to 0 of the run command.
- [Out. contactor Assign] ▢ ▢ ▢ and [Output contact. fdbk] ▢ ▢ ▢ can be used individually.
- If the DC injection braking function is used, the output contactor does not close as long as DC injection braking is active

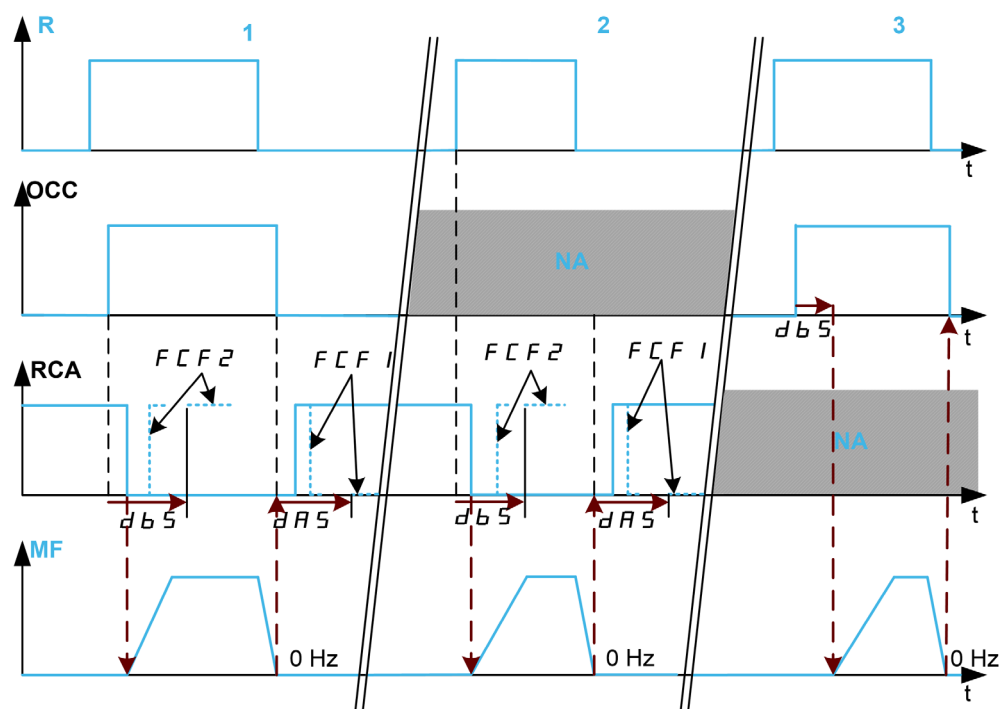

- 1 OCC and RCA assigned
- 2 RCA assigned
- 3 OCC assigned
- t Time
- R Run command
- OCC Output contactor
- RCA Output contactor feedback
- NA Not Assigned
- MF Motor frequency

[Out. Contactor Assign] o C C

Output contactor control.

Setting	Code / Value	Description
[No]	n o	Function not assigned. Factory setting
[R2]...[R3]	r 2...r 3	Relay output R2...R3
[R4]...[R6]	r 4...r 6	Relay output R4...R6 if VW3A3204 relay output option module has been inserted.
[DQ1 Digital Output]	d o 1	Digital output DQ1.
[DQ11 Digital Output]...[DQ12 Digital Output]	d o 1 1...d o 1 2	Digital output DQ11...DQ12 if VW3A3203 I/O extension module has been inserted.
[R61]...[R66]	r 6 1...r 6 6	Relay R61 ...R66 NOTE: This selection can be accessed on ATV960, ATV980 equipped with Cabinet IO.

[Output contact fdbk] r C F

Output contactor fdbk.

The motor starts to run when the assigned digital input or bit switches to 0.

Setting	Code / Value	Description
[Not Assigned]	n o	Not assigned Factory setting

Setting	Code / Value	Description
[DI1 (Low level)]...[DI8 (Low level)]	L 1 L ... L 8 L	Digital input DI1...DI8 used at low level
[DI11 (Low level)]...[DI16 (Low level)]	L 11 L ... L 16 L	Digital input DI11...DI16 used at low level if VW3A3203 I/O extension module has been inserted
[C101]...[C110]	C 10 I ... C 11 I	Virtual digital input CMD1.01...CMD1.10 with integrated Modbus Serial in [I/O profile] configuration
[C111]...[C115]	C 11 I ... C 115 I	Virtual digital input CMD1.11...CMD1.15 with integrated Modbus Serial regardless of configuration
[C201]...[C210]	C 20 I ... C 21 I	Virtual digital input CMD2.01...CMD2.10 with CANopen® fieldbus module in [I/O profile] configuration
[C211]...[C215]	C 21 I ... C 215 I	Virtual digital input CMD2.11...CMD2.15 with CANopen® fieldbus module regardless of configuration
[C301]...[C310]	C 30 I ... C 31 I	Virtual digital input CMD3.01...CMD3.10 with a fieldbus module in [I/O profile] configuration
[C311]...[C315]	C 31 I ... C 315 I	Virtual digital input CMD3.11...CMD3.15 with a fieldbus module regardless of configuration
[C501]...[C510]	C 50 I ... C 51 I	Virtual digital input CMD5.01...CMD5.10 with integrated Ethernet in [I/O profile] configuration
[C511]...[C515]	C 51 I ... C 515 I	Virtual digital input CMD5.11...CMD5.15 with integrated Ethernet regardless of configuration

[Delay to motor run] d b 5

Delay to close o/p cont.

This parameter delays:

- Motor control following the sending of a run command when the drive only monitors the output contactor.
- The [Out Contact Opened Error] F C F 2 error monitoring if the [Output contact fdbk] r C R is assigned.

The time delay must be greater than the closing time of the output contactor.

This parameter can be accessed if [Out. contactor Assign] a C C or [Output contact fdbk] r C R is assigned.

Setting	Description
0.05...60.00 s	Setting range Factory setting: 0.15 s

[Delay to open con.] d R 5

Delay to open contactor

This delay must be greater than the opening time of the output contactor.

If the value of digital input assigned to the [Output contact fdbk] r C R is not 0 at the end of this delay, [Out Contact Closed Error] F C F 1 error is triggered. If this parameter is set to 0, the [Out Contact Closed Error] F C F 1 error is not monitored.

This parameter can be accessed if [Output contact fdbk] r C R is assigned.

Setting	Description
0.00...5.00 s	Setting range Factory setting: 0.10 s

Section 8.32

[Generic functions] - [Reverse disable]

[Reverse disable] 𐀀 𐀁 - Menu

Access

[Complete settings] → [Generic functions] → [Reverse disable]

[Reverse Disable] 𐀁 𐀂

Reverse direction disable.

Reverse direction requests sent by digital inputs are taken into account.

Reverse direction requests sent by the Graphic Display Terminal or sent by the line are not taken into account.

Any reverse speed reference originating from the PID, summing input, and so on, is interpreted as a zero reference (0 Hz).

Setting	Code / Value	Description
[No]	𐀁 𐀂	No Factory setting
[Yes]	𐀃 𐀄 𐀅	Yes

Section 8.33

[Generic functions] - [Torque limitation]

[Torque limitation] $E \square L$ - Menu

Access

[Complete settings] → [Generic functions] → [Torque limitation]

About This Menu

There are 2 types of torque limitation:

- With a value that is fixed by a parameter (torque or power)
- With a value that is set by an analog input (AI or pulse)

If both types are enabled, the lowest value is taken into account.

These 2 types can be configured or switched remotely using a digital input or via the communication bus.

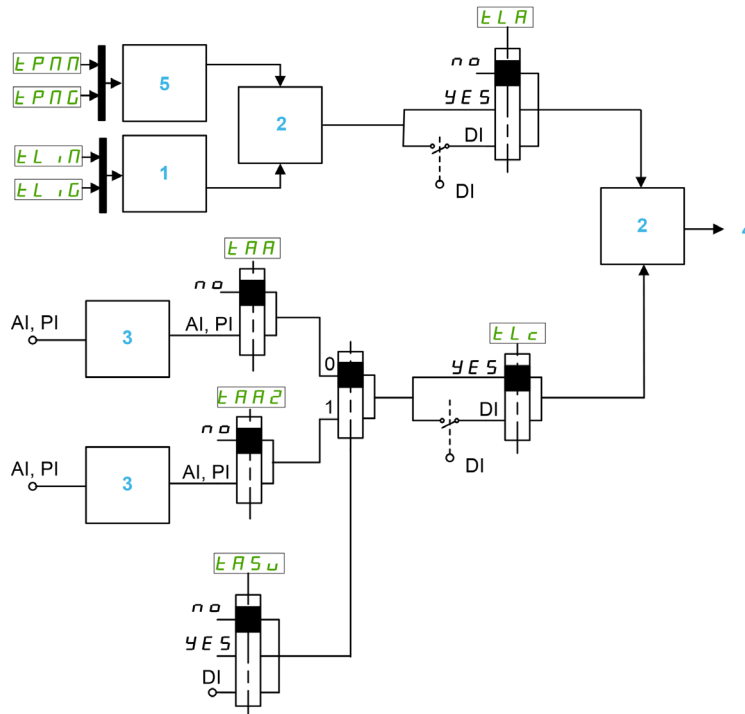

- 1 Torque limitation via parameter
- 2 Lowest value taken into account
- 3 Torque limitation via analog input, RP
- 4 Limitation value
- 5 Torque limitation via parameter in power

[Torque limit activ.] $E L A$

Activation of the permanent torque limitation.

If the assigned input or bit is at 0, the function is inactive.

If the assigned input or bit is at 1, the function is active.

Setting	Code / Value	Description
[Not Assigned]	$n a$	Not assigned Factory setting
[Yes]	$Y E S$	Yes
[DI1]...[DI8]	$L 1 \dots L 8$	Digital input DI1...DI8

Setting	Code / Value	Description
[DI11]...[DI16]	L 1 1 1...L 1 1 6	Digital input DI11...DI16 if VW3A3203 I/O extension module has been inserted
[CD00]...[CD10]	C d 0 0...C d 1 0	Virtual digital input CMD.0...CMD.10 in [I/O profile] , a configuration
[CD11]...[CD15]	C d 1 1...C d 1 5	Virtual digital input CMD.11...CMD.15 regardless of configuration
[C101]...[C110]	C 1 0 1...C 1 1 0	Virtual digital input CMD1.01...CMD1.10 with integrated Modbus Serial in [I/O profile] , a configuration
[C111]...[C115]	C 1 1 1...C 1 1 5	Virtual digital input CMD1.11...CMD1.15 with integrated Modbus Serial regardless of configuration
[C201]...[C210]	C 2 0 1...C 2 1 0	Virtual digital input CMD2.01...CMD2.10 with CANopen® fieldbus module in [I/O profile] , a configuration
[C211]...[C215]	C 2 1 1...C 2 1 5	Virtual digital input CMD2.11...CMD2.15 with CANopen® fieldbus module regardless of configuration
[C301]...[C310]	C 3 0 1...C 3 1 0	Virtual digital input CMD3.01...CMD3.10 with a fieldbus module in [I/O profile] , a configuration
[C311]...[C315]	C 3 1 1...C 3 1 5	Virtual digital input CMD3.11...CMD3.15 with a fieldbus module regardless of configuration
[C501]...[C510]	C 5 0 1...C 5 1 0	Virtual digital input CMD5.01...CMD5.10 with integrated Ethernet in [I/O profile] , a configuration
[C511]...[C515]	C 5 1 1...C 5 1 5	Virtual digital input CMD5.11...CMD5.15 with integrated Ethernet regardless of configuration

[Pmax Motor] $\epsilon P \Pi \Pi$ ★

Maximum power in motor mode.

This parameter can be accessed if **[Torque limit activ.] $\epsilon L H$** is not set to **[Not Assigned] n a**.

Setting ()	Description
10...300%	Setting range Factory setting: 300%

[Pmax Generator] $\epsilon P \Pi G$ ★

Maximum acceptable power in generator mode.

This parameter can be accessed if **[Torque limit activ.] $\epsilon L H$** is not set to **[Not Assigned] n a**.

Setting ()	Description
10...300%	Setting range Factory setting: 300%

[Torque increment] $\epsilon n \epsilon P$ ★

Torque limitation increment.

This parameter can be accessed if **[Torque limit activ.] $\epsilon L H$** is not set to **[No] n a**.

Selection of units for the **[Motoring torque lim] $\epsilon L , \Pi$** and **[Gen. torque limit] $\epsilon L , G$** parameters.

Setting	Code / Value	Description
0.1%	D. 1	Unit 0.1%
1%	I	Unit 1% Factory setting

[Motoring torque lim] $\text{E L } , \text{P} \star$

Motor torque limitation.

This parameter can be accessed if **[Torque limit activ.] $\text{E L } \text{R}$** is not set to **[No] n o** .

Torque limitation in motor mode, as a % or in 0.1% increments of the rated torque in accordance with the **[Torque increment] $, \text{n } \text{E } \text{P}$** parameter.

Setting ()	Description
0...300%	Setting range Factory setting: 100%

[Gen. torque limit] $\text{E L } , \text{G} \star$

Generative torque limitation.

This parameter can be accessed if **[Torque limit activ.] $\text{E L } \text{R}$** is not set to **[No] n o** .

Torque limitation in generator mode, as a % or in 0.1% increments of the rated torque in accordance with the **[Torque increment] $, \text{n } \text{E } \text{P}$** parameter.

Setting ()	Description
0...300%	Setting range Factory setting: 100%

[Analog limit activ.] $\text{E L } \text{C} \star$

Activation (analog input) by a digital input.

This parameter cannot be accessed if **[Ref Torque Assign] $\text{E } \text{R } \text{R}$** or **[Ref Torque 2 Assign] $\text{E } \text{R } \text{R } \text{2}$** is configured.

Identical to **[Torque limit activ.] $\text{E L } \text{R}$** .

If the assigned input or bit is at 0:

- The limitation is specified by the **[Motor torque limit] $\text{E L } , \text{P}$** and **[Gen. torque limit] $\text{E L } , \text{G}$** parameters if **[Torque limit activ.] $\text{E L } \text{R}$** is not set to **[No] n o** .
- No limitation if **[Torque limit activ.] $\text{E L } \text{R}$** is set to **[No] n o** .

If the assigned input or bit is at 1: the limitation depends on the input assigned by **[Ref Torque Assign] $\text{E } \text{R } \text{R}$** or **[Ref Torque 2 Assign] $\text{E } \text{R } \text{R } \text{2}$** .

NOTE: If both limitation (by input assigned and parameter) are enabled at the same time, the lowest value is taken into account.

[Ref Torque Assign] $\text{E } \text{R } \text{R}$

Activation by an analog value.

If the function is assigned, the limitation varies between 0% and 300% of the rated torque based on the 0% to 100% signal applied to the assigned input.

Examples: 12 mA on a 4-20 mA input results in a limitation to 150% of the rated torque 2.5 Vdc on a 10 Vdc input results in 75% of the rated torque.

Setting	Code / Value	Description
[No]	n o	Analog input is not assigned Factory setting
[AI1]...[AI3]	$\text{R } , \text{1} \dots \text{R } , \text{3}$	Analog input AI1...AI3
[AI4]...[AI5]	$\text{R } , \text{4} \dots \text{R } , \text{5}$	Analog input AI4...AI5 if VW3A3203 I/O extension module has been inserted
[AI Virtual 1]	$\text{R } , \text{V } \text{1}$	Virtual analogic input 1
[DI7 PulseInput]...[DI8 PulseInput]	$\text{P } , \text{7} \dots \text{P } , \text{8}$	Digital input DI7...DI8 used as pulse input
[Encoder]	$\text{P } \text{G}$	Encoder reference if an encoder module has been inserted.

[Ref Torque Switch Assign] L R S U

Reference torque switch assignment.

This parameter can be accessed if **[Ref Torque Assign] L R R** or **[Ref Torque 2 Assign] L R R 2** are not set to **[No] n o**.

Identical to **[Torque limit activ.] L L R**.

[Ref Torque 2 Assign] L R R 2

Activation by another analog value.

Identical to **[Ref Torque Assign] L R R**.

[Trq/l limit. stop] S S b

Torque current limitation: behavior configuration.

Setting	Code / Value	Description
[Ignore]	n o	Detected error ignored Factory setting
[Freewheel Stop]	Y E S	Freewheel stop
[Per STT]	S t t	Stop according to [Type of stop] S t t parameter but without an error triggered after stop
[Fallback Speed]	L F F	Change to fallback speed, maintained as long as the detected error persists and the run command has not been removed ⁽¹⁾
[Spd maintained]	r L S	Speed maintained as long as the detected error persists and the run command has not been removed ⁽¹⁾
[Ramp stop]	r P P	Stop on ramp
[Fast stop]	F S t	Fast stop
[DC injection]	d C i	DC injection
1 Because, in this case, the detected error does not trigger a stop, it is recommended to assign a relay or logic output to its indication.		

[Trq/l limit. time out] S t o

Torque current limitation: **[Torque Limitation Error] S S F** error delay and **[Torque Limit Reached] S S R** warning delay.

Setting ()	Description
0...9,999 ms	Setting range Factory setting: 1,000 ms

Section 8.34

[Generic functions] - [2nd current limit.]

[2nd current limit.] *L L* , - Menu

Access

[Complete settings] → [Generic functions] → [2nd current limit.]

[Current Limitation2] *L C 2*

Current limitation switching assignment

If the assigned input or bit is at 0, the first current limitation is active.

If the assigned input or bit is at 1, the second current limitation is active.

Setting	Code / Value	Description
[Not Assigned]	<i>n a</i>	Not assigned Factory setting
[DI1]...[DI8]	<i>L , I...L , B</i>	Digital input DI1...DI8
[DI11]...[DI16]	<i>L , I I...L , I B</i>	Digital input DI11...DI16 if VW3A3203 I/O extension module has been inserted
[CD00]...[CD10]	<i>C d 0 0...C d 1 0</i>	Virtual digital input CMD.0...CMD.10 in [I/O profile] , <i>a</i> configuration
[CD11]...[CD15]	<i>C d 1 1...C d 1 5</i>	Virtual digital input CMD.11...CMD.15 regardless of configuration
[C101]...[C110]	<i>C 1 0 1...C 1 1 0</i>	Virtual digital input CMD1.01...CMD1.10 with integrated Modbus Serial in [I/O profile] , <i>a</i> configuration
[C111]...[C115]	<i>C 1 1 1...C 1 1 5</i>	Virtual digital input CMD1.11...CMD1.15 with integrated Modbus Serial regardless of configuration
[C201]...[C210]	<i>C 2 0 1...C 2 1 0</i>	Virtual digital input CMD2.01...CMD2.10 with CANopen® fieldbus module in [I/O profile] , <i>a</i> configuration
[C211]...[C215]	<i>C 2 1 1...C 2 1 5</i>	Virtual digital input CMD2.11...CMD2.15 with CANopen® fieldbus module regardless of configuration
[C301]...[C310]	<i>C 3 0 1...C 3 1 0</i>	Virtual digital input CMD3.01...CMD3.10 with a fieldbus module in [I/O profile] , <i>a</i> configuration
[C311]...[C315]	<i>C 3 1 1...C 3 1 5</i>	Virtual digital input CMD3.11...CMD3.15 with a fieldbus module regardless of configuration
[C501]...[C510]	<i>C 5 0 1...C 5 1 0</i>	Virtual digital input CMD5.01...CMD5.10 with integrated Ethernet in [I/O profile] , <i>a</i> configuration
[C511]...[C515]	<i>C 5 1 1...C 5 1 5</i>	Virtual digital input CMD5.11...CMD5.15 with integrated Ethernet regardless of configuration

[Current Limit2 Value] $C L 2$ ★

Current limitation 2 value.

This parameter can be accessed if **[Current Limitation2] $C L 2$** is not set to **[No] $n o$** .

NOTICE**OVERHEATING**

- Verify that the motor is properly rated for the maximum current to be applied to the motor.
- Verify that the parameter **[Current Limitation] $C L 1$** is set to a value lower or equal to the value shown in this table.
- Consider the duty cycle of the motor and all factors of your application including derating requirements in determining the current limit.

Failure to follow these instructions can result in equipment damage.

The adjustment range is limited to 1.5 I_n .

NOTE: If the setting is less than 0.25 I_n , the drive may lock in **[Output Phase Loss] $O P L$** if this has been enabled. If it is less than the no-load motor current, the motor cannot run.

Setting (°)	Description
0...1.5 $I_n^{(1)}$	Setting range Factory setting: 1.2 $I_n^{(1)}$
(1) I_n corresponds to the rated drive current indicated in the Installation Manual and on the drive nameplate.	

[Current limitation] $C L 1$ ★

First current limitation value

NOTICE**OVERHEATING**

- Verify that the motor is properly rated for the maximum current to be applied to the motor.
- Verify that the parameter **[Current Limitation] $C L 1$** is set to a value lower or equal to the value shown in this table.
- Consider the duty cycle of the motor and all factors of your application including derating requirements in determining the current limit.

Failure to follow these instructions can result in equipment damage.

The adjustment range is limited to 1.5 I_n .

NOTE: If the setting is less than 0.25 I_n , the drive may lock in **[Output Phase Loss] $O P L$** if this has been enabled. If it is less than the no-load motor current, the motor cannot run.

Setting (°)	Description
0...1.5 $I_n^{(1)}$	Setting range Factory setting: 1.2 $I_n^{(1)}$
(1) I_n corresponds to the rated drive current indicated in the Installation Manual and on the drive nameplate.	

Section 8.35

[Generic functions] - [Jog]

[Jog] JOG - Menu

Access

[Complete settings] → [Generic functions] → [Jog]

[Jog Assign] JOG

Jog assignment.

The JOG function is only active if the command channel and the reference channels are on the terminals.

This function can be used if:

- [PID Feedback] PIF is set to [Not Configured] no, and
- [Brake logic control] bllc is set to [No] no, and
- [High speed hoisting] H50 is set to [No] no, and
- [+ Speed Assign] u51 and [- Speed Assign] d51 are set to [Not Assigned] no, and
- [Ref Freq 2 Config] Fr2 is set to [Ref Frequency via DI] uPdt.

The function is active when the assigned input or bit is at 1.

Example: 2-wire control operation ([2/3-Wire Control] tlc = [2-Wire Control] zc).

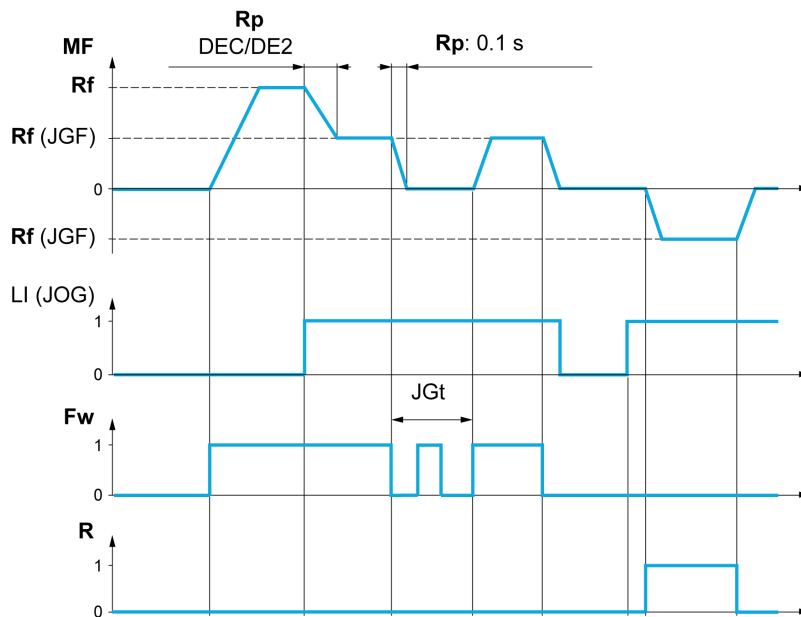

- MF Motor frequency
- Rf Reference
- Rp Ramp
- Rp: 0.1 s Ramp forced to 0.1 S
- Fw Forward
- R Reverse

Setting	Code / Value	Description
[Not Assigned]	no	Not assigned Factory setting
[DI1]...[DI8]	L1...L8	Digital input DI1...DI8
[DI11]...[DI16]	L11...L16	Digital input DI11...DI16 if VW3A3203 I/O extension module has been inserted
[CD00]...[CD10]	CD00...CD10	Virtual digital input CMD.0...CMD.10 in [I/O profile] configuration

Setting	Code / Value	Description
[CD11]...[CD15]	C d 1 1...C d 1 5	Virtual digital input CMD.11...CMD.15 regardless of configuration
[C101]...[C110]	C 1 0 1...C 1 1 0	Virtual digital input CMD1.01...CMD1.10 with integrated Modbus Serial in [I/O profile] configuration
[C111]...[C115]	C 1 1 1...C 1 1 5	Virtual digital input CMD1.11...CMD1.15 with integrated Modbus Serial regardless of configuration
[C201]...[C210]	C 2 0 1...C 2 1 0	Virtual digital input CMD2.01...CMD2.10 with CANopen® fieldbus module in [I/O profile] configuration
[C211]...[C215]	C 2 1 1...C 2 1 5	Virtual digital input CMD2.11...CMD2.15 with CANopen® fieldbus module regardless of configuration
[C301]...[C310]	C 3 0 1...C 3 1 0	Virtual digital input CMD3.01...CMD3.10 with a fieldbus module in [I/O profile] configuration
[C311]...[C315]	C 3 1 1...C 3 1 5	Virtual digital input CMD3.11...CMD3.15 with a fieldbus module regardless of configuration
[C501]...[C510]	C 5 0 1...C 5 1 0	Virtual digital input CMD5.01...CMD5.10 with integrated Ethernet in [I/O profile] configuration
[C511]...[C515]	C 5 1 1...C 5 1 5	Virtual digital input CMD5.11...CMD5.15 with integrated Ethernet regardless of configuration

[Jog frequency] JGF ★

This parameter can be accessed if [Jog Assign] JAG is not set to [No] no.

Setting (°)	Description
0.0...10.0 Hz	Setting range Factory setting: 10.0 Hz

[Jog Delay] JGE ★

This parameter can be accessed if [Jog Assign] (JAG) is not set to [No] (no).

Setting (°)	Description
0.0...2.0 s	Setting range Factory setting: 0.5 s

Section 8.36

[Generic functions] - [High Speed Switching]

[High Speed Switching] CH5 - Menu

Access

[Complete settings] → [Generic functions] → [High Speed Switching]

[2 High speed] 5H2

2 High speed assign.

Setting	Code / Value	Description
[Not Assigned]	n a	Not assigned Factory setting
[Mot Freq High Thd]	F t H	Motor frequency high threshold reached
[2nd Freq Thd Reached]	F 2 H	Second frequency threshold reached
[DI1]...[DI8]	L , I...L , B	Digital input DI1...DI8
[DI11]...[DI16]	L , I I...L , I B	Digital input DI11...DI16 if VW3A3203 I/O extension module has been inserted
[CD00]...[CD10]	C d 0 0...C d 1 0	Virtual digital input CMD.0...CMD.10 in [I/O profile] , a configuration
[CD11]...[CD15]	C d 1 1...C d 1 5	Virtual digital input CMD.11...CMD.15 regardless of configuration
[C101]...[C110]	C 1 0 1...C 1 1 0	Virtual digital input CMD1.01...CMD1.10 with integrated Modbus Serial in [I/O profile] , a configuration
[C111]...[C115]	C 1 1 1...C 1 1 5	Virtual digital input CMD1.11...CMD1.15 with integrated Modbus Serial regardless of configuration
[C201]...[C210]	C 2 0 1...C 2 1 0	Virtual digital input CMD2.01...CMD2.10 with CANopen® fieldbus module in [I/O profile] , a configuration
[C211]...[C215]	C 2 1 1...C 2 1 5	Virtual digital input CMD2.11...CMD2.15 with CANopen® fieldbus module regardless of configuration
[C301]...[C310]	C 3 0 1...C 3 1 0	Virtual digital input CMD3.01...CMD3.10 with a fieldbus module in [I/O profile] , a configuration
[C311]...[C315]	C 3 1 1...C 3 1 5	Virtual digital input CMD3.11...CMD3.15 with a fieldbus module regardless of configuration
[C501]...[C510]	C 5 0 1...C 5 1 0	Virtual digital input CMD5.01...CMD5.10 with integrated Ethernet in [I/O profile] , a configuration
[C511]...[C515]	C 5 1 1...C 5 1 5	Virtual digital input CMD5.11...CMD5.15 with integrated Ethernet regardless of configuration

[4 High speed] 5H4

4 High speed assign.

NOTE: In order to obtain 4 High speed, **[2 High speed] 5H2** must also be configured.

Identical to **[2 High speed] 5H2**.

[High speed] H 5 P

Motor frequency at maximum reference, can be set between **[Low speed] L 5 P** and **[Max frequency] F r**.

The factory setting changes to 60 Hz if **[Motor Standard] b F r** is set to **[60Hz NEMA] B D**.

Setting ()	Description
0...599 Hz	Setting range Factory setting: 50 Hz

[High speed 2] H 5 P 2 ★

Visible if **[2 High speed] 5 H 2** is not set to **[No] n o**.

Identical to **[High speed] H 5 P**.

[High speed 3] H 5 P 3 ★

Visible if **[4 High speed] 5 H 4** is not set to **[No] n o**.

Identical to **[High speed] H 5 P**.

[High speed 4] H 5 P 4 ★

Visible if **[4 High speed] 5 H 4** is not set to **[No] n o**.

Identical to **[High speed] H 5 P**.

Section 8.37

[Generic functions] - [Memo reference frequency]

[Memo reference frequency] 5 P 7 - Menu

Access

[Complete settings] → [Generic functions] → [Memo reference frequency]

About This Menu

Saving a speed reference value using a digital input command lasting longer than 0.1 s.

- This function is used to control the speed of several drives alternately via a single analog reference and one digital input for each drive.
- It is also used to confirm a line reference (communication bus or network) on several drives via a digital input. This allows movements to be synchronized by getting rid of variations when the reference is set.
- The reference is acquired 100 ms after the rising edge of the request. A new reference is not then acquired until a new request is made.

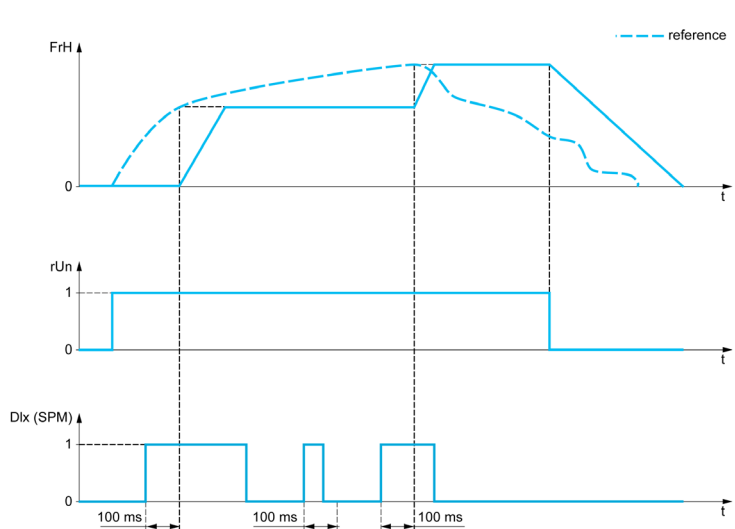

rFr Motor frequency
 FrH Reference frequency before ramp
 rUn Run command
 Dlx (SPM) [Ref Freq Memo assign] 5 P 7

[Ref Freq Memo assign] 5 P 7

Reference frequency memory assignment
 Function active if the assigned input is at active state.

Setting	Code / Value	Description
[Not Assigned]	n o	Not assigned Factory setting
[DI1]...[DI8]	L , I...L , B	Digital input DI1...DI8
[DI11]...[DI16]	L , I I...L , I B	Digital input DI11...DI16 if VW3A3203 I/O extension module has been inserted

Section 8.38

[Generic functions] - [Brake logic control]

[Brake logic control] *b l c* - Menu

Access

[Complete settings] → [Generic functions] → [Brake logic control]

About This Menu

Identical to [Brake logic control] *b l c* - menu (*see page 323*).

Section 8.39

[Generic functions] - [Limit switches]

[Limit switches] L 5 E - Menu

Access

[Complete settings] → [Generic functions] → [Limit switches]

About This Menu

This function can be used to manage trajectory limits using limit switches

The stop mode is configurable. When the stop contact is activated, startup in the other direction is authorized.

Example:

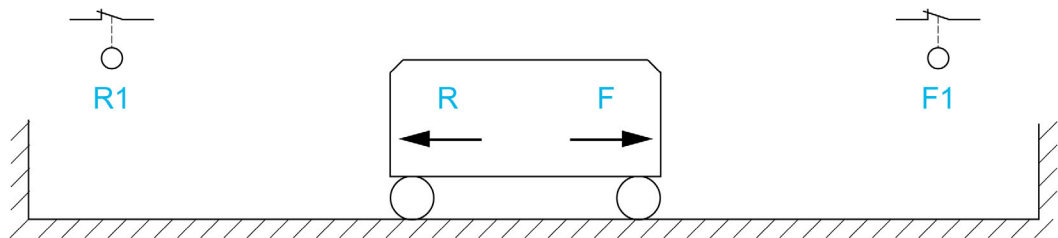

- R Reverse
- R1 Reverse stop
- F Forward
- F1 Forward stop

The stop is activated when the input is at 0 (contact open).

[Stop FW assign] L R F

Stop forward limit assignment.

Setting	Code / Value	Description
[Not Assigned]	n o	Not assigned Factory setting
[CD00]...[CD10]	C d 0 0 ... C d 1 0	Virtual digital input CMD.0...CMD.10 in [I/O profile] , o configuration
[CD11]...[CD15]	C d 1 1 ... C d 1 5	Virtual digital input CMD.11...CMD.15 regardless of configuration
[C101]...[C110]	C 1 0 1 ... C 1 1 0	Virtual digital input CMD1.01...CMD1.10 with integrated Modbus Serial in [I/O profile] , o configuration
[C111]...[C115]	C 1 1 1 ... C 1 1 5	Virtual digital input CMD1.11...CMD1.15 with integrated Modbus Serial regardless of configuration
[C201]...[C210]	C 2 0 1 ... C 2 1 0	Virtual digital input CMD2.01...CMD2.10 with CANopen® fieldbus module in [I/O profile] , o configuration
[C211]...[C215]	C 2 1 1 ... C 2 1 5	Virtual digital input CMD2.11...CMD2.15 with CANopen® fieldbus module regardless of configuration
[C301]...[C310]	C 3 0 1 ... C 3 1 0	Virtual digital input CMD3.01...CMD3.10 with a fieldbus module in [I/O profile] , o configuration
[C311]...[C315]	C 3 1 1 ... C 3 1 5	Virtual digital input CMD3.11...CMD3.15 with a fieldbus module regardless of configuration
[C501]...[C510]	C 5 0 1 ... C 5 1 0	Virtual digital input CMD5.01...CMD5.10 with integrated Ethernet in [I/O profile] , o configuration
[C511]...[C515]	C 5 1 1 ... C 5 1 5	Virtual digital input CMD5.11...CMD5.15 with integrated Ethernet regardless of configuration

Setting	Code / Value	Description
[DI1 (Low level)]...[DI8 (Low level)]	<i>L 1 L ... L 8 L</i>	Digital input DI1...DI8 used at low level
[DI11 (Low level)]...[DI16 (Low level)]	<i>L 11 L ... L 16 L</i>	Digital input DI11...DI16 used at low level if VW3A3203 I/O extension module has been inserted
[DI52 (Low level)]...[DI59 (Low level)]	<i>d 5 2 L ... d 5 9 L</i>	Cabinet low level assignment digital inputs NOTE: This selection can be accessed on ATV960, ATV980 equipped with Cabinet IO.

[Stop RV assign] L R r

Stop reverse limit assignment.

Identical to **[Stop FW assign] L R F**.

[Stop type] L R S

Stop type on limit switch.

This parameter can be accessed if **[Stop FW assign] L R F** or **[Stop RV assign] L R r** is assigned.

When the assigned input changes to 0, the stop is controlled in accordance with the selected type. Restarting is only authorized for the other operating direction once the motor has stopped. If the two inputs **[Stop FW assign] L R F** and **[Stop RV assign] L R r** are assigned and at state 0, restarting will be impossible.

Setting	Code / Value	Description
[On Ramp]	<i>r n P</i>	Stop on ramp
[Fast stop]	<i>F S t</i>	Fast stop
[Freewheel Stop]	<i>n S t</i>	Freewheel stop Factory setting

Section 8.40

[Generic functions] - [Positioning by sensors]

[Positioning by sensors] L P □

Access

[Complete settings] → [Generic functions] → [Positioning by sensors]

About This Menu

This function is used for managing positioning using position sensors or limit switches linked to digital inputs or using control word bits:

- Slowing down
- Stopping

The action digital for the inputs and bits can be configured on a rising edge (change from 0 to 1) or a falling edge (change from 1 to 0). The example below has been configured on a rising edge:

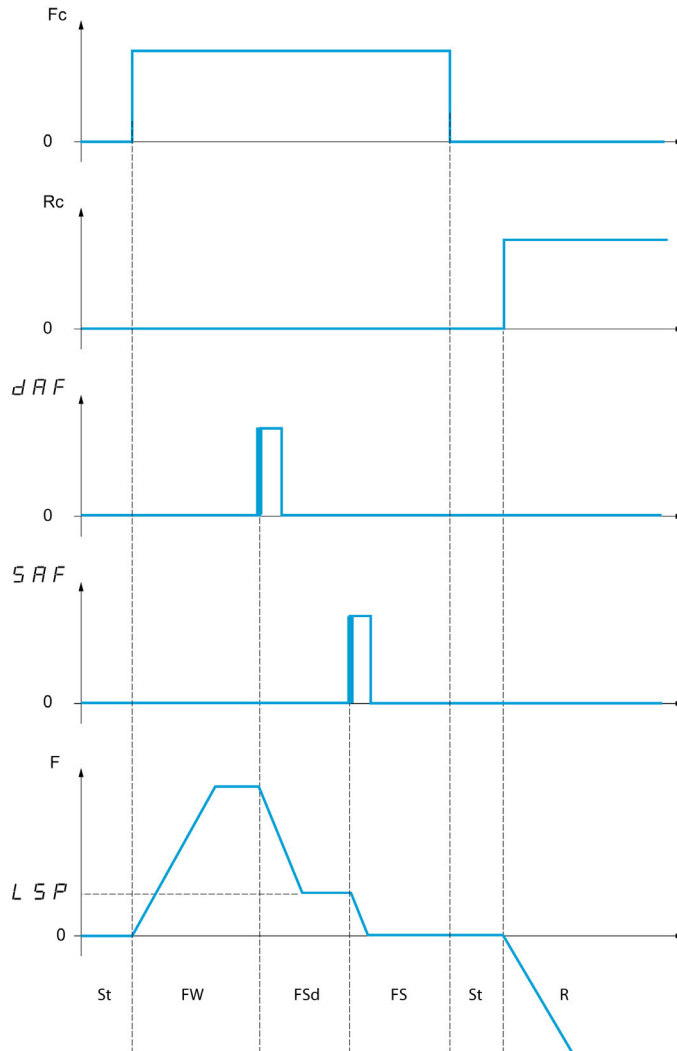

- Fc** Forward run command
- Rc** Reverse run command
- F** Frequency
- FW** Forward
- FSd** Forward Slowdown
- FS** Forward Stopping
- St** Stop
- R** Reverse

The slowdown mode and stop mode can be configured.

The operation is identical for both directions of operation. Slowdown and stopping operate according to the same logic, described below.

Example: Forward slowdown, on rising edge

- Forward slowdown takes place on a rising edge (change from 0 to 1) of the input or bit assigned to forward slowdown if this rising edge occurs in forward operation. The slowdown command is then stored, even in the event of a power outage. Operation in the opposite direction is authorized at high speed. The slowdown command is deleted on a falling edge (change from 1 to 0) of the input or bit assigned to forward slowdown if this falling edge occurs in reverse operation.
- A bit or a digital input can be assigned to disable this function.
- Although forward slowdown is disabled while the disable input or bit is at 1, sensor changes continue to be monitored and saved.

Example: Positioning on a limit switch, on rising edge

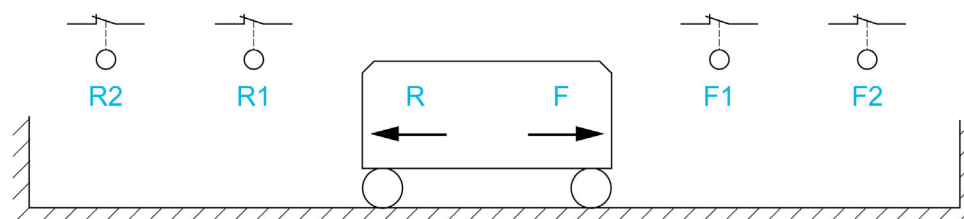

- R** Reverse
R1 Reverse slowdown
R2 Reverse stop
F Forward
F1 Forward slowdown
F2 Forward stop

⚠ WARNING

LOSS OF CONTROL

- Verify correct connection of the limit switches.
- Verify the correct installation of the limit switches. The limit switches must be mounted in a position far enough away from the mechanical stop to allow for an adequate stopping distance.
- You must release the limit switches before you can use them.
- Verify the correct function of the limit switches.

Failure to follow these instructions can result in death, serious injury, or equipment damage.

Operation with short cams:

⚠ WARNING

LOSS OF CONTROL

When operating for the first time or after a reset of the configuration to the factory settings, the motor must always be started outside of the Slowdown and Stop ranges.

Failure to follow these instructions can result in death, serious injury, or equipment damage.

⚠ WARNING

LOSS OF CONTROL

When the drive is switched off, it stores the range which it is currently in.

If the system is moved manually while the drive is off, you must restore the original position before switching it on again.

Failure to follow these instructions can result in death, serious injury, or equipment damage.

In this instance, when operating for the first time or after restoring the factory settings, the drive must initially be started outside the slowdown and stop zones in order to initialize the function.

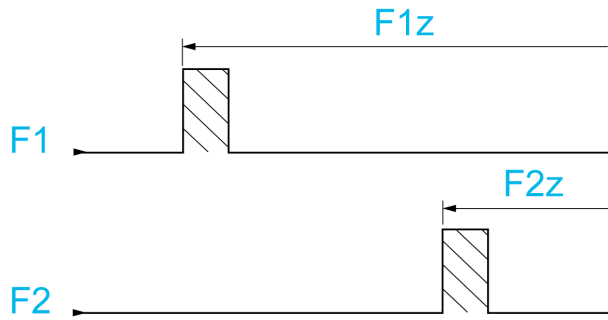

F1 Forward slowdown
F1z Forward slowdown zone
F2 Forward stop
F2z Forward stop zone

Operation with long cams:

In this instance, there is no restriction, which means that the function is initialized across the whole trajectory.

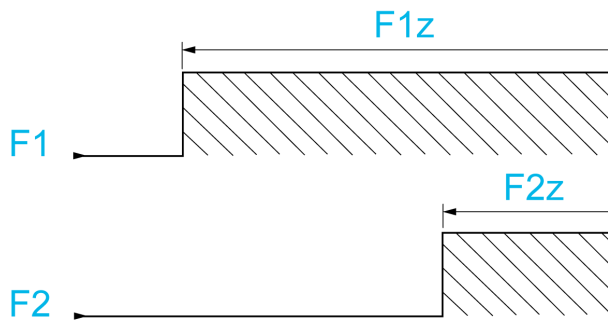

F1 Forward slowdown
F1z Forward slowdown zone
F2 Forward stop
F2z Forward stop zone

Stop at distance calculated after deceleration limit switch

This function can be used to control the stopping of the moving part automatically once a preset distance has been traveled after the slowdown limit switch. On the basis of the rated linear speed and the speed estimated by the drive when the slowdown limit switch is tripped, the drive will induce the stop at the configured distance. This function is useful in applications where one manual-reset overtravel limit switch is common to both directions. It will then only respond to help management if the distance is exceeded. The stop limit switch retains priority in respect of the function.

The **[Deceleration type] d 5 F** parameter can be configured to obtain either of the functions described below:

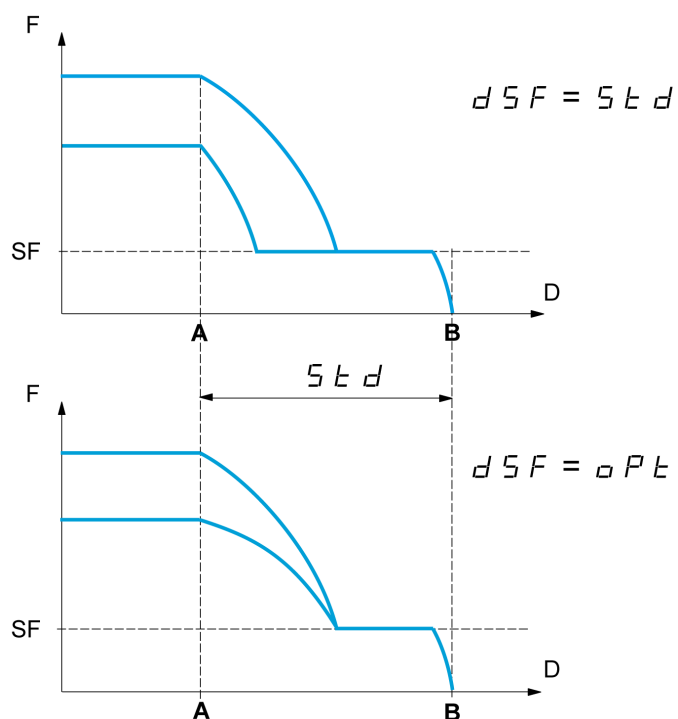

- A** Slowdown limit switch reached
- B** Automatic stop at a distance
- D** Distance
- F** Frequency
- SF** Slowdown frequency

Note:

- If the deceleration ramp is modified while stopping at a distance is in progress, this distance will not be observed.
- If the direction is modified while stopping at a distance is in progress, this distance will not be observed.

⚠ WARNING

LOSS OF CONTROL

Verify that the configured distance is actually possible.

This function does not replace the limit switch.

Failure to follow these instructions can result in death, serious injury, or equipment damage.

[Stop FW limit sw.] 5 FF

Stop switch forward.

Setting	Code / Value	Description
[Not Assigned]	n o	Not assigned Factory setting
[DI1]...[DI8]	L , I...L , B	Digital input DI1...DI8
[DI11]...[DI16]	L , I I...L , I B	Digital input DI11...DI16 if VW3A3203 I/O extension module has been inserted
[CD00]...[CD10]	C d 0 0...C d 1 0	Virtual digital input CMD.0...CMD.10 in [I/O profile] , o configuration
[CD11]...[CD15]	C d 1 1...C d 1 5	Virtual digital input CMD.11...CMD.15 regardless of configuration
[C101]...[C110]	C 1 0 1...C 1 1 0	Virtual digital input CMD1.01...CMD1.10 with integrated Modbus Serial in [I/O profile] , o configuration
[C111]...[C115]	C 1 1 1...C 1 1 5	Virtual digital input CMD1.11...CMD1.15 with integrated Modbus Serial regardless of configuration
[C201]...[C210]	C 2 0 1...C 2 1 0	Virtual digital input CMD2.01...CMD2.10 with CANopen® fieldbus module in [I/O profile] , o configuration
[C211]...[C215]	C 2 1 1...C 2 1 5	Virtual digital input CMD2.11...CMD2.15 with CANopen® fieldbus module regardless of configuration
[C301]...[C310]	C 3 0 1...C 3 1 0	Virtual digital input CMD3.01...CMD3.10 with a fieldbus module in [I/O profile] , o configuration
[C311]...[C315]	C 3 1 1...C 3 1 5	Virtual digital input CMD3.11...CMD3.15 with a fieldbus module regardless of configuration
[C501]...[C510]	C 5 0 1...C 5 1 0	Virtual digital input CMD5.01...CMD5.10 with integrated Ethernet in [I/O profile] , o configuration
[C511]...[C515]	C 5 1 1...C 5 1 5	Virtual digital input CMD5.11...CMD5.15 with integrated Ethernet regardless of configuration
[DI52 (High level)]... [DI59 (High level)]	d 5 2 H...d 5 9 H	Cabinet high level digital inputs NOTE: This selection can be accessed on ATV960, ATV980 equipped with Cabinet IO.

[Stop RV limit sw.] 5 R r

Stop switch reverse.

Identical to **[Stop FW limit sw.] 5 FF**.

[Forward Slowdown] d FF

Slowdown attained forward.

Identical to **[Stop FW limit sw.] 5 FF**.

[Reverse Slowdown] d R r

Slowdown attained reverse.

Identical to **[Stop FW limit sw.] 5 FF**.

[Disable limit sw.] C L 5 ★

Limits switches clearing.

⚠ WARNING**LOSS OF CONTROL**If **[Disable limit sw.] C L 5** is set to an input and activated, the limit switch management will be disabled.

- Verify that activating this function does not result in unsafe conditions.

Failure to follow these instructions can result in death, serious injury, or equipment damage.

The action of the limit switches is disabled when the assigned bit or input is at 1. If, at this time, the drive is stopped or being slowed down by limit switches, it will restart up to its speed reference.

This parameter can be accessed if at least one limit switch or one sensor has been assigned.

Setting	Code / Value	Description
[Not Assigned]	n a	Not assigned Factory setting
[DI1]...[DI8]	L , 1...L , 8	Digital input DI1...DI8
[DI11]...[DI16]	L , 11...L , 16	Digital input DI11...DI16 if VW3A3203 I/O extension module has been inserted
[CD00]...[CD10]	C d 0 0...C d 1 0	Virtual digital input CMD.0...CMD.10 in [I/O profile] , a configuration
[CD11]...[CD15]	C d 1 1...C d 1 5	Virtual digital input CMD.11...CMD.15 regardless of configuration
[C101]...[C110]	C 1 0 1...C 1 1 0	Virtual digital input CMD1.01...CMD1.10 with integrated Modbus Serial in [I/O profile] , a configuration
[C111]...[C115]	C 1 1 1...C 1 1 5	Virtual digital input CMD1.11...CMD1.15 with integrated Modbus Serial regardless of configuration
[C201]...[C210]	C 2 0 1...C 2 1 0	Virtual digital input CMD2.01...CMD2.10 with CANopen® fieldbus module in [I/O profile] , a configuration
[C211]...[C215]	C 2 1 1...C 2 1 5	Virtual digital input CMD2.11...CMD2.15 with CANopen® fieldbus module regardless of configuration
[C301]...[C310]	C 3 0 1...C 3 1 0	Virtual digital input CMD3.01...CMD3.10 with a fieldbus module in [I/O profile] , a configuration
[C311]...[C315]	C 3 1 1...C 3 1 5	Virtual digital input CMD3.11...CMD3.15 with a fieldbus module regardless of configuration
[C501]...[C510]	C 5 0 1...C 5 1 0	Virtual digital input CMD5.01...CMD5.10 with integrated Ethernet in [I/O profile] , a configuration
[C511]...[C515]	C 5 1 1...C 5 1 5	Virtual digital input CMD5.11...CMD5.15 with integrated Ethernet regardless of configuration
[DI52 (High level)]... [DI59 (High level)]	d 5 2 H...d 5 9 H	Cabinet high level digital inputs NOTE: This selection can be accessed on ATV960, ATV980 equipped with Cabinet IO.

[Stop type] P A 5 ★

Stop type on limit switch activation.

This parameter can be accessed if at least one limit switch or one sensor has been assigned.

Setting	Code / Value	Description
[On Ramp]	r P P	Follow ramp Factory setting
[Fast stop]	F 5 t	Fast stop (ramp time reduced by [Ramp Divider] d C F
[Freewheel Stop]	n 5 t	Freewheel stop

[Deceleration type] d E F ★

Limit switch deceleration adaptation.

This parameter can be accessed if at least one limit switch or one sensor has been assigned.

Setting	Code / Value	Description
[Standard]	5 E d	Uses the [Deceleration] d E C or [Deceleration 2] d E P ramp (depending on which has been enabled) Factory setting
[Optimized]	a P t	The ramp time is calculated on the basis of the actual speed when the slowdown contact switches, in order to limit the operating time at low speed (optimization of the cycle time: the slowdown time is constant regardless of the initial speed)

[Stop distance] S E d ★

Stop distance.

This parameter can be accessed if at least one limit switch or one sensor has been assigned. Activation and adjustment of the "Stop at distance calculated after the slowdown limit switch" function.

Setting	Code / Value	Description
[No]	n o	Function inactive Factory setting
[0.01...10.00]	0.0 1... 10.0 0	Stop distance range in meters

[Nom linear speed] n L S ★

Rated linear speed.

This parameter can be accessed if at least one limit switch or one sensor has been assigned and [Stop distance] S E d is not set to [No] n o.

Setting	Description
0.20...5.00 m/s	Factory setting: 1.00 m/s

[Stop corrector] S F d ★

Scaling factor applied to the stop distance to compensate, for example, a non-linear ramp.

This parameter can be accessed if at least one limit switch or one sensor has been assigned and [Stop distance] S E d is not set to [No] n o.

Setting	Description
50...200%	Factory setting: 100%

[Memo Stop] n S E P ★

Stop switch memorization.

This parameter can be accessed if at least one limit switch or one sensor has been assigned.

Setting	Code / Value	Description
[No]	n o	No memorization of limit switch
[Yes]	Y E S	Memorization of limit switch Factory setting

[Priority restart] PrSt ★

Priority given to the starting even if stop switch is activated.

This parameter can be accessed if at least one limit switch or one sensor has been assigned.

Setting	Code / Value	Description
[No]	no	No restart priority if stop switch is activated Factory setting
[Yes]	Yes	Priority to restart even if stop switch is activated

Section 8.41

[Generic functions] - [Torque control]

[Torque control] *t o r* - Menu

Access

[Complete settings] → [Generic functions] → [Torque control]

About This Menu

This function can be used if [Motor control type] *L E E* is set to [SVCV] *S V L* or [FVC] *F V L* or [Sync. mot.] *S Y n* or [Sync.CL] *F S Y*.

NOTE: This function cannot be used with some other functions.

NOTE: This function is not compatible with the handling of the [Load slipping] *R n F* error.

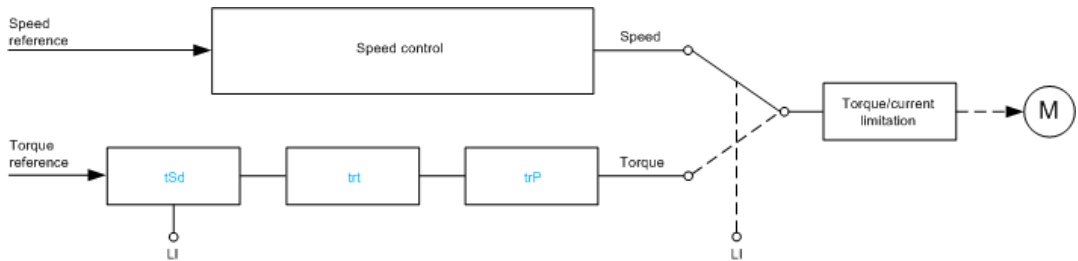

The function can be used to switch between operation in speed regulation mode and operation in torque control mode.

In torque control mode, the speed may vary within a configurable "deadband". When it reaches a lower or upper limit, the drive automatically reverts to speed regulation mode and remains at this limit speed. The regulated torque is therefore no longer maintained and two scenarios may occur.

- If the torque returns to the required value, the drive returns to torque control mode.
- If the torque does not return to the required value at the end of a configurable period, the drive switches to [Torque Reg Warning] *r E R* or [Torque timeout] *S r F*.

⚠ WARNING

UNANTICIPATED EQUIPMENT OPERATION

Verify that activating this function does not result in unsafe conditions.

Failure to follow these instructions can result in death, serious injury, or equipment damage.

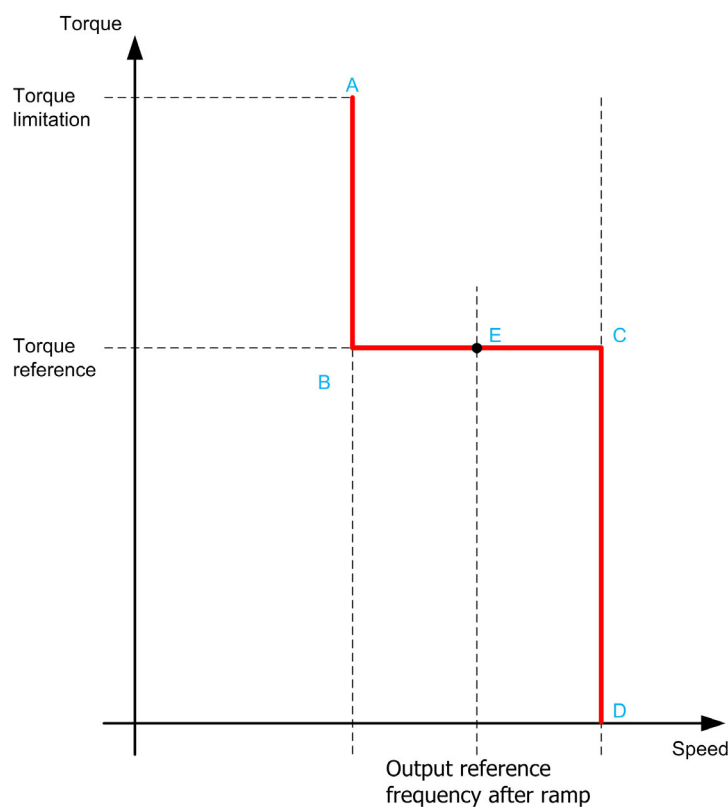

AB, CD Fallback" to speed regulation

BC Torque control zone

E Ideal operating point

The torque sign and value can be transmitted via a logic output and an analog output.

[Trq/spd switching] 5 5

Torque / speed regulation switching by a logic input.

Setting	Code / Value	Description
[Not Assigned]	n o	Not assigned Factory setting
[Yes]	Y E 5	Yes
[DI1]...[DI8]	L , I ... L , 8	Digital input DI1...DI8
[DI11]...[DI16]	L , I I ... L , 1 6	Digital input DI11...DI16 if VW3A3203 I/O extension module has been inserted
[CD00]...[CD10]	C d 0 0 ... C d 1 0	Virtual digital input CMD.0...CMD.10 in [I/O profile] , o configuration
[CD11]...[CD15]	C d 1 1 ... C d 1 5	Virtual digital input CMD.11...CMD.15 regardless of configuration
[C101]...[C110]	C 1 0 1 ... C 1 1 0	Virtual digital input CMD1.01...CMD1.10 with integrated Modbus Serial in [I/O profile] , o configuration
[C111]...[C115]	C 1 1 1 ... C 1 1 5	Virtual digital input CMD1.11...CMD1.15 with integrated Modbus Serial regardless of configuration
[C201]...[C210]	C 2 0 1 ... C 2 1 0	Virtual digital input CMD2.01...CMD2.10 with CANopen® fieldbus module in [I/O profile] , o configuration
[C211]...[C215]	C 2 1 1 ... C 2 1 5	Virtual digital input CMD2.11...CMD2.15 with CANopen® fieldbus module regardless of configuration
[C301]...[C310]	C 3 0 1 ... C 3 1 0	Virtual digital input CMD3.01...CMD3.10 with a fieldbus module in [I/O profile] , o configuration
[C311]...[C315]	C 3 1 1 ... C 3 1 5	Virtual digital input CMD3.11...CMD3.15 with a fieldbus module regardless of configuration
[C501]...[C510]	C 5 0 1 ... C 5 1 0	Virtual digital input CMD5.01...CMD5.10 with integrated Ethernet in [I/O profile] , o configuration
[C511]...[C515]	C 5 1 1 ... C 5 1 5	Virtual digital input CMD5.11...CMD5.15 with integrated Ethernet regardless of configuration

[Torque ref. channel] *t r 1* ★

Channel for torque reference.

This parameter can be accessed if **[Trq/spd switching] *t 5 5*** is not set to **[No] *n o***.

NOTE: **[Torque reference] *L t r*** can be accessed in **[Display]** menu, **[Drive parameters]** submenu.

Setting	Code / Value	Description
[Not Configured]	<i>n o</i>	Not assigned Factory setting
[AI1]...[AI3]	<i>A 1...A 3</i>	Analog input AI1...AI3
[AI4]...[AI5]	<i>A 4...A 5</i>	Analog input AI4...AI5 if VW3A3203 I/O extension module has been inserted
[Ref. Freq-Rmt.Term]	<i>L C C</i>	Reference frequency via remote terminal
[Ref. Freq-Modbus]	<i>M d b</i>	Reference frequency via Modbus
[Ref. Freq-CANopen]	<i>C A n</i>	Reference frequency via CANopen
[Ref. Freq-Com. Module]	<i>n E t</i>	Reference frequency via communication module
[Embedded Ethernet]	<i>E t H</i>	Embedded Ethernet
[DI7 PulseInput]...[DI8 PulseInput]	<i>P 7...P 8</i>	Digital input DI7...DI8 used as pulse input
[Encoder]	<i>P G</i>	Encoder reference if an encoder module has been inserted.

[Torque Ref Assign] *t r 2* ★

Torque reference channel assignment.

This parameter can be accessed if **[Trq/spd switching] *t 5 5*** is not set to **[No] *n o***.

Setting	Code / Value	Description
[DI1]...[DI8]	<i>L 1...L 8</i>	Digital input DI1...DI8
[DI11]...[DI16]	<i>L 11...L 16</i>	Digital input DI11...DI16 if VW3A3203 I/O extension module has been inserted
[C101]...[C110]	<i>C 10 1...C 11 0</i>	Virtual digital input CMD1.01...CMD1.10 with integrated Modbus Serial in [I/O profile] <i>i o</i> configuration
[C111]...[C115]	<i>C 11 1...C 11 5</i>	Virtual digital input CMD1.11...CMD1.15 with integrated Modbus Serial regardless of configuration
[C201]...[C210]	<i>C 20 1...C 21 0</i>	Virtual digital input CMD2.01...CMD2.10 with CANopen® fieldbus module in [I/O profile] <i>i o</i> configuration
[C211]...[C215]	<i>C 21 1...C 21 5</i>	Virtual digital input CMD2.11...CMD2.15 with CANopen® fieldbus module regardless of configuration
[C301]...[C310]	<i>C 30 1...C 31 0</i>	Virtual digital input CMD3.01...CMD3.10 with a fieldbus module in [I/O profile] <i>i o</i> configuration
[C311]...[C315]	<i>C 31 1...C 31 5</i>	Virtual digital input CMD3.11...CMD3.15 with a fieldbus module regardless of configuration
[C501]...[C510]	<i>C 50 1...C 51 0</i>	Virtual digital input CMD5.01...CMD5.10 with integrated Ethernet in [I/O profile] <i>i o</i> configuration
[C511]...[C515]	<i>C 51 1...C 51 5</i>	Virtual digital input CMD5.11...CMD5.15 with integrated Ethernet regardless of configuration
[Torque ref. channel]	<i>t r 1</i>	Torque reference channel 1
[Torque ref. 2 channel]	<i>t r 2</i>	Torque reference channel 2

[Torque ref. 2 channel] $\text{Er}2$ ★

Torque reference channel 2.

This parameter can be accessed if **[Trq/spd switching] $\text{E}55$** is not set to **[No] $n\alpha$** .

Identical to **[Torque ref. channel] $\text{Er}1$** (see page 440).

[Torque ref. sign] $\text{E}5d$ ★

Assignment for the inversion of the sign of the reference for the torque regulation function.

This parameter can be accessed if **[Trq/spd switching] $\text{E}55$** is not set to **[No] $n\alpha$** .

Identical to **[Trq/spd switching] $\text{E}55$** (see page 439).

[Torque ratio] $\text{Er}t$ ★

Torque regulation: torque ratio.

This parameter can be accessed if **[Trq/spd switching] $\text{E}55$** is not set to **[No] $n\alpha$** .

Setting ()	Description
0.0...1000.0%	Coefficient applied to [Torque ref. channel] $\text{Er}1$ or [Torque ref. 2 channel] $\text{Er}2$ Factory setting: 100.0%

[Torque Ratio Assign] $\text{Er}r$ ★

Torque regulation: torque ratio value selection.

This parameter can be accessed if **[Trq/spd switching] $\text{E}55$** is not set to **[No] $n\alpha$** .

Setting	Code / Value	Description
[No]	$n\alpha$	Analog input is not assigned Factory setting
[AI1]...[AI3]	$R, 1...R, 3$	Analog input AI1...AI3
[AI4]...[AI5]	$R, 4...R, 5$	Analog input AI4...AI5 if VW3A3203 I/O extension module has been inserted
[AI Virtual 1]	$R, V1$	Virtual analogic input 1
[DI7 PulseInput]...[DI8 PulseInput]	$P, 7...P, 8$	Digital input DI7...DI8 used as pulse input
[Encoder]	PG	Encoder reference if an encoder module has been inserted.

[Torque Ref Offset] $\text{Er}oP$ ★

Torque reference offset.

This parameter can be accessed if **[Trq/spd switching] $\text{E}55$** is not set to **[No] $n\alpha$** .

Setting ()	Description
-1000.0...1000.0%	Setting range Factory setting: 0.0%

[Torque Offset Assign] $\text{Er}o$ ★

Torque regulation: Torque offset value selection

This parameter can be accessed if **[Trq/spd switching] $\text{E}55$** is not set to **[No] $n\alpha$** .

Identical to **[Torque Ratio Assign] $\text{Er}r$** (see page 441).

[Low Torque] L E 9 ★

Low torque threshold.

This parameter can be accessed if [Trq/spd switching] E 5 5 is not set to [No] n o .

This parameter cannot be higher than [High Torque] H E 9 .

Setting ()	Description
-300.0...[High Torque] H E 9	Setting range Factory setting: -300.0%

[High Torque] H E 9 ★

High torque threshold.

This parameter can be accessed if [Trq/spd switching] E 5 5 is not set to [No] n o .

This parameter cannot be lower than [Low Torque] L E 9 .

Setting ()	Description
[Low Torque] L E 9...300.0%	Setting range Factory setting: 300.0%

[Torque ramp time] E r P ★

Torque ramp time.

This parameter can be accessed if [Trq/spd switching] E 5 5 is not set to [No] n o .

Setting ()	Description
0.00...99.99 s	Rise and fall time for a variation of 100% of the rated torque Factory setting: 3.00 s

[Torque Filter] E r F ★

Torque filter activation.

This parameter can be accessed if [Trq/spd switching] E 5 5 is not set to [No] n o .

Setting	Code / Value	Description
[No]	n o	Not activated. Factory setting
[Yes]	Y E 5	Activated

[Torque Filter Bandwidth] E r W ★

Torque filter bandwidth.

This parameter can be accessed if [Torque Filter] E r F is set to [Yes] Y E 5 .

Setting ()	Description
1...1000 Hz	Setting range Factory setting: 20 Hz

[Torque control stop] E 5 E ★

Torque regulation: stop command type.

This parameter can be accessed if [Trq/spd switching] E 5 5 is not set to [No] n o .

Setting	Code / Value	Description
[Speed]	S P d	Speed regulation stop, in accordance with the [Type of stop] 5 E E configuration

Setting	Code / Value	Description
[Freewheel Stop]	$n5t$	Freewheel stop Factory setting
[Spin]	$5Pn$	Zero torque stop, but maintaining the flux in the motor (only in close loop)

[Spin time] $5Pt$ ★

Torque regulation: spin time.

Spin time following stop, in order to remain ready to restart quickly.

This parameter can be accessed if:

- [Trq/spd switching] $t55$ is not set to [No] na , and
- [Torque control stop] $t5t$ is set to [Spin] $5Pn$.

Setting (°)	Description
0.0...3600.0 s	Setting range Factory setting: 1.0 s

[Positive deadband] dbP ★

Torque regulation positive deadband.

This parameter can be accessed if [Trq/spd switching] $t55$ is not set to [No] na .

Value added algebraically to the speed reference.

Example for $dbP = 10$:

- If reference = +50 Hz : +50 + 10 = 60 Hz
- If reference = -50 Hz : -50 + 10 = -40 Hz

Setting (°)	Description
0...2 x [Max Frequency] tFr	Setting range Factory setting: 10 Hz

[Negative deadband] dbn ★

Torque regulation negative deadband.

This parameter can be accessed if [Trq/spd switching] $t55$ is not set to [No] na .

Value subtracted algebraically from the speed reference.

Example for $dbn = 10$:

- If reference = +50 Hz: + 50 - 10 = 40 Hz
- If reference = -50 Hz: -50 - 10 = -60 Hz

Setting (°)	Description
0...2 x [Max Frequency] tFr	Setting range Factory setting: 10 Hz

[Torque ctrl time out] $rtot$ ★

Torque control time-out.

This parameter can be accessed if [Trq/spd switching] $t55$ is not set to [No] na .

Time following automatic exit of torque control mode in the event of an error or a warning has been triggered.

Setting	Description
0.0...999.9 s	Setting range Factory setting: 60 s

[Torque Ctrl ErrorResp] *τ 0 b* ★

Response to torque control error.

This parameter can be accessed if **[Trq/spd switching]** *τ 5 5* is not set to **[No]** *0 0*.

Response of drive once time **[Torque ctrl time out]** *τ 0* has elapsed.

Setting	Code / Value	Description
[Warning]	<i>FL r Π</i>	Warning is triggered on time-out Factory setting
[Error]	<i>FL τ</i>	An error is triggered with freewheel stop

Section 8.42

[Generic functions] - [Parameters switching]

What Is in This Section?

This section contains the following topics:

Topic	Page
[Parameters switching] <i>Π L P</i> - Menu	446
[Set 1] <i>P 5 1</i> - Menu	450
[Set 2] <i>P 5 2</i> - Menu	450
[Set 3] <i>P 5 3</i> - Menu	450

[Parameters switching] *Π L P* - Menu

Access

[Complete settings] → [Generic functions] → [Parameters switching]

About This Menu

A set of 1 to 15 parameters from the [Parameter Selection] *5 P 5* list (*see page 447*) can be selected and 2 or 3 different values assigned. These 2 or 3 sets of values can then be switched using 1 or 2 digital inputs or control word bits. This switching can be performed during operation (motor running). It can also be controlled based on 1 or 2 frequency thresholds, whereby each threshold acts as a digital input (0 = threshold not reached, 1 = threshold reached).

	Values 1	Values 2	Values 3
Parameter 1 ... Parameter 15	Parameter 1 ... Parameter 15	Parameter 1 ... Parameter 15	Parameter 1 ... Parameter 15
Input DI or bit or frequency threshold 2 values	0	1	0 or 1
Input DI or bit or frequency threshold 3 values	0	0	1

NOTE: Do not modify the parameters in [Parameter Selection] *5 P 5* (*see page 447*), because any modifications made in this menu will be lost on the next power-up. The parameters can be adjusted during operation in the [Parameters switching] *Π L P* - menu, on the active configuration.

[2 Parameter sets] *CHAI*

Parameter switching assignment 1.

Switching 2 parameter sets.

Setting	Code / Value	Description
[Not Assigned]	<i>n o</i>	Not assigned Factory setting
[Mot Freq High Thd]	<i>F L R</i>	Motor frequency high threshold reached
[2nd Freq Thd Reached]	<i>F 2 R</i>	Second frequency threshold reached
[DI1]...[DI8]	<i>L , I ... L , B</i>	Digital input DI1...DI8
[DI11]...[DI16]	<i>L , I I ... L , I B</i>	Digital input DI11...DI16 if VW3A3203 I/O extension module has been inserted
[CD00]...[CD10]	<i>C d 0 0 ... C d 1 0</i>	Virtual digital input CMD.0...CMD.10 in [I/O profile] , <i>o</i> configuration
[CD11]...[CD15]	<i>C d 1 1 ... C d 1 5</i>	Virtual digital input CMD.11...CMD.15 regardless of configuration
[C101]...[C110]	<i>C 1 0 1 ... C 1 1 0</i>	Virtual digital input CMD1.01...CMD1.10 with integrated Modbus Serial in [I/O profile] , <i>o</i> configuration
[C111]...[C115]	<i>C 1 1 1 ... C 1 1 5</i>	Virtual digital input CMD1.11...CMD1.15 with integrated Modbus Serial regardless of configuration
[C201]...[C210]	<i>C 2 0 1 ... C 2 1 0</i>	Virtual digital input CMD2.01...CMD2.10 with CANopen® fieldbus module in [I/O profile] , <i>o</i> configuration
[C211]...[C215]	<i>C 2 1 1 ... C 2 1 5</i>	Virtual digital input CMD2.11...CMD2.15 with CANopen® fieldbus module regardless of configuration
[C301]...[C310]	<i>C 3 0 1 ... C 3 1 0</i>	Virtual digital input CMD3.01...CMD3.10 with a fieldbus module in [I/O profile] , <i>o</i> configuration
[C311]...[C315]	<i>C 3 1 1 ... C 3 1 5</i>	Virtual digital input CMD3.11...CMD3.15 with a fieldbus module regardless of configuration
[C501]...[C510]	<i>C 5 0 1 ... C 5 1 0</i>	Virtual digital input CMD5.01...CMD5.10 with integrated Ethernet in [I/O profile] , <i>o</i> configuration
[C511]...[C515]	<i>C 5 1 1 ... C 5 1 5</i>	Virtual digital input CMD5.11...CMD5.15 with integrated Ethernet regardless of configuration

[3 Parameter sets] C H R 2

Parameter switching assignment 2.

Identical to **[2 Parameter sets] C H R 1**.

Switching 3 parameter sets.

NOTE: In order to obtain 3 parameter sets, it is necessary to configure first **[2 Parameter sets] C H R 1**.

[Parameter Selection] S P 5

This parameter can be accessed if **[2 Parameter sets] C H R 1** is not set to **[No] n o**.

Making an entry in this parameter opens a window containing all the adjustment parameters that can be accessed. Select 1 to 15 parameters using **OK** key. Parameter(s) can also be deselected using **OK** key.

Available parameters for parameters switching function are:

Parameter	Code
[Ramp increment]	i n r
[Acceleration]	A C C
[Deceleration]	d E C
[Acceleration 2]	A C 2
[Deceleration 2]	d E 2
[Begin Acc round]	t A 1
[End Acc round]	t A 2
[Begin Dec round]	t A 3
[End Dec round]	t A 4
[Low Speed]	L S P
[High Speed]	H S P
[High Speed 2]	H S P 2
[High Speed 3]	H S P 3
[High Speed 4]	H S P 4
[Motor Th Current]	i t H
[IR compensation]	u F r
[Slip compensation]	S L P
[K speed loop filter]	S F C
[Speed time integral]	S i t
[Speed prop. gain]	S P G
[Inertia Factor]	S P G u
[Ramp Divider]	d C F
[DC Inj Level 1]	i d C
[DC Inj Time 1]	t d i
[DC Inj Level 2]	i d C 2
[DC Inj Time 2]	t d C
[Auto DC inj Level 1]	S d C 1
[Auto DC Inj Time 1]	t d C 1
[Auto DC inj Level 2]	S d C 2
[Auto DC Inj Time 2]	t d C 2
[Switching frequency]	S F r
[Current Limitation]	C L 1
[Current Limit2 Value]	C L 2
[Motor fluxing]	F L u
[Low Speed Timeout]	t L S
[Sleep Offset Thres.]	S L E

Parameter	Code
[Jog frequency]	<i>J G F</i>
[Jog Delay]	<i>J G t</i>
[Preset speed 2]...[Preset speed 16]	<i>S P 2... S P 16</i>
[+/- Speed limitation]	<i>S r P</i>
[Multiplying coeff.]	<i>Π F r</i>
[ENA prop gain]	<i>G P E</i>
[ENA integral gain]	<i>G i E</i>
[Brk Release Current]	<i>i b r</i>
[Brake release I Rev]	<i>i r d</i>
[Brake Release time]	<i>b r t</i>
[Brake release freq]	<i>b i r</i>
[Brake engage freq]	<i>b E n</i>
[Brake engage delay]	<i>t b E</i>
[Brake engage time]	<i>b E t</i>
[Jump at reversal]	<i>J d C</i>
[Time to restart]	<i>t t r</i>
[BRH b4 freq]	<i>b F t d</i>
[Motor torque limit]	<i>t L i Π</i>
[Gen. torque limit]	<i>t L i G</i>
[Torque ratio]	<i>t r t</i>
[Low Torque]	<i>L t 9</i>
[High Torque]	<i>H t 9</i>
[PID Prop.Gain]	<i>r P G</i>
[PID Intgl.Gain]	<i>r i G</i>
[PID derivative gain]	<i>r d G</i>
[PID ramp]	<i>P r P</i>
[PID Min Output]	<i>P o L</i>
[PID Max Output]	<i>P o H</i>
[PID Start Ref Freq]	<i>S F S</i>
[PID acceleration time]	<i>A C C P</i>
[Min fbk Warning]	<i>P A L</i>
[Max fbk Warning]	<i>P A H</i>
[PID error Warning]	<i>P E r</i>
[Speed input %]	<i>P S r</i>
[Ref PID Preset 2]	<i>r P 2</i>
[Ref PID Preset 3]	<i>r P 3</i>
[Ref PID Preset 4]	<i>r P 4</i>
[PID Fdbk Range]	<i>P F Π r</i>
[PID Fdbk Error Delay]	<i>P F Π d</i>
[Low Freq.Threshold]	<i>J G t</i>
[High Current Thd]	<i>C t d</i>
[Low I Threshold]	<i>C t d L</i>
[High torque thd.]	<i>t t H</i>
[Low torque thd.]	<i>t t L</i>
[Motor Freq Thd]	<i>F t d</i>
[Low Freq.Threshold]	<i>F t d L</i>
[Freq. threshold 2]	<i>F 2 d</i>
[2 Freq. Threshold]	<i>F 2 d L</i>

Parameter	Code
[Freewheel stop Thd]	<i>F F t</i>
[Motor Therm Thd]	<i>t t d</i>
[Reference high Thd]	<i>r t d</i>
[Reference low Thd]	<i>r t d L</i>
[Skip Frequency]	<i>J P F</i>
[Skip Frequency 2]	<i>J F 2</i>
[3rd Skip Frequency]	<i>J F 3</i>
[Skip Freq.Hysteresis]	<i>J F H</i>
[Unld.Thr.Nom.Speed]	<i>L u n</i>
[Unld.Thr.0.Speed]	<i>L u L</i>
[Unld. FreqThr. Det.]	<i>r n u d</i>
[Hysteresis Freq]	<i>S r b</i>
[Underload T.B.Rest.]	<i>F t u</i>
[Ovid Detection Thr.]	<i>L o C</i>
[Overload T.B.Rest.]	<i>F t o</i>
[Fan mode]	<i>F F n</i>
[Pmax Motor]	<i>t P n n</i>
[Pmax Generator]	<i>t P n G</i>
[Stall Max Time]	<i>S t P 1</i>
[Stall Current]	<i>S t P 2</i>
[Stall Frequency]	<i>S t P 3</i>
[AI1 Th Warn Level]	<i>t H 1 A</i>
[AI3 Th Warn Level]	<i>t H 3 A</i>
[AI4 Th Warn Level]	<i>t H 4 A</i>
[AI5 Th Warn Level]	<i>t H 5 A</i>
[AI1 Th Error Level]	<i>t H 1 F</i>
[AI3 Th Error Level]	<i>t H 3 F</i>
[AI4 Th Error Level]	<i>t H 4 F</i>
[AI5 Th Error Level]	<i>t H 5 F</i>
[Sleep Min Speed]	<i>S L S L</i>
[Sleep Power Level]	<i>S L P r</i>
[Sleep Delay]	<i>S L P d</i>
[Sleep Boost Speed]	<i>S L b S</i>
[Sleep Boost Time]	<i>S L b t</i>
[Wake Up Process level]	<i>W u P F</i>
[Wake Up Process Error]	<i>W u P E</i>
[Load correction]	<i>L b C</i>
[AFE Generator Mode]	<i>C L i G</i>

[Set 1] P 5 1 - Menu

Access

[Complete settings] → [Generic functions] → [Parameters switching] → [Set 1]

About This Menu

Making an entry in this menu opens a settings window containing the selected parameters in the order in which they were selected.

[Set 2] P 5 2 - Menu

Access

[Complete settings] → [Generic functions] → [Parameters switching] → [Set 2]

About This Menu

Identical to [Set 1] P 5 1 - (*see page 450*).

[Set 3] P 5 3 - Menu

Access

[Complete settings] → [Generic functions] → [Parameters switching] → [Set 3]

About This Menu

Identical to [Set 1] P 5 1 - (*see page 450*).

Section 8.43

[Generic functions] - [Stop after speed timeout]

[Stop after speed timeout] $P r 5 P$ - Menu

Access

[Complete settings] → [Generic functions] → [Stop after speed timeout]

Sleep/Wake-Up in Speed Control Mode

The drive is in Speed control mode, when PID is not active, typically when:

- PID is not configured (the motor speed setpoint is controlled by an external PLC, for example).
- PID is in manual mode (manual application mode, for example).
- PID is not active because Channel 1 is not selected (forced local mode enabled, for example).

When the drive is used in Speed Control (PID not used or not active), a speed condition is used to switch the application to the sleep state. When the drive is in sleep state, the motor is restarted if the sleep condition disappears.

This function avoids prolonged operation at low speeds when neither useful nor compliant with the system constraints. It stops the motor after a period of operation at reduced speed. This time and speed can be adjusted.

In Speed control mode, Sleep/Wake-up is managed according to the following rules:

- The motor is stopped when [Pre-Ramp Ref Freq] $F r H$ and [Output frequency] $r F r$ become and stay lower than [Low speed] $L 5 P$ + [Sleep Offset Thres.] $5 L E$ during [Low Speed Timeout] $t L 5$.
- The motor is restarted when [Pre-Ramp Ref Freq] $F r H >$ [Low speed] $L 5 P$ + [Sleep Offset Thres.] $5 L E$.

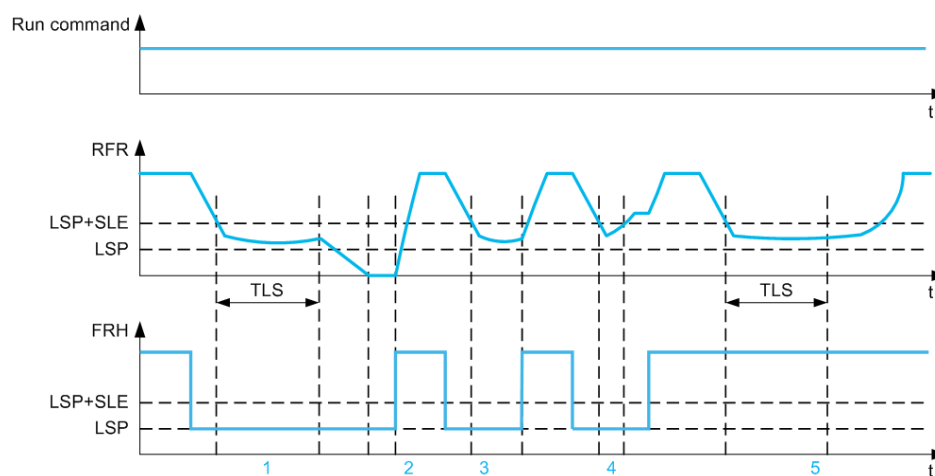

- 1 Nominal [Low Speed Timeout] $t L 5$ function action: after [Low Speed Timeout] $t L 5$ time, the motor is stopped according to the current deceleration ramp
- 2 [Pre-Ramp Ref Freq] $F r H$ becomes greater than [Low speed] $L 5 P$ + [Sleep Offset Thres.] $5 L E$ and run order still present [Low Speed Timeout] $t L 5$ function is deactivated
- 3 [Low Speed Timeout] $t L 5$ function is not activated because [Pre-Ramp Ref Freq] $F r H$ becomes greater than [Low speed] $L 5 P$ + [Sleep Offset Thres.] $5 L E$ before [Low Speed Timeout] $t L 5$ has expired
- 4 [Low Speed Timeout] $t L 5$ function is not activated because [Output frequency] $r F r$ becomes greater than [Low speed] $L 5 P$ + [Sleep Offset Thres.] $5 L E$ before [Low Speed Timeout] $t L 5$ has expired
- 5 [Low Speed Timeout] $t L 5$ function is not activated because [Pre-Ramp Ref Freq] $F r H$ stays greater than [Low speed] $L 5 P$ + [Sleep Offset Thres.] $5 L E$

[Low Speed Timeout] L L 5

Low speed timeout

Setting ()	Description
0.0...999.9 s	Setting range Factory setting: 0.0 s

[Sleep Offset Thres.] S L E ★

Sleep offset threshold.

This parameter can be accessed if **[Low Speed Timeout] L L 5** is not set to 0.Adjustable restart threshold (offset) following a stop after prolonged operation at **[Low speed] L S P + [Sleep Offset Thres.] S L E**, in Hz. The motor restarts if the reference rises above (LSP + SLE) and if a run command is still present.

Setting ()	Description
1.0... [Max Frequency] L F r	Setting range Factory setting: 1.0 Hz

Section 8.44

[Generic functions] - [Active Front End]

[Active Front End] *AFE* - Menu

Access

[Complete settings] → [Generic functions] → [Active Front End]

About This Menu

This menu is used to set the current limitation for active front end used in generator mode.

If the active front end is running in motor mode, a warning **[AFE Motor Limitation]** *L L , Π* is triggered if the current limitation of 120% is reached, a warning **[AFE Regen Limitation]** *L L , G* is triggered when the limitation set with parameter **[AFE Generator Mode]** *L L , G* is reached.

NOTE: This menu can be accessed on ATV980 and ATV9B0.

[AFE Generator Mode] *L L , G* ★

AFE Generator Mode

This parameter sets the current limitation in generator operation mode. If the parameter is set to **[Low Harmonic]** *L H Π* the drive will operate in Low Harmonic but not regenerate energy to the mains.

Setting	Code / Value	Description
[Low Harmonic]	<i>L H Π</i>	Low Harmonic mode (current to the mains less than 10%).
[Low Harmonic & Regen]	<i>L H r Π</i>	Low Harmonic and Regeneration mode (120%). Factory setting
0.0...120.0 %		Current limitation in generator mode (for specific setting).

Section 8.45

[Generic functions] - [Bus Ref Link]

[Bus Ref Link] *д б 5* -

Access

[Complete settings] → [Generic functions] → [Bus Ref Link]

About This Menu

This menu is used to configure the DC bus link on Multi-Drive configuration with common DC bus supply. This menu can be access if [Access Level] *Л Н С* is set to [Expert] *Е Р С*.

[DC Bus Source Type] *д л б 5*

DC bus source type.

This parameter is used to select the type of product used as DC Bus source.

Setting	Code / Value	Description
[Not configured]	<i>н о</i>	Function inactive. Factory setting
[Supply Unit REC]	<i>С у р Е С</i>	The drive is connected to a common DC bus which is supplied by a MultiDrive Rectifier Supply Unit.
[Supply Unit AFE]	<i>С у А F E</i>	The drive is connected to a common DC bus which is supplied by a MultiDrive AFE Supply Unit. The DC voltage level has to be shared between the AFE Supply Unit and all connected drives - set by parameter [AFE Bus Ref Link] <i>П д л П</i> .
[Drive with AFE]	<i>П С Е Л Н</i>	The drive is connected to the DC bus of a Regenerative Drive System. The DC voltage level has to be shared between the Regenerative Drive System and all connected drives - set by parameter [AFE Bus Ref Link] <i>П д л П</i> .
[Drive with REC]	<i>П С Р Е</i>	The drive is connected to a common DC bus which is supplied by another drive.

[AFE Bus Ref Link] *П д л П* ★

AFE bus reference link

This parameter is used to select the transmission type used to send the DC bus reference.

This parameter can be accessed if [DC Bus Source Type] *д л б 5* is set to:

- [Supply Unit AFE] *С у А F E*, or
- [MCE with AFE] *П С Е Л Н*.

Setting	Code / Value	Description
[No]	<i>н о</i>	Function inactive Factory setting
[PTO]	<i>W P T o</i>	PTO is used
[Modbus]	<i>W П д б</i>	Modbus communication is used

[DC Bus Charge Time] d C t ★

DC Bus charge option time.

This parameter can be accessed if [DC Bus Source Type] d C b 5 is set to:

- [Supply Unit AFE] 5 u A F E, or
- [MCE with AFE] M C E L H.

Setting	Description
0.00...10.00 s	Factory setting: 0.00 s

Section 8.46

[Generic functions] - [DC bus supply]

[DC bus supply] d C o - Menu

Access

[Complete settings] → [Generic functions] → [DC bus supply]

About This Menu

This menu can be accessed on 220V Drives with power **greater than 15kW** or 480V Drives with power **greater than 22kW**.

It gives the possibility to switch off/on drives supplied by a common DC bus without stopping the supply unit. Direct power supply via the DC bus requires a protected direct current source with adequate power and voltage as well as a suitably dimensioned resistor and capacitor precharging contactor. Consult Schneider Electric for information about specifying these components.

The **Direct Power Supply via Dc Bus** function can be used to control the precharging contactor via a relay or a logic input on the drive.

Example circuit using R2 relay:

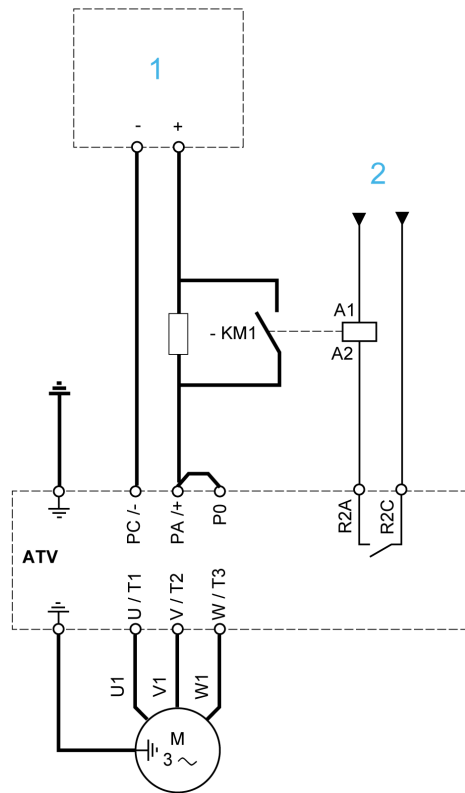

- 1 DC power supply
- 2 +24 Vdc

[DC Charging Assign] *d C a* ★

DC Bus charge assignment.

Setting	Code / Value	Description
[No]	<i>n a</i>	Not assigned Factory setting
[R2]...[R3]	<i>r 2...r 3</i>	Relay output R2...R3
[R4]...[R6]	<i>r 4...r 6</i>	Relay output R4...R6 if VW3A3204 relay output option module has been inserted
[DQ1 Digital Output]	<i>d a 1</i>	Digital output DQ1
[DQ11 Digital Output]...[DQ12 Digital Output]	<i>d a 1 1...d a 1 2</i>	Digital output DQ11...DQ12 if VW3A3203 I/O extension module has been inserted
[R61]...[R66]	<i>r 6 1...r 6 6</i>	Relay R61 ...R66 NOTE: This selection can be accessed on ATV960, ATV980 equipped with Cabinet IO.

[DC Bus Charge Time] *d C t* ★

DC Bus charge option time.

This parameter can be accessed if **[DC Charging Assign]** *d C a* is not set to **[Not Assigned]** *n a*.

Setting	Description
0.00...10.00 s	Factory setting: 0.00 s

Section 8.47

[Generic functions] - [Multimotors config]

[Multimotors config] ППЦ - Menu

Access

[Complete settings] → [Generic functions] → [Multimotors config]

Motor or Configuration Switching

The drive may contain up to 4 configurations, which can be saved using the **[Save Configuration] 5 C 5** parameter.

Each of these configurations can be activated remotely, enabling adaptation to:

- 2 to 4 different motors or mechanisms (multi-motors mode).
- 2 to 4 different configurations for a single motor (multi-configurations mode).

The two switching modes cannot be combined.

Note: Observe the following conditions:

- Switching may take place when stopped (drive locked). If a switching request is sent during operation, it will be executed at next stop.
- When switching between motors, the concerned power and control terminals must be switched as appropriate.
- All configurations must share the same hardware configuration; otherwise the drive locks in **[Incorrect Configuration] C F F**.
- Switching to a configuration that does not exist causes the drive to lock in **[Empty Configuration] C F , 4**.

Menus and Parameters Switched in Multi-Motor Mode

In multi-configurations mode, communication parameters are not switched.

- **[Motor parameters] П P A** - menu.
- **[Input/Output] , o** - menu.
- **[Generic functions] C 5 C F** - menu except for the **[Multimotors config] П П Ц** - function (to be configured once only).
- **[Generic monitoring] C P r** - menu.
- **[My menu] П У П n** - menu.

Transfer of a Drive Configuration to Another one, With Graphic Display Terminal, When the Drive Uses [Multimotors config] $\Pi\Pi C$ - Function

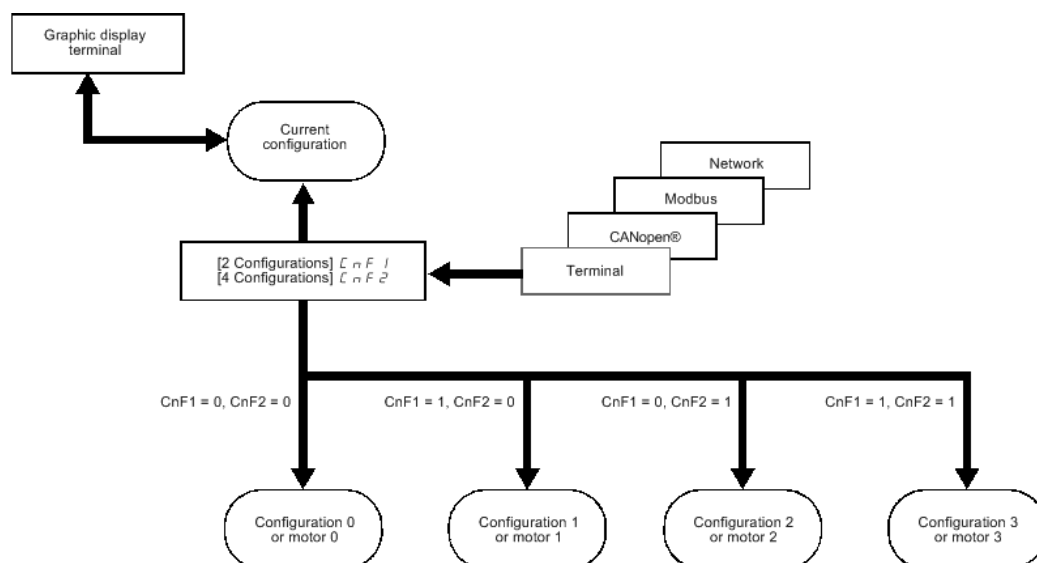

Switching Command

Depending on the number of motors or selected configurations (2 to 4), the switching command is sent using one or two digital inputs. The table below lists the possible combinations.

DI ($CnF1$) 2 motors or configurations	DI ($CnF2$) 3 motors or configurations	Number of configurations or active motors
0	0	0
1	0	1
0	1	2
1	1	3

Schematic Diagram for Multi-Motor Mode

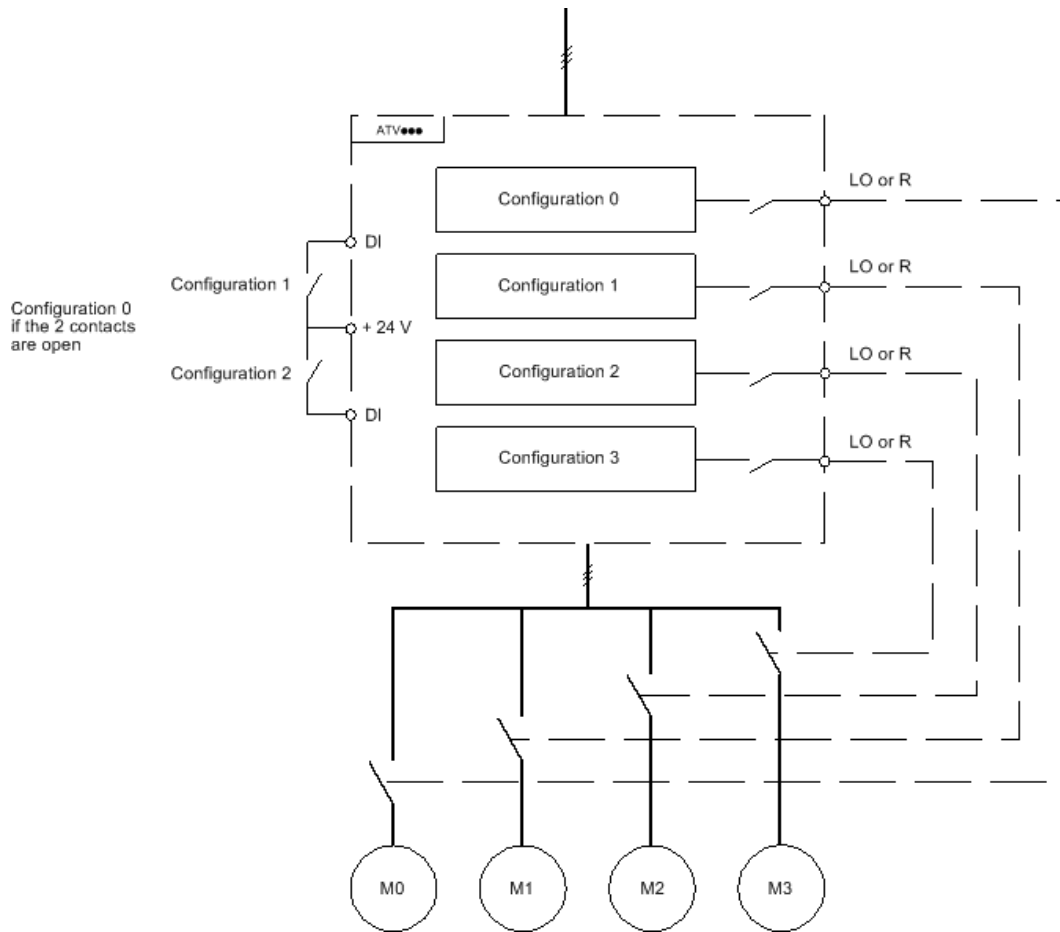

Auto-Tuning in Multi-Motor Mode

This auto-tuning can be performed:

- Manually using a Digital input when the motor changes.
- Automatically each time the motor is activated for the first time after switching on the drive if the [Automatic autotune] *Aut* parameter is set to [Yes] *Yes*.

Motor thermal states in multimotor mode:

The drive helps to protect the three motors individually. Each thermal state takes into account all stop times if the drive power is not switched off.

<i>NOTICE</i>
<p>MOTOR OVERHEATING</p> <p>The motor thermal state of each motor is not saved when drive is switched off.</p> <p>When the drive is switched on, it is not aware of the thermal state of the connected motor or motors.</p> <ul style="list-style-type: none"> • To enable correct temperature monitoring of the motors, install an external temperature sensor for each motor. <p>Failure to follow these instructions can result in equipment damage.</p>

Configuration Information Output

In the [Input/Output] *IO* - menu, a Digital output can be assigned to each configuration or motor (2 to 4) for remote information transmission.

NOTE: As the [Input/Output] *IO* - menu is switched, these outputs must be assigned in all configurations in which information is required.

[Multimotors] C H 7

Multimotors selection.

Setting	Code / Value	Description
[No]	0 0	Multiconfiguration possible Factory setting
[Yes]	4 E 5	Multimotor possible

[2 Configurations] C n F 1

Switching of two motors or 2 configurations.

[3 Configurations] C n F 2

Switching of three motors or 3 configurations.

NOTE: In order to obtain 4 motors or 4 configurations, **[2 Configurations] C n F 1** must also be configured.

Identical to **[2 Configurations] C n F 1**

Section 8.48

[Generic Functions] [External Weight Measurement]

[External weight meas.] E L Π - Menu

Access

[Complete settings] → [Generic Functions] → [External weight meas.]

About This Menu

⚠ **WARNING**

LOSS OF CONTROL

Perform a comprehensive commissioning test to verify correct operation of the weight sensor under all operating and error conditions.

Failure to follow these instructions can result in death, serious injury, or equipment damage.

This function uses the information supplied by a weight sensor to adapt the [Brk Release Current] *br* (the torque current) of the [Brake logic control] *blc* - function. Depending on the settings, the brake release current can be positive or negative. The signal from the weight sensor can be assigned to an analog input (usually a 4 - 20 mA signal), to the pulse-in input or to the encoder input, according to the type of weight sensor.

For example, but not limited to, the weight sensor can measure the total weight of a hoisting winch and its load.

The brake release current is adapted in accordance with the curve below.

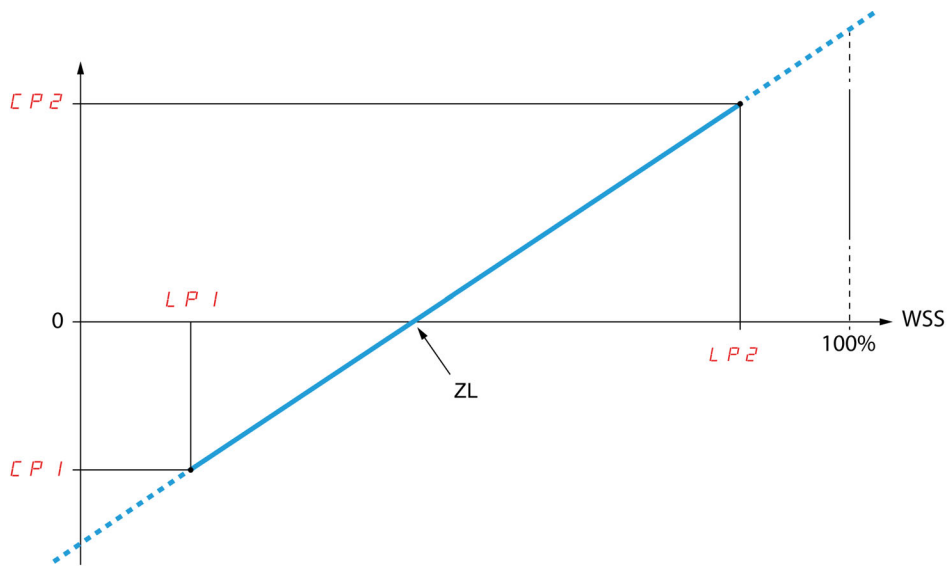

- CP1** Point 1 Y
- CP2** Point 2 Y
- LP1** Point 1 X
- LP2** Point 2 X
- ZL** Zero Load
- WSS** Weight Sensor Signal

This curve can represent a weight sensor on an application, where zero load on the motor is different from zero load on the application.

[Weight Sensor Assign] P E 5

Weight sensor assignment.

If **[Brake assignment] b L C** is not configured, this parameter is forced to **[Not Configured] n o**.

Setting	Code / Value	Description
[Not Configured]	n o	Not configured. Factory setting
[AI1]...[AI3]	R , 1..R , 3	Analog input AI1...AI3.
[AI4]...[AI5]	R , 4..R , 5	Analog input AI4...AI5 if VW3A3203 I/O extension module has been inserted.
[AI Virtual 1]	R , V 1	Virtual analogic input 1.
[DI7 PulseInput]...[DI8 PulseInput]	P , 7..P , 8	Digital input DI7...DI8 used as pulse input.
[Encoder]	P G	Encoder reference if an encoder module has been inserted.

[Point 1 X] L P 1

Ext weight point 1 X.

This parameter can be accessed if **[Weight sensor Assign] P E 5** is assigned.

Setting	Description
0.0...99.99 %	Setting range This parameter can't be equal or higher than [Point 2 X] L P 2 . Factory setting: 0.00 %

[Point 1Y] C P 1

Ext weight point 1Y.

This parameter can be accessed if **[Weight sensor Assign] P E 5** is assigned.

Setting	Description
-1.1...1.1 In ⁽¹⁾	Setting range in A Factory setting: 0.7 * [Nom Motor Current] n C r
(1) In corresponds to the rated drive current indicated in the Installation Manual and on the drive nameplate.	

[Point 2 X] L P 2

Ext weight point 2 X.

This parameter can be accessed if **[Weight sensor Assign] P E 5** is assigned.

Setting	Description
0.01...100.00 %	Setting range This parameter can't be equal or higher than [Point 1 X] L P 1 . Factory setting: 50.00 %

[Point 2Y] C P 2

Ext weight point 2Y.

This parameter can be accessed if **[Weight sensor Assign] P E 5** is assigned.

Setting	Description
-1.1...1.1 In ⁽¹⁾	Setting range in A Factory setting: [Nom Motor Current] n C r
(1) In corresponds to the rated drive current indicated in the Installation Manual and on the drive nameplate.	

[ibr 4-20 mA loss] , b r #

Brake release current in the event of the loss of the weight sensor information.

This parameter can be accessed if the weight sensor is assigned to an analog current input (PES = AIx) and the 4-20 mA loss monitoring function is deactivated (LFLx = No).

[AIx min. value] C r L X must be equal or greater than 4 mA and **[ibr 4-20 mA loss] , b r #** must be set to a value consistent with your application.

For a hoisting application, the advisable setting is **[Nom Motor Current] n C r**.

Setting	Description
0...1.1 In ⁽¹⁾	Setting range in A. Factory setting: 0 A
(1) In corresponds to the rated drive current indicated in the Installation Manual and on the drive nameplate.	

Section 8.49

[Generic monitoring]

What Is in This Section?

This section contains the following topics:

Topic	Page
[Process underload] <i>u L d</i> - Menu	466
[Process overload] <i>o L d</i> - Menu	468
[Stall monitoring] <i>S t P r</i> - Menu	470
[Thermal monitoring] <i>t P P</i> - Menu	470
[Frequency meter] <i>F q F</i> - Menu	471

[Process underload] $\cup L d$ - Menu

Access

[Complete settings] → [Generic monitoring] → [Process underload]

Process Underload Detected Error

A process underload is detected when the next event occurs and remains pending for a minimum time [Unld T. Del. Detect] $\cup L t$, which is configurable:

- The motor is in steady state and the torque is below the set underload limit ([Unld.Thr.0.Speed] $L \cup L$, [Unld.Thr.Nom.Speed] $L \cup n$, [Unld. FreqThr. Det.] $r \Pi \cup d$ parameters).
- The motor is in steady state when the offset between the frequency reference and motor frequency falls below the configurable threshold [Hysteresis Freq] $S r b$.

Between zero frequency and the rated frequency, the curve reflects the following equation: torque = $L \cup L + (L \cup n - L \cup L) \times (\text{frequency})^2 / (\text{rated frequency})^2$ The underload function is not active for frequencies below $r \Pi \cup d$.

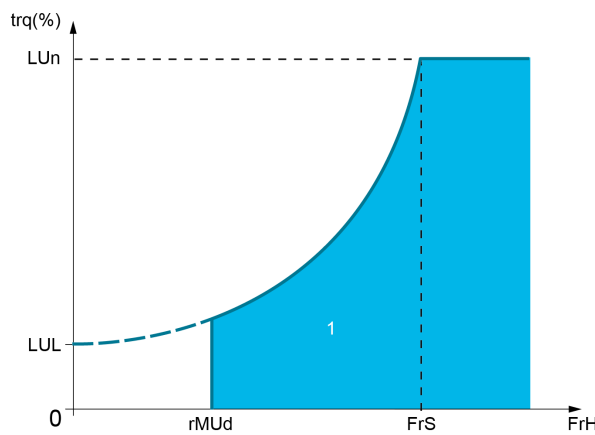

1 Underload zone.

A relay or a digital output can be assigned to the signaling of this detected error in the [Input/Output] $i o$ - [I/O assignment] $i o R 5$ - menus.

[Unld T. Del. Detect] $\cup L t$

Underload detection time delay.

A value of 0 deactivates the function and makes the other parameters inaccessible.

Setting	Description
0...100 s	Setting range Factory setting: 0 s

[Unld.Thr.Nom.Speed] $L \cup n$ ★

Underload threshold at nominal motor speed [Nominal Motor Freq] $F r S$, as a % of the rated motor torque.

This parameter can be accessed if [Unld T. Del. Detect] $\cup L t$ is not set to 0.

Setting (°)	Description
20...100%	Setting range Factory setting: 60%

[Unld.Thr.0.Speed] L u L ★

Underload threshold at zero frequency as a % of the rated motor torque.

This parameter can be accessed if **[Unld T. Del. Detect] u L E** is not set to 0.

Setting ()	Description
0... [Unld.Thr.Nom.Speed] L u n	Setting range Factory setting: 0%

[Unld. FreqThr. Det.] r n u d ★

Minimum frequency underload detection threshold.

This parameter can be accessed if **[Unld T. Del. Detect] u L E** is not set to 0.

Setting ()	Description
0.0...599.0 Hz	Setting range Factory setting: 0.0 Hz

[Hysteresis Freq] S r b ★

Maximum deviation between the frequency reference and the motor frequency, which defines a steady state operation.

This parameter can be accessed if **[Unld T. Del. Detect] u L E** or **[Ovld Time Detect.] E o L** is not set to 0.

Setting ()	Description
0.3...599.0 Hz	Setting range Factory setting: 0.3 Hz

[Underload Mangmt.] u d L ★

Underload management.

Behavior on switching to underload detection.

This parameter can be accessed if **[Unld T. Del. Detect] u L E** is not set to 0.

Setting	Code / Value	Description
[Ignore]	n o	Detected error ignored
[Freewheel stop]	Y E S	Freewheel stop Factory setting
[Ramp stop]	r n P	Stop on ramp
[Fast stop]	F S E	Fast stop

[Underload T.B.Rest.] F E u ★

Minimum time permitted between an underload being detected and any automatic restart.

To allow an automatic restart, the value of **[Fault Reset Time] E R r** must exceed this parameter by at least 1 minute.

This parameter can be accessed if **[Underload Mangmt.] u d L** is not set to **[Ignore] n o**.

Setting ()	Description
0...6 min	Setting range Factory setting: 0 min

[Process overload] $\sigma L d$ - Menu

Access

[Complete settings] → [Generic monitoring] → [Process overload]

About This Menu

A process overload error is detected when the next event occurs and remains pending for a minimum time [Ovld Time Detect.] $t_{\sigma L}$, which is configurable:

- The drive is in [Current limitation] $C L$, mode during acceleration, deceleration, or,
- The motor is in steady state and the [Motor Current] $L C r$ is above the set overload threshold [Ovld Detection Thr.] $L_{\sigma L}$.

The motor is in steady state when the offset difference between [Pre-Ramp Ref Freq] $F_{r H}$ and [Motor Frequency] $r F r$ is less than the configurable threshold [Hysteresis Freq] $S_{r b}$.

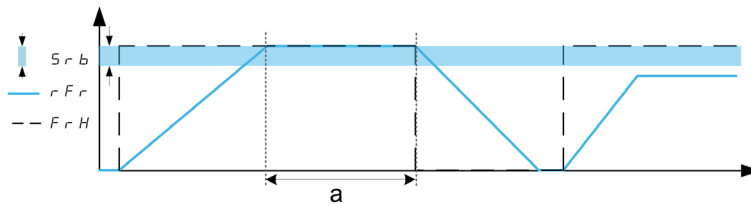

NOTE: Process overload monitoring is always active in [Current limitation] $C L$, state.

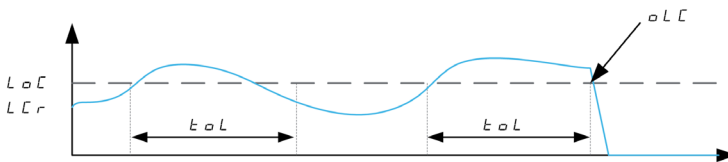

[Ovld Time Detect.] $t_{\sigma L}$

Overload reaction time.

A value of 0 deactivates the function and makes the other parameters inaccessible.

Setting	Description
0...100 s	Setting range Factory setting: 0 s

[Ovld Detection Thr.] $L_{\sigma L}$ ★

Overload threshold.

Overload detection threshold, as a % of the rated motor current [Nom Motor Current] $n C r$. This value must be less than the limit current in order for the function to work.

This parameter can be accessed if [Ovld Time Detect.] $t_{\sigma L}$ is not set to 0.

Setting (↻)	Description
70...150%	Setting range Factory setting: 110%

[Hysteresis Freq] S r b ★

Hysteresis for steady state.

Maximum deviation between the frequency reference and the motor frequency, which defines a steady state operation.

This parameter can be accessed if **[Ovld Time Detect.] t o L** or **[Unld T. Del. Detect.] u L t** is not set to 0.

Setting ()	Description
0.3...599.0 Hz	Setting range Factory setting: 0.3 Hz

[Ovld.Proces.Mngmt] o d L ★

Behavior on switching to overload detection.

This parameter can be accessed if **[Ovld Time Detect.] t o L** is not set to 0.

Setting	Code / Value	Description
[Ignore]	n o	Detected error ignored
[Freewheel stop]	y E 5	Freewheel stop Factory setting
[Ramp stop]	r n P	Stop on ramp
[Fast stop]	F 5 t	Fast stop

[Overload T.B.Rest.] F t o ★

Minimum time permitted between an overload being detected and any automatic restart.

In order to allow an automatic restart, the value of **[Fault Reset Time] t R r** must exceed this parameter by at least 1 minute.

This parameter can be accessed if **[Ovld Time Detect.] t o L** or **[Ovld.Process.Mngmt] o d L** is not set to 0.

Setting ()	Description
0...6 min	Setting range Factory setting: 0 min

[Stall monitoring] 5 Ƨ P Ʀ - Menu

Access

[Complete settings] → [Generic monitoring] → [Stall monitoring]

About This Menu

This function helps to prevent a motor overload by monitoring the motor current and the speed rise time.

A stalling condition is when:

- An output frequency is smaller than the stalling frequency [Stall Frequency] 5 Ƨ P Ƴ
- And an output current is higher than the stalling current [Stall Current] 5 Ƨ P Ƴ
- During a time longer than the stalling time [Stall Max Time] 5 Ƨ P 1

When a stalling condition occurs, a [Motor Stall Error] 5 Ƨ F error is triggered.

[Stall Monitoring] 5 Ƨ P Ƨ

Stall monitoring activation.

Setting	Code / Value	Description
[No]	n o	Function disabled Factory setting
[Yes]	y e s	Function enabled

[Stall Max Time] 5 Ƨ P 1★

Motor stall maximum time.

This parameter can be accessed if [Stall Monitoring] 5 Ƨ P Ƨ is not set to [No] n o.

Setting (↻)	Description
0.0...200 s	Setting range Factory setting: 60.0 s

[Stall Current] 5 Ƨ P Ƴ★

Stall monitoring current level, as a % of the rated motor current [Nom Motor Current] n Ƨ r .

This parameter can be accessed if [Stall Monitoring] 5 Ƨ P Ƨ is not set to [No] n o.

The factory setting changes to 150,0 % if [Dual rating] d r Ƨ is set to [Heavy Duty] H i G h.

Setting (↻)	Description
0.0...150.0%	Setting range Factory setting: 150.0%

[Stall Frequency] 5 Ƨ P Ƴ★

Stall monitoring frequency level.

This parameter can be accessed if [Stall Monitoring] 5 Ƨ P Ƨ is not set to [No] n o.

Setting (↻)	Description
0.0...[Max Frequency] Ƨ F r	Setting range Factory setting: 2.0 Hz

[Thermal monitoring] Ƨ P P - Menu

Access

[Complete settings] → [Generic monitoring] → [Thermal monitoring]

About This Menu

Identical to [Thermal monitoring] Ƨ P P - Menu (see page 185).

[Frequency meter] F 9 F - Menu

Access

[Complete settings] → [Generic monitoring] → [Frequency meter]

About This Menu

This function uses the "Pulse input" input and can only be used if the "Pulse input" input is not being used for another function.

Example of Use

An indexed disk driven by the motor and connected to a proximity sensor can be used to generate a frequency signal that is proportional to the speed of rotation of the motor.

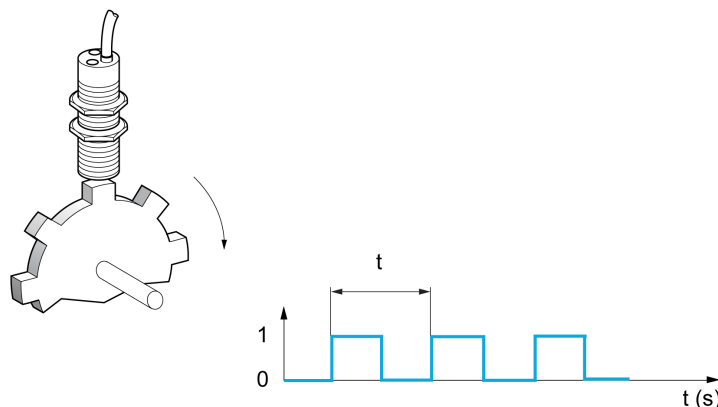

When applied to the "Pulse input" input, this signal supports:

- Measurement and display of the motor speed: signal frequency = $1/T$. This frequency is displayed with the [Measured Freq] F 9 5.
- Overspeed detection (if the measured speed exceeds a preset threshold, the drive triggers an error).
- Brake failure detection if brake logic control has been configured: If the speed does not drop sufficiently quickly following a command to engage the brake, the drive triggers an error. This function can be used to detect worn brake linings.
- Detection of a speed threshold that can be adjusted using [Pulse warning thd.] F 9 L (see page 472) and is assignable to a relay or digital output.

[Frequency meter] F 9 F

Frequency Meter function activation.

Setting	Code / Value	Description
[Not Configured]	n a	Not assigned Factory Setting
[DI7 PulseInput]...[DI8 PulseInput]	P , 7...P , 8	Digital input DI7...DI8 used as pulse input

[Pulse scal. divider] F 9 C

Coefficient for measure.

The frequency measured is displayed with the [Measured Freq] F 9 5 parameter.

Setting ()	Description
1.0...100.0	Setting range Factory setting: 1.0

[Overspd. pulse thd.] F 9 F

Maximum frequency authorized.

Activation and adjustment of overspeed monitoring: **[Motor Overspeed] 5 0 F**.

Setting	Code / Value	Description
[No]	n 0	No motor overspeed monitoring Factory setting
0...30 kHz		Adjustment of the frequency tripping threshold on the "Pulse input" input divided by [Pulse scal. divider] F 9 C .

[Pulse overspd delay] E d 5

Time before triggering in over-speed.

Setting	Description
0.0...10.0 s	Setting range Factory setting: 0.0 s

[Level fr. pulse ctrl] F d E

Feedback detection threshold.

Activation and adjustment of monitoring for the pulse input (speed feedback): **[Encoder Feedback Loss] 5 P F**.

Setting	Code / Value	Description
[No]	n 0	No monitoring of speed feedback Factory setting
0.0...599 Hz		Adjustment of the motor frequency threshold for tripping a speed feedback detection. (difference between the estimated frequency and the measured speed).

[Pulse thd. wo Run] F 9 E

Frequency threshold wear brake.

Activation and adjustment of brake feedback monitoring: **[Brake Feedback] b r F**. If brake logic control **[Brake assignment] b L C** is not configured, this parameter is forced to **[No] n 0**.

Setting	Code / Value	Description
[No]	n 0	No brake monitoring Factory setting
1...1,000 Hz		Adjustment of the motor frequency threshold to trigger a [Brake Feedback] b r F error (detection of speeds other than 0).

[Pulse wo Run delay] E 9 b

Time before triggering in wear brake.

Setting	Description
0.0...10.0 s	Setting range Factory setting: 0.0 s

[Pulse warning thd.] F 9 L

Frequency level.

This parameter can be accessed if **[Frequency meter] F 9 F** is not set to **[Not configured] n 0**.

Setting	Description
0...30,000 Hz	Setting range Factory setting: 0 Hz

Section 8.50

[Input/Output] - [I/O assignment]

What Is in This Section?

This section contains the following topics:

Topic	Page
[DI1 assignment] <i>L 1 A</i> - Menu	474
[DI2 assignment] <i>L 2 A</i> - Menu	474
[DI3 assignment] <i>L 3 A</i> - Menu	474
[DI4 assignment] <i>L 4 A</i> - Menu	475
[DI5 assignment] <i>L 5 A</i> - Menu	475
[DI6 assignment] <i>L 6 A</i> - Menu	475
[DI7 assignment] <i>L 7 A</i> - Menu	476
[DI8 assignment] <i>L 8 A</i> - Menu	476
[DI11 assignment] <i>L 11 A</i> - Menu	476
[DI12 assignment] <i>L 12 A</i> - Menu	477
[DI13 assignment] <i>L 13 A</i> - Menu	477
[DI14 assignment] <i>L 14 A</i> - Menu	477
[DI15 assignment] <i>L 15 A</i> - Menu	478
[DI16 assignment] <i>L 16 A</i> - Menu	478
[DI7 Pulse Input Assign] <i>P 7 A</i> - Menu	479
[DI8 Pulse Input Assign] <i>P 8 A</i> - Menu	480
[Encoder Pulse Assign] <i>P E G A</i> - Menu	480
[AI1 assignment] <i>A 1 A</i> - Menu	480
[AI2 assignment] <i>A 2 A</i> - Menu	481
[AI3 assignment] <i>A 3 A</i> - Menu	481
[AI4 assignment] <i>A 4 A</i> - Menu	481
[AI5 assignment] <i>A 5 A</i> - Menu	481
[AIV1 assignment] <i>A V 1 A</i> - Menu	482
[DI50 Assignment] <i>d 5 0 A</i> - Menu	482
[DI51 Assignment] <i>d 5 1 A</i> - Menu	482
[DI52 Assignment] <i>d 5 2 A</i> - Menu	483
[DI53 Assignment] <i>d 5 3 A</i> - Menu	484
[DI54 Assignment] <i>d 5 4 A</i> - Menu	484
[DI55 Assignment] <i>d 5 5 A</i> - Menu	484
[DI56 Assignment] <i>d 5 6 A</i> - Menu	485
[DI57 Assignment] <i>d 5 7 A</i> - Menu	485
[DI58 Assignment] <i>d 5 8 A</i> - Menu	485
[DI59 Assignment] <i>d 5 9 A</i> - Menu	486

[DI1 assignment] L 1 A - Menu

Access

[Complete settings] → [Input/Output] → [I/O assignment] → [DI1 assignment]

[DI1 Low Assignment] L 1 L

DI1 low assignment.

Read-only parameter, cannot be configured. It displays all the functions associated with digital input DI1 in order to verify, for example, for compatibility problems.

If no functions have been assigned, **[No]** $n \square$ is displayed.

[DI1 High Assignment] L 1 H

DI1 high assignment.

Read-only parameter, cannot be configured. It displays all the functions associated with digital input DI1 in order to verify, for example, for compatibility problems.

If no functions have been assigned, **[No]** $n \square$ is displayed.

[DI2 assignment] L 2 A - Menu

Access

[Complete settings] → [Input/Output] → [I/O assignment] → [DI2 assignment]

About This Menu

Identical to [DI1 assignment] L 1 A - menu (*see page 474*).

[DI2 Low Assignment] L 2 L

DI2 low assignment.

[DI2 High Assignment] L 2 H

DI2 high assignment.

[DI3 assignment] L 3 A - Menu

Access

[Complete settings] → [Input/Output] → [I/O assignment] → [DI3 assignment]

About This Menu

Identical to [DI1 assignment] L 1 A - menu (*see page 474*).

[DI3 Low Assignment] L 3 L

DI3 low assignment.

[DI3 High Assignment] L 3 H

DI3 high assignment.

[DI4 assignment] L 4 R - Menu

Access

[Complete settings] → [Input/Output] → [I/O assignment] → [DI4 assignment]

About This Menu

Identical to [DI1 assignment] L 1 R - menu (*see page 474*).

[DI4 Low Assignment] L 4 L

DI4 low assignment.

[DI4 High Assignment] L 4 H

DI4 high assignment.

[DI5 assignment] L 5 R - Menu

Access

[Complete settings] → [Input/Output] → [I/O assignment] → [DI5 assignment]

About This Menu

Identical to [DI1 assignment] L 1 R - menu (*see page 474*).

[DI5 Low Assignment] L 5 L

DI5 low assignment.

[DI5 High Assignment] L 5 H

DI5 high assignment.

[DI6 assignment] L 6 R - Menu

Access

[Complete settings] → [Input/Output] → [I/O assignment] → [DI6 assignment]

About This Menu

Identical to [DI1 assignment] L 1 R - menu (*see page 474*).

[DI6 Low Assignment] L 6 L

DI6 low assignment.

[DI6 High Assignment] L 6 H

DI6 high assignment.

[DI7 assignment] L 7 H - Menu

Access

[Complete settings] → [Input/Output] → [I/O assignment] → [DI7 assignment]

About This Menu

Identical to [DI1 assignment] L 1 H - menu (*see page 474*).

[DI7 Low Assignment] L 7 L

DI7 low assignment.

[DI7 High Assignment] L 7 H

DI7 high assignment.

[DI8 assignment] L 8 H - Menu

Access

[Complete settings] → [Input/Output] → [I/O assignment] → [DI8 assignment]

About This Menu

Identical to [DI1 assignment] L 1 H - menu (*see page 474*).

[DI8 Low Assignment] L 8 L

DI8 low assignment.

[DI8 High Assignment] L 8 H

DI8 high assignment.

[DI11 assignment] L 11 H - Menu

Access

[Complete settings] → [Input/Output] → [I/O assignment] → [DI11 assignment]

About This Menu

Identical to [DI1 assignment] L 1 H - menu (*see page 474*).

Following parameters can be accessed if VW3A3203 I/O extension module has been inserted.

[DI11 Low Assignment] L 11 L ★

DI11 low assignment.

[DI11 High Assignment] L 11 H ★

DI11 high assignment.

[DI12 assignment] L 12A - Menu

Access

[Complete settings] → [Input/Output] → [I/O assignment] → [DI12 assignment]

About This Menu

Identical to [DI1 assignment] L 1A - menu (*see page 474*).

Following parameters can be accessed if VW3A3203 I/O extension module has been inserted.

[DI12 Low Assignment] L 12L ★

DI12 low assignment.

[DI12 High Assignment] L 12H ★

DI12 high assignment.

[DI13 assignment] L 13A - Menu

Access

[Complete settings] → [Input/Output] → [I/O assignment] → [DI13 assignment]

About This Menu

Identical to [DI1 assignment] L 1A - menu (*see page 474*).

Following parameters can be accessed if VW3A3203 I/O extension module has been inserted.

[DI13 Low Assignment] L 13L ★

DI13 low assignment.

[DI13 High Assignment] L 13H ★

DI13 high assignment.

[DI14 assignment] L 14A - Menu

Access

[Complete settings] → [Input/Output] → [I/O assignment] → [DI14 assignment]

About This Menu

Identical to [DI1 assignment] L 1A - menu (*see page 474*).

Following parameters can be accessed if VW3A3203 I/O extension module has been inserted.

[DI14 Low Assignment] L 14L ★

DI14 low assignment.

[DI14 High Assignment] L 14H ★

DI14 high assignment.

[DI15 assignment] L I5R - Menu

Access

[Complete settings] → [Input/Output] → [I/O assignment] → [DI15 assignment]

About This Menu

Identical to [DI1 assignment] L I R - menu (*see page 474*).

Following parameters can be accessed if VW3A3203 I/O extension module has been inserted.

[DI15 Low Assignment] L I5L ★

DI15 low assignment.

[DI15 High Assignment] L I5H ★

DI15 high assignment.

[DI16 assignment] L I6R - Menu

Access

[Complete settings] → [Input/Output] → [I/O assignment] → [DI16 assignment]

About This Menu

Identical to [DI1 assignment] L I R - menu (*see page 474*).

Following parameters can be accessed if VW3A3203 I/O extension module has been inserted.

[DI16 Low Assignment] L I6L ★

DI16 low assignment.

[DI16 High Assignment] L I6H ★

DI16 high assignment.

[DI7 Pulse Input Assign] P , 7 A - Menu

Access

[Complete settings] → [Input/Output] → [I/O assignment] → [DI7 Pulse Input Assign]

About This Menu

Following parameters can be accessed on the Graphic Display Terminal by pressing the OK key on the [DI7 Frequency Measured] P F C 7 parameter.

[DI7 Pulse Input Assign] P , 7 A

DI7 pulse input assignment.

It displays all the functions associated with the pulse input in order to verify, for example, for compatibility problems.

If no functions have been assigned, [No] n o is displayed.

Setting	Code / Value	Description
[No]	n o	Not assigned
[Torque Ref Offset]	t q o	Torque offset source
[Torque Ref Ratio]	t q r	Torque ratio source
[Ref Frequency 1]	F r 1	Reference frequency 1
[Ref Frequency 2]	F r 2	Reference frequency 2
[Ref Frequency 2 Summing]	S A 2	Reference frequency 2 summing
[PID Feedback]	P , F	PI controller feedback
[Torque limitation]	t A A	Torque limitation: activation by an analog value
[Torque limitation 2]	t A A 2	Torque limitation: activation by an analog value
[Subtract Ref Freq 2]	d A 2	Subtract reference frequency 2
[Manual PID Ref.]	P , n	Manual speed reference of the PID controller (auto-man)
[PID Ref Frequency]	F P ,	PID reference frequency
[Ref Frequency 3 Summing]	S A 3	Reference frequency 3 summing
[Ref Frequency 1B]	F r 1 b	Reference frequency 1B
[Subtract Ref Freq 3]	d A 3	Subtract reference frequency 3
[Forced local]	F L o C	Forced local reference source1
[Ref Frequency 2 multiplier]	n A 2	Reference frequency 2 multiplier
[Ref Frequency 3 multiplier]	n A 3	Reference frequency 3 multiplier
[Torque reference]	t r 1	Torque regulation: torque set point 1
[Torque reference 2]	t r 2	Torque regulation: torque set point 2
[Frequency Meter]	F q F	Frequency meter function activation
[External Feed Forward]	t E F F	External feed-forward

[DI8 Pulse Input Assign] P , B R - Menu

Access

[Complete settings] → [Input/Output] → [I/O assignment] → [Pulse Input DI8 Assign]

About This Menu

Identical to [DI7 Pulse Input Assign] P , 7 R - .

Following parameters can be accessed on the Graphic Display Terminal by pressing the OK key on the [DI8 Frequency Measured] P F C B parameter.

[Pulse Input DI8 Assign] P , B R

Pulse Input DI8 Assignment.

Identical to [Pulse Input DI7 Assign] P , 7 R (see page 479)

[Encoder Pulse Assign] P E C R - Menu

Access

[Complete settings] → [Input/Output] → [I/O Assignment] → [Encoder Pulse Assign]

About This Menu

Following parameters can be accessed on the Graphic Display Terminal by pressing the OK key on the [Encoder Config] P C parameter.

This parameter can be accessed if an encoder module has been plugged.

[Encoder Pulse Assign] P E C R

Encoder pulse assignment.

It displays all the functions associated with the pulse input in order to verify, for example, compatibility problems.

If no functions have been assigned, [No] n o is displayed.

Identical to [Pulse Input DI7 Assign] P , 7 R (see page 479).

[AI1 assignment] A , 1 R - Menu

Access

[Complete settings] → [Input/Output] → [I/O assignment] → [AI1 assignment]

[AI1 Assignment] A , 1 R

Analog input AI1 functions assignment.

Read-only parameter, cannot be configured. It displays all the functions associated with input AI1 in order to verify, for example, for compatibility problems.

If no functions have been assigned, [No] n o is displayed.

[AI2 assignment] R , 2 R - Menu**Access**

[Complete settings] → [Input/Output] → [I/O assignment] → [AI2 assignment]

About This Menu

Identical to [AI1 assignment] R , 1 R - menu (*see page 480*).

[AI2 Assignment] R , 2 R

AI2 assignment.

[AI3 assignment] R , 3 R - Menu**Access**

[Complete settings] → [Input/Output] → [I/O assignment] → [AI3 assignment]

About This Menu

Identical to [AI1 assignment] R , 1 R - menu (*see page 480*).

[AI3 assignment] R , 3 R

AI3 assignment.

[AI4 assignment] R , 4 R - Menu**Access**

[Complete settings] → [Input/Output] → [I/O assignment] → [AI4 assignment]

About This Menu

Identical to [AI1 assignment] R , 1 R - menu (*see page 480*).

[AI4 Assignment] R , 4 R ★

AI4 assignment.

This parameter can be accessed if VW3A3203 I/O extension module has been inserted.

[AI5 assignment] R , 5 R - Menu**Access**

[Complete settings] → [Input/Output] → [I/O assignment] → [AI5 assignment]

About This Menu

Identical to [AI1 assignment] R , 1 R - menu (*see page 480*).

[AI5 Assignment] R , 5 R ★

AI5 assignment.

This parameter can be accessed if VW3A3203 I/O extension module has been inserted.

[AIV1 assignment] *A V I A* - Menu

Access

[Complete settings] → [Input/Output] → [I/O assignment] → [AIV1 assignment]

[AIV1 Assignment] *A V I A*

Virtual analog input 1 function assignment.

Read-only parameter, cannot be configured. It displays all the functions associated with virtual analog input 1 in order to verify, for example, for compatibility problems. If no functions have been assigned, **[No]** *n o* is displayed.

[DI50 Assignment] *D S D A* - Menu

Access

[Complete settings] → [Input/Output] → [I/O assignment] → [DI50 Assignment]

About This Menu

Following parameters can be accessed on ATV960 or ATV980, equipped with cabinet IO, and if **[Access Level]** *L A C* is set to **[Expert]** *E P r*.

[DI50 Low Assignment] *D S D L*

DI50 low assignment.

[DI50 High Assignment] *D S D H*

DI50 high assignment.

[DI51 Assignment] *D S I A* - Menu

Access

[Complete settings] → [Input/Output] → [I/O assignment] → [DI51 Assignment]

About This Menu

Following parameters can be accessed on ATV960 or ATV980, equipped with cabinet IO, and if **[Access Level]** *L A C* is set to **[Expert]** *E P r*.

[DI51 Low Assignment] *D S I L*

DI51 low assignment.

[DI51 High Assignment] *D S I H*

DI51 high assignment.

[DI52 Assignment] d 5 2 A - Menu**Access**

[Complete settings] → [Input/Output] → [I/O assignment] → [DI52 Assignment]

About This Menu

Following parameters can be accessed on ATV960 or ATV980, equipped with cabinet IO, and if [Access Level] *L A C* is set to [Expert] *E P r*.

[DI52 Low Assignment] d 5 2 L

DI52 low assignment.

Settings	Code/Value	Description
[No]	<i>n o</i>	Not assigned
[Freewheel stop]	<i>n S t</i>	Freewheel stop
[Ext Error assign]	<i>E t F</i>	External error assignment
[Drive Lock]	<i>L E S</i>	Drive lock assignment
[Monitor Circuit A]	<i>, F A A</i>	Monitoring circuit A assignment
[Monitor Circuit B]	<i>, F A b</i>	Monitoring circuit B assignment
[Monitor Circuit C]	<i>, F A C</i>	Monitoring circuit C assignment
[Monitor Circuit D]	<i>, F A d</i>	Monitoring circuit D assignment
[Cabinet Circuit A]	<i>C F A A</i>	Cabinet circuit A assignment
[Cabinet Circuit B]	<i>C F A b</i>	Cabinet circuit B assignment
[Cabinet Circuit C]	<i>C F A C</i>	Cabinet circuit C assignment
[Motor Winding A]	<i>t F A A</i>	Motor winding A assignment
[Motor Winding B]	<i>t F A b</i>	Motor winding B assignment
[Motor Bearing A]	<i>t F A C</i>	Motor bearing A assignment
[Motor Bearing B]	<i>t F A d</i>	Motor bearing B assignment

[DI52 High Assignment] d 5 2 H

DI52 high assignment.

Settings	Code/Value	Description
[No]	<i>n o</i>	Not assigned
[Forced local]	<i>F L o</i>	Forced local mode
[Fault reset]	<i>r S F</i>	Fault reset
[Eternal Error]	<i>E t F</i>	External error
[Drive Lock]	<i>L E S</i>	Drive lock assignment
[Product Restart Assign]	<i>r P A</i>	Restart product
[Monitor Circuit A]	<i>, F A A</i>	Monitoring circuit A assignment
[Monitor Circuit B]	<i>, F A b</i>	Monitoring circuit B assignment
[Monitor Circuit C]	<i>, F A C</i>	Monitoring circuit C assignment
[Monitor Circuit D]	<i>, F A d</i>	Monitoring circuit D assignment
[Cabinet Circuit A]	<i>C F A A</i>	Cabinet circuit A assignment
[Cabinet Circuit B]	<i>C F A b</i>	Cabinet circuit B assignment
[Cabinet Circuit C]	<i>C F A C</i>	Cabinet circuit C assignment
[Motor Winding A]	<i>t F A A</i>	Motor winding A assignment
[Motor Winding B]	<i>t F A b</i>	Motor winding B assignment
[Motor Bearing A]	<i>t F A C</i>	Motor bearing A assignment
[Motor Bearing B]	<i>t F A d</i>	Motor bearing B assignment
[Mains Contactor]	<i>L L C</i>	Mains contactor control

[DI53 Assignment] *d 5 3 R* - Menu

Access

[Complete settings] → [Input/Output] → [I/O assignment] → [DI53 Assignment]

About This Menu

Identical to [DI52 Assignment] *d 5 2 R* - Menu. (*see page 483*)

Following parameters can be accessed on ATV960 or ATV980, equipped with cabinet IO, and if [Access Level] *L R C* is set to [Expert] *E P r*.

[DI53 Low Assignment] *d 5 3 L*

DI53 low assignment.

[DI53 High Assignment] *d 5 3 H*

DI53 high assignment.

[DI54 Assignment] *d 5 4 R* - Menu

Access

[Complete settings] → [Input/Output] → [I/O assignment] → [DI54 Assignment]

About This Menu

Identical to [DI52 Assignment] *d 5 2 R* - Menu. (*see page 483*)

Following parameters can be accessed on ATV960 or ATV980, equipped with cabinet IO, and if [Access Level] *L R C* is set to [Expert] *E P r*.

[DI54 Low Assignment] *d 5 4 L*

DI54 low assignment.

[DI54 High Assignment] *d 5 4 H*

DI54 high assignment.

[DI55 Assignment] *d 5 5 R* - Menu

Access

[Complete settings] → [Input/Output] → [I/O assignment] → [DI55 Assignment]

About This Menu

Identical to [DI52 Assignment] *d 5 2 R* - Menu. (*see page 483*)

Following parameters can be accessed on ATV960 or ATV980, equipped with cabinet IO, and if [Access Level] *L R C* is set to [Expert] *E P r*.

[DI55 Low Assignment] *d 5 5 L*

DI55 low assignment.

[DI55 High Assignment] *d 5 5 H*

DI55 high assignment.

[DI56 Assignment] *d 5 6 A* - Menu

Access

[Complete settings] → [Input/Output] → [I/O assignment] → [DI56 Assignment]

About This Menu

Identical to [DI52 Assignment] *d 5 2 A* - Menu. (*see page 483*)

Following parameters can be accessed on ATV960 or ATV980, equipped with cabinet IO, and if [Access Level] *L A C* is set to [Expert] *E P r*.

[DI56 Low Assignment] *d 5 6 L*

DI56 low assignment.

[DI56 High Assignment] *d 5 6 H*

DI56 high assignment.

[DI57 Assignment] *d 5 7 A* - Menu

Access

[Complete settings] → [Input/Output] → [I/O assignment] → [DI57 Assignment]

About This Menu

Identical to [DI52 Assignment] *d 5 2 A* - Menu. (*see page 483*)

Following parameters can be accessed on ATV960 or ATV980, equipped with cabinet IO, and if [Access Level] *L A C* is set to [Expert] *E P r*.

[DI57 Low Assignment] *d 5 7 L*

DI57 low assignment.

[DI57 High Assignment] *d 5 7 H*

DI57 high assignment.

[DI58 Assignment] *d 5 8 A* - Menu

Access

[Complete settings] → [Input/Output] → [I/O assignment] → [DI58 Assignment]

About This Menu

Identical to [DI52 Assignment] *d 5 2 A* - Menu. (*see page 483*)

Following parameters can be accessed on ATV960 or ATV980, equipped with cabinet IO, and if [Access Level] *L A C* is set to [Expert] *E P r*.

[DI58 Low Assignment] *d 5 8 L*

DI58 low assignment.

[DI58 High Assignment] *d 5 8 H*

DI58 high assignment.

[DI59 Assignment] *d 5 9 A* - Menu

Access

[Complete settings] → [Input/Output] → [I/O assignment] → [DI59 Assignment]

About This Menu

Identical to [DI52 Assignment] *d 5 2 A* - Menu. (*see page 483*)

Following parameters can be accessed on ATV960 or ATV980, equipped with cabinet IO, and if [Access Level] *L R C* is set to [Expert] *E P r*.

[DI59 Low Assignment] *d 5 9 L*

DI59 low assignment.

[DI59 High Assignment] *d 5 9 H*

DI59 high assignment.

Section 8.51

[Input/Output] - [DI/DQ]

What Is in This Section?

This section contains the following topics:

Topic	Page
[DI1 Configuration] <i>d , 1</i> - Menu	488
[DI2 Configuration] <i>d , 2</i> - Menu	488
[DI3 Configuration] <i>d , 3</i> - Menu	489
[DI4 Configuration] <i>d , 4</i> - Menu	489
[DI5 Configuration] <i>d , 5</i> - Menu	490
[DI6 Configuration] <i>d , 6</i> - Menu	490
[DI7 Configuration] <i>d , 7</i> - Menu	491
[DI8 Configuration] <i>d , 8</i> - Menu	491
[DI11 Configuration] <i>d , 11</i> - Menu	492
[DI12 Configuration] <i>d , 12</i> - Menu	492
[DI13 Configuration] <i>d , 13</i> - Menu	493
[DI14 Configuration] <i>d , 14</i> - Menu	493
[DI15 Configuration] <i>d , 15</i> - Menu	494
[DI16 Configuration] <i>d , 16</i> - Menu	494
[DI7 Pulse Config] <i>PR , 7</i> - Menu	495
[DI8 Pulse Config] <i>PR , 8</i> - Menu	497
[Encoder Config] <i>PG</i> - Menu	498
[DQ1 Configuration] <i>do 1</i> - Menu	499
[DQ11 Configuration] <i>do 11</i> - Menu	500
[DQ12 Configuration] <i>do 12</i> - Menu	501
[DI50 Configuration] <i>d , 50</i> - Menu	502
[DI51 Configuration] <i>d , 51</i> - Menu	502
[DI52 Configuration] <i>d , 52</i> - Menu	503
[DI53 Configuration] <i>d , 53</i> - Menu	504
[DI54 Configuration] <i>d , 54</i> - Menu	505
[DI55 Configuration] <i>d , 55</i> - Menu	505
[DI56 Configuration] <i>d , 56</i> - Menu	506
[DI57 Configuration] <i>d , 57</i> - Menu	506
[DI58 Configuration] <i>d , 58</i> - Menu	507
[DI59 Configuration] <i>d , 59</i> - Menu	507

[DI1 Configuration] *d , 1* - Menu

Access

[Complete settings] → [Input/Output] → [DI/DQ] → [DI1 Configuration]

[DI1 Low Assignment] *L 1 L*

DI1 low assignment.

Read-only parameter, cannot be configured. It displays all the functions associated with digital input DI1 in order to verify, for example, for compatibility problems.

If no functions have been assigned, **[No]** *n o* is displayed.

[DI1 High Assignment] *L 1 H*

DI1 high assignment.

Read-only parameter, cannot be configured. It displays all the functions associated with digital input DI1 in order to verify, for example, for compatibility problems.

If no functions have been assigned, **[No]** *n o* is displayed.

[DI1 Delay] *L 1 d*

DI1 delay.

NOTE: Commands received via this digital input are processed once the delay time set via this parameter has elapsed.

Setting	Description
0...200 ms	Setting range Factory setting: 2 ms

[DI2 Configuration] *d , 2* - Menu

Access

[Complete settings] → [Input/Output] → [DI/DQ] → [DI2 Configuration]

About This Menu

Identical to [DI1 Configuration] *d , 1* - menu (*see page 488*).

[DI2 Low Assignment] *L 2 L*

DI2 low assignment.

[DI2 High Assignment] *L 2 H*

DI2 high assignment.

[DI2 Delay] *L 2 d*

DI2 delay.

[DI3 Configuration] \mathcal{D} , \exists - Menu

Access

[Complete settings] → [Input/Output] → [DI/DQ] → [DI3 Configuration]

About This Menu

Identical to [DI1 Configuration] \mathcal{D} , 1 - menu (*see page 488*).

[DI3 Low Assignment] $L \exists L$

DI3 low assignment.

[DI3 High Assignment] $L \exists H$

DI3 high assignment.

[DI3 Delay] $L \exists \mathcal{D}$

DI3 delay.

[DI4 Configuration] \mathcal{D} , 4 - Menu

Access

[Complete settings] → [Input/Output] → [DI/DQ] → [DI4 Configuration]

About This Menu

Identical to [DI1 Configuration] \mathcal{D} , 1 - menu (*see page 488*).

[DI4 Low Assignment] $L 4 L$

DI4 low assignment.

[DI4 High Assignment] $L 4 H$

DI4 high assignment.

[DI4 Delay] $L 4 \mathcal{D}$

DI4 delay.

[DI5 Configuration] *d* , *5* - Menu

Access

[Complete settings] → [Input/Output] → [DI/DQ] → [DI5 Configuration]

About This Menu

Identical to [DI1 Configuration] *d* , *1* - menu (*see page 488*).

[DI5 Low Assignment] *L 5 L*

DI5 low assignment.

[DI5 High Assignment] *L 5 H*

DI5 high assignment.

[DI5 Delay] *L 5 d*

DI5 delay.

[DI6 Configuration] *d* , *6* - Menu

Access

[Complete settings] → [Input/Output] → [DI/DQ] → [DI6 Configuration]

About This Menu

Identical to [DI1 Configuration] *d* , *1* - menu (*see page 488*).

[DI6 Low Assignment] *L 6 L*

DI6 low assignment.

[DI6 High Assignment] *L 6 H*

DI6 high assignment.

[DI6 Delay] *L 6 d*

DI6 delay.

[DI7 Configuration] *d* , 7 - Menu

Access

[Complete settings] → [Input/Output] → [DI/DQ] → [DI7 Configuration]

About This Menu

Identical to [DI1 Configuration] *d* , 1 - menu (*see page 488*).

[DI7 Low Assignment] *L* 7 *L*

DI7 low assignment.

[DI7 High Assignment] *L* 7 *H*

DI7 high assignment.

[DI7 Delay] *L* 7 *d*

DI7 delay.

[DI8 Configuration] *d* , 8 - Menu

Access

[Complete settings] → [Input/Output] → [DI/DQ] → [DI8 Configuration]

About This Menu

Identical to [DI1 Configuration] *d* , 1 - menu (*see page 488*).

[DI8 Low Assignment] *L* 8 *L*

DI8 low assignment.

[DI8 High Assignment] *L* 8 *H*

DI8 high assignment.

[DI8 Delay] *L* 8 *d*

DI8 delay.

[DI11 Configuration] d, I, I - Menu

Access

[Complete settings] → [Input/Output] → [DI/DQ] → [DI11 Configuration]

About This Menu

Identical to [DI1 Configuration] d, I, I - menu (*see page 488*).

Following parameters can be accessed if VW3A3203 I/O extension module has been inserted.

[DI11 Low Assignment] L, I, I, L ★

DI11 low assignment.

[DI11 High Assignment] L, I, I, H ★

DI11 high assignment.

[DI11 Delay] L, I, I, d ★

DI11 delay.

[DI12 Configuration] $d, I, I, 2$ - Menu

Access

[Complete settings] → [Input/Output] → [DI/DQ] → [DI12 Configuration]

About This Menu

Identical to [DI1 Configuration] d, I, I - menu (*see page 488*).

Following parameters can be accessed if VW3A3203 I/O extension module has been inserted.

[DI12 Low Assignment] $L, I, 2, L$ ★

DI12 low assignment.

[DI12 High Assignment] $L, I, 2, H$ ★

DI12 high assignment.

[DI12 Delay] $L, I, 2, d$ ★

DI12 delay.

[DI13 Configuration] **d** , **13** - Menu

Access

[Complete settings] → [Input/Output] → [DI/DQ] → [DI13 Configuration]

About This Menu

Identical to [DI1 Configuration] **d** , **1** - menu (*see page 488*).

Following parameters can be accessed if VW3A3203 I/O extension module has been inserted.

[DI13 Low Assignment] **L** **13L** ★

DI13 low assignment.

[DI13 High Assignment] **L** **13H** ★

DI13 high assignment.

[DI13 Delay] **L** **13d** ★

DI13 delay.

[DI14 Configuration] **d** , **14** - Menu

Access

[Complete settings] → [Input/Output] → [DI/DQ] → [DI14 Configuration]

About This Menu

Identical to [DI1 Configuration] **d** , **1** - menu (*see page 488*).

Following parameters can be accessed if VW3A3203 I/O extension module has been inserted.

[DI14 Low Assignment] **L** **14L** ★

DI14 low assignment.

[DI14 High Assignment] **L** **14H** ★

DI14 high assignment.

[DI14 Delay] **L** **14d** ★

DI14 delay.

[DI15 Configuration] *d* , 15 - Menu

Access

[Complete settings] → [Input/Output] → [DI/DQ] → [DI15 Configuration]

About This Menu

Identical to [DI1 Configuration] *d* , 1 - menu (*see page 488*).

Following parameters can be accessed if VW3A3203 I/O extension module has been inserted.

[DI15 Low Assignment] *L* 15 *L* ★

DI15 low assignment.

[DI15 High Assignment] *L* 15 *H* ★

DI15 high assignment.

[DI15 Delay] *L* 15 *d* ★

DI15 delay.

[DI16 Configuration] *d* , 16 - Menu

Access

[Complete settings] → [Input/Output] → [DI/DQ] → [DI16 Configuration]

About This Menu

Identical to [DI1 Configuration] *d* , 1 - menu (*see page 488*).

Following parameters can be accessed if VW3A3203 I/O extension module has been inserted.

[DI16 Low Assignment] *L* 16 *L* ★

DI16 low assignment.

[DI16 High Assignment] *L* 16 *H* ★

DI16 high assignment.

[DI16 Delay] *L* 16 *d* ★

DI16 delay.

[DI7 Pulse Config] *P A , 7* - Menu

Access

[Complete settings] → [Input/Output] → [DI/DQ] → [DI7 Pulse Config]

About This Menu

Following parameters can be accessed on the Graphic Display Terminal by pressing the **OK** key on the [DI7 Frequency Measured] *P F C 7* parameter.

[DI7 Pulse Input Assign] *P , 7 A*

DI7 pulse input assignment.

It displays all the functions associated with the pulse input in order to verify, for example, for compatibility problems.

If no functions have been assigned, **[No]** *n o* is displayed.

Setting	Code / Value	Description
[No]	<i>n o</i>	Not assigned
[Torque Ref Offset]	<i>t r o</i>	Torque offset source
[Torque Ref Ratio]	<i>t r r</i>	Torque ratio source
[Ref Frequency 1]	<i>f r 1</i>	Reference frequency 1
[Ref Frequency 2]	<i>f r 2</i>	Reference frequency 2
[Ref Frequency 2 Summing]	<i>s r 2</i>	Reference frequency 2 summing
[PID Feedback]	<i>p , f</i>	PI controller feedback
[Torque limitation]	<i>t r r</i>	Torque limitation: activation by an analog value
[Torque limitation 2]	<i>t r r 2</i>	Torque limitation: activation by an analog value
[Subtract Ref Freq 2]	<i>d r 2</i>	Subtract reference frequency 2
[Manual PID Ref.]	<i>p , n</i>	Manual speed reference of the PID controller (auto-man)
[PID Ref Frequency]	<i>f p ,</i>	PID reference frequency
[Ref Frequency 3 Summing]	<i>s r 3</i>	Reference frequency 3 summing
[Ref Frequency 1B]	<i>f r 1 b</i>	Reference frequency 1B
[Subtract Ref Freq 3]	<i>d r 3</i>	Subtract reference frequency 3
[Forced local]	<i>f l o c</i>	Forced local reference source1
[Ref Frequency 2 multiplier]	<i>m r 2</i>	Reference frequency 2 multiplier
[Ref Frequency 3 multiplier]	<i>m r 3</i>	Reference frequency 3 multiplier
[Torque reference]	<i>t r 1</i>	Torque regulation: torque set point 1
[Torque reference 2]	<i>t r 2</i>	Torque regulation: torque set point 2
[Frequency Meter]	<i>f q f</i>	Frequency meter function activation
[External Feed Forward]	<i>t e f f</i>	External feed-forward

[DI7 PulseInput Low Freq] *P , L 7*

DI7 pulse input low frequency.

Pulse input scaling parameter of 0% in Hz x 10 unit.

Setting	Description
0.00...30,000.00 Hz	Setting range Factory setting: 0.00 Hz

[DI7 PulseInput High Freq] P , H 7

DI7 pulse input high frequency.

Pulse input scaling parameter of 100% in Hz x 10 unit.

Setting	Description
0.00...30.00 kHz	Setting range Factory setting: 30.00 kHz

[DI7 Frequency Filter] P F , 7

Interference filtering pulse input cut-off time of the low-filter.

Setting	Description
0...1,000 ms	Setting range Factory setting: 0 ms

[DI8 Pulse Config] *P A , B* - Menu

Access

[Complete settings] → [Input/Output] → [DI/DQ] → [DI8 Pulse Config]

About This Menu

Following parameters can be accessed on the Graphic Display Terminal by pressing the **OK** key on the [DI8 Frequency Measured] *P F C B* parameter.

[DI8 Pulse Input Assign] *P , B A*

DI8 Pulse Input assignment.

Identical to [DI7 Pulse Input Assign] *P , 7 A* (*see page 495*).

[DI8 PulseInput Low Freq] *P , L B*

DI8 pulse input low frequency.

Identical to [DI7 PulseInput Low Freq] *P , L 7* (*see page 495*).

[DI8 PulseInput High Freq] *P , H B*

DI8 pulse input high frequency.

Identical to [DI7 PulseInput High Freq] *P , H 7* (*see page 496*).

[DI8 Frequency Filter] *P F , B*

Interference filtering pulse input cut-off time of the low-filter.

Identical to [DI7 Frequency Filter] *P F , 7* (*see page 496*).

[Encoder Config] P G - Menu

Access

[Complete settings] → [Input/Output] → [DI/DQ] → [Encoder Config]

About This Menu

Following parameters can be accessed on the Graphic Display Terminal by pressing the OK key on the [Encoder Config] P G parameter.

This parameter can be accessed if an encoder module has been plugged.

[Encoder Pulse Assign] P L G R

Encoder pulse assignment.

It displays all the functions associated with the pulse input in order to verify, for example, compatibility problems.

If no functions have been assigned, [No] n a is displayed.

[Encoder Pulse Assign] P G R

Reference Type.

Setting	Code / Value	Description
[Encoder]	E n C	Encoder Factory Setting
[Frequency Generator]	P L G	Pulse train generator is connected to the encoder board.

[Freq Min Value] P E , L

Frequency min value.

Pulse input scaling parameter of 0% in kHz x 10 unit.

Setting	Description
-300.00..300.00 kHz	Setting range Factory setting: 0.00 kHz

[Freq Max Value] P E F r

Frequency max value.

Pulse input scaling parameter of 100% in kHz x 10 unit.

Setting	Description
-300.00..300.00 kHz	Setting range Factory setting: 300 kHz

[Freq Signal Filter] E F ,

Frequency signal filter.

Setting	Description
0...1000 ms	Setting range Factory setting: 0 ms

[DQ1 Configuration] *d o 1* - Menu

Access

[Complete settings] → [Input/Output] → [DI/DQ] → [DQ1 Configuration]

[DQ1 Assignment] *d o 1* ★

Digital output 1 assignment.

Identical to [R2 Assignment] *r 2* (see page 527).

[DQ1 Delay time] *d o 1 d* ★

DQ1 activation delay time

Setting	Description
0...60,000 ms	Setting range 0...9,999 ms then 10.00...60.00 s on the Graphic Display Terminal Factory setting: 0 ms

[DQ1 Active at] *d o 1 S* ★

DQ1 status (output active level)

Setting	Code / Value	Description
[1]	<i>P o S</i>	State 1 when the information is true Factory Setting
[0]	<i>n E G</i>	State 0 when the information is true

[DQ1 Holding time] *d o 1 H* ★

DQ1 holding delay time.

Setting	Description
0...9,999 ms	Setting range Factory setting: 0 ms

[DQ11 Configuration] d o / / - Menu

Access

[Complete settings] → [Input/Output] → [DI/DQ] → [DQ11 Configuration]

About This Menu

Following parameters can be accessed if VW3A3203 I/O extension module has been inserted.

[DQ11 Assignment] d o / / ★

Digital output 11 assignment.
 Identical to [R2 Assignment] r 2 (see page 527)

[DQ11 actv delay] d / / d ★

DQ11 activation delay time.
 The delay cannot be set for the [Operating State "Fault"] F L E and [Mains Contactor] L L C assignments, and remains at 0.
 The state modification only takes effect once the configured time has elapsed when the information becomes true.

Setting	Description
0...60,000 ms	Setting range 0...9,999 ms then 10.00...60.00 s on the Graphic Display Terminal Factory setting: 0 ms

[DQ11 status] d / / 5 ★

DQ11 status (output active level).

Setting	Code / Value	Description
[1]	P o 5	State 1 when the information is true Factory Setting
[0]	n E G	State 0 when the information is true

The configuration [1] P o 5 cannot be modified for the following assignments:

- [Operating State "Fault"] F L E ,
- [Mains Contactor] L L C ,
- [Brake Sequence] b L C ,

[DQ11 hold delay] d / / H ★

DQ11 holding delay time.
 The holding time cannot be set for the [Operating State "Fault"] F L E , [Brake Sequence] b L C , and [Mains Contactor] L L C assignments, and remains at 0.

The holding time cannot be set and remains at 0 for the following assignments:

- [Operating State "Fault"] F L E ,
- [Mains Contactor] L L C ,
- [Brake Sequence] b L C ,

The state modification only takes effect once the configured time has elapsed when the information becomes false.

Setting	Description
0...9,999 ms	Setting range Factory setting: 0 ms

[DQ12 Configuration] *d o 12* - Menu

Access

[Complete settings] → [Input/Output] → [DI/DQ] → [DQ12 Configuration]

About This Menu

Identical to [DQ11 Configuration] *d o 11* - Menu (*see page 500*).

Following parameters can be accessed if VW3A3203 I/O extension module has been inserted.

[DQ12 Assignment] *d o 12* ★

Digital output 12 assignment.

[DQ12 actv delay] *d 12 d* ★

DQ12 activation delay time.

[DQ12 status] *d 12 S* ★

DQ12 status (output active level).

[DQ12 hold delay] *d 12 H* ★

DQ12 holding delay time.

[DI50 Configuration] *d 5 0* - Menu

Access

[Complete settings] → [Input/Output] → [DI/DQ] → [DI50 Configuration]

About This Menu

NOTE: DI50 up to DI59 Inputs are used inside the Drive Systems enclosure for control and monitoring circuits.

Following parameters can be accessed on ATV960 or ATV980, equipped with cabinet IO, and if [Access Level] *L R C* is set to [Expert] *E P r*.

[DI50 Low Assignment] *d 5 0 L*

DI50 low assignment.

[DI50 High Assignment] *d 5 0 H*

DI50 high assignment.

[DI50 delay] *d 5 0 d*

DI50 delay.

NOTE: Commands received via this digital input are processed once the delay time set via this parameter has elapsed.

Setting	Description
0...200 ms	Setting range Factory setting: 5 ms

[DI51 Configuration] *d 5 1* - Menu

Access

[Complete settings] → [Input/Output] → [DI/DQ] → [DI51 Configuration]

About This Menu

NOTE: DI50 up to DI59 Inputs are used inside the Drive Systems enclosure for control and monitoring circuits.

Following parameters can be accessed on ATV960 or ATV980, equipped with cabinet IO, and if [Access Level] *L R C* is set to [Expert] *E P r*.

[DI51 Low Assignment] *d 5 1 L*

DI51 low assignment.

[DI51 High Assignment] *d 5 1 H*

DI51 high assignment.

[DI51 delay] *d 5 1 d*

DI51 delay.

NOTE: Commands received via this digital input are processed once the delay time set via this parameter has elapsed.

Setting	Description
0...200 ms	Setting range Factory setting: 5 ms

[DI52 Configuration] d 5 2 - Menu**Access**

[Complete settings] → [Input/Output] → [DI/DQ] → [DI52 Configuration]

About This Menu

NOTE: DI50 up to DI59 Inputs are used inside the Drive Systems enclosure for control and monitoring circuits.

Following parameters can be accessed on ATV960 or ATV980, equipped with cabinet IO, and if **[Access Level] L A C** is set to **[Expert] E P r**.

[DI52 Low Assignment] d 5 2 L

DI52 low assignment.

Settings	Code/Value	Description
[No]	n o	Not assigned
[Freewheel stop]	n 5 t	Freewheel stop
[Ext Error assign]	E t F	External error assignment
[Drive Lock]	L E 5	Drive lock assignment
[Monitor Circuit A]	, F A A	Monitoring circuit A assignment
[Monitor Circuit B]	, F A b	Monitoring circuit B assignment
[Monitor Circuit C]	, F A C	Monitoring circuit C assignment
[Monitor Circuit D]	, F A d	Monitoring circuit D assignment
[Cabinet Circuit A]	C F A A	Cabinet circuit A assignment
[Cabinet Circuit B]	C F A b	Cabinet circuit B assignment
[Cabinet Circuit C]	C F A C	Cabinet circuit C assignment
[Motor Winding A]	t F A A	Motor winding A assignment
[Motor Winding B]	t F A b	Motor winding B assignment
[Motor Bearing A]	t F A C	Motor bearing A assignment
[Motor Bearing B]	t F A d	Motor bearing B assignment

[DI52 High Assignment] d 5 2 H

DI52 high assignment.

Settings	Code/Value	Description
[No]	n o	Not assigned
[Forced local]	F L o	Forced local mode
[Fault reset]	r 5 F	Fault reset
[Eternal Error]	E t F	External error
[Drive Lock]	L E 5	Drive lock assignment
[Product Restart Assign]	r P A	Restart product
[Monitor Circuit A]	, F A A	Monitoring circuit A assignment
[Monitor Circuit B]	, F A b	Monitoring circuit B assignment
[Monitor Circuit C]	, F A C	Monitoring circuit C assignment
[Monitor Circuit D]	, F A d	Monitoring circuit D assignment
[Cabinet Circuit A]	C F A A	Cabinet circuit A assignment
[Cabinet Circuit B]	C F A b	Cabinet circuit B assignment
[Cabinet Circuit C]	C F A C	Cabinet circuit C assignment
[Motor Winding A]	t F A A	Motor winding A assignment
[Motor Winding B]	t F A b	Motor winding B assignment
[Motor Bearing A]	t F A C	Motor bearing A assignment
[Motor Bearing B]	t F A d	Motor bearing B assignment

Settings	Code/Value	Description
[Mains Contactor]	L L C	Mains contactor control

[DI52 delay] d 5 2 d

DI52 delay.

NOTE: Commands received via this digital input are processed once the delay time set via this parameter has elapsed.

Setting	Description
0...200 ms	Setting range Factory setting: 5 ms

[DI53 Configuration] d , 5 3 - Menu

Access

[Complete settings] → [Input/Output] → [DI/DQ] → [DI53 Configuration]

About This Menu

Identical to [DI52 Configuration] d , 5 2 Menu. (see page 503)

NOTE: DI50 up to DI59 Inputs are used inside the Drive Systems enclosure for control and monitoring circuits.

Following parameters can be accessed on ATV960 or ATV980, equipped with cabinet IO, and if [Access Level] L R C is set to [Expert] E P r .

[DI53 Low Assignment] d 5 3 L

DI53 low assignment.

[DI53 High Assignment] d 5 3 H

DI53 high assignment.

[DI53 delay] d 5 3 d

DI53 delay.

NOTE: Commands received via this digital input are processed once the delay time set via this parameter has elapsed.

Setting	Description
0...200 ms	Setting range Factory setting: 5 ms

[DI54 Configuration] *d 5 4* - Menu

Access

[Complete settings] → [Input/Output] → [DI/DQ] → [DI54 Configuration]

About This Menu

Identical to [DI52 Configuration] *d 5 2* - Menu. (*see page 503*)

NOTE: DI50 up to DI59 Inputs are used inside the Drive Systems enclosure for control and monitoring circuits.

Following parameters can be accessed on ATV960 or ATV980, equipped with cabinet IO, and if [Access Level] *L A C* is set to [Expert] *E P r*.

[DI54 Low Assignment] *d 5 4 L*

DI54 low assignment.

[DI54 High Assignment] *d 5 4 H*

DI54 high assignment.

[DI54 delay] *d 5 4 d*

DI54 delay.

NOTE: Commands received via this digital input are processed once the delay time set via this parameter has elapsed.

Setting	Description
0...200 ms	Setting range Factory setting: 5 ms

[DI55 Configuration] *d 5 5* - Menu

Access

[Complete settings] → [Input/Output] → [DI/DQ] → [DI55 Configuration]

About This Menu

Identical to [DI52 Configuration] *d 5 2* - Menu. (*see page 503*)

NOTE: DI50 up to DI59 Inputs are used inside the Drive Systems enclosure for control and monitoring circuits.

Following parameters can be accessed on ATV960 or ATV980, equipped with cabinet IO, and if [Access Level] *L A C* is set to [Expert] *E P r*.

[DI55 Low Assignment] *d 5 5 L*

DI55 low assignment.

[DI55 High Assignment] *d 5 5 H*

DI55 high assignment.

[DI55 delay] *d 5 5 d*

DI55 delay.

NOTE: Commands received via this digital input are processed once the delay time set via this parameter has elapsed.

Setting	Description
0...200 ms	Setting range Factory setting: 5 ms

[DI56 Configuration] *d 5 6* - Menu

Access

[Complete settings] → [Input/Output] → [DI/DQ] → [DI56 Configuration]

About This Menu

Identical to [DI52 Configuration] *d 5 2* - Menu. *(see page 503)*

NOTE: DI50 up to DI59 Inputs are used inside the Drive Systems enclosure for control and monitoring circuits.

Following parameters can be accessed on ATV960 or ATV980, equipped with cabinet IO, and if [Access Level] *L R C* is set to [Expert] *E P r*.

[DI56 Low Assignment] *d 5 6 L*

DI56 low assignment.

[DI56 High Assignment] *d 5 6 H*

DI56 high assignment.

[DI56 delay] *d 5 6 d*

DI56 delay.

NOTE: Commands received via this digital input are processed once the delay time set via this parameter has elapsed.

Setting	Description
0...200 ms	Setting range Factory setting: 5 ms

[DI57 Configuration] *d 5 7* - Menu

Access

[Complete settings] → [Input/Output] → [DI/DQ] → [DI57 Configuration]

About This Menu

Identical to [DI52 Configuration] *d 5 2* - Menu. *(see page 503)*

NOTE: DI50 up to DI59 Inputs are used inside the Drive Systems enclosure for control and monitoring circuits.

Following parameters can be accessed on ATV960 or ATV980, equipped with cabinet IO, and if [Access Level] *L R C* is set to [Expert] *E P r*.

[DI57 Low Assignment] *d 5 7 L*

DI57 low assignment.

[DI57 High Assignment] *d 5 7 H*

DI57 high assignment.

[DI57 delay] *d 5 7 d*

DI57 delay.

NOTE: Commands received via this digital input are processed once the delay time set via this parameter has elapsed.

Setting	Description
0...200 ms	Setting range Factory setting: 5 ms

[DI58 Configuration] *d 5 B* - Menu

Access

[Complete settings] → [Input/Output] → [DI/DQ] → [DI58 Configuration]

About This Menu

Identical to [DI52 Configuration] *d 5 2* - Menu. (*see page 503*)

NOTE: DI50 up to DI59 Inputs are used inside the Drive Systems enclosure for control and monitoring circuits.

Following parameters can be accessed on ATV960 or ATV980, equipped with cabinet IO, and if [Access Level] *L A C* is set to [Expert] *E P r*.

[DI58 Low Assignment] *d 5 B L*

DI58 low assignment.

[DI58 High Assignment] *d 5 B H*

DI58 high assignment.

[DI58 delay] *d 5 B d*

DI58 delay.

NOTE: Commands received via this digital input are processed once the delay time set via this parameter has elapsed.

Setting	Description
0...200 ms	Setting range Factory setting: 5 ms

[DI59 Configuration] *d 5 9* - Menu

Access

[Complete settings] → [Input/Output] → [DI/DQ] → [DI59 Configuration]

About This Menu

Identical to [DI52 Configuration] *d 5 2* - Menu. (*see page 503*)

NOTE: DI50 up to DI59 Inputs are used inside the Drive Systems enclosure for control and monitoring circuits.

Following parameters can be accessed on ATV960 or ATV980, equipped with cabinet IO, and if [Access Level] *L A C* is set to [Expert] *E P r*.

[DI59 Low Assignment] *d 5 9 L*

DI59 low assignment.

[DI59 High Assignment] *d 5 9 H*

DI59 high assignment.

[DI59 delay] *d 5 9 d*

DI59 delay.

NOTE: Commands received via this digital input are processed once the delay time set via this parameter has elapsed.

Setting	Description
0...200 ms	Setting range Factory setting: 5 ms

Section 8.52

[Input/Output] - [Analog I/O]

What Is in This Section?

This section contains the following topics:

Topic	Page
[AI1 configuration] <i>R</i> , <i>1</i> - Menu	509
[AI2 configuration] <i>R</i> , <i>2</i> - Menu	511
[AI3 configuration] <i>R</i> , <i>3</i> - Menu	512
[AI4 configuration] <i>R</i> , <i>4</i> - Menu	513
[AI5 configuration] <i>R</i> , <i>5</i> - Menu	514
[AQ1 configuration] <i>R</i> <i>o</i> <i>1</i> - Menu	515
[AQ2 configuration] <i>R</i> <i>o</i> <i>2</i> - Menu	519
[PTO configuration] <i>P</i> <i>t</i> <i>o</i> - Menu	521
[Virtual AI1] <i>R</i> <i>V</i> <i>1</i> - Menu	523

[AI1 configuration] R , I - Menu

Access

[Complete settings] → [Input/Output] → [AI/AQ] → [AI1 configuration]

About This Menu

The input can be delinearized by configuring an intermediate point on the input/output curve of this input:

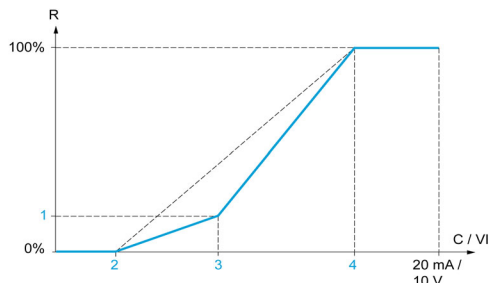

- R Reference
 C / VI Current or Voltage Input
 1 [Y Intern. point]
 2 [Min value] (0%)
 3 [X Intern. point]
 4 [Max value] (100%)

NOTE: For [X Intern. point], 0% corresponds to [Min value] and 100% to [Max value].

[AI1 Assignment] R , I R

Analog input AI1 functions assignment.

Read-only parameter, cannot be configured. It displays all the functions associated with input AI1 in order to verify, for example, for compatibility problems.

If no functions have been assigned, [No] n o is displayed.

[AI1 Type] R , I E

Configuration of analog input AI1.

Setting	Code / Value	Description
[Voltage]	I 0 u	0-10 Vdc Factory setting
[Current]	0 R	0-20 mA

[AI1 Min. value] u , L I ★

AI1 voltage scaling parameter of 0%.

This parameter can be accessed if [AI1 Type] R , I E is set to [Voltage] I 0 u.

Setting	Description
0.0...10.0 Vdc	Setting range Factory setting: 0.0 Vdc

[AI1 Max. value] u , H I ★

AI1 voltage scaling parameter of 100%.

This parameter can be accessed if [AI1 Type] R , I E is set to [Voltage] I 0 u.

Setting	Description
0.0...10.0 Vdc	Setting range Factory setting: 10.0 Vdc

[AI1 Min. value] C r L I ★

AI1 current scaling parameter of 0%.

This parameter can be accessed if **[AI1 Type] R , I E** is set to **[Current] D R**.

Setting	Description
0.0...20.0 mA	Setting range Factory setting: 0.0 mA

[AI1 Max. value] C r H I ★

AI1 current scaling parameter of 100%.

This parameter can be accessed if **[AI1 Type] R , I E** is set to **[Current] D R**.

Setting	Description
0.0...20.0 mA	Setting range Factory setting: 20.0 mA

[AI1 filter] R , I F

AI1 cutoff time of the low filter.

Setting ()	Description
0.00...10.00 s	Setting range Factory setting: 0.00 s

[AI1 Intern. point X] R , I E

Input delinearization point coordinate. Percentage of the physical input signal.

0% corresponds to **[AI1 min value] (u I L ,)**

100% corresponds to **[AI1 max value] (u I H ,)**

Setting ()	Description
0...100%	Setting range Factory setting: 0%

[AI1 Intern. point Y] R , I S

Input delinearization point coordinate (frequency reference).

Percentage of the internal frequency reference corresponding to the **[AI1 Intern. point X] (R , I E)** percentage of physical input signal.

Setting ()	Description
0...100%	Setting range Factory setting: 0%

[AI1 Range] R , 1 L

AI1 scaling selection.

This parameter can be accessed if **[AI1 Type] R , 1 E** is set to **[Current] D R**.

This parameter is forced to **[0-100%] P 0 5** if:

- **[AI1 Type] R , 1 E** is not set to **[Current] D R**, or
- **[AI1 min. value] C r L 1** is lower than 3.0 mA

Setting	Code / Value	Description
[0-100%]	P 0 5	Unidirectional: AI1 current scaling is 0% up to 100%. Factory Setting
[+/-100%]	P 0 5 n E G	Bidirectional: AI1 current scaling is -100% up to 100%. [AI1 min. value] C r L 1 corresponds to -100%. [AI1 max. value] C r H 1 corresponds to 100%.

[AI2 configuration] R , 2 - Menu**Access**

[Complete settings] → [Input/Output] → [AI/AQ] → [AI2 configuration]

[AI2 Assignment] R , 2 R

AI2 functions assignment.

Identical to **[AI1 Assignment] R , 1 R** (*see page 509*).

[AI2 Type] R , 2 E

Configuration of analog input AI2.

Setting	Code / Value	Description
[Voltage]	1 0 u	0-10 Vdc
[Voltage +/-]	n 1 0 u	-10/+10 Vdc Factory setting

[AI2 min value] u , L 2 ★

AI2 voltage scaling parameter of 0%.

This parameter can be accessed if **[AI2 Type] R , 2 E** is set to **[Voltage] 1 0 u**.

Identical to **[AI1 min value] u , L 1** (*see page 509*).

[AI2 Max .value] u , H 2 ★

AI2 voltage scaling parameter of 100%.

This parameter can be accessed if **[AI2 Type] R , 2 E** is set to **[Voltage] 1 0 u**.

Identical to **[AI1 Max. value] u , H 1** (*see page 509*).

[AI2 filter] R , 2 F

AI2 filter.

Identical to **[AI1 filter] R , 1 F** (*see page 510*).

[AI2 Interm. point X] R , 2 E

AI2 delinearization input level.

Identical to **[AI1 Interm. point X] R , 1 E** (*see page 510*).

[AI2 Interm. point Y] R , 2 S

AI2 delinearization output level.

Identical to **[AI1 Interm. point Y] R , 1 S** (*see page 510*).

[AI3 configuration] R , 3 - Menu**Access**

[Complete settings] → [Input/Output] → [AI/AQ] → [AI3 configuration]

[AI3 Assignment] R , 3 R

AI3 functions assignment.

Identical to [AI1 Assignment] R , 1 R (see page 509).

[AI3 Type] R , 3 L

Configuration of analog input AI3.

Identical to [AI2 Type] R , 2 L (see page 511) with factory setting: [Current] 0 R.

[AI3 Min. value] L , L 3 ★

AI3 voltage scaling parameter of 0%.

Identical to [AI1 Min. value] L , L 1 (see page 509).

This parameter can be accessed if [AI3 Type] R , 3 L is set to [Voltage] 1 0 L.

[AI3 Max. value] L , H 3 ★

AI3 voltage scaling parameter of 100%.

Identical to [AI1 Max. value] L , H 1 (see page 509).

This parameter can be accessed if [AI3 Type] R , 3 L is set to [Voltage] 1 0 L.

[AI3 Min. value] C r L 3 ★

AI3 current scaling parameter of 0%.

Identical to [AI1 Min. value] C r L 1 (see page 510).

This parameter can be accessed if [AI3 Type] R , 3 L is set to [Current] 0 R.

[AI3 Max. value] C r H 3 ★

AI3 current scaling parameter of 100%.

Identical to [AI1 Max. value] C r H 1 (see page 510).

This parameter can be accessed if [AI3 Type] R , 3 L is set to [Current] 0 R.

[AI3 filter] R , 3 F

AI3 cutoff time of the low filter.

Identical to [AI1 filter] R , 1 F (see page 510).

[AI3 X Interm. point] R , 3 E

AI3 delinearization input level.

Identical to [AI1 Interm. point X] R , 1 E (see page 510).

[AI3 Y Interm. point] R , 3 S

AI3 delinearization output level.

Identical to [AI1 Interm. point Y] R , 1 S (see page 510).

[AI3 Range] R , 3 L

AI3 scaling selection.

This parameter can be accessed if [AI3 Type] R , 3 L is set to [Current] 0 R.

Identical to [AI1 Type] R , 1 L (see page 512)

[AI4 configuration] *R* , *4* - Menu

Access

[Complete settings] → [Input/Output] → [AI/AQ] → [AI4 configuration]

[AI4 Assignment] *R* , *4R* ★

AI4 functions assignment.

This parameter can be accessed if VW3A3203 I/O extension module has been inserted.

Identical to [AI1 Assignment] *R* , *1R* (see page 509).

[AI4 Type] *R* , *4E* ★

Configuration of analog input AI4.

This parameter can be accessed if VW3A3203 I/O extension module has been inserted.

Setting	Code / Value	Description
[Voltage]	<i>10</i> <i>u</i>	0-10 Vdc
[Current]	<i>0R</i>	0-20 mA Factory setting
[Voltage +/-]	<i>n 10</i> <i>u</i>	-10/+10 Vdc

[AI4 Min value] *u* , *L 4* ★

AI4 voltage scaling parameter of 0%.

Identical to [AI1 Min value] *u* , *L 1* (see page 509).

[AI4 Max. value] *u* , *H 4* ★

AI4 voltage scaling parameter of 100%.

Identical to [AI1 Max. value] *u* , *H 1* (see page 509).

[AI4 Min. value] *C r L 4* ★

AI4 current scaling parameter of 0%.

Identical to [AI1 Min. value] *C r L 1* (see page 510).

[AI4 Max. value] *C r H 4* ★

AI4 current scaling parameter of 100%.

Identical to [AI1 Max. value] *C r H 1* (see page 510).

[AI4 filter] *R* , *4F* ★

AI4 cutoff time of the low filter.

This parameter can be accessed if VW3A3203 I/O extension module has been inserted.

Identical to [AI1 filter] *R* , *1F* (see page 510).

[AI4 X Interm. point] *R* , *4E* ★

AI4 delinearization input level.

This parameter can be accessed if VW3A3203 I/O extension module has been inserted.

Identical to [AI1 Interm. point X] *R* , *1E* (see page 510).

[AI4 Y Interm. point] R , 4 5 ★

AI4 delinearization output level.

This parameter can be accessed if VW3A3203 I/O extension module has been inserted.

Identical to **[AI1 Interm. point Y] R , 1 5** (see page 510).

[AI4 Range] R , 4 L

AI4 scaling selection.

This parameter can be accessed if **[AI4 Type] R , 4 E** is set to **[Current] D R**.

Identical to **[AI1 Type] R , 1 E** (see page 514)

[AI5 configuration] R , 5 - Menu

Access

[Complete settings] → [Input/Output] → [AI/AQ] → [AI5 configuration]

[AI5 Assignment] R , 5 R ★

AI5 functions assignment.

This parameter can be accessed if VW3A3203 I/O extension module has been inserted.

Identical to **[AI1 Assignment] R , 1 R** (see page 509).

[AI5 Type] R , 5 E ★

Configuration of analog input AI5.

This parameter can be accessed if VW3A3203 I/O extension module has been inserted.

Identical to **[AI4 Type] R , 4 E** . (see page 513)

[AI5 Min. value] U , L 5 ★

AI5 voltage scaling parameter of 0%.

Identical to **[AI1 Min. value] U , L 1** (see page 509).

[AI5 Max. value] U , H 5 ★

AI5 voltage scaling parameter of 100%.

Identical to **[AI1 Max. value] U , H 1** (see page 509).

[AI5 Min. value] C r L 5 ★

AI5 current scaling parameter of 0%.

Identical to **[AI1 Min. value] C r L 1** (see page 510).

[AI5 Max. value] C r H 5 ★

AI5 current scaling parameter of 100%.

Identical to **[AI1 Max. value] C r H 1** (see page 510).

[AI5 filter] R , 5 F ★

AI5 cutoff time of the low filter.

This parameter can be accessed if VW3A3203 I/O extension module has been inserted.

Identical to **[AI1 filter] R , 1 F** (see page 510).

[AI5 X Interm. point] R , 5 E ★

AI5 delinearization input level.

This parameter can be accessed if VW3A3203 I/O extension module has been inserted.

Identical to **[AI1 Interm. point X] R , 1 E** (see page 510).

[AI5 Y Interm. point] R , 5 S ★

AI5 delinearization output level.

This parameter can be accessed if VW3A3203 I/O extension module has been inserted.

Identical to **[AI1 Interm. point Y] R , 1 S** (see page 510).

[AI5 Range] R , 5 L

AI5 scaling selection.

This parameter can be accessed if **[AI5 Type] R , 5 E** is set to **[Current] D R**.

Identical to **[AI1 Type] R , 1 E** (see page 515)

[AQ1 configuration] R 0 1 - Menu**Access**

[Complete settings] → [Input/Output] → [AI/AQ] → [AQ1 configuration]

Minimum and Maximum Output Values

The minimum output value, in volts, corresponds to the lower limit of the assigned parameter and the maximum value corresponds to its upper limit. The minimum value may be greater than the maximum value.

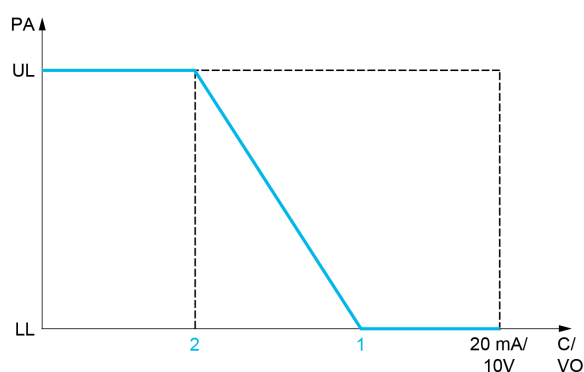
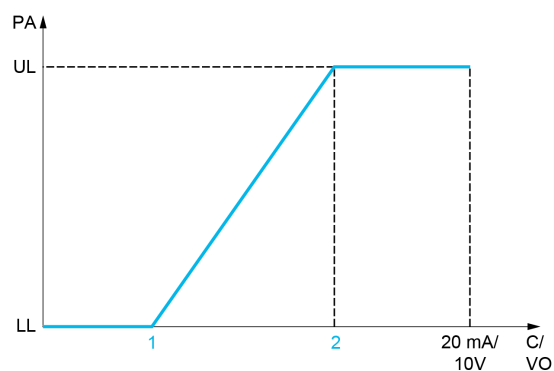

PA Parameter assigned

C / VO Current or voltage output

UL Upper limit

LL Lower limit

1 **[Min Output] R 0 L X or u 0 L X**

2 **[Max Output] R 0 H X or u 0 H X**

Scaling of the Assigned Parameter

The scale of the assigned parameter can be adapted in accordance with the requirements by modifying the values of the lower and upper limits with two parameters for each analog output.

These parameters are given in %. 100% corresponds to the total variation range of the configured parameter, so: 100% = upper limit - lower limit.

For example, **[Sign. torque] 5 L 9** which varies between -3 and +3 times the rated torque, 100% corresponds to 6 times the rated torque.

- The **[Scaling AQx min] P 5 L X** parameter modifies the lower limit: new value = lower limit + (range x **P 5 L X**). The value 0% (factory setting) does not modify the lower limit.
- The **[Scaling AQx max] P 5 H X** parameter modifies the upper limit: new value = lower limit + (range x **P 5 L X**). The value 100% (factory setting) does not modify the upper limit.
- **[Scaling AQx min] P 5 L X** must always be lower than **[Scaling AQx max] P 5 H X**.

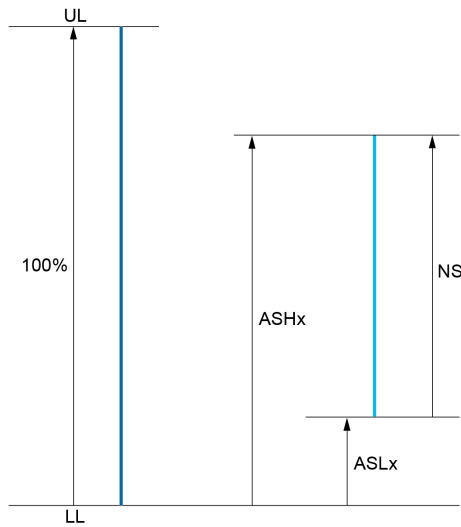

- UL** Upper limit of the assigned parameter
- LL** Lower limit of the assigned parameter
- NS** New scale
- 1 P 5 H X**
- 2 P 5 L X**

Application Example

The value of the motor current at the AQ1 output is to be transferred with 0...20 mA, range 2 in motor, In motor being the equivalent of a 0.8 In drive.

- The **[Motor Current] P 5 L 1** parameter varies from 0 to 2 times the rated drive current.
- **[Scaling AQ1 min] P 5 L 1** must not modify the lower limit, which therefore remains at its factory setting of 0%.
- **[Scaling AQ1 max] P 5 H 1** must modify the upper limit by 0.5x the rated motor torque, or 100 - 100/5 = 80% (new value = lower limit + (range x **[Scaling AQ1 max] P 5 H 1**)).

[AQ1 Assignment] # 0 1

AQ1 assignment.

Setting	Code / Value	Description
[Not Configured]	n 0	Not assigned
[Motor Current]	0 L r	Current in the motor, from 0 to 2 In (In = rated drive current indicated in the Installation manual and on the drive nameplate)
[Motor Frequency]	0 F r	Output frequency, from 0 to [Max Frequency] L F r Factory Setting
[Ramp out.]	0 r P	From 0 to [Max Frequency] L F r
[Motor torq.]	L r 9	Motor torque, from 0 to 3 times the rated motor torque
[Sign. torque]	5 L 9	Signed motor torque, between -3 and +3 times the rated motor torque. The + sign corresponds to the motor mode and the - sign to the generator mode (braking).
[sign ramp]	0 r 5	Signed ramp output, between -[Max Frequency] L F r and +[Max Frequency] L F r
[PID ref.]	0 P 5	PID controller reference between [Min PID reference] P , P 1 and [Max PID reference] P , P 2
[PID feedbk]	0 P F	PID controller feedback between [Min PID feedback] P , F 1 and [Max PID feedback] P , F 2
[PID error]	0 P E	PID controller detected error between -5% and +5% of [Max PID feedback] P , F 2 - [Min PID feedback] P , F 1
[PID output]	0 P ,	PID controller output between [Low speed] L 5 P and [High speed] H 5 P
[Motor power]	0 P r	Motor power, between 0 and 2.5 times [Nominal Motor Power] n P r
[Mot thermal]	L H r	Motor thermal state, from 0 to 200% of the rated thermal state
[Drv thermal]	L H d	Drive thermal state, from 0 to 200% of the rated thermal state
[Torque 4Q]	L r 4 9	Signed motor torque, between -3 and +3 times the rated motor torque. The + and - signs correspond to the physical direction of the torque, regardless of mode (motor or generator)
[Measured Motor Freq]	0 F r r	Measured motor frequency
[Sig. o/p frq.]	0 F 5	Signed output frequency, between -[Max Frequency] L F r and +[Max Frequency] L F r
[Mot therm2]	L H r 2	Motor thermal 2 state
[Mot therm3]	L H r 3	Motor thermal 3 state
[Mot therm4]	L H r 4	Motor thermal 4 state
[Unsigned Trq Ref]	u L r	Unsigned torque reference
[Signed Trq Ref]	5 L r	Signed torque reference
[Torque lim.]	L 9 L	Torque limit
[Motor volt.]	u 0 P	Voltage applied to the motor, between 0 and [Nom Motor Voltage] u n 5
[M/S Out Speed Reference]	n 5 5 0	Master / slave output speed reference
[M/S Out Torque Reference]	n 5 L 0	Master / slave output torque reference

[AQ1 Type] # 0 1 L

AQ1 type.

Setting	Code / Value	Description
[Voltage]	1 0 u	0-10 Vdc Factory setting
[Current]	0 A	0-20 mA

[AQ1 min output] R 0 L I ★

AQ1 current scaling parameter of 0%.

This parameter can be accessed if [AQ1 Type] R 0 I E is set to [Current] 0 R.

Setting	Description
0.0...20.0 mA	Setting range Factory setting: 0.0 mA

[AQ1 max output] R 0 H I ★

AQ1 current scaling parameter of 100%.

This parameter can be accessed if [AQ1 Type] R 0 I E is set to [Current] 0 R.

Setting	Description
0.0...20.0 mA	Setting range Factory setting: 20.0 mA

[AQ1 min Output] 0 0 L I ★

AQ1 voltage scaling parameter of 0%.

This parameter can be accessed if [AQ1 Type] R 0 I E is set to [Voltage] 1 0 0.

Setting	Description
0.0...10.0 Vdc	Setting range Factory setting: 0.0 Vdc

[AQ1 max Output] 0 0 H I ★

AQ1 voltage scaling parameter of 100%.

This parameter can be accessed if [AQ1 Type] R 0 I E is set to [Voltage] 1 0 0.

Setting	Description
0.0...10.0 Vdc	Setting range Factory setting: 10.0 Vdc

[Scaling AQ1 min] R 5 L I

AQ1 scaling parameter of 0%.

Scaling of the lower limit of the assigned parameter, as a % of the maximum possible variation.

Setting	Description
0.0...100.0%	Setting range Factory setting: 0.0%

[Scaling AQ1 max] R 5 H I

AQ1 scaling parameter of 100%.

Scaling of the upper limit of the assigned parameter, as a % of the maximum possible variation.

Setting	Description
0.0...100.0%	Setting range Factory setting: 100.0%

[AQ1 Filter] $\rho 1 F$

AQ1 cutoff time of the low-filter.

Setting	Description
0.00...10.00 s	Setting range Factory setting: 0.00 s

[AQ2 configuration] $\rho 2$ - Menu**Access**

[Complete settings] → [Input/Output] → [AI/AQ] → [AQ2 configuration]

[AQ2 assignment] $\rho 2$

AQ2 assignment.

Setting	Code / Value	Description
[Not Configured]	ρ	Not assigned
[Motor Current]	$\rho C r$	Current in the motor, from 0 to 2 In (In = rated drive current indicated in the Installation manual and on the drive nameplate) Factory Setting
[Motor Frequency]	$\rho F r$	Output frequency, from 0 to [Max Frequency] $\rho F r$
[Ramp out.]	$\rho r P$	From 0 to [Max Frequency] $\rho F r$
[Motor torq.]	$\rho r 9$	Motor torque, from 0 to 3 times the rated motor torque
[Sign. torque]	$5 \rho r 9$	Signed motor torque, between -3 and +3 times the rated motor torque. The + sign corresponds to the motor mode and the - sign to the generator mode (braking).
[sign ramp]	$\rho r 5$	Signed ramp output, between -[Max Frequency] $\rho F r$ and +[Max Frequency] $\rho F r$
[PID ref.]	$\rho P 5$	PID controller reference between [Min PID reference] $P, P 1$ and [Max PID reference] $P, P 2$
[PID feedbk]	$\rho P F$	PID controller feedback between [Min PID feedback] $P, F 1$ and [Max PID feedback] $P, F 2$
[PID error]	$\rho P E$	PID controller detected error between -5% and +5% of [Max PID feedback] $P, F 2$ - [Min PID feedback] $P, F 1$
[PID output]	$\rho P, i$	PID controller output between [Low speed] $L 5 P$ and [High speed] $H 5 P$
[Motor power]	$\rho P r$	Motor power, between 0 and 2.5 times [Nominal Motor Power] $\rho n P r$
[Mot thermal]	$\rho H r$	Motor thermal state, from 0 to 200% of the rated thermal state
[Drv thermal]	$\rho H d$	Drive thermal state, from 0 to 200% of the rated thermal state
[Torque 4Q]	$\rho r 4 9$	Signed motor torque, between -3 and +3 times the rated motor torque. The + and - signs correspond to the physical direction of the torque, regardless of mode (motor or generator)
[Measured Motor Freq]	$\rho F r r$	Measured motor frequency
[Sig. o/p frq.]	$\rho F 5$	Signed output frequency, between -[Max Frequency] $\rho F r$ and +[Max Frequency] $\rho F r$
[Mot therm2]	$\rho H r 2$	Motor thermal 2 state
[Mot therm3]	$\rho H r 3$	Motor thermal 3 state
[Mot therm4]	$\rho H r 4$	Motor thermal 4 state
[Unsigned Trq Ref]	$\rho t r$	Unsigned torque reference
[Signed Trq Ref]	$5 \rho t r$	Signed torque reference
[Torque lim.]	$\rho 9 L$	Torque limit
[Motor volt.]	$\rho o P$	Voltage applied to the motor, between 0 and [Nom Motor Voltage] $\rho n 5$
[M/S Out Speed Reference]	$\rho 5 5 \rho$	Master / slave output speed reference
[M/S Out Torque Reference]	$\rho 5 t \rho$	Master / slave output torque reference

[AQ2 Type] R 0 2 E

AQ2 type.

Setting	Code / Value	Description
[Voltage]	1 0 u	0-10 Vdc
[Current]	0 R	0-20 mA Factory setting

[AQ2 min output] R 0 L 2 ★

AQ2 current scaling parameter of 0%.

This parameter can be accessed if [AQ2 Type] R 0 2 E is set to [Current] 0 R.

Identical to [AQ1 min output] R 0 L 1 (see page 518).

[AQ2 max output] R 0 H 2 ★

AQ2 current scaling parameter of 100%.

This parameter can be accessed if [AQ2 Type] R 0 2 E is set to [Current] 0 R.

Identical to [AQ1 max output] R 0 H 1 (see page 518).

[AQ2 min Output] u 0 L 2 ★

AQ2 voltage scaling parameter of 0%.

This parameter can be accessed if [AQ2 Type] R 0 2 E is set to [Voltage] 1 0 u.

Identical to [AQ1 min Output] u 0 L 1 (see page 518).

[AQ2 max Output] u 0 H 2 ★

AQ2 voltage scaling parameter of 100%.

This parameter can be accessed if [AQ2 Type] R 0 2 E is set to [Voltage] 1 0 u.

Identical to [AQ1 max Output] u 0 H 1 (see page 518).

[Scaling AQ2 min] R 5 L 2

AQ2 scaling parameter of 0%.

Identical to [Scaling AQ1 min] R 5 L 1 (see page 518).

[Scaling AQ2 max] R 5 H 2

AQ2 scaling parameter of 100%.

Identical to [Scaling AQ1 max] R 5 H 1 (see page 518).

[AQ2 Filter] R 0 2 F

AQ2 cutoff time of the low-filter.

Identical to [AQ1 Filter] R 0 1 F (see page 519).

[PTO configuration] P t o - Menu

Access

[Complete settings] → [Input/Output] → [AI/AQ] → [PTO configuration]

About This Menu

[PTO Assign] P t o

Pulse train output assignment.

Setting	Code / Value	Description
[Not Configured]	n o	Not assigned
[Motor Current]	a C r	Current in the motor, from 0 to 2 In (In = rated drive current indicated in the Installation manual and on the drive nameplate) Factory Setting
[Motor Frequency]	a F r	Output frequency, from 0 to [Max Frequency] t F r
[Ramp out.]	a r P	From 0 to [Max Frequency] t F r
[Motor torq.]	t r 9	Motor torque, from 0 to 3 times the rated motor torque
[Sign. torque]	5 t 9	Signed motor torque, between -3 and +3 times the rated motor torque. The + sign corresponds to the motor mode and the - sign to the generator mode (braking).
[sign ramp]	a r 5	Signed ramp output, between -[Max Frequency] t F r and +[Max Frequency] t F r
[PID ref.]	a P 5	PID controller reference between [Min PID reference] P , P 1 and [Max PID reference] P , P 2
[PID feedbk]	a P F	PID controller feedback between [Min PID feedback] P , F 1 and [Max PID feedback] P , F 2
[PID error]	a P E	PID controller detected error between -5% and +5% of [Max PID feedback] P , F 2 - [Min PID feedback] P , F 1
[PID output]	a P ,	PID controller output between [Low speed] L 5 P and [High speed] H 5 P
[Motor power]	a P r	Motor power, between 0 and 2.5 times [Nominal Motor Power] n P r
[Mot thermal]	t H r	Motor thermal state, from 0 to 200% of the rated thermal state
[Drv thermal]	t H d	Drive thermal state, from 0 to 200% of the rated thermal state
[Torque 4Q]	t r 4 9	Signed motor torque, between -3 and +3 times the rated motor torque. The + and - signs correspond to the physical direction of the torque, regardless of mode (motor or generator)
[Measured Motor Freq]	a F r r	Measured motor frequency
[Sig. o/p frq.]	a F 5	Signed output frequency, between -[Max Frequency] t F r and +[Max Frequency] t F r
[Mot therm2]	t H r 2	Motor thermal 2 state
[Mot therm3]	t H r 3	Motor thermal 3 state
[Mot therm4]	t H r 4	Motor thermal 4 state
[Unsigned Trq Ref]	u t r	Unsigned torque reference
[Signed Trq Ref]	5 t r	Signed torque reference
[Torque lim.]	t 9 L	Torque limit
[Motor volt.]	u o P	Voltage applied to the motor, between 0 and [Nom Motor Voltage] u n 5
[DC Bus voltage]	V b u 5	DC bus voltage
[Copy P18]	C o P 4	Copy Pulse
[M/S Out Speed Reference]	π 5 5 o	Master / slave output speed reference
[M/S Out Torque Reference]	π 5 t o	Master / slave output torque reference

[PTO Max Output Freq] P L O H ★

Pulse train output maximum output frequency.

This parameter can be accessed if **[PTO Assign] P L O** is not set to **[Not configured] n o**.

Setting	Description
1.00...30.00 kHz	Setting range Factory setting: 4.00 kHz

[PTO Min Output Freq] P L O L ★

Pulse train output minimum output frequency.

This parameter can be accessed if **[PTO Assign] P L O** is not set to **[Not configured] n o**.

Setting	Description
1.00...30.00 kHz	Setting range Factory setting: 1.00 kHz

[Virtual AI1] #V I - Menu**Access**

[Complete settings] → [Input/Output] → [AI/AQ] → [Virtual AI1]

[AIV1 Assignment] #V I#

Virtual AI1 function assignment.

Setting	Code / Value	Description
[No]	n o	Not assigned
[Torque Ref Offset]	t q o	Torque offset source
[Torque Ref Ratio]	t q r	Torque ratio source
[Ref Frequency 2 Summing]	s r 2	Reference frequency 2 summing
[PID Feedback]	p i f	PI controller feedback
[Torque limitation]	t r r	Torque limitation: activation by an analog value
[Torque limitation 2]	t r r 2	Torque limitation: activation by an analog value
[Subtract Ref Freq 2]	d r 2	Subtract reference frequency 2
[Ref Frequency 3 Summing]	s r 3	Reference frequency 3 summing
[Subtract Ref Freq 3]	d r 3	Subtract reference frequency 3
[Ref Frequency 2 multiplier]	m r 2	Reference frequency 2 multiplier
[Ref Frequency 3 multiplier]	m r 3	Reference frequency 3 multiplier

[AIV1 Channel Assignment] # I C I

Channel assignment for virtual analog input AIV1.

Setting	Code / Value	Description
[Not Configured]	n o	Not assigned Factory setting
[Ref. Freq-Modbus]	m d b	Reference frequency via Modbus
[Ref. Freq-CANopen]	c a n	Reference frequency via CANopen if a CANopen module has been inserted
[Ref. Freq-Com. Module]	n e t	Reference frequency via fieldbus module if a fieldbus module has been inserted
[Embedded Ethernet]	e t h	Embedded Ethernet

[AIV1 Type] #V I#

Configuration of virtual analog input AIV1.

Setting	Code / Value	Description
[+/-8192]	i n e g	-8192/+8192 Factory setting
[+/-100%]	p n e g	-100.00/+100.00 %

Section 8.53

[Input/Output] - [Relay]

What Is in This Section?

This section contains the following topics:

Topic	Page
[R1 configuration] r 1 - Menu	525
[R2 configuration] r 2 - Menu	527
[R3 configuration] r 3 - Menu	528
[R4 configuration] r 4 - Menu	528
[R5 configuration] r 5 - Menu	529
[R6 configuration] r 5 - Menu	529
[R60 configuration] r 5 0 - Menu	530
[R61 configuration] r 5 1 - Menu	530
[R62 configuration] r 5 2 - Menu	531
[R63 configuration] r 5 3 - Menu	531
[R64 configuration] r 5 4 - Menu	532
[R65 configuration] r 5 5 - Menu	532
[R66 configuration] r 5 5 - Menu	533
[Input/Output] r 5 - Menu	534

[R1 configuration] *r / - Menu***Access**

[Complete settings] → [Input/Output] → [Relay] → [R1 configuration]

[R1 Assignment] *r /*

R1 assignment.

Setting	Code / Value	Description
[No]	<i>n a</i>	Not assigned
[Operating State Fault]	<i>F L t</i>	Operating state fault Factory setting
[Drive Running]	<i>r u n</i>	Drive running
[Mot Freq High Thd]	<i>F t R</i>	Motor frequency threshold ([Motor Freq Thd] <i>F t d</i>) reached
[High Speed Reached]	<i>F L R</i>	High speed reached
[Current Thd Reached]	<i>C t R</i>	Motor current threshold ([High Current Thd] <i>C t d</i>) reached
[Ref Freq Reached]	<i>S r R</i>	Frequency reference reached
[Motor Therm Thd Reached]	<i>t S R</i>	Motor thermal threshold ([Motor Therm Thd] <i>t t d</i>) reached
[PID Error Warning]	<i>P E E</i>	PID error warning
[PID Feedback Warning]	<i>P F R</i>	PID feedback warning
[Mot Freq High Thd 2]	<i>F 2 R</i>	Second frequency threshold ([Freq. threshold 2] <i>F 2 d</i>) reached
[Drv Therm Thd Reached]	<i>t R d</i>	Drive thermal threshold reached
[Ref Freq High Thd Reached]	<i>r t R H</i>	Frequency reference high threshold reached
[Ref Freq Low Thd Reached]	<i>r t R L</i>	Frequency reference low threshold reached
[Mot Freq Low Thd]	<i>F t R L</i>	Frequency low threshold ([Low Freq. Threshold] <i>F t d L</i>) reached
[Motor Freq Low Thd 2]	<i>F 2 R L</i>	Second frequency low threshold ([2 Freq. Threshold] <i>F 2 d L</i>) reached
[Low Current Reached]	<i>C t R L</i>	Current low threshold ([Low I Threshold] <i>C t d L</i>) reached
[Process Undld Warning]	<i>u L R</i>	Underload warning
[Process Overload Warning]	<i>o L R</i>	Overload warning
[PID High Fdbck Warning]	<i>P F R H</i>	PID feedback high threshold (PAH) reached
[PID Low Fdbck Warning]	<i>P F R L</i>	PID feedback low threshold (PAL) reached
[Regulation Warning]	<i>P i S H</i>	PID regulation unable to reach the set point
[Forced Run]	<i>E r n</i>	Emergency Run
[Slack Rope Warning]	<i>r S d R</i>	Rope Slack
[High Torque Warning]	<i>t t H R</i>	High torque threshold
[Low Torque Warning]	<i>t t L R</i>	Low torque threshold
[Forward]	<i>Π F r d</i>	Run forward
[Reverse]	<i>Π r r S</i>	Run reverse
[HMI Cmd]	<i>b Π P</i>	Control via the Graphic Display Terminal is active. (only active with Local/Remote button)
[Ramp switching]	<i>r P 2</i>	Ramp switching state
[Mot2 Therm Thd reached]	<i>t S 2</i>	Motor 2 thermal threshold (TTD2) reached
[Mot3 Therm Thd reached]	<i>t S 3</i>	Motor 3 thermal threshold (TTD3) reached
[Mot4 Therm Thd reached]	<i>t S 4</i>	Motor 4 thermal threshold (TTD4) reached
[Neg Torque]	<i>R t S</i>	Actual torque sign
[Cnfg.0 act.]	<i>C n F 0</i>	Configuration 0 active
[Cnfg.1 act.]	<i>C n F 1</i>	Configuration 1 active
[Cnfg.2 act.]	<i>C n F 2</i>	Configuration 2 active
[Configuration 3 Active]	<i>C n F 3</i>	Configuration 3 active
[set 1 active]	<i>C F P 1</i>	Parameter set 1 active

Setting	Code / Value	Description
[set 2 active]	<i>C F P 2</i>	Parameter set 2 active
[set 3 active]	<i>C F P 3</i>	Parameter set 3 active
[DC Bus Charged]	<i>d b L</i>	DC bus charged
[In braking]	<i>b r 5</i>	In braking sequence
[Power removal state]	<i>P r 0</i>	Power removal state. Without power supply, the information cannot be delivered. With this setting value, the power supply must be not external.
[Pulse Warn Thd Reached]	<i>F 9 L R</i>	Pulse warning threshold reached
[I present]	<i>0 C P</i>	Motor current present
[Limit Switch Reached]	<i>L 5 R</i>	Limit switch function activated
[Dynamic Load Warning]	<i>d L d R</i>	Dynamic load detection
[Warning Grp 1]	<i>R G 1</i>	Warning group 1
[Warning Grp 2]	<i>R G 2</i>	Warning group 2
[Warning Grp 3]	<i>R G 3</i>	Warning group 3
[Warning Grp 4]	<i>R G 4</i>	Warning group 4
[Warning Grp 5]	<i>R G 5</i>	Warning group 5
[External Error Warning]	<i>E F R</i>	External error warning
[Undervoltage Warning]	<i>u 5 R</i>	Undervoltage warning
[Preventive UnderV Active]	<i>u P R</i>	Undervoltage prevention warning
[Slipping warn]	<i>R n R</i>	Anti-veering warning
[Drive Thermal Warning]	<i>t H R</i>	Drive thermal state warning
[Load Mvt Warn]	<i>b 5 R</i>	Brake speed warning
[Brake Contact Warn]	<i>b C R</i>	Brake contact warning
[Lim T/I Reached]	<i>S 5 R</i>	Torque current limitation warning
[Trq ctrl Warning]	<i>r t R</i>	Torque control time-out warning
[IGBT Thermal Warning]	<i>t J R</i>	Thermal junction warning
[BR Temp Warning]	<i>b o R</i>	Braking resistor temperature warning
[DBR Active]	<i>b r R 5</i>	DBR Active
[AI3 4-20 Loss Warning]	<i>R P 3</i>	AI3 4-20 mA loss warning
[AI4 4-20 Loss Warning]	<i>R P 4</i>	AI4 4-20 mA loss warning
[AI5 4-20 Loss Warning]	<i>R P 5</i>	AI5 4-20 mA loss warning
[Ready]	<i>r d Y</i>	Ready to start
[AI1 4-20 Loss Warning]	<i>R P 1</i>	AI1 4-20 mA loss warning
[AI1 Th Warning]	<i>t P 1 R</i>	Thermal 1 alarm
[Fallback speed]	<i>F r F</i>	Reaction on event / fallback speed
[Speed Maintained]	<i>r L 5</i>	Reaction on event / maintain speed
[Per Type of Stop]	<i>S t t</i>	Reaction on event / stop on STT without an error triggered after stop.
[AI3 Th Warning]	<i>t P 3 R</i>	Thermal 3 warning
[AI4 Th Warning]	<i>t P 4 R</i>	Thermal 4 warning
[AI5 Th Warning]	<i>t P 5 R</i>	Thermal 5 warning
[AI5 4-20 Loss Warning]	<i>R P 5</i>	AI5 4-20 mA loss warning
[Temp Sens AI2 Warn]	<i>t S 1 R</i>	Temperature sensor AI1 warning (open circuit)
[Temp Sens AI3 Warn]	<i>t S 3 R</i>	Temperature sensor AI3 warning (open circuit)
[Temp Sens AI4 Warn]	<i>t S 4 R</i>	Temperature sensor AI4 warning (open circuit)
[Temp Sens AI5 Warn]	<i>t S 5 R</i>	Temperature sensor AI5 warning (open circuit)

[R1 Delay time] *r 1 d*

R1 activation delay time.

The state modification takes effect once the configured time has elapsed when the information becomes true.

The delay cannot be set for the **[Operating State Fault] F L E** assignment; and remains at 0.

Setting	Description
0...60,000 ms	Setting range Factory setting: 0 ms

[R1 Active at] r 15

R1 status (output active level).

Setting	Code / Value	Description
1	P o 5	State 1 when the information is true Factory setting
0	n E G	State 0 when the information is true

Configuration **[1] P o 5** cannot be modified for the **[Operating State "Fault"] F L E** assignment.

[R1 Holding time] r 1H

R1 holding delay time.

The state modification takes effect once the configured time has elapsed when the information becomes false.

The holding time cannot be set for the **[Operating State "Fault"] F L E** assignment, and remains at 0.

Setting	Description
0...9,999 ms	Setting range Factory setting: 0 ms

[R2 configuration] r 2 - Menu

Access

[Complete settings] → [Input/Output] → [Relay] → [R2 configuration]

About This Menu

Identical to **[R1 configuration] r 1 - Menu** (*see page 525*).

[R2 Assignment] r 2

R2 assignment.

Identical to **[R1 Assignment] r 1** (*see page 525*) in addition to:

Setting	Code / Value	Description
[No]	n o	Not assigned Factory setting
[Brake Sequence]	b L C	Brake sequence
[Mains Contactor]	L L C	Mains contactor control
[DC charging]	d C o	DC charging
[M/S Device Warn]	M S d R	M/S device warning
[CB Start Pulse]	C b E P	Circuit Breaker start pulse.
[CB Stop Pulse]	C b d P	Circuit Breaker stop pulse.
[Output cont]	o C C	Output contactor control.

[R2 Delay time] r 2d

R2 activation delay time.

[R2 Active at] r 25

R2 status (output active level).

[R2 Holding time] r 2H

R2 holding delay time.

[R3 configuration] r 3 - Menu

Access

[Complete settings] → [Input/Output] → [Relay] → [R3 configuration]

About This Menu

Identical to [R1 configuration] r 1 - Menu (*see page 525*).

[R3 Assignment] r 3

R3 assignment.

Identical to [R2 Assignment] r 2 (*see page 527*).

[R3 Delay time] r 3 d

R3 activation delay time.

[R3 Active at] r 3 5

R3 status (output active level).

[R3 Holding time] r 3 H

R3 holding delay time.

[R4 configuration] r 4 - Menu

Access

[Complete settings] → [Input/Output] → [Relay] → [R4 configuration]

About This Menu

Identical to [R1 configuration] r 1 - Menu (*see page 525*).

Following parameters can be accessed if VW3A3204 relay output option module has been inserted.

[R4 Assignment] r 4 ★

R4 assignment.

Identical to [R2 Assignment] r 2 (*see page 527*).

[R4 Delay time] r 4 d ★

R4 activation delay time.

[R4 Active at] r 4 5 ★

R4 status (output active level).

[R4 Holding time] r 4 H ★

R4 holding delay time.

[R5 configuration] r 5 - Menu

Access

[Complete settings] → [Input/Output] → [Relay] → [R5 configuration]

About This Menu

Identical to [R1 configuration] r 1 - Menu (*see page 525*).

Following parameters can be accessed if VW3A3204 relay output option module has been inserted.

[R5 Assignment] r 5 ★

R5 assignment.

Identical to [R2 Assignment] r 2 (*see page 527*).

[R5 Delay time] r 5 d ★

R5 activation delay time.

[R5 Active at] r 5 5 ★

R5 status (output active level).

[R5 Holding time] r 5 H ★

R5 holding delay time.

[R6 configuration] r 6 - Menu

Access

[Complete settings] → [Input/Output] → [Relay] → [R6 configuration]

About This Menu

Identical to [R1 configuration] r 1 - Menu (*see page 525*).

Following parameters can be accessed if VW3A3204 relay output option module has been inserted.

[R6 Assignment] r 6 ★

R6 assignment.

Identical to [R2 Assignment] r 2 (*see page 527*).

[R6 Delay time] r 6 d ★

R6 activation delay time.

[R6 Active at] r 6 5 ★

R6 status (output active level).

[R6 Holding time] r 6 H ★

R6 holding delay time.

[R60 configuration] *r 6 0* - Menu

Access

[Complete settings] → [Input/Output] → [Relay] → [R60 configuration]

About This Menu

Identical to [R2 configuration] *r 2* - Menu (*see page 527*).

NOTE: R60 up to R66 Relays are used inside the Drive Systems enclosure for control and monitoring circuits.

Following parameters can be accessed on ATV960 or ATV980, equipped with cabinet IO, and if [Access Level] *L A C* is set to [Expert] *E P r*.

[R60 Assignment] *r 6 0*

R60 assignment.

[R60 Delay time] *r 6 0 d*

R60 activation delay time.

[R60 Active at] *r 6 0 S*

R60 status (output active level).

[R60 Holding time] *r 6 0 H*

R60 holding delay time.

[R61 configuration] *r 6 1* - Menu

Access

[Complete settings] → [Input/Output] → [Relay] → [R61 configuration]

About This Menu

Identical to [R2 configuration] *r 2* - Menu (*see page 527*).

NOTE: R60 up to R66 Relays are used inside the Drive Systems enclosure for control and monitoring circuits.

Following parameters can be accessed on ATV960 or ATV980, equipped with cabinet IO, and if [Access Level] *L A C* is set to [Expert] *E P r*.

[R61 Assignment] *r 6 1*

R61 assignment.

[R61 Delay time] *r 6 1 d*

R61 activation delay time.

[R61 Active at] *r 6 1 S*

R61 status (output active level).

[R61 Holding time] *r 6 1 H*

R61 holding delay time.

[R62 configuration] *r 6 2* - Menu

Access

[Complete settings] → [Input/Output] → [Relay] → [R62 configuration]

About This Menu

Identical to [R2 configuration] *r 2* - Menu (*see page 527*).

NOTE: R60 up to R66 Relays are used inside the Drive Systems enclosure for control and monitoring circuits.

Following parameters can be accessed on ATV960 or ATV980, equipped with cabinet IO, and if [Access Level] *L A C* is set to [Expert] *E P r*.

[R62 Assignment] *r 6 2*

R62 assignment.

[R62 Delay time] *r 6 2 d*

R62 activation delay time.

[R62 Active at] *r 6 2 5*

R62 status (output active level).

[R62 Holding time] *r 6 2 H*

R62 holding delay time.

[R63 configuration] *r 6 3* - Menu

Access

[Complete settings] → [Input/Output] → [Relay] → [R63 configuration]

About This Menu

Identical to [R2 configuration] *r 2* - Menu (*see page 527*).

NOTE: R60 up to R66 Relays are used inside the Drive Systems enclosure for control and monitoring circuits.

Following parameters can be accessed on ATV960 or ATV980, equipped with cabinet IO, and if [Access Level] *L A C* is set to [Expert] *E P r*.

[R63 Assignment] *r 6 3*

R63 assignment.

[R63 Delay time] *r 6 3 d*

R63 activation delay time.

[R63 Active at] *r 6 3 5*

R63 status (output active level).

[R63 Holding time] *r 6 3 H*

R63 holding delay time.

[R64 configuration] r 5 4 - Menu

Access

[Complete settings] → [Input/Output] → [Relay] → [R64 configuration]

About This Menu

Identical to [R2 configuration] r 2 - Menu (*see page 527*).

NOTE: R60 up to R66 Relays are used inside the Drive Systems enclosure for control and monitoring circuits.

Following parameters can be accessed on ATV960 or ATV980, equipped with cabinet IO, and if [Access Level] L A C is set to [Expert] E P r .

[R64 Assignment] r 5 4

R64 assignment.

[R64 Delay time] r 5 4 d

R64 activation delay time.

[R64 Active at] r 5 4 5

R64 status (output active level).

[R64 Holding time] r 5 4 H

R64 holding delay time.

[R65 configuration] r 5 5 - Menu

Access

[Complete settings] → [Input/Output] → [Relay] → [R65 configuration]

About This Menu

Identical to [R2 configuration] r 2 - Menu (*see page 527*).

NOTE: R60 up to R66 Relays are used inside the Drive Systems enclosure for control and monitoring circuits.

Following parameters can be accessed on ATV960 or ATV980, equipped with cabinet IO, and if [Access Level] L A C is set to [Expert] E P r .

[R65 Assignment] r 5 5

R65 assignment.

[R65 Delay time] r 5 5 d

R65 activation delay time.

[R65 Active at] r 5 5 5

R65 status (output active level).

[R65 Holding time] r 5 5 H

R65 holding delay time.

[R66 configuration] *r 66* - Menu

Access

[Complete settings] → [Input/Output] → [Relay] → [R66 configuration]

About This Menu

Identical to [R2 configuration] *r 2* - Menu (*see page 527*).

NOTE: R60 up to R66 Relays are used inside the Drive Systems enclosure for control and monitoring circuits.

Following parameters can be accessed on ATV960 or ATV980, equipped with cabinet IO, and if [Access Level] *L A C* is set to [Expert] *E P r*.

[R66 Assignment] *r 66*

R66 assignment.

[R66 Delay time] *r 66 d*

R66 activation delay time.

[R66 Active at] *r 66 5*

R66 status (output active level).

[R66 Holding time] *r 66 H*

R66 holding delay time.

[Input/Output] , ▢ - Menu

Access

[Complete settings] → [Input/Output]

[Ref Freq Template] b 5 P

Reference frequency template selection.

This parameter defines how the speed reference is taken into account, for analog inputs and pulse input. In the case of the PID controller, this is the PID output reference.

The limits are set by the [Low speed] L 5 P and [High speed] H 5 P parameters

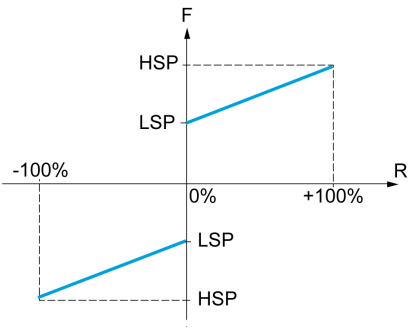
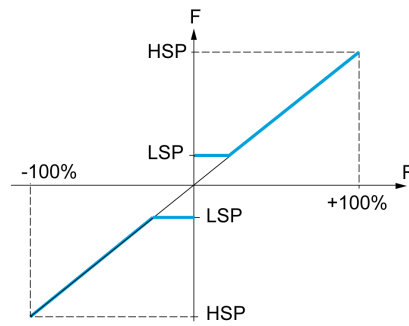
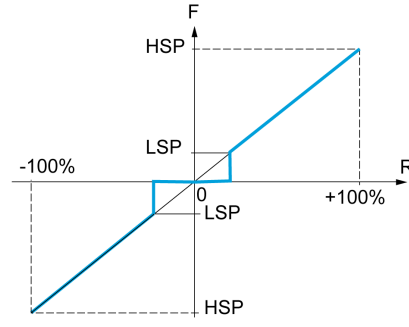
Setting ()	Code / Value	Description
[Standard]	b 5 d	 <p>F Frequency R Reference</p> <p>At reference = 0, the frequency = [Low speed] L 5 P Factory setting</p>
[Pedestal]	b L 5	 <p>F Frequency R Reference</p> <p>At reference = 0 to [Low speed] L 5 P, the frequency = [Low speed] L 5 P</p>
[Deadband]	b n 5	 <p>F Frequency R Reference</p> <p>At reference = 0 to [Low speed] L 5 P the frequency = 0</p>

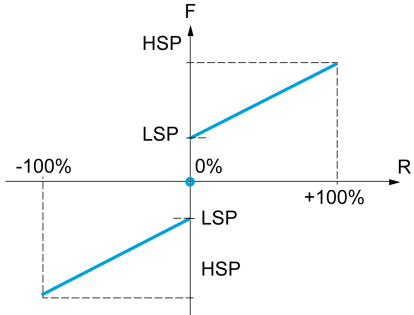
Setting (C)	Code / Value	Description
[Deadband at 0%]	<i>b n 5 d</i>	 <p>F Frequency R Reference</p> <p>This operation is the same as [Standard] b 5 d, except that in the following cases at zero reference, the frequency = 0: The signal is less than [Min nvalue], which is greater than 0 (example: 1 Vdc on a 2–10 Vdc input) The signal is greater than [Min nvalue], which is greater than [Max value] (example: 11 Vdc on a 10–0 Vdc input). If the input range is configured as “bidirectional”, operation remains identical to [Standard] b 5 d.</p>

Section 8.54

[Encoder configuration]

[Encoder configuration] , E n - Menu

Access

[Complete settings] → [Encoder configuration]

About This Menu

This menu can be accessed if an encoder module (VW3A3420, VW3A3422, VW3A3423, or VW3A3424) has been inserted, and the available selections depend on the type of encoder module used.

Encoder Check Procedure

This procedure applies to all types of encoder.

Step	Action
1	Configure the parameters of the encoder used
2	Set [Motor control type] C L E to a value other than [FVC] F V C even if it is the required configuration. For example, use [SVC V] V V C for an asynchronous motor and [Sync. mot.] S Y n for a synchronous motor.
3	Configure the motor parameters in accordance with the specifications on the nameplate. <ul style="list-style-type: none"> ● Asynchronous motor: [Nominal motor power] n P r, [Nom Motor Voltage] u n S, [Nom Motor Current] n C r, [Nominal Motor Freq] F r S, [Nominal Motor Speed] n S P. ● Synchronous motor: [Sync Nominal I] n C r S, [Nom SyncMotor Speed] n S P S, [Pole pairs] P P n S, [Syn. EMF constant] P H S, [Autotune L d-axis] L d S, [Autotune L q-axis] L q S, [SyncMotor Stator R] r S R S.
4	Set [Encoder usage] E n u to [No] n o .
5	Perform auto-tuning
6	Set [Encoder check] E n C to [Yes] Y E S
7	Set the motor rotating at stabilized speed around 15% of the rated speed for at least 3 seconds, and use the [Display] n o n menu to monitor its behavior using [Measured output fr.] n n F parameter.
8	If an [Encoder] E n F error is detected, [Encoder check] E n C returns to [No] n o . <ul style="list-style-type: none"> ● Check the parameter settings (see steps 1 to 5 above). ● Check that the mechanical and electrical operation of the encoder, its power supply, and connections are all OK. ● Reverse the direction of rotation of the motor ([Output Ph Rotation] P H r parameter) or the encoder signals
9	Repeat the operations from step 6 onwards until [Encoder check] E n C changes to [Done] d o n E
10	If necessary, change [Motor control type] C L E to [FVC] F V C or [Sync.CL] F S Y . NOTE: In this case [Encoder usage] E n u is automatically set to [Speed Regulation] r E G .

[Encoder Type] u E C P

Encoder type.

This parameter can be accessed if VW3A3420 or VW3A3422 or VW3A3424 are inserted.

The list of choice depends on the encoder module inserted.

Setting	Code / Value	Description
[Undefined]	u n d	Unknow / No encoder type selected Factory setting
[Hiperface]	S C H P	SinCos Hiperface encoder
[SinCos]	S C	SinCos encoder
[SSI]	S S i	SSI encoder

Setting	Code / Value	Description
[RS422]	<i>R b</i>	AB encoder
[Resolver]	<i>r E 5</i>	Resolver encoder
[Biss]	<i>b , 5 5</i>	BISS encoder
[EnDat 2.2]	<i>E n 2 2</i>	Endat 2.2 encoder
[HTL]	<i>H t L</i>	HTL encoder

[AB Encoder Type] *E n 5*

AB Encoder type configuration

This parameter can be accessed if [Encoder Type] *u E C P* is set to [RS422] *R b* or [HTL] *H t L*.

NOTE: This parameter is forced to [AABB] *R R b b* if the encoder module is different from HTL encoder.

⚠ WARNING

LOSS OF CONTROL

If you use an HTL encoder module (VW3A3424) and set [Encoder Usage] *E n u* to [Speed Regulation] *r E G*, you must set the parameter [AB Encoder Type] *E n 5* to [AABB] *R R b b*.

Failure to follow these instructions can result in death, serious injury, or equipment damage.

Setting	Code / Value	Description
[AABB]	<i>R R b b</i>	A, /A, B, /B signals Factory setting
[AB]	<i>R b</i>	A, B signals
[A]	<i>R</i>	A signal NOTE: In the case of an HTL encoder module, this parameter cannot be set to [A] <i>R</i> , if [Encoder usage] <i>E n u</i> is set to [Speed Regulation] <i>r E G</i> .

[Encoder supply volt.] *u E C V* ★

Encoder supply voltage.

Rated voltage of encoder used. The list of choice depends on the encoder module inserted.

This parameter can be accessed if [Encoder Type] *u E C P* is not set to:

- [Undefined] *u n d*, or
- [Resolver] *r E 5*.

Setting	Code / Value	Description
[Undefined]	<i>u n d</i>	Not defined Factory setting
[5 Vdc]	<i>5 V</i>	5 Volts
[12 Vdc]	<i>1 2 V</i>	12 Volts
[15 Vdc]	<i>1 5 V</i>	15 Volts
[24 Vdc]	<i>2 4 V</i>	24 Volts

[Number of pulses] *P G* , ★

Number of pulses per encoder revolution.

The parameter can be accessed if

- An encoder module VW3A3420 has been inserted and if [Encoder Type] *u E C P* is set to [RS422] *R b* or,
- An encoder module VW3A3424 has been inserted and if [Encoder Type] *u E C P* is set to [HTL] *H t L*.

Setting	Description
100...10,000	Factory setting: 1024

[Encoder check] E n C

Encoder check activation.

Setting	Code / Value	Description
[Not done]	n o	Check not performed
[Yes]	y e s	Activates monitoring of the encoder.
[Done]	d o n e	Check performed successfully. The check procedure checks: <ul style="list-style-type: none"> • The direction of rotation of the encoder/motor • The presence of signals (wiring continuity) • The number of pulses/revolution. If an error is detected, the drive triggers an [Encoder] E n F.

[Encoder usage] E n u

Setting	Code / Value	Description
[No]	n o	Function inactive
[Speed Monitoring]	s e c	The encoder provides speed feedback for monitoring only.
[Speed Regulation]	r e g	The encoder provides speed feedback for regulation and monitoring. This configuration is automatic if the drive is configured for closed-loop operation [Motor control type] C t t = [FVC] F v c or [Sync.CL] F s y . If [Motor control type] C t t = [SVC V] v v c the encoder operates in speed feedback mode and enables static correction of the speed to be performed. This configuration is not accessible for other [Motor control type] C t t values. NOTE: In the case of a HTL encoder module, this parameter cannot be set to [Speed Regulation] r e g if [AB Encoder Type] E n 5 is set to [A] R .
[Speed Reference]	P G r	The encoder provides a speed reference. It can only be selected with an incremental encoder module.

[Encoder rotation inv.] E n r i

Inversion of encoder rotation direction.

Setting	Code / Value	Description
[No]	n o	Inversion of the encoder deactivated Factory setting
[Yes]	y e s	Inversion of the encoder activated

[Resolver Exct. Freq.] r e f 9 ★

Resolver excitation frequency.

This parameter can be accessed if **[Encoder Type] u e c P** is set to **[Resolver] r e 5**.

Setting	Code / Value	Description
[3 kHz]	3 K	3 kHz
[4 kHz]	4 K	4 kHz
[5 kHz]	5 K	5 kHz
[6 kHz]	6 K	6 kHz
[7 kHz]	7 K	7 kHz
[8 kHz]	8 K	8 kHz Factory setting
[9 kHz]	9 K	9 kHz
[10 kHz]	1 0 K	10 kHz
[11 kHz]	1 1 K	11 kHz
[12 kHz]	1 2 K	12 kHz

[Transformation ratio] *r E 5* ★

Resolver transformation ratio.

This parameter can be accessed if **[Encoder Type] *u E L P*** is set to **[Resolver] *r E 5***.

Setting	Code / Value	Description
[0.3]	<i>0 3</i>	0.3
[0.5]	<i>0 5</i>	0.5 Factory setting
[0.8]	<i>0 8</i>	0.8
[1.0]	<i>1 0</i>	1.0

[Resolver poles nbr] *r P P n* ★

Resolver poles pair number.

This parameter can be accessed if **[Encoder Type] *u E L P*** is set to **[Resolver] *r E 5***.

Setting	Code / Value	Description
[2 poles]	<i>2 P</i>	2 poles Factory setting
[4 poles]	<i>4 P</i>	4 poles
[6 poles]	<i>6 P</i>	6 poles
[8 poles]	<i>8 P</i>	8 poles

[SinCos lines count] *u E L L* ★

SinCos lines count.

This parameter can be accessed if **[Encoder Type] *u E L P*** is set to **[SinCos] *5 L***.

Setting	Code / Value	Description
[Undefined]	<i>u n d</i>	Undefined Factory setting
[1...10000]		Setting range

[SSI parity] *5 5 L P* ★

SSI Parity

This parameter can be accessed if **[Encoder Type] *u E L P*** is set to **[SSI] *5 5***.

Setting	Code / Value	Description
[Undefined]	<i>u n d</i>	Undefined Factory setting
[No parity]	<i>n o</i>	No parity
[Even parity]	<i>E V E n</i>	Even parity

[SSI frame size] *5 5 F 5* ★

SSI frame size (in number of bits).

The parameter can be accessed if **[Encoder Type] *u E L P*** is set to **[SSI] *5 5***.

Setting	Description
[Auto] <i>A u t o</i> ...31	Setting range Factory setting: [Auto] <i>A u t o</i>

[Nbr of revolutions] *E n Π r* ★

Number of revolutions.

Format of the number of revolutions (in number of bits).

The parameter can be accessed if **[Encoder Type] *υ E C P*** is set to **[SSI] *5 5*** ,

Setting	Description
[Undefined] <i>υ n d...25</i>	Setting range Factory setting: [Undefined] <i>υ n d</i>

[Turn bit resolution] *E n E r* ★

Turn bit resolution.

Resolution per revolution (in number of bits).

The parameter can be accessed if **[Encoder Type] *υ E C P*** is set to **[SSI] *5 5*** ,

Setting	Description
[Undefined] <i>υ n d...25</i>	Setting range Factory setting: [Undefined] <i>υ n d</i>

[SSI code type] *5 5 C d* ★

SSI code type.

The parameter can be accessed if **[Encoder Type] *υ E C P*** is set to **[SSI] *5 5*** ,

Setting	Code / Value	Description
[Undefined]	<i>υ n d</i>	Undefined Factory setting
[Binary code]	<i>b i n</i>	Binary code
[Gray code]	<i>G r A y</i>	Gray code

[Clock frequency] *E n 5 P* ★

Clock frequency.

The parameter can be accessed if **[Encoder Type] *υ E C P*** is set to **[SSI] *5 5*** ,

Setting	Code / Value	Description
[200 kHz]	<i>2 0 0 K</i>	200 kHz Factory setting
[1 Mhz]	<i>1 Π</i>	1 MHz

[AB Encoder Max Freq] *A b Π F* ★

AB encoder maximum frequency.

This parameter can be accessed if **[Encoder Type] *υ E C P*** is set to **[RS422] *A b*** or **[HTL] *H E L*** and, **[Access Level] *L A C*** is set to **[Expert] *E P r*** .

This parameter can be used in case of EMC perturbations to adjust the filter of the encoder.

Setting	Code / Value	Description
[150 kHz]	<i>1 5 0 K</i>	150 kHz
[300 kHz]	<i>3 0 0 K</i>	300 kHz Factory setting
[500 kHz]	<i>5 0 0 K</i>	500 kHz
[1000 kHz]	<i>1 Π</i>	1000 kHz

[Encoder filter activ.] FFR ★

Encoder feedback filter activation.

This parameter can be accessed if **[Access Level] LAL** is set to **[Expert] EPR** and **[Encoder usage] ENU** is not set to **[No] NO**.

Setting	Code / Value	Description
[No]	NO	Filter deactivated Factory setting
[Yes]	YES	Filter activated

[Encoder filter value] FFR ★

Encoder feedback filter value.

This parameter can be accessed if:

- **[Access Level] LAL** is set to **[Expert] EPR**, and
- **[Encoder filter activ.] FFR** is set to **[Yes] YES**.

Setting	Description
0.0...40.0 ms	Setting range Factory setting: according to encoder rating

[Stop on top Z] LOST ★

Stop on next top Z detection.

This parameter can be used for homing. If the approach speed is set to high an **[DC Bus Overvoltage] OBF** error will be triggered.

This parameter can be accessed if:

- A VW3A3420 Digital encoder module has been inserted and **[Encoder type] LELP** is set to **[RS422] RB**.

Setting	Code / Value	Description
[Not Assigned]	NO	Not assigned Factory setting
[DI1]...[DI8]	L I...L I B	Digital input DI1...DI8
[DI11]...[DI16]	L I I I...L I I B	Digital input DI11...DI16 if VW3A3203 I/O extension module has been inserted
[CD00]...[CD10]	C D D D...C D I D	Virtual digital input CMD.0...CMD.10 in [I/O profile] IO configuration
[CD11]...[CD15]	C D I I...C D I B	Virtual digital input CMD.11...CMD.15 regardless of configuration
[C101]...[C110]	C I D I...C I I D	Virtual digital input CMD1.01...CMD1.10 with integrated Modbus Serial in [I/O profile] IO configuration
[C111]...[C115]	C I I I...C I I B	Virtual digital input CMD1.11...CMD1.15 with integrated Modbus Serial regardless of configuration
[C201]...[C210]	C 2 D I...C 2 I D	Virtual digital input CMD2.01...CMD2.10 with CANopen® fieldbus module in [I/O profile] IO configuration
[C211]...[C215]	C 2 I I...C 2 I B	Virtual digital input CMD2.11...CMD2.15 with CANopen® fieldbus module regardless of configuration
[C301]...[C310]	C 3 D I...C 3 I D	Virtual digital input CMD3.01...CMD3.10 with a fieldbus module in [I/O profile] IO configuration
[C311]...[C315]	C 3 I I...C 3 I B	Virtual digital input CMD3.11...CMD3.15 with a fieldbus module regardless of configuration
[C501]...[C510]	C 5 D I...C 5 I D	Virtual digital input CMD5.01...CMD5.10 with integrated Ethernet in [I/O profile] IO configuration
[C511]...[C515]	C 5 I I...C 5 I B	Virtual digital input CMD5.11...CMD5.15 with integrated Ethernet regardless of configuration

[Reset Position Assign] r P o S

Reset position assignment.

This parameter resets the value of **[PLC Encoder Pulse] P u C** and **[Enc pulse count] P u C d** parameters.

This parameter can be accessed if **[Access Level] L R C** is set to **[Expert] E P r**

Identical to **[Stop on top Z] E o S t**.

Section 8.55

[Error/Warning handling]

What Is in This Section?

This section contains the following topics:

Topic	Page
[Auto fault reset] <i>R E r</i> - Menu	544
[Fault reset] <i>r S E</i> - Menu	545
[Catch on the fly] <i>F L r</i> - Menu	547
[Error detection disable] <i>i n H</i> - Menu	549
[External error] <i>E E F</i> - Menu	552
[Output phase loss] <i>o P L</i> - Menu	553
[Input phase loss] <i>i P L</i> - Menu	554
[4-20mA loss] <i>L F L</i> - Menu	555
[Fallback speed] <i>L F F</i> - Menu	556
[Fieldbus monitoring] <i>C L L</i> - Menu	557
[Embedded Modbus TCP] <i>E n E C</i> - Menu	558
[Communication module] <i>C o m o</i> - Menu	559
[Undervoltage handling] <i>u S b</i> - Menu	561
[Ground Fault] <i>G r F L</i> - Menu	563
[Motor thermal monit] <i>t H E</i> - Menu	564
[Encoder monitoring] <i>S d d</i> - Menu	566
[Braking Resistor monit] <i>b r P</i> - Menu	567
[Torque or i lim. detect] <i>t i d</i> - Menu	568
[Drive overload monit] <i>o b r</i> - Menu	569
[Warn grp 1 definition] <i>R 1 C</i> - Menu	570
[Warn grp 2 definition] <i>R 2 C</i> - Menu	570
[Warn grp 3 definition] <i>R 3 C</i> - Menu	570
[Warn grp 4 definition] <i>R 4 C</i> - Menu	570
[Warn grp 5 definition] <i>R 5 C</i> - Menu	570
[Error/Warning Handling] <i>C S W n</i> - menu	571

[Auto fault reset] *F E r* - Menu

Access

[Complete settings] → [Error/Warning handling] → [Auto fault reset]

[Auto Fault Reset] *F E r* 

Automatic fault reset.

This function can be used to automatically perform individual or multiple Fault Resets. If the cause of the error that has triggered the transition to the operating state Fault disappears while this function is active, the drive resumes normal operation. While the Fault Reset attempts are performed automatically, the output signal [Operating state Fault] is not available. If the attempts to perform the Fault Reset are not successful, the drive remains in the operating state Fault and the output signal [Operating state Fault] becomes active.

 WARNING
<p>UNANTICIPATED EQUIPMENT OPERATION</p> <ul style="list-style-type: none"> Verify that activating this function does not result in unsafe conditions. Verify that the fact that the output signal "Operating state Fault" is not available while this function is active does not result in unsafe conditions. <p>Failure to follow these instructions can result in death, serious injury, or equipment damage.</p>

The drive fault relay remains activated if this function is active. The speed reference and the operating direction must be maintained.

It is recommended to use 2-wire control ([2/3-wire control] *E C C* is set to [2 wire] *2 C* and [2-wire type] *E C E* is set to [Level] *L E L*, refer to [2/3-wire control] *E C C*.

If the restart has not taken place once the configurable time [Fault Reset Time] *E F r* has elapsed, the procedure is aborted and the Drive response to external error. remains locked until it is turned off and then on again.

The detected error codes, which permit this function, are listed in the Diagnostics part of the manual.

Setting	Code / Value	Description
[No]	<i>n 0</i>	Function inactive Factory setting
[Yes]	<i>Y E 5</i>	Automatic restart, after locking in error state, if the detected error has disappeared and the other operating conditions permit the restart. The restart is performed by a series of automatic attempts separated by increasingly longer waiting periods: 1 s, 5 s, 10 s, then 1 minute for the following attempts.

[Fault Reset Time] *E F r* ★

Maximum time for automatic restart function.

This parameter appears if [Auto Fault Reset] *F E r* is set to [Yes] *Y E 5*. It can be used to limit the number of consecutive restarts on a recurrent detected error.

Setting	Code / Value	Description
[5 minutes]	<i>5</i>	5 minutes Factory setting
[10 minutes]	<i>1 0</i>	10 minutes
[30 minutes]	<i>3 0</i>	30 minutes
[1 hour]	<i>1 h</i>	1 hour
[2 hours]	<i>2 h</i>	2 hours
[3 hours]	<i>3 h</i>	3 hours
[Unlimited]	<i>C E</i>	Continuous

[Fault reset] r 5 E - Menu**Access**

[Complete settings] → [Error/Warning handling] → [Fault reset]

[Fault Reset Assign] r 5 F

Fault reset input assignment.

Detected errors are cleared manually when the assigned input or bit changes to 1 if the cause of the detected error has been removed.

The **STOP/RESET** key on the Graphic Display Terminal performs the same function.

Setting	Code / Value	Description
[Not Assigned]	n o	Not assigned
[DI1]...[DI8]	L , 1...L , 8	Digital input DI1...DI8 Factory setting: [DI4] L , 4
[DI11]...[DI16]	L , 11...L , 16	Digital input DI11...DI16 if VW3A3203 I/O extension module has been inserted
[DI52 (High level)]...[DI59 (High level)]	d 5 2 H...d 5 9 H	Cabinet high level digital inputs NOTE: This selection can be accessed on ATV960, ATV980 equipped with Cabinet IO.
[C201]...[C210]	C 2 0 1...C 2 1 0	Virtual digital input CMD2.01...CMD2.10 with CANopen® fieldbus module in [I/O profile] , o configuration
[C211]...[C215]	C 2 1 1...C 2 1 5	Virtual digital input CMD2.11...CMD2.15 with CANopen® fieldbus module regardless of configuration
[C501]...[C510]	C 5 0 1...C 5 1 0	Virtual digital input CMD5.01...CMD5.10 with integrated Ethernet in [I/O profile] , o configuration
[C511]...[C515]	C 5 1 1...C 5 1 5	Virtual digital input CMD5.11...CMD5.15 with integrated Ethernet regardless of configuration

[Product Restart] r P ★

The Restart function performs a Fault Reset and then restarts the drive. During this Restart procedure, the drive goes through the same steps as if it had been switched off and on again. Depending on the wiring and the configuration of the drive, this may result in immediate and unanticipated operation.

⚠ WARNING

UNANTICIPATED EQUIPMENT OPERATION

The Restart function performs a Fault Reset and restarts the drive

- Verify that activating this function does not result in unsafe conditions.

Failure to follow these instructions can result in death, serious injury, or equipment damage.

Product restart.

This parameter can be accessed if **[Access Level]** L R C is set to **[Expert]** E P r mode.

This parameter can be used to reset all detected errors without having to disconnect the drive from the supply mains.

Setting	Code / Value	Description
[No]	n o	Function inactive Factory setting
[Yes]	y e 5	Reinitialization. Press and hold down the OK key for 2 s. The parameter changes back to [No] n o automatically as soon as the operation is complete. The drive can only be reinitialized when locked.

[Prod Restart Assign] *r P R* ★ ⏳

Product restart assignment.

The Restart function performs a Fault Reset and then restarts the drive. During this Restart procedure, the drive goes through the same steps as if it had been switched off and on again. Depending on the wiring and the configuration of the drive, this may result in immediate and unanticipated operation. The Restart function can be assigned to a digital input

⚠ WARNING
UNANTICIPATED EQUIPMENT OPERATION
The Restart function performs a Fault Reset and restarts the drive <ul style="list-style-type: none"> • Verify that activating this function does not result in unsafe conditions.
Failure to follow these instructions can result in death, serious injury, or equipment damage.

This parameter can be accessed if **[Access Level]** *L A C* is set to **[Expert]** *E P r* mode.

Setting	Code / Value	Description
[Not Assigned]	<i>n o</i>	Not assigned Factory setting
[DI1]...[DI8]	<i>L , I ... L , B</i>	Digital input DI1...DI8
[DI11]...[DI16]	<i>L , I I ... L , I B</i>	Digital input DI11...DI16 if VW3A3203 I/O extension module has been inserted

[Catch on the fly] *F L r* - Menu

Access

[Complete settings] → [Error/Warning handling] → [Catch on the fly]

[Catch On Fly] *F L r*

Catch on the fly.

Used to enable a smooth restart if the run command is maintained after the following events:

- Loss of line supply or disconnection.
- Clearing clearance of current detected error or automatic restart.
- Freewheel stop.

The speed given by the drive resumes from the estimated or measured speed of the motor at the time of the restart, then follows the ramp to the reference speed.

This function requires 2-wire level control.

When the function is operational, it activates at each run command, resulting in a slight delay of the current (0.5 s max).

[Catch On Fly] *F L r* is forced to [No] *n o* if

- Motor Control Type *C L E* is set to [FVC] *F V C* or [Sync.CL] *F 5 Y*, or
- [Auto DC Injection] *R d C* is set to [Continuous] *C E*, or
- [Brake assignment] *b L C* is not set to [No] *n o*, or
- [BL Mode] *b 9 P* is not set to [No] *n o*.

Setting	Code / Value	Description
[Not Configured]	<i>n o</i>	Function inactive. Factory setting
[Yes On Freewheel]	<i>Y E 5</i>	Function active only after freewheel stop.
[Yes Always]	<i>A L L</i>	Function active after all stop type

NOTE: For synchronous reluctant motor, it is recommended to set [Angle Setting Type] *A 5 E* to [Rotational Current Injection] *r C i*.

[Catch on Fly Sensitivity] *V C b* ★

Catch on fly sensitivity.

This parameter can only be accessed if [Access Level] *L A C* is set to [Expert] *E P r*.

Setting the value of parameter [Catch on Fly Sensitivity] *V C b* too low may cause a wrong estimation of the speed of the motor.

⚠ WARNING

LOSS OF CONTROL

- Only reduce gradually the value of parameter [Catch on Fly Sensitivity] *V C b*.
- During commissioning, verify that the drive and the system operate as intended by performing tests and simulations in a controlled environment under controlled conditions

Failure to follow these instructions can result in death, serious injury, or equipment damage.

Setting	Description
0.10...100.00 V	Setting range Factory setting: 0.20 V

[Catch On Fly Mode] C_{OF}

Velocity detection method for the Catch on Fly function.

[Catch On Fly Mode] C_{OF} is forced to **[Measured] HW_{COF}** for synchronous motors.

Setting	Code / Value	Description
[Measured]	HW_{COF}	Hardware catch on the fly The motor voltage signal should be greater than [Catch on Fly Sensitivity] V_{CB} to be able to estimate the speed. Factory setting
[Computed]	SW_{COF}	Software catch on the fly A signal is injected to estimate the speed and the position of the rotor. [Computed] SW_{COF} method is not effective for a motor velocity range exceeding -HSP or +HSP.

[Error detection disable] *INH* - Menu

Access

[Complete settings] → [Error/Warning handling] → [Error detection disable]

[ErrorDetect Disabled] *INH* ★

Disable error detection.

In rare cases, the monitoring functions of the drive may be unwanted because they impede the purpose of the application. A typical example is a smoke extractor fan operating as a part of a fire protection system. If a fire occurs, the smoke extractor fan should operate as long as possible, even if, for example, the permissible ambient temperature of the drive is exceeded. In such applications, damage to or destruction of the device may be acceptable as collateral damage, for example, to keep other damage from occurring whose hazard potential is assessed to be more severe.

A parameter is provided to disable certain monitoring functions in such applications so that automatic error detection and automatic error responses of the device are no longer active. You must implement alternative monitoring functions for disabled monitoring functions that allow operators and/or master control systems to adequately respond to conditions which correspond to detected errors. For example, if overtemperature monitoring of the drive is disabled, the drive of a smoke extractor fan may itself cause a fire if errors go undetected. An overtemperature condition can be, for example, signaled in a control room without the drive being stopped immediately and automatically by its internal monitoring functions.

⚠ DANGER

MONITORING FUNCTIONS DISABLED, NO ERROR DETECTION

- Only use this parameter after a thorough risk assessment in compliance with all regulations and standards that apply to the device and to the application.
- Implement alternative monitoring functions for disabled monitoring functions that do not trigger automatic error responses of the drive, but allow for adequate, equivalent responses by other means in compliance with all applicable regulations and standards as well as the risk assessment.
- Commission and test the system with the monitoring functions enabled.
- During commissioning, verify that the drive and the system operate as intended by performing tests and simulations in a controlled environment under controlled conditions.

Failure to follow these instructions will result in death or serious injury.

This parameter can be accessed if **[Access Level]** *LRC* is set to **[Expert]** *EP*.

If the assigned input or bit state is:

- 0: error detection is enabled.
- 1: error detection is disabled.

Current errors are cleared on a rising edge from 0 to 1 of the assigned input or bit.

Detection of following errors can be disabled: ACF1, ANF, BOF, BSQF, BUHF, CFA, CFB, CFC, CHF, CNF, COF, DLF, ENF, EPF1, EPF2, ETHF, FCF1, FCF2, FDR1, FDR2, FWER, IFA, IFB, IFC, IFD, IHF, INFB, INFD, INFJ, INFK, INFN, INFP, INFR, INFS, INFT, INFU, INFV, LFF1, LFF3, LFF4, LFF5, MDF, MDLF, MFF, MSDF, OBF, OHF, OLC, OLF, OPF1, OPF2, OSF, P24C, PCPF, PFMF, PGLF, PHF, SLF1, SLF2, SLF3, SOF, SPF, SRF, SSF, STF, T1CF, T3CF, T4CF, T5CF, TECF, TFA, TFB, TFC, TFD, TH1F, TH3F, TH4F, TH5F, THEF, TJF, TJF2, TLOF, TNF, ULF, URF, USF.

Setting	Code / Value	Description
[Not Assigned]	<i>na</i>	Not assigned Factory setting
[DI1]...[DI8]	<i>L, I...L, B</i>	Digital input DI1...DI8
[DI11]...[DI16]	<i>L, I I...L, I B</i>	Digital input DI11...DI16 if VW3A3203 I/O extension module has been inserted
[CD00]...[CD10]	<i>C d 0 0...C d 1 0</i>	Virtual digital input CMD.0...CMD.10 in [I/O profile] <i>na</i> configuration
[CD11]...[CD15]	<i>C d 1 1...C d 1 5</i>	Virtual digital input CMD.11...CMD.15 regardless of configuration
[C101]...[C110]	<i>C 1 0 1...C 1 1 0</i>	Virtual digital input CMD1.01...CMD1.10 with integrated Modbus Serial in [I/O profile] <i>na</i> configuration

Setting	Code / Value	Description
[C111]...[C115]	C 1 1 1 ... C 1 1 5	Virtual digital input CMD1.11...CMD1.15 with integrated Modbus Serial regardless of configuration
[C201]...[C210]	C 2 0 1 ... C 2 1 0	Virtual digital input CMD2.01...CMD2.10 with CANopen® fieldbus module in [I/O profile] , 0 configuration
[C211]...[C215]	C 2 1 1 ... C 2 1 5	Virtual digital input CMD2.11...CMD2.15 with CANopen® fieldbus module regardless of configuration
[C301]...[C310]	C 3 0 1 ... C 3 1 0	Virtual digital input CMD3.01...CMD3.10 with a fieldbus module in [I/O profile] , 0 configuration
[C311]...[C315]	C 3 1 1 ... C 3 1 5	Virtual digital input CMD3.11...CMD3.15 with a fieldbus module regardless of configuration
[C501]...[C510]	C 5 0 1 ... C 5 1 0	Virtual digital input CMD5.01...CMD5.10 with integrated Ethernet in [I/O profile] , 0 configuration
[C511]...[C515]	C 5 1 1 ... C 5 1 5	Virtual digital input CMD5.11...CMD5.15 with integrated Ethernet regardless of configuration

[Forced Run] *r r 5* ★

Disable error detection on run order.

In rare cases, the monitoring functions of the drive may be unwanted because they impede the purpose of the application. In addition, the Run command is to be forced via a digital input. A typical example is a smoke extractor fan operating as a part of a fire protection system. If a fire occurs, the smoke extractor fan should operate as long as possible, even if, for example, the permissible ambient temperature of the drive is exceeded or the wiring is destroyed. In such applications, damage to or destruction of the device may be acceptable as collateral damage, for example, to keep other damage from occurring whose hazard potential is assessed to be more severe.

A parameter is provided to disable certain monitoring functions in such applications so that automatic error detection and automatic error responses of the device are no longer active. You must implement alternative monitoring functions for disabled monitoring functions that allow operators and/or master control systems to adequately respond to conditions which correspond to detected errors. For example, if overtemperature monitoring of the drive is disabled, the drive of a smoke extractor fan may itself cause a fire if errors go undetected. An overtemperature condition can be, for example, signaled in a control room without the drive being stopped immediately and automatically by its internal monitoring functions. In addition, it may not be possible to stop the drive.

DANGER

MONITORING FUNCTIONS DISABLED, NO ERROR DETECTION, UNANTICIPATED EQUIPMENT OPERATION

- Only use this parameter after a thorough risk assessment in compliance with all regulations and standards that apply to the device and to the application.
- Implement alternative monitoring functions for disabled monitoring functions that do not trigger automatic error responses of the drive, but allow for adequate, equivalent responses by other means in compliance with all applicable regulations and standards as well as the risk assessment.
- Verify that permanently forcing the Run command via a digital input does not result in unsafe conditions.
- Commission and test the system with the monitoring functions enabled.
- During commissioning, verify that the drive and the system operate as intended by performing tests and simulations in a controlled environment under controlled conditions.

Failure to follow these instructions will result in death or serious injury.

Setting	Code / Value	Description
[Disabled]	n 0	Function inactive Factory setting
[Forced Run FW]	F r d	Forced forward run.
[Forced Run RV]	r r 5	Forced reverse run.

[Forced Run Ref] f_{Hr} ★

Forced Run Reference Frequency.

This parameter can be accessed if **[Forced Run]** f_{H5} is not set to **[Disabled]** n_0 .

This parameter causes the reference to be forced to the configured value when the input or bit for error detection disabled is at 1, with priority over all other references. Value 0 = function inactive. The factory setting changes to 60 Hz if **[Motor Standard]** $b_{Fr} = \text{[60 Hz NEMA] } 5 \square$.

Setting	Description
0... [Max Frequency] f_{Fr}	Factory setting: 50 Hz

[External error] E E F - Menu

Access

[Complete settings] → [Error/Warning handling] → [External error]

[Ext Error Assign] E E F

External error assignment.

If the assigned bit state is:

- 0: there is no external error.
- 1: there is an external error

Setting	Code / Value	Description
[Not Assigned]	n o	Not assigned Factory setting
[DI1]...[DI8]	L , I ... L , B	Digital input DI1...DI8
[DI11]...[DI16]	L , I I ... L , I B	Digital input DI11...DI16 if VW3A3203 I/O extension module has been inserted
[CD00]...[CD10]	C d 0 0 ... C d 1 0	Virtual digital input CMD.0...CMD.10 in [I/O profile] , o configuration
[CD11]...[CD15]	C d 1 1 ... C d 1 5	Virtual digital input CMD.11...CMD.15 regardless of configuration
[C101]...[C110]	C 1 0 1 ... C 1 1 0	Virtual digital input CMD1.01...CMD1.10 with integrated Modbus Serial in [I/O profile] , o configuration
[C111]...[C115]	C 1 1 1 ... C 1 1 5	Virtual digital input CMD1.11...CMD1.15 with integrated Modbus Serial regardless of configuration
[C201]...[C210]	C 2 0 1 ... C 2 1 0	Virtual digital input CMD2.01...CMD2.10 with CANopen® fieldbus module in [I/O profile] , o configuration
[C211]...[C215]	C 2 1 1 ... C 2 1 5	Virtual digital input CMD2.11...CMD2.15 with CANopen® fieldbus module regardless of configuration
[C301]...[C310]	C 3 0 1 ... C 3 1 0	Virtual digital input CMD3.01...CMD3.10 with a fieldbus module in [I/O profile] , o configuration
[C311]...[C315]	C 3 1 1 ... C 3 1 5	Virtual digital input CMD3.11...CMD3.15 with a fieldbus module regardless of configuration
[C501]...[C510]	C 5 0 1 ... C 5 1 0	Virtual digital input CMD5.01...CMD5.10 with integrated Ethernet in [I/O profile] , o configuration
[C511]...[C515]	C 5 1 1 ... C 5 1 5	Virtual digital input CMD5.11...CMD5.15 with integrated Ethernet regardless of configuration
[DI52 (High level)]... [DI59 (High level)]	d 5 2 H ... d 5 9 H	Cabinet high level digital inputs NOTE: This selection can be accessed on ATV960, ATV980 equipped with Cabinet IO.

[Ext Error Resp] E P L

Drive response to external error.

Type of stop in the event of an external detected error.

Setting	Code / Value	Description
[Ignore]	n o	External detected error ignored
[Freewheel Stop]	4 E 5	Freewheel stop Factory setting
[Per STT]	5 E E	Stop according to configuration of [Type of stop] 5 E E (see page 364), without tripping. In this case, the detected error relay does not open and the drive is ready to restart as soon as the detected error has been removed, according to the restart conditions of the active command channel (for example, according to [2/3-wire control] E E E and [2-wire type] E E E (see page 233) if control is via the terminals). Configuring a warning for this detected error is recommended (assigned to a digital output, for example) in order to indicate the cause of the stop.
(1) Because, in this case, the detected error does not trigger a stop, it is advisable to assign a relay or digital output to its indication.		

Setting	Code / Value	Description
[Fallback speed]	<i>L F F</i>	Change to fallback speed, maintained as long as the detected error persists and the run command has not been removed ⁽¹⁾
[Speed maintained]	<i>r L S</i>	The drive maintains the speed being applied when the detected error occurred, as long as the detected error is active and the run command has not been removed ⁽¹⁾
[Ramp stop]	<i>r P P</i>	Stop on ramp
[Fast stop]	<i>F S t</i>	Fast stop
[DC Injection]	<i>d C i</i>	DC injection stop. This type of stop cannot be used with some other functions.

(1) Because, in this case, the detected error does not trigger a stop, it is advisable to assign a relay or digital output to its indication.

[Fallback Speed] *L F F* ★

Fall back speed.

This parameter can be accessed if the error response parameter is set to [Fallback Speed] *L F F*.

Setting	Description
0.0...599.0 Hz	Setting range Factory setting: 0.0 Hz

[Output phase loss] *o P L* - Menu

Access

[Complete settings] → [Error/Warning handling] → [Output phase loss]

[OutPhaseLoss Assign] *o P L* ⌚

Output phase loss assignment.

DANGER

HAZARD OF ELECTRIC SHOCK, EXPLOSION OR ARC FLASH

If output phase monitoring is disabled, phase loss and, by implication, accidental disconnection of cables, are not detected.

- Verify that the setting of this parameter does not result in unsafe conditions.

Failure to follow these instructions will result in death or serious injury.

NOTE: [OutPhaseLoss Assign] *o P L* is set to [Function Inactive] *n o* when [Motor control type] *C t t* is set to [SYN_U VC] *S Y n*, [Sync.CL.] *F S Y*, [SYN_U VC] *S Y n u* or [Rel. Mot.] *S r V C*. Additionally if [HF inj. activation] [HFI] is set to [No] *n o*, [OutPhaseLoss Assign] *o P L* is forced to [Function Inactive] *n o*.

Setting	Code / Value	Description
[Function Inactive]	<i>n o</i>	Function inactive
[OPF Error Triggered]	<i>Y E S</i>	Tripping on [OutPhaseLoss Assign] <i>o P L</i> with freewheel stop Factory setting
[No Error Triggered]	<i>o P L</i>	No detected error triggered, but management of the output voltage in order to avoid an overcurrent when the link with the motor is re-established and catch on the fly performed (even if this function has not been configured). The drive switches to [Output cut] <i>S o C</i> state after [OutPhL Time] <i>o d t</i> time. Catch on fly is possible as soon as the drive is in stand by output cut [Output cut] <i>S o C</i> state.

[OutPhaseLoss Delay] *o d t*

Output (motor) phase loss detection time.

Time delay for taking the **[OutPhaseLoss Assign]** $\mu P L$ detected error into account.

Setting (↔)	Description
0.5...10 s	Setting range Factory setting: 0.5 s

[Input phase loss] , $P L$ - Menu

Access

[Complete settings] → **[Error/Warning handling]** → **[Input phase loss]**

[InPhaseLoss Assign] , $P L$

Loss of input phase error response.

If one supply mains phase is missing and if this leads to performance decrease, an **[Input phase loss]** $P H F$ error is triggered.

If 2 or 3 supply mains phases are missing, the drive operate until an **[Supply Mains UnderV]** $\mu 5 F$ error is triggered.

Setting	Code / Value	Description
[Ignore]	$n \square$	The input phase loss monitoring function is disabled to be used when the drive is supplied via a single-phase supply or by the DC bus
[Freewheel]	$4 E 5$	The drive stops in freewheel in case of a supply mains phase loss has been detected

[4-20mA loss] L F L - Menu**Access**

[Complete settings] → [Error/Warning handling] → [4-20mA loss]

[AI1 4-20mA Loss] L F L 1

Response to 4-20mA loss on AI1.

Drive behavior on AI1 4-20 event.

Setting	Code / Value	Description
[Ignore]	<i>n o</i>	Detected error ignored. This is the only possible configuration if [AI1 min. value] C r L 1 is not greater than 3 mA Factory setting
[Freewheel]	<i>y e 5</i>	Freewheel stop
[Per STT]	<i>5 t t</i>	Stop according to configuration of [Type of stop] 5 t t , without tripping. In this case, the error relay does not open and the drive is ready to restart as soon as the detected error disappears, according to the restart conditions of the active command channel (for example, according to [2/3-wire control] t C C and [2-wire type] t C t if control is via the terminals). Configuring a warning for this detected error is recommended (assigned to a digital output, for example) in order to indicate the cause of the stop
[fallback spd]	<i>L F F</i>	Change to fallback speed, maintained as long as the detected error persists and the run command has not been removed ⁽¹⁾
[Spd maint.]	<i>r L 5</i>	The drive maintains the speed being applied when the detected error occurred, as long as the detected error is active and the run command has not been removed ⁽¹⁾
[Ramp stop]	<i>r n P</i>	Stop on ramp
[Fast stop]	<i>F 5 t</i>	Fast stop
[DC injection]	<i>d C ,</i>	DC injection stop. This type of stop cannot be used with some other functions

(1) Because, in this case, the detected error does not trigger a stop, it is advisable to assign a relay or digital output to its indication.

[AI3 4-20mA loss] L F L 3

Response to 4-20mA loss on AI3.

Drive behavior on AI3 4-20 event.

Identical to **[AI1 4-20mA Loss] L F L 1**

[AI4 4-20mA loss] L F L 4 ★

Response to 4-20mA loss on AI4.

Drive behavior on AI4 4-20 event.

Identical to **[AI1 4-20mA Loss] L F L 1**

This parameter can be accessed if VW3A3203 I/O extension module has been inserted.

[AI5 4-20mA loss] L F L 5 ★

Response to 4-20mA loss on AI5.

Drive behavior on AI5 4-20 event.

Identical to **[AI1 4-20mA Loss] L F L 1**

This parameter can be accessed if VW3A3203 I/O extension module has been inserted.

[Fallback Speed] L F F ★

Fall back speed.

Setting	Description
0.0...599.0 Hz	Setting range Factory setting: 0.0 Hz

[Fallback speed] L F F - Menu

Access

[Complete settings] → [Error/Warning handling] → [Fallback speed]

[Fallback Speed] L F F

Fall back speed.

Setting	Description
0.0...599.0 Hz	Setting range Factory setting: 0.0 Hz

[Fieldbus monitoring] L L L - Menu**Access**

[Complete settings] → [Error/Warning handling] → [Fieldbus monitoring]

[Modbus Error Resp] 5 L L

Response to Modbus interruption.

⚠ WARNING	
LOSS OF CONTROL	
If this parameter is set to <i>n o</i> , Modbus communication monitoring is disabled.	
<ul style="list-style-type: none"> • Only use this setting after a thorough risk assessment in compliance with all regulations and standards that apply to the device and to the application. • Only use this setting for tests during commissioning. • Verify that communication monitoring has been re-enabled before completing the commissioning procedure and performing the final commissioning test. 	
Failure to follow these instructions can result in death, serious injury, or equipment damage.	

Behavior of the drive in the event of a communication interruption with integrated Modbus.

Setting	Code / Value	Description
[Ignore]	<i>n o</i>	Detected error ignored
[Freewheel]	<i>y e s</i>	Freewheel stop Factory setting
[Per STT]	<i>s t t</i>	Stop according to configuration of [Type of stop] <i>s t t</i> , without tripping. In this case, the error relay does not open and the drive is ready to restart as soon as the detected error disappears, according to the restart conditions of the active command channel (for example, according to [2/3-wire control] <i>t c c</i> and [2-wire type] <i>t c t</i> if control is via the terminals) ⁽¹⁾
[fallback spd]	<i>l f f</i>	Change to fallback speed, maintained as long as the detected error persists and the run command has not been removed ⁽¹⁾
[Spd maint.]	<i>r l s</i>	The drive maintains the speed being applied when the detected error occurred, as long as the detected error is active and the run command has not been removed ⁽¹⁾
[Ramp stop]	<i>r p p</i>	Stop on ramp
[Fast stop]	<i>f s t</i>	Fast stop
[DC injection]	<i>d c i</i>	DC injection stop. This type of stop cannot be used with some other functions

(1) Because, in this case, the detected error does not trigger a stop, it is advisable to assign a relay or digital output to its indication.

[Fallback Speed] L F F

Fall back speed.

Setting	Description
0.0...599.0 Hz	Setting range Factory setting: 0.0 Hz

[Embedded Modbus TCP] E Π E C - Menu

Access

[Complete settings] → [Error/Warning handling] → [Embedded Modbus TCP]

[Eth Error Response] E E H L

Ethernet error response.

⚠ WARNING
<p>LOSS OF CONTROL</p> <p>If this parameter is set to <i>n o</i>, Ethernet communication monitoring is disabled.</p> <ul style="list-style-type: none"> ● Only use this setting after a thorough risk assessment in compliance with all regulations and standards that apply to the device and to the application. ● Only use this setting for tests during commissioning. ● Verify that communication monitoring has been re-enabled before completing the commissioning procedure and performing the final commissioning test. <p>Failure to follow these instructions can result in death, serious injury, or equipment damage.</p>

The error response to a communication interruption is effective if the communication channel is involved in the active command channel.

Setting	Code / Value	Description
[Ignore]	<i>n o</i>	Detected error ignored
[Freewheel]	<i>y e s</i>	Freewheel stop Factory setting
[Per STT]	<i>s t t</i>	Stop according to configuration of [Type of stop] <i>s t t</i> , without tripping. In this case, the error relay does not open and the drive is ready to restart as soon as the detected error disappears, according to the restart conditions of the active command channel (for example, according to [2/3-wire control] <i>e c c</i> and [2-wire type] <i>e c t</i> if control is via the terminals) ⁽¹⁾
[fallback spd]	<i>l f f</i>	Change to fallback speed, maintained as long as the detected error persists and the run command has not been removed ⁽¹⁾
[Spd maint.]	<i>r l s</i>	The drive maintains the speed being applied when the detected error occurred, as long as the detected error is active and the run command has not been removed ⁽¹⁾
[Ramp stop]	<i>r n p</i>	Stop on ramp
[Fast stop]	<i>f s t</i>	Fast stop
[DC injection]	<i>d c i</i>	DC injection stop. This type of stop cannot be used with some other functions

(1) Because, in this case, the detected error does not trigger a stop, it is advisable to assign a relay or digital output to its indication.

[Fallback Speed] L F F ★

Fall back speed.

Setting	Description
0.0...599.0 Hz	Setting range Factory setting: 0.0 Hz

[Communication module] $\llcorner \square \Pi \square$ - Menu

Access

[Complete settings] → [Error/Warning handling] → [Communication module]

[Fieldbus Interrupt Resp] $\llcorner \llcorner \llcorner$

WARNING

LOSS OF CONTROL

If this parameter is set to $n \square$, fieldbus communication monitoring is disabled.

- Only use this setting after a thorough risk assessment in compliance with all regulations and standards that apply to the device and to the application.
- Only use this setting for tests during commissioning.
- Verify that communication monitoring has been re-enabled before completing the commissioning procedure and performing the final commissioning test.

Failure to follow these instructions can result in death, serious injury, or equipment damage.

Response to fieldbus module communication interruption.

Setting	Code / Value	Description
[Ignore]	$n \square$	Detected error ignored
[Freewheel]	$Y E 5$	Freewheel stop Factory setting
[Per STT]	$S E E$	Stop according to configuration of [Type of stop] $S E E$, without tripping. In this case, the error relay does not open and the drive is ready to restart as soon as the detected error disappears, according to the restart conditions of the active command channel (for example, according to [2/3-wire control] $E E E$ and [2-wire type] $E E E$ if control is via the terminals) ⁽¹⁾
[fallback spd]	$L F F$	Change to fallback speed, maintained as long as the detected error persists and the run command has not been removed ⁽¹⁾
[Spd maint.]	$r L 5$	The drive maintains the speed being applied when the detected error occurred, as long as the detected error is active and the run command has not been removed ⁽¹⁾
[Ramp stop]	$r \Pi P$	Stop on ramp
[Fast stop]	$F S E$	Fast stop
[DC injection]	$d C \cdot$	DC injection stop. This type of stop cannot be used with some other functions

(1) Because, in this case, the detected error does not trigger a stop, it is advisable to assign a relay or digital output to its indication.

[CANopen Error Resp] $\llcorner \square \llcorner$

WARNING

LOSS OF CONTROL

If this parameter is set to $n \square$, CANopen communication monitoring is disabled.

- Only use this setting after a thorough risk assessment in compliance with all regulations and standards that apply to the device and to the application.
- Only use this setting for tests during commissioning.
- Verify that communication monitoring has been re-enabled before completing the commissioning procedure and performing the final commissioning test.

Failure to follow these instructions can result in death, serious injury, or equipment damage.

Response to CANopen error.

Behavior of the drive in the event of a communication interruption with CANopen®.

Setting	Code / Value	Description
[Ignore]	n o	Detected error ignored
[Freewheel]	4 E 5	Freewheel stop Factory setting
[Per STT]	5 t t	Stop according to configuration of [Type of stop] 5 t t, without tripping. In this case, the error relay does not open and the drive is ready to restart as soon as the detected error disappears, according to the restart conditions of the active command channel (for example, according to [2/3-wire control] t c c and [2-wire type] t c t if control is via the terminals) ⁽¹⁾
[fallback spd]	L F F	Change to fallback speed, maintained as long as the detected error persists and the run command has not been removed ⁽¹⁾
[Spd maint.]	r L 5	The drive maintains the speed being applied when the detected error occurred, as long as the detected error is active and the run command has not been removed ⁽¹⁾
[Ramp stop]	r P P	Stop on ramp
[Fast stop]	F 5 t	Fast stop
[DC injection]	d C i	DC injection stop. This type of stop cannot be used with some other functions

(1) Because, in this case, the detected error does not trigger a stop, it is advisable to assign a relay or digital output to its indication.

[Eth Error Response] E t H L

⚠ WARNING

LOSS OF CONTROL

If this parameter is set to n o, Ethernet communication monitoring is disabled.

- Only use this setting after a thorough risk assessment in compliance with all regulations and standards that apply to the device and to the application.
- Only use this setting for tests during commissioning.
- Verify that communication monitoring has been re-enabled before completing the commissioning procedure and performing the final commissioning test.

Failure to follow these instructions can result in death, serious injury, or equipment damage.

Response to Ethernet error.

Setting	Code / Value	Description
[Ignore]	n o	Detected error ignored
[Freewheel Stop]	4 E 5	Freewheel stop Factory setting
[Per STT]	5 t t	Stop according to [Type of stop] 5 t t parameter but without an error triggered after stop
[Fallback Speed]	L F F	Change to fallback speed, maintained as long as the detected error persists and the run command has not been removed ⁽¹⁾
[Spd maintained]	r L 5	Speed maintained as long as the detected error persists and the run command has not been removed ⁽¹⁾
[Ramp stop]	r P P	Stop on ramp
[Fast stop]	F 5 t	Fast stop

¹ Because, in this case, the detected error does not trigger a stop, it is recommended to assign a relay or logic output to its indication.

[Fallback Speed] L F F ★

Fall back speed.

Setting	Description
0.0...599.0 Hz	Setting range Factory setting: 0.0 Hz

[Undervoltage handling] ↪ 5 b - Menu

Access

[Complete settings] → [Error/Warning handling] → [Undervoltage handling]

[Undervoltage Resp] ↪ 5 b

Response to undervoltage.

Setting	Code / Value	Description
[Error Triggered]	0	The drive triggers an error (the detected error relay assigned to [Operating State Fault] F L E will be opened) Factory setting
[Error Triggered w/o Relay]	1	The drive triggers an error (the detected error relay assigned to [Operating State Fault] F L E remains closed)
[Warning Triggered]	2	The warning and detected error relay remain closed. The warning can be assigned to a digital output or a relay

[Mains Voltage] ↪ r E 5

Rated voltage of the mains supply in Vac.

The factory setting value of this parameter depends of drive rating.

Settings	Code / Value	Description
[200 Vac]	2 0 0	200 Vac
[220 Vac]	2 2 0	220 Vac
[230 Vac]	2 3 0	230 Vac
[240 Vac]	2 4 0	240 Vac
[380 Vac]	3 8 0	380 Vac
[400 Vac]	4 0 0	400 Vac
[415 Vac]	4 1 5	415 Vac
[440 Vac]	4 4 0	440 Vac
[460 Vac]	4 6 0	460 Vac
[480 Vac]	4 8 0	480 Vac
[525 Vac]	5 2 5	525 Vac
[575 Vac]	5 7 5	575 Vac
[600 Vac]	6 0 0	600 Vac
[690 Vac]	6 9 0	690 Vac

[Undervoltage Level] ↪ 5 L

Undervoltage level.

The factory setting is determined by the drive voltage rating.

Setting	Description
100...354 Vac	Setting range, according to drive rating Factory setting: According to drive rating

[UnderVolt Timeout] ↪ 5 t

Undervoltage timeout.

Setting	Description
0.2...999.9 s	Setting range Factory setting: 0.2 s

[Stop Type PLoss] 5 E P

Controlled stop on power loss.

Behavior in the event of the undervoltage prevention level being reached.

Setting	Code / Value	Description
[No]	n o	No action Factory setting
[DC Maintain]	π π 5	This stop mode uses the inertia of the application to maintain the control block powered, and thus to keep operational I/O state and fieldbus link as long as possible.
[Ramp stop]	r π P	Stop following an adjustable deceleration ramp [Max stop time] 5 E π in order to help to prevent from uncontrolled stop of the application.
[Freewheel Stop]	L n F	Lock (freewheel stop) without triggering an error

[UnderV. Restart Tm] E 5 π ★

Undervoltage restart time.

This parameter can be accessed if **[CtrlStopPLoss] 5 E P** is set to **[Ramp stop] r π P**.

The time delay before authorizing the restart after a complete stop for **[CtrlStopPLoss] 5 E P** is set to **[Ramp stop] r π P** if the voltage has returned to normal.

Setting ()	Description
1.0...999.9 s	Setting range Factory setting: 1.0 s

[Prevention Level] u P L ★

Undervoltage prevention level.

This parameter can be accessed if **[CtrlStopPLoss] 5 E P** is set to **[No] n o**.

The adjustment range and factory setting are determined by the drive voltage rating and the **[Mains Voltage] u r E 5** value.

Setting	Description
141...414 V	Setting range Factory setting: According to drive rating

[Max Stop Time] 5 E π ★

Maximum stop time.

This parameter can be accessed if **[CtrlStopPLoss] 5 E P** is set to **[Ramp stop] r π P**.

This parameter defines the deceleration ramp time in case of mains loss. During this controlled stop, the drive is powered thanks to the inertia of the application, the motor is in generator mode. It is recommended to verify that the deceleration set is compatible with the application inertia.

Setting ()	Description
0.01...60.00 s	Setting range Factory setting: 1.00 s

[DC Bus Maintain Time] E b 5 ★

DC bus maintain time.

This parameter can be accessed if **[CtrlStopPLoss] 5 E P** is set to **[DC Maintain] π π 5**.

Setting ()	Description
1...9999 s	Setting range Factory setting: 9999 s

[Ground Fault] *G r F L* - Menu

Access

[Complete settings] → [Error/Warning handling] → [Ground Fault]

About This Menu

This menu can be accessed if [Access Level] is set to [Expert] *E P r*

If the internal ground fault detection [Ground Fault] *G r F L* causes unwanted results in your application, it is possible to substitute the internal ground fault detection by an appropriate external ground fault monitoring system. Setting the parameter [Ground Fault] *G r F L* to [ErrorDetect Disable] *i n H* or to a percentage value of the nominal current of the drive disables the internal ground fault detection of the drive or reduces its effectiveness. Therefore, you must install an external ground fault detection system that is able to reliably detect ground faults.

⚠ DANGER

GROUND FAULT MONITORING DISABLED

- Only set the parameter [Ground Fault] *G r F L* to [ErrorDetect Disable] *i n H* or to a percentage value of the nominal current of the drive after a thorough risk assessment in compliance with all regulations and standards that apply to the device and to the application.
- Implement an alternative, external ground fault monitoring function that allows for an adequate, equivalent response to a ground fault of the drive in compliance with all applicable regulations and standards as well as the risk assessment.
- Commission and test the system with all monitoring functions enabled.
- During commissioning, verify that the alternative, external ground fault detection system properly detects any type of ground faults by performing tests and simulations in a controlled environment under controlled conditions.

Failure to follow these instructions will result in death or serious injury.

[Ground Fault Activation] *G r F L*

Ground fault error response.

NOTE: The setting of this parameter is taken into account after a product restart.

Setting	Code / Value	Description
[ErrorDetect Disable]	<i>i n H</i>	Disables error detection
[Yes]	<i>Y E 5</i>	Use product internal value. Around 25% of the drive nominal current. Factory setting
0.0...100.0%	–	Setting range, in % of the drive nominal current

[Motor thermal monit] E H E - Menu

Access

[Complete settings] → [Error/Warning handling] → [Motor thermal monit]

About this Menu

Motor thermal protection by calculating the I^2t .

NOTE: The motor thermal state is memorized when the drive is switched off. The power-off time is used to calculate the motor thermal state at the next startup.

- Self-cooled motors: The trigger curves depend on the motor frequency.
- Forced-cooled motors: Only the 50 Hz trigger curves needs to be considered, regardless of the motor frequency.

Below a curve for 50Hz motor.

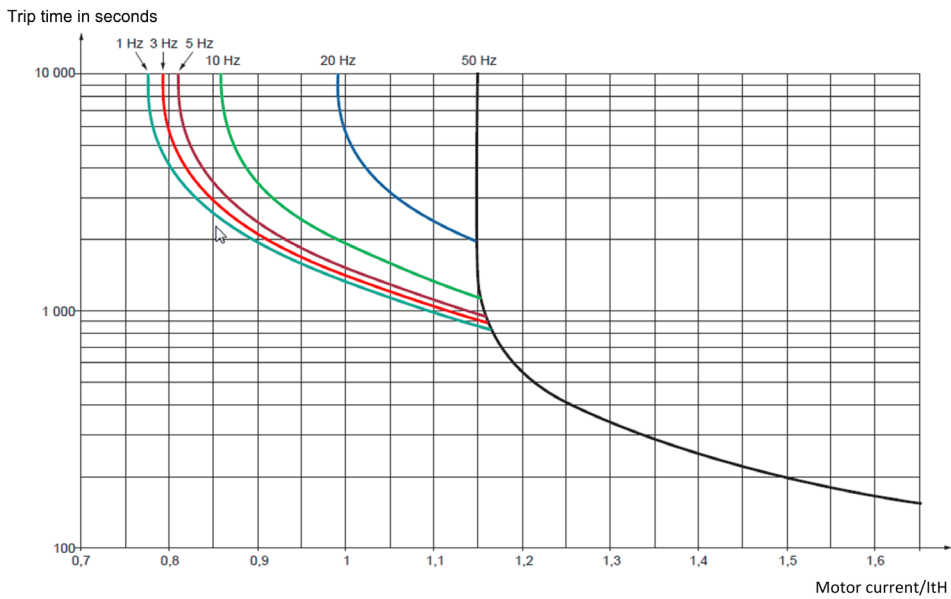

Below a curve for 60Hz motor.

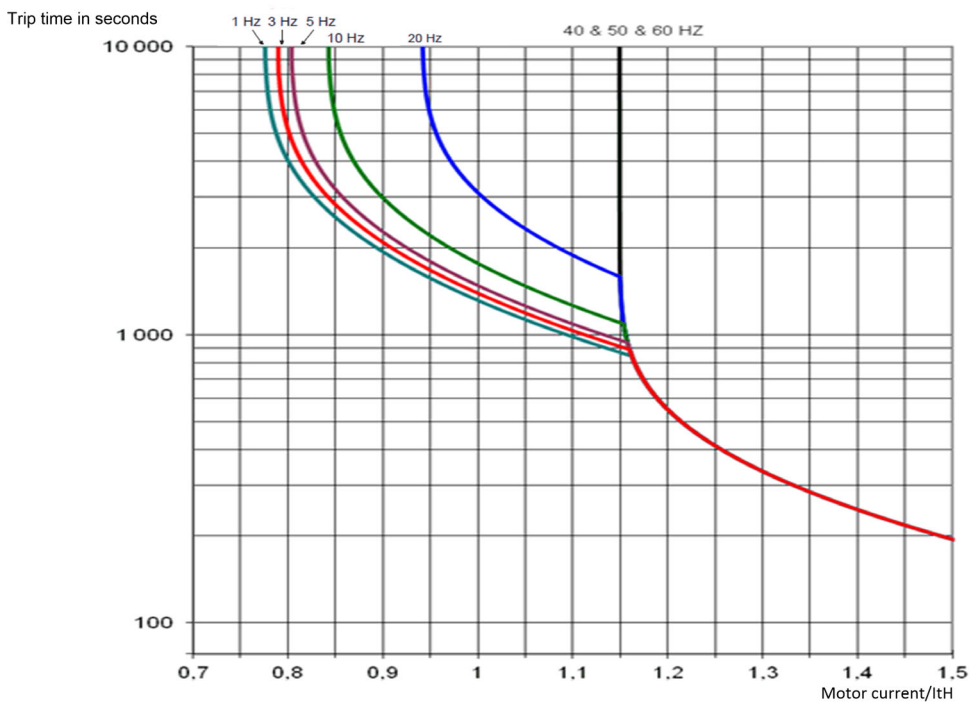

[Motor Th Current] , L H

Motor thermal monitoring current to be set to the rated current indicated on the nameplate.

Setting ()	Description
0.2...1.5_In ⁽¹⁾	Setting range Factory setting: According to drive rating
(1) Corresponding to the rated drive current indicated in the installation manual and on the drive nameplate.	

[Motor Thermal Mode] L H L

Motor thermal monitoring mode.

NOTE: An error is detected when the thermal state reaches 118% of the rated state and reactivation occurs when the state falls back below 100%.

Setting	Code / Value	Description
[No]	n a	No thermal monitoring
[Self cooled]	F C L	Self ventilated motor Factory setting
[Force-cool]	F C L	Fan-cooled motor

[Encoder monitoring] 5 d d - Menu

Access

[Complete settings] → [Error/Warning handling] → [Encoder monitoring]

[Load slip detection] 5 d d

Load slipping monitoring function.

Setting	Code / Value	Description
[No]	n o	No error triggered. The warning may be assigned to a digital output or a relay Factory setting
[Yes]	y e 5	Error triggered. [Load slip detection] 5 d d is set to [Yes] y e 5 if [Motor control type] c t t is set to [FVC] f v c or [Sync.CL] f 5 y. The [Load slipping] R n F error is triggered by comparing the ramp output and the speed feedback, and is effective for speeds greater than 10% of the [Nominal Motor Freq] F r 5. In the event of an error is triggered, the drive will stop in freewheel, and if the brake logic control function has been configured, the brake command will be set to 0.

[Encoder Coupling Monit] E C C ★

Encoder coupling monitoring.

This parameter can be accessed if [Encoder usage] E n u is not set to [No] n o .

Setting	Code / Value	Description
[No]	n o	Error not monitored Factory setting
[Yes]	y e 5	Error monitored. If the brake logic control function has been configured, the factory setting changes to [Yes] y e 5. [Encoder Coupling Monit] E C C set to [Yes] y e 5 is only possible if: <ul style="list-style-type: none"> • [Load slip detection] 5 d d is set to [Yes] y e 5, and • [Encoder usage] E n u is not set to [NO] n o, and • [Brake assignment] b L C is not set to [No] n o The error monitored is the break in the mechanical coupling of the encoder. In the event of an error, the drive will switch to a freewheel stop, and if the brake logic control function has been configured, the brake command will be released.

[Encoder check time] E C t ★

Encoder check time.

This parameter can be accessed if:

- [Encoder usage] E n u is not set to [No] n o, and
- [Encoder Coupling Monit] E C C is not set to [No] n o.

Setting ()	Description
2.0...10.0 s	Setting range Factory setting: 2.0 s

[Braking Resistor monit] *b r P* - Menu

Access

[Complete settings] → [Error/Warning handling] → [Braking Resistor monit]

About This Menu

This menu can be accessed if the drive embeds a braking transistor (size 1 to size 5).

This menu can be accessed if the Drive System is built in the variant with Braking Unit Option (BUO).

[Braking Resistor Monit] *b r o*

Braking resistor monitoring.

Setting	Code / Value	Description
[Ignore]	<i>n o</i>	No braking resistor monitoring (thereby preventing access to the other function parameters). Factory setting
[Warning]	<i>w e s</i>	The warning may be assigned to a logic output or a relay.
[Error]	<i>f l t</i>	Triggering a [Braking Resistor ovd] <i>b o f</i> with locking of drive (freewheel stop).

[Braking Resistor Power] *b r P* ★

Rated power of the resistor used.

Insert the total power of all installed braking resistors.

This parameter can be accessed if [Braking Resistor Monit] *b r o* is not set to [No] *n o*.

Setting ()	Description
0.1...3,000.0 kW	Setting range Factory setting: 0.1 kW

[Braking Resistor Value] *b r V* ★

Rated value of the braking resistor in ohms.

This parameter can be accessed if [Braking Resistor Monit] *b r o* is not set to [No] *n o*.

Setting ()	Description
0.1...200.0 Ohm	Setting range Factory setting: 0.1 Ohm

[Braking Resist T Constant] *b r t c* ★

Braking resistor time constant.

This parameter can be accessed if [Braking Resistor Monit] *b r o* is not set to [No] *n o*.

NOTE: The factory setting is changed to 80 s for Drive Systems.

Setting ()	Description
0...200 s	Setting range Factory setting: 45 s

[DBR thermal state] *t H b*

Braking Resistor thermal state.

Setting	Description
0...118%	Setting range Factory setting: _

[Torque or i lim. detect] *E I d* - Menu

Access

[Complete settings] → [Error/Warning handling] → [Torque or I limit detect]

[Trq/I limit. stop] *S S b*

Torque current limitation: behaviour configuration.

Setting	Code / Value	Description
[Ignore]	<i>n o</i>	Detected error ignored Factory setting
[Freewheel Stop]	<i>y E S</i>	Freewheel stop
[Per STT]	<i>S E E</i>	Stop according to [Type of stop] <i>S E E</i> parameter but without an error triggered after stop
[Fallback Speed]	<i>L F F</i>	Change to fallback speed, maintained as long as the detected error persists and the run command has not been removed ⁽¹⁾
[Spd maintained]	<i>r L S</i>	Speed maintained as long as the detected error persists and the run command has not been removed ⁽¹⁾
[Ramp stop]	<i>r P P</i>	Stop on ramp
[Fast stop]	<i>F S E</i>	Fast stop
[DC injection]	<i>d C I</i>	DC injection
1 Because, in this case, the detected error does not trigger a stop, it is recommended to assign a relay or logic output to its indication.		

[Trq/I limit. time out] *S E o*

Torque current limitation: [Torque Limitation Error] *S S F* error delay and [Torque Limit Reached] *S S R* warning delay.

Setting ()	Description
1...9,999 ms	Setting range Factory setting: 1,000 ms

[Drive overload monit] ▯ b r - Menu**Access**

[Complete settings] → [Error/Warning handling] → [Drive overload monit]

[DriveTemp ErrorResp] ▯ H L

Drive overtemperature error response.

Setting	Code / Value	Description
[Ignore]	n o	Detected error ignored
[Freewheel Stop]	Y E S	Freewheel stop Factory setting
[Per STT]	S t t	Stop according to [Type of stop] S t t parameter but without an error triggered after stop
[Fallback Speed]	L F F	Change to fallback speed, maintained as long as the detected error persists and the run command has not been removed ⁽¹⁾
[Spd maintained]	r L S	Speed maintained as long as the detected error persists and the run command has not been removed ⁽¹⁾
[Ramp stop]	r n P	Stop on ramp
[Fast stop]	F S t	Fast stop
<p>1 Because, in this case, the detected error does not trigger a stop, it is recommended to assign a relay or logic output to its indication.</p>		

[Drv Thermal Warning] t H H

Drive thermal state warning (for [Drv Therm Thd reached] t H d warning).

Setting (°)	Description
0...118%	Setting range Factory setting: 100%

[Drive Overload Monit] t L o L

Drive overload monitoring activation.

NOTICE
<p>OVERHEATING AND DAMAGE TO THE DRIVE</p> <p>If [Drive Overload Monit] t L o L is set to [Disable] d i S, the monitoring of the drive overheating is disabled.</p> <ul style="list-style-type: none"> • Verify that the settings of this parameter does not result in equipment damage. <p>Failure to follow these instructions can result in equipment damage.</p>

NOTE: If [Drive Overload Monit] t L o L is set to [Reduce to I Nom Drive] L i n the drive will reduce, after the specified overload time, an overload current down to the drive nominal current. This function will not work for constant load applications. For all applications with increasing loads the drive will therefore operate on slightly reduced speed but without triggering an error.

Setting	Code / Value	Description
[Disabled]	d i S	Disabled
[Error Triggered]	t r i P	Error triggered
[Reduce to I Nom Drive]	L i n	The motor current is limited to drive nominal current.

[Warn grp 1 definition] *H 1 C* - Menu

Access

[Complete settings] → [Error/Warning handling] → [Warning groups config] → [Warn grp 1 definition]

About This Menu

The following submenus group the warnings into 1 to 5 groups, each of which can be assigned to a relay or a digital output for remote signaling.

When one or a number of warnings selected in a group occur, this warning group is activated.

List of Warnings

The list of warning codes is available in the chapter "Diagnostics and Troubleshooting" (*see page 636*).

[Warn grp 2 definition] *H 2 C* - Menu

Access

[Complete settings] → [Error/Warning handling] → [Warning groups config] → [Warn grp 2 definition]

About This Menu

Identical to [Warn grp 1 definition] *H 1 C* (*see page 570*)

[Warn grp 3 definition] *H 3 C* - Menu

Access

[Complete settings] → [Error/Warning handling] → [Warning groups config] → [Warn grp 3 definition]

About This Menu

Identical to [Warn grp 1 definition] *H 1 C* (*see page 570*)

[Warn grp 4 definition] *H 4 C* - Menu

Access

[Complete settings] → [Error/Warning handling] → [Warning groups config] → [Warn grp 4 definition]

About This Menu

Identical to [Warn grp 1 definition] *H 1 C* (*see page 570*)

[Warn grp 5 definition] *H 5 C* - Menu

Access

[Complete settings] → [Error/Warning handling] → [Warning groups config] → [Warn grp 5 definition]

About This Menu

Identical to [Warn grp 1 definition] *H 1 C* (*see page 570*)

[Error/Warning Handling] *CSWΠ* - menu**Access**

[Complete Settings] → [Error/Warning Handling]

About This Menu

This parameter can be accessed on ATV960 or ATV980, equipped with cabinet IO, and if [Access Level] *LFL* is set to [Expert] *EP*.

[Cabinet I/O 24V Timeout] *P24d*

Cabinet I/O 24V missing error timeout

Settings	Description
[Warning]	Warning is triggered.
1...3000 s	Delay before triggering a [Cab I/O 24V Error] <i>P24E</i> error Factory setting: 3 s

Section 8.56

[Maintenance]

What Is in This Section?

This section contains the following topics:

Topic	Page
[Diagnostics] <i>d R U</i> - Menu	573
[Drive warranty mgnt] <i>d W P R</i> - Menu	574
[Customer event 1] <i>C E 1</i> - Menu	575
[Customer event 2] <i>C E 2</i> - Menu	576
[Customer event 3] <i>C E 3</i> - Menu	576
[Customer event 4] <i>C E 4</i> - Menu	577
[Customer event 5] <i>C E 5</i> - Menu	577
[Customer events] <i>C U E V</i> - Menu	578
[Fan management] <i>F A P R</i> - Menu	579
[Maintenance] <i>C S P R</i> - Menu	580

[Diagnostics] *d F u* - Menu

Access

[Complete settings] → [Maintenance] → [Diagnostics]

About This Menu

This menu allows you to make simple test sequences for diagnostics.

[FAN Diagnostics] *F n t*

Diagnostics of internal fan(s).

This starts a test sequence.

NOTE:

Fan diagnostics of internal fan(s) will be not-successful if the DC bus is not fully charged. This will be the case:

- on separate control (e.g. the control block is only supplied on 24V), or
- if the drive is in **[Energy saving]** *i d L E* mode (e.g. Stop and go function is active).

[LED Diagnostics] *H L t*

Diagnostics of product LED(s).

This starts a test sequence.

[IGBT Diag w motor] *i W t*

Diagnostics of product IGBT(s).

This will start a test sequence with the connected motor (open circuit/short-circuit).

[IGBT Diag w/o motor] *i W o t*

Diagnostics of product IGBT(s).

This starts a test sequence without the motor (short-circuit).

[Drive warranty mgnt] ㉔㉕㉖㉗ - Menu

Access

[Complete settings] → [Maintenance] → [Drive warranty mgnt]

About This Menu

The product life cycle date is initialized during product manufacturing.

A [Life Cycle Warn 1] ㉘㉙㉚ is triggered 2 months before the end of the warranty period. At the end of the warranty period a [Life Cycle Warn 2] ㉛㉜㉝ is triggered. This function requires date and time data coming from Graphic Display Terminal or a time server configured through Ethernet.

[LifeCycle Warning] ㉞㉟㊀

Life cycle warning configuration.

Setting ()	Code / Value	Description
[No]	㉞ ㉟	No
[YES]	㉛ ㉜ ㉝	Yes Factory setting

[Warranty Expired] ㊁㊂㊃

Life cycle date.

End of warranty date (YYYY/MM/DD).

Setting	Description
YYYY/MM/DD	Setting range Factory setting: _

[Customer event 1] *C E 1* - Menu

Access

[Complete settings] → [Maintenance] → [Customer events] → [Customer event 1]

About This Menu

This menu allows you to define customized customer events based on the time.

[Config Warning 1] *C C W 1*

Configuration of customer warning 1.

Setting	Code / Value	Description
[Not Configured]	<i>n o</i>	Not configured Factory setting
[Counter]	<i>C P t</i>	Counter
[Date And Time]	<i>d t</i>	Date and time

[Counter Limit 1] *C C L 1*

Configuration counter limit 1.

Setting	Description
0...4294967295 s	Setting range Factory setting: 0 s

[Counter Source 1] *C C S 1*

Configuration counter source 1.

Setting	Code / Value	Description
[Mains/Control ON]	<i>0</i>	Mains or control supply on
[Mains Supply ON]	<i>1</i>	Mains supply on
[Drv In Run State]	<i>2</i>	Drive in running state Factory setting

[Current Counter 1] *C C I*

Current counter 1.

Setting	Description
0...4294967295 s	Setting range Factory setting: 0 s

[Date Time Warn 1] *C d t 1* ★

Date time warning 1.

This parameter can be accessed with the Graphic Display Terminal only.

Setting ()	Description
hh:mm DD/MM/YYYY	Setting range Factory setting: 00:00 01/01/2000

[Customer event 2] *C E 2* - Menu

Access

[Complete settings] → [Maintenance] → [Customer events] → [Customer event 2]

About This Menu

Identical to [Customer event 1] *C E 1* - menu (*see page 575*).

[Config Warning 2] *C C R 2*

Configuration of customer warning 2.

[Counter Limit 2] *C C L 2*

Configuration counter limit 2.

[Counter Source 2] *C C S 2*

Configuration counter source 2.

[Current Counter 2] *C C 2*

Current counter 2.

[Date Time Warn 2] *C d t 2* ★

Date time warning 2.

This parameter can be accessed with the Graphic Display Terminal only.

[Customer event 3] *C E 3* - Menu

Access

[Complete settings] → [Maintenance] → [Customer events] → [Customer event 3]

About This Menu

Identical to [Customer event 1] *C E 1* - menu (*see page 575*).

[Config Warning 3] *C C R 3*

Configuration of customer warning 3.

[Counter Limit 3] *C C L 3*

Configuration counter limit 3.

[Counter Source 3] *C C S 3*

Configuration counter source 3.

[Current Counter 3] *C C 3*

Current counter 3.

[Date Time Warn 3] *C d t 3* ★

Date time warning 3.

This parameter can be accessed with the Graphic Display TerminalGraphic display terminal only.

[Customer event 4] *C E 4* - Menu

Access

[Complete settings] → [Maintenance] → [Customer events] → [Customer event 4]

About This Menu

Identical to [Customer event 1] *C E 1* - menu (*see page 575*).

[Config Warning 4] *C C W 4*

Configuration of customer warning 4.

[Counter Limit 4] *C C L 4*

Configuration counter limit 4.

[Counter Source 4] *C C S 4*

Configuration counter source 4.

[Current Counter 4] *C C 4*

Current counter 4.

[Date Time Warn 4] *C D T 4* ★

Date time warning 4.

This parameter can be accessed with the Graphic Display Terminal/Graphic display terminal only.

[Customer event 5] *C E 5* - Menu

Access

[Complete settings] → [Maintenance] → [Customer events] → [Customer event 5]

About This Menu

Identical to [Customer event 1] *C E 1* - menu (*see page 575*).

[Config Warning 5] *C C W 5*

Configuration of customer warning 5.

[Counter Limit 5] *C C L 5*

Configuration counter limit 5.

[Counter Source 5] *C C S 5*

Configuration counter source 5.

[Current Counter 5] *C C 5*

Current counter 5.

[Date Time Warn 5] *C D T 5* ★

Date time warning 5.

This parameter can be accessed with the Graphic Display Terminal only.

[Customer events] [EV - Menu**Access**

[Complete settings] → [Maintenance] → [Customer events]

[Warning Clearing] [R r

Customer warning clearing.

Setting ()	Code / Value	Description
[No Warning Clearing]	r 0	No warning clearing Factory setting
[Clear Event 1 Warning]	r R 1	Clear event 1 warning
[Clear Event 2 Warning]	r R 2	Clear event 2 warning
[Clear Event 3 Warning]	r R 3	Clear event 3 warning
[Clear Event 4 Warning]	r R 4	Clear event 4 warning
[Clear Event 5 Warning]	r R 5	Clear event 5 warning

[Fan management] *F A N A* - Menu

Access

[Complete settings] → [Maintenance] → [Fan management]

About This Menu

Fan speed and [Fan Operation Time] *F P b t* are monitored values.

An abnormal low speed or the fan trigger a warning [Fan Feedback Warning] *F F d A*. As soon as [Fan Operation Time] *F P b t* reach the predefined value of 45,000 hours, a warning [Fan Counter Warning] *F C t A* is triggered.

[Fan Operation Time] *F P b t* counter can be set to 0 by using the [Counter Reset] *r P r* parameter.

Additional fan management on ATV960 and ATV980:

- If any of the cabinet fan is running at an abnormal low speed a warning [Cabinet Fan Fdbck Warn] *F F C A* is triggered.
- If [Cabinet Fan Oper Time] *F C t* has reached the predefined value of 30,000 hours, a warning [Cabinet Fan Counter Warn] *F C C A* is triggered.

Additional fan management on ATV980 and ATV9B0:

- If any of the AFE fan bricks is running at an abnormal low speed the [AFE Fan Fdbck Warn] *F F b A* is triggered.
- If [AFE Fan Operation Time] *F b A t* has reached the predefined value of 45,000 hours, a warning [AFE Fan Counter Warn] *F C b A* is triggered.

[Fan Mode] *F F M*

Fan activation mode.

NOTE: For ATV960 and ATV9A0 and ATV980 and ATV9B0, this parameter is forced to [Standard] *S t d*.

Setting ()	Code / Value	Description
[Standard]	<i>S t d</i>	The operation of the fan is enabled when the motor is running. According to the drive rating, this could be the only available setting Factory setting
[Always]	<i>r u n</i>	The fan is always activated
[Never]	<i>S t P</i>	If the software version is: <ul style="list-style-type: none"> • up to V1.6 (excluded), the fan of the drive is disabled. • V1.6 or higher, this selection has no effect. The operation of the fan is enabled when the motor is running.
[Economy]	<i>E c o</i>	The fan is activated only if necessary, according to the internal thermal state of the drive

NOTICE

OVERHEATING

Verify that the ambient temperature does not exceed 40 °C (104° F) if the fan is disabled.

Failure to follow these instructions can result in equipment damage.

If the software version is up to V1.6 (excluded) and the [Fan Mode] *F F M* is set to [Never] *S t P*, the fan of the drive is disabled.

[Maintenance] C 5 P A - Menu**Access**

[Complete settings] → [Maintenance]

[Time Counter Reset] r P r

Time counter reset.

NOTE: The list of possible values depends on the product size.

Setting ()	Code / Value	Description
[No]	n o	No Factory setting
[Run Time Reset]	r t h	Run time reset
[Power ON Time Reset]	P t h	Power ON time reset
[Reset Fan Counter]	F t h	Reset fan counter
[Clear NSM]	n s n	Clear number of motor starts
[AFE Fan Operation Time]	F b A t	Fan operation time ⁽¹⁾
[Clear Cabinet Fan]	F C t	Clear cabinet fan operation time NOTE: This selection can be accessed on ATV960 and ATV980.
[Clear AFE Power ON Time]	b P t h	Clear AFE power ON time ⁽¹⁾
[Clear BRTH]	b r t h	Clear AFE run time ⁽¹⁾
[Clear AFE Nb. start]	b n s A	Clear AFE brick number of start ⁽¹⁾
1 This selection can be accessed on ATV980.		

Section 8.57

[Cabinet I/O Function] *C A B F* -

What Is in This Section?

This section contains the following topics:

Topic	Page
[Monitoring circuit A] <i>C A C A</i> - Menu	582
[Monitoring circuit B] <i>C A C B</i> - Menu	583
[Monitoring circuit C] <i>C A C C</i> - Menu	584
[Monitoring circuit D] <i>C A C d</i> - Menu	584
[Cabinet circuit A] <i>C C A A</i> - Menu	585
[Cabinet circuit B] <i>C C A B</i> - Menu	585
[Cabinet circuit C] <i>C C A C</i> - Menu	586
[Motor winding A] <i>C E , A</i> - Menu	586
[Motor winding B] <i>C E , B</i> - Menu	587
[Motor bearing A] <i>C E , C</i> - Menu	587
[Motor bearing B] <i>C E , d</i> - Menu	588
[Circuit breaker] <i>C C B</i> - Menu	588
[Cabinet I/O functions] <i>C A B F</i> - menu	590

[Monitoring circuit A] *C P C R* - Menu

Access

[Complete settings] → [Cabinet I/O functions] → [Monitoring circuit A]

About This Menu

The use of this function is part of the wiring for monitoring and control functions inside the enclosure.

The Monitoring Circuits give the possibility to manage 2 levels of monitoring:

- A Warning level: the drive triggers an event without stopping the application. If [MonitorCircuit ErrorResp] *, F r X* is set to [Ignore] *n o* the [MonitorCircuit Warn] *, W X* will be triggered.
- An Error level: the drive triggers an event and stops the application. If [MonitorCircuit ErrorResp] *, F r X* is set to a different value [MonitorCircuit Error] *, F X* will be triggered.

This menu is used to assign a value on a cabinet digital input active at a High Level *d 5 2 H...d 5 9 H* or a low level *d 5 2 L ...d 5 9 L*, and to control its behavior.

These parameters can be accessed on ATV960 or ATV980, equipped with cabinet IO, and if [Access Level] *L R C* is set to [Expert] *E P r*

[MonitorCircuit A Assign] *, F R R*

Monitoring circuit A assignment

Setting	Code / Value	Description
[Not Assigned]	<i>n o</i>	Not assigned Factory setting
[DI52 High Level]...[DI59 High Level]	<i>d 5 2 H...d 5 9 H</i>	Cabinet high assignment digital inputs
[DI52 Low Level]...[DI59 Low Level]	<i>d 5 2 L ...d 5 9 L</i>	Cabinet low assignment digital inputs

[MonitorCircuit A Monitor] *, F P R*★

Monitoring circuit A error monitoring type

This parameter can be accessed if [MonitorCircuit A Assign] *, F R R* is not set to [No] *n o*

Setting	Code / Value	Description
[Always Active]	<i>A L L</i>	Always active Factory setting
[Ready & Run State]	<i>r r y</i>	Ready and Run state
[Run State]	<i>r u n</i>	Run state

[MonitorCircuit A Delay] *, F d R*★

Monitoring circuit A delay after Run

This parameter can be accessed if [MonitorCircuit A Assign] *, F R R* is not set to [No] *n o*

Setting	Description
0...300 s	Setting range Factory setting: 0 s

[MonitorCircuit A ErrorResp] , F r A ★

Response to monitoring circuit A error

This parameter can be accessed if **[MonitorCircuit A Assign] , F R A** is not set to **[No] n o**

Setting	Code / Value	Description
[Ignore]	n o	Detected error ignored Factory setting
[Freewheel Stop]	Y E S	Freewheel stop
[Per STT]	S T T	Stop according to [Type of stop] S T T parameter but without an error triggered after stop
[Fallback Speed]	L F F	Change to fallback speed, maintained as long as the detected error persists and the run command has not been removed ⁽¹⁾
[Spd maintained]	r L S	Speed maintained as long as the detected error persists and the run command has not been removed ⁽¹⁾
[Ramp stop]	r P P	Stop on ramp
[Fast stop]	F S T	Fast stop
[DC injection]	d C i	DC injection
<p>1 Because, in this case, the detected error does not trigger a stop, it is recommended to assign a relay or logic output to its indication.</p>		

[Monitoring circuit B] C P C b - Menu**Access**

[Complete settings] → [Cabinet I/O functions] → [Monitoring circuit B]

About This Menu

Identical to **[Monitoring circuit A] C P C A** - menu (*see page 582*)

[MonitorCircuit B Assign] , F R b

Monitoring circuit B assignment

[MonitorCircuit B Monitor] , F P b ★

Monitoring circuit B error monitoring type

[MonitorCircuit B Delay] , F d b ★

Monitoring circuit B delay after Run

[MonitorCircuit B ErrorResp] , F r b ★

Response to monitoring circuit B error

[Monitoring circuit C] *LCCL* - Menu

Access

[Complete settings] → [Cabinet I/O functions] → [Monitoring circuit C]

About This Menu

Identical to [Monitoring circuit A] *LCCL* - menu (*see page 582*)

[MonitorCircuit C Assign] *LCCL*

Monitoring circuit C assignment

[MonitorCircuit C Monitor] *LCCL*★

Monitoring circuit C error monitoring type

[MonitorCircuit C Delay] *LCCL*★

Monitoring circuit C delay after Run

[MonitorCircuit C ErrorResp] *LCCL*★

Response to monitoring circuit C error

[Monitoring circuit D] *LCCLd* - Menu

Access

[Complete settings] → [Cabinet I/O functions] → [Monitoring circuit D]

About This Menu

Identical to [Monitoring circuit A] *LCCL* - menu (*see page 582*)

[MonitorCircuit D Assign] *LCCLd*

Monitoring circuit D assignment

[MonitorCircuit D Monitor] *LCCLd*★

Monitoring circuit D error monitoring type

[MonitorCircuit D Delay] *LCCLd*★

Monitoring circuit D delay after Run

[MonitorCircuit D ErrorResp] *LCCLd*★

Response to monitoring circuit D error

[Cabinet circuit A] $\mathcal{L} \mathcal{L} \mathcal{P} \mathcal{A}$ - Menu

Access

[Complete settings] → [Cabinet I/O functions] → [Cabinet circuit A]

About This Menu

These functions can be used to manage warnings or detected errors inside the cabinet enclosure.

The cabinet circuits give the possibility to manage 2 levels of monitoring:

- A Warning level: the drive triggers an event without stopping the application.
If [CabinetCircuit ErrorResp] $\mathcal{L} \mathcal{F} \mathcal{r} \mathcal{X}$ is set to [Ignore] $n \square$ the [CabinetCircuit Warn] $\mathcal{L} \mathcal{W} \mathcal{X}$ will be triggered.
- An Error level: the drive triggers an event and stops the application.
If [CabinetCircuit ErrorResp] $\mathcal{L} \mathcal{F} \mathcal{r} \mathcal{X}$ is set to a different value [CabinetCircuit Error] $\mathcal{L} \mathcal{F} \mathcal{X}$ will be triggered.

Identical to [Monitoring circuit A] $\mathcal{L} \mathcal{P} \mathcal{L} \mathcal{A}$ - menu (*see page 582*)

[CabinetCircuit A Assign] $\mathcal{L} \mathcal{F} \mathcal{A} \mathcal{A}$

Cabinet circuit A assignment

[CabinetCircuit A Monitor] $\mathcal{L} \mathcal{F} \mathcal{P} \mathcal{A}$ ★

Cabinet circuit A error monitoring type

[CabinetCircuit A Delay] $\mathcal{L} \mathcal{F} \mathcal{d} \mathcal{A}$ ★

Cabinet circuit A delay after Run

[CabinetCircuit A ErrorResp] $\mathcal{L} \mathcal{F} \mathcal{r} \mathcal{A}$ ★

Response to Cabinet circuit A error

[Cabinet circuit B] $\mathcal{L} \mathcal{L} \mathcal{P} \mathcal{B}$ - Menu

Access

[Complete settings] → [Cabinet I/O functions] → [Cabinet circuit B]

About This Menu

Identical to [Cabinet circuit A] $\mathcal{L} \mathcal{L} \mathcal{P} \mathcal{A}$ - menu (*see page 582*)

[CabinetCircuit B Assign] $\mathcal{L} \mathcal{F} \mathcal{A} \mathcal{B}$

Cabinet circuit B assignment

[CabinetCircuit B Monitor] $\mathcal{L} \mathcal{F} \mathcal{P} \mathcal{B}$ ★

Cabinet circuit B error monitoring type

[CabinetCircuit B Delay] $\mathcal{L} \mathcal{F} \mathcal{d} \mathcal{B}$ ★

Cabinet circuit B delay after Run

[CabinetCircuit B ErrorResp] $\mathcal{L} \mathcal{F} \mathcal{r} \mathcal{B}$ ★

Response to Cabinet circuit B error

[Cabinet circuit C] C C P C - Menu**Access**

[Complete settings] → [Cabinet I/O functions] → [Cabinet circuit C]

About This Menu

Identical to [Cabinet circuit A] C C P A - menu (*see page 582*)

[CabinetCircuit C Assign] C F A C

Cabinet circuit C assignment

[CabinetCircuit C Monitor] C F P C ★

Cabinet circuit C error monitoring type

[CabinetCircuit C Delay] C F d C ★

Cabinet circuit C delay after Run

[CabinetCircuit C ErrorResp] C F r C ★

Response to Cabinet circuit C error

[Motor winding A] C E , A - Menu**Access**

[Complete settings] → [Cabinet I/O functions] → [Motor winding A]

About This Menu

These functions will be mainly used with additional thermal relays to monitor the motor winding temperature.

These functions give the possibility to manage 2 levels of monitoring:

- A Warning level: the drive triggers an event without stopping the application.
If [MotorWinding/Bearing ErrorResp] E F r X is set to [Ignore] no the [MotorWinding/Bearing Warn] C W X will be triggered.
- An Error level: the drive triggers an event and stops the application.
If [MotorWinding/Bearing ErrorResp] E F r X is set to a different value [MotorWinding/Bearing Error] E F X will be triggered.

Identical to [Monitoring circuit A] C P C A - menu (*see page 582*)

[MotorWinding A Assign] E F A A

Motor winding A assignment

[MotorWinding A Monitor] E F P A ★

Motor winding A monitoring

[MotorWinding A Delay] E F d A ★

Motor winding A delay after Run

[MotorWinding A ErrorResp] E F r A ★

Response to Motor winding A error

[Motor winding B] C E , b - Menu**Access**

[Complete settings] → [Cabinet I/O functions] → [Motor winding B]

About This Menu

Identical to [Motor winding A] C E , R - menu (*see page 586*)

[MotorWinding B Assign] E F R b

Motor winding B assignment

[MotorWinding B Monitor] E F R b ★

Motor winding B monitoring

[MotorWinding B Delay] E F d b ★

Motor winding B delay after Run

[MotorWinding B ErrorResp] E F r b ★

Response to Motor winding B error

[Motor bearing A] C E , C - Menu**Access**

[Complete settings] → [Cabinet I/O functions] → [Motor bearing A]

About This Menu

Identical to [Motor winding A] C E , R - menu (*see page 586*)

[MotorBearing A Assign] E F R C

Motor bearing A assignment

[MotorBearing A Monitor] E F R C ★

Motor winding A monitoring

[MotorBearing A Delay] E F d C ★

Motor bearing A delay after Run

[MotorBearing A ErrorResp] E F r C ★

Response to Motor bearing A error

[Motor bearing B] *CL* *id* - Menu

Access

[Complete settings] → [Cabinet I/O functions] → [Motor bearing B]

About This Menu

Identical to [Motor winding A] *CL* *id* - menu (*see page 586*)

[MotorBearing B Assign] *EF* *id*

Motor bearing B assignment

[MotorBearing B Monitor] *EF* *id* ★

Motor winding B monitoring

[MotorBearing B Delay] *EF* *id* ★

Motor bearing B delay after Run

[MotorBearing B ErrorResp] *EF* *id* ★

Response to Motor bearing B error

[Circuit breaker] *CL* *b* - Menu

Access

[Complete settings] → [Cabinet I/O functions] → [Circuit breaker]

About This Menu

This menu is used to control the circuit breaker behavior

This menu can be accessed on ATV660 or ATV680, equipped with Cabinet IO, and if [Access Level] *LF* *CL* is set to [Expert] *EP* *r*.

[CB start pulse activated] *CL* *b* *EP*

Circuit breaker start pulse assignment

Setting	Code / Value	Description
[R61 Assignment]...[R66 Assignment]	<i>r</i> <i>b</i> <i>1</i> ... <i>r</i> <i>b</i> <i>b</i>	Cabinet I/O relays outputs

[CB stop pulse activated] *CL* *b* *d* *P*

Circuit breakers stop pulse assignment

Setting	Code / Value	Description
[R61 Assignment]...[R66 Assignment]	<i>r</i> <i>b</i> <i>1</i> ... <i>r</i> <i>b</i> <i>b</i>	Cabinet I/O relays outputs

[CB status] C b 5

Circuit breaker status

If **[CB start pulse activated] C b E P** and **[CB stop pulse activated] C b d P** are not configured the **[CB Invalid Config] C b C i** status is displayed. Both values must be set in order to configure the circuit breaker.

The **[CB stop disable] C b 5 d** status is displayed until **[CB Disable stop delay] C b E 5** is reached.

Setting	Code / Value	Description
[CB Not Configured]	n o	Circuit breaker not configured
[CB Invalid Config]	C b C i	Circuit breaker invalid configuration
[CB In Start Pulse]	C b 5 t	Circuit breaker in start pulse
[CB Not Closed]	C b n C	Circuit breaker not closed
[CB Open]	C b o 5	Circuit breaker in open
[CB In Stop Pulse]	C b 5 P	Circuit breaker in stop pulse
[CB Not Open]	C b n o	Circuit breaker not open
[CB Closed]	C b C 5	Circuit breaker closed
[CB stop disable]	C b 5 d	Circuit breaker stop is disable

[CB start pulse time] C b E 1

Circuit Breaker start pulse time.

Setting	Description
0.1...60.0 s	Setting range Factory setting: 0.5 s

[CB stop pulse time] C b E 2

Circuit Breaker stop pulse time.

Identical to **[CB start pulse time] C b E 1**

[CB Switch-on delay] C b E 3

Circuit Breaker Switch-on delay.

This parameter is used to set a minimal delay between a star pulse and a stop pulse.

Identical to **[CB start pulse time] C b E 1**

[CB Switch-off delay] C b E 4

Circuit Breaker Switch-off delay.

This parameter is used to set a minimal delay between a stop pulse and a start pulse.

Identical to **[CB start pulse time] C b E 1**

[CB Disable stop delay] C b E 5

Circuit Breaker Disable stop delay.

Setting	Description
0.0...360.0 s	Setting range Factory setting: 60.0 s

[Mains V. time out] L C E

Monitoring time for closing of line contactor.

Setting	Description
1...999 s	Setting range Factory setting: 5 s

[CB Error Resp] C b S r

The Circuit breaker gives the possibility to manage 2 levels of monitoring:

- A Warning level: the drive triggers an event without stopping the application.
- An Error level: the drive triggers an event and stops the application.

If after a start command, no voltage is detected after the **[Mains V. time out] L C E**, the **[CB Error Resp] C b S r** is triggered and the **[CB Not Closed] C b n C** status is displayed.

If after a stop command, the voltage is still detected after **[Mains V. time out] L C E**, the **[CB Error Resp] C b S r** is triggered and the **[CB Not Open] C b n O** status is displayed.

Setting	Code / Value	Description
[Error]	<i>F L E</i>	The drive stops the application Factory setting
[Warning]	<i>W R r</i>	A warning is triggered and the drive remains in operation enable.

[Cabinet I/O functions] C R b F - menu

Access

[Complete Settings] → [Cabinet I/O functions]

About This Menu

This parameter can be accessed on ATV960 or ATV980, equipped with cabinet IO, and if **[Access Level] L R C** is set to **[Expert] E P r**.

[Cabinet I/O 24V Timeout] P 2 4 d

Cabinet I/O 24V missing error timeout

Settings	Description
[Warning]	Warning is triggered.
1...3000 s	Delay before triggering a [Cab I/O 24V Error] P 2 4 C error Factory setting: 3 s

Chapter 9

[Communication] *C o M* -

Introduction



[Communication] *C o M* - menu presents the fieldbus submenus.

What Is in This Chapter?

This chapter contains the following topics:

Topic	Page
[Modbus Fieldbus] <i>M d I</i> - Menu	592
[Com. scanner input] <i>, C S</i> - Menu	594
[Com. scanner output] <i>o C S</i> - Menu	595
[Modbus HMI] <i>M d 2</i> - Menu	596
[Embd Eth Config] <i>E t E</i> - Menu	597
[Fast Device Replacement] <i>F d r</i> - Menu	598
[CANopen] <i>C n o</i> - Menu	599
[DeviceNet] <i>d n C</i> - Menu	599
[Profibus] <i>P b C</i> - Menu	599
[Profinet] <i>P n C</i> - Menu	599
[EtherCAT Module] <i>E t C</i> - Menu	600
[Powerlink] <i>E P L</i> - Menu	600

[Modbus Fieldbus] П д I - Menu

Access

[Communication] → [Comm parameters] → [Modbus SL] → [Modbus Fieldbus]

About This Menu

This menu is related to the Modbus serial communication port on the bottom of the control block. Refer to the Modbus serial manual.

[Modbus Address] Р д д

Drive Modbus address.

Setting	Description
[OFF] 0 F F ...247	Setting range Factory setting: [OFF] 0 F F

[Modbus add Com.C.] Р П 0 L

Modbus address of COM option board

Setting	Description
[OFF] 0 F F ...247	Setting range Factory setting: [OFF] 0 F F

[Bd.RateModbus] t b r

Baud rate Modbus.

Setting	Code / Value	Description
[4800 bps]	4 K B	4,800 Bauds
[9600 bps]	9 K B	9,600 Bauds
[19200 bps]	1 9 K 2	19,200 Bauds Factory setting
[38.4 Kbps]	3 8 K 4	38,400 Bauds

[Term Word Order] t w 0 ★

Terminal Modbus: word order.

This parameter can be accessed if [Access Level] L A C is set to [Expert] E P r .

Setting	Code / Value	Description
[OFF]	0 F F	Low word first
[ON]	0 n	High word first Factory setting

[Modbus Format] t F 0

Modbus communication format.

Setting	Code / Value	Description
[8-O-1]	B 0 1	8 bits odd parity 1 stop bit
[8-E-1]	B E 1	8 bits even parity 1 stop bit Factory setting
[8-N-1]	B n 1	8 bits no parity 1 stop bit
[8-N-2]	B n 2	8 bits no parity 2 stop bits

[Modbus Timeout] Ɨ Ɨ 0

Modbus timeout.

Setting	Description
0.1 ...30.0 s	Setting range Factory setting: 10.s

[Mdb Com Stat] Ɨ 0 1 1

Modbus communication status.

Setting	Code / Value	Description
[r0t0]	r 0 Ɨ 0	Modbus no reception, no transmission
[r0t1]	r 0 Ɨ 1	Modbus no reception, transmission
[r1t0]	r 1 Ɨ 0	Modbus reception, no transmission
[r1t1]	r 1 Ɨ 1	Modbus reception and transmission

[Com. scanner input] , C 5 - Menu

Access

[Communication] → [Comm parameters] → [Modbus SL] → [Modbus Fieldbus] → [Com. scanner input]

[Scan. IN1 address] n P A 1

Address of the first input word.

Setting	Description
0...65535	Setting range Factory setting: 3201 (E L A)

[Scan. IN2 address] n P A 2

Address of the second input word.

Setting	Description
0...65535	Setting range Factory setting: 8604 (r F r d)

[Scan. IN3 address] n P A 3

Address of the third input word.

Setting	Description
0...65535	Setting range Factory setting: 0

[Scan. IN4 address] n P A 4

Address of the fourth input word.

Identical to [Scan. IN3 address] n P A 3.

[Scan. IN5 address] n P A 5

Address of the fifth input word.

Identical to [Scan. IN3 address] n P A 3.

[Scan. IN6 address] n P A 6

Address of the sixth input word.

Identical to [Scan. IN3 address] n P A 3.

[Scan. IN7 address] n P A 7

Address of the seventh input word.

Identical to [Scan. IN3 address] n P A 3.

[Scan. IN8 address] n P A 8

Address of the eighth input word.

Identical to [Scan. IN3 address] n P A 3.

[Com. scanner output] ▢ C 5 - Menu**Access**

[Communication] → [Comm parameters] → [Modbus SL] → [Modbus Fieldbus] → [Com. scanner output]

[Scan.Out1 address] n C R 1

Address of the first output word.

Setting	Description
0...65535	Setting range Factory setting: 8501(C P d)

[Scan.Out2 address] n C R 2

Address of the second output word.

Setting	Description
0...65535	Setting range Factory setting: 8602(L F r d)

[Scan.Out3 address] n C R 3

Address of the third output word.

Setting	Description
0...65535	Setting range Factory setting: 0

[Scan.Out4 address] n C R 4

Address of the fourth output word.

Identical to [Scan.Out3 address] n C R 3.

[Scan.Out5 address] n C R 5

Address of the fifth output word.

Identical to [Scan.Out3 address] n C R 3.

[Scan.Out6 address] n C R 6

Address of the sixth output word.

Identical to [Scan.Out3 address] n C R 3.

[Scan.Out7 address] n C R 7

Address of the seventh output word.

Identical to [Scan.Out3 address] n C R 3.

[Scan.Out8 address] n C R 8

Address of the eighth output word.

Identical to [Scan.Out3 address] n C R 3.

[Modbus HMI] 7 d 2 - Menu

Access

[Communication] → [Comm parameters] → [Modbus SL] → [Modbus HMI]

About This Menu

This menu is related to the Modbus serial communication port on the front of the control block. It is used by default for the Graphic Display Terminal. The Graphic Display Terminal is only compliant with the following settings: [HMI Baud Rate] 4 b r 2 equal to [19200 bps] 1 9 K 2, [Term 2 word order] 4 W o 2 equal to [HIGH] o n and [HMI Format] 4 F o 2 equal to [8-E-1] B E 1.

[HMI Baud Rate] 4 b r 2

Baud rate Modbus.

Setting	Code / Value	Description
[4800 bps]	4 K B	4,800 Bauds
[9600 bps]	9 K B	9,600 Bauds
[19200 bps]	1 9 K 2	19,200 Bauds Factory setting
[38.4 Kbps]	3 8 K 4	38,400 Bauds

[Term 2 word order] 4 W o 2 ★

Terminal Modbus 2: Word order.

This parameter can be accessed if [Access Level] L R C is set to [Expert] E P r .

Setting	Code / Value	Description
[LOW]	o F F	Low word first
[HIGH]	o n	High word first Factory setting

[HMI Format] 4 F o 2

HMI format.

Setting	Code / Value	Description
[8-O-1]	B o 1	8.o.1.
[8-E-1]	B E 1	8.E.1. Factory setting
[8-N-1]	B n 1	8.n.1.
[8-N-2]	B n 2	8.n.2.

[Mdb com start] C o n 2

Modbus communication status.

Setting	Code / Value	Description
[r0t0]	r 0 t 0	Modbus no reception, no transmission
[r0t1]	r 0 t 1	Modbus no reception, transmission
[r1t0]	r 1 t 0	Modbus reception, no transmission
[r1t1]	r 1 t 1	Modbus reception and transmission

[Embd Eth Config] E E E - Menu

Access

[Communication] → [Comm parameters] → [Embd Eth Config]

About This Menu

Refer to the Ethernet embedded manual.

[Device Name] P A n

The FDR (Fast Device Replacement) service is based on identification of the device by a "Device Name". In the case of the Altivar drive, this is represented by the **[Device Name] P A n** parameter. Check that all the network devices have different "Device Names".

[IP Mode Ether. Embd] , n n n

IP mode Ethernet embedded.

Setting ()	Code / Value	Description
[Fixed]	<i>n A n u</i>	Fixed address
[BOOTP]	<i>b o o t P</i>	BOOTP
[DHCP]	<i>d H C P</i>	DHCP Factory setting

[IP address] , C 0

IP Address (, C 0 1, , C 0 2, , C 0 3, , C 0 4).

Setting	Description
0...255	Setting range Factory setting: 0.0.0.0

[Mask] , n 0

Subnet mask (, n 0 1, , n 0 2, , n 0 3, , n 0 4).

Setting	Description
0...255	Setting range Factory setting: 0.0.0.0

[Gateway] , G 0

Gateway address (, G 0 1, , G 0 2, , G 0 3, , G 0 4).

Setting	Description
0...255	Setting range Factory setting: 0.0.0.0

[Fast Device Replacement] F d r - Menu

Access

[Communication] → [Comm parameters] → [Embd Eth Config] → [Fast Device Replacement]

About This Menu

This menu can be accessed if [IP mode Ether. Embd] i n d d is set to [DHCP] d h c p.

[Enable FDR] F d v d

Enable FDR function.

Setting	Code / Value	Description
[No]	n o	FDR service disabled Factory setting
[Yes]	y e s	FDR service enabled

[FDR Action] F d a d

FDR action.

Setting ()	Code / Value	Description
[Not active]	i d l e	No FDR action Factory setting
[Save]	s a v e	FDR save command
[Rest]	r e s t	FDR restore command

[FDR Operating State] F d s d

FDR operating state.

Setting	Code / Value	Description
[Initialization]	i n i t	Initialization
[Not active]	i d l e	Function not active Factory setting
[Operational]	o p e	Operational
[Ready]	r e a d y	Ready
[IP Configuration]	i p c	IP configuration
[Not Configured]	u n c f	Function not configured
[Reading Configuration]	g e t	Download the current configuration
[Writing Configuration]	s e t	Save the current configuration
[Applying Configuration]	a p p	Applying the configuration to the drive

[FDR Error Status] F d r d

FDR error status.

Setting	Code / Value	Description
[No Error]	n o	No error Factory setting
[Server Timeout]	t o u t	Server timeout
[Server No File]	s n f	No file on server
[Server Corrupt File]	c r p t	Invalid file on server
[Server Empty File]	e p t y	Empty file on server

Setting	Code / Value	Description
[Drive Invalid File]	<i>H I N V</i>	Invalid file on drive
[CRC Error]	<i>C R C</i>	CRC error
[Version Incompatibility]	<i>V R N</i>	Version incompatibility between drive and file
[Drive No File]	<i>H N F</i>	No file on drive
[Server Reading Size]	<i>S I Z E</i>	File size reading error on server
[Drive Opening File]	<i>O P E n</i>	drive can not open the file
[Drive Reading File]	<i>r E A d</i>	drive can not read the file
[Incompatibility]	<i>S C n t</i>	File incompatibility
[Drive Invalid Name]	<i>n I n V</i>	drive name is invalid
[Server Incorrect File Size]	<i>F S I Z</i>	Incorrect file size on server
[Drive Writing File]	<i>H W F</i>	drive can not write the file
[Server Writing File]	<i>S W F</i>	Server can not write the file

[CANopen] *C n o* - Menu

Access

[Communication] → [Comm parameters] → [CANopen]

About This Menu

Refer to the CANopen fieldbus module manual.

[DeviceNet] *d n C* - Menu

Access

[Communication] → [Comm parameters] → [DeviceNet]

About This Menu

Refer to the DeviceNet fieldbus module manual.

[Profibus] *P b C* - Menu

Access

[Communication] → [Comm parameters] → [Profibus]

About This Menu

Refer to the Profibus DP fieldbus module manual.

[Profinet] *P n C* - Menu

Access

[Communication] → [Comm parameters] → [Profinet]

About This Menu

Refer to the PROFINET fieldbus module manual.

[EtherCAT Module] *E L C* - Menu

Access

[Communication] → [EtherCAT Module]

About This Menu

Following parameters can be accessed if EtherCAT module has been inserted.

Refer to the EtherCAT manual.

[EthCat slave status] *E L S S* ★

EtherCAT slave status

Setting	Code / Value	Description
[Init]	<i>i n i t</i>	Init
[PrOP]	<i>P r o P</i>	Pre-operational
[bOOT]	<i>b o o t</i>	Pre-operational
[SFOP]	<i>S F o P</i>	Safe operational
[OP]	<i>o P</i>	Operational

[EthCat 2nd addr] *E L S A* ★

EtherCAT second address

Setting	Description
0...65,535	Setting range Factory setting: 0

[EthCat addr] *E L A A* ★

EtherCAT second address actual value

Setting	Description
0...65,535	Setting range Factory setting: 0

[Powerlink] *E P L* - Menu

Access

[Communication] → [Comm parameters] → [Powerlink]

About This Menu

Following parameters can be access if Powerlink module (VW3A3619) has been inserted.Refer to the Powerlink communication manual.

Chapter 10

[File management] *F Π E* -

Introduction



[File management] *F Π E* - menu presents the management of drive configuration files.

What Is in This Chapter?

This chapter contains the following topics:

Topic	Page
[Transfer config file] <i>E C F</i> - Menu	602
[Factory settings] <i>F C S</i> - Menu	602
[Parameter group list] <i>F r Y</i> - Menu	603
[Factory settings] <i>F C S</i> - Menu	604
[Pre-settings] <i>P r E S</i> - Menu	605
[Firmware update diag] <i>F W u d</i> - Menu	606
[Identification] <i>i d</i> - Menu	607
[Package version] <i>P F V</i> - Menu	608
[Firmware update] <i>F W u P</i> - Menu	608

[Transfer config file] $\mathcal{L} \mathcal{C} \mathcal{F}$ - Menu**Access**

[File management] → [Transfer config file]

[Copy to the drive] $\mathcal{C} \mathcal{P} \mathcal{F}$

This allows to select a previously saved drive configuration from the Graphic Display Terminal memory and transfer it to the drive.

The drive needs to be restarted after a configuration file transfer.

[Copy from the drive] $\mathcal{S} \mathcal{R} \mathcal{F}$

This allows to save the actual drive configuration into the Graphic Display Terminal memory.

NOTE: The Graphic Display Terminal can store up to 16 configuration files.

[Factory settings] $\mathcal{F} \mathcal{C} \mathcal{S}$ - Menu**Access**

[File management] → [Factory settings]

About This Menu

This parameter allows to select the configuration to restore in case of factory setting operation.

[Config. Source] $\mathcal{F} \mathcal{C} \mathcal{S}$, ★

Setting	Code / Value	Description
[Macro-Conf]	$\mathcal{M} \mathcal{C}$	Factory setting parameter set Factory setting
[Config 1]	$\mathcal{C} \mathcal{F} \mathcal{G} \mathcal{1}$	Customer parameter set 1
[Config 2]	$\mathcal{C} \mathcal{F} \mathcal{G} \mathcal{2}$	Customer parameter set 2
[Config 3]	$\mathcal{C} \mathcal{F} \mathcal{G} \mathcal{3}$	Customer parameter set 3

[Parameter group list] *F r Y* - Menu

Access

[File management] → [Factory settings] → [Parameter group list]

About This Menu

Selection of menus to be loaded.

NOTE: In factory configuration and after a return to "factory settings", [Parameter group list] *F r Y* will be empty.

[All] *ALL*

All parameters in all menus.

[Drive Configuration] *d r Π*

Load [Complete settings] *C S E* - menu.

[Motor Param] *Π α ε*

Load [Motor parameters] *Π P R* - menu.

[Comm. Menu] *C α Π* ★

Load [Communication] *C α Π* - menu.

This parameter can be accessed if [Config. Source] *F C S* is set to [Macro-Conf] *ι η ι*.

[Display Config.] *d , 5* ★

Load [Display screen type] *Π S C* - menu.

This parameter can be accessed if [Config. Source] *F C S* is set to [Macro-Conf] *ι η ι*.

[Factory settings] F C 5 - Menu**Access**

[File management] → [Factory settings]

[Go to Factory settings] G F 5**⚠ WARNING****UNANTICIPATED EQUIPMENT OPERATION**

Verify that restoring the factory settings is compatible with the type of wiring used.

Failure to follow these instructions can result in death, serious injury, or equipment damage.

It is only possible to revert to the factory settings if at least one group of parameters has previously been selected.

[Save Configuration] S C 5 , ★

Save configuration.

The active configuration to be saved does not appear for selection. For example, if it is **[Config 0] S E r 0**, only **[Config 1] S E r 1**, **[Config 2] S E r 2** and **[Config 3] S E r 3** appear. The parameter changes back to **[No] n o** as soon as the operation is complete.

Setting	Code / Value	Description
[No]	n o	No Factory setting
[Config 0]	S E r 0	Store customer parameter set 0
[Config 1]	S E r 1	Store customer parameter set 1
[Config 2]	S E r 2	Store customer parameter set 2
[Config 3]	S E r 3	Store customer parameter set 3

[Pre-settings] P r E S - Menu

Access

[File management] → [Factory settings] → [Pre-settings]

About This Menu

ATV960, ATV980 and ATV993 give possibility to defined pre-settings for drive parameters.

It allows pre configuration and protection from modifications of:

- Drive functions
- Cabinet I/O functions

This pre-setting is done during the manufacturing of the drive system.

[Pre-settings Status] P 5 5

Drive Systems pre-settings status.

Setting	Code / Value	Description
[Not locked]	n R C t	Pre-setting configuration is not locked. Parameters defined in the pre-setting list can be modified
[Locked]	R c t	Pre-setting configuration is locked. Parameters defined in the pre-setting list cannot be modified

[Pre-settings Unlock] P 5 r t

Drive Systems pre-settings unlock.

This parameter can be used, by a Schneider Electric representative, to unlock the pre-setting configuration.

Setting	Description
0...65535	Setting range Factory setting: 0

[Firmware update diag] FWUD - Menu**Access**

[File management] → [Firmware update] → [Firmware update diag]

About This Menu

This menu can be accessed in expert mode.

[Firmware Update Status] FWSE

Setting	Code / Value	Description
[Inactive]	<i>C H E C K</i>	Firmware update inactive
[PwrUpd in progress]	<i>P o W E r</i>	Power update in progress
[PwrUpd Pending]	<i>P E n d</i>	Power update pending
[Ready]	<i>r d Y</i>	Firmware update ready
[Inactive]	<i>n o</i>	Firmware update inactive
[Succeeded]	<i>S u C C d</i>	Firmware update succeeded
[Update Error]	<i>F R I L E d</i>	Update error
[In Progress]	<i>P r o G</i>	Firmware update in progress
[Requested]	<i>r e S t d</i>	Firmware update requested
[Transfer In Progress]	<i>t r L d</i>	Transfer in progress
[Transfer Done]	<i>t r o K</i>	Transfer done
[Package cleared]	<i>C L E A r</i>	Package cleared
[Warning]	<i>S u C W r</i>	Firmware update succeeded with warnings
[Drive State Error]	<i>F L S t R</i>	Drive state error
[Package Error]	<i>F L P K G</i>	Package error
[Saving conf]	<i>S A V E</i>	Firmware update is saving the current configuration
[Post Script]	<i>P o S t</i>	Firmware update is doing the post FWUPD

[Firmware Update Error] FWER

Setting	Code / Value	Description
[No Error]	<i>n o</i>	No error
[Lock Error]	<i>L o C K</i>	Lock error
[Package Error]	<i>P d S</i>	Package error
[Package compatibility error]	<i>C o M P</i>	Package compatibility error
[Ask error]	<i>A S K</i>	Ask error
[Reset Drive Error]	<i>r E S E t</i>	Reset drive error
[Conf Saving Warning]	<i>S A V E</i>	Configuration saving warning
[Conf Loading Warning]	<i>L o A d</i>	Configuration loading warning
[Post Script Warning]	<i>S C P</i>	Post script warning
[Package Description Error]	<i>d E S</i>	Package description error
[Package not found]	<i>P K G</i>	Package not found
[Power Supply error]	<i>S P W r</i>	Power supply error
[Boot M3 error]	<i>b t M 3</i>	Boot M3 error

Setting	Code / Value	Description
[Boot C28 error]	<i>b t C 2 B</i>	Boot C28 error
[M3 Error]	<i>M 3</i>	M3 error
[C28 error]	<i>C 2 B</i>	C28 error
[CPLD error]	<i>C P L d</i>	CPLD error
[Boot Power Error]	<i>P W r</i>	Boot power error
[Emb. Eth Boot Error]	<i>E n b t</i>	Embedded ethernet boot error
[Emb. Eth Error]	<i>E n , L</i>	Embedded ethernet error
[Emb. Eth Web Error]	<i>E n W b</i>	Embedded ethernet WebServer error
[Module Eth Boot Error]	<i>o P t b t</i>	Module ethernet boot error
[Module Eth Error]	<i>o P t , L</i>	Module ethernet error
[Module Eth Web Error]	<i>o P t W b</i>	Module ethernet WebServer error
[Password enabled]	<i>P 5 W d</i>	Password enabled
[Flash Error]	<i>M E M</i>	Flash error
[Package error]	<i>, F o</i>	Package information error

[Identification] *o , d* - Menu

Access

[File management] → [Firmware update] → [Identification]

About This Menu

This is a read-only menu that cannot be configured. It enables the following information to be displayed:

- Drive reference, power rating, and voltage
- Drive software version
- Drive serial number
- Type of option modules present, with their software version
- Graphic Display Terminal type and version

[Package version] P F V - Menu**Access**

[File management] → [Firmware update] → [Package version]

About This Menu

This menu can be accessed in expert mode.

[Package Type] P K T P

Firmware Update Package Type

Setting	Code / Value	Description
[Product]	<i>P r d</i>	Firmware update product package
[Module]	<i>o P t</i>	Firmware update option package
[Spare part]	<i>S P r</i>	Firmware update spare parts package
[Customized]	<i>C u s</i>	Firmware update customized package
[Indus]	<i>i n d</i>	Firmware update industrialization package

[Package Version] P K V S

Firmware Update Package Version

Setting ()	Description
0...65,535	Setting range Factory setting: _

[Firmware update] F W U P - Menu**Access**

[File management] → [Firmware update]

About This Menu

This menu can be accessed in expert mode.

[Update Firmware] F W R P

Firmware Update Application.

Setting ()	Code / Value	Description
[No]	<i>n o</i>	No Factory setting
[Yes]	<i>y e s</i>	Yes

[Abort Firmware Update] F W C L

Firmware Update Clear.

Setting ()	Code / Value	Description
[No]	<i>n o</i>	No Factory setting
[Yes]	<i>y e s</i>	Yes

Chapter 11

[My preferences] ПУР -

Introduction



[My preferences] ПУР - menu presents the possible settings for the user-defined HMI and parameter access.

What Is in This Chapter?

This chapter contains the following sections:

Section	Topic	Page
11.1	[Language]	610
11.2	[Password]	611
11.3	[Parameter access]	613
11.4	[Customization]	615
11.5	[Date & Time settings]	618
11.6	[Access level]	619
11.7	[Webserver]	620
11.8	[Functions key mgnt]	621
11.9	[LCD settings]	622
11.10	[Stop and go]	623
11.11	[QR code]	625
11.12	[QR code] - [My link 1]	626
11.13	[QR code] - [My link 2]	627
11.14	[QR code] - [My link 3]	628
11.15	[QR code] - [My link 4]	629
11.16	[Pairing password]	630

Section 11.1

[Language]

[Language] L n G - Menu

Access

[My preferences] → [Language]

About This Menu

This menu allows to select the Graphic Display Terminal language.

Section 11.2

[Password]

[Password] *C o d* - Menu

Access

[My preferences] → [Password]

About This Menu

Enables the configuration to be protected with an access code or a password to be entered in order to access a protected configuration:

- The drive is unlocked when the password is set to **[No password defined]** *n o* or when the correct password has been entered. All menus can be accessed.
- Before protecting the configuration with a password, you must:
 - Define the **[Upload rights]** *u L r* and **[Download rights]** *d L r*.
 - Make a careful note of the password and keep it in a place where you are able to find it.

Locking the drive modifies the menu access. If the password is locked:

- **[My Menu]** *М Y П n* - menu (in **[Simply Start]** *5 Y 5* - menu) remains visible if not empty,
- **[Dashboard]** *d 5 H* -, **[Diagnostics]** *d , R* - and **[Display]** *П o n* - menus remain visible with the read-only parameters. Sub-menus with settable parameters are not visible.
- **[Complete Settings]** *С 5 E* - and **[Communication]** *С o П* - menus are not visible,
- **[Transfer config file]** *Т С F* - menu (in **[File Management]** *F П E* - menu) remains visible.
- in the **[My preferences]** *М Y P* - menu, remains visible:
 - **[Language]** *L n G*,
 - **[Password]** *C o d* - menu,
 - **[Display screen Type]** *П 5 C* - menu (in **[Customization]** *С u 5* - menu),
 - **[Date & Time settings]** *r E C*,
 - **[Access Level]** *L R C*, and
 - **[LCD settings]** *С n L* - menu.

[Password status] *P 5 5 E*

Password status.

Read only parameter.

Setting	Code / Value	Description
[No password defined]	<i>n o</i>	No password defined Factory setting
[Password is unlocked]	<i>u L</i>	Password is unlocked
[Password is locked]	<i>L o C</i>	Password is locked

[Password] *P w d*

6-characters password. To lock the drive, define and enter your password. **[Password status]** *P 5 5 E* value switches to **[Password is locked]** *L o C*.

To unlock the drive, the password must be entered. Once the correct code has been entered, the drive is unlocked and **[Password status]** *P 5 5 E* value switches to **[Password is unlocked]** *u L*. Access will be locked again the next time the drive is switched on.

To modify the password, unlock the drive then enter the new password. Entering a new password locks the drive.

To remove the password, the drive must be unlocked and the password 000000 must be entered. **[Password status]** *P 5 5 E* value switches to **[No password defined]** *n o*. At next switch-on, the drive remains unlocked.

[Upload rights] *u L r*

Upload rights.

Setting 	Code / Value	Description
[Permitted]	<i>u L r 0</i>	Commissioning tools or the Graphic Display Terminal can save the whole configuration (password, monitoring, configuration) Factory setting
[Not allowed]	<i>u L r 1</i>	Commissioning tools or the Graphic Display Terminal cannot save the configuration if the drive is not protected by a password or if the in-correct password has been entered

[Download rights] *d L r*

Download rights.

Setting 	Code / Value	Description
[Locked drv]	<i>d L r 0</i>	Lock drive: the configuration can be downloaded to the drive only if the drive is protected by a password, which is the same as the password of the configuration to be downloaded
[Unlock. drv]	<i>d L r 1</i>	Unlock drive: the configuration can be downloaded to the drive or a configuration can be modified if the drive is unlocked or is not protected by a password Factory setting
[Not allowed]	<i>d L r 2</i>	The configuration cannot be downloaded
[Lock/unlock]	<i>d L r 3</i>	Combination of [Locked drv] <i>d L r 0</i> and [Unlock. drv] <i>d L r 1</i>

Section 11.3

[Parameter access]

What Is in This Section?

This section contains the following topics:

Topic	Page
[Restricted channels] <i>PC d</i> - Menu	614
[Restricted param] <i>PPA</i> - Menu	614
[Visibility] <i>V , S</i> - Menu	614

[Restricted channels] P C d - Menu

Access

[My preferences] → [Parameter access] → [Restricted access] → [Restricted channels]

About This Menu

Following channels can be selected to disable the accessibility to the related parameters.

[HMI] C o n

Graphic Display Terminal.

[PC Tool] P w S

DTM-based commissioning software.

[Modbus] n d b

Embedded Modbus serial.

[CANopen] C A n

CANopen fieldbus module.

[Com. Module] n E t

Fieldbus option module.

[Restricted param] P P R - Menu

Access

[My preferences] → [Parameter access] → [Restricted access] → [Restricted param]

About This Menu

In these screens, all parameters in the [Complete settings] C S t - menu can be protected and are displayed for selection, except for the Expert parameters.

Press the **All** key to select all the parameters. Press the **None** key again to deselect all the parameters.

Content of the [Complete settings] C S t - menu. No selections can be made in this screen if there are no parameters.

[Visibility] V , S - Menu

Access

[My preferences] → [Parameter access] → [Visibility]

About This Menu

Selection to display all parameters or only the active parameters.

[Parameters] P V , S

Parameters.

Setting()	Code / Value	Description
[Active]	R C t	Only active parameters can be accessed Factory setting
[All]	R L L	All parameters can be accessed

Section 11.4

[Customization]

What Is in This Section?

This section contains the following topics:

Topic	Page
[My menu config.] <i>MYC</i> - Menu	616
[Display screen type] <i>DSL</i> - Menu	616
[Param. Bar Select] <i>PBS</i> - Menu	616
[Customer parameters] <i>CYP</i> - Menu	617
[Service message] <i>SER</i> - Menu	617

[My menu config.] ПУС - Menu

Access

[My preferences] → [Customization] → [My menu config.]

About This Menu

This menu allows to customize the [My Menu] ПУПП - menu (*see page 61*).

[Parameter Selection] ППР

Content of the [Complete settings] ПСЛ - menu.

No selection can be made in this screen if there are no parameters.

[Selected List] ППЛ

This menu allows to sort the selected parameters.

[My Menu] ПУПП

Used to define the name of the customized menu.

[Display screen type] ПСЛ - Menu

Access

[My preferences] → [Customization] → [Display screen type]

About This Menu

This parameter allows to select the type of display for the default screen.

[Display value type] ПДЕ

Type of screen display.

Setting ()	Code / Value	Description
[Digital]	ДЕС	Digital values Factory setting
[Bar graph]	БРГ	Bar graph
[List]	ЛСЛ	List of values
[Vu Meter]	ВУМЕТ	Vu meter

[Parameter Selection] ППЛ

Customized selection.

This view allows to select the parameters to display on the default screen.

[Param. Bar Select] ПБС - Menu

Access

[My preferences] → [Customization] → [Param. Bar Select]

About This Menu

This view allows to select the parameters to display on the top line of the Graphic Display Terminal screen.

[Customer parameters] *C Y P* - Menu

Access

[My preferences] → [Customization] → [Customer parameters]

About This Menu

This menu allows to rename up to 15 parameters.

[Parameter Selection] *S C P*

Parameter selection.

This view allows to select up to 15 parameters.

[Custom Selection] *C P N*

Customized selection.

This view allows to set for each selected parameter:

- The name
- The unit if relevant (a custom unit is available)
- A multiplier (1...1000) if relevant
- A divisor (1...1000) if relevant
- An offset (-99.00...99.00) if relevant

[Service message] *S E r* - Menu

Access

[My preferences] → [Customization] → [Service message]

About This Menu

This menu allows to define a user-defined service message (5 lines, 23 digits per line).

This message can be displayed in **[theDiagnostics] d r** -, **[Diag. data] d d t** - menu and **[Service message] S E r** - submenus.

[LINE 1] *S N L O 1*

Line 1.

[LINE 2] *S N L O 2*

Line 2.

[LINE 3] *S N L O 3*

Line 3.

[LINE 4] *S N L O 4*

Line 4.

[LINE 5] *S N L O 5*

Line 5.

Section 11.5

[Date & Time settings]

[Date/time settings] - Menu

Access

[My preferences] → [Date/time settings]

About This Menu

This view allows to set date and time. This information is used for the time stamping of all logged data.

If a time server is connected over Ethernet and configured in the webserver, date and time data are updated automatically according to the configuration.

Date and time information shall be available (time server available and configured, or Graphic Display Terminal plugged) at drive power up to enable the time stamping of the logged data.

Modifying these settings will modify previously logged data value in case of average data based on time.

Section 11.6

[Access level]

[Access level] L R C - Menu

Access

[My preferences] → [Access level]

[Access Level] L R C

Level of access control.

Setting ()	Code / Value	Description
[Basic]	<i>b R S</i>	Access to the [Simply start] <i>S Y S</i> -, [Dashboard] <i>d S H</i> -, [Diagnostics] <i>d i R</i> -, [File management] <i>F M E</i> - and [My preferences] <i>M Y P</i> - menus only.
[Standard]	<i>S E d</i>	Access to all menus. Factory setting
[Expert]	<i>E P r</i>	Access to all menus and to additional parameters.

Section 11.7

[Webserver]

[Webserver] *w b s* - Menu

Access

[My preferences] → [Webserver]

About This Menu

This menu allows to manage Web services.

[EnableWebserver] *E W E E*

Enable Web services for the embedded Ethernet adapter.

Setting	Code / Value	Description
[No]	<i>n o</i>	Webserver disabled
[Yes]	<i>y e s</i>	Webserver enabled Factory setting

[Reset EmbWeb] *r w p e*

Reset the embedded Ethernet webserver to its default configuration.

Setting ()	Code / Value	Description
[No]	<i>n o</i>	No Factory setting
[Yes]	<i>y e s</i>	Yes

[Webserver default password] *w d p*

8-digits password. A unique password is provided and must be entered at the first connection of the webserver in order to have access to the administrator account (username = ADMIN).

Section 11.8

[Functions key mgnt]

[Functions key mgnt] *F K G* - Menu

Access

[My preferences] → [Functions key mgnt]

About This Menu

This menu allows to assign functions to the Graphic Display Terminal function keys.

[F1 key assignment] *F n 1*

Function key 1. Following possible assignments cannot be accessed in **[I/O profile]** configuration.

Setting	Code / Value	Description
[Not assigned]	<i>n o</i>	Not assigned Factory setting
[Jog]	<i>F J o G</i>	Function key jog affectation
[Preset Speed 1]	<i>F P S 1</i>	Function key preset speed 1 assignment
[Preset Speed 2]	<i>F P S 2</i>	Function key preset speed 2 assignment
[PID Ref Frequency 1]	<i>F P r 1</i>	Function key preset PID 1 assignment
[PID Ref Frequency 2]	<i>F P r 2</i>	Function key preset PID 2 assignment
[+Speed]	<i>F u S P</i>	Function key faster assignment
[-Speed]	<i>F d S P</i>	Function key slower assignment

[F2 key assignment] *F n 2*

Function key 2.

Identical to **[F1 key assignment]** *F n 1*.

[F3 key assignment] *F n 3*

Function key 3.

Identical to **[F1 key assignment]** *F n 1*.

[F4 key assignment] *F n 4*

Function key 4.

Identical to **[F1 key assignment]** *F n 1*.

Section 11.9 [LCD settings]

[LCD settings] *L n L - Menu*

Access

[My preferences] → [LCD settings]

About This Menu

This menu allows to set the Graphic Display Terminal related parameters.

[Screen Contrast] *L 5 L*

Screen contrast setting.

Setting	Description
0...100%	Setting range Factory setting: 50%

[Standby] *5 b Y*

Stand-by delay.

NOTE: Disabling the automatic standby function of the display terminal backlight will reduce the backlight service time.

Setting	Description
<i>n a</i> ...10 min	Automatic backlight OFF time Factory setting: 10 min

[Display Terminal locked] *K L L K*

Graphic Display Terminal key locked. Press **ESC** and **Home** keys to Lock manually & unlock the Graphic Display Terminal keys. The **Stop** key remains active when the Graphic Display Terminal is locked.

Setting ()	Description
<i>n a</i> ...10 min	Setting range Factory setting: 5 min

[Red Backlight] *b L K L ★*

Graphic Display Terminal red backlight function disabled in case or an error triggered.

Setting ()	Code / Value	Description
[No]	<i>n a</i>	Red backlight disabled
[Yes]	<i>Y E 5</i>	Red backlight enabled Factory setting

Section 11.10

[Stop and go]

[Stop and go] S E G - Menu

Access

[My preferences] → [Stop and go]

About This Menu

This function is available for drives from frame size 4 to 7. When the function is active, the DC bus voltage is no longer maintained at operational level in order to save energy. When the drive is in energy saving state, the next run command shall be delayed up to 1 second during the DC bus charge.

[Energy Saving Delay] , d L Π

Wait time before going to [Energy Saving] , d L E mode after motor is stopped.

At power-on, if [Energy Saving Delay] , d L Π is not set to [No] n o , the drive goes directly to [Energy Saving] , d L E

The value [No] n o deactivate the function.

Setting	Description
[No] n o ...32,400 s	Setting range Factory setting: n o

[Energy Saving Assign] , d L 5

Energy saving mode digital input assignment.

At active state rising edge, the drive switches to energy saving state if the motor is stopped without a run command active. A falling edge switch the drive to normal operation.

Setting	Code / Value	Description
[Not Assigned]	n o	Not assigned Factory setting
[DI1]...[DI8]	L , I ... L , B	Digital input DI1...DI8
[DI11]...[DI16]	L , I I ... L , I B	Digital input DI11...DI16 if VW3A3203 I/O extension module has been inserted
[CD00]...[CD10]	C d 0 0 ... C d 1 0	Virtual digital input CMD.0...CMD.10 in [I/O profile] , o configuration
[CD11]...[CD15]	C d 1 1 ... C d 1 5	Virtual digital input CMD.11...CMD.15 regardless of configuration
[C101]...[C110]	C 1 0 1 ... C 1 1 0	Virtual digital input CMD1.01...CMD1.10 with integrated Modbus Serial in [I/O profile] , o configuration
[C111]...[C115]	C 1 1 1 ... C 1 1 5	Virtual digital input CMD1.11...CMD1.15 with integrated Modbus Serial regardless of configuration
[C201]...[C210]	C 2 0 1 ... C 2 1 0	Virtual digital input CMD2.01...CMD2.10 with CANopen® fieldbus module in [I/O profile] , o configuration
[C211]...[C215]	C 2 1 1 ... C 2 1 5	Virtual digital input CMD2.11...CMD2.15 with CANopen® fieldbus module regardless of configuration
[C301]...[C310]	C 3 0 1 ... C 3 1 0	Virtual digital input CMD3.01...CMD3.10 with a fieldbus module in [I/O profile] , o configuration
[C311]...[C315]	C 3 1 1 ... C 3 1 5	Virtual digital input CMD3.11...CMD3.15 with a fieldbus module regardless of configuration
[C501]...[C510]	C 5 0 1 ... C 5 1 0	Virtual digital input CMD5.01...CMD5.10 with integrated Ethernet in [I/O profile] , o configuration
[C511]...[C515]	C 5 1 1 ... C 5 1 5	Virtual digital input CMD5.11...CMD5.15 with integrated Ethernet regardless of configuration

[Egy Saving Timeout] , d L t

Energy Saving Timeout.

If the value of the parameter [Egy Saving Timeout] , d L t is increased, the run command can be delayed for the amount of time set by the parameter **[Egy Saving Timeout] , d L t** as long as the condition to leave **[Energy Saving] , d L E** state is not fulfilled (for example, but not limited to, undervoltage or overvoltage of the supply mains).

⚠ WARNING

UNANTICIPATED EQUIPMENT

Verify that the modification of the setting of this parameter does not result in unsafe conditions.

Failure to follow these instructions can result in death, serious injury, or equipment damage.

After **[Egy Saving Timeout] , d L t** time, if the drive is still in **[Energy Saving] , d L E** mode, the error **[Egy Saving Exit Error] , d L F** is triggered

NOTE: The factory setting value is changed to 8 s for ATV980 and ATV9B0.

Setting	Description
1...999 s	Setting range Factory setting: 5 s

Section 11.11

[QR code]

[QR code] 9 F C - Menu

Access

[My preferences] → [QR code]

About This Menu

This menu gives access to a QR Codes on the Graphic Display Terminal.

[QR Code] 9 C C

Scan of this QR code brings to a landing page on Internet with the information on:

- Technical product datasheet,
- Link for Schneider Electric App available for services.

Section 11.12

[QR code] - [My link 1]

[My link 1] 7 9 L 1 - Menu

Access

[My preferences] → [QR code] → [My link 1]

About This Menu

This menu gives access to a QR Code customized with the commissioning software.

[MyLink 1] 9 L 1

Section 11.13

[QR code] - [My link 2]

[My link 2] 11.13 - Menu

Access

[My preferences] → [QR code] → [My link 2]

About This Menu

This menu gives access to a QR Code customized with the commissioning software.

[MyLink 2] 11.13

Section 11.14

[QR code] - [My link 3]

[My link 3] ПУЛ Э - Menu

Access

[My preferences] → [QR code] → [My link 3]

About This Menu

This menu gives access to a QR Code customized with the commissioning software.

[MyLink 3] 9 L Э

Section 11.15

[QR code] - [My link 4]

[My link 4] ПУЛ 4 - Menu

Access

[My preferences] → [QR code] → [My link 4]

About This Menu

This menu gives access to a QR Code customized with the commissioning software.

[MyLink 4] 9 L 4

Section 11.16

[Pairing password]

[Pairing password] P P ,

Access

[My preferences] → [Pairing password]

About This Menu

This function can only be accessed in Expert mode. This function is used to detect whenever an option module has been replaced or the software has been modified in any way. When a pairing password is entered, the parameters of the option modules currently inserted are stored. On every subsequent power-up, these parameters are verified and, in the event of a discrepancy, the drive locks in **[Boards Compatibility] H C F**. Before the drive can be restarted, it is necessary to revert to the original situation or reenter the pairing password.

The following parameters are verified:

- The type of option modules.
- The software version of the drive and the option modules.
- The serial number for the control block boards.

[Pairing password] P P ,

Operation as a pair password.

Setting	Description
[OFF] 0 F F ...9,999	Setting range Factory setting: 0 F F

The [OFF] 0 F F value signifies that the pairing password function is inactive.

The [ON] 0 n value signifies that the pairing password function is active and that a password is required to start the drive in the event of a **[Boards Compatibility] H C F** detected error.

As soon as the password has been entered, the drive is unlocked and the code changes to [ON] 0 n.

Part III

Maintenance and diagnostics

What Is in This Part?

This part contains the following chapters:

Chapter	Chapter Name	Page
12	Maintenance	633
13	Diagnostics and Troubleshooting	635

Chapter 12

Maintenance

Maintenance

Limitation of Warranty

The warranty does not apply if the product has been opened, except by Schneider Electric services.

Servicing

 **DANGER**

HAZARD OF ELECTRIC SHOCK, EXPLOSION OR ARC FLASH

Read and understand the instructions in **Safety Information** chapter before performing any procedure in this chapter.

Failure to follow these instructions will result in death or serious injury.

The temperature of the products described in this manual may exceed 80 °C (176 °F) during operation.

 **WARNING**

HOT SURFACES

- Ensure that any contact with hot surfaces is avoided.
- Do not allow flammable or heat-sensitive parts in the immediate vicinity of hot surfaces.
- Verify that the product has sufficiently cooled down before handling it.
- Verify that the heat dissipation is sufficient by performing a test run under maximum load conditions.

Failure to follow these instructions can result in death, serious injury, or equipment damage.

 **WARNING**

INSUFFICIENT MAINTENANCE

Verify that the maintenance activities described below are performed at the specified intervals.

Failure to follow these instructions can result in death, serious injury, or equipment damage.

Adherence to the environmental conditions must be ensured during operation of the drive. In addition, during maintenance, verify and, if appropriate, correct all factors that may have an impact on the environmental conditions.

	Part concerned	Activity	Interval (1)
Overall condition	All parts such as housing, HMI, control block, connections, etc.	Perform a visual inspection	At least every year
Corrosion	Terminals, connectors, screws, EMC plate	Inspect and clean if required	
Dust	Terminals, fans, enclosures air inlets and air outlets, air filters of cabinet	Inspect and clean if required	
	Floor standing drives filter mats	Inspect	At least every year
		Change	At least every 4 years

(1) Maximum maintenance intervals from the date of commissioning. Reduce the intervals between maintenance to adapt maintenance to the environmental conditions, the operating conditions of the drive, and to any other factor that may influence the operation and/ or maintenance requirements of the drive.

	Part concerned	Activity	Interval (1)
Cooling	Wall mounting drives fan	Verify the fan operation	At least every year
		Replace the fan, see catalog and the instructions sheets on www.schneider-electric.com .	After 3 to 5 years, depending on the operating conditions
	Floor standing drives fan for power part and enclosure door fan	Replace the fans, see catalog and the instructions sheets on www.schneider-electric.com .	Every 35000 operating hours or every 6 years
Fastening	All screws for electrical and mechanical connections	Verify tightening torques	At least every year
<p>(1) Maximum maintenance intervals from the date of commissioning. Reduce the intervals between maintenance to adapt maintenance to the environmental conditions, the operating conditions of the drive, and to any other factor that may influence the operation and/ or maintenance requirements of the drive.</p>			

Spares and Repairs

Serviceable product. Please contact your Customer Care Center on:

www.schneider-electric.com/CCC.

Long Time Storage

If the drive was not connected to mains for an extended period of time, the capacitors must be restored to their full performance before the motor is started.

<i>NOTICE</i>
<p>REDUCED CAPACITOR PERFORMANCE</p> <ul style="list-style-type: none"> ● Apply mains voltage to the drive for one hour before starting the motor if the drive has not been connected to mains for the following periods of time: <ul style="list-style-type: none"> ○ 12 months at a maximum storage temperature of +50°C (+122°F) ○ 24 months at a maximum storage temperature of +45°C (+113°F) ○ 36 months at a maximum storage temperature of +40°C (+104°F) ● Verify that no Run command can be applied before the period of one hour has elapsed. ● Verify the date of manufacture if the drive is commissioned for the first time and run the specified procedure if the date of manufacture is more than 12 months in the past. <p>Failure to follow these instructions can result in equipment damage.</p>

If the specified procedure cannot be performed without a Run command because of internal mains contactor control, perform this procedure with the power stage enabled, but the motor being at standstill so that there is no appreciable mains current in the capacitors.

Fan Replacement

It is possible to order a new fan for the drive maintenance, see the catalog numbers on www.schneider-electric.com.

Customer Care Center

For additional support, you can contact our Customer Care Center on:

www.schneider-electric.com/CCC.

Chapter 13

Diagnostics and Troubleshooting

Overview

This chapter describes the various types of diagnostics and provides troubleshooting assistance.

 DANGER		
HAZARD OF ELECTRIC SHOCK, EXPLOSION OR ARC FLASH		
Read and understand the instructions in Safety Information chapter before performing any procedure in this chapter.		
Failure to follow these instructions will result in death or serious injury.		

What Is in This Chapter?

This chapter contains the following sections:

Section	Topic	Page
13.1	Warning Codes	636
13.2	Error Codes	639
13.3	FAQ	709

Section 13.1

Warning Codes

Warning Codes

List of Available Warnings Messages

Setting	Code	Description
[No Warning stored]	n o R	No warning stored
[Fallback Frequency]	F r F	Reaction on event: Fallback frequency
[Speed Maintained]	r L S	Reaction on event: Speed maintained
[Type of stop]	S t t	Reaction on event: Stop following [Type of stop] S t t without triggering an error
[Ref Frequency Warning]	S r R	Frequency reference reached
[Life Cycle Warn 1]	L C R 1	Life cycle warning 1 (see page 574)
[Life Cycle Warn 2]	L C R 2	Life cycle warning 2 (see page 574)
[PumpCycle warning]	P C P R	Pumpcycle monitoring warning (see page 270)
[PID error Warning]	P E E	PID error warning (see page 403)
[PID Feedback Warn]	P F R	PID feedback warning (see page 395)
[PID High Fdbck Warn]	P F R H	PID feedback high threshold reached (see page 395)
[PID Low Fdbck Warn]	P F R L	PID feedback low threshold reached (see page 395)
[Regulation Warning]	P , S H	PID feedback monitoring warning (see page 263)
[Limit Switch Reached]	L S R	Limit switch reached (see page 428)
[Slack Rope Warning]	r S d R	Slack rope warning (see page 350)
[Dynamic Load Warning]	d L d R	Dynamic load warning (see page 351)
[AI3 Th Warning]	t P 3 R	AI3 Thermal warning (see page 185)
[AI4 Th Warning]	t P 4 R	AI4 Thermal warning (see page 185)
[AI5 Th Warning]	t P 5 R	AI5 Thermal warning (see page 185)
[AI1 4-20 Loss Warning]	A P 1	AI1 4-20 mA loss warning (see page 555)
[AI3 4-20 Loss Warning]	A P 3	AI3 4-20 mA loss warning (see page 555)
[AI4 4-20 Loss Warning]	A P 4	AI4 4-20 mA loss warning (see page 555)
[AI5 4-20 Loss Warning]	A P 5	AI5 4-20 mA loss warning (see page 555)
[Drive Thermal Warning]	t H R	Drive overheating warning
[IGBT Thermal Warning]	t J R	IGBT thermal state warning
[Fan Counter Warning]	F C t R	Fan counter speed warning (see page 579)
[Fan Feedback Warning]	F F d R	Fan feedback warning (see page 579)
[BR Thermal Warning]	b o R	Braking resistor thermal warning
[Ext. Error Warning]	E F R	External error warning (see page 552)
[Undervoltage Warning]	u S R	Undervoltage warning (see page 561)
[Preventive UnderV Active]	u P R	Controlled stop threshold is reached (see page 561)
[Forced Run]	E r n	Drive in forced run (see page 550)
[Mot Freq High Thd]	F t R	Motor frequency high threshold 1 reached (see page 406)
[Mot Freq Low Thd]	F t R L	Motor frequency low threshold 1 reached (see page 406)
[Pulse Warn Thd Reached]	F 9 L R	Pulse warning threshold reached (see page 471)
[Mot Freq Low Thd 2]	F 2 R L	Motor frequency low threshold 2 reached (see page 406)
[High Speed Reached]	F L R	High speed reached warning

Setting	Code	Description
[Ref Freq High Thd reached]	r t R H	Reference frequency high threshold reached (see page 407)
[Ref Freq Low Thd reached]	r t R L	Reference frequency low threshold reached (see page 407)
[2nd Freq Thd Reached]	F 2 R	Motor frequency high threshold 2 reached (see page 406)
[Current Thd Reached]	C t R	Motor current high threshold reached (see page 406)
[Low Current Reached]	C t R L	Motor current low threshold reached (see page 406)
[High Torque Warning]	t t H R	High torque threshold reached (see page 407)
[Low Torque Warning]	t t L R	Low torque threshold reached (see page 408)
[Process Undld Warning]	u L R	Underload warning (see page 466)
[Process Overload Warning]	o L R	Overload warning (see page 468)
[Torque Limit Reached]	S S R	Torque limit reached (see page 568)
[Torque Control Warning]	r t R	Torque control warning (see page 438)
[Drv Therm Thd reached]	t R d	Drive thermal threshold reached (see page 569)
[Motor Therm Thd reached]	t S R	Motor thermal threshold reached (see page 407)
[Mot2 Therm Thd reached]	t S 2	Motor 2 thermal threshold reached (see page 407)
[Mot3 Therm Thd reached]	t S 3	Motor 3 thermal threshold reached (see page 407)
[Mot4 Therm Thd reached]	t S 4	Motor 4 thermal threshold reached (see page 407)
[Power High Threshold]	P t H R	Power high threshold reached
[Power Low Threshold]	P t H L	Power low threshold reached
[Cust Warning 1]	C R S 1	Customer warning 1 active (see page 575)
[Cust Warning 2]	C R S 2	Customer warning 2 active (see page 576)
[Cust Warning 3]	C R S 3	Customer warning 3 active (see page 576)
[Cust Warning 4]	C R S 4	Customer warning 4 active (see page 577)
[Cust Warning 5]	C R S 5	Customer warning 5 active (see page 577)
[AFE Mains Undervoltage]	u r R	AFE mains undervoltage
[Power Cons Warning]	P o W d	Power consumption warning
[Slipping warn]	R n R	Slipping warning (see page 566)
[Load Mvt Warn]	b S R	Load movement warning
[Brake Cont Warn]	b C R	Brake contact warning (see page 336)
[AI1 Th Warning]	t P I R	AI1 Thermal warning (see page 185)
[Backspin Active]	b S C	Backspin control function is active (see page 267)
[MonitorCircuit A Warn]	, W R	Monitoring circuit A warning (see page 582)
[MonitorCircuit B Warn]	, W b	Monitoring circuit B warning (see page 583)
[MonitorCircuit C Warn]	, W C	Monitoring circuit C warning (see page 584)
[MonitorCircuit D Warn]	, W d	Monitoring circuit D warning (see page 584)
[CabinetCircuit A Warn]	C W R	Cabinet circuit A warning (see page 585)
[CabinetCircuit B Warn]	C W b	Cabinet circuit B warning (see page 585)
[CabinetCircuit C Warn]	C W C	Cabinet circuit C warning (see page 586)
[MotorWinding A Warn]	t W R	Motor winding A warning (see page 586)
[MotorWinding B Warn]	t W b	Motor winding B warning (see page 587)
[MotorBearing A Warn]	t W C	Motor bearing A warning (see page 587)
[MotorBearing B Warn]	t W d	Motor bearing B warning (see page 588)
[Circuit Breaker Warn]	C b W	Circuit breaker warning (see page 588)
[Cab I/O 24V Warn]	P 2 4 C	Cabinet I/O 24V missing warning
[AFE Motor Limitation]	C L , P	AFE motor limitation (see page 453)
[AFE Generator Limitation]	C L , G	AFE regen limitation (see page 453)
[AFE Sensor thermal state]	t H S R	AFE thermal state warning
[AFE IGBT thermal state]	t H J R	AFE IGBT thermal warning
[Cabinet Fan Fdbck Warn]	F F C R	Cabinet fan feedback warning (see page 579)

Setting	Code	Description
[Cabinet Fan Counter Warn]	<i>F C C R</i>	Cabinet fan counter warning (<i>see page 579</i>)
[Cabinet Overheat Warn]	<i>C H R</i>	Cabinet overheat warning
[CMI Jumper Warn]	<i>C M , J</i>	CMI jumper warning
[AFE Fan Counter Warn]	<i>F C b R</i>	AFE fan counter warning (<i>see page 579</i>)
[AFE Fan Fdbck Warn]	<i>F F b R</i>	AFE fan feedback warning (<i>see page 579</i>)
[M/S Device Warn]	<i>M S d R</i>	Master/Slave device warning (<i>see page 273</i>)
[Backlash Warn]	<i>b S 9 R</i>	Backlash warning (<i>see page 312</i>)
[Encoder Thermal Warn]	<i>E P E R</i>	Encoder module thermal warning (<i>see page 185</i>)
[Temp Sens AI1 Warn]	<i>E S 1 R</i>	Temperature sensor AI1 warning (open circuit)
[Temp Sens AI3 Warn]	<i>E S 3 R</i>	Temperature sensor AI3 warning (open circuit)
[Temp Sens AI4 Warn]	<i>E S 4 R</i>	Temperature sensor AI4 warning (open circuit)
[Temp Sens AI5 Warn]	<i>E S 5 R</i>	Temperature sensor AI5 warning (open circuit)
[DC Bus Ripple Warn]	<i>d C r W</i>	DC Bus Ripple Warning (<i>see page 219</i>)

Section 13.2

Error Codes

What Is in This Section?

This section contains the following topics:

Topic	Page
Overview	643
[AFE Modulation Rate Error] <i>A C F 1</i>	644
[AFE Current Control Error] <i>A C F 2</i>	644
[Load slipping] <i>A n F</i>	645
[Angle error] <i>A S F</i>	645
[Brake Control] <i>b L F</i>	646
[Brake Resistor ovid] <i>b o F</i>	646
[Brake Feedback] <i>b r F</i>	647
[Backlash Error] <i>b S 9 F</i>	647
[DB unit sh. circuit] <i>b u F</i>	648
[DB unit op. circuit] <i>b u F o</i>	648
[BUO Overheat error] <i>b u H F</i>	649
[BUO Overcurrent error] <i>b u o C</i>	649
[Circuit Breaker Error] <i>C b F</i>	650
[CabinetCircuit A Error] <i>C F A</i>	650
[CabinetCircuit B Error] <i>C F b</i>	651
[CabinetCircuit C Error] <i>C F C</i>	651
[Incorrect Configuration] <i>C F F</i>	652
[Invalid Configuration] <i>C F , 1</i>	652
[Conf Transfer Error] <i>C F , 2</i>	653
[Pre-settings Transfer Error] <i>C F , 3</i>	653
[Empty Configuration] <i>C F , 4</i>	654
[Cabinet Overheat Error] <i>C H F</i>	654
[Fieldbus Com Interrupt] <i>C n F</i>	655
[CANopen Com Interrupt] <i>C o F</i>	655
[Precharge Capacitor] <i>C r F 1</i>	656
[AFE contactor fdbk error] <i>C r F 3</i>	656
[Channel Switch Error] <i>C S F</i>	657
[Dynamic Load Error] <i>d L F</i>	657
[DC Bus Ripple Error] <i>d C r E</i>	658
[Encoder Coupling] <i>E C F</i>	658
[EEPROM Control] <i>E E F 1</i>	659
[EEPROM Power] <i>E E F 2</i>	659
[Encoder] <i>E n F</i>	660
[External Error] <i>E P F 1</i>	660
[Fieldbus Error] <i>E P F 2</i>	661
[Embd Eth Com Interrupt] <i>E t H F</i>	661
[Out Contact Closed Error] <i>F C F 1</i>	662
[Out Contact Opened Error] <i>F C F 2</i>	662
[FDR 1 Error] <i>F d r 1</i>	663

Topic	Page
[FDR 2 Error] <i>F d r 2</i>	663
[Firmware Update Error] <i>F W E r</i>	664
[Boards Compatibility] <i>H C F</i>	664
[Egy Saving Exit Error] <i>i d L F</i>	665
[MonitorCircuit A Error] <i>i F A</i>	665
[MonitorCircuit B Error] <i>i F b</i>	666
[MonitorCircuit C Error] <i>i F C</i>	666
[MonitorCircuit D Error] <i>i F d</i>	667
[Input Overheating] <i>i H F</i>	667
[Internal Link Error] <i>i L F</i>	668
[Internal Error 0] <i>i n F 0</i>	668
[Internal Error 1] <i>i n F 1</i>	668
[Internal Error 2] <i>i n F 2</i>	669
[Internal Error 3] <i>i n F 3</i>	669
[Internal Error 4] <i>i n F 4</i>	669
[Internal Error 6] <i>i n F 6</i>	670
[Internal Error 7] <i>i n F 7</i>	670
[Internal Error 8] <i>i n F 8</i>	670
[Internal Error 9] <i>i n F 9</i>	671
[Internal Error 10] <i>i n F A</i>	671
[Internal Error 11] <i>i n F b</i>	671
[Internal Error 12] <i>i n F C</i>	672
[Internal Error 13] <i>i n F d</i>	672
[Internal Error 14] <i>i n F E</i>	672
[Internal Error 15] <i>i n F F</i>	673
[Internal Error 16] <i>i n F G</i>	673
[Internal Error 17] <i>i n F H</i>	673
[Internal Error 18] <i>i n F i</i>	674
[Internal Error 19] <i>i n F J</i>	674
[Internal Error 20] <i>i n F K</i>	674
[Internal Error 21] <i>i n F L</i>	675
[Internal Error 22] <i>i n F M</i>	675
[Internal Error 23] <i>i n F n</i>	675
[Internal Error 25] <i>i n F P</i>	676
[Internal Error 27] <i>i n F r</i>	676
[Internal Error 28] <i>i n F S</i>	676
[Internal Error 29] <i>i n F t</i>	677
[Internal Error 30] <i>i n F u</i>	677
[Internal Error 31] <i>i n F v</i>	677
[Internal Error 32] <i>i n F w</i>	678
[Input Contactor] <i>L C F</i>	678
[AI1 4-20mA loss] <i>L F F 1</i>	679
[AI3 4-20mA loss] <i>L F F 3</i>	679
[AI4 4-20mA loss] <i>L F F 4</i>	680
[AI5 4-20mA loss] <i>L F F 5</i>	680
[AFE Bus Ref Error] <i>M d F</i>	681

Topic	Page
[Load Mvt Error] <i>Π d C F</i>	681
[MultiDrive Link Error] <i>Π d L F</i>	682
[Mains Freq Out Of Range] <i>Π F F</i>	682
[M/S Device Error] <i>Π S d F</i>	683
[DC Bus Overvoltage] <i>α b F</i>	683
[AFE Bus unbalancing] <i>α b F 2</i>	684
[Overcurrent] <i>α C F</i>	684
[Drive Overheating] <i>α H F</i>	685
[Process Overload] <i>α L C</i>	685
[Motor Overload] <i>α L F</i>	686
[Single Output Phase Loss] <i>α P F 1</i>	686
[Output Phase Loss] <i>α P F 2</i>	687
[Supply Mains Overvoltage] <i>α S F</i>	687
[Cab I/O 24V Error] <i>P 2 4 C</i>	688
[PumpCycle Start Error] <i>P C P F</i>	688
[PID Feedback Error] <i>P F Π F</i>	689
[Program Loading Error] <i>P G L F</i>	689
[Program Running Error] <i>P G r F</i>	690
[Input phase loss] <i>P H F</i>	690
[Rotation Angle Monit] <i>r R d F</i>	691
[Safety Function Error] <i>S A F F</i>	691
[Motor short circuit] <i>S C F 1</i>	692
[Ground Short Circuit] <i>S C F 3</i>	692
[IGBT Short Circuit] <i>S C F 4</i>	693
[Motor Short Circuit] <i>S C F 5</i>	693
[AFE ShortCircuit error] <i>S C F 6</i>	694
[Modbus Com Interruption] <i>S L F 1</i>	694
[PC Com Interruption] <i>S L F 2</i>	695
[HMI Com Interruption] <i>S L F 3</i>	695
[Motor Overspeed] <i>S α F</i>	696
[Encoder Feedback Loss] <i>S P F</i>	696
[Torque timeout] <i>S r F</i>	697
[Torque Limitation Error] <i>S S F</i>	697
[Motor Stall Error] <i>S t F</i>	698
[AI1 Thermal Sensor Error] <i>t 1 C F</i>	698
[AI3 Thermal Sensor Error] <i>t 3 C F</i>	699
[AI4 Thermal Sensor Error] <i>t 4 C F</i>	699
[AI5 Thermal Sensor Error] <i>t 5 C F</i>	700
[Encoder Th Sensor Error] <i>t E C F</i>	700
[MotorWinding A Error] <i>t F A</i>	701
[MotorWinding B Error] <i>t F b</i>	701
[MotorBearing A Error] <i>t F C</i>	702
[MotorBearing B Error] <i>t F d</i>	702
[AI1 Th Level Error] <i>t H 1 F</i>	703
[AI3 Th Level Error] <i>t H 3 F</i>	703
[AI4 Th Level Error] <i>t H 4 F</i>	704

Topic	Page
[AI5 Th Level Error] <i>£ H 5 F</i>	704
[Encoder Th Detected Error] <i>£ H E F</i>	705
[IGBT Overheating] <i>£ J F</i>	705
[AFE IGBT over-heat error] <i>£ J F 2</i>	706
[Drive Overload] <i>£ L 0 F</i>	706
[Autotuning Error] <i>£ n F</i>	707
[Process Underload] <i>μ L F</i>	707
[AFE Mains Undervoltage] <i>μ r F</i>	708
[Supply Mains UnderV] <i>μ 5 F</i>	708

Overview

Clearing the Detected Error

This table presents the steps to follow if intervention on the drive system is required:

Step	Action
1	Disconnect all power, including external control power that may be present.
2	Lock all power disconnects in the open position.
3	Wait 15 minutes to allow the DC bus capacitors to discharge (the drive LEDs are not indicators of the absence of DC bus voltage).
4	Measure the voltage of the DC bus between the PA/+ and PC/- terminals to ensure that the voltage is less than 42 Vdc.
5	If the DC bus capacitors do not discharge completely, contact your local Schneider Electric representative. Do not repair or operate the drive.
6	Find and correct the cause of the detected error.
7	Restore power to the drive to confirm that the detected error has been rectified.

After the cause has been removed, the detected error can be cleared by:

- Switching off the drive.
- Using the **[Product Restart]** $r P$ parameter.
- Using the digital input or the control bit assigned to **[Prod Restart Assign]** $r P A$.
- Using the **[Auto Fault Reset]** $A E r$ - function.
- A digital input or control bit set to the **[Fault reset]** $r 5 E$ - function.
- Pressing the **STOP/RESET** key on the Graphic Display Terminal depending on the setting of **[Stop Key Enable]** $P 5 E$.

How To Clear the Error Code?

The following table summarizes the possibilities to clear a detected error:

How to clear the error code after the cause has been removed	List of the cleared error
<ul style="list-style-type: none"> • Switch off the drive. • Use the [Product Restart] $r P$ parameter. • Use the digital input or the control bit assigned to [Prod Restart Assign] $r P A$. 	All detected error.
<ul style="list-style-type: none"> • As soon as its cause has been removed. 	CFF, CFI, CF12, CF13, CF14, CSF, FWER, HCF, PGLF, PHF, URF, USF
<ul style="list-style-type: none"> • Use the digital input or the control bit assigned to [Fault Reset Assign] $r 5 F$. • Press the STOP/RESET key. 	ACF1, ACF2, ANF, ASF, BRf, BSQF, ECF, ENF, MDCF, MDF, MFF, SOF, SPF, TNF
<ul style="list-style-type: none"> • Use the digital input or the control bit assigned to [Fault Reset Assign] $r 5 F$. • Press the STOP/RESET key. • Use the [Auto Fault Reset] $A E r$ - function. 	BLF, BOF, BUHF, CFA, CFB, CFC, CHF, CNF, COF, DLF, EPF1, EPF2, ETHF, FCF2, FDR1, FDR2, IDLF, IFA, IFB, IFC, IFD, IHF, INF9, INFB, INFD, INFV, LCF, LFF1, LFF3, LFF4, LFF5, MDLF, MSDF, OBF, OBF2, OHF, OLC, OLF, OPF1, OPF2, OSF, P24C, PCPF, PFMF, RADF, SCF4, SCF5, SLF1, SLF2, SLF3, SRF, SSF, STF, T1CF, T3CF, T4CF, T5CF, TECF, TFA, TFB, TFC, TFD, TH1F, TH3F, TH4F, TH5F, THEF, TJF, TJF2, TLOF, ULF

[AFE Modulation Rate Error] *A C F 1*



Probable Cause

Mains voltage is on a low limit, the modulation rate of the AFE increases to help protect the DC link capacitors the **[AFE Modulation Rate Error] *A C F 1*** is triggered.



Remedy

- Verify mains voltage.
- Verify parameter setting for mains voltage.



Clearing the Error Code

This detected error can be cleared manually with the **[Fault Reset Assign] *r 5 F*** parameter after the cause has been removed.

[AFE Current Control Error] *A C F 2*



Probable Cause

Mains voltage interruption.



Remedy

- Verify mains voltage.
- Reduce number of voltage drop-downs.



Clearing the Error Code

This detected error can be cleared manually with the **[Fault Reset Assign] *r 5 F*** parameter after the cause has been removed.

[Load slipping] A n F**Probable Cause**

Not following the ramp. The difference between the output frequency and the speed feedback is not correct.

**Remedy**

- Confirm the drive rating according to the application (motor, load, and so on.)
- Verify the motor, gain, and stability parameters.
- Add a braking resistor.
- Verify the mechanical coupling and wiring of the encoder.
- If the torque control function is used and if the encoder is assigned to speed feedback,
 - Set **[Load slip detection] S d d = [No] n a**.
 - Set both **[Positive deadband] d b P** and **[Negative deadband] d b n** to a value less than 10% of the nominal motor frequency.

**Clearing the Error Code**

This detected error can be cleared manually with the **[Fault Reset Assign] r 5 F** parameter after the cause has been removed.

[Angle error] A 5 F**Probable Cause**

For synchronous motors, incorrect setting of the speed loop when the reference goes through 0.

**Remedy**

- Verify the speed loop parameters.
- Verify the motor phases and the maximum current allowed by the drive.

**Clearing the Error Code**

This detected error can be cleared manually with the **[Fault Reset Assign] r 5 F** parameter after the cause has been removed.

[Brake Control] b L F



Probable Cause

- Brake release current not reached.
- The torque set point is not reached.
- The fluxing current is not stable.



Remedy

- Verify the drive/motor connection.
- Verify the motor windings.
- Verify the **[Brk Release Current] i b r** and **[Brake release I Rev] i r d** settings.



Clearing the Error Code

This detected error can be cleared with the **[Auto Fault Reset] A L r** or manually with the **[Fault Reset Assign] r 5 F** parameter after the cause has been removed.

[Brake Resistor ovid] b o F



Probable Cause

The braking resistor is overloaded



Remedy

- Wait for the braking resistor to cool down.
- Verify the nominal power of the braking resistor.
- Verify the **[Braking Resistor Power] b r P** and **[Braking Resistor Value] b r V** parameters.



Clearing the Error Code

This detected error can be cleared with the **[Auto Fault Reset] A L r** or manually with the **[Fault Reset Assign] r 5 F** parameter after the cause has been removed.

[Brake Feedback] b r F**Probable Cause**

- The status of the brake feedback contact or the status of the brake relay feedback is not correct compared to the brake logic control.
- The brake does not stop the motor quickly enough (detected by measuring the speed on the "Pulse input" input).

**Remedy**

- Verify the brake feedback circuit.
- Verify the brake logic control circuit.
- Verify the brake behavior.
- Verify that the setting of **[Brake Release Time] b r L** and **[Brake Engage Time] BET** take into account the brake response time, **[Brake Fdbk Filter] F b C**, and **[Brake Rly Fdbk Filter] F b r i**.

**Clearing the Error Code**

This detected error can be cleared manually with the **[Fault Reset Assign] r S F** parameter after the cause has been removed.

[Backlash Error] b S 9 F**Probable Cause**

The torque threshold used for backlash function can not be reached after **[BL Monit Delay] b 9 L**.

**Remedy**

- Verify the settings
- Verify the coupling

**Clearing the Error Code**

This detected error can be cleared manually with the **[Fault Reset Assign] r S F** parameter after the cause has been removed.

[DB unit sh. circuit] *b u F*



Probable Cause

- Short-circuit from braking unit.
- Braking unit not connected. (not applicable for drive system braking unit option).



Remedy

- Verify the wiring of the braking unit.
- Verify that the braking unit value is not too low.



Clearing the Error Code

This detected error requires a power reset.

[DB unit op. circuit] *b u F □*



Probable Cause

- Open-circuit from braking unit and/or braking resistor.
- Low current from braking unit and/or braking resistor.
- Braking unit not connected and/or braking resistor.



Remedy

- Verify the wiring of the braking unit and braking resistor.
- Verify that the total resistance value of the braking resistor is not too high.



Clearing the Error Code

This detected error requires a power reset.

[BUO Overheat error] b u H F**Probable Cause**

The cabinet thermal switch of the braking unit option is at active state, the fan cabinet has been switched on but there is no fan feedback.

The digital inputs DI50 and DI51 of supply units equipped with Cabinet IO are configured as cabinet temperature monitoring. If the enclosure thermo switch opens in case of over temperature, the **[BUO Overheat Error] b u H F** is triggered. Or the braking unit option internal temperature is too high.

**Remedy**

- Verify the braking unit option cabinet fan and its wiring.
- Verify the temperature in the braking unit option enclosure is not too high.
- Verify the setting of the thermo switch of the BUO (must be 60 °C (140 °F)).
- Verify the BUO load, the ventilation, and the ambient temperature. Wait for the supply unit to cool down before restarting.

**Clearing the Error Code**

This detected error can be cleared with the **[Auto Fault Reset] A L r** or manually with the **[Fault Reset Assign] r 5 F** parameter after the cause has been removed.

[BUO Overcurrent error] b u o C**Probable Cause**

- Parameters in the **[Braking Resistor monit] b r P** - menu are not correct.
- Braking load too high.

**Remedy**

- Verify the braking unit parameters.
- Check the braking resistor.

**Clearing the Error Code**

This detected error requires a power reset.

[Circuit Breaker Error] *L C F***Probable Cause**

The DC bus voltage level is not correct compared to the circuit breaker logic control (start or stop pulse) after the configured timeout **[Mains V. time out] *L C E***.

**Remedy**

- Verify the circuit breaker logic control (pulse time for start and stop).
- Verify the mechanical state of the circuit breaker.

**Clearing the Error Code**

This detected error requires a power reset.

[CabinetCircuit A Error] *L F R***Probable Cause**

The monitoring function has detected an error. The digital input assigned to **[CabinetCircuit A Assign] *L F R R*** is active when the detected error duration is longer than **[CabinetCircuit A Delay] *F d R***.

**Remedy**

- Identify the cause of detection.
- Verify the connected device (door switch, thermal switch,...) and its wiring.
- Verify the **[CabinetCircuit A Assign] *L F R R*** parameter assignment.

**Clearing the Error Code**

This detected error can be cleared with the **[Auto Fault Reset] *R E r*** or manually with the **[Fault Reset Assign] *r S F*** parameter after the cause has been removed.

[CabinetCircuit B Error] *C F B***Probable Cause**

The monitoring function has detected an error. The digital input assigned to **[CabinetCircuit B Assign] *C F B*** is active when the detected error duration is longer than **[CabinetCircuit B Delay] *F d B***.

**Remedy**

- Identify the cause of detection.
- Verify the connected device (door switch, thermal switch,...) and its wiring.
- Verify the **[CabinetCircuit B Assign] *C F B*** parameter assignment.

**Clearing the Error Code**

This detected error can be cleared with the **[Auto Fault Reset] *A E r*** or manually with the **[Fault Reset Assign] *r S F*** parameter after the cause has been removed.

[CabinetCircuit C Error] *C F C***Probable Cause**

The monitoring function has detected an error. The digital input assigned to **[CabinetCircuit C Assign] *C F C*** is active when the detected error duration is longer than **[CabinetCircuit C Delay] *F d C***.

**Remedy**

- Identify the cause of detection.
- Verify the connected device (door switch, thermal switch,...) and its wiring.
- Verify the **[CabinetCircuit C Assign] *C F C*** parameter assignment.

**Clearing the Error Code**

This detected error can be cleared with the **[Auto Fault Reset] *A E r*** or manually with the **[Fault Reset Assign] *r S F*** parameter after the cause has been removed.

[Incorrect Configuration] C F F



Probable Cause

- Option module changed or removed.
- Control block replaced by a control block configured on a drive with a different rating.
- The current configuration is inconsistent.



Remedy

- Verify that there is no detected error on the option module.
- In the event of the control block being changed deliberately, see the remarks below.
- Return to factory settings or retrieve the backup configuration if it is valid.



Clearing the Error Code

This detected error is cleared as soon as its cause has been removed.

[Invalid Configuration] C F I



Probable Cause

Invalid configuration. The configuration loaded in the drive via the commissioning tool or fieldbus is inconsistent.



Remedy

- Verify the loaded configuration.
- Load a valid configuration.



Clearing the Error Code

This detected error is cleared as soon as its cause has been removed.

[Conf Transfer Error] [F , 2



Probable Cause

- The configuration transfer to the drive was not successful or interrupted.
- The configuration loaded is not compatible with the drive.



Remedy

- Verify the configuration loaded previously.
- Load a compatible configuration.
- Use PC software commissioning tool to transfer a compatible configuration
- Perform a factory setting



Clearing the Error Code

This detected error is cleared as soon as its cause has been removed.

[Pre-settings Transfer Error] [F , 3



Probable Cause

The configuration transfer to the drive was not successful or interrupted.



Remedy

Contact your local Schneider Electric representative.



Clearing the Error Code

This detected error is cleared as soon as its cause has been removed.

[Empty Configuration] C F , 4**Probable Cause**

The selected configuration for the **[Multimotors config] P P C** - function has not been created previously.

**Remedy**

- Verify the configurations saved.
- Switch to a compatible configuration.

**Clearing the Error Code**

This detected error is cleared as soon as its cause has been removed.

[Cabinet Overheat Error] C H F**Probable Cause**

The cabinet thermal switch is at active state, the cabinet fan(s) has been switched on but there is no fan feedback.

The digital inputs DI50 and DI51 of drives equipped with Cabinet IO are configured as cabinet temperature monitoring. If the enclosure thermo switch opens in case of over temperature, the **[Cabinet Overheat Error] C H F** is triggered.

This error can be triggered only in RUN state. On other state, the **[Cabinet Overheat Warn] C H W** is active.

**Remedy**

- Verify cabinet fan(s) and its wiring.
- Verify the temperature in the enclosure is not too high.
- Verify the setting of the thermosthich (must be 60°C (140°F))

**Clearing the Error Code**

This detected error can be cleared with the **[Auto Fault Reset] R E r** or manually with the **[Fault Reset Assign] r S F** parameter after the cause has been removed.

[Fieldbus Com Interrupt] E n F**Probable Cause**

Communication interruption on fieldbus module.

This error is triggered when the communication between the fieldbus module and the master (PLC) is interrupted.

**Remedy**

- Verify the environment (electromagnetic compatibility).
- Verify the wiring.
- Verify the timeout.
- Replace the option module.
- Contact your local Schneider Electric representative

**Clearing the Error Code**

This detected error can be cleared with the **[Auto Fault Reset] R E r** or manually with the **[Fault Reset Assign] r S F** parameter after the cause has been removed.

[CANopen Com Interrupt] E o F**Probable Cause**

Communication interruption on the CANopen® fieldbus

**Remedy**

- Verify the communication fieldbus.
- Verify the timeout.
- Refer to the CANopen® user manual.

**Clearing the Error Code**

This detected error can be cleared with the **[Auto Fault Reset] R E r** or manually with the **[Fault Reset Assign] r S F** parameter after the cause has been removed.

[Precharge Capacitor] *C r F I*



Probable Cause

- Charging circuit control detected error or charging resistor damaged.



Remedy

- Turn off the drive and then turn on again.
- Verify the setting of **[DC Bus Source Type]** *d C b 5*
- Verify the internal connections.
- Contact your local Schneider Electric representative



Clearing the Error Code

This detected error requires a power reset.

[AFE contactor fdbk error] *C r F 3*



Probable Cause

- The mains contactor feedback is inactive during DC Bus charging phase.
- The mains contactor feedback becomes inactive without mains phase loss detection while the drive is in operation (Ready or Run state).



Remedy

- Verify the feedback circuit.
- Verify the mechanical state of the mains contactor.



Clearing the Error Code

This detected error requires a power reset.

[Channel Switch Error] C 5 F**Probable Cause**

Switch to an invalid channel.

**Remedy**

Verify the function parameters.

**Clearing the Error Code**

This detected error is cleared as soon as its cause has been removed.

[Dynamic Load Error] d L F**Probable Cause**

Load variation out of range.

**Remedy**

Verify for a mechanical cause of load instability.

**Clearing the Error Code**

This detected error can be cleared with the **[Auto Fault Reset] A E r** or manually with the **[Fault Reset Assign] r 5 F** parameter after the cause has been removed.

[DC Bus Ripple Error] d C r E**Probable Cause**

Persistent ripple observed on the DC bus or DC bus capacitors damaged.

**Remedy**

- Turn off the drive and then turn on again.
- Verify correct behavior of the input filter.
- Verify the mains wirings.
- Verify the internal connections.
- Contact your local Schneider Electric representative.

**Clearing the Error Code**

This detected error requires a power reset.

[Encoder Coupling] E C F**Probable Cause**

The mechanical coupling of the encoder is broken.

The detection is active when **[Encoder Coupling Monit] E C C** parameter is set to **[Yes] Y E 5**.

It triggers the error when the speed feedback is 0 and the drive is in torque or current limitation.

The limits for speed feedback are:

- 5 Hz for minimum
- 10% of **[Nominal Motor Freq] F r 5** for maximum
- Verify the setting of **[Encoder Coupling Monit] E C C** parameter.
- Verify the setting of **[Encoder check time] E C E** parameter.

The monitoring is not compatible with torque or current limitation functions.

**Remedy**

Verify the mechanical coupling of the encoder.

**Clearing the Error Code**

This detected error can be cleared manually with the **[Fault Reset Assign] r 5 F** parameter after the cause has been removed.

[EEPROM Control] E E F 1**Probable Cause**

An error of the internal memory of the control block has been detected.

**Remedy**

- Verify the environment (electromagnetic compatibility).
- Switch off the product.
- Return to factory settings.
- Contact your local Schneider Electric representative.

**Clearing the Error Code**

This detected error requires a power reset.

[EEPROM Power] E E F 2**Probable Cause**

An error of the internal memory of the power board has been detected.

**Remedy**

- Verify the environment (electromagnetic compatibility).
- Switch off the product.
- Return to factory settings.
- Contact your local Schneider Electric representative.

**Clearing the Error Code**

This detected error requires a power reset.

[Encoder] E n F**Probable Cause**

Encoder feedback error.

The difference between the measured and estimated speed is greater than 4% of **[Nominal Motor Freq] F r 5** or **[Sync Nominal Freq] F r 5 5**.

**Remedy**

- Verify the configuration parameters for the encoder used.
- Verify the mechanical and electrical operation of the encoder.
- Verify the consistency between the encoder signals and the direction of rotation of the motor.
- If necessary, reverse the direction of rotation of the motor (**[Output Ph rotation] P H r** parameter)
- Verify the encoder module.
- Verify the encoder type and supply voltage.

**Clearing the Error Code**

This detected error can be cleared manually with the **[Fault Reset Assign] r 5 F** parameter after the cause has been removed.

[External Error] E P F I**Probable Cause**

- Event triggered by an external device, depending on user.
- An external error has been triggered via Embedded Ethernet.

**Remedy**

Remove the cause of the external error.

**Clearing the Error Code**

This detected error can be cleared with the **[Auto Fault Reset] A E r** or manually with the **[Fault Reset Assign] r 5 F** parameter after the cause has been removed.

[Fieldbus Error] E P F 2**Probable Cause**

An external error has been triggered via fieldbus.

**Remedy**

Remove the cause of the external error.

**Clearing the Error Code**

This detected error can be cleared with the **[Auto Fault Reset] R E r** or manually with the **[Fault Reset Assign] r S F** parameter after the cause has been removed.

[Embd Eth Com Interrupt] E E H F**Probable Cause**

Communication interruption on the Ethernet IP ModbusTCP bus.

**Remedy**

- Verify the communication bus.
- Refer to the Ethernet user manual.

**Clearing the Error Code**

This detected error can be cleared with the **[Auto Fault Reset] R E r** or manually with the **[Fault Reset Assign] r S F** parameter after the cause has been removed.

[Out Contact Closed Error] F C F 1



Probable Cause

The output contactor remains closed although the opening conditions have been met.



Remedy

- Verify the output contactor and its wiring.
- Verify the contactor feedback wiring.



Clearing the Error Code

This detected error requires a power reset.

[Out Contact Opened Error] F C F 2



Probable Cause

The output contactor remains opened although the closing conditions have been met.



Remedy

Verify the output contactor and its wiring. Verify the contactor feedback wiring.



Clearing the Error Code

This detected error can be cleared with the **[Auto Fault Reset] # L r** or manually with the **[Fault Reset Assign] r 5 F** parameter after the cause has been removed.

[FDR 1 Error] *F d r 1***Probable Cause**

- Embedded Ethernet FDR error
- Communication interruption between the drive and the PLC
- Configuration file incompatible, empty or invalid
- Drive rating not consistent with the configuration file

**Remedy**

- Verify the drive and PLC connection
- Verify the communication workload
- Restart the transfer of configuration file from drive to PLC

**Clearing the Error Code**

This detected error can be cleared with the **[Auto Fault Reset] *A E r*** or manually with the **[Fault Reset Assign] *r S F*** parameter after the cause has been removed.

[FDR 2 Error] *F d r 2***Probable Cause**

- Ethernet fieldbus module FDR error
- Communication interruption between the drive and the PLC
- Configuration file incompatible, empty or corrupted
- Drive rating not consistent with the configuration file

**Remedy**

- Verify the drive and PLC connection
- Verify the communication workload
- Restart the transfer of configuration file from drive to PLC

**Clearing the Error Code**

This detected error can be cleared with the **[Auto Fault Reset] *A E r*** or manually with the **[Fault Reset Assign] *r S F*** parameter after the cause has been removed.

[Firmware Update Error] *FWE r*



Probable Cause

Firmware update function has detected an error.



Remedy

Contact your local Schneider Electric representative.



Clearing the Error Code

This detected error is cleared as soon as its cause has been removed.

[Boards Compatibility] *HCF*



Probable Cause

Hardware configuration error.

The **[Pairing password] *PP*** , parameter has been enabled and an option module has been changed.



Remedy

- Refit the original option module.
- Confirm the configuration by entering the **[Pairing password] *PP*** , if the module was changed deliberately.



Clearing the Error Code

This detected error is cleared as soon as its cause has been removed.

[Egy Saving Exit Error] , d L F**Probable Cause**

The drive is not turned on even though **[Egy Saving Timeout] , d L E** has elapsed.

**Remedy**

- Verify the Supply Mains/contactor/drive wiring.
- Verify the timeout.

**Clearing the Error Code**

This detected error can be cleared with the **[Auto Fault Reset] R E r** or manually with the **[Fault Reset Assign] r S F** parameter after the cause has been removed.

[MonitorCircuit A Error] , F R**Probable Cause**

The digital input assigned to **[MonitorCircuit A Assign] , F R R** is active for longer than **[MonitorCircuit A Delay] , F d R**.

**Remedy**

- Verify the connected device and its wiring.
- Verify the **[MonitorCircuit A Assign] , F R R** parameter assignment.

**Clearing the Error Code**

This detected error can be cleared with the **[Auto Fault Reset] R E r** or manually with the **[Fault Reset Assign] r S F** parameter after the cause has been removed.

[MonitorCircuit B Error] , F B



Probable Cause

The digital input assigned to **[MonitorCircuit B Assign] , F B** is active for longer than **[MonitorCircuit B Delay] , F d b**.



Remedy

- Verify the connected device and its wiring.
- Verify the **[MonitorCircuit B Assign] , F B** parameter assignment.



Clearing the Error Code

This detected error can be cleared with the **[Auto Fault Reset] R E r** or manually with the **[Fault Reset Assign] r S F** parameter after the cause has been removed.

[MonitorCircuit C Error] , F C



Probable Cause

The digital input assigned to **[MonitorCircuit C Assign] , F C** is active for longer than **[MonitorCircuit C Delay] , F d C**.



Remedy

- Verify the connected device and its wiring.
- Verify the **[MonitorCircuit C Assign] , F C** parameter assignment.



Clearing the Error Code

This detected error can be cleared with the **[Auto Fault Reset] R E r** or manually with the **[Fault Reset Assign] r S F** parameter after the cause has been removed.

[MonitorCircuit D Error] , F d**Probable Cause**

The digital input assigned to **[MonitorCircuit D Assign] , F R d** is active for longer than **[MonitorCircuit D Delay] , F d d**.

**Remedy**

- Verify the connected device and its wiring.
- Verify the **[MonitorCircuit D Assign] , F R d** parameter assignment.

**Clearing the Error Code**

This detected error can be cleared with the **[Auto Fault Reset] R E r** or manually with the **[Fault Reset Assign] r S F** parameter after the cause has been removed.

[Input Overheating] , H F**Probable Cause**

The AFE brick temperature is too high.

**Remedy**

Verify the drive ventilation and the ambient temperature. Wait for the drive to cool down before restarting.

**Clearing the Error Code**

This detected error can be cleared with the **[Auto Fault Reset] R E r** or manually with the **[Fault Reset Assign] r S F** parameter after the cause has been removed.

[Internal Link Error] *ILF*



Probable Cause

Communication interruption between option module and the drive.



Remedy

- Verify the environment (electromagnetic compatibility).
- Verify the connections.
- Replace the option module.
- Contact your local Schneider Electric representative.



Clearing the Error Code

This detected error requires a power reset.

[Internal Error 0] *INF0*



Probable Cause

- Communication interruption between microprocessors of the control board.
- The power board rating is not valid.



Remedy

Contact your local Schneider Electric representative.



Clearing the Error Code

This detected error requires a power reset.

[Internal Error 1] *INF1*



Probable Cause

The power board rating is not valid.



Remedy

Contact your local Schneider Electric representative.



Clearing the Error Code

This detected error requires a power reset.

[Internal Error 2] INF2**Probable Cause**

The power board is incompatible with the control block software.

**Remedy**

Contact your local Schneider Electric representative.

**Clearing the Error Code**

This detected error requires a power reset.

[Internal Error 3] INF3**Probable Cause**

Internal communication detected error.

**Remedy**

- Verify the wiring on drive control terminals (internal 10V supply for analog inputs overloaded).
- Contact your local Schneider Electric representative.

**Clearing the Error Code**

This detected error requires a power reset.

[Internal Error 4] INF4**Probable Cause**

Internal data inconsistent.

**Remedy**

Contact your local Schneider Electric representative.

**Clearing the Error Code**

This detected error requires a power reset.

[Internal Error 6] 1 n F 6



Probable Cause

- The option module installed in the drive is not recognized.
- The removable control terminal modules (if existing) are not present or not recognized.
- The embedded Ethernet adapter is not recognized.



Remedy

- Verify the catalog number and compatibility of the option module.
- Plug the removable control terminal modules after the drive has been switched off.
- Contact your local Schneider Electric representative.



Clearing the Error Code

This detected error requires a power reset.

[Internal Error 7] 1 n F 7



Probable Cause

Communication interruption with CPLD component of Control board.



Remedy

Contact your local Schneider Electric representative.



Clearing the Error Code

This detected error requires a power reset.

[Internal Error 8] 1 n F 8



Probable Cause

The internal power switching supply is not correct.



Remedy

Contact your local Schneider Electric representative.



Clearing the Error Code

This detected error requires a power reset.

[Internal Error 9] INF9**Probable Cause**

An error on the current circuit measurement has been detected.

**Remedy**

Contact your local Schneider Electric representative.

**Clearing the Error Code**

This detected error can be cleared with the **[Auto Fault Reset] ALR** or manually with the **[Fault Reset Assign] rSF** parameter after the cause has been removed.

[Internal Error 10] INF10**Probable Cause**

The input stage is not operating correctly.

**Remedy**

Contact your local Schneider Electric representative.

**Clearing the Error Code**

This detected error requires a power reset.

[Internal Error 11] INF11**Probable Cause**

The internal drive thermal sensor is not operating correctly.

**Remedy**

Contact your local Schneider Electric representative.

**Clearing the Error Code**

This detected error can be cleared with the **[Auto Fault Reset] ALR** or manually with the **[Fault Reset Assign] rSF** parameter after the cause has been removed.

[Internal Error 12] *INF C*



Probable Cause

Internal current supply error.



Remedy

Contact your local Schneider Electric representative.



Clearing the Error Code

This detected error requires a power reset.

[Internal Error 13] *INF d*



Probable Cause

Differential current deviation.



Remedy

Verify connection of DigiLink cable (GG45).
Contact your local Schneider Electric representative.



Clearing the Error Code

This detected error can be cleared with the **[Auto Fault Reset] *AE r*** or manually with the **[Fault Reset Assign] *r 5 F*** parameter after the cause has been removed.

[Internal Error 14] *INF E*



Probable Cause

Internal microprocessor detected error.



Remedy

- Verify that the error code can be cleared.
- Contact your local Schneider Electric representative.



Clearing the Error Code

This detected error requires a power reset.

[Internal Error 15] INF F**Probable Cause**

Serial memory flash format error.

**Remedy**

Contact your local Schneider Electric representative.

**Clearing the Error Code**

This detected error requires a power reset.

[Internal Error 16] INF G**Probable Cause**

Communication interruption or internal error of output relays option module

**Remedy**

- Verify that the option module is correctly connected to the slot
- Replace the option module.
- Contact your local Schneider Electric representative.

**Clearing the Error Code**

This detected error requires a power reset.

[Internal Error 17] INF H**Probable Cause**

Communication interruption with the Extension module of digital & analog I/O or internal error of the Extension module of digital & analog I/O.

**Remedy**

- Verify that the option module is correctly connected to the slot
- Replace the option module.
- Contact your local Schneider Electric representative.

**Clearing the Error Code**

This detected error requires a power reset.

[Internal Error 18] 内部故障



Probable Cause

Communication interruption with Safety function module or internal error of the Safety function module.



Remedy

- Verify that the option module is correctly connected to the slot
- Replace the option module.
- Contact your local Schneider Electric representative.



Clearing the Error Code

This detected error requires a power reset.

[Internal Error 19] 内部故障



Probable Cause

An error on the encoder module has been detected.



Remedy

- Verify if the encoder option module is connected correctly to the slot.
- Verify the compatibility of the encoder.
- Contact your local Schneider Electric representative.



Clearing the Error Code

This detected error requires a power reset.

[Internal Error 20] 内部故障



Probable Cause

Option module interface board error.



Remedy

Contact your local Schneider Electric representative.



Clearing the Error Code

This detected error requires a power reset.

[Internal Error 21] INF L**Probable Cause**

Internal Real Time Clock error. It could be a communication error between the keypad and the drive or a clock oscillator start error.

**Remedy**

Contact your local Schneider Electric representative.

**Clearing the Error Code**

This detected error requires a power reset.

[Internal Error 22] INF Π**Probable Cause**

An error on the embedded Ethernet adapter has been detected.
Unstability of external 24 Vdc supply.

**Remedy**

Verify the connection to the Ethernet port.
Contact your local Schneider Electric representative.
Verify the 24 Vdc stability.

**Clearing the Error Code**

This detected error requires a power reset.

[Internal Error 23] INF n**Probable Cause**

A communication interruption between the control block and AFE or BU bricks has been detected.

**Remedy**

Contact your local Schneider Electric representative.

**Clearing the Error Code**

This detected error requires a power reset.

[Internal Error 25] *INF P*



Probable Cause

Incompatibility between Control Board hardware version and firmware version.



Remedy

- Update the firmware package.
- Contact your local Schneider Electric representative.



Clearing the Error Code

This detected error requires a power reset.

[Internal Error 27] *INF r*



Probable Cause

Diagnostics in CPLD have detected an error.



Remedy

Contact your local Schneider Electric representative.



Clearing the Error Code

This detected error requires a power reset.

[Internal Error 28] *INF 5*



Probable Cause

An error on the AFE brick has been detected.



Remedy

Contact your local Schneider Electric representative.



Clearing the Error Code

This detected error requires a power reset.

[Internal Error 29] *INFL***Probable Cause**

An error on the power unit / inverter brick has been detected.

**Remedy**

Contact your local Schneider Electric representative.

**Clearing the Error Code**

This detected error requires a power reset.

[Internal Error 30] *INFU***Probable Cause**

An error on the rectifier brick has been detected or an **[Input phase loss] PHF** error has been triggered when the DC bus is charged.

**Remedy**

Turn off the drive and then turn on again.

If **[Input phase loss] PHF** error code replaces **[Internal Error 30] *INFU***, refer to the instructions of **[Input phase loss] PHF** error (*see page 690*) otherwise contact your local Schneider Electric representative.

**Clearing the Error Code**

This detected error requires a power reset.

[Internal Error 31] *INFLV***Probable Cause**

An error on the brick architecture has been detected (brick unavailable).

**Remedy**

Contact your local Schneider Electric representative.

**Clearing the Error Code**

This detected error can be cleared with the **[Auto Fault Reset] FLr** or manually with the **[Fault Reset Assign] rSF** parameter after the cause has been removed.

[Internal Error 32] *i n F W*



Probable Cause

Firmware update function has detected an error.



Remedy

Contact your local Schneider Electric representative.



Clearing the Error Code

This detected error requires a power reset.

[Input Contactor] *L C F*



Probable Cause

The drive is not switched on even though **[Mains V. time out] L C E** timeout has elapsed.



Remedy

- Verify the input contactor and its wiring.
- Verify the **[Mains V. time out] L C E** timeout.
- Verify the supply mains/contactor/drive wiring.



Clearing the Error Code

This detected error can be cleared with the **[Auto Fault Reset] R E r** or manually with the **[Fault Reset Assign] r 5 F** parameter after the cause has been removed.

[AI1 4-20mA loss] L F F I**Probable Cause**

Loss of the 4-20 mA on analog input AI1.
This error is triggered when the measured current is below 2 mA.

**Remedy**

- Verify the connection on the analog inputs.
- Verify the setting of **[AI1 4-20mA loss] L F L I** parameter.

**Clearing the Error Code**

This detected error can be cleared with the **[Auto Fault Reset] # L r** or manually with the **[Fault Reset Assign] r S F** parameter after the cause has been removed.

[AI3 4-20mA loss] L F F E**Probable Cause**

Loss of the 4-20 mA on analog input AI3.
This error is triggered when the measured current is below 2 mA.

**Remedy**

- Verify the connection on the analog inputs.
- Verify the setting of **[AI3 4-20mA loss] L F L E** parameter.

**Clearing the Error Code**

This detected error can be cleared with the **[Auto Fault Reset] # L r** or manually with the **[Fault Reset Assign] r S F** parameter after the cause has been removed.

[AI4 4-20mA loss] L F F 4



Probable Cause

Loss of the 4-20 mA on analog input AI4.
This error is triggered when the measured current is below 2mA.



Remedy

- Verify the connection on the analog inputs.
- Verify the setting of [AI4 4-20mA loss] L F L 4 parameter.



Clearing the Error Code

This detected error can be cleared with the [Auto Fault Reset] *r 5 r* or manually with the [Fault Reset Assign] *r 5 F* parameter after the cause has been removed.

[AI5 4-20mA loss] L F F 5



Probable Cause

Loss of the 4-20 mA on analog input AI5.
This error is triggered when the measured current is below 2 mA.



Remedy

- Verify the connection on the analog inputs.
- Verify the setting of [AI5 4-20mA loss] L F L 5 parameter.



Clearing the Error Code

This detected error can be cleared with the [Auto Fault Reset] *r 5 r* or manually with the [Fault Reset Assign] *r 5 F* parameter after the cause has been removed.

[AFE Bus Ref Error] Π d F **Probable Cause**

Communication interruption or disturbance of the DC bus reference link between the Supply Unit AFE and the drives during operation.

- If the DC bus reference is shared using PTI/PTO, the error is triggered if the PTI signal is less than 10 kHz.
- If the DC bus reference is shared using Modbus Serial line, the error is triggered if the drive does not receive a new value within the **[Modbus Timeout] t t d** value.

**Remedy**

If DC bus reference is shared using PTI/PTO:

- Verify the values of PTI and PTO signals.
- Verify PTI parameters configuration on drive side.
- Verify PTO parameters configuration on Supply Unit AFE side.
- Verify that only 4 drives maximum are connected on PTO signal (PTO max current is 20 mA and PTI consumption is 5 mA)

If DC bus reference is shared using Modbus Serial:

- Verify the Modbus serial communication line.

**Clearing the Error Code**

This detected error can be cleared manually with the **[Fault Reset Assign] r 5 F** parameter after the cause has been removed.

[Load Mvt Error] Π d C F **Probable Cause**

Load movement for which no command has been given.

**Remedy**

Verify the brake command circuit. Verify the brake.

**Clearing the Error Code**

This detected error can be cleared manually with the **[Fault Reset Assign] r 5 F** parameter after the cause has been removed.

[MultiDrive Link Error] $\Pi d L F$



Probable Cause

- The communication has been interrupted while running.
- The function has detected an inconsistency in the system configuration.



Remedy

- Check the communication network.
- Check the configuration of the multi-drive link function.



Clearing the Error Code

This detected error can be cleared with the **[Auto Fault Reset] $R E r$** or manually with the **[Fault Reset Assign] $r 5 F$** parameter after the cause has been removed.

[Mains Freq Out Of Range] $\Pi F F$



Probable Cause

[Mains Frequency] $F H C$ on the AFE brick is out of range.



Remedy

Verify the mains frequency.



Clearing the Error Code

This detected error can be cleared manually with the **[Fault Reset Assign] $r 5 F$** parameter after the cause has been removed.

[M/S Device Error] Π 5 d F**Probable Cause**

- For a master, one or more slaves are not present or not ready.
- For a slave, the master is not present.

**Remedy**

- Verify the drive status.
- Verify the settings of the master/slave architecture.

**Clearing the Error Code**

This detected error can be cleared with the **[Auto Fault Reset] Π 5 r** or manually with the **[Fault Reset Assign] Π 5 F** parameter after the cause has been removed.

[DC Bus Overvoltage] α b F**Probable Cause**

- Deceleration time too short or driving load too high.
- Supply mains voltage too high.

**Remedy**

- Increase the deceleration time.
- Configure the **[Dec ramp adapt.] β r H** function if it is compatible with the application.
- Verify the supply mains voltage.
- Verify the braking circuit capability if present.

**Clearing the Error Code**

This detected error can be cleared with the **[Auto Fault Reset] Π 5 r** or manually with the **[Fault Reset Assign] Π 5 F** parameter after the cause has been removed.

[AFE Bus unbalancing] $\square b F \square$ **Probable Cause**

- AFE DC bus unbalancing.
- Supply mains voltage too high.
- Total generative power too high

**Remedy**

- Verify the supply mains voltage.
- Contact your local Schneider Electric representative

**Clearing the Error Code**

This detected error can be cleared with the **[Auto Fault Reset] $\square E r$** or manually with the **[Fault Reset Assign] $r 5 F$** parameter after the cause has been removed.

[Overcurrent] $\square C F$ **Probable Cause**

- Parameters in the **[Motor data] $\square \square R$** - menu are not correct.
- Inertia or load too high.
- Mechanical locking.

**Remedy**

- Verify the motor parameters.
- Verify the size of the motor/drive/load.
- Verify the state of the mechanism.
- Decrease **[Current limitation] $C L \square$** .
- Increase the switching frequency.

**Clearing the Error Code**

This detected error requires a power reset.

[Drive Overheating] ▫ H F



Probable Cause

Drive temperature too high.



Remedy

Verify the motor load, the drive ventilation, and the ambient temperature. Wait for the drive to cool down before restarting.



Clearing the Error Code

This detected error can be cleared with the **[Auto Fault Reset] # E r** or manually with the **[Fault Reset Assign] r S F** parameter after the cause has been removed.

[Process Overload] ▫ L C



Probable Cause

Process overload.



Remedy

- Verify and remove the cause of the overload.
- Verify the parameters of the **[Process overload] ▫ L d** - function.



Clearing the Error Code

This detected error can be cleared with the **[Auto Fault Reset] # E r** or manually with the **[Fault Reset Assign] r S F** parameter after the cause has been removed.

[Motor Overload] □ L F



Probable Cause

Triggered by excessive motor current.



Remedy

- Verify the setting of the motor thermal monitoring
- Verify the motor load. Wait for the motor to cool down before restarting
- Verify the setting of the following parameters:
 - [Motor Th Current] i L H
 - [Motor Thermal Mode] L H L
 - [Motor Therm Thd] L L d
 - [MotorTemp ErrorResp] □ L L



Clearing the Error Code

This detected error can be cleared with the **[Auto Fault Reset] R L r** or manually with the **[Fault Reset Assign] r 5 F** parameter after the cause has been removed.

[Single Output Phase Loss] □ P F I



Probable Cause

Loss of one phase at drive output.



Remedy

Verify the wiring from the drive to the motor.



Clearing the Error Code

This detected error can be cleared with the **[Auto Fault Reset] R L r** or manually with the **[Fault Reset Assign] r 5 F** parameter after the cause has been removed.

[Output Phase Loss] $\alpha P F 2$ **Probable Cause**

- Motor not connected or motor power too low.
- Output contactor opened.
- Instantaneous instability in the motor current.

**Remedy**

- Verify the wiring from the drive to the motor.
- If an output contactor is being used, set **[OutPhaseLoss Assign] $\alpha P L$** to **[No Error Triggered] $\alpha H L$** .
- If the drive is connected to a low-power motor or not connected to a motor: In factory settings mode, motor phase loss detection is active **[Output Phase Loss] $\alpha P L$ = [OPF Error Triggered] $\psi E 5$** . Deactivate motor phase loss detection **[Output Phase Loss] $\alpha P L$ = [Function Inactive] $n \alpha$** .
- Verify and optimize the following parameters: **[IR compensation] $\mu F r$** , **[Nom Motor Voltage] $\mu n 5$** and **[Rated mot. current] $n L r$** and perform **[Autotuning] $t u n$** .

**Clearing the Error Code**

This detected error can be cleared with the **[Auto Fault Reset] $H L r$** or manually with the **[Fault Reset Assign] $r 5 F$** parameter after the cause has been removed.

[Supply Mains Overvoltage] $\alpha 5 F$ **Probable Cause**

- Supply mains voltage too high.
- Disturbed supply mains.

**Remedy**

Verify the supply mains voltage.

**Clearing the Error Code**

This detected error can be cleared with the **[Auto Fault Reset] $H L r$** or manually with the **[Fault Reset Assign] $r 5 F$** parameter after the cause has been removed.

[Cab I/O 24V Error] P 2 4 C**Probable Cause**

The input DI58 is used to monitor the 24V on input terminal. If it breaks down, all inputs are suppressed to avoid unintended error messages (from software version V1.3).

- DI58 cabinet I/O input is not wired to the internal terminal X231.
- DI58 is used by another cabinet I/O function.

**Remedy**

- Verify if the terminal X231 is wired to the cabinet I/O input DI58.
- If the DI58 is used by another cabinet function, it is needed to change the function to another free cabinet I/O input on the X220 terminals. Additionally, it is needed to adapt the parameter setting of the new selected input.

**Clearing the Error Code**

This detected error can be cleared with the **[Auto Fault Reset] R E r** or manually with the **[Fault Reset Assign] r 5 F** parameter after the cause has been removed.

[PumpCycle Start Error] P C P F**Probable Cause**

The Pumpcycle monitoring function has exceeded the maximum number of start sequences allowed in the time window.

**Remedy**

- Search for a possible cause of repetitive start of system.
- Verify the settings of the monitoring function.

**Clearing the Error Code**

This detected error can be cleared with the **[Auto Fault Reset] R E r** or manually with the **[Fault Reset Assign] r 5 F** parameter after the cause has been removed.

[PID Feedback Error] P F Π F**Probable Cause**

The PID feedback error was out of the allowed range around the set point during the time window.

**Remedy**

- Check for mechanical breakdown of pipes.
- Check for water leakage.
- Check for open discharge valve.
- Check for fire hydrant opened.
- Verify the settings of the monitoring function.

**Clearing the Error Code**

This detected error can be cleared with the **[Auto Fault Reset] # E r** or manually with the **[Fault Reset Assign] r S F** parameter after the cause has been removed.

[Program Loading Error] P G L F**Probable Cause**

Verify that the error code can be cleared.

**Remedy**

Contact your local Schneider Electric representative.

**Clearing the Error Code**

This detected error is cleared as soon as its cause has been removed.

[Program Running Error] *P G r F*



Probable Cause

Verify that the error code can be cleared.



Remedy

Contact your local Schneider Electric representative.



Clearing the Error Code

This detected error requires a power reset.

[Input phase loss] *P H F*



Probable Cause

- Drive incorrectly supplied or a tripped fused.
- One phase is unavailable.
- 3-phase Drive used on a single-phase supply mains.
- Unbalanced load.



Remedy

- Verify the power connection and the fuses.
- Use a 3-phase supply mains.
- Disable the detected error by **[Input phase loss]** , *P L* = **[No]** *n o* if single phase supply mains or DC bus supply is used.



Clearing the Error Code

This detected error is cleared as soon as its cause has been removed.

[Rotation Angle Monit] r R d F**Probable Cause**

The monitoring of the rotation angle has detected a too high deviation.

**Remedy**

- Check for mechanical problems in the system.
- Verify the settings of the monitoring function.

**Clearing the Error Code**

This detected error can be cleared with the **[Auto Fault Reset] R L r** or manually with the **[Fault Reset Assign] r S F** parameter after the cause has been removed.

[Safety Function Error] S R F F**Probable Cause**

- Debounce time exceeded.
- Internal hardware error.
- STOA and STOB have a different status (high/low) for more than 1 second.

**Remedy**

- Verify the wiring of the digital inputs STOA and STOB.
- Contact your local Schneider Electric representative.

**Clearing the Error Code**

This detected error requires a power reset.

[Motor short circuit] 5 C F 1



Probable Cause

Short-circuit or grounding at the drive output.



Remedy

- Verify the cables connecting the drive to the motor, and the motor insulation.
- Adjust the switching frequency.
- Connect chokes in series with the motor.
- Verify the adjustment of speed loop and brake.
- Increase the **[Time to restart] t E r**



Clearing the Error Code

This detected error requires a power reset.

[Ground Short Circuit] 5 C F 3



Probable Cause

Significant ground leakage current at the drive output if several motors are connected in parallel.



Remedy

- Verify the cables connecting the drive to the motor, and the motor insulation.
- Adjust the switching frequency.
- Connect chokes in series with the motor.
- Verify the adjustment of speed loop and brake.
- Increase the **[Time to restart] t E r**



Clearing the Error Code

This detected error requires a power reset.

[IGBT Short Circuit] 5 C F 4**Probable Cause**

Power component detected error.

At product power-on, the IGBTs are tested for short circuit. Thereby an error (short circuit or interruption) has been detected on at least one IGBT. The time to check each transistor is between 1 and 10 μ s.

**Remedy**

Verify the setting of **[Output Short Circuit Test] 5 E r E** parameter.

Contact your local Schneider Electric representative.

**Clearing the Error Code**

This detected error can be cleared with the **[Auto Fault Reset] A E r** or manually with the **[Fault Reset Assign] r 5 F** parameter after the cause has been removed.

[Motor Short Circuit] 5 C F 5**Probable Cause**

Short-circuit at drive output.

**Remedy**

- Verify the cables connecting the drive to the motor, and the motor's insulation.
- Contact your local Schneider Electric representative.

**Clearing the Error Code**

This detected error can be cleared with the **[Auto Fault Reset] A E r** or manually with the **[Fault Reset Assign] r 5 F** parameter after the cause has been removed.

[AFE ShortCircuit error] 5 L F 6



Probable Cause

AFE rectifier IGBT short-circuit.

AFE over current due to power factor correction systems in the grid. Each switch of the capacitor produces over voltage in the mains which can lead an over current in the AFE.



Remedy

- Verify the mains voltage when the power factor correction system is changing the capacitive load. Install only power factor correction systems with integrated reactors
- Verify the cables connecting the AFE brick to the mains.
- Contact your local Schneider Electric representative.



Clearing the Error Code

This detected error requires a power reset.

[Modbus Com Interruption] 5 L F 1



Probable Cause

Communication interruption on the Modbus port.



Remedy

- Verify the communication bus.
- Verify the timeout.
- Refer to the Modbus user manual.



Clearing the Error Code

This detected error can be cleared with the **[Auto Fault Reset] # L r** or manually with the **[Fault Reset Assign] r 5 F** parameter after the cause has been removed.

[PC Com Interruption] 5 L F 2



Probable Cause

Communication interruption with the commissioning software.



Remedy

- Verify the commissioning software connecting cable.
- Verify the timeout.



Clearing the Error Code

This detected error can be cleared with the **[Auto Fault Reset] # E r** or manually with the **[Fault Reset Assign] r 5 F** parameter after the cause has been removed.

[HMI Com Interruption] 5 L F 3



Probable Cause

Communication interruption with the Graphic display terminal.

This error is triggered when the command or reference value are given using the Graphic Display Terminal and if the communication is interrupted during more than 2 seconds.



Remedy

- Verify the Graphic display terminal connection.
- Verify the timeout.



Clearing the Error Code

This detected error can be cleared with the **[Auto Fault Reset] # E r** or manually with the **[Fault Reset Assign] r 5 F** parameter after the cause has been removed.

[Motor Overspeed] 5 □ F**Probable Cause**

- Instability or driving load too high.
- If a downstream contactor is used, the contacts between the motor and the drive have not been closed before applying a Run command.

**Remedy**

- Verify the motor parameter settings.
- Verify the size of the motor/drive/load.
- Verify and close the contacts between the motor and the drive before applying a Run command.

**Clearing the Error Code**

This detected error can be cleared manually with the **[Fault Reset Assign] r 5 F** parameter after the cause has been removed.

[Encoder Feedback Loss] 5 P F**Probable Cause**

- Encoder feedback signal missing.
- No top Z signal after two rotations has been done.
- No signal on the pulse input, if the input is used for speed measurement.
- Noise on the encoder feedback signal.
- Encoder consumption exceeds power supply maximum current.

**Remedy**

- Verify the error code value **[Encoder Fdbck Error] E n C E**.
- Verify the wiring between the encoder and the drive.
- Verify the encoder.
- Verify the encoder settings.
- Verify the wiring of the pulse input and the sensor used.
- Use a shielded cable and ground both ends.
- Verify the encoder power supply. Reduce **[Encoder Supply Voltage] u E C V** value.

**Clearing the Error Code**

This detected error can be cleared manually with the **[Fault Reset Assign] r 5 F** parameter after the cause has been removed.

[Torque timeout] 5 r F**Probable Cause**

The torque control function is not able to regulate the torque within the configured dead band. The drive has switched to speed control for longer than **[Torque ctrl time out] r t o**.

**Remedy**

- Verify the settings of the **[Torque control] t o r** - function.
- Verify that there are no mechanical constraints.

**Clearing the Error Code**

This detected error can be cleared with the **[Auto Fault Reset] A t r** or manually with the **[Fault Reset Assign] r S F** parameter after the cause has been removed.

[Torque Limitation Error] 5 5 F**Probable Cause**

The drive was in torque limitation or current limitation state during **[Trq/I Limit Timeout] 5 t o**.

**Remedy**

- Verify the settings of the **[Torque limitation] t o L** - function.
- Verify that there are no mechanical constraints.

**Clearing the Error Code**

This detected error can be cleared with the **[Auto Fault Reset] A t r** or manually with the **[Fault Reset Assign] r S F** parameter after the cause has been removed.

[Motor Stall Error] 5 E F**Probable Cause**

The stall monitoring function has detected an error.

The **[Motor Stall Error] 5 E F** is triggered on the following conditions:

- The output frequency is smaller than the stalling frequency **[Stall Frequency] 5 E P 3**
- The output current is higher than the stalling current **[Stall Current] 5 E P 2**
- For a duration longer than the stalling time **[Stall Max Time] 5 E P 1**.

**Remedy**

- Search for a mechanical blocking of the motor.
- Search for a possible cause of motor overload.
- Verify the settings of the monitoring function.

**Clearing the Error Code**

This detected error can be cleared with the **[Auto Fault Reset] R E r** or manually with the **[Fault Reset Assign] r 5 F** parameter after the cause has been removed.

[AI1 Thermal Sensor Error] E I C F**Probable Cause**

The thermal monitoring function has detected an error of the thermal sensor connected to the analog input AI1:

- Open circuit, or
- Short circuit

**Remedy**

- Verify the sensor and its wiring.
- Replace the sensor.

**Clearing the Error Code**

This detected error can be cleared with the **[Auto Fault Reset] R E r** or manually with the **[Fault Reset Assign] r 5 F** parameter after the cause has been removed.

[AI3 Thermal Sensor Error] E 3 C F**Probable Cause**

The thermal monitoring function has detected an error of the thermal sensor connected to the analog input AI3:

- Open circuit, or
- Short circuit

**Remedy**

- Verify the sensor and its wiring.
- Replace the sensor.
- Verify the setting of **[AI3 Type] R 1 3 E** parameter.

**Clearing the Error Code**

This detected error can be cleared with the **[Auto Fault Reset] R E r** or manually with the **[Fault Reset Assign] r 5 F** parameter after the cause has been removed.

[AI4 Thermal Sensor Error] E 4 C F**Probable Cause**

The thermal monitoring function has detected an error of the thermal sensor connected to the analog input AI4:

- Open circuit, or
- Short circuit

**Remedy**

- Verify the sensor and its wiring.
- Replace the sensor.
- Verify the setting of **[AI4 Type] R 1 4 E** parameter

**Clearing the Error Code**

This detected error can be cleared with the **[Auto Fault Reset] R E r** or manually with the **[Fault Reset Assign] r 5 F** parameter after the cause has been removed.

[AI5 Thermal Sensor Error] E 5 C F**Probable Cause**

The thermal monitoring function has detected an error of the thermal sensor connected to the analog input AI5:

- Open circuit, or
- Short circuit

**Remedy**

- Verify the sensor and its wiring.
- Replace the sensor.
- Verify the setting of **[AI5 Type] # 1 5 E** parameter.

**Clearing the Error Code**

This detected error can be cleared with the **[Auto Fault Reset] # E r** or manually with the **[Fault Reset Assign] r 5 F** parameter after the cause has been removed.

[Encoder Th Sensor Error] E E C F**Probable Cause**

The thermal sensor monitoring function has detected a thermal sensor on the encoder module analog input:

- Open circuit, or
- Short circuit.

**Remedy**

- Verify the sensor and its wiring.
- Replace the sensor.

**Clearing the Error Code**

This detected error can be cleared with the **[Auto Fault Reset] # E r** or manually with the **[Fault Reset Assign] r 5 F** parameter after the cause has been removed.

[MotorWinding A Error] $E F A$ **Probable Cause**

The digital input assigned to **[MotorWinding A Assign] $E F A A$** is active for longer than **[MotorWinding A Delay] $E F d A$** .

**Remedy**

- Verify the connected device (motor winding thermal switch) and its wiring.
- Verify the motor load and the ambient temperature. Wait for the motor to cool down before restarting.

**Clearing the Error Code**

This detected error can be cleared with the **[Auto Fault Reset] $A E r$** or manually with the **[Fault Reset Assign] $r S F$** parameter after the cause has been removed.

[MotorWinding B Error] $E F B$ **Probable Cause**

The digital input assigned to **[MotorWinding B Assign] $E F B B$** is active for longer than **[MotorWinding B Delay] $E F d B$** .

**Remedy**

- Verify the connected device (motor winding thermal switch) and its wiring.
- Verify the motor load and the ambient temperature. Wait for the motor to cool down before restarting.

**Clearing the Error Code**

This detected error can be cleared with the **[Auto Fault Reset] $A E r$** or manually with the **[Fault Reset Assign] $r S F$** parameter after the cause has been removed.

[MotorBearing A Error] E F C**Probable Cause**

The digital input assigned to **[MotorBearing A Assign] E F A C** is active for longer than **[MotorBearing A Delay] E F d C**.

**Remedy**

- Verify the connected device (motor winding thermal switch) and its wiring.
- Verify the motor load and the ambient temperature. Wait for the motor to cool down before restarting.

**Clearing the Error Code**

This detected error can be cleared with the **[Auto Fault Reset] A E r** or manually with the **[Fault Reset Assign] r S F** parameter after the cause has been removed.

[MotorBearing B Error] E F d**Probable Cause**

The digital input assigned to **[MotorBearing B Assign] E F A d** is active for longer than **[MotorBearing B Delay] E F d d**.

**Remedy**

- Verify the connected device (motor winding thermal switch) and its wiring.
- Verify the motor load and the ambient temperature. Wait for the motor to cool down before restarting.

**Clearing the Error Code**

This detected error can be cleared with the **[Auto Fault Reset] A E r** or manually with the **[Fault Reset Assign] r S F** parameter after the cause has been removed.

[AI1 Th Level Error] E H 1 F**Probable Cause**

The thermal sensor monitoring function has detected a high temperature on analog input AI1.

**Remedy**

- Search for a possible cause of overheating.
- Verify the settings of the monitoring function.

**Clearing the Error Code**

This detected error can be cleared with the **[Auto Fault Reset] R E r** or manually with the **[Fault Reset Assign] r 5 F** parameter after the cause has been removed.

[AI3 Th Level Error] E H 3 F**Probable Cause**

The thermal sensor monitoring function has detected a high temperature on analog input AI3.

**Remedy**

- Search for a possible cause of overheating.
- Verify the settings of the monitoring function.

**Clearing the Error Code**

This detected error can be cleared with the **[Auto Fault Reset] R E r** or manually with the **[Fault Reset Assign] r 5 F** parameter after the cause has been removed.

[AI4 Th Level Error] *E H 4 F*



Probable Cause

The thermal sensor monitoring function has detected a high temperature on analog input AI4.



Remedy

- Search for a possible cause of overheating.
- Verify the settings of the monitoring function.



Clearing the Error Code

This detected error can be cleared with the **[Auto Fault Reset] *R E r*** or manually with the **[Fault Reset Assign] *r 5 F*** parameter after the cause has been removed.

[AI5 Th Level Error] *E H 5 F*



Probable Cause

The thermal sensor monitoring function has detected a high temperature on analog input AI5.



Remedy

- Search for a possible cause of overheating.
- Verify the settings of the monitoring function.



Clearing the Error Code

This detected error can be cleared with the **[Auto Fault Reset] *R E r*** or manually with the **[Fault Reset Assign] *r 5 F*** parameter after the cause has been removed.

[Encoder Th Detected Error] ϵ H E F**Probable Cause**

The thermal sensor monitoring function has detected a high temperature on encoder module analog input.

**Remedy**

- Search for a possible cause of overheating.
- Verify the settings of the monitoring function.

**Clearing the Error Code**

This detected error can be cleared with the **[Auto Fault Reset] $\# \epsilon r$** or manually with the **[Fault Reset Assign] $r 5 F$** parameter after the cause has been removed.

[IGBT Overheating] ϵ J F**Probable Cause**

Drive power stage overheating.

On AFE drives: the thermal model of the AFE IGBT thermal monitoring has detected an overheat.

**Remedy**

- Verify the size of the load/motor/drive according to environment conditions.
- Reduce the switching frequency.

**Clearing the Error Code**

This detected error can be cleared with the **[Auto Fault Reset] $\# \epsilon r$** or manually with the **[Fault Reset Assign] $r 5 F$** parameter after the cause has been removed.

[AFE IGBT over-heat error] E J F 2



Probable Cause

Rectifier IGBT power stage overheating.



Remedy

- Verify the size of the load/motor/drive according to environment conditions.
- Verify and clean, if necessary, the cooling channel.
- Clean or replace the filter mats on IP54 products.



Clearing the Error Code

This detected error can be cleared with the **[Auto Fault Reset] A E r** or manually with the **[Fault Reset Assign] r 5 F** parameter after the cause has been removed.

[Drive Overload] E L 0 F



Probable Cause

The **[Drive overload monit] 0 b r** - function has detected an error.



Remedy

- Verify the size of the load/motor/drive according to environment conditions.
- Verify the settings of the **[Drive Overload Monit] E L 0 L** parameter.



Clearing the Error Code

This detected error can be cleared with the **[Auto Fault Reset] A E r** or manually with the **[Fault Reset Assign] r 5 F** parameter after the cause has been removed.

[Autotuning Error] E_{nF} **Probable Cause**

- Special motor or motor whose power is not suitable for the drive.
- Motor not connected to the drive.
- Motor not stopped.

**Remedy**

- Verify that the motor/drive are compatible.
- Verify that the motor is connected to the drive during autotuning.
- If an output contactor is being used, verify that it is closed during autotuning.
- Verify that the motor is present and stopped during autotuning.
- In case of reluctant motor, reduce **[PSI Align Curr Max] P_{Cr}** .

**Clearing the Error Code**

This detected error can be cleared manually with the **[Fault Reset Assign] r_{5F}** parameter after the cause has been removed.

[Process Underload] u_{LF} **Probable Cause**

Process underload.

**Remedy**

- Verify and remove the cause of the underload.
- Verify the parameters of the **[Process underload] u_{Ld}** - function

**Clearing the Error Code**

This detected error can be cleared with the **[Auto Fault Reset] R_{Er}** or manually with the **[Fault Reset Assign] r_{5F}** parameter after the cause has been removed.

[AFE Mains Undervoltage] $\mu r F$



Probable Cause

- Too low DC-Bus voltage due to mains undervoltage.
- AFE overload.



Remedy

- Verify mains voltage.
- Verify the size of the load/motor/drive according to environment conditions.



Clearing the Error Code

This detected error is cleared as soon as its cause has been removed.

[Supply Mains UnderV] $\mu 5 F$



Probable Cause

- Supply mains too low.
- Transient voltage dips.



Remedy

Verify the voltage and the parameters of **[Undervoltage handling]** $\mu 5 b$.



Clearing the Error Code

This detected error is cleared as soon as its cause has been removed.

Section 13.3

FAQ

FAQ

Introduction

If the display does not light up, verify the supply mains to the drive.

The assignment of the fast stop or freewheel functions help to prevent the drive starting if the corresponding digital inputs are not switched on. The drive then displays **[Freewheel] n 5 E** in freewheel stop and **[Fast stop] F 5 E** in fast stop. This is a normal behavior since these functions are active at zero so that the drive is stopped if there is a wire break.

Verify that the run command input is activated in accordance with the selected control mode (**[2/3-wire control] E C C** and **[2-wire type] E C E** parameters).

If the reference channel or command channel is assigned to a fieldbus, when the supply mains is connected, the drive displays **[Freewheel] n 5 E**. It remains in stop mode until the fieldbus gives a command.

Drive lock in blocking state

The drive is locked in a blocking state and displays **[Freewheel Stop] n 5 E**, if a Run command such as Run forward, Run reverse, DC injection is still active during:

- A product reset to the factory settings,
- A manual "Fault Reset" using **[Fault Reset Assign] r 5 F**,
- A manual "Fault reset" by applying a product switched off and on again,
- A stop command given by a channel that is not the active channel command (such as Stop key of the display terminal in 2/3 wires control),

It will be necessary to deactivate all active Run commands prior to authorizing a new Run command.

Option Module Changed or Removed

When an option module is removed or replaced by another, the drive locks in **[Incorrect configuration] C F F** error mode at power-on. If the option module has been deliberately changed or removed, the detected error can be cleared by pressing the **OK** key twice, which causes the factory settings to be restored for the parameter groups affected by the option module.

Control Block Changed

When a control block is replaced by a control block configured on a drive with a different rating, the drive locks in **[Incorrect configuration] C F F** error mode at power-on. If the control block has been deliberately changed, the detected error can be cleared by pressing the **OK** key twice, which **causes all the factory settings to be restored.**



D

Display terminal

The display terminal menus are shown in square brackets.

For example: **[Communication]**

The codes are shown in round brackets.

For example: **(C a Π -**

Parameter names are displayed on the display terminal in square brackets.

For example: **[Fallback Speed]**

Parameter codes are displayed in round brackets.

For example: **(L F F**

E

Error

Discrepancy between a detected (computed, measured, or signaled) value or condition and the specified or theoretically correct value or condition.

F

Factory setting

Factory settings when the product is shipped

Fault

Fault is an operating state. If the monitoring functions detect an error, a transition to this operating state is triggered, depending on the error class. A "Fault reset" is required to exit this operating state after the cause of the detected error has been removed. Further information can be found in the pertinent standards such as IEC 61800-7, ODVA Common Industrial Protocol (CIP).

Fault Reset

A function used to restore the drive to an operational state after a detected error is cleared by removing the cause of the error so that the error is no longer active.

M

Monitoring function

Monitoring functions acquire a value continuously or cyclically (for example, by measuring) in order to check whether it is within permissible limits. Monitoring functions are used for error detection.

P

Parameter

Device data and values that can be read and set (to a certain extent) by the user.

PELV

Protective Extra Low Voltage, low voltage with isolation. For more information: IEC 60364-4-41

PLC

Programmable logic controller

Power stage

The power stage controls the motor. The power stage generates current for controlling the motor.

W

Warning

If the term is used outside the context of safety instructions, a warning alerts to a potential error that was detected by a monitoring function. A warning does not cause a transition of the operating state.

