

Operating Instructions

Proline Promag W 400

EtherNet/IP

Electromagnetic flowmeter

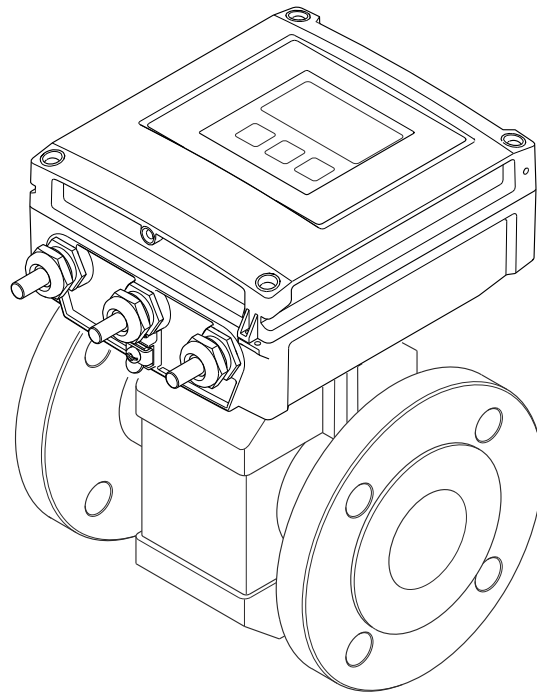

- Make sure the document is stored in a safe place such that it is always available when working on or with the device.
- To avoid danger to individuals or the facility, read the "Basic safety instructions" section carefully, as well as all other safety instructions in the document that are specific to working procedures.
- The manufacturer reserves the right to modify technical data without prior notice. Your Endress+Hauser Sales Center will supply you with current information and updates to these Instructions.

Table of contents

1	Document information	6		
1.1	Document function	6		
1.2	Symbols used	6		
1.2.1	Safety symbols	6		
1.2.2	Electrical symbols	6		
1.2.3	Tool symbols	6		
1.2.4	Symbols for certain types of information	7		
1.2.5	Symbols in graphics	7		
1.3	Documentation	7		
1.3.1	Standard documentation	8		
1.3.2	Supplementary device-dependent documentation	8		
1.4	Registered trademarks	8		
2	Basic safety instructions	9		
2.1	Requirements for the personnel	9		
2.2	Designated use	9		
2.3	Workplace safety	10		
2.4	Operational safety	10		
2.5	Product safety	11		
2.6	IT security	11		
3	Product description	12		
3.1	Product design	12		
4	Incoming acceptance and product identification	13		
4.1	Incoming acceptance	13		
4.2	Product identification	13		
4.2.1	Transmitter nameplate	14		
4.2.2	Sensor nameplate	15		
4.2.3	Symbols on measuring device	16		
5	Storage and transport	17		
5.1	Storage conditions	17		
5.2	Transporting the product	17		
5.2.1	Measuring devices without lifting lugs	17		
5.2.2	Measuring devices with lifting lugs	18		
5.2.3	Transporting with a fork lift	18		
5.3	Packaging disposal	18		
6	Installation	19		
6.1	Installation conditions	19		
6.1.1	Mounting position	19		
6.1.2	Requirements from environment and process	21		
6.1.3	Special mounting instructions	23		
6.2	Mounting the measuring device	24		
6.2.1	Required tools	24		
6.2.2	Preparing the measuring device	24		
6.2.3	Mounting the sensor	24		
6.2.4	Mounting the transmitter of the remote version	30		
6.2.5	Turning the transmitter housing	32		
6.2.6	Turning the display module	34		
6.3	Post-installation check	35		
7	Electrical connection	36		
7.1	Connection conditions	36		
7.1.1	Required tools	36		
7.1.2	Requirements for connecting cable	36		
7.1.3	Terminal assignment	38		
7.1.4	Pin assignment, device plug	39		
7.1.5	Shielding and grounding	40		
7.1.6	Requirements for the supply unit	40		
7.1.7	Preparing the measuring device	40		
7.1.8	Preparing the connecting cable for the remote version	40		
7.2	Connecting the measuring device	41		
7.2.1	Connecting the remote version	41		
7.2.2	Connecting the transmitter	43		
7.2.3	Ensuring potential equalization	44		
7.3	Special connection instructions	46		
7.4	Hardware settings	46		
7.4.1	Setting the device address	46		
7.5	Ensuring the degree of protection	47		
7.5.1	Degree of protection IP66/67, Type 4X enclosure	47		
7.5.2	Degree of protection IP68, Type 6P enclosure, with "Cust-potted" option	47		
7.6	Post-connection check	47		
8	Operation options	49		
8.1	Overview of operation options	49		
8.2	Structure and function of the operating menu	50		
8.2.1	Structure of the operating menu	50		
8.2.2	Operating philosophy	51		
8.3	Access to the operating menu via the local display	52		
8.3.1	Operational display	52		
8.3.2	Navigation view	53		
8.3.3	Editing view	55		
8.3.4	Operating elements	57		
8.3.5	Opening the context menu	57		
8.3.6	Navigating and selecting from list	59		
8.3.7	Calling the parameter directly	59		
8.3.8	Calling up help text	60		
8.3.9	Changing the parameters	61		
8.3.10	User roles and related access authorization	62		
8.3.11	Disabling write protection via access code	62		

8.3.12	Enabling and disabling the keypad lock	62	11	Operation	100
8.4	Access to the operating menu via the Web browser	63	11.1	Read out and modify current Ethernet settings	100
8.4.1	Function range	63	11.2	Reading the device locking status	100
8.4.2	Prerequisites	63	11.3	Adjusting the operating language	101
8.4.3	Establishing a connection	64	11.4	Configuring the display	101
8.4.4	Logging on	65	11.5	Reading measured values	101
8.4.5	User interface	66	11.5.1	Process variables	101
8.4.6	Disabling the Web server	67	11.5.2	Totalizer	102
8.4.7	Logging out	67	11.6	Adapting the measuring device to the process conditions	102
8.5	Access to the operating menu via the operating tool	67	11.7	Performing a totalizer reset	102
8.5.1	Connecting the operating tool	68	11.8	Showing data logging	103
8.5.2	FieldCare	68	12	Diagnostics and troubleshooting ..	105
9	System integration	70	12.1	General troubleshooting	105
9.1	Overview of device description files	70	12.2	Diagnostic information via light emitting diodes	107
9.1.1	Current version data for the device ...	70	12.2.1	Transmitter	107
9.1.2	Operating tools	70	12.3	Diagnostic information on local display	108
9.2	Overview of system files	70	12.3.1	Diagnostic message	108
9.3	Integrating the measuring device in the system	70	12.3.2	Calling up remedial measures	110
9.4	Cyclic data transmission	71	12.4	Diagnostic information in the Web browser ..	111
9.4.1	Block model	71	12.4.1	Diagnostic options	111
9.4.2	Input and output groups	71	12.4.2	Calling up remedy information	111
10	Commissioning	75	12.5	Diagnostic information in FieldCare	112
10.1	Function check	75	12.5.1	Diagnostic options	112
10.2	Switching on the measuring device	75	12.5.2	Calling up remedy information	113
10.3	Establishing a connection via FieldCare	75	12.6	Diagnostic information via communication interface	113
10.4	Configuring the device address via software ..	75	12.6.1	Reading out diagnostic information	113
10.4.1	Ethernet network and Web server ...	75	12.7	Adapting the diagnostic information	113
10.5	Setting the operating language	75	12.7.1	Adapting the diagnostic behavior ...	113
10.6	Configuring the measuring device	76	12.8	Overview of diagnostic information	114
10.6.1	Defining the tag name	80	12.9	Pending diagnostic events	116
10.6.2	Setting the system units	80	12.10	Diagnostic list	117
10.6.3	Configuring the communication interface	82	12.11	Event logbook	117
10.6.4	Configuring the local display	83	12.11.1	Event history	117
10.6.5	Configuring the low flow cut off	84	12.11.2	Filtering the event logbook	118
10.6.6	Configuring empty pipe detection ...	86	12.11.3	Overview of information events	118
10.7	Advanced settings	87	12.12	Resetting the measuring device	119
10.7.1	Carrying out a sensor adjustment	89	12.12.1	Function scope of "Device reset" parameter	120
10.7.2	Configuring the totalizer	89	12.13	Device information	120
10.7.3	Carrying out additional display configurations	91	12.14	Firmware history	122
10.7.4	Performing electrode cleaning	93	13	Maintenance	123
10.7.5	Administration configuration	94	13.1	Maintenance tasks	123
10.8	Configuration management	94	13.1.1	Exterior cleaning	123
10.8.1	Function range of "Configuration management" parameter	95	13.1.2	Interior cleaning	123
10.9	Simulation	96	13.1.3	Replacing seals	123
10.10	Protecting settings from unauthorized access	97	13.2	Measuring and test equipment	123
10.10.1	Write protection via access code	97	13.3	Endress+Hauser services	123
10.10.2	Write protection via write protection switch	98	14	Repair	124
			14.1	General notes	124

14.2	Spare parts	124
14.3	Endress+Hauser services	124
14.4	Return	124
14.5	Disposal	124
14.5.1	Removing the measuring device	124
14.5.2	Disposing of the measuring device ..	125
15	Accessories	126
15.1	Device-specific accessories	126
15.1.1	For the transmitter	126
15.1.2	For the sensor	126
15.2	Service-specific accessories	126
15.3	System components	127
16	Technical data	128
16.1	Application	128
16.2	Function and system design	128
16.3	Input	128
16.4	Output	131
16.5	Power supply	134
16.6	Performance characteristics	135
16.7	Installation	137
16.8	Environment	137
16.9	Process	138
16.10	Mechanical construction	139
16.11	Operability	156
16.12	Certificates and approvals	158
16.13	Application packages	159
16.14	Accessories	160
16.15	Documentation	160
17	Appendix	162
17.1	Overview of the operating menu	162
17.1.1	"Operation" menu	162
17.1.2	"Setup" menu	163
17.1.3	"Diagnostics" menu	166
17.1.4	"Expert" menu	170
Index	181	





1 Document information

1.1 Document function







These Operating Instructions contain all the information that is required in various phases of the life cycle of the device: from product identification, incoming acceptance and storage, to mounting, connection, operation and commissioning through to troubleshooting, maintenance and disposal.

1.2 Symbols used



1.2.1 Safety symbols

Symbol	Meaning
	DANGER! This symbol alerts you to a dangerous situation. Failure to avoid this situation will result in serious or fatal injury.
	WARNING! This symbol alerts you to a dangerous situation. Failure to avoid this situation can result in serious or fatal injury.
	CAUTION! This symbol alerts you to a dangerous situation. Failure to avoid this situation can result in minor or medium injury.
	NOTE! This symbol contains information on procedures and other facts which do not result in personal injury.











1.2.2 Electrical symbols

Symbol	Meaning	Symbol	Meaning
	Direct current		Alternating current
	Direct current and alternating current		Ground connection A grounded terminal which, as far as the operator is concerned, is grounded via a grounding system.
	Protective ground connection A terminal which must be connected to ground prior to establishing any other connections.		Equipotential connection A connection that has to be connected to the plant grounding system: This may be a potential equalization line or a star grounding system depending on national or company codes of practice.





1.2.3 Tool symbols

Symbol	Meaning
	Torx screwdriver
	Phillips head screwdriver
	Open-ended wrench



1.2.4 Symbols for certain types of information

Symbol	Meaning
	Permitted Procedures, processes or actions that are permitted.
	Preferred Procedures, processes or actions that are preferred.
	Forbidden Procedures, processes or actions that are forbidden.
	Tip Indicates additional information.
	Reference to documentation
	Reference to page
	Reference to graphic
	Series of steps
	Result of a sequence of actions
	Help in the event of a problem
	Visual inspection

1.2.5 Symbols in graphics

Symbol	Meaning	Symbol	Meaning
1, 2, 3,...	Item numbers		Series of steps
A, B, C, ...	Views	A-A, B-B, C-C, ...	Sections
	Hazardous area		Safe area (non-hazardous area)
	Flow direction		

1.3 Documentation

-  For an overview of the scope of the associated Technical Documentation, refer to the following:
- The CD-ROM provided for the device (depending on the device version, the CD-ROM might not be part of the delivery!)
 - The *W@M Device Viewer* : Enter the serial number from the nameplate (www.endress.com/deviceviewer)
 - The *Endress+Hauser Operations App*: Enter the serial number from the nameplate or scan the 2-D matrix code (QR code) on the nameplate.
-  For a detailed list of the individual documents along with the documentation code

1.3.1 Standard documentation

Document type	Purpose and content of the document
Technical Information	Planning aid for your device The document contains all the technical data on the device and provides an overview of the accessories and other products that can be ordered for the device.
Brief Operating Instructions	Guide that takes you quickly to the 1st measured value The Brief Operating Instructions contain all the essential information from incoming acceptance to initial commissioning.

1.3.2 Supplementary device-dependent documentation

Additional documents are supplied depending on the device version ordered: Always comply strictly with the instructions in the supplementary documentation. The supplementary documentation is an integral part of the device documentation.

1.4 Registered trademarks

EtherNet/IP™

Trademark of ODVA, Inc.

Microsoft®

Registered trademark of the Microsoft Corporation, Redmond, Washington, USA

Applicator®, FieldCare®, Field Xpert™, HistoROM®, Heartbeat Technology™

Registered or registration-pending trademarks of the Endress+Hauser Group

2 Basic safety instructions

2.1 Requirements for the personnel

The personnel for installation, commissioning, diagnostics and maintenance must fulfill the following requirements:

- ▶ Trained, qualified specialists must have a relevant qualification for this specific function and task
- ▶ Are authorized by the plant owner/operator
- ▶ Are familiar with federal/national regulations
- ▶ Before beginning work, the specialist staff must have read and understood the instructions in the Operating Instructions and supplementary documentation as well as in the certificates (depending on the application)
- ▶ Following instructions and basic conditions

The operating personnel must fulfill the following requirements:

- ▶ Being instructed and authorized according to the requirements of the task by the facility's owner-operator
- ▶ Following the instructions in these Operating Instructions

2.2 Designated use

Application and media

The measuring device described in these Instructions is intended only for flow measurement of liquids with a minimum conductivity of 5 $\mu\text{S}/\text{cm}$.

Depending on the version ordered, the measuring device can also measure potentially explosive, flammable, poisonous and oxidizing media.

Measuring devices for use in hazardous areas, in hygienic applications or in applications where there is an increased risk due to process pressure, are labeled accordingly on the nameplate.

To ensure that the measuring device remains in proper condition for the operation time:

- ▶ Only use the measuring device in full compliance with the data on the nameplate and the general conditions listed in the Operating Instructions and supplementary documentation.
- ▶ Based on the nameplate, check whether the ordered device is permitted for the intended use in the hazardous area (e.g. explosion protection, pressure vessel safety).
- ▶ Use the measuring device only for media against which the process-wetted materials are adequately resistant.
- ▶ If the measuring device is not operated at atmospheric temperature, compliance with the relevant basic conditions specified in the associated device documentation is absolutely essential: "Documentation" section →  7.

 This measuring device is optionally tested in accordance with OIML R49 and has an EC type-examination certificate according to Measuring Instruments Directive 2004/22/EC (MID) for service subject to legal metrological control ("custody transfer") for cold water (Annex MI-001).

The permitted fluid temperature in these applications is 0 to 50 °C.

Incorrect use

Non-designated use can compromise safety. The manufacturer is not liable for damage caused by improper or non-designated use.

⚠ WARNING**Danger of breakage of the sensor due to corrosive or abrasive fluids!**

- ▶ Verify the compatibility of the process fluid with the sensor material.
- ▶ Ensure the resistance of all fluid-wetted materials in the process.
- ▶ Observe the specified pressure and temperature range.

Verification for borderline cases:

- ▶ For special fluids and fluids for cleaning, Endress+Hauser is glad to provide assistance in verifying the corrosion resistance of fluid-wetted materials, but does not accept any warranty or liability as minute changes in the temperature, concentration or level of contamination in the process can alter the corrosion resistance properties.

Residual risks

The external surface temperature of the housing can increase by max. 10 K due to the power consumption of the electronic components. Hot process fluids passing through the measuring device will further increase the surface temperature of the housing. The surface of the sensor, in particular, can reach temperatures which are close to the fluid temperature.

Possible burn hazard due to fluid temperatures!

- ▶ For elevated fluid temperature, ensure protection against contact to prevent burns.

2.3 Workplace safety

For work on and with the device:

- ▶ Wear the required personal protective equipment according to federal/national regulations.

For welding work on the piping:

- ▶ Do not ground the welding unit via the measuring device.

If working on and with the device with wet hands:

- ▶ It is recommended to wear gloves on account of the higher risk of electric shock.

2.4 Operational safety

Risk of injury.

- ▶ Operate the device in proper technical condition and fail-safe condition only.
- ▶ The operator is responsible for interference-free operation of the device.

Conversions to the device

Unauthorized modifications to the device are not permitted and can lead to unforeseeable dangers.

- ▶ If, despite this, modifications are required, consult with Endress+Hauser.

Repair

To ensure continued operational safety and reliability,

- ▶ Carry out repairs on the device only if they are expressly permitted.
- ▶ Observe federal/national regulations pertaining to repair of an electrical device.
- ▶ Use original spare parts and accessories from Endress+Hauser only.

Environmental requirements

If a plastic transmitter housing is permanently exposed to certain steam and air mixtures, this can damage the housing.

- ▶ If you are unsure, please contact your Endress+Hauser Sales Center for clarification.
- ▶ If used in an approval-related area, observe the information on the nameplate.

2.5 Product safety

This measuring device is designed in accordance with good engineering practice to meet state-of-the-art safety requirements, has been tested, and left the factory in a condition in which it is safe to operate.

It meets general safety standards and legal requirements. It also complies with the EC directives listed in the device-specific EC Declaration of Conformity. Endress+Hauser confirms this by affixing the CE mark to the device.

2.6 IT security

We only provide a warranty if the device is installed and used as described in the Operating Instructions. The device is equipped with security mechanisms to protect it against any inadvertent changes to the device settings.

IT security measures in line with operators' security standards and designed to provide additional protection for the device and device data transfer must be implemented by the operators themselves.

3 Product description

The device consists of a transmitter and a sensor.

Two device versions are available:

- Compact version - transmitter and sensor form a mechanical unit.
- Remote version - transmitter and sensor are mounted in separate locations.

3.1 Product design

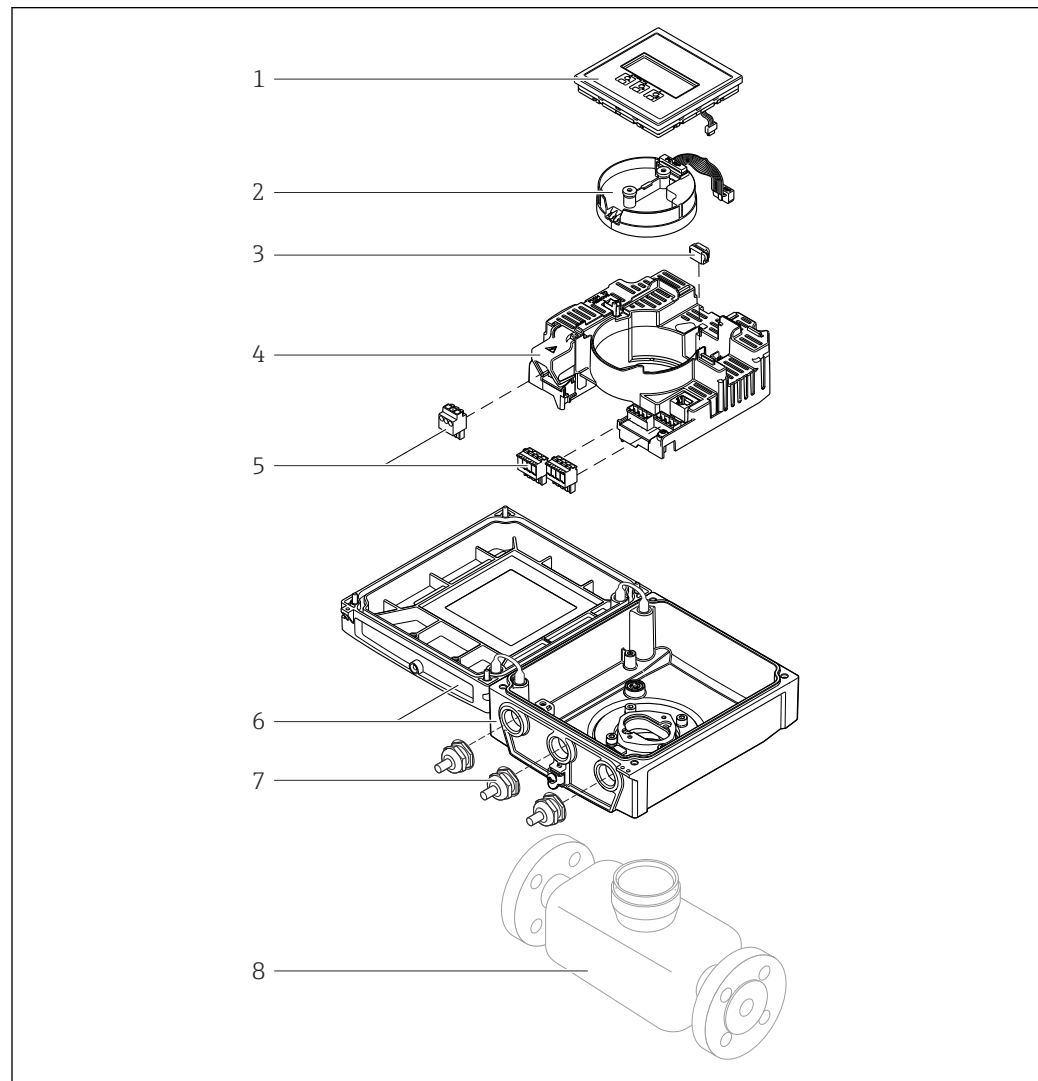

A001721B

1 Important components of the compact version

- 1 Display module
- 2 Smart sensor electronics module
- 3 HistoROM DAT (plug-in memory)
- 4 Main electronics module
- 5 Terminals (screw terminals, some available as plug-in terminals) or fieldbus connectors
- 6 Transmitter housing, compact version
- 7 Cable glands
- 8 Sensor, compact version

4 Incoming acceptance and product identification

4.1 Incoming acceptance

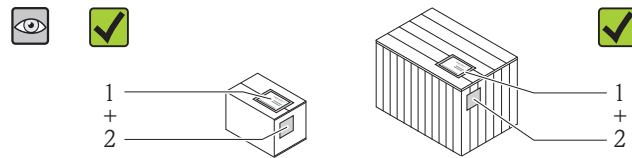

Are the order codes on the delivery note (1) and the product sticker (2) identical?

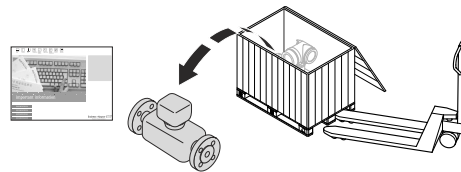



Are the goods undamaged?

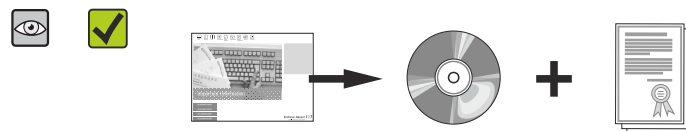

Do the nameplate data match the ordering information on the delivery note?



Is the CD-ROM with the Technical Documentation (depends on device version) and documents present?



-  If one of the conditions is not satisfied, contact your Endress+Hauser Sales Center.
- Depending on the device version, the CD-ROM might not be part of the delivery! The Technical Documentation is available via the Internet or via the *Endress+Hauser Operations App*, see the "Product identification" section →  14.

4.2 Product identification

The following options are available for identification of the measuring device:

- Nameplate specifications
- Order code with breakdown of the device features on the delivery note
- Enter serial numbers from nameplates in *W@M Device Viewer* (www.endress.com/deviceviewer): All information about the measuring device is displayed.
- Enter the serial number from the nameplates into the *Endress+Hauser Operations App* or scan the 2-D matrix code (QR code) on the nameplate with the *Endress+Hauser Operations App*: all the information for the measuring device is displayed.

For an overview of the scope of the associated Technical Documentation, refer to the following:

- The chapters "Additional standard documentation on the device" →  8 and "Supplementary device-dependent documentation" →  8
- The *W@M Device Viewer*: Enter the serial number from the nameplate (www.endress.com/deviceviewer)
- The *Endress+Hauser Operations App*: Enter the serial number from the nameplate or scan the 2-D matrix code (QR code) on the nameplate.

4.2.1 Transmitter nameplate

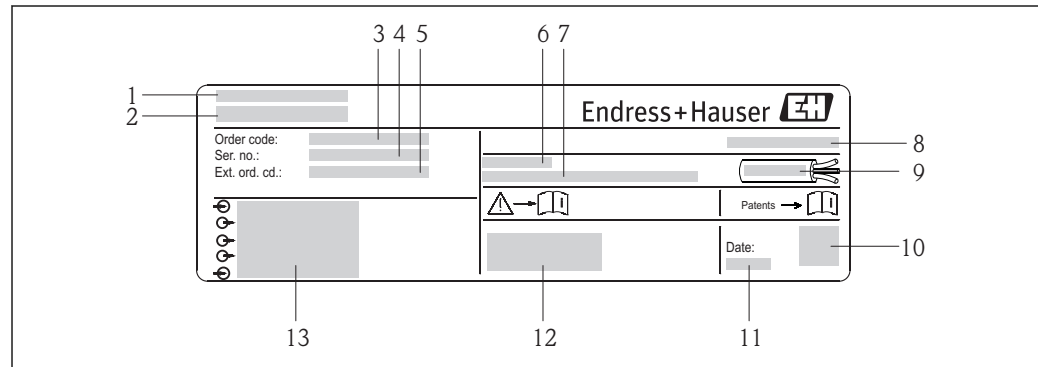

A0017346

 2 Example of a transmitter nameplate

- 1 Manufacturing location
- 2 Name of the transmitter
- 3 Order code
- 4 Serial number (Ser. no.)
- 5 Extended order code (Ext. ord. cd.)
- 6 Permitted ambient temperature (T_a)
- 7 Firmware version (FW) and device revision (Dev.Rev.) from the factory
- 8 Degree of protection
- 9 Permitted temperature range for cable
- 10 2-D matrix code
- 11 Manufacturing date: year-month
- 12 CE mark, C-Tick
- 13 Electrical connection data, e.g. available inputs and outputs, supply voltage

4.2.2 Sensor nameplate

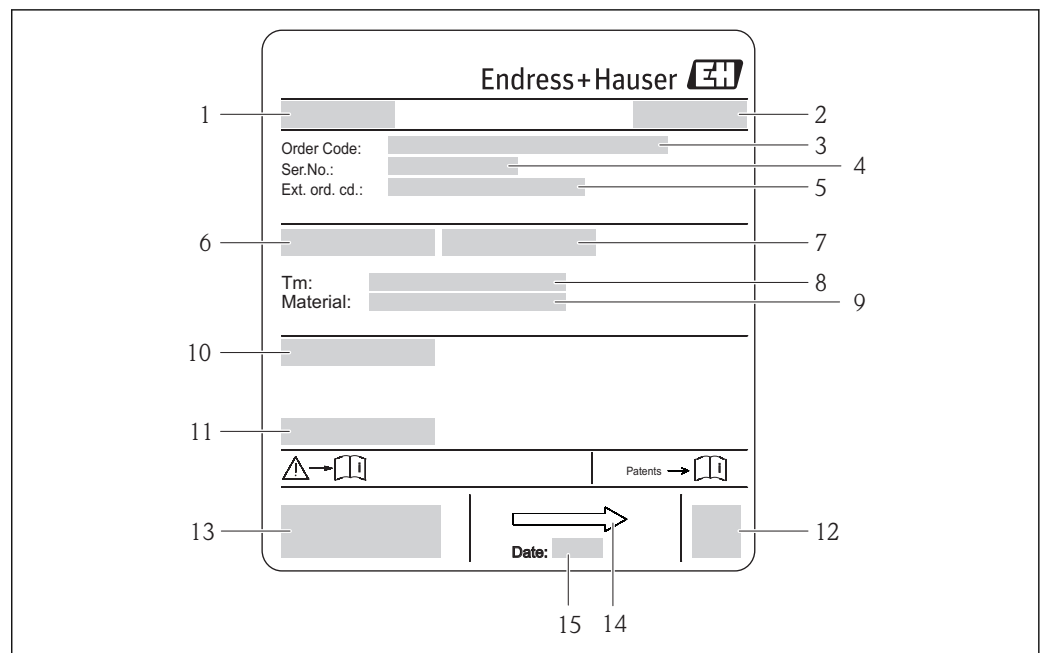

A0017186

3 Example of sensor nameplate

- 1 Name of the sensor
- 2 Manufacturing location
- 3 Order code
- 4 Serial number (ser. no.)
- 5 Extended order code (ext. ord. cd.)
- 6 Nominal diameter of sensor
- 7 Test pressure of the sensor
- 8 Fluid temperature range
- 9 Material of lining and electrodes
- 10 Degree of protection: e.g. IP, NEMA
- 11 Permitted ambient temperature (T_a)
- 12 2-D matrix code
- 13 CE mark, C-Tick
- 14 Flow direction
- 15 Manufacturing date: year-month



Order code

The measuring device is reordered using the order code.

Extended order code

- The device type (product root) and basic specifications (mandatory features) are always listed.
- Of the optional specifications (optional features), only the safety and approval-related specifications are listed (e.g. LA). If other optional specifications are also ordered, these are indicated collectively using the # placeholder symbol (e.g. #LA#).
- If the ordered optional specifications do not include any safety and approval-related specifications, they are indicated by the + placeholder symbol (e.g. XXXXXX-ABCDE+).

4.2.3 Symbols on measuring device

Symbol	Meaning
	WARNING! This symbol alerts you to a dangerous situation. Failure to avoid this situation can result in serious or fatal injury.
	Reference to documentation Refers to the corresponding device documentation.
	Protective ground connection A terminal which must be connected to ground prior to establishing any other connections.

5 Storage and transport

5.1 Storage conditions

Observe the following notes for storage:

- Store in the original packaging to ensure protection from shock.
- Do not remove protective covers or protective caps installed on process connections. They prevent mechanical damage to the sealing surfaces and contamination in the measuring tube.
- Protect from direct sunlight to avoid unacceptably high surface temperatures.
- Select a storage location where moisture cannot collect in the measuring device as fungus and bacteria infestation can damage the lining.
- Store in a dry and dust-free place.
- Do not store outdoors.
- Storage temperature →  137

5.2 Transporting the product

Transport the measuring device to the measuring point in the original packaging.

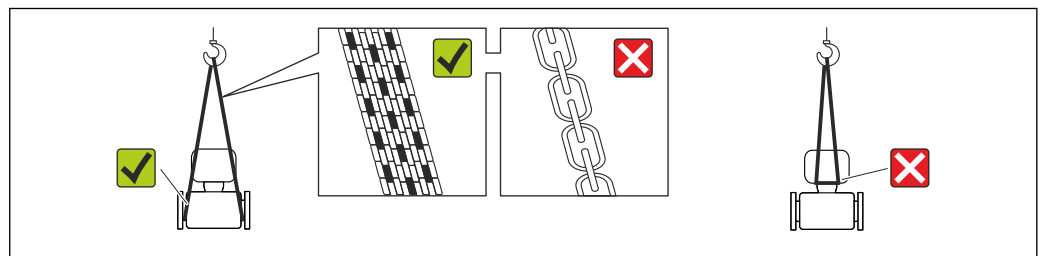

A0015604

-  Do not remove protective covers or caps installed on process connections. They prevent mechanical damage to the sealing surfaces and contamination in the measuring tube.

5.2.1 Measuring devices without lifting lugs

WARNING

Center of gravity of the measuring device is higher than the suspension points of the webbing slings.

Risk of injury if the measuring device slips.

- ▶ Secure the measuring device against slipping or turning.
- ▶ Observe the weight specified on the packaging (stick-on label).

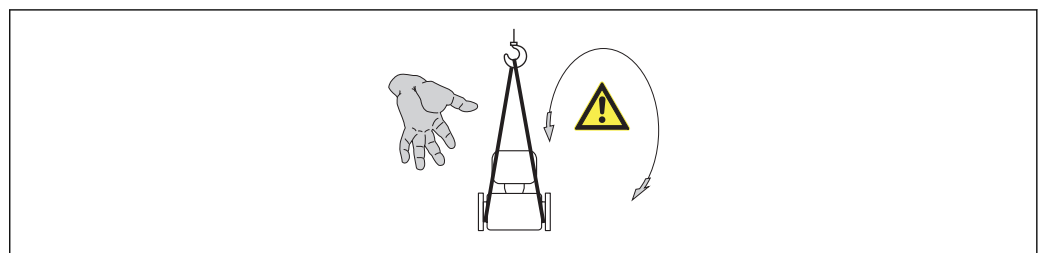

A0015606

5.2.2 Measuring devices with lifting lugs

⚠ CAUTION

Special transportation instructions for devices with lifting lugs

- ▶ Only use the lifting lugs fitted on the device or flanges to transport the device.
- ▶ The device must always be secured at two lifting lugs at least.

5.2.3 Transporting with a fork lift

If transporting in wood crates, the floor structure enables the crates to be lifted lengthwise or at both sides using a forklift.

⚠ CAUTION

Risk of damaging the magnetic coil

- ▶ If transporting by forklift, do not lift the sensor by the metal casing.
- ▶ This would buckle the casing and damage the internal magnetic coils.

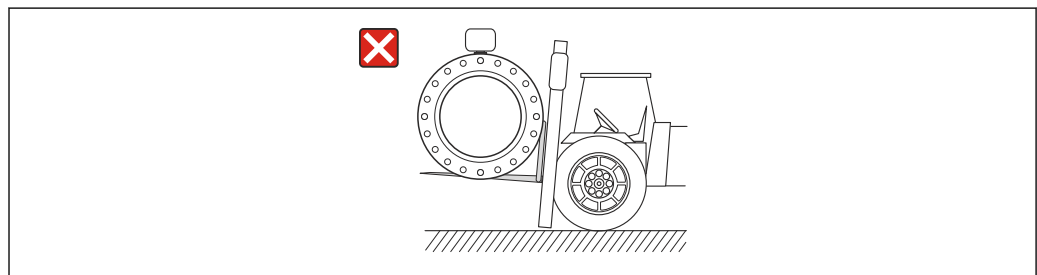

A0023726

5.3 Packaging disposal

All packaging materials are environmentally friendly and 100% recyclable:

- Measuring device secondary packaging: polymer stretch film that conforms to EC Directive 2002/95/EC (RoHS).
- Packaging:
 - Wood crate, treated in accordance with ISPM 15 standard, which is confirmed by the affixed IPPC logo.
 - or
 - Carton in accordance with European Packaging Directive 94/62EC; recyclability is confirmed by the affixed RESY symbol.
- Seaworthy packaging (optional): Wood crate, treated in accordance with ISPM 15 standard, which is confirmed by the affixed IPPC logo.
- Carrying and mounting hardware:
 - Disposable plastic pallet
 - Plastic straps
 - Plastic adhesive strips
- Dunnage: Paper cushion

6 Installation

6.1 Installation conditions

6.1.1 Mounting position

Mounting location

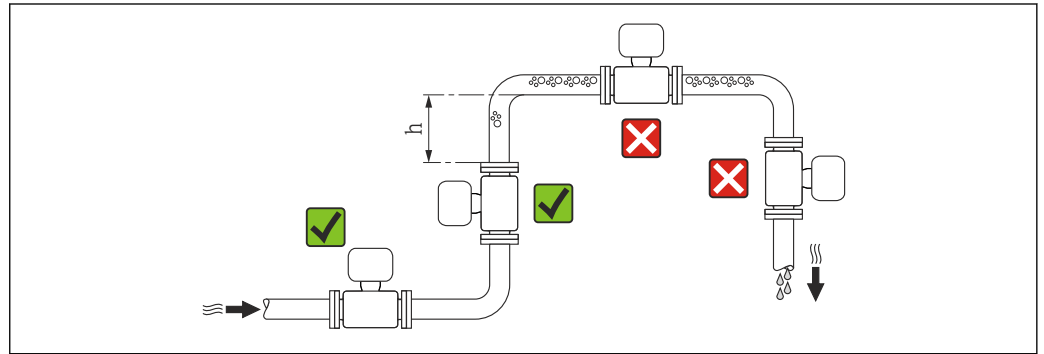

A0023343

Preferably install the sensor in an ascending pipe, and ensure a sufficient distance to the next pipe elbow: $h \geq 2 \times DN$

To prevent measuring errors arising from accumulation of gas bubbles in the measuring tube, avoid the following mounting locations in the pipe:

- Highest point of a pipeline.
- Directly upstream of a free pipe outlet in a down pipe.

Installation in down pipes

Install a siphon with a vent valve downstream of the sensor in down pipes whose length $h \geq 5 \text{ m}$ (16.4 ft). This precaution is to avoid low pressure and the consequent risk of damage to the measuring tube. This measure also prevents the system losing prime.

 For information on the liner's resistance to partial vacuum

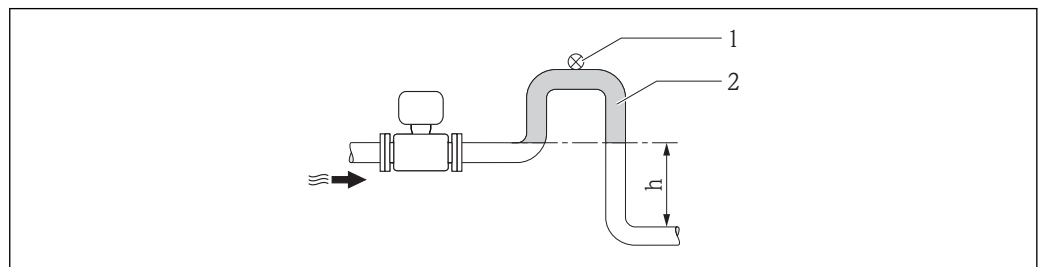

A0017064

4 Installation in a down pipe

- 1 Vent valve
- 2 Pipe siphon
- h Length of down pipe

Installation in partially filled pipes

A partially filled pipe with a gradient necessitates a drain-type configuration.

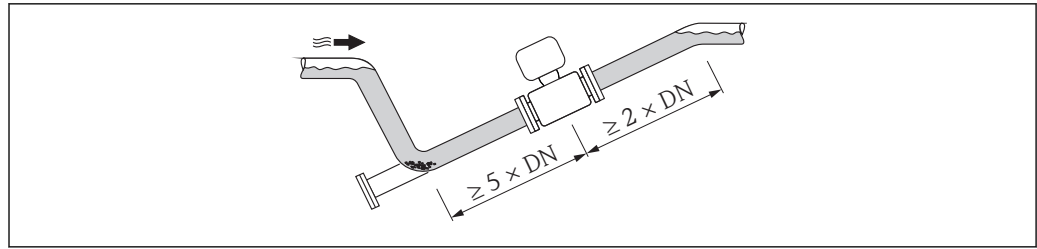

A0017063

Orientation

The direction of the arrow on the sensor nameplate helps you to install the sensor according to the flow direction (direction of medium flow through the piping).

An optimum orientation position helps avoid gas and air accumulations and deposits in the measuring tube.

The measuring device also offers the empty pipe detection function to detect partially filled measuring pipes in the event of outgassing fluids or variable process pressures.

Vertical

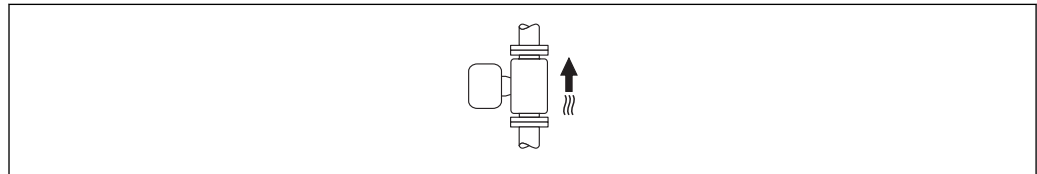

A0015591

Optimum for self-emptying pipe systems and for use in conjunction with empty pipe detection.

Horizontal

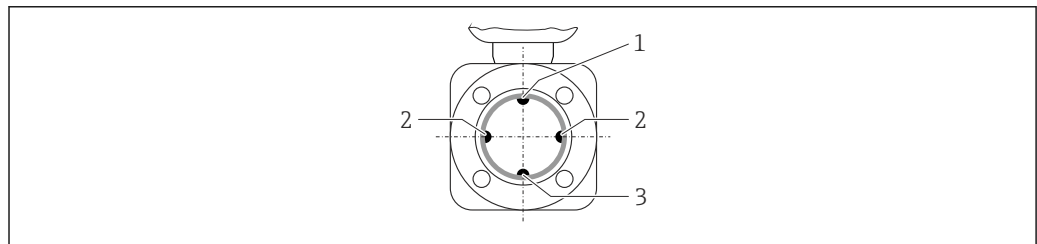

A0016260

- 1 EPD electrode for empty pipe detection
- 2 Measuring electrodes for signal detection
- 3 Reference electrode for potential equalization

- i
 - The measuring electrode plane must be horizontal. This prevents brief insulation of the two measuring electrodes by entrained air bubbles.
 - Empty pipe detection only works if the transmitter housing is pointing upwards as otherwise there is no guarantee that the empty pipe detection function will actually respond to a partially filled or empty measuring tube.

Inlet and outlet runs

If possible, install the sensor upstream from fittings such as valves, T-pieces or elbows.

Observe the following inlet and outlet runs to comply with accuracy specifications:

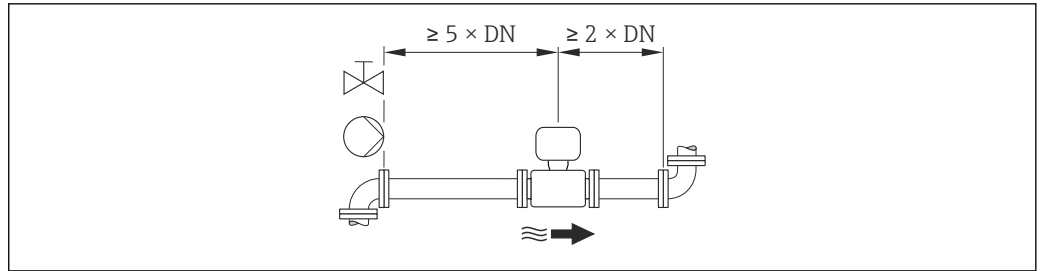

A0016275

i To keep within the in-service maximum permissible errors for custody transfer no additional requirements apply with regard to the graphic illustrated above.

Installation dimensions

i For the dimensions and installation lengths of the device, see the "Technical Information" document, "Mechanical construction" section

6.1.2 Requirements from environment and process

Ambient temperature range

Transmitter	-40 to +60 °C (-40 to +140 °F)
Local display	-20 to +60 °C (-4 to +140 °F), the readability of the display may be impaired at temperatures outside the temperature range.
Sensor	
Liner	Do not exceed or fall below the permitted temperature range of the liner .

If operating outdoors:

- Install the measuring device in a shady location.
- Avoid direct sunlight, particularly in warm climatic regions.
- Avoid direct exposure to weather conditions.

Temperature tables

i Observe the interdependencies between the permitted ambient and fluid temperatures when operating the device in hazardous areas.

i For detailed information on the temperature tables, see the separate document entitled "Safety Instructions" (XA) for the device.

System pressure

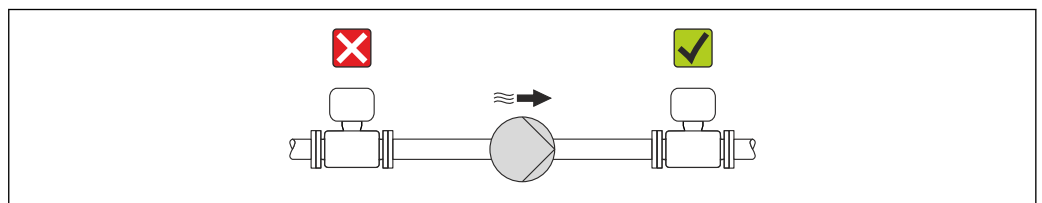

A0015594

Never install the sensor on the pump suction side in order to avoid the risk of low pressure, and thus damage to the liner.

i Furthermore, install pulse dampers if reciprocating, diaphragm or peristaltic pumps are used.

- i** ■ For information on the liner's resistance to partial vacuum → [139](#)
- For information on the shock resistance of the measuring system → [138](#)
- For information on the vibration resistance of the measuring system → [138](#)

Vibrations

In the event of very strong vibrations, the pipe and sensor must be supported and fixed.

It is also advisable to mount the sensor and transmitter separately.

- i** ■ For information on the shock resistance of the measuring system → [138](#)
- For information on the vibration resistance of the measuring system → [138](#)

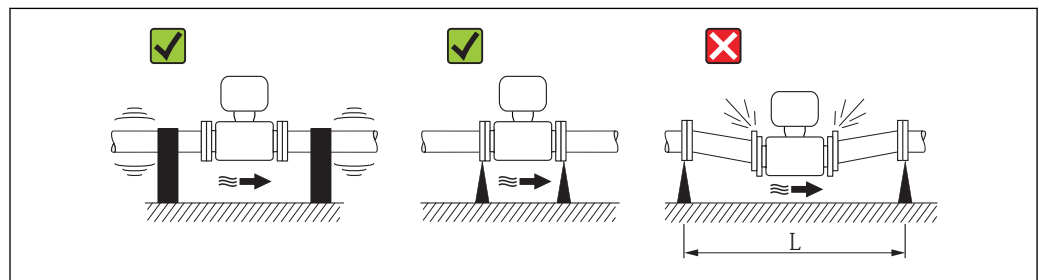

5 Measures to avoid device vibrations ($L > 10\text{ m (33 ft)}$)

Adapters

Suitable adapters to DIN EN 545 (double-flange reducers) can be used to install the sensor in larger-diameter pipes. The resultant increase in the rate of flow improves measuring accuracy with very slow-moving fluids. The nomogram shown here can be used to calculate the pressure loss caused by reducers and expanders.

i The nomogram only applies to liquids with a viscosity similar to that of water.

1. Calculate the ratio of the diameters d/D .
2. From the nomogram read off the pressure loss as a function of flow velocity (downstream from the reduction) and the d/D ratio.

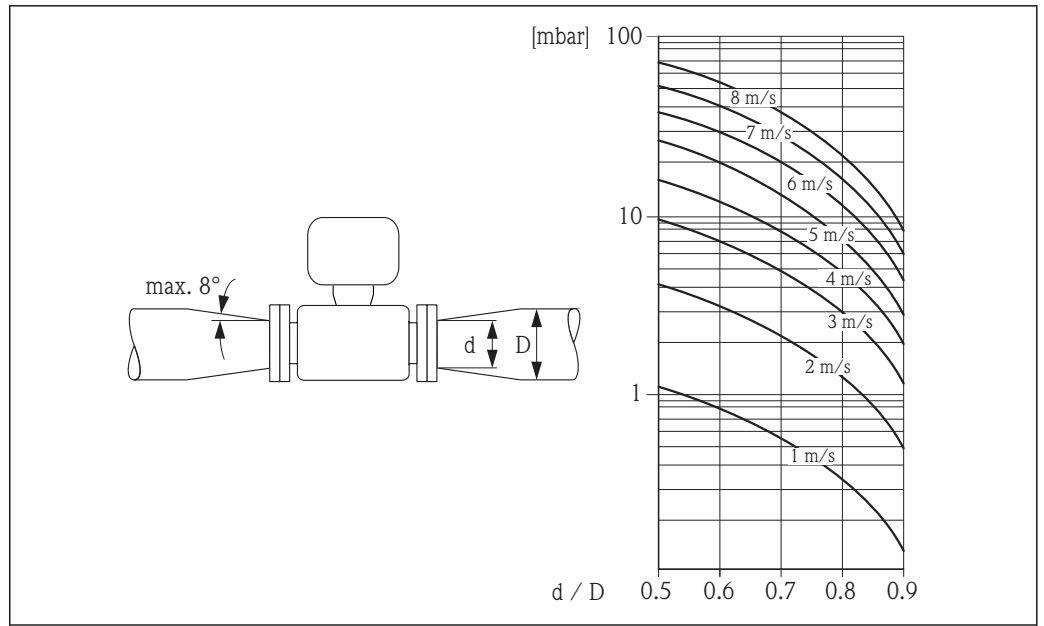

A0016359

6.1.3 Special mounting instructions

Display protection

- To ensure that the optional display protection can be easily opened, maintain the following minimum head clearance: 350 mm (13.8 in)

Permanent immersion in water

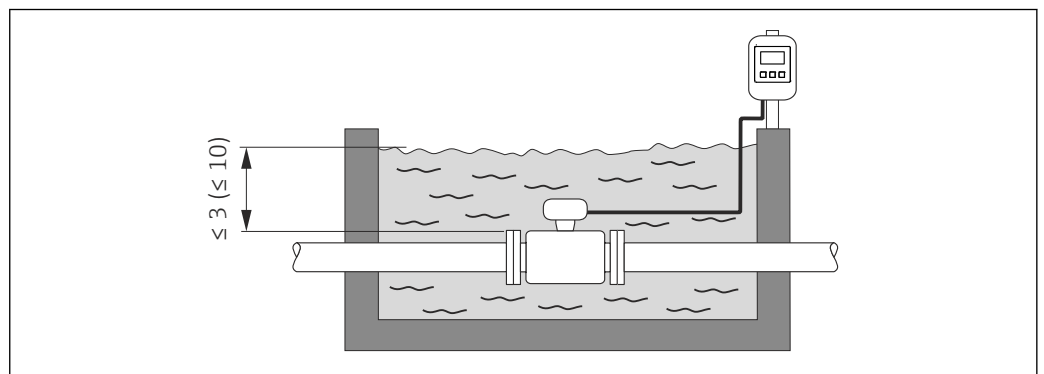

A0017296

6 Engineering unit in m(ft)

i Replacement of cable gland on connection housing → 135

Buried applications

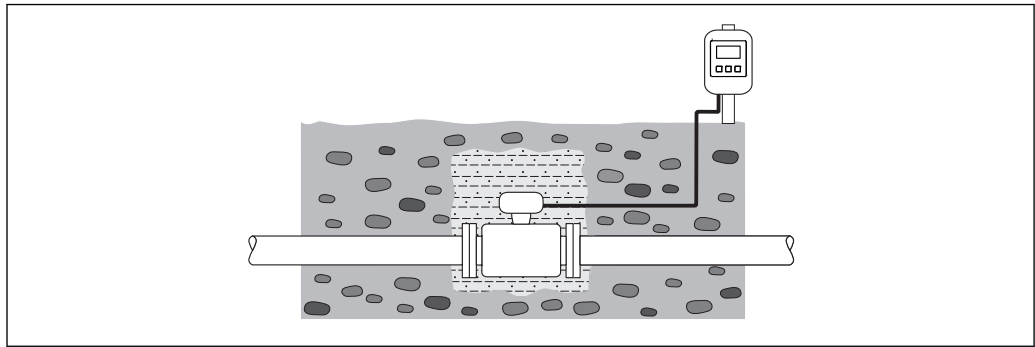

A0017298

6.2 Mounting the measuring device

6.2.1 Required tools

For transmitter

- Torque wrench
- For wall mounting:
 - Open-ended wrench for hexagonal screw max. M5
- For pipe mounting:
 - Open-ended wrench AF 8
 - Phillips head screwdriver PH 2
- For turning the transmitter housing (compact version):
 - Phillips head screwdriver PH 2
 - Torx screwdriver TX 20
 - Open-ended wrench AF 7

For sensor

For flanges and other process connections:

- Screws, nuts, seals etc. are not included in the scope of supply and must be provided by the customer.
- Appropriate mounting tools

6.2.2 Preparing the measuring device

1. Remove all remaining transport packaging.
2. Remove any protective covers or protective caps present from the sensor.
3. Remove stick-on label on the electronics compartment cover.

6.2.3 Mounting the sensor

⚠ WARNING

Danger due to improper process sealing!

- ▶ Ensure that the inside diameters of the gaskets are greater than or equal to that of the process connections and piping.
 - ▶ Ensure that the gaskets are clean and undamaged.
 - ▶ Install the gaskets correctly.
1. Ensure that the direction of the arrow on the sensor matches the flow direction of the medium.

2. To ensure compliance with device specifications, install the measuring device between the pipe flanges in a way that it is centered in the measurement section.
3. If using ground disks, comply with the Installation Instructions provided.
4. Observe required screw tightening torques → 25.
5. Install the measuring device or turn the transmitter housing so that the cable entries do not point upwards.

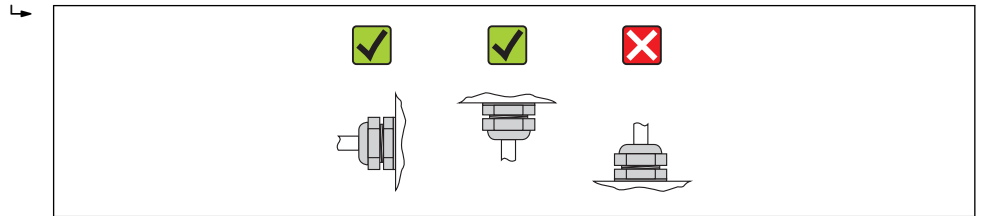

A0013964

Mounting the seals

⚠ CAUTION

An electrically conductive layer could form on the inside of the measuring tube!

Risk of measuring signal short circuit.

- ▶ Do not use electrically conductive sealing compounds such as graphite.

Comply with the following instructions when installing seals:

- Make sure that the seals do not protrude into the piping cross-section.
- For DIN flanges: only use seals according to DIN EN 1514-1.
- For "hard rubber" lining: additional seals are **always** required.
- For "polyurethane" lining: generally additional seals are **not** required.

Mounting the ground cable/ground disks

Comply with the information on potential equalization and detailed mounting instructions for the use of ground cables/ground disks → 44.

Screw tightening torques

Please note the following:

- The screw tightening torques listed below apply only to lubricated threads and to pipes not subjected to tensile stress.
- Tighten the screws uniformly and in diagonally opposite sequence.
- Overtightening the screws will deform the sealing faces or damage the seals.

Screw tightening torques for EN 1092-1 (DIN 2501), PN 6/10/16/25/40

Nominal diameter [mm]	Pressure rating [bar]	Threaded fasteners [mm]	Max. screw tightening torque [Nm]	
			Hard rubber	Polyurethane
25	PN 40	4 × M12	-	15
32	PN 40	4 × M16	-	24
40	PN 40	4 × M16	-	31
50	PN 40	4 × M16	48	40
65 ¹⁾	PN 16	8 × M16	32	27
65	PN 40	8 × M16	32	27
80	PN 16	8 × M16	40	34
80	PN 40	8 × M16	40	34
100	PN 16	8 × M16	43	36
100	PN 40	8 × M20	59	50

Nominal diameter [mm]	Pressure rating [bar]	Threaded fasteners [mm]	Max. screw tightening torque [Nm]	
			Hard rubber	Polyurethane
125	PN 16	8 × M16	56	48
125	PN 40	8 × M24	83	71
150	PN 16	8 × M20	74	63
150	PN 40	8 × M24	104	88
200	PN 10	8 × M20	106	91
200	PN 16	12 × M20	70	61
200	PN 25	12 × M24	104	92
250	PN 10	12 × M20	82	71
250	PN 16	12 × M24	98	85
250	PN 25	12 × M27	150	134
300	PN 10	12 × M20	94	81
300	PN 16	12 × M24	134	118
300	PN 25	16 × M27	153	138
350	PN 6	12 × M20	111	120
350	PN 10	16 × M20	112	118
350	PN 16	16 × M24	152	165
350	PN 25	16 × M30	227	252
400	PN 6	16 × M20	90	98
400	PN 10	16 × M24	151	167
400	PN 16	16 × M27	193	215
400	PN 25	16 × M33	289	326
450	PN 6	16 × M20	112	126
450	PN 10	20 × M24	153	133
450	PN 16	20 × M27	198	196
450	PN 25	20 × M33	256	253
500	PN 6	20 × M20	119	123
500	PN 10	20 × M24	155	171
500	PN 16	20 × M30	275	300
500	PN 25	20 × M33	317	360
600	PN 6	20 × M24	139	147
600	PN 10	20 × M27	206	219
600 ¹⁾	PN 16	20 × M33	415	443
600	PN 25	20 × M36	431	516
700	PN 6	24 × M24	148	139
700	PN 10	24 × M27	246	246
700	PN 16	24 × M33	278	318
700	PN 25	24 × M39	449	507
800	PN 6	24 × M27	206	182
800	PN 10	24 × M30	331	316
800	PN 16	24 × M36	369	385
800	PN 25	24 × M45	664	721
900	PN 6	24 × M27	230	637

Nominal diameter [mm]	Pressure rating [bar]	Threaded fasteners [mm]	Max. screw tightening torque [Nm]	
			Hard rubber	Polyurethane
900	PN 10	28 × M30	316	307
900	PN 16	28 × M36	353	398
900	PN 25	28 × M45	690	716
1000	PN 6	28 × M27	218	208
1000	PN 10	28 × M33	402	405
1000	PN 16	28 × M39	502	518
1000	PN 25	28 × M52	970	971
1200	PN 6	32 × M30	319	299
1200	PN 10	32 × M36	564	568
1200	PN 16	32 × M45	701	753
1400	PN 6	36 × M33	430	398
1400	PN 10	36 × M39	654	618
1400	PN 16	36 × M45	729	762
1600	PN 6	40 × M33	440	417
1600	PN 10	40 × M45	946	893
1600	PN 16	40 × M52	1007	1100
1800	PN 6	44 × M36	547	521
1800	PN 10	44 × M45	961	895
1800	PN 16	44 × M52	1108	1003
2000	PN 6	48 × M39	629	605
2000	PN 10	48 × M45	1047	1092
2000	PN 16	48 × M56	1324	1261

1) Designed acc. to EN 1092-1 (not to DIN 2501)

Screw tightening torques for ASME B16.5, Class 150/300

Nominal diameter		Pressure rating [psi]	Threaded fasteners [in]	Max. screw tightening torque [Nm] ([lbf · ft])	
[mm]	[in]			Hard rubber	Polyurethane
25	1	Class 150	4 × ½	–	7 (5)
25	1	Class 300	4 × 5/8	–	8 (6)
40	1 ½	Class 150	4 × ½	–	10 (7)
40	1 ½	Class 300	4 × ¾	–	15 (11)
50	2	Class 150	4 × 5/8	35 (26)	22 (16)
50	2	Class 300	8 × 5/8	18 (13)	11 (8)
80	3	Class 150	4 × 5/8	60 (44)	43 (32)
80	3	Class 300	8 × ¾	38 (28)	26 (19)
100	4	Class 150	8 × 5/8	42 (31)	31 (23)
100	4	Class 300	8 × ¾	58 (43)	40 (30)
150	6	Class 150	8 × ¾	79 (58)	59 (44)
150	6	Class 300	12 × ¾	70 (52)	51 (38)
200	8	Class 150	8 × ¾	107 (79)	80 (59)

Nominal diameter		Pressure rating [psi]	Threaded fasteners [in]	Max. screw tightening torque [Nm] ([lbf · ft])	
[mm]	[in]			Hard rubber	Polyurethane
250	10	Class 150	12 × 7/8	101 (74)	75 (55)
300	12	Class 150	12 × 7/8	133 (98)	103 (76)
350	14	Class 150	12 × 1	135 (100)	158 (117)
400	16	Class 150	16 × 1	128 (94)	150 (111)
450	18	Class 150	16 × 1 1/8	204 (150)	234 (173)
500	20	Class 150	20 × 1 1/8	183 (135)	217 (160)
600	24	Class 150	20 × 1 ¼	268 (198)	307 (226)

Screw tightening torques for AWWA C207, Class D

Nominal diameter		Threaded fasteners [in]	Max. screw tightening torque [Nm] ([lbf · ft])	
[mm]	[in]		Hard rubber	Polyurethane
700	28	28 × 1 ¼	247 (182)	292 (215)
750	30	28 × 1 ¼	287 (212)	302 (223)
800	32	28 × 1 ½	394 (291)	422 (311)
900	36	32 × 1 ½	419 (309)	430 (317)
1000	40	36 × 1 ½	420 (310)	477 (352)
1050	42	36 × 1 ½	528 (389)	518 (382)
1200	48	44 × 1 ½	552 (407)	531 (392)
1350	54	44 × 1 ¾	730 (538)	–
1500	60	52 × 1 ¾	758 (559)	–
1650	66	52 × 1 ¾	946 (698)	–
1800	72	60 × 1 ¾	975 (719)	–
2000	78	64 × 2	853 (629)	–

Screw tightening torques for AS 2129, Table E

Nominal diameter [mm]	Threaded fasteners [mm]	Max. screw tightening torque [Nm]	
		Hard rubber	Polyurethane
50	4 × M16	32	–
80	4 × M16	49	–
100	8 × M16	38	–
150	8 × M20	64	–
200	8 × M20	96	–
250	12 × M20	98	–
300	12 × M24	123	–
350	12 × M24	203	–
400	12 × M24	226	–
450	16 × M24	226	–
500	16 × M24	271	–
600	16 × M30	439	–
700	20 × M30	355	–

Nominal diameter [mm]	Threaded fasteners [mm]	Max. screw tightening torque [Nm]	
		Hard rubber	Polyurethane
750	20 × M30	559	–
800	20 × M30	631	–
900	24 × M30	627	–
1000	24 × M30	634	–
1200	32 × M30	727	–

Screw tightening torques for AS 4087, PN 16

Nominal diameter [mm]	Threaded fasteners [mm]	Max. screw tightening torque [Nm]	
		Hard rubber	Polyurethane
50	4 × M16	32	–
80	4 × M16	49	–
100	4 × M16	76	–
150	8 × M20	52	–
200	8 × M20	77	–
250	8 × M20	147	–
300	12 × M24	103	–
350	12 × M24	203	–
375	12 × M24	137	–
400	12 × M24	226	–
450	12 × M24	301	–
500	16 × M24	271	–
600	16 × M27	393	–
700	20 × M27	330	–
750	20 × M30	529	–
800	20 × M33	631	–
900	24 × M33	627	–
1000	24 × M33	595	–
1200	32 × M33	703	–

Screw tightening torques for JIS B2220, 10/20K

Nominal diameter [mm]	Pressure rating [bar]	Threaded fasteners [mm]	Max. screw tightening torque [Nm]	
			Hard rubber	Polyurethane
25	10K	4 × M16	–	19
25	20K	4 × M16	–	19
32	10K	4 × M16	–	22
32	20K	4 × M16	–	22
40	10K	4 × M16	–	24
40	20K	4 × M16	–	24
50	10K	4 × M16	40	33
50	20K	8 × M16	20	17
65	10K	4 × M16	55	45

Nominal diameter [mm]	Pressure rating [bar]	Threaded fasteners [mm]	Max. screw tightening torque [Nm]	
			Hard rubber	Polyurethane
65	20K	8 × M16	28	23
80	10K	8 × M16	29	23
80	20K	8 × M20	42	35
100	10K	8 × M16	35	29
100	20K	8 × M20	56	48
125	10K	8 × M20	60	51
125	20K	8 × M22	91	79
150	10K	8 × M20	75	63
150	20K	12 × M22	81	72
200	10K	12 × M20	61	52
200	20K	12 × M22	91	80
250	10K	12 × M22	100	87
250	20K	12 × M24	159	144
300	10K	16 × M22	74	63
300	20K	16 × M24	138	124

6.2.4 Mounting the transmitter of the remote version

⚠ CAUTION

Ambient temperature too high!

Danger of electronics overheating and housing deformation.

- ▶ Do not exceed the permitted maximum ambient temperature .
- ▶ If operating outdoors: Avoid direct sunlight and exposure to weathering, particularly in warm climatic regions.

⚠ CAUTION

Excessive force can damage the housing!

- ▶ Avoid excessive mechanical stress.

The transmitter of the remote version can be mounted in the following ways:

- Wall mounting
- Pipe mounting

Wall mounting

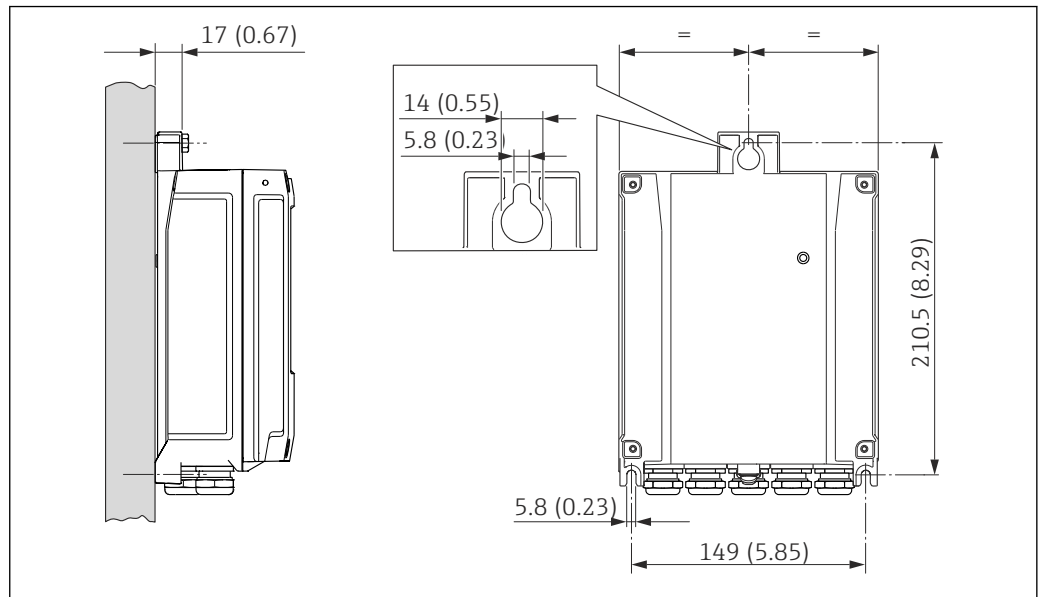

7 Engineering unit mm (in)

1. Drill the holes.
2. Insert wall plugs into the drilled holes.
3. Screw in the securing screws slightly at first.
4. Fit the transmitter housing over the securing screws and mount in place.
5. Tighten the securing screws.

Post mounting

⚠ WARNING

Excessive tightening torque applied to the fixing screws on plastic housing!
Risk of damaging the plastic transmitter.

- ▶ Tighten the fixing screws as per the tightening torque: 2 Nm (1.5 lbf ft)

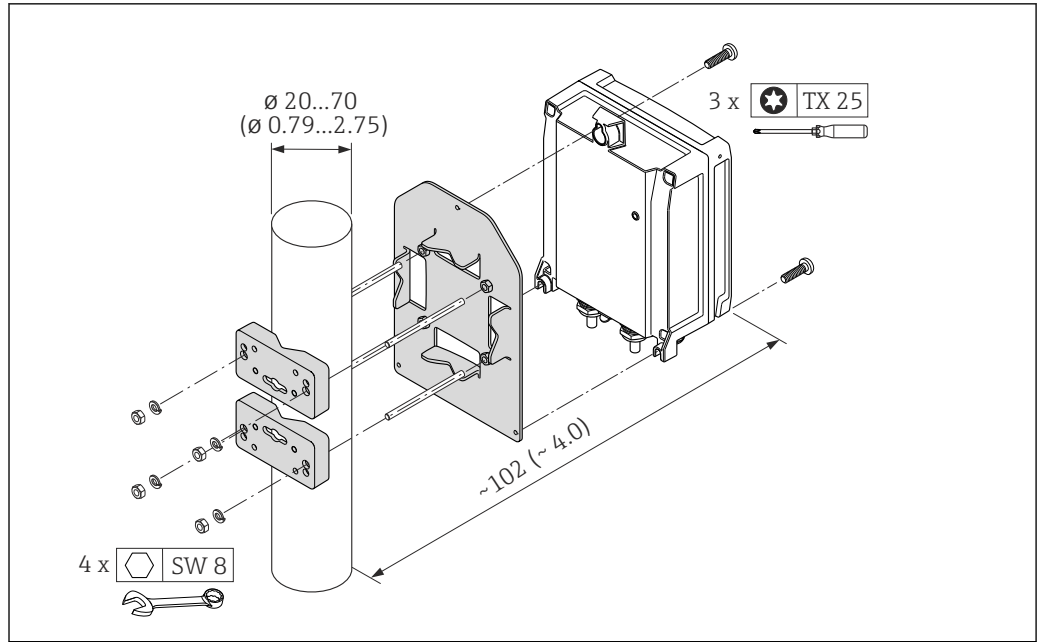

A0020705

8 Engineering unit mm (in)

6.2.5 Turning the transmitter housing

To provide easier access to the connection compartment or display module, the transmitter housing can be turned.

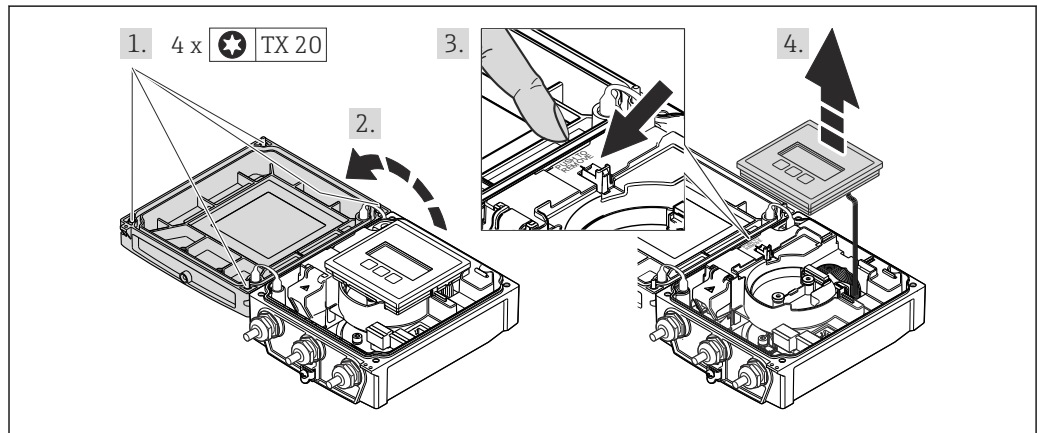

A0021602

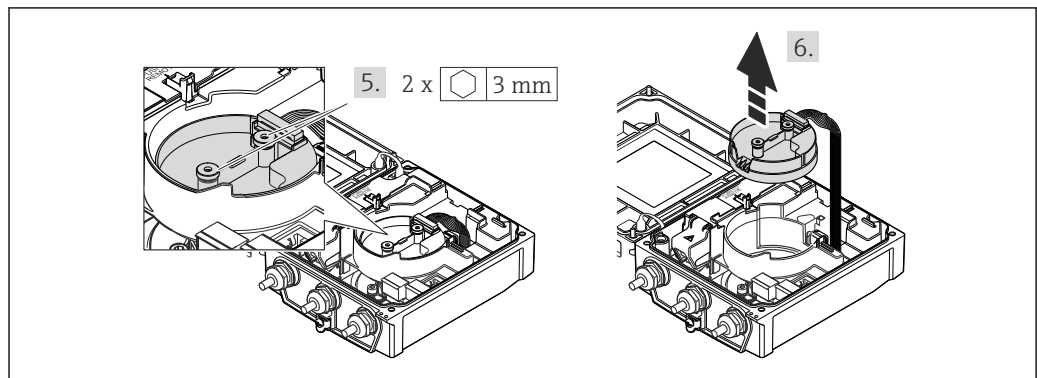

A0021603

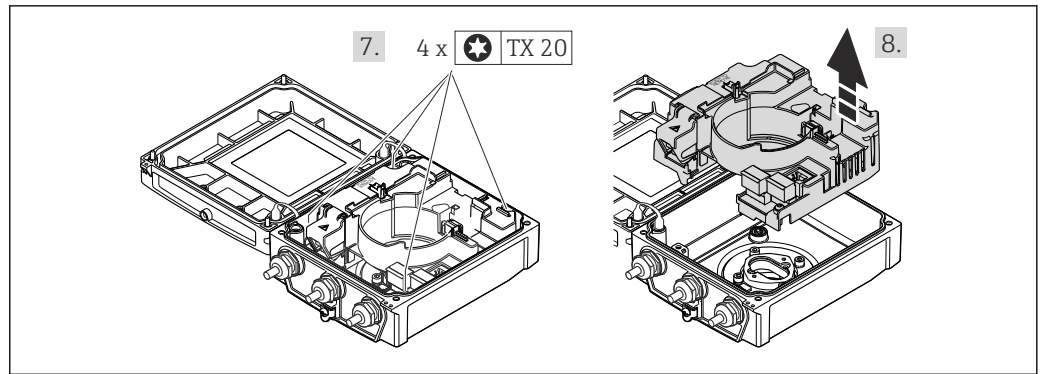

A0021604

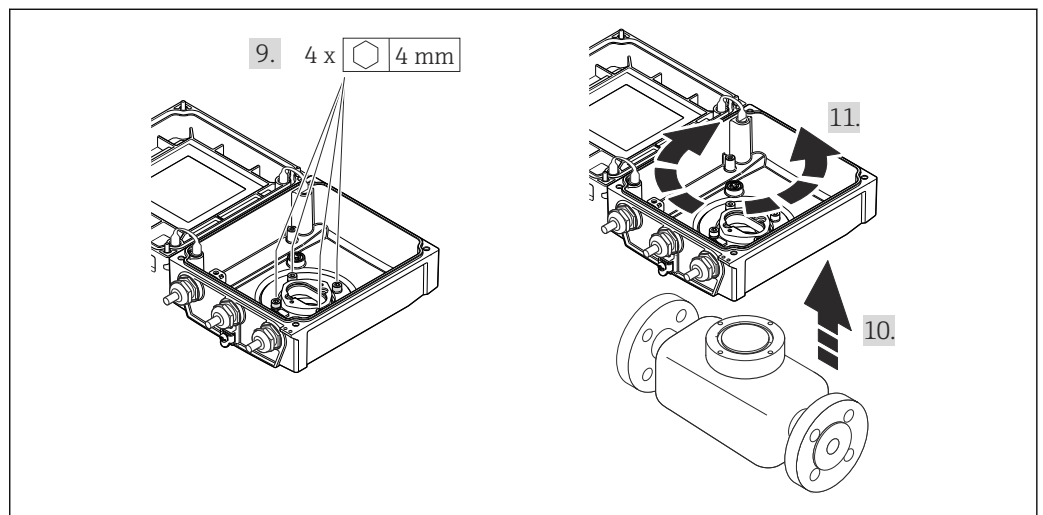

A0021605

1. Loosen the fixing screws of the housing cover (when reassembling, pay attention to the tightening torque → 34).
2. Open the housing cover.
3. Unlock the display module.
4. Remove the display module.
5. Loosen the fixing screws of the smart sensor electronics module (when reassembling, pay attention to the tightening torque → 34).
6. Remove the smart sensor electronics module (when reassembling, pay attention to the coding of the plug → 33).
7. Loosen the fixing screws of the main electronics module (when reassembling, pay attention to the tightening torque → 34).
8. Remove the main electronics module.
9. Loosen the fixing screws of the transmitter housing (when reassembling, pay attention to the tightening torque → 34).
10. Lift the transmitter housing.
11. Turn the housing to the desired position in increments of 90°.

Reassembling the transmitter housing

⚠ WARNING

Excessive tightening torque applied to the fixing screws!

Damage to the transmitter.

- ▶ When reassembling, tighten the fixing screws as per the tightening torque:

Step	Fixing screw	Tightening torques for housing made of:	
		Aluminum	Plastic
1	Housing cover	2.5 Nm (1.8 lbf ft)	1 Nm (0.7 lbf ft)
5	Smart sensor electronics module	0.6 Nm (0.4 lbf ft)	
7	Main electronics module	1.5 Nm (1.1 lbf ft)	
10	Transmitter housing	5.5 Nm (4.1 lbf ft)	

NOTICE**Plug of the smart sensor electronics module connected incorrectly!**

No measuring signal is output.

- ▶ Plug in the plug of the smart sensor electronics module as per the coding.

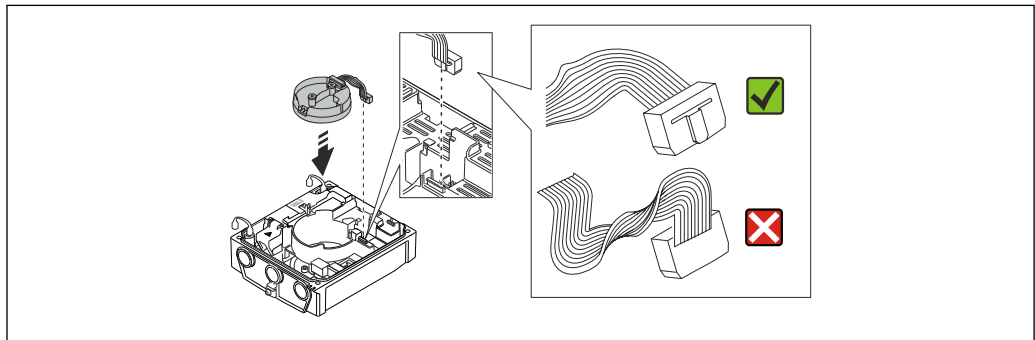

A0021585

- ▶ Reverse the procedure to reassemble the measuring device.

6.2.6 Turning the display module

The display module can be turned to optimize display readability and operability.

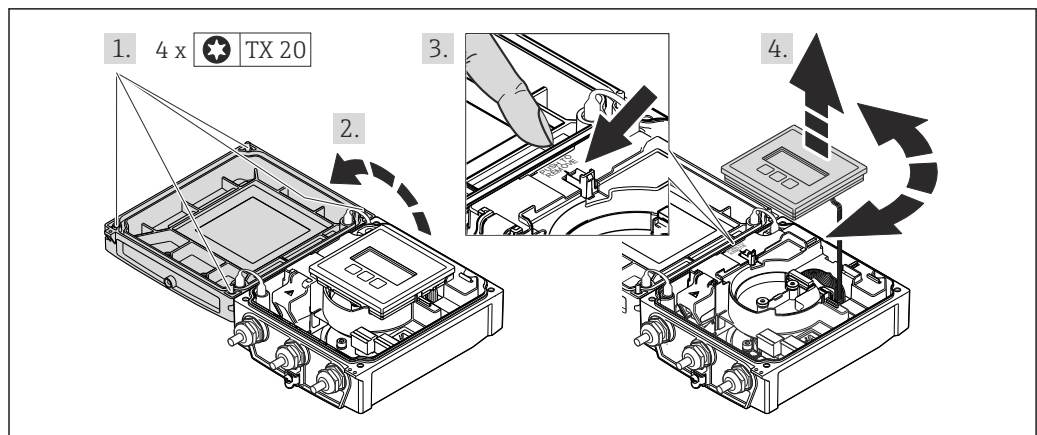

A0021617

1. Loosen the fixing screws of the housing cover (when reassembling, pay attention to the tightening torque → 35).
2. Open the housing cover.
3. Unlock the display module.
4. Pull out the display module and turn it to the desired position in increments of 90°.

Reassembling the transmitter housing



Excessive tightening torque applied to the fixing screws!

Damage to the transmitter.

- ▶ When reassembling, tighten the fixing screws as per the tightening torque:

Step	Fixing screw	Tightening torque for housing made of:	
		Aluminum	Plastic
1	Housing cover	2.5 Nm (1.8 lbf ft)	1 Nm (0.7 lbf ft)

- ▶ Reverse the procedure to reassemble the measuring device.

6.3 Post-installation check

Is the device undamaged (visual inspection)?	<input type="checkbox"/>
Does the measuring device conform to the measuring point specifications? For example: <ul style="list-style-type: none"> ▪ Process temperature ▪ Process pressure (refer to the section on "Pressure-temperature ratings" in the "Technical Information" document) ▪ Ambient temperature ▪ Measuring range 	<input type="checkbox"/>
Has the correct orientation for the sensor been selected ? <ul style="list-style-type: none"> ▪ According to sensor type ▪ According to medium temperature ▪ According to medium properties (outgassing, with entrained solids) 	<input type="checkbox"/>
Does the arrow on the sensor nameplate match the direction of flow of the fluid through the piping ?	<input type="checkbox"/>
Are the measuring point identification and labeling correct (visual inspection)?	<input type="checkbox"/>
Is the device adequately protected from precipitation and direct sunlight?	<input type="checkbox"/>
Have the fixing screws been tightened with the correct tightening torque?	<input type="checkbox"/>

7 Electrical connection

 The measuring device does not have an internal circuit breaker. For this reason, assign the measuring device a switch or power-circuit breaker so that the power supply line can be easily disconnected from the mains.

7.1 Connection conditions

7.1.1 Required tools

- Torque wrench
- For cable entries: Use corresponding tools
- For housing cover: Torx screwdriver or flat-blade screwdriver
- Wire stripper
- When using stranded cables: crimping tool for ferrule

7.1.2 Requirements for connecting cable

The connecting cables provided by the customer must fulfill the following requirements.

Electrical safety

In accordance with applicable federal/national regulations.

Permitted temperature range

- -40 °C (-40 °F) to +80 °C (+176 °F)
- Minimum requirement: cable temperature range \geq ambient temperature +20 K

Power supply cable

Standard installation cable is sufficient.

Signal cable

EtherNet/IP

The standard ANSI/TIA/EIA-568-B.2 Annex specifies CAT 5 as the minimum category for a cable used for EtherNet/IP. CAT 5e and CAT 6 are recommended.

 For more information on planning and installing EtherNet/IP networks, please refer to the "Media Planning and Installation Manual. EtherNet/IP" of ODVA Organization.

Connecting cable for remote version

Electrode cable

Standard cable	3 × 0.38 mm ² (20 AWG) with common, braided copper shield (ϕ ~7 mm (0.28 in)) and individual shielded cores
Cable for empty pipe detection (EPD)	4 × 0.38 mm ² (20 AWG) with common, braided copper shield (ϕ ~7 mm (0.28 in)) and individual shielded cores
Conductor resistance	\leq 50 Ω /km (0.015 Ω /ft)
Capacitance: core/shield	\leq 420 pF/m (128 pF/ft)
Operating temperature	-20 to +80 °C (-68 to +176 °F)

Coil current cable

Standard cable	2 × 0.75 mm ² (18 AWG) with common, braided copper shield (ϕ ~ 7 mm (0.28")) and individually shielded cores
Conductor resistance	≤ 37 Ω/km (0.011 Ω/ft)
Capacitance: core/core, shield grounded	≤ 120 pF/m (37 pF/ft)
Operating temperature	-20 to +80 °C (-68 to +176 °F)
Test voltage for cable insulation	≤ AC 1433 V r.m.s. 50/60 Hz or ≥ DC 2026 V

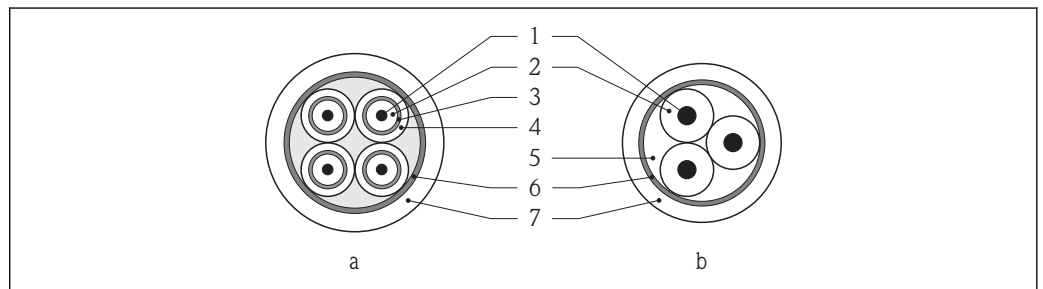

A0003194

9 Cable cross-section

- a* Electrode cable
b Coil current cable
 1 Core
 2 Core insulation
 3 Core shield
 4 Core jacket
 5 Core reinforcement
 6 Cable shield
 7 Outer jacket

Reinforced connecting cables

Reinforced connecting cables with an additional, reinforcing metal braid should be used for:

- When laying the cable directly in the ground
- Where there is a risk of damage from rodents
- If using the device below IP68 degree of protection

Operation in zones of severe electrical interference

The measuring system meets the general safety requirements → 159 and EMC specifications → 138.

Grounding is by means of the ground terminal provided for the purpose inside the connection housing. The stripped and twisted lengths of cable shield to the ground terminal must be as short as possible.

Cable diameter

- Cable glands supplied:
 - For standard cable: M20 × 1.5 with cable ϕ6 to 12 mm (0.24 to 0.47 in)
 - For reinforced cable: M20 × 1.5 with cable ϕ9.5 to 16 mm (0.37 to 0.63 in)
- (Plug-in) spring terminals for wire cross-sections 0.5 to 2.5 mm² (20 to 14 AWG)

7.1.3 Terminal assignment

Transmitter

EtherNet/IP connection version

The sensor can be ordered with terminals or a device plug.

Connection methods available		Possible options for order code "Electrical connection"
Outputs	Power supply	
Terminals	Terminals	<ul style="list-style-type: none"> ▪ Option A: coupling M20x1 ▪ Option B: thread M20x1 ▪ Option C: thread G ½" ▪ Option D: thread NPT ½"
Device plug	Terminals	<ul style="list-style-type: none"> ▪ Option L: plug M12x1 + thread NPT ½" ▪ Option N: plug M12x1 + coupling M20 ▪ Option P: plug M12x1 + thread G ½" ▪ Option U: plug M12x1 + thread M20

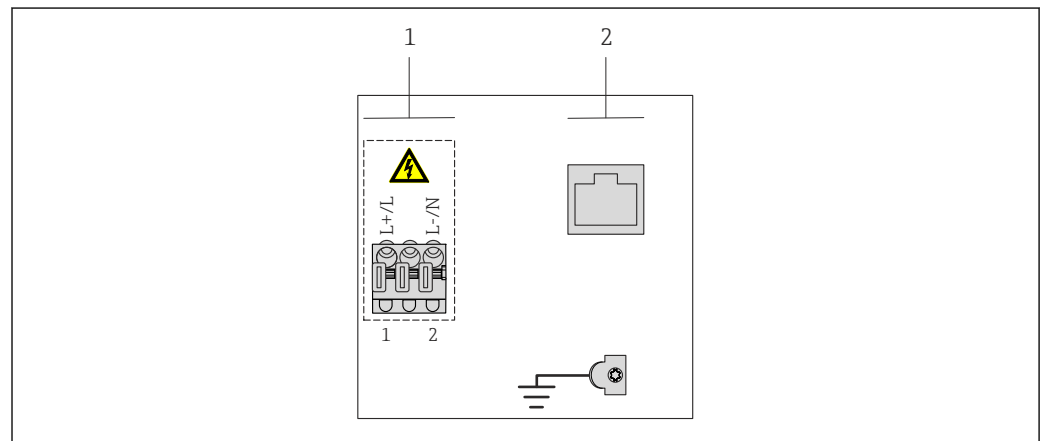

A0020428

- 1 Supply voltage (wide range power unit)
- 2 EtherNet/IP

Supply voltage

Order code for "Power supply"	Terminal numbers	
	1 (L+/L)	2 (L-/N)
Option L (wide range power unit)	AC100 to 240 V	
	AC/DC24 V	

EtherNet/IP signal transmission

Order code for "Output"	Connection via
Option N	EtherNet/IP connector

Remote version

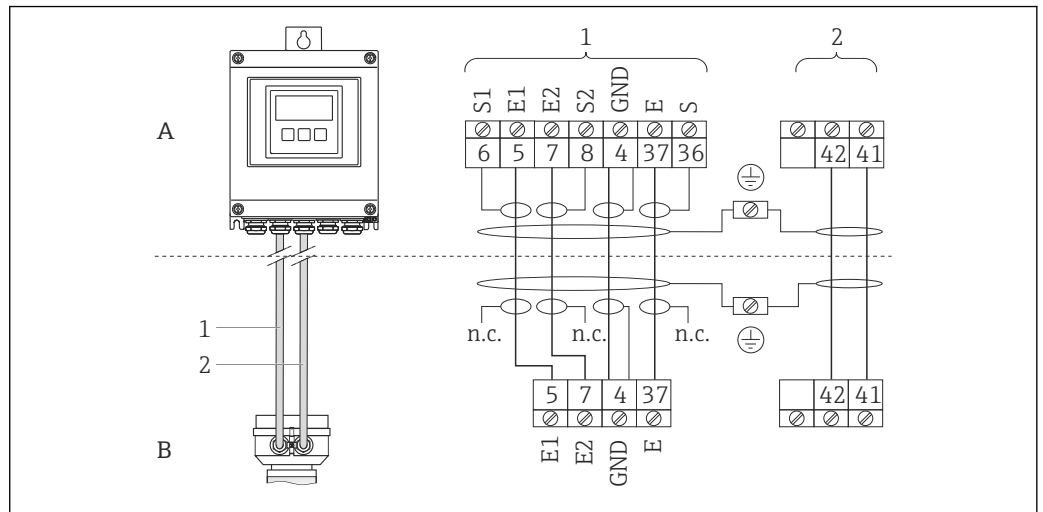

10 Remote version terminal assignment

- A Transmitter wall-mount housing
- B Sensor connection housing
- 1 Electrode cable
- 2 Coil current cable
- n.c. Not connected, insulated cable shields

Terminal No. and cable colors: 6/5 = brown; 7/8 = white; 4 = green; 36/37 = yellow

7.1.4 Pin assignment, device plug

i Order codes for the M12x1 connectors, see the "Order code for electrical connection" column:
EtherNet/IP

EtherNet/IP

Device plug for signal transmission (device side)

	Pin	Assignment	Coding	Plug/socket
	1	+		
2	+	Rx		
3	-	Tx		
4	-	Rx		

7.1.5 Shielding and grounding

7.1.6 Requirements for the supply unit

Supply voltage

Transmitter

Order code for "Power supply"	Terminal voltage	Frequency range
Option L	AC100 to 240 V	50/ 60 Hz, ±4 Hz
	AC/DC24 V	50/ 60 Hz, ±4 Hz

7.1.7 Preparing the measuring device

1. Remove dummy plug if present.
2. If measuring device is delivered with cable glands:
Observe cable specification → 36.

7.1.8 Preparing the connecting cable for the remote version

When terminating the connecting cable, pay attention to the following points:

- In the case of electrode cables, make sure that the ferrules do not touch the core shields on the sensor side. Minimum distance = 1 mm (exception: green "GND" cable)
- In the case of coil current cables, insulate one core of the three-core wire at the level of the core reinforcement. You only require two cores for the connection.
- Fit the fine-wire cores with ferrules.

Transmitter

Electrode cable	Coil current cable
<p>11 Engineering unit mm (in)</p>	<p>12 Engineering unit mm (in)</p>
<p>A = Termination of the cables B = Termination of the fine-wire cores with ferrules 1 = Red ferrules, ϕ1.0 mm (0.04 in) 2 = White ferrules, ϕ0.5 mm (0.02 in) * = Stripping only for reinforced cables</p>	

Sensor

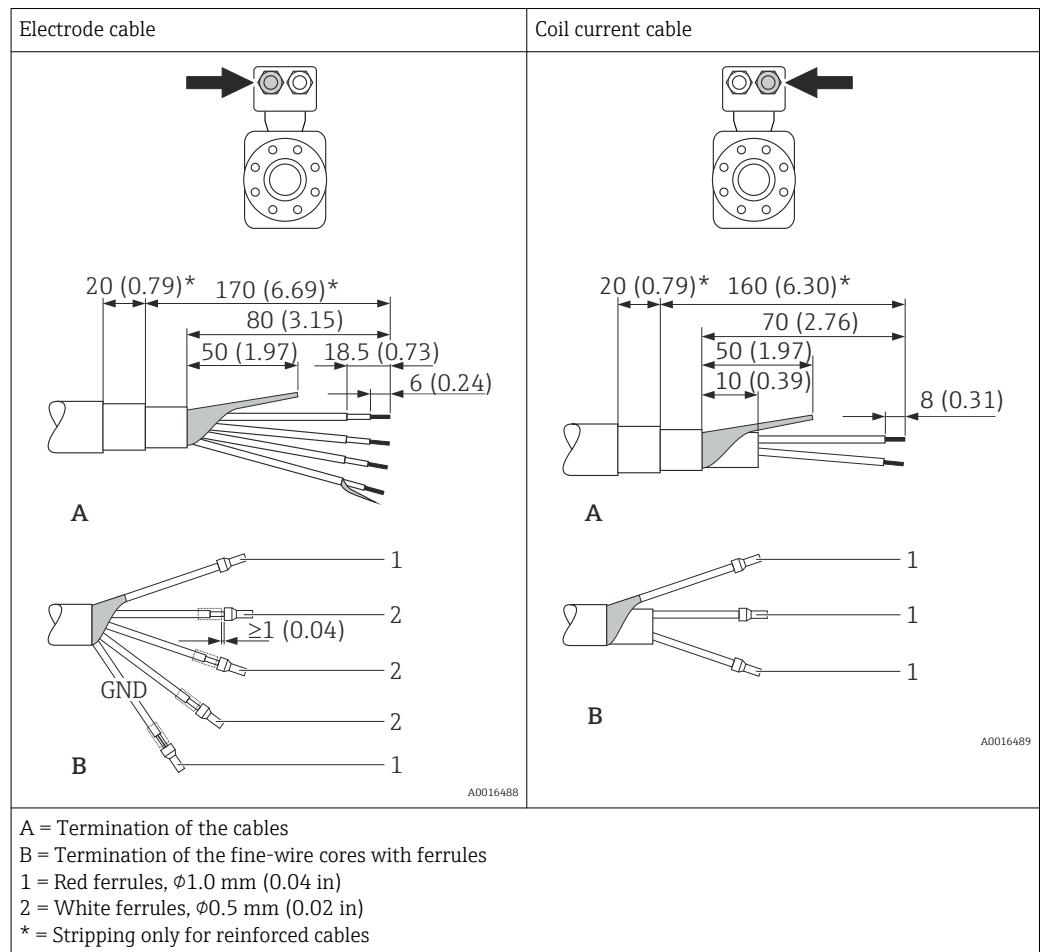

7.2 Connecting the measuring device

⚠ WARNING

Risk of electric shock! Components carry dangerous voltages!

- ▶ Have electrical connection work carried out by correspondingly trained specialists only.
- ▶ Observe applicable federal/national installation codes and regulations.
- ▶ Comply with local workplace safety regulations.
- ▶ Observe grounding concept of the plant.
- ▶ Never mount or wire the measuring device while it is connected to the supply voltage.
- ▶ Before the supply voltage is applied, connect the protective ground to the measuring device.

7.2.1 Connecting the remote version

⚠ WARNING

Risk of damaging the electronic components!

- ▶ Ground the remote version: connect the sensor and transmitter to the same potential equalization.
- ▶ Only connect the sensor to a transmitter with the same serial number.
- ▶ Ground the connection housing of the sensor via the external screw terminal.

The following procedure (in the action sequence given) is recommended for the remote version:

1. Mount the sensor and transmitter.
2. Connect the connecting cable.

3. Connect the transmitter.

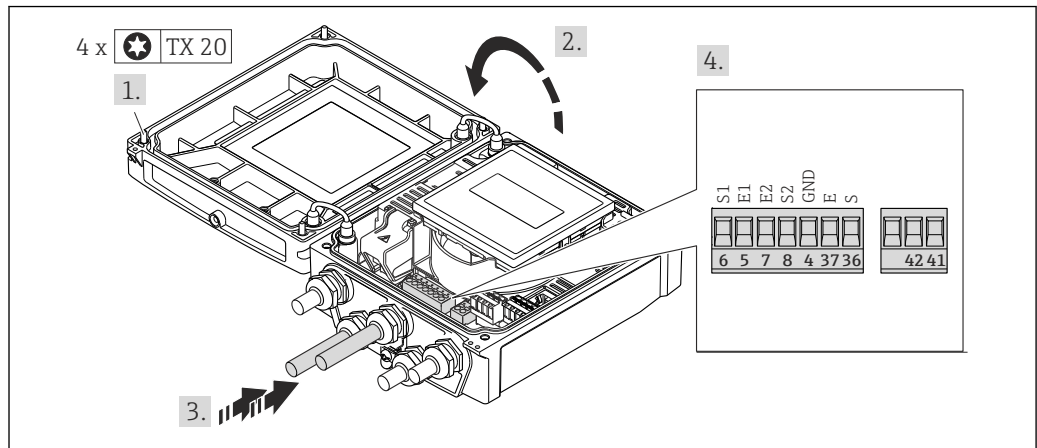

A0017445

13 Transmitter: main electronics module with terminals

1. Loosen the 4 fixing screws on the housing cover.
2. Open the housing cover.
3. Push the cable through the cable entry . To ensure tight sealing, do not remove the sealing ring from the cable entry.
4. Strip the cable and cable ends. In the case of stranded cables, also fit ferrules → 40.
5. Connect the cable in accordance with the terminal assignment → 39.
6. Firmly tighten the cable glands.
7. **WARNING!** Housing degree of protection may be voided due to insufficient sealing of the housing. Screw in the screw without using any lubricant.
Reverse the removal procedure to reassemble the transmitter.

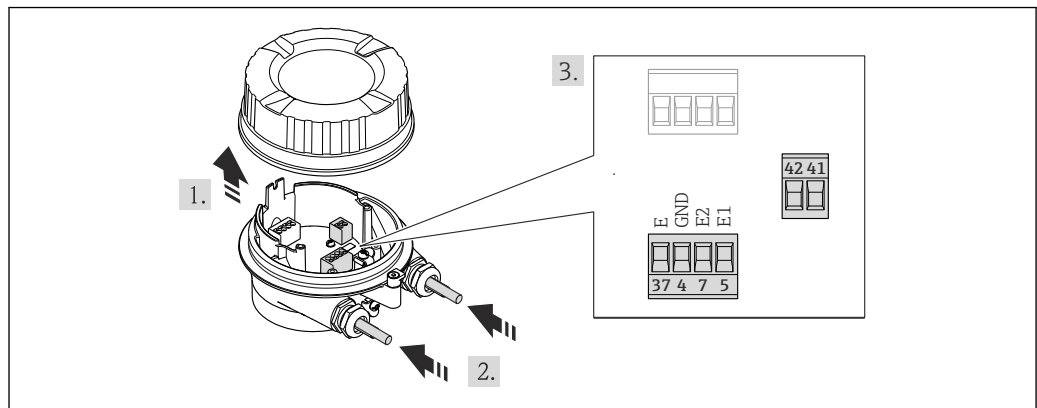

A0021527

14 Sensor: connection module

1. Loosen the securing clamp of the housing cover.
2. Unscrew and lift off the housing cover.
3. **NOTICE!** For conduit extensions: Fit O-ring on cable and push it back sufficiently. When inserting the cable, the O-ring must be located outside the conduit extension. Push the cable through the cable entry . To ensure tight sealing, do not remove the sealing ring from the cable entry.
4. Strip the cable and cable ends. In the case of stranded cables, also fit ferrules → 40.
5. Connect the cable in accordance with the terminal assignment → 39.

6. Firmly tighten the cable glands.
7. **WARNING!** Housing degree of protection may be voided due to insufficient sealing of the housing. Screw in the screw without using any lubricant. The threads on the cover are coated with a dry lubricant.
Reverse the procedure to reassemble the sensor.

7.2.2 Connecting the transmitter

⚠ WARNING

Housing degree of protection may be voided due to insufficient sealing of the housing.

- ▶ Screw in the screw without using any lubricant. The threads on the cover are coated with a dry lubricant.

Tightening torques for plastic housing

Housing cover fixing screw	1.3 Nm
Cable entry	4.5 to 5 Nm
Ground terminal	2.5 Nm

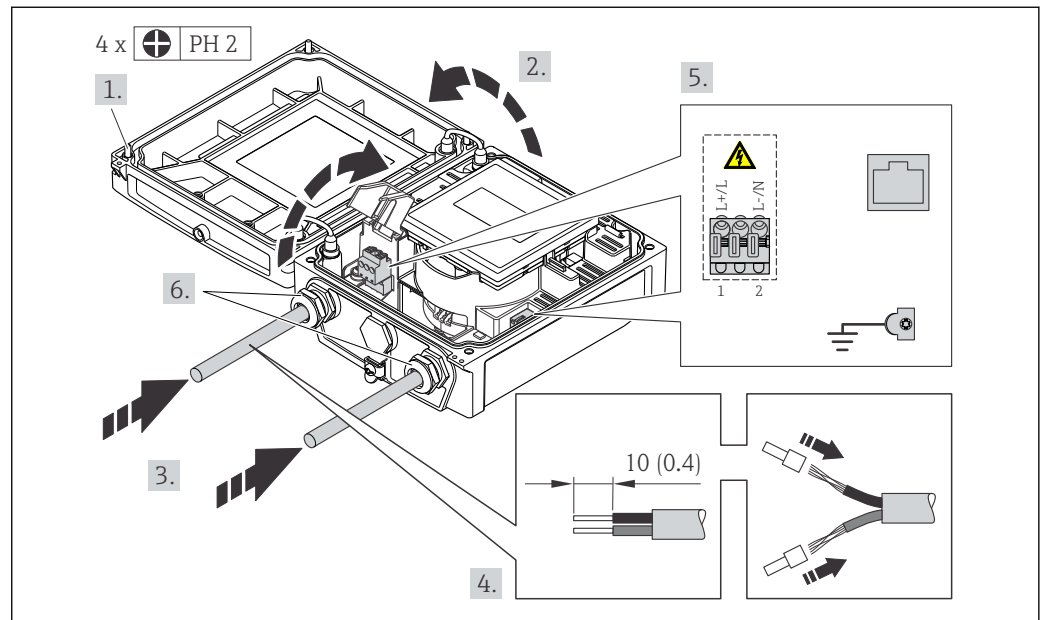

15 Connecting the supply voltage and EtherNet/IP

1. Loosen the 4 fixing screws on the housing cover.
2. Open the housing cover.
3. Push the cable through the cable entry. To ensure tight sealing, do not remove the sealing ring from the cable entry.
4. Strip the cable and cable ends. In the case of stranded cables, also fit ferrules.
5. Connect the cable in accordance with the terminal assignment → 38. For supply voltage: open the shock protection cover.
6. Firmly tighten the cable glands.
7. **WARNING!** Housing degree of protection may be voided due to insufficient sealing of the housing. Screw in the screw without using any lubricant.
Reverse the removal procedure to reassemble the transmitter.

7.2.3 Ensuring potential equalization

Requirements

⚠ CAUTION

Electrode damage can result in the complete failure of the device!

- ▶ Same electrical potential for the fluid and sensor
- ▶ Remote version: same electrical potential for the sensor and transmitter
- ▶ Company-internal grounding concepts
- ▶ Pipe material and grounding

Connection examples for standard situations

Metal, grounded pipe

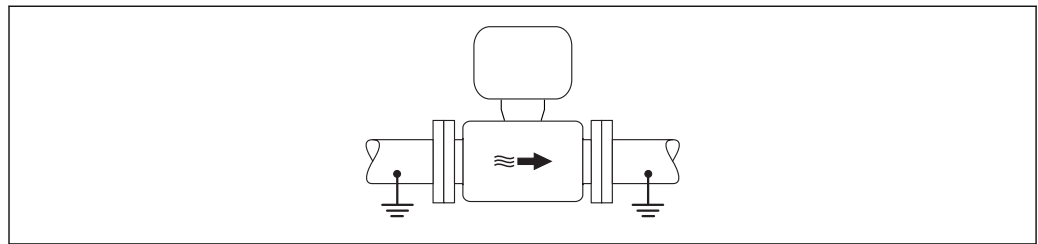

A0016315

16 Potential equalization via measuring tube

Connection example in special situations

Unlined and ungrounded metal pipe

This connection method also applies in situations where:

- The customary potential equalization is not used
- Equalizing currents are present

Ground cable	Copper wire, at least 6 mm ² (0.0093 in ²)
--------------	---

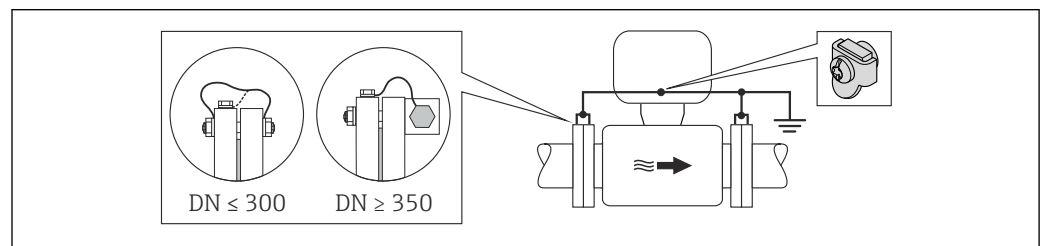

A0016317

17 Potential equalization via ground terminal and pipe flanges

1. Connect both sensor flanges to the pipe flange via a ground cable and ground them.
2. If DN ≤ 300 (12"): Mount the ground cable directly on the conductive flange coating of the sensor with the flange screws. If DN ≥ 350 (14"): Mount the ground cable directly on the metal transport bracket. Observe torques → 25.
3. Connect the connection housing of the transmitter or sensor to ground potential by means of the ground terminal provided for the purpose.

i For remote device versions, the ground terminal in the example always refers to the sensor and **not** to the transmitter.

Plastic pipe or pipe with insulating liner

This connection method also applies in situations where:

- The customary potential equalization is not used
- Equalizing currents are present

Ground cable	Copper wire, at least 6 mm ² (0.0093 in ²)
---------------------	---

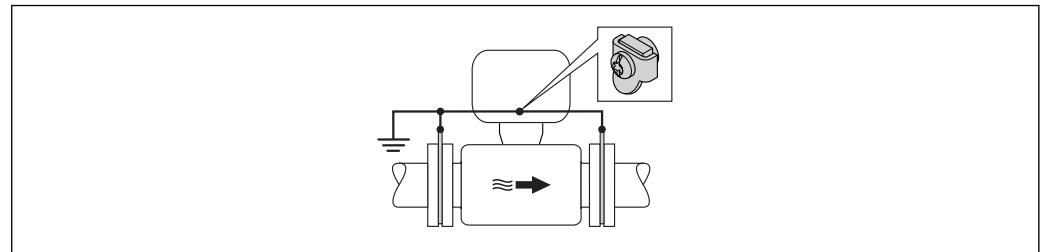

A0016318

18 Potential equalization via ground terminal and ground disks

1. Connect the ground disks to the ground terminal via the ground cable.
2. Connect the ground disks to ground potential.

i For remote device versions, the ground terminal in the example always refers to the sensor and **not** to the transmitter.

Pipe with a cathodic protection unit

This connection method is only used if the following two conditions are met:

- Metal pipe without liner or pipe with electrically conductive liner
- Cathodic protection is integrated in the personal protection equipment

Ground cable	Copper wire, at least 6 mm ² (0.0093 in ²)
---------------------	---

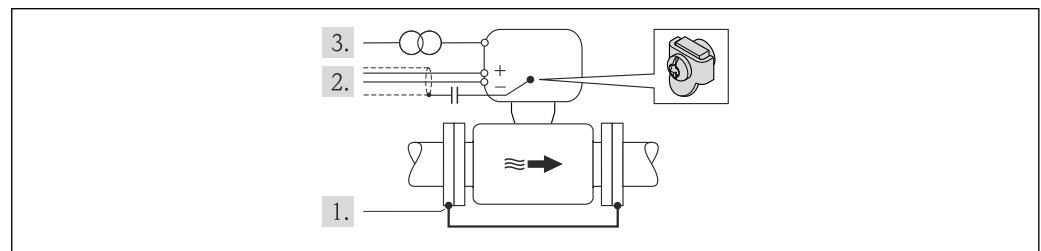

A0016319

Prerequisite: The sensor is installed in the pipe in a way that provides electrical insulation.

1. Connect the two flanges of the pipe to one another via a ground cable.
2. Guide the shield of the signal lines through a capacitor.
3. Connect the measuring device to the power supply such that it is floating in relation to the protective ground (isolation transformer).

i For remote device versions, the ground terminal in the example always refers to the sensor and **not** to the transmitter.

7.3 Special connection instructions

7.4 Hardware settings

7.4.1 Setting the device address

EtherNet/IP

The IP address of the measuring device can be configured for the network via DIP switches.

Addressing data

IP address and configuration options			
1st octet	2nd octet	3rd octet	4th octet
192.	168.	1.	XXX
	↓		↓
	Can only be configured via software addressing		Can be configured via software addressing and hardware addressing

IP address range	1 to 254 (4th octet)
IP address broadcast	255
Addressing mode ex works	Software addressing; all DIP switches for hardware addressing are set to OFF.
IP address ex works	DHCP server active

 For device addressing via software

Setting the address

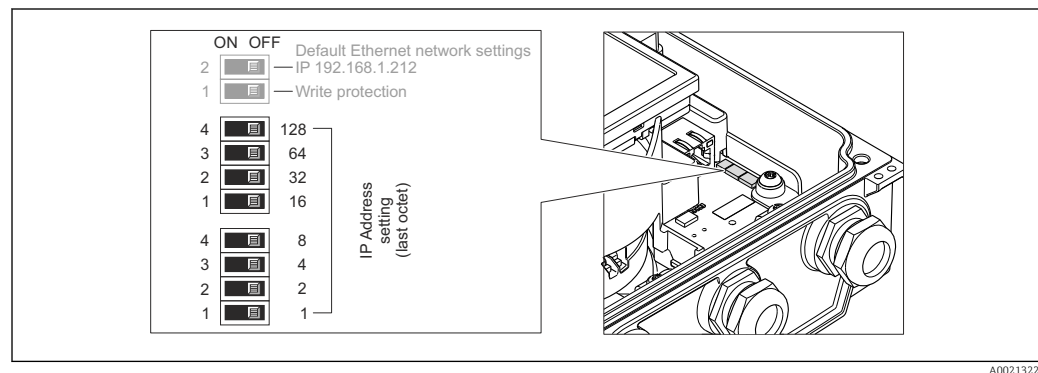

1. Loosen the 4 fixing screws on the housing cover.
2. Open the housing cover.
3. Set the desired IP address using the corresponding DIP switches on the I/O electronics module.
 - ↳ Hardware addressing with the configured IP address is enabled after 10 s.
4. Reverse the removal procedure to reassemble the transmitter.

7.5 Ensuring the degree of protection

7.5.1 Degree of protection IP66/67, Type 4X enclosure

The measuring device fulfills all the requirements for the IP66/67 degree of protection, Type 4X enclosure.

To guarantee IP66/67 degree of protection, Type 4X enclosure, carry out the following steps after the electrical connection:

1. Check that the housing seals are clean and fitted correctly. Dry, clean or replace the seals if necessary.
2. Tighten all housing screws and screw covers.
3. Firmly tighten the cable glands.
4. To ensure that moisture does not enter the cable entry, route the cable so that it loops down before the cable entry ("water trap").

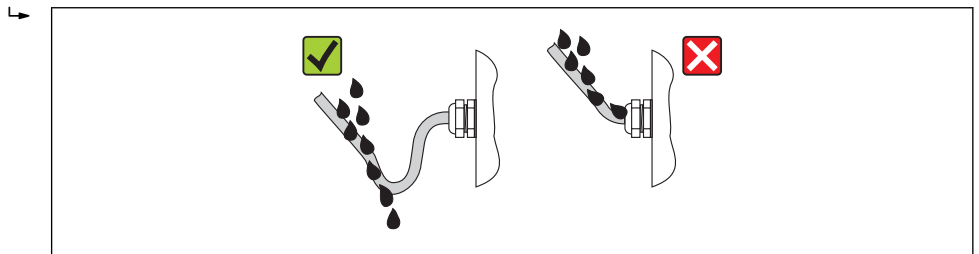

A0013960

5. Insert dummy plugs into unused cable entries.

7.5.2 Degree of protection IP68, Type 6P enclosure, with "Cust-potted" option

Depending on the version, the sensor fulfills all the requirements for the IP68 degree of protection, Type 6P enclosure and can be used as a remote version → 23.

The degree of protection of the transmitter is always only IP66/67, Type 4X enclosure and the transmitter must therefore be treated accordingly → 47.

To guarantee IP68 degree of protection, Type 6P enclosure for the "Cust-potted" options, carry out the following steps after the electrical connection:

1. Firmly tighten the cable glands (torque: 2 to 3.5 Nm) until there is no gap between the bottom of the cover and the housing support surface.
2. Firmly tighten the union nut of the cable glands.
3. Pot the field housing with a potting compound.
4. Check that the housing seals are clean and fitted correctly. Dry, clean or replace the seals if necessary.
5. Tighten all housing screws and screw covers (torque: 20 to 30 Nm).

7.6 Post-connection check

Are cables or the device undamaged (visual inspection)?	<input type="checkbox"/>
Do the cables comply with the requirements → 36?	<input type="checkbox"/>
Do the cables have adequate strain relief?	<input type="checkbox"/>
Are all the cable glands installed, firmly tightened and leak-tight? Cable run with "water trap" → 47 ?	<input type="checkbox"/>

Only for remote version: is the sensor connected to the right transmitter? Check the serial number on the nameplate of the sensor and transmitter.	<input type="checkbox"/>
Does the supply voltage match the specifications on the transmitter nameplate ?	<input type="checkbox"/>
Is the terminal assignment correct ?	<input type="checkbox"/>
If supply voltage is present, do values appear on the display module?	<input type="checkbox"/>
Is the potential equalization established correctly →  44?	<input type="checkbox"/>
Are all housing covers installed and the screws tightened with the correct tightening torque?	<input type="checkbox"/>

8 Operation options

8.1 Overview of operation options

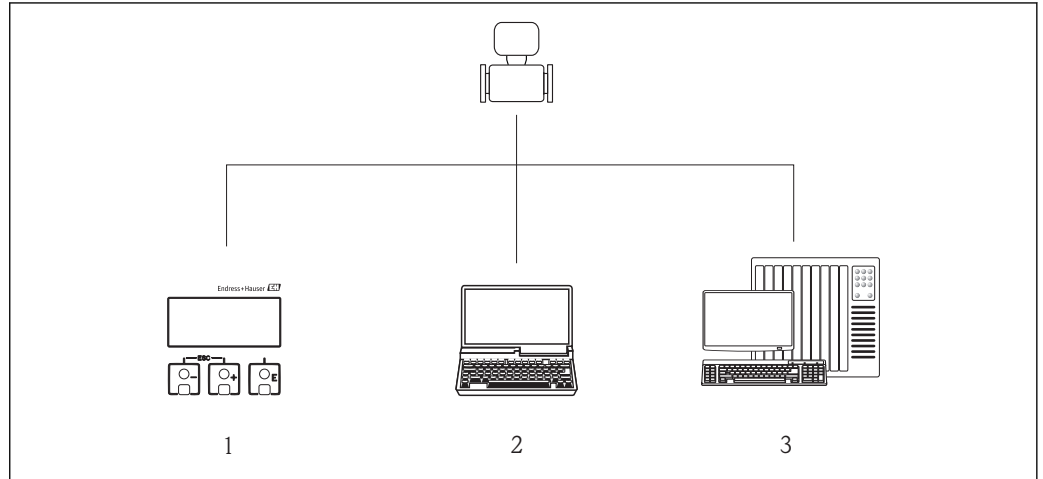



A0019091

- 1 Local operation via display module
- 2 Computer with Web browser (e.g. Internet Explorer) or with operating tool (e.g. FieldCare, AMS Device Manager, SIMATIC PDM)
- 3 Control system (e.g. PLC)

 For custody transfer, once the device has been put into circulation or sealed, its operation is restricted.

8.2 Structure and function of the operating menu

8.2.1 Structure of the operating menu

 For an overview of the operating menu with menus and parameters →  162

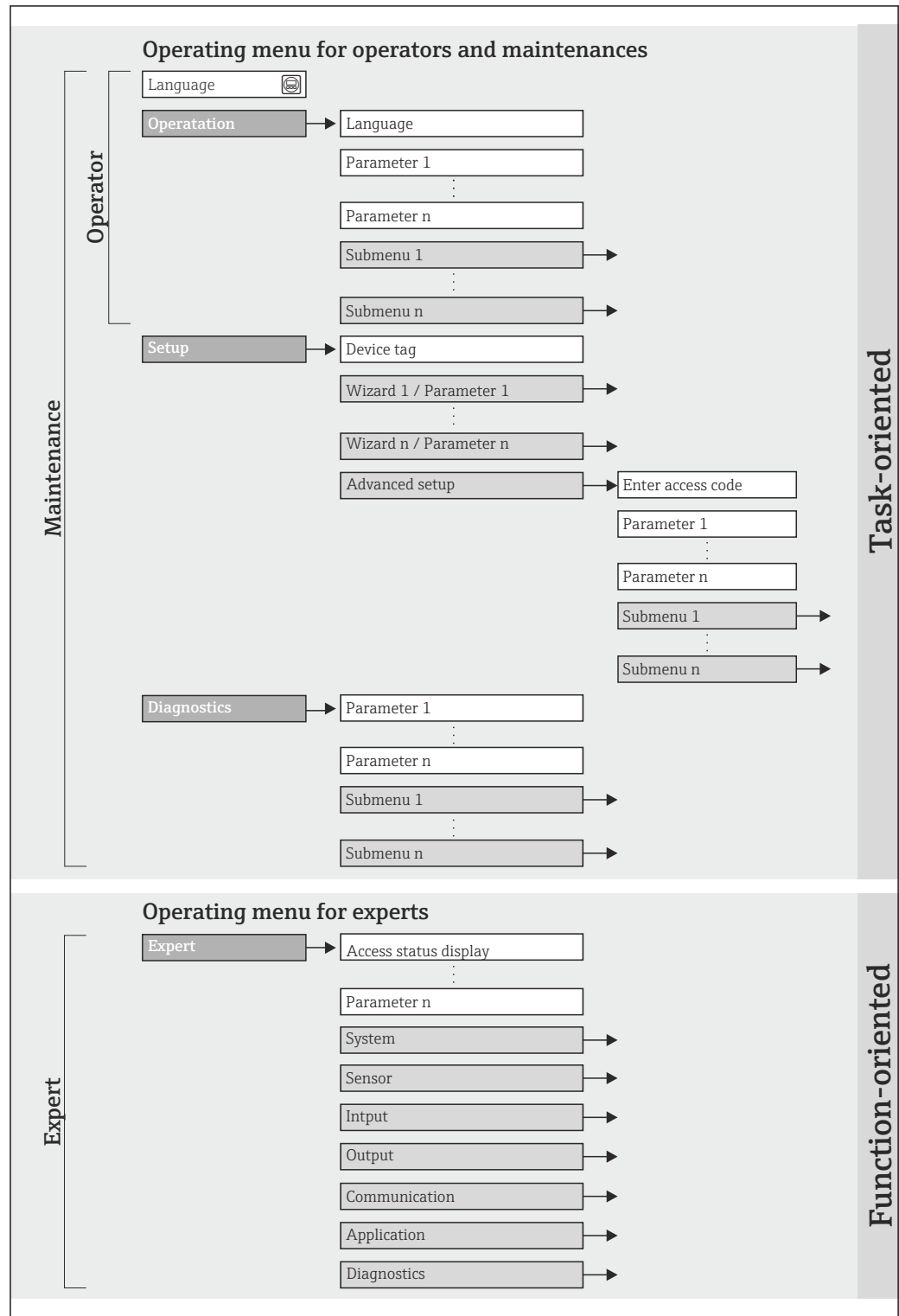

A0018237-EN

 19 Schematic structure of the operating menu

8.2.2 Operating philosophy

The individual parts of the operating menu are assigned to certain user roles (operator, maintenance etc.). Each user role contains typical tasks within the device lifecycle.

 For custody transfer, once the device has been put into circulation or sealed, its operation is restricted.

Menu		User role and tasks	Content/meaning
Operation	task-oriented	Role "Operator", "Maintenance" Tasks during operation: Reading measured values	<ul style="list-style-type: none"> ▪ Defining the Web server operating language ▪ Resetting and controlling totalizers
Setup		"Maintenance" role Commissioning: <ul style="list-style-type: none"> ▪ Configuration of the measurement ▪ Configuration of the communication interface 	Submenus for fast commissioning: <ul style="list-style-type: none"> ▪ Setting the individual system units ▪ Defining the medium ▪ Configuration of the digital communication interface ▪ Configuring the low flow cut off "Advanced setup" submenu: <ul style="list-style-type: none"> ▪ For more customized configuration of the measurement (adaptation to special measuring conditions) ▪ Configuration of totalizers ▪ "Device reset" submenu Resets the device configuration to certain settings
Diagnostics		"Maintenance" role Fault elimination: <ul style="list-style-type: none"> ▪ Diagnostics and elimination of process and device errors ▪ Measured value simulation 	Contains all parameters for error detection and analyzing process and device errors: <ul style="list-style-type: none"> ▪ "Diagnostic list" submenu Contains up to 5 currently pending diagnostic messages. ▪ "Event logbook" submenu Contains 20 event messages that have occurred. ▪ "Device information" submenu Contains information for identifying the device. ▪ "Measured values" submenu Contains all current measured values. ▪ "Simulation" submenu Is used to simulate measured values or output values.
Expert	function-oriented	Tasks that require detailed knowledge of the function of the device: <ul style="list-style-type: none"> ▪ Commissioning measurements under difficult conditions ▪ Optimal adaptation of the measurement to difficult conditions ▪ Detailed configuration of the communication interface ▪ Error diagnostics in difficult cases 	Contains all the parameters of the device and makes it possible to access these parameters directly using an access code. The structure of this menu is based on the function blocks of the device: <ul style="list-style-type: none"> ▪ "System" submenu Contains all higher-order device parameters that do not pertain either to measurement or the measured value communication. ▪ "Sensor" submenu Configuration of the measurement. ▪ "Communication" submenu Configuration of the digital communication interface and the Web server. ▪ "Application" submenu Configuration of the functions that go beyond the actual measurement (e.g. totalizer). ▪ "Diagnostics" submenu Error detection and analysis of process and device errors and for device simulation and Heartbeat Technology.

8.3 Access to the operating menu via the local display

8.3.1 Operational display

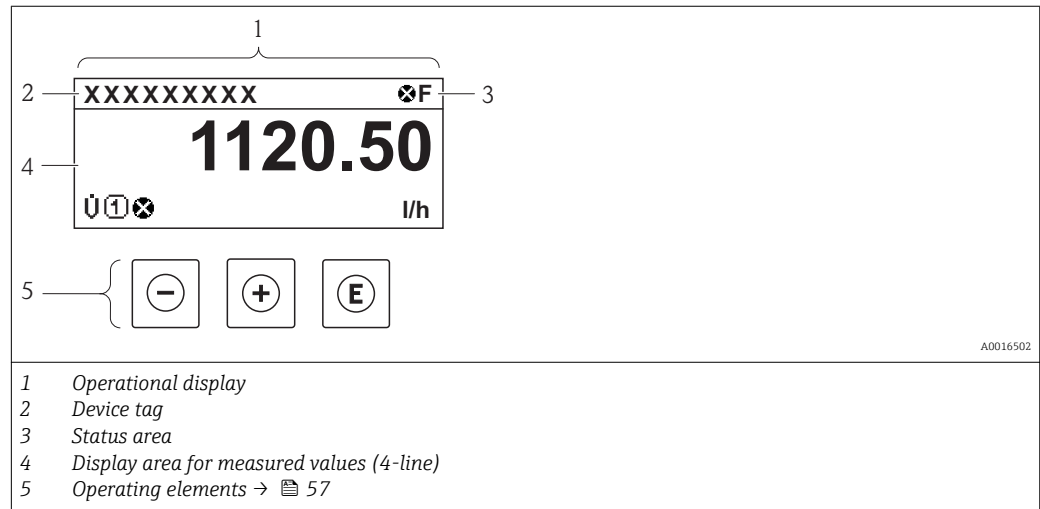

Status area

The following symbols appear in the status area of the operational display at the top right:

- Status signals → 108
 - **F**: Failure
 - **C**: Function check
 - **S**: Out of specification
 - **M**: Maintenance required
- Diagnostic behavior → 109
 - : Alarm
 - : Warning
- : Locking (the device is locked via the hardware)
- : Communication (communication via remote operation is active)

Display area

In the display area, each measured value is prefaced by certain symbol types for further description:

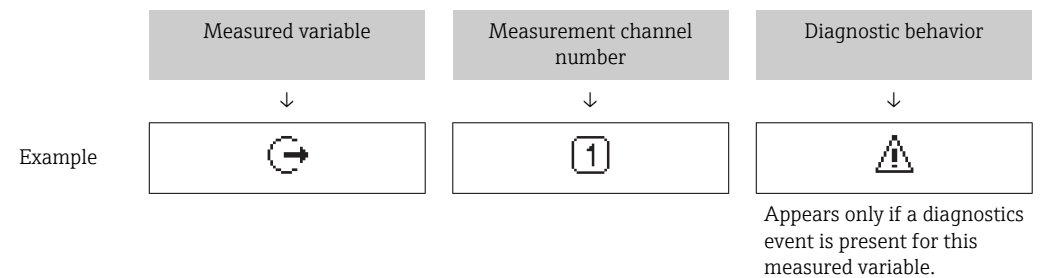

Measured variables

Symbol	Meaning
U	Volume flow
G	Conductivity

	Mass flow
	Totalizer The measurement channel number indicates which of the three totalizers is displayed.
	Output The measurement channel number indicates which of the outputs is displayed.
	Status input

Measurement channel numbers

Symbol	Meaning
	Measurement channel 1 to 4
The measurement channel number is displayed only if more than one channel is present for the same measured variable type (e.g. Totalizer 1 to 3).	

Diagnostic behavior

The diagnostic behavior pertains to a diagnostic event that is relevant to the displayed measured variable. For information on the symbols → 109

The number and display format of the measured values can be configured via the "Format display" parameter → 83. "Operation" menu → Display → Format display



8.3.2 Navigation view



In the submenu	In the wizard
<p>1 Navigation view 2 Navigation path to current position 3 Status area 4 Display area for navigation 5 Operating elements → 57</p>	

Navigation path

The navigation path - displayed at the top left in the navigation view - consists of the following elements:

<ul style="list-style-type: none"> In the submenu: Display symbol for menu In the wizard: Display symbol for wizard 	Omission symbol for operating menu levels in between	Name of current <ul style="list-style-type: none"> Submenu Wizard Parameter
↓	↓	↓



Examples		/../	Display
		/../	Display

 For more information about the menu icons, refer to the "Display area" section →  54

Status area





The following appears in the status area of the navigation view in the top right corner:

- Of the submenu
 - The direct access code for the parameter you are navigating to (e.g. 0022-1)
 - If a diagnostic event is present, the diagnostic behavior and status signal
- In the wizard
 - If a diagnostic event is present, the diagnostic behavior and status signal





-  ▪ For information on the diagnostic behavior and status signal →  108
- For information on the function and entry of the direct access code →  59

Display area

Menus

Symbol	Meaning
	Operation Appears: <ul style="list-style-type: none"> ▪ In the menu next to the "Operation" selection ▪ At the left in the navigation path in the "Operation" menu
	Setup Appears: <ul style="list-style-type: none"> ▪ In the menu next to the "Setup" selection ▪ At the left in the navigation path in the "Setup" menu
	Diagnostics Appears: <ul style="list-style-type: none"> ▪ In the menu next to the "Diagnostics" selection ▪ At the left in the navigation path in the "Diagnostics" menu
	Expert Appears: <ul style="list-style-type: none"> ▪ In the menu next to the "Expert" selection ▪ At the left in the navigation path in the "Expert" menu



Submenus, wizards, parameters

Symbol	Meaning
	Submenu
	Wizard
	Parameters within a wizard  No display symbol exists for parameters in submenus.

Locking

Symbol	Meaning
	Parameter locked When displayed in front of a parameter name, indicates that the parameter is locked. <ul style="list-style-type: none"> By a user-specific access code By the hardware write protection switch

Wizard operation

Symbol	Meaning
	Switches to the previous parameter.
	Confirms the parameter value and switches to the next parameter.
	Opens the editing view of the parameter.



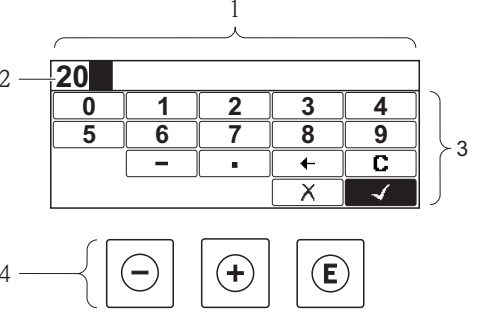
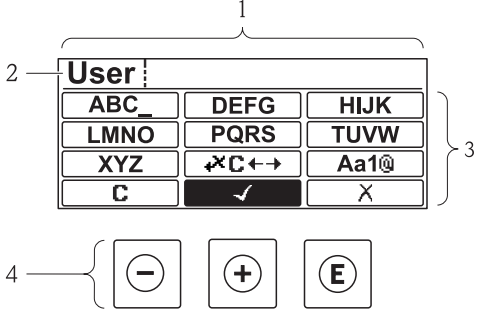

8.3.3 Editing view

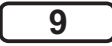

Numeric editor	Text editor
	
<p>1 Editing view 2 Display area of the entered values 3 Input mask 4 Operating elements → 57</p>	

Input mask



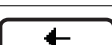







The following input symbols are available in the input mask of the numeric and text editor:

Numeric editor





Symbol	Meaning
	Selection of numbers from 0 to 9.
	
	Inserts decimal separator at the input position.
	Inserts minus sign at the input position.
	Confirms selection.
	Moves the input position one position to the left.

	Exits the input without applying the changes.
	Clears all entered characters.







Text editor

Symbol	Meaning
	Toggle <ul style="list-style-type: none"> ▪ Between upper-case and lower-case letters ▪ For entering numbers ▪ For entering special characters
 ... 	Selection of letters from A to Z.
 ... 	Selection of letters from a to z.
 ... 	Selection of special characters.
	Confirms selection.
	Switches to the selection of the correction tools.
	Exits the input without applying the changes.
	Clears all entered characters.

Correction symbols under 

Symbol	Meaning
	Clears all entered characters.
	Moves the input position one position to the right.
	Moves the input position one position to the left.
	Deletes one character immediately to the left of the input position.

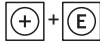
8.3.4 Operating elements

Key	Meaning
	<p>Minus key</p> <p><i>In a menu, submenu</i> Moves the selection bar upwards in a choose list.</p> <p><i>With a Wizard</i> Confirms the parameter value and goes to the previous parameter.</p> <p><i>With a text and numeric editor</i> In the input mask, moves the selection bar to the left (backwards).</p>
	<p>Plus key</p> <p><i>In a menu, submenu</i> Moves the selection bar downwards in a choose list.</p> <p><i>With a Wizard</i> Confirms the parameter value and goes to the next parameter.</p> <p><i>With a text and numeric editor</i> Moves the selection bar to the right (forwards) in an input screen.</p>
	<p>Enter key</p> <p><i>For operational display</i></p> <ul style="list-style-type: none"> ▪ Pressing the key briefly opens the operating menu. ▪ Pressing the key for 2 s opens the context menu. <p><i>In a menu, submenu</i></p> <ul style="list-style-type: none"> ▪ Pressing the key briefly: <ul style="list-style-type: none"> - Opens the selected menu, submenu or parameter. - Starts the wizard. - If help text is open, closes the help text of the parameter. ▪ Pressing the key for 2 s for parameter: <ul style="list-style-type: none"> - If present, opens the help text for the function of the parameter. <p><i>With a Wizard</i> Opens the editing view of the parameter.</p> <p><i>With a text and numeric editor</i></p> <ul style="list-style-type: none"> ▪ Pressing the key briefly: <ul style="list-style-type: none"> - Opens the selected group. - Carries out the selected action. ▪ Pressing the key for 2 s confirms the edited parameter value.
	<p>Escape key combination (press keys simultaneously)</p> <p><i>In a menu, submenu</i></p> <ul style="list-style-type: none"> ▪ Pressing the key briefly: <ul style="list-style-type: none"> - Exits the current menu level and takes you to the next higher level. - If help text is open, closes the help text of the parameter. ▪ Pressing the key for 2 s returns you to the operational display ("home position"). <p><i>With a Wizard</i> Exits the wizard and takes you to the next higher level.</p> <p><i>With a text and numeric editor</i> Closes the text or numeric editor without applying changes.</p>
	<p>Minus/Enter key combination (press the keys simultaneously)</p> <p>Reduces the contrast (brighter setting).</p>
	<p>Plus/Enter key combination (press and hold down the keys simultaneously)</p> <p>Increases the contrast (darker setting).</p>
	<p>Minus/Plus/Enter key combination (press the keys simultaneously)</p> <p><i>For operational display</i> Enables or disables the keypad lock (only SD02 display module).</p>

8.3.5 Opening the context menu

Using the context menu, the user can call up the following menus quickly and directly from the operational display:

- Setup
- Simulation

Calling up and closing the context menu

The user is in the operational display.

1. Press \square for 2 s.
 - ↳ The context menu opens.

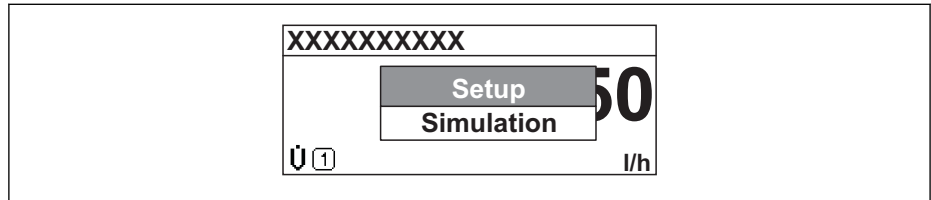

A0017421-EN

2. Press \square + \oplus simultaneously.
 - ↳ The context menu is closed and the operational display appears.

Calling up the menu via the context menu

1. Open the context menu.
2. Press \oplus to navigate to the desired menu.
3. Press \square to confirm the selection.
 - ↳ The selected menu opens.

8.3.6 Navigating and selecting from list

Different operating elements are used to navigate through the operating menu. The navigation path is displayed on the left in the header. Icons are displayed in front of the individual menus. These icons are also shown in the header during navigation.

i For an explanation of the navigation view with symbols and operating elements → 53

Example: Setting the number of displayed measured values to "2 values"

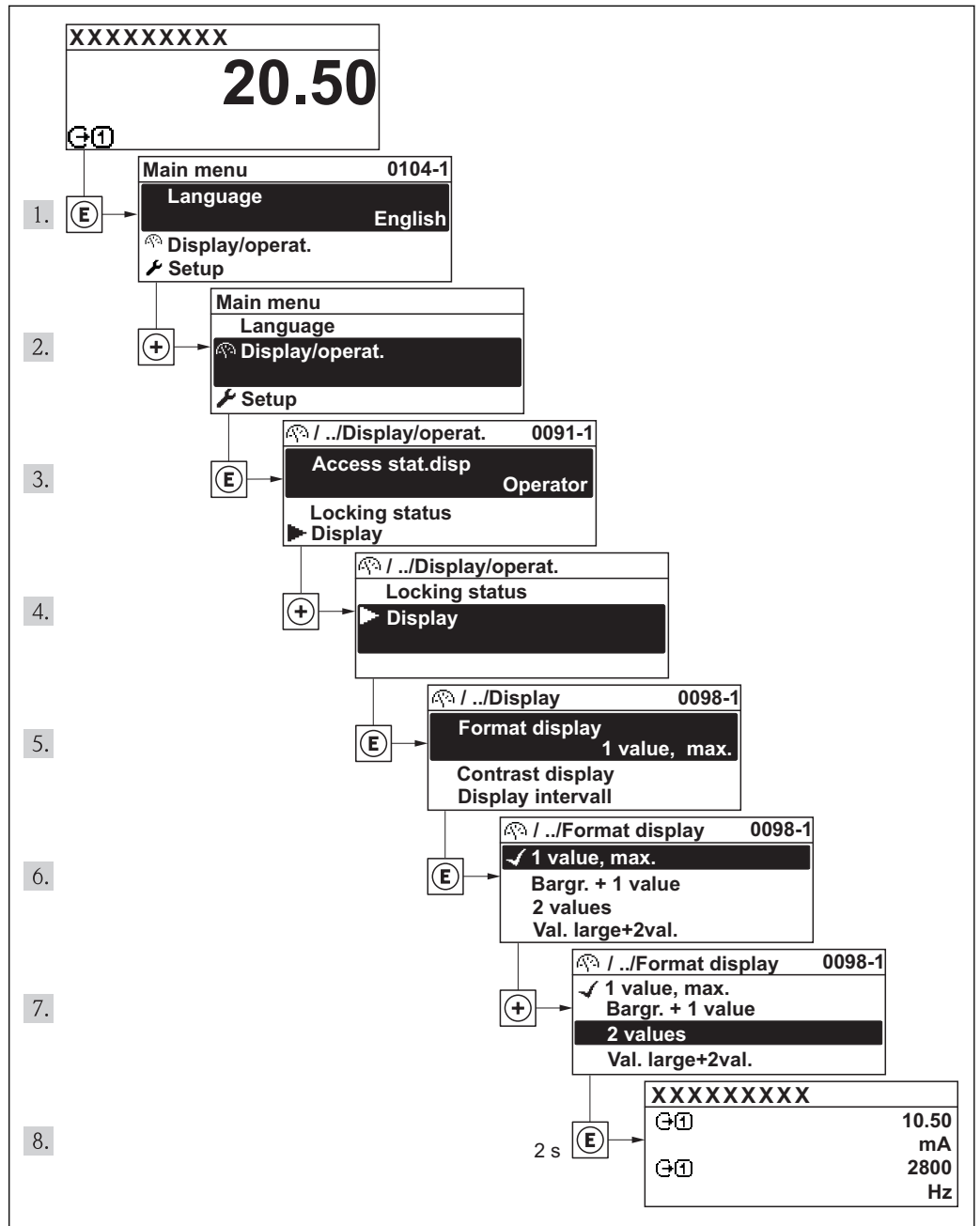

A0017448-EN

8.3.7 Calling the parameter directly

A parameter number is assigned to every parameter to be able to access a parameter directly via the onsite display. Entering this access code in the **Direct access** parameter calls up the desired parameter directly.

Navigation path

"Expert" menu → Direct access

The direct access code consists of a 4-digit number and the channel number, which identifies the channel of a process variable: e.g. 0914-1. In the navigation view, this appears on the right-hand side in the header of the selected parameter.

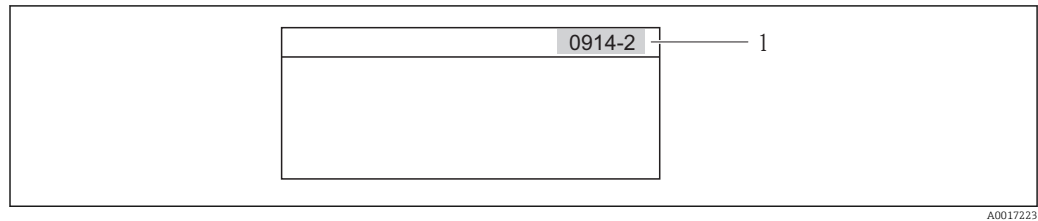

A0017223

1 Direct access code

Note the following when entering the direct access code:

- The leading zeros in the direct access code do not have to be entered.
Example: Input of "914" instead of "0914"
- If no channel number is entered, channel 1 is jumped to automatically.
Example: Input of "0914" → Parameter **Totalizer 1**
- If a different channel is jumped to: Enter the direct access code with the corresponding channel number.
Example: Input of "0914-2" → Parameter **Totalizer 2**



For the direct access codes of the individual parameters

8.3.8 Calling up help text

For some parameters, help texts exist, which the user can call up from the navigation view. These briefly describe the function of the parameter and thus support fast and reliable commissioning.

Calling up and closing the help text

The user is in the navigation view and the selection bar is on a parameter.

1. Press for 2 s.
↳ The help text for the selected parameter opens.

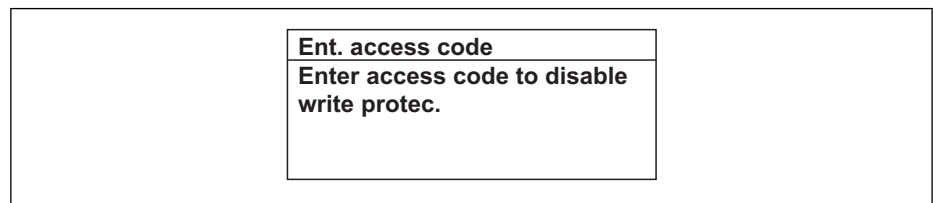



A0014002-EN

20 Example: Help text for parameter "Enter access code"

2. Press + simultaneously.
↳ The help text is closed.

8.3.9 Changing the parameters

 For a description of the editing display - consisting of text editor and numeric editor - with symbols →  55, for a description of the operating elements →  57

Example: Changing the tag name in the "Tag description" parameter from 001-FT-101 to 001-FT-102

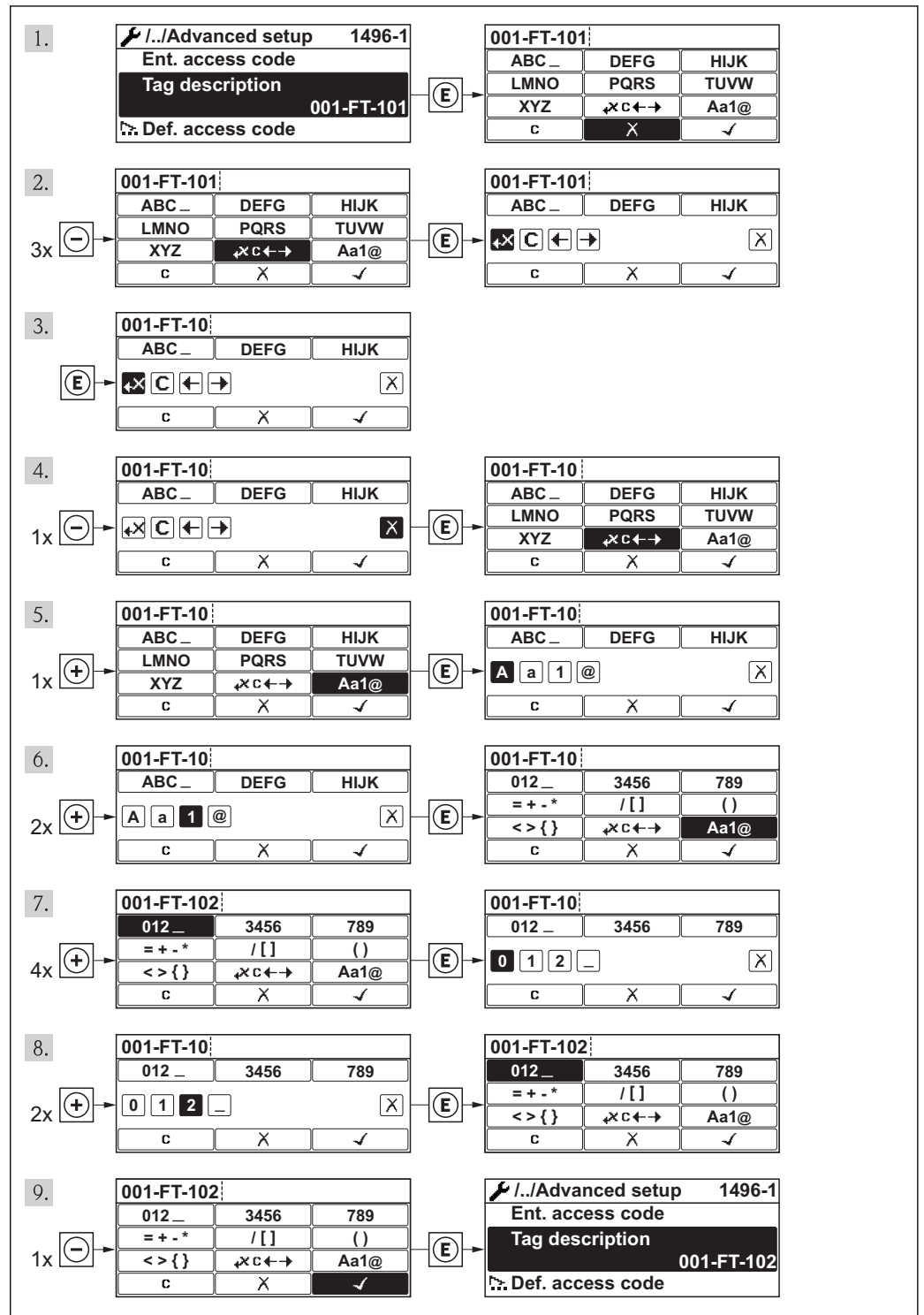

A0014020-EN

A message is displayed if the value entered is outside the permitted value range.

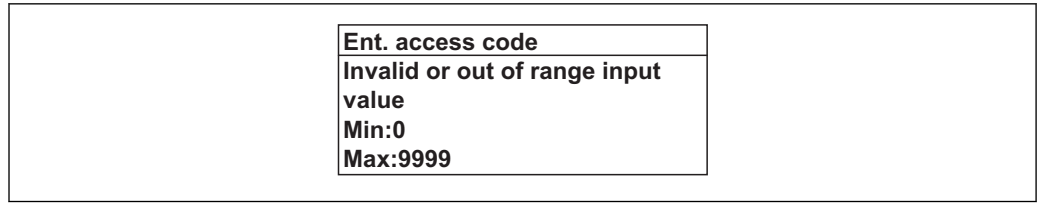

A0014049-EN

8.3.10 User roles and related access authorization

The two user roles "Operator" and "Maintenance" have different write access to the parameters if the customer defines a user-specific access code. This protects the device configuration via the local display from unauthorized access .

Access authorization to parameters

User role	Read access		Write access	
	Without access code (from the factory)	With access code	Without access code (from the factory)	With access code
Operator	✓	✓	✓	-- 1)
Maintenance	✓	✓	✓	✓

- 1) Despite the defined access code, certain parameters can always be modified and thus are excepted from the write protection, as they do not affect the measurement. Refer to the "Write protection via access code" section



If an incorrect access code is entered, the user obtains the access rights of the "Operator" role.

 The user role with which the user is currently logged on is indicated by the **Access status display** parameter. Navigation path: Operation → Access status display

8.3.11 Disabling write protection via access code

If the -symbol appears on the local display in front of a parameter, the parameter is write-protected by a user-specific access code and its value cannot be changed at the moment using the local display .

The locking of the write access via local operation can be disabled by entering the customer-defined access code via the respective access option.

1. After you press , the input prompt for the access code appears.
2. Enter the access code.
 - ↳ The -symbol in front of the parameters disappears; all previously write-protected parameters are now re-enabled.

8.3.12 Enabling and disabling the keypad lock

The keypad lock makes it possible to block access to the entire operating menu via local operation. As a result, it is no longer possible to navigate through the operating menu or change the values of individual parameters. Users can only read the measured values on the operational display.

Local operation with touch control

The keypad lock is switched on and off via the context menu.

Switching on the keypad lock

The keypad lock is switched on automatically:

- Each time the device is restarted.
- If the device has not been operated for longer than one minute in the measured value display.

1. The device is in the measured value display.
Press the  key for longer than 2 seconds.
↳ A context menu appears.
2. In the context menu, select the **Keylock on** option.
↳ The keypad lock is switched on.

 If the user attempts to access the operating menu while the keypad lock is active, the message **Keylock on** appears.

Switching off the keypad lock

1. The keypad lock is switched on.
Press the  key for longer than 2 seconds.
↳ A context menu appears.
2. In the context menu, select the **Keylock off** option.
↳ The keypad lock is switched off.

8.4 Access to the operating menu via the Web browser

8.4.1 Function range

Thanks to the integrated Web server the device can be operated and configured via a Web browser. The operating menu structure is the same as in the local display. In addition to the measured values, status information on the device is also displayed and allows the user to monitor the status of the device. Furthermore the device data can be managed and the network parameters can be configured.

8.4.2 Prerequisites

Computer hardware

Interface	The computer must have an RJ45 interface.
Connecting cable	Standard Ethernet cable with RJ45 connector.
Screen	Recommended size: ≥12" (depends on the screen resolution)  Web server operation is not optimized for touch screens!

Computer software

Recommended operating systems	Microsoft Windows 7 or higher.  Microsoft Windows XP is supported.
Web browsers supported	<ul style="list-style-type: none"> ▪ Microsoft Internet Explorer 8 or higher ▪ Mozilla Firefox ▪ Google chrome

Computer settings

User rights	User rights are required for TCP/IP and proxy server settings (for changes to the IP address, subnet mask etc.).
Proxy server settings of the Web browser	The Web browser setting <i>Use proxy server for LAN</i> must be disabled .
JavaScript	<p>JavaScript must be enabled.</p> <p>i If JavaScript cannot be enabled: enter <code>http://192.168.1.212/basic.html</code> in the address line of the Web browser. A fully functional but simplified version of the operating menu structure starts in the Web browser.</p> <p>i When installing a new firmware version: To enable correct data display, clear the temporary memory (cache) of the Web browser under Internet options.</p>

Measuring device

Web server	<p>Web server must be enabled; factory setting: ON</p> <p>i For information on enabling the Web server → 67</p>
IP address	<p>If the IP address of the device is not known:</p> <ul style="list-style-type: none"> The IP address can be read out via local operation: "Diagnostics" menu → Device information → IP address Communication with the Web server can be established via the standard IP address 192.168.1.212. <p>The DHCP function is enabled in the device at the factory, i.e. the device expects an IP address to be assigned by the network. This function can be disabled and the device can be set to the standard IP address 192.168.1.212: set top DIP switch No. 2 from OFF → ON.</p> <div style="text-align: center;"> </div> <p>i</p> <ul style="list-style-type: none"> Once the DIP switch has been activated, the device must be restarted before the device uses the standard IP address. If the standard IP address (top DIP switch No. 2 = ON) is used, there is no connection to the EtherNet/IP network.

8.4.3 Establishing a connection

Configuring the Internet protocol of the computer

IP address	192.168.1.XXX; for XXX all numerical values except: 0, 212 and 255 → e.g. 192.168.1.213
Subnet mask	255.255.255.0
Default gateway	192.168.1.212 or leave cells empty

1. Switch on the measuring device and connect to the computer via the cable → 68.

2. If a 2nd network card is not used: all the applications on the notebook should be closed, or all the applications that require the Internet or network, such as e-mail, SAP applications, Internet or Windows Explorer, i.e. close all open Internet browsers.
3. Configure the properties of the Internet protocol (TCP/IP) as defined in the table above.

Starting the Web browser

1. Start the Web browser on the computer.
2. If the IP address of the measuring device is known, enter the defined device address in the address line of the Web browser. If it is unknown, read the IP address via local operation ("Diagnostics" menu → Device information → IP address) or set the upper DIP switch No. 2 to ON, restart the device and enter the standard IP address 192.168.1.212 → 64.

The login page appears.

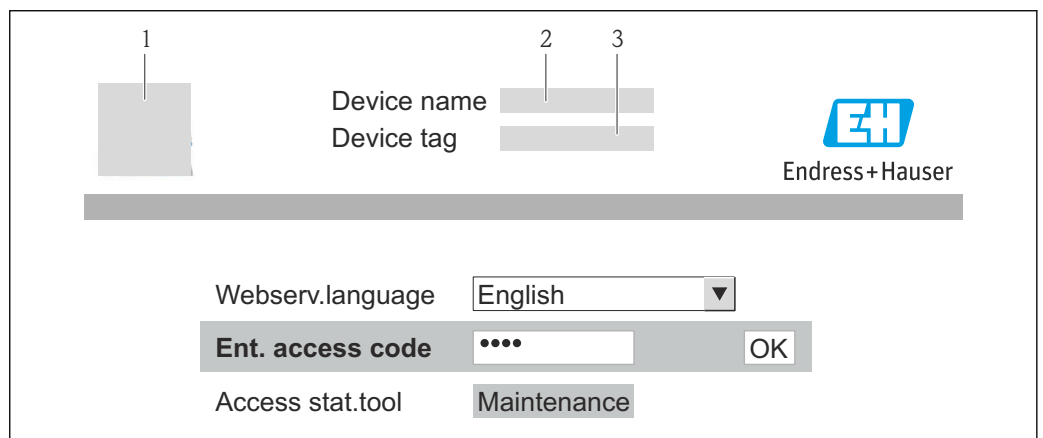

- 1 Device tag
- 2 Picture of device

i If a login page does not appear, or if the page is incomplete → 106

8.4.4 Logging on

1. Select the preferred operating language for the Web browser.
2. Enter the access code.
3. Press **OK** to confirm your entry.

Access code	0000 (factory setting); can be changed by customer
--------------------	--

i If no action is performed for 10 minutes, the Web browser automatically returns to the login page.

8.4.5 User interface

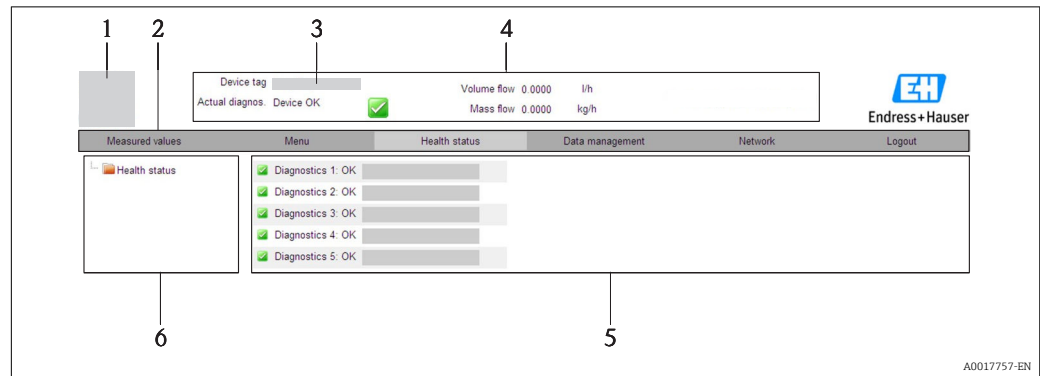

- 1 Picture of device
- 2 Function row with 6 functions
- 3 Device tag
- 4 Header
- 5 Working area
- 6 Navigation area

Header

The following information appears in the header:

- Device tag
- Device status with status signal → 111
- Current measured values

Function row

Functions	Meaning
Measured values	The measured values of the device are displayed
Menu	Access to the operating menu structure of the device, same as for the local display and operating tool
Device status	Displays the diagnostic messages currently pending, listed in order of priority
Data management	<ul style="list-style-type: none"> ▪ Data exchange between PC and measuring device: <ul style="list-style-type: none"> – Upload the configuration from the device (XML format, create configuration back-up) – Save the configuration to the device (XML format, restore configuration) – Export the event list (.csv file) – Export parameter settings (.csv file, create documentation of the measuring point configuration) – Export the Heartbeat verification log (PDF file, only available with the "Heartbeat Verification" application package) ▪ Upload the device driver for system integration from the device
Network configuration	Configuration and checking of all the parameters required for establishing the connection to the device: <ul style="list-style-type: none"> ▪ Network settings (e.g. IP address, MAC address) ▪ Device information (e.g. serial number, firmware version)
Logout	End the operation and call up the login page

Navigation area

If a function is selected in the function bar, the submenus of the function open in the navigation area. The user can now navigate through the menu structure.

Working area

Depending on the selected function and the related submenus, various actions can be performed in this area:

- Configuring parameters
- Reading measured values
- Calling up help text
- Starting an upload/download

8.4.6 Disabling the Web server

The Web server for the measuring device can be enabled and disabled as required via the **Web server functionality** parameter.

Navigation

"Expert" menu → Communication → Web server

Parameter overview with brief description

Parameter	Description	Selection	Factory setting
Web server functionality	Switch the Web server on and off.	<ul style="list-style-type: none"> ■ Off ■ On 	On

Enabling the Web server

If the Web server is disabled it can only be re-enabled with the **Web server functionality** parameter via the following operating options:

- Via local display
- Via "FieldCare" operating tool

8.4.7 Logging out

 Before logging out, perform a data backup via the **Data management** function (upload configuration from device) if necessary.

1. Select the **Logout** entry in the function row.
↳ The home page with the Login box appears.
2. Close the Web browser.
3. Reset the modified properties of the Internet protocol (TCP/IP) if they are no longer needed →  64.

 If communication with the Web server was established via the standard IP address 192.168.1.212, DIP switch No. 10 must be reset (from ON → OFF) and the IP address of the device is active again for network communication.

8.5 Access to the operating menu via the operating tool

The structure of the operating menu in the operating tools is the same as for operation via the local display.

8.5.1 Connecting the operating tool

Via service interface (CDI-RJ45)

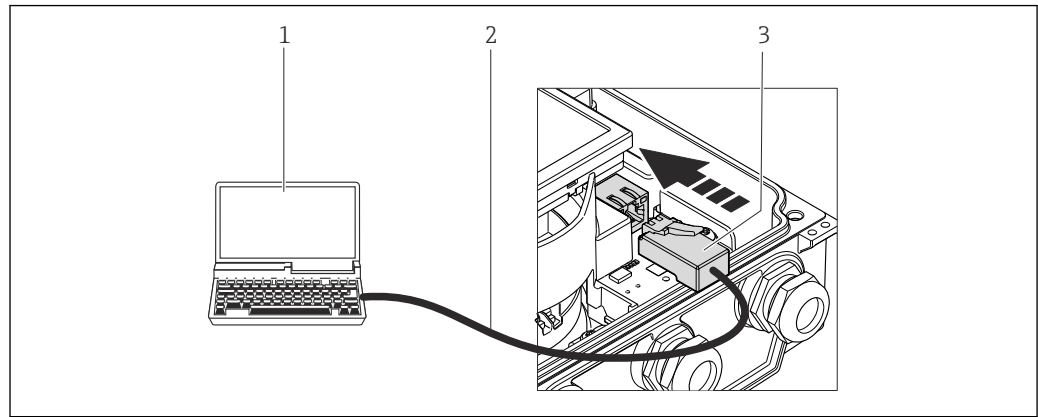

- 1 Computer with Web browser (e.g. Internet Explorer) for accessing the integrated device Web server or with "FieldCare" operating tool with COM DTM "CDI Communication TCP/IP"
- 2 Standard Ethernet connecting cable with RJ45 plug
- 3 Service interface (CDI -RJ45) of the measuring device with access to the integrated Web server

8.5.2 FieldCare

Function scope

FDT-based plant asset management tool from Endress+Hauser. It can configure all smart field devices in a system and helps you manage them. By using the status information, it is also a simple but effective way of checking their status and condition.

Access takes place via:

Service interface CDI-RJ45 → 68

Typical functions:

- Configuring parameters of transmitters
- Loading and saving device data (upload/download)
- Documentation of the measuring point
- Visualization of the measured value memory (line recorder) and event logbook

For details, see Operating Instructions BA00027S and BA00059S

Source for device description files

See data → 70

Establishing a connection

Via service interface (CDI-RJ45)

1. Start FieldCare and launch the project.
2. In the network: Add a device.
 - ↳ The **Add device** window opens.
3. Select the **CDI Communication TCP/IP** option from the list and press **OK** to confirm.
4. Right-click **CDI Communication TCP/IP** and select the **Add device** option in the context menu that opens.
5. Select the desired device from the list and press **OK** to confirm.
 - ↳ The **CDI Communication TCP/IP (Configuration)** window opens.

6. Enter the device address in the **IP address** field: 192.168.1.212 and press **Enter** to confirm.
7. Establish the online connection to the device.

 For details, see Operating Instructions BA00027S and BA00059S

User interface

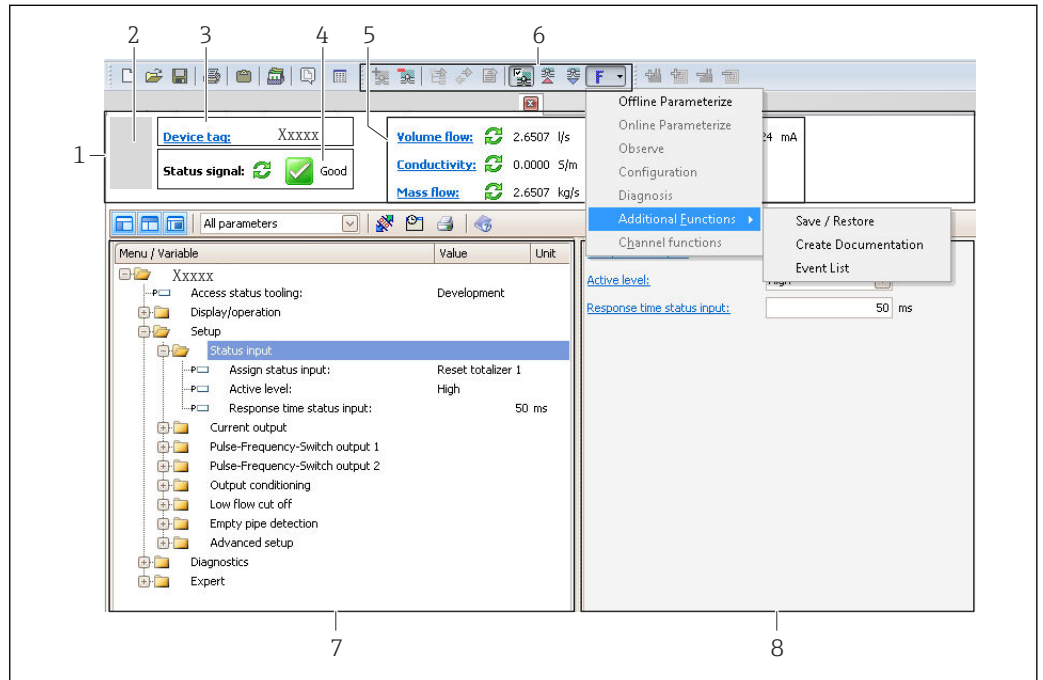



A0021053-EN

- 1 Header
- 2 Picture of device
- 3 Device tag
- 4 Status area with status signal →  111
- 6 Display area for current measured values
- 5 Event list with additional functions such as save/load, events list and document creation
- 7 Navigation area with operating menu structure
- 8 Operating range

9 System integration

9.1 Overview of device description files

9.1.1 Current version data for the device

Firmware version	01.01.zz	<ul style="list-style-type: none"> ▪ On the title page of the Operating instructions ▪ On transmitter nameplate →  13 ▪ Parameter firmware version Diagnostics → Device info → Firmware version
Release date of firmware version	05.2014	---
Manufacturer ID	0x49E	Manufacturer ID parameter Diagnostics → Device info → Manufacturer ID
Device type ID	0x1047	Device type parameter Diagnostics → Device info → Device type
Device revision	<ul style="list-style-type: none"> ▪ Major revision 2 ▪ Minor revision 1 	<ul style="list-style-type: none"> ▪ On transmitter nameplate →  13 ▪ Device revision parameter Diagnostics → Device info → Device revision
Device profile	Generic device (product type: 0x2B)	

9.1.2 Operating tools

Operating tool via Service interface (CDI)	Sources for obtaining device descriptions
FieldCare	<ul style="list-style-type: none"> ▪ www.endress.com → Download Area ▪ CD-ROM (contact Endress+Hauser) ▪ DVD (contact Endress+Hauser)

9.2 Overview of system files

System files	Version	Description	How to acquire
Electronic Data Sheet (EDS system file)	2.1	Certified in accordance with the following ODVA guidelines: <ul style="list-style-type: none"> ▪ Conformance test ▪ Performance test ▪ PlugFest Embedded EDS Support (File Object 0x37)	<ul style="list-style-type: none"> ▪ www.endress.com → Download Area ▪ EDS system file integrated in the device: can be downloaded via the Web browser →  66
Add-on Profile Level 3	<ul style="list-style-type: none"> ▪ Major revision 2 ▪ Minor revision 1 	System file for "RSLogix 5000" software (Rockwell Automation)	www.endress.com → Download Area

9.3 Integrating the measuring device in the system

 A detailed description of how to integrate the device into an automation system (e.g. from Rockwell Automation) is available as a separate document: www.endress.com → Select country → Automation → Digital Communication → Fieldbus device integration → EtherNet/IP

 For information on the protocol-specific data of EtherNet/IP

9.4 Cyclic data transmission

Cyclic data transmission when using the device master file (GSD).

9.4.1 Block model

The block model shows which input and output data the measuring device makes available for implicit messaging. Cyclical data exchange is performed using an EtherNet/IP scanner, e.g. a distributed control system etc.

Measuring device				Control system
Transducer Block	Input Assembly Fix (Assem100) 44 Byte	→	☰ 72	Permanently assigned input group →
	Output Assembly Fix (Assem102) 64 Byte	→	☰ 73	Permanently assigned output group ←
	Input Assembly Fix (Assem101) 88 Byte	→	☰ 73	Configurable input group →
				EtherNet/IP

9.4.2 Input and output groups

Possible configurations

Configuration 1: Exclusive Owner Multicast

Input Assembly Fix		Instance	Size [byte]	min. RPI (ms)
Input Assembly Configurable	Configuration	0 x 64	398	–
Output Assembly Fix	O → T Configuration	0 x 66	64	5
Input Assembly Fix	T → O Configuration	0 x 64	44	5

Configuration 2: Input Only Multicast

Input Assembly Fix		Instance	Size [byte]	min. RPI (ms)
Input Assembly Configurable	Configuration	0 x 68	398	–
Output Assembly Fix	O → T Configuration	0 x C7	–	–
Input Assembly Fix	T → O Configuration	0 x 64	44	5

Configuration 3: Exclusive Owner Multicast

Input Assembly Configurable		Instance	Size [byte]	min. RPI (ms)
Input Assembly Configurable	Configuration	0 x 68	398	–
Output Assembly Fix	O → T Configuration	0 x 66	64	5
Input Assembly Fix	T → O Configuration	0 x 65	88	5

Configuration 4: Input Only Multicast

Input Assembly Configurable		Instance	Size [byte]	min. RPI (ms)
Input Assembly Configurable	Configuration	0 x 68	398	–
Output Assembly Fix	O → T Configuration	0 x C7	–	–
Input Assembly Fix	T → O Configuration	0 x 64	88	5

Configuration 5: Exclusive Owner Multicast

Input Assembly Fix		Instance	Size [byte]	min. RPI (ms)
Input Assembly Configurable	Configuration	0 x 69	–	–
Output Assembly Fix	O → T Configuration	0 x 66	64	5
Input Assembly Fix	T → O Configuration	0 x 64	44	5

Configuration 6: Input Only Multicast

Input Assembly Fix		Instance	Size [byte]	min. RPI (ms)
Input Assembly Configurable	Configuration	0 x 69	–	–
Output Assembly Fix	O → T Configuration	0 x C7	–	–
Input Assembly Fix	T → O Configuration	0 x 65	44	5

Configuration 7: Exclusive Owner Multicast

Input Assembly Configurable		Instance	Size [byte]	min. RPI (ms)
Input Assembly Configurable	Configuration	0 x 69	–	–
Output Assembly Fix	O → T Configuration	0 x 66	64	5
Input Assembly Fix	T → O Configuration	0 x 64	88	5

Configuration 8: Input Only Multicast

Input Assembly Configurable		Instance	Size [byte]	min. RPI (ms)
Input Assembly Configurable	Configuration	0 x 69	–	–
Output Assembly Fix	O → T Configuration	0 x C7	–	–
Input Assembly Fix	T → O Configuration	0 x 65	88	5

Permanently assigned input group

Input Assembly Fix (Assem100) 44 Byte

Name	Description	Byte
Input Assembly Fix	1. File header (not visible)	1 to 4
	2. Current diagnosis ¹⁾	5 to 8
	3. Mass flow	9 to 12
	4. Volume flow	13 to 16
	5. Corrected volume flow	17 to 20
	6. Temperature	21 to 24
	7. Density	25 to 28
	8. Reference density	29 to 32
	9. Totalizer 1	33 to 36

Name	Description	Byte
	10. Totalizer 2	37 to 40
	11. Totalizer 3	41 to 44

1) Structure: Code, number, description (e.g.: 16777265 F882 input signal)



Detailed description

- Diagnostic information → 114
- Information events → 118

Configurable input group

Input Assembly Configurable (Assem101) 88 byte

Name	Description	Format
Input Assembly Configurable	1. - 10. Input values 1 to 10	Real
	11. - 20. Input values 11 to 20	Double integer

Possible input values

Possible input values 1 to 10:		
▪ Off	▪ Temperature	▪ Tube damping fluctuation 0
▪ Mass flow	▪ Carrier pipe temperature	▪ Tube damping fluctuation 1
▪ Volume flow	▪ Electronics temperature	▪ Exciter current 0
▪ Corrected volume flow	▪ Oscillation frequency 0	▪ Exciter current 1
▪ Target mass flow	▪ Oscillation frequency 1	▪ Monitoring of exciter current 0
▪ Carrier mass flow	▪ Oscillation amplitude 0	▪ Monitoring of exciter current 1
▪ Density	▪ Oscillation amplitude 1	▪ Totalizer 1
▪ Reference density	▪ Oscillation frequency 0	▪ Totalizer 2
▪ Concentration	▪ Oscillation frequency 1	▪ Totalizer 3
	▪ Oscillation damping 0	▪ Sensor integrity
	▪ Oscillation damping 1	
	▪ Signal shift	

Possible input values 11 to 20:		
▪ Off	▪ Temperature unit	▪ Totalizer 1 unit
▪ Current diagnosis	▪ Density unit	▪ Totalizer 2 unit
▪ Previous diagnosis	▪ Reference density unit	▪ Totalizer 3 unit
▪ Mass flow unit	▪ Concentration unit	▪ Verification result
▪ Volume flow unit	▪ Current unit	
▪ Corrected volume flow unit	▪ Status verification	

Permanently assigned output group

Output Assembly Fix (Assem102) 64 byte



Name	Description (format)	Byte	Bit	Value
Output Assembly Fix	1. Totalizer 1	1	1	<ul style="list-style-type: none"> ▪ 0: Enable ▪ 1: Disable
	2. Totalizer 2		2	
	3. Totalizer 3		3	
	4. Pressure compensation		4	
	5. Reference density compensation		5	
	6. Temperature compensation		6	
	7. Verification		7	

Name	Description (format)	Byte	Bit	Value
	8. Not used		8	–
	9. Not used	2 to 4	0 to 8	–
	10. Control totalizer 1 (integer)	5 to 6	0 to 8	<ul style="list-style-type: none"> ▪ 32226: Add ▪ 32490: Reset and stop ▪ 32228: Default value and stop ▪ 198: Reset and add ▪ 199: Default value and add
	11. Not used	7 to 8	0 to 8	–
	12. Control totalizer 2 (integer)	9...10	0 to 8	See totalizer 1
	13. Not used	11 to 12	0 to 8	–
	14. Control totalizer 3 (integer)	13 to 14	0 to 8	See totalizer 1
	15. Not used	15 to 16	0 to 8	–
	16. External pressure (real)	17 to 20	0 to 8	Data format: Byte 1 to 4: External pressure Floating-point number (IEEE754)
	17. External pressure unit (integer)	21 to 22	0 to 8	<ul style="list-style-type: none"> ▪ 2165: Pa a ▪ 2116: kPa a ▪ 2137: MPa a ▪ 4871: bar a ▪ 2166: Pa g ▪ 2117: kPa a ▪ 2138: MPa a ▪ 2053: bar g ▪ 2182: Psi a ▪ 2183: Psi g ▪ 2244: Customer-specific
	18. Not used	23 to 24	0 to 8	–
	19. External reference density (real)	25 to 28	0 to 8	Data format: Byte 1 to 4: External ref. density Floating-point number (IEEE754)
	20. External reference density unit (integer)	29 to 30	0 to 8	<ul style="list-style-type: none"> ▪ 2112: kg/Nm³ ▪ 2113: kg/Nl ▪ 2092: g/Scm³ ▪ 2114: kg/Scm³ ▪ 2181: lb/Sft³
	21. Not used	31 to 32	0 to 8	–
	22. External temperature (real)	33 to 36	0 to 8	Data format: Byte 1 to 4: External temperature Floating-point number (IEEE754)
	23. External temperature unit (integer)	37 to 38	0 to 8	<ul style="list-style-type: none"> ▪ 4608: °C ▪ 4609: °F ▪ 4610: K ▪ 4611: °R
	24. Not used	39 to 40	0 to 8	–
	25. Start verification (integer)	41 to 42	0 to 8	<ul style="list-style-type: none"> ▪ 32378: Start ▪ 32713: Cancel
	26. Not used	43 to 64	0 to 8	–

10 Commissioning



10.1 Function check

Before commissioning the measuring device:



- ▶ Make sure that the post-installation and post-connection checks have been performed.
- "Post-installation check" checklist →  35
- "Post-connection check" checklist →  47

10.2 Switching on the measuring device

- ▶ After a successful function check, switch on the measuring device.
 - ↳ After a successful startup, the local display switches automatically from the startup display to the operational display.

 If nothing appears on the local display or a diagnostic message is displayed, refer to the section on "Diagnostics and troubleshooting" →  105.

10.3 Establishing a connection via FieldCare

- For FieldCare connection →  68
- For establishing a connection via FieldCare →  68
- For FieldCare user interface →  69

10.4 Configuring the device address via software

In the "**Communication**" submenu the device address can be set.



Navigation

"Setup" menu → Communication → Device address

10.4.1 Ethernet network and Web server

When delivered, the measuring device has the following factory settings:

IP address	192.168.1.212
Subnet mask	255.255.255.0
Default gateway	192.168.1.212

- 
 - If hardware addressing is active, software addressing is disabled.
 - If a switch is made to hardware addressing, the address configured via software addressing is retained for the first 9 places (the first three octets).
 - If the IP address of the device is not known, the device address currently configured can be read out →  100.

10.5 Setting the operating language

Factory setting: English or ordered local language

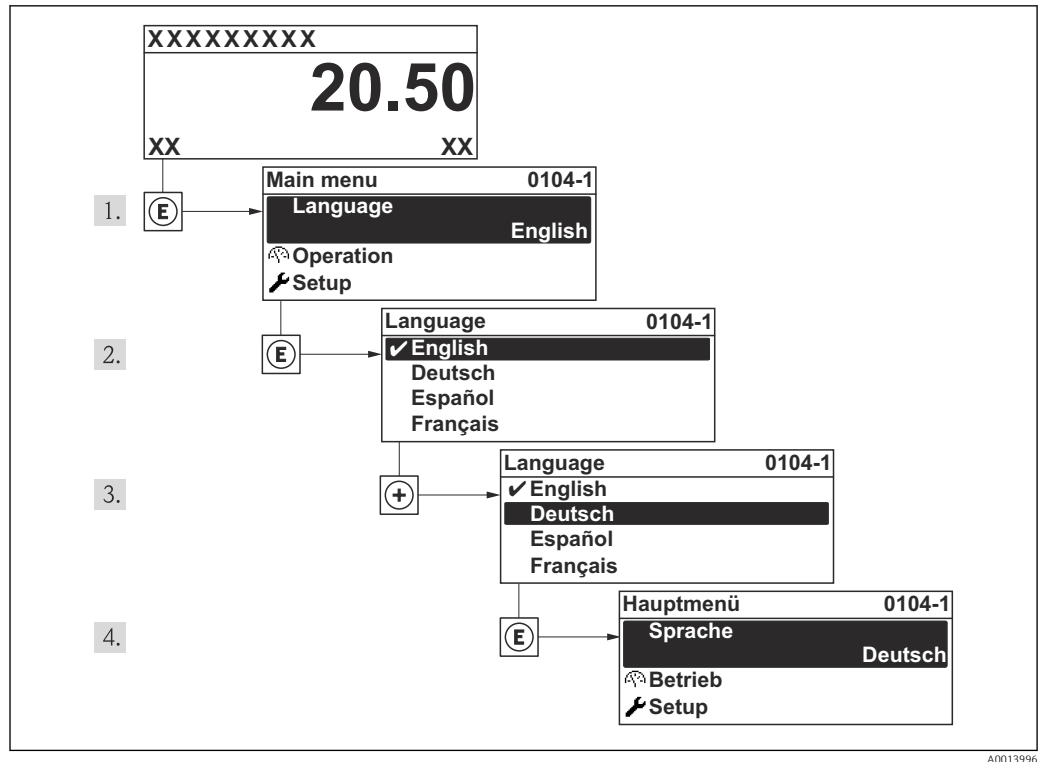

21 Taking the example of the local display

10.6 Configuring the measuring device

The **Setup** menu with its guided wizards contains all the parameters needed for standard operation.

Navigation to the **Setup** menu

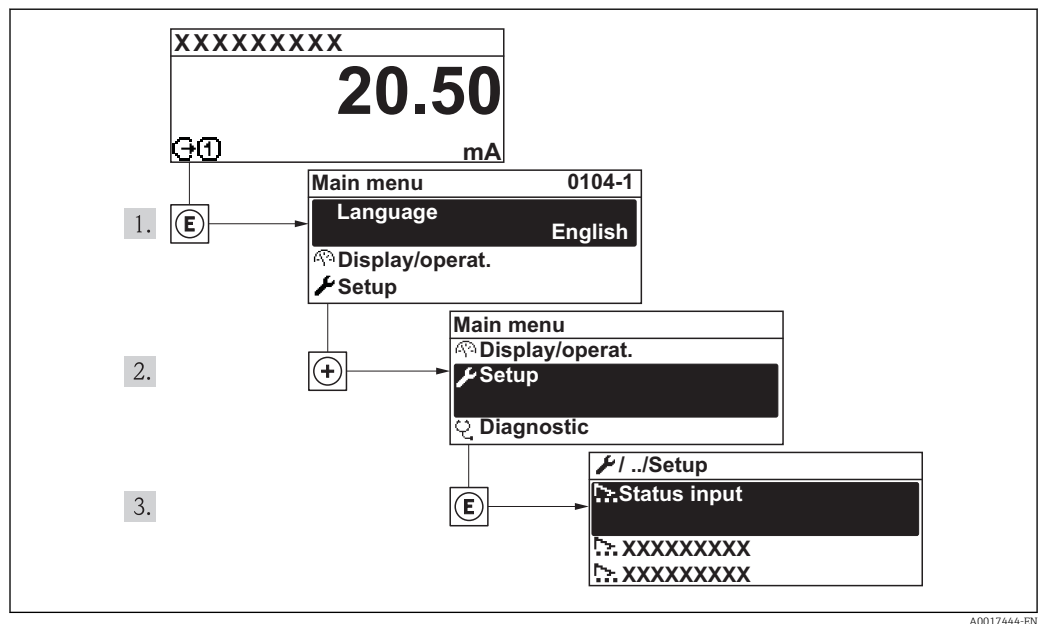

22 Using the example of the local display

Navigation
"Setup" menu

Setup

Device tag

System units

Volume flow unit

Volume unit

Conductivity unit

Temperature unit

Mass flow unit

Mass unit

Density unit

Communication

MAC address

Default network settings

DHCP client

IP address

Subnet mask

Default gateway

Display

Format display

Value 1 display

0% bargraph value 1

100% bargraph value 1

Value 2 display

Value 3 display

0% bargraph value 3

100% bargraph value 3
Value 4 display
► Low flow cut off
Assign process variable
On value low flow cutoff
Off value low flow cutoff
Pressure shock suppression
► Empty pipe detection
Empty pipe detection
New adjustment
Switch point empty pipe detection
Response time empty pipe detection
► Advanced setup
Enter access code
► Sensor adjustment
Installation direction
► Totalizer 1 to 3
Assign process variable
Unit totalizer
Totalizer operation mode
Failure mode
► Display
Format display
Value 1 display
0% bargraph value 1

100% bargraph value 1
Decimal places 1
Value 2 display
Decimal places 2
Value 3 display
0% bargraph value 3
100% bargraph value 3
Decimal places 3
Value 4 display
Decimal places 4
Display language
Display interval
Display damping
Header
Header text
Separator
Backlight
► Electrode cleaning circuit
Electrode cleaning circuit
ECC duration
ECC recovery time

ECC cleaning cycle

ECC Polarity

▶ Administration

▶ Define access code

Define access code

Confirm access code

Device reset

10.6.1 Defining the tag name

To enable fast identification of the measuring point within the system, you can enter a unique designation using the **Device tag** parameter and thus change the factory setting.

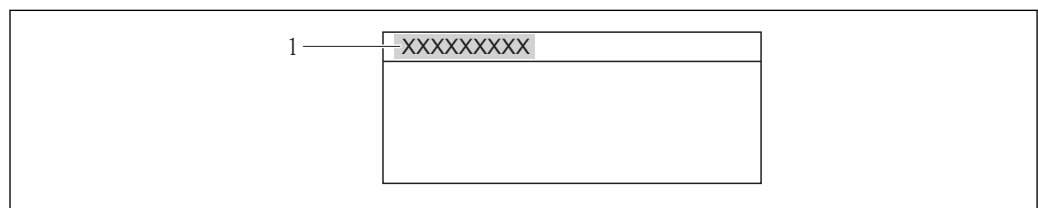

A0013375

23 Header of the operational display with tag name

1 Device tag

i The number of characters displayed depends on the characters used.

Entry of the tag name in the "FieldCare" operating tool → 69

Navigation

"Setup" menu → Device tag

Parameter overview with brief description

Parameter	Description	User entry	Factory setting
Device tag	Enter the name for the measuring point.	Max. 32 characters, such as letters, numbers or special characters (e.g. @, %, /).	Promag 400

10.6.2 Setting the system units

In the **System units** submenu the units of all the measured values can be set.

Navigation

"Setup" menu → Advanced setup → System units

▶ System units

Parameter overview with brief description

Parameter	Description	Selection	Factory setting
Volume flow unit	Select volume flow unit. <i>Result</i> The selected unit applies for: <ul style="list-style-type: none"> ▪ Output ▪ Low flow cut off ▪ Simulation process variable 	Unit choose list	Country-specific: <ul style="list-style-type: none"> ▪ l/h ▪ gal/min (us)
Volume unit	Select volume unit. Result The selected unit is taken from: Volume flow unit parameter	Unit choose list	Country-specific: <ul style="list-style-type: none"> ▪ l ▪ gal (us)
Conductivity unit	Select conductivity unit. <i>Result</i> The selected unit applies for: Simulation process variable	Unit choose list	µS/cm
Temperature unit	Select temperature unit. <i>Result</i> The selected unit applies for: <ul style="list-style-type: none"> ▪ Output ▪ Reference temperature ▪ Simulation process variable 	Unit choose list	Country-specific: <ul style="list-style-type: none"> ▪ °C (Celsius) ▪ °F (Fahrenheit)
Mass flow unit	Select mass flow unit. <i>Result</i> The selected unit applies for: <ul style="list-style-type: none"> ▪ Output ▪ Low flow cut off ▪ Simulation process variable 	Unit choose list	Country-specific: <ul style="list-style-type: none"> ▪ kg/h ▪ lb/min

Parameter	Description	Selection	Factory setting
Mass unit	Select mass unit. <i>Result</i> The selected unit is taken from: Mass flow unit parameter	Unit choose list	Country-specific: <ul style="list-style-type: none"> ▪ kg ▪ lb
Density unit	Select density unit. <i>Result</i> The selected unit applies for: <ul style="list-style-type: none"> ▪ Output ▪ Simulation process variable ▪ Density adjustment (in Expert menu) 	Unit choose list	Country-specific: <ul style="list-style-type: none"> ▪ kg/l ▪ lb/ft³

10.6.3 Configuring the communication interface



The **Communication** submenu guides you systematically through all the parameters that have to be configured for selecting and setting the communication interface.

Navigation

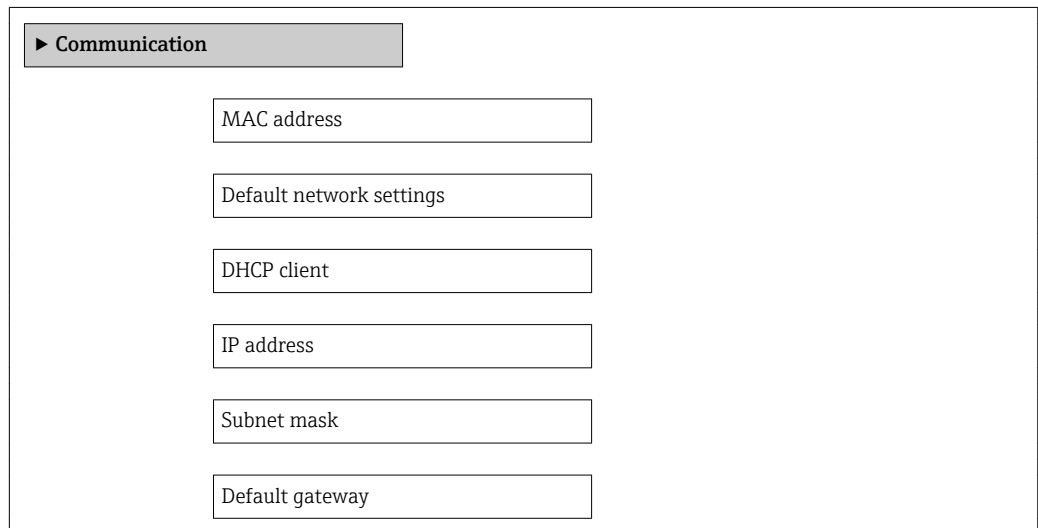
"Setup" menu → Communication



Parameter overview with brief description

Parameter	Description	User interface / Selection / User entry	Factory setting
MAC address	Displays the MAC address of the measuring device.  MAC = Media Access Control	Unique 12-digit character string comprising letters and numbers, e.g.: 00:07:05:10:01:5F	Each measuring device is given an individual address.
Default network settings	Select whether to restore network settings.	<ul style="list-style-type: none"> ▪ Off ▪ On 	Off
DHCP client	Select to activate/deactivate DHCP client functionality. Result If the web server's DHCP client functionality is activated, the IP address, subnet mask and default gateway are automatically set.  Identification is via the MAC address of the measuring device.	<ul style="list-style-type: none"> ▪ Off ▪ On 	On

Parameter	Description	User interface / Selection / User entry	Factory setting
IP address	IP address of the Web server of the measuring device.	4 octet: 0 to 255 (in the particular octet)	192.168.1.212
Subnet mask	Displays the subnet mask.	4 octet: 0 to 255 (in the particular octet)	255.255.255.0
Default gateway	Displays the default gateway.	4 octet: 0 to 255 (in the particular octet)	0.0.0.0

10.6.4 Configuring the local display

The **Display** wizard guides you systematically through all the parameters that can be configured for configuring the local display.

Navigation

"Setup" menu → Display

Structure of the wizard

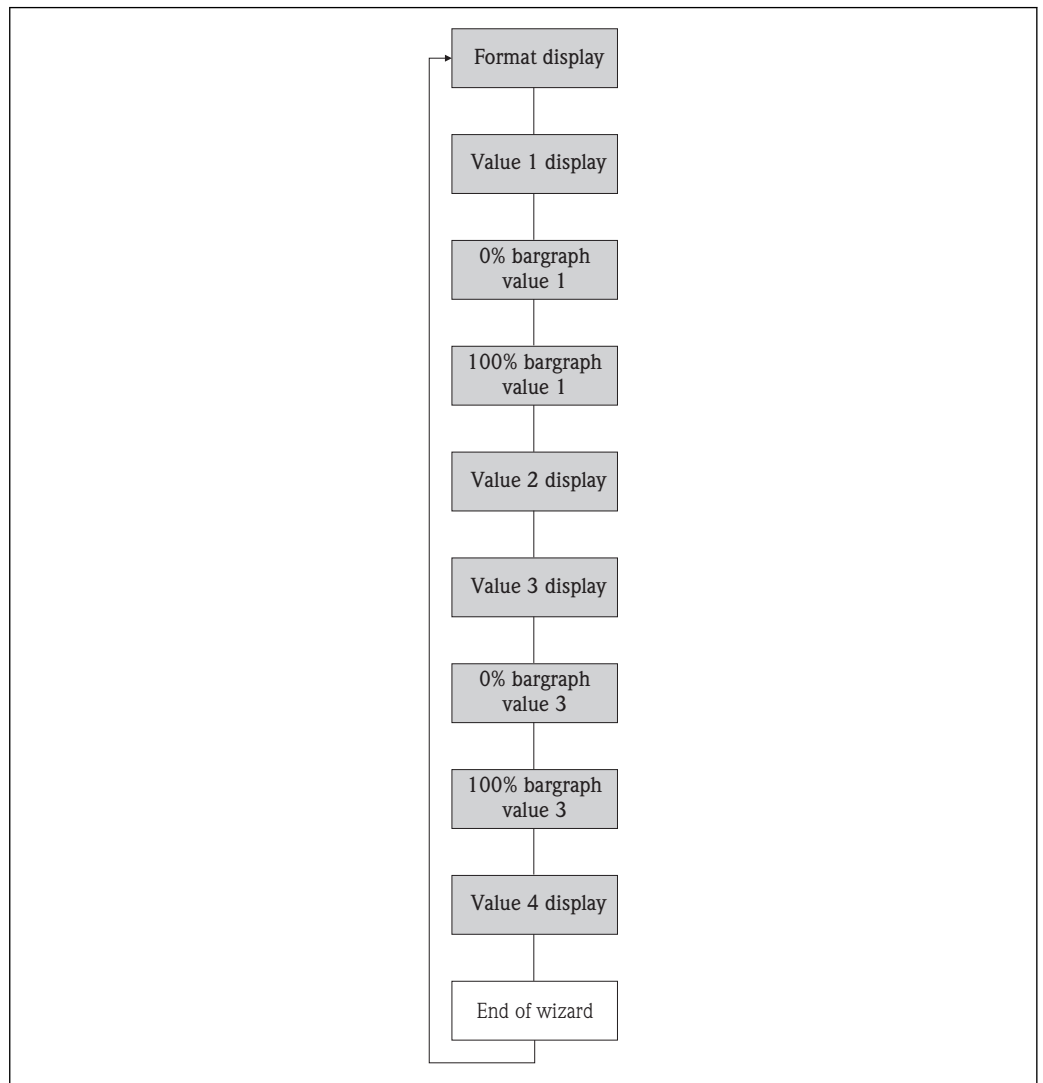

24 "Display" wizard in the "Setup" menu

A0013797-EN

Parameter overview with brief description

Parameter	Prerequisite	Description	Selection / User entry	Factory setting
Format display	–	Select how measured values are shown on the display.	<ul style="list-style-type: none"> ▪ 1 value, max. size ▪ 1 bargraph + 1 value ▪ 2 values ▪ 1 value large + 2 values ▪ 4 values 	1 value, max. size
Value 1 display	–	Select the measured value that is shown on the local display.	<ul style="list-style-type: none"> ▪ Volume flow ▪ Mass flow ▪ Conductivity ▪ Temperature ▪ Electronic temperature ▪ Totalizer 1 ▪ Totalizer 2 ▪ Totalizer 3 	Volume flow
0% bargraph value 1	–	Enter 0% value for bar graph display.	Signed floating-point number	0 l/h
100% bargraph value 1	–	Enter 100% value for bar graph display.	Signed floating-point number	0.025 l/h
Value 2 display	–	Select the measured value that is shown on the local display.	Picklist (see 1st display value)	None
Value 3 display	–	Select the measured value that is shown on the local display.	Picklist (see 1st display value)	None
0% bargraph value 3	An option was selected in the Value 3 display parameter.	Enter 0% value for bar graph display.	Signed floating-point number	0
100% bargraph value 3	An option was selected in the Value 3 display parameter.	Enter 100% value for bar graph display.	Signed floating-point number	0
Value 4 display	–	Select the measured value that is shown on the local display.	Picklist (see 1st display value)	None

10.6.5 Configuring the low flow cut off

The **Low flow cut off** wizard guides you systematically through all the parameters that have to be set for configuring the low flow cut off.

Navigation

"Setup" menu → Low flow cut off

Structure of the wizard

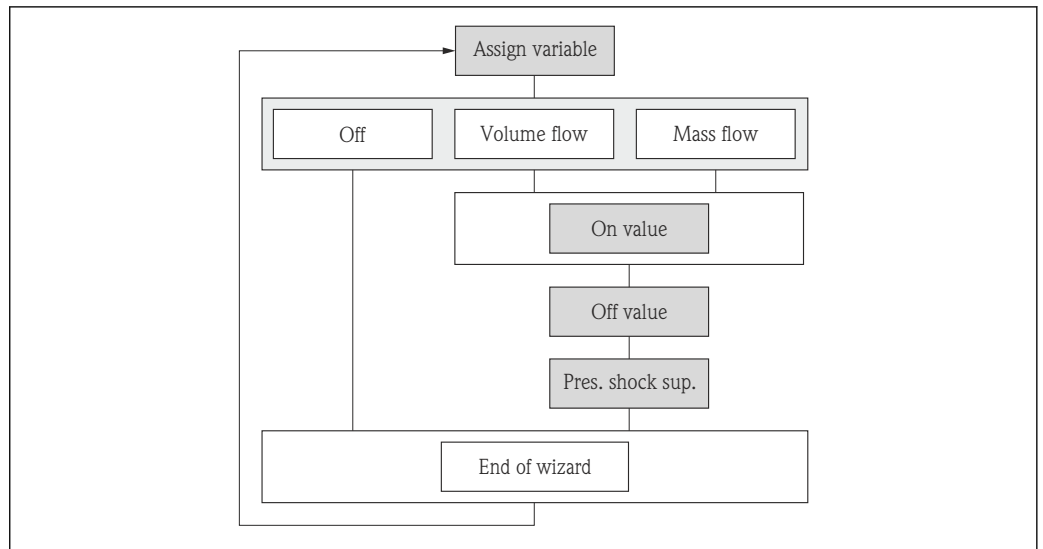

A0020524-EN

25 "Low flow cut off" wizard in the "Setup" menu

Parameter overview with brief description

Parameter	Description	Selection / User entry	Factory setting
Assign process variable	Select process variable for low flow cut off.	<ul style="list-style-type: none"> ■ Off ■ Volume flow ■ Mass flow 	Volume flow
On value low flow cutoff	Enter on value for low flow cut off.	Signed floating-point number	0 l/h
Off value low flow cutoff	Enter off value for low flow cut off.	0 to 100.0 %	50 %
Pressure shock suppression	Enter time frame for signal suppression (= active pressure shock suppression).	0 to 100 s	0 s

10.6.6 Configuring empty pipe detection

The **Empty pipe detection** wizard guides you systematically through all the parameters that have to be set for configuring the low flow cut off.

Navigation

"Setup" menu → Empty pipe detection

Structure of the wizard

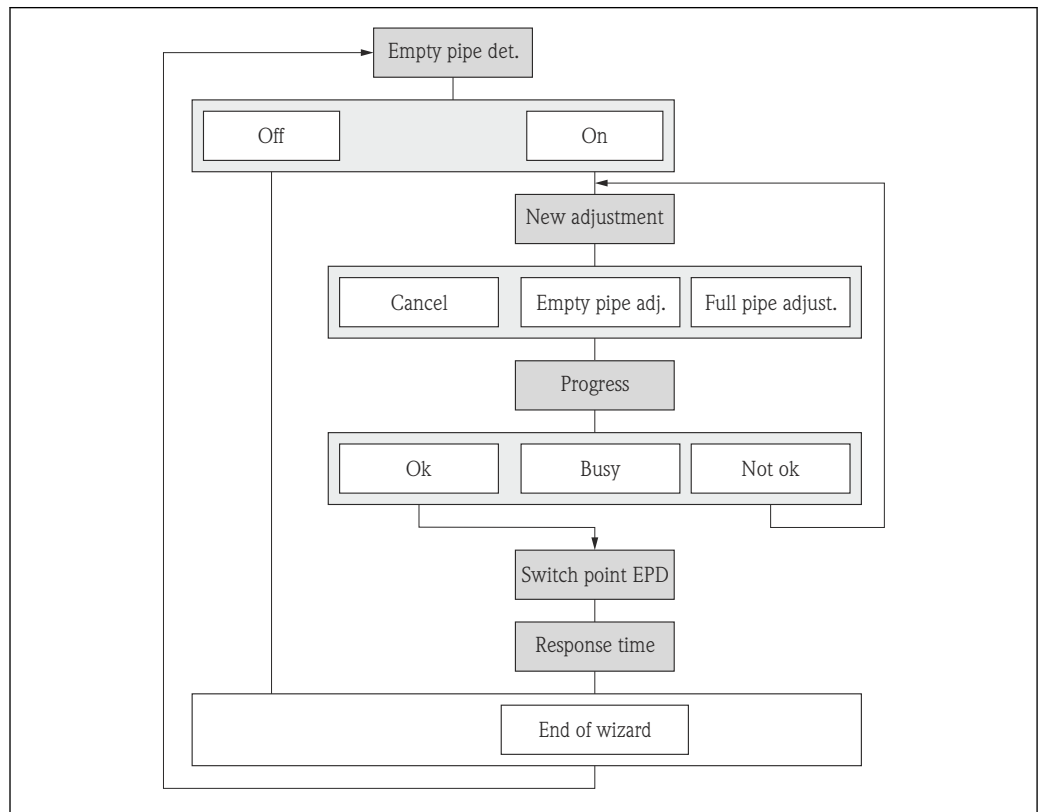

26 "Empty pipe detection" wizard in the "Setup" menu

Parameter overview with brief description

Parameter	Description	Selection / User interface / User entry	Factory setting
Empty pipe detection	Switch empty pipe detection on and off.	<ul style="list-style-type: none"> ▪ Off ▪ On 	Off
New adjustment	Select type of adjustment.	<ul style="list-style-type: none"> ▪ Cancel ▪ Empty pipe adjust ▪ Full pipe adjust 	Cancel
Progress		<ul style="list-style-type: none"> ▪ Ok ▪ Busy ▪ Not ok 	
Switch point empty pipe detection	Enter hysteresis in %, below this value the measuring tube will be detected as empty.	0 to 100 %	50 %
Response time empty pipe detection	Enter the time before diagnostic message S862 "Pipe empty" is displayed for empty pipe detection.	0 to 100 s	1 s

10.7 Advanced settings

The **Advanced setup** submenu with its submenus contains parameters for specific settings.

Navigation to the "Advanced setup" submenu

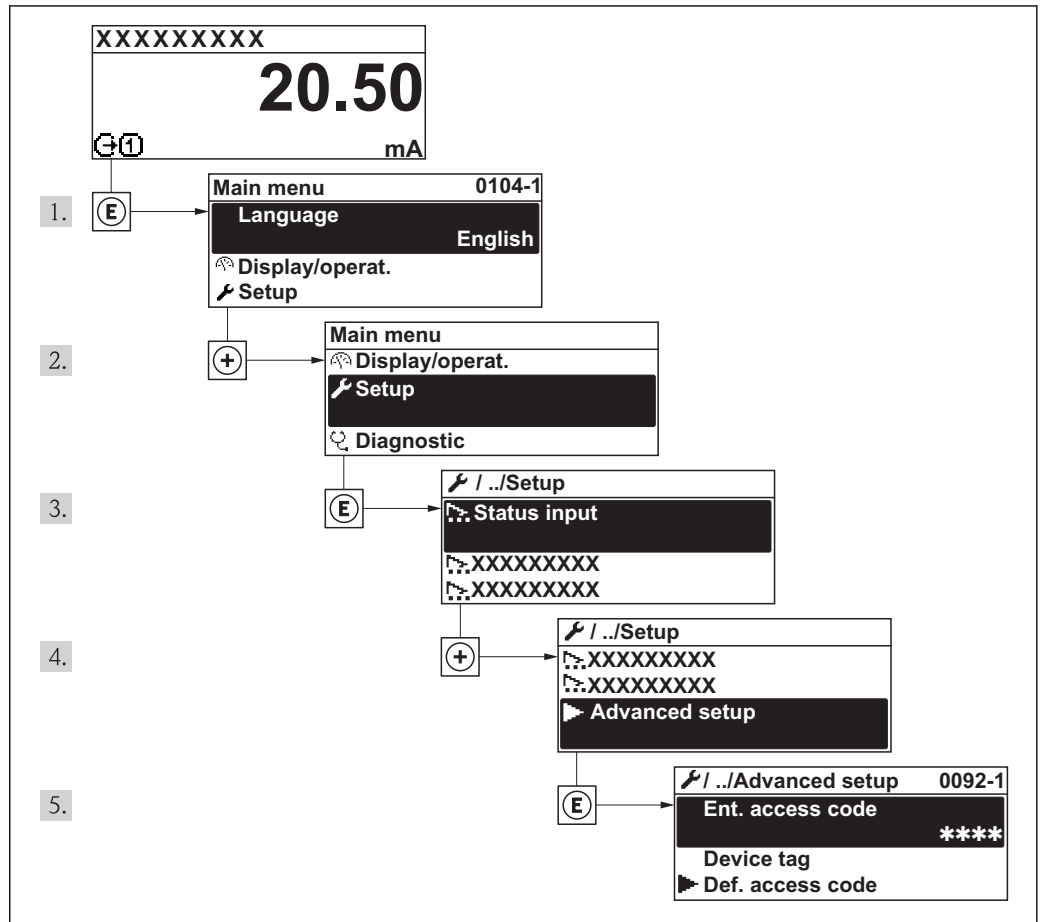

A0017519-EN

27 Taking the example of the local display

Navigation

"Setup" menu → Advanced setup

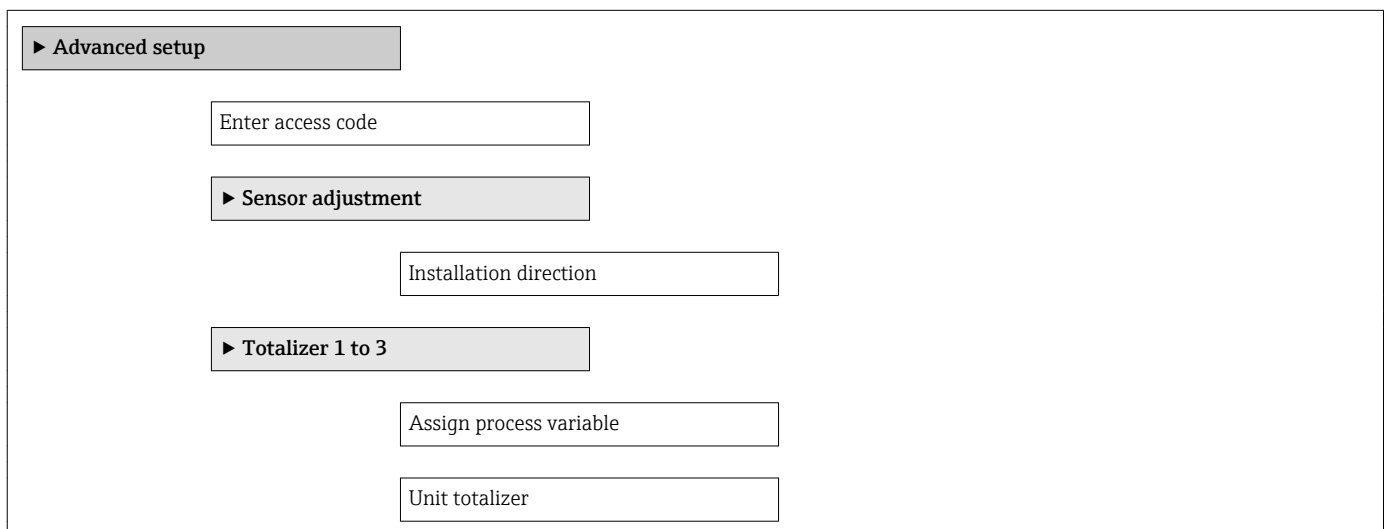

► Display**► Electrode cleaning circuit**

10.7.1 Carrying out a sensor adjustment

The **Sensor adjustment** submenu contains parameters that pertain to the functionality of the sensor.

Navigation

"Setup" menu → Advanced setup → Sensor adjustment

Parameter overview with brief description

Parameter	Description	Selection	Factory setting
Installation direction	Set sign of flow direction to match the direction of the arrow on the sensor.	<ul style="list-style-type: none"> ▪ Flow in arrow direction ▪ Flow against arrow direction 	Flow in arrow direction

10.7.2 Configuring the totalizer

In the "**Totalizer 1 to 3**" submenu the individual totalizer can be configured.

Navigation

"Setup" menu → Advanced setup → Totalizer 1 to 3

Totalizer operation mode
Failure mode

Parameter overview with brief description

Parameter	Description	Selection	Factory setting
Assign process variable	Select process variable for totalizer.	<ul style="list-style-type: none"> ■ Off ■ Volume flow ■ Mass flow 	Volume flow
Unit totalizer	Select process variable totalizer unit.	Unit choose list	1
Totalizer operation mode	Select totalizer calculation mode.	<ul style="list-style-type: none"> ■ Net flow total ■ Forward flow total ■ Reverse flow total 	Net flow total
Failure mode	Define totalizer behavior in alarm condition.	<ul style="list-style-type: none"> ■ Stop ■ Actual value ■ Last valid value 	Stop

10.7.3 Carrying out additional display configurations

In the **Display** submenu you can set all the parameters associated with the configuration of the local display.

Navigation

"Setup" menu → Advanced setup → Display

The image shows a screenshot of the 'Display' configuration submenu. At the top, there is a grey header bar with a right-pointing arrow and the text 'Display'. Below this header, there is a vertical list of 18 rectangular input fields, each containing a parameter name. The parameters are: Format display, Value 1 display, 0% bargraph value 1, 100% bargraph value 1, Decimal places 1, Value 2 display, Decimal places 2, Value 3 display, 0% bargraph value 3, 100% bargraph value 3, Decimal places 3, Value 4 display, Decimal places 4, Display language, Display interval, Display damping, Header, Header text, Separator, and Backlight.

Parameter Name
Format display
Value 1 display
0% bargraph value 1
100% bargraph value 1
Decimal places 1
Value 2 display
Decimal places 2
Value 3 display
0% bargraph value 3
100% bargraph value 3
Decimal places 3
Value 4 display
Decimal places 4
Display language
Display interval
Display damping
Header
Header text
Separator
Backlight

Parameter overview with brief description

Parameter	Prerequisite	Description	Selection / User entry	Factory setting
Format display	–	Select how measured values are shown on the display.	<ul style="list-style-type: none"> ▪ 1 value, max. size ▪ 1 bargraph + 1 value ▪ 2 values ▪ 1 value large + 2 values ▪ 4 values 	1 value, max. size
Value 1 display	–	Select the measured value that is shown on the local display.	<ul style="list-style-type: none"> ▪ Volume flow ▪ Mass flow ▪ Conductivity ▪ Temperature ▪ Electronic temperature ▪ Totalizer 1 ▪ Totalizer 2 ▪ Totalizer 3 	Volume flow
0% bargraph value 1	–	Enter 0% value for bar graph display.	Signed floating-point number	0 l/h
100% bargraph value 1	–	Enter 100% value for bar graph display.	Signed floating-point number	0.025 l/h
Decimal places 1	–	Select the number of decimal places for the display value.	<ul style="list-style-type: none"> ▪ x ▪ x.x ▪ x.xx ▪ x.xxx ▪ x.xxxx 	x.xx
Value 2 display	–	Select the measured value that is shown on the local display.	Picklist (see 1st display value)	None
Decimal places 2	–	Select the number of decimal places for the display value.	<ul style="list-style-type: none"> ▪ x ▪ x.x ▪ x.xx ▪ x.xxx ▪ x.xxxx 	x.xx
Value 3 display	–	Select the measured value that is shown on the local display.	Picklist (see 1st display value)	None
0% bargraph value 3	An option was selected in the Value 3 display parameter.	Enter 0% value for bar graph display.	Signed floating-point number	0
100% bargraph value 3	An option was selected in the Value 3 display parameter.	Enter 100% value for bar graph display.	Signed floating-point number	0
Decimal places 3	–	Select the number of decimal places for the display value.	<ul style="list-style-type: none"> ▪ x ▪ x.x ▪ x.xx ▪ x.xxx ▪ x.xxxx 	x.xx
Value 4 display	–	Select the measured value that is shown on the local display.	Picklist (see 1st display value)	None
Decimal places 4	–	Select the number of decimal places for the display value.	<ul style="list-style-type: none"> ▪ x ▪ x.x ▪ x.xx ▪ x.xxx ▪ x.xxxx 	x.xx

Parameter	Prerequisite	Description	Selection / User entry	Factory setting
Display language	-	Set display language.	<ul style="list-style-type: none"> ■ English ■ Deutsch ■ Français ■ Español ■ Italiano ■ Nederlands ■ Portuguesa ■ Polski ■ русский язык (Russian) ■ Svenska ■ Türkçe ■ 中文 (Chinese) ■ 日本語 (Japanese) ■ 한국어 (Korean) ■ العربية (Arabic) ■ Bahasa Indonesia ■ ภาษาไทย (Thai) ■ tiếng Việt (Vietnamese) ■ čeština (Czech) 	English (alternatively, the ordered language is preset in the device)
Display interval	-	Set time measured values are shown on display if display alternates between values.	1 to 10 s	5 s
Display damping	-	Set display reaction time to fluctuations in the measured value.	0.0 to 999.9 s	0.0 s
Header	-	Select header contents on local display.	<ul style="list-style-type: none"> ■ Device tag ■ Free text 	Device tag
Header text	-	Enter display header text.		-----
Separator	-	Select decimal separator for displaying numerical values.	<ul style="list-style-type: none"> ■ . ■ , 	.
Backlight	-	Switch the local display backlight on and off.  Only for device version with onsite display SDO3 (touch control)	<ul style="list-style-type: none"> ■ Disable ■ Enable 	Enable

10.7.4 Performing electrode cleaning

The **Electrode cleaning circuit** wizard guides you systematically through all the parameters that have to be set for configuring electrode cleaning.

 The wizard only appears if the device was ordered with an electrode cleaning circuit.

Navigation

"Setup" menu → Advanced setup → Electrode cleaning circuit

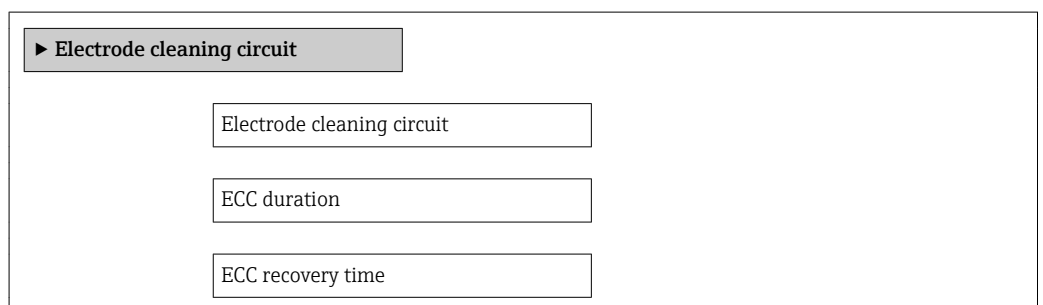

ECC cleaning cycle
ECC Polarity

Parameter overview with brief description

Parameter	Description	Selection / User entry / User interface	Factory setting
Electrode cleaning circuit	Enable the cyclic electrode cleaning circuit.	<ul style="list-style-type: none"> ▪ Off ▪ On 	Off
ECC duration	Enter the duration of electrode cleaning in seconds.	0.01 to 30 s	2 s
ECC recovery time	Define recovery time after electrode cleaning. During this time the current output values will be held at last valid value.	1 to 3.0 ⁺³⁸ s	5 s
ECC cleaning cycle	Enter the pause duration between electrode cleaning cycles.	0.5 to 168 h	40 min
ECC Polarity	Select the polarity of the electrode cleaning circuit.	<ul style="list-style-type: none"> ▪ Positive ▪ Negative 	Depends on the electrode material

10.7.5 Administration configuration

The **Administration** submenu contains administrative parameters.

Navigation

"Setup" menu → Advanced setup → Administration

▶ Administration
Define access code
Device reset

Parameter overview with brief description

Parameter	Description	User entry / Selection	Factory setting
Define access code	Restrict write-access to parameters to protect the configuration of the device against unintentional changes via the local display.	0 to 9 999	0
Device reset	Restart or reset device manually.	<ul style="list-style-type: none"> ▪ Cancel ▪ To delivery settings ▪ Restart device 	Cancel

10.8 Configuration management

After commissioning, you can save the current device configuration, copy it to another measuring point or restore the previous device configuration.

You can do so using the **Configuration management** parameter and the related options found in the **Configuration backup display** submenu.

Navigation

"Setup" menu → Advanced setup → Configuration backup display

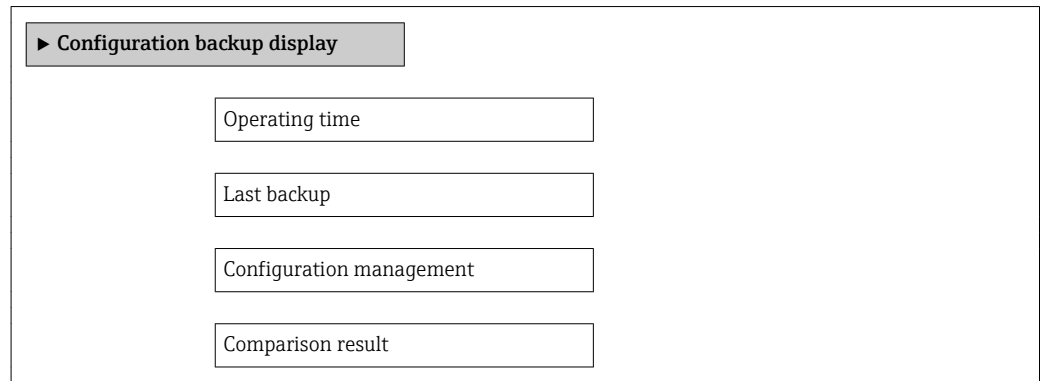

Parameter overview with brief description

Parameter	Prerequisite	Description	User interface / Selection	Factory setting
Operating time	–	Indicates how long the device has been in operation.	Days (d), hours (h), minutes (m), seconds (s)	–
Last backup	–	Indicates when the last data backup was saved to the display module.	Days (d), hours (h), minutes (m), seconds (s)	–
Configuration management	A local display is provided.	Select action for managing the device data in the display module.	<ul style="list-style-type: none"> ▪ Cancel ▪ Execute backup ▪ Restore ▪ Duplicate ▪ Compare ▪ Clear backup data 	Cancel
Comparison result	–	Comparison between present device data and display backup.	<ul style="list-style-type: none"> ▪ Settings identical ▪ Settings not identical ▪ No backup available ▪ Backup settings corrupt ▪ Check not done ▪ Dataset incompatible 	Check not done

10.8.1 Function range of "Configuration management" parameter

Options	Description
Execute backup	The current device configuration is backed up from the integrated HistoROM to the device's display module. The backup copy includes the transmitter data of the device.
Restore	The last backup copy of the device configuration is restored from the display module to the device's integrated HistoROM. The backup copy includes the transmitter data of the device.
Duplicate	The transmitter configuration from another device is duplicated to the device using the display module.

Options	Description
Compare	The device configuration saved in the display module is compared with the current device configuration of the integrated HistoROM.
Clear backup data	The backup copy of the device configuration is deleted from the display module of the device.

i While this action is in progress, the configuration cannot be edited via the local display and a message on the processing status appears on the display.

10.9 Simulation

The **Simulation** submenu enables you to simulate, without a real flow situation, various process variables in the process and the device alarm mode and to verify downstream signal chains (switching valves or closed-control loops).

i The parameters displayed depend on:

- The selected device order
- The set operating mode of the pulse/frequency/switch outputs

Navigation

"Diagnostics" menu → Simulation

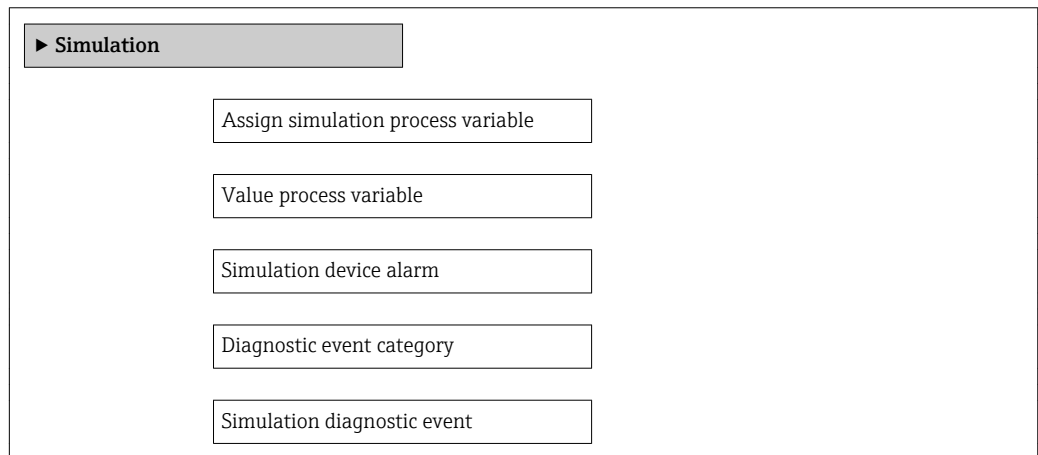

Parameter overview with brief description

Parameter	Prerequisite	Description	Selection / User entry	Factory setting
Assign simulation process variable	–	Select a process variable for the simulation process that is activated.	<ul style="list-style-type: none"> ▪ Off ▪ Volume flow ▪ Mass flow ▪ Conductivity 	Off
Value process variable	A process variable is selected in the Assign simulation process variable parameter.	Enter the simulation value for the selected process variable.	Signed floating-point number	0
Simulation device alarm	–	Switch the device alarm on and off.	<ul style="list-style-type: none"> ▪ Off ▪ On 	Off

Parameter	Prerequisite	Description	Selection / User entry	Factory setting
Diagnostic event category	–	Select the category of the diagnostic event.	<ul style="list-style-type: none"> ■ Sensor ■ Electronics ■ Configuration ■ Process 	Process
Simulation diagnostic event	–	Switch simulation of the diagnostic event on and off. For the simulation, you can choose from the diagnostic events of the category selected in the Diagnostic event category parameter.	<ul style="list-style-type: none"> ■ Off ■ Picklist Diagnostic events (depends on the selected category) 	Off

10.10 Protecting settings from unauthorized access

The following options exist for protecting the configuration of the measuring device from unintentional modification after commissioning:

- Write protection via access code for the local display and Web browser
- Write protection via write protection switch
- Write protection via keypad lock →  62

10.10.1 Write protection via access code

The effects of the customer-specific access code are as follows:

- Via local operation, the parameters for the measuring device configuration are write-protected and their values can no longer be changed.
- Device access via the Web browser is protected, as are the parameters for the measuring device configuration.

Navigation

"Setup" menu → Advanced setup → Administration → Define access code

▶ Define access code

Defining the access code via local display

1. Navigate to the **Enter access code** parameter.
2. Max. Define a max. 4-digit numeric code as an access code.
3. Enter the access code again to confirm the code.
 - ↳ The -symbol appears in front of all write-protected parameters.

The device automatically locks the write-protected parameters again if a key is not pressed for 10 minutes in the navigation and editing view. The device locks the write-protected

parameters automatically after 60 s if the user skips back to the operational display mode from the navigation and editing view.

- i** ■ If write access is activated via access code, it can be also be deactivated only via the access code → 62.
- The user role with which the user is currently logged on via the local display → 62 is indicated by the **Access status display** parameter. Navigation path: "Operation" menu → Access status display

Parameters which can always be modified via the local display

Certain parameters that do not affect the measurement are excepted from write protection via the local display. Despite the defined access code, these parameters can always be modified even if the other parameters are locked.

Defining the access code via the Web browser

1. Navigate to the **"Enter access code" parameter**.
2. Max. Define a max. 4-digit numeric code as an access code.
3. Enter the access code again to confirm the code.
 - ↳ The Web browser switches to the login page.

i If no action is performed for 10 minutes, the Web browser automatically returns to the login page.

i The user role with which the user is currently logged on via the Web browser is indicated by the **Access status tooling** parameter.

Navigation path: "Operation" menu → Access status tooling

10.10.2 Write protection via write protection switch

Unlike write protection via a user-specific access code, this allows write access to the entire operating menu - other than the **"Contrast display" parameter** - to be locked.

The parameter values are now read only and cannot be edited any more (exception **"Contrast display" parameter**):

Via local display

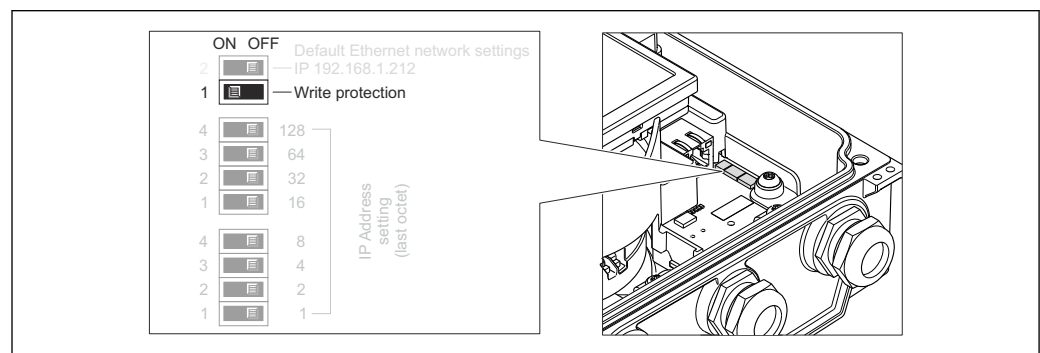

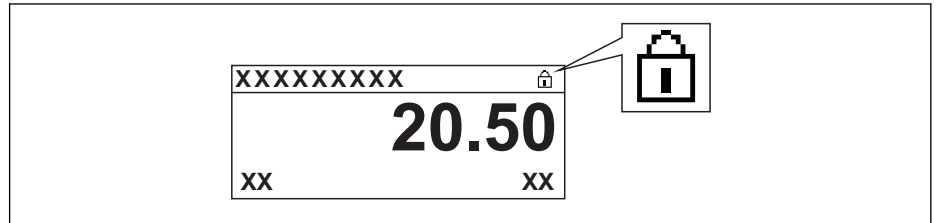

1. Loosen the 4 fixing screws on the housing cover and open the housing cover.

2. Setting the write protection switch (WP) on the main electronics module to the **ON** position enables the hardware write protection. Setting the write protection switch (WP) on the main electronics module to the **OFF** position (factory setting) disables the hardware write protection.
 - ↳ If hardware write protection is enabled, the **Locking status** parameter displays the **Hardware locked** option. In addition, on the local display the -symbol appears in front of the parameters in the header of the operational display and in the navigation view.



A0015870

If hardware write protection is disabled, no option is displayed in the **Locking status** parameter. On the local display, the -symbol disappears from in front of the parameters in the header of the operational display and in the navigation view.

3. **WARNING!** Excessive tightening torque applied to the fixing screws! Risk of damaging the plastic transmitter. Tighten the fixing screws as per the tightening torque →  32.

Reverse the removal procedure to reassemble the transmitter.

11 Operation

11.1 Read out and modify current Ethernet settings

If the Ethernet settings such as the IP address of the measuring device are unknown, they can be read out and modified as explained in the following example for an IP address.

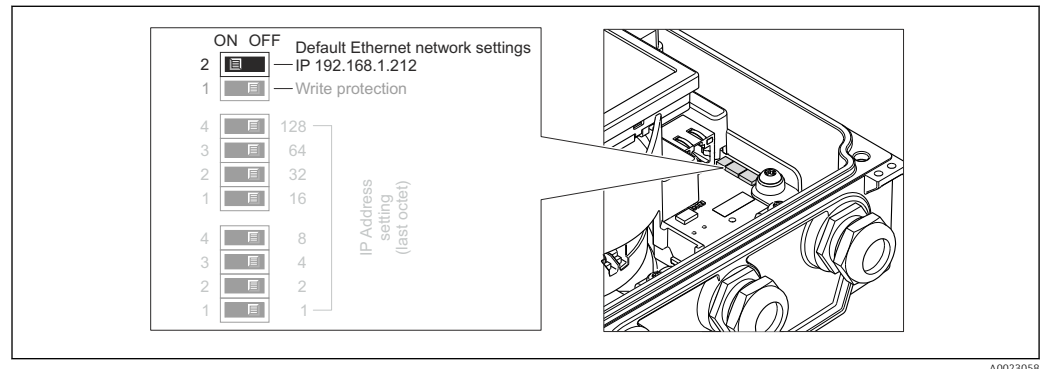

A0023058

Prerequisite

- Software addressing is enabled: All the DIP switches for hardware addressing are set to **OFF**. → 46
- Measuring device is switched on.

1. Set the DIP switch for "Default Ethernet network settings, IP 192.168.1.212" from **OFF** → **ON**.
2. Restart the device.
 - ↳ The device's Ethernet settings are reset to their factory settings:
IP address: 192.168.1.212; Subnet mask: 255.255.255.0; Default gateway: 192.168.1.212
3. Enter the default setting for the IP address in the address line of the Web browser.
4. Navigate to **IP address** parameter in the operating menu: "Setup" menu
→ Communication → IP address
 - ↳ The parameter displays the configured IP address.
5. Change the IP address of the device if necessary.
6. Set the DIP switch for "Default Ethernet network settings, IP 192.168.1.212" from **ON** → **OFF**.
7. Restart the device.
 - ↳ The modified IP address of the device is now enabled.

11.2 Reading the device locking status

The write protection types that are currently active can be determined using the **Locking status** parameter.

Navigation

"Operation" menu → Locking status

Function scope of "Locking status" parameter

Options	Description
None	The access status displayed in " Access status display " parameter applies → 62. Only appears on local display.
Hardware locked	The DIP switch for hardware locking is activated on the main electronics module. This locks write access to the parameters .
Temporarily locked	Write access to the parameters is temporarily lock due to device-internal processing (e.g. data upload/download, reset). Once the internal processing has been completed, the parameters can be changed once again.

11.3 Adjusting the operating language

Information → 75

i For information on the operating languages supported by the measuring device → 158

11.4 Configuring the display

- Basic settings for local display → 83
- Advanced settings for local display → 91

11.5 Reading measured values

With the **Measured values** submenu, it is possible to read all the measured values.

11.5.1 Process variables

The **Process variables** submenu contains all the parameters needed to display the current measured values for every process variable.

Navigation

"Diagnostics" menu → Measured values → Process variables

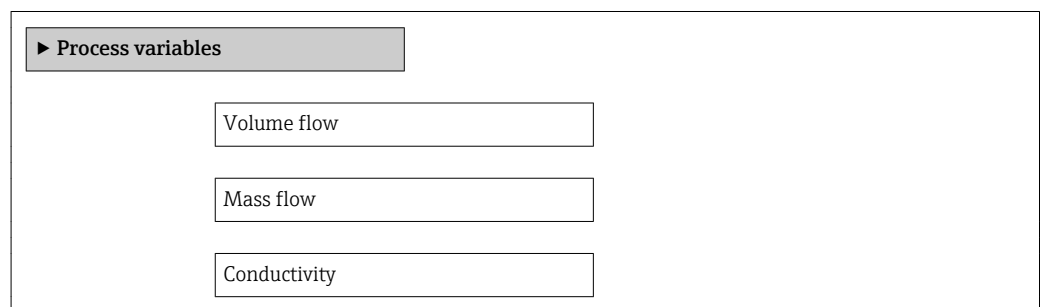

Parameter overview with brief description

Parameter	Description	User interface
Volume flow	Displays the volume flow currently measured.	Signed floating-point number
Mass flow	Displays the mass flow currently calculated.	Signed floating-point number
Conductivity	Displays the corrected volume flow currently calculated.	Signed floating-point number

11.5.2 Totalizer

The **Totalizer** submenu contains all the parameters needed to display the current measured values for every totalizer.

Navigation

"Diagnostics" menu → Measured values → Totalizer

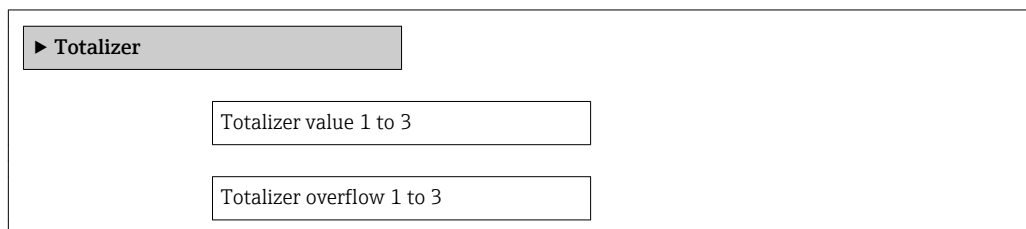

Parameter overview with brief description

Parameter	Prerequisite	Description	User interface	Factory setting
Totalizer value 1 to 3	In the Assign process variable parameter in the Totalizer 1 to 3 submenu, one of the following options is selected: <ul style="list-style-type: none"> ▪ Volume flow ▪ Mass flow 	Displays the current totalizer counter value.	Signed floating-point number	0 l
Totalizer overflow 1 to 3	In the Assign process variable parameter in the Totalizer 1 to 3 submenu, one of the following options is selected: <ul style="list-style-type: none"> ▪ Volume flow ▪ Mass flow 	Displays the current totalizer overflow.	Integer with sign	0

11.6 Adapting the measuring device to the process conditions

The following are available for this purpose:

- Basic settings using the **Setup** menu
- Advanced settings using the **Advanced setup** submenu

11.7 Performing a totalizer reset

Function scope of "Control Totalizer" parameter

Options	Description
Totalize	The totalizer is started.
Reset + hold	The totaling process is stopped and the totalizer is reset to 0.
Preset + hold	The totaling process is stopped and the totalizer is set to its defined start value from the Preset value parameter.
Reset + totalize	The totalizer is reset to 0 and the totaling process is restarted.
Preset + totalize	The totalizer is set to the defined start value in Preset value parameter and the totaling process is restarted.

Function scope of "Reset all totalizers" parameter

Options	Description
Reset + totalize	Resets all totalizers to 0 and restarts the totaling process. This deletes all the flow values previously totalized.

Navigation

"Operation" menu → Operation

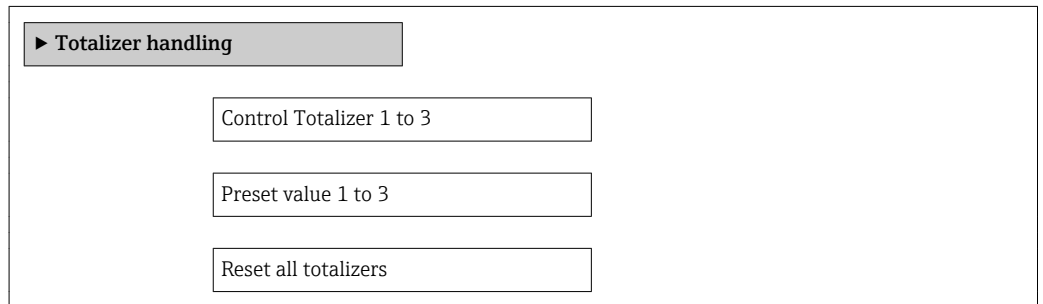

Parameter overview with brief description

Parameter	Description	Selection / User entry	Factory setting
Control Totalizer 1 to 3	Control totalizer value.	<ul style="list-style-type: none"> ■ Totalize ■ Reset + hold ■ Preset + hold ■ Reset + totalize ■ Preset + totalize 	Totalize
Preset value 1 to 3	Specify start value for totalizer.	Signed floating-point number	0 l
Reset all totalizers	Reset all totalizers to 0 and start.	<ul style="list-style-type: none"> ■ Cancel ■ Reset + totalize 	Cancel

11.8 Showing data logging

In the device, the extended function of the HistoROM must be enabled (order option) so that the **Data logging** submenu appears. This contains all the parameters for the measured value history.

 The data logging history is also available via the FieldCare plant asset management tool →  68.

Function scope

- A total of 1000 measured values can be stored
- 4 logging channels
- Adjustable logging interval for data logging
- Display of the measured value trend for each logging channel in the form of a chart

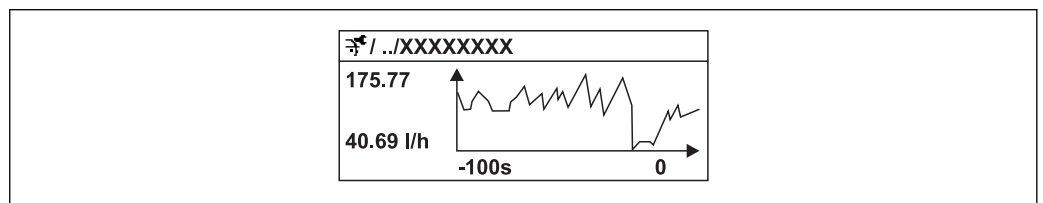

 28 Chart of a measured value trend

A0016222

- x-axis: depending on the number of channels selected displays 250 to 1000 measured values of a process variable.
- y-axis: displays the approximate measured value span and constantly adapts this to the ongoing measurement.

i If the length of the logging interval or the assignment of the process variables to the channels is changed, the content of the data logging is deleted.

Navigation

"Diagnostics" menu → Data logging

"Data logging" submenu

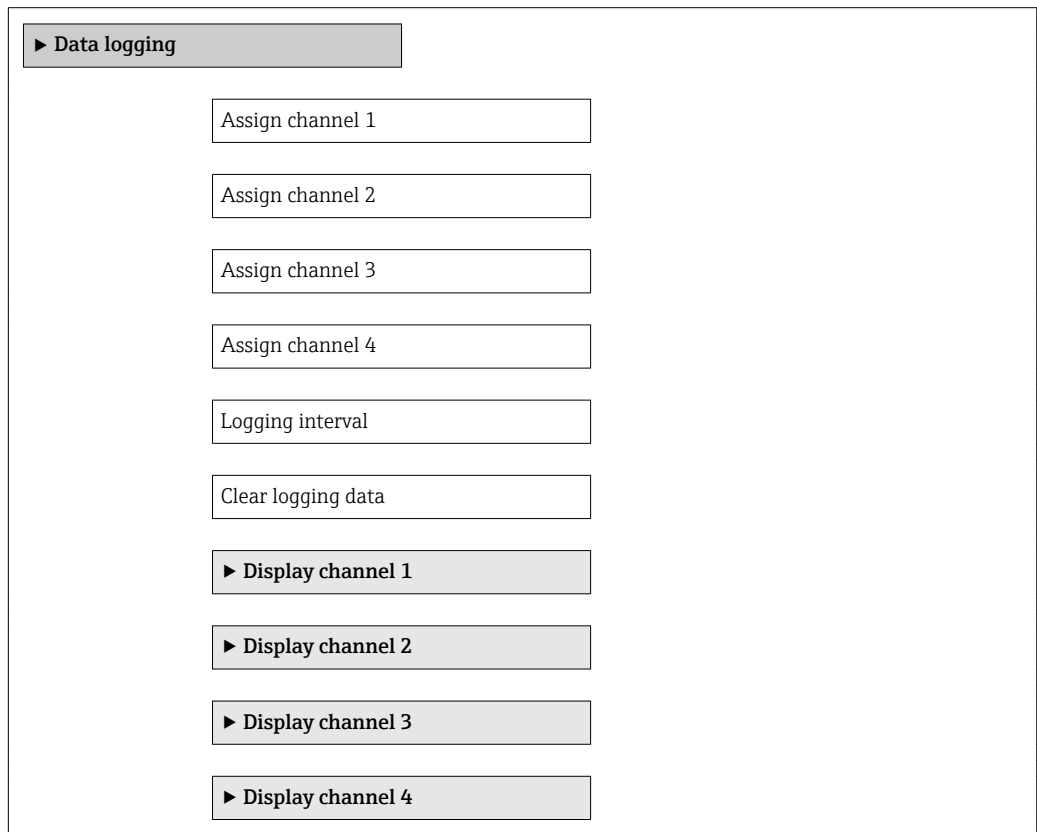

Parameter overview with brief description

Parameter	Description	Selection / User entry	Factory setting
Assign channel 1 to 4	Assign process variable to logging channel.	<ul style="list-style-type: none"> ▪ Off ▪ Volume flow ▪ Mass flow ▪ Flow velocity ▪ Conductivity ▪ Electronic temperature 	Off
Logging interval	Define the logging interval for data logging. This value defines the time interval between the individual data points in the memory.	1.0 to 3 600.0 s	10.0 s
Clear logging data	Clear the entire logging data.	<ul style="list-style-type: none"> ▪ Cancel ▪ Clear data 	Cancel

12 Diagnostics and troubleshooting

12.1 General troubleshooting

For local display

Problem	Possible causes	Remedial action
Local display dark and no output signals	Supply voltage does not match that specified on the nameplate.	Apply the correct supply voltage .
Local display dark and no output signals	No contact between connecting cables and terminals.	Check the connection of the cables and correct if necessary.
Local display dark and no output signals	Terminals are not plugged into the main electronics module correctly.	Check terminals.
Local display dark and no output signals	Main electronics module is defective.	Order spare part → 124.
Local display dark and no output signals	The connector between the main electronics module and display module is not plugged in correctly.	Check the connection and correct if necessary.
Local display dark and no output signals	The connecting cable is not plugged in correctly.	<ol style="list-style-type: none"> 1. Check the connection of the electrode cable and correct if necessary. 2. Check the connection of the coil current cable and correct if necessary.
Local display is dark, but signal output is within the valid range	Display is set too bright or too dark.	<ul style="list-style-type: none"> ▪ Set the display brighter by simultaneously pressing \oplus + \boxtimes. ▪ Set the display darker by simultaneously pressing \ominus + \boxtimes.
Local display is dark, but signal output is within the valid range	Display module is defective.	Order spare part → 124.
Backlighting of local display is red	Diagnostic event with "Alarm" diagnostic behavior has occurred.	Take remedial measures → 114
Text on local display appears in a foreign language and cannot be understood.	Incorrect operating language is configured.	<ol style="list-style-type: none"> 1. Press \ominus + \oplus for 2 s ("home position"). 2. Press \boxtimes. 3. Set the desired language in the Language parameter.
Message on local display: "Communication Error" "Check Electronics"	Communication between the display module and the electronics is interrupted.	<ul style="list-style-type: none"> ▪ Check the cable and the connector between the main electronics module and display module. ▪ Order spare part → 124.

For output signals

Problem	Possible causes	Remedial action
Signal output outside the valid range	Main electronics module is defective.	Order spare part → 124.
Device shows correct value on local display, but signal output is incorrect, though in the valid range.	Configuration error	Check and correct parameter configuration.
Device measures incorrectly.	Configuration error or device is operated outside the application.	<ol style="list-style-type: none"> 1. Check and correct parameter configuration. 2. Observe limit values specified in the "Technical Data".

For access

Problem	Possible causes	Remedial action
No write access to parameters	Hardware write protection enabled	Set the write protection switch on the main electronics module to the OFF position .
No write access to parameters	Current user role has limited access authorization	1. Check user role → 62. 2. Enter correct customer-specific access code → 62.
No connection via EtherNet/IP	Device plug connected incorrectly	Check the pin assignment of the device plug .
Not connecting to Web server	Incorrect setting for the Ethernet interface of the computer	1. Check the properties of the Internet protocol (TCP/IP) → 64. 2. Check the network settings with the IT manager.
Not connecting to Web server	Web server disabled	Via the "FieldCare" operating tool check whether the Web server of the measuring device is enabled and enable it if necessary → 67.
Not connecting to Web server	The use of the proxy server is not disabled in the Web browser settings of the computer.	Disable the use of the proxy server in the Web browser settings of the computer. Using the example of MS Internet Explorer: 1. Under <i>Control Panel</i> open <i>Internet options</i> . 2. Select the <i>Connections</i> tab and then double-click <i>LAN settings</i> . 3. In the <i>LAN settings</i> disable the use of the proxy server and select <i>OK</i> to confirm.
Not connecting to Web server	Other network connections or programs are still active on the computer.	<ul style="list-style-type: none"> ■ Make sure that no other network connections are established by the computer (also no WLAN) and close other programs with network access to the computer. ■ If using a docking station for notebooks make sure that a network connection to another network is not active.
No or incomplete display of contents in the Web browser	<ul style="list-style-type: none"> ■ JavaScript not enabled ■ JavaScript cannot be enabled 	1. Enable JavaScript. 2. Enter http://192.168.1.212/basic.html as the IP address.
Web browser frozen and operation no longer possible	Data transfer active	Wait until data transfer or current action is finished.
Web browser frozen and operation no longer possible	Connection lost	1. Check cable connection and power supply. 2. Refresh the Web browser and restart if necessary.
Content of Web browser incomplete or difficult to read	Not using optimum version of Web server.	1. Use the correct Web browser version → 63. 2. Clear the Web browser cache and restart the Web browser.
Content of Web browser incomplete or difficult to read	Unsuitable view settings.	Change the font size/display ratio of the Web browser.

12.2 Diagnostic information via light emitting diodes

12.2.1 Transmitter

Various light emitting diodes (LEDs) on the main electronics module of the transmitter provide information on device status.

LED	Color	Meaning
Power	Off	Supply voltage is off or too low
	Green	Supply voltage is ok
Device status	Green	Device status is ok
	Flashing red	A device error of diagnostic behavior "Warning" has occurred
	Red	A device error of diagnostic behavior "Alarm" has occurred
	Alternately flashing red/ green	Boot loader is active
Network status	Off	Device has no EtherNet/IP address
	Green	Device's EtherNet/IP connection is active
	Flashing green	Device has EtherNet/IP address but no EtherNet/IP connection
	Red	EtherNet/IP address of the device has been assigned twice
	Flashing red	Device's EtherNet/IP connection is in timeout mode
Link/Activity	Orange	Link available but no activity
	Flashing orange	Activity present
Communication	Flashing white	
Alarm	Green	Measuring device is ok
	Flashing green	Measuring device not configured
	Off	Firmware error
	Red	Main error
	Flashing red	Error
	Flashing red/green	Start measuring device

12.3 Diagnostic information on local display

12.3.1 Diagnostic message

Faults detected by the self-monitoring system of the measuring device are displayed as a diagnostic message in alternation with the operational display.

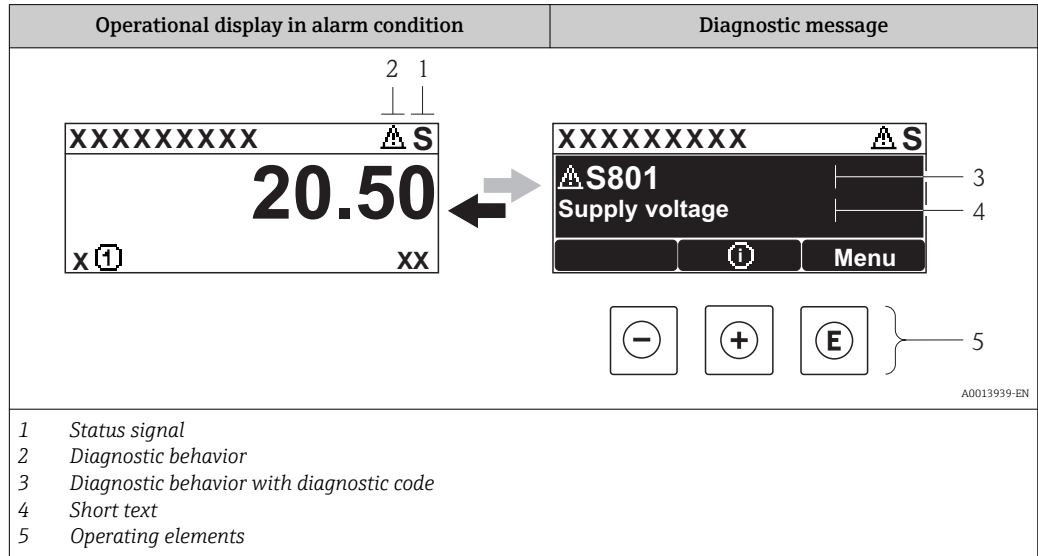

If two or more diagnostic events are pending simultaneously, only the message of the diagnostic event with the highest priority is shown.

- i** Other diagnostic events that have occurred can be called up in the **Diagnostics** menu:
 - Via parameters → 116
 - Via submenus → 117



Status signals

The status signals provide information on the state and reliability of the device by categorizing the cause of the diagnostic information (diagnostic event).

- i** The status signals are categorized according to VDI/VDE 2650 and NAMUR Recommendation NE 107: F = Failure, C = Function Check, S = Out of Specification, M = Maintenance Required

Symbol	Meaning
F <small>A0013956</small>	Failure A device error has occurred. The measured value is no longer valid.
C <small>A0013959</small>	Function check The device is in service mode (e.g. during a simulation).
S <small>A0013958</small>	Out of specification The device is operated: Outside its technical specification limits (e.g. outside the process temperature range)
M <small>A0013957</small>	Maintenance required Maintenance is required. The measured value remains valid.

Diagnostic behavior



Symbol	Meaning
 <small>A0013961</small>	Alarm <ul style="list-style-type: none"> Measurement is interrupted. Signal outputs and totalizers assume the defined alarm condition. A diagnostic message is generated. The background lighting changes to red.
 <small>A0013962</small>	Warning Measurement is resumed. The signal outputs and totalizers are not affected. A diagnostic message is generated.

Diagnostic information

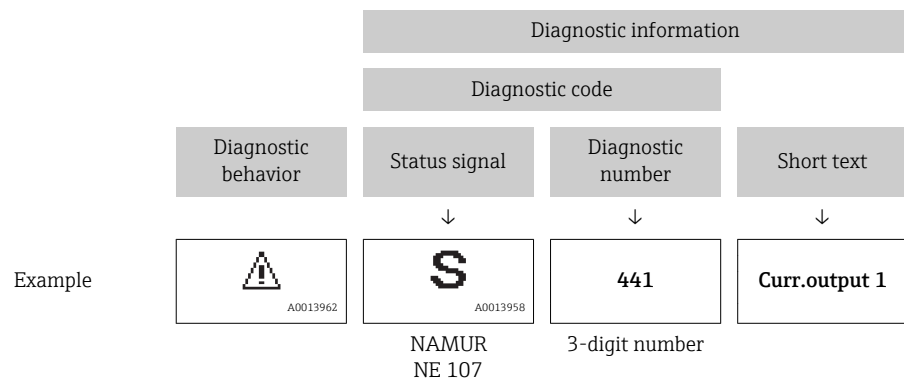
The fault can be identified using the diagnostic information. The short text helps you by providing information about the fault. In addition, the corresponding symbol for the diagnostic behavior is displayed in front of the diagnostic information on the local display.



Operating elements

Key	Meaning
 <small>A0013970</small>	Plus key <i>In a menu, submenu</i> Opens the message about the remedial measures.
 <small>A0013952</small>	Enter key <i>In a menu, submenu</i> Opens the operating menu.

12.3.2 Calling up remedial measures

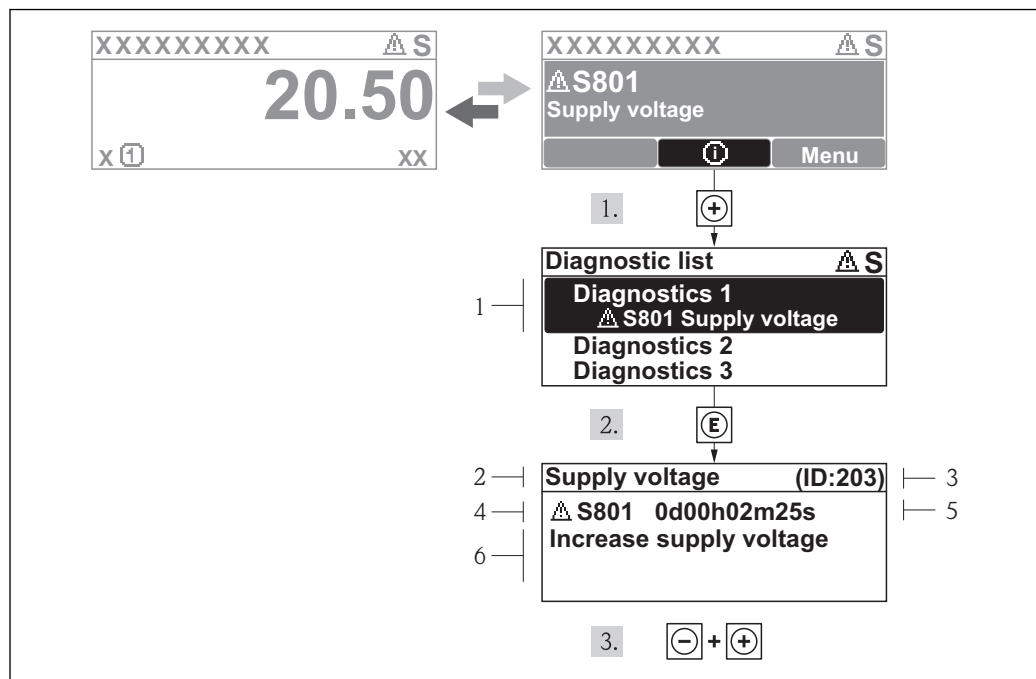

29 Message for remedial measures

- 1 Diagnostic information
- 2 Short text
- 3 Service ID
- 4 Diagnostic behavior with diagnostic code
- 5 Operation time of occurrence
- 6 Remedial measures

The user is in the diagnostic message.

- Press \oplus (ⓘ symbol).
 - ↳ The **Diagnostic list** submenu opens.
- Select the desired diagnostic event with \oplus or \ominus and press \boxplus .
 - ↳ The message for the remedial measures for the selected diagnostic event opens.
- Press \ominus + \oplus simultaneously.
 - ↳ The message for the remedial measures closes.

The user is in the **Diagnostics** menu at an entry for a diagnostics event, e.g. in the **Diagnostic list** submenu or the **Previous diagnostics** parameter.

- Press \boxplus .
 - ↳ The message for the remedial measures for the selected diagnostic event opens.
- Press \ominus + \oplus simultaneously.
 - ↳ The message for the remedial measures closes.

12.4 Diagnostic information in the Web browser

12.4.1 Diagnostic options

Any faults detected by the measuring device are displayed in the Web browser on the home page once the user has logged on.

1 Status area with status signal
 2 Diagnostic information → 109
 3 Remedial measures with Service ID

- i** Furthermore, diagnostic events that have occurred can be viewed in the **Diagnostics** menu:
 - Via parameters → 116
 - Via submenus → 117

Status signals

The status signals provide information on the state and reliability of the device by categorizing the cause of the diagnostic information (diagnostic event).

Symbol	Meaning
 A0017271	Failure A device error has occurred. The measured value is no longer valid.
 A0017278	Function check The device is in service mode (e.g. during a simulation).
 A0017277	Out of specification The device is operated: Outside its technical specification limits (e.g. outside the process temperature range)
 A0017276	Maintenance required Maintenance is required. The measured value is still valid.

- i** The status signals are categorized in accordance with VDI/VDE 2650 and NAMUR Recommendation NE 107.

12.4.2 Calling up remedy information

Remedy information is provided for every diagnostic event to ensure that problems can be rectified quickly. These measures are displayed in red along with the diagnostic event and the related diagnostic information.

12.5 Diagnostic information in FieldCare

12.5.1 Diagnostic options

Any faults detected by the measuring device are displayed on the home page of the operating tool once the connection has been established.

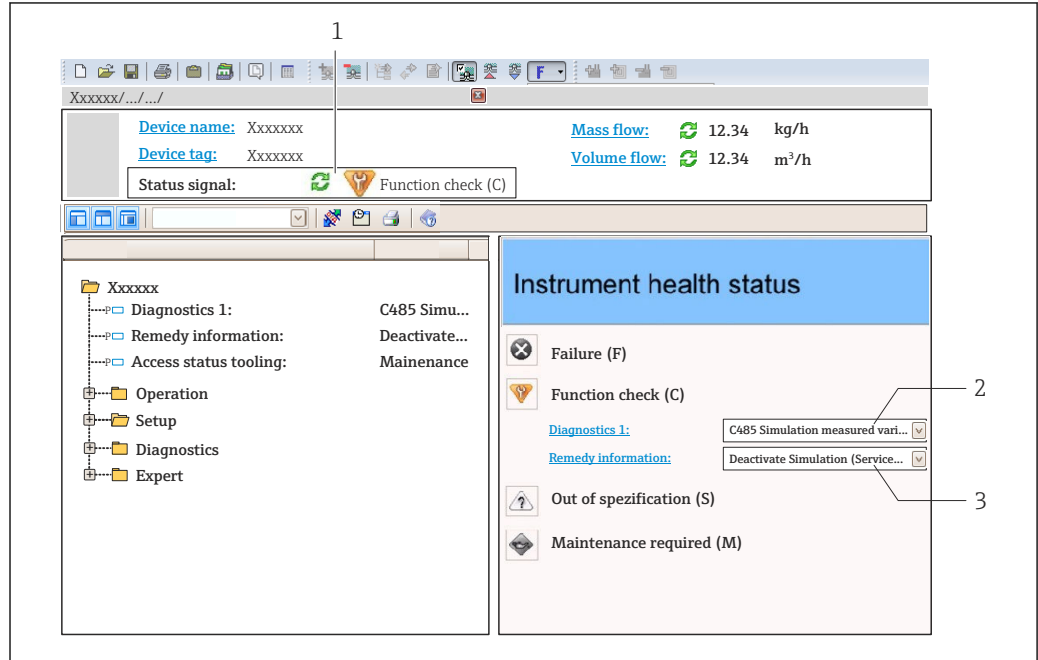

A0021799-EN

- 1 Status area with status signal → 108
- 2 Diagnostic information → 109
- 3 Remedial measures with Service ID

i Furthermore, diagnostic events that have occurred can be viewed in the **Diagnostics** menu:

- Via parameters → 116
- Via submenu → 117

Diagnostic information

The fault can be identified using the diagnostic information. The short text helps you by providing information about the fault. In addition, the corresponding symbol for the diagnostic behavior is displayed in front of the diagnostic information on the local display.

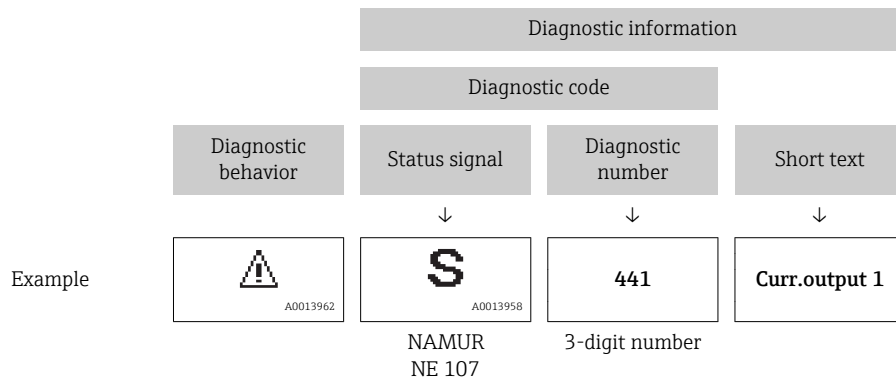

12.5.2 Calling up remedy information

Remedy information is provided for every diagnostic event to ensure that problems can be rectified quickly:

- On the home page
Remedy information is displayed in a separate field below the diagnostics information.
- In the **Diagnostics** menu
Remedy information can be called up in the working area of the user interface.

The user is in the **Diagnostics** menu.

1. Call up the desired parameter.
2. On the right in the working area, mouse over the parameter.
 - ↳ A tool tip with remedy information for the diagnostic event appears.

12.6 Diagnostic information via communication interface

12.6.1 Reading out diagnostic information

The current diagnostic event and associated diagnostic information can be read out via the input assembly (fix assembly):

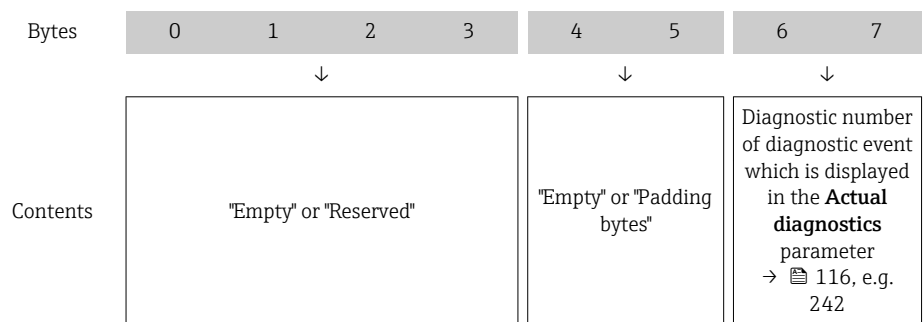

 For content of bytes 8 to 16

12.7 Adapting the diagnostic information

12.7.1 Adapting the diagnostic behavior

Each item of diagnostic information is assigned a specific diagnostic behavior at the factory. The user can change this assignment for certain diagnostic information in the **Diagnostic behavior** submenu .

"Expert" menu → System → Diagnostic handling → Diagnostic behavior

You can assign the following options to the diagnostic number as the diagnostic behavior:

Options	Description
Alarm	Measurement is interrupted. The totalizers assume the defined alarm condition. A diagnostic message is generated. The background lighting changes to red.
Warning	Measurement is resumed. The totalizers are not affected. A diagnostics message is generated.

Options	Description
Logbook entry only	The device continues to measure. The diagnostic message is entered in the Event logbook (events list) submenu only and is not displayed in alternation with the measured value display.
Off	The diagnostic event is ignored, and no diagnostic message is generated or entered.

12.8 Overview of diagnostic information

 The amount of diagnostic information and the number of measured variables affected increase if the measuring device has one or more application packages.

 In the case of some items of diagnostic information, the status signal and the diagnostic behavior can be changed. Adapt the diagnostic information →  113

Diagnostic number	Short text	Remedy instructions	Status signal [from the factory]	Diagnostic behavior [from the factory]
Diagnostic of sensor				
004	Sensor	1. Change sensor 2. Contact service	S	Alarm
022	Sensor temperature	1. Change main electronic module 2. Change sensor	F	Alarm
043	Sensor short circuit	1. Check sensor and cable 2. Change sensor or cable	S	Warning
062	Sensor connection	1. Check sensor connections 2. Contact service	F	Alarm
082	Data storage	1. Check module connections 2. Contact service	F	Alarm
083	Memory content	1. Restart device 2. Contact service	F	Alarm
190	Special event 1	Contact service	F	Alarm
Diagnostic of electronic				
201	Device failure	1. Restart device 2. Contact service	F	Alarm
222	Electronic drift	Change main electronic module	F	Alarm
242	Software incompatible	1. Check software 2. Flash or change main electronics module	F	Alarm
252	Modules incompatible	1. Check electronic modules 2. Change electronic modules	F	Alarm
262	Module connection	1. Check module connections 2. Change main electronics	F	Alarm
270	Main electronic failure	Change main electronic module	F	Alarm
271	Main electronic failure	1. Restart device 2. Change main electronic module	F	Alarm
272	Main electronic failure	1. Restart device 2. Contact service	F	Alarm
273	Main electronic failure	Change electronic	F	Alarm
281	Electronic initialization	Firmware update active, please wait!	F	Alarm
283	Memory content	1. Reset device 2. Contact service	F	Alarm

Diagnostic number	Short text	Remedy instructions	Status signal [from the factory]	Diagnostic behavior [from the factory]
302	Device verification active	Device verification active, please wait.	C	Warning
311	Electronic failure	1. Reset device 2. Contact service	F	Alarm
311	Electronic failure	1. Do not reset device 2. Contact service	M	Warning
322	Electronic drift	1. Perform verification manually 2. Change electronic	S	Warning
382	Data storage	1. Insert DAT module 2. Change DAT module	F	Alarm
383	Memory content	1. Restart device 2. Check or change DAT module 3. Contact service	F	Alarm
390	Special event 2	Contact service	F	Alarm
Diagnostic of configuration				
410	Data transfer	1. Check connection 2. Retry data transfer	F	Alarm
411	Up-/download active	Up-/download active, please wait	C	Warning
437	Configuration incompatible	1. Restart device 2. Contact service	F	Alarm
438	Dataset	1. Check data set file 2. Check device configuration 3. Up- and download new configuration	M	Warning
453	Flow override	Deactivate flow override	C	Warning
484	Simulation failure mode	Deactivate simulation	C	Alarm
485	Simulation measured variable	Deactivate simulation	C	Warning
495	Simulation diagnostic event	Deactivate simulation	C	Warning
500	Electrode 1 potential exceeded	1. Check process cond. 2. Increase system pressure	F	Alarm
500	Electrode difference voltage too high	1. Check process cond. 2. Increase system pressure	F	Alarm
530	Electrode cleaning is running	1. Check process cond. 2. Increase system pressure	C	Warning
531	Empty pipe detection	Execute EPD adjustment	S	Warning
537	Configuration	1. Check IP addresses in network 2. Change IP address	F	Warning
590	Special event 3	Contact service	F	Alarm
Diagnostic of process				
832	Electronic temperature too high	Reduce ambient temperature	S	Warning ¹⁾
833	Electronic temperature too low	Increase ambient temperature	S	Warning ¹⁾
834	Process temperature too high	Reduce process temperature	S	Warning ¹⁾
835	Process temperature too low	Increase process temperature	S	Warning ¹⁾



Diagnostic number	Short text	Remedy instructions	Status signal [from the factory]	Diagnostic behavior [from the factory]
842	Process limit	Low flow cut off active! 1. Check low flow cut off configuration	S	Warning
862	Empty pipe	1. Check for gas in process 2. Adjust empty pipe detection	S	Warning
882	Input signal	1. Check input configuration 2. Check external device or process conditions	F	Alarm
937	EMC interference	Change main electronic module	S	Warning ¹⁾
938	EMC interference	1. Check ambient conditions regarding EMC influence 2. Change main electronic module	F	Alarm
990	Special event 4	Contact service	F	Alarm

1) Diagnostic status is changeable.

12.9 Pending diagnostic events

The **Diagnostics** menu allows the user to view the current diagnostic event and the previous diagnostic event separately.

 To call up the measures to rectify a diagnostic event:

- Via local display →  110
- Via Web browser →  111
- Via "FieldCare" operating tool →  113

 Other pending diagnostic events can be displayed in the **Diagnostic list** submenu →  117

Navigation

"Diagnostics" menu

Structure of the submenu

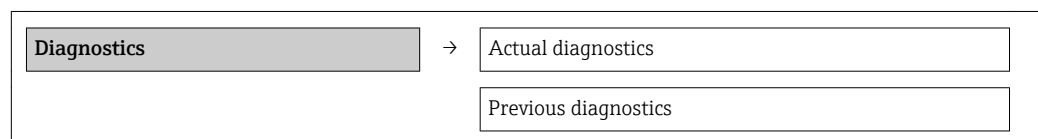

Parameter overview with brief description

Parameter	Prerequisite	Description	User interface	Factory setting
Actual diagnostics	1 diagnostic event has occurred.	Displays the current diagnostic event along with the diagnostic information.  If two or more messages occur simultaneously, the message with the highest priority is shown on the display.	Symbol for diagnostic behavior, diagnostic code and short message.	-
Previous diagnostics	2 diagnostic events have already occurred.	Displays the diagnostic event that occurred prior to the current diagnostic event along with the diagnostic information.	Symbol for diagnostic behavior, diagnostic code and short message.	-

12.10 Diagnostic list

In the **Diagnostic list** submenu, up to 5 currently pending diagnostic events can be displayed along with the related diagnostic information. If more than 5 diagnostic events are pending, the events with the highest priority are shown on the display.

Navigation path

Diagnostics menu → **Diagnostic list** submenu

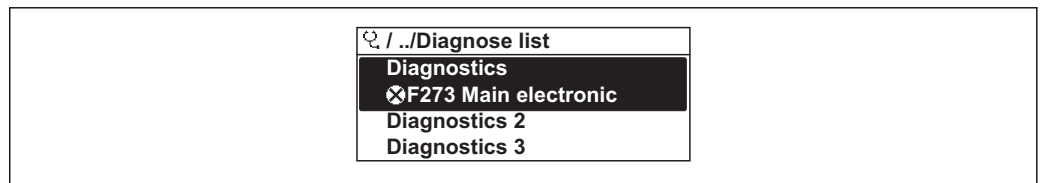



A0014006-EN

 30 Illustrated using the example of the local display



To call up the measures to rectify a diagnostic event:

- Via local display →  110
- Via Web browser →  111
- Via "FieldCare" operating tool →  113

12.11 Event logbook

12.11.1 Event history

A chronological overview of the event messages that have occurred is provided in the **Events list** submenu.

Navigation path

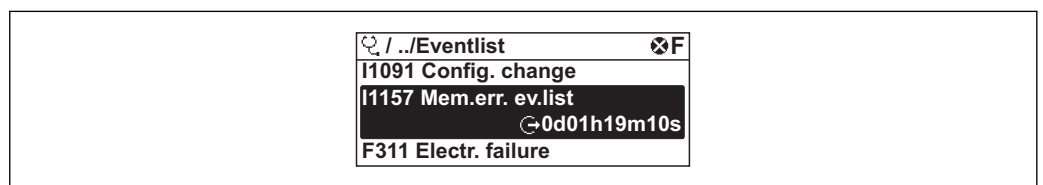

"Diagnostics" menu → Event logbook → Events list





A0014008-EN

 31 Illustrated using the example of the local display



The event history includes entries for:

- Diagnostic events →  114
- Information events →  118

In addition to the operation time of its occurrence, each event is also assigned a symbol that indicates whether the event has occurred or is ended:

- Diagnostic event
 - : Event has occurred
 - : Event has ended
- Information event
 - : Event has occurred

 To call up the measures to rectify a diagnostic event:

- Via local display →  110
- Via Web browser →  111
- Via "FieldCare" operating tool →  113

 For filtering the displayed event messages →  118

12.11.2 Filtering the event logbook

Using the **Filter options** parameter, you can define which category of event messages is displayed in the **Events list** submenu.

Navigation path

"Diagnostics" menu → Event logbook → Filter options

Filter categories

- All
- Failure (F)
- Function check (C)
- Out of specification (S)
- Maintenance required (M)
- Information (I)

12.11.3 Overview of information events

Unlike a diagnostic event, an information event is displayed in the event logbook only and not in the diagnostic list.

Info number	Info name
I1000	----- (Device ok)
I1089	Power on
I1090	Configuration reset
I1091	Configuration changed
I1092	Trend data deleted
I1110	Write protection switch changed
I1137	Electronic changed
I1151	History reset
I1155	Reset electronic temperature
I1156	Memory error trend
I1157	Memory error event list
I1185	Display backup done
I1186	Restore via display done
I1187	Settings downloaded with display
I1188	Display data cleared

Info number	Info name
I1189	Backup compared
I1256	Display: access status changed
I1264	Safety sequence aborted
I1335	Firmware changed
I1351	Empty pipe detection adjustment failure
I1353	Empty pipe detection adjustment ok
I1361	Wrong web server login
I1397	Fieldbus: access status changed
I1398	CDI: access status changed
I1444	Device verification passed
I1445	Device verification failed
I1457	Failed:Measured error verification
I1459	Failed: I/O module verification
I1461	Failed: Sensor verification
I1462	Failed:Sensor electronic module verific.

12.12 Resetting the measuring device

Using the **Device reset** parameter it is possible to reset the entire device configuration or some of the configuration to a defined state.

Navigation

"Setup" menu → Advanced setup → Administration → Device reset

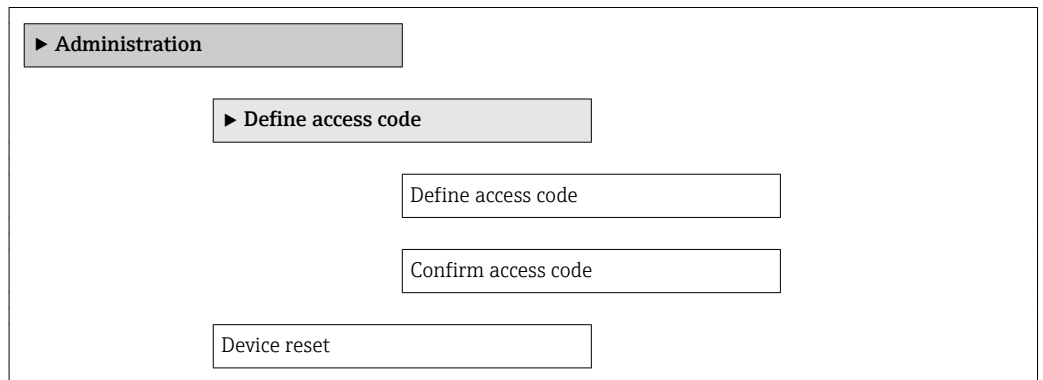

Parameter overview with brief description

Parameter	Description	Selection	Factory setting
Device reset	Restart or reset device manually.	<ul style="list-style-type: none"> ■ Cancel ■ To delivery settings ■ Restart device 	Cancel

12.12.1 Function scope of "Device reset" parameter

Options	Description
Cancel	No action is executed and the user exits the parameter.
To delivery settings	Every parameter for which a customer-specific default setting was ordered is reset to this customer-specific value. All other parameters are reset to the factory setting.
Restart device	The restart resets every parameter whose data are in the volatile memory (RAM) to the factory setting (e.g. measured value data). The device configuration remains unchanged.
History reset	Every parameter is reset to its factory setting.

12.13 Device information

The **Device information** submenu contains all the parameters that display different information for identifying the device.

Navigation

"Diagnostics" menu → Device information



▶ Device information

Parameter overview with brief description

Parameter	Description	User interface / User entry	Factory setting
Device tag	Enter the name for the measuring point.	Max. 32 characters, such as letters, numbers or special characters (e.g. @, %, /)	Promag 400
Serial number	Displays the serial number of the measuring device.	Max. 11-digit character string comprising letters and numbers.	79AFFF16000
Firmware version	Displays the device firmware version installed.	Character string with the following format: xx.yy.zz	01.01
Device name	Displays the name of the transmitter.	Character string composed of letters, numbers and certain punctuation marks.	Promag 400
Order code	Displays the device order code.	Character string composed of letters, numbers and certain punctuation marks	-
Extended order code 1	Displays the 1st part of the extended order code.	Character string	-
Extended order code 2	Displays the 2nd part of the extended order code.	Character string	-
Extended order code 3	Displays the 3rd part of the extended order code.	Character string	-
ENP version	Displays the version of the electronic nameplate.	Character string in the format xx.yy.zz	2.02.00
IP address	Displays the IP address of the Web server of the measuring device.	4 octet: 0 to 255 (in the particular octet)	192.168.1.212
Subnet mask	Displays the subnet mask.	4 octet: 0 to 255 (in the particular octet)	255.255.255.0
Default gateway	Displays the default gateway.	4 octet: 0 to 255 (in the particular octet)	0.0.0.0

12.14 Firmware history

Release date	Firmware version	Order code for "Firmware version"	Firmware changes	Documentation type	Documentation
10.2013	01.00.00	Option 77	Original firmware	Operating Instructions	BA01214D/06/EN/01.13
07.2014	01.01.zz	Option 74	Update	Operating Instructions	BA01214D/06/EN/02.14

-  Flashing the firmware to the current version or to the previous version is possible via the service interface (CDI) .
-  For the compatibility of the firmware version with the previous version, the installed device description files and operating tools, observe the information about the device in the "Manufacturer's information" document.
-  The manufacturer's information is available:
 - In the Download Area of the Endress+Hauser Internet site: www.endress.com → Download
 - Specify the following details:
 - Text search: Manufacturer's information
 - Search range: documentation

13 Maintenance

13.1 Maintenance tasks

No special maintenance work is required.

13.1.1 Exterior cleaning

When cleaning the exterior of measuring devices, always use cleaning agents that do not attack the surface of the housing or the seals.

WARNING

Cleaning agents can damage the plastic transmitter housing!

- ▶ Do not use high-pressure steam.
- ▶ Only use the permitted cleaning agents specified.

Permitted cleaning agents for the plastic transmitter housing

- Commercially available household cleaners
- Methyl alcohol or isopropyl alcohol
- Mild soap solutions

13.1.2 Interior cleaning

No interior cleaning is planned for the device.

13.1.3 Replacing seals

The sensor's seals (particularly aseptic molded seals) must be replaced periodically.

The interval between changes depends on the frequency of the cleaning cycles, the cleaning temperature and the medium temperature.

Replacement seals (accessory) →  160

13.2 Measuring and test equipment

Endress+Hauser offers a wide variety of measuring and test equipment, such as W@M or device tests.

 Your Endress+Hauser Sales Center can provide detailed information on the services.

 For a list of some of the measuring and test equipment, refer to the "Accessories" chapter of the "Technical Information" document for the device.

13.3 Endress+Hauser services

Endress+Hauser offers a wide variety of services for maintenance such as recalibration, maintenance service or device tests.

 Your Endress+Hauser Sales Center can provide detailed information on the services.

14 Repair

14.1 General notes

Repair and conversion concept

The Endress+Hauser repair and conversion concept provides for the following:

- The measuring devices have a modular design.
- Spare parts are grouped into logical kits with the associated Installation Instructions.
- Repairs are carried out by Endress+Hauser Service or by correspondingly trained customers.
- Certified devices can be converted into other certified devices by Endress+Hauser Service or at the factory only.

Notes for repair and conversion



For repair and modification of a measuring device, observe the following notes:

- Use only original Endress+Hauser spare parts.
- Carry out the repair according to the Installation Instructions.
- Observe the applicable standards, federal/national regulations, Ex documentation (XA) and certificates.
- Document every repair and each conversion and enter them into the *W@M* life cycle management database.

14.2 Spare parts

W@M Device Viewer (www.endress.com/deviceviewer):

All the spare parts for the measuring device, along with the order code, are listed here and can be ordered. If available, users can also download the associated Installation Instructions.

-  Measuring device serial number:
 - Is located on the nameplate of the device.
 - Can be read out via the **Serial number** parameter in the **Device information** submenu →  120.

14.3 Endress+Hauser services

-  Contact your Endress+Hauser Sales Center for information on services and spare parts.

14.4 Return

The measuring device must be returned if it is need of repair or a factory calibration, or if the wrong measuring device has been delivered or ordered. Legal specifications require Endress+Hauser, as an ISO-certified company, to follow certain procedures when handling products that are in contact with the medium.

To ensure safe, swift and professional device returns, please refer to the procedure and conditions for returning devices provided on the Endress+Hauser website at <http://www.endress.com/support/return-material>

14.5 Disposal

14.5.1 Removing the measuring device

1. Switch off the device.

2. **WARNING!** Danger to persons from process conditions. Beware of hazardous process conditions such as pressure in the measuring device, high temperatures or aggressive fluids.

Carry out the mounting and connection steps from the chapters "Mounting the measuring device" and "Connecting the measuring device" in the logically reverse sequence. Observe the safety instructions.

14.5.2 Disposing of the measuring device

⚠ WARNING

Danger to personnel and environment from fluids that are hazardous to health.

- ▶ Ensure that the measuring device and all cavities are free of fluid residues that are hazardous to health or the environment, e.g. substances that have permeated into crevices or diffused through plastic.

Observe the following notes during disposal:

- Observe valid federal/national regulations.
- Ensure proper separation and reuse of the device components.

15 Accessories

Various accessories, which can be ordered with the device or subsequently from Endress+Hauser, are available for the device. Detailed information on the order code in question is available from your local Endress+Hauser sales center or on the product page of the Endress+Hauser website: www.endress.com.

15.1 Device-specific accessories

15.1.1 For the transmitter

Accessories	Description
Display protection	Is used to protect the display against impact or scoring from sand in desert areas.  For details, see Special Documentation SD00333F
Connecting cable for remote version	Coil current and electrode cables, various lengths, reinforced cables available on request.
Ground cable	Set, consisting of two ground cables for potential equalization.
Post mounting kit	Post mounting kit for transmitter.
Compact → remote conversion kit	For converting a compact device version to a remote device version.
Promag 50/53 → Promag 400 conversion kit	For converting a Promag with transmitter 50/53 to a Promag 400.

15.1.2 For the sensor

Accessories	Description
Ground disks	Are used to ground the fluid in lined measuring tubes to ensure proper measurement.  For details, see Installation Instructions EA00070D

15.2 Service-specific accessories

Accessories	Description
Applicator	Software for selecting and sizing Endress+Hauser measuring devices: <ul style="list-style-type: none"> ▪ Calculation of all the necessary data for identifying the optimum flowmeter: e.g. nominal diameter, pressure loss, accuracy or process connections. ▪ Graphic illustration of the calculation results Administration, documentation and access to all project-related data and parameters throughout the entire life cycle of a project. Applicator is available: <ul style="list-style-type: none"> ▪ Via the Internet: https://wapps.endress.com/applicator ▪ On CD-ROM for local PC installation.

W@M	<p>Life cycle management for your plant</p> <p>W@M supports you with a wide range of software applications over the entire process: from planning and procurement, to the installation, commissioning and operation of the measuring devices. All the relevant device information, such as the device status, spare parts and device-specific documentation, is available for every device over the entire life cycle.</p> <p>The application already contains the data of your Endress+Hauser device. Endress+Hauser also takes care of maintaining and updating the data records.</p> <p>W@M is available:</p> <ul style="list-style-type: none"> ▪ Via the Internet: www.endress.com/lifecyclemanagement ▪ On CD-ROM for local PC installation.
FieldCare	<p>FDT-based plant asset management tool from Endress+Hauser.</p> <p>It can configure all smart field units in your system and helps you manage them. By using the status information, it is also a simple but effective way of checking their status and condition.</p> <p> For details, see Operating Instructions BA00027S and BA00059S</p>

15.3 System components

Accessories	Description
Memograph M graphic display recorder	<p>The Memograph M graphic display recorder provides information on all relevant measured variables. Measured values are recorded correctly, limit values are monitored and measuring points analyzed. The data are stored in the 256 MB internal memory and also on a SD card or USB stick.</p> <p> For details, see "Technical Information" TI00133R and Operating Instructions BA00247R</p>

16 Technical data

16.1 Application

The measuring device described in these Instructions is intended only for flow measurement of liquids with a minimum conductivity of 5 $\mu\text{S}/\text{cm}$.

Depending on the version ordered, the measuring device can also measure potentially explosive, flammable, poisonous and oxidizing media.

To ensure that the device remains in proper operating condition for its service life, use the measuring device only for media against which the process-wetted materials are adequately resistant.

16.2 Function and system design

Measuring principle Electromagnetic flow measurement on the basis of *Faraday's law of magnetic induction*.

Measuring system The device consists of a transmitter and a sensor.
 Two device versions are available:
 ■ Compact version - transmitter and sensor form a mechanical unit.
 ■ Remote version - transmitter and sensor are mounted in separate locations.
 For information on the structure of the device

16.3 Input

Measured variable **Direct measured variables**
 ■ Volume flow (proportional to induced voltage)
 ■ Electrical conductivity
 In custody transfer: only volume flow

Calculated measured variables
 Mass flow

Measuring range Typically $v = 0.01$ to 10 m/s (0.03 to 33 ft/s) with the specified accuracy
 Electrical conductivity: 5 to 10000 $\mu\text{S}/\text{cm}$

Flow characteristic values in SI units

Nominal diameter		Recommended flow Min./max. full scale value ($v \sim 0.3/10$ m/s) [m ³ /h]	Factory settings		
[mm]	[in]		Full scale value current output ($v \sim 2.5$ m/s) [m ³ /h]	Pulse value (~ 2 pulse/s) [m ³]	Low flow cut off ($v \sim 0.04$ m/s) [m ³ /h]
25	1	9 to 300 dm ³ /min	75 dm ³ /min	0.5 dm ³	1 dm ³ /min
32	–	15 to 500 dm ³ /min	125 dm ³ /min	1 dm ³	2 dm ³ /min
40	1 ½	25 to 700 dm ³ /min	200 dm ³ /min	1.5 dm ³	3 dm ³ /min

Nominal diameter		Recommended flow	Factory settings		
			Min./max. full scale value (v ~ 0.3/10 m/s)	Full scale value current output (v ~ 2.5 m/s)	Pulse value (~ 2 pulse/s)
[mm]	[in]	[m ³ /h]	[m ³ /h]	[m ³]	[m ³ /h]
50	2	35 to 1 100 dm ³ /min	300 dm ³ /min	2.5 dm ³	5 dm ³ /min
65	-	60 to 2 000 dm ³ /min	500 dm ³ /min	5 dm ³	8 dm ³ /min
80	3	90 to 3 000 dm ³ /min	750 dm ³ /min	5 dm ³	12 dm ³ /min
100	4	145 to 4 700 dm ³ /min	1 200 dm ³ /min	10 dm ³	20 dm ³ /min
125	-	220 to 7 500 dm ³ /min	1 850 dm ³ /min	15 dm ³	30 dm ³ /min
150	6	20 to 600	150	0.025	2.5
200	8	35 to 1 100	300	0.05	5
250	10	55 to 1 700	500	0.05	7.5
300	12	80 to 2 400	750	0.1	10
350	14	110 to 3 300	1 000	0.1	15
375	15	140 to 4 200	1 200	0.15	20
400	16	140 to 4 200	1 200	0.15	20
450	18	180 to 5 400	1 500	0.25	25
500	20	220 to 6 600	2 000	0.25	30
600	24	310 to 9 600	2 500	0.3	40
700	28	420 to 13 500	3 500	0.5	50
750	30	480 to 15 000	4 000	0.5	60
800	32	550 to 18 000	4 500	0.75	75
900	36	690 to 22 500	6 000	0.75	100
1 000	40	850 to 28 000	7 000	1	125
-	42	950 to 30 000	8 000	1	125
1 200	48	1 250 to 40 000	10 000	1.5	150
-	54	1 550 to 50 000	13 000	1.5	200
1 400	-	1 700 to 55 000	14 000	2	225
-	60	1 950 to 60 000	16 000	2	250
1 600	-	2 200 to 70 000	18 000	2.5	300
-	66	2 500 to 80 000	20 500	2.5	325
1 800	72	2 800 to 90 000	23 000	3	350
-	78	3 300 to 100 000	28 500	3.5	450
2 000	-	3 400 to 110 000	28 500	3.5	450

Flow characteristic values in US units

Nominal diameter		Recommended flow	Factory settings		
			Min./max. full scale value (v ~ 0.3/10 m/s)	Full scale value current output (v ~ 2.5 m/s)	Pulse value (~ 2 pulse/s)
[in]	[mm]	[gal/min]	[gal/min]	[gal]	[gal/min]
1	25	2.5 to 80	18	0.2	0.25
-	32	4 to 130	30	0.2	0.5

Nominal diameter		Recommended flow	Factory settings		
			Min./max. full scale value (v ~ 0.3/10 m/s)	Full scale value current output (v ~ 2.5 m/s)	Pulse value (~ 2 pulse/s)
[in]	[mm]	[gal/min]	[gal/min]	[gal]	[gal/min]
1 ½	40	7 to 190	50	0.5	0.75
2	50	10 to 300	75	0.5	1.25
-	65	16 to 500	130	1	2
3	80	24 to 800	200	2	2.5
4	100	40 to 1 250	300	2	4
-	125	60 to 1 950	450	5	7
6	150	90 to 2 650	600	5	12
8	200	155 to 4 850	1 200	10	15
10	250	250 to 7 500	1 500	15	30
12	300	350 to 10 600	2 400	25	45
14	350	500 to 15 000	3 600	30	60
15	375	600 to 19 000	4 800	50	60
16	400	600 to 19 000	4 800	50	60
18	450	800 to 24 000	6 000	50	90
20	500	1 000 to 30 000	7 500	75	120
24	600	1 400 to 44 000	10 500	100	180
28	700	1 900 to 60 000	13 500	125	210
30	750	2 150 to 67 000	16 500	150	270
32	800	2 450 to 80 000	19 500	200	300
36	900	3 100 to 100 000	24 000	225	360
40	1 000	3 800 to 125 000	30 000	250	480
42	-	4 200 to 135 000	33 000	250	600
48	1 200	5 500 to 175 000	42 000	400	600
54	-	9 to 300 Mgal/d	75 Mgal/d	0.0005 Mgal/d	1.3 Mgal/d
-	1 400	10 to 340 Mgal/d	85 Mgal/d	0.0005 Mgal/d	1.3 Mgal/d
60	-	12 to 380 Mgal/d	95 Mgal/d	0.0005 Mgal/d	1.3 Mgal/d
-	1 600	13 to 450 Mgal/d	110 Mgal/d	0.0008 Mgal/d	1.7 Mgal/d
66	-	14 to 500 Mgal/d	120 Mgal/d	0.0008 Mgal/d	2.2 Mgal/d
72	1 800	16 to 570 Mgal/d	140 Mgal/d	0.0008 Mgal/d	2.6 Mgal/d
78	-	18 to 650 Mgal/d	175 Mgal/d	0.0010 Mgal/d	3.0 Mgal/d
-	2 000	20 to 700 Mgal/d	175 Mgal/d	0.0010 Mgal/d	2.9 Mgal/d

Recommended measuring range



"Flow limit" section →  139

 For custody transfer, the applicable approval determines the permitted measuring range and the pulse value.

Operable flow range Over 1000 : 1

 For custody transfer, the operable flow range is 100 : 1 to 250 : 1, depending on the nominal diameter. Further details are specified by the applicable approval.

Input signal **External measured values**

 Various pressure transmitters and temperature measuring devices can be ordered from Endress+Hauser: see "Accessories" section →  127

It is recommended to read in external measured values to calculate the following measured variables:
Corrected volume flow

Fieldbuses

The measured values are written from the automation system to the measuring device via EtherNet/IP.

16.4 Output

Output signal **EtherNet/IP**

Standards	In accordance with IEEE 802.3
------------------	-------------------------------

Signal on alarm Depending on the interface, failure information is displayed as follows:

EtherNet/IP

Device diagnostics	Device condition can be read out in Input Assembly
---------------------------	--

Local display

Plain text display	With information on cause and remedial measures
Backlight	Red backlighting indicates a device error.

 Status signal as per NAMUR recommendation NE 107

Operating tool

- Via digital communication:
EtherNet/IP
- Via service interface

Plain text display	With information on cause and remedial measures
---------------------------	---

Web browser

Plain text display	With information on cause and remedial measures
---------------------------	---

Light emitting diodes (LED)

Status information	Status indicated by various light emitting diodes The following information is displayed depending on the device version: <ul style="list-style-type: none"> ▪ Supply voltage active ▪ Data transmission active ▪ Device alarm/error has occurred ▪ EtherNet/IP network available ▪ EtherNet/IP connection established
---------------------------	--

Low flow cut off The switch points for low flow cut off are user-selectable.

Galvanic isolation The following connections are galvanically isolated from each other:

- Outputs
- Power supply

Protocol-specific data **EtherNet/IP**

Protocol	<ul style="list-style-type: none"> ▪ The CIP Networks Library Volume 1: Common Industrial Protocol ▪ The CIP Networks Library Volume 2: EtherNet/IP Adaptation of CIP 		
Communication type	<ul style="list-style-type: none"> ▪ 10Base-T ▪ 100Base-TX 		
Device profile	Generic device (product type: 0x2B)		
Manufacturer ID	0x49E		
Device type ID	0x1067		
Baud rates	Automatic ¹⁹ / ₁₀₀ Mbit with half-duplex and full-duplex detection		
Polarity	Auto-polarity for automatic correction of crossed TxD and RxD pairs		
Supported CIP connections	Max. 3 connections		
Explicit connections	Max. 6 connections		
I/O connections	Max. 6 connections (scanner)		
Configuration options for measuring device	<ul style="list-style-type: none"> ▪ DIP switches on the electronics module for IP addressing ▪ Manufacturer-specific software (FieldCare) ▪ Add-on Profile Level 3 for Rockwell Automation control systems ▪ Web browser ▪ Electronic Data Sheet (EDS) integrated in the measuring device 		
Configuration of the EtherNet interface	<ul style="list-style-type: none"> ▪ Speed: 10 MBit, 100 MBit, auto (factory setting) ▪ Duplex: half-duplex, full-duplex, auto (factory setting) 		
Configuration of the device address	<ul style="list-style-type: none"> ▪ DIP switches on the electronics module for IP addressing (last octet) ▪ DHCP ▪ Manufacturer-specific software (FieldCare) ▪ Add-on Profile Level 3 for Rockwell Automation control systems ▪ Web browser ▪ EtherNet/IP tools, e.g. RSLinx (Rockwell Automation) 		
Device Level Ring (DLR)	No		
Fix Input			
RPI	5 ms to 10 s (factory setting: 20 ms)		
Exclusive Owner Multicast		Instance	Size [byte]
	Instance configuration:	0x68	398
	O → T configuration:	0x66	56
	T → O configuration:	0x64	32
Exclusive Owner Multicast		Instance	Size [byte]

	Instance configuration:	0x69	-
	O → T configuration:	0x66	56
	T → O configuration:	0x64	32
Input only Multicast		Instance	Size [byte]
	Instance configuration:	0x68	398
	O → T configuration:	0xC7	-
	T → O configuration:	0x64	32
Input only Multicast		Instance	Size [byte]
	Instance configuration:	0x69	-
	O → T configuration:	0xC7	-
	T → O configuration:	0x64	32
Input Assembly	<ul style="list-style-type: none"> ■ Current device diagnostics ■ Volume flow ■ Mass flow ■ Conductivity ■ Totalizer 1 ■ Totalizer 2 ■ Totalizer 3 		
Configurable Input			
RPI	5 ms to 10 s (factory setting: 20 ms)		
Exclusive Owner Multicast		Instance	Size [byte]
	Instance configuration:	0x68	398
	O → T configuration:	0x66	56
	T → O configuration:	0x65	88
Exclusive Owner Multicast		Instance	Size [byte]
	Instance configuration:	0x69	-
	O → T configuration:	0x66	56
	T → O configuration:	0x65	88
Input only Multicast		Instance	Size [byte]
	Instance configuration:	0x68	398
	O → T configuration:	0xC7	-
	T → O configuration:	0x65	88
Input only Multicast		Instance	Size [byte]
	Instance configuration:	0x69	-
	O → T configuration:	0xC7	-
	T → O configuration:	0x65	88

Configurable Input Assembly	<ul style="list-style-type: none"> ▪ Volume flow ▪ Mass flow ▪ Electronic temperature ▪ Conductivity ▪ Totalizer 1 to 3 ▪ Flow velocity ▪ Volume flow unit ▪ Mass flow unit ▪ Temperature unit ▪ Conductivity unit ▪ Unit totalizer 1-3 ▪ Flow velocity unit ▪ Verification result ▪ Verification status <p> The range of options increases if the measuring device has one or more application packages.</p>
Fix Output	
Output Assembly	<ul style="list-style-type: none"> ▪ Activation of reset totalizers 1-3 ▪ Activation of reference density compensation ▪ Reset totalizers 1-3 ▪ External density ▪ Density unit ▪ Activation verification ▪ Start verification
Configuration	
Configuration Assembly	<p>Only the most common configurations are listed below.</p> <ul style="list-style-type: none"> ▪ Software write protection ▪ Mass flow unit ▪ Mass unit ▪ Volume flow unit ▪ Volume unit ▪ Density unit ▪ Conductivity ▪ Temperature unit ▪ Totalizer 1-3: <ul style="list-style-type: none"> - Assignment - Unit - Operating mode - Failure mode ▪ Alarm delay

16.5 Power supply

Terminal assignment →  38

Pin assignment, device plug →  39

Supply voltage

Transmitter

Order code for "Power supply"	Terminal voltage	Frequency range
Option L	AC100 to 240 V	50/ 60 Hz, ±4 Hz
	AC/DC24 V	50/ 60 Hz, ±4 Hz

Power consumption

Order code for "Output"	Maximum power consumption
Option N: EtherNet/IP	30 VA/8 W

Current consumption

Transmitter

Order code for "Power supply"	Maximum Current consumption	Maximum switch-on current
Option L: AC 100 to 240 V	145 mA	25 A (< 5 ms)
Option L: AC/DC 24 V	350 mA	27 A (< 5 ms)

Power supply failure

- Totalizers stop at the last value measured.
- Configuration is retained in the plug-in memory (HistoROM DAT).
- Error messages (incl. total operated hours) are stored.

Electrical connection

Potential equalization

→  44

Terminals

Transmitter

- Supply voltage cable: plug-in spring terminals for wire cross-sections 0.5 to 2.5 mm² (20 to 14 AWG)
- Signal cable: plug-in spring terminals for wire cross-sections 0.5 to 2.5 mm² (20 to 14 AWG)
- Electrode cable: spring terminals for wire cross-sections 0.5 to 2.5 mm² (20 to 14 AWG)
- Coil current cable: spring terminals for wire cross-sections 0.5 to 2.5 mm² (20 to 14 AWG)

Sensor connection housingSpring terminals for wire cross-sections 0.5 to 2.5 mm² (20 to 14 AWG)

Cable entries

Cable entry thread

- M20 x 1.5
- Via adapter:
 - NPT ½"
 - G ½"

Cable gland

- For standard cable: M20 × 1.5 with cable ϕ 6 to 12 mm (0.24 to 0.47 in)
- For reinforced cable: M20 × 1.5 with cable ϕ 9.5 to 16 mm (0.37 to 0.63 in)

 If metal cable entries are used, use a grounding plate.

Cable specification

16.6 Performance characteristics

Reference operating conditions

In accordance with DIN EN 29104

- Medium temperature: $+28 \pm 2 \text{ }^\circ\text{C}$ ($+82 \pm 4 \text{ }^\circ\text{F}$)
- Ambient temperature: $+22 \pm 2 \text{ }^\circ\text{C}$ ($+72 \pm 4 \text{ }^\circ\text{F}$)
- Warm-up period: 30 min

Installation

- Inlet run > 10 × DN
- Outlet run > 5 × DN
- Sensor and transmitter grounded.
- The sensor is centered in the pipe.

i No special requirements must be observed at the inlet and outlet runs to keep within the in-service maximum permissible errors for custody transfer.

Maximum measured error

Error limits under reference operating conditions

o.r. = of reading

Volume flow

- ±0.5 % o.r. ± 1 mm/s (0.04 in/s)
- Optional: ±0.2 % o.r. ± 2 mm/s (0.08 in/s)

i Fluctuations in the supply voltage do not have any effect within the specified range.

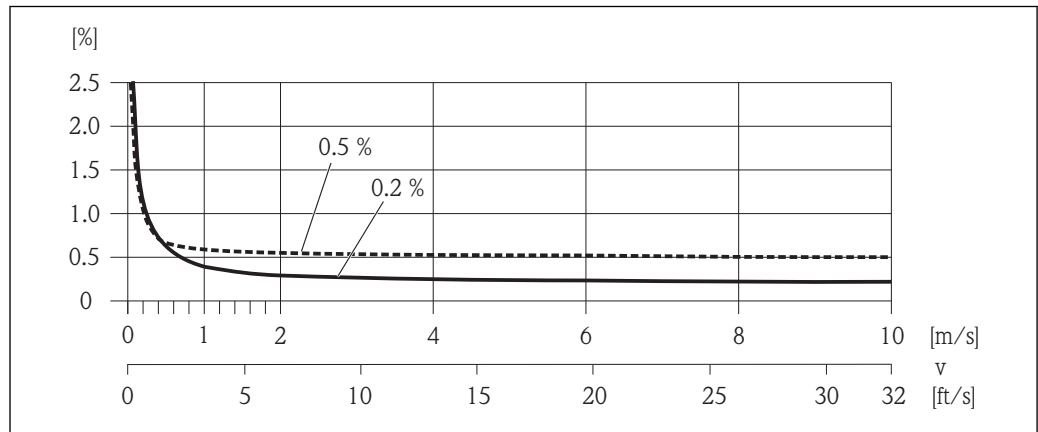

A0005531

32 Maximum measured error in % o.r.

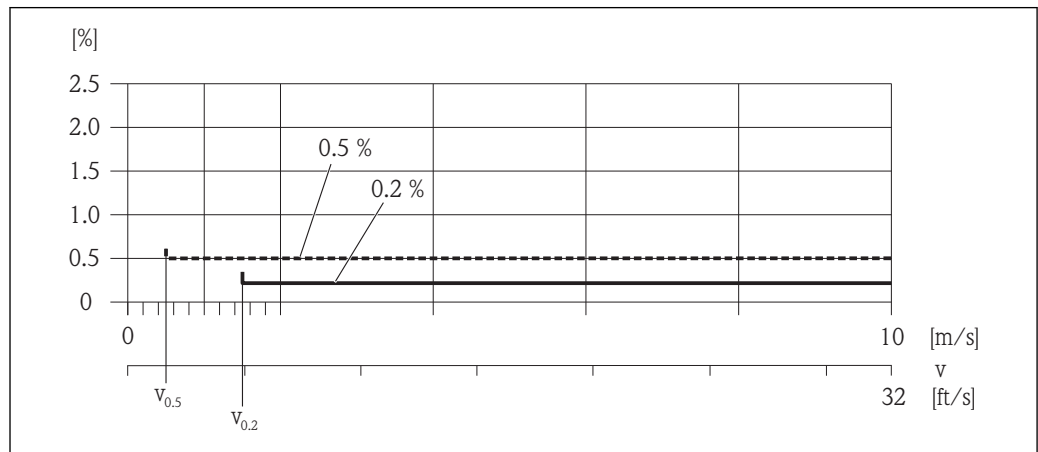

A0017051

33 Flat Spec in % o.r.

Flat Spec flow values 0.5 %

Nominal diameter		v _{0.5}	
[mm]	[in]	[m/s]	[ft/s]
25 to 600	1 to 24	0.5	1.64

Flat Spec flow values 0.2 %

Nominal diameter		v _{0.2}	
[mm]	[in]	[m/s]	[ft/s]
25 to 600	1 to 24	1.5	4.92

Electrical conductivity

Max. measured error not specified.

Repeatability

o.r. = of reading

Volume flow

max. ±0.1 % o.r. ± 0.5 mm/s (0.02 in/s)

Electrical conductivity

Max. ±5 % o.r.

16.7 Installation

"Mounting requirements" →  19

16.8 Environment

Ambient temperature range

→  21

Storage temperature

The storage temperature corresponds to the operating temperature range of the measuring transmitter and the appropriate measuring sensors.

- Protect the measuring device against direct sunlight during storage in order to avoid unacceptably high surface temperatures.
- Select a storage location where moisture cannot collect in the measuring device as fungus or bacteria infestation can damage the liner.
- If protection caps or protective covers are mounted these should never be removed before installing the measuring device.

Atmosphere

If a plastic transmitter housing is permanently exposed to certain steam and air mixtures, this can damage the housing.



If you are unsure, please contact your Endress+Hauser Sales Center for clarification.

Degree of protection

Transmitter

- As standard: IP66/67, type 4X enclosure
- When housing is open: IP20, type 1 enclosure

Sensor

- As standard: IP66/67, type 4X enclosure
- Optionally available for remote version:
 - IP66/67, type 4X enclosure; fully welded, with protective varnish EN ISO 12944 C5-M. Suitable for use in corrosive atmospheres.
 - IP68, type 6P enclosure; fully welded, with protective varnish as per EN ISO 12944 C5-M. Suitable for permanent immersion in water ≤3 m (10 ft) or 48 hours at depths ≤ 10 m (30 ft).
 - IP68, type 6P enclosure; fully welded, with protective varnish as per EN ISO 12944 Im1/Im2/Im3. Suitable for permanent immersion in saline water ≤3 m (10 ft) or 48 hours at depths ≤10 m (30 ft) or in buried applications.

Shock resistance

Compact version

6 ms 30 g, according to IEC 60068-2-27

Remote version

- Transmitter: 6 ms 30 g, according to IEC 60068-2-27
- Sensor: 6 ms 50 g, according to IEC 60068-2-27

Vibration resistance

Compact version

- Vibration sinusoidal, 1 g peak, according to IEC 60068-2-6
- Vibration broad-band random, 1.54 g rms, according to IEC 60068-2-64

Remote version

- Transmitter
 - Vibration sinusoidal, 1 g peak, according to IEC 60068-2-6
 - Vibration broad-band random, 1.54 g rms, according to IEC 60068-2-64
- Sensor:
 - Vibration sinusoidal, 2 g peak, according to IEC 60068-2-6
 - Vibration broad-band random, 2.70 g rms, according to IEC 60068-2-64

Mechanical load

- Protect the transmitter housing against mechanical effects, such as shock or impact; the use of the remote version is sometimes preferable.
- Never use the transmitter housing as a ladder or climbing aid.

Electromagnetic compatibility (EMC)

- As per IEC/EN 61326 and NAMUR Recommendation 21 (NE 21)
- Complies with emission limits for industry as per EN 55011 (Class A)

 For details refer to the Declaration of Conformity.

16.9 Process

Medium temperature range

- 0 to +80 °C (+32 to +176 °F) for hard rubber, DN 50 to 2000 (2 to 78")
- -20 to +50 °C (-4 to +122 °F) for polyurethane, DN 25 to 1200 (1 to 48")

 In custody transfer mode, the permitted fluid temperature is 0 to +50 °C (+32 to +122 °F).

Conductivity

≥ 5 µS/cm for liquids in general

 Note that in the case of the remote version, the requisite minimum conductivity also depends on the cable length .

Pressure-temperature ratings



An overview of the pressure-temperature ratings for the process connections is provided in the "Technical Information" document

Pressure tightness

Liner: hard rubber

Nominal diameter		Limit values for absolute pressure in [mbar] ([psi]) for fluid temperatures:		
[mm]	[in]	+25 °C (+77 °F)	+50 °C (+122 °F)	+80 °C (+176 °F)
50...2000	2...78	0 (0)	0 (0)	0 (0)

Liner: polyurethane

Nominal diameter		Limit values for absolute pressure in [mbar] ([psi]) for fluid temperatures:	
[mm]	[in]	+25 °C (+77 °F)	+50 °C (+122 °F)
25...1200	1...48	0 (0)	0 (0)

Flow limit

The diameter of the pipe and the flow rate determine the nominal diameter of the sensor. The optimum velocity of flow is between 2 to 3 m/s (6.56 to 9.84 ft/s). Also match the velocity of flow (v) to the physical properties of the fluid:

- $v < 2$ m/s (6.56 ft/s): for abrasive fluids (e.g. potter's clay, lime milk, ore slurry)
- $v > 2$ m/s (6.56 ft/s): for fluids producing buildup (e.g. wastewater sludges)



A necessary increase in the flow velocity can be achieved by reducing the sensor nominal diameter.



For an overview of the measuring range full scale values, see the "Measuring range" section → 128



For custody transfer, the applicable approval determines the permitted measuring range.

Pressure loss

- No pressure loss occurs if the sensor is installed in a pipe with the same nominal diameter.
- Pressure losses for configurations incorporating adapters according to DIN EN 545 → 22

System pressure

→ 21

Vibrations

→ 22

16.10 Mechanical construction

Design, dimensions



For the dimensions and installation lengths of the device, see the "Technical Information" document, "Mechanical construction" section

Weight

Compact version

Weight data:

- Including the transmitter
 - Order code for "Housing", option M, Q: 1.3 kg (2.9 lb)
 - Order code for "Housing", option A, R: 2.0 kg (4.4 lb)
- Excluding packaging material

Weight in SI units

Standard version

EN 1092-1 (DIN 2501)			
DN [mm]	Pressure rating	Weight [kg]	
		Order code for "Housing", option M, Q Polycarbonate plastic	Order code for "Housing", option A, R Aluminum, AlSi10Mg, coated
25	PN 40	5	5.7
32	PN 40	6	6.7
40	PN 40	8	8.7
50	PN 40	9	9.7
65	PN 16	10	10.7
80	PN 16	12	12.7
100	PN 16	14	14.7
125	PN 16	20	20.7
150	PN 16	24	24.7
200	PN 10	43	43.7
250	PN 10	63	63.7
300	PN 10	68	68.7
350	PN 6	105	105.7
375	PN 6	120	120.7
400	PN 6	120	120.7
450	PN 6	161	161.7
500	PN 6	156	156.7
600	PN 6	208	208.7
700	PN 6	304	304.7
800	PN 6	357	357.7
900	PN 6	485	485.7
1000	PN 6	589	589.7
1200	PN 6	850	850.7
1400	PN 6	1300	1300.7
1600	PN 6	1700	1700.7
1800	PN 6	2200	2200.7
2000	PN 6	2800	2800.7

AS 4087, PN 16		
DN [mm]	Weight [kg]	
	Order code for "Housing", option M, Q Polycarbonate plastic	Order code for "Housing", option A, R Aluminum, AlSi10Mg, coated
80	12	12.7
100	14	14.7
150	24	24.7

JIS B2220, 10K		
DN [mm]	Weight [kg]	
	Order code for "Housing", option M, Q Polycarbonate plastic	Order code for "Housing", option A, R Aluminum, AlSi10Mg, coated
25	5	5.7
32	5	5.7
40	6	6.7
50	7	7.7
65	9	9.7
80	11	11.7
100	13	13.7
125	19	19.7
150	23	23.7
200	40	40.7
250	68	68.7
300	70	70.7

Order code for "Design", option A

Option A "Insertion length short; ISO/DVGW to DN400, DN450-2000 1:1"

EN 1092-1 (DIN 2501)			
DN [mm]	Order code for "Housing", option M, Q Polycarbonate plastic ¹⁾		
	Weight [kg]		
	PN 6	PN 10	PN 16
450	100	113	139
500	115	133	179
600	156	163	224
700	191	241	288
800	241	316	350
900	309	394	441
1000	360	469	563
1200	530	718	840
1400	785	1115	1201
1600	1059	1625	1842
1800	1419	2108	2354
2000	1878	2631	2926

1) Values for aluminum transmitter, AlSi10Mg, coated: + 0.7 kg

AS 2129, Table E		
DN [mm]	Weight [kg]	
	Order code for "Housing", option M, Q Polycarbonate plastic	Order code for "Housing", option A, R Aluminum, AlSi10Mg, coated
450	144	144.7
500	183	183.7

AS 2129, Table E		
DN [mm]	Weight [kg]	
	Order code for "Housing", option M, Q Polycarbonate plastic	Order code for "Housing", option A, R Aluminum, AlSi10Mg, coated
600	261	261.7
700	347	347.7
750	434	434.7
800	494	494.7
900	691	691.7
1000	762	762.7
1200	1238	1238.7

AS 4087, PN 16		
DN [mm]	Weight [kg]	
	Order code for "Housing", option M, Q Polycarbonate plastic	Order code for "Housing", option A, R Aluminum, AlSi10Mg, coated
450	134	134.7
500	183	183.7
600	261	261.7
700	368	368.7
750	446	446.7
800	504	504.7
900	703	703.7
1000	760	760.7
1200	1220	1220.7

Order code for "Calibration flow", options H and K, or options H/K or order code for "Sensor option", option CA

Option	Description
H	MID Type Examination Cert MI-001
K	OIML R49 Class 2
CA	IP66/67, Type 4X, fully welded; corrosion protection EN ISO 12944 C5-M

EN 1092-1 (DIN 2501)			
DN [mm]	Pressure rating	Weight [kg]	
		Order code for "Housing", option M, Q Polycarbonate plastic	Order code for "Housing", option A, R Aluminum, AlSi10Mg, coated
25	PN 40	9	9.7
32	PN 40	10	10.7
40	PN 40	11	11.7
50	PN 40	12	12.7
65	PN 16	13	13.7
80	PN 16	15	15.7
100	PN 16	17	17.7

EN 1092-1 (DIN 2501)			
DN [mm]	Pressure rating	Weight [kg]	
		Order code for "Housing", option M, Q Polycarbonate plastic	Order code for "Housing", option A, R Aluminum, AlSi10Mg, coated
125	PN 16	22	22.7
150	PN 16	27	27.7
200	PN 10	38	38.7
250	PN 10	51	51.7
300	PN 10	60	60.7

AS 2129, PN 16		
DN [mm]	Weight [kg]	
	Order code for "Housing", option M, Q Polycarbonate plastic	Order code for "Housing", option A, R Aluminum, AlSi10Mg, coated
80	15	15.7
100	17	17.7
125	22	22.7
150	27	27.7

JIS B2220, 10K		
DN [mm]	Weight [kg]	
	Order code for "Housing", option M, Q Polycarbonate plastic	Order code for "Housing", option A, R Aluminum, AlSi10Mg, coated
25	9	9.7
32	10	10.7
40	10	10.7
50	11	11.7
65	12	12.7
80	13	13.7
100	15	15.7
125	20	20.7
150	25	25.7
200	34	34.7
250	50	50.7
300	57	57.7

Weight in US units

Standard version

ASME B16.5, Class 150		
DN [in]	Weight [lbs]	
	Order code for "Housing", option M, Q Polycarbonate plastic	Order code for "Housing", option A, R Aluminum, AISI10Mg, coated
1	11	12.5
1½	18	19.5
2	20	21.5
3	26	27.5
4	31	32.5
6	53	54.5
8	95	96.5
10	161	162.5
12	238	239.5
14	386	387.5
16	452	453.5
18	562	563.5
20	628	629.5
24	893	894.5

AWWA C207, Class D		
DN [in]	Weight [lbs]	
	Order code for "Housing", option M, Q Polycarbonate plastic	Order code for "Housing", option A, R Aluminum, AISI10Mg, coated
28	882	883.5
30	1014	1015.5
32	1213	1214.5
36	1764	1765.5
40	1985	1986.5
42	2426	2427.5
48	3087	3088.5
54	4851	4852.5
60	5954	5955.5
66	8159	8160.5
72	9041	9042.5
78	10143	10144.5

Order code for "Design", option A

Option A "Insertion length short; ISO/DVGW to DN400, DN450-2000 1:1"

ASME B16.5, Class 150		
DN [in]	Weight [lbs]	
	Order code for "Housing", option M, Q Polycarbonate plastic	Order code for "Housing", option A, R Aluminum, AlSi10Mg, coated
18	423	424.5
20	505	506.5
24	668	667.5

AWWA C207, Class D		
DN [in]	Weight [lbs]	
	Order code for "Housing", option M, Q Polycarbonate plastic	Order code for "Housing", option A, R Aluminum, AlSi10Mg, coated
28	589	590.5
30	703	704.5
32	847	848.5
36	1039	1040.5
40	1297	1298.5
42	1480	1481.5
48	1989	1990.5
54	2809	2810.5
60	3517	3518.5
66	4701	4702.5
72	5665	5666.5
78	6866	6867.5

Order code for "Sensor option", option CA

Option CA "IP66/67, Type 4X, fully welded; corrosion protection EN ISO 12944 C5-M

ASME B16.5, Class 150	
DN [in]	Weight [lbs]
1	17.6
1½	19.8
2	24.3
3	33.1
4	41.9
6	61.7
8	97.0
10	134.5
12	189.6

Transmitter remote version

Wall-mount housing

Depends on the material of the wall-mount housing:

- Polycarbonate plastic: 1.3 kg (2.9 lb)
- Aluminum, AlSi10Mg, coated: 2.0 kg (4.4 lb)

Sensor remote version

Weight data:

- Including sensor connection housing
- Excluding the connecting cable
- Excluding packaging material

Weight in SI units

Standard version

EN 1092-1 (DIN 2501)		
DN [mm]	Pressure rating	Weight [kg]
25	PN 40	5
32	PN 40	6
40	PN 40	7
50	PN 40	9
65	PN 16	10
80	PN 16	12
100	PN 16	14
125	PN 16	20
150	PN 16	24
200	PN 10	43
250	PN 10	63
300	PN 10	68
350	PN 6	103
375	PN 6	118
400	PN 6	118
450	PN 6	159
500	PN 6	154
600	PN 6	206
700	PN 6	302
800	PN 6	355
900	PN 6	483
1000	PN 6	587
1200	PN 6	848
1400	PN 6	1298
1600	PN 6	1698
1800	PN 6	2198
2000	PN 6	2798

AS 4087, PN 16	
DN [mm]	Weight [kg]
80	12
100	14
125	20
150	24

JIS B2220, 10K	
DN [mm]	Weight [kg]
25	5
32	5
40	6
50	7
65	9
80	11
100	13
125	19
150	23
200	40
250	67
300	70

Order code for "Design", option A

Option A "Insertion length short; ISO/DVGW to DN400, DN450-2000 1:1"

EN 1092-1 (DIN 2501)			
DN [mm]	Weight [kg]		
	PN 6	PN 10	PN 16
450	98	111	139
500	113	131	179
600	154	161	224
700	190	240	288
800	240	315	350
900	308	393	441
1000	359	468	563
1200	529	717	840
1400	784	1 114	1200
1600	1058	1 624	1841
1800	1418	2 107	2353
2000	1877	2 630	2925

AS 2129, Table E	
DN [mm]	Weight [kg]
450	142
500	181
600	259
700	346
750	433
800	493
900	690
1000	761
1200	1237

AS 4087, PN 16	
DN [mm]	Weight [kg]
450	132
500	181
600	259
700	367
750	445
800	503
900	702
1000	759
1200	1219

Order code for "Calibration flow", options H and K or order code for "Sensor option", option CA

Option	Description
H	MID Type Examination Cert MI-001
K	OIML R49 Class 2
CA	IP66/67, Type 4X, fully welded; corrosion protection EN ISO 12944 C5-M

EN 1092-1 (DIN 2501)		
DN [mm]	Pressure rating	[kg]
25	PN 40	6.5
32	PN 40	8
40	PN 40	8.5
50	PN 40	10
65	PN 16	11
80	PN 16	13
100	PN 16	15
125	PN 16	20

EN 1092-1 (DIN 2501)		
DN [mm]	Pressure rating	[kg]
150	PN 16	25
200	PN 10	36
250	PN 10	49
300	PN 10	58

AS 4087, PN 16	
DN [mm]	[kg]
80	13
100	15
150	25

JIS B2220, 10K	
DN [mm]	Weight [kg]
25	6.5
32	7.5
40	7.5
50	9
65	10
80	11
100	13
125	18
150	23
200	32
250	48
300	55

Weight in US units

Standard version

ASME B16.5, Class 150	
DN [in]	Weight [lbs]
1	11
1½	15
2	20
3	26
4	31
6	53
8	95

ASME B16.5, Class 150	
DN [in]	Weight [lbs]
10	161
12	238
14	381
16	448
18	558
20	624
24	889

AWWA C207, Class D	
DN [in]	Weight [lbs]
28	878
30	1010
32	1208
36	1760
40	1980
42	2421
48	3083
54	4847
60	5949
66	8154
72	9036
78	10139

Order code for "Design", option A

Option A "Insertion length short; ISO/DVGW to DN400, DN450-2000 1:1"

ASME B16.5, Class 150	
DN [in]	Weight [lbs]
18	420
20	501
24	664

AWWA C207, Class D	
DN [in]	Weight [lbs]
28	587
30	701
32	845
36	1036
40	1294

AWWA C207, Class D	
DN [in]	Weight [lbs]
42	1477
48	1987
54	1273
60	3515
66	4699
72	5662
78	6864

Order code for "Sensor option", option CA

Option CA "IP66/67, Type 4X, fully welded; corrosion protection EN ISO 12944 C5-M"

ASME B16.5, Class 150	
DN [in]	Weight [lbs]
1	13
1½	15.5
2	20
3	29
4	37
6	57
8	93
10	130
12	185

Measuring tube
specification

Nominal diameter		Pressure rating				Measuring tube internal diameter			
		EN (DIN)	ASME AWWA	AS 2129 AS 4087	JIS	Hard rubber		Polyurethane	
[mm]	[in]					[mm]	[in]	[mm]	[in]
25	1	PN 40	Class 150	-	20K	-	-	24	0.94
32	-	PN 40	-	-	20K	-	-	32	1.26
40	1 ½	PN 40	Class 150	-	20K	-	-	38	1.50
50	2	PN 40	Class 150	Table E, PN 16	10K	50	1.97	50	1.97
65	-	PN 16	-	-	10K	66	2.60	66	2.60
80	3	PN 16	Class 150	Table E, PN 16	10K	79	3.11	79	3.11
100	4	PN 16	Class 150	Table E, PN 16	10K	102	4.02	102	4.02
125	-	PN 16	-	-	10K	127	5.00	127	5.00
150	6	PN 16	Class 150	Table E, PN 16	10K	156	6.14	156	6.14
200	8	PN 10	Class 150	Table E, PN 16	10K	204	8.03	204	8.03
250	10	PN 10	Class 150	Table E, PN 16	10K	258	10.2	258	10.2
300	12	PN 10	Class 150	Table E, PN 16	10K	309	12.2	309	12.2
350	14	PN 6	Class 150	Table E, PN 16	-	342	13.5	342	13.5

Nominal diameter		Pressure rating				Measuring tube internal diameter			
		EN (DIN)	ASME AWWA	AS 2129 AS 4087	JIS	Hard rubber		Polyurethane	
[mm]	[in]					[mm]	[in]	[mm]	[in]
375	15	-	-	PN 16	-	392	15.4	-	-
400	16	PN 6	Class 150	Table E, PN 16	-	392	15.4	392	15.4
450	18	PN 6	Class 150	-	-	437	17.2	437	17.2
500	20	PN 6	Class 150	Table E, PN 16	-	492	19.4	492	19.4
600	24	PN 6	Class 150	Table E, PN 16	-	594	23.4	594	23.4
700	28	PN 6	Class D	Table E, PN 16	-	692	27.2	692	27.2
750	30	-	Class D	Table E, PN 16	-	742	29.2	742	29.2
800	32	PN 6	Class D	Table E, PN 16	-	794	31.3	794	31.3
900	36	PN 6	Class D	Table E, PN 16	-	891	35.1	891	35.1
1000	40	PN 6	Class D	Table E, PN 16	-	994	39.1	994	39.1
-	42	-	Class D	-	-	1043	41.1	1043	41.1
1200	48	PN 6	Class D	Table E, PN 16	-	1197	47.1	1197	47.1
-	54	-	Class D	-	-	1339	52.7	-	-
1400	-	PN 6	-	-	-	1402	55.2	-	-
-	60	-	Class D	-	-	1492	58.7	-	-
1600	-	PN 6	-	-	-	1600	63.0	-	-
-	66	-	Class D	-	-	1638	64.5	-	-
1800	72	PN 6	Class D	-	-	1786	70.3	-	-
2000	78	PN 6	Class D	-	-	1989	78.3	-	-

Materials

Transmitter housing

Compact version, standard

- Order code for "Housing", option **A** "Compact, aluminum coated":
Aluminum, AlSi10Mg, coated
- Order code for "Housing", option **M**: polycarbonate plastic
- Window material:
 - For order code for "Housing", option **A**: glass
 - For order code for "Housing", option **M**: plastic

Compact version, inclined

- Order code for "Housing", option **R** "Compact, aluminum coated":
Aluminum, AlSi10Mg, coated
- Order code for "Housing", option **Q**: polycarbonate plastic
- Window material:
 - For order code for "Housing", option **R**: glass
 - For order code for "Housing", option **Q**: plastic

Remote version (wall-mount housing)

- Order code for "Housing", option **P** "Compact, aluminum coated": Aluminum, AlSi10Mg, coated
- Order code for "Housing", option **N**: polycarbonate plastic
- Window material:
 - For order code for "Housing", option **P**: glass
 - For order code for "Housing", option **N**: plastic

Cable entries/cable glands

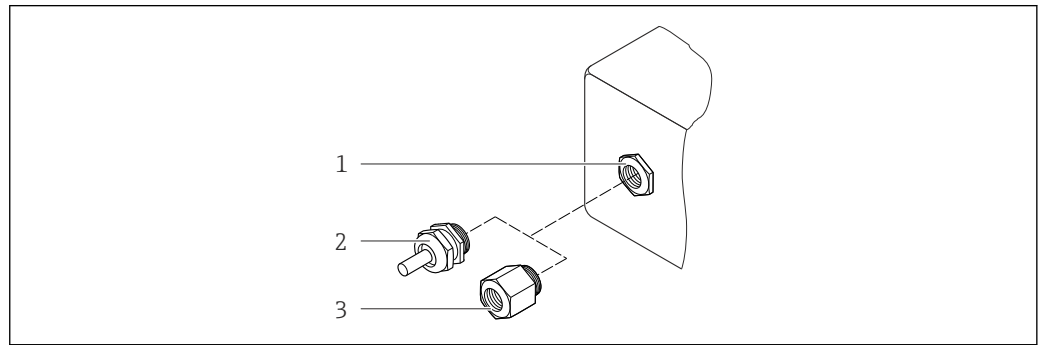

34 Possible cable entries/cable glands

- 1 Cable entry in transmitter housing, wall-mount housing or connection housing with internal thread M20 x 1.5
- 2 Cable gland M20 x 1.5
- 3 Adapter for cable entry with internal thread G 1/2" or NPT 1/2"

Compact and remote versions and sensor connection housing

Cable entry/cable gland	Material
Cable gland M20 x 1.5	Plastic
Remote version: cable gland M20 x 1.5 Option of reinforced connecting cable	<ul style="list-style-type: none"> ■ Sensor connection housing: Nickel-plated brass ■ Transmitter wall-mount housing: Plastic
Adapter for cable entry with internal thread G 1/2" or NPT 1/2"	Nickel-plated brass

Device plug

Electrical connection	Material
Plug M12x1	<ul style="list-style-type: none"> ■ Socket: Stainless steel, 1.4404 (316L) ■ Contact housing: Polyamide ■ Contacts: Gold-plated brass

Connecting cable for remote version

Electrode and coil current cable

- Standard cable: PVC cable with copper shield
- Reinforced cable: PVC cable with copper shield and additional steel wire braided jacket

Sensor housing

- DN 25 to 300 (1 to 12"):
 – Aluminum, AlSi10Mg, coated
 – Carbon steel with Al/Zn protective coating
- DN 50 to 300 (2 to 12"):
 Carbon steel with protective varnish (IP68)
- DN 350 to 2000 (14 to 78"):
 Carbon steel with protective varnish

Sensor connection housing

- Standard: aluminum, AlSi10Mg, coated (IP66/67)
- Option:
 – Polycarbonate for IP68 with DN 50 to 300 (2 to 12")
 – Polycarbonate for order code "Sensor option", option CA...CE "Corrosion protection" with DN 350 to 2000 (14 to 78")

Measuring tubes

- DN 25 to 300 (1 to 12")¹⁾: stainless steel, 1.4301/1.4306/304/304L
- DN 350 to 1200 (14 to 48")¹⁾: stainless steel, 1.4301/304
- DN 1350 to 2000 (54 to 78")¹⁾: stainless steel, 1.4301 similar to 304

Liner

- DN 25 to 1200 (1 to 48"): polyurethane
- DN 50 to 2000 (2 to 78"): hard rubber

Electrodes

- Stainless steel, 1.4435 (316L)
- Alloy C22, 2.4602 (UNS N06022)
- Tantalum

Process connections*EN 1092-1 (DIN 2501)*

- DN 25 to 1200¹⁾:
 – Stainless steel, 1.4404/1.4571/F316L
 – Carbon steel, A105/FE410WB/P250GH/S235JRG2/S235JR+N
- DN 1350 to 2000¹⁾:
 – Stainless steel, 1.4404/1.4571
 – Carbon steel, P250GH/S235JRG2
- DN 450 to 2000²⁾:
 Carbon steel, A105/S235JRG2

EN 1092-1 (DIN 2501), PN6:

DN 350 to 1000¹⁾:
 Carbon steel, A105/FE410WB/S235JRG2

1) For carbon steel flange material with Al/Zn protective coating (DN 25 to 300 (1 to 12")), protective varnish (IP68) (DN 50 to 300 (2 to 12")) or protective varnish ≥ DN 350 (14")

2) Order Code for "Design", Option A "Insertion length short"

ASME B16.5

- DN 25 to 1200 (1 to 48"):
 - Stainless steel, F316L similar to 1.4404
- DN 25 to 300 (1 to 12")²⁾:
 - Carbon steel, A105 similar to 1.0432
- DN 350 to 1200 (14 to 48")²⁾:
 - Carbon steel, A105/A515 Grade 70

AWWA C207

- DN 48":
 - Carbon steel, A105/A181/P265GH/S275JR
- DN 54 to 72":
 - Carbon steel, P265GH similar to 1.0425
- DN 48 to 78")²⁾:
 - Carbon steel, A105/A181/P265GH/S275JR

AS 2129

- DN 50 to 1200:
 - Carbon steel, A105/S235JRG2
- DN 350 to 1200²⁾:
 - Carbon steel, A105/FE410WB/P235GH/P265GH/S235JRG2

AS 4087

- DN 50 to 1200:
 - Carbon steel, A105/S275JR
- DN 350 to 1200²⁾:
 - Carbon steel, A105/P265GH/S275JR

JIS B2220

- Stainless steel, F316L similar to 1.4404
- Carbon steel, A105/A350LF2¹⁾

Seals

In accordance with DIN EN 1514-1

Accessories*Display protection*

Stainless steel, 1.4301 (304L)

Ground disks

- Stainless steel, 1.4435 (316L)
- Alloy C22, 2.4602 (UNS N06022)
- Tantalum

Fitted electrodes



Measurement, reference and empty pipe detection electrodes available as standard with:

- 1.4435 (316L)
- Alloy C22, 2.4602 (UNS N06022)
- Tantalum

Optionally available with DN 350 to 2000 (14 to 78"):
Exchangeable measuring electrodes made from 1.4435 (316L)

Process connections

- EN 1092-1 (DIN 2501) ³⁾
 - DN ≤ 300: fixed flange (PN 10/16/25/40) = form A
 - DN ≥ 350: fixed flange (PN 6/10/16/25) = flat face
 - DN 450 to 2000 ⁴⁾: fixed flange (PN 6/10/16) = flat face
- ASME B16.5
 - DN 25 to 600 (1 to 24"): fixed flange (Class 150)
 - DN 350 to 2000 (14 to 78") ⁴⁾: fixed flange (Class 150)
 - DN 25 to 150 (1 to 6"): fixed flange (Class 300)
- AWWA C207
 - DN 48 to 72": fixed flange (Class D)
 - DN 48 to 78" ⁴⁾: fixed flange (Class D)
- AS 2129
 - DN 50 to 1200: fixed flange (Table E)
 - DN 350 to 1200 ⁴⁾: fixed flange (Table E)
- AS 4087
 - DN 50 to 1200): fixed flange (PN 16)
 - DN 350 to 1200 ⁴⁾: fixed flange (PN 16)
- JIS B2220
 - DN 50 to 300: fixed flange (10K)
 - DN 25 to 300: fixed flange (20K)

 For information on the materials of the process connections →  154

Surface roughness

Electrodes with 1.4435 (316L); Alloy C22, 2.4602 (UNS N06022); tantalum:
 ≤ 0.3 to 0.5 µm (11.8 to 19.7 µin)
 (All data relate to parts in contact with fluid)

16.11 Operability

Local operation

Via display module

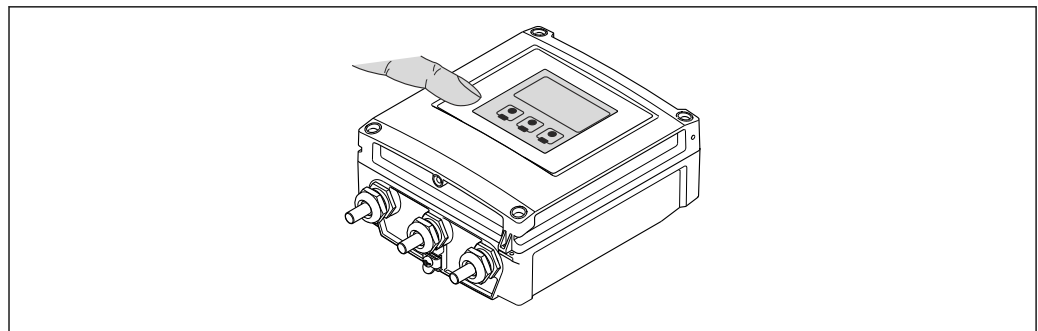

A0020538

Display elements

- 4-line display
- White background lighting; switches to red in event of device errors
- Format for displaying measured variables and status variables can be individually configured
- Permitted ambient temperature for the display: -20 to +50 °C (-4 to +122 °F)
 The readability of the display may be impaired at temperatures outside the temperature range.

3) Dimensions as per DIN 2501, DN 65 (2 1/2") PN 16 and DN 600 (24") PN 16 only as per EN 1092-1

4) Order code for "Design", option A "Insertion length short"

Operating elements

External operation via touch control; 3 optical keys: ☺, ☹, ☺

Additional functionality

- Data backup function
The device configuration can be saved in the display module.
- Data comparison function
The device configuration saved in the display module can be compared to the current device configuration.
- Data transfer function
The transmitter configuration can be transmitted to another device using the display module.

Remote operation

Via Ethernet-based fieldbus

This communication interface is available in device versions with EtherNet/IP.

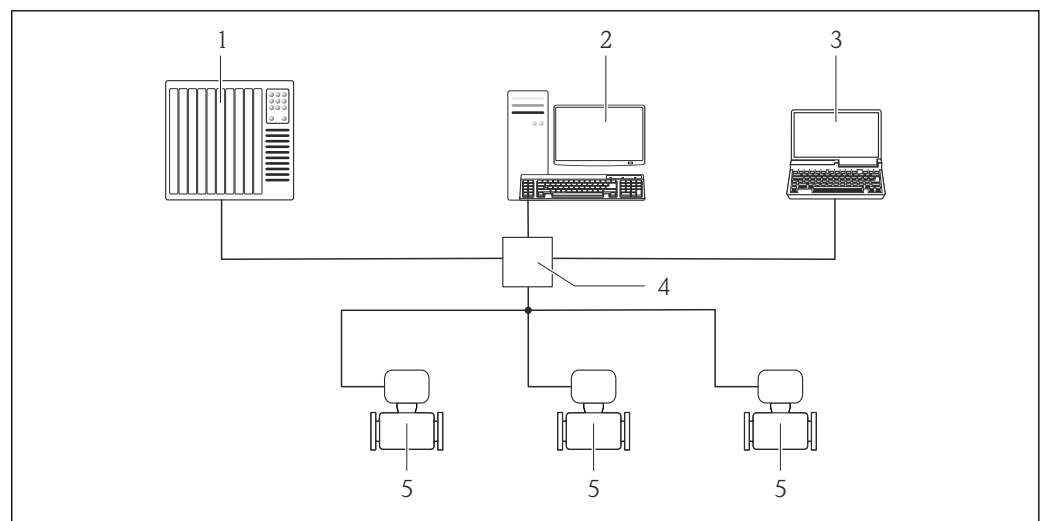

35 Options for remote operation via Ethernet-based fieldbus

- 1 Control system, e.g. "RSLogix" (Rockwell Automation)
- 2 Workstation for measuring device operation: with Add-on Profile Level 3 for "RSLogix 5000" (Rockwell Automation) or with Electronic Data Sheet (EDS)
- 3 Computer with Web browser (e.g. Internet Explorer) for accessing the integrated device Web server or with "FieldCare" operating tool with COM DTM "CDI Communication TCP/IP"
- 4 Ethernet switch
- 5 Measuring device

Service interface

Via service interface (CDI-RJ45)

EtherNet/IP

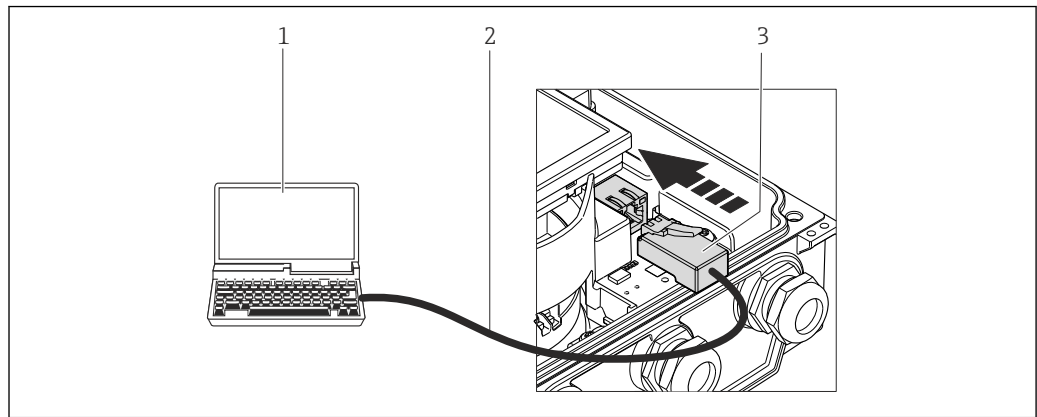

A0023113

- 1 Computer with Web browser (e.g. Internet Explorer) for accessing the integrated device Web server or with "FieldCare" operating tool with COM DTM "CDI Communication TCP/IP"
- 2 Standard Ethernet connecting cable with RJ45 plug
- 3 Service interface (CDI -RJ45) of the measuring device with access to the integrated Web server

Languages

Can be operated in the following languages:

- Via local display:
English, German, French, Spanish, Italian, Dutch, Portuguese, Polish, Russian, Turkish, Chinese, Japanese, Bahasa (Indonesian), Vietnamese, Czech
- Via "FieldCare" operating tool:
English, German, French, Spanish, Italian, Chinese, Japanese
- Via Web browser
English, German, French, Spanish, Italian, Dutch, Portuguese, Polish, Russian, Turkish, Chinese, Japanese, Bahasa (Indonesian), Vietnamese, Czech

16.12 Certificates and approvals

CE mark

The measuring system is in conformity with the statutory requirements of the applicable EC Directives. These are listed in the corresponding EC Declaration of Conformity along with the standards applied.

Endress+Hauser confirms successful testing of the device by affixing to it the CE mark.

C-Tick symbol

The measuring system meets the EMC requirements of the "Australian Communications and Media Authority (ACMA)".

Ex approval

The devices are certified for use in hazardous areas and the relevant safety instructions are provided in the separate "Control Drawing" document. Reference is made to this document on the nameplate.

Drinking water approval

- ACS
- KTW/W270
- NSF 61
- WRAS BS 6920

EtherNet/IP certification	<p>The measuring device is certified and registered by the ODVA (Open Device Vendor Association). The measuring system meets all the requirements of the following specifications:</p> <ul style="list-style-type: none"> ■ Certified in accordance with the ODVA Conformance Test ■ EtherNet/IP Performance Test ■ EtherNet/IP PlugFest compliance ■ The device can also be operated with certified devices of other manufacturers (interoperability)
Measuring instrument approval	<p>Promag W 400 is (optionally) approved as a cold water meter (MI-001) for volume measurement in service subject to legal metrological control in accordance with the European Measuring Instruments Directive 2004/22/EC (MID).</p> <p>Promag W 400 is qualified to OIML R49 and has an OIML Certificate of Conformity (optional).</p>
Other standards and guidelines	<ul style="list-style-type: none"> ■ EN 60529 Degrees of protection provided by enclosures (IP code) ■ EN 61010-1 Safety requirements for electrical equipment for measurement, control and laboratory use ■ IEC/EN 61326 Emission in accordance with Class A requirements. Electromagnetic compatibility (EMC requirements). ■ ANSI/ISA-61010-1 (82.02.01): 2004 Safety Requirements for Electrical Equipment for Measurement, Control and Laboratory Use - Part 1 General Requirements ■ CAN/CSA-C22.2 No. 61010-1-04 Safety Requirements for Electrical Equipment for Measurement, Control and Laboratory Use - Part 1 General Requirements ■ NAMUR NE 21 Electromagnetic compatibility (EMC) of industrial process and laboratory control equipment ■ NAMUR NE 32 Data retention in the event of a power failure in field and control instruments with microprocessors ■ NAMUR NE 43 Standardization of the signal level for the breakdown information of digital transmitters with analog output signal. ■ NAMUR NE 53 Software of field devices and signal-processing devices with digital electronics ■ NAMUR NE 105 Specifications for integrating fieldbus devices in engineering tools for field devices ■ NAMUR NE 107 Self-monitoring and diagnosis of field devices ■ NAMUR NE 131 Requirements for field devices for standard applications

16.13 Application packages

Many different application packages are available to enhance the functionality of the device. Such packages might be needed to address safety aspects or specific application requirements.

The application packages can be ordered with the device or subsequently from Endress+Hauser. Detailed information on the order code in question is available from your local Endress+Hauser sales center or on the product page of the Endress+Hauser website: www.endress.com.

Cleaning

Package	Description
Electrode cleaning circuit (ECC)	The electrode cleaning circuit (ECC) function has been developed to have a solution for applications where magnetite (Fe ₃ O ₄) deposits frequently occur (e.g. hot water). Since magnetite is highly conductive this build up leads to measuring errors and ultimately to the loss of signal. The application package is designed to AVOID build up of highly conductive matter and thin layers (typical of magnetite).



Diagnostics functions

Package	Description
HistoROM extended function	Comprises extended functions concerning the event log and the activation of the measured value memory. Event log: Memory volume is extended from 20 message entries (basic version) to up to 100 entries. Data logging (line recorder): <ul style="list-style-type: none"> ▪ Memory capacity for up to 1000 measured values is activated. ▪ 250 measured values can be output via each of the 4 memory channels. The recording interval can be defined and configured by the user. ▪ Data logging is visualized via the local display or FieldCare.

Heartbeat Technology

Package	Description
Heartbeat Verification +Monitoring	<p>Heartbeat Monitoring: Continuously supplies monitoring data, which are characteristic of the measuring principle, for an external condition monitoring system. This makes it possible to:</p> <ul style="list-style-type: none"> ▪ Draw conclusions - using these data and other information - about the impact the measuring application has on the measuring performance over time. ▪ Schedule servicing in time. ▪ Monitor the product quality, e.g. gas pockets. <p>Heartbeat Verification: Makes it possible to check the device functionality on demand when the device is installed, without having to interrupt the process.</p> <ul style="list-style-type: none"> ▪ Access via onsite operation or other operating interfaces, such as FieldCare for instance. ▪ End-to-end, traceable documentation of the verification results, including report. ▪ Makes it possible to extend calibration intervals in accordance with operator's risk assessment.

16.14 Accessories

 Overview of accessories available for order →  126

16.15 Documentation

-  For an overview of the scope of the associated Technical Documentation, refer to the following:
- The CD-ROM provided for the device (depending on the device version, the CD-ROM might not be part of the delivery!)
 - The *W@M Device Viewer* : Enter the serial number from the nameplate (www.endress.com/deviceviewer)
 - The *Endress+Hauser Operations App*: Enter the serial number from the nameplate or scan the 2-D matrix code (QR code) on the nameplate.

Standard documentation

Brief Operating Instructions

Measuring device	Documentation code
Promag W 400	KA01114D

Technical Information



Measuring device	Documentation code
Promag W 400	TI01046D

Supplementary device-
dependent documentation

Special documentation

Contents	Documentation code
Heartbeat Technology	SD01183D
Information on Custody Transfer Measurement	SD01230D

Installation Instructions

Contents	Documentation code
Installation Instructions for spare part sets	 Overview of accessories available for order →  126





17 Appendix

17.1 Overview of the operating menu

The following graphic provides an overview of the entire operating menu structure with its menus, submenus and parameters. The page reference indicates where a description of the parameter can be found in the manual.

Depending on the device version, not all submenus and parameters are available in every device. The selection can vary depending on the order code.

For the Order Code "Application Package", the associated parameters are described in the Special Documentation.

Display language	→ 93
 Operation	→ 162
 Setup	→ 163
 Diagnostics	→ 166
 Expert	→ 170

17.1.1 "Operation" menu

Navigation  Operation

 Operation	→ 100
Display language	→ 93
Web server language	
Access status display	
Access status tooling	
Locking status	
► Display	→ 83
Format display	→ 84
Contrast display	

Backlight	→ 93
Display interval	→ 93
► Totalizer handling	
Control Totalizer 1 to 3	→ 103
Preset value 1 to 3	→ 103
Reset all totalizers	→ 103

17.1.2 "Setup" menu

Navigation  Setup

Setup	→ 76
Device tag	→ 80
► System units	→ 80
Volume flow unit	→ 81
Volume unit	→ 81
Conductivity unit	→ 81
Temperature unit	→ 81
Mass flow unit	→ 81
Mass unit	→ 82
Density unit	→ 82
► Communication	→ 82
MAC address	→ 82
Default network settings	→ 82
DHCP client	→ 82
IP address	→ 83

Subnet mask	→ 83
Default gateway	→ 83
► Display	→ 83
Format display	→ 84
Value 1 display	→ 84
0% bargraph value 1	→ 84
100% bargraph value 1	→ 84
Value 2 display	→ 84
Value 3 display	→ 84
0% bargraph value 3	→ 84
100% bargraph value 3	→ 84
Value 4 display	→ 84
► Low flow cut off	→ 84
Assign process variable	→ 85
On value low flow cutoff	→ 85
Off value low flow cutoff	→ 85
Pressure shock suppression	→ 85
► Empty pipe detection	→ 86
Empty pipe detection	→ 86
New adjustment	→ 86
Switch point empty pipe detection	→ 86
Response time empty pipe detection	→ 86
► Advanced setup	→ 87
Enter access code	

► Sensor adjustment	→ 89
Installation direction	→ 89
► Totalizer 1 to 3	→ 89
Assign process variable	→ 90
Unit totalizer	→ 90
Totalizer operation mode	→ 90
Failure mode	→ 90
► Display	→ 83
Format display	→ 84
Value 1 display	→ 84
0% bargraph value 1	→ 84
100% bargraph value 1	→ 84
Decimal places 1	→ 92
Value 2 display	→ 84
Decimal places 2	→ 92
Value 3 display	→ 84
0% bargraph value 3	→ 84
100% bargraph value 3	→ 84
Decimal places 3	→ 92
Value 4 display	→ 84
Decimal places 4	→ 92
Display language	→ 93
Display interval	→ 93
Display damping	→ 93
Header	→ 93









Header text	→ 93
Separator	→ 93
Backlight	→ 93
▶ Electrode cleaning circuit	→ 93
Electrode cleaning circuit	→ 94
ECC duration	→ 94
ECC recovery time	→ 94
ECC cleaning cycle	→ 94
ECC Polarity	→ 94
▶ Administration	→ 94
▶ Define access code	→ 97
Define access code	→ 94
Confirm access code	
Device reset	→ 94

17.1.3 "Diagnostics" menu

Navigation  Diagnostics

🔍 Diagnostics	→ 116
Actual diagnostics	→ 117
Previous diagnostics	→ 117
Operating time from restart	
Operating time	→ 95
▶ Diagnostic list	
Diagnostics 1	
Diagnostics 2	

Diagnostics 3	
Diagnostics 4	
Diagnostics 5	
▶ Event logbook	
Filter options	
▶ Event list	
▶ Device information	→ 120
Device tag	→ 121
Serial number	→ 121
Firmware version	→ 121
Device name	→ 121
Order code	→ 121
Extended order code 1	→ 121
Extended order code 2	→ 121
Extended order code 3	→ 121
ENP version	→ 121
IP address	→ 121
Subnet mask	→ 121
Default gateway	→ 121
▶ Measured values	
▶ Process variables	→ 101
Volume flow	→ 101

Mass flow	→  101
Conductivity	→  101
► Totalizer	→  89
Totalizer value 1 to 3	→  102
Totalizer overflow 1 to 3	→  102
► Data logging	→  103
Assign channel 1	→  104
Assign channel 2	
Assign channel 3	
Assign channel 4	
Logging interval	→  104
Clear logging data	→  104
► Display channel 1	
► Display channel 2	
► Display channel 3	
► Display channel 4	
► Heartbeat	
► Performing verification	
Year	
Month	
Day	
Hour	
AM/PM	
Minute	
Verification mode	

External device information	
External reference voltage 1	
External reference voltage 2	
Start verification	
Progress	
Status	
Overall result	
► Verification results	
Date/time	
Verification ID	
Operating time	
Overall result	
Sensor	
Sensor electronic module	
I/O module	
► Monitoring results	
Noise	
Coil current shot time	
Reference electrode potential against PE	
► Simulation	→ 96
Assign simulation process variable	→ 96
Value process variable	→ 96
Simulation device alarm	→ 96

Diagnostic event category	→ 97
Simulation diagnostic event	→ 97

17.1.4 "Expert" menu

The following tables provide an overview of the **Expert** menu with its submenus and parameters. The direct access code to the parameter is given in brackets. The page reference indicates where a description of the parameter can be found in the manual.

Navigation Expert

Expert	
Direct access (0106)	
Locking status (0004)	
Access status display (0091)	
Access status tooling (0005)	
Enter access code (0003)	
▶ System	→ 170
▶ Sensor	→ 172
▶ Communication	→ 175
▶ Application	→ 177
▶ Diagnostics	→ 177

"System" submenu

Navigation Expert → System

▶ System	
▶ Display	→ 83
Display language (0104)	→ 93
Format display (0098)	→ 84
Value 1 display (0107)	→ 84

0% bargraph value 1 (0123)	→ 84
100% bargraph value 1 (0125)	→ 84
Decimal places 1 (0095)	→ 92
Value 2 display (0108)	→ 84
Decimal places 2 (0117)	→ 92
Value 3 display (0110)	→ 84
0% bargraph value 3 (0124)	→ 84
100% bargraph value 3 (0126)	→ 84
Decimal places 3 (0118)	→ 92
Value 4 display (0109)	→ 84
Decimal places 4 (0119)	→ 92
Display interval (0096)	→ 93
Display damping (0094)	→ 93
Header (0097)	→ 93
Header text (0112)	→ 93
Separator (0101)	→ 93
Contrast display (0105)	
Backlight (0111)	→ 93
Access status display (0091)	
► Diagnostic handling	
Alarm delay (0651)	
► Diagnostic behavior	
Assign behavior of diagnostic no. 531 (0741)	
Assign behavior of diagnostic no. 832 (0681)	

Assign behavior of diagnostic no. 833 (0682)	
Assign behavior of diagnostic no. 862 (0745)	
Assign behavior of diagnostic no. 937 (0743)	
Assign behavior of diagnostic no. 302 (0739)	
► Administration	→ 94
► Define access code	→ 97
Define access code	→ 94
Confirm access code	
Device reset (0000)	→ 94
Activate SW option (0029)	
Software option overview (0015)	

"Sensor" submenu

Navigation  Expert → Sensor

► Sensor	
► Measured values	
► Process variables	→ 101
Volume flow (1838)	→ 101
Mass flow (1847)	→ 101
Conductivity (1850)	→ 101
► Totalizer	→ 89
Totalizer value 1 to 3 (0911-1 to 3)	→ 102
Totalizer overflow 1 to 3 (0910-1 to 3)	→ 102

▶ System units	→ 80
Volume flow unit (0553)	→ 81
Volume unit (0563)	→ 81
Conductivity unit (0582)	→ 81
Temperature unit (0557)	→ 81
Mass flow unit (0554)	→ 81
Mass unit (0574)	→ 82
Density unit (0555)	→ 82
Date/time format (2812)	
▶ User-specific units	
User volume text (0567)	
User volume offset (0569)	
User volume factor (0568)	
User mass text (0560)	
User mass offset (0562)	
User mass factor (0561)	
▶ Process parameters	
Filter options (6710)	
Flow damping (6661)	
Flow override (1839)	
Conductivity damping (1803)	
Conductivity measurement (6514)	
▶ Low flow cut off	→ 84
Assign process variable (1837)	→ 85
On value low flow cutoff (1805)	→ 85

Off value low flow cutoff (1804)	→ 85
Pressure shock suppression (1806)	→ 85
► Empty pipe detection	→ 86
Empty pipe detection (1860)	→ 86
Switch point empty pipe detection (6562)	→ 86
Response time empty pipe detection (1859)	→ 86
Empty pipe adjust value (6527)	
Full pipe adjust value (6548)	
Measured value EPD (6559)	
► Empty pipe adjust	
New adjustment (6560)	→ 86
► Electrode cleaning circuit	→ 93
Electrode cleaning circuit (6528)	→ 94
ECC duration (6555)	→ 94
ECC recovery time (6556)	→ 94
ECC cleaning cycle (6557)	→ 94
ECC Polarity (6631)	→ 94
► External compensation	
Density source (6615)	
External density (6630)	
Fixed density (6623)	
► Sensor adjustment	→ 89
Installation direction (1809)	→ 89
Integration time (6533)	

Measuring period (6536)

► **Process variable adjustment**

Volume flow offset (1831)

Volume flow factor (1832)

Mass flow offset (1841)

Mass flow factor (1846)

Conductivity offset (1848)

Conductivity factor (1849)

► **Calibration**

Nominal diameter (2807)

Calibration factor (6522)

Zero point (6546)

Conductivity calibration factor (6718)

► **Communication** → ⓘ 75

► **Configuration**

Web server language (7221)

MAC address (7214) → ⓘ 82

Default network settings (7401) → ⓘ 82

DHCP client (7212) → ⓘ 82

IP address (7209) → ⓘ 83

Subnet mask (7211) → ⓘ 83

Default gateway (7210) → ⓘ 83

Web server functionality (7222)

→ 67

► Configurable input assembly

Input assembly position 1 (7402)

Input assembly position 2 (7413)

Input assembly position 3 (7415)

Input assembly position 4 (7416)

Input assembly position 5 (7417)

Input assembly position 6 (7418)

Input assembly position 7 (7419)

Input assembly position 8 (7420)

Input assembly position 9 (7421)

Input assembly position 10 (7403)

Input assembly position 11 (7404)

Input assembly position 12 (7405)

Input assembly position 13 (7406)

Input assembly position 14 (7407)

Input assembly position 15 (7408)

Input assembly position 16 (7409)

Input assembly position 17 (7410)

















Input assembly position 18 (7411)

Input assembly position 19 (7412)

Input assembly position 20 (7414)

► Application		
Reset all totalizers (2806)		→ 103
► Totalizer 1 to 3		→ 89
Assign process variable (0914-1 to 3)		→ 90
Unit totalizer (0915-1 to 3)		→ 90
Totalizer operation mode (0908-1 to 3)		→ 90
Control Totalizer 1 to 3 (0912-1 to 3)		→ 103
Preset value 1 to 3 (0913-1 to 3)		→ 103
Failure mode (0901-1 to 3)		→ 90

► Diagnostics		→ 116
Actual diagnostics (0691)		→ 117
Previous diagnostics (0690)		→ 117
Operating time from restart (0653)		
Operating time (0652)		→ 95
► Diagnostic list		
Diagnostics 1 (0692)		
Diagnostics 2 (0693)		
Diagnostics 3 (0694)		
Diagnostics 4 (0695)		
Diagnostics 5 (0696)		
► Event logbook		
Filter options (0705)		
► Event list		

► Device information	→  120
Device tag (0011)	→  121
Serial number (0009)	→  121
Firmware version (0010)	→  121
Device name (0013)	→  121
Order code (0008)	→  121
Extended order code 1 (0023)	→  121
Extended order code 2 (0021)	→  121
Extended order code 3 (0022)	→  121
Configuration counter (2751)	
ENP version (0012)	→  121
IP address (7209)	→  121
Subnet mask (7211)	→  121
Default gateway (7210)	→  121
► Data logging	→  103
Assign channel 1 (0851)	→  104
Assign channel 2 (0852)	
Assign channel 3 (0853)	
Assign channel 4 (0854)	
Logging interval (0856)	→  104
Clear logging data (0855)	→  104
► Display channel 1	
► Display channel 2	
► Display channel 3	
► Display channel 4	

► Min/max values

Reset min/max values (6541)

► Main electronic temperature

Minimum value (6547)

Maximum value (6545)

► Heartbeat**► Heartbeat base settings**

Plant operator (2754)

Location (2755)

► Performing verification

Year (2846)

Month (2845)

Day (2842)

Hour (2843)

AM/PM (2813)

Minute (2844)

Verification mode (12105)

External device information (12101)

External reference voltage 1 (12106)

External reference voltage 2 (12107)

Start verification (12127)

Progress (2808)

Status (12153)

Overall result (12149)

► Verification results

Date/time (12142)

Verification ID (12141)

Operating time (12126)

Overall result (12149)

Sensor (12152)

Sensor electronic module (12151)

I/O module (12145)

► Monitoring results

Noise (12158)

Coil current shot time (12150)

Reference electrode potential against
PE (12155)

► Simulation

→ 96

Assign simulation process variable
(1810)

→ 96

Value process variable (1811)

→ 96

Simulation device alarm (0654)

→ 96

Diagnostic event category (0738)

→ 97

Simulation diagnostic event (0737)

→ 97

Index

A

- Access authorization to parameters
 - Read access 62
 - Write access 62
- Access code 62
 - Incorrect input 62
- Adapters 22
- Adapting the diagnostic behavior 113
- Ambient temperature range 21
- Application 9, 128
- Applicator 128
- Approvals 158

B

- Buried applications 24

C

- C-Tick symbol 158
- Cable entries
 - Technical data 135
- Cable entry
 - Degree of protection 47
- CE mark 11, 158
- Certificates 158
- Checklist
 - Post-connection check 47
 - Post-installation check 35
- Cleaning
 - Exterior cleaning 123
 - Interior cleaning 123
- Commissioning 75
 - Advanced settings 87
 - Configuring the measuring device 76
- Conductivity 138
- Connecting cable 36
- Connecting the measuring device 41
- Connection
 - see Electrical connection
- Connection examples, potential equalization 44
- Connection preparations 40
- Connection tools 36
- Context menu
 - Closing 57
 - Explanation 57
 - Opening 57
- Current consumption 135
- Cyclic data transmission 71

D

- Declaration of Conformity 11
- Define access code 97, 98
- Degree of protection 47, 137
- Design
 - Measuring device 12
- Designated use 9
- Device components 12

- Device description files 70
- Device documentation
 - Supplementary documentation 8
- Device locking, status 100
- Device name
 - Sensor 15
 - Transmitter 14
- Device repair 124
- Device revision 70
- Device type ID 70
- Diagnostic behavior
 - Explanation 109
 - Symbols 109
- Diagnostic information
 - Communication interface 113
 - Design, description 109, 112
 - FieldCare 112
 - Light emitting diodes 107
 - Local display 108
 - Overview 114
 - Remedial measures 114
 - Web browser 111
- Diagnostic list 117
- Diagnostic message 108
- Diagnostics
 - Symbols 108
- Diagnostics (Menu) 166
- DIP switch
 - see Write protection switch
- Direct access 59
- Direct access code 54
- Disabling write protection 97
- Display
 - Current diagnostic event 116
 - Previous diagnostic event 116
 - see Local display
- Display area
 - For operational display 52
 - In the navigation view 54
- Display values
 - For locking status 100
- Disposal 124
- Document
 - Function 6
 - Symbols used 6
- Document function 6
- Documentation 160
- Down pipe 19
- Drinking water approval 158

E

- ECC 93
- Electrical connection
 - Degree of protection 47
 - Measuring device 36
 - Operating tools

- Via Ethernet network 157
 - Via service interface (CDI-RJ45) 68, 157
 - RSLogix 5000 157
 - Web server 68, 157
 - Electromagnetic compatibility 138
 - Enabling write protection 97
 - Endress+Hauser services
 - Maintenance 123
 - Repair 124
 - Environment
 - Ambient temperature 21
 - Mechanical load 138
 - Shock resistance 138
 - Storage temperature 137
 - Vibration resistance 138
 - Error messages
 - see Diagnostic messages
 - EtherNet/IP
 - Diagnostic information 113
 - EtherNet/IP certification 159
 - Event history 117
 - Events list 117
 - Ex approval 158
 - Expert (Menu) 170
 - Extended order code
 - Sensor 15
 - Transmitter 14
 - Exterior cleaning 123
- F**
- Field of application
 - Residual risks 10
 - FieldCare 68
 - Device description file 70
 - Establishing a connection 68
 - Function 68
 - User interface 69
 - Filtering the event logbook 118
 - Firmware
 - Release date 70
 - Version 70
 - Firmware history 122
 - Fitted electrodes 155
 - Fix assembly 113
 - Flow direction 20
 - Flow limit 139
 - Function check 75
 - Functions
 - see Parameter
- G**
- Galvanic isolation 132
- H**
- Hardware write protection 98
 - Help text
 - Calling up 60
 - Close 60
 - Explanation 60
- HistoROM 94
- I**
- I/O electronics module 12, 43
 - Identifying the measuring device 13
 - Immersion in water 23
 - Incoming acceptance 13
 - Information on the document 6
 - Inlet runs 20
 - Input 128
 - Input mask 55
 - Inspection
 - Installation 35
 - Received goods 13
 - Inspection check
 - Connection 47
 - Installation 19
 - Installation conditions
 - Adapters 22
 - Buried applications 24
 - Down pipe 19
 - Immersion in water 23
 - Inlet and outlet runs 20
 - Mounting location 19
 - Orientation 20
 - Partially filled pipe 19
 - System pressure 21
 - Vibrations 22
 - Installation dimensions 21
 - Interior cleaning 123
- K**
- Keypad lock
 - Disabling 62
 - Enabling 62
- L**
- Languages, operation options 158
 - Line recorder 103
 - Local display 156
 - Editing view 55
 - Navigation view 53
 - see Diagnostic message
 - see In alarm condition
 - see Operational display
 - Low flow cut off 132
- M**
- Main electronics module 12
 - Maintenance tasks 123
 - Replacing seals 123
 - Managing the device configuration 94
 - Manufacturer ID 70
 - Manufacturing date 14, 15
 - Materials 152
 - Maximum measured error 136
 - Measured variables
 - Calculated 128
 - Measured 128
 - see Process variables

- Measuring and test equipment 123
- Measuring device
 - Configuration 76
 - Conversion 124
 - Design 12
 - Disposal 125
 - Integrating via HART protocol 70
 - Mounting the sensor 24
 - Mounting the ground cable/ground disks 25
 - Mounting the seals 25
 - Screw tightening torques 25
 - Preparing for electrical connection 40
 - Preparing for mounting 24
 - Removing 124
 - Repair 124
 - Switch-on 75
- Measuring instrument approval 159
- Measuring principle 128
- Measuring range 128
- Measuring system 128
- Measuring tube specification 151
- Mechanical load 138
- Media 9
- Medium temperature range 138
- Menu
 - Diagnostics 116, 166
 - Expert 170
 - Operation 100, 162
 - Setup 76, 80, 163
- Menus
 - For measuring device configuration 76
 - For specific settings 87
- Mounting dimensions
 - see Installation dimensions
- Mounting location 19
- Mounting preparations 24
- Mounting requirements
 - Installation dimensions 21
- Mounting tools 24
- N**
- Nameplate
 - Sensor 15
 - Transmitter 14
- Navigation path (navigation view) 53
- Navigation view
 - In the submenu 53
 - In the wizard 53
- Numeric editor 55
- O**
- Operable flow range 131
- Operating elements 57, 109
- Operating keys
 - see Operating elements
- Operating menu
 - Menus, submenus 50
 - Overview of menus with parameters 162
 - Structure 50
 - Submenus and user roles 51
- Operating philosophy 51
- Operation 100
- Operation (Menu) 162
- Operation options 49
- Operational display 52
- Operational safety 10
- Order code 14, 15
- Orientation (vertical, horizontal) 20
- Outlet runs 20
- Output 131
- Output signal 131
- Overview
 - Operating menu 162
- P**
- Packaging disposal 18
- Parameter
 - Changing 61
 - Enter a value 61
- Parameter settings
 - Administration (Submenu) 94, 119
 - Communication (Submenu) 82
 - Configuration backup display (Submenu) 94
 - Data logging (Submenu) 103
 - Device information (Submenu) 120
 - Diagnostics (Menu) 116
 - Display (Submenu) 91
 - Display (Wizard) 83
 - Electrode cleaning circuit (Submenu) 93
 - Empty pipe detection (Wizard) 86
 - Low flow cut off (Wizard) 84
 - Operation (Submenu) 102
 - Process variables (Submenu) 101
 - Sensor adjustment (Submenu) 89
 - Setup (Menu) 80
 - Simulation (Submenu) 96
 - System units (Submenu) 80
 - Totalizer (Submenu) 102
 - Totalizer 1 to 3 (Submenu) 89
 - Web server (Submenu) 67
- Partially filled pipe 19
- Performance characteristics 135
- Post-connection check (checklist) 47
- Post-installation check 75
- Post-installation check (checklist) 35
- Potential equalization 44
- Power consumption 134
- Power supply failure 135
- Pressure loss 139
- Pressure tightness 139
- Pressure-temperature ratings 139
- Process conditions
 - Conductivity 138
 - Flow limit 139
 - Medium temperature 138
 - Pressure loss 139
 - Pressure tightness 139
- Process connections 156

- Product safety 11
- Protecting parameter settings 97
- R**
- Read access 62
- Reading measured values 101
- Reading out diagnostic information, EtherNet/IP . . . 113
- Recalibration 123
- Reference operating conditions 135
- Registered trademarks 8
- Remedial measures
 - Calling up 110
 - Closing 110
- Remote operation 157
- Remote version
 - Connecting the signal cables 41
- Repair 124
 - Notes 124
- Repair of a device 124
- Repeatability 137
- Replacement
 - Device components 124
- Replacing seals 123
- Requirements for personnel 9
- Return 124
- S**
- Safety 9
- Screw tightening torques 25
- Sensor
 - Mounting 24
- Sensor (Submenu) 172
- Serial number 14, 15
- Setting the operating language 75
- Settings
 - Adapting the measuring device to the process conditions 102
 - Administration 94
 - Advanced display configurations 91
 - Communication interface 82
 - Device reset 119
 - Device tag 80
 - Electrode cleaning circuit (ECC) 93
 - Empty pipe detection (EPD) 86
 - Local display 83
 - Low flow cut off 84
 - Managing the device configuration 94
 - Operating language 75
 - Resetting the totalizer 102
 - Sensor adjustment 89
 - Simulation 96
 - System units 80
 - Totalizer 89
 - Totalizer reset 102
- Setup (Menu) 163
- Shock resistance 138
- Showing data logging 103
- Signal on alarm 131
- Software release 70
- Spare part 124
- Spare parts 124
- Special connection instructions 46
- Standards and guidelines 159
- Status area
 - For operational display 52
 - In the navigation view 54
- Status signals 108, 111
- Storage conditions 17
- Storage temperature 17
- Storage temperature range 137
- Structure
 - Operating menu 50
- Submenu
 - Administration 94, 119
 - Advanced setup 87
 - Communication 75, 82
 - Configuration backup display 94
 - Data logging 103
 - Device information 120
 - Display 91
 - Electrode cleaning circuit 93
 - Events list 117
 - Operation 102
 - Overview 51
 - Process variables 101
 - Sensor 172
 - Sensor adjustment 89
 - Simulation 96
 - System 170
 - System units 80
 - Totalizer 102
 - Totalizer 1 to 3 89
 - Web server 67
- Supply unit
 - Requirements 40
- Supply voltage 40, 134
- Surface roughness 156
- Symbols
 - For communication 52
 - For correction 55
 - For diagnostic behavior 52
 - For locking 52
 - For measured variable 52
 - For measurement channel number 52
 - For menus 54
 - For parameters 54
 - For status signal 52
 - For submenu 54
 - For wizard 54
 - In the status area of the local display 52
 - In the text and numeric editor 55
- System (Submenu) 170
- System design
 - Measuring system 128
 - see Measuring device design
- System file
 - Release date 70
 - Source 70

Version	70
System integration	70
System pressure	21

T

Technical data, overview	128
Temperature range	
Ambient temperature range for display	156
Storage temperature	17
Terminal assignment	38, 41, 43
Terminals	135
Text editor	55
Tool tip	
see Help text	
Tools	
Electrical connection	36
For mounting	24
Transport	17
Transmitter	
Connecting the signal cables	43
Turning the display module	34
Turning the housing	32
Transporting the measuring device	17
Troubleshooting	
General	105
Turning the display module	34
Turning the electronics housing	
see Turning the transmitter housing	
Turning the transmitter housing	32

U

Use of the measuring device	
Borderline cases	9
Incorrect use	9
see Designated use	
User roles	51

V

Version data for the device	70
Vibration resistance	138
Vibrations	22

W

W@M	123, 124
W@M Device Viewer	13, 124
Weight	
Compact version	139
Sensor remote version	146
Transport (notes)	17
Wizard	
Define access code	97
Display	83
Empty pipe detection	86
Low flow cut off	84
Workplace safety	10
Write access	62
Write protection	
Via access code	97
Via write protection switch	98
Write protection switch	98

www.addresses.endress.com
