

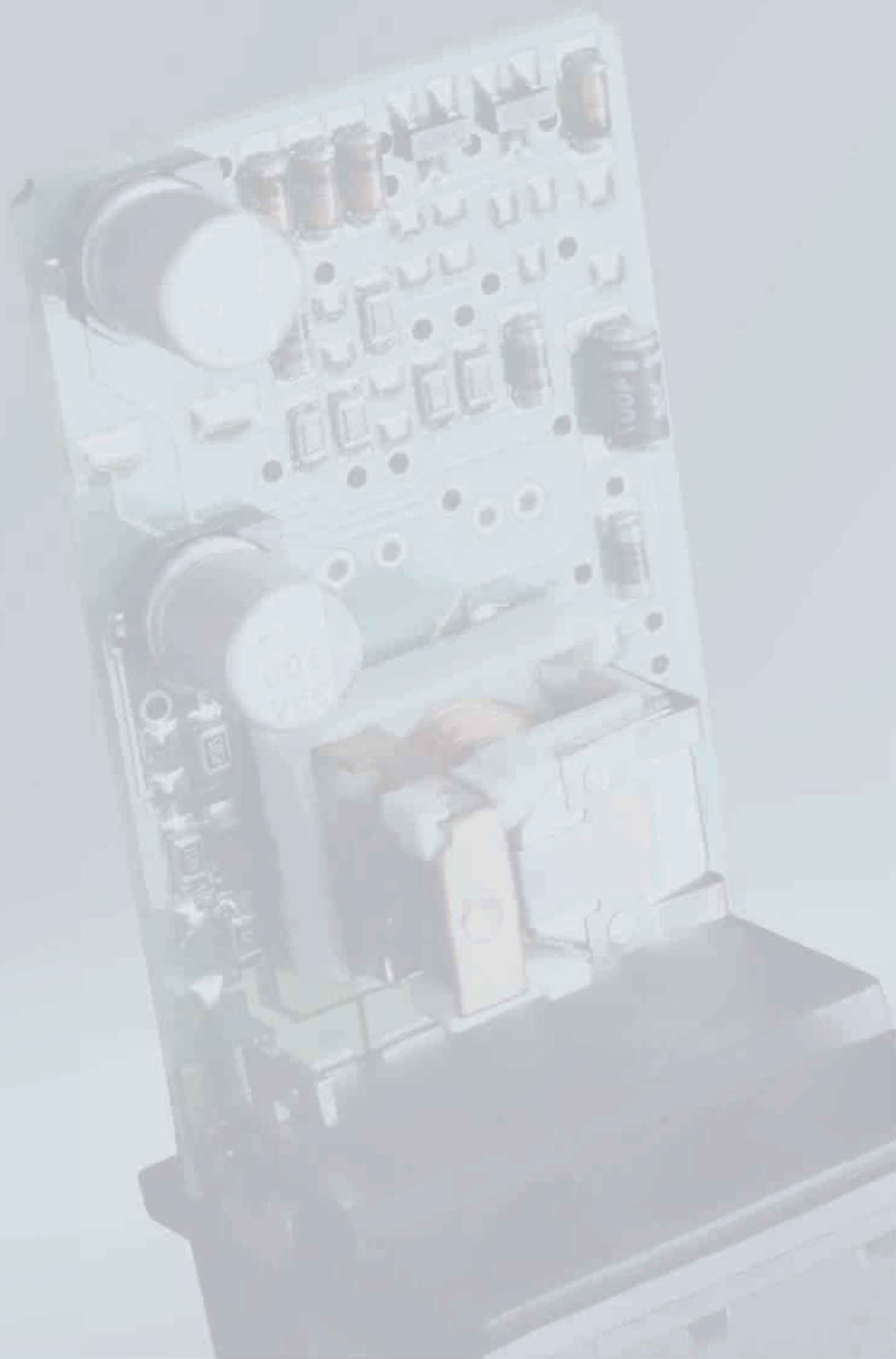

RELAYS AND RELAY DEVICES
PRODUCTS AND APPLICATIONS





INTRODUCTION	2
A small component with a big history	4
How HELLA checks and ensures quality	7
ELECTROMECHANICAL RELAYS	8
Explanation and uses	8
Relay types	12
Mini relay 12 V – make contact with holder	13
Mini relay 12 V, make contact without holder	14
Mini relay 12 V, change-over contact with holder	15
Mini relay 12 V, make contact without holder	16
Mini relay 24 V – make contact with holder	17
Mini relay 24 V, make contact without holder	18
Mini relay 24 V, change-over contact with holder	19
Mini relay 24 V, make contact without holder	20
MICRO RELAY	22
Micro relay 12V, make contact without holder / change-over contact without holder	22
Micro relay 24V, change-over contact without holder	23
HIGH-POWER RELAY	24
High-power relay 12V, make contact with holder/without holder	24
High-power relay 24V, make contact with holder/without holder	25
BATTERY DISCONNECT RELAY/SOLID STATE RELAY	26
Battery disconnect relay and solid state relay 12V, make contact	26
Summary of battery disconnect and solid state relays	27
TECHNICAL DATA	28
Technical data of the relays – Overview	28
Climatic and mechanical tests	30
FLASHER UNITS	32
Explanation and uses	32
Test circuits	36
Flasher unit 6V, 4-pole and 12V, 3-pole	38
Flasher unit 12V, 3-pole	39
Flasher unit 12V, 4-pole	40
Flasher unit 12V, 5-pole/6-pole	41
Flasher unit 12V, 6-pole/7-pole	42
Flasher unit 24V, 3-pole/4-pole	43
Flasher unit 24V, 4-pole/5-pole	44
Flasher unit 24V, 6-pole/7-pole	45
Flasher unit 24 V, 11-pole and 12/24 V, 6-pole	46
LED flasher unit 12/24V, 3-pole; 12V, 4-pole/5-pole and 24V, 4-pole	47
Overview of flasher unit technical data	48
Legal regulations for flasher units	48
LED indicators and failure control from HELLA	49
The right solution for your vehicle electronics	50
WASH/WIPE INTERVAL CONTROL UNITS	52
Explanation and uses	52
Wash/wipe interval control units 12V	54
Wash/wipe interval control units 24V	55
Headlight cleaning system 12V/24V	56
CLOCK RELAYS	58
Explanation and uses	58
Clock relays 12V	60
Clock relays 24V	61
ACCESSORIES	62
Overview	62
SWITCHING AND PLUG MATRICES	64
Circuit diagrams – electromechanical relays	64
Pin diagrams – electromechanical relays	65
Pin diagrams – flasher units	66
Pin diagrams – wash/wipe interval control units	67
Pin diagrams – clock relays	67
Pin diagrams – control units for headlight cleaning systems	67
HELLA ROCKER SWITCHES	68
The new HELLA switch configurator	68
Rocker switch, 3100 series	70
Switch functions	71

A small component with a big history

Relays have been used to remotely control circuits for over 180 years. The technology has proven its reliability millions of times and is today still the first choice for many applications, such as in automotive engineering.

From the telegraph to automotive engineering

- The relay owes its name to former times when mail was still carried by horse. At what were known as relay stations, post riders could swap their horses for rested ones. Today, we call an electromagnetic, remotely operated switch a relay.
- The American physician Joseph Henry invented the electric relay in 1835. The pioneer in communications engineering used it to send messages from his laboratory to his home. Relays were first used on a larger scale in 1837, as signal amplifiers for Samuel Morse's recording telegraphs. They would later make possible the widespread use of telephones and became a cornerstone of safety in railway engineering. In 1941, Konrad Zuse utilised 2,000 relays in his legendary Z3, the first digital computer. HELLA produced its first automotive relay in 1960.
- As electronics matured in the 20th century, the age of the relay was often seen as over; nevertheless, they retain a place in specific applications. The automotive industry, for example, needs relays, since relay functions cannot always be replaced by control units. Only relays make galvanic isolation possible between input and output. Semi-conductors cannot manage this at the moment. The cost advantage relays have over electronic solutions is also unbeatable.
- Relays are used in automotive engineering to switch high currents. The engine control unit, for example, is switched by a relay. Because relays are robust and not particularly susceptible to failure, they can be installed near electric devices. They require only low control currents, making small line cross-sections sufficient. The switching and amplifier function of a relay could only be achieved with a lot more effort and a lot less reliability using more "modern" electronics. Another benefit of the relay is that it is quick and easy to replace. These positive characteristics are the reason why relays are still in use. And they ensure that, in the future, relays will still be at home in many vehicles.

Quality relays from HELLA – versatile and reliable

- **Manufacturing expertise:**
HELLA produces more than 100 million units per year at its own facilities – thanks to optimised production at an attractive price and with one of the lowest failure rates in the entire industry.
- **Flexibility:**
Large volumes are produced in a fully automated process, small volumes with semi-automation. This means we are in a position to change over quickly to semi-automatic production. HELLA is able to respond promptly to customer requirements and create new variants in addition to its existing product range at short notice.
- **OEM customers:**
HELLA develops and produces relays for AGCO, Claas, Daimler AG, Ford, VW, GM, JCB, Opel/Vauxhall, Nissan, John Deere, Chrysler, Jaguar/Land Rover and others. Many of our customer relationships have existed for decades.
- **Production locations:**
Berlin (Germany); Flora, Illinois (USA); Xiamen (China).

1951	First hot-wire flasher unit
1960	A-relay with metal housing. Mechanical threshold voltage controller for windshield wipers
1965	E-relay: the first fully electronic flasher unit
1968	L-relay: the first modular system
1969	Wipe/wash interval control unit
1970	K-relay: current controlled relay for direction indicator lamps Bi-stable relay for switching between low and high beam
1972	Q-relay with plastic base plate, also available with built-in fuse
1973	V-relay: PCB relay for automatic placement
1976	S1-relay: replacement for Q-relay. Can be produced fully automatically, also available with built-in fuse
1978	H-relay: high-power relay for different motor loads
1982	Sounding relay for controlling direction indicator lamps
1989	Round connector relay: specially produced for Daimler AG, with plastic housing
1994	Micro relay: designed for fully automated production
1998	Mini solid state relay
2003	Bi-stable battery disconnect relay with flexible attachment system
2005	Micro relay: high-current and bi-stable version
2006	Intelligent flasher units for active LED flashers with current pulse evaluation in acc. with ISO 13207-1
2008	Flasher unit with microprocessor technology
2012	New and refined relay products with lower power consumption to help reduce CO ₂ emissions



How HELLA checks and ensures quality

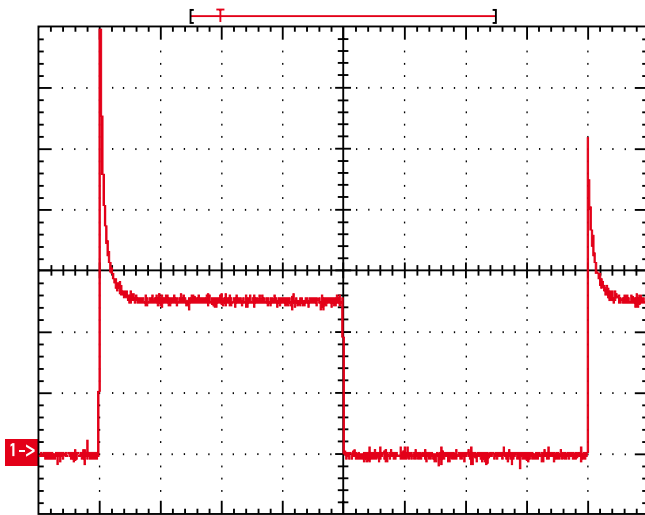
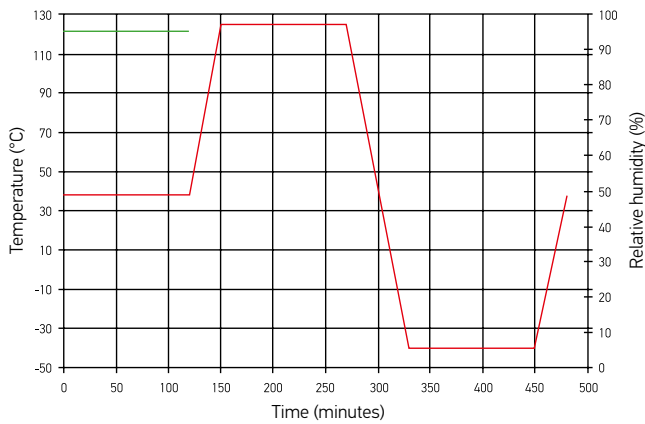

1) Load curve, 20 A resistive 10 A 500 ms

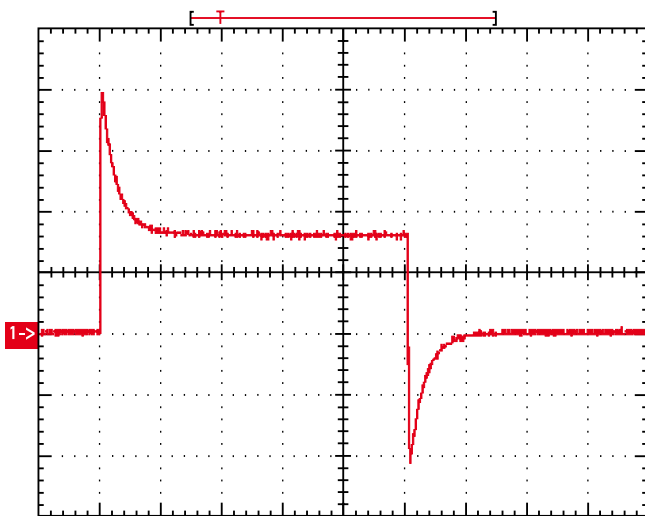

1) Load curve, 3x high beam 10 A 500 ms

■ Design life tests:

The relays are switched on/off in cycles on fully automated test racks. Original loads or simulated resistive, inductive, capacitive or combined loads whose current characteristics are recorded as the original loads are connected. In addition, the relays can be subjected to different ambient temperature ranges or temperature profiles. The test is continuously documented.

■ Electrical parameters:

Within the context of product release, starting voltage, dropout voltage, contact voltage drop, coil resistance and insulation resistance are tested, for example. Accompanying the manufacturing process, the electrical parameters are recorded at the end of the production process by end-of-line testers. These can be evaluated statistically. One important factor for guaranteeing the consistent high quality of the relays produced.

■ Environmental and mechanical tests:

Every relay has to pass tests such as the alternating temperature test, salt spray fog test, mechanical shock test or drop test and the vibration test within the context of the product release process. These tests are carried out using HELLA equipment.

■ Analytical tests:

Here, the materials used and the different connecting processes such as soldering and welding are tested. The tests are carried out randomly during incoming goods testing and following production.

■ Certificates:

HELLA has been certified in a range of relevant areas e.g. DIN EN ISO 9001:2008, ISO / TS 16949:2009, ISO 14001. HELLA relays also comply with the ROHS (2002/95/EC) and REACH standards.

Explanation and uses

Key components of an electromechanical relay



Legend

- | | |
|---------------------------|--|
| 1 Contact plates | 7 Blade terminal (load) made of E-Cu (electrolytic copper) with tin-plated surface |
| 2 Armature | 8 Blade terminal (coil) made of CuZn (brass) with tin-plated surface |
| 3 Pins for coil wire | 9 Base plate |
| 4 Switch contacts | 10 Coil body |
| 5 Coil made of Cu wire | 11 Yoke |
| 6 Iron core (in the coil) | |

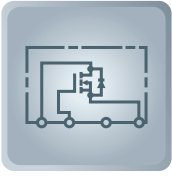

Functional principle

Relays are basically electrically operated switches which use an electromagnet to move a switching mechanism by switching one or more contacts. They are used where one or more load circuits need to be switched on or off by means of a control signal. Characteristic of the electromechanical relay is the complete (galvanic) isolation between the control and controlled circuits.

Make relays

Make relays are used to close an electric circuit between a power source and one or more electrical loads, i.e. the loads are switched on. Relays are operated by means of switches, pulse generators or control devices. Typical vehicle applications are headlights, auxiliary lights and fog lights, horns, heaters, air conditioner systems, etc.

How make relays work

Fig.1) The control circuit (86/85) is inactive and the return spring keeps the armature open. The make contacts are open and the load circuit (30/87) is interrupted.

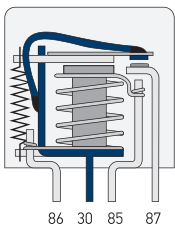

Fig. 1

Fig. 2) The control circuit (86/85) is active and the copper coil induces a magnetic field which pulls the armature down onto the magnetic core. The make contacts are closed and the load circuit (30/87) is therefore also closed.

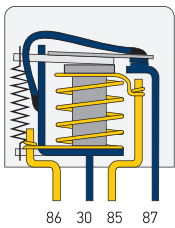

Fig. 2

Change-over relays

Change-over relays switch the load circuit over from one electrical load to another. These relays can be operated by a dashboard switch, for example. Change-over relays are used for switch applications with two stages/speeds such as heated rear windows or fan motors etc.

How change-over relays work

A change-over relay operates on the same principle as a make relay. The only difference is that the armature is connected to a second (alternative) output (87a) when released. As soon as the control circuit is active, the armature is pulled in, opens the break contact (87a) and switches over to the make contact (87). A change-over relay can be used as either a make or a break relay. By design, the switching current of the make contact is always higher than that of the break contact.



Rated voltage

- 12 V: for passenger cars, agricultural and construction machinery etc.
- 24 V: for commercial vehicles, buses, municipal vehicles etc.

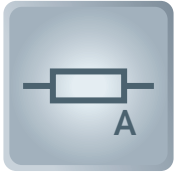

Rated load (depending on load type)

→ Resistive load:

The current remains around the same from switch-on to switch-off (e.g. rear window heater).

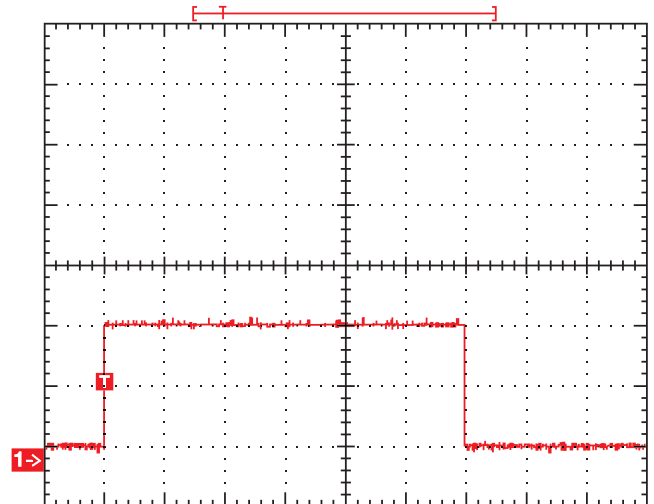

Example load curve, resistive load

→ Inductive load:

The inrush current increases to the rated current with a specific delay time due to the build-up of the inductor's magnetic field and then levels off (e.g. switching on a solenoid switch). During switch-off, a voltage of up to several thousand volts is (theoretically) induced, resulting in an electric arc between the relay contacts just opened.

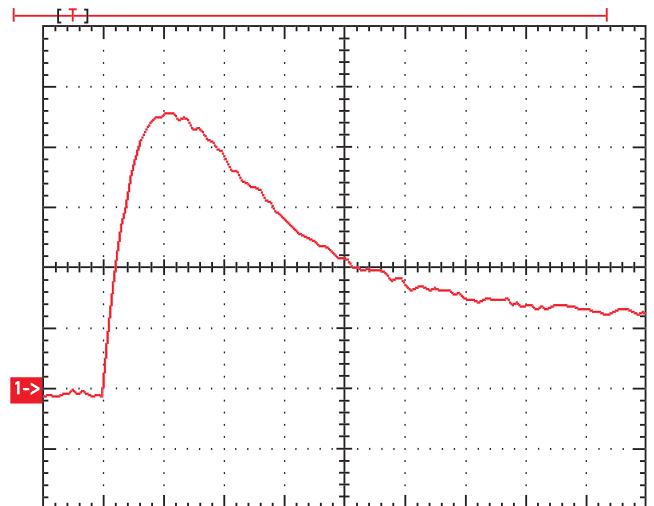

Example load curve, inductive load

→ Capacitive/bulb load:

The inrush current of a capacitive load or a lamp can rise to ten times the rated current before leveling off to the rated current.

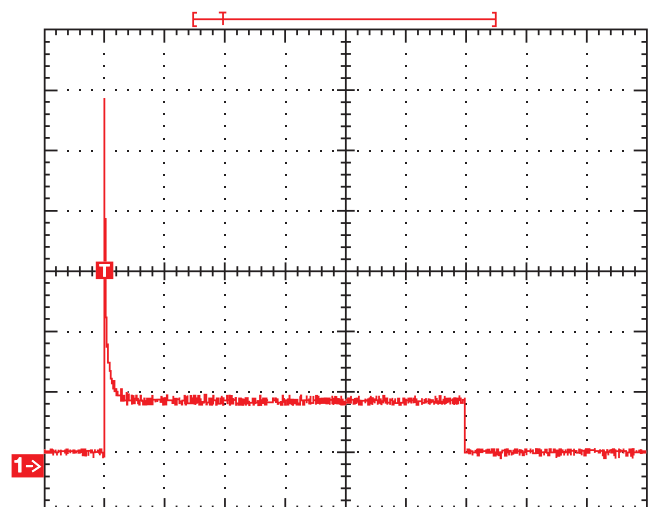

Example load curve, capacitive/bulb load



Coil circuit

In order to prevent voltage spikes caused by mutual inductance when switching off the coil current, our relays are in part equipped with resistors or diodes parallel to the coil.



Contacts and connector configurations

30	Load current +, terminal 15 (input)
85	Relay coil - (input)
86	Relay coil + (input)
87	Load current, make contact (output)
87a	Load current, break contact (output)

Relay types



Mini relays

Mini relays according to ISO 7588-1, blade terminals according to ISO 8092-1.

Contact arrangements: make contact, change-over contact, max. 40 A switching power (make contact), rated voltage: 12 V, 24 V

Areas of application include: headlights, starters, fuel pumps, fan motors, horns and fanfares.



Micro relay

Micro relays according to ISO 7588-3 (1988), blade terminals according to ISO 8092-1.

Contact arrangements: make contact, change-over contact, max. 20 A switching power (make contact), rated voltage: 12 V, 24 V

Areas of application include: fuel pumps, air conditioning systems, windshield washer systems, wiper motors.



High-power relay

Mini relay version with larger dimensions, blade terminals according to ISO 8092-1.

Contact arrangement: make contact, change-over contact, max. 60 A switching power, rated voltage: 12 V, 24 V

Areas of application include: battery disconnect relays, starter motors, glow plugs, ignitions, windshield heating.



Solid state relay

Mini semiconductor relays according to ISO 7588-1, blade terminals according to ISO 8092-1.

Contact arrangement: make contact, max. 22 A switching power (make contact), rated voltage: 12 V

Areas of application include: vacuum pumps for brake booster support, daytime running lights.



Battery disconnect relay

Bi-stable electromechanical relay with one or two coils.

Contact arrangement: make contact, max. 180 A switching power, rated voltage: 12 V

Areas of application include: disconnecting the vehicle electric system from the battery in the event of accidents or for maintenance, retain battery charge by switching off quiescent current







Mini relay 12 V – make contact with holder

Product photo	Resistive load		Inductive load		Bulb load		Pin arrangement	Circuit diagram	Coil resistance [ohm]	Parallel resistance [ohm]	Part number						
	Make contact	Break contact	Make contact	Break contact	Make contact	Break contact											
	15	100	-	-	15	100	-	-	15	100	-	-	A	S10	85	-	4RA 003 530-001 with fuse link 15 A
	25	100	-	-	25	100	-	-	25	100	-	-	A	S10	85	-	4RA 003 530-042 with fuse link 25 A
	40	100	-	-	35	100	-	-	30	100	-	-	B	S2	100	680	4RA 007 791-021
	50	100	-	-	46	75	-	-	44	100	-	-	B3	S2	100	680	4RA 007 793-041 with 9.5 mm load connections
	40	100	-	-	30	100	-	-	30	100	-	-	B2	S6	85	-	4RA 933 791-061 with dual-output
	40	100	-	-	30	100	-	-	30	100	-	-	B2	S8	85	-	4RA 933 791-091 with dual output and parallel diode
	30	100	-	-	30	100	-	-	15	100	-	-	A	S1	90	-	4RA 965 400-001

● Rated switching current (A) at 80°C ambient temperature

▲ Number of switching operations (thousands)

Mini relay 12 V, make contact without holder

Product photo	Resistive load		Inductive load				Bulb load				Pin arrangement	Circuit diagram	Coil resistance [ohm]	Parallel resistance [ohm]	Part number		
	Make contact	Break contact	Make contact	Break contact	Make contact	Break contact	Make contact	Break contact	Make contact	Break contact							
	40	100	-	-	35	100	-	-	30	100	-	-	B	S2	100	680	4RA 007 791-011
	50	100	-	-	46	75	-	-	44	100	-	-	B3	S2	100	680	4RA 007 793-031 with 9.5 mm load connections
	40	100	-	-	30	100	-	-	30	100	-	-	B	S1	85	-	4RA 933 332-101
	40	100	-	-	30	100	-	-	30	100	-	-	B2	S6	85	-	4RA 933 332-151 with dual-output
	40	100	-	-	30	100	-	-	30	100	-	-	B	S2	85	560	4RA 933 332-211
	40	100	-	-	30	100	-	-	30	100	-	-	B	S3	85	-	4RA 933 332-221 with parallel diode
	30	100	-	-	30	100	-	-	16	100	-	-	A	S1	90	-	4RA 965 400-017

● Rated switching current (A) at 80°C ambient temperature

▲ Number of switching operations (thousands)

Mini relay 12 V, change-over contact with holder

Product photo	Resistive load		Inductive load		Bulb load		Pin arrangement	Circuit diagram	Coil resistance [ohm]	Parallel resistance [ohm]	Part number						
	Make contact	Break contact	Make contact	Break contact	Make contact	Break contact											
	30	100	20	100	20	100	5	300	30	100	10	100	B1	W2	100	680	4RD 007 794-031
	30	100	20	100	20	100	6	60	20	100	10	100	B1	W1	85	-	4RD 933 332-011
	30	100	20	100	20	100	6	60	20	100	10	100	B1	W2	85	560	4RD 933 332-031 Dust and waterproof, IP 6K7 / IP 6K9K*
	30	100	20	100	20	100	6	60	20	100	10	100	B1	W1	85	-	4RD 933 332-041
	30	100	20	100	20	100	6	60	20	100	10	100	B1	W1	85	-	4RD 933 332-237
	30	100	20	100	20	100	6	60	20	100	10	100	B1	W3	85	-	4RD 933 332-277 with parallel diode

● Rated switching current (A) at 80°C ambient temperature

▲ Number of switching operations (thousands)

* in conjunction with mating connector 8JD 745 801-001/-011

Mini relay 12 V, make contact without holder





Product photo	Resistive load		Inductive load		Bulb load		Pin arrangement	Circuit diagram	Coil resistance [ohm]	Parallel resistance [ohm]	Part number						
	Make contact	Break contact	Make contact	Break contact	Make contact	Break contact											
	30	100	20	100	20	100	5	300	30	100	10	100	B1	W2	100	680	4RD 007 794-021
	30	100	20	100	20	100	5	300	30	100	10	100	B1	W3	100	-	4RD 007 794-041 with parallel diode
	30	100	20	100	20	100	5	300	30	100	10	100	B1	W2	100	680	4RD 007 794-077
	30	100	20	100	20	100	6	60	20	100	10	100	B1	W3	85	-	4RD 933 332-021 with parallel diode
	30	100	20	100	20	100	6	60	20	100	10	100	B1	W1	85	-	4RD 933 332-051
	30	100	20	100	20	100	6	60	20	100	10	100	B1	W2	85	560	4RD 933 332-177 Dust and waterproof, IP 6K7 / IP 6K9K*
	30	100	15	100	33	150	20	150	16	100	8	100	A1	W3	95	-	4RD 965 400-027 with parallel diode

● Rated switching current (A) at 80°C ambient temperature

▲ Number of switching operations (thousands)

* in conjunction with mating connector 8JD 745 801-001/-011





Mini relay 24 V – make contact with holder

Product photo	Resistive load		Inductive load				Bulb load				Pin arrangement	Circuit diagram	Coil resistance [ohm]	Parallel resistance [ohm]	Part number		
	Make contact	Break contact	Make contact	Break contact	Make contact	Break contact	Make contact	Break contact	Make contact	Break contact							
	15	100	-	-	15	100	-	-	15	100	-	-	A	S10	315	-	4RA 003 530-051 with fuse link 15 A
	20	150	-	-	16	100	-	-	16	135	-	-	B	S2	305	1200	4RA 007 957-011
	20	250	-	-	16	100	-	-	16	250	-	-	B2	S6	350	-	4RA 933 791-071 with dual-output
	30	250	-	-	16	100	-	-	16	250	-	-	A	S1	360	-	4RA 965 400-031

● Rated switching current (A) at 80°C ambient temperature

▲ Number of switching operations (thousands)

Mini relay 24 V, make contact without holder

Product photo	Resistive load		Inductive load				Bulb load				Pin arrangement	Circuit diagram	Coil resistance [ohm]	Parallel resistance [ohm]	Part number		
	Make contact	Break contact	Make contact	Break contact	Make contact	Break contact	Make contact	Break contact	Make contact	Break contact							
	20	150	-	-	16	100	-	-	16	135	-	-	B	S2	305	1200	4RA 007 957-001
	40	100	-	-	30	100	-	-	30	100	-	-	B3	S1	360	-	4RA 933 321-021
	20	250	-	-	16	100	-	-	16	250	-	-	B	S1	350	-	4RA 933 332-111
	20	250	-	-	16	100	-	-	16	250	-	-	B2	S6	350	-	4RA 933 791-081

● Rated switching current (A) at 80°C ambient temperature

▲ Number of switching operations (thousands)





Mini relay 24 V, change-over contact with holder

Product photo	Resistive load		Inductive load		Bulb load		Pin arrangement	Circuit diagram	Coil resistance [ohm]	Parallel resistance [ohm]	Part number						
	Make contact	Break contact	Make contact	Break contact	Make contact	Break contact											
	20	150	10	100	16	100	10	100	16	135	5	135	B1	W2	305	1200	4RD 007 903-011
	20	100	10	100	16	100	8	100	15	135	5	135	B1	W1	350	-	4RD 933 332-061
	20	100	10	100	16	100	8	100	15	135	5	135	B1	W3	350	-	4RD 933 332-081 with parallel diode

● Rated switching current (A) at 80°C ambient temperature

▲ Number of switching operations (thousands)

Mini relay 24 V, make contact without holder



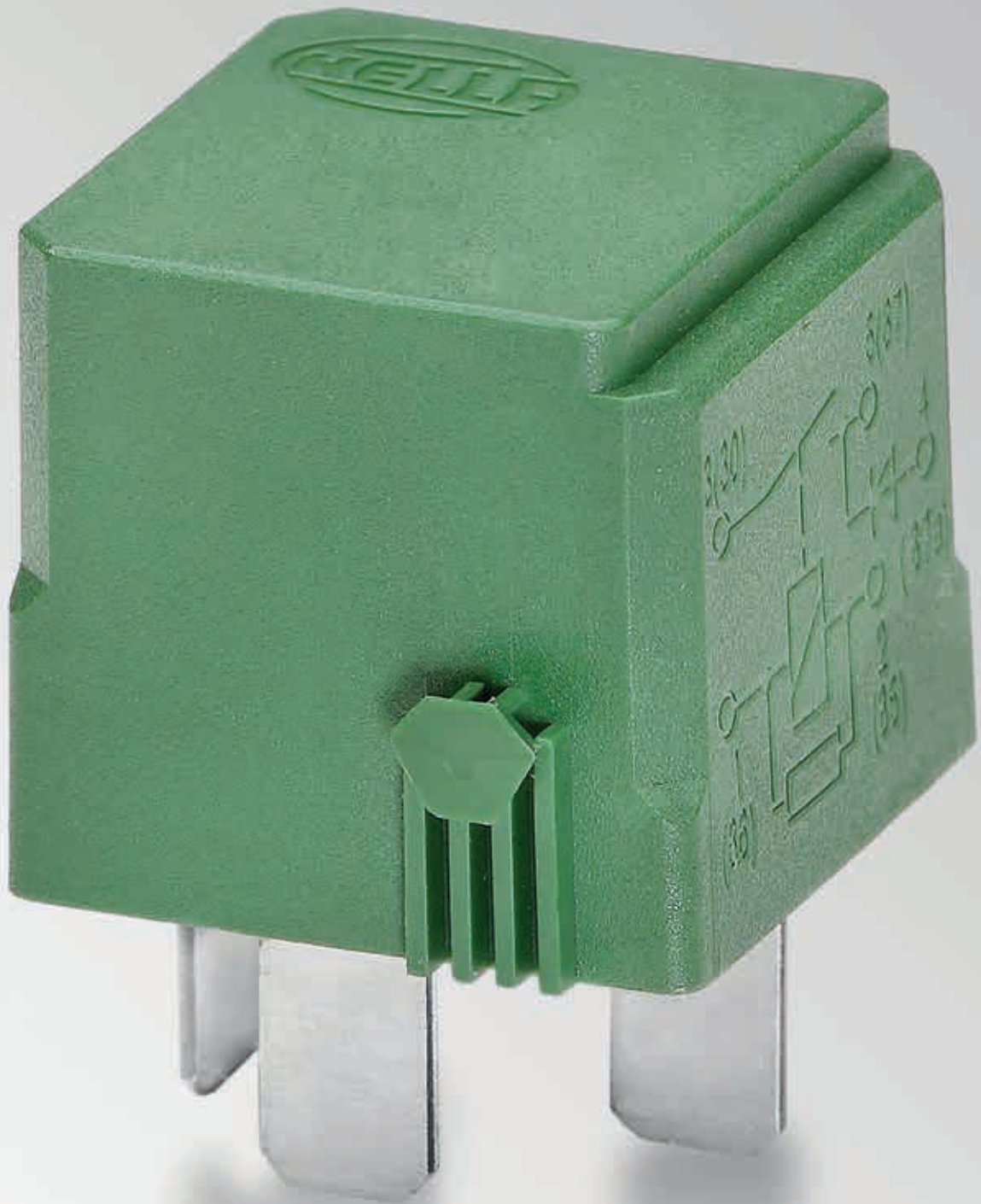

Product photo	Resistive load		Inductive load		Bulb load		Pin arrangement	Circuit diagram	Coil resistance [ohm]	Parallel resistance [ohm]	Part number						
	Make contact	Break contact	Make contact	Break contact	Make contact	Break contact											
	20	150	10	100	16	100	10	100	16	135	5	135	B1	W2	305	1200	4RD 007 903-001
	20	150	10	100	16	100	10	100	16	135	5	135	B1	W2	305	-	4RD 007 903-021 with parallel diode
	20	100	10	100	16	100	8	100	15	135	5	135	B1	W1	350	-	4RD 933 332-071
	20	100	10	100	16	100	8	100	15	135	5	135	B1	W3	350	-	4RD 933 332-091 with parallel diode
	20	100	10	100	16	100	8	100	15	135	5	135	B1	W2	350	1200	4RD 933 332-261

● Rated switching current (A) at 80°C ambient temperature

▲ Number of switching operations (thousands)



Micro relay 12V, make contact without holder / change-over contact without holder

Product photo	Resistive load		Inductive load				Bulb load				Pin arrangement	Circuit diagram	Coil resistance [ohm]	Parallel resistance [ohm]	Part number		
	Make contact	Break contact	Make contact	Break contact	Make contact	Break contact	Make contact	Break contact	Make contact	Break contact							
	20	150	-	-	15	150	-	-	16	150	-	-	C	S2	92	470	4RA 007 813-011
	20	100	-	-	20	100	-	-	20	100	-	-	C3	L1	2 x 75	-	4RC 933 364-027 Bi-stable
	20	150	10	150	11	100	11	100	20	100	10	100	C1	W2	92	470	4RD 007 814-011
	35	100	20	100	30	100	10	100	30	100	10	100	C1	W2	140	1000	4RD 933 319-007 with locating lugs

● Rated switching current (A) at 80°C ambient temperature

▲ Number of switching operations (thousands)



Micro relay 24V, change-over contact without holder



Product photo	Resistive load		Inductive load		Bulb load		Pin arrangement	Circuit diagram	Coil resistance [ohm]	Parallel resistance [ohm]	Part number						
	Make contact	Break contact	Make contact	Break contact	Make contact	Break contact											
	● 20	▲ 100	● 10	▲ 100	● 15	▲ 100	● 5	▲ 50	7	100	● 5	▲ 50	C1	W2	360	2700	4RD 933 319-011

- Rated switching current (A) at 80°C ambient temperature
- ▲ Number of switching operations (thousands)





High-power relay 12V, make contact with holder/without holder

Product photo	Resistive load		Inductive load		Bulb load		Pin arrangement	Circuit diagram	Coil resistance [ohm]	Parallel resistance [ohm]	Part number						
	Make contact	Break contact	Make contact	Break contact	Make contact	Break contact											
	60	100	-	-	50	100	-	-	25	50	-	-	B3	S1	85	-	4RA 003 437-081
	60	100	-	-	50	100	-	-	25	50	-	-	B3	S5	85	-	4RA 003 437-101 with parallel and polarity reversal protection diode
	60	100	-	-	50	100	-	-	25	50	-	-	B3	S1	85	-	4RA 003 437-111

 Rated switching current (A) at 80°C ambient temperature
 Number of switching operations (thousands)

High-power relay 24V, make contact with holder/without holder



Product photo	Resistive load		Inductive load		Bulb load		Pin arrangement	Circuit diagram	Coil resistance [ohm]	Parallel resistance [ohm]	Part number						
	Make contact	Break contact	Make contact	Break contact	Make contact	Break contact											
	60	100	-	-	50	100	-	-	25	50	-	-	B3	S1	310	-	4RA 003 437-091
	60	100	-	-	50	100	-	-	25	50	-	-	B3	S1	310	-	4RA 003 437-121

● Rated switching current (A) at 80°C ambient temperature

▲ Number of switching operations (thousands)



Battery disconnect relay and solid state relay 12V, make contact

Product photo	Resistive load		Inductive load		Bulb load		Pin arrangement	Circuit diagram	Coil resistance [ohm]	Parallel resistance [ohm]	Part number						
	Make contact	Break contact	Make contact	Break contact	Make contact	Break contact											
	180	15	-	-	180	15	-	-	180	15	-	-	BDR1	L3	2 x 5	-	4RC 011 152-007 with parallel diode
	150	50	-	-	150	50	-	-	150	50	-	-	BDR2	L4	2 x 2.34	-	4RC 011 152-011
	22	1000	-	-	22	1000	-	-	22	1000	-	-	B	SSR1	-	-	4RA 007 865-031

● Rated switching current (A) at 80°C ambient temperature

▲ Number of switching operations (thousands)

Summary of battery disconnect and solid state relays



Battery disconnect relay

- Disconnects the vehicle electric system from the battery, as a component of vehicle electric system control units and pre-fuse devices
- Battery charge is maintained by avoiding quiescent current: large vehicle electric system parts are switched off during longer periods of vehicle standstill
- Voltage to the vehicle electric system or its parts is interrupted for maintenance work
- Safety switch-off in the event of an accident or cable damage to avoid fire hazard

Advantages:

- **Mechanically bi-stable switching unit:**
Impulse at the closing coil closes the contacts, these are stopped mechanically, impulse at the opening coil opens the contacts
- Contact bridge double breaking
- All load circuit components with large cross-section (>30 mm²) for high continuous current carrying capacity
- **Coil terminal:**
2-pole or 4-pole AMP connector

Solid state relay

- Semi-conductor relays, designed for resistive, lamp and inductive loads
- Pulse width modulation (PWM) makes controlled power regulation of loads (up to 1 kHz) possible
- Maximum switching safety, particularly suitable for all safety-related switching functions
- In terms of design size and plug matrix, compatible with conventional ISO mini relays (standardised dimensions according to ISO 7588-1)
- Silent switching e.g. in the passenger compartment
- Resistant to short-circuit and excess load
- Resistant to reverse polarity
- Impact and vibration-resistant
- Sealed and waterproof
- Overheating protection
- Low quiescent current

The solid state relay is a modern semi-conductor switch and makes switching possible without moving parts. It can be connected via standardised pin bases.

With this development, HELLA is doing justice to the increasing trend of controlling loads (e.g. fan motors, glow plugs, headlights and heaters) using power regulation. The increased switching frequency makes continual setting by means of pulse width modulation (PWM) possible e.g. for daytime running lights.

The silent semi-conductor relay is particularly attractive for use inside vehicles. In addition, the wear and bounce-free switching means it can be used for applications with a high number of switching processes e.g. ABS or air-conditioning compressor clutch or vacuum pump for brake booster support in hybrid vehicles made by leading OEMs.

High-power relay		Micro relay		Solid state relay		Battery disconnect relay
12 V	24 V	12 V		24 V	12 V	12 V
4RA 003 437-...	4RA 003 437-...	4RA 007 813-... 4RD 007 814-... 4RD 933 319-...	4RC 933 364-...	4RD 933 319-...	4RA 007 865-... 4RA 931 773-...	4RC 011 152-...

13.5 V	27 V	13.5 V	13.5 V	27 V	13.5 V	13.5 V
+23°C ± 5°C	+23°C ± 5°C	+23°C ± 5°C	+23°C ± 5°C	+23°C ± 5°C	+23°C ± 5°C	+23°C ± 5°C
-40°C ... +85°C	-40°C ... +85°C	-40°C ... +125°C	-40°C ... +105°C	-40°C ... +125°C	-40°C ... +125°C	-30°C ... +85°C
-40°C ... +125°C	-40°C ... +125°C	-40°C ... +130°C	-40°C ... +125°C	-40°C ... +85°C	-40°C ... +150°C	-30°C ... +85°C

9.5 x 1.2 mm	9.5 x 1.2 mm	6.3 x 0.8 mm	6.3 x 0.8 mm	6.3 x 0.8 mm	6.3 x 0.8 mm	2-pole/4-pole AMP, M8/M10 screw bolts
6.3 x 0.8 mm	6.3 x 0.8 mm	4.8 x 0.8 mm	4.8 x 0.8 mm	4.8 x 0.8 mm	6.3 x 0.8 mm	
6.3 x 0.8 mm	6.3 x 0.8 mm	4.8 x 0.8 mm	4.8 x 0.8 mm	4.8 x 0.8 mm	6.3 x 0.8 mm	
9.5 x 1.2 mm	9.5 x 1.2 mm	6.3 x 0.8 mm	6.3 x 0.8 mm	6.3 x 0.8 mm	6.3 x 0.8 mm	
-	-	4.8 x 0.8 mm	4.8 x 0.8 mm	4.8 x 0.8 mm	-	

12 V	24 V	12 V	12 V	24 V	12 V	12 V
8 V ... 16 V	16 V ... 30 V	8 V ... 16 V	8 V ... 16 V	16 V ... 30 V	8 V ... 16 V	8 V ... 16 V
< 7.5 V	< 17 V	< 8 V	< 6 V	< 14.4 V	< 9 V	< 6.5 V
< 1 V	> 5 V	< 1 V	-	< 2.4 V	< 12.5 V	> 3 V
85 Ohm ± 10%	310 Ohm ± 10%	92 / 140 Ohm ± 10%	2 x 75 Ohm ± 10%	360 Ohm ± 10%	-	1 x 2.34 / 2 x 4.3 ± 10%
< 10 ms	< 10 ms	< 10 ms	< 5 ms	< 10 ms	< 150 µs	< 20 ms
< 10 ms	< 10 ms	< 10 ms	< 5 ms	< 10 ms	< 75 µs	< 20 ms
> 100 MOhm	> 100 MOhm	> 100 MOhm	> 100 MOhm	> 100 MOhm	-	> 100 MOhm
> 1000 VDC	> 1000 VDC	> 500 VDC / VAC	> 800 VDC	> 500 VAC	-	> 500 VAC

< 3 mV/A	< 3 mV/A	< 10 mV/A	< 5 mV/A	< 10 mV/A	-	< 2.5 mV/A
-	-	< 10 mV/A	-	< 10 mV/A	-	-
< 10 mV/A	< 10 mV/A	< 25 mV/A	< 10 mV/A	< 25 mV/A	-	< 2.5 mV/A
-	-	< 25 mV/A	-	< 25 mV/A	-	-
1 A / 6 V	1 A / 6 V	1 A / 6 V	1 A / 6 V	1 A / 6 V	1 A / 6 V	1 A / 6 V
10 ⁷	10 ⁷	10 ⁷	10 ⁷	10 ⁷	-	2 x 10 ⁵

Climatic and mechanical tests

Vibration test

DIN EN 600 68-2-6; test: Fc (sinusoidal);
20–200 Hz, 5 g, 6 h per axis

Damp/heat test, constant

DIN EN 600 68-2-78, test: Cab;
Upper temperature: +55°C, 93% rel. hum., 56 d

Shock test

DIN EN 600 68-2-27; test: Ea (semi-sinusoidal);
max. 50 g, 11 ms, 1,000 shocks per direction

Temperature cycle test

DIN EN ISO 600 68-2-14, test; Nb;
-40°C / +85°C (5°C per minute), 10 cycles

Corrosion test

DIN EN 600 68-2-42; test: Kc;
10 ± 2 cm³/m³ SO₂, +25°C, 75 % rel. hum., 10 d

Condensation-water test

DIN EN ISO 6988;
+40°C, 0.2 dm³ SO₂, 6 cycles (24 h cycle),
Storage: 8 h per cycle

Damp/heat test, cyclic

DIN EN 600 68-2-30, test: Db, variant 1;
Upper temperature: +55°C, min. 90% rel. hum., 6 cycles

Protection class

IP54 according to ISO 20653

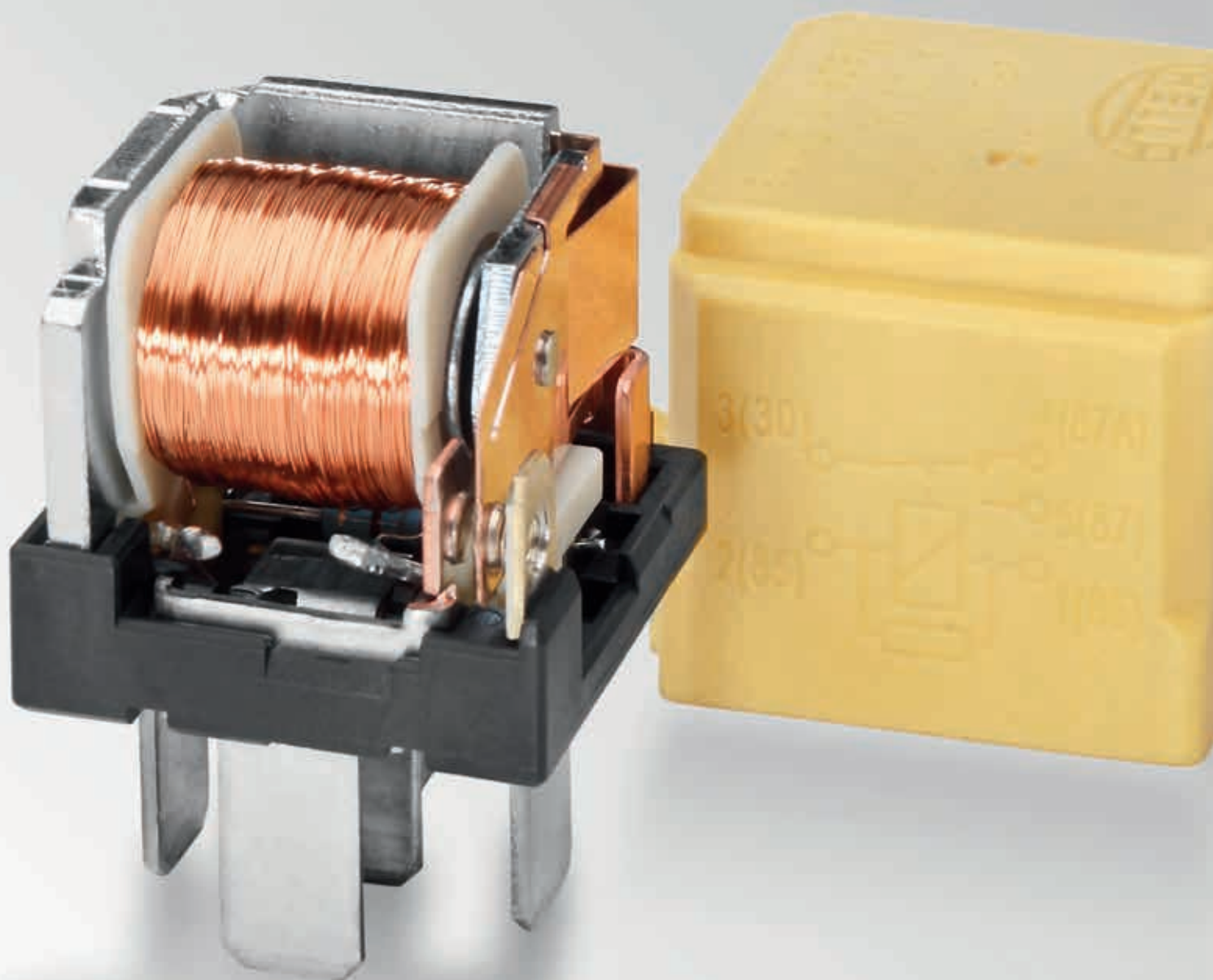

Explanation and uses

Key components of a flasher unit

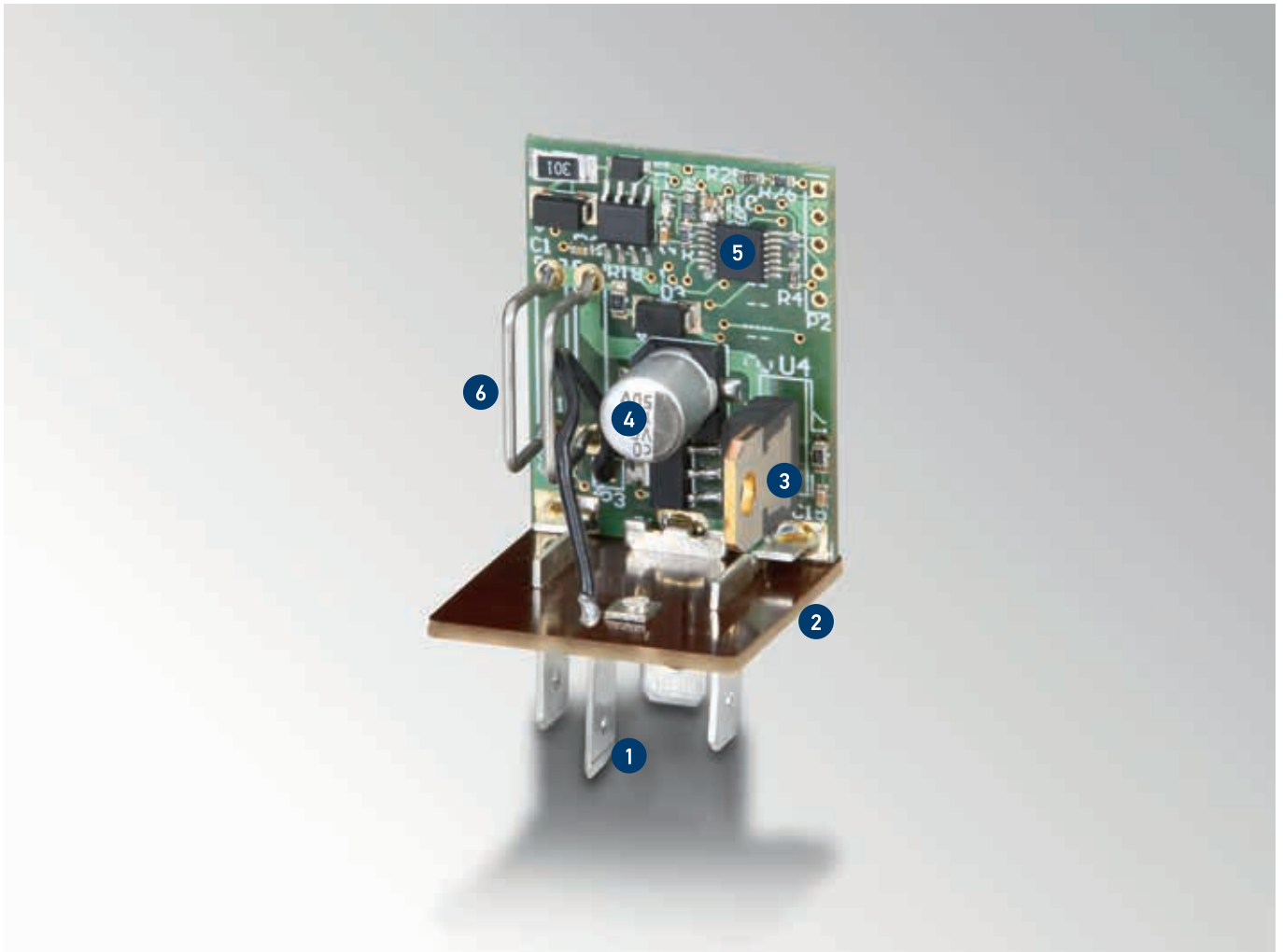

Legend

- 1 Blade terminal made of E-Cu with tin-plated surface
- 2 Base plate
- 3 Power transistor
- 4 Capacitor
- 5 IC module
- 6 Measuring resistor for flasher current

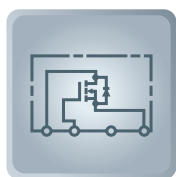

Functional principle

- In terms of circuitry, every flasher unit is an “astable multivibrator”. Its role is to operate blinker lights at the statutory frequency of 1.5 +/- 0.5 Hz or 90 +/- 30 rpm. This value applies to both directional and hazard warning lights.
- Each flasher unit is assigned a separate output load or a permissible number of flashing indicator lights. This specific load case variant may not be exceeded or undercut, as otherwise the failure control will fail to work correctly. Some typical load cases which are supported are shown below:

Scenario	Direction flashing	Hazard warning flashing	Pictogram
Towcar only	2 x 21 W	4 x 21 W	
	2 x 21 W + 0 ... 5 W	4 x 21 W + 2 x 5 W	
Towcar + 1 trailer	2 + 1 x 21 W	6 x 21 W	
	2 + 1 x 21 W + 0 ... 5 W	6 x 21 W + 2 x 5 W	
	3 + 1 x 21 W	8 x 21 W	
	3 + 1 x 27 W (32 CP) + 3 W (SAE)	8 x 27 W (32 CP) + 2 x 3 W (SAE)	–
	4 + 1 x 21 W	10 x 21 W	
Towcar + 2 trailers	2 + 1 + 1 x 21 W	8 x 21 W	

In addition to the load cases above, there are other use cases which do not feature failure control. These variants can be found in the tabular overview from page 38 on.

- The failure of an indicator light must be clearly displayed to the driver. The law permits failure control by doubling the flashing frequency (E-control) or the indicator control lamp remaining off (P-control). The failure control applies to motor vehicles and all trailers.
- Segmentation into different current and control circuits is typical of flashing circuits. We distinguish between:
 - Single-circuit flasher units
 - Dual-circuit flasher units
 - Three-circuit flasher units
 - Pulse generators
- In addition to the flasher circuits listed above, HELLA also supplies pulse generators. In principle, these are flasher units without failure control. In contrast to the above types, pulse generators can be operated with small loads (e.g. 10 W).



Rated voltage

- 6 V: for motorbikes etc.
- 12 V: for passenger cars, agricultural and construction machinery etc.
- 24 V: for commercial vehicles, buses, municipal vehicles etc.

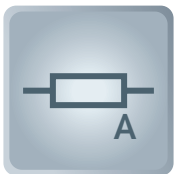

Rated load, rated switching current (depending on load case)

- The number of connected flashing indicator lamps must not exceed the use cases/rated loads indicated for the respective flasher units
- Special-purpose variants available for LED lights



Contacts and connector configurations

Single-circuit flasher unit

C	Towcar failure control lamp
C2	1st trailer failure control lamp
C3	2nd trailer failure control lamp
31	Ground
49	Input
49a	Output

Dual-circuit flasher unit

L	Indicator, left (input)
R	Indicator, right (input)
LL	Towcar indicator, left
RL	Towcar indicator, right
C	Towcar failure control lamp
C2	1st trailer failure control lamp
31	Ground
49	Input
49a	Output
54L	Trailer indicator, left
54R	Trailer indicator, right

Three-circuit flasher unit

L	Indicator, left (input)
R	Indicator, right (input)
LLH	Towcar indicator, left rear
LLV	Towcar indicator, left front
RLH	Towcar indicator, right rear
RLV	Towcar indicator, right front
C	Towcar failure control lamp
C2	1st trailer failure control lamp
C3	2nd trailer failure control lamp
31	Ground
49	Input
49a	Output
54L	Trailer indicator, left
54R	Trailer indicator, right

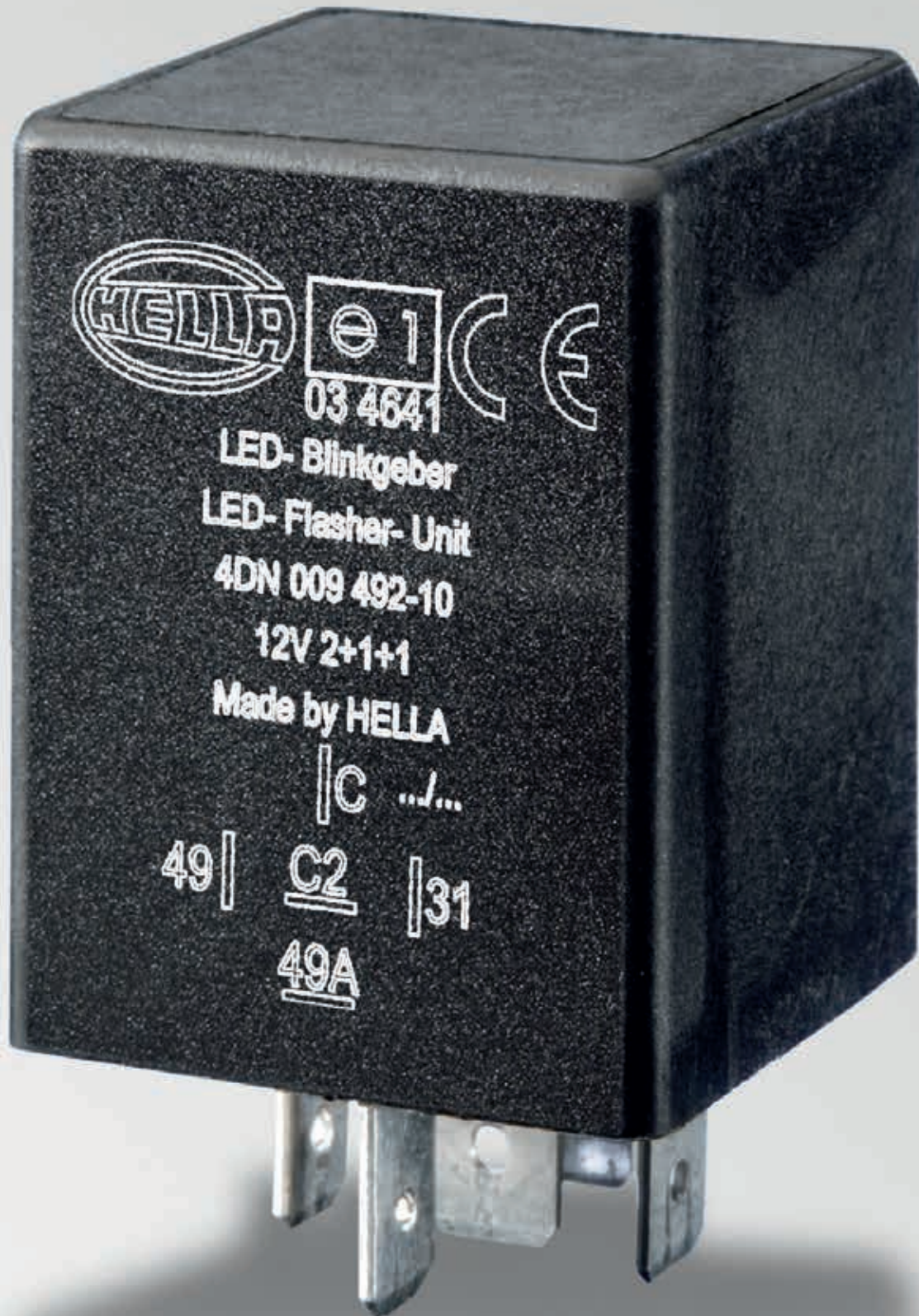

Test circuits

The single-circuit test circuit

Single-circuit units are used in load cases (per 21 W bulb) 2x, 4x, 5x, 2+1, 3+1, 2+1+1 for passenger cars, light commercial vehicles and tow vehicles. It is not possible to distinguish between the failure of a lamp on the towcar or on the trailer, as there is only one measuring resistor for the load current.

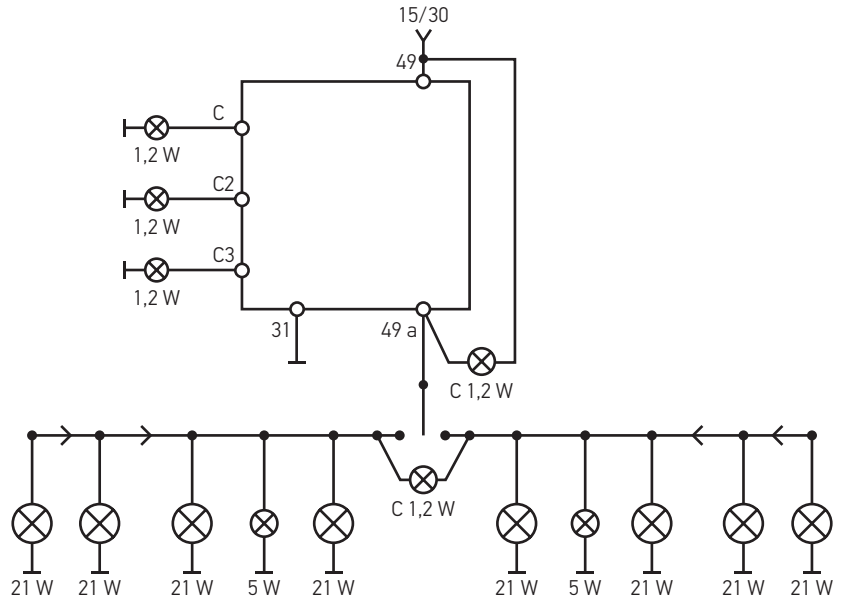

Load case variant	Control types:		
	Towcar	1st trailer	2nd trailer
2 (4) x 21 W + 5 W 12 V	E, P	-	-
2 + 1 (6) x 21 W + 5 W 12 / 24 V	E, P	P	-
3 + 1 (8) x 21 W 12 / 24 V	P	P	-
2 + 1 + 1 (8) x 21 W 12 V	P	P	P

The dual-circuit test circuit

Dual-circuit units (separate test circuits for trailer and towcar) are typical in large commercial vehicles and help to minimise power losses caused by long cables and numerous connectors.

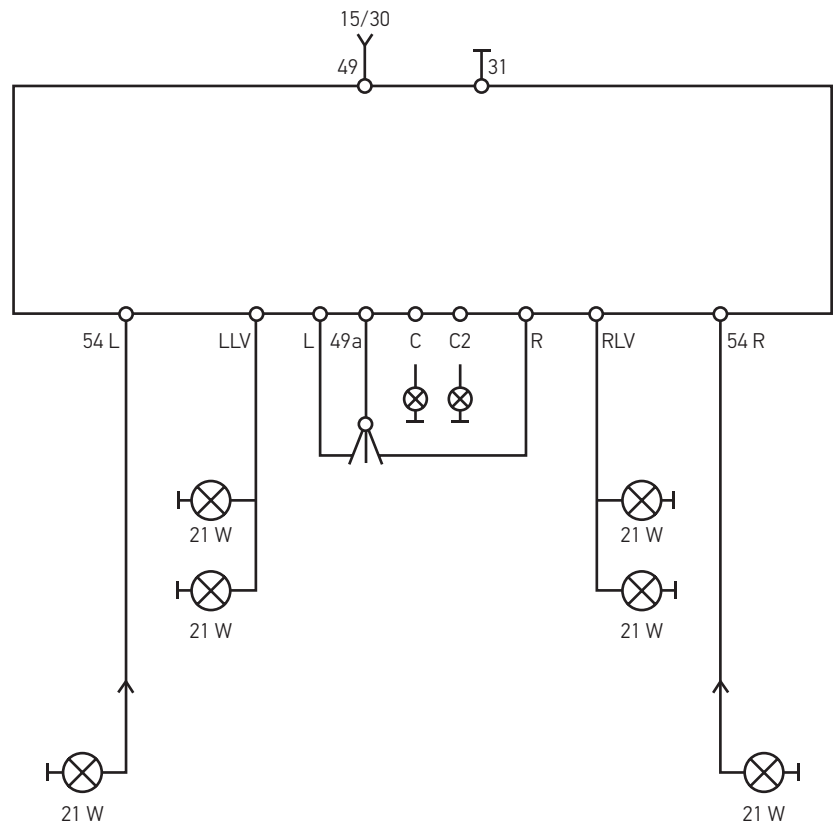

Load case variant	Control types:	
	Towcar	1st trailer
2 + 1 (6) x 21 W 12 / 24 V	E, P	P
3 + 1 (8) x 21 W 12 / 24 V	E, P	P

The three-circuit test circuit



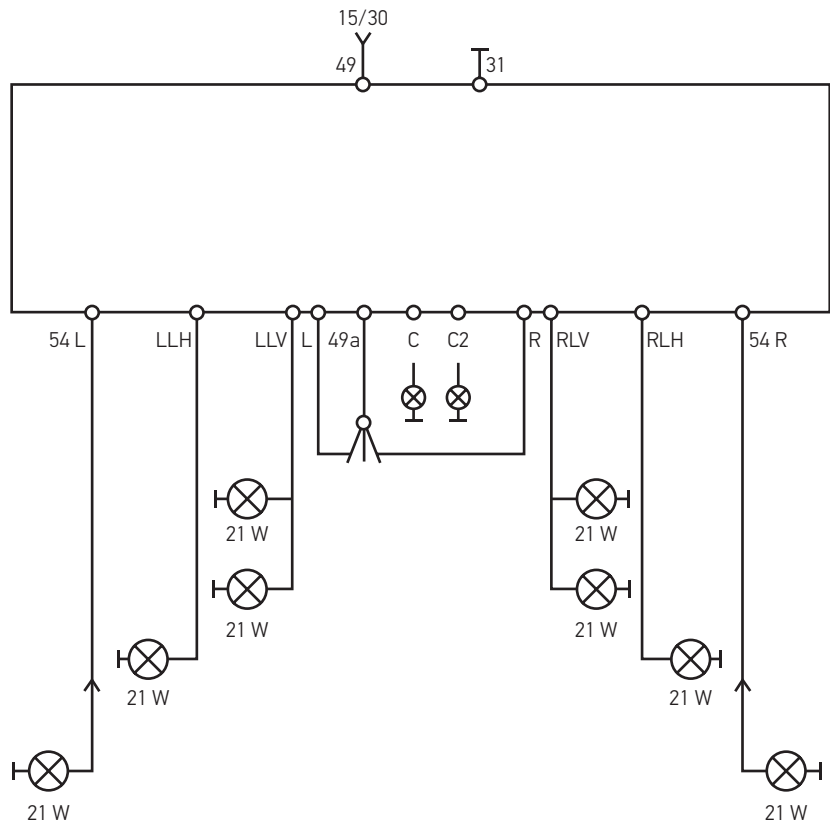

Three-circuit units (separate test circuits for front and rear indicators of the towcar and of the trailer) are useful for commercial vehicles and buses and help to minimise power losses caused by long cables and numerous connectors.

Due to the complexity of wiring, they are less common.



Load case variant	Control types:	
	Towcar	1st trailer
1 + 1... 3 + 1... 3 x 21 W 24 V	P	P
1 + 1... 3 + 1... 3 x 21 W 24 V	P	P

Flasher unit 6V, 4-pole and 12V, 3-pole

Product photo	Load case/rated power		Flashing frequency [per minute]*	Bright-light time [%]*	Failure control			Pin arrangement	Voltage range [V]	Temperature range [°C]	Holder	Part number
	Direction flashing	Hazard warning flashing			C	C2	C3					
	1 to 5 x 18/21 W	10 to 110 W	90 ± 15	46.5 ± 8.5	-	-	-	BG	5 to 7.5	-40 to +85	Included	4AZ 003 787-051 Universal, pulse generator, without failure control Not permitted under StVZO (German Road Vehicle Registration Regulation)
	10 to 140 W	10 to 140 W	90 ± 15	50 ± 8	E	-	-	BG1	9 to 16	-40 to +85	Included	4AZ 001 879-041 Universal, pulse generator, without failure control Not permitted under StVZO (German Road Vehicle Registration Regulation)
	2 x 21 W + 0 to 5 W	4 x 21 W + 2 x 5 W	90 ± 30	50 ± 5	E	-	-	BG1	10 to 15	-40 to +85	Included	4DB 003 750-721
	2 x 21 W + 5 W 2 x 32 cp + 5 W	4 x 21 W + 2 x 5 W	90 ± 15	50 ± 10	E	-	-	BG1	9 to 16	-40 to +85	No	4DB 003 750-391
	2 x 10 W	4 x 10 W	90 ± 30	57.5 ± 17.5	E	-	-	BG1	10 to 15	-40 to +85	No	4DB 003 750-707 For motorbikes

* at room temperature and test voltage

C = Towcar
C2 = 1st trailer
C3 = 2nd trailer





Flasher unit 12V, 3-pole

Product photo	Load case/rated power		Flashing frequency [per minute]*	Bright-light time [%]*	Failure control			Pin arrangement	Voltage range [V]	Temperature range [°C]	Holder	Part number
	Direction flashing	Hazard warning flashing			C	C2	C3					
	2 x 21 W + 0 to 5 W	4 x 21 W + 2 x 5 W	90 ± 30	50 ± 5	E	-	-	BG1	10 to 15	-40 to +85	No	4DB 003 750-711
	10 W + 16 W	2 x 10 W + 2 x 16 W	87.5 ± 12.5	50 ± 3	E	-	-	BG1	9 to 16	-40 to +85	No	4DB 003 750-737 For motorbikes
	2 + 1 x 21 W + 5 W	6 x 21 W + 2 x 5 W	87 ± 18	50 ± 3	E	P	-	BG1	10 to 15	-30 to +60	No	4DM 005 698-021 31 + C2 on top of housing
	2 x 21 W + 0 to 5 W	4 x 21 W + 2 x 5 W	80 ± 15	50 ± 10	E	-	-	BG2	11 to 15	-20 to +60	Included	4DB 001 887-041
	2 + 1 x 21 W + 0 to 5 W	6 x 21 W + 2 x 5 W	87.5 ± 12.5	50 ± 3	E	P	-	BG3	9 to 16	-40 to +85	Included	4DM 003 360-021 31 + C2 on top of housing

* at room temperature and test voltage

C = Towcar
C2 = 1st trailer
C3 = 2nd trailer

Flasher unit 12V, 4-pole

Product photo	Load case/rated power		Flashing frequency [per minute]*	Bright-light time [%]*	Failure control			Pin arrangement	Voltage range [V]	Temperature range [°C]	Holder	Part number
	Direction flashing	Hazard warning flashing			C	C2	C3					
	3 + 1 x 21 W	8 x 21 W	85 ± 15	50 ± 3	E	P	-	BG3	10 to 15	-25 to +75	No	4DW 003 390-01
	10 to 200 W	10 to 200 W	82.5 ± 12.5	52 ± 3	-	-	-	BG	9 to 16	-40 to +85	Included	4AZ 003 787-081 Universal, pulse generator, without failure control Not permitted under StVZO (German Road Vehicle Registration Regulation)
	3 + 1 x 21 W	8 x 21 W	90 ± 20	50.5 ± 4.5	E	P	-	BG3	9 to 16	-40 to +85	No	4DW 004 639-077
	2 + 1 x 21 W + 5 W	6 x 21 W + 2 x 5 W	87 ± 18	50 ± 3	E	P	-	BG4	10 to 15	-30 to +60	No	4DM 005 698-011 31 + C2 on top of housing
	2 x 21 W + 0 to 5 W	4 x 21 W + 2 x 5 W	87.5 ± 12.5	50 ± 3	E	-	-	BG4	10 to 15	-40 to +70	No	4DB 007 218-001

* at room temperature and test voltage

C = Towcar
C2 = 1st trailer
C3 = 2nd trailer

Flasher unit 12V, 5-pole/6-pole

Product photo	Load case/rated power		Flashing frequency [per minute]*	Bright-light time [%]*	Failure control			Pin arrangement	Voltage range [V]	Temperature range [°C]	Holder	Part number
	Direction flashing	Hazard warning flashing			C	C2	C3					
	2 + 1 x 21 W + 5 W	6 x 21 W + 2 x 5 W	85 ± 15	50 ± 3	P	P	-	BG5	11 to 15	-30 to +60	Yes	4DM 003 460-021
	3 + 1 x 27 W + 3 W 3 + 1 x 32 cp + 3 W	8 x 27 W + 2 x 3 W	97 ± 10	50 ± 5	-	-	-	BG8	10 to 15	-30 to +70	Included	4AZ 006 252-021 Universal, pulse generator, without failure control Not permitted under StVZO (German Road Vehicle Registration Regulation) For SAE
	2 + 1 + 1 x 21 W	8 x 21 W	90 ± 15	50 ± 5	E	P	P	BG7	9 to 16	-40 to +85	No	4DN 008 768-001
	2 + 1 + 1 x 21 W	8 x 21 W	90 ± 15	50 ± 5	E	P	P	BG7	9 to 16	-40 to +85	Yes	4DN 008 768-011
	2 + 1 + 1 x 21 W	8 x 21 W	90 ± 15	50 ± 5	E	P	P	BG7	9 to 16	-40 to +85	Yes	4DN 008 768-021

* at room temperature and test voltage

C = Towcar
C2 = 1st trailer
C3 = 2nd trailer

Flasher unit 12V, 6-pole/7-pole

Product photo	Load case/rated power		Flashing frequency [per minute]*	Bright-light time [%]*	Failure control			Pin arrangement	Voltage range [V]	Temperature range [°C]	Holder	Part number
	Direction flashing	Hazard warning flashing			C	C2	C3					
	2 + 1 + 1 x 21 W	8 x 21 W	90 ± 15	50 ± 5	E	P	P	BG7	9 to 16	-40 to +85	Yes	4DN 008 768-031 Holder angled at 90°
	2 + 1 + 1 x 21 W	8 x 21 W	90 ± 15	50 ± 5	E	P	P	BG7	9 to 16	-40 to +85	Yes	4DN 008 768-041 Holder angled at 90°, with vibration damper
	2 + 1 + 1 x 18 W	8 x 18 W	90 ± 15	50 ± 5	E	P	P	BG7	9 to 16	-40 to +85	Yes	4DN 008 768-051 Holder angled at 90°, with vibration damper
	2 + 1 + 1 x 21 W	8 x 21 W	90 ± 30	52.5 ± 22.5	P	P	P	BG7	10.8 to 15	-40 to +85	Yes	4DN 996 173-017
	2 x 21 W + 0 to 5 W	4 x 21 W + 2 x 5 W	87.5 ± 17.5	52.5 ± 7.5	E	-	-	BG10	9 to 16	-40 to +85	Included	4DB 006 716-041

* at room temperature and test voltage

C = Towcar
C2 = 1st trailer
C3 = 2nd trailer





Flasher unit 24V, 3-pole/4-pole

Product photo	Load case/rated power		Flashing frequency [per minute]*	Bright-light time [%]*	Failure control			Pin arrangement	Voltage range [V]	Temperature range [°C]	Holder	Part number
	Direction flashing	Hazard warning flashing			C	C2	C3					
	10 to 140 W	10 to 140 W	90 ± 15	50 ± 8	-	-	-	BG1	18 to 32	-40 to +85	Yes	4AZ 001 879-051 Universal, pulse generator, without failure control Not permitted under StVZO (German Road Vehicle Registration Regulation)
	2 x 21 W + 0 to 5 W	4 x 21 W + 2 x 5 W	87,5 ± 12,5	50 ± 3	E	-	-	BG1	20 to 30	-40 to +85	No	4DB 003 675-011
	10 bis 200 W	10 to 200 W	90 ± 15	46,5 ± 8,5	-	-	-	BG	20 to 32	-40 to +85	Included	4AZ 003 787-071 Universal, pulse generator, without failure control Not permitted under StVZO (German Road Vehicle Registration Regulation)
	3 + 1 x 21 W	8 x 21 W	95 ± 20	50 ± 10	E	P	-	BG3	20 to 30	-30 to +70	No	4DW 004 513-021 Silent
	4 + 1 x 21 W	10 x 21 W	95 ± 20	50 ± 10	E	P	-	BG3	20 to 30	-30 to +70	No	4DW 004 513-031 Silent

* at room temperature and test voltage

C = Towcar
C2 = 1st trailer
C3 = 2nd trailer

Flasher unit 24V, 4-pole/5-pole

Product photo	Load case/rated power		Flashing frequency [per minute]*	Bright-light time [%]*	Failure control			Pin arrangement	Voltage range [V]	Temperature range [°C]	Holder	Part number
	Direction flashing	Hazard warning flashing			C	C2	C3					
	2 + 1 x 21 W + 5 W	6 x 21 W + 2 x 5 W	90 ± 15	48.5 ± 8.5	E	P	-	BG3	20 to 30	-40 to +85	No	4DW 004 639-061
	2 x 21 W + 2 W	4 x 21 W + 2 x 2 W	85 ± 15	50 ± 10	E	-	-	BG1	22 to 30	-20 to +60	Included	4DB 009 123-031
	2 x 21 W + 0 to 4 W	4 x 21 W + 2 x 4 W	85 ± 15	50 ± 5	E	-	-	BG4	20 to 30	-20 to +60	Included	4DB 009 123-041
	2 + 1 x 21 W + 5 W	6 x 21 W + 2 x 5 W	87.5 ± 12.5	48 ± 8	P	P	-	BG6	21 to 31	-25 to +55	Yes	4DM 003 474-001
	2 + 1 x 21 W + 5 W	6 x 21 W + 2 x 5 W	87.5 ± 12.5	48 ± 8	P	P	-	BG6	21 to 31	-25 to +55	No	4DM 003 474-017

* at room temperature and test voltage

C = Towcar
C2 = 1st trailer
C3 = 2nd trailer



Flasher unit 24V, 6-pole/7-pole

Product photo	Load case/rated power		Flashing frequency [per minute]*	Bright-light time [%]*	Failure control			Pin arrangement	Voltage range [V]	Temperature range [°C]	Holder	Part number
	Direction flashing	Hazard warning flashing			C	C2	C3					
	3 + 1 x 21 W	8 x 21 W	90 ± 15	53.5 ± 8.5	P	P	-	BG9	21.6 to 30	-40 to +85	Yes	4DW 003 944-071
	2 + 1 x 21 W + 5 W	6 x 21 W + 2 x 5 W	90 ± 15	48.5 ± 8.5	P	P	-	BG9	21.6 to 30	-40 to +85	No	4DM 003 944-081
	2 + 1 x 21 W + 5 W	6 x 21 W + 2 x 5 W	90 ± 15	48.5 ± 8.5	P	P	-	BG9	21.6 to 30	-40 to +85	Yes	4DM 003 944-091
	2 + 1 x 21 W + 0 to 5 W	6 x 21 W + 2 x 5 W	90 ± 30	57.5 ± 17.5	E	P	-	BG9	21 to 28	-40 to +85	No	4DM 006 475-087
	2 + 1 + 1 x 21 W	8 x 21 W	85 ± 15	50 ± 20	P	P	P	BG11	20 to 30	-30 to +85	Yes	4DN 009 124-011

* at room temperature and test voltage

C = Towcar
C2 = 1st trailer
C3 = 2nd trailer

Flasher unit 24 V, 11-pole and 12/24 V, 6-pole

Product photo	Load case/rated power		Flashing frequency [per minute]*	Bright-light time [%]*	Failure control			Pin arrangement	Voltage range [V]	Temperature range [°C]	Holder	Part number
	Direction flashing	Hazard warning flashing			C	C2	C3					
	1 to 4 x 18/21 W	2 to 8 x 18/21 W	90 ± 30	50 ± 20	-	-	-	BG12	22 to 30	-30 to +70	Yes	4DZ 002 834-162
	1 to 8 x 18/21 W	8 x 18/21 W	90 ± 15	37.5 ± 5.5	-	-	-	BG9	10 to 32	-20 to +70	Yes	4DZ 004 019-021

* at room temperature and test voltage

C = Towcar
C2 = 1st trailer
C3 = 2nd trailer

LED flasher unit 12/24V, 3-pole; 12V, 4-pole/5-pole and 24V, 4-pole

Product photo	Load case/rated power		Flashing frequency [per minute]*	Bright-light time [%]*	Failure control			Pin arrangement	Voltage range [V]	Temperature range [°C]	Holder	Part number
	Direction flashing	Hazard warning flashing			C	C2	C3					
	42 W	42 W	90 ± 30	50 ± 10	-	-	-	BG1	9 to 33	-40 to +85	No	4JZ 177 846-007 Universal, pulse generator, without failure control Not permitted under StVZO (German Road Vehicle Registration Regulation)
	3 + 1 x 21 W	8 x 21 W	90 ± 30	57.5 ± 17.5	E	P	-	BG2	10 to 15	-40 to +85	Included	4DW 009 492-111
	2 + 1 + 1 x 21 W	8 x 21 W	90 ± 30	57.5 ± 17.5	E	P	P	BG13	10 to 15	-40 to +85	Included	4DN 009 492-101
	2 + 1 x 21 W	6 x 21 W	90 ± 30	57.5 ± 17.5	E	P	-	BG2	18 to 32	-40 to +85	Included	4DM 009 492-001
	3 + 1 x 21 W	8 x 21 W	90 ± 30	57.5 ± 17.5	E	P	-	BG2	18 to 32	-40 to +85	Included	4DW 009 492-011

* at room temperature and test voltage

C = Towcar
C2 = 1st trailer
C3 = 2nd trailer

Overview of flasher unit technical data

GENERAL AND ELECTRICAL DATA		
Rated voltage	12 V	24 V
Test voltage	13 V	28 V
Test temperature	23°C ± 5°C	23°C ± 5°C
Flashing cycle	90 ± 30 Flashing cycle/min	90 ± 30 Flashing cycle/min
Bright-light time normal	50 % ± 10 %	50 % ± 10 %
Bright-light time with rapid flashing	40 % ± 5 %	40 % ± 10 %
Control type	E / P, EP, PP, PPP	EP, PP
Voltage drop 49 → 49a	49 → 49a < 450 mV	450 mV
Short-circuit strength 49 → 49a	49 → 49a 15 A fuse	15 A fuse
Minimum device protection	IP 54 according to ISO 20653	IP 54 according to ISO 20653

Legal regulations for flasher units

HELLA flasher units comply with national and international regulations:

- StVZO Article 54 direction indicators
- ECE guideline 48 lighting devices
- EC Directive 76/756 lighting devices
- US Federal Standard FMV88 108 lighting devices
- SAE J590 turn signal flashers
- SAE J945 vehicle hazard warning signal flashers
- EC Directive 72/245 radio interference

LED indicators and failure control from HELLA

Legal requirement in all ECE states

In the case of vehicles approved for use on public roads, the indicators must be monitored: the failure of an indicator must be shown optically or acoustically in the vehicle. This applies to all ECE states in which regulation ECE R 48 is in effect. This means possible indicator failure must be monitored by the vehicle. Manufacturers use different control procedures for this.

The failure controls currently in use cannot detect simple LED lights and indicate a fault. Many HELLA LED indicators have integrated failure control electronics. The indicators are self-monitoring. When functioning correctly, they create a pulse according to ISO 13207-1 which can be evaluated by the vehicle electronics. If the available vehicle electronics cannot evaluate the pulse themselves, HELLA provides various solutions for evaluating this pulse, shown below.

As soon as one single LED fails, the light can be considered faulty, the impulse is not generated. In this case, for instance, the ballast switches off the bulb simulation and the flasher unit reports the error to the driver.

Safe conversion to LED indicators using HELLA electronics according to ISO 13207-1

As indicators must be checked by law, we recommend operating the lights only in conjunction with a failure control according to ISO 13207-1.

For LED indicators with a control pulse, HELLA offers electronic ballasts which make it possible to display indicator failure for various vehicle assemblies and modifications. This is necessary if the vehicle manufacturer does not guarantee indicator bulb failure control via the vehicle electric system.

There are three different ballasts and several different LED indicators available:

As a new solution, HELLA recommends detecting the electrical pulse directly in the vehicle manufacturer's vehicle electric system. It is merely necessary to integrate the check according to ISO 13207-1. This obviates the need for interim solutions via the indicator control units.

LED light failure control and correct electrical connection

Operation of the LED lamp with alternating voltage or clocked direct voltage is not permitted. The individual light functions may only be operated with a vehicle fuse of max. 3A.

Due to the low watt output of LED lights, which are distinctly different from a bulb version, problems can arise in bulb failure control when operating traction vehicles. As checking of the indicators is required by law, we recommend operating the light only in conjunction with the indicator control unit, HELLA part no. 5DS 009 552-xxx.

In addition, further lighting functions are detected by some towing vehicles. This is a vehicle comfort function which is not required by legislation and does not release drivers from their obligation to see for themselves that the lighting equipment is working. Here, too, faulty diagnosis can occur on account of the low power levels involved (instrument panel in the driver cab indicates light failure although the function is working).

Should misdiagnosis occur, as described above, while operating your traction vehicle, please contact the traction vehicle manufacturer.



LED indicator control unit



LED flasher unit



Simulation device for cold checking



Vehicle electric system check according to ISO 13207-1

The right solution for your vehicle electronics

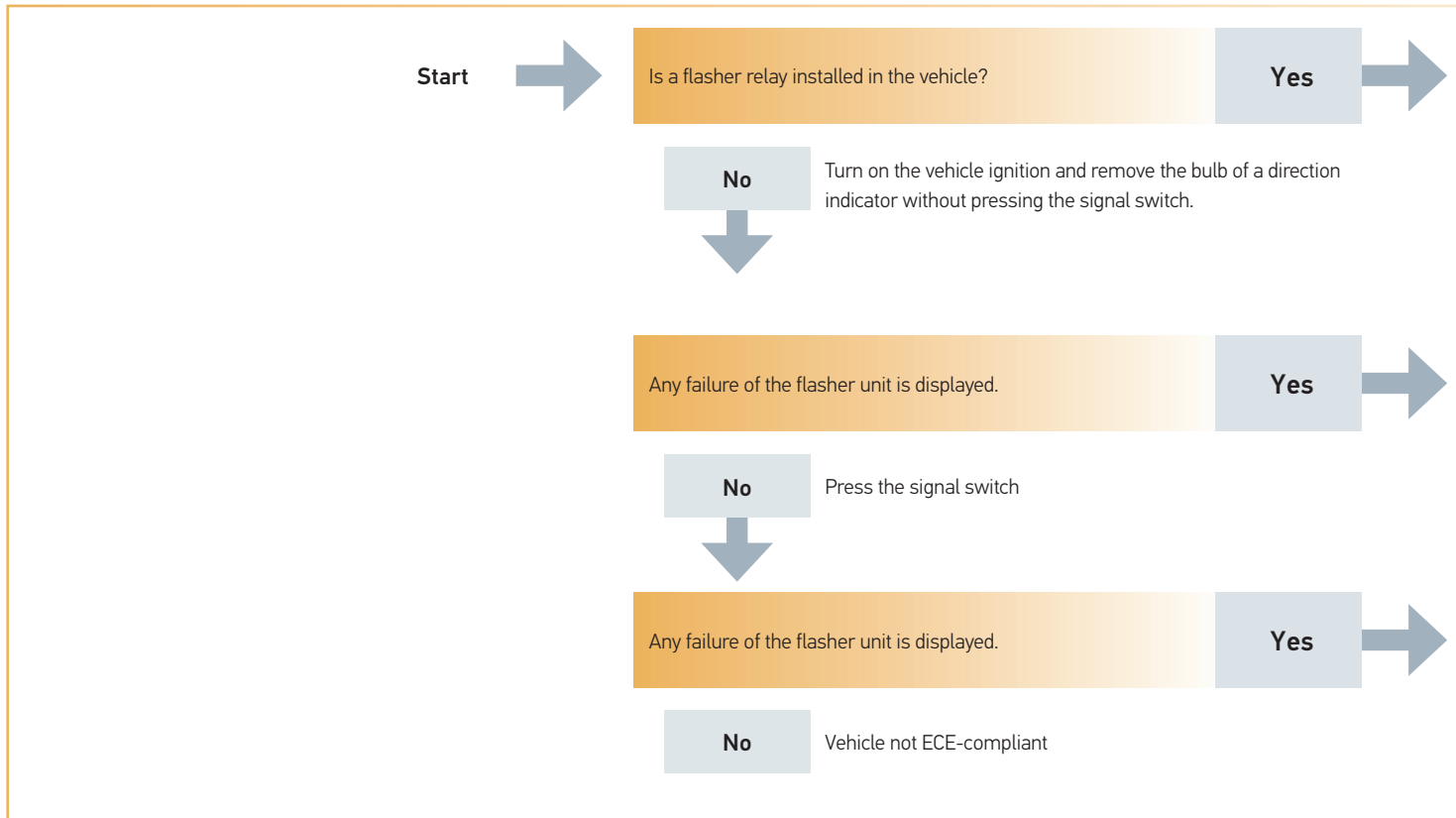

UNIVERSAL SOLUTION
for 24V vehicle electric systems



ISO 13207-1 SOLUTION
for 24V vehicle electric systems



Solution 1:
LED flasher unit

	12 V	24 V
Operating voltage	10–15 V	18–32 V
Functional voltage	11–14 V	20–28 V
Operating temperature	-40° to +85°C	-40° to +85°C
Protection class	IP 53 (contacts underneath)	IP 53 (contacts underneath)
LED flasher unit 3+1		
	4DW 009 492-111	4DW 009 492-011
LED flasher unit 2+1		
	-	4DM 009 492-001
LED flasher unit 2+1+1		
	4DM 009 492-101	-



Solution 2:
Simulation device for cold checking

	12 V	24 V
Operating voltage	9–16 V	18–32 V
Rated current	1.5 A	1.5 A
Operating temperature	-40° to +85°C	-40° to +85°C
Protection class	IP 54 (contacts underneath)	IP 54 (contacts underneath)
Simulation device		
	5DS 009 602-011	5DS 009 602-001

Solution 1:

Replace the existing indicator unit with an LED indicator unit from HELLA with an ISO pin base



One flasher unit per vehicle required. Any possible combination of bulbs and HELLA LED direction indicators is permitted: from a full package with bulbs through mixed versions to a full package with LED lights. Bulbs or HELLA LED direction indicators are also permitted on trailers.

Solution 2:

Through simulation unit for cold check



One simulation device is required per LED light.

Solution 3:

By LED indicator control unit



Two LED direction indicators can be monitored per vehicle using one simulation device.

(Only one simulation device per vehicle can be used.)

Solution 3:

By LED indicator control unit

**Solution 4:**

By monitoring in compliance with ISO 13207-1 in the vehicle manufacturer's vehicle electric system.



Failure pulse according to ISO 13207-1

2BA 959 070-631



2BA 959 050-401



2BA 959 822-601



2BA 344.200-...



2BA 343 390-...



2SD 343 910-...



Solution 3:
Indicator control unit
Universal solution



Solution 4:
Light control unit with integrated check of the failure pulse according to ISO 13207-1

24 V

Operating voltage	18–32 V
Reverse-polarity protection voltage	- 28 V
On-board voltage input Flasher unit left / right	24 V
Operating temperature	-40 to +50 °C
Extended operating temperature*	- 40 °C to 80 °C
Storage temperature	- 40 °C to 90 °C
With blade terminal sleeves	5DS 009 552-011
For EasyConn connectors	5DS 009 552-001

* Simulation of the filament bulb is deactivated for thermal reasons if the temperature exceeds 50°C.

In future, vehicle manufacturers' light control units will be able to check the failure pulse in a standardised and unified manner according to ISO 13207-1.

Interim solutions 1 to 3 are therefore unnecessary, as communication takes place directly with the indicators. HELLA recommends this solution.

Since not every vehicle currently has its own vehicle electric system, this solution must be integrated.

Explanation and uses

Key components of a wash/wipe interval control unit



Legend

- 1 Blade terminal made of E-Cu with tin-plated surface
- 2 Base plate
- 3 Capacitor
- 4 PCB relay
- 5 SMD components (resistors, diodes etc.)

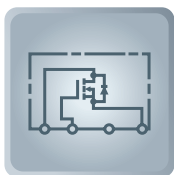

Functional principle

The wash/wipe interval control unit essentially comprises a pulse generator with a fixed or variable pulse/pause ratio. Every pulse with which the wipe/wash motor is controlled via a relay causes a one-off back-and-forth movement of the windshield wipers. Depending on the design, the length of the wipe pause is 4 s to X s.

The WWI control unit comprises the following:

- PCB with electronic components, blade terminals and a PCB relay
- Synthetic material housing, sometimes with holder

Similarly to flasher units, the timer is designed as an astable multivibrator in the wipe/wash interval control unit. A failure control stage as required by the flasher system is not needed for the WWI control unit.

HELLA also supplies headlight washer systems which clean the headlights using a spray of high-pressure water. Depending on the variant, the length of the spray varies between 0.4 s and 0.8 s.



Rated voltage

- 12 V: for passenger cars, agricultural and construction machinery etc.
- 24 V: for commercial vehicles, buses, municipal vehicles etc.

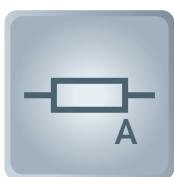

Rated load, rated switching current

- 3.5 A to 10 A, depending on vehicle type



Contacts and connector configurations

Wash/wipe interval control units

I	Intermittent wiping (input)
S, 53 M	Wiper motor field winding (output)
T, 86	Wash button (input)
15	Battery +, switched (input)
31	Ground
31b, 53S	Wiper motor cam switch/ park position/limit switch (input)

Headlight cleaning system control unit

P	Water pump (output)
S	Actuating switch (input)
30	Load current +, terminal 15 (input)
31	Ground
56	Light (input)

Wash/wipe interval control units 12V

Product photo	Function times [s]			Load current [A]		Pin arrangement	Voltage range [V]	Temperature range [°C]	Holder	Part number
	■	□	◇	Make contact	Break contact					
	4 ± 1	1	5 ± 1	10	-	I	9 to 16	-30 to +70	Yes	5WG 002 450-111
	4 ± 1	1	5 ± 1	3.5	-	I	9 to 16	-40 to +85	Yes	5WG 002 450-311
	6 ± 1	1	6 ± 1	5	-	BG8	11 to 16	-30 to +85	No	5WG 003 620-081
	3.9 ± 1	0.8 to 0.4	6.5 ± 1.5	20	10	I1	10 to 15	-20 to +60	No	5WG 996 165-001

- Release delay, wipe/wash operation
- Turn-on delay, intermittent operation
- ◇ Pause time, intermittent operation

Wash/wipe interval control units 24V

Product photo	Function times [s]			Load current [A]		Pin arrangement	Voltage range [V]	Temperature range [°C]	Holder	Part number
	■	□	◇	Make contact	Break contact					
	4 ± 1	1	5 ± 1	10	-	I2	21 to 30	-30 to +70	Yes	5WG 002 450-121
	4 ± 1	1	5 ± 1	3.5	-	I	21.2 to 30	-40 to +85	Yes	5WG 002 450-287
	4 ± 1	1	5 ± 1	3.5	-	I	21.2 to 30	-40 to +85	Yes	5WG 002 450-291
	4 ± 1	1	5 ± 1	3.5	-	I	21.2 to 30	-40 to +85	No	5WG 002 450-301

- Release delay, wipe/wash operation
- Turn-on delay, intermittent operation
- ◇ Pause time, intermittent operation

Headlight cleaning system 12V/24V

Product photo	Duty time Output [s]	Pin arrangement	Rated voltage [V]	Voltage range [V]	Temperature range [°C]	Part number
	0.8 ± 0.04	SW	12	9 to 15	-40 to +90	5WD 005 674-131
	0.6 ± 0.06	SW	12	9 to 15	-40 to +90	5WD 005 674-151
	0.43 ± 0.02	SW	24	18 to 30	-40 to +90	5WD 003 547-071
	0.8 ± 0.04	SW	24	18 to 30	-40 to +90	5WD 005 674-141



Explanation and uses

Key components of a time relay



Legend

- 1 Blade terminal made of E-Cu with tin-plated surface
- 2 Base plate
- 3 Potentiometer (for fine adjustment of delay time)
- 4 DIP switch (for setting the time base)
- 5 PCB relay

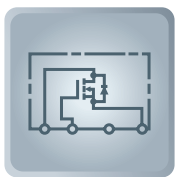

Functional principle

A time relay is a monostable flip-flop with connected relay.

The time relay is available in two variants:

- **Pick-up delay:** the monostable flip-flop is activated by applying a voltage to the device input. Depending on the set time, the relay is then switched on with a delay. After deactivating the input, the relay voltage drops immediately.
- **Drop-off delay:** the relay is switched on immediately by applying a voltage to the input of the monovibrator. After deactivating the input, the relay voltage drops after a predetermined time.

HELLA also supplies time relays with neither pick-up nor drop-off delay. In this case, the output is activated or switched on for a specific period of time.

The delay or turn-on time can be adjusted with a DIP switch and fine-tuned with a potentiometer.

If a more powerful relay is used, higher current strengths or different load types – e.g. inductive, capacitive/lamps – can be easily activated.



Rated voltage

- 12 V: for passenger cars, agricultural and construction machinery etc.
- 24 V: for commercial vehicles, buses, municipal vehicles etc.

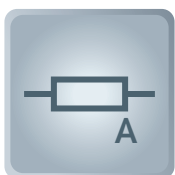

Rated load, rated switching current

- Up to 20 A, make contact
- Up to 10 A, break contact

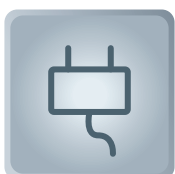

Contacts and connector configurations

HL	Handbrake control (input)
HK	Handbrake contact (input)
L, 87	Load current, make contact (output)
N	Emergency-off switch (input)
S, 15	Actuating switch (input)
SK	Grounding contact (input)
30	Load current +, terminal 15 (input)
31	Ground
87a	Load current, break contact (output)

Clock relays 12V

Product photo	Duty time Output [s]		Load current [A]		Pin arrangement	Voltage range [V]	Temperature range [°C]	Holder	Part number	
	With turn-on delay	With turn-off delay	Make contact	Break contact						
	2 ± 0.7	–	X	0.31	–	Z2	10 to 15	-10 to +60	No	5HE 003 724-027
	25 ± 5	–	–	10	–	Z3	10 to 15	-20 to +85	No	5HE 004 911-037
	5 ± 1.5	–	–	10	–	Z1	9 to 16	-40 to +85	No	5HE 006 207-027
	10 - 5 / 120 ± 30	–	–	20	10	Z	9 to 15	-25 to +80	Included	5HE 996 152-087
	0 to 900 ± 90	–	X	20	10	Z	9 to 16	-25 to +80	Included	5HE 996 152-131
	0 to 900 ± 90	X	–	20	10	Z	9 to 16	-25 to +80	Included	5HE 996 152-151

Clock relays 24V

Product photo	Duty time Output [s]		Load current [A]		Pin arrangement	Voltage range [V]	Temperature range [°C]	Holder	Part number	
	With turn-on delay	With turn-off delay	Make contact	Break contact						
	0.8 ± 0.2	-	-	5	5	Z5	18 to 32	-40 to +85	No	5HE 009 130-001
	1.5 ± 0.5	X	-	3	-	Z4	18 to 32	-40 to +85	No	5HE 004 236-017
	0.9 ± 0.09	X	-	10	5	Z	18 to 32	-40 to +85	Included	5HE 996 152-127
	0 to 900 ± 90	-	X	20	10	Z	18 to 32	-25 to +80	Included	5HE 996 152-141
	0 to 900 ± 90	X	-	20	10	Z	18 to 32	-25 to +80	Included	5HE 996 152-161
	5 ± 0.5	-	X	20	10	Z	18 to 32	-25 to +80	Included	5HE 996 152-177

Overview

Product photo	Product description	Available accessories	Part number
	Female connector housing, 2-pole	Blade terminal sleeve: 8KW 744 837-002, Single conductor seal: 9GD 746 185-002	8JA 746 184-022
	Female connector housing, 4-pole	Blade terminal sleeves and single conductor seals, enclosed separately	8KW 188 577-001
	Female connector housing, 5-pole	Blade terminal sleeves: 8KW 744 819-003, 8KW 701 235-..., 8KW 744 820-003	8JA 715 606-001
	Female connector housing, 5-pole	Blade terminal sleeve: 8KW 719 874-007	8JA 717 291-007
	Female connector housing, 5-pole	Pin contacts already equipped	8JA 733 963-001
	Female connector housing, 5-pole	Blade terminal sleeves: 8KW 744 819-003, 8KW 701 235-..., 8KW 744 820-003, 8KW 733 815-003	8JD 733 767-001
	Female connector housing, 5-pole	Pin contacts already equipped	8JD 733 962-001

Product photo	Product description	Available accessories	Part number
	Female connector housing, 5-pole	With pre-fitted cable assembly	8JD 745 801-001
	Female connector housing, 5-pole	Blade terminal sleeves: 8KW 863 904-003, 8KW 863 904-013	8JD 745 801-011
	Cable sachet housing, 6-pin	Blade terminal sleeves: 8KW 744 819-003, 8KW 701 235-..., 8KW 744 820-003	9NH 701 230-001
	Cable sachet housing, 8-pin	Blade terminal sleeves: 8KW 744 819-003, 8KW 701 235-..., 8KW 744 820-003	8JD 008 151-061
	Cable sachet housing, 9-pin, mountable side by side	Blade terminal sleeves: 8KW 744 819-003, 8KW 701 235-..., 8KW 744 820-003	8JA 003 526-001
	Cable sachet housing, 9-pin, mountable side by side	Blade terminal sleeves: 8KW 744 819-003, 8KW 701 235-..., 8KW 744 820-003, 8KW 744 822-003	8JA 183 161-002

Circuit diagrams – electromechanical relays

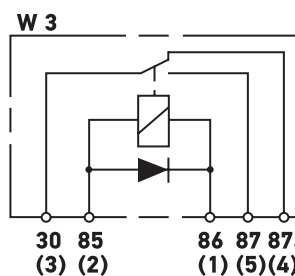
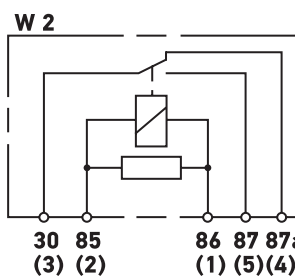
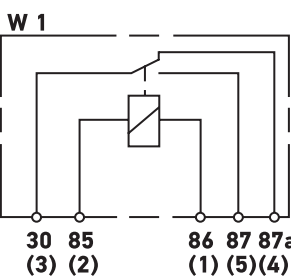
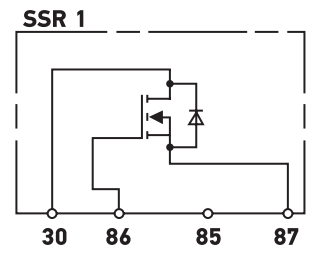
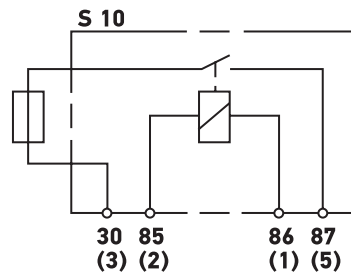
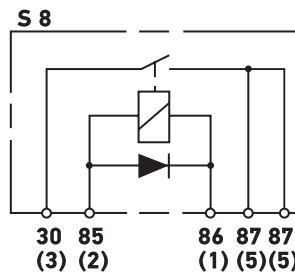
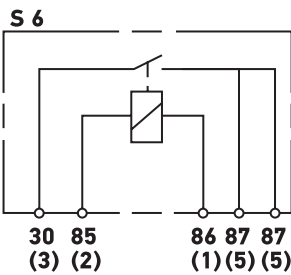
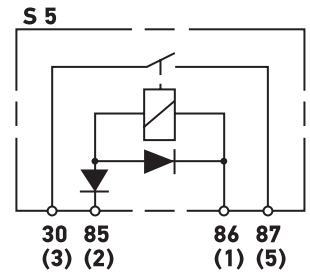
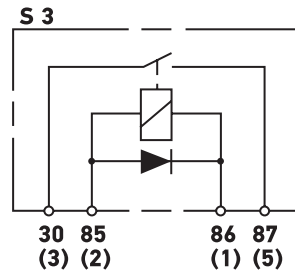
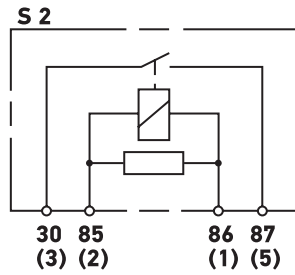
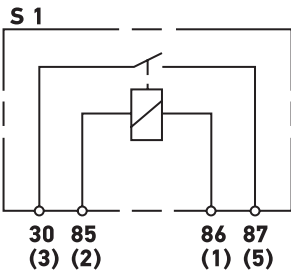
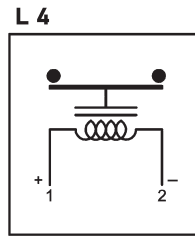
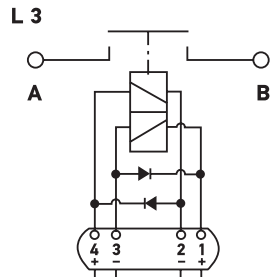
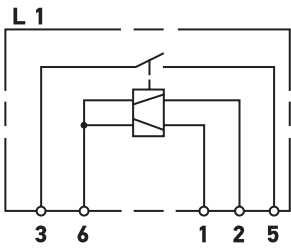

Pin diagrams – electromechanical relays

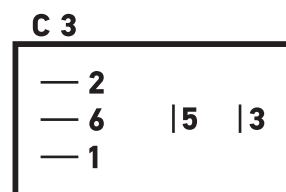
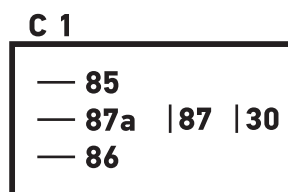
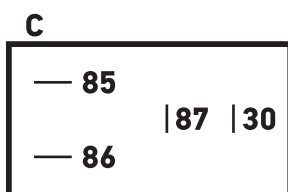
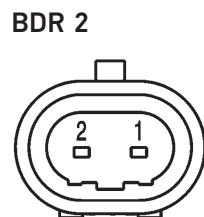
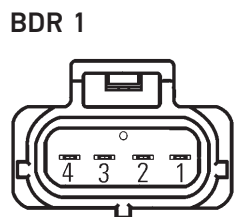
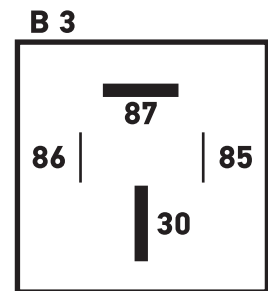
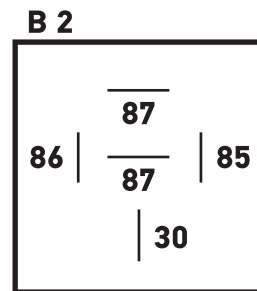
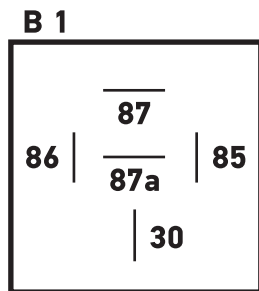
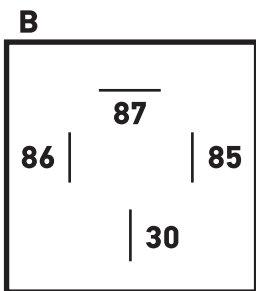
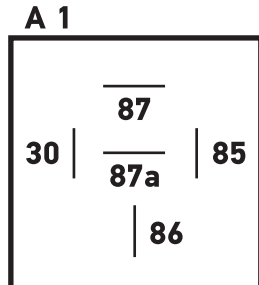
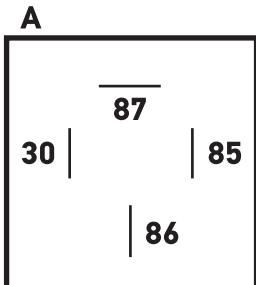

Pin diagrams – flasher units

BG

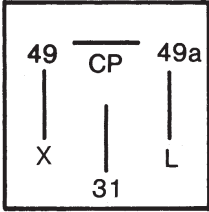

BG1

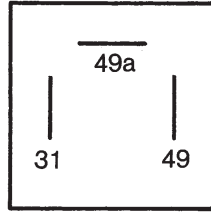

BG2

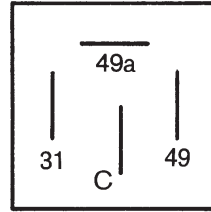

BG3

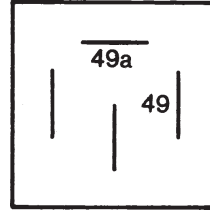

BG4

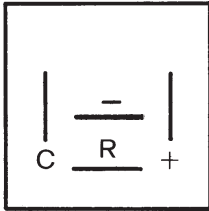

BG5

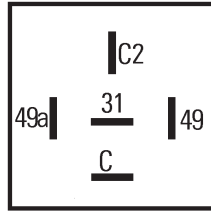

BG6

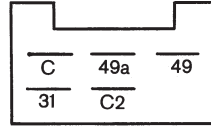

BG7

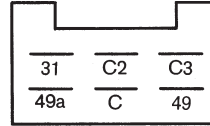

BG8

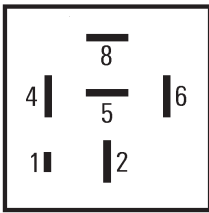

BG9

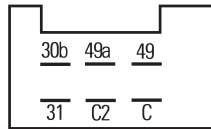

BG10

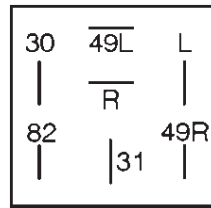

BG11

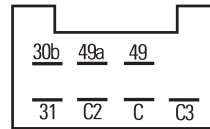

BG12

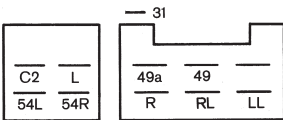

BG13

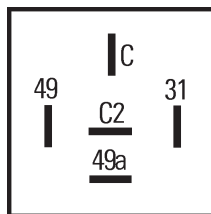

Pin diagrams – wash/wipe interval control units

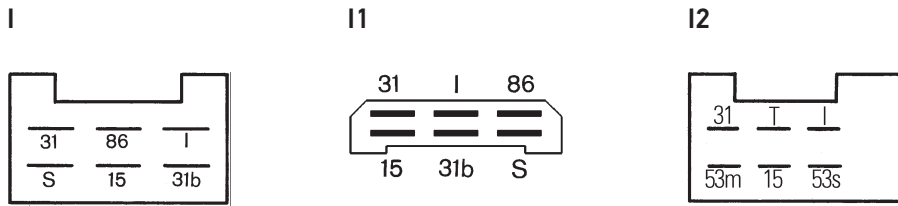

Pin diagrams – clock relays

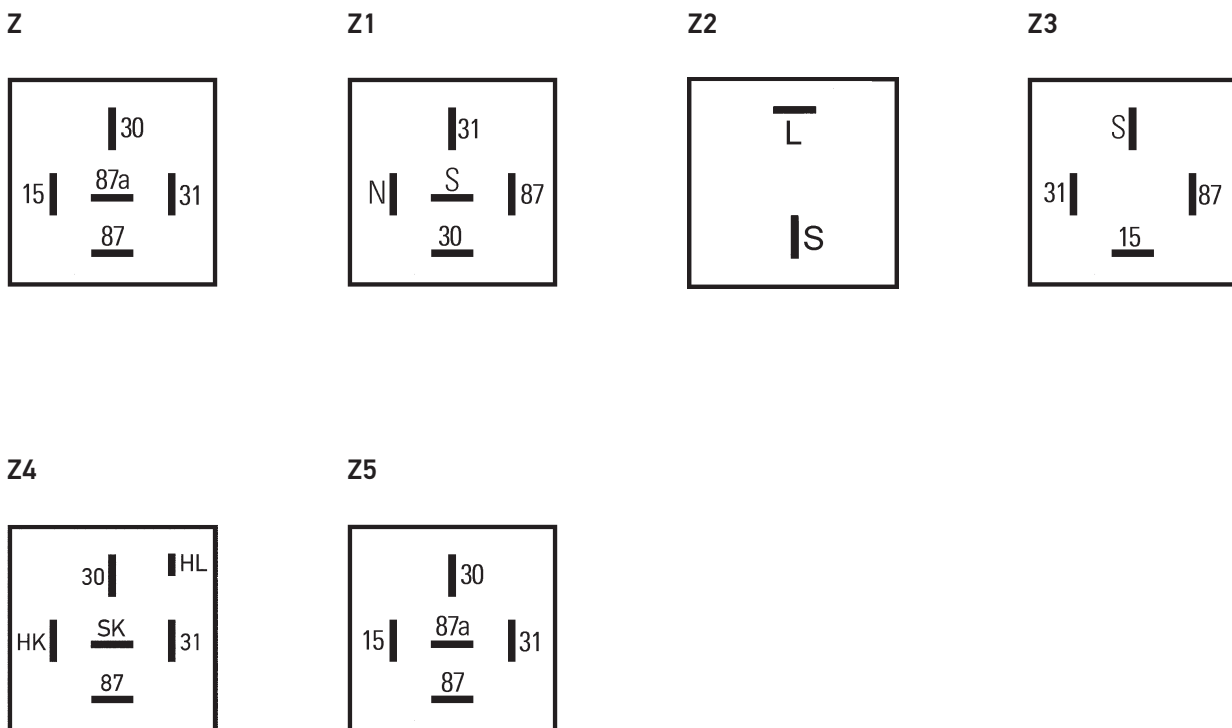

Pin diagrams – control units for headlight cleaning systems

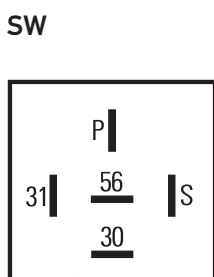

The new HELLA switch configurator



- SERIES
- SWITCH AND INDICATOR LIGHTS
- ACCESSORIES
- SYMBOLS
- NOTES LIST
- ENQUIRY

Please select your switch series



Model series 3100

- New waterproof series of module switches
- Suitable for outdoor use!
- for electrical systems
- Protection class IP 68: absolutely waterproof
- LED illumination of the symbols
- Symbol lighting green, function indicator red (unless otherwise indicated)



Model series 4100

- Module switch series with self-cleaning microswitches
- Reliable switching of small currents without soiling the contacts
- suitable for electrical and electronic systems
- Protection class IP 54
- LED illumination of the symbols
- Symbol lighting green, function indicator red (unless otherwise indicated)



www.hella.com/switch

www.hella.com/switch



HELLA module switch configuration tool

Configure your switches yourself! First, choose between the new waterproof 3100 series (interior and exterior applications) or the 4100 series (interior applications).

You can select any switch functions as well as the operating voltage, combinations of symbols and the corresponding accessories with only a few clicks. They can easily be transferred to a favourites list, printed out or sent as an online request.

Your request will be processed individually with the desired symbol configuration and customer-specific article number on a project-specific basis.

Rocker switch, 3100 series

The new waterproof series of rocker switches for electrical systems. Meets the requirements of protection class IP 68. The lasered symbols are lit by integrated LEDs.



- IP 68 according to test standard IEC EN 60529
- Extremely reliable in extreme conditions
- Ideal for use in agricultural and construction machinery
- Wide range of switching functions 12/24 V
 - Make contact/change-over contact
 - Button/latch
 - Disable function
 - Hazard light switch
- Wide range of standard and customer-specific laser symbols
- Up to two LED light sources enable direct symbol illumination
- Simple to install, directly in the mounting hole or using a modular mounting frame
- Display lights in the same design for safety-related feedback

TECHNICAL DATA

Mounting opening	21.1 mm x 37.0 mm
Material rocker	PC transparent, painted
Base plate material	PBT
Connecting contacts	6.3 mm x 0.8 mm
Coating of switch contacts	CuZn silver-plated
Light source	Max. 2 LEDs 1 x orientation light, green 1 x function light, red Warning lights available in amber and green
Symbol type	lasered
Design life	6 A/24 V at 150,000 switching cycles
Leak tightness	IP 68, IP 66 terminal side
Operating temperature	-40°C to +85°C
Storage temperature	-40°C to +85°C
Dashboard thickness	For directly installed switches, 2 mm

ACCESSORIES

Installation frame	
Modular	
End piece left, right	9AR 169 209-102/-107
Centre piece	9AR 169 208-102/-107
Dummy cover	9HB 172 229-102/-107
Female connector housing	
Type I	8JD 010 076-102/-107
Type II	8JD 010 076-112/-117
Type III	8JD 010 076-122/-127
Blade terminal sleeve, 6.3 mm	
0.5 mm ² to 1 mm ²	8KW 744 882-003
1.5 mm ² to 2.5 mm ²	8KW 744 820-003
Dismantling tool	8PE 197 631-001

Switch functions

Latching change-over contact, 1-stage, 2-pole

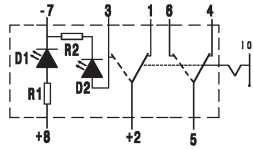

Switch function -03
with orientation light,
with internal function light

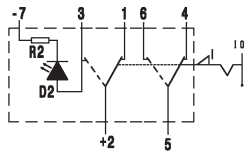

Switch function -04
with internal function light,
with lock-out

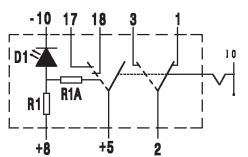

Switch function -08
Hazard light switch,
with orientation light, red,
with internal function light

Non-latching change-over contact, 1-stage, 1-pole

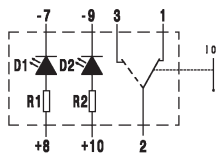

Switch function -09
with orientation light,
with external function light

Latching change-over contact, 2-stage, 1-pole

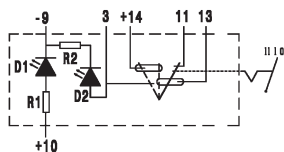

Switch function -07
with orientation light,
with internal function light

Latching change-over contact, 2-stage, 2-pole

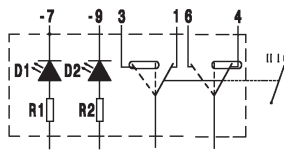

Switch function -11
with orientation light,
with external function light
stage I: latching
stage II: non-latching

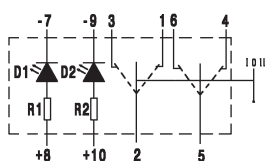

Switch function -15
with orientation light,
with external function light
switching stage I-0-II

Non-latching change-over contact, 1-stage, 2-pole

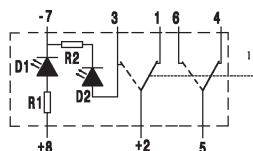

Switch function -05
with orientation light,
with internal function light

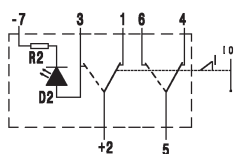

Switch function -06
with internal function light,
with lock-out

Non-latching change-over contact, 2-stage, 2-pole

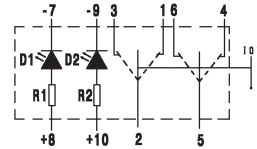

Switch function -12
with orientation light,
with external function light
Switching stage I-0-II

Latching make contact, 1-stage, 2-pole

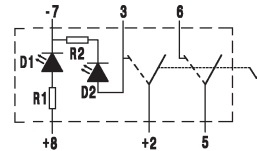

Switch function -10
with orientation light
with internal function light

Latching make contact, 2-stage, 2-pole

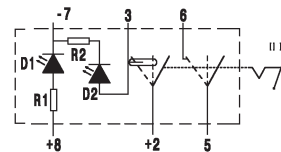

Switch function -02
with orientation light,
with internal function light

Latching make contact, 1-stage, 1-pole

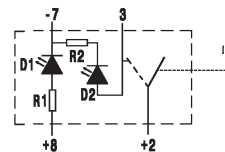

Switch function -00
with orientation light,
with internal function light

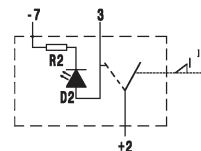

Switch function -01
with internal function light,
with lock-out

Warning lights

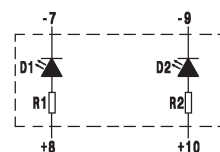

Switch function -13
with external function light, 2x, green

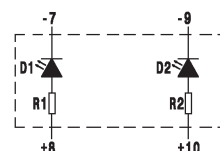

Switch function -14
with external function light, 2x, amber

HELLA KGaA Hueck & Co.

Rixbecker Straße 75
59552 Lippstadt/Germany
Tel.: +49 2941 38-0
Fax: +49 2941 38-7133
E-Mail: info@hella.com
Internet: www.hella.com

HELLA Benelux BV

Celsiusbaan 2, Postbus 1398
3430 BJ Nieuwegein
Nederland
T 030-6095611
F 030-6051677
E nl.info@hella.com
I www.hella.nl
Langlaarsteenweg 168
2630 Aartselaar
België
T 03-887 97 21
F 03-887 56 18
E be.info@hella.com
I www.hella.be

HELLA CZ, s.r.o.

Revoluční 785
285 22 Zruč nad Sázavou
Česká republika
Tel.: (+420) 327 536 425
(+420) 606 619 472
Fax: (+420) 327 536 421
Internet: www.hella.cz
e-mail: hella.cz@hella.com
www.facebook.com/hella.czech

HELLA Asia Singapore Pte Ltd

Regional Headquarters Asia Pacific
Independent Aftermarket
2 International Business Park
#02-12 The Strategy
Singapore 609930
Tel: +65 6854 7300
Fax: +65 6854 7302
E-mail: singapore@hella.com
Internet: www.hellaasia.com

HELLA Automotive South Africa (Pty) Ltd

P O Box 6130
Moselville, Uitenhage,
SOUTH AFRICA
6232
Tel.: +27 (0) 41-996-5700
Fax.: +27 (0) 41-996-5720
<http://www.hella.co.za>

© HELLA KGaA Hueck & Co., Lippstadt
9Z2 999 135-961 J00845/GR/10.14/1.0
Printed in Germany
Subject to technical and price modifications.