

CO₂ Product Guide 2021

for Refrigeration Applications



Table of contents

Introduction	
1. Criteria for refrigerant selection	4
2. Properties of R744	4
3. An Introduction of transcritical operation	7
4. Behaviour in the reference cycle	8
5. R744 hazards	9
6. Comparison of R744 with other refrigerants	10
7. Advantage and disadvantage of R744 as a refrigerant	12
Products	
ZO & ZOD Copeland™ scroll compressor range for CO ₂ -subcritical refrigeration	13
Copeland semi-hermetic compressor with compressor electronics technology for R744-transcritical applications	15
Copeland semi-hermetic compressor with compressor electronics technology for R744-subcritical applications requiring high standstill pressures (90 bar)	18
Copeland outdoor refrigeration units for R744 transcritical applications	20
Electronic expansion valves series CX2	22
High-pressure electrical controls valves series CV4-7	23
Electrical control valves series EX4-8	25
Universal driver modules series EXD-U02	28
Superheat controllers series EXD-SH1/2	29
2-way solenoid valves series 200 RH	32
Coils ESC and cable assemblies	33
Pressure transmitter PT5N	34
Pressure Controls Series CS1	36
Pressure controls series CS3	37
Filter driers series ADK	40
Filter drier shells series FDH	41
Moisture / Liquid indicators series CIA	42
OM4 and OM5 TraxOil oil management	43
Electronic oil level monitoring traxOil™ OW4 and OW5	47
Level watch LW4 and LW5 liquid level control	49
Ball valves series CVE/CVS	51

Introduction

Currently it is not an easy matter for decision makers in commercial refrigeration to make a definite choice of refrigerants and system type. For the last decade, many refrigerant options and system architectures have appeared both on paper and in practice. The sector has been in the environmental spotlight in recent years, especially as leakage studies have revealed the true effects of HFC emissions in centralised systems. Considerable reductions in emissions are certainly possible, but they do require changes.

Emerson conducted a study on this topic, comparing various options. The conclusion was clear, there is no best option for key criteria, environment, cost and power consumption. A tool, The Right Balance calculator, is available on the Emerson website to enable customers to make tailored comparisons. Different options are likely to develop in the next decade depending on regional trends, legislation, genuine green initiatives and green image enhancement.

R744 (CO₂) is a leading option for environmental reasons, and it can be a winner for power consumption as developments of component technology and application methods continue to reveal potential performance gains. Good experience has been gained with different system configurations over many years, particularly in central and northern Europe. The confidence resulting from this experience ensures that CO₂ will be a long-term option in the foreseeable future.

CO₂ is termed a “Natural Refrigerant” because it exists in the natural environment. Released into the atmosphere from refrigeration systems has a negligible effect compared to other CO₂ sources that are driving the global warming debate. As a refrigerant, it is a manufactured product that conforms to strict purity specifications. Its physical properties require special handling. The system pressures are much higher than in conventional systems, and all the components are designed accordingly. Today there is no difficulty in sourcing all the necessary equipment. High investment costs were characteristic of early CO₂ projects, but these costs are now on a downward trend. The refrigerant itself is a fraction of the cost of some of the specialty HFCs.



CO₂ Basics and considerations as a refrigerant

This chapter introduces carbon dioxide as a refrigerant, describes its properties and compares it to other refrigerants, both traditional and new. It outlines the hazards of CO₂ and explains why CO₂ refrigeration systems differ from conventional systems.

Section 1. Criteria for refrigerant selection

Various criteria should be considered when selecting properties, safety, environmental impact, ease of use, and availability of components and expertise.

The following table lists the criteria that are important when selecting a refrigerant and shows how well R744 meets these criteria. More detail is provided later in this chapter.

R744 meets the demand for a natural refrigerant with a low global warming impact, but presents challenges in both its application and handling

Table 1. How R744 meets different conditions and criteria

Criteria	How well does R744 meet the criteria?
Cooling capacity	Significantly higher volumetric capacity than conventional refrigerants
Efficiency	Efficiency depends on system type and ambient temperature
Operating conditions	Operating and standstill pressures significantly higher than for all other common retail refrigeration refrigerants
Environmental properties	Global Warming Potential (GWP) = 1, significantly lower than for commonly used HFCs
Availability of refrigerant	Varies globally but generally available
Availability of system components	Many components are different to those used on HFC retail systems, but these are now generally available
Availability of competent engineers and technicians	Varies globally but generally low; engineers must have a good understanding of basic refrigeration and good refrigeration practice and will require further training for R744
Cost	Refrigerant cost lower than for HFCs, but system costs are generally higher
Safety	Low toxicity and nonflammable: high-pressures and associated hazards present additional challenges. It is asphyxiating even at low concentration
Ease of use	High-pressure and low critical point drive the need for more complex systems
Availability of appropriate standards	Safety Standards EN378 & ISO 51491 include R744
Composition	Single molecule, no temperature glide in subcritical operations
Suitability as a retrofit refrigerant	Not suitable due to higher pressures

¹ EN378 Refrigerating systems and heat pumps – Safety and environmental requirements

ISO 5149 mechanical refrigerating systems used for cooling and heating - Safety requirements.

Section 2. Properties of R744

Carbon dioxide is a naturally occurring substance – the atmosphere is comprised of approximately 0.04% CO₂ (370 ppm). It is produced during respiration by most living organisms and is absorbed by plants. It is also produced during many industrial processes, in particular when fossil fuels such as coal, gas or oil are burned to generate power or drive vehicles.

The triple point of carbon dioxide is high and the critical point is low compared to other refrigerants. The chart in figure 3 shows the triple point and the critical point on a phase diagram.

The triple point occurs at 4.2 bar g and -57°C, below this point there is no liquid phase. At atmospheric pressure (0 bar g), solid R744 sublimates directly to a gas. Solid R744 will have a surface temperature of -78°C. If R744 is at a pressure higher than the triple point and it reduces to a pressure below the triple point (for example to atmospheric pressure), it will deposit directly to solid. This can occur when charging an evacuated refrigeration system with liquid R744 for example. Solid R744 is also known as dry ice.

The critical point occurs at 31°C, which is below typical system condensing temperatures for part or all of the year, depending on the climate. Above the critical point the refrigerant is a transcritical fluid. There is no phase change when heat is removed from a transcritical fluid while it is above the critical pressure and temperature.

In a refrigeration system transcritical R744 will not condense until the pressure has dropped below the critical pressure. No other commonly used refrigerant has such a low critical temperature so they always condense as heat is removed on the high side of the system.

The **critical point** is the condition at which the liquid and gas densities are the same. Above this point distinct liquid and gas phases do not exist.

The **triple point** is the condition at which solid, liquid and gas co-exist. The glossary has a full explanation of the terms used in this section.

The boundaries of the transcritical fluid region are:

- The critical temperature (31°C) to the sub-cooled liquid region
- The critical pressure (72.8 bar g) to the superheated gas region

Table 2 on page 6 compares the basic properties of R744 with different refrigerants which are commonly used in the retail sector

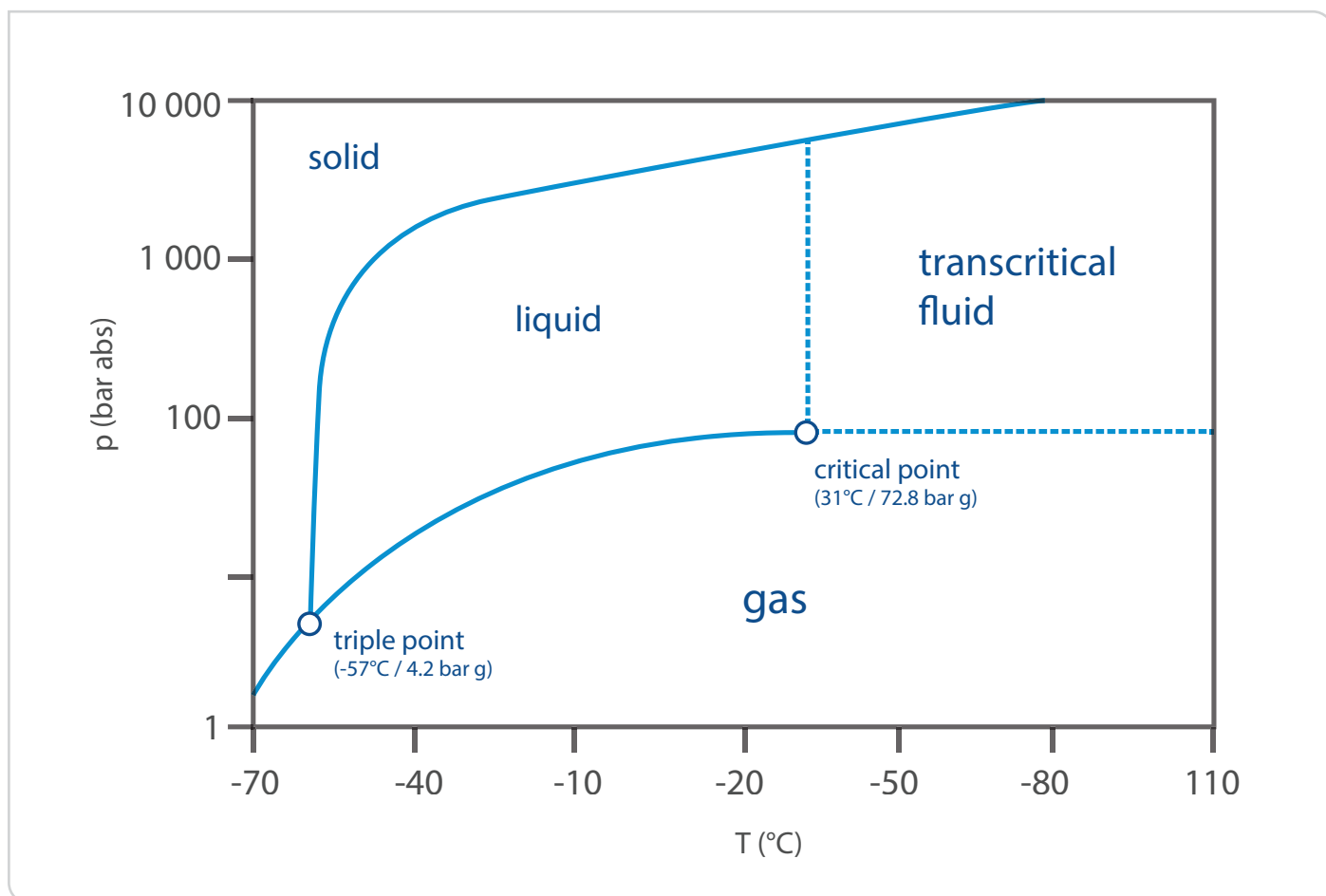

Figure 3. R744 / CO₂ phase diagram

The pressure enthalpy chart in figure 4 shows the critical point and the extent of the transcritical fluid region.

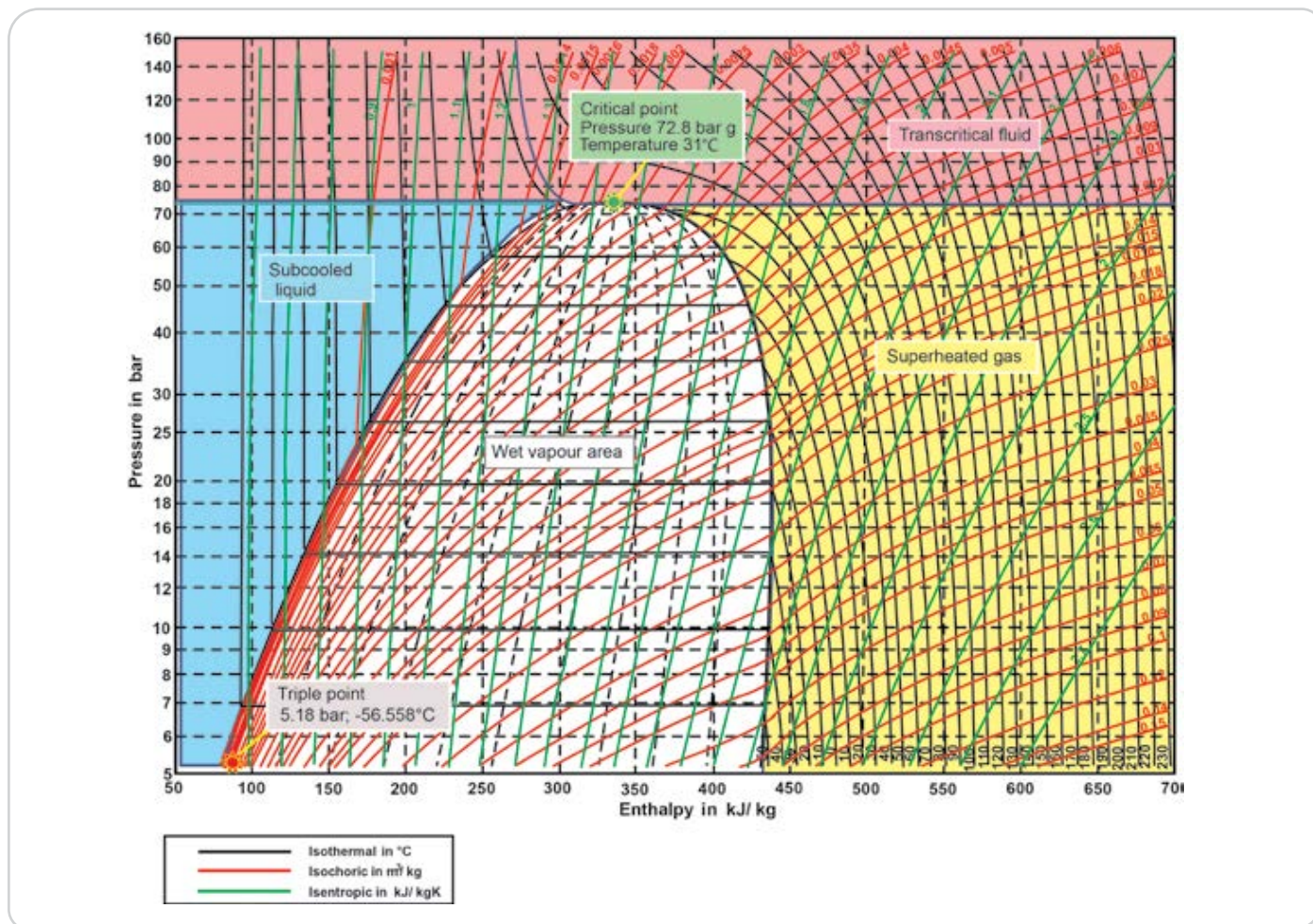

Figure 4. Pressure enthalpy chart for R744

Table 2. Basic properties of R744 compared with other refrigerants

Refrigerant	HFC	HFC	HFC	HFC	HCFC	HFO	
	R744	R404A	R134a	R407A	R407F	R22	R1234yf
Temperature at atmospheric pressure (see information above)	-78.5°C (Temp. of the dry ice)	-46°C (Saturation temp.)	-26°C (Saturation temp.)	-41°C (Mid point saturation temp.)	-43°C (Mid point saturation temp.)	-41°C Saturation (temp.)	-30°C Saturation (temp.)
Critical temperature	31°C	72°C	101°C	82°C	83°C	96°C	95°C
Critical pressure	73.8 bar g	35.7 bar g	41.7 bar g	45.2 bar g	47.5 bar g	49.8 bar g	33.8 bar g
Triple-point pressure	5.2 bar	0.03 bar	0.005 bar	0.013 bar	TBC	< 0.005 bar	TBC
Pressure at a saturated temperature of 20°C	57.2 bar g	10.9 bar g	5.7 bar g	10.2 bar g	10.6 bar g	9.1 bar g	5.9 bar g
Global warming potential	1 ¹	3922 ¹	1430 ¹	1990 ²	1824 ³	1700	4

¹ The GWP values are from the Intergovernmental Panel on Climate Change, 4th assessment report: Climate Change 2007

² GWP for R407A from EN378

³ GWP for R407F from supplier's data

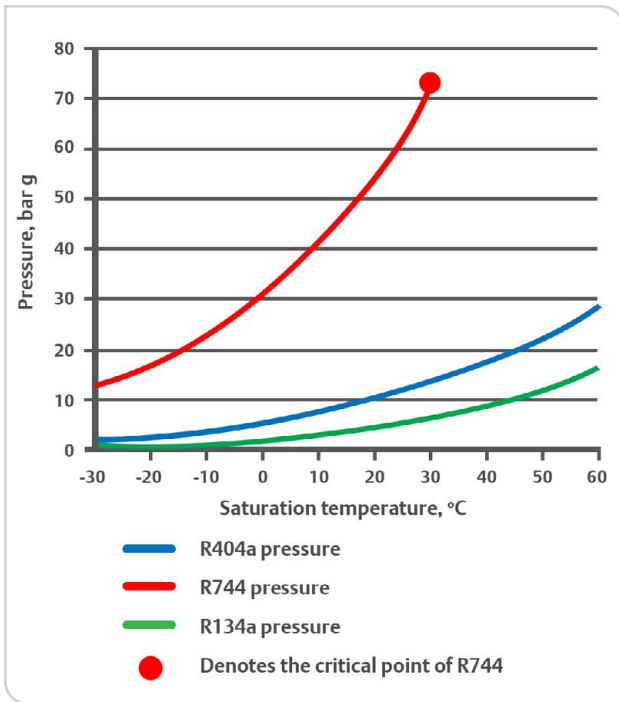

Figure 5. Pressure-temperature relationship comparison

A significant challenge with the application of CO₂ as a refrigerant is the higher operating pressures compared to other commercial refrigerants. The chart in figure 5 compares the pressure of R744 with R404A and R134a.

The saturation curve for R744 does not extend beyond 31°C because this is the critical point - above this condition there is no distinction between liquid and gas. Operation above this pressure is current practice in transcritical systems.

Section 3. An introduction to transcritical operation

Many R744 systems operate above the critical point some or all of the time. This is not a problem, the system just works differently.

- R744 systems work subcritical when the condensing temperature is below 31°C
- R744 systems work supercritical when the “gas cooler exit temperature” is above 31°C and the evaporating temperature is below 31°C

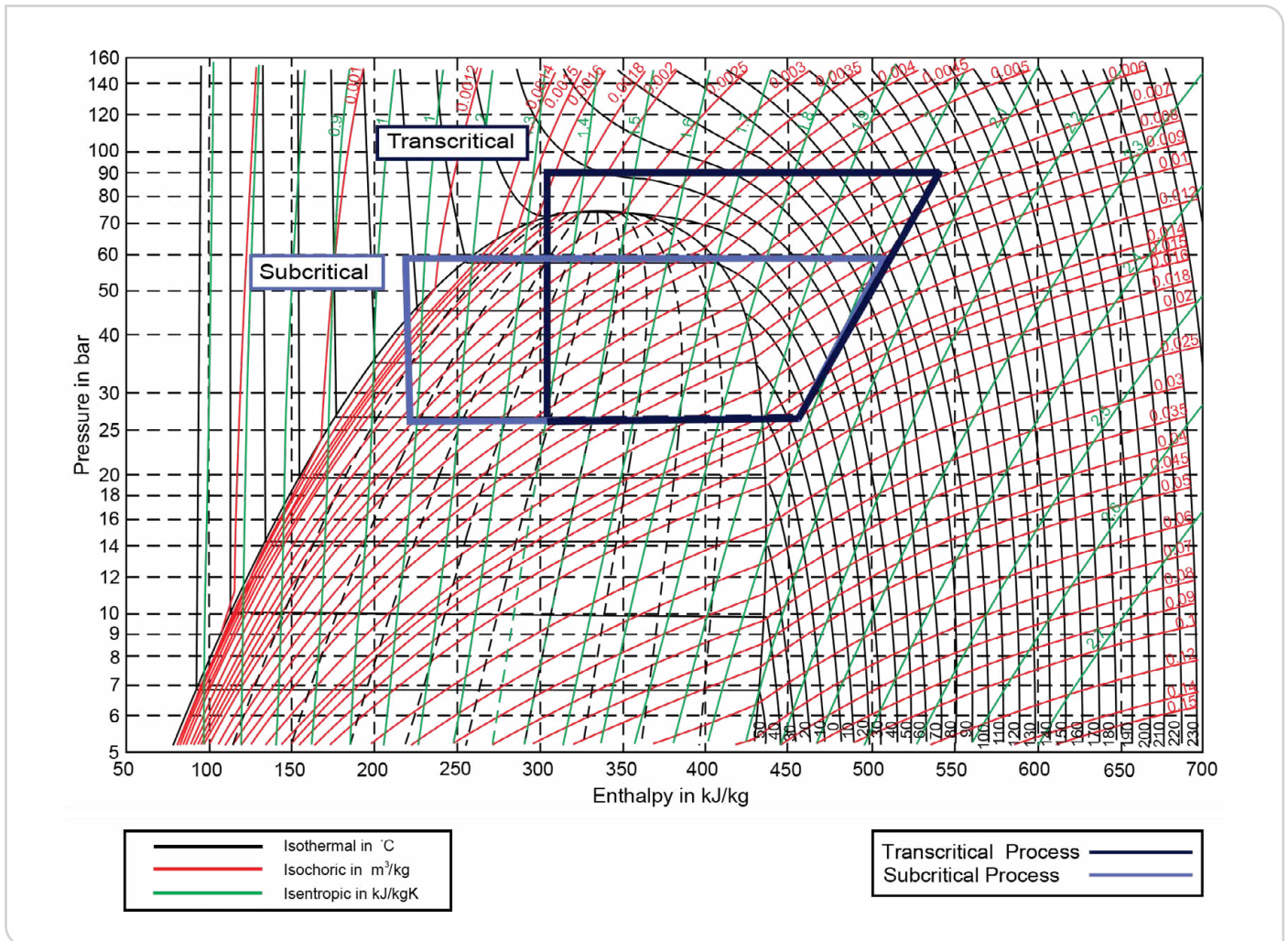

Figure 6. R744 pressure enthalpy chart showing subcritical and transcritical system

HFC systems work always subcritical because the condensing temperature never exceeds the critical temperature (e.g., 101°C in the case of R134a).

The pressure enthalpy chart in figure 6 shows an example of a simple R744 system operating subcritically at a low ambient temperature and transcritically at a higher ambient temperature. The chart shows that the cooling capacity at the evaporator is significantly less for transcritical operation.

A capacity drop also occurs with HFC systems when the ambient temperature increases, but the change is not as great as it is with R744 when the change is from sub- to transcritical.

It is important that appropriate control of the high side (gas cooler) pressure is used to optimise the cooling capacity and efficiency when supercritical.

For example, increasing the high side pressure will increase the cooling capacity. This is covered in more detail in chapter 4.

Section 4. Behaviour in the reference cycle

Simple comparisons between R744 and other refrigerants can be misleading because the low critical temperature of R744 either leads to differences in system design, such as the use of cascade systems, or to supercritical operation. So like-for-like comparisons are not easy to make.

The table below provides a simple theoretical comparison between R744 and common HFC refrigerants and shows the performance of ideal cycles.

Table 3. Theoretical comparison between R744 and common HFC refrigerants.

		Psuc	Tsuc	Pdis	Tdis_sat	Tdis	ΔH	ΔW	COP	Pressure ratio	Vol. cooling cap	
		(bar abs)	(°C)	(bar abs)	(°C)	(°C)	(kJ/kg)	(kJ/kg)	(-)	(-)	(kJ/m ³)	
Overview refrigerant data related to 4 different system cases												
1	R744	MT	30.47	-5	97.00	+38*	103.39	135.56	68.53	1.98	3.2	10624
	R744	LT	14.30	-30	30.47	-5	37.30	255.03	44.04	5.79	2.1	9089
2	R134a	MT	2.17	-8	10.16	+40	60.67	141.63	43.98	3.22	4.7	1496
	R744	LT	14.30	-30	30.47	-5	37.30	255.03	44.04	5.79	2.1	9089
3	R134a	MT	2.17	-8	10.16	+40	60.67	141.63	43.98	3.22	4.7	1496
	R404A	LT	1.81	-33	5.57	-3	16.74	157.28	30.99	5.08	3.1	1428
4	R134a	MT	2.17	-8	10.16	+40	60.67	141.63	43.98	3.22	4.7	1496
	R404A	LT	1.81	-33	18.30	+40	68.77	89.29	64.57	1.38	10.1	811

The four systems are:

Case	1	2	3	4
	R744 booster	Hybrid R744/R134a	HFC cascade R404A/R134a	Centralized direct expansion
MT to	-5 °C	-8 °C	-8 °C	-8 °C
tc	+38 °C	+40 °C	+40 °C	+40 °C
LT to	-30 °C	-30 °C	-33 °C	-33 °C
tc	-5 °C	-5 °C	-3 °C	+40 °C

Superheat = 6K in all examples
 Subcooling = 0K in all examples
 *gas cooler outlet temperature

Compressor isentropic efficiency:

For R744 >> 0.75
 For R404A >> 0.65
 For R134a >> 0.6

Legend for above table

Psuc = Suction pressure
 Tsuc = Suction temperature, saturated
 Pdis = Discharge pressure
 Tdis_sat = Discharge temperature, saturated
 Tdis = Calculated real discharge temperature
 ΔH = Enthalpie-difference through evaporator
 ΔW = Enthalpie-difference through compressor
 COP = Coefficient of performance
 Pressure ratio = Compression ratio
 Vol. cooling cap = Volumetric Cooling Capacity as ratio of evaporator enthalpy difference to the specific volume of suction gas

Assumptions:

- No suction or discharge line pressure losses
- R744 transcritical: optimum discharge pressure 97 bar

The table highlights the following key points:

- R744 compares reasonably well with the HFCs when subcritical and at low condensing temperatures (e.g., the LT comparison). But at higher condensing temperatures (MT example) and when transcritical (HT example), it does not compare well.
- The high suction pressure and high gas density of R744 results in very good evaporator performance. In like-for-like systems the evaporator temperature of an R744 system would, in reality, be higher than for HFC systems.
- The index of compression is very high for R744, so the discharge temperature is higher than for the HFCs. This can improve heat reclaim potential in retail systems, although the requirement for heat in the summer when the system is transcritical is limited.
- The density of R744 results in very high volumetric capacity. This reduces the required compressor displacement (but not the motor size, which would be similar to that required for HFC refrigerants).
- The required suction pipe cross section area is in proportion to the volumetric capacity. For R744 the diameter of the suction line is approximately half that required for R404A.
- The compression ratio for R744 is less than for the HFCs. This can result in higher isentropic efficiency.

Section 5. R744 hazards

R744 is not flammable, but its high-pressures, toxicity at high concentration and potential for dry ice formation must be taken into account when applying and handling. This section explains some of the hazards and provides very general guidance on reducing them. More detailed information relating to the design of systems to minimise the hazards is provided later in this document.

Asphyxiation

R744 is odourless, heavier than air and is an asphyxiant. The practical limit¹ of R744 is lower than HFCs because of its potential for high toxicity (HFCs are non toxic):

Practical limit of R744, 0.1 kg/m³ (56.000 ppm);
 Practical limit of R404A, 0.48 kg/m³ (120.000 ppm)

Note – The practical limit is defined in EN378 but may vary in regional regulations.

The table below summarises the effect of CO₂ at various concentrations in air.

Table 4. Effects of CO₂ at various concentrations in air

ppm of CO ₂	Effects
370	Concentration in atmosphere
5,000	Long-term exposure limit (8 hours)
15,000	Short-term exposure limit (10 min)
30,000	Can be “tasted”
30,000	Discomfort, breathing, difficulties, headache, dizziness, etc.
100,000	Loss of consciousness, death
300,000	Quick death

If a leak of R744 could result in a concentration exceeding the practical limit in an enclosed occupied space such as a cold room, precautions must be taken to prevent asphyxiation. These include the use of permanent leak detection which activates an alarm in the event of a leak.

High-pressures

System components, pipe work, tools and equipment must be rated for these pressures. It should be noted that the standstill pressure on some systems (e.g., cascade systems) is higher than the maximum rated pressure PS (hence the pressure-relief valve setting). The pressure-relief valve will discharge in the event of a fault such as a power failure.

Table 5. R744 standstill and typical system operating pressures

Standstill at 10°C ambient	44 bar g
Standstill at 30°C ambient	71.1 bar g
Low temperature evaporator (frozen food)	10 - 15 bar g
High temperature evaporator (chilled food)	25 - 30 bar g
Cascade condenser	30 - 35 bar g
Cascade high-pressure cut out (high side)	36 bar g
Cascade pressure-relief-valve (high side)	40 bar g
Transcritical high side	90 bar g
Transcritical high-pressure cut out (high side)	108 to 126 bar g
Transcritical pressure-relief valve (high side)	120 to 140 bar g

¹ EN378 Refrigerating systems and heat pumps – Safety and environmental requirements
 ISO 5149 mechanical refrigerating systems used for cooling and heating - Safety requirements.

To ensure the pressure does not rise to the relief pressure in the event of such a fault, these systems can be fitted with a small auxiliary cooling system. This typically runs on an auxiliary (uninterruptable) power supply and will switch on when the pressure rises above a set point (this is lower than maximum allowable suction pressure PS, but higher than the normal operating pressure). The auxiliary cooling system is sized to remove sufficient heat to keep the standstill pressure below safe low side limit when there is no load on the system (apart from heat absorbed from the ambient).

Care must be taken when charging R744 systems. The maximum operating pressure of some systems (such as cascade systems and parts of transcritical systems) is normally below the R744 cylinder pressure. These systems must be charged slowly and carefully to prevent pressure relief valves discharging. Further information is given in Chapter 5.

Trapped liquid

The coefficient of expansion for R744 is significantly higher than for other refrigerants. The practical impact of this on liquid R744 trapped between closed valves is shown in the graph in figure 7:

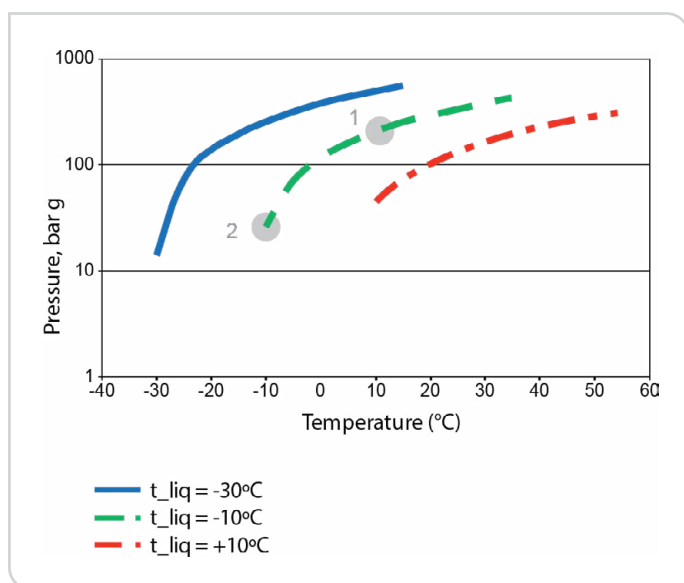

Figure 7. Relationship between temperature and pressure of trapped liquid R744. Source: Danish Technological Institute

The example shows the effect of a 20K temperature rise on liquid that is trapped at an initial temperature of -10°C. The pressure will increase from 44 bar g to approximately 240 bar g. This condition could potentially occur in a liquid line of a cascade system, and similar situations can arise in other parts of the system and in other R744 systems. As a rule of thumb, trapped R744 liquid will increase in pressure by 10 bar for every 1K temperature increase.

The pressure of trapped liquid refrigerant always increases, but the pressure increase of R744 is much greater than for other refrigerants. This is exacerbated by the potential to trap R744 at low temperatures (LT) and hence for the

liquid temperature to rise more than for other refrigerants. Systems should be fitted with pressure-relief protection wherever liquid could be trapped, either during operation or service. Methods of providing this protection are covered in the section on design of R744 systems.

Dry ice

Dry ice (solid R744) is formed when R744 pressure and temperature is reduced to below the triple point (4.2 bar g, -56°C). This will not occur within a properly working refrigeration system, but can occur when:

- A pressure-relief valve discharges if it is venting vapor R744
- Venting R744 during service (component change or replacement, for example)
- Charging a system which is below 4.2 bar g (e.g., an evacuated system)

Dry ice does not expand when it is formed, but dry ice will become gas as it absorbs heat (e.g., from ambient). If the dry ice is trapped within the system, it will absorb heat from the surroundings and turn into gas. This will result in a significant pressure increase.

Dry ice can block vent lines, so care must be taken to ensure that this cannot occur:

- Appropriate pressure-relief valves should be used – see the section on system design for more information about these and how safety valves should be applied;
- When R744 is vented from a system during service it should be vented as a liquid, and the pressure in the system monitored. R744 should always be vented outside a building.

Freeze burns

Contact with solid or liquid R744 will cause freeze burns and should be avoided. Suitable gloves and goggles should always be worn when working with R744.

Section 6. Comparison of R744 with other refrigerants

The table below shows a simple comparison of R744 with other types of refrigerant, including those that are currently commonly used and those that are currently evaluated for future use. It uses a simple “traffic light” system and employs the common HFCs, such as R404A and R134a as a baseline.

This provides a very simple introduction to the options – the situation varies globally, especially in the availability of refrigerants, components and expertise.

For retail applications a well designed and installed R407A/F system generally has better efficiency than R744 systems.

However, the overall environmental performance of R744 systems is better, primarily due to the low GWP in the event of leakage.

Table 6. Comparison of R744 with other refrigerants

	R744	HFOs	HCs	R717
Capacity	Green	Orange	Orange	Orange
Efficiency	Orange	Red	Orange	Green
Pressure	Red	Orange	Orange	Orange
Environmental impact	Green	Orange	Green	Green
Flammability	Green	Red	Red	Red
Toxicity	Orange	Red	Orange	Red
Availability of refrigerant	Orange	Red	Red	Green
Availability of components	Orange	Red	Orange	Green
Availability of expertise	Orange	Red	Red	Orange
Cost of refrigerant	Green	Red	Green	Green
Cost of system	Red	Orange	Orange	Red

- Refrigerant is similar to HFCs;
- Aspect of the refrigerant is worse than HFCs;
- Aspect of the refrigerant is better than HFCs.

HFO: Hydro Fluoro Olefin, e.g., R1234yf

HC: Hydrocarbon, e.g., R290

R717: Ammonia

*Reference: Refrigerant choices for commercial refrigeration (TGE124-0910/E) available on climate.emerson.com/en-gb.



Section 7. Advantages and disadvantages of R744 as a refrigerant

R744 has the following advantages and disadvantages as a refrigerant. The list of disadvantages appears less than the advantages, but these issues should not be overlooked as they have a significant impact on the safety and reliability of R744 systems. More information on the impact of the differences is highlighted below.

Table 7. Advantages and disadvantages of R744 as a refrigerant

Advantages	Disadvantages
<ul style="list-style-type: none"> • High refrigeration capacity due to high volumetric cooling capacity (e.g., it is approximately up to 5 times that of R404A). This has a positive impact on compressor displacement and the sizing of heat exchangers and pipe work. • Lower pressure drops in pipe work and heat exchangers. • For example, the impact of long suction and liquid lines is less. • High heat transfer in evaporators and condensers due to the high pressure and density. This will either allow lower temperature differences between the refrigerant and the air; therefore improving efficiency, or allow the use of smaller evaporators and condensers. Tubing wall thickness may need to be increased to handle the higher pressures, so careful design is required to take advantage of the R744 properties. • The pressure drop across an expansion valve is greater than with other refrigerants, so the minimum setting for head pressure control can be lower. This improves efficiency. • Lower compression ratios leading to higher compressor isentropic efficiency. • Non-corrosive with most materials. There are very few differences to the materials used in HFC systems. • Good miscibility with compressor lubricants for oil return. Polyolester type lubricants can continue to be used as with HFCs. • Low toxicity and nonflammable. • Negligible GWP so that, in the event of a leak, the direct impact on climate change is very low. • Inexpensive to produce and widely available, although the purity of the R744 should be 99.99% for use in a refrigeration system with hermetic and semi-hermetic compressors, i.e., refrigerant grade. • High discharge temperatures due to the high index of compression. This provides good potential for heat reclaim. Note – the discharge temperature is excessively high in transcritical systems with a large difference between evaporating and heat rejection temperatures. • Stable molecule leading to a low potential for decomposition within the refrigeration system. • There is no impending legislation phasing down or phasing out R744 so it can be viewed as a long-term refrigerant. 	<ul style="list-style-type: none"> • High operating and standstill pressures are more hazardous and increase the leak potential. Specially designed components are required. • Special compressors are required because of the higher refrigeration capacity (different motor / displacement combination). • R744 systems are more complex – either cascade or transcritical. This leads to higher costs in components and installation. • Pipe working on-site potentially includes steel or stainless steel, the need for specially licensed welders, and different jointing techniques due to higher pressure and different materials. • The greater complexity also increases the probability of poor performance and reliability, particularly if commissioning is not done well. • For transcritical systems two stage compression is required for frozen food applications because of the high discharge temperature of R744. • R744 transcritical systems provide better efficiency performance in mild ambient conditions than in warmer climates, where they operate predominantly above the critical point. The implementation of parallel compression or ejector technology increases efficiency levels in warm climates but also increases the complexity and overall cost of these systems. Other technologies are available from various manufactures to boost efficiency performance in warm environments. • R744 is not controlled by any regulation such as the European Fluorinated Gas Regulation, so its use is not as carefully monitored as HFCs and leak detection is not as rigorous. However, the high pressures make the system leak prone, and performance will suffer if the leak rate is high. • Very sensitive to water contamination and can form unusual compounds when there is a leak in a cascade heat exchanger.

ZO & ZOD Copeland™ Scroll compressor range for CO₂- subcritical refrigeration

ZO Copeland Scroll Compressors have been designed for use in R744 (CO₂) low temperature refrigeration systems. These compressors are suitable for usage in CO₂-subcritical cascade and booster systems.

Increasing environmental concerns about potential direct emissions from HFC-based refrigeration systems into the atmosphere have led to the revival of R744 in parts of the European refrigeration market. Regionally, this trend is reinforced by legislation and taxation schemes which favor the usage of refrigerant R744.

In comparison with HFC refrigerants, the specific properties of R744 require changes in the design of the refrigeration system. The ZO range of Copeland Scroll compressors has been particularly designed to exploit the characteristics of the R744 refrigeration system. Efficiency, reliability and liquid handling advantages of the Copeland scroll technology equally apply.

The optimized design of ZO compressors effectively address the challenges of R744 systems i.e., high pressure levels, higher mass flow for a given displacement while securing proper lubrication.

The range consists of 6 models including 2 digital models for 10 to 100% continuous cooling capacity modulation.



ZO compressor for low temperature refrigeration

ZO/ZOD compressor range

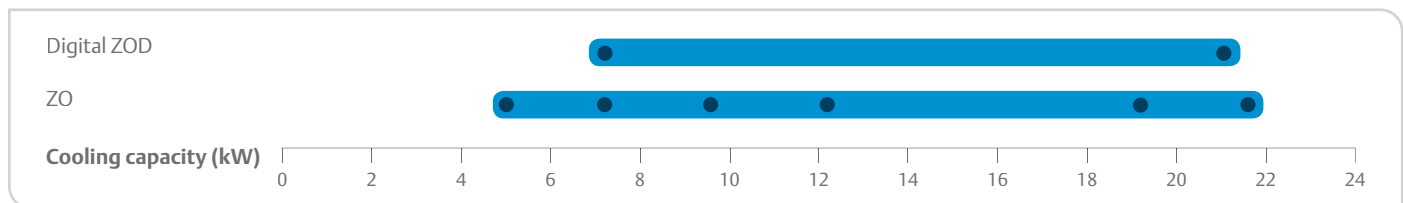

Conditions EN12900 R744: Evaporating -35°C, Condensing -5°C, Suction Superheat 10K, Subcooling 0K

Features and benefits

- Optimized for high efficiency in CO₂ subcritical cascade and booster systems
- 52 bar standstill pressure on discharge side for ZO Scroll
- High condensing temperature limit allowing for optimized overall system design
- Compact design minimizing required machine room space
- Half the weight of equivalent semi-hermetic compressors
- Optional Sound Shell allowing 10 dBA sound attenuation
- High bearing reliability and lubrication of all critical parts under all conditions including liquid slugging
- Availability of a digital model offering simple, stepless 10 to 100% capacity modulation

Operating envelope R744

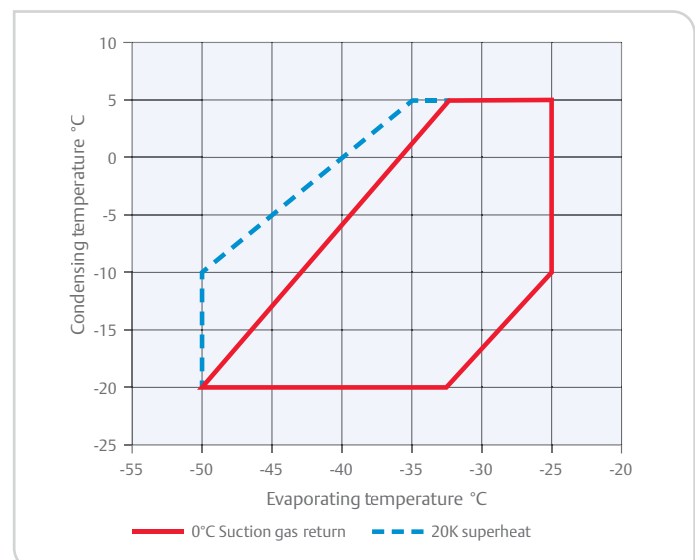

ZO & ZOD Copeland™ scroll compressor range for CO₂- subcritical refrigeration

Technical overview

Model	Nominal (hp)	Displacement (m ³ /h)	Stub suction (inch)	Stub discharge (inch)	Oil quantity (l)	Length / width / height (mm)	Net weight (kg)	Motor version / code	Maximum operating current (A)	Locked rotor current (A)	Sound pressure @1 m - dB(A)***
								3 Ph**	3 Ph**	3 Ph**	
ZO21K5E	1.5	2.6	1 1/4	1	1.0	228/228/388	22.2	TFD	3.6	27	60
ZO34K3E	2	4.1	1 1/4	1	1.4	242/242/381	30	TFD	5.5	26	54
ZO45K3E	2.5	5.4	1 1/4	1	1.4	242/242/403	31	TFD	6.2	35	56
ZO58K3E	3.5	6.9	1 1/4	1	1.4	242/242/417	32.5	TFD	8	48	56
ZO88KCE	5	10.1	1 1/4	1	1.9	245/249/440	40.3	TFD	11.8	64	60
ZO104KCE	6	11.7	1 1/4	1	1.9	242/242/461	40	TFD	15	74	61
Digital models											
ZOD34K3E	2	4.07	1 1/4	1	1.4	242/242/377	30	TFD	5.5	26	62
ZOD104KCE	6	11.7	1 1/4	1	1.9	241/246/484	41	TFD	15	75	67

Capacity data

R744	Condensing temperature (°C)	Cooling capacity (kW)				Power input (kW)			
		Evaporating temperature °C				Evaporating temperature (°C)			
Model		-45	-40	-35	-30	-45	-40	-35	-30
ZO21K5E	-10°C	3.2	4.1	5.1	6.2	1.2	1.2	1.2	1.1
ZO34K3E		4.8	6.2	7.8	9.7	1.8	1.8	1.8	1.7
ZO45K3E		7.0	8.8	10.9	13.3	2.3	2.3	2.3	2.2
ZO58K3E		8.9	11.2	13.9	17.0	3.0	3.0	2.9	2.8
ZO88KCE		13.3	17.0	21.0	25.4	4.5	4.5	4.4	4.2
ZO104KCE		15.9	19.7	24.1	29.2	4.9	5.0	5.1	5.2
Digital models									
ZOD34K3E	-10°C	5.1	6.4	7.9	9.7	1.8	1.8	1.8	1.7
ZOD104KCE		15.6	19.1	23.2	27.9	5.0	5.0	5.1	5.3

Note: 10 K Superheat

Copeland™ semi-hermetic compressor with compressor electronics technology for R744-transcritical applications

Stream series of 4 cylinder CO₂ compressors is the ideal solution for R744 medium temperature cascade and booster systems. It is characterized by a design pressure of 135 bar. Refrigerant flow and heat transfer have been optimized for best performance. All compressors are equipped with Copeland compressor electronics technology and offer the possibility to diagnose system-related problems faster or even before they occur.



Copeland Stream Compressors for R744

Stream compressor range

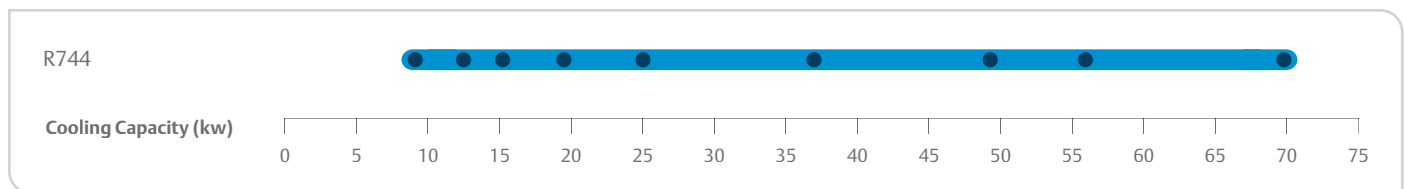

Conditions: EN12900 R744: Evaporating -10°C, Gas cooler exit: 35°C/ 90 bar, Superheat: 10K

Features and benefits

Stream provides for flexibility in pack design and operation:

- Compact dimensions
- Integrated low pressure relief valve
- Discharge Temperature Protection
- Service valve 360° rotation for ease of piping design
- 2 sight glasses for mounting of oil management control and visual inspection
- One oil port for oil equalization in parallel system
- Oil splasher system ensuring lubrication at constant and variable speed

Designed for durability and performance in R744 applications:

- Low sound, low vibration and large discharge chamber to eliminate pulsation
- High design pressures of 135 bar (high side) and 90 bar (low side)
- Burst pressures in excess of safety factor 3
- Cylinder head and discharge plenum design minimizing heat transfer to suction side
- Stepless capacity modulation via inverter from 25 to 70Hz
- Copeland compressor electronics technology
- Individual compressor power consumption monitoring

Operating envelope R744

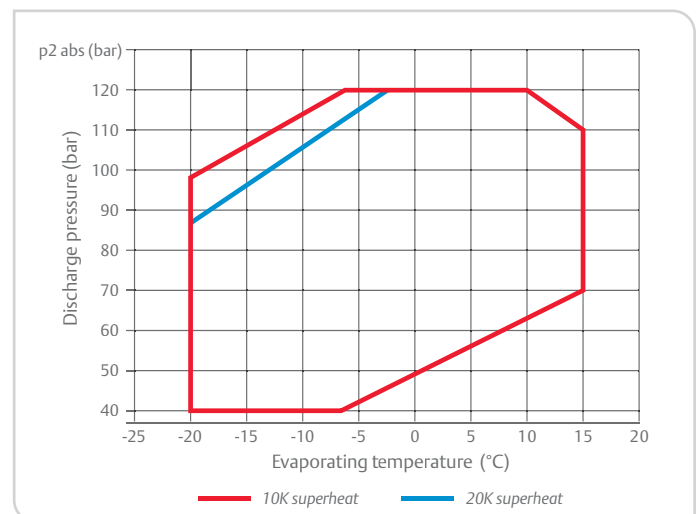

Technical overview

Model	Nominal (hp)	Displacement (m³/h)	Capacity (kw)	COP	Oil quantity (l)	Length / width / height (mm)	Net weight (kg)	Motor version / code	Maximum operating current (A)	Locked rotor current (A)	Sound pressure @1 m - dB(A)***
								3 Ph**	3 Ph**	3 Ph**	
4MTL-05X	5.0	4.6	9.3	1.6	1.5	630/425/410	123.0	EWL	13.3	80.5	76.0
4MTL-07X	7.0	6.2	12.5	1.6	1.5	630/425/410	124.0	EWL	17.5	81.2	76.0
4MTL-09X	9.0	7.4	15.3	1.6	1.5	630/425/410	123.0	EWL	21.0	93.5	76.0
4MTL-12X	12.0	9.5	19.2	1.7	1.8	697/444/423	170.0	AWM	26.5	145.0	67.4
4MTL-15X	15.0	12.5	25.2	1.8	1.8	697/445/422	170.0	AWM	34.8	156.0	71.3
4MTL-30X	30.0	18.0	37.0	1.8	1.8	697/445/422	175.0	AWM	50.0	221.0	75.1
4MTL-35X	35	22.7	49.0	1.79	2.5	842/468/467	257.9	AWM	67.1	304	85.0
4MTL-40X	40	26.6	56.0	1.84	2.5	842/468/467	264.0	AWM	72.6	306	85.0
4MTL-50X	50	32.0	70.0	1.81	2.5	842/468/467	269.4	AWM	90.3	393	85.0

** 3 Ph: 380-420V/ 50Hz

*** @ 1m: sound pressure level at 1m distance from the compressor, free field condition

Capacity data

Model		Temperature (°C)	Pressure (bar)	Cooling capacity (kW)					Power input (kW)				
				Evaporating temperature °C					Evaporating temperature °C				
				-20	-15	-10	-5	0	-20	-15	-10	-5	0
				Equivalent evaporation pressure (bar)					Equivalent evaporation pressure (bar)				
				19.7	22.9	26.5	30.5	34.9	19.7	22.9	26.5	30.5	34.9
4MTL-05X	Condensing	10	45	11.0	13.5	16.4	19.8		3.1	3.0	2.7	2.4	
		15	50	9.9	12.3	14.9	17.9	21.5	3.4	3.4	3.2	3.0	2.6
		20	57	8.8	10.9	13.3	16.1	19.3	3.8	3.8	3.7	3.5	3.2
		25	64	7.6	9.5	11.6	14.1	16.9	4.1	4.2	4.1	4.0	3.8
		30	75	6.0	7.5	9.3	11.2	13.5	4.4	4.5	4.6	4.6	4.4
	Cool gas	35	90		7.1	8.8	10.8	13.0		5.3	5.5	5.6	5.6
		40	100			7.6	9.3	11.3			5.9	6.1	6.2
	40	110				9.7	11.8				6.5	6.7	
4MTL-07X	Condensing	10	45	15.1	18.4	22.2	26.5		3.9	3.7	3.4	3.0	
		15	50	13.7	16.7	20.2	24.1	28.6	4.4	4.3	4.1	3.7	3.3
		20	57	12.2	14.9	18.1	21.6	25.7	4.8	4.8	4.7	4.5	4.1
		25	64	10.5	13.0	15.7	18.8	22.4	5.3	5.4	5.3	5.2	4.9
		30	75	8.3	10.3	12.5	15.0	17.9	5.7	5.9	6.0	5.9	5.7
	Cool gas	35	90		9.7	11.9	14.3	17.2		6.9	7.2	7.3	7.4
		40	100			10.2	12.4	14.9			7.7	8.0	8.2
	40	110				12.8	15.4				8.6	8.9	
4MTL-09X	Condensing	10	45	18.4	22.4	27.0	32.2		4.7	4.5	4.2	3.7	
		15	50	16.6	20.3	24.5	29.4	34.9	5.3	5.2	4.9	4.5	4.0
		20	57	14.8	18.2	22.0	26.3	31.3	5.8	5.8	5.7	5.4	5.0
		25	64	12.8	15.8	19.2	23.0	27.4	6.4	6.5	6.5	6.3	6.0
		30	75	10.1	12.6	15.3	18.4	21.9	6.9	7.1	7.2	7.2	7.0
	Cool gas	35	90		11.9	14.6	17.7	21.1		8.4	8.7	8.9	9.0
		40	100			12.7	15.3	18.4			9.4	9.8	10.0
	40	110				15.9	19.0				10.6	10.9	
4MTL-12X	Condensing	10	45	24.1	29.1	35.0	41.7		6.1	5.9	5.5	4.9	
		15	50	21.8	26.4	31.9	38.1	45.0	6.8	6.8	6.5	6.0	5.3
		20	57	19.5	23.7	28.6	34.3	40.6	7.6	7.6	7.4	7.0	6.5
		25	64	16.9	20.6	25.0	30.0	35.6	8.3	8.4	8.4	8.2	7.7
		30	75	13.5	16.4	20.0	24.1	28.6	9.0	9.3	9.4	9.3	9.0
	Cool gas	35	90	12.8	15.7	19.3	23.3	27.9	10.2	10.9	11.3	11.6	11.6
		40	100		13.6	16.8	20.4	24.4		11.5	12.2	12.6	12.8
	40	110			17.4	21.2	25.5			12.8	13.5	13.9	

Suction superheat 10K / Subcooling 0K

Capacity data

Model		Temperature (°C)	Pressure (bar)	Cooling capacity (kW)					Power input (kW)				
				Evaporating temperature °C					Evaporating temperature °C				
				-20	-15	-10	-5	0	-20	-15	-10	-5	0
				Equivalent evaporation pressure (bar)					Equivalent evaporation pressure (bar)				
				19.7	22.9	26.5	30.5	34.9	19.7	22.9	26.5	30.5	34.9
4MTL-15X	Condensing	10	45	31.2	37.9	45.6	54.4		7.9	7.6	7.1	6.3	
		15	50	28.3	34.5	41.6	49.7	58.7	8.8	8.7	8.4	7.8	6.9
		20	57	25.3	30.9	37.4	44.8	53.0	9.7	9.7	9.6	9.2	8.6
		25	64	22.0	26.9	32.7	39.3	46.6	10.5	10.8	10.8	10.7	10.2
		30	75	17.5	21.5	26.2	31.6	37.5	11.4	11.8	12.0	12.1	11.8
	Cool gas	35	90	16.5	20.5	25.2	30.5	36.5	13.1	13.8	14.4	14.8	15.0
		40	100		17.7	21.8	26.6	31.8		14.8	15.5	16.1	16.4
		40	110			22.5	27.5	33.1			16.6	17.3	17.9
4MTL-30X	Condensing	10	45	45.6	54.9	65.9	78.3		11.4	11.0	10.4	9.3	
		15	50	41.5	50.2	60.3	71.7	84.4	12.6	12.5	12.1	11.4	10.2
		20	57	37.2	45.1	54.3	64.7	76.3	13.9	14.0	13.9	13.4	12.5
		25	64	32.4	39.4	47.6	56.9	67.2	15.2	15.5	15.6	15.4	14.8
		30	75	25.9	31.6	38.3	45.8	54.2	16.4	16.9	17.3	17.4	17.1
	Cool gas	35	90	24.7	30.3	37.0	44.6	53.1	18.8	19.8	20.6	21.2	21.5
		40	100		26.3	32.2	39.0	46.5		21.2	22.2	23.0	23.6
		40	110			33.4	40.5	48.5			23.8	24.8	25.6
4MTL-35X	Condensing	10	45	57.9	69.9	84.2	100.5		14.3	13.7	12.6	11.2	
		15	50	52.6	63.7	76.8	91.9	109.0	15.9	15.6	14.8	13.6	12.0
		20	57	47.1	57.1	69.1	82.8	98.2	17.6	17.6	17.1	16.2	14.9
		25	64	41.1	49.9	60.5	72.6	86.2	19.3	19.6	19.4	18.8	17.8
		30	75	32.8	40.0	48.5	58.4	69.4	20.9	21.5	21.7	21.5	20.8
	Cool gas	35	90	31.5	38.4	46.9	56.7	67.7	23.6	25.1	26.1	26.7	26.9
		40	100		33.5	40.9	49.5	59.3		26.5	28.0	29.1	29.7
		40	110			42.5	51.6	61.9			29.5	31.1	32.1
4MTL-40X	Condensing	10	45	69.0	83.1	99.7	118.5		16.5	15.9	14.7	13.0	
		15	50	62.8	75.8	91.1	108.5	128.0	18.5	18.2	17.4	16.1	14.1
		20	57	56.4	68.1	81.9	97.9	115.5	20.4	20.4	20.0	19.1	17.6
		25	64	49.3	59.6	71.8	85.9	101.5	22.4	22.7	22.6	22.1	21.1
		30	75	39.5	47.8	57.7	69.1	81.9	24.3	25.0	25.3	25.2	24.6
	Cool gas	35	90	38.1	46.2	55.9	67.2	79.9	28.2	29.4	30.4	31.1	31.4
		40	100		40.3	48.8	58.8	70.0		31.8	33.0	34.1	34.8
		40	110			50.8	61.2	73.1			35.6	36.9	37.9
4MTL-50X	Condensing	10	45	82.8	99.7	119.5	142.0		20.2	19.6	18.4	16.7	
		15	50	75.6	91.1	109.5	130.5	153.5	22.6	22.3	21.5	20.0	18.0
		20	57	67.9	82.0	98.6	117.5	139.0	24.9	25.1	24.6	23.5	21.9
		25	64	59.5	71.9	86.5	103.5	122.0	27.3	27.8	27.8	27.2	25.9
		30	75	47.7	57.8	69.7	83.4	98.6	29.6	30.6	31.1	30.9	30.1
	Cool gas	35	90	46.2	56.0	67.8	81.4	96.7	33.9	35.9	37.4	38.3	38.6
		40	100		49.0	59.3	71.3	84.8		38.2	40.3	41.8	42.6
		40	110			61.9	74.5	88.8			42.6	44.7	46.2

Suction Superheat 10K / Subcooling 0K

Copeland™ semi-hermetic compressor with compressor electronics technology for R744- subcritical applications requiring high standstill pressures (90 bar)

Stream series of 4 cylinder CO₂ compressors is the ideal solution for R744 low temperature cascade and booster systems requiring high standstill pressure of up to 90 bar Suction. The use of transcritical compressors in medium / transcritical side as well as on the low temperature / subcritical side ensures that in case of power outage, the refrigeration system features full resilience and no operation disruption.

Stream is characterized by a design pressure of 135 bar. Refrigerant flow and heat transfer have been optimized for best performance. All compressors are equipped with Copeland compressor electronics technology and offer the possibility to diagnose system-related problems faster or even before they occur.



Copeland Stream Compressors for R744

Stream compressor range

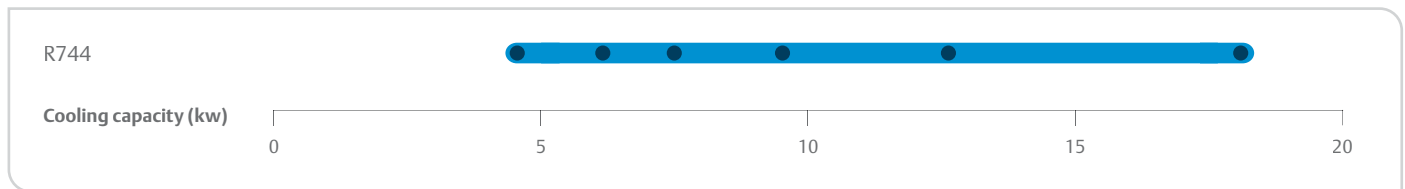

Conditions: EN12900 R744: Evaporating -35C, Condensing -5C, Superheat 10K, Subcooling OK

Features and benefits

Stream provides for flexibility in pack design and operation:

- Compressor max. pressures (suction/discharge): 90 bar / 135 bar
- Compact dimensions
- Integrated low pressure relief valve
- Discharge Temperature Protection
- Service valve 360° rotation for ease of piping design
- 2 sight glasses for mounting of oil management control and visual inspection
- One oil port for oil equalization in parallel system
- Oil splasher system ensuring lubrication at constant and variable speed

Designed for durability and performance in R744 applications:

- Low sound, low vibration and large discharge chamber to eliminate pulsation
- Optimized motor selection for low temperature running conditions
- Burst pressures in excess of safety factor 3
- Cylinder head and discharge plenum design minimizing heat transfer to suction side
- Stepless capacity modulation via inverter from 25 to 70Hz
- Copeland compressor electronics technology for advanced protection, diagnostics, communication
- Individual compressor power consumption monitoring

Operating envelope R744

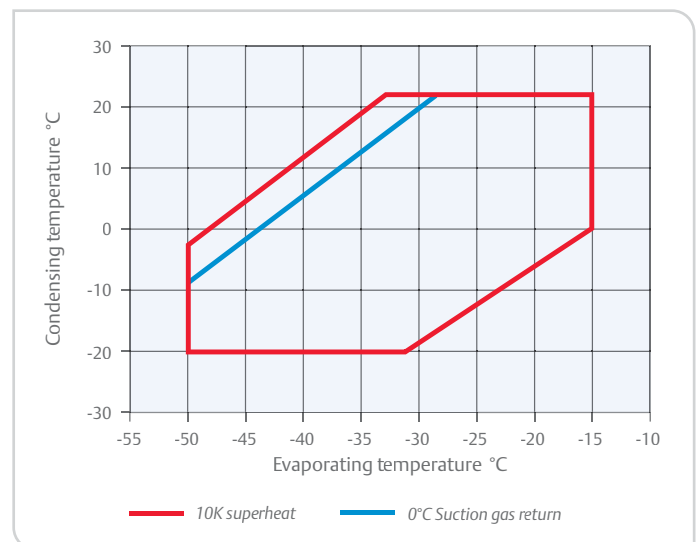

Technical overview

R744	Nominal (hp)	Displacement (m³/h)	Capacity (kW)	COP	Oil quantity (l)	Length / width / height (mm)	Net weight (kg)	Motor version/ code	Maximum operating current (A)	Locked rotor current (A)	Sound pressure @1 m - dB(A)***
								3 Ph**	3 Ph**	3 Ph**	
4MSL-03X	3.0	4.6	7.2	3.2	1.5	630/425/410	120.0	EWL	7.0	49.6	54.0
4MSL-04X	4.0	6.2	9.9	3.6	1.5	630/425/410	120.0	EWL	8.8	49.6	56.0
4MSL-06X	5.0	7.4	12.4	3.7	1.5	630/425/410	120.0	EWL	10.5	61.9	56.0
4MSL-08X	10.0	9.5	15.9	3.6	1.8	697/444/423	170.0	AWM	13.9	87.4	76.0
4MSL-12X	12.0	12.5	21.0	3.7	1.8	697/445/422	170.0	AWM	18.7	145.0	76.0
4MSL-15X	15.0	17.9	31.0	3.8	1.8	697/445/422	170.0	AWM	25.7	156.0	76.0

** 3 Ph: 380-420V/ 50Hz

*** @ 1m: sound pressure level at 1m distance from the compressor, free field condition

Capacity data

R744	Condensing temperature (°C)	Cooling capacity (kW)				Power input (kW)			
		Evaporating temperature (°C)				Evaporating temperature (°C)			
Model		-45	-40	-35	-30	-45	-40	-35	-30
4MSL-03X	-10°C	4.8	6.3	8.2	10.5	1.9	2.0	2.0	1.9
4MSL-04X		6.7	8.8	11.3	14.2	2.5	2.6	2.5	2.4
4MSL-06X		8.0	10.5	13.5	16.9	2.9	3.0	2.9	2.7
4MSL-08X		10.3	13.5	17.2	21.5	3.8	4.0	3.9	3.7
4MSL-12X		13.8	17.9	22.7	28.4	4.9	5.0	5.0	4.8
4MSL-15X		20.3	26.3	33.4	41.5	7.0	7.2	7.2	7.0

Conditions: Suction Gas Return 20°C / Subcooling 0K

*Conditions: Suction Superheat 10K, Subcooling 0K

Copeland™ Outdoor Refrigeration Units for R744-Transcritical Applications

With this range of outdoor refrigeration units, Emerson offers a solution which responds to the increasing demand for future proof refrigeration technology.

These models are designed for operation with the natural refrigerant CO₂ which has a very low global warming potential (GWP) of only 1.

The range features the latest technology like Stream series compressors which are characterized by their silent and reliable operation. The integrated frequency inverter controls the compressor speed exactly to the capacity demand of the application. EC-fans remove the heat from the gas cooler in the most efficient and silent way.

The state of the art electronic controller allows for precise adjustment and control of all relevant parameters and comprises numerous electronic protection functions for highly reliable operation.

The refrigeration units are future-proof choice for various target applications:

- Convenience stores
- Cold rooms
- Forecourt sites
- Fast food stores, bars and restaurants



Copeland outdoor refrigeration unit for R744-transcritical applications

R744 refrigeration unit line-up

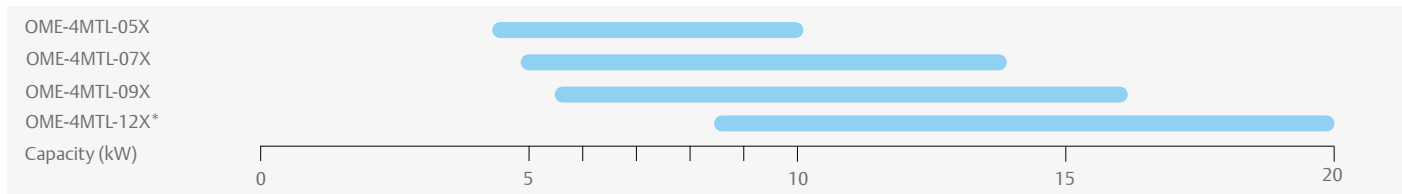

* Preliminary Data

Technical overview

Model	Displacement @ 50 Hz (m ³ /h)	Cooling capacity @ 50 Hz (kW)	Receiver capacity (l)	Suction line diameter (inch)	Liquid line diameter (inch)	Width/depth/height (mm)	Net weight (kg)	Power supply	Nominal current (A)	Sound pressure @10m - d(BA) *
OME-4MTL-05X (HP**)	4.6	8.69	24.9	3/4	5/8	1574/920/1135	450	3/N/PE~50Hz 400/230V TN-S	19	42 - 44
OME-4MTL-07X (HP**)	6.2	11.80		3/4	5/8	1574/920/1135	450		22	42 - 44
OME-4MTL-09X (HP**)	7.4	14.25		7/8	5/8	1574/920/1135	462		27	42 - 44
OME-4MTL-12X	9.5	17.00		7/8	5/8	1574/920/1135	473		33	45 - 47

Conditions EN13215: R744, evaporating temperature -10°C, ambient temperature 32°C, suction superheat 10 K

* @ 10m: sound pressure level at 10m distance from the compressor, free field condition

**90 bar liquid line.

Preliminary data

For detailed capacity data please refer to Emerson's Select software

Features and benefits

- Future-proof solution with natural GWP 1 refrigerant, not impacted by F-Gas legislation
- Low carbon footprint
- Silent operation due to special attenuation on panels and sound optimized EC fans
- High energy efficiency through inverter controlled compressor and EC fans
- Space saving design
- Time saving commissioning by pre-set parameters
- High reliability with electronic protection against incorrect voltage, phase, current and discharge temperature
- State of the art controller for precise system control
- Modbus communication and monitoring functionality
- LCD display to show the operation status
- OilWatch maintains correct system oil level
- Controller prepared for heat recovery
- Easy access for time saving service
- Built and tested in advanced industrial processes
- Individual compressor power consumption monitoring

Design pressure:

- 90 bar in receiver and liquid line
- 120 bar on high-pressure side

Emerson CO₂ valve application possibilities

Hypothetical layout of a large booster transcritical and subcritical CO₂ system to demonstrate application of Emerson CO₂ valve CV and CX2 series as well EX series valves.

Guideline table - applicability

Duty	CV4-7 PS: 130 bar PT: 186 bar	Position	EX4 PS: 90 bar PT: 99 bar	EX5-7 PS: 60 bar PT: 66 bar	EX8 PS: 45 bar PT: 49.5 bar	Recommended Emerson driver	CX2 PS: 90 bar PT: 129 bar
High pressure gas valve	Yes	(A)	No	No	No	EXD-U02	No
Bypass valve	Yes	(B)	No	No	No	EXD-U02	No
Heat reclaim valve	Yes	(C)	No	No	No	EXD-U02	No
Expansion valve	Yes	(D)	Yes	Yes	Yes	EXD-SH1/2	Yes
Suction pressure regulation	Yes	(E)	Yes	Yes	Yes	EXD-U02 EXD-SH1/2	No

Note: PS = Maximum allowable pressure, PT = Factory pressure test / Standstill pressure
(System manufacturer can apply PT pressure to the assembly of valve and piping for strength and leakage test).

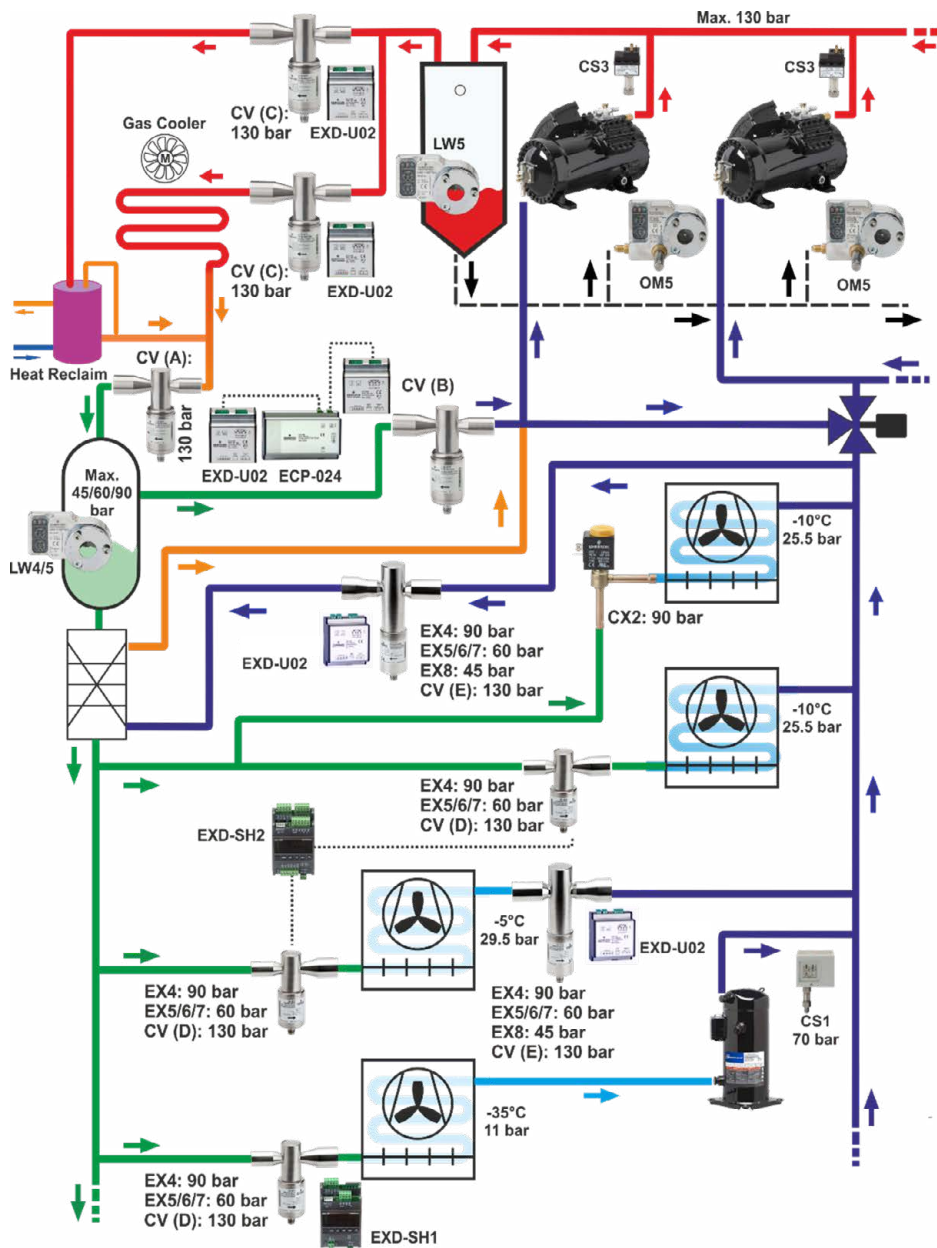

Electronic expansion valves series CX2

Pulse width modulated expansion valve with exchangeable orifices for high-pressure CO₂ applications (display cases).



CX2 with orifice

Features and benefits

- Pulse width modulated
- Shut-off function eliminates the necessity of a separate solenoid valve
- Dampened plunger reduces noise effects of water hammer
- One valve body can be combined with 6 orifices to make 7 capacity ranges up to 28.2 kW
- Long lifetime, high reliability
- PS: 90bar
- MOPD: 65 bar

Selection table

Valve						
Type	Part No.	Description	Type	Part no.	Description	Nominal capacity R477 (kW)
CX2-I00	801 095	Valve: 3/8" x1/2" ODF				28.2
			EXO-004	801089	Orifice 4	17.9
			EXO-003	801088	Orifice 3	11.8
			EXO-002	801087	Orifice 2	7.0
			EXO-001	801086	Orifice 1	5.2
			EXO-000	801085	Orifice 0	2.6
			EXO-00X	801084	Orifice X	1.5

Note 1: Nominal capacity at -10°C evaporating temperature, +10°C liquid temperature (45 bar) and 1K subcooling.
For other operating conditions the selection tool "Controls Navigator" can be downloaded from climate.emerson.com/en-gb.

Coil						
Type coils	Part No.	Supply voltage	Power input	Description	Ambient temperature	Picture
ESC-24VAC	801033	24 VAC ±10% 50(60) Hz	17VA	IP 65 properly installed on enclosing tube with plug/cable assembly acc. EN 60529 test conditions	-40...+60°C	
ESC-230VAC	801031/M*	230 VAC ±10% 50(60) Hz				

Note: Orifice should be selected at max. 80% of Qn to allow covering the load fluctuation.

Cable assembly for ESC coils

Type	Part No.	Description	Cable length	Temperature range	Picture
ASC-N15	804570/M*	Connector Cable Assembly	1.5 m	-50...+80°C (valid for stationary use)	
ASC-N30	804571/M*		3.0 m		
ASC-N60	804572/M*		6.0 m		
Plug PG9	801012	Plug acc. EN175301 with cable gland			
Plug PG11	801013	Plug acc. EN175301 with cable gland			
ESC-K01	801034	Screw cap (incl. 2x O-ring & fixing retainer)			

Note: *) Multipack = 20 pcs.

High-pressure electrical controls valves series CV4-7

Emerson CV4-7 are stepper motor driven valves for precise control of refrigerant mass flow in CO₂ systems and can be applied as (see next page):

- High pressure gas valve (A)
- Bypass valve (B)
- Heat reclaim valve (C)
- Expansion valves (D)
- Suction pressure regulating valve (E)

Features and benefits

- Maintenance free
- Multifunction
- Fully hermetic design with ODF connections
- Stepper motor driven
- Short opening and closing time
- Very fast full stroke time
- High resolution and excellent repeatability
- Positive shut-off function to eliminate the use of an additional solenoid valve
- Linear flow capacity
- Extremely wide capacity range (10...100%)



CV5-HPV

- Optimal solution applied to offer the highest reliability and lifespan, accordingly to the high differential pressures in the CO₂ systems
- Ceramic slide and port for precise flow and minimal wear
- Balanced force design
- Corrosion resistant stainless-steel body and connections

Selection table

Type	Part No.	Kv (m ³ /hr)	Capacity range	Inlet connection	Outlet connection	Electric connector
CV4-HPV	802056	0.21	10...100%	3/8" ODF	5/8" (16 mm) ODF	M12 Plug
CV5-HPV	802057	0.68		5/8" (16 mm) ODF	7/8" (22 mm) ODF	
CV6-HPV	802058	1.57		7/8" (22 mm) ODF	1-1/8" ODF	
CV7-HPV		5.58		1-1/8" ODF	1-1/8" ODF	

Note1: The valves are delivered without cable/connector assembly (order separately).

Cable and connector assembly

Type	Part No.	Length (m)	Temperature Range	Connector type to valve	Connector type to driver board or controller	Illustration
EXV-M15	804663	1.5	-50...+80°C	M12	Loose wires	
EXV-M30	804664	3.0				
EXV-M60	804665	6.0				

Emerson driver / controller to drive CV valves

Type	Function	Analogue signal input	Remark
EXD-U02 for one valve	Slave	0-10VDC or 4-20 mA signal from master controller	Refer to technical bulletin of EXD-U02
EXD-SH1 for one valve	Superheat or temperature controller	Pressure transmitter and temperature sensor	Refer to technical bulletin of EXD-SH1/2
EXD-SH2 for two valves			
Third party driver/controller	See page 4 for requirements		

Technical data

Marking	 not required (Out of scope of PED) CV4/5/6 (No.MP604)	Protection accordance to IEC 529, DIN 40050	IP67 with EXV-Mxx plug and cable assembly
Compatibility	CO ₂ and POE lubricants	Vibration	4g (0...1000 Hz, 1 octave /min.)
MOPD	70 bar (In conjunction with EXD-U02 driver)	Shock (CV4-6)	20g at 11 ms 80g at 1 ms
Max. allowable pressure PS	130 bar	External leakage	6.4*10 ⁻⁶ mbar*liter/sec.
Factory test pressure PT	186 bar	Humidity	100% R.H.
Temperatures	Ambient -40...+65°C Storage -40...+70°C Medium -50...+100°C		

Electrical data

Stepper motor type	Bi-polar, phase current by chopper control (constant current)	Step mode	2 phase full step
Electrical connection	4 pins terminal for M12 plug	Stepping rate	500 Hz
Driver supply voltage to the valve	18...36VDC	Total number of steps	CV4-6: 750 full steps CV7: 6400 full steps.
Operating (moving) current peak	CV4: 625 mA CV5-7: 800 mA	Winding resistance per phase	CV4: 14 Ohm ±10% CV5-7: 10 Ohm ±10%
Holding current peak	CV4: 100 mA CV5-7: 300 mA	Full travel time	CV4-6: 1.5 seconds CV7: 12.8 seconds
Phase inductance	CV4: 30 mH ± 25% CV5/6/7: 20 mH ± 25%	Reference position	Mechanical stop at fully close position

Dimensions (mm)

Type	CV4-HPV	CV5-HPV	CV6-HPV	CV7-HPV
Part No.	802056	802057	802058	
Ø A x Ø F (ODF)	3/8" x 5/8" (16 mm)	5/8" (16 mm) x 7/8" (22 mm)	7/8" (22 mm) x 1-1/8"	1-1/8" x 1-1/8"
B (mm)	8	11	16	20
C (mm)	45	55	65	78
D (mm)	55	65	75	83
E (mm)	11	16	19	20
H1 (mm)	113	125	125	205
H2 (mm)	26	26	26	42
H2 (mm)	26	26	26	42

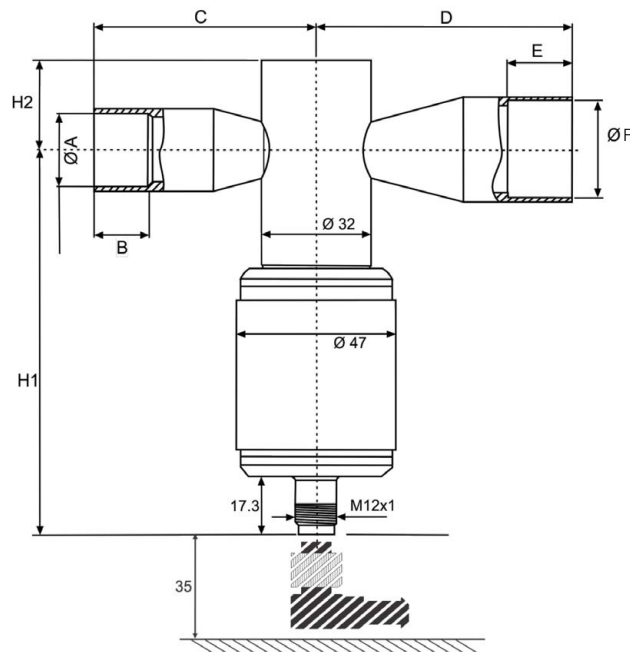

Electrical control valves series EX4-8

Features and benefits

- Multifunction as expansion valve, hot gas bypass, suction gas throttling, head pressure, liquid level actuator etc.
- Fully hermetic design (no thread joints between valve body and motor compartment)
- Applicable to all common refrigerants (HCFC, HFC) and for subcritical CO₂ applications
- Stepper motor driven
- Short opening and closing time
- High resolution and excellent repeatability
- Positive shut-off function to eliminate the need for additional solenoid valve
- Bi-flow versions for heat pump applications
- High linear flow capacity
- Extremely wide capacity range (10 ... 100%)
- Continuous modulation of mass flow, no stress (liquid hammering) in the refrigeration circuit
- Direct coupling of motor and valve for high reliability (no gear mechanism)
- Ceramic slide and port for highly accurate flow and minimal wear
- Balanced force design
- Corrosion resistant stainless steel body and stainless steel connections
- PS: EX4 (uni-flow) 90bar, EX4 (bi-flow) 60bar, EX5-7 60bar, EX8 56bar
- Liquid Inlet Temperature TS:
Uniflow: -50...+100°C, Biflow: -40...+80°C



Selection table

Type	Part no.	Flow pattern	Nominal capacity range (kW)	Inlet connection	Outlet connection	Electrical connection
EX4-I21	800615	Uni-flow	27	3/8" ODF	5/8" ODF	M12 Plug
EX4-M21	800616			10 mm ODF	16 mm ODF	
EX5-U21	800618		82	5/8" (16 mm) ODF	7/8" (22 mm) ODF	
EX6-I21	800620		197	7/8" ODF	1-1/8" ODF	
EX6-M21	800621			22 mm ODF	28 mm ODF	
EX7-I21	800624		541	1-1/8" ODF	1-3/8" ODF	
EX7-M21	800625			28 mm ODF	35 mm ODF	
EX8-M21	800629		1442	42 mm ODF	42 mm ODF	
EX8-U21	800630			1-3/8" (35 mm) ODF	1-3/8" (35 mm) ODF	
EX8-I21	800631			1-5/8" ODF	1-5/8" ODF	
EX4-U31	800617	Bi-flow (Heat pump)	27	5/8" (16 mm) ODF	5/8" (16 mm) ODF	
EX5-U31	800619			7/8" (22 mm) ODF	7/8" (22 mm) ODF	
EX6-I31	800622		197	1-1/8" ODF	1-1/8" ODF	
EX6-M31	800623			28 mm ODF	28 mm ODF	
EX7-U31	800626		541	1-3/8" (35 mm) ODF	1-3/8" (35 mm) ODF	

Note1: EX4-8 are delivered without cable/connector assembly -to be ordered separately.

Note2: Nominal capacity at -10°C evaporating temperature, +10°C liquid temperature and 0K subcooling.

Note3: For selection of other operating condition, please use quick selection tables in the next pages or Navigator selection program 2019.

Cable connector assemblies

Type	Part no.	Temperature range	Length	Connector type to valve	Connector type to driver board or controller	Picture
EXV-M15	804 663	-50 ... +80°C	1.5 m	M12, 4 pins	Loose wires	
EXV-M30	804 664		3.0 m			
EXV-M60	804 665		6.0 m			

Capacity data

Application expansion valve and liquid injection valve

Valve type	Condensing temperature (°C)	Subcooling	Nominal capacity kW (R744)
EX4	-10°C	1K	3...33.5
EX5			10...102
EX6			24...244
EX7			70...670
EX8			180...1789

Guideline for selection of electrical control valves as expansion valves

Controls navigator

For easy and quick selection of Electrical Control Valves as Expansion Valves, the “Controls Navigator” selection tool can be downloaded from the website at climate.emerson.com/en-gb.



The following guideline should be taken into consideration in order to obtain full advantages of the control valves:

- Published capacities are maximum and there are no reserve capacities
- Shorter travel time i.e. faster response also for larger size of valve. For example, the EX7 has a maximum travel time of 3.2 seconds. The valve has approximately 1.6 seconds travel time at 50% capacity operation.

Technical data

Compatibility *	A1: R134a, R404A, R507, R407C, R450A, R513A, R452A, R448A, R449A, R410A, R744 (subcritical), R23 A2L: R32, R452B, R454B, R454A, R454C, R1234ze, R124 Mineral and POE lubricants
MOPD (maximum operating pressure differential)	EX4/EX5/EX6: 40 bar EX7: 35 bar EX8: 30 bar
Max. allowable pressure PS	EX4 (uni-flow): 90 bar EX4/5/6/7 (bi-flow): 60 bar EX8: 45 bar UL Approval: EX4/5/6/7: 60 bar UL Approval: EX8: 45 bar
Factory test pressure PT	EX4 (uni-flow): 99 bar EX4/5/6: 66 bar EX7: 86 bar EX8: 65 bar
Ambient temperature Storage temperature	-40...+55°C -40...+70°C
Medium inlet temperature Bi-flow version: Uni-flow version:	TS: -50...+80°C TS: -50...+100°C (UL-Approval based on $\geq -40^\circ\text{C}$)

Note: *UL only for use with A1 refrigerants.

Evaporating temperature	-100...+55°C
Salt spray test	non-corrosion stainless steel body
Connections	ODF stainless steel fittings
Humidity	5 to 95% r.H.
Protection accordance to IEC 529, DIN 40050	IP67 with EMERSON supplied cable connector assembly
Vibration for non-connected and fastened valve	4g (0...1000 Hz, 1 octave /min.)
Shock	20g at 11 ms 80g at 1 ms
Net weight (kg)	0.5 kg (EX4), 0.52 kg (EX5), 0.60 kg (EX6), 1.1 kg (EX7), 1.5 kg (EX8)
External leakage	≤ 3 gram / year
Seat leakage	Positive shut-off better than solenoid valves
Marking	EX4/5/6: None (Out of PED scope) EX7/8:  1017 (Module D1) c  us EX4/5/6/7/8:

Block diagrams

Superheat Control with EXD-SH12

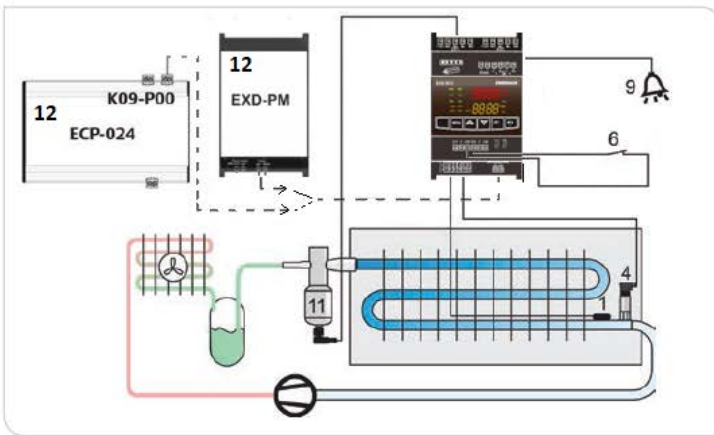

- 1 TP1-NP sensor
- 4 PT5N pressure transmitter
- 6 Digital Input
- 9 Alarm out
- 11 EX4 ... EX8 valve
- 12 Uninterruptible power supply - optional

Refrigerant Mass Flow Control with EXD-U

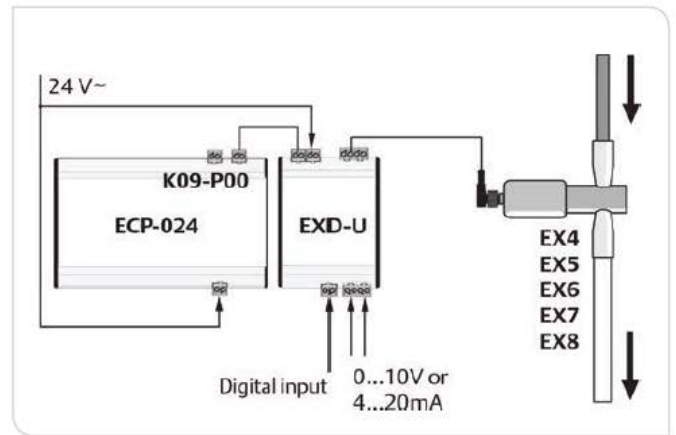

Universal Driver Module Series EXD-U02

EXD-U02 is a Universal Driver Module that enables the operation of Emerson stepper motor driven valves EX4-8, as well as the new series CV4-7 as:

- High pressure gas valve for flash tank (applies only to CV valves for CO₂)
- Bypass valve from flash tank (applies only to CV valves for CO₂)
- Capacity control by means of hot gas bypass or evaporating pressure regulator
- Crankcase pressure regulator
- Heat reclaim regulator
- Liquid level regulator



EXD-U01/ EXD-U02

Features

- 4...20 mA or 0...10 V analog input signal
- Step recovery function selectable
- Plug and run, no parameter setting i.e. automatic operation
- Easy configurable by Dip-switches
- Digital input for valve closure at any time
- Aluminum housing for DIN rail mounting

Emerson overcurrent built-in protection

EXD-U02 drivers offer an exclusive, built-in internal hardware that ensures the valve stepper motor is never bearing an overcurrent, so the current is modulated accordingly to optimize the valve best working conditions in the safest way.

Optional uninterruptible power supply ECP-024

The optional uninterruptible power supply ECP-024 contains a rechargeable lead-acid battery, which provides enough energy to close the valve in case of power loss. One single ECP-024 can be connected to two EXD-U02 driver modules for closure of up to two valves.

Selection table

Description	Type	Valves applicable	Part No. single pack
Universal Driver Module	EXD-U02	EX,CX,CV	804752
Electrical Terminal Kit	K09-U00	-	804559

* Controller Kit contains terminal kit

Accessories

Description	Type	Part No.	Note
Uninterruptible Power Supply	ECP-024	804 558	for up to 2 driver modules
Electrical Terminal Kit	K09-P00	804 560	for ECP-024
Transformer 230V/24V	25VA	ECT-323	804 424
	60VA	ECT-623	804 421 DIN-rail mounting



K09-U00



K09-P00

Capacity data

See "Electrical control valves EX4-8 / CV4-7" data.

See technical bulletin "EXD-U02 Technical Bulletin" for detailed data and its application in CO₂ systems.



ECP-024



ECT-323

Superheat controller series EXD-SH1/2 with ModBus communication capability

EXD-SH1/2 are stand-alone universal superheat and or temperature controllers for air conditioning units or refrigeration systems.

Features

- EXD-SH1: Control of one valve
- EXD-SH2: Control of two valves in two independent circuits
- Main function

	Circuit 1	Circuit 2
EXD-SH1	Superheat or temperature control	
EXD-SH2	Superheat or temperature control	Superheat Control

- Other functions: Limitation of evaporating pressure (MOP), Low pressure switch, freeze protection and manual positioning of valve(s)
- Self-adapting superheat control function in conjunction with Emerson EX4-8 series
- For multiple refrigerants
- Modbus (RTU) communication
- Integrated keyboard with two lines display
- Monitoring of sensors and detection of sensor (TP1-N/PT5N)/ stepper motor wiring failures
- Optional upload/download key (accessory) for transmission of parameter settings among controllers with the same setting



EXD-M03



EXD-SH2

- Low/high superheat alarm as well as other function alarms
- Electrical connection via plug-in type screw terminals included with controller and Micro Molex EXD-M03 (must be ordered separately)
- DIN rail mounting housing

Selection table

Type	Description	Part No.	
		Multipack (pcs)	Single pack
Controllers			
EXD-SH1	Controller for single refrigeration circuit	-	807855
EXD-SH2	Controller for two independent refrigeration circuits	-	807856
EXD-M03	Molex terminal with 3 m wires	-	807865
Temperature sensors			
TP1-NP3	Temperature sensor with 3 m cable	804489M (20)	804489
TP1-NP6	Temperature sensor with 6 m cable	804490M (20)	804490
ECN-Z60	Ultralow Temperature sensor with 6 m cable	-	807826
Pressure transmitters: PT5N (7/16-20UNF connection)			
PT5N-07M	Sensing pressure range -0.8...7 bar	805350M (25)	805350
PT5N-18M	Sensing pressure range 0...18 bar	805351M (25)	805351
PT5N-30M	Sensing pressure range 0...30 bar	805352M (25)	805352
PT5N-50M	Sensing pressure range 0...50 bar	805353M (25)	805353
PT5N-150D	Sensing pressure range 0...150 bar (1/4- 18 NPT)	805379M (25)	805379
Pressure transmitters: PT5N (Brazeing connection)			
PT5N-07T / PT5N-07P-FLR	Sensing pressure range -0.8...7 bar	805380M / 805390M (25)	805380 / 805390
PT5N-010P-FLR	Sensing pressure range -0.8...10 bar	805391M (25)	805391
PT5N-18T	Sensing pressure range 0...18 bar	805381M (25)	805381
PT5N-30T / PT5N-30P-FLR	Sensing pressure range 0...30 bar	805382M / 805389M (25)	805382 / 805389
PT5N-50T	Sensing pressure range 0...50 bar	805383M (25)	805383

Note: Pressure range 18 bar for system with R410A, 30 bar for R410A economizer, 50/150 bar for CO₂

EXD-SH1/2 Controller for EX

Accessories

Type	Description	Part No.	
		Multipack (pcs)	Single pack
M12 Plug and cable for pressure transmitters PT5N(FLR)			
PT4-M15	1.5 m	804803M	804803
PT4-M30	3.0 m	804804M	804804
PT4-M60	6.0 m	804805M	804805
PT4-M60 FLR	6.0 m	-	804806
Uninterruptible Power supply			
ECP-024	Backup battery with two outputs for two controllers	-	804558
K09-P00	Electrical Terminal Kit for ECP-024	-	804560
EXD-PM	Super cap for only EXD-SH1 (two pieces of EXD-PM required for one EXD-SH2)	-	807854

Technical data: EXD-SH1/2

Supply voltage	24VAC/DC ±10%, 50/60Hz	Mounting	DIN rail mounted
Power consumption	EXD-SH1: Max. 25VA EXD-SH2: Max. 50VA	Temperatures	Storage Operating/ surrounding -25 ... +60°C 0 ... +60°C
Terminals 1 to 12	Suitable for 12 poles molex plug	Relative humidity	
Terminals 13 to 36	Suitable for removable screw version: wire size 0.14 ... 1.5mm ² Included in controller delivery	Accessory (12 poles molex plug with 3 meter cable)	Type: EXD-M03 Part: No 807826 (to be ordered separately)
Protection class	IP 00	Housing	Self-extinguishing ABS
Compliance	EMC, RoHS,	Weight	320 g
Marking			

Input, output EXD-SH1/2

Description	Specification
Analogue input(s): NTC Temperature sensor Analogue input: PT1000 Temperature sensor	TP1-N... (-40...+150°C sensing range) ECN-Z60 (-80 ... -40°C sensing range)
Analogue input(s): 4-20 mA pressure transmitters Analogue input(s): 0.5 ... 4.5 V pressure transmitters	PT5N Third party ratio metric pressure transmitters (total error: ≤ 1%)
Digital input(s)	Dry contact, potential free
Digital output(s): Alarm relay(s) Contact is closed: During alarm condition Contact is open: During normal operation and supply power OFF	Resistive Load 24 V AC/DC, max. 1 A Inductive Load 24 V AC, max. 0.5 A
Communication	RS485 RTU Modbus, two wires
Stepper motor output	Valves: EX4-8, CV4-7

EXD-SH1/2 Controller for EX

Optional EXD-PM supercap

Supply voltage	24 VAC/DC \pm 10%, 50/60 Hz
Output voltage	12 VDC
Max. output current	- 1.2 A - 350 mA during charging
Power consumption	12 VA
Terminals	Suitable for removable screw version: wire size 0.14...1.5 mm ²
Output: to driver/controller	Suitable for one EXD-SH1
Charging time	60 seconds
Protection class	IP 20
Mounting	DIN rail mounted

Max. cable length between EXD-PM and EXD-SH1/2	50 cm AWG18 wire size
Temperatures operating/ surrounding	Storage -20°C...+70°C -10°C...+60°C
Housing	Self-extinguishing ABS
Relative humidity	20...85%
Weight	125 g
Marking	CE EAC

Optional EXD-PM supercap

Backup battery type	Lead acid gel rechargeable battery
Number of backup batteries	2, each 12 VDC, 0.8 Ah
Supply voltage	24 VAC \pm 10%, 50-60 Hz
Output voltage, UB	18 VDC
Number of outputs to drivers	2
Battery recharge time	approximately 2 hours
Protection class	IP 20
Mounting	DIN rail mounted
Temperatures operating/ surrounding	Storage -20°C...+65°C -10°C...+60°C

Housing	Aluminum
Relative humidity	< 90% non-condensing
Connection	Screw terminals for wire size 0.5...2.5 mm ²
Accessories: Terminals	K09-U00 Part No: 804559
Weight	1200 g
Marking	CE EAC

2-Way Solenoid valves series 200 RH

Normally closed

Features

- Compact size
- Media temperature range -40...+120 °C
- No disassembly necessary for brazing
- Extended copper tubes for easy installation
- IP 65 Solenoid coil and cable assembly
- One coil fits to all sizes and valve series
- PS: 60 bar

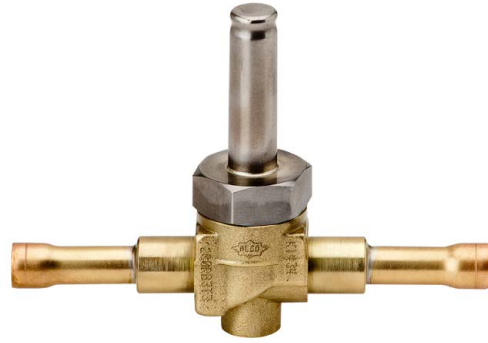

Capacity data

Type	Nominal capacity Q_n (kW)	
	Liquid	Hot gas
	R744	
200 RH 3	8.1	7.2
200 RH 4	19.1	16.1
200 RH 6	33.6	28.7

Note: Nominal capacities at +10°C condensing temperature, -10°C evaporating temperature, subcooling 1 K
 0.15 bar pressure drop between valve inlet and outlet in liquid applications.
 1 bar pressure drop for hot gas applications

Selection table

Type		Part No.	Connection solder / ODF	
			mm	inch
200 RH 3	T3	802 070	10 mm	3/8"
	T3	802 071	10 mm	
200 RH 4	T3	802 072		3/8"
	T4	802 073	12 mm	
	T4	802 074		1/2"
200 RH 6	T4	802 075	12 mm	
	T4	802 076		1/2"
	T5	802 077	16 mm	5/8"

Coils ESC and cable assemblies

Features

- Compact hermetic design with a low weight
- Standard coils for AC and DC
- Designed for continuous operation
- Reduced power consumption
- Insulated coil windings provide a high shock and vibration resistance
- Short response times
- Simple and quick assembly with clip, cap or screw cap
- All models meet the requirements for CE & EAC marking; additional models with UL



Type Coils	Part No.	Supply voltage	Power Input	Description	Ambient temperature
ESC-24VAC	801033	24 VAC ±10% 50(60) Hz	8W	IP 65 with properly installed plug/cable assembly acc. EN 60529 test conditions	-40...+60°C
ESC-230VAC	801031 801031M*	230 VAC ±10% 50(60) Hz	8W		
ESC120	801032 801032M*	120 V AC ±10% 50(60) Hz	8W		
ESC-24VDC	801030 801030M*	24 V DC	15W	IP 65 delivered with plug and cable assembly	
DS2-N15 + ESC 24VAC	804620 + 801033	24 V DC	3W		

Note1: ESC coil is the successor model of ASC- and ASC3 Coils. Replacement with ASC3-.../ ASC-... always requires the replacement of existing O-rings. Only use O-rings approved for ESC!

Note2: Coils are delivered with retainer Kit. Please order plug and cable assembly separately.



Cable assemblies for ASC coils

Type	Part No.	Temperature range	Cable length	Wire diameter	Connector type
ASC-N15	804 570	-50 .. +80°C for stationary use only	1.5m	3 x 0.75 mm ²	loose wires
ASC-N30	804 571		3.0m		
ASC-N60	804 572		6.0m		

Cable assembly with 24V DC chopper plug

- Enables standard 24V AC Coil to be used for DC applications
- Low power assumption (3W only)
- No MOPD degradation



Type	Part No.	Description	Cable length	Temperature range
DS2-N15	804620	Chopper Plug (Low power assumption, 3W only, not released for mobile applications) Connector type: lose wires, 2x0.75mm ²	1.5 m	-25...+80°C



Other accessories

Type	Part No.	Description
Plug PG9	801012	Plug acc. EN175301 with cable gland
Plug PG11	801013	Plug acc. EN175301 with cable gland
ESC-K01	801034	Screw cap (incl. 2x O-ring & fixing retainer)

Pressure Transmitter PT5N

PT5N Pressure Transmitters convert a pressure into a linear electrical 4...20 mA output signal suitable for controlling simple compressor and fan switching to the more sophisticated application of superheat modulation of Electronic Control Valves.

With competitive performance to price characteristics and an easy to install pre-fabricated M12 cable assembly, PT5N transmitters are the designers choice for all heat pump, refrigeration and air conditioning applications.

Features

- Hybrid film technology where the pressure measuring cell is fully welded with the pressure transducer without seals.
- With output signal 4...20 mA and 2-wire connection for the precise operation of superheat, compressor or fan control systems
- Fully hermetic
- Calibrated for specific temperature and pressure ranges
- Easy install M12 electrical connection with pre-assembled cable assemblies available in various lengths
- PT5N-xxM with 7/16"-20UNF pressure connection and Schrader valve opener
- PT5N-xxT with 6x40 mm stainless steel tube and integrated brazing neck for easy mounting in applications requiring a fully hermetic system solution
- PT5N-150D with pressure connection 1/4"-18 NPT male suitable for subcritical and transcritical CO₂ systems
- Vibration, shock and pulsation resistant
- Protection class IP67 with mounted Plug and Cable Assembly



PT5N-xxM



PT5N-xxT

Selection table Pressure Transmitter

Type	Part No.		Pressure range for signal output (bar)*	Output signal	Medium temperature range	Max. allowable pressure PS (bar)*	Pressure connection
	Single pack	Multi pack**					
PT5N-07M	805350	805350M	-0.8...7	4...20 mA	-40...+135°C	27	7/16" – 20 UNF (with Schrader valve opener)
PT5N-18M	805351	805351M	0...18			48	
PT5N-30M	805352	805352M	0...30			60	
PT5N-50M	805353	805353M	0...50			75	
PT5N-07T	805380	805380M	-0.8...7			27	6 mm tube x 40 mm long
PT5N-18T	805381	805381M	0...18			48	
PT5N-30T	805382	805382M	0...30			60	
PT5N-50T	805383	805383M	0...50			75	
PT5N-150D	805379	805379M	0...150				150

Note: *) Sealed gauge pressure



Selection table Cable Assemblies: assembly fits all models

Type	Part No.		Cable length**	Temperature range
	Single pack	Multipack 20 pcs		
PT4-M15	804803	804803M	1.5 m	-50...+80°C static application -25...+80°C mobile application
PT4-M30	804804	804804M	3.0 m	
PT4-M60	804805	804805M	6.0 m	

Note: **) Longer length of the electrical connection cable beyond 6.0 m must be verified by user in term of output signal as well as EMC within installed system.

Pressure Transmitter PT5N

Technical Data

Supply voltage (polarity protected)	Nominal: 24VDC Range: 7...33VDC	Electrical connection PT4-Mxx Cable Assembly	M12 connection according to EN61076-2-101 Part 2 Prefabricated, various cable lengths
Operating current	Maximum ≤ 23 mA 4...20 mA output	Medium compatibility	A1 group refrigerants
Load resistance	RL * Ub - 7.0V_ 0.02A	Approvals/Marking	 acc. EMC Directive (EN 61326-2-3, EN 50121-3-2)  (E499688)
Response time	≤ 2 ms	Protection class (EN 60529)	IP67 with mounted plug and cable assembly
Weight (without plug and cable ass.)	PT5N-xxM: ~ 87 g PT5N-150D: 73 g PT5N-xxT: ~ 103 g	Vibration at 15...2000Hz	20 g according to IEC 60068-2-6
Mounting position	Non position sensitive; details see operating instructions	Materials	Housing Stainless steel 1.4404 / AISI316L pressure connection Stainless steel 1.4301 / AISI 304 PT5N-xxT
Temperatures Transport and storage Operating ambient housing Medium	-50...+100°C -30...+85°C -40...+135°C		

Accuracy performance

Type	Total error *	Temperature range
PT5N-07 / -18	$\leq \pm 1\%$ FS	-40...+20°C
PT5N-30 / -50	$\leq \pm 1\%$ FS	+10...+50°C
	$\leq \pm 2\%$ FS	-10...+80°C
PT5N-150D	$\leq \pm 1\%$ FS	+10...+50°C
	$\leq \pm 2\%$ FS	-10...+90°C

Note: *) Total error includes non-linearity, hysteresis, repeatability as well as offset and span drift due to the temperature changes.
%FS is related to Percentage of Full sensor Scale.

Pressure Controls Series CS1

CS1 is an adjustable safety pressure for application in refrigeration systems in compliance with standard EN 378.

Features

- Adjustable pressure range
- Narrow adjustable differential
- Range and differential pointer in units bar and psig
- High rated SPDT contacts for all versions
- Chatter resistant bounce free contacts
- Captive terminal and cover screws
- 2 million cycles reliability (TÜV approved according to EN 12263 to meet requirements of EN 378)
- Locking plate and mounting screws included



Options

- Customer specific types available, minimum order quantity 100 pieces

Applied standards

- acc. PED 2014/68/EU & LVD 2014/35/EU

Selection table - Pressure Limiter for high pressure protection EN 12263 PSH (automatic reset)

Type	Part No.	Adjustment range		Lowest setpoint (cut-in) (bar)	Factory setting (bar)	Max. allowable pressure PS (bar)	Test pressure (bar)	Pressure connection
		Upper setpoint (cut-out) (bar)	Differential setpoint (bar)					
CS1-W6A	812004/ 812004M*	10...45	4 - 10	6	28 / 20	70	77	7/16"-20 UNF male
CS1-W7A	812005/ 812005M*	15...65	5 - 10	10	40 / 32	70	77	

Note: *) M = Multipack = 20 pcs

Selection table - Accessories

Type	Part No.	Description
Mounting bracket angle	803799	incl. screws, see dimensions
Mounting plate for unit with hood	803801	incl. screws, see dimensions
Extension bracket	803800	incl. screws, see dimensions
Univ. mounting bracket	803798	incl. screws, see dimensions
Locking plate	803783	20 pcs

Accuracy performance

Type	Total error *	Temperature range
PT5N-07 / -18	≤ ±1% FS	-40...+20°C
PT5N-30 / -50	≤ ±1% FS	+10...+50°C
	≤ ±2% FS	-10...+80°C
PT5N-150D	≤ ±1% FS	+10...+50°C
	≤ ±2% FS	-10...+90°C

Note: *) Total error includes non-linearity, hysteresis, repeatability as well as offset and span drift due to the temperature changes.
%FS is related to Percentage of Full sensor Scale.

Technical Data

Type of contacts	1 x SPDT contact
Contact material standard	CuAg ₃
Load resistance	RL * Ub - 7.0V ₋ 0.02A
Response time	≤ 2 ms
Weight (without plug and cable ass.)	PT5N-xxM: ~ 87 g PT5N-150D: 73 g PT5N-xxT: ~ 103 g
Mounting position	Non position sensitive; details see operating instructions
Temperatures	
Transport and storage	-50...+100°C
Operating ambient housing	-30...+85°C
Medium	-40...+135°C

Electrical connection	M12 connection according to EN61076-2-101 Part 2
PT4-Mxx Cable Assembly	Prefabricated, various cable lengths
Medium compatibility	A1 group refrigerants
Approvals/Marking	acc. EMC Directive (EN 61326-2-3, EN 50121-3-2) (E499688)
Protection class (EN 60529)	IP67 with mounted plug and cable assembly
Vibration at 15...2000Hz	20 g according to IEC 60068-2-6
Materials	
Housing	Stainless steel 1.4404 / AISI316L
pressure connection	Stainless steel 1.4301 / AISI 304
PT5N-xxT	

Pressure controls series CS3

Safety pressure switch with fixed switch-point settings for R744 applications

Features

- Pressure range 8/Q
 - Versions with fixed factory cut-out setting available between 60 bar to 140 bar
 - Maximum allowable pressure of 140 bar
 - Factory Test Pressure of 154 bar
 - Narrow differential (approx. 6 bar) between cut-out and cut-in (in Microswitch version)
- Pressure range 7/P
 - Versions with fixed factory cut-out setting available between 40 bar to 70 bar
 - Maximum allowable pressure of 90 bar
 - Factory Test Pressure of 100 bar
 - Narrow differential (approx. 4 bar) between cut-out and cut-in (in Microswitch version)
- Manual reset versions available
- Precise switching and repeatability; Snap Action Contacts => Chatter Free (Bounce free) and Accurate Operation
- Contacts are designed as SPDT (Single pole double throw) for control function and alarm/status reporting
- Direct compressor mounting with adapter option
- 2 million cycles reliability (TÜV EN 12263 approved)
- IP65 protection if used with PS3-Nxx with plug (acc. EN 175301-803), no additional gasket required (molded into plug)



CS3

Applied standards

- **CE** per Low Voltage Directive
- **CE** per PED Directive 2014/68/EU
- **EAC**
- **UL** LISTED Underwriter Laboratories (File No. E85974)

Selection table

1. Standard types

Pressure range 8/Q

Type	Part No. (multi-pack*)	Fixed setting (bar)		Reset	Electrical switch	Pressure connection
		Cut-out	Cut-in			
Pressure Limiter for high pressure protection PSH EN 12263						
CS3-WQS	814015M	72	Approx.67	Automatic	Micro switch	7/16"-20 UNF female thread with Schrader opener
CS3-WQS	814018M	81	Approx.74			
CS3-WQS	0718008M	106	Approx. 100			
CS3-WQS	0718000M	106	Approx.103			
CS3-WQS	0718010M	108	Approx.102			
CS3-WQS	814007M	114	Approx.107			
CS3-WQS	0718013M	117	Approx.110			
CS3-WQS	814024M	123	Approx.117.5			
CS3-W8S	0718003M	106	75		Standard switch	
CS3-W8S	0718009M	106	80			
CS3-W8S	0718014M	108	85			
CS3-W8S	814002M	120	95			
CS3-W8S	814003M	126	80			
Pressure Cut-out for high pressure protection PZH EN 12663						
CS3-B8S	0718001M	108	Approx. 25 bar below cut-out	External manual	Standard switch	7/16"-20 UNF female thread with Schrader opener
CS3-B8S	814012M	112				
CS3-B8S	814016M	115				
CS3-B8S	814022M	120				
CS3-B8S	814023M	122				
Safety Pressure Cut-out for high pressure protection PZHH EN 12663						
CS3-S8S	814026M	72	Approx. 25 bar below cut-out	Internal manual	Standard switch	7/16"-20 UNF female thread with Schrader opener
CS3-S8S	0718002M	108				
CS3-S8S	0718011M	130				

Note1: *) Multipack = 60 pcs

Note2: Cables with plug must be ordered separately

Pressure controls series CS3

Pressure Range 7/P

Type	Part No. (multi-pack*)	Fixed setting (bar)		Reset	Electrical switch	Pressure connection
		Cut-out	Cut-in			
Pressure Limiter for high pressure protection PSH EN 12263						
CS3-WPS	814013M	41	Approx.37	Automatic	Micro switch	7/16"-20 UNF female thread with Schrader opener
CS3-WPS	814021M	45	Approx.41			
CS3-WPS	814020M	45,5	Approx.50			
CS3-WPS	0718012M	46	Approx.42			
CS3-WPS	814014M	48	Approx.44			
CS3-WPS	814009M	50	Approx.45			
CS3-WPS	0718007M	54	Approx. 50		Standard switch	
CS3-W7S	814025M	40	27			
CS3-W7S	814017M	45	32			
CS3-W7S	0718006M	54	41			
Pressure Cut-out for high pressure protection PZH EN 12663						
CS3-B7S	814001M	42	Approx. 13 bar below cut-out	External manual	Standard switch	7/16"-20 UNF female thread with Schrader opener
CS3-B7S	814010M	43				
CS3-B7S	814008M	47				
CS3-B7S	814011M	50				
CS3-B7S	0718004M	54				
CS3-B7S	814004M	56				
CS3-B7S	814005M	57				
CS3-B7S	814006M	58				
Safety Pressure Cut-out for high pressure protection PZHH EN 12663						
CS3-S7S	814019M	47	Approx. 13 bar below cut-out	Internal manual	Standard switch	7/16"-20 UNF female thread with Schrader opener
CS3-S7S	0718005M	54				

Note1: *) Multipack = 60 pcs

Note2: Cables with plug must be ordered separately





Pressure controls series CS3

2. Customer specific types

Other settings upon request and within technical capabilities of the product

- Pressure Range 8/Q: Versions with fixed factory cut-out settings available between 60 bar to 140 bar
- Pressure Range 7/P: Versions with fixed factory cut-out settings available between 40 bar to 70 bar

Technical data

Protection class acc. to EN 60529	IP 65 with PS3-Nxx IP00 without appliance socket	Vibration resistance	4g (at 10...250 Hz) R744
Max. allowable pressure PS	Pressure Range 8/Q: 140 bar Pressure Range 7/P: 90 bar	Medium compatibility	Note: CS3 are not released for use with flammable refrigerants!
Factory Test pressure PT	Pressure Range 8/Q: 154 bar Pressure Range 7/P: 100 bar	Storage and transportation temperature	-40°C...+70°C
Tolerances (As per EN 12263) - Only for Standard types	Pressure Range 8/Q Cut-out Tolerance: 0 to -6bar Cut-in Tolerance: +/-3bar	Ambient temperature (housing)*	-40°C...+70°C
Note: Tolerances are valid between -20...+55°C.	Pressure Range 7/P Cut-out Tolerance: 0 to -3bar Cut-in Tolerance: +/-1.5bar	Medium temperature*	-40°C...+150°C
		Marking	 acc. Low voltage Directive  0035 acc. To PED 2014/68/EU  

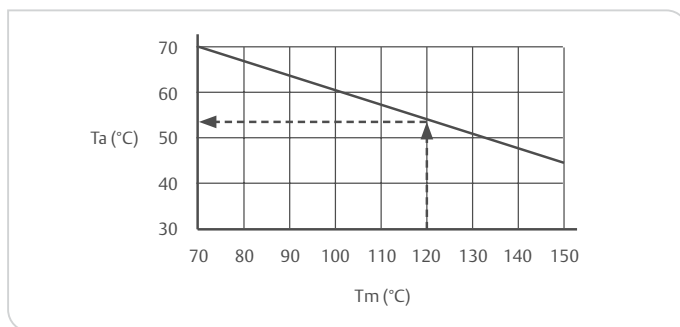

*) Note: For high temperature applications, i.e. medium temperatures between 70°C and 150°C, the maximum ambient temperature must be derated as per drawing.

E.g.: On medium temperature 120°C the ambient temperature of 55°C around the switch housing should not be exceeded.

Tm = Medium temperature
Ta = Ambient temperature

Electrical data

	Standard (SPDT)	Micro switch (SPDT)
Inductive load (AC15)	3A / 230VAC	1.5A / 230VAC
Inductive load (DC)	0.1A / 230VDC	0.1A / 230VDC
Motor rating amps (FLA)	6A / 120 / 240VAC	2.5A / 120 / 240VAC
Lock rotor amps (LRA)	36A / 120 / 240VAC	15A / 120 / 240VAC

Accessories

Cable assemblies					
Type	Part No.	No of leads	Diameter of leads	Temperature range (°C)	Cable length
PS3-N15	804 580	3	0.75 mm ²	-50...+80	1.5 m
PS3-N30	804 581				3.0 m
PS3-N60	804 582				6.0 m

Plug according to EN75301	Part No.
PG9	801 012
PG11	801 013

Filter driers series ADK

Hermetic design for liquid refrigerants

Features

- Solid block
- Hermetic design. rugged steel shells
- Corrosion resistant epoxy paint
- Cushioned flow for non-turbulent performance
- High water and acid adsorption capacity
- High filtration capacity / efficiency
- temperature range TS: -45°C ... +65°C
- Max. allowable pressure PS: 46 bar (680 psi)

ADK



Connections

Type	Part No.	Nominal flow capacity (kW)	
		at 0.07 bar pressure drop	at 0.14 bar pressure drop
		R744	R744
ADK-032	003 595	10.6	15.4
ADK-036MMS	003 597	11.6	17.4
ADK-032S	003 596	12.8	18.8
ADK-052	003 598	11.0	16.0
ADK-056MMS	003 600	14.5	21.8
ADK-052S	003 599	15.7	24.8
ADK-053	003 601	20.6	31.0
ADK-0510MMS	003 603	23.8	35.1
ADK-053S	003 602	23.8	35.1
ADK-082	003 604	11.3	16.4
ADK-086MMS	003 606	15.5	23.3
ADK-082S	003 605	17.4	25.2
ADK-083	003 607	23.8	34.8
ADK-0810MMS	003 609	23.8	35.0
ADK-083S	003 608	23.9	35.1
ADK-084	003 610	37.3	56.9
ADK-0812MMS	003 612	38.3	57.4
ADK-084S	003 611	39.0	58.7
ADK-162	003 613	11.6	16.7
ADK-163	003 614	24.4	35.1
ADK-1610MMS	003 616	27.2	39.0
ADK-163S	003 615	27.2	39.0
ADK-164	003 617	45.5	68.6
ADK-1612MMS	003 619	47.0	70.5
ADK-164S	003 618	52.3	72.6
ADK-165	003 620	65.2	96.7
ADK-165S	003 621	72.3	105.3
ADK-303	003 622	25.7	36.9
ADK-304	003 623	45.5	68.6
ADK-304S	003 624	52.4	75.0
ADK-305	003 626	76.6	104.8
ADK-305S	003 627	76.8	106.1
ADK-307S	003 628	96.4	152.1
ADK-414	003 629	53.5	80.3
ADK-415	003 632	85.2	127.8
ADK-415S	003 633	91.6	137.4
ADK-417S	003 634	113.3	170.0
ADK-757S	003 635	153.5	230.2
ADK-759S	003 636	170.4	255.6

Type	Part No.	Connection			
		Solder/ODF		Flare/SAE	
		mm	inch	mm	inch
ADK-032	003 595			6	1/4
ADK-036MMS	003 597	6			
ADK-032S	003 596		1/4		
ADK-052	003 598			6	1/4
ADK-056MMS	003 600	6			
ADK-052S	003 599		1/4		
ADK-053	003 601			10	3/8
ADK-0510MMS	003 603	10			
ADK-053S	003 602		3/8		
ADK-082	003 604			6	1/4
ADK-086MMS	003 606	6			
ADK-082S	003 605		1/4		
ADK-083	003 607			10	3/8
ADK-0810MMS	003 609	10			
ADK-083S	003 608		3/8		
ADK-084	003 610			12	1/2
ADK-0812MMS	003 612	12			
ADK-084S	003 611		1/2		
ADK-162	003 613			6	1/4
ADK-163	003 614			10	3/8
ADK-1610MMS	003 616	10			
ADK-163S	003 615		3/8		
ADK-164	003 617			12	1/2
ADK-1612MMS	003 619	12			
ADK-164S	003 618		1/2		
ADK-165	003 620			16	5/8
ADK-165S	003 621		5/8		
ADK-303	003 622			10	3/8
ADK-304	003 623			12	1/2
ADK-304S	003 624		1/2		
ADK-305	003 626			16	5/8
ADK-305S	003 627		5/8		
ADK-307S	003 628	22	7/8		
ADK-414	003 629			12	1/2
ADK-415	003 632			16	5/8
ADK-415S	003 633		5/8		
ADK-417S	003 634	22	7/8		
ADK-757S	003 635	22	7/8		
ADK-759S	003 636		1-1/8		

Note: Nominal flow capacity are at -10 °C liquid temperature and -40°C evaporating temperature.

Filter drier shells series FDH

For liquid- and suction applications with replaceable cores

Features

- Steel flange cover with notch hole for ease of mounting
- Plated steel ODF connections
- Rigid core holder from steel (no plastic)
- Service-friendly core holder and flange cover
- Optimum flow capacity at low pressure drop
- Temperature range TS: -45°C to +65°C
- Max. allowable pressure PS:
 - 46 bar (-10°C to +65°C)
 - 25,9 bar (-45°C to -10°C)
- CE marking according PED



FDH

Type	Part No.	Connection solder / ODF		Nominal flow capacity (kW)		Number of blocks
				Pressure drop 0.07 bar	Pressure drop 0.14 bar	
		mm	inch	R744	R744	
Conformity assessment cat. I, procedure module A						
FDH-485	880 300	16	5/8"	114	146	1
FDH-487	880 301	22	7/8"	211	265	
FDH-489	880 302		1 1/8"	297	380	
FDH-969	880 306		1 1/8"	364	436	2
FDH-9611	880 307	35	1 3/8"	443	585	

Features

- Water capacities to suit specific system conditions
- Exceptional acid capacities for normal system protection, or to effectively clean-up following a compressor burnout (W48)



Core H48

Cores for FDH (have to be ordered separately)

Size	Part No.	Water adsorption capacity (gram)								Acid adsorption capacity (g)
		Liquid temperature 24°C				Liquid temperature 52°C				
		R134a	R22	R404A R507	R407C	R134	R22	R404A R507	R407C	
S48	003 508	79.7	74.7	82.3	56.7	73.0	66.7	75.9	48.9	16.3
H48	006 969	35.0	31.7	37.0	24.4	29.0	24.5	28.9	18.1	44.6
W48	006 970	24.7	22.1	26.2	17.1	19.9	16.4	19.5	12.1	39.7
F48	006 973	Filter for suction line								

Moisture / liquid indicators series CIA

Features

- Max. allowable pressure 60 bar
- Fully hermetic
- Corrosion-resistant stainless steel body
- Crystal indicator element for long lifetime and reliability
- Indication of dryness according to ASERCOM recommendation
- Easy determination of moisture content
- Sensitive indicator with calibrated four colours
- Large clear viewing area
- Lightweight
- ODF extended tube configurations suitable for all commercial applications



MIA

Selection table

Type	Part No.	For tube outside Ø	Height A (mm)	Length B (mm)	Weight (g)
CIA 014	805910	1/4"	25.7	98.0	60
CIA 038	805911	3/8"	28.5	109.0	70
CIA 012	805912	1/2"	31.8	113.0	75
CIA 058 / M16	805913	5/8" or 16mm	31.8	108.5	85
CIA M06	805914	6mm	25.9	98.0	60
CIA M10	805915	10mm	28.5	109.0	70
CIA M12	805916	12mm	28.5	113.0	75

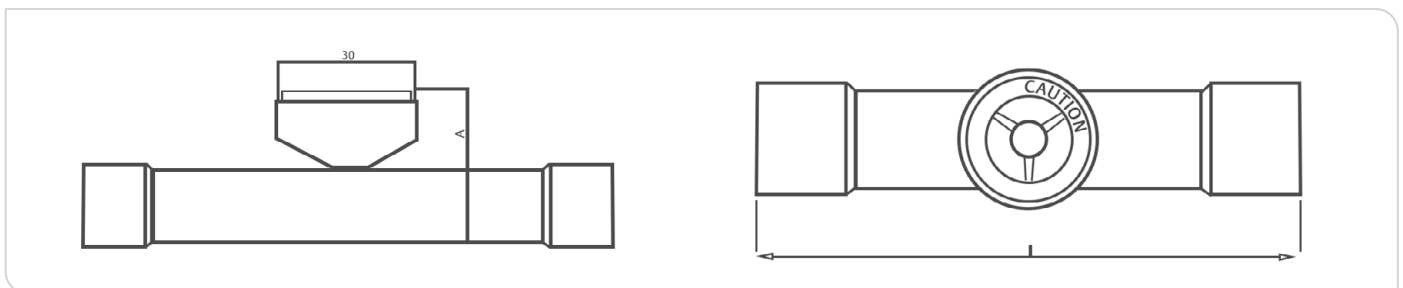

Water contents* by indicator color

Refrigerant	Liquid temperature (°C)	Blue: dry	Purple	Fushia: Caution	Rose: Caution - wet
R744	-40	3	5	10	16
	-20	6	10	20	32
	-10	8	14	29	46
	0	11	19	39	63
	+5	13	22	46	75
	+20	20	34	72	116

Note: *) Water content in mg Water per kg refrigerant (ppm)

OM4 and OM5 TraxOil™ oil management

The Emerson TraxOil oil management is a self-contained and reliable electronically controlled system with an integrated solenoid valve, which feeds missing oil directly into the compressor sump. The sight glass function remains fully available, status and level information is indicated by LED's. The integrated alarm function with compressor shut down completes the overall proven solution for compressor protection.

OM4 can be used for subcritical CO₂ systems and OM5 TraxOil has been specially developed for transcritical CO₂ applications, the new adapters are equipped with special types of O-rings to guarantee safe long-term and reliable operation.

Features

- OM4 for liquid R744 (CO₂) subcritical and HFCs
 - max. allowable pressure PS 60 bar
- OM5 for liquid R744 (CO₂) transcritical
 - max. allowable pressure PS 130 bar
 - max. operating pressure differential 100 bar
 - CO₂ optimized gasket material
 - Adapters with CO₂ optimized gasket material
 - High wattage ESC-W coil to achieve high pressure differential MOPD of 100 bar
- Self-contained unit with oil level sensor and integral solenoid to manage oil level supply
- 3 Zone Level Control by using precise Hall-Sensor measurement, not prone to errors by foaming or light like optical sensors
- Alarm, status and level indication by LED's
- Supply 24VAC or 230VAC (only OM4)
- SPDT output contact for compressor shut down or alarming, rating 230VAC / 3A
- Easy installation by sight-glass replacement and front side mounting without nuts
- Adapters suitable for various types of compressors
- Recommended by leading compressor manufacturers
- CE marking under Low Voltage and EMC Directive, **EAC**



OM4 + ESC Coil 230V + OM-230V



OM5 + ESC Coil 24V

Oil Management System Series OM3, OM4 and OM5 - TraxOil™

Product selection OM3 and OM4 (select one item of each group)

1. Base units (supplied without adapter and coil)

Type	Part No.	Max. allowable pressure PS	Time delay alarm
OM3-020	805133	46 bar	20 sec
OM3-120	805134		120 sec
OM4-020	805135	60 bar	20 sec
OM4-120	805136		120 sec



2. Adapter

Type	Part No.	Description
OM0-CUA	805037	Flange adapter 3- / 4-hole
OM0-CCC	805041	Flange adapter 3-hole
OM0-CBB	805038	Screw adapter 1-1/8"-18 UNEF
OM0-CCA	805039	Screw adapter 3/4"-14 NPTF
OM0-CCB	805040	Screw adapter 1-1/8"-12 UNF
OM0-CCD	805042	Rotalock adapter 1-3/4"-12UNF
OM0-CCE	805043	Rotalock adapter 1-1/4"-12UNF
OM0-CCL	805261	Braze adapter Ø22.5 mm

3. Cables alarm relay

Type	Part No.	Description
OM3-N30	805141	Connection to Relay 3 m
OM3-N60	805142	Connection to Relay 6 m
OM3-N100	805146	Connection to Relay 10 m



Supply Voltage 24V

4. Solenoid coil

Type	Part No.	Frequency
ESC 24 VAC	801033	50Hz, 17 VA



Supply Voltage 230V

4. Solenoid coil

Type	Part No.	Frequency
ESC 230 VAC	801031	50Hz, 17 VA



5. Cable assembly power supply and solenoid

Type	Part No.	Description
OM3-P30	805151	24 V, 3 m
OM3-P60	805152	24 V, 6 m
OM3-P100	805153	24 V, 10 m



5. Cable assembly power supply and solenoid

Type	Part No.	Description
OM-230V-3	805163	230 V, 3 m
OM-230V-6	805164	230 V, 6 m



Oil management kits including base unit, adapter and 24V ESC Coil

Kit inc. adapter	Part No.	Base unit	Part No.	Adapter	Part No.	Coil	Part No.
OM4-CUA	805307	OM4-020	805135	OM0-CUA	805037	ESC 24 VAC	801031
OM4-CBB	805309			OM0-CBB	805038		
OM4-CCA	805310			OM0-CCA	805039		
OM4-CCB	805311			OM0-CCB	805040		
OM4-CCC	805312			OM0-CCC	805041		
OM4-CCD	805308			OM0-CCD	805042		
OM4-CCE	805313			OM0-CCE	805043		

Oil Management System Series OM3, OM4 and OM5 - TraxOil™

Product selection OM5 (select one item of each group)

1. Base units (supplied without adapter and coil)

Type	Part No.	Max. allowable pressure	Time delay alarm
OM5-020	805230	130 bar	20 sec
OM5-120	805231		120 sec



2. Adapter flanges

Type	Part No.	Description
OM0-CUA CO2	805337	Flange adapter 3- / 4-hole
OM0-CCC CO2	805341	Flange adapter 3-hole
OM0-CUD CO2	805049	Flange adapter 6- / 6-hole
OM0-CBB CO2	805338	Screw adapter 1-1/8"-18 UNEF
OM0-CCA CO2	805339	Screw adapter 3/4"-14 NPTF
OM0-CCB CO2	805340	Screw adapter 1-1/8"-12 UNF
OM0-CCD CO2	805342	Rotalock adapter 1-3/4"-12UNF
OM0-CCE CO2	805343	Rotalock adapter 1-1/4"-12UNF

3. Cables alarm relay

Type	Part No.	Description
OM3-N30	805141	Connection to Relay 3 m
OM3-N60	805142	Connection to Relay 6 m
OM3-N100	805146	Connection to Relay 10 m



Supply Voltage 24V

4. Solenoid coil

Type	Part No.	Frequency
ESC-W24VAC	801028	50 Hz, 38 VA



5. Cable assembly power supply and Solenoid

Type	Part No.	Description
OM3-P30	805 151	24V, 3 m
OM3-P60	805 152	24V, 6 m
OM3-P100	805 153	24V, 10 m



Oil management kits including base unit, adapter and 24V ESC Coil

Type	Part No.	Description	Weight
ECT-623	804421	Transformer 230 VAC / 24 VAC, 60 VA (supply of 3 pieces Base unit)	1.20 kg
ESC-K01	801034	Screw cap (incl. 2x O-ring & fixing retainer)	
ODP-33A	800366	Differential Oil Check Valve 3.5 bar, PS: 46 bar (Inlet 5/8"-UNF female, outlet 5/8"-UNF male)	0.14 kg
OM3-K01	805036	Repair Kit OM3/OM4 (consists of sight glass with O-ring and screws, oil adapter with strainer, O-ring back side)	0.26 kg
OM5-K01	805067	Repair Kit OM5 for CO ₂ (consists of sight glass with O-ring and screws, oil adapter with strainer, O-ring back side)	0.26 kg
OM-HFC-K01	805081	Sealing Kit OM3/OM4 (consists of all O-rings for OM3/OM4 and for all types of adapters)	
OM-HFC-K02	805083	Enclosing tube for OM3/OM4 (including O-ring), only for replacement of new version with hexagonal nut!	
OM-CO2-K01	805079	Sealing Kit CO ₂ for OM5 (consists of all O-rings for OM5 and for all types of adapters)	
OM-CO2-K02	805082	Enclosing tube for OM5 (including O-ring), only for replacement of new version with hexagonal nut!	

Oil Management System Series OM3, OM4 and OM5 - TraxOil™

Adapter selection guideline OM4 / OM5

Please refer to free program "Controls Navigator" revision 2019 for selection of adapter matching to each compressor brand/ type.

Technical data

Markings:	CE under: -Low Voltage Directive 2014/35/EU -EMC Directive 2014/30/EU ERC	Materials Body and Adaptor	aluminum (EN AW 6060)
Applied Standards	EN 12284, EN 378, EN 61010, EN 50081-1, EN 50082-1	Screws	galvanized steel
Max. allowable pressure PS	OM4: 60 bar	Sight Glass	nickel-plated steel (ISO 2081)
Max. test pressure PT	OM5: HP side (inlet): 130 bar LP side (outlet): 100 bar OM4: 66 bar OM5: 143 bar (390 bar burst press)	Flow rate	OM4 at $\Delta P = 3$ bar: 340g/min. (22°C oil temperature, oil type HM46) OM5: see Fig. 1
Supply voltage / total power:	OM4:	Orientation of base unit	horizontal, +/- 1°
<ul style="list-style-type: none"> with ESC-24VAC coil with ESC-230VAC coil and OM-230V-x module 	24 VAC $\pm 10\%$, 50Hz, 17 VA 230 VAC $\pm 10\%$, 50Hz, 17 VA	Level control	40% to 60% of sight glass height
<ul style="list-style-type: none"> with ESC-W24VAC coil 	OM5: 24VAC, 50Hz, $\pm 10\%$, 38VA	Alarm contact	max. 3A, 230VAC SPDT dry contact
Solenoid valve MOPD	OM4: 30 bar OM5: 100 bar (50Hz) see Fig. 1 59 bar (60Hz)	Time Delay Alarm	20 sec.: OM4/5-020, all OM4 Kits 120 sec.: OM4/5-120
Vibration resistance (EN60068-2-6)	max. 4g, 10...250Hz	Time Delay Filling	10 sec.
Medium temperature Ambient/Storage temperature	-20...+80°C -20...+50°C	Protection class	IP 65 (IEC529/EN 60529)
		Weight:	
		24V System	750 ... 920g inc. adapter
		230V System	1100 ... 1270g inc. adapter
		Oil connection	7/16"-20 UNF male, with strainer and O-ring (replaceable, see acc.)
		Enclosing tube	Replaceable for cleaning, hexagon wrench size 18, see spare parts

Fig. 1: OM5: Performance related to supply voltage: Flow rate and differential pressure between inlet and outlet (Oil type reniso C85E, oil temperature 54°C)

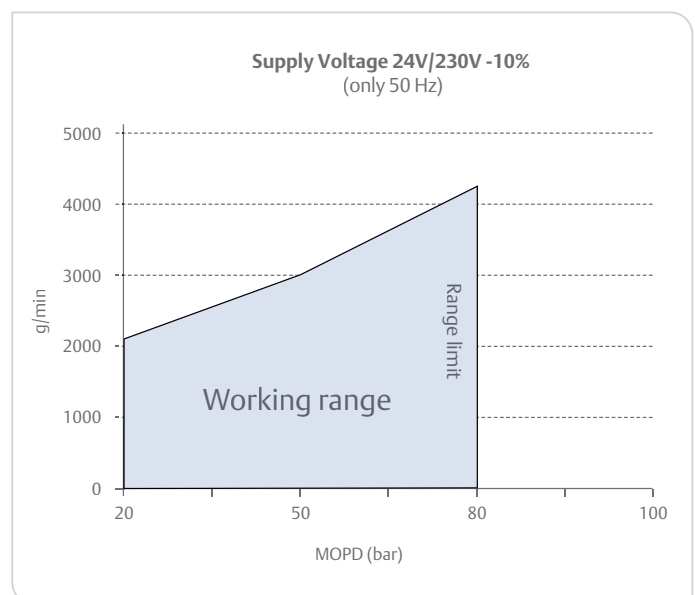
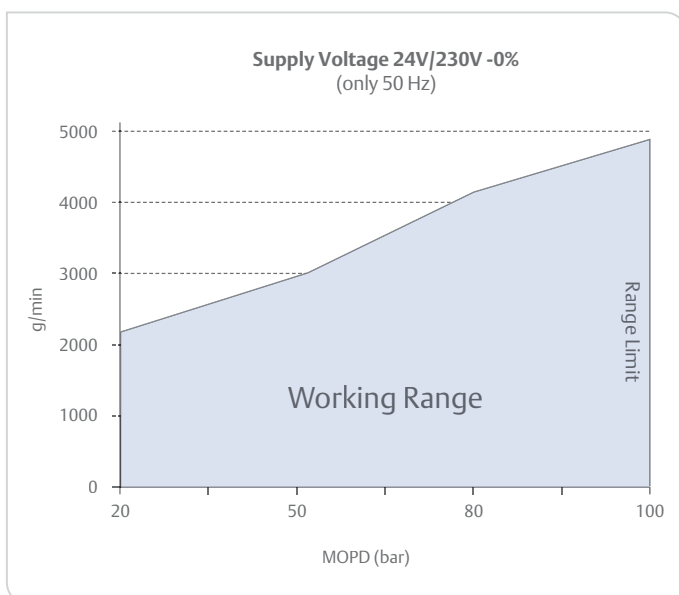

Electronic oil level monitoring TraxOil™ OW4 and OW5

OW4 and OW5 TraxOil are intended for systems which require oil level monitoring and alarming instead of active oil level balancing.

Features

- OW5 for CO₂ transcritical (MWP 100 bar)
- OW4 for subcritical CO₂ (MWP 60 bar)
- 3 Zone Level Control by using precise Hall-sensor measurement, not prone to errors by foaming or light like optical sensors
- Alarm, status and 3 zone indication by LED's
- SPDT output contact for compressor shut down or alarming, rating 230VAC / 3A
- Easy installation by sight-glass replacement and front side mounting without WOWnuts
- Supply 24V AC, 50/60Hz
- Recommended by leading compressor manufacturers
- CE marking under Low Voltage and EMC Directive, EAC



OW4 TraxOil



OW5 TraxOil

Product Selection OW4 (select one item of each group)

1. Base units

Type	Part no.	Max. allowable pressure PS	Time delay alarm
OW4-020	805116	60 bar	20 sec

2. Adapter flanges

OM0-CUA	805037	Flange adapter 3- / 4-hole
OM0-CCC	805041	Flange adapter 3-hole
OM0-CBB	805038	Screw adapter 1-1/8"-18 UNEF
OM0-CCA	805039	Screw adapter 3/4"-14 NPTF
OM0-CCB	805040	Screw adapter 1-1/8"-12 UNF
OM0-CCD	805042	Rotalock adapter 1-3/4"-12UNF
OM0-CCE	805043	Rotalock adapter 1-1/4"-12UNF

3. Cables alarm relay

OM3-N30	805141	Connection to relay 3m
OM3-N60	805142	Connection to relay 6m
OM3-N100	805146	Connection to relay 10m

4. Cable power supply

OW-24V-3	804672	Connection to power supply 24VAC 3m
----------	--------	-------------------------------------

Electronic oil level monitoring TraxOil™ OW4 and OW5

Product Selection OW5 (select one item of each group)

1. Base Units

Type	Part no.	Max. allowable pressure PS	Time delay alarm
OW5-120	805241	100 bar	120 sec

2. Adapter flanges

OM0-CUA CO2	805337	Flange adapter 3- / 4-hole
OM0-CCC CO2	805341	Flange adapter 3-hole
OM0-CUD CO2	805049	Flange adapter 6- / 6-hole
OM0-CBB CO2	805338	Screw adapter 1-1/8"-18 UNEF
OM0-CCA CO2	805339	Screw adapter 3/4"-14 NPTF
OM0-CCB CO2	805340	Screw adapter 1-1/8"-12 UNF
OM0-CCD CO2	805342	Rotalock adapter 1-3/4"-12UNF
OM0-CCE CO2	805343	Rotalock adapter 1-1/4"-12UNF

3. Cables alarm relay

OM3-N30	805141	Connection to Relay 3m
OM3-N60	805142	Connection to Relay 6m
OM3-N100	805146	Connection to Relay 10m

4. Cable power supply

OW-24V-3	804672	Connection to Power Supply 24VAC 3m
----------	--------	-------------------------------------

Accessories and spare parts

Type	Part no.	Description	Weight
ECT-623	804 421	Transformer 230 VAC / 24VAC, 60 VA (supply of 3 pieces Base unit)	1.20 kg
OM-HFC-K01	805 081	Sealing Kit OW4 (consists of all O-rings, incl. adapter gaskets)	-
OM-CO2-K01	805 079	Sealing Kit OW5 (consists of all O-rings, incl. adapter gaskets)	-

Technical data

Markings	CE under: -Low Voltage Directive 2014/35/EU -EMC Directive 2014/30/EU ERC	Materials Body and Adaptor Screws Sight Glass OW4 Sight Glass OW5	Aluminum (EN AW 6060) galvanized steel nickel-plated Steel (1.05.03 DIN EN10027) galvanized steel (ISO 2081)
Applied Standards	EN 12284, EN 378, EN 61010, EN 50081-1, EN 50082-1	Orientation of base unit Level control	horizontal, +/- 1° 40% to 60% sight glass height
Max. allowable pressure PS Max. test pressure PT Burst Pressure:	OW4: 60 bar, OW5: 100 bar OW4: 66 bar, OW5: 110 bar OW4: 230 bar, OW5: 390 bar	Alarm contact	max. 3A, 230VAC SPDT dry contact
Supply voltage current	24VAC, 50/60Hz, ±10%, 0.05A	Time Delay Alarm	20 sec or 120 sec
Vibration resistance (EN60068-2-6)	max. 4g, 10...250Hz	Protection class	IP 65 (DIN / EN 60529)
Medium temperature Ambient/Storage temperature	-20...80°C -20...50°C	Weight	850 ... 920g incl. adapter

Level watch LW4 and LW5 liquid level control

LW4 and LW5 are self-contained units intended for liquid level monitoring and control at the sight glass connection of vessels, maintaining a permanent visibility of the liquid level versus other liquid level sensors.

Features

- LW4 for liquid CO₂, HFC refrigerants and oil (MWP: 60 bar)
- LW5 for liquid CO₂ and oil (MWP: 130 bar)
 - CO₂ optimized gasket material, not released for HFCs
 - Adapters with CO₂ optimized gasket material
- Two versions of each model:
 - LW4/5-H for high liquid level monitoring
 - LW4/5-L for low liquid level monitoring
- 3 Zone Level Control by using precise Hall-sensor measurement, not prone to errors by foaming or light like optical sensors
- Alarm, status and 3 zone indication by LED's
- Dual monitoring and protection:
- 24V output signal for critical liquid levels
- SPDT output contact for alarming (230VAC / 3A) at very low liquid levels
- SPDT output contact for alarming, rating 230VAC / 3A
- Easy installation by sight-glass replacement and front side mounting without nuts
- Supply 24V AC, 50/60Hz
- CE marking under Low Voltage and EMC Directive

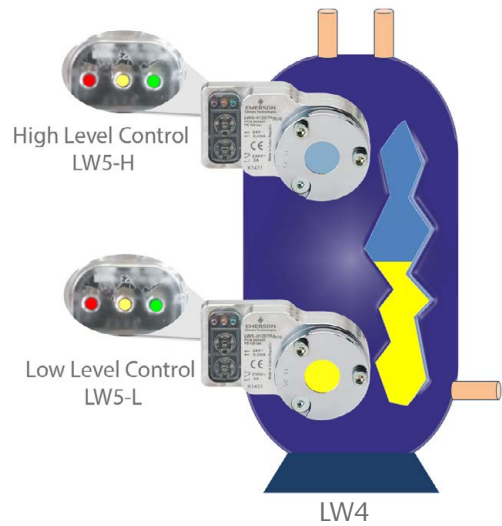

Product selection LW4 – max. allowable pressure: 60 bar (select one item of each group)

1. Base units

Type	Part no.	Function
LW4-L120	805490	Low liquid level monitoring
LW4-H120	805491	High liquid level monitoring

2. Adapter flanges/Maximum allowable pressure: 60 bar

Type	Part no.	Description/size
LW0-1/2	805256	Thread adapter 1/2"-14 NPTF
OM0-CCA	805039	Thread adapter 3/4"-14 NPTF
OM0-CBB	805038	Thread adapter 1-1/8"-18 UNF
OM0-CCB	805040	Thread adapter 1-1/8"-12 UNF
OM0-CCD	805042	Thread adapter 1-3/4"-12UNF
OM0-CCE	805043	Rotalock adapter 1-1/4"-12UNF
OM0-CUA	805037	Flange adapter 3- / 4-hole

3. Plug and cable assembly for digital output signal

Type	Part no.	Cable length
OM3-N30	805141	3m
OM3-N60	805142	6m
OM3-N100	805146	10m

4. Plug and cable assembly for power Supply 24VAC

Type	Part no.	Cable length
LW-24V-3	805500	3m
LW-24V-6	805501	6m
LW-24V-10	805502	10m

Note 1: Corresponding sealing parts are included and need not to be ordered separately.

Level watch LW4 and LW5 liquid level control

Product selection LW5 – max. allowable pressure: 130 bar (select one item of each group)

1. Base units

Type	Part no.	Function
LW5-L120	805480	Low liquid level monitoring
LW5-H120	805481	High liquid level monitoring

2. Adapter flanges/Maximum allowable pressure: 130 bar

Type	Part no.	Description/size
LW0-1/2 CO2	805257	Thread adapter 1/2"-14 NPTF
LW0-CCA CO2	805254	Thread adapter 3/4"-14 NPTF

3. Plug and cable assembly for digital output signal

Type	Part no.	Cable length
OM3-N30	805141	3m
OM3-N60	805142	6m
OM3-N100	805146	10m

4. Plug and cable assembly for power Supply 24VAC

Type	Part no.	Cable length
LW-24V-3	805500	3m
LW-24V-6	805501	6m
LW-24V-10	805502	10m

Note 1: Corresponding sealing parts are included and need not to be ordered separately.
 Note 2: Flange or Rotolock adapters for high pressure application upon request.

Accessories and spare parts

Type	Part no.	Description	Weight
ECT-623	804 421	Transformer 230 VAC / 24VAC, 60 VA	1.20 kg
OM-HFC-K01	805 081	Sealing-Kit LW4 (contains all gaskets incl. adapter gaskets)	-
OM-CO2-K01	805 079	Sealing-Kit LW5 for CO ₂ (contains all gaskets incl. adapter gaskets)	-

Technical data

Markings	CE under: -Low voltage directive 2014/35/EU -EMC directive 2014/30/EU EAC	Materials Body and adaptor Aluminum (EN AW 6060) Screws Galvanized steel Sight glass LW4 Nickel-plated Steel (1.05.03 DIN EN10027) Sight glass LW5 Galvanized steel (ISO 2081)
Applied standards	EN 12284, EN 378, EN 61010, EN 50081-1, EN 50082-1	Orientation of base unit level control horizontal, +/- 1° 30% to 60% sight glass height
Max. allowable pressure PS Max. test pressure PT Burst pressure	LW4: 60 bar LW5: 130 bar LW4: 66 bar LW5: 143 bar LW4: 230 bar LW5: 390 bar	Alarm contact max. 3A, 230VAC SPDT dry contact
Supply voltage current	24VAC, 50/60Hz, ±10%, 0.05A	Output signal 24V AC Inductive load: 35VA
Vibration resistance (EN60068-2-6)	max. 4g, 10...250Hz	Time delay alarm 120 sec
Medium temperature Ambient/Storage temperature	-20...80°C -20...50°C	Protection class IP 65 (IEC529/EN 60529)
		Weight 850 ... 920g incl. adapter

Ball valves series CVE/CVS

The CVE/CVS are ball valves with fully hermetic body design for the Refrigeration and A/C industry.

Features

- Maximum allowable pressure 60 bar CVS version with schrader valve opener
- Hermetic design with Laser welded valve body
- Patented (pending) Laser process
- Full flow design for minimal pressure drop
- Two threads at valve body for easy mounting
- Bi-directional flow characteristics
- Valve cap retained by strap attached to main body
- Applied Standards EN 122284. EN 378. EN 12420. PED 2014/68/EU
- RoHS 2002/95/EC
- UL File No: SA5312 acc. PED 2014/68/EU



CVE



CVS

CVE/CVS selection table (Not UL approved)

Type	Part no.	Type CVS	Part no.	Connection size ODF	
				inch	Metric
CVE-014	808 130	CVS-014	808 150	1/4"	
CVE-M06	808 131	CVS-M06	808 151		6mm
CVE-038	808 132	CVS-038	808 152	3/8"	
CVE-M10	808 133	CVS-M10	808 153		10mm
CVE-012	808 134	CVS-012	808 154	1/2"	
CVE-M12	808 135	CVS-M12	808 155		12mm
CVE-058	808 136	CVS-058	808 156	5/8"	16mm
CVE-034	808 137	CVS-034	808 157	3/4"	
CVE-078	808 138	CVS-078	808 158	7/8"	22mm

Technical data

Max. allowable pressure PS	CVE/CVS 60 bar
Test pressure PT	CVE/CVS 66 bar
Medium temperature TS	-40 ... 120°C (150°C short term)

Special seal caps

to protect valve from unauthorized use

CVE / CVS Valve size	Part No.	Thread (3)	Quantity per pack
1/4" ... 7/8" (6 ... 22mm)	806 770	M18x1	10 pcs
1-1/8" ... 1 3/8" (28 ... 35mm)	806 771	M27x1	10 pcs



Emerson at a glance

Emerson is the world's leading provider of heating, ventilation, air conditioning, and refrigeration solutions for residential, industrial and commercial applications. We combine technically superior products and services from our industry leading divisions and brands with our global engineering, design and distribution capabilities to create reliable, energy efficient climate systems that improve human comfort, safeguard food, and protect the environment.

TCE175-EN-2102

For more details, see climate.emerson.com/en-gb

Emerson Commercial & Residential Solutions

Emerson Climate Technologies GmbH - Pascalstrasse 65 - 52076 Aachen, Germany

Tel. +49 (0) 2408 929 0 - Fax: +49 (0) 2408 929 570 - Internet: climate.emerson.com/en-gb

The Emerson logo is a trademark and service mark of Emerson Electric Co. Emerson Climate Technologies Inc. is a subsidiary of Emerson Electric Co. Copeland is a registered trademark and Copeland Scroll is a trademark of Emerson Climate Technologies Inc.. All other trademarks are property of their respective owners. Emerson Climate Technologies GmbH shall not be liable for errors in the stated capacities, dimensions, etc., as well as typographic errors. Products, specifications, designs and technical data contained in this document are subject to modification by us without prior notice. Illustrations are not binding.

© 2021 Emerson Climate Technologies, Inc.

EMERSON. CONSIDER IT SOLVED.™