

GARMIN[®]

G3X[™] Pilot's Guide



SYSTEM OVERVIEW

FLIGHT INSTRUMENTS

EIS

CNS INTERFACE

GPS NAVIGATION

FLIGHT PLANNING

HAZARD AVOIDANCE

ADDITIONAL FEATURES

INTEGRATED AUTOPILOT

ANNUNCIATIONS & ALERTS

APPENDIX

INDEX

Copyright © 2009 - 2012 Garmin Ltd. or its subsidiaries. All rights reserved.

This manual reflects the operation of System Software version 006.40 or later. Some differences in operation may be observed when comparing the information in this manual to earlier or later software versions.

Garmin International, Inc., 1200 East 151st Street, Olathe, Kansas 66062, U.S.A.
Toll free: 800/800.1020 or 866/739.5687 Tel: 913/397.8200 Fax: 913/397.8282

Garmin AT, Inc., 2345 Turner Road SE, Salem, OR 97302, U.S.A.
Tel: 503/391.3411 Fax 503/364.2138

Garmin (Europe) Ltd, Liberty House, Bulls Copse Road, Hounslow Business Park,
Southampton, SO40 9RB, U.K.
Tel: 44/0870.8501241 Fax: 44/0870.8501251

Garmin Corporation, No. 68, Jangshu 2nd Road, Shijr, Taipei County, Taiwan
Tel: 886/02.2642.9199 Fax: 886/02.2642.9099

Web Site Address: www.garmin.com

Except as expressly provided herein, no part of this manual may be reproduced, copied, transmitted, disseminated, downloaded or stored in any storage medium, for any purpose without the express written permission of Garmin. Garmin hereby grants permission to download a single copy of this manual and of any revision to this manual onto a hard drive or other electronic storage medium to be viewed for personal use, provided that such electronic or printed copy of this manual or revision must contain the complete text of this copyright notice and provided further that any unauthorized commercial distribution of this manual or any revision hereto is strictly prohibited.

Garmin®, FliteCharts®, SafeTaxi®, and MapSource® are registered trademarks of Garmin Ltd. or its subsidiaries. G3X™ is a trademark of Garmin Ltd. or its subsidiaries. These trademarks may not be used without the express permission of Garmin.

Jeppesen® is a registered trademark of Jeppesen, Inc.

NavData™ is a trademark of Jeppesen, Inc.

SiriusXM Weather is provided by SiriusXM Satellite Radio, Inc.

SiriusXM Radio is provided by SiriusXM Satellite Radio, Inc.



WARNING: Navigation and terrain separation must NOT be predicated upon the use of the terrain function. The G3X Terrain Proximity feature is NOT intended to be used as a primary reference for terrain avoidance and does not relieve the pilot from the responsibility of being aware of surroundings during flight. The Terrain Proximity feature is only to be used as an aid for terrain avoidance and is not certified for use in applications requiring a certified terrain awareness system. Terrain data is obtained from third party sources. Garmin is not able to independently verify the accuracy of the terrain data.



WARNING: To reduce the risk of unsafe operation, carefully review and understand all aspects of the G3X Pilot's Guide documentation and the Pilot's Operating Handbook of the aircraft. Thoroughly practice basic operation prior to actual use. During flight operations, carefully compare indications from the G3X to all available navigation sources, including the information from other NAVAIDs, visual sightings, charts, etc. For safety purposes, always resolve any discrepancies before continuing navigation.



WARNING: The displayed minimum safe altitudes (MSAs) are only advisory in nature and should not be relied upon as the sole source of obstacle and terrain avoidance information. Always refer to current aeronautical charts for appropriate minimum clearance altitudes.



WARNING: The altitude calculated by G3X internal GPS receivers is geometric height above Mean Sea Level and could vary significantly from the altitude displayed by pressure altimeters. Always use pressure altitude displayed by the G3X PFD when determining or selecting aircraft altitude.



WARNING: Do not use outdated database information. Databases used in the G3X system must be updated regularly in order to ensure that the information remains current. Pilots using any outdated database do so entirely at their own risk.



WARNING: SiriusXM Weather should not be used for hazardous weather penetration. Weather information is approved only for weather avoidance, not penetration.



WARNING: NEXRAD weather data is to be used for long-range planning purposes only. Due to inherent delays in data transmission and the relative age of the data, NEXRAD weather data should not be used for short-range weather avoidance.



WARNING: The data contained in the terrain and obstacle databases comes from government agencies. Garmin accurately processes and cross-validates the data, but cannot guarantee the accuracy and completeness of the data.



WARNING: The illustrations in this guide are only examples. Never use the G3X to attempt to penetrate a thunderstorm. Both the FAA Advisory Circular, Subject: Thunderstorms, and the Aeronautical Information Manual (AIM) recommend avoiding “by at least 20 miles any thunderstorm identified as severe or giving an intense radar echo.”



WARNING: For safety reasons, G3X operational procedures must be learned on the ground.



WARNING: Because of variation in the earth’s magnetic field, operating the G3X within the following areas could result in loss of reliable attitude and heading indications. North of 72° North latitude at all longitudes; South of 70° South latitude at all longitudes; North of 65° North latitude between longitude 75° W and 120° W. (Northern Canada); North of 70° North latitude between longitude 70° W and 128° W. (Northern Canada); North of 70° North latitude between longitude 85° E and 114° E. (Northern Russia); South of 55° South latitude between longitude 120° E and 165° E. (Region south of Australia and New Zealand)



WARNING: The Garmin G3X has a very high degree of functional integrity. However, the pilot must recognize that providing monitoring and/or self-test capability for all conceivable system failures is not practical. Although unlikely, it may be possible for erroneous operation to occur without a fault indication shown by the G3X. It is thus the responsibility of the pilot to detect such an occurrence by means of cross-checking with all redundant or correlated information available in the cockpit.



WARNING: The United States government operates the Global Positioning System and is solely responsible for its accuracy and maintenance. The GPS system is subject to changes which could affect the accuracy and performance of all GPS equipment. Portions of the Garmin G3X utilize GPS as a precision electronic NAVigation AID (NAVAID). Therefore, as with all NAVAIDs, information presented by the G3X can be misused or misinterpreted and, therefore, become unsafe.



WARNING: Do not use basemap (land and water data) information for primary navigation. Basemap data is intended only to supplement other approved navigation data sources and should be considered as an aid to enhance situational awareness.



WARNING: Do not use the approach information provided by the VFR navigation database residing within the G3X as a means of navigating any instrument approach. The G3X VFR navigation database is limited to present only the waypoints for the final approach leg of a published procedure. These waypoints and associated course line are made available for monitoring purposes only.



CAUTION: The display uses a lens coated with a special anti-reflective coating that is very sensitive to skin oils, waxes, and abrasive cleaners. **CLEANERS CONTAINING AMMONIA WILL HARM THE ANTI-REFLECTIVE COATING.** It is very important to clean the lens using a clean, lint-free cloth and an eyeglass lens cleaner that is specified as safe for anti-reflective coatings.



CAUTION: The Garmin G3X does not contain any user-serviceable parts. Repairs should only be made by an authorized Garmin service center. Unauthorized repairs or modifications could void both the warranty and the pilot's authority to operate this device under FAA/FCC regulations.



NOTE: All visual depictions contained within this document, including screen images of the G3X panel and displays, are subject to change and may not reflect the most current G3X system and aviation databases. Depictions of equipment may differ slightly from the actual equipment.



NOTE: This product, its packaging, and its components contain chemicals known to the State of California to cause cancer, birth defects, or reproductive harm. This notice is being provided in accordance with California's Proposition 65. If you have any questions or would like additional information, please refer to our web site at www.garmin.com/prop65.



NOTE: Interference from GPS repeaters operating inside nearby hangars can cause an intermittent loss of attitude and heading displays while the aircraft is on the ground. Moving the aircraft more than 100 yards away from the source of the interference should alleviate the condition.



NOTE: Use of polarized eyewear may cause the flight displays to appear dim or blank.



NOTE: Temporary Flight Restriction (TFR) data is provided by the FAA and may not be updated outside of normal business hours. Confirm data currency through alternate sources and contact your local FSS for interpretation of TFR data.



NOTE: The Garmin G3X system includes products like the GDU 37X and the GSU 73 that are not TSO-certified products and have not received FAA approval or endorsement. Consequently the G3X system is not suitable for installation in type-certificated aircraft.

Part Number		Change Summary
190-01115-00		Initial release
Rev	Date	Description
A	August, 2009	Production Release
B	January, 2010	Added System Software Version 2.50 parameters
C	March, 2010	System Software Version 2.50-2.60 changes: <ul style="list-style-type: none"> • Added message to indicate if config module is missing • Added warning text to Weight & Balance Page
D	June, 2010	System Software Version 2.60-2.70: <ul style="list-style-type: none"> • Added support for Integrated Autopilot control and display via the PFD Page • Added PFD Setup Menu • Added second Bearing Pointer to PFD HSI • Added fuel range ring to map • Added menu option to XM Page to allow selection of a specific channel number System Software Version 2.70-3.00: <ul style="list-style-type: none"> • Added Synthetic Vision • Added mach number to configurable Data Fields
E	April, 2011	System Software Version 3.00-3.10: <ul style="list-style-type: none"> • Added ability to import/export flight plans using the SD card • Added Softkeys to Nearest Airports Page to quickly show/hide private airports and heliports • Removed ability to adjust Roll Mode reference using the FMS Joystick System Software Version 3.10-3.20: <ul style="list-style-type: none"> • Added ability to display checklist files from SD Card • Added ability to log data to SD Card • Added ability to export Track Log and User Waypoints to SD Card • Added ability to display fuel calculator values in data bar System Software Version 3.20-4.00: <ul style="list-style-type: none"> • Added support for Jeppesen ChartView and geo-referenced FliteCharts • Added ability to use VNAV when using an external GPS navigation Source • Added Softkey to Terrain Page to quickly enabled/disable terrain alerts • Added display of Navaid frequency to PFD bearing pointer data fields

Rev	Date	Description
E	April, 2011	<p>System Software Version 4.00-4.10:</p> <ul style="list-style-type: none"> • Added support for displaying flight time in databar <p>System Software Version 4.10 - 5.00 :</p> <ul style="list-style-type: none"> • Added support for VOR, localizer, and glideslope modes for integrated autopilot • Added option to display trim and flap position on PFD • Added persistent sky/ground display to PFD • Added ability to configure and display Vse (blue line) and Vmc (red line) on PFD airspeed tape for multiengine aircraft • Added 'User Selected' configuration option to allow the position of the EIS strip to be changed via the Display Setup Page • Added ability to view EGT/CHT cylinder temperature bar graph on a single-display system • Added automatic sync of altimeter setting to local terrain elevation when FMS Joystick is pressed and held while BARO Softkey is selected and aircraft is stationary on the ground • Added display of displaced runway threshold distance to Airport Review Page • Added menu options to the Waypoint Page to quickly view the departure and destination airports • Added menu option and softkey to the FPL VNAV Page to force a capture of a VNAV profile • Added Sirius/XM warning text • Improved HSI localizer course auto-slew and localizer backcourse presentation <p>System Software Version 5.0 - 5.10 :</p> <ul style="list-style-type: none"> • Added Fuel Flow to list of configurable data fields <p>System Software Version 5.10 - 6.00 :</p> <ul style="list-style-type: none"> • Added pathways • Note about VPX Page
F	October, 2011	<p>System Software Version 6.00 - 6.10 :</p> <ul style="list-style-type: none"> • Added baro minimums altitude reference bug and audio alert to PFD • Changed CRS Softkey on PFD Page to indicate which course it controls (LOC, VOR, or OBS).

Rev	Date	Description
F	October, 2011	<p>System Software Version 6.10 - 6.20 :</p> <ul style="list-style-type: none"> • Added remote transponder interface information • Added ability to switch between internal and external GPS flight plan sources • Added optional dedicated Traffic Page • Added softkey to Map Page to enable/disable traffic display • Added ability to enable/disable 'Traffic Not Available' audio alert • Added ability to enable/disable traffic data on Synthetic Vision display • Added ability to change the layout of PFD1 between full-screen and split-screen in normal mode via the Display Setup Page • Added arrows to PFD traffic and terrain messages to indicate traffic and terrain alerts which are outside the Synthetic Vision field of view • Added display of peak EGT temperature to bar graph display on Engine Page when Lean Mode is active • Added softkey to Terrain page • Changed EGT gauge in EIS strip to display the cylinder with the temperature closest to its own peak value when Lean Mode is active • Changed AP NAV Softkey on PFD Page to cancel armed GS Mode on the first press if GPS Mode is active and LOC and GS Modes are both armed

Rev	Date	Description
G	May, 2012	<p>System Software Version 6.20 to 6.30:</p> <ul style="list-style-type: none"> • Added ability to adjust PFD pitch attitude offset, using the PFD Setup page. • Added ability to configure the initial MFD page that is displayed after powerup, using the Display Setup page. • Added ability to display synthetic vision field of view on the map. • Added configurable data fields to display current climb gradient in percent or altitude gain per nautical mile. • Added runway number labels to runway extension lines on map. • Added items to Map Setup page to adjust visibility of water labels, park and land cover areas, runway numbers, and runway extension lines. • Simplified requirements for availability of autopilot VNAV mode, and reduced the need for pilot acknowledgement before VNAV mode can be activated. • Changed screenshot utility to be activated when Menu key is pressed and held. • Changed selected altitude data field on PFD to flash in conjunction with armed autopilot VNAV indicator if an altitude has not been selected prior to VNAV descent. • Changed Fuel Calculator display on Engine page to show fuel quantity and pressure gauges if space is available. • Changed wind direction display on PFD to use system units settings for heading offset. • Changed display of XTK data fields to more closely resemble G1000 presentation. • Improved flight log to more closely match airframe timer, and to account for time spent with the engine running while on the ground before or after a flight. <p>System Software Version 6.30 - 6.40 :</p> <ul style="list-style-type: none"> • Added option to display G-meter on PFD. • Added option to display track-up orientation on PFD HSI. • Added support for GTS 8xx active traffic system. • Added support for GNS 480.

Section 1 System Overview	1
1.1 Line Replaceable Units	1
G3X Single Display	4
G3X Dual Display	5
Split-Screen vs. Full-Screen Configurations	6
External Navigators (Optional)	6
Integrated Autopilot (Optional)	7
1.2 Display Overview	8
1.3 Secure Digital (SD) Cards	9
1.4 G3X Controls	10
1.5 System Power-up	12
1.6 System Operation	13
Display Operation.....	13
PFD Display Configuration	16
G3X System Annunciations	17
AHRS Operation	18
1.7 Accessing System Functionality	19
Menus	19
Data Entry.....	21
Pages.....	22
Main Page Softkeys	27
Flight Planning Softkeys.....	38
Nearest Page Softkeys	39
1.8 Accessing the Information (INFO) Page	39
Viewing GPS Receiver Status	40
Position.....	43
Data Fields and Layout (Full-Screen MFD)	44
1.9 System Settings	45
Transponder	46
Data Bar Fields.....	47
Display.....	49
Sound	52
Units.....	53
Date & Time	54
Position.....	55
Alarms	55
Setting Airport Criteria.....	57
Section 2 Flight Instruments	59
2.1 Flight Instruments	59
Airspeed Indicator	62
Attitude Indicator.....	64
Altimeter.....	65

Vertical Speed Indicator (VSI).....	69
Vertical Deviation Indicator and VNAV Indicator	69
Horizontal Situation Indicator (HSI)	71
Trim and Flap Position Indicators (optional).....	84
Heading Strip and Turn Rate Indicator	85
OBS Mode	86
2.2 Supplemental Flight Data	87
Outside Air Temperature	87
Wind Data	88
2.3 Vertical Navigation (VNAV)	89
Using the VNAV Feature	90
Section 3 Engine Indication System	93
3.1 EIS Display & ENG Page	93
ENG Page Softkeys (Example Configuration)	97
3.2 Lean Assist Mode (Optional)	97
3.3 Fuel Calculator (Optional)	101
Fuel Calculator Softkeys.....	103
Confirming Fuel Quantity.....	104
Confirm Fuel Quantity Softkeys	104
3.4 CAS Messages (Optional)	106
Section 4 CNS Interface	109
4.1 Auto-tuning Frequencies (Optional).....	109
4.2 Remote Transponder Interface (Optional).....	111
Transponder Mode Selection.....	114
Entering a Transponder Code.....	116
IDENT Function	116
Flight ID Reporting.....	117
Section 5 GPS Navigation.....	119
5.1 Introduction.....	119
Compass Arc.....	119
5.2 Using Map Displays.....	120
Map Page Setup.....	121
Map Range	125
Map Panning	126
Fuel Range Ring.....	128
Measuring Bearing and Distance	129
Topography.....	130
Satellite View	131
Map Page Traffic.....	132
Map Symbols	132

5.3 Airways	134
5.4 Waypoints	136
Nearest Information	141
Weather Information	143
Intersections	144
NDBs.....	145
VORs.....	145
User Waypoints	146
Automatic Waypoint Selection	150
5.5 Airspace.....	151
Airspace Alert Messages.....	152
Smart Airspace	152
5.6 Direct-to Navigation Using the G3X.....	153
Section 6 Flight Planning.....	157
6.1 Introduction.....	157
Flight Plan Data Fields.....	158
Manually Switching Between Internal and External Flight Plan Sources.....	160
Failure of the External GPS Navigation Source.....	161
6.2 Flight Plan Creation Using the G3X.....	162
6.3 Flight Plan Storage Using the G3X.....	164
6.4 Flight Plan Activation Using the G3X.....	165
6.5 Flight Plan Editing.....	166
Adding Waypoints to an Existing Flight Plan.....	166
Editing Flight Plan Speed, Fuel, and/or Name	168
Copying Flight Plans.....	171
Deleting Flight Plans	171
Inverting a Flight Plan	173
Importing/Exporting Flight Plans.....	174
6.6 Approaches (Without External Navigator Configured)	174
Selecting an Approach.....	175
Activating Vectors-to-Final.....	178
Section 7 Hazard Avoidance.....	181
7.1 SIRIUSXM Weather.....	181
SIRIUSXM Datalink Weather Advisory.....	181
Activating Services	182
SIRIUSXM Weather Products	182
Using SIRIUSXM Weather Products.....	193
7.2 Terrain	197
Synthetic Vision.....	198
Terrain Information.....	198
Terrain Views.....	199

Terrain Settings	200
Terrain Alerts.....	202
7.3 Traffic Systems	205
Traffic Information Service (TIS) (Optional).....	205
Garmin GTS 800 Traffic.....	212
Section 8 Additional Features.....	221
8.1 Synthetic Vision (SVX)	222
Synthetic Vision Operation	223
8.2 SafeTaxi®	235
SafeTaxi Cycle Number and Revision.....	236
8.3 ChartView	236
Aircraft Symbol.....	238
Chart Range.....	239
Jeppesen Database-published NOTAMs	239
8.4 FliteCharts®	240
Aircraft Symbol.....	242
Chart Range.....	243
FliteCharts Cycle Number and Expiration Date	243
8.5 Airport Directory Data.....	244
8.6 SIRIUSXM Radio Entertainment (Optional).....	245
Activating SiriusXM Satellite Radio Services	246
Using SIRIUSXM Radio.....	247
8.7 Vertical Power (Optional).....	250
8.8 Electronic Checklists (Optional).....	253
8.9 Flight Data Logging	253
Section 9 Integrated Autopilot (Optional).....	255
9.1 Integrated Autopilot Operation	256
Controls.....	256
G3X Autopilot Status Box	259
Integrated Autopilot Modes.....	261
9.2 Vertical Modes.....	262
Pitch Hold Mode (PIT).....	263
Selected Altitude Capture mode (ALTS)	264
Altitude Hold Mode (ALT)	265
Vertical Speed Mode (VS)	267
Vertical Navigation Mode (VNAV).....	269
Glidepath Mode (GP) (WAAS Only).....	273
Glideslope Mode (GS).....	274
9.3 Lateral Modes.....	277
Roll Hold Mode (ROL).....	278
Heading Mode (HDG).....	279

GPS, VOR & LOC Modes	280
Approaches without Vertical Guidance.....	285
Approaches with Lateral + Vertical Guidance.....	289
Coupled Approach.....	293
9.4 Integrated Autopilot Alerts	294
Section 10 Annunciations & Alerts	295
10.1 Miscellaneous Message Advisories	295
10.2 System Status Messages (INFO Page)	297
10.3 Aural Alerts.....	302
10.4 PFD Annunciations and Alerting Functions.....	302
Uncertain Heading	302
External Navigator Messages (Optional).....	303
CAS Messages (Optional)	303
Terrain Annunciations.....	305
Traffic Annunciations	306
Integrated Autopilot Alerts (Optional)	306
Vertical Power Fault Indications	308
Section 11 Appendices.....	309
Appendix A: Data Field Options.....	309
Appendix B: Utilities	315
Flight Log.....	315
Track Log	317
Heading Line.....	321
Weight & Balance	322
EPE Circle	324
Proximity Waypoints	324
Appendix C: SD Card Use and Databases.....	327
Installing and Removing SD Cards	327
G3X Databases	328
Updating G3X Databases	331
Exporting Track Logs and User Waypoints.....	334
Importing/Exporting Flight Plans.....	334
Flight Data Logging.....	334
Appendix D: Map Datum and Location Formats	335
Map Datums	335
Location Formats.....	335
Appendix E: General TIS Information.....	337
TIS vs. TAS/TCAS.....	337
TIS Limitations	337

Appendix F: Abnormal Operation341

- Loss of GPS Position 341
- Hazard Display with Loss of GPS Position 341
- G3X System Failure Annunciations 342
- Unusual Attitudes 343
- Reversionary Mode (Full-Screen) 344
- Failure of the External GPS Navigation Source 344
- Synthetic Vision Troubleshooting 346

Appendix G: Display Symbols347

- VFR Symbols 347
- IFR Symbols 348
- Airspace Symbols 350

Appendix H: Glossary353

Appendix I: License Agreement and Warranty359

- Contact Garmin 359
- Software License Agreement 359
- Limited Warranty 359
- AOPA Airport Directory Notice 360
- AC-U-KWIK LICENSE AGREEMENT 361
- SIRIUSXM Satellite Radio Service Agreement 361
- Weather Data Warranty 361

Index..... Index-1

SECTION 1 SYSTEM OVERVIEW

The G3X System presents flight instrumentation, position, navigation, communication, and identification information to the pilot using Wide VGA (800x480) flat-panel color display(s). The seven-inch diagonally measured display(s) provides 22 square-inches (each) of viewing area.

1.1 LINE REPLACEABLE UNITS

The system consists of the following Line Replaceable Units (LRUs):

- **Garmin Display Unit (GDU) 375 (with XM)**
 - Single Display: Split Primary Flight Display (PFD) & Multi Function Display (MFD)
 - Multiple Displays: MFD (recommended)
- **GDU 370 (without XM)**
 - Single Display: Split Primary Flight Display (PFD) & Multi Function Display (MFD)
 - Multiple Displays: MFD, PFD, or split-screen



GDU 37X

- System Overview
- Flight Instruments
- EIS
- CNS Interface
- GPS Navigation
- Flight Planning
- Hazard Avoidance
- Additional Features
- Integrated Autopilot
- Annun/Alerts
- Appendix
- Index

- **GSU 73**

- Garmin Sensor Unit sub-system for the G3X (Air Data Computer (ADC), Engine/Airframe Unit, and the Attitude and Heading Reference System (AHRS))
 - ADC: Processes data from the pitot-static system and outside air temperature (OAT) sensor.
 - Engine/Airframe Unit: Receives and processes signals from the engine and airframe sensors.
 - AHRS: Provides aircraft attitude and heading information to the PFD. The AHRS contains advanced sensors (including accelerometers and rate sensors) and interfaces with the Magnetometer to obtain magnetic field information, with the ADC to obtain air data, and with the GDU to obtain GPS information. AHRS operation is discussed later in this section.



GSU 73

- **GMU 44**

- Magnetometer: Measures the local magnetic field and sends data to the AHRS for processing to determine aircraft magnetic heading. This unit receives power directly from the AHRS and communicates with it via an RS-485 digital interface.



GMU 44

- **GTP 59**

- Temperature Probe: Provides raw air temperature data.



GTP 59

G3X SINGLE DISPLAY

In the single display, split-screen configuration, the Primary Flight Display (PFD) and the Multi Function Display (MFD) are displayed in split-screen mode on a single GDU.

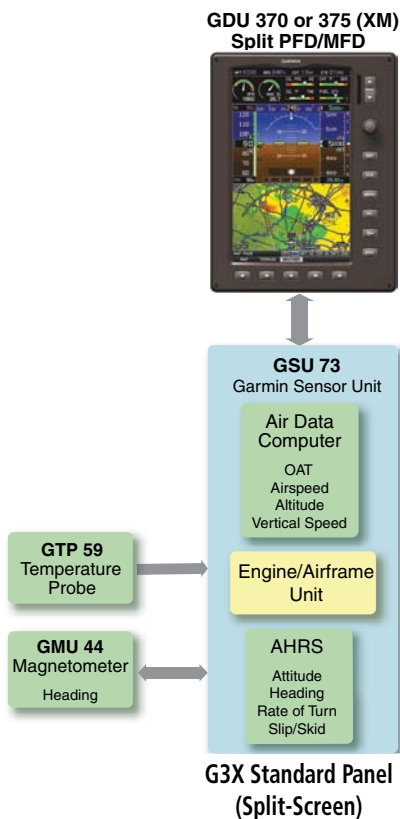

- System Overview
- Flight Instruments
- EIS
- CNS Interface
- GPS Navigation
- Flight Planning
- Hazard Avoidance
- Additional Features
- Integrated Autopilot
- Annun/Alerts
- Appendix
- Index

G3X DUAL DISPLAY



NOTE: The G3X System can be configured with more than two displays.

A typical dual display panel would have the left GDU configured as a full-screen PFD and the right GDU configured as a full-screen MFD. The following is an example of an upgraded G3X panel using a GDU 370 and a GDU 375; however, two GDU 370s can be used if SiriusXM is not needed.

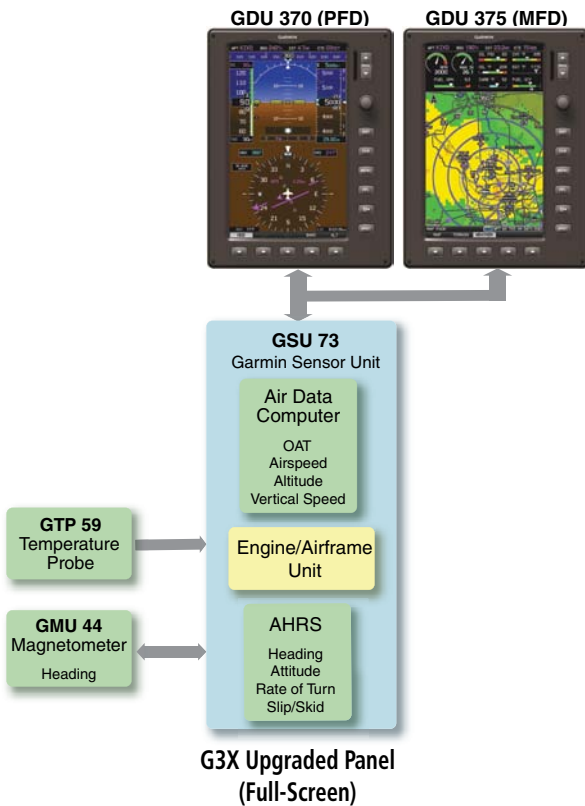

SPLIT-SCREEN VS. FULL-SCREEN CONFIGURATIONS

Various combinations of split and full-screen configurations are available in systems with 2 or more GDUs. For example, a system with 2 GDUs (MFD and PFD1) can be configured to have a split-screen layout on PFD1, and a system with 3 GDUs (PFD1, MFD, PFD2) can be configured to have full-screen MFD pages displayed on PFD2 if desired.

EXTERNAL NAVIGATORS (OPTIONAL)

The G3X can also communicate with the following optional external navigators:

- SL30 Nav/Comm Transceiver
- GTN or GNS Series Units

USING THE G3X WITH AN EXTERNAL GPS NAVIGATOR



WARNING: Do not use the approach information provided by the VFR navigation database residing within the G3X as a means of navigating any instrument approach. The G3X VFR navigation database is limited to present only the waypoints for the final approach leg of a published procedure. These waypoints and associated course line are made available for monitoring purposes only.

In a configuration which includes one or more external GPS navigators (i.e., GTN or GNS Series), the G3X displays the selected external GPS Navigator's flight plan and guidance information. When using an external GPS navigator with the G3X, press the **INTERNAL** Softkey on the Active Flight Plan Page or Direct-To Page to make changes to the active flight plan from the G3X. Press the **EXTERNAL** Softkey to return to the external GPS navigator's flight plan. When an external navigator is configured the internal GPS can still be used for VFR navigation.



NOTE: The G3X internal GPS flight plan is only for VFR use.

CHANGING THE NAVIGATION SOURCE

When an external navigator that supports both GPS and VOR/ILS capabilities (i.e., GTN or GNS Series) is selected, the external navigator's **CDI** Key is used to switch the G3X HSI between GPS and VOR/ILS navigation.

SELECTION BETWEEN MULTIPLE NAVIGATORS

The G3X **CDI SRC** Softkey (refer to Section 1.7) becomes available when more than one source of navigation data is configured. The **CDI SRC** Softkey toggles between the available navigation sources (e.g., between the internal G3X GPS and external SL30 VLOC sources, between an SL30 and a GNS 430, or between two GNS 430s, etc). Refer to the Flight Instruments section for more information.

USING MAPMX SERIAL DATA INPUT FORMAT

When using a WAAS enabled external GPS navigator (i.e., GNS 430W/530W, GNS 480 or any GTN Series navigator), and configuring an RS-232 input for 'MapMX' instead of 'Aviation In', a more accurate depiction of the flight plan legs are displayed on the moving map (i.e., holds, procedure turns, etc). Non-WAAS external navigators do not support MapMX. Refer to the G3X Installation Manual for more information.

EXTERNAL GPS NAVIGATOR FAILURE

In the event that all configured external GPS navigators fail, the G3X reverts to its internal VFR GPS for navigation and flight plan modifications.

INTEGRATED AUTOPILOT (OPTIONAL)

The G3X can also communicate with various third-party external autopilot units. With the Integrated Autopilot configured, the G3X issues pitch and roll steering commands to the external autopilot unit. Refer to Section 9 (Integrated Autopilot) for more information.

1.2 DISPLAY OVERVIEW



Display Overview (Split-Screen)

- System Overview
- Flight Instruments
- EIS
- CNS Interface
- GPS Navigation
- Flight Planning
- Hazard Avoidance
- Additional Features
- Integrated Autopilot
- Annun/Alerts
- Appendix
- Index

1.3 SECURE DIGITAL (SD) CARDS



NOTE: Refer to Appendix C for more information on SD Card use and databases.

The G3X data card slot uses Secure Digital (SD) cards and is located on the upper right side of the display bezel(s). The SD card can be used for software updates, checklist files, flight data logging, exporting Track Logs/User Waypoints, and Importing/Exporting Flight Plans.

Installing an SD Card:

- 1) Insert the SD card in the SD card slot with the card contacts facing the display (the card should be flush with the face of the bezel).
- 2) To eject the card, gently press on the SD card to release the spring latch.

SD Card Slot



Display Bezel SD Card Slot

1.4 G3X CONTROLS

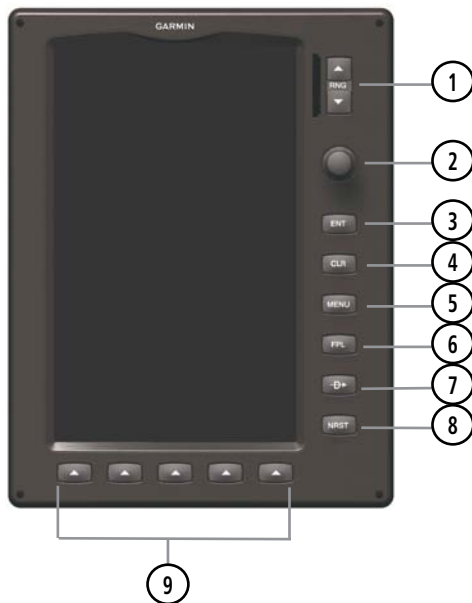

① **RNG Key**

Press to increase or decrease the viewing range of the map
Press to increase or decrease the HSI Scale on the PFD or PFD Page

② **FMS Joystick**

Press the **FMS Joystick** to toggle input focus between user interaction with the current page and the page navigation bar
Turn the **FMS Joystick** clockwise to access a drop down menu within the highlighted field

Turn the **FMS Joystick** to change the selected value within the highlighted field

Move the **FMS Joystick** (up, down, left, or right) to highlight a field

Move the **FMS Joystick** (up, down, left, right, or diagonally) to move the map pointer

With the **HDG** or **HDG/ROLL** Softkey selected, press and hold the **FMS Joystick** to sync to the current heading

With the appropriate autopilot mode selected, move the **FMS Joystick** (up/down) to adjust the mode reference for Vertical Speed, Altitude Hold, and Pitch Hold modes, or move the **FMS Joystick** (left/right) to decrease the mode reference for Roll Hold mode.

- 3 ENT Key** Press to confirm menu selection or data entry
 Press to acknowledge messages
 Press and hold to mark a waypoint
- 4 CLR Key** Press to cancel an entry, revert to the previous value in a data entry field or remove menus
 Press and hold to return to the default page
- 5 MENU Key** Press once to view the Page Menu
 Press twice to view the Main Menu
 Press a third time to clear the Main Menu
- 6 FPL Key** Press to display the Flight Plan Page
- 7 Direct-To Key** Press to activate the Direct-To function, enter a destination waypoint and establish a direct course to the selected destination
- 8 NRST Key** Press to display the Nearest Page for viewing the nearest airports, intersections, NDBs, VORs, waypoints, frequencies, and airspaces
- 9 Softkey Selection Keys** Press to select softkey shown above the bezel key on the display

- System Overview
- Flight Instruments
- EIS
- CNS Interface
- GPS Navigation
- Flight Planning
- Hazard Avoidance
- Additional Features
- Integrated Autopilot
- Annun/Alerts
- Appendix
- Index

1.5 SYSTEM POWER-UP

During system initialization, the AHRS displays the message 'AHRS ALIGN, KEEP WINGS LEVEL' over the attitude indicator. The AHRS should display valid attitude and heading fields typically within the first minute of power-up. The AHRS can align itself both while taxiing and during level flight.



System Initialization

Current database information is displayed during power-up including valid operating dates, cycle number, and database type. When this information has been reviewed for currency (to ensure that no databases have expired), the pilot is prompted to continue.

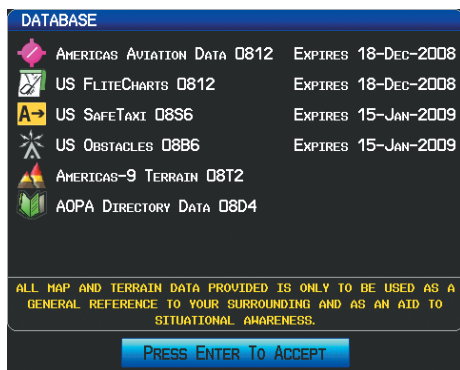

Database Information

Pressing the **ENT** Key acknowledges this information.

After acknowledgement of the database information, the pilot is prompted to acknowledge a datalink weather advisory.

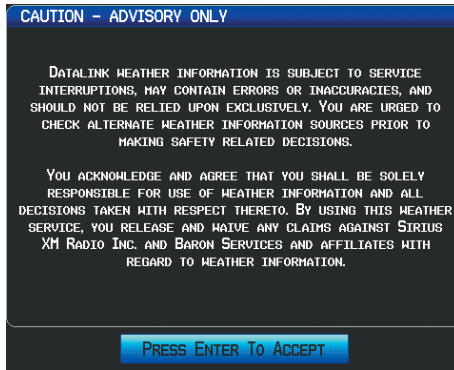

Datalink Weather Advisory

Pressing the **ENT** Key acknowledges this information.

1.6 SYSTEM OPERATION



NOTE: The G3X display operation can be configured from the DSPL Page in Config Mode (refer to the G3X Installation Manual for more information).

DISPLAY OPERATION



NOTE: In a reversionary situation where failure occurs with all the GDUs configured to use their own internal GPS receivers, any remaining GDUs will attempt to approximate their position using GPS data from an external GPS navigator (if configured).

In normal operating mode, the PFD presents graphical flight instrumentation (attitude, heading, airspeed, altitude, vertical speed), replacing the traditional flight instrument cluster.

- System Overview
- Flight Instruments
- EIS
- CNS Interface
- GPS Navigation
- Flight Planning
- Hazard Avoidance
- Additional Features
- Integrated Autopilot
- Annun/Alerts
- Appendix
- Index

• Split-Screen Only

- The PFD occupies the top portion of the display at all times, and a full display PFD can be accessed by navigating to the PFD Page (see Section 1.7, Accessing System Functionality).
- The MFD occupies the bottom portion of the display.



G3X Split-Screen Only (Normal Mode)

• Full-Screen PFD/MFD Configuration (Normal Mode)

- In normal mode the displays can be configured to have a dedicated PFD and MFD or have an optional split-screen PFD.



G3X Full-Screen (Normal Mode)



G3X Normal Mode (Optional Split-Screen PFD)

- Full-Screen PFD/MFD Configuration (Reversionary Mode)

In the event of a display failure, the G3X System automatically switches to reversionary (backup) mode. In reversionary mode, all flight information is presented on the remaining display in the split-screen configuration.

If a display failure occurs with the GDU 375, the **WX** and **XM** Pages will no longer be available since the XM receiver resides in the GDU 375.



G3X Full-Screen Reversionary Mode (Failed PFD)

- System Overview
- Flight Instruments
- EIS
- CNS Interface
- GPS Navigation
- Flight Planning
- Hazard Avoidance
- Additional Features
- Integrated Autopilot
- Annun/Alerts
- Appendix
- Index

- System Overview
- Flight Instruments
- EIS
- CNS Interface
- GPS Navigation
- Flight Planning
- Hazard Avoidance
- Additional Features
- Integrated Autopilot
- Annun/Alerts
- Appendix
- Index

• Multi-Display (Normal Mode)

- In normal mode an example Multi-Display system includes a pilot-side PFD (PFD1), MFD, and co-pilot side PFD (PFD2). PFD1 can also be configured as a split-screen. PFD2 can be configured as a split-screen or PFD/MFD (full-screen PFD page and full-screen MFD pages without split-screen)



PFD1

MFD

PFD2

G3X Multi-display Normal Mode (example)

• Multi-Display (Reversionary Mode)

If the system detects a failure in PFD1, the MFD enters reversionary mode. If the MFD fails, PFD1 and PFD2 enter reversionary mode. A failure of PFD2 is not considered an emergency and will not cause either of the remaining displays to enter reversionary mode.

PFD DISPLAY CONFIGURATION

If the system is configured for multiple GDUs, the pilot has the ability to change the layout of PFD1 between full-screen and split-screen in normal mode.

Changing the PFD1 Display Layout:

- 1) Press the **MENU** Key twice to display the Main Menu.
- 2) Turn or move the **FMS** Joystick to highlight 'System Setup...' and press the **ENT** Key.
- 3) Turn or move the **FMS** Joystick to highlight 'Display', and press the **ENT** Key.

- 4) Move the **FMS** Joystick to highlight the PFD Display Layout field.
- 5) Turn the **FMS** Joystick to highlight 'Auto' or 'Split'.
- 6) Press the **FMS** Joystick, the **CLR** Key, the **EXIT** Softkey or the **MENU** Key to return to the previous page.

Changing the PFD2 Display Layout:

If the system is configured for multiple GDUs, the pilot has the ability to change the layout of PFD2 between full-screen PFD, split-screen, or full-screen PFD/MFD.

- 1) Press the **MENU** Key twice to display the Main Menu.
- 2) Turn or move the **FMS** Joystick to highlight 'System Setup...' and press the **ENT** Key.
- 3) Turn or move the **FMS** Joystick to highlight 'Display', and press the **ENT** Key.
- 4) Move the **FMS** Joystick to highlight the PFD2 Display Layout field.
- 5) Turn the **FMS** Joystick to highlight 'Auto', 'Split', or 'PFD/MFD'.
- 6) Press the **FMS** Joystick, the **CLR** Key, the **EXIT** Softkey or the **MENU** Key to return to the previous page.

G3X SYSTEM ANNUNCIATIONS

When an LRU or an LRU function fails, a large red 'X' is typically displayed over the instrument(s) or data experiencing the failure (Refer to Appendix F, Abnormal Operation). Upon G3X power-up, certain instruments remain invalid as equipment begins to initialize. All instruments should be operational within one minute of power-up. If any instrument remains flagged, and it is not likely an installation related problem, the G3X should be serviced by a Garmin-authorized repair facility .



PFD Initialization

AHRS OPERATION

The Attitude and Heading Reference System (AHRS) performs attitude, heading, and vertical acceleration calculations for the G3X System, utilizing GPS, magnetometer, and air data in addition to information from its internal sensors. Attitude and heading information are updated on the PFD while the AHRS receives appropriate combinations of information from the external sensor inputs.

The AHRS (GSU 73) corrects for shifts and variations in the Earth’s magnetic field by applying the Magnetic Field Variation Database. The Magnetic Field Variation Database is derived from the International Geomagnetic Reference Field (IGRF). The IGRF is a mathematical model that describes the Earth’s main magnetic field and its annual rate of change. The database is updated approximately every 5 years. Failure to update this database could lead to erroneous heading information being displayed to the pilot.

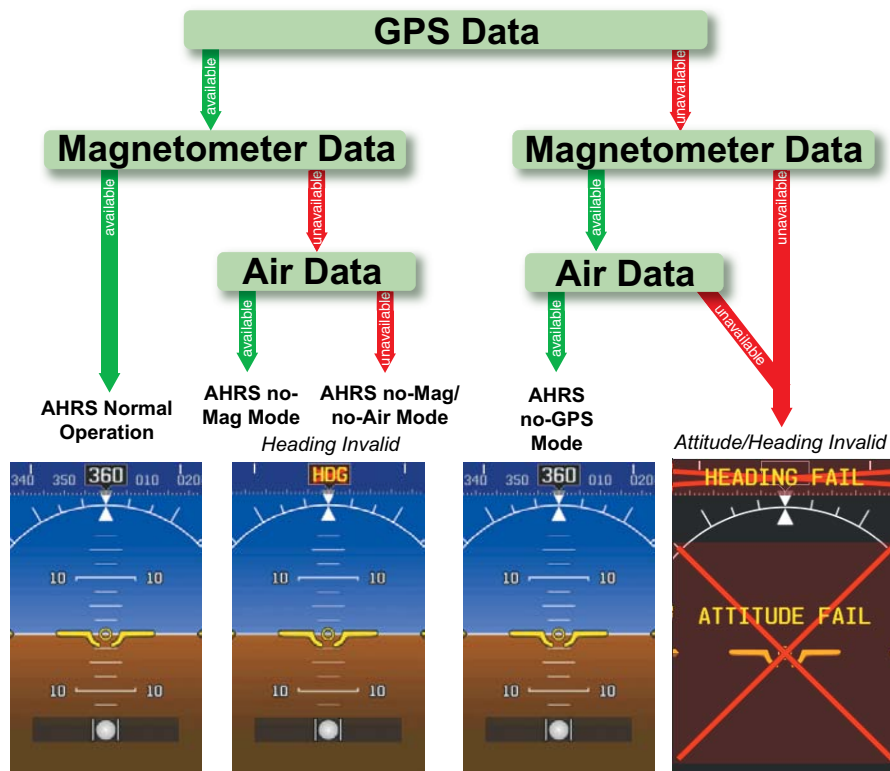

Loss of GPS, magnetometer, or air data inputs is communicated to the pilot by message advisory alerts. Any failure of the internal AHRS inertial sensors results in loss of attitude and heading information (indicated by red 'X' flags over the corresponding flight instruments). If the G3X senses that the magnetic heading measurement is valid, but possibly outside of the internal accuracy limits, the numeric heading value on the PFD is display in yellow.

If GPS input fails, the AHRS can continue to provide attitude and heading information to the PFD as long as magnetometer and airspeed data are available and valid.

If the magnetometer input fails, the AHRS continues to output valid attitude information; however, the heading output on the PFD Page is flagged as invalid with a red 'X'.

Failure of the air data input has no effect on the AHRS output while AHRS is receiving valid GPS information. Invalid/unavailable airspeed data in addition to GPS failure results in loss of all attitude and heading information. Likewise, loss of magnetometer (heading) data, in combination with loss of GPS data results in a loss of all attitude and heading information.

1.7 ACCESSING SYSTEM FUNCTIONALITY

MENUS



NOTE: *Flight Log and Track Log must be accessed from the MFD in a Multiple Display system.*

The G3X has a dedicated **MENU** Key. Press once to display a context-sensitive list of options for the page or the dedicated PFD. Press twice to display the Main Menu.

The Page Menu allows the user to access additional features or make setting changes which specifically relate to the currently displayed page. The menu will display 'No Options' when there are no options for the page selected.

Navigating the page menu:

- 1) Press the **MENU** Key once to display the Page Menu.
- 2) Turn or move the **FMS** Joystick to scroll through a list of available options (a scroll bar always appears to the right of the window/box when the option list is longer than the window/box).

- 3) Press the **ENT** Key to select the desired option.
- 4) Press the **FMS** Joystick, **CLR** Key, or press the **MENU** Key twice to remove the menu and cancel the operation.

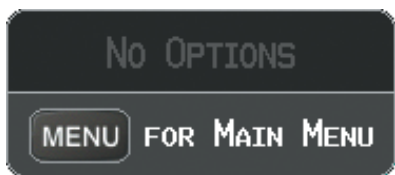

Page Menu (No Options)



TER Page Menu

Navigating the main menu:

- 1) Press the **MENU** Key twice to display the Main Menu.
- 2) Turn or move the **FMS** Joystick to scroll through a list of available options (a scroll bar always appears to the right of the window/box when the option list is longer than the window/box).
- 3) Press the **ENT** Key to select the desired option.
- 4) Press the **FMS** Joystick, **CLR** Key, **EXIT** Softkey, or press the **MENU** Key to remove the menu and cancel the operation.

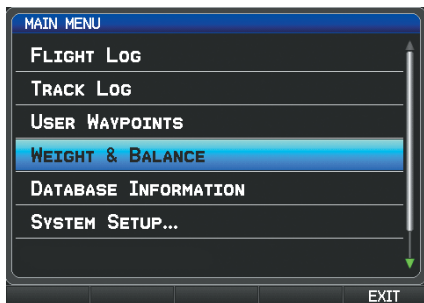

Main Menu (Split-Screen)



Main Menu (Full-Screen MFD)

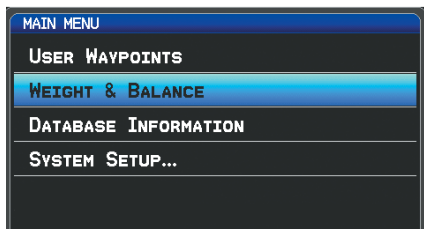

Main Menu (Split-Screen PFD)

DATA ENTRY

The **FMS** Joystick can be used for directly entering alphanumeric data into the G3X. In some instances, such as when entering an identifier, the G3X tries to predict the desired identifier based on the characters being entered. In this case, if the desired identifier appears, use the **ENT** Key to confirm the entry without entering the rest of the identifier manually. This can save the pilot from having to enter all the characters of the identifier.

Besides character-by-character data entry, the system also provides a shortcut for entering waypoint identifiers. When the cursor is on a field awaiting entry of a waypoint identifier, turning the **FMS** Joystick counter-clockwise accesses a menu with three different lists of identifiers for quick selections: recent waypoints (RECENT WPTS), nearest airports (NRST APTS), and flight plan waypoints (FPL WPTS). The G3X automatically fills in the identifier, facility, and city fields with the information for the selected waypoint.

Using the FMS Joystick to enter data:

- 1) Press the **FMS** Joystick to activate the cursor.
- 2) Move the **FMS** Joystick to highlight the desired field.
- 3) Begin entering data.
 - a) To quickly enter a waypoint identifier, turn the **FMS** Joystick counter-clockwise to display a list of recent waypoints (RECENT WPTS), nearest airports (NRST APTS) or flight plan waypoints (FPL WPTS).
 - b) Move the **FMS** Joystick to highlight the desired waypoint from the list and press the **ENT** Key.

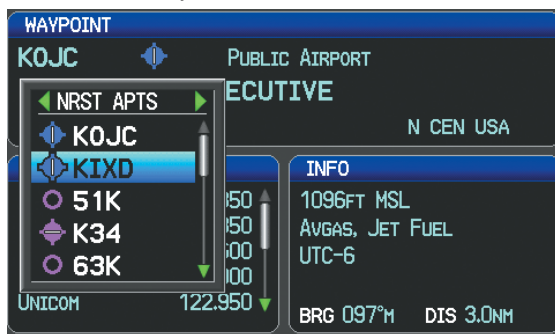

Waypoint Entry on Waypoint Page (Split-Screen)

Or:

- a) Turn the **FMS** Joystick clockwise to select a character for the first placeholder.



Data Entry

Turning the **FMS** Joystick clockwise scrolls through the alphabet (where appropriate) toward the letter Z, starting in the middle at K (US only), and the digits zero through nine. Turning the **FMS** Joystick counter-clockwise scrolls in the opposite direction.

- b) Use the **FMS** Joystick to move the cursor to the next placeholder in the field.
- c) Repeat, turning the **FMS** Joystick to select a character and then moving the **FMS** Joystick to move the cursor, until the fields are complete.
- d) Press the **ENT** Key to confirm entry.

Or:

Press the **FMS** Joystick or the **CLR** Key to cancel data entry (the field reverts back to its previous information).

PAGES

The Main Pages, Flight Plan Pages, and Nearest Pages are linked together in a series that you can cycle through using the **FMS** Joystick. A page navigation bar is displayed on the lower portion of the display, directly above the softkey bar. The right side of the page navigation bar shows a list of abbreviated names for each of the pages, and the left side shows the name of the current page.

Press the **FMS** Joystick to toggle input focus between the Page Navigation Bar and interaction with the current page (i.e., turning the page cursor on/off). When the Page Navigation Bar is highlighted blue, the user can cycle through the pages using the

FMS Joystick. If the Page Navigation Bar is not highlighted blue, the user can interact with the current page (if available).

On the split-screen example below, the PFD occupies the top portion of the display while the selected page occupies the bottom portion of the display.

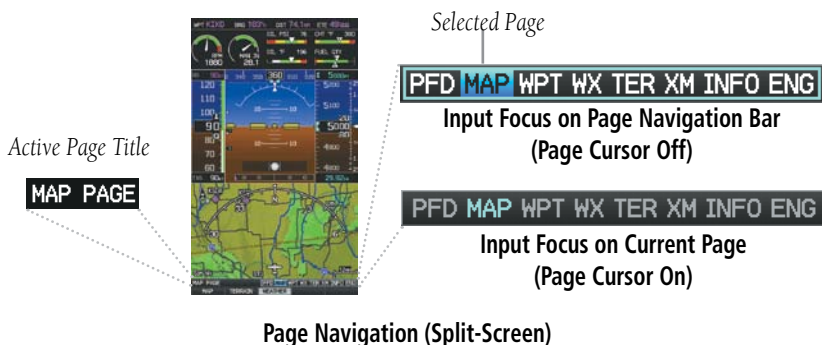

MAIN PAGES



NOTE: Contact Vertical Power for more information regarding the VPX Page.

There are up to nine Main Pages that can be navigated using the **FMS Joystick**. The Traffic (TRF) Page can be displayed or removed from the Display Setup menu.

Selecting a main page using the FMS Joystick:

- 1) If necessary, press the **FMS Joystick** to begin interaction with the Page Navigation Bar.
- 2) Turn the **FMS Joystick** until the desired page is selected (**PFD** (split-screen only), **MAP**, **WPT**, **WX**, **TER**, **TRF** (optional) **XM**, **INFO**, **ENG**).

- System Overview
- Flight Instruments
- EIS
- CNS Interface
- GPS Navigation
- Flight Planning
- Hazard Avoidance
- Additional Features
- Integrated Autopilot
- Annun/Alerts
- Appendix
- Index

• Main Pages

- | | |
|-------------------------------|----------------------------------|
| PFD Page (PFD) (split-screen) | Traffic Page (TRF) |
| Map Page (MAP) | XM Audio Page (XM) (optional) |
| Waypoint Page (WPT) | Vertical Power (VP-X) (optional) |
| Weather Page (WX) (optional) | Info Page (INFO) |
| Terrain Page (TER) | Engine Page (ENG) |

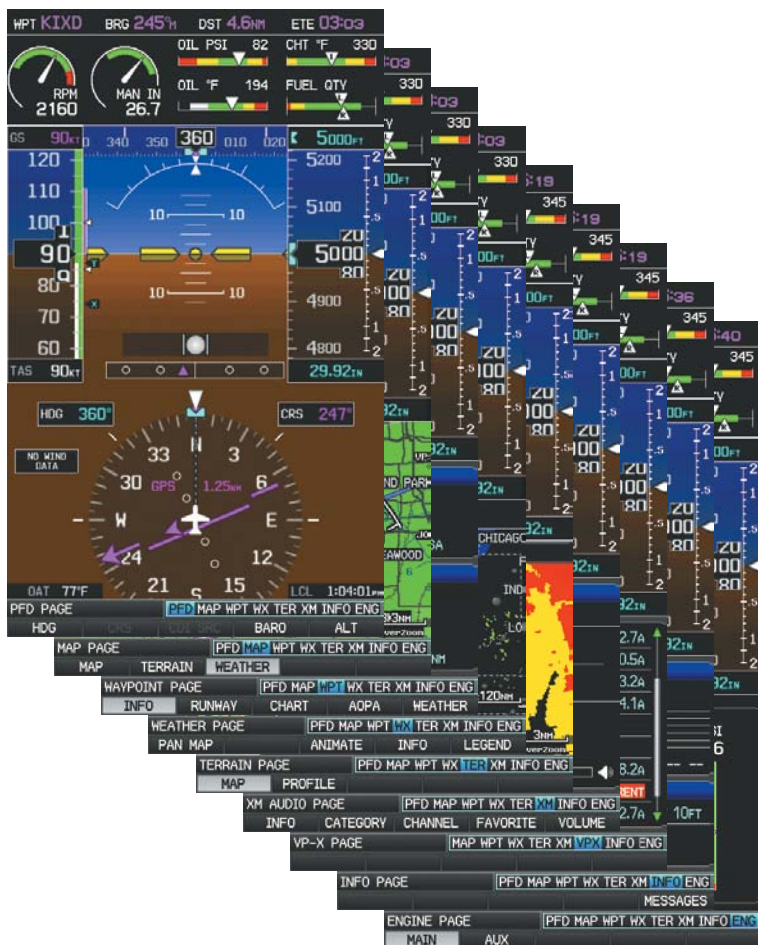

Main Pages (Split-Screen)

Displaying/Removing the Traffic Page:

- 1) Press the **MENU** Key twice to display the Main Menu.
- 2) Turn or move the **FMS** Joystick to highlight 'System Setup...' and press the **ENT** Key.
- 3) Turn or move the **FMS** Joystick to highlight 'Display', and press the **ENT** Key.
- 4) Move the **FMS** Joystick to highlight the Traffic Page field.
- 5) Turn the **FMS** Joystick to highlight 'Show' or 'Hide'.
- 6) Press the **FMS** Joystick, the **CLR** Key, the **EXIT** Softkey or the **MENU** Key to return to the previous page.

FLIGHT PLAN AND NEAREST PAGES

The Flight Plan and Nearest Pages are selected by pressing the **FPL** Key or **NRST** Key.

Selecting the FPL or NRST pages:

- 1) Press the **FPL** or **NRST** Key.
- 2) Turn the **FMS** Joystick until the desired page is selected.
- 3) To return to the Main Pages, press the **EXIT** Softkey.

The Nearest Pages contain the following information.

- APT (Airport)—identifier, bearing, distance, length of the longest runway, and common traffic advisory (CTAF) or tower frequency.
- WX (Airport Weather) (GDU 375 Only)—identifier, bearing, distance, METAR text, and ATIS, AWOS, or ASOS frequency.
- VOR (VHF Omnidirectional Radio Beacon)—identifier, facility type (symbol), bearing, distance, and frequency.
- NDB (Non Directional Beacons)—identifier, facility, type (symbol), bearing, distance, and frequency.
- INT (Intersection)—identifier, bearing, and distance.
- VRP (Visual Reporting Point) (Atlantic)—identifier, bearing, and distance.
- USR (User Waypoints)—name, bearing, and distance.

- CTY (City)—name, bearing, and distance.
- ATC (Air Route Traffic Control Center)—bearing, distance, and frequency.
- FSS (Flight Service Station)—name, bearing, distance, frequency, and VOR (if applicable).
- ASPC (Airspace)—name, time to entry (when applicable), and status.

• Nearest Pages (NRST)

- | | |
|---|------------------------------|
| Nearest Airports (APT) | Nearest User Waypoints (USR) |
| Nearest Airport Weather (WX) (GDU 375) | Nearest Cities (CTY) |
| Nearest VORs (VOR) | Nearest ARTCC (ATC) |
| Nearest NDBs (NDB) | Nearest FSS (FSS) |
| Nearest Intersections (INT) | Nearest Airspace (ASPC) |
| Visual Reporting Point (VRP) (Atlantic) | |

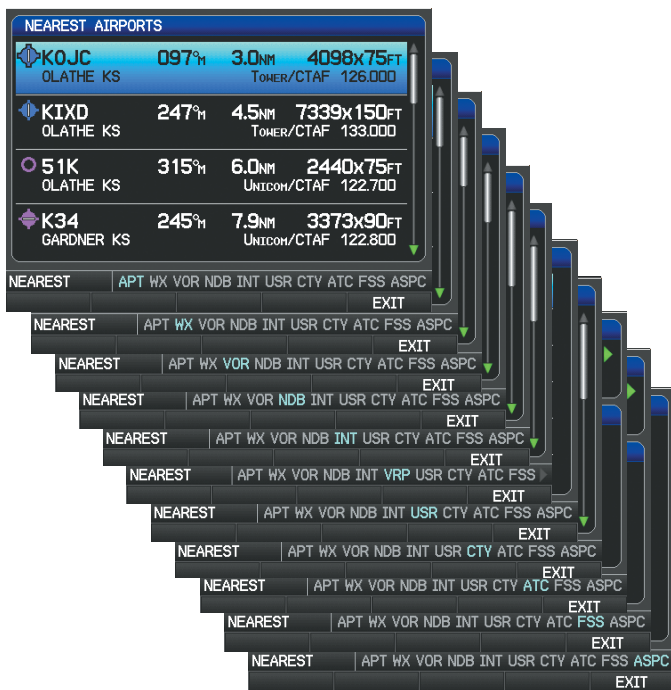

Nearest Pages (Split-Screen)

- System Overview
- Flight Instruments
- EIS
- CNS Interface
- GPS Navigation
- Flight Planning
- Hazard Avoidance
- Additional Features
- Integrated Autopilot
- Annun/Alerts
- Appendix
- Index

- **Flight Planning Pages (FPL)**

Active Flight Plan (ACTV)

Vertical Navigation (VNAV)

Flight Plan List (LIST) (only available from the MFD in two display system)

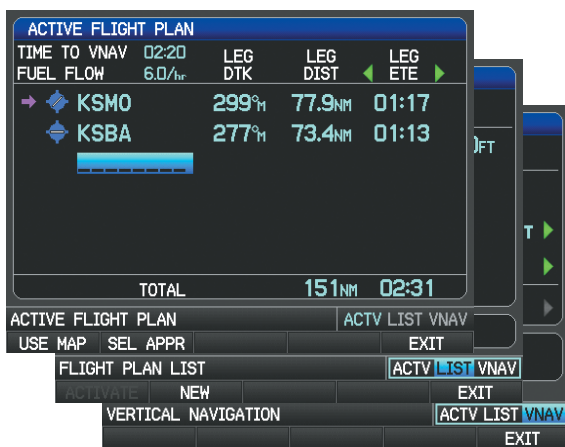

Flight Planning Pages (Split-Screen)

MAIN PAGE SOFTKEYS

The softkeys are located along the bottom of the display(s). The softkeys shown depend on the softkey level or page being displayed. The bezel keys below the softkeys can be used to select the appropriate softkey. When a softkey is selected, its color undergoes a momentary change to black text on blue background then automatically switches to black text on gray background and remains this way until it is turned off, at which time it reverts to white text on black background. When a softkey function is disabled, the softkey label is subdued (dimmed).



Softkeys (WPT Page)

PFD SOFTKEYS

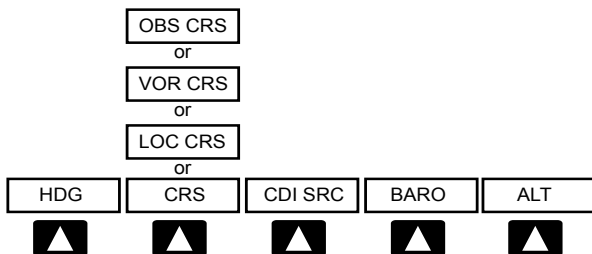

- HDG Allows the pilot to adjust the heading bug
- CRS (subdued) A navigation source is not selected
- or
- OBS CRS Allows the pilot to adjust the OBS course
- or
- VOR CRS Allows the pilot to adjust the VOR course
- or
- LOC CRS Allows the pilot to adjust the localizer course
- CDI SRC Toggles between available NAV sources (when configured)
- BARO Allows the pilot to change the barometric setting and enables the second-level BARO Softkeys
- ALT Allows the pilot to adjust the selected altitude

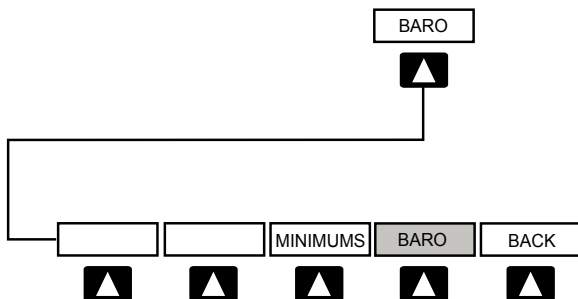

- MINIMUMS Allows the pilot to set or clear the barometric minimums altitude reminder
- BARO Allows the pilot to change the barometric setting
- BACK Returns to top-level softkeys

OPTIONAL TRANSPONDER SOFTKEY

With a remote transponder configured, the #2 PFD Softkey becomes **XPDR** (if a navigation source is not selected) or **XPDR /CRS** (when the pilot can control the navigation course).

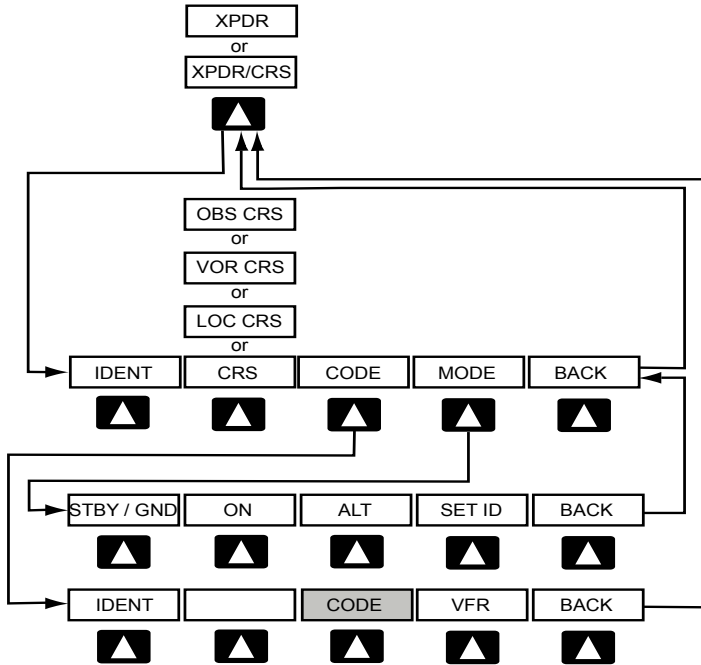

- IDENT Sends a distinct identity indication to Air Traffic Control (ATC).
- CRS (subdued) A navigation source is not selected
- or
- OBS CRS Allows the pilot to adjust the OBS course
- or
- VOR CRS Allows the pilot to adjust the VOR course
- or
- LOC CRS Allows the pilot to adjust the localizer course
- CODE Allows the pilot to enter the transponder code and displays the second-level **CODE** softkeys

- System Overview
- Flight Instruments
- EIS
- CNS Interface
- GPS Navigation
- Flight Planning
- Hazard Avoidance
- Additional Features
- Integrated Autopilot
- Annun/Alerts
- Appendix
- Index

MODE	Displays second-level MODE softkeys
BACK	Returns to top-level softkeys

CODE Softkey selected

IDENT	Sends a distinct identity indication to Air Traffic Control (ATC).
-------	--

CODE	Returns to top-level softkeys
------	-------------------------------

VFR	The pre-programmed VFR code is automatically displayed in the code field of the Transponder Data Box. Pressing the VFR softkey again restores the previous identification code.
-----	--

BACK or DONE	Returns to top-level softkeys
--------------	-------------------------------

MODE Softkey selected

STBY	Selects the standby mode. When in standby mode, the remote transponder will not reply to any interrogations. Press and hold to put the transponder in Ground (GND) Mode. Ground Mode is normally selected automatically when the aircraft is on the ground.
------	---

ON	Generates Mode A and Mode S replies, but Mode C altitude reporting is inhibited.
----	--

ALT	Selects ALT Mode. All transponder replies requesting altitude information are provided with pressure altitude information.
-----	--

SET ID	Allows the pilot to set the Flight ID. (The Flight ID must be configured to 'Set By Pilot' for the SET ID softkey to be displayed).
--------	--

BACK	Returns to previous level softkeys
------	------------------------------------

OPTIONAL AUTOPILOT SOFTKEYS

With a integrated autopilot configured, the #1 PFD Softkey becomes **HDG/ROLL** and the #5 PFD Softkey becomes **ALT/PTCH**.

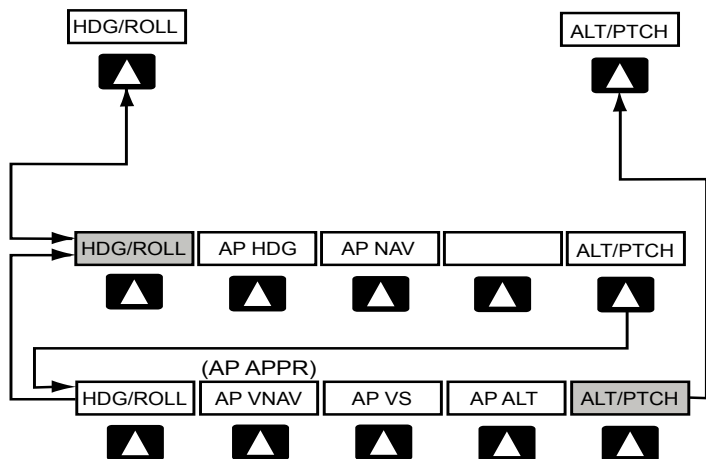

HDG/ROLL Softkey selected

- HDG/ROLL Initial press allows the pilot to adjust the heading bug and displays lateral mode softkeys; subsequent press returns to top-level softkeys
- AP HDG Selects/deselects heading mode
- AP NAV Selects/deselects navigation mode. Cancels GS Mode if LOC Mode is either active or armed. Cancels GP Mode if GPS Mode is either active or armed. Cancels LOC Mode if GPS Mode is active and LOC Mode is armed.
- ALT/PTCH Initial press allows the pilot to adjust the selected altitude and displays the vertical mode softkeys; subsequent press returns to top-level softkeys

ALT/PTCH Softkey selected

- HDG/ROLL Initial press allows the pilot to adjust the heading bug and displays lateral mode softkeys; subsequent press returns to top-level softkeys

System Overview	AP VNAV	Selects/deselects altitude hold mode
	or	
Flight Instruments	AP APPR	Selects/deselects approach mode
	AP VS	Selects/deselects vertical speed mode
	AP ALT	Selects/deselects altitude hold mode
EIS	ALT/PTCH	Initial press allows the pilot to adjust the selected altitude and displays the vertical mode softkeys; subsequent press returns to top-level softkeys

MAP PAGE SOFTKEYS



MAP	Enables second-level Map Page softkeys
TERRAIN	Displays/removes terrain awareness information
WEATHER	Displays/removes weather information
TRAFFIC	Displays/removes traffic information

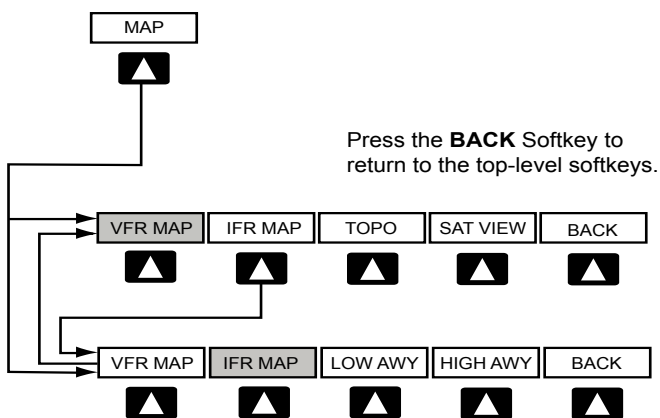

VFR MAP Softkey selected

IFR MAP	Displays IFR map information and softkeys
TOPO	Displays/removes topographical terrain shading
SAT VIEW	Displays/removes satellite imagery (above 20nm scale)
BACK	Returns to top-level softkeys

IFR MAP Softkey selected

VFR MAP	Displays VFR map information and softkeys
LOW AWY	Low Altitude (Victor) Airways displayed
HIGH AWY	High Altitude Airways (Jet Routes) displayed
BACK	Returns to top-level softkeys

WAYPOINT PAGE SOFTKEYS

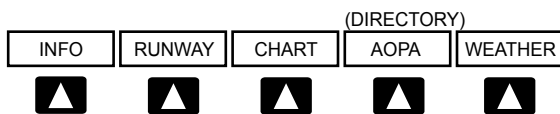

Waypoint (WPT) Page Softkeys
(Split-Screen)

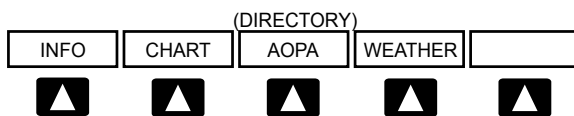

Waypoint (WPT) Page Softkeys
(Full-Screen)

INFO	Displays waypoint information
RUNWAY	Displays runway information (split-screen only)
CHART	Displays optional FliteCharts
AOPA or DIRECTORY	Displays airport directory information
WEATHER	Displays METAR and TAF text (optional)

WEATHER PAGE SOFTKEYS (OPTIONAL)



PAN MAP	Activates the map pointer for panning the map
ANIMATE	Animates NEXRAD Radar and Satellite Mosaic weather
INFO	Displays XM Information
LEGEND	Displays weather legends

TERRAIN PAGE SOFTKEYS



Terrain (TER) Page Softkeys
(Split-Screen)



Terrain (TER) Page Softkeys
(Full-Screen)

MAP	Displays the Terrain Page Map View
PROFILE	Displays the Terrain Page Profile View.
SETTINGS	Displays the Terrain Setup Page
DISABLE	Toggles terrain alerts on/off.

XM AUDIO PAGE SOFTKEYS (OPTIONAL)



INFO	Displays XM Information
CATEGORY	Highlights the Category field
CHANNEL	Highlights the Channels field
FAVORITE	Displays a list of favorite channels
VOLUME	Enables second-level VOLUME softkeys Press and hold to toggle Mute on/off.

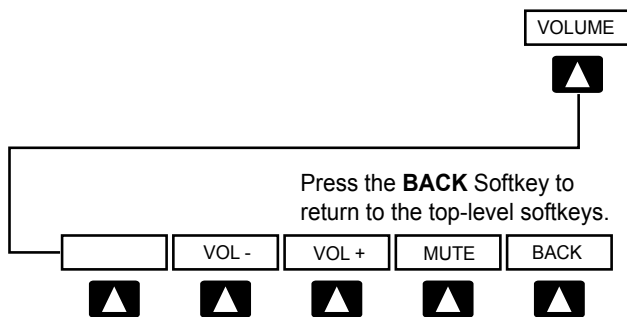

VOL -	Decreases XM audio volume
VOL +	Increases XM audio volume
MUTE	Toggles XM audio on/off
BACK	Returns to top-level softkeys

VP-X PAGE SOFTKEYS (OPTIONAL)

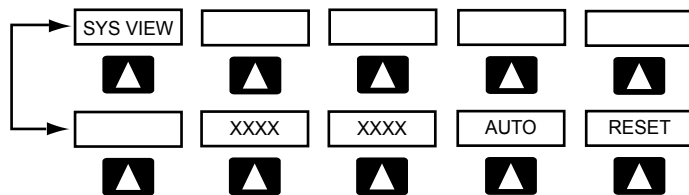

Vertical Power (VPX) Softkeys
(Split-Screen)



Vertical Power (VPX) Softkeys
(Full-Screen)

SYS VIEW	SYS VIEW is only available on a Split-Screen installation and toggles between a list of configured devices and the schematic showing the connected devices.
XXXX	Device Sensitive Softkey (e.g., 'ON', 'TRIM UP', 'TRIM L', or 'FLAPS UP')
XXXX	Device Sensitive Softkey (e.g., 'OFF', 'TRIM DN', 'TRIM R', or 'FLAPS DN')
AUTO	Only appears when the landing light is selected and it has been configured for 'wig-wag'.
RESET	Only available when the selected device is in a fault condition. Select RESET to reset the device, similar to resetting a circuit breaker.

INFO PAGE SOFTKEY



MESSAGES Displays system status messages

ENG PAGE SOFTKEYS (EXAMPLE CONFIGURATION)



NOTE: The Engine (ENG) Page softkeys displayed are dependant on the configuration. Refer to the G3X Installation Manual for information on configuring the Engine Page.

If the Engine Page information configured exceeds one page, additional engine gauges may be distributed among the 1st, 2nd, and 3rd softkeys as required.

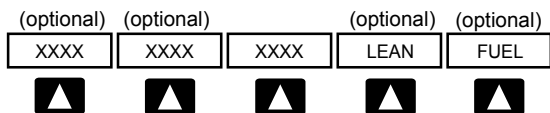

MAIN, TEMPS

Displays main engine gauges (optional)

AUX, AUX1, AUX2, ELEC,
TRIM, TEMPS

Displays additional engine gauges as required (optional)

LEAN

Activates/deactivates Lean Assist (optional)

FUEL

Displays Fuel Calculator (optional)

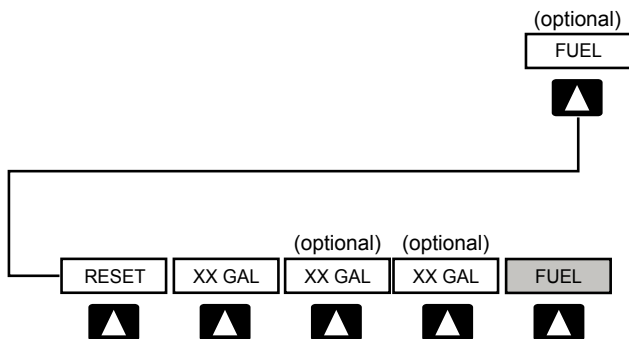

RESET

Resets fuel used to zero and fuel remaining to full tanks

XX GAL

Sets fuel remaining to the full tank quantity where XX is the airframe specific full fuel quantity

System Overview	XX GAL	Sets fuel remaining to a partial tank quantity (i.e., filler neck tab) where XX is an airframe specific partial fuel quantity (optional)
Flight Instruments	XX GAL	Sets fuel remaining to a partial tank quantity (i.e., filler neck tab) where XX is an airframe specific partial fuel quantity (optional)
EIS	FUEL	Returns to top-level softkeys

FLIGHT PLANNING SOFTKEYS

ACTIVE FLIGHT PLAN PAGE SOFTKEYS



GPS Navigation	USE MAP	Activates the Map Pointer
Flight Planning	SEL APPR	Displays the Select Approach Window
Hazard Avoidance	INTERNAL	(Optional) Allows the pilot to select the internal GPS flight plan source.
Additional Features	EXTERNAL	(Optional) Allows the pilot to select the external GPS flight plan source.
Integrated Autopilot	EXIT	Exits the Flight Plan Pages

FLIGHT PLAN LIST PAGE SOFTKEYS



Annun/Alerts	ACTIVATE	Displays the 'Activate Flight Plan?' Window
Appendix	NEW	Displays the 'New Flight Plan' Window
Index	IMPORT	Displays the available flight plans to import from the SD Card
	EXPORT	Exports the selected flight plan
	EXIT	Exits the Flight Plan Pages

VERTICAL NAVIGATION (VNAV) PAGE SOFTKEYS



- CAPTURE Captures/cancels VNAV profile
- EXIT Exits the Flight Plan Pages

NEAREST PAGE SOFTKEYS

NEAREST AIRPORT PAGE SOFTKEYS



- PRIVATE Displays/removes the nearest private airports
- HELIPORT Displays/removes the nearest heliports
- EXIT Exits the Nearest Pages

Various softkeys revert to the previous level after 45 seconds of inactivity (e.g., PAN MAP, VOLUME, etc), other softkeys require manual de-selection (e.g., TERRAIN, WEATHER, PANEL, etc.).

1.8 ACCESSING THE INFORMATION (INFO) PAGE



NOTE: Refer to Section 10.2 for the INFO Page System Status Messages.



NOTE: A System Status Message and the word 'External' appearing next to the GPS Status indicates that the display connected to the GPS antenna is unavailable and the remaining display(s) are using the external GPS navigator for 2D GPS position data. In this case, the data collected from the external navigator is not considered a sufficient source of GPS data by the GSU 73 AHRS.

VIEWING GPS RECEIVER STATUS

Internal system checking is performed to ensure the GPS receiver is providing accurate data to the GDU(s).

The G3X GDUs can be configured to share GPS information (refer to the G3X Installation Manual for configuration information). For example, a GDU can be configured to share its GPS position, velocity, and time data with another GDU. If a GDU is not using its own GPS receiver, the name of the GDU providing the data (i.e., '3D GPS Location (PFD)' or '3D GPS Location (MFD)') is displayed following the GPS Status text on the INFO Page.

The GPS Status will display one of the following conditions:

- Autolocate—Receiver is looking for any satellite whose almanac has been collected, which can take up to 5 minutes
- Searching the Sky—Receiver is looking for satellites
- Acquiring Satellites—Receiver is looking for and collecting data from satellites visible at its last known or initialized location, but has not acquired a fix
- 2D GPS Location—At least three satellites have been acquired and a two-dimensional location fix has been calculated. "2D Differential" appears when you are receiving DGPS corrections in 2D mode
- 3D GPS Location—At least four satellites have been acquired and a three-dimensional fix has been calculated. "3D Differential" appears when you are receiving DGPS corrections in 3D mode
- Lost Satellite Reception—the receiver is no longer tracking enough satellites for a 2D or 3D fix

GPS Status, Position, and Data Fields (full-screen only) can be accessed from the Information Page.

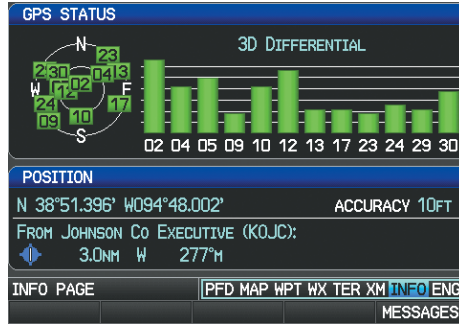

INFO Page (Split-Screen)

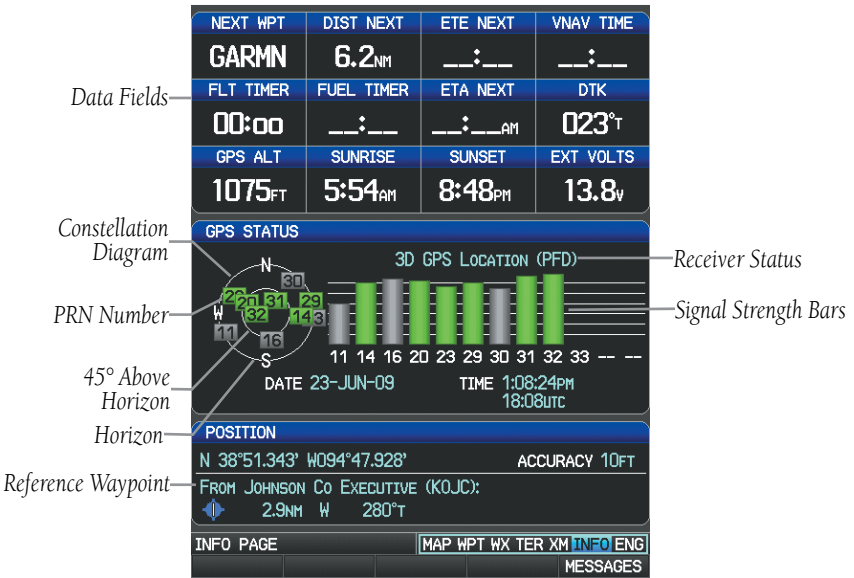

INFO Page (Full Screen)

Viewing GPS receiver status information:

- 1) If necessary press the **FMS** Joystick to begin interaction with the Navigation Bar.
- 2) Turn the **FMS** Joystick until the Info Page is selected.

NEW LOCATION

The 'New Location' menu option on the **INFO** Page is used when the GPS Receiver is having trouble finding the satellites it expects to be there.

Entering a new location:

- 1) From the **INFO** Page, while the unit is searching for satellites, press the **MENU** Key.
- 2) With 'New Location' menu option highlighted, press the **INFO** Key.
- 3) Move the **FMS** Joystick to highlight 'Use Map' or 'Use Identifier', and press the **ENT** Key.
- 4) After selecting your approximate position using the map pointer or entering an identifier, press the **ENT** Key.
- 5) The GPS Receiver will begin a new search based on the location entered.

ACQUIRING SATELLITES

When the receiver is in the process of acquiring enough satellite signals for navigation, the receiver uses satellite orbital data (collected continuously from the satellites) and last known position to determine the satellites that should be in view. "Acquiring Satellites" is indicated as the solution until a sufficient number of satellites have been acquired for computing a solution.

When the receiver is in the process of acquiring a 3D differential GPS solution, "3D GPS Location" is indicated as the solution until the 3D differential fix has finished acquisition.

SATELLITE INFORMATION

Satellites currently in view are shown at their respective positions on a satellite constellation diagram. The outer circle of the constellation diagram represents the horizon, the inner circle represents 45° above the horizon, and the center point shows the position directly overhead. Each satellite is represented by a square containing the Pseudo-Random Noise (PRN) number (i.e., satellite identification number).

The **INFO** Page can be helpful in troubleshooting weak (or missing) signal levels due to poor satellite coverage or installation problems. As the GPS receiver locks onto satellites, a signal strength bar is displayed for each satellite in view, with the

appropriate satellite PRN number (01-32 or 33-64 for WAAS) below each bar. The progress of satellite acquisition is shown in three stages, as indicated by signal bar appearance:

- No bar—Receiver is looking for the indicated satellite
- Gray bar—Receiver has collected the necessary data and the satellite signal can be used
- Green bar—Satellite is being used for the GPS solution

POSITION

The Position box on the **INFO** Page displays latitude, longitude, accuracy (in feet), reference waypoint, type, distance, direction, and bearing. The reference waypoint is designed to display the current position in relation to a prominent landmark. The pilot can change the reference waypoint 'Nearest Type' using the 'Change Nearest Type' page menu option. By default the Nearest Type is set to 'Automatic', which will display the nearest large airport, enroute VOR, or city (in that order).

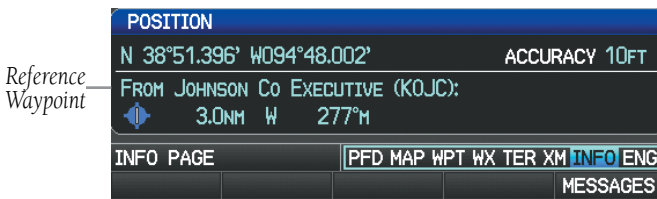

Position Information on INFO Page (Split-Screen)

Changing the Nearest Type:

- 1) From the Info Page press the **MENU** Key.
- 2) Turn or move the **FMS** Joystick to highlight 'Change Nearest Type' and press the **ENT** Key.
- 3) Move the **FMS** Joystick to highlight the desired nearest type option (Automatic, Airport, VOR, NDB, Intersection, City, Waypoint), and press the **ENT** Key.

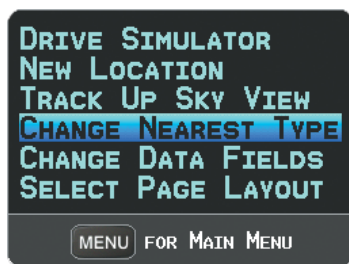

INFO Page Menu

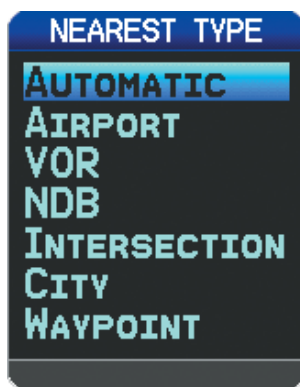

Nearest Type Menu

SHOW/HIDE LAT/LON ON THE INFO PAGE

If the Location Format selected on the Position Setup Page (refer to Appendix D, Map Datum and Location Formats) is not set to a Lat/Lon format, a new menu option 'Show/Hide Lat/Lon' will appear on the **INFO** Page. Selecting 'Show Lat/Lon' allows simultaneous display of the current position in both the selected location format as well as Lat/Lon format.

DATA FIELDS AND LAYOUT (FULL-SCREEN MFD)

The page layout and Data Fields of the full-screen Info Page can be independently configured by the user. Refer to the Annunciations and Alerts Section for a list of available Info Page Data Field options.

Changing the Info Page Data Fields (Full-Screen):

- 1) From the Info Page press the **MENU** Key.
- 2) Turn or move the **FMS** Joystick to highlight 'Change Data Fields' and press the **ENT** Key. The cursor is displayed on the first Data Field.
- 3) Move the **FMS** Joystick to highlight the desired Data Field.
- 4) Turn the **FMS** Joystick to access a list of available Data Field options.
- 5) Turn or move the **FMS** Joystick to highlight the desired Data Field, and press the **ENT** Key.



INFO Page Menu

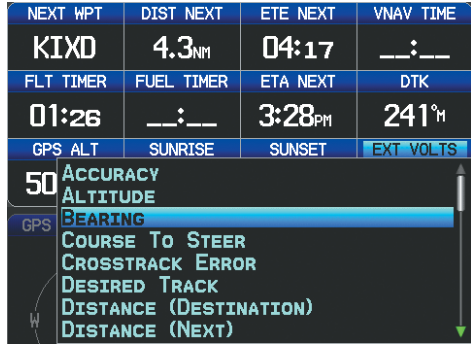

Data Field Options

Changing the Info Page layout:

- 1) From the Info Page press the **MENU** Key.
- 2) Turn or move the **FMS** Joystick to highlight 'Select Page Layout' and press the **ENT** Key.
- 3) Move the **FMS** Joystick to highlight the desired page layout option (1 Row, 2 Rows, 3 Rows), and press the **ENT** Key.

1.9 SYSTEM SETTINGS

The System Setup option in the Main Menu allows management of the following system parameters:

- Transponder (optional)
- Data Bar Fields
- Display
- Sound
- Units
- Date & Time
- Position
- Alarms

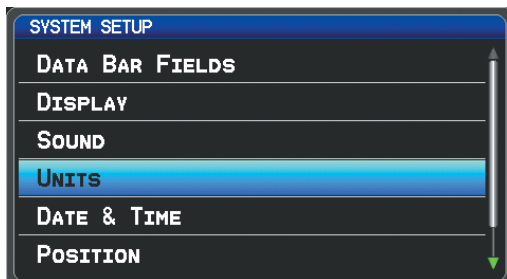

System Setup Menu (Split-Screen)

- System Overview
- Flight Instruments
- EIS
- CNS Interface
- GPS Navigation
- Flight Planning
- Hazard Avoidance
- Additional Features
- Integrated Autopilot
- Annun/Alerts
- Appendix
- Index

Restoring system setting defaults:

- 1) Press the **MENU** Key twice to display the Main Menu.
- 2) Turn or move the **FMS** Joystick to highlight 'System Setup...' and press the **ENT** Key.
- 3) Turn or move the **FMS** Joystick to highlight the desired menu option (Data Bar Fields, Display, Date & Time, Position, or Alarms), and press the **ENT** Key.
- 4) Press the **MENU** Key.
- 5) With 'Restore Default' highlighted press the **ENT** Key.

TRANSPONDER

If configured to 'Set By Pilot' in configuration mode, (refer to the Installation Manual for configuration information) the pilot can change the Flight ID and enable/disable ADS-B Transmit from the Transponder Setup Page.

Setting the Flight ID:

- 1) Press the **MENU** Key twice to display the Main Menu.
- 2) Turn or move the **FMS** Joystick to highlight 'System Setup...' and press the **ENT** Key.
- 3) Turn or move the **FMS** Joystick to highlight 'Transponder', and press the **ENT** Key.
- 4) Move the **FMS** Joystick to highlight the 'Flight ID' Field.
- 5) Use the **FMS** Joystick to enter the desired Flight ID and press the **ENT** Key.

Enabling/disabling ADS-B Transmit:

- 1) Press the **MENU** Key twice to display the Main Menu.
- 2) Turn or move the **FMS** Joystick to highlight 'System Setup...' and press the **ENT** Key.
- 3) Turn or move the **FMS** Joystick to highlight 'Transponder', and press the **ENT** Key.
- 4) Move the **FMS** Joystick to highlight the 'ADS-B Transmit' Field.
- 5) Turn the **FMS** Joystick to highlight 'Enabled' or 'Disabled'.
- 6) Press the **FMS** Joystick, the **CLR** Key, the **EXIT** Softkey or the **MENU** Key to return to the previous page.

DATA BAR FIELDS

The content of the four data bar fields are independently configured by the user. The full-screen MFD and PFD Data Bar Fields are independently configured from each display.



Data Bar (Split-Screen)

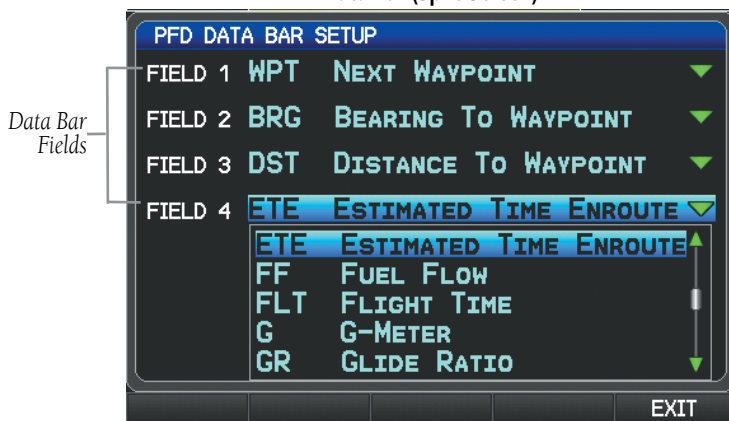

Data Bar Setup Page (Split-Screen)

By default, the split-screen PFD Page data bar fields and the full-screen PFD data bar fields are set to display Next Waypoint (WPT), Bearing to Waypoint (BRG), Distance to Waypoint (DIS), and Estimated Time Enroute (ETE). The full-screen MFD data bar fields default to Ground Speed (GS), Ground Track (TRK), Minimum Safe Altitude (MSA), and Vertical Speed Required (VSR). These four data fields can be changed to display any of the Data Bar Field Options. Refer to the Annunciations and Alerts Section for a list of available Data Bar Field options.

Changing the information shown in the data bar fields:

- 1) Press the **MENU** Key twice to display the Main Menu.
- 2) Turn or move the **FMS** Joystick to highlight 'System Setup...' and press the **ENT** Key.
- 3) With 'Data Bar Fields' highlighted, press the **ENT** Key.
- 4) Move the **FMS** Joystick to highlight the desired 'Field'.

- 5) Turn the **FMS** Joystick to access the list of options, then turn or move the **FMS** Joystick to highlight the desired option and press the **ENT** Key.
- 6) To restore defaults, press the **MENU** Key. With 'Restore Default' highlighted, press the **ENT** Key.

ADDITIONAL DATA BAR INFORMATION

If more than one GPS Navigator is configured, the active GPS Navigator is displayed in magenta in the upper left corner of the Data Bar.

*Data Fields
Using External
Navigator 1
(GPS1)*



Data Bar (GPS1)

'INT' is displayed in cyan and 'GPS' is displayed in magenta in the upper left corner of the Data Bar when one or more GPS Navigators are configured and the pilot elects to use the internal GPS navigation source.

*Using Internal GPS
Flight Plan*



Internal Flight Plan Indication

'REV' is displayed in yellow and 'GPS' is displayed in magenta in the upper left corner of the Data Bar when all external GPS navigation sources fail.

*External
GPS Failure.
Reverted to
Internal GPS*



External GPS Navigation Failure

DISPLAY

The Backlight Intensity (display brightness) can be set to 'Auto' or 'Manual'. 'Auto' sets the Backlight Intensity based on the aircraft's instrument lighting bus voltage. With 'Manual' selected, the pilot can manually adjust the desired backlight intensity (1-10). After each power cycle the Backlight Intensity is set to the default, which is configurable. Refer to the G3X Installation Manual for more information.

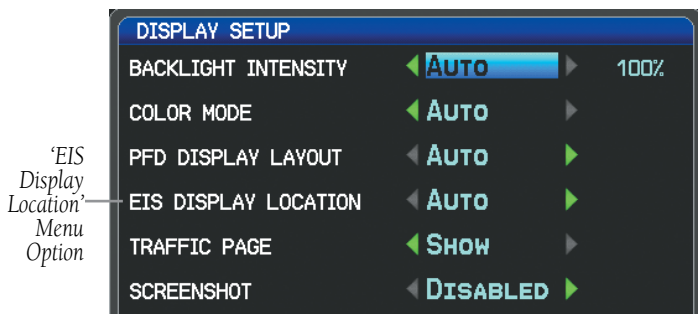

Display Setup Page

Adjusting backlight intensity:

- 1) Press the **MENU** Key twice to display the Main Menu.
- 2) Turn or move the **FMS** Joystick to highlight 'System Setup...' and press the **ENT** Key.
- 3) Turn or move the **FMS** Joystick to highlight 'Display', and press the **ENT** Key.
- 4) Turn the **FMS** Joystick to highlight 'Auto'.

Or:

- a) Turn the **FMS** Joystick to highlight 'Manual'.
 - b) Move the **FMS** Joystick to highlight the desired Backlight Intensity (1-10).
- 5) Press the **FMS** Joystick, the **CLR** Key, the **EXIT** Softkey or the **MENU** Key to return to the previous page.

COLOR MODE

The Color Mode setting is used to adjust the color brightness used on the map and synthetic vision display for day or night use.

Adjusting the color mode:

- 1) Press the **MENU** Key twice to display the Main Menu.
- 2) Turn or move the **FMS** Joystick to highlight 'System Setup...' and press the **ENT** Key.
- 3) Turn or move the **FMS** Joystick to highlight 'Display', and press the **ENT** Key.
- 4) Move the **FMS** Joystick to highlight the Color Mode field.
- 5) Turn the **FMS** Joystick to highlight 'Day', 'Night', or 'Auto'.
- 6) Press the **FMS** Joystick, the **CLR** Key, the **EXIT** Softkey or the **MENU** Key to return to the previous page.

Setting the Startup Page

- 1) Press the **MENU** Key twice to display the Main Menu.
- 2) Turn or move the **FMS** Joystick to highlight 'System Setup...' and press the **ENT** Key.
- 3) Turn or move the **FMS** Joystick to highlight 'Display', and press the **ENT** Key.
- 4) Move the **FMS** Joystick to highlight the Startup Page field.
- 5) Turn the **FMS** Joystick to highlight the desired Startup Page.

EIS DISPLAY LOCATION (OPTIONAL)

In Configuration Mode the 'EIS Display Location' setting can be set to one of the following:

- **AUTO**—Displays the EIS Strip on the MFD, or on the PFD1 (and PFD2 if applicable) if the MFD is not displayed.
- **PFD**—Always displays the EIS Strip on PFD1 (and PFD2 if applicable).
- **User Selected**—Enables the user to choose between 'AUTO' and 'PFD' via the Display Setup menu.

For more information on how to enable the 'EIS Display Location' setting in Configuration Mode refer to the G3X Installation Manual.

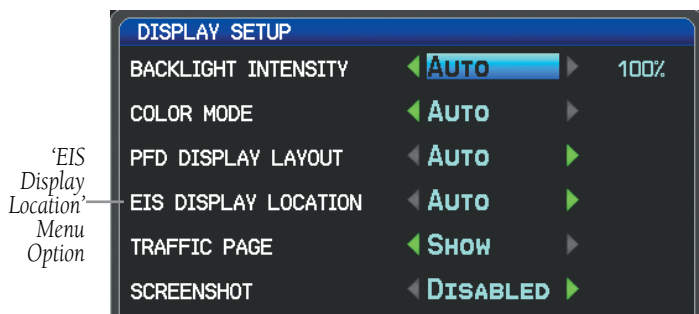

Display Setup Page

Changing the EIS display location:

- 1) Press the **MENU** Key twice to display the Main Menu.
- 2) Turn or move the **FMS** Joystick to highlight 'System Setup...' and press the **ENT** Key.
- 3) Turn or move the **FMS** Joystick to highlight 'Display', and press the **ENT** Key.
- 4) Move the **FMS** Joystick to highlight the EIS Display Location field.
- 5) Turn the **FMS** Joystick to highlight 'Auto' or 'PFD'.
- 6) Press the **FMS** Joystick, the **CLR** Key, the **EXIT** Softkey or the **MENU** Key to return to the previous page.

SCREENSHOT

Enabling/disabling screenshots:

- 1) Press the **MENU** Key twice to display the Main Menu.
- 2) Turn or move the **FMS** Joystick to highlight 'System Setup...' and press the **ENT** Key.
- 3) Turn or move the **FMS** Joystick to highlight 'Display', and press the **ENT** Key.
- 4) Move the **FMS** Joystick to highlight the Screenshot field.
- 5) Turn the **FMS** Joystick to highlight 'Enabled' or 'Disabled'.

Saving a Screenshot:

- 1) With screenshots enabled (see above), navigate to the desired screen.
- 2) Press and hold the **MENU** Key until the screen flashes indicating the screenshot was saved to the SD Card.

SOUND

The pilot can manually adjust the desired XM Volume (0-10), Message Volume (Off or 1-10), Altitude Alert (On/Off), and Minimums Alert (On/Off). Message Volume controls the banner message tones (e.g., "Approaching Airspace" or "Arriving at Waypoint"). Alert Volume (e.g., terrain, traffic, autopilot, etc.) is set in configuration mode (refer to the G3X Installation Manual for more information).

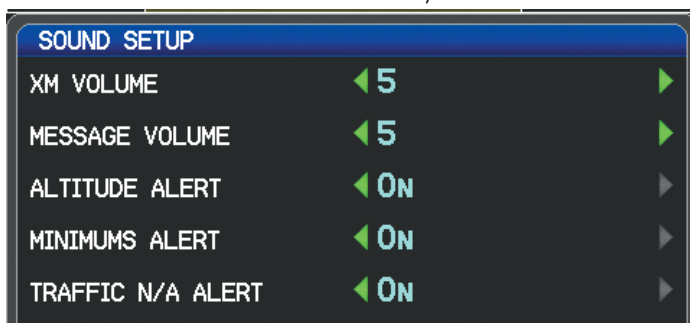

Sound Setup Page (Split-Screen)

Adjusting XM and/or Message Volume:

- 1) Press the **MENU** Key twice to display the Main Menu.
- 2) Turn or move the **FMS** Joystick to highlight 'System Setup...' and press the **ENT** Key.
- 3) Turn or move the **FMS** Joystick to highlight 'Sound', and press the **ENT** Key.
- 4) Move the **FMS** Joystick to highlight the desired field (XM Volume or Message Volume), and select the desired volume by turning the **FMS** Joystick.
- 5) Press the **FMS** Joystick, the **CLR** Key, the **EXIT** Softkey or the **MENU** Key to return to the previous page.

Turning the altitude alert tone on/off:



NOTE: Refer to the *Flight Instruments* section for more information regarding the *Altitude Alert Tone*.

- 1) Press the **MENU** Key twice to display the Main Menu.
- 2) Turn or move the **FMS** Joystick to highlight 'System Setup...' and press the **ENT** Key.

- 3) Turn or move the **FMS** Joystick to highlight 'Sound', and press the **ENT** Key.
- 4) Move the **FMS** Joystick to highlight the Altitude Alert field, and select 'On/Off' by turning the **FMS** Joystick.

Turning the minimums alert tone on/off:



NOTE: Refer to the Flight Instruments section for more information regarding the Minimums Alert Tone.

- 1) Press the **MENU** Key twice to display the Main Menu.
- 2) Turn or move the **FMS** Joystick to highlight 'System Setup...' and press the **ENT** Key.
- 3) Turn or move the **FMS** Joystick to highlight 'Sound', and press the **ENT** Key.
- 4) Move the **FMS** Joystick to highlight the Minimums Alert field, and select 'On/Off' by turning the **FMS** Joystick.

Enable/disable the 'Traffic Not Available' audio alert:



NOTE: Refer to the Hazard Avoidance section for more information regarding the 'Traffic Not Available' audio alert.

- 1) Press the **MENU** Key twice to display the Main Menu.
- 2) Turn or move the **FMS** Joystick to highlight 'System Setup...' and press the **ENT** Key.
- 3) Turn or move the **FMS** Joystick to highlight 'Sound', and press the **ENT** Key.
- 4) Move the **FMS** Joystick to highlight the Traffic N/A Alert field.
- 5) Turn the **FMS** Joystick to highlight 'On' or 'Off'.
- 6) Press the **FMS** Joystick, the **CLR** Key, the **EXIT** Softkey or the **MENU** Key to return to the previous page.

UNITS

Changing unit settings:

- 1) Press the **MENU** Key twice to display the Main Menu.
- 2) Turn or move the **FMS** Joystick to highlight 'System Setup...' and press the **ENT** Key.
- 3) Turn or move the **FMS** Joystick to highlight 'Units' and press the **ENT** Key.

- 4) Move the **FMS** Joystick to highlight the desired field, and select the desired unit by turning the **FMS** Joystick.
- 5) Press the **FMS** Joystick, the **CLR** Key, the **EXIT** Softkey or the **MENU** Key to return to the previous page.

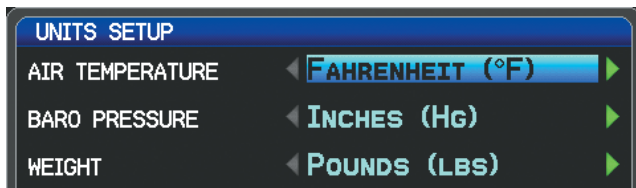

Units Setup Page (Split-Screen)

DATE & TIME

Changing date & time settings:

- 1) Press the **MENU** Key twice to display the Main Menu.
- 2) Turn or move the **FMS** Joystick to highlight 'System Setup...' and press the **ENT** Key.
- 3) Turn or move the **FMS** Joystick to highlight 'Date & Time' and press the **ENT** Key.
- 4) Move the **FMS** Joystick to highlight the desired field, and select the desired option by turning the **FMS** Joystick.
- 5) Press the **FMS** Joystick, the **CLR** Key, the **EXIT** Softkey or the **MENU** Key to return to the previous page.

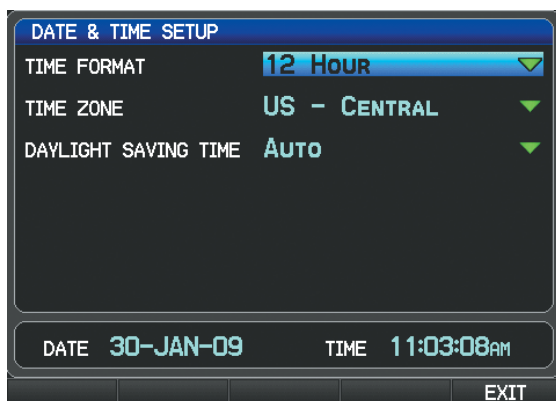

Date & Time Setup Page (Split-Screen)

POSITION



NOTE: Refer to Appendix D for more information on Map Datums and Location Formats.



NOTE: 'Heading' and 'Mag. Variation' settings always display magnetic heading and have no effect on the HSI or Heading Tape since they are driven by the magnetometer data.

Changing position settings:

- 1) Press the **MENU** Key twice to display the Main Menu.
- 2) Turn or move the **FMS** Joystick to highlight 'System Setup...' and press the **ENT** Key.
- 3) Turn or move the **FMS** Joystick to highlight 'Position' and press the **ENT** Key.
- 4) Move the **FMS** Joystick to highlight the desired field, and select the desired option by turning the **FMS** Joystick.
- 5) Press the **FMS** Joystick, the **CLR** Key, the **EXIT** Softkey or the **MENU** Key to remove the menu.

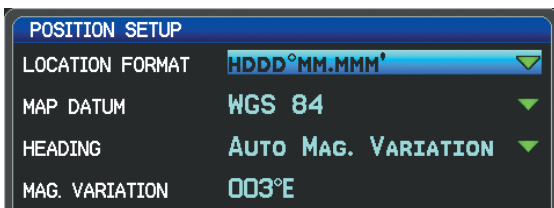

Position Setup Page (Split-Screen)

ALARMS

The Alarms Page allows the pilot to turn airspace alarms On/Off, set an Altitude Buffer, Arrival Alarm, Next Waypoint Alarm, Proximity Alarm, and Fuel Tank Reminder Alarm.

Changing alarm settings:

- 1) Press the **MENU** Key twice to display the Main Menu.
- 2) Turn or move the **FMS** Joystick to highlight 'System Setup...', and press the **ENT** Key.
- 3) Turn or move the **FMS** Joystick to highlight 'Alarms' and press the **ENT** Key. Pressing the **AIRSPACE** Softkey displays the Airspace Alarms Page. Pressing the **NAV** Softkey displays the Arrival Alarm, Next Waypoint Alarm, Proximity Alarm, and Fuel Tank Reminder (Split-Screen Only).
- 4) Move the **FMS** Joystick to highlight the desired field, and select the desired option by turning the **FMS** Joystick.
- 5) Press the **FMS** Joystick, the **CLR** Key, the **EXIT** Softkey or the **MENU** Key to remove the menu.

FUEL TANK REMINDER ALARM AND FUEL TANK TIMER

The 'Fuel Tank' Reminder alarm is used as a reminder to switch fuel tanks. The reminder message repeats at the specified interval after the beginning of each trip. The Fuel Tank Timer (FUEL TIMER) data field option is the elapsed time since the 'Fuel Tank' Reminder alarm was last issued (HH:MM).



Airspace Alarms (Split-Screen)



Nav Alarms (Split-Screen)

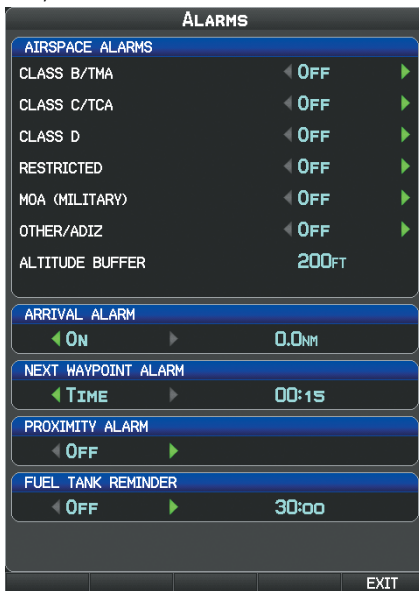

Alarms (Full-Screen MFD)

SETTING AIRPORT CRITERIA

The Page Menu on the Nearest Airports Page allows the pilot to filter out airports that do not meet a defined criteria. Specific surface types and runway lengths can be defined, as well as the option to include private airports and/or heliports.

- **Runway Surface:** Allows the pilot to set criteria for the type of surface on the runway.
 - Any: Shows any runway, regardless of surface type, including water landing facilities.
 - Hard Only: Shows only runways with a concrete, asphalt, or similar sealed surface.
 - Hard or Soft: Shows all runways except water landing facilities.
 - Water Only: Shows only water landing facilities.
- **Minimum Runway Length:** Allows the pilot to enter a specific length for the shortest runway allowed.
- **Include Private Airports:** Allows the pilot include Private Airports in the search criteria.

Entering airport criteria:

- 1) Press the **NRST** Key.
- 2) Turn the **FMS** Joystick to select the Nearest Airports Page.
- 3) Press the **MENU** Key to display the Page Menu.
- 4) Turn or move the **FMS** Joystick to select 'Set Airport Criteria', and then press the **ENT** Key. The Airport Criteria Window appears with the current settings.



Nearest Airports Page Menu

- 5) Move the **FMS** Joystick to highlight the desired field and turn the **FMS** Joystick to select the desired option from the menu. Press the **ENT** Key if necessary to highlight the next field.

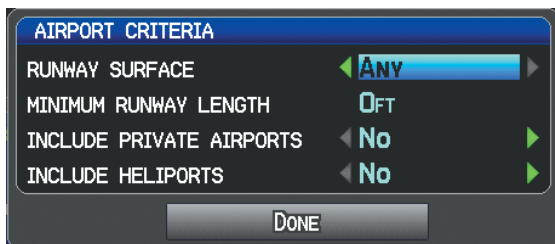

Airport Criteria Window

- 6) With 'Done' highlighted press the **ENT** Key.

Restoring airport criteria defaults:

- 1) Press the **NRST** Key.
- 2) Turn the **FMS** Joystick to select the Nearest Airports Page.
- 3) Press the **MENU** Key to display the Page Menu.
- 4) Turn or move the **FMS** Joystick to select 'Set Airport Criteria', and then press the **ENT** Key. A window appears with the current settings.
- 5) Press the **MENU** Key.
- 6) With 'Restore Default' highlighted press the **ENT** Key.

SECTION 2 FLIGHT INSTRUMENTS

2.1 FLIGHT INSTRUMENTS



NOTE: Refer to Section 9 for Integrated Autopilot information.

Increased situational awareness is provided by replacing the traditional instruments on the panel with an easy-to-scan Primary Flight Display (PFD) that features a horizon, airspeed, attitude, altitude, vertical speed, heading, and course deviation information.

The split-screen display has a PFD that occupies the top portion of the display at all times. Select the PFD Page in order to view the Horizontal Situation Indicator (HSI), Outside Air Temperature (OAT), System Time, selected course, and selected heading.



PFD Page (Split-Screen)



PFD (Full Screen)

Selecting the PFD Page (split-screen):

- 1) Press the **FMS** Joystick if necessary to begin interaction with the Page Navigation Bar.
- 2) Turn the **FMS** Joystick to select the **PFD** Page.

The following flight instruments and supplemental flight data are displayed on the PFD and/or PFD Page (split-screen).

- System Overview
- Flight Instruments
- EIS
- CNS Interface
- GPS Navigation
- Flight Planning
- Hazard Avoidance
- Additional Features
- Integrated Autopilot
- Annun/Alerts
- Appendix
- Index



- | | |
|--|--|
| ① Heading Strip | ②② Transponder Code |
| ② Ground Speed (GS) | ②③ Transponder Mode |
| ③ Airspeed Indicator | ②④ System Time |
| ④ Attitude Indicator | ②⑤ Bearing 2 Information Window |
| ⑤ Pathways | ②⑥ Bearing Pointer |
| ⑥ Flight Path Marker | ②⑦ Selected Heading Bug (HSI) |
| ⑦ Aircraft Symbol | ②⑧ Selected Course |
| ⑧ Vspeed Reference | ②⑨ Altimeter Barometric Setting |
| ⑨ Pitch Scale | ③⑩ Current Vertical Speed |
| ⑩ Slip/Skid Indicator | ③① VNAV / Vertical Deviation Indicator |
| ⑪ True Airspeed (TAS) | ③② Altimeter |
| ⑫ Lateral Deviation Scale & Course Deviation | ③③ Vertical Speed Indicator (VSI) |
| ⑬ Selected Heading | ③④ Reference Altitude |
| ⑭ Current Track Indicator | ③⑤ Selected Altitude Bug |
| ⑮ Wind Data (Speed & Direction) | ③⑥ Turn Rate Indicator |
| ⑯ Course Deviation Indicator (CDI) | ③⑦ Zero Pitch Line |
| ⑰ Trim Indicator | ③⑧ Current Track Indicator (Heading Strip) |
| ⑱ Flap Indicator | ③⑨ Current Heading |
| ⑲ Navigation Source | ④⑩ Selected Heading Bug |
| ⑳ Bearing 1 Information Window | ④① Turn Rate Indicator |
| ㉑ Outside Air Temperature (OAT) | ④② Autopilot Status Box |

AIRSPEED INDICATOR



NOTE: The G3X Vspeed Reference values and Flaps Tick Mark values depend upon the aircraft's specific system configuration and may vary from the examples discussed in this section.

The Airspeed Indicator displays airspeed on a rolling number gauge using a moving tape. The true airspeed (TAS) is displayed in knots below the Airspeed Indicator. The numeric labels and major tick marks on the moving tape are marked at intervals of 10 knots. Speed indication starts at 30 knots, with 60 knots of airspeed viewable at any time. The actual airspeed is displayed inside the black pointer. The pointer remains black until reaching never-exceed speed (V_{NE}), at which point it turns red.

A color-coded (red, white, green, yellow, and red/white "barber pole") speed range strip is located on the moving tape. The colors denote flaps operating range, normal operating range, caution range, and never-exceed speed (V_{NE}). A red range is also present for low speed awareness.

The Airspeed Trend Vector is a vertical, magenta line, extending up or down on the airspeed scale, shown to the right of the color-coded speed range strip. The end of the trend vector corresponds to the predicted airspeed in 6 seconds if the current rate of acceleration is maintained. If the trend vector crosses V_{NE} , the text of the actual airspeed readout changes to yellow. The trend vector is absent if the speed remains constant or if any data needed to calculate airspeed is not available due to a system failure.

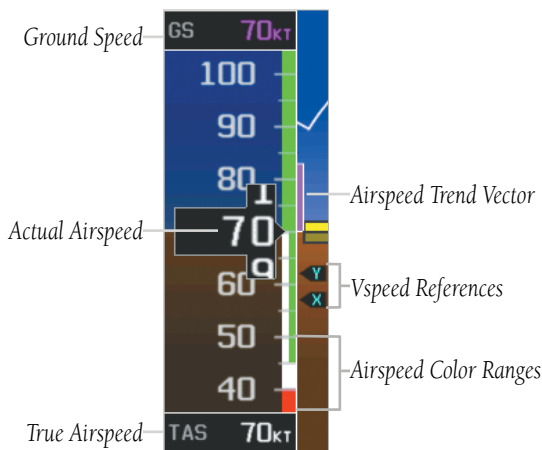

Airspeed Indicator

- System Overview
- Flight Instruments
- EIS
- CNS Interface
- GPS Navigation
- Flight Planning
- Hazard Avoidance
- Additional Features
- Integrated Autopilot
- Annun/Alerts
- Appendix
- Index

V_{NE} ADJUSTED FOR TRUE AIRSPEED (OPTIONAL)

The airspeed indicator can optionally be configured to display V_{ne} adjusted for true airspeed. This is useful in aircraft where true airspeed (instead of indicated airspeed) must be kept below V_{ne}. Using TAS instead of IAS causes V_{ne} to be reduced at high altitudes. If configured, the G3X can calculate and display this reduction in V_{ne}. A solid red band is used between the TAS adjusted V_{ne} and the actual indicated value for V_{ne}.

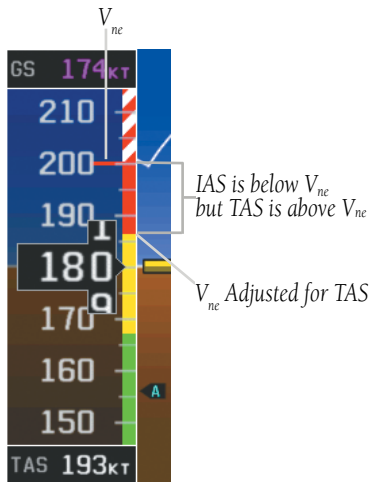

V_{ne} Adjusted for True Airspeed

VSPEED REFERENCE

Vspeed references including V_{ne'}, V_{no'}, V_{so'}, V_{s1'}, V_{fe'}, V_{a'}, V_{x'}, V_{y'}, V_{yse'}, V_{g'}, V_{r'}, as well as several custom Vspeeds can be configured from the Aircraft Configuration Page, refer to the G3X Installation Manual for more information.

When airspeed is present, the Vspeeds configured are also displayed at their respective locations to the right of the airspeed scale, otherwise the Vspeeds are displayed at the bottom of the airspeed indicator.

- System Overview
- Flight Instruments
- EIS
- CNS Interface
- GPS Navigation
- Flight Planning
- Hazard Avoidance
- Additional Features
- Integrated Autopilot
- Annun/Alerts
- Appendix
- Index

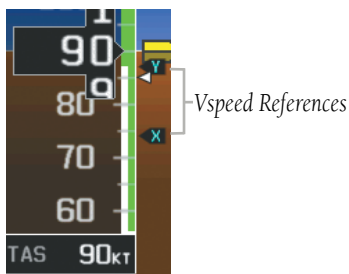

Vspeed References (with airspeed)

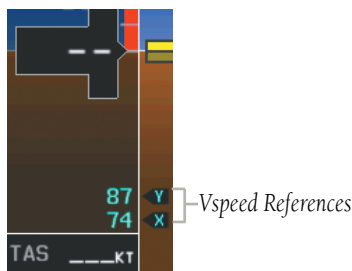

Vspeed References (without airspeed)

ATTITUDE INDICATOR

Attitude information is displayed over a virtual blue sky and brown ground with a white horizon line. The Attitude Indicator displays the pitch (indicated by the yellow symbolic aircraft on the pitch scale), roll, and slip/skid information.

The horizon line is part of the pitch scale. Pitch markings occur at 2.5° intervals through all pitch ranges.

The inverted white triangle indicates zero on the roll scale. Major tick marks at 30° and 60° and minor tick marks at 10°, 20°, and 45° are shown to the left and right of the zero. Angle of bank is indicated by the position of the pointer on the roll scale.

Slip/skid is indicated by the location of the ball.

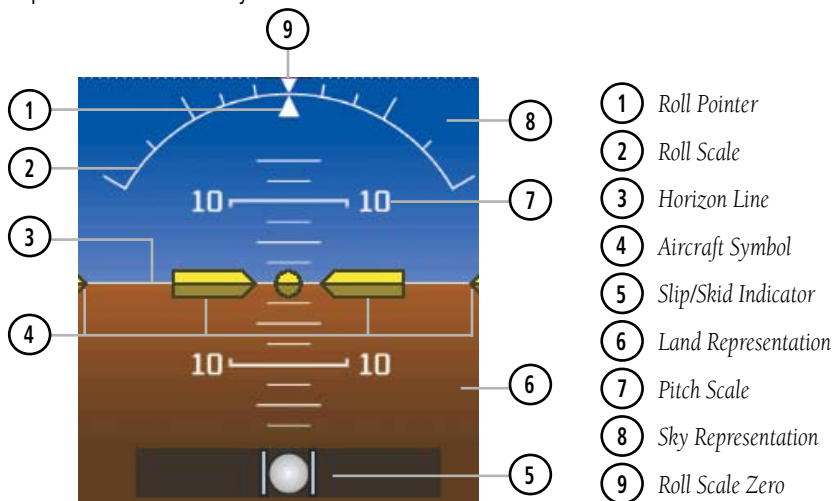

Attitude Indicator

ALTIMETER

The Altimeter displays 400 feet of barometric altitude values at a time on a rolling number gauge using a moving tape. Numeric labels and major tick marks are shown at intervals of 100 feet. Minor tick marks are at intervals of 20 feet. The current altitude is displayed in the black pointer.

The Selected Altitude is displayed above the Altimeter in the box indicated by a selection bug symbol. A bug corresponding to this altitude is shown on the tape; if the Selected Altitude exceeds the range shown on the tape, the bug appears at the corresponding edge of the tape.

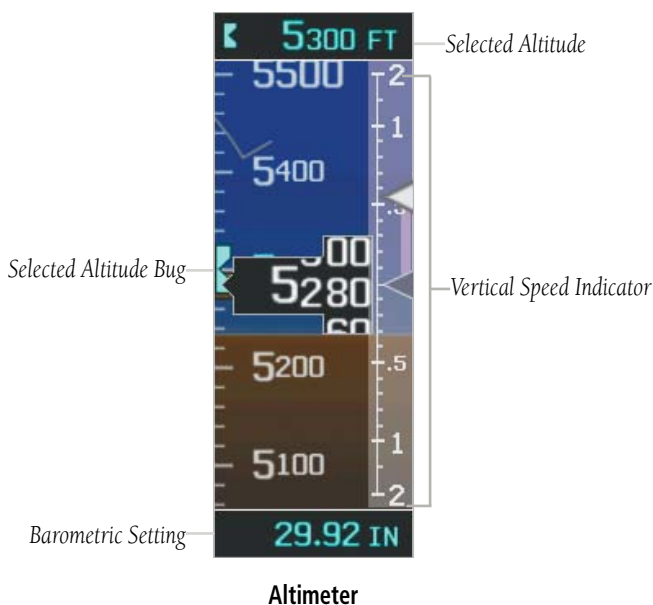

Setting the selected altitude:

- 1) From the PFD Page (one display) or PFD (two display), press the **ALT** (or **ALT/PTCH** if the Integrated Autopilot is configured) Softkey.
- 2) Turn the **FMS** Joystick to set the Selected Altitude in 100-ft increments.

Syncing to the current altitude:

- 1) From the PFD Page (one display) or PFD (two display), press the **ALT** (or **ALT/PTCH** if the Integrated Autopilot is configured) Softkey.
- 2) Press and hold the **FMS** Joystick. The current altitude is now displayed as the Selected Altitude.

BAROMETRIC PRESSURE

The barometric pressure setting is displayed below the Altimeter in inches of mercury (in Hg) or hectopascals (hPa) when metric units are selected.

Selecting the altimeter barometric pressure setting:

- 1) From the PFD Page (one display) or PFD (two display), press the **BARO** Softkey to highlight the barometric pressure setting.
- 2) Turn the **FMS** Joystick to display the desired barometric pressure setting and press the **ENT** Key.

Syncing to the local barometric pressure setting:

- 1) From the PFD Page (one display) or PFD (two display), press the **BARO** Softkey.
- 2) While stationary on the ground, press and hold the **FMS** Joystick.
- 3) Verify indicated altitude matches local field elevation.

BAROMETRIC MINIMUM ALERT

For altitude awareness, a barometric Minimum Descent Altitude (MDA) or Decision Height (DH) can be set by the user and is reset when the power is cycled. Once the user-defined altitude is within the range of the tape, a cyan bug appears at the reference altitude on the Altimeter. Once the aircraft reaches the user-defined MDA/DH, the bug and text turn yellow and the aural alert, "Minimums. Minimums", is heard.

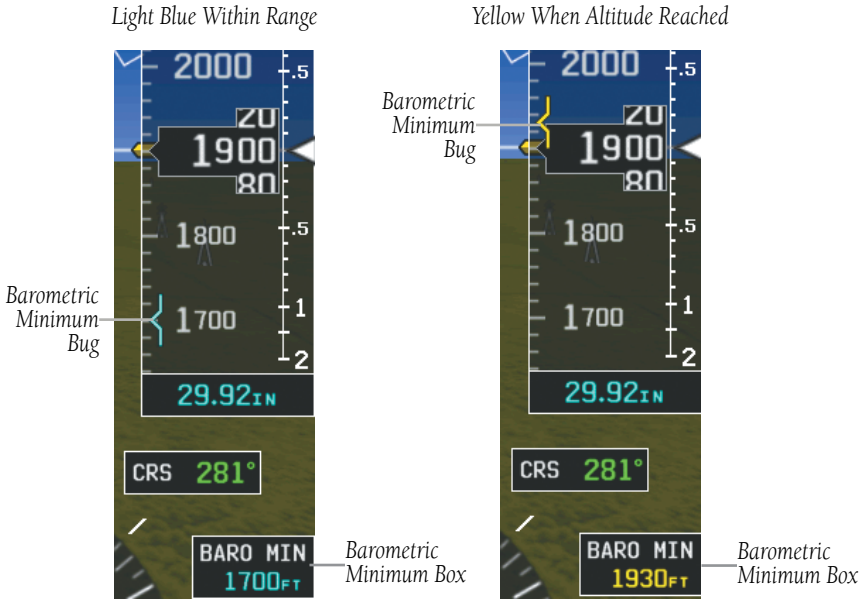

Barometric Minimum Visual Annunciations

Setting the barometric minimum alert bug:

- 1) From the PFD Page (one display) or PFD (two display), press the **BARO** Softkey.
- 2) Press the **MINIMUMS** Softkey.
- 3) Turn the **FMS** Joystick to display the desired alert altitude and press the **ENT** Key.

Canceling the barometric minimum alert bug:

- 1) From the PFD Page (one display) or PFD (two display), press the **BARO** Softkey.
- 2) Press the **MINIMUMS** Softkey.
- 3) Press the **CLR** Key.

Turning the minimums alert tone on/off:

- 1) Press the **MENU** Key twice to display the Main Menu.
- 2) Turn or move the **FMS** Joystick to highlight 'System Setup...' and press the **ENT** Key.

- 3) Turn or move the **FMS** Joystick to highlight 'Sound', and press the **ENT** Key.
- 4) Move the **FMS** Joystick to highlight the Minimums Alert field, and select 'On/Off' by turning the **FMS** Joystick.

ALTITUDE ALERTING

The Altitude Alerting function provides the pilot with visual and aural alerts when approaching the Selected Altitude. Whenever the Selected Altitude is changed, the Altitude Alerter is reset. The following will occur when approaching the Selected Altitude:

- Passing within 1000 feet of the Selected Altitude, the Selected Altitude (shown above the Altimeter) flashes for 5 seconds and an aural tone is generated.
- When the aircraft passes within 200 ft of the Selected Altitude, the Selected Altitude flashes for 5 seconds and an aural tone is generated to indicate that the aircraft is approaching the selected altitude.
- After reaching the Selected Altitude, if the pilot flies outside the deviation band (± 200 Feet of the Selected Altitude), the Selected Altitude changes to yellow text on a black background, flashes for 5 seconds, and an aural tone is generated.



Altitude Alerting Visual Annunciation

Turning the altitude alert tone on/off:

- 1) Press the **MENU** Key twice to display the Main Menu.
- 2) Turn or move the **FMS** Joystick to highlight 'System Setup...' and press the **ENT** Key.
- 3) Turn or move the **FMS** Joystick to highlight 'Sound', and press the **ENT** Key.
- 4) Move the **FMS** Joystick to highlight the Altitude Alert field, and select 'On/Off' by turning the **FMS** Joystick.

VERTICAL SPEED INDICATOR (VSI)

The Vertical Speed Indicator displays the aircraft vertical speed using a non-moving tape labeled at 500, 1000 and 2000 fpm with minor tick marks every 100 feet up to 1000 fpm. The current vertical speed is displayed using a white arrow along the tape.

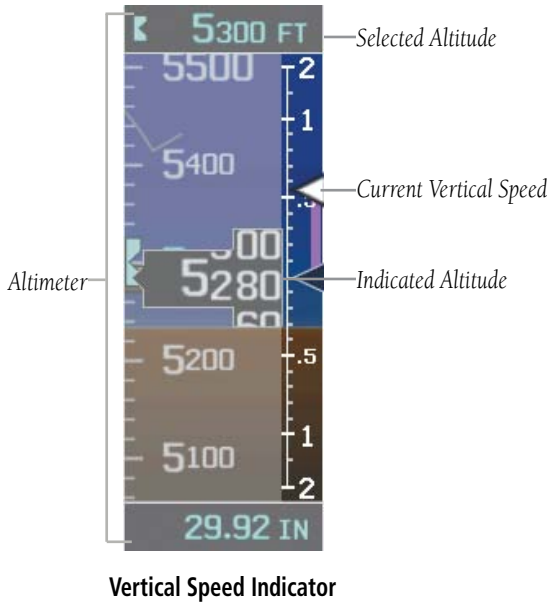

VERTICAL DEVIATION INDICATOR AND VNAV INDICATOR



NOTE: An external navigator (i.e., SL30 Nav/Comm Transceiver and/or the GTN or GNS Series Units) must be configured to receive glideslope and/or glidepath vertical deviation indications.

GLIDESLOPE - ILS SOURCE

The Vertical Deviation (Glideslope) Indicator (VDI) appears to the left of the altimeter whenever an ILS frequency is tuned in the active NAV field of an external navigator. A green diamond acts as the VDI Indicator, like a glideslope needle on a conventional indicator. If a localizer frequency is tuned and there is no glideslope signal, "NO GS" is annunciated.

VNAV INDICATOR

An external navigation source is not required to receive VNAV indications. When the VNAV profile is defined, the pilot is informed of the progress by message alerts. A magenta chevron (VNAV Indicator) to the left of the altimeter on the Vertical Deviation Scale shows the VNAV profile, and a magenta chevron (Required Vertical Speed Indicator (RVSI)) on the Vertical Speed Indicator indicates the required vertical speed to reach the target altitude. Refer to section 2.3 for more information.

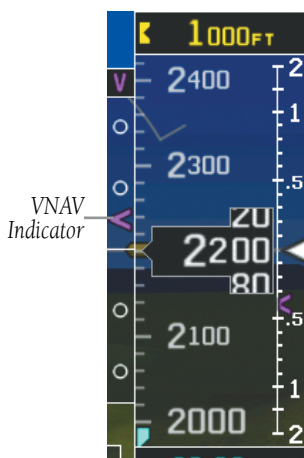

VNAV Indicator

HORIZONTAL SITUATION INDICATOR (HSI)

The Horizontal Situation Indicator (HSI) displays a rotating compass card in a heading-up orientation at the bottom of the page. Letters indicate the cardinal points and numeric labels occur every 30°. Major tick marks are at 10° intervals and minor tick marks at 5° intervals. The current track is represented on the HSI by a magenta triangle and dashed line. The HSI also presents course deviation, bearing, and navigation source information.

The Selected Heading is shown to the left of the HSI. The light blue bug on the compass rose corresponds to the Selected Heading.

Adjusting the selected heading:

- 1) From the PFD Page (one display) or PFD (two display), press the **HDG** (or **HDG/ROLL** if the Integrated Autopilot is configured) Softkey (if necessary). The Heading Box is highlighted.

- Turn the **FMS** Joystick to select the desired heading, and press the **FMS** Joystick. The Selected Course is shown to the right of the HSI.

Syncing to the current heading:

- From the PFD Page (one display) or PFD (two display), press the **HDG** (or **HDG/ROLL** if the Integrated Autopilot is configured) Softkey (if necessary).
- Press and hold the **FMS** Joystick. The current heading is now displayed as the Selected Heading.



- | | |
|------------------------------------|--|
| ① Lubber Line | ⑦ To/From Indicator |
| ② Current Track Indicator | ⑧ Aircraft Symbol |
| ③ Course Pointer | ⑨ Lateral Deviation Scales |
| ④ Navigation Source | ⑩ Selected Heading Bug |
| ⑤ Course Deviation Indicator (CDI) | ⑪ Course Deviation & To/From Indicator |
| ⑥ Rotating Compass Rose | |

Horizontal Situation Indicator (HSI)

HSI ANNUNCIATIONS



NOTE: Some or all HSI annunciations may appear in the four quadrants of the G3X HSI depending on the external navigator(s) configured (i.e., SL30 Nav/Comm Transceiver and/or the GTN or GNS Series Units).

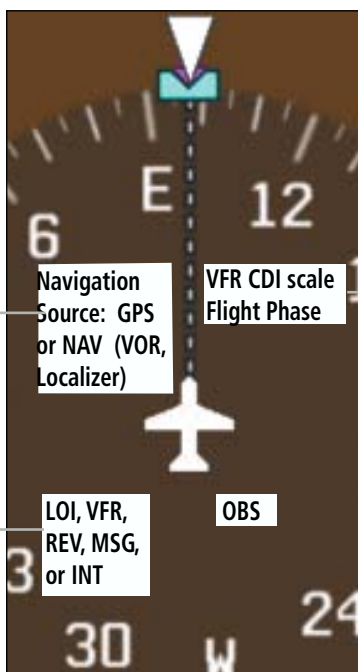

'1' or '2' will appear after the Navigation Source if more than one external navigation source is configured.

LOI: Loss of GPS integrity.

VFR: An external GPS source is configured but there is not enough guidance data for IFR use.

REV: External Navigation Source failed. Reverted to internal VFR GPS for navigation.

MSG: External navigation source has a pending message

INT: The pilot has elected to use the internal GPS navigation source instead of the external GPS navigation source.

VFR CDI Scales:
0.25nm, 1.25nm,
5.00nm

Flight Phase
(IFR): APR, TERM,
ENR, OCN, LNAV,
L/VNAV, LNAV+V,
or LPV

HSI Annunciations

BEARING POINTERS AND INFORMATION WINDOWS

Two bearing pointers and associated information can be displayed on the HSI for NAV (VOR, Localizer) and GPS sources as well as nearest airports. The bearing pointers are light blue and are single-line (Bearing Pointer 1) or double-line (Bearing Pointer 2). A pointer symbol is shown in the information windows to indicate the navigation source. The bearing pointers never override the CDI and are visually separated from the CDI by a white ring (shown when the bearing pointers are selected but not necessarily visible due to data unavailability).

When a bearing pointer is displayed, its associated information window is also displayed. The Bearing Information Windows are displayed at the lower sides of the HSI. The following information may be displayed in the Bearing Information Windows:

- Bearing source (NAV, GPS)
- Pointer icon (single lined or double lined)
- Frequency (NAV)
- Station/waypoint identifier (NAV, GPS)
- GPS-derived great circle distance to bearing source

If an external NAV radio is the bearing source and it is tuned to an ILS frequency, the bearing source and the bearing pointer are removed from the HSI and the frequency is replaced with "ILS". If VLOC1 or VLOC2 is the bearing source and it is tuned to a VOR frequency, the frequency is replaced with the station identifier. If GPS is the bearing source, the active waypoint identifier is displayed in lieu of a frequency.

The bearing pointer is removed from the HSI and "NO DATA" is displayed in the information window if:

- The NAV radio is not receiving the tuned VOR station
- GPS is the bearing source and an active waypoint is not selected



Bearing 1 Information Window
-Identifier
-Bearing Source

Bearing 2 Information Window
-Identifier
-Distance

HSI with Bearing Pointers

Enabling/disabling the bearing pointer and changing sources:

- 1) From the full screen PFD and/or split screen PFD Page, press the **MENU** Key.
- 2) Move the **FMS** Joystick to highlight the desired Bearing Pointer.
- 3) Turn the **FMS** Joystick to highlight the desired source (dependant on the external navigators configured), or to remove the bearing pointer and information window, highlight 'Off'.

COURSE DEVIATION INDICATOR (CDI)

The HSI contains a Course Deviation Indicator (CDI), with a Course Pointer, To/From Indicator, and a sliding deviation bar and scale. The course pointer is a single line arrow (GPS1, VOR1, and LOC1) or a double line arrow (GPS2, VOR2, and LOC2) which points in the direction of the set course. The To/From arrow rotates with the course pointer and is displayed when the active NAVAID is received.

The Course Deviation Indicator (CDI) moves left or right from the course pointer along a lateral deviation scale to display aircraft position relative to the course. If the course deviation data is not valid, the CDI is not displayed.

Another Lateral Deviation Scale and combination Course Deviation and To-From Indicator is located below the slip/skid indicator.

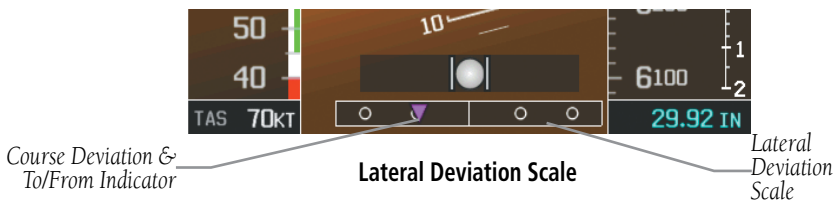

The CDI is capable of displaying two sources of navigation: GPS or NAV (VOR, localizer) depending on the external navigator(s) configured (refer to the G3X Installation Manual for more information). Color indicates the current navigation source: magenta (for GPS) or green (for VOR and LOC). The full-scale limits for the CDI are defined by a GPS-derived distance when coupled to GPS. When coupled to a VOR or localizer (LOC), the CDI has the same angular limits as a mechanical CDI. If the CDI exceeds the maximum deviation on the scale (two dots) while coupled to GPS, the crosstrack error (XTK) is displayed below the white aircraft symbol.

CHANGING THE EXTERNAL NAVIGATOR

Changing the external navigator:

- 1) If more than one navigator is configured, press the **CDI SRC** Softkey to toggle between available navigation sources.
- 2) Verify the external navigation source by the indication in the upper left quadrant of the HSI and on the external navigator.

CHANGING THE NAVIGATION SOURCE

Changing the navigation source (GPS, VOR, LOC, or VLOC):

Use the associated external navigator to toggle between GPS and VOR/LOC source types. Refer to the appropriate external navigator Pilot's Guide (e.g., SL30 Nav/Comm Transceiver Pilot's Guide, or the GTN or GNS Series Pilot's Guides) for more information. When an external navigator is configured the internal GPS can still be used for VFR navigation.



NOTE: *The G3X internal GPS flight plan is only for VFR use.*

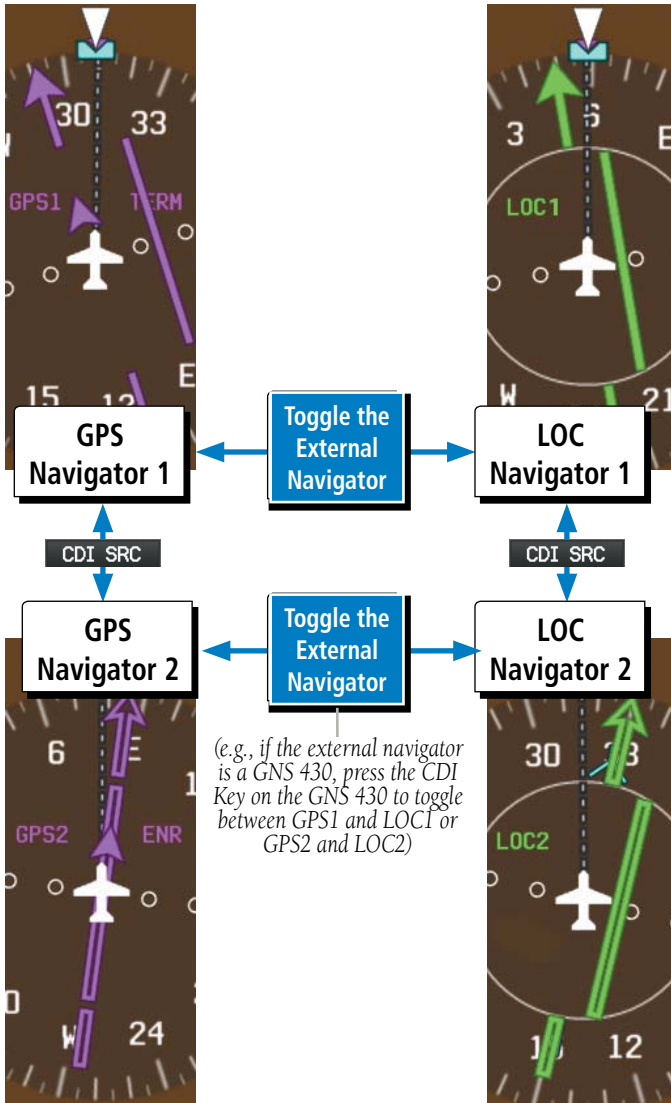

CDI Source

G-METER

Whenever the G load on the airplane goes above +2.1G or below -0.5G the HSI is temporarily replaced with a large graphical G-meter. To remove the G-meter press the **CLR** Key. Regardless of the current G load, the HSI can be replaced with a G-meter by changing the 'G METER' setting on the PFD setup page. The G-meter will be displayed until the setting is changed to auto or the power is cycled. Small white triangles are used to indicate the minimum and maximum recorded G loads. Refer to the G3X installation manual for more information on configuring the G-meter.

Manually displaying the G-meter:

- 1) From the full screen PFD and/or split screen PFD Page, press the **MENU** Key.
- 2) Move the **FMS** Joystick to highlight G METER.
- 3) Turn the **FMS** Joystick to select 'ON (NO HSI)'.

Resetting the G-meter minimum and maximum markers:

- 1) From the full screen PFD and/or split screen PFD Page, press the **MENU** Key.
- 2) Press the **RESET G** Softkey to reset the minimum and maximum recorded G loads.



G-meter

HSI ORIENTATION

The HSI may be configured to provide directional information in either 'Heading' or 'Auto Trk/Hdg' "Track-up" modes. Selecting Heading Mode orients the HSI to display aircraft heading in a conventional manner with heading shown at the top of the compass card as indicated by the lubber line. In 'Auto Trk/Hdg' "Track-up" mode, the aircraft symbol and lubber line move to indicate heading and wind correction while ground track in shown at the top of the compass card. While in 'Auto Trk/Hdg' the HSI will remain heading-based when the aircraft is on the ground or when the autopilot is in HDG mode. Refer to the G3X installation manual for more information on configuring the HSI Orientation.

Changing HSI orientation:

- 1) From the full screen PFD and/or split screen PFD Page, press the **MENU** Key.
- 2) Press the **MORE** Softkey.
- 3) Move the **FMS** Joystick to highlight HSI ORIENTATION.
- 4) Turn the **FMS** Joystick to highlight 'Heading' or 'Auto Trk/Hdg'.



Track up HSI

PFD PITCH ATTITUDE OFFSET

The Pitch attitude offset function allows the yellow aircraft symbol on the attitude indicator to be adjusted up or down much like the aircraft on a mechanical attitude indicator. The pitch attitude can be adjusted as much as +/- 2.5°.

- System Overview
- Flight Instruments**
- EIS
- CNS Interface
- Navigation
- Flight Planning
- Hazard Avoidance
- Additional Features
- Integrated Autopilot
- Annun/Alerts
- Appendix
- Index

Changing the PFD Pitch Attitude Offset:

- 1) From the full screen PFD and/or split screen PFD Page, press the **MENU** Key.
- 2) Press the **MORE** Softkey.
- 3) Move the **FMS** Joystick to highlight PITCH OFFSET.
- 4) Turn the **FMS** Joystick to select the desired setting.



Pitch Attitude Offset

- System Overview
- Flight Instruments
- EIS
- CNS Interface
- GPS Navigation
- Flight Planning
- Hazard Avoidance
- Additional Features
- Integrated Autopilot
- Annun/Alerts
- Appendix
- Index

MANUALLY SWITCHING BETWEEN INTERNAL AND EXTERNAL FLIGHT PLAN SOURCES

Press the **INTERNAL** Softkey on the Active Flight Plan Page or the Direct-to Page, to temporarily allow flight planning through the G3X using the internal GPS flight plan when an external GPS Navigator is configured. Press the **EXTERNAL** Softkey to return to the external GPS navigator’s flight plan.

When manually selecting the internal GPS flight plan, 'INT' is displayed in light blue in the upper left corner of the Data Bar as well as the lower left quadrant of the HSI.

Using Internal GPS Flight Plan



INT: The pilot has elected to use the internal GPS navigation source instead of the external GPS navigation source.

Internal Flight Plan Indication

- System Overview
- Flight Instruments
- EIS
- CNS Interface
- GPS Navigation
- Flight Planning
- Hazard Avoidance
- Additional Features
- Integrated Autopilot
- Annun/Alerts
- Appendix
- Index

Switching between internal and external flight plan sources:

From the Active Flight Plan Page or the Direct-to Page, touch the **INTERNAL** or **EXTERNAL** Softkey to switch between the internal and external flight plan sources when an external GPS Navigator is configured.

FAILURE OF THE EXTERNAL GPS NAVIGATION SOURCE

If the external GPS navigation source fails, the system reverts to the internal GPS navigation source and 'REV' is shown in yellow in the upper left corner of the Data Bar as well as the lower left quadrant of the HSI.

External GPS Failure. Reverted to Internal GPS



REV:
External Navigation Source failed. Reverted to internal VFR GPS for navigation.

External GPS Navigation Failure

- System Overview
- Flight Instruments
- EIS
- CNS Interface
- GPS Navigation
- Flight Planning
- Hazard Avoidance
- Additional Features
- Integrated Autopilot
- Annun/Alerts
- Appendix
- Index

AUTOMATIC CDI SCALE SELECTION (INTERNAL GPS ONLY)



NOTE: When an external GPS navigator is in use, the pilot cannot change the CDI scale.

Three factors determine the default distance from the center of the CDI to full left or right limits:

- CDI scale = 1.25 nm - within 30 nm of any airport in the active route.
- CDI scale = 0.25 nm - on an approach leg or within 2 nm of the FAF or MAP.
- CDI scale = 5.0 nm - if the previous two conditions do not exist.

MANUAL CDI SCALE SELECTION (INTERNAL GPS ONLY)

Adjusting the CDI scale:

From the full-screen PFD and/or split-screen PFD Page, press the **RNG** Key down arrow to zoom in (decrease CDI scale), or the up arrow to zoom out (increase CDI scale).

The current CDI scale appears in the upper right corner of the HSI.



Current
CDI Scale

Horizontal Situation Indicator (HSI)

The Automatic CDI Scale Selection will resume once the default determining factor for the current phase of flight matches the user-selected CDI scale.

AUTO-SLEWING

The G3X will automatically slew the LOC course pointer to the correct final approach course when an ILS, LOC, BC, LDA, or SDF approach is active in the external navigator and the appropriate CDI and navigation source are selected on the G3X.

Setting up Auto-Slew:

- 1) With the desired approach activated in the external navigator, verify the appropriate CDI Source is selected (i.e., GPS1 or GPS2).
- 2) Once inside the FAF (Final Approach Fix), the course pointer will change from magenta to green and the course pointer will move, or slew, to the final approach course as received from the external GPS navigator.

When flying a localizer backcourse approach, verify that the selected course matches the published front course. The course selected can be manually changed by pressing the **LOC CRS** Softkey from the PFD or PFD Page (or press **XPDR/CRS > LOC CRS** (from the PFD or PFD Page) if a transponder is configured). A 'Set APPR CRS' message will appear if the course selection is not within 5° of either the front or back course for the selected approach.



'SET APPR CRS' Message

Auto-Slewing Message

TRIM AND FLAP POSITION INDICATORS (OPTIONAL)



NOTE: If the aircraft is configured with a remote transponder rudder and aileron trim indicators are not available on the PFD. All trim gauges are available from the ENG page.

Elevator Trim, Aileron Trim, Rudder Trim, and Flap Position indicators can be configured from the Engine/Airframe Input Configuration Page in Configuration Mode. Refer to the G3X Installation Manual for more information.



Trim and Flap Position Indicators

HEADING STRIP AND TURN RATE INDICATOR

The Heading Strip displays the Current Heading, Selected Heading Bug, Current Heading, and Current Track Indicator. Numeric labels occur every 10°. Major tick marks are at 5° intervals and minor tick marks at 1° intervals. A digital reading of the current heading appears in the center of the Heading Strip.

The Turn Rate Indicator is located above the Heading Strip. Tick marks to the left and right of the displayed heading denote standard turn rates (3 deg/sec). A magenta Turn Rate Trend Vector shows the current turn rate. The end of the trend vector gives the heading predicted in 6 seconds, based on the present turn rate. A standard-rate turn is shown on the indicator by the trend vector stopping at the standard turn rate tick mark, corresponding to a predicted heading of 18° from the current heading. At rates greater than 4 deg/sec, an arrowhead appears at the end of the magenta trend vector and the prediction is no longer valid.



Heading Strip/Turn Rate Indicator

OBS MODE



NOTE: If configured, the selected external GPS navigator (i.e., GTN or GNS Series Units) is used to set the OBS Mode.

Enabling Omni-bearing Selector (OBS) Mode suspends the automatic sequencing of waypoints in a GPS flight plan, but retains the current “active-to” waypoint as the navigation reference even after passing the waypoint. ‘OBS’ is annunciated to the left of the aircraft symbol when OBS Mode is selected.

While OBS Mode is enabled, a course line is drawn through the “active-to” waypoint on the moving map. If desired, the course to/from the waypoint can now be adjusted. When OBS Mode is disabled, the GPS flight plan returns to normal operation with automatic sequencing of waypoints, following the course set in OBS Mode. The flight path on the moving map retains the modified course line.

Extended Course Line

OBS Mode Annunciation OBS Mode Box



Omni-bearing Selector (OBS) Mode (Split-Screen)

OBS Course Softkey

Enabling/disabling OBS Mode (without external GPS navigator):

- 1) From the Active Flight Plan Page press the **MENU** Key while navigating a flight plan or Direct-to.
- 2) With ‘Set OBS and Hold’ highlighted, press the **ENT** Key. The OBS Mode Box is highlighted.
- 3) Turn the **FMS** Joystick to select the desired course to/from the waypoint.
- 4) To cancel OBS Mode and return to automatic waypoint sequencing, press the **MENU** Key, with ‘Release Hold’ highlighted, press the **ENT** Key.

Enabling/disabling OBS Mode (with external GPS navigator configured):

- 1) Press the **OBS** Key on the external navigator. The 'Set OBS and Hold' Active Flight Plan Page menu option is now available.
- 2) Turn the **FMS** Joystick on the G3X to select the desired course to/from the waypoint.

Syncing to the current aircraft location (without external GPS navigator):

- 1) With OBS Mode enabled, press the **OBS CRS** Softkey or press **XPDR/CRS > OBS CRS** (if necessary).
- 2) Press and hold the **FMS** Joystick.

2.2 SUPPLEMENTAL FLIGHT DATA

In addition to the flight instruments, the PFD or PFD Page also displays various supplemental information, including the Outside Air Temperature (OAT), wind data, and Vertical Navigation (VNAV) indications.

OUTSIDE AIR TEMPERATURE

The Outside Air Temperature (OAT) is displayed in degrees Fahrenheit (°F) or degrees Celsius (°C) in the lower left of the PFD or PFD Page.

Outside Air Temperature



Outside Air Temperature on PFD Page (Split-Screen)

Changing the outside air temperature setting:

- 1) Press the **MENU** Key twice to display the Main Menu.
- 2) Turn or move the **FMS** Joystick to highlight 'System Setup...' and press the **ENT** Key.
- 3) Turn or move the **FMS** Joystick to highlight 'Units' and press the **ENT** Key.

- 4) Turn the **FMS** Joystick to select the desired unit (**Fahrenheit (°F)** or **Celsius (°C)**).
- 5) Press the **FMS** Joystick, the **CLR** Key, the **EXIT** Softkey or the **MENU** Key to return to the previous page.

WIND DATA

Wind direction/speed or headwind/Crosswind information can be displayed in a window to the upper left of the HSI. When the window is selected for display, but wind information is invalid or unavailable, the window displays "No Wind Data".

Showing/hiding wind data:

- 1) From the full-screen PFD and/or split-screen PFD Page, press the **MENU** Key.
- 2) Move the **FMS** Joystick to highlight the Wind Vector field.
- 3) Turn the **FMS** Joystick to highlight 'Speed/Dir' or 'Head/X-wind'.

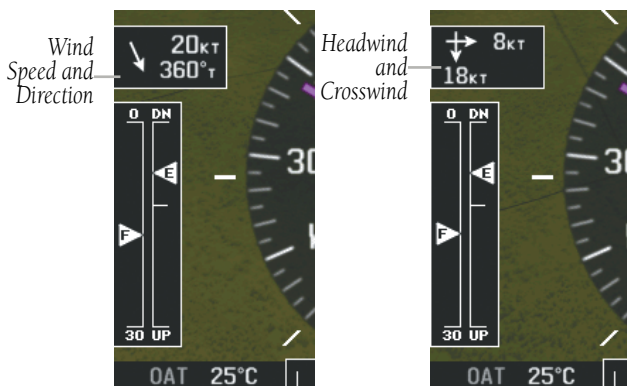

Wind Data

2.3 VERTICAL NAVIGATION (VNAV)



CAUTION: VNAV is only a VFR navigation aid and is not intended for instrument approaches.

The Vertical Navigation Page provides settings for the vertical navigation feature. These settings create a three-dimensional profile from the present location and altitude to a final (target) altitude at a specified location.

When the VNAV profile is defined, the pilot is informed of the progress by message alerts. A magenta chevron (VNAV Indicator) to the left of the altimeter on the Vertical Deviation Scale shows the VNAV profile, and a magenta chevron (Required Vertical Speed Indicator (RVSI)) on the Vertical Speed Indicator indicates the required vertical speed to reach the target altitude.

The Vertical Navigation feature is only available when navigating a Direct-to or flight plan, and the ground speed is greater than 35 knots.

One minute prior to the initial descent point the “Approaching VNAV Profile” message appears and the ‘Estimated Time to VNAV’ (on Active Flight Plan Page) goes blank. The descent angle locks to prevent changes in speed from altering the profile. The VNAV feature does not take into account any changes in ground speed that occur during the transition from level flight to descent or climb.

APPROACHING VNAV PROFILE

At 200 ft above the target altitude, the “Approaching Target Altitude” message appears, and the VNAV indicator disappears from the PFD.

APPROACHING TARGET ALTITUDE

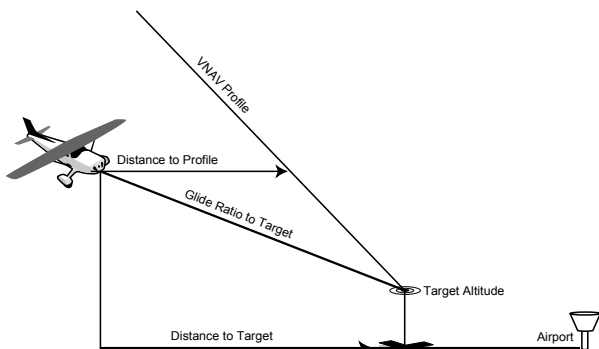

Visual Representation of VNAV

USING THE VNAV FEATURE

Use the VNAV (Vertical Navigation) feature to ensure the aircraft is at the proper altitude. The magenta VNAV Indicator appears on the PFD. A message appears when approaching the VNAV Profile. When the VNAV Indicator is in the vertical center of the Vertical Deviation Scale, the aircraft is at the proper altitude for the VNAV Profile.

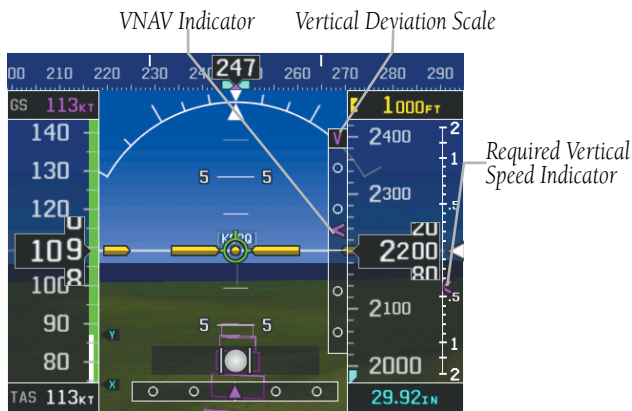

VNAV Indications (PFD)

Configuring a VNAV profile:

- 1) Press the **FPL** Key.
- 2) Turn the **FMS** Joystick to select the Vertical Navigation Page.
- 3) Press the **FMS** Joystick to activate the cursor.
- 4) Enter the desired profile into the fields, and press the **EXIT** Softkey.

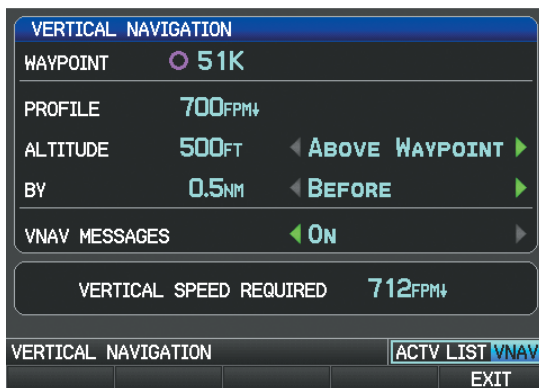

Vertical Navigation Page (Split-Screen)

- Waypoint—Enter any waypoint along the currently active route as the reference waypoint. The reference waypoint defines the target location.
- Profile—Enter the descent rate.
- Altitude—Enter the desired reference waypoint altitude. Select ‘Above Waypoint’ to use field elevation for airports in the Jeppesen database or ‘MSL’ to specify an exact MSL altitude target.
- By—Enter the target location with settings of distance ‘Before’ or ‘After’ a reference waypoint. To set a target location at a reference waypoint, enter a distance of zero.
- VNAV Messages—Select ‘On’ or ‘Off’ to enable/disable VNAV alert messages.

Enabling/disabling the VNAV indicator:

- 1) From the full-screen PFD and/or the split-screen PFD Page, press the **MENU** Key.
- 2) Move the **FMS** Joystick to highlight the VNAV Indicator field.
- 3) Turn the **FMS** Joystick to highlight ‘On’ or ‘Off’.

Force capture of the VNAV profile:

- 1) Enter a valid VNAV profile and begin navigation.
- 2) Press the **FPL** Key.
- 3) Turn the **FMS** Joystick to highlight the Vertical Navigation Page.
- 4) Press the **MENU** Key.

- 5) Turn or move the **FMS** Joystick to highlight 'Capture VNAV Profile' and press the **ENT** Key. Selecting 'Capture VNAV Profile' centers the VNAV indicator (must be navigating a Flight Plan or Direct-to).

Or:

- 1) Enter a valid VNAV profile and begin navigation.
- 2) From the VNAV Page, press (select) the **CAPTURE** Softkey.

Force cancel of the VNAV profile:

- 1) Press the **FPL** Key.
- 2) Turn the **FMS** Joystick to highlight the Vertical Navigation Page.
- 3) Press the **MENU** Key.
- 4) Turn or move the **FMS** Joystick to highlight 'Cancel VNAV Capture' and press the **ENT** Key.

Or:

- 1) Enter a valid VNAV profile and begin navigation.
- 2) From the VNAV Page, press (deselect) the **CAPTURE** Softkey.

SECTION 3 ENGINE INDICATION SYSTEM

3.1 EIS DISPLAY & ENG PAGE



NOTE: The display of the G3X Engine Indication System depends upon the current configuration and may vary from the examples discussed in this section.

The G3X Engine Indication System (EIS) displays critical engine, electrical, and other system parameters on the top portion of the display (split-screen and/or full-screen MFD). Additional EIS information can be viewed by selecting the **ENG** Page.

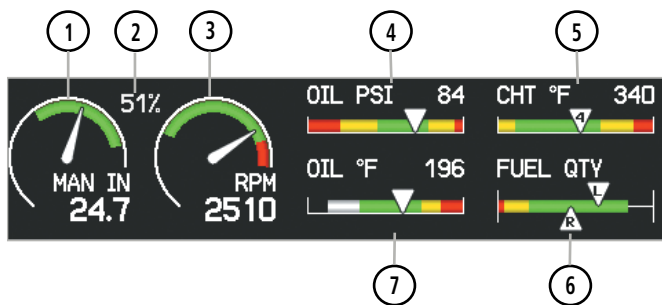

Engine Instrument Display (Split-Screen)

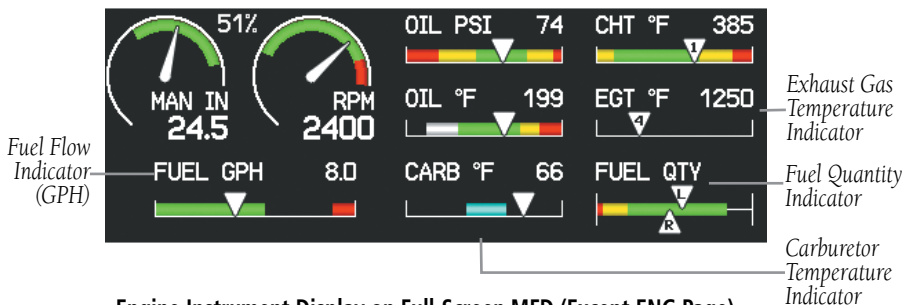

Engine Instrument Display on Full-Screen MFD (Except ENG Page)

If the Engine Page information configured exceeds one page, additional engine gauges may be distributed among the 1st, 2nd, and 3rd softkeys as required.

- System Overview
- Flight Instruments
- EIS**
- CNS Interface
- GPS Navigation
- Flight Planning
- Hazard Avoidance
- Additional Features
- Integrated Autopilot
- Annun/Alerts
- Appendix
- Index

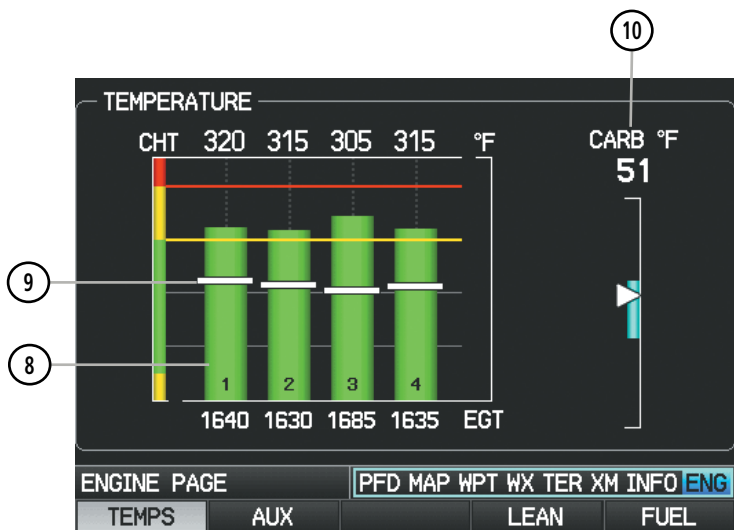

Example Engine (ENG) Page Configuration - TEMPS Softkey Selected (Split-Screen)

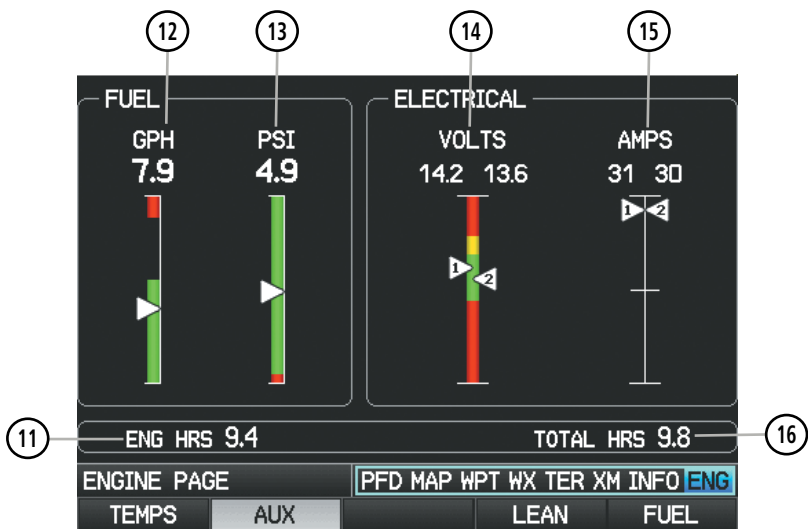

Example Engine (ENG) Page Configuration- AUX Softkey Selected (Split-Screen)

① 23	Engine Manifold Pressure	Displays manifold pressure to indicate engine power
② 24	Percent Power	Displays engine power as a percentage
③ 25	Tachometer (RPM)	Displays propeller speed in revolutions per minute (rpm)
④ 26	Oil Pressure Indicator	Displays oil pressure
⑤ 9 22	Cylinder Head Temperature Indicator	Displays the head temperature of the hottest cylinder
⑥ 19	Fuel Quantity Indicator	Displays the fuel quantity
⑦ 27	Oil Temperature Indicator	Displays oil temperature
⑧ 21	Exhaust Gas Temperature Indicator	Displays the Exhaust Gas Temperature
⑩ 28	Carburetor Temperature Indicator	Displays carburetor temperature; the yellow range indicates where carburetor icing is most likely to occur
⑪ 17	Engine Hours (Tach) (ENG HOURS)	Counted whenever a valid RPM is detected. Refer to G3X Installation Manual for more information.
⑫ 20	Fuel Flow Indicator	Displays fuel flow.
⑬ 18	Fuel Pressure Indicator	Displays fuel pressure
⑭ 29	Voltmeter	Displays the main bus voltage
⑮ 30	Ammeter	Displays the battery load in amperes
⑯ 31	Total Hours (HOURS)	Refer to G3X Installation Manual for more information.

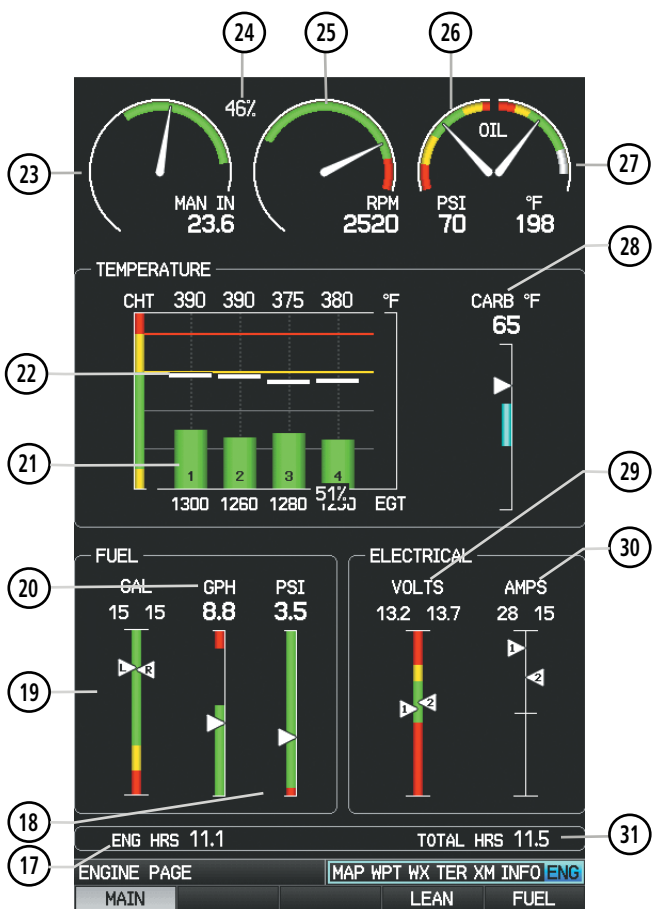

**Example Engine (ENG) Page Configuration
(Full-Screen MFD)**

Green bands on the instruments indicate normal ranges of operation; yellow and red bands indicate caution and warning, respectively. When unsafe operating conditions occur, the corresponding caution readout will display solid yellow and the warning readout will flash red. If sensory data to an instrument becomes invalid or unavailable, a red "X" is displayed across the instrument.

ENG PAGE SOFTKEYS (EXAMPLE CONFIGURATION)



NOTE: The Engine (ENG) Page softkeys displayed are dependant on the configuration. Refer to the G3X Installation Manual for information on configuring the Engine Page.

If the Engine Page information configured exceeds one page, additional engine gauges may be distributed among the 1st, 2nd, and 3rd softkeys as required.

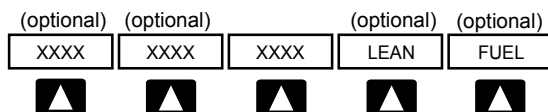

MAIN, TEMPS	Displays engine gauges as required (optional)
AUX, AUX1, AUX2, ELEC, TRIM, TEMPS	Displays additional engine gauges as required (optional)
LEAN	Activates/deactivates Lean Assist (optional)
FUEL	Displays Fuel Calculator (optional)

3.2 LEAN ASSIST MODE (OPTIONAL)



NOTE: The pilot should follow the engine manufacturer's recommended leaning procedures as described in the Pilot's Operating Handbook (POH).

A **LEAN** Softkey is displayed on the ENG Page if Lean Assist Mode is enabled and at least one Exhaust Gas Temperature (EGT) or Turbine Inlet Temperature (TIT) input is configured (refer to the G3X Installation Manual for more information).

Using Lean Assist Mode:

From the ENG Page, press the **LEAN** Softkey. As the mixture is leaned, one of the cylinders' exhaust temperature will peak. Continuing to lean the mixture will cause each additional cylinder to peak (if applicable) until the last of the cylinders peaks. To cancel Lean Assist Mode, press the **LEAN** Softkey again.

When the **LEAN** Softkey is selected, the Lean Assist Mode waits for a cylinder's EGT to reach a peak temperature and decrease by at least 7°F. The peak EGT for each cylinder is displayed as a small grey number above each bar on the graph. To prevent detection of false peaks, the system waits for a cylinder's EGT to increase by at least 15°F before detecting a peak. In addition, if the cylinder temperature rises above a previously detected peak by more than 100°F, the previous peak is considered false.

A cylinder temperature bar graph appears if CHT/EGT data is configured on 4 or more cylinders. A readout showing the temperature deviation from peak (Δ EGT) is displayed in place of the normal EGT temperature number. The temperature deviation of the first cylinder to peak is highlighted light blue. A light blue outline appears around the temperature deviation of the last cylinder to peak. A light blue hollow box appears above the cylinder's bar to represent the peak EGT for that cylinder.

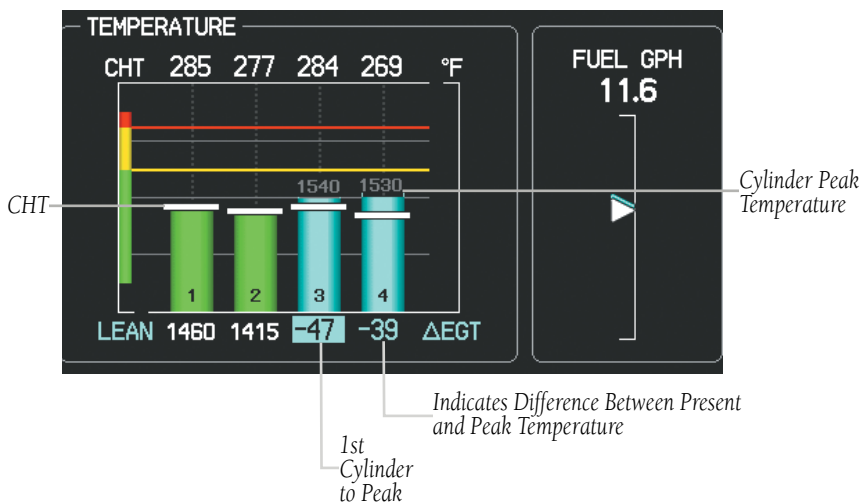

Leaning to First Peak (ENG Page - Full-Screen MFD)

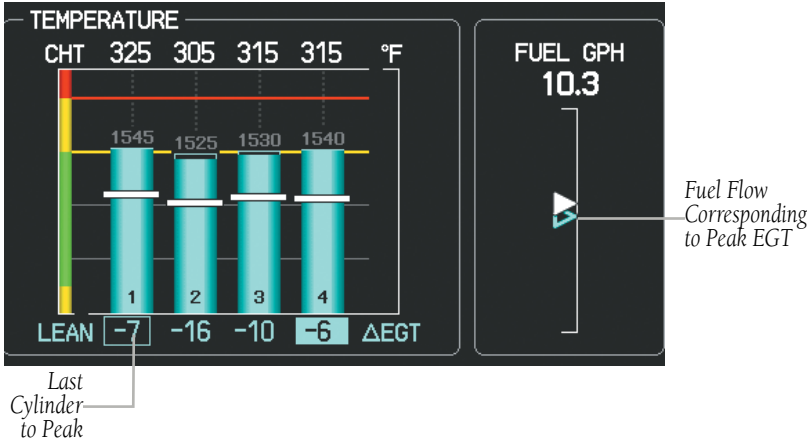

Leaning to Last Peak (ENG Page - Full-Screen MFD)

If a fuel flow sensor is configured, the fuel flow value detected as the first cylinder peaks is saved (see above). The fuel flow corresponding to peak EGT is drawn on the fuel flow gauge as a hollow blue pointer. This can be used to determine if you are on the rich side of peak (ROP) or the lean side of peak (LOP). Rich of Peak (ROP) if the fuel flow pointer is above the blue triangle, or Lean of Peak (LOP) if the fuel flow pointer is below the blue triangle.

The EIS Display (See Section 3.1) and the split-screen ENG Page will display the cylinder whose temperature is currently closest to its own peak value (when Lean Assist Mode is active) as a white pointer with the cylinder number. The peak temperature is depicted by a hollow blue pointer, and the temperature deviation from peak (Δ EGT or Δ TIT) is displayed in place of the normal temperature number in light blue text.

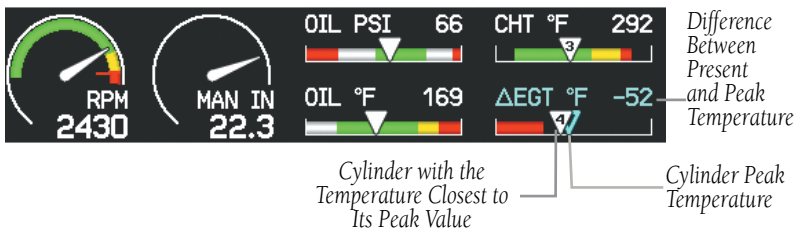

Engine Instrument Display (Split-Screen)

- System Overview
- Flight Instruments
- EIS**
- CNS Interface
- GPS Navigation
- Flight Planning
- Hazard Avoidance
- Additional Features
- Integrated Autopilot
- Annun/Aerts
- Appendix
- Index

- System Overview
- Flight Instruments
- EIS**
- CNS Interface
- GPS Navigation
- Flight Planning
- Hazard Avoidance
- Additional Features
- Integrated Autopilot
- Annun/Alerts
- Appendix
- Index

Difference Between Present and Peak Temperature

Cylinder Peak Temperature

1st Cylinder to Peak

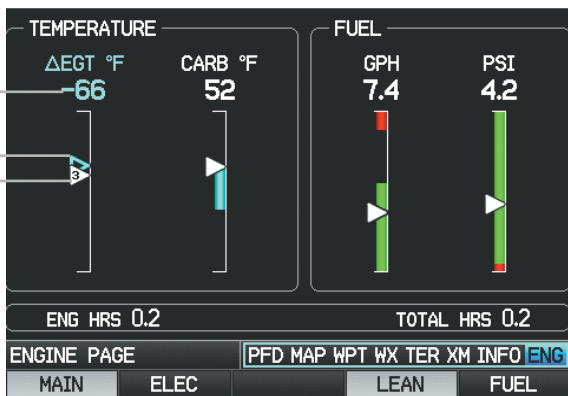

Lean Assist Mode - ENG Page (Split-Screen)

If Turbine Inlet Temperature (TIT) inputs are configured, the first and last TIT to peak are not identified.

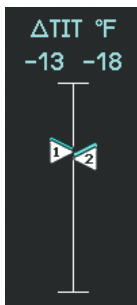

Lean Assist Mode - Turbine Inlet Temperature (ENG Page)

3.3 FUEL CALCULATOR (OPTIONAL)



WARNING: *The G3X Fuel Calculator and/or Fuel Range Rings are NOT intended to be relied upon as the primary fuel indicator(s), and does not relieve the pilot from the responsibility of proper flight planning. G3X fuel calculations do not use the aircraft fuel quantity indicators and are calculated from the last time the fuel was reset.*



NOTE: *An optional Fuel Flow Sensor must be configured for the FUEL Softkey to appear on the ENG Page. Refer to the Installation Manual for more information.*

Refer to the Section 5.2, Using Map Displays, for information on displaying fuel range rings on the Navigation Map.

Adjusting the Fuel Remaining or Fuel Used quantity:

- 1) From the ENG Page, press the **FUEL** Softkey.
- 2) Press the **FMS** Joystick to activate the cursor.
- 3) Move the **FMS** Joystick to the Fuel Remaining or Fuel Used Field (if necessary).
- 4) Turn the **FMS** Joystick to adjust the desired quantity.

Resetting the Fuel Used to zero and Fuel Remaining to full tanks:

- 1) From the ENG Page, press the **FUEL** Softkey.
- 2) Press the **RESET** Softkey; this resets Fuel Used to zero and Fuel Remaining to the maximum fuel capacity for the aircraft.

Resetting Fuel Remaining only:

- 1) From the ENG Page, press the **FUEL** Softkey.
- 2) Press Softkey #2 (**XX GAL**); this resets only Fuel Remaining to the maximum fuel capacity for the aircraft. XX is the airframe specific full fuel quantity.

Resetting Fuel Remaining to partial fuel quantities (optional):

- 1) From the ENG Page, press the **FUEL** Softkey.
- 2) Press Softkey #3 or #4 (**XX GAL**); this resets fuel remaining to a partial tank quantity (i.e., filler neck tab). XX is the airframe specific partial fuel quantity (if configured).

- System Overview
- Flight Instruments
- EIS**
- CNS Interface
- GPS Navigation
- Flight Planning
- Hazard Avoidance
- Additional Features
- Integrated Autopilot
- Annun/Alerts
- Appendix
- Index

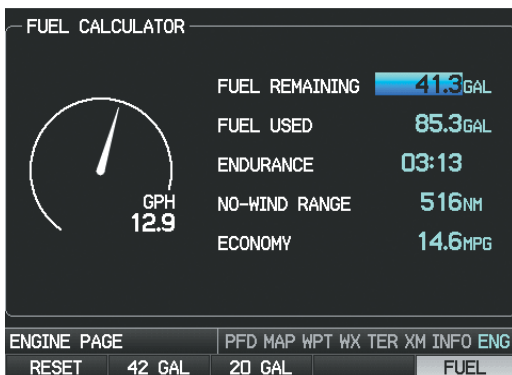

Fuel Calculator (Split-Screen)

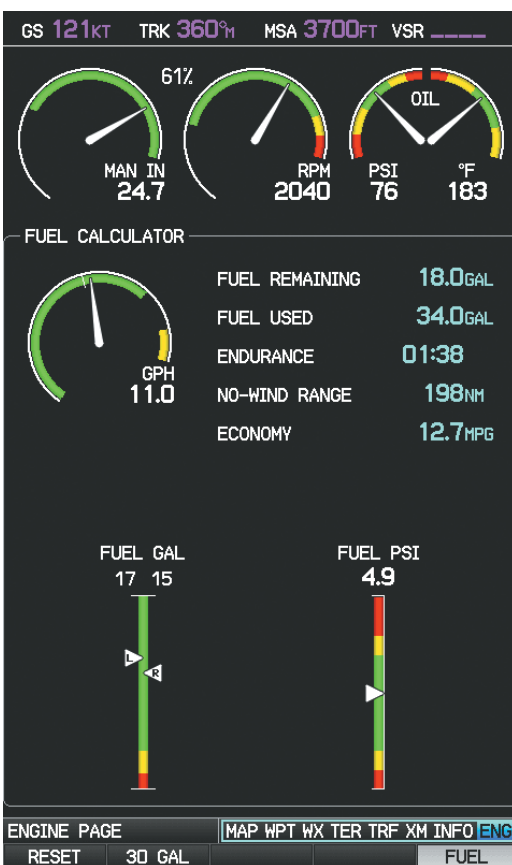

Fuel Calculator (Full-Screen MFD)

FUEL CALCULATOR SOFTKEYS

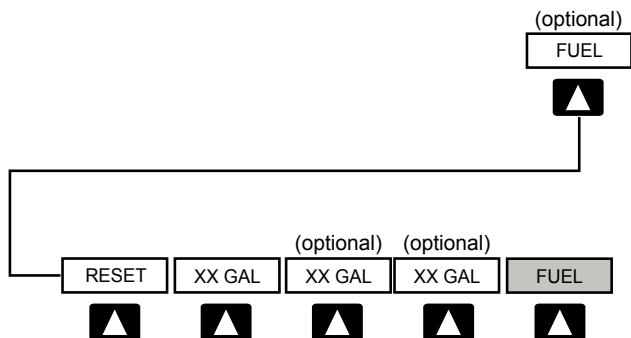

RESET	Resets fuel used to zero and fuel remaining to full tanks
XX GAL	Sets fuel remaining to the full tank quantity where XX is the airframe specific full fuel quantity
XX GAL	Sets fuel remaining to a partial tank quantity (i.e., filler neck tab) where XX is an airframe specific partial fuel quantity (optional)
XX GAL	Sets fuel remaining to a partial tank quantity (i.e., filler neck tab) where XX is an airframe specific partial fuel quantity (optional)
FUEL	Returns to top-level softkeys

CONFIRMING FUEL QUANTITY

When the system detects that fuel has been added, a 'Confirm Fuel Quantity' Reminder Page appears when the system is powered on.

CONFIRM FUEL QUANTITY SOFTKEYS



RESET	Resets fuel used to zero and fuel remaining to full tanks
XX GAL	Sets fuel remaining to the full tank quantity where XX is the airframe specific full fuel quantity
XX GAL	Sets fuel remaining to a partial tank quantity (i.e., filler neck tab) where XX is an airframe specific partial fuel quantity (optional)
DONE	Returns to top-level softkeys

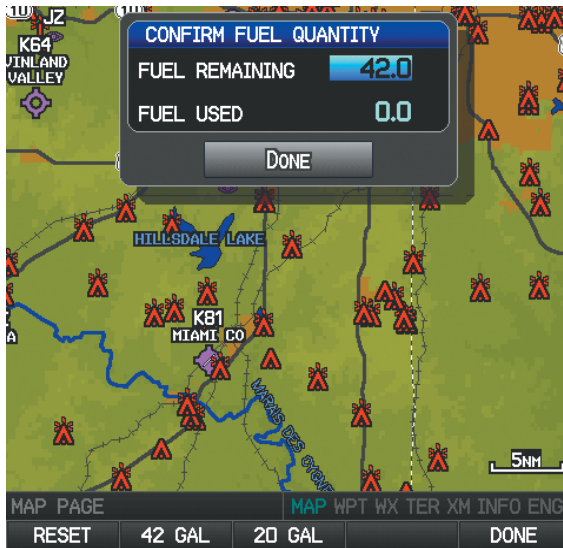

'Confirm Fuel Quantity' Reminder Page

Adjusting the Fuel Remaining or Fuel Used quantity:

- 1) Move the **FMS** Joystick to the Fuel Remaining or Fuel Used Field (if necessary).
- 2) Turn the **FMS** Joystick to adjust the desired quantity.

Resetting the Fuel Used to zero and Fuel Remaining to full tanks:

Press the **RESET** Softkey; this resets Fuel Used to zero and Fuel Remaining to the maximum fuel capacity for the aircraft

Resetting Fuel Remaining only:

Press Softkey #2 (**XX GAL**); this resets only Fuel Remaining to the maximum fuel capacity for the aircraft. XX is the airframe specific full fuel quantity.

Resetting Fuel Remaining to partial fuel quantities (optional):

Press Softkey #3 or #4 (**XX GAL**); this resets fuel remaining to a partial tank quantity (i.e., filler neck tab). XX is the airframe specific partial fuel quantity (if configured).

3.4 CAS MESSAGES (OPTIONAL)

The CAS messages displayed depend upon the current configuration, and will vary from the examples listed below. Refer to the G3X Installation Manual for more information on configuring CAS messages (if applicable).

CAS Messages are grouped by criticality (warning, caution, advisory). The color of the message is based on its urgency and on required action:

- **WARNING (red):** Requires immediate attention. Warning messages will flash until acknowledged by pressing the **ENT** Key.
- **CAUTION (yellow):** Requires pilot awareness and possible future corrective action.
- **ADVISORY (white):** Provides general information.

Warning annunciation text is shown in red in the CAS Annunciation Window on the full-screen PFD and/or the split-screen PFD Page (dependent on number of CAS messages configured). The CAS Annunciation Window is located to the right of the Horizontal Situation Indicator.



CAS Warning Example

Important CAS Messages may not be visible at all times (e.g., the split-screen PFD Page is not displayed, or FPL/NRST Pages are displayed on the full-screen PFD). In that case a Check Alerts Triangle is displayed to the right of the Airspeed Indicator as a reminder to check the CAS Messages.

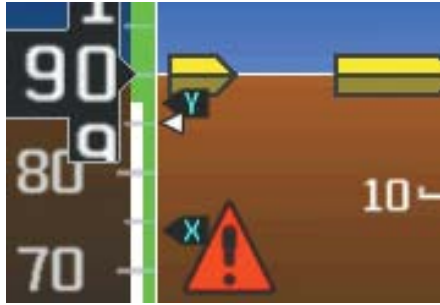

CAS Warning Example (Check Alerts Triangle)

If less than four CAS Messages are configured for the system, the CAS Messages are displayed to the right of the Airspeed Indicator and the Check Alerts Triangle is not displayed.

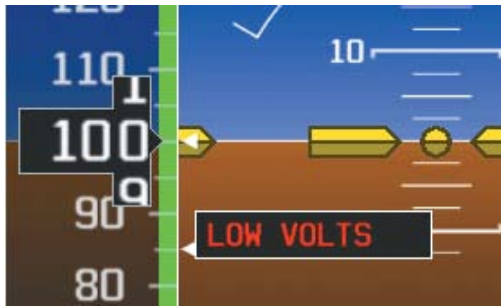

CAS Warning Example

- System Overview
- Flight Instruments
- EIS
- CNS Interface
- GPS Navigation
- Flight Planning
- Hazard Avoidance
- Additional Features
- Integrated Autopilot
- Annun/Alerts
- Appendix
- Index

- System Overview
- Flight Instruments
- EIS**
- CNS Interface
- GPS Navigation
- Flight Planning
- Hazard Avoidance
- Additional Features
- Integrated Autopilot
- Annun/Alerts
- Appendix
- Index

Blank Page

SECTION 4 CNS INTERFACE

4.1 AUTO-TUNING FREQUENCIES (OPTIONAL)



NOTE: Refer to the G3X Installation Manual for more information on the G3X optional communication interfaces.

Frequencies can be automatically tuned from the following:

- Map Page
- Weather Page
- Waypoint Page
- Nearest Airports Page
- Nearest Airport Weather Page
- Nearest ARTCC Page
- Nearest FSS Page
- Nearest Airspace Page

Auto-tuning a frequency from the Nearest Pages:

- 1) Press the **NRST** Key to display the Nearest Pages.
- 2) Turn the **FMS** Joystick to select the Nearest (Airports, Airport Weather, ARTCC, FSS, or Airspace) Page.
- 3) From the Nearest ARTCC or Nearest FSS, move the **FMS** Joystick to highlight the desired frequency.



Nearest ARTCC (Split-Screen)

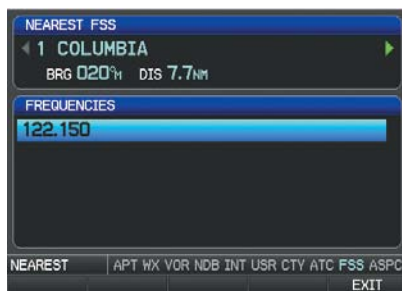

Nearest FSS (Split-Screen)

Or:

- a) From the Nearest Airport Weather Page, highlight the desired airport weather, and press the **ENT** Key.
- b) With the Weather Information Page displayed, press the **INFO** Softkey.
- c) Move the **FMS** Joystick to highlight the desired frequency.

Or:

- a) From the Nearest Airspace Page, highlight the desired airspace, and press the **ENT** Key.
- b) Press the **FREQS** Softkey.
- c) Move the **FMS** Joystick to highlight the desired frequency.

Or:

- a) From the Nearest Airport Page, highlight the desired airport and press the **ENT** Key. The Airport Information Page is displayed.
- b) Move the **FMS** Joystick to highlight the desired frequency.



Airport Information Page (Split-Screen)

- 4) Press the **ENT** Key to load the frequency into the standby field of the SL40. If the frequency has an * (additional information available) next to it, press the **ENT** Key a second time with 'Tune' highlighted.

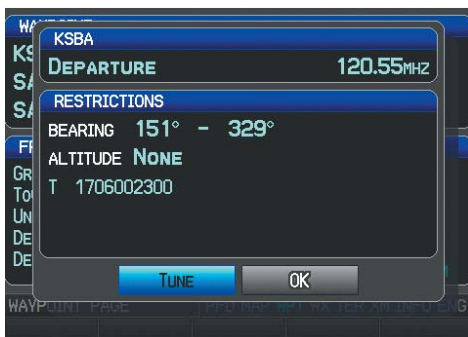

Frequency with Additional Information (Split-Screen)

System Overview

Flight Instruments

EIS

CNS Interface

GPS Navigation

Flight Planning

Hazard Avoidance

Additional Features

Integrated Autopilot

Annun/Alerts

Appendix

Index

Auto-tuning a frequency from the Map Page and Weather Page:

- 1) Press the **FMS** Joystick on the Map Page (or **PAN MAP** Softkey on the Weather (WX) Page) to display the Map Pointer.
- 2) Place the Map Pointer on a map feature (airport, METAR Flag, etc). If multiple map features are present at the Map Pointer position (green arrow in the information box), turn the **FMS** Joystick to cycle through the list.
- 3) Press the **ENT** Key to display the review page for the highlighted feature.
- 4) If necessary, press the **INFO** Softkey to access the Airport Information Page.
- 5) Move the **FMS** Joystick to highlight the desired frequency.
- 6) Press the **ENT** Key to load the frequency into the standby field of the SL40. If the frequency has an * (additional information available) next to it, press the **ENT** Key a second time with 'Tune' highlighted.

Auto-tuning a frequency from the Waypoint Page:

- 1) From the Waypoint Page, enter the desired waypoint using the **FMS** Joystick.
- 2) Move the **FMS** Joystick to highlight the desired frequency.
- 3) Press the **ENT** Key to load the frequency into the standby field of the SL40. If the frequency has an * (additional information available) next to it, press the **ENT** Key a second time with 'Tune' highlighted.

4.2 REMOTE TRANSPONDER INTERFACE (OPTIONAL)



NOTE: If the aircraft is configured with a remote transponder rudder and aileron trim indicators are not available on the PFD. All trim gauges are available from the ENG page.

The G3X is capable of interfacing with several remote transponders providing Mode S interrogation and reply capabilities. Selective addressing or Mode Select (Mode S) capability includes the following features:

- Level-2 reply data link capability (used to exchange information between aircraft and ATC facilities)

- System Overview
- Flight Instruments
- EIS
- CNS Interface
- GPS Navigation
- Flight Planning
- Hazard Avoidance
- Additional Features
- Integrated Autopilot
- Annun/Alerts
- Appendix
- Index

- Surveillance identifier capability
- Flight ID (Flight Identification) reporting - The Mode S Transponder reports identification as either the aircraft registration or a unique Flight ID.
- Altitude Reporting
- Airborne status determination
- Transponder capability reporting
- Mode S Enhanced Surveillance (EHS) requirements
- Acquisition squitter - Acquisition squitter, or short squitter, is the transponder 24 bit identification address. The transmission is sent periodically, regardless of the presence of interrogations. The purpose of the acquisition squitter is to enable Mode S ground stations and aircraft equipped with a Traffic Avoidance System (TAS) to recognize the presence of Mode S-equipped aircraft for selective interrogation.

When configured the transponder interface is displayed on three levels of softkeys on the PFD: Top-level, Mode Selection, and Code Selection. When the top-level XPDR Softkey is pressed, the associated transponder softkeys appear: IDENT, CODE, and MODE.

When the CODE Softkey is pressed, the pilot can enter the desired code using the FMS Joystick.

Pressing the IDENT Softkey initiates the ident function and reverts to the top-level softkeys.

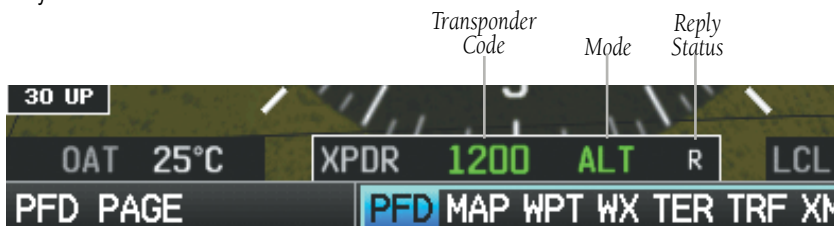

Transponder Data Box (Split-Screen)

With a remote transponder configured, the #2 PFD Softkey becomes **XPDR** (if a navigation source is not selected) or **XPDR/CRS** (when the pilot can control the navigation course).

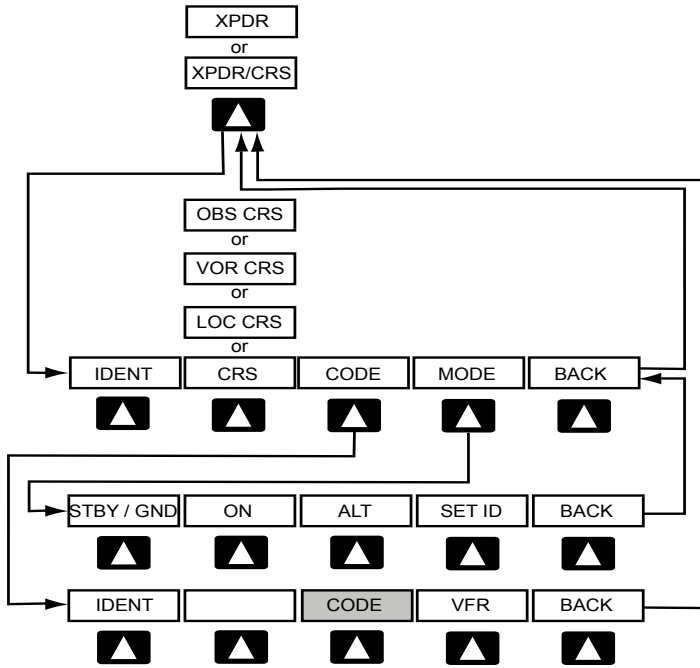

- IDENT Sends a distinct identity indication to Air Traffic Control (ATC).
- CRS (subdued) A navigation source is not selected
- or
- OBS CRS Allows the pilot to adjust the OBS course
- or
- VOR CRS Allows the pilot to adjust the VOR course
- or
- LOC CRS Allows the pilot to adjust the localizer course
- CODE Allows the pilot to enter the transponder code and displays the second-level **CODE** softkeys
- MODE Displays second-level **MODE** softkeys
- BACK Returns to top-level softkeys

CODE Softkey selected

- IDENT Sends a distinct identity indication to Air Traffic Control (ATC).

System Overview	CODE	Returns to top-level softkeys
Flight Instruments	VFR	The pre-programmed VFR code is automatically displayed in the code field of the Transponder Data Box. Pressing the VFR softkey again restores the previous identification code.
EIS	BACK or DONE	Returns to top-level softkeys
CNS Interface	MODE Softkey selected	
GPS Navigation	STBY	Selects the standby mode. When in standby mode, the remote transponder will not reply to any interrogations. Press and hold to put the transponder in Ground (GND) Mode. Ground Mode is normally selected automatically when the aircraft is on the ground.
Flight Planning	ON	Generates Mode A and Mode S replies, but Mode C altitude reporting is inhibited.
Hazard Avoidance	ALT	Selects ALT Mode. All transponder replies requesting altitude information are provided with pressure altitude information.
Additional Features	SET ID	Allows the pilot to set the Flight ID. (The Flight ID must be configured to 'Set By Pilot' for the SET ID softkey to be displayed).
Integrated Autopilot	BACK	Returns to previous level softkeys

TRANSPONDER MODE SELECTION

The transponder mode will automatically switch between GND Mode and ALT Mode. The mode can also be manually set using the softkeys.

Selecting a transponder mode:

- 1) From the full-screen PFD and/or the split-screen PFD Page, press the **XPDR** Softkey.
- 2) Press the **MODE** Softkey.
- 3) Press the desired mode softkey (**STBY / GND, ON, or ALT**). Pressing and holding the **STBY** Softkey activates Ground (GND) Mode and the **STBY** Softkey becomes the **GND** Softkey.

GROUND MODE

Ground Mode is normally selected automatically when the aircraft is on the ground. The transponder powers up in the last mode it was in when shut down. To manually select Ground Mode, press and hold the **STBY** Softkey. A green GND indication and transponder code appear in the mode field of the Transponder Data Box and the **STBY** Softkey becomes the **GND** Softkey. In Ground Mode, the transponder does not allow Mode A and Mode C replies, but it does permit acquisition squitter and replies to discretely addressed Mode S interrogations.

Deselect (press) the **GND** Softkey to return to Standby Mode.

STANDBY MODE (MANUAL)

Standby Mode can be selected at any time by pressing the **STBY** Softkey. In Standby, the transponder does not reply to interrogations, but new codes can be entered. When Standby Mode is selected, a white STBY indication and transponder code appear in the mode field of the Transponder Data Box.

MANUAL ON MODE

ON Mode can be selected at any time by pressing the **ON** Softkey. ON Mode generates Mode A and Mode S replies, but Mode C altitude reporting is inhibited. In ON Mode, a green ON indication and transponder code appear in the mode field of the Transponder Data Box.

ALTITUDE MODE (AUTOMATIC OR MANUAL)

Altitude Mode is automatically selected when the aircraft becomes airborne. Altitude Mode may also be selected manually by pressing the **ALT** Softkey.

If Altitude Mode is selected, a green ALT indication and transponder code appear in the mode field of the Transponder Data Box, and all transponder replies requesting altitude information are provided with pressure altitude information.

REPLY STATUS

When the transponder sends replies to interrogations, a white R indication appears momentarily in the Transponder Data Box.

ENTERING A TRANSPONDER CODE

Entering a transponder code:

- 1) From the full-screen PFD and/or split-screen PFD Page, press the **XPDR** Softkey.
- 2) Press the **CODE** Softkey. A Transponder Code Box appears with the cursor on the first digit in the code.
- 3) Enter the desired code using the **FMS** Joystick and press the **ENT** Key.



*Transponder
Code Entry*

*CODE
Softkey*

Transponder Code Entry (Split-Screen PFD Page)

VFR CODE

The VFR code can be entered either manually or by pressing the **XPDR** Softkey, then the **CODE** Softkey, then the **VFR** Softkey. When the **VFR** Softkey is pressed, the pre-programmed VFR code is automatically displayed in the code field of the Transponder Data Box. Pressing the **VFR** Softkey again restores the previous identification code.

IDENT FUNCTION

Pressing the **IDENT** Softkey sends a distinct identity indication to Air Traffic Control (ATC). The indication distinguishes the identifying transponder from all the others on the air traffic controller's screen. When the **IDENT** Softkey is pressed, a white IDENT indication is displayed in the mode field of the Transponder Data Box for a duration of 18 seconds.

FLIGHT ID REPORTING



NOTE: The Flight ID must be configured to 'Set By Pilot' in Configuration Mode for the **SET ID** Softkey to appear. Refer to the G3X Installation Manual for more information.

Entering a Flight ID:

- 1) From the full-screen PFD and/or the split-screen PFD Page, press the **XPDR** Softkey.
- 2) Press the **MODE** Softkey.
- 3) Press the **SET ID** Softkey. The 'SET FLIGHT ID' Window appears.
- 4) Enter the desired Flight ID using the **FMS** Joystick and press the **ENT** Key.



Transponder

Flight ID
Entry

Flight ID Entry (Split-Screen PFD Page)

- System Overview
- Flight Instruments
- EIS
- CNS Interface**
- GPS Navigation
- Flight Planning
- Hazard Avoidance
- Additional Features
- Integrated Autopilot
- Annun/Alerts
- Appendix
- Index

Blank Page

SECTION 5 GPS NAVIGATION

5.1 INTRODUCTION

The Map Page displays aviation data (e.g., airports, VORs, airways, airspaces), geographic data (e.g., cities, lakes, highways, borders), and topographic data (map shading indicating elevation) to be used for situational awareness only. The Navigation Map can be oriented three different ways: North Up (NORTH UP), Track Up (TRK UP) or Desired Track Up (DTK UP).

An aircraft icon is placed on the Navigation Map at the location corresponding to the calculated present position. The aircraft position and the flight plan legs are accurately based on GPS calculations. The basemap upon which these are placed are from a source with less resolution, therefore the relative position of the aircraft to map features is not exact. The leg of the active flight plan currently being flown is shown as a magenta line on the navigation map. The other legs are shown in white.

The Direct-to Window, the Flight Plan Pages, and the Nearest Airports Pages can be displayed by pressing the corresponding hardkeys.

COMPASS ARC



NOTE: *The compass arc is not available in 'North Up' map orientation.*

A compass arc representing the aircraft's ground track, appears by default on the Map Page. The route line represents the course.

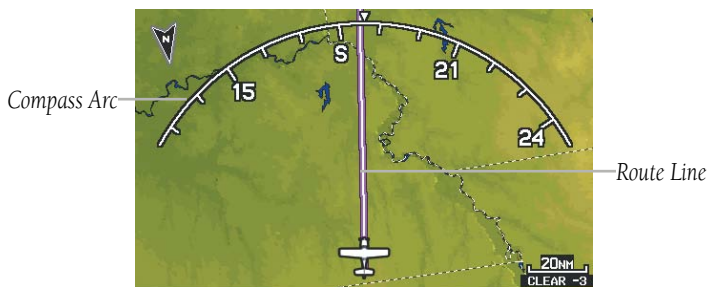

Compass Arc (Map Page)

Removing the Compass Arc from the Map Page:

- 1) With the Map Page displayed, press the **MENU** Key.
- 2) Turn or move the **FMS** Joystick to highlight 'Set Up Map' and press the **ENT** Key.
- 3) Turn the **FMS** Joystick to highlight the 'General' Menu.
- 4) Move the **FMS** Joystick to highlight the 'Compass Arc' field.
- 5) Turn the **FMS** Joystick to access the 'On/Off' drop down list.
- 6) Turn or move the **FMS** Joystick to highlight 'Off', and press the **ENT** Key.

5.2 USING MAP DISPLAYS



WARNING: The G3X map displays are to be used for situational awareness only.

Map displays are used extensively in the G3X to provide situational awareness in flight. Most G3X maps can display the following information:

- Airports, NAVAIDs, airspaces, airways, land data (highways, cities, lakes, rivers, borders, etc.) with names
- Map Pointer information (distance and bearing to pointer, location of pointer, name, and other pertinent information)
- Map range
- Aircraft icon (representing present position)
- Flight plan legs
- User waypoints
- Track vector
- Topography data

The information in this section applies to the following maps unless otherwise noted:

- All Map Pages (MAP)
- Waypoint Page (WPT)

- Split-Screen: The Waypoint Page when the **RUNWAY** Softkey is pressed.
- Full-Screen: The Waypoint Page when the **INFO** Softkey is pressed.

- All Nearest Pages (NRST) (Full-Screen)
- Flight Plan Pages (FPL) (Full-Screen)
- Direct-to Window (Full-Screen)

MAP PAGE SETUP

MAP ORIENTATION

Maps are shown in one of three different orientation options, allowing flexibility in determining aircraft position relative to other items on the map (North Up) or for determining where map items are relative to where the aircraft is going (Track Up), or desired track up (DTK UP).

- North Up aligns the top of the map display to north (default setting).
- Track Up aligns the top of the map display to the current ground track.
- Desired Track (DTK) Up aligns the top of the map display to the desired course.



NOTE: Map orientation can only be changed on the Map Page. Any other pages that show navigation data reflect the orientation selected for the Map Page.

Changing the Navigation Map orientation:

- 1) With the Map Page displayed, press the **MENU** Key.
 - 2) Turn or move the **FMS** Joystick to highlight 'Set Up Map' and press the **ENT** Key.
 - 3) Turn the **FMS** Joystick to highlight the 'General' Menu.
 - a) Move the **FMS** Joystick to highlight the 'Orientation' field.
 - b) Turn the **FMS** Joystick to access a list of available options.
 - c) Turn or move the **FMS** Joystick to highlight 'North Up', 'Track Up', or 'DTK Up', and press the **ENT** Key.
- Or:**
- a) Move the **FMS** Joystick to highlight the 'North Up Above' field.

- b) Turn the **FMS** Joystick to access a list of available range options.
- c) Turn or move the **FMS** Joystick to highlight the desired range above which to display North Up orientation.

Or:

- a) Move the **FMS** Joystick to highlight the 'North Up On GRND' field.
- b) Using the **FMS** Joystick highlight 'On' or 'Off', and press the **ENT** Key. When 'North Up On GRND' is 'ON' (default), the map orientation will change to North Up when the aircraft is on the ground.



Map Page Menu

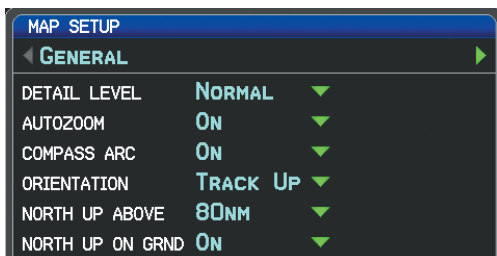

General Menu (Map Setup Page)

AIRPORTS & NAVAIDS

Airport and NAVAID information can be customized to display a variety of information including: runway extension lines, runway numbers and visual reporting points (VRP). Runway extension lines show runway orientation relative to other landmarks and terrain features and are intended to aid in planning traffic pattern entry and/or departure routing.



Runway Extensions and Numbers (Map Page)

Setting up and customizing airports and NAVAIDs for the map page:

- 1) From the Map Page press the **MENU** Key.
- 2) Turn or move the **FMS** Joystick to highlight 'Set Up Map' and press the **ENT** Key.
- 3) Turn the **FMS** Joystick to select the 'Airport' or 'NAVAID' Category from the horizontal list.
- 4) Move the **FMS** Joystick to highlight the desired feature.
- 5) Turn the **FMS** Joystick to access a list of options for each feature (On/Off, Auto, range settings, text size, etc).
- 6) Using the **FMS** Joystick select the desired option and press the **ENT** Key.
- 7) Press the **FMS** Joystick, the **CLR** Key, or the **EXIT** Softkey to return to the Map Page with the changed settings.



Map Setup Page (Airport Category)

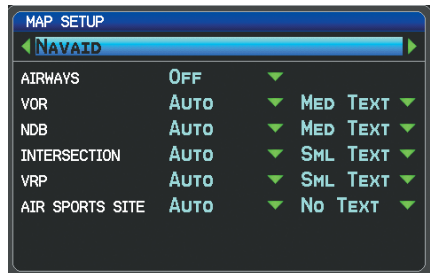

Map Setup Page (NAVAID Category)

CITIES & ROADS

Setting up and customizing cities and roads for the map page:

- 1) From the Map Page press the **MENU** Key.
- 2) Turn or move the **FMS** Joystick to highlight 'Set Up Map' and press the **ENT** Key.
- 3) Turn the **FMS** Joystick to select the 'City' or 'Road' Category from the horizontal list.
- 4) Move the **FMS** Joystick to highlight the desired feature.
- 5) Turn the **FMS** Joystick to access a list of options for each feature (On/Off, Auto, range settings, or text size).
- 6) Using the **FMS** Joystick select the desired option and press the **ENT** Key.

- Press the **FMS** Joystick, the **CLR** Key, or the **EXIT** Softkey to return to the Map Page with the changed settings.



Map Setup Page (City Category)

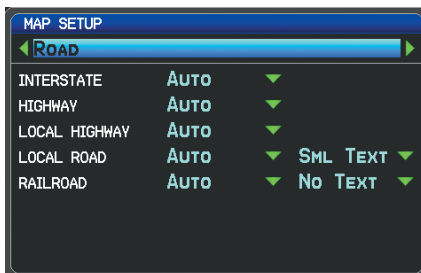

Map Setup Page (Road Category)

AIRSPACE

Setting up and customizing airspace for the map page:

- From the Map Page press the **MENU** Key.
- Turn or move the **FMS** Joystick to highlight 'Set Up Map' and press the **ENT** Key.
- Turn the **FMS** Joystick to select the 'Airspace' or 'SUA' (Special Use Airspace) Category from the horizontal list.
- Move the **FMS** Joystick to highlight the desired feature.
- Turn the **FMS** Joystick to access a list of options for each feature (On/Off, Auto, range settings, All (Atlantic), or Below (Atlantic)).
- Using the **FMS** Joystick select the desired option and press the **ENT** Key.
- Press the **FMS** Joystick, the **CLR** Key, or the **EXIT** Softkey to return to the Map Page with the changed settings.



Map Setup Page (Airspace Category)

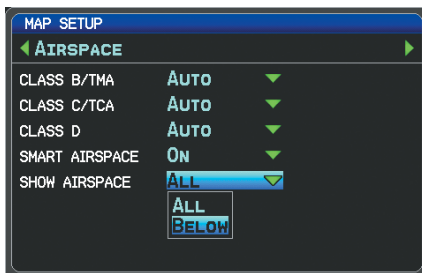

Map Setup Page (Airspace Category - Atlantic)

MAP RANGE



NOTE: Refer to the Additional Features section for information on changing the FliteCharts® or ChartView range.

There are 23 different map ranges available, from 200 feet to 800 nm. The current range is indicated in the lower right corner of the map. The scale bar represents the map scale. To change the map range on any map, use the down arrow on the **RNG** Key to zoom in (decreasing), or the up arrow to zoom out (increasing).

When the selected range exceeds the resolution of the map data, 'overzoom' appears below the map range scale.



Scale Bar Representing a Map Scale of 3 nm Per Scale Width.

Map Range/Overzoom
(Split-Screen)

AUTO ZOOM

Auto Zoom allows the G3X to change the map display range to the smallest range clearly showing the active waypoint. Auto Zoom can be overridden by adjusting the range and remains that way until the active waypoint changes, a terrain or traffic alert occurs, or the aircraft takes off.

Enabling/disabling autozoom:

- 1) With the Map Page displayed, press the **MENU** Key.
- 2) Turn or move the **FMS** Joystick to highlight 'Set Up Map' and press the **ENT** Key.
- 3) Turn the **FMS** Joystick to highlight the 'General' Menu.
- 4) Move the **FMS** Joystick to highlight the 'Autozoom' field.
- 5) Turn the **FMS** Joystick to access the 'On/Off' drop down list.
- 6) Turn or move the **FMS** Joystick to highlight the desired option, and press the **ENT** Key.

MAP PANNING

Map panning allows the pilot to:

- View parts of the map outside the displayed range without adjusting the map range
- Highlight and select locations on the map
- Review information for a selected airport, NAVAID or user waypoint
- Designate locations for use in flight planning
- View airspace and airway information

When the panning function is selected by pressing the **FMS** Joystick (**PAN MAP** Softkey on the Weather Page) the Map Pointer flashes on the map display. A window also appears at the top of the map display showing the latitude/longitude position of the pointer, the bearing and distance to the pointer from the aircraft's present position, the elevation of the land at the position of the pointer, or the object's (airports, obstacles, etc) elevation, if known.

When the Map Pointer is placed on a map feature, the map feature is highlighted and an information box appears (even if the name was not originally displayed on the map).

Pressing the **ENT** Key displays a review page for the highlighted map feature. If multiple features are present at the Map Pointer position, a green arrow will appear in the information box. Turning the **FMS** Joystick will cycle through the list of map features present at that position.

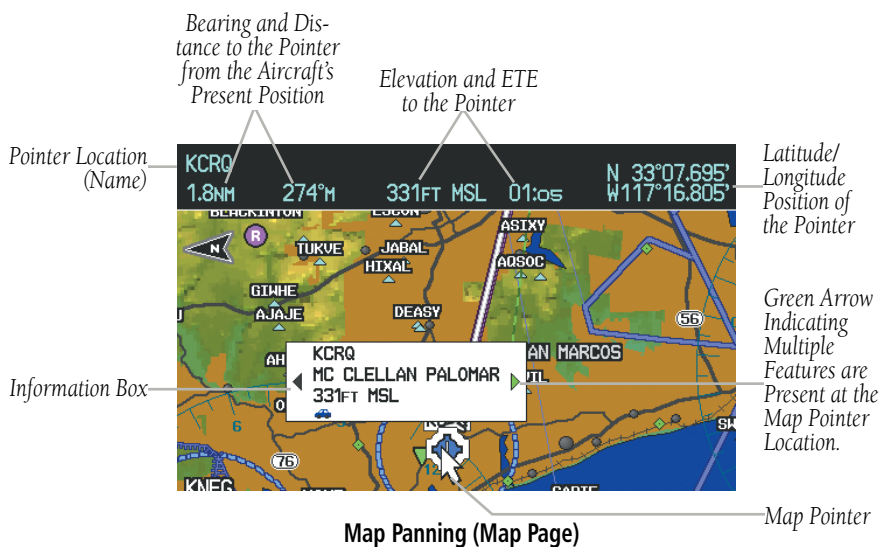

Panning the map:

- 1) Press the **FMS** Joystick (or **PAN MAP** Softkey on the Weather (WX) Page) to display the Map Pointer.
- 2) Move the **FMS** Joystick to move the Map Pointer around the map.
- 3) Press the **FMS** Joystick to remove the Map Pointer and re-center the map on the aircraft's current position.

Reviewing information for a map feature:

- 1) Place the Map Pointer on a map feature. If multiple map features are present at the Map Pointer position (green arrow in the information box), turn the **FMS** Joystick to cycle through the list.
- 2) Press the **ENT** Key to display the review page for the highlighted feature.
- 3) Press the **FMS** Joystick, the **CLR** Key, or the **ENT** Key to exit the review page and return to the Map Page showing the selected waypoint.

FUEL RANGE RING



WARNING: The G3X Fuel Calculator and/or Fuel Range Rings are NOT intended to be relied upon as the primary fuel indicator(s), and does not relieve the pilot from the responsibility of proper flight planning. G3X fuel calculations do not use the aircraft fuel quantity indicators and are calculated from the last time the fuel was reset.

The Navigation Map can display fuel range rings which show the remaining flight distance. If current fuel endurance is greater than reserve, range-to-empty is shown as a solid green circle and range-to-reserve is a dashed green circle. If current endurance is less than reserve, range-to-empty is shown as a solid yellow circle. Fuel range rings are offset to show the effects of the wind at the current location (e.g., does not account for wind variations throughout the range).

Displaying/removing the fuel range rings and selecting a fuel reserve time:

- 1) From the Map Page, press the **MENU** Key.
- 2) Turn or move the **FMS** Joystick to highlight 'Set Up Map', and press the **ENT** Key.
- 3) Turn the **FMS** Joystick to highlight the 'Map' Category from the horizontal list.
- 4) Move the **FMS** Joystick to highlight the 'Fuel Range (RSV)' field.
- 5) Using the **FMS** Joystick select (On/Off) or set the fuel reserve time and press the **ENT** Key.
- 6) Press the **FMS** Joystick, the **CLR** Key, or the **EXIT** Softkey to return to the Map Page with the changed settings.

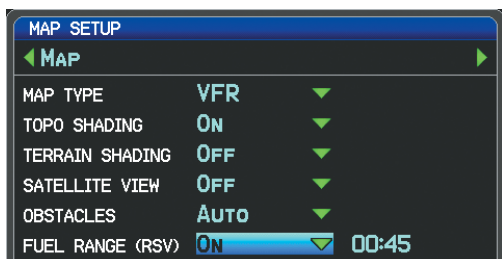

Map Menu (Map Setup Page)

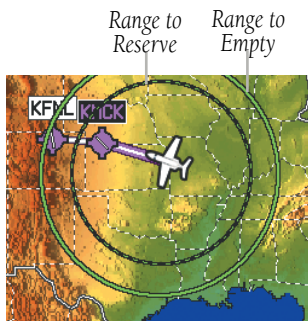

Navigation Map

Fuel Reserve Time

MEASURING BEARING AND DISTANCE

Distance and bearing from the aircraft's present position to any point on the viewable navigation map may be calculated using the 'Measure Distance' selection from Map Page menu. The distance tool displays a dashed Measurement Line and a Map Pointer to aid in graphically identifying points to measure. Lat/Long, bearing, distance, and elevation data for the Map Pointer is provided in a window at the top of the Map Page.

Measuring bearing and distance between any two points:

- 1) From the Map Page, press the **MENU** Key.
- 2) Turn or move the **FMS** Joystick to highlight 'Measure Distance' and press the **ENT** Key. A Measure Pointer is displayed on the map at the aircraft's present position.
- 3) Move the **FMS** Joystick to place the reference pointer at the desired location. The bearing and distance are displayed at the top of the map. Elevation at the current pointer position is also displayed. Pressing the **ENT** Key changes the starting point for measuring.
- 4) To exit the Measure Bearing/Distance option, press the **FMS** Joystick; or select 'Stop Measuring' from the Page Menu and press the **ENT** Key.

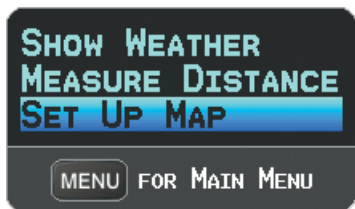

Map Page Menu

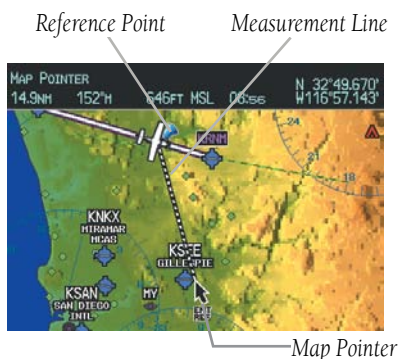

Map Page (Measure Distance)

TOPOGRAPHY

Topographic data can be displayed or removed as described in the following procedures.

Displaying/removing topographic data:

- 1) Press the **MAP** Softkey on the Map Page. Press the **VFR MAP** Softkey (if necessary).
- 2) Press the **TOPO** Softkey. Topographic data is displayed.
- 3) Press the **TOPO** Softkey again to remove topographic data from the Navigation Map.

Or:

- 1) From the Map Page, press the **MENU** Key.
- 2) Turn or move the **FMS** Joystick to highlight 'Set Up Map', and press the **ENT** Key.
- 3) Turn the **FMS** Joystick to highlight the 'Map' Category from the horizontal list.
- 4) Move the **FMS** Joystick to highlight the 'Topo Shading' field.
- 5) Turn the **FMS** Joystick to select 'On' or 'Off', and press the **ENT** Key.



VFR MAP Softkey

TOPO Softkey

Topographic Data (Map Page) (Split-Screen)

SATELLITE VIEW

The Satellite View displays satellite imagery above 20nm.

Displaying/removing satellite imagery on the map page:

- 1) Press the **MAP** Softkey on the Map Page. Press the **VFR MAP** Softkey (if necessary).
- 2) Press the **SAT VIEW** Softkey. Satellite imagery is displayed on the map.
- 3) Press the **SAT VIEW** Softkey again to remove satellite imagery from the Navigation Map.

Or:

- 1) From the Map Page, press the **MENU** Key.
- 2) Turn or move the **FMS** Joystick to highlight 'Set Up Map', and press the **ENT** Key.
- 3) Turn the **FMS** Joystick to highlight the 'Map' Category from the horizontal list.
- 4) Move the **FMS** Joystick to highlight the 'Satellite View' field.
- 5) Turn the **FMS** Joystick to select 'On' or 'Off', and press the **ENT** Key.

System
Overview

Flight
Instruments

EIS

CNS
Interface

GPS
Navigation

Flight
Planning

Hazard
Avoidance

Additional
Features

Integrated
Autopilot

Annun/Alerts

Appendix

Index



VFR MAP Softkey

SAT VIEW Softkey

Satellite View (Map Page) (Split-Screen)

MAP PAGE TRAFFIC

Enabling/disabling traffic on the Map Page:

- 1) From the Map Page, press the **MENU** Key.
- 2) Turn or move the **FMS** Joystick to highlight 'Set Up Map', and press the **ENT** Key.
- 3) If necessary, turn the **FMS** Joystick to highlight the 'Map' Category from the horizontal list.
- 4) Move the **FMS** Joystick to highlight the 'Traffic Data' field.
- 5) Turn the **FMS** Joystick to select 'On' or 'Off', and press the **ENT** Key.

MAP SYMBOLS

Refer to Appendix G for a list of map symbols.

MAP DECLUTTER

The pilot can remove (declutter) unwanted items, such as highways from the map.

Decluttering the Map Page:

- 1) From any Map Page, press the **CLR** Key. 'CLEAR-1' appears below the map range. The background symbols (such as highways, cities, rivers, and smaller lakes) are removed from the map.
- 2) Press the **CLR** Key again. 'CLEAR-2' appears below the map range and airspace boundary detail is removed from the map.
- 3) Press the **CLR** Key again. 'CLEAR-3' appears below the map range. Only the waypoints and nav aids that are part of the current flight plan appear on the map.
- 4) Press the **CLR** Key again to return 'ALL' detail to the map.



Map Declutter (Split-Screen)

MAP DETAIL

The map detail can also be adjusted. Map detail changes the amount of detail with respect to the zoom scale.

Adjusting the map detail:

- 1) From the Map Page, press the **MENU** Key.
- 2) Turn or move the **FMS** Joystick to highlight 'Set Up Map', and press the **ENT** Key.
- 3) Turn the **FMS** Joystick to highlight the 'General' Category from the horizontal list.
- 4) Move the **FMS** Joystick to highlight the 'Detail Level' field.
- 5) Turn the **FMS** Joystick to select the desired detail level ('Most', 'More', 'Normal', 'Less', or 'Least'), and press the **ENT** Key.

5.3 AIRWAYS



WARNING: Do not use the approach information provided by the VFR navigation database residing within the G3X as a means of navigating any instrument approach. The G3X VFR navigation database is limited to present only the waypoints for the final approach leg of a published procedure. These waypoints and associated course line are made available for monitoring purposes only.

Low Altitude Airways (or Victor Airways) primarily serve smaller piston-engine, propeller-driven airplanes on shorter routes and at lower altitudes. Airways are eight nautical miles wide and start 1,200 feet above ground level (AGL) and extend up to but not including 18,000 feet mean sea level (MSL). Low Altitude Airways are designated with a "V" before the airway number (hence the name "Victor Airways") since they run primarily between VORs.

High Altitude Airways (or Jet Routes) primarily serve airliners, jets, turboprops, and turbocharged piston aircraft operating above 18,000 feet MSL. Jet Routes start at 18,000 feet MSL and extend upward to 45,000 feet MSL (altitudes above 18,000 feet are called "flight levels" and are described as FL450 for 45,000 feet MSL). Jet Routes are designated with a "J" before the route number.

Low Altitude Airways are drawn in gray. High Altitude Airways are drawn in green. When both types of airways are displayed, high altitude airways are drawn on top of Low Altitude Airways.

When airways are selected for display on the map, the airway waypoints (VORs, NDBs, and Intersections) are also displayed.

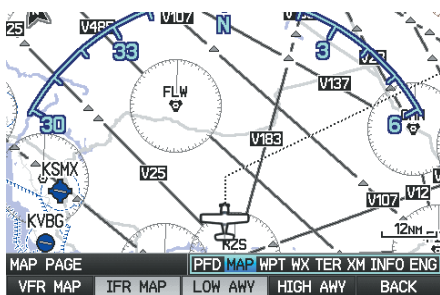

IFR Map - Low Airways (Victor Airways)
(Split-Screen)

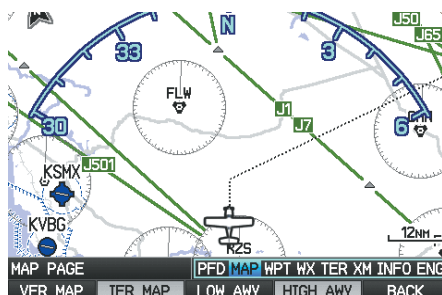

IFR Map - High Airways (Jet Routes)
(Split-Screen)

Airways may be displayed on the map at the pilot's discretion using the **MAP** Softkey on the Map Page.

Displaying/removing airways:

- 1) Press the **MAP** Softkey on the Map Page.
- 2) Press the **IFR MAP** Softkey to display the IFR Map and related softkeys.
- 3) Press the **LOW AWY** Softkey to display/remove the Low Altitude Airways.
- 4) Press the **HIGH AWY** Softkey to display/remove the High Altitude Airways.
- 5) Press the **BACK** Softkey to return to the top-level softkeys.

Reviewing information for an airway:

- 1) From the Map Page, press the **MAP** Softkey.
- 2) Press the **IFR MAP** Softkey (if necessary).
- 3) With the **LOW AWY** and/or **HIGH AWY** Softkeys selected, press the **FMS** Joystick to display the Map Pointer.
- 4) Place the Map Pointer on an airway. The MEA, name of airway, endpoints, distance, and calculated radials are displayed.

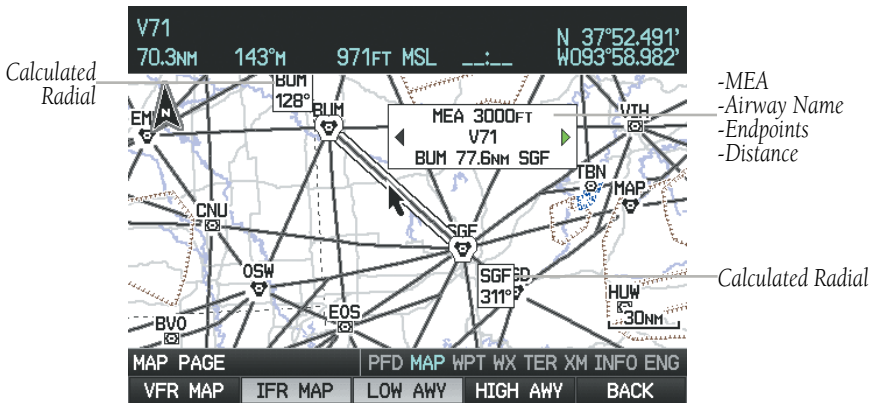

Reviewing Airway Information (Map Page)
(Split-Screen)

- 5) Press the **ENT** Key to display the review page for the airway.

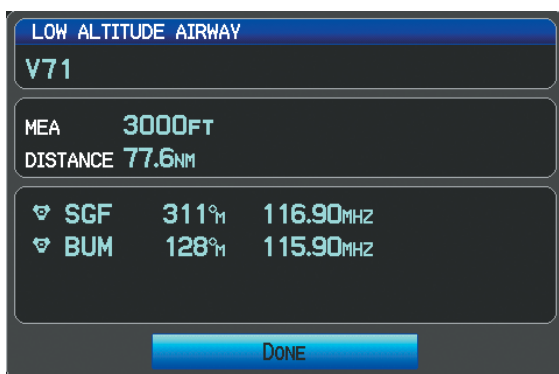

Low Altitude Airway Review Page
(Split-Screen)

- Press the **FMS** Joystick, the **CLR** Key, or the **ENT** Key to exit the review page and return to the Map Page.

5.4 WAYPOINTS

The Waypoint (WPT) Page provides airport and waypoint information.

Waypoints are predetermined geographical positions (internal database) or pilot-entered positions, and are used for all phases of flight planning and navigation.

Waypoints can be changed by entering the ICAO identifier, entering the name of the facility, or by entering the city name. As a waypoint identifier, facility name, or location is entered, the G3X's Spell'N'Find™ feature scrolls through the database, displaying those waypoints matching the characters which have been entered up to that point. A direct-to navigation leg to the selected waypoint can be initiated by pressing the Direct-to Key from the Waypoint Page.

The Waypoint Page allows the pilot to review airport information, runway information, frequencies, instrument procedures, airport directory information, and weather information. The pilot can manually enter the identifier or the G3X will choose the most appropriate identifier based on the current position and phase of flight.

The following descriptions and abbreviations are used:

- Usage type: Public, Military, or Private
- Runway surface type: Hard, Turf, Sealed, Gravel, Dirt, Soft, Unknown, or Water
- Runway lighting type: No Lights, Part Time, Full Time, Unknown, or PCL Freq (for pilot-controlled lighting)
- COM Availability: TX (transmit only), RX (receive only), PT (part time), * (additional information available)

-Waypoint Identifier/Symbol/Type
-Facility Name
-City/Region

COM/NAV
Freq. Info.
-Identification
-Frequency
-Availability
-Additional
Information

Airport
Information
-Elevation
-Fuel Available
-Time Zone
(UTC Offset)
-Lat/Long (Full)
-Bearing/Distance

INFO Softkey Selected

**Waypoint Page (INFO Softkey Selected)
(Split-Screen)**

Runway
Information
-Designation
-Length/Width
-Surface
-Lighting
-Traffic Pattern
-Wind (Full)

Map
Showing
Selected
Waypoint

RUNWAY Softkey Selected

**Waypoint Page (RUNWAY Softkey Selected)
(Split-Screen)**



Waypoint Page (INFO Softkey Selected)
(Full-Screen MFD)

Selecting an airport for review by identifier, facility name, or location:

- 1) From the Waypoint (WPT) Page, press the **INFO** Softkey.
- 2) Press the **FMS** Joystick to activate the cursor.
- 3) Turn the **FMS** Joystick clockwise to begin entering a waypoint identifier (turning it counter-clockwise brings up the waypoint selection submenu - press the **CLR** Key or the **FMS** Joystick to remove it), or move the **FMS** Joystick to select the facility name, or city field.
- 4) Press the **ENT** Key.

If duplicate entries exist for the entered facility name or location, additional entries may be viewed by continuing to turn the **FMS** Joystick during the selection process. If duplicate entries exist for an identifier, a Duplicate Waypoints Window is displayed. Press the **ENT** Key to move the cursor to the Duplicate Waypoints Window.

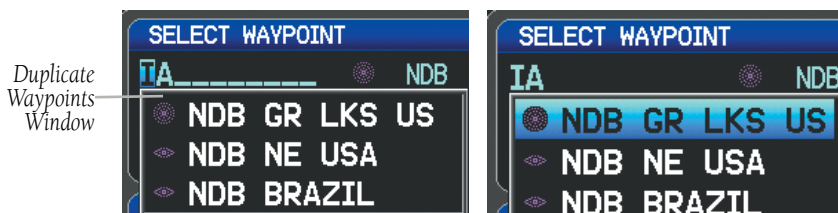

Waypoint Information Window-Duplicate Identifier

Selecting a runway:

- 1) With the Waypoint (WPT) Page displayed, press the **INFO** Softkey.
- 2) Press the **FMS** Joystick to activate the cursor.
- 3) Turn the **FMS** Joystick clockwise to begin entering a waypoint identifier for the desired runway (turning it counter-clockwise brings up the waypoint selection submenu - press the **CLR** Key or the **FMS** Joystick to remove it), or move the **FMS** Joystick to select the facility name, or city field.
- 4) Press the **ENT** Key. Full-Screen: continue to **Step 7**.
- 5) Press the **RUNWAY** Softkey (split-screen only).
- 6) Press the **FMS** Joystick to activate the cursor (split-screen only).
- 7) Move the **FMS** Joystick to place the cursor in the 'Runway' Box, on the runway designator.



Runways Box (Waypoint Page)

- 8) Turn the **FMS** Joystick to display the desired runway (if more than one) for the selected airport.

Viewing additional information for a frequency:

The Frequencies Box uses the descriptions and abbreviations listed in the following table:

Communication Frequencies			Navigation Frequencies
Approach *	Control	Pre-Taxi	ILS
Arrival *	CTA *	Radar	LOC
ASOS	Departure *	Ramp	
ATIS	Gate	Terminal*	
AWOS	Ground	TMA *	
Center	Helicopter	Tower	
Class B *	Multicom	TRSA *	
Class C *	Other	Unicom	
Clearance			
* May include Additional Information			

Frequency Abbreviations

- 1) With the Waypoint (WPT) Page displayed, press the **INFO** Softkey.
- 2) Press the **FMS** Joystick to activate the cursor.
- 3) Move the **FMS** Joystick to place the cursor in the 'Frequencies' Box, on the frequency denoted with an *.

FREQUENCIES		
ATIS	RX	132.650
ASOS	RX	132.650
CLEARANCE		132.900
GROUND		121.700
TOWER		119.700
UNICOM		122.950
DEPARTURE	*	120.550

Additional Frequency Information (Waypoint Page)

- 4) Press the **ENT** Key to view the Additional Information Window.
- 5) To remove the window, press the **FMS** Joystick, **ENT** Key, or **CLR** Key.

To quickly view the departure or destination airport information:

- 1) From the Waypoint (WPT) Page, press the **INFO, RUNWAY, CHART, AOPA / DIRECTORY**, or **WEATHER** Softkey.
- 2) Press the **MENU** Key.
- 3) Turn or move the **FMS** Joystick to highlight 'View Destination Airport' or 'View Departure Airport', and press the **ENT** Key.

NEAREST INFORMATION

The G3X provides a **NRST** Key which gives the pilot quick access to nearest airport, weather, VOR, NDB, intersection, user waypoint, city, ARTCC, FSS, and airspace information. If none are available, "None Within 200 NM" is displayed.

Pressing the **ENT** Key displays the associated 'Information Page' for the highlighted selection (except for the Nearest ARTCC, and Nearest FSS pages), similar to the Waypoint Page. Pressing the **ENT** Key again returns to the Nearest Page.

Viewing nearest information:

- 1) Press the **NRST** Key.
- 2) Turn the **FMS** Joystick to select the desired Nearest Page (APT, WX, VOR, NDB, INT, USR, CTY, ATC, FSS, or ASPC). If none are available, "None Within 200 NM" is displayed.
- 3) Press the **FMS** Joystick to highlight the first selection in the list. Turn or move the **FMS** Joystick to highlight the desired nearest option.
- 4) Press the **ENT** Key to display the associated 'Information Page' (except for the Nearest ARTCC and Nearest FSS pages). From the Airport Information Page, press the **INFO, CHART, AOPA / DIRECTORY**, or **WEATHER** Softkeys for additional information. From the User Waypoint Information Page, press the **DELETE**, or **EDIT** softkeys to make changes to the selected user waypoint.
- 5) To return to the Nearest Page, press the **FMS** Joystick, the **ENT** Key, or the **CLR** Key.



Nearest Airports Page
(Split-Screen)



Airport Information Page
(Split-Screen)

NEAREST AIRPORT CRITERIA

From the Menu on the Nearest Airports Page the pilot can define the minimum runway length and surface type used when determining the 15 nearest airports to display on the Nearest Airports Page. A minimum runway length and/or surface type can be entered to prevent airports with small runways or runways that are not appropriately surfaced from being displayed. Default settings are 0 feet (or meters) for runway length and "Any" for runway surface type. Private airports and Heliports can also be included.

The Page Menu also allows the pilot to choose between displaying the facility names, city names, bearing, or direction arrows.

To quickly show/hide private airport and heliports from the Nearest Airports Page, press the **PRIVATE** or **HELIPORT** Softkeys.

Setting nearest airport criteria:

- 1) With the Nearest Airports Page displayed, press the **MENU** Key.
- 2) Turn or move the **FMS** Joystick to select 'Set Airport Criteria' from the Page Menu.
- 3) Press the **ENT** Key. The Airport Criteria Window is displayed.
- 4) Move the **FMS** Joystick to select the desired criteria to be defined.
- 5) Turn the **FMS** Joystick to select the desired option.
- 6) Press the **ENT** Key.



Nearest Airports Page Menu

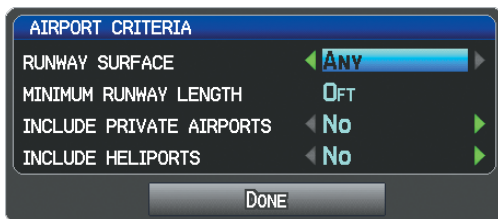

Airport Criteria Window

Restoring nearest airport criteria defaults:

- 1) With the Nearest Airports Page displayed, press the **MENU** Key.
- 2) Turn or move the **FMS** Joystick to select 'Set Airport Criteria' from the Page Menu.
- 3) Press the **ENT** Key. The Airport Criteria Window is displayed.
- 4) Move the **FMS** Joystick to select the desired criteria to be restored.
- 5) Press the **MENU** Key.
- 6) With 'Restore Default' highlighted, press the **ENT** Key.

WEATHER INFORMATION

Textual weather information can be viewed from the Waypoint Page or the Nearest WX Page. Refer to the Hazard Avoidance section for information on XM Weather.

Selecting airport weather information:

- 1) From the Waypoint Page, press the **WEATHER** Softkey.
- 2) Press the **FMS** Joystick to activate the cursor.
- 3) Turn the **FMS** Joystick clockwise to begin entering an airport identifier (turning it counter-clockwise brings up the waypoint selection submenu - press the **CLR** Key or the **FMS** Joystick to remove it).
- 4) Press the **ENT** Key.

Or:

- 1) Press the **NRST** Key.
- 2) Turn the **FMS** Joystick to select the Nearest Airport WX Page. If Nearest Airport Weather is not available, "None Within 200 NM" is displayed.
- 3) Press the **FMS** Joystick to highlight the first airport in the nearest airport weather list. Turn or move the **FMS** Joystick to highlight the desired airport weather.

- 4) Press the **ENT** Key to display the Weather Information Page.
- 5) Turn the **FMS** Joystick to scroll up or down on the page.
- 6) To return to the Nearest Airport Weather Page, press the **FMS** Joystick, the **ENT** Key, or the **CLR** Key.



Nearest Airport Weather Page
(Split-Screen)



Weather Information Page
(Split-Screen)

INTERSECTIONS

Intersections can be viewed from the Waypoint Page or the Nearest Intersections Page. In addition to displaying a map of the currently selected intersection and surrounding area, the Intersection Information Page displays the region, bearing, distance, latitude, and longitude.

Selecting an intersection:

- 1) From the Waypoint Page, press the **INFO** Softkey.
- 2) Press the **FMS** Joystick to activate the cursor.
- 3) Turn the **FMS** Joystick clockwise to begin entering an intersection identifier (turning it counter-clockwise brings up the waypoint selection submenu - press the **CLR** Key or the **FMS** Joystick to remove it), or move the **FMS** Joystick to select the facility name, or city field.
- 4) Press the **ENT** Key.

Or:

 - 1) Press the **NRST** Key.
 - 2) Turn the **FMS** Joystick to select the Nearest Intersections Page.
 - 3) Press the **FMS** Joystick to activate the cursor.
 - 4) Turn or move the **FMS** Joystick to highlight the desired intersection.
 - 5) Press the **ENT** Key to display the Intersection Information Page.

NDBs

NDBs can be viewed from the Waypoint Page or the Nearest NDBs Page. In addition to displaying a map of the currently selected NDB and surrounding area, the page displays the region, bearing, distance, latitude, longitude, and frequency.

The Nearest NDB Page can be used to quickly find a NDB close to the flight path. The list only includes NDBs that are within 200nm. If there are no NDBs in the list, text indicating that there are no nearest NDBs is displayed. If there are no nearest NDBs in the list, the information and frequency fields are dashed.

Selecting a NDB:

- 1) From the Waypoint Page, press the **INFO** Softkey if necessary.
- 2) Press the **FMS** Joystick to activate the cursor.
- 3) Turn the **FMS** Joystick clockwise to begin entering the identifier (turning it counter-clockwise brings up the waypoint selection submenu - press the **CLR** Key or the **FMS** Joystick to remove it), or move the **FMS** Joystick to select the facility name, or city field.
- 4) Press the **ENT** Key.

Or:

- 1) Press the **NRST** Key.
- 2) Turn the **FMS** Joystick to select the Nearest NDBs Page.
- 3) Press the **FMS** Joystick to activate the cursor.
- 4) Turn the **FMS** Joystick to highlight the desired NDB.
- 5) Press the **ENT** Key to display the NDB Information Page.

VORs

VORs can be viewed from the Waypoint Page or the Nearest VORs Page. In addition to displaying a map of the currently selected VOR and surrounding area, the page displays the region, city, state, bearing, distance, latitude, longitude, frequency, and class (High, Low, or Terminal VOR).

The Nearest VOR Page can be used to quickly find a VOR close to the flight path. The list only includes VORs that are within 200nm. If there are no VORs in the list, text indicating that there are no nearest VORs is displayed. If there are no nearest VORs in the list, the information and frequency fields are dashed.

Localizer information cannot be viewed on the VOR Information Page. If a VOR station is combined with a TACAN station it is listed as a VORTAC on the VOR Information Page and if it includes only DME, it's displayed as VOR-DME.

Selecting a VOR:

- 1) From the Waypoint Page, press the **INFO** Softkey.
- 2) Press the **FMS** Joystick to activate the cursor.
- 3) Turn the **FMS** Joystick clockwise to begin entering identifier (turning it counter-clockwise brings up the waypoint selection submenu - press the **CLR** Key or the **FMS** Joystick to remove it), or move the FMS Joystick to select the facility name, or city field.
- 4) Press the **ENT** Key.

Or:

- 1) Press the **NRST** Key.
- 2) Turn the **FMS** Joystick to select the Nearest VOR Page.
- 3) Press the **FMS** Joystick to activate the cursor.
- 4) Turn the **FMS** Joystick to highlight the desired VOR.
- 5) Press the **ENT** Key to display the VOR Information Page.

USER WAYPOINTS

The G3X can create and store up to 3,000 user-defined waypoints. Once a waypoint has been created, it can be renamed, deleted, or moved.

Creating user waypoints:

- 1) To create a user waypoint at the current location, using the Map Pointer, or from the Main Menu:
 - a) To create a user waypoint at the current location, press and hold the **ENT** Key from any page.
 - b) The 'Mark a New User Waypoint?' Window appears.
- Or:**
- a) Press the **MENU** Key twice to access the Main Menu.
 - b) Move the **FMS** Joystick to highlight 'User Waypoints' and press the **ENT** Key.

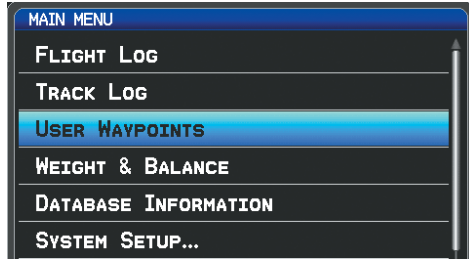

Main Menu (User Waypoints Selected)
(Split-Screen)

- c) Press the **NEW** Softkey. The message "Create a New User Waypoint?" is displayed.
 - d) Enter a user waypoint name (up to 10 characters). The current aircraft position is the default location of the new waypoint.
- Or:**
- a) From a map page, press the **FMS** Joystick to activate the Map Pointer (on the WX Page, press the **PAN MAP** Softkey).
 - b) Find an empty area without any map features and press the **ENT** Key. The message "Create a New User Waypoint?" is displayed.
- Or:**
- a) From a map page, press the **FMS** Joystick to activate the Map Pointer (on the WX Page, press the **PAN MAP** Softkey).
 - b) Select a map feature using the Map Pointer and press the **MENU** Key.
 - c) With 'Create User Waypoint' highlighted, press the **ENT** Key. The message "Create a New User Waypoint?" is displayed.
- 2) With 'Yes' highlighted, press the **ENT** Key. The New Waypoint Window is displayed.
 - 3) Move the **FMS** Joystick to the User Waypoint Name Field and enter the waypoint name, if desired.
 - 4) If desired, select the waypoint symbol:
 - a) Move the **FMS** Joystick to highlight the Symbol.
 - b) Turn the **FMS** Joystick to access the 'Select Symbol' Menu.
 - c) Turn or move the **FMS** Joystick to highlight the desired symbol from the menu, and press the **ENT** Key.

- System Overview
- Flight Instruments
- EIS
- CNS Interface
- GPS Navigation
- Flight Planning
- Hazard Avoidance
- Additional Features
- Integrated Autopilot
- Annun/Alerts
- Appendix
- Index

- System Overview
- Flight Instruments
- EIS
- CNS Interface
- GPS Navigation
- Flight Planning
- Hazard Avoidance
- Additional Features
- Integrated Autopilot
- Annun/Alerts
- Appendix
- Index

Symbol Field (Selected) User Waypoint Name Field

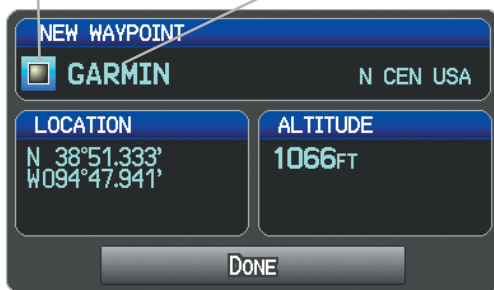

New Waypoint Window (Symbol Selected)

- 5) If desired, press the **POSITION** Softkey and enter the latitude, longitude, name, or altitude for the waypoint **or** press the **REF WPTS** Softkey to enter a bearing and distance from another waypoint or the bearing from two other waypoints to define the new waypoint location.



**New Waypoint Window
(POSITION Softkey Selected)
(Split-Screen)**



**New Waypoint Window
(REF WPTS Softkey Selected)
(Split-Screen)**

- 6) With 'Done' highlighted, press the **ENT** Key.

Selecting and viewing nearest user waypoints:

- 1) Press the **NRST** Key.
- 2) Turn the **FMS** Joystick to select the Nearest USR Page.
- 3) Press the **FMS** Joystick to activate the cursor.
- 4) Turn the **FMS** Joystick to highlight the desired user waypoint.
- 5) Press the **ENT** Key to display the User Waypoint Information Window.

Editing or renaming a user waypoint:

- 1) Press the **MENU** Key twice to access the Main Menu.
- 2) Move the **FMS** Joystick to highlight 'User Waypoints' and press the **ENT** Key.
- 3) Move the **FMS** Joystick to highlight the appropriate waypoint and press the **EDIT** Softkey. The Edit Waypoint Window is displayed.
- 4) Move the cursor to the desired field(s) and make any necessary changes (to edit the Reference Waypoints, press the **REF WPTS** Softkey).
- 5) With 'Done' highlighted, press the **ENT** Key.

Deleting user waypoints:

- 1) Press the **MENU** Key twice to access the Main Menu.
- 2) Turn or Move the **FMS** Joystick to highlight 'User Waypoints' and press the **ENT** Key. If deleting all user waypoints, go to Step 4.
- 3) Highlight a User Waypoint in the User Waypoint List, or enter a waypoint in the User Waypoint field.
- 4) Press the **MENU** Key.

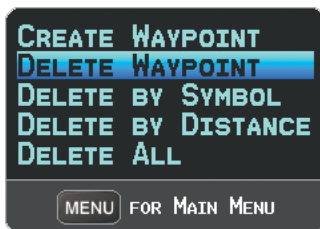

User Waypoints Page Menu

- 5) Select 'Delete Waypoint' or 'Delete All'.
- 6) Press the **ENT** Key. 'No' is highlighted in the confirmation window.
- 7) With 'Yes' highlighted in the confirmation window, press the **ENT** Key.

Or:

- 1) Press the **MENU** Key twice to access the Main Menu.
- 2) Turn or Move the **FMS** Joystick to highlight 'User Waypoints' and press the **ENT** Key.
- 3) Highlight a User Waypoint in the User Waypoint List, or enter a waypoint in the User Waypoint field.
- 4) Press the **ENT** Key.
- 5) Press the **DELETE** Softkey. 'No' is highlighted in the confirmation window.
- 6) Highlight 'Yes' and press the **ENT** Key.

User Waypoints can also be deleted by 'Symbol' or 'Distance' from the User Waypoints Page Menu.

AUTOMATIC WAYPOINT SELECTION

Automatic waypoint selection is the system's attempt to deduce what Waypoint to display based on the aircraft's location in relation to the departure airport and/or the waypoints in the Flight Plan.

The pilot can override Automatic Waypoint Selection by manually entering a waypoint. The automatic selection will not resume until such time that the manually entered waypoint and the automatically selected waypoint coincide (does not apply if the **CHART** Softkey is selected). To manually return to Automatic Waypoint Selection, highlight the identifier and press the **CLR** Key.

5.5 AIRSPACE

The Nearest Airspace Page and Airspace Alerts provide information about airspaces and the location of the aircraft in relationship to them. The Nearest Airspace Page can be used to quickly find airspaces close to the flight path.

The Nearest Airspace Page displays the class of airspace, controlling agency, vertical boundaries, and status.

Selecting and viewing nearest airspaces:

- 1) Press the **NRST** Key.
- 2) Turn the **FMS** Joystick to select the Nearest Airspace Page.
- 3) Press the **FMS** Joystick to highlight the nearest airspace. Turn or move the **FMS** Joystick to highlight the desired airspace.
- 4) Press the **ENT** Key to display the Airspace Information Page.
- 5) Press the **FREQS** Softkey (if available) to display frequency and additional airport information similar to the Waypoint Information Page.

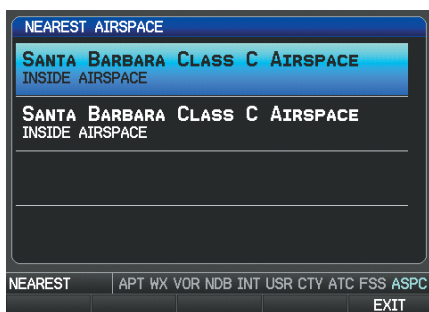

Nearest Airspace Page
(Split-Screen)

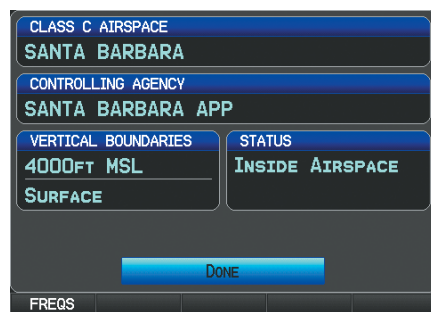

Airspace Information Page
(Split-Screen)

The Full-Screen Display will also show a map with the nearest airspace highlighted.

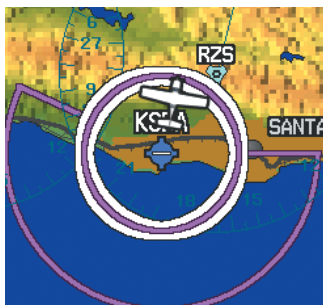

Nearest Airspace Page Map

AIRSPACE ALERT MESSAGES

When an airspace alert appears, press the **NRST** Key to automatically show nearby airspace information on the Nearest Airspace Page. This information includes name, time to entry (if applicable), and status.

There are four types of status information:

- Ahead—Projected to enter the airspace within the next 10 minutes or less
- Near—Within two nautical miles of an airspace but not projected to enter it
- Near & Ahead—Projected to enter the airspace within two nautical miles
- Inside Airspace—Within the boundaries of the airspace

SMART AIRSPACE

Smart Airspace shows airspace at and immediately surrounding the aircraft's current altitude in bold. Airspaces at all other altitudes are de-emphasized.



Smart Airspace

5.6 DIRECT-TO NAVIGATION USING THE G3X



NOTE: The G3X **Direct-to** Key is disabled while using an external GPS navigator. Press the **INTERNAL** Softkey on the Direct-to Page to make changes to the active flight plan from the G3X. Press the **EXTERNAL** Softkey to return to the external GPS navigator's flight plan.

The Direct-to method of navigation, initiated by pressing the **Direct-to** Key is quicker to use than a flight plan when the desire is to navigate to a single point such as a nearby airport.

Once a direct-to is activated, the G3X establishes a point-to-point course line from the present position to the selected direct-to destination. Course guidance is provided until the direct-to is replaced with a new direct-to or flight plan, or cancelled.

Entering a waypoint identifier, facility name, or city as a direct-to destination:

- 1) Press the **Direct-to** Key. The Direct-to Window is displayed (with the active flight plan waypoint as the default selection or a blank waypoint field if no flight plan is active).
- 2) If an external navigator is configured, press the **INTERNAL** Softkey.
- 3) Turn the **FMS** Joystick clockwise to begin entering a waypoint identifier (turning it counter-clockwise brings up the waypoint selection submenu - press the **CLR** Key or the **FMS** Joystick to remove it), press the **RECENT** Softkey to display a list of recent waypoints, or move the **FMS** Joystick to select the facility name, or city field.
- 4) Press the **ENT** Key.
- 5) With 'Activate' highlighted, press the **ENT** Key.



Direct-to Window (Split-Screen)

Selecting RECENT WPTS, NRST APTS, or FPL WPTS as a direct-to destination:

- 1) Press the **Direct-to** Key. The Direct-to Window is displayed (with the active flight plan destination as the default selection or a blank destination if no flight plan is active).
- 2) If an external navigator is configured, press the **INTERNAL** Softkey.
- 3) Press the **RECENT** Softkey to display a list of recent waypoints (RECENT WPTS) only or turn the **FMS** Joystick counter-clockwise to display a list of recent waypoints (RECENT WPTS), nearest airports (NRST APTS), and flight plan waypoints (FPL WPTS).
- 4) Move the **FMS** Joystick to select the desired waypoint.
- 5) Press the **ENT** Key.
- 6) With 'Activate' highlighted, press the **ENT** Key.



Direct-to Window (Flight Plan Waypoints Selected)
(Split-Screen)

Selecting a nearby airport as a direct-to destination:

- 1) Press the **NRST** Key.
- 2) Select the desired airport (the nearest one is already selected).
- 3) Press the **Direct-to** Key.
- 4) If an external navigator is configured, press the **INTERNAL** Softkey.
- 5) Press the **ENT** Key.
- 6) With 'Activate' highlighted, press the **ENT** Key.

Direct-to destinations may also be selected by using the pointer on the navigation map pages. If no airport, NAVAID, or user waypoint exists at the desired location, a temporary waypoint named 'MAP POINTER' is automatically created at the location of the map arrow.

Selecting a waypoint as a direct-to destination using the pointer:

- 1) From a navigation map page, press the **FMS** Joystick to display the pointer.
- 2) Move the **FMS** Joystick to place the pointer at the desired destination location.
- 3) If the pointer is placed on an existing airport, NAVAID, or user waypoint, the waypoint name is highlighted.
- 4) Press the **Direct-to** Key to display the Direct-to Window with the selected point entered as the direct-to destination.
- 5) If an external navigator is configured, press the **INTERNAL** Softkey.

- 6) Press the **ENT** Key.
- 7) With 'Activate' highlighted, press the **ENT** Key.

Canceling or resuming a direct-to:

- 1) Press the **Direct-to** Key to display the Direct-to Window.
- 2) If an external navigator is configured, press the **INTERNAL** Softkey.
- 3) Move the **FMS** Joystick to highlight 'Stop Navigation' or 'Resume Flight Plan' if a flight plan was active.
- 4) Press the **ENT** Key. If a flight plan is still active, the G3X resumes navigating the flight plan.

Or:

- 1) Press the **FPL** Key.
- 2) If an external navigator is configured, press the **INTERNAL** Softkey.
- 3) Press the **Menu** Key.
- 4) Turn or move the **FMS** Joystick to highlight 'Stop Navigation' or 'Resume Flight Plan' if a flight plan was active.
- 5) Press the **ENT** Key. If a flight plan is still active, the system resumes navigating the flight plan.

SECTION 6 FLIGHT PLANNING

6.1 INTRODUCTION



NOTE: In order to add, delete, or change flight plan waypoints from the G3X when an external GPS navigator is configured, press the **INTERNAL** Softkey from the Active Flight Plan Page or Direct-to Page. Press the **EXTERNAL** Softkey to return to the external GPS navigator's flight plan.



NOTE: While navigating using an external GPS navigation source, the ability to edit/invert/delete the Active Flight Plan or activate a Saved Flight Plan is disabled.



NOTE: The Saved Flight Plan Page is not available from the full-screen PFD.

Flight planning on the G3X consists of building a flight plan by entering waypoints one at a time and inserting approaches as needed. The flight plan is displayed on maps using different line widths, colors, and types, based on the type of leg and the segment of the flight plan currently being flown.

Up to 50 flight plans with up to 300 waypoints each can be created and stored in memory. One flight plan can be activated at a time and becomes the active flight plan. The active flight plan is erased when the destination is reached and the system is turned off. When storing flight plans with an approach, the G3X uses the waypoint information from the current database to define the waypoints. If the database is changed or updated, the G3X automatically updates the information if the procedure has not been modified. If an approach is no longer available, the procedure is deleted from the affected stored flight plan(s), and an alert is displayed.

Whenever an approach is loaded into the active flight plan it replaces the destination airport with a sequence of waypoints for the selected approach. The airport must have a published instrument approach and only the final course segment (usually from final approach fix to missed approach point) of the published approach is available if an external navigator (i.e., GTN or GNS Series) is not configured.

FLIGHT PLAN DATA FIELDS

By default, the Data Fields on the Active and Saved Flight Plan Pages are set to display Leg Desired Track (DTK), Leg Distance (DIST), and Leg Estimated Time En Route (ETE). The first two Data Fields can be changed using the Page Menu. The last Data Field can be changed using the **FMS** Joystick.

Changing the information shown in the flight plan data fields:

From the Active Flight Plan Page or the Saved Flight Plan Page, move the **FMS** Joystick (right or left) to quickly change the third data field.

Or:

- 1) From the Active Flight Plan Page or the Saved Flight Plan Page, press the **MENU** Key.
- 2) If an external navigator is configured, press the **INTERNAL** Softkey.
- 3) Turn or move the **FMS** Joystick to highlight 'Change Data Fields' and press the **ENT** Key. The cursor is displayed on the first Data Field.
- 4) If desired, move the **FMS** Joystick to highlight the second Data Field.
- 5) Turn the **FMS** Joystick to access the list of available Data Fields.
- 6) Turn or Move the **FMS** Joystick to highlight the desired option from the list and press the **ENT** Key.

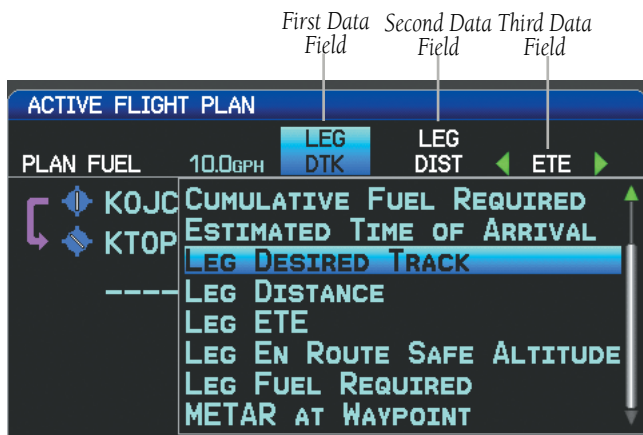

Data Field Selection (Active Flight Plan Page)

Viewing fuel remaining at each waypoint:

From the Active Flight Plan Page, move the **FMS** Joystick (right or left) to quickly change the third data field to Fuel Remaining (FUEL REM).

MANUALLY SWITCHING BETWEEN INTERNAL AND EXTERNAL FLIGHT PLAN SOURCES



NOTE: The selection of the internal GPS navigation source to persist through power cycles or reset to the external GPS navigation source is dependant on the configuration. Refer to the G3X Installation Manual for more information.

Press the **INTERNAL** Softkey on the Active Flight Plan Page or the Direct-to Page, to temporarily allow flight planning through the G3X using the internal GPS flight plan when an external GPS Navigator is configured. Press the **EXTERNAL** Softkey to return to the external GPS navigator's flight plan.

When manually selecting the internal GPS flight plan, 'INT' is displayed in light blue in the upper left corner of the Data Bar as well as the lower left quadrant of the HSI.

Using Internal GPS Flight Plan



INT: The pilot has elected to use the internal GPS navigation source instead of the external GPS navigation source.

Internal Flight Plan Indication

Switching between internal and external flight plan sources:

From the Active Flight Plan Page or the Direct-to Page, touch the **INTERNAL** or **EXTERNAL** Softkey to switch between the internal and external flight plan sources when an external GPS Navigator is configured.

FAILURE OF THE EXTERNAL GPS NAVIGATION SOURCE

If the external GPS navigation source fails, the system reverts to the internal GPS navigation source and 'REV' is shown in yellow in the upper left corner of the Data Bar as well as the lower left quadrant of the HSI.



External
GPS Failure.
Reverted to
Internal GPS

REV: External
Navigation Source
failed. Reverted to
internal VFR GPS
for navigation.

External GPS Navigation Failure

- System Overview
- Flight Instruments
- EIS
- CNS Interface
- GPS Navigation
- Flight Planning
- Hazard Avoidance
- Additional Features
- Integrated Autopilot
- Annun/Alerts
- Appendix
- Index

6.2 FLIGHT PLAN CREATION USING THE G3X

The active flight plan is listed on the Active Flight Plan Page. It is the flight plan to which the G3X is currently providing guidance, and is shown on the navigation maps. Stored flight plans are listed on the Flight Plan List Page, and are available for activation (becomes the active flight plan).

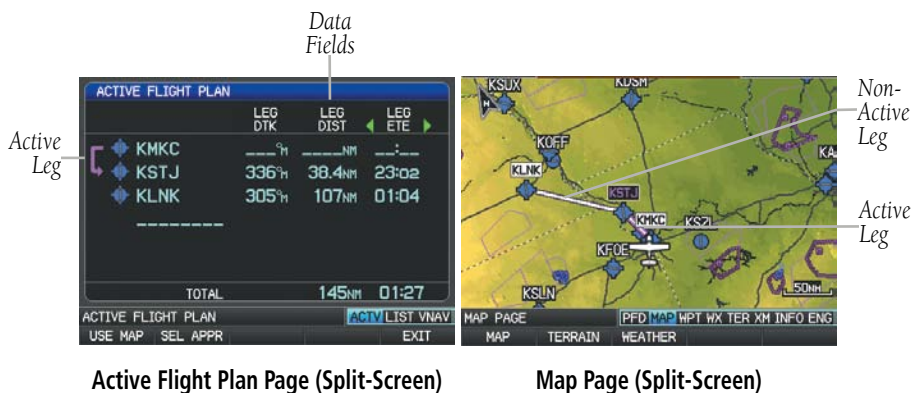

Creating an active flight plan using the G3X:

- 1) Press the **FPL** Key.
- 2) If an external navigator is configured, press the **INTERNAL** Softkey.
- 3) Press the **FMS** Joystick to activate the cursor.
- 4) Turn the **FMS** Joystick to display the Insert Waypoint Window. (Turning it clockwise displays a blank Insert Waypoint Window, turning it counter-clockwise displays a list of recent waypoints (RECENT WPTS), nearest airports (NRST APTS), or flight plan waypoints (FPL WPTS)).



Insert Waypoint Window (Split-Screen)

- 5) Enter the identifier, facility, or city name of the departure waypoint or select a waypoint from the submenu of waypoints and press the **ENT** Key. The active flight plan is modified as each waypoint is entered.
- 6) Repeat step numbers 3 and 4 to enter each additional flight plan waypoint.
- 7) When all waypoints have been entered, press the **FMS** Joystick to remove the cursor.

Creating a stored flight plan using the G3X:

- 1) Press the **FPL** Key.
- 2) If an external navigator is configured, press the **INTERNAL** Softkey.
- 3) Turn the **FMS** Joystick to display the Flight Plan List Page.
- 4) Press the **NEW** Softkey; or press the **MENU** Key, highlight 'New Flight Plan', and press the **ENT** Key to display a blank flight plan for the first empty storage location.
- 5) Turn the **FMS** Joystick to display the Insert Waypoint Window (Turning it clockwise displays a blank Insert Waypoint Window, turning it counter-clockwise displays the a list of recent waypoints (RECENT WPTS), nearest airports (NRST APTS), or flight plan waypoints (FPL WPTS)).
- 6) Enter the identifier, facility, or city name of the departure waypoint or select a waypoint from the submenu of waypoints and press the **ENT** Key.
- 7) Repeat steps 4 and 5 to enter each additional flight plan waypoint.
- 8) When all waypoints have been entered, press the **FMS** Joystick to return to the Flight Plan List Page. The new flight plan is now in the list.

6.3 FLIGHT PLAN STORAGE USING THE G3X

The G3X can store up to 50 flight plans. The active flight plan is erased when another flight plan is activated. Details about each stored flight plan can be viewed on the Flight Plan List Page

Viewing information about a stored flight plan:

- 1) Press the **FPL** Key.
- 2) Turn the **FMS** Joystick to display the Flight Plan List Page.
- 3) Press the **FMS** Joystick to activate the cursor and turn or move the **FMS** Joystick to highlight the desired flight plan.
- 4) Press the **ENT** Key. The Saved Flight Plan Page is displayed showing departure, destination, total distance, and enroute safe altitude information for the selected Flight Plan.
- 5) Press the **FMS** Joystick or **DONE** Softkey to exit the Saved Flight Plan Page.



Flight Plan List Page (Split-Screen)



Saved Flight Plan Page (Split-Screen)

Storing an active flight plan from the Active Flight Plan Page:

- 1) Press the **FPL** Key.
- 2) Turn the **FMS** Joystick to select the Active Flight Plan Page.
- 3) Press the **MENU** Key. The Active Flight Plan Page Menu is displayed.
- 4) Turn or move the **FMS** Joystick to Highlight 'Save Flight Plan'.
- 5) Press the **ENT** Key.
- 6) With 'Yes' highlighted, press the **ENT** Key. A copy of the flight plan is stored in the next available position in the flight plan list on the Flight Plan List Page.

- System Overview
- Flight Instruments
- EIS
- CNS Interface
- GPS Navigation
- Flight Planning
- Hazard Avoidance
- Additional Features
- Integrated Autopilot
- Annun/Alerts
- Appendix
- Index

6.4 FLIGHT PLAN ACTIVATION USING THE G3X

Activating a stored flight plan erases the active flight plan and replaces it with a copy of the flight plan being activated. Inverting a stored flight plan reverses the waypoint order, erases the active flight plan, and replaces it with the flight plan being activated (the stored flight plan is not changed).

Activating a stored flight plan:

- 1) Press the **FPL** Key and turn the **FMS** Joystick to display the Flight Plan List Page.
- 2) If an external navigator is configured, press the **INTERNAL** Softkey.
- 3) Press the **FMS** Joystick to activate the cursor, and turn or move the **FMS** Joystick to highlight the desired flight plan.
- 4) Press the **ACTIVATE** Softkey; or press the **MENU** Key, highlight 'Activate Flight Plan', and press the **ENT** Key. The 'Activate XXXXX-XXXXX' confirmation window appears (only if already navigating a flight plan).
- 5) With 'Yes' highlighted, press the **ENT** Key. To cancel the request, press the **CLR** Key, the **FMS** Joystick, or highlight 'No' and press the **ENT** Key.

Activating a Flight Plan Leg:

- 1) Press the **FPL** Key.
- 2) If an external navigator is configured, press the **INTERNAL** Softkey.
- 3) Turn the **FMS** Joystick to display the Active Flight Plan Page.
- 4) Press the **FMS** Joystick to activate the cursor and move the **FMS** Joystick to highlight the waypoint leg to be activated.
- 5) Press the **Direct-to** Key twice. The "Activate Leg XXXXX - XXXXX?" window is displayed.



Activate Leg Window

- 6) With 'Yes' highlighted, press the **ENT** Key. To cancel the request, press the **CLR** Key, the **FMS** Joystick, or highlight 'No' and press the **ENT** Key.

6.5 FLIGHT PLAN EDITING

ADDING WAYPOINTS TO AN EXISTING FLIGHT PLAN

Waypoints can be added to the active flight plan or any stored flight plan. Choose the flight plan, select the desired point of insertion, enter the waypoint, and it is added in front of the selected waypoint. Flight plans are limited to 300 waypoints (including approach waypoints).

Adding a waypoint to a stored flight plan:

- 1) On the Flight Plan List Page, press the **FMS** Joystick to activate the cursor.
- 2) Turn or move the **FMS** Joystick to highlight the desired flight plan.
- 3) Press the **ENT** Key.
- 4) Move the **FMS** Joystick select the point in the flight plan to add the new waypoint. The new waypoint is placed directly in front of the highlighted waypoint.
- 5) Turn the **FMS** Joystick to display the Insert Waypoint Window. Turning it clockwise displays a blank Insert Waypoint Window, turning it counter-clockwise displays the a list of recent waypoints (RECENT WPTS), nearest airports (NRST APTS), or flight plan waypoints (FPL WPTS).

Or:

Press the **MENU** Key, highlight 'Insert Waypoint', and press the **ENT** Key.

- 6) Enter the identifier, facility, or city name of the departure waypoint or select a waypoint from the submenu of waypoints.
- 7) Press the **ENT** Key.

Adding a waypoint to the active flight plan:

- 1) Press the **FPL** Key.
- 2) If an external navigator is configured, press the **INTERNAL** Softkey.
- 3) Press the **FMS** Joystick to activate the cursor.
- 4) Using the **FMS** Joystick select the point in the flight plan before which to add the new waypoint. The new waypoint is placed directly in front of the highlighted waypoint.

- Turn the **FMS** Joystick to display the Insert Waypoint Window. Turning it clockwise displays a blank Insert Waypoint Window, turning it counter-clockwise displays the a list of recent waypoints (RECENT WPTS), nearest airports (NRST APTS), or flight plan waypoints (FPL WPTS).

Or:

Press the **MENU** Key, highlight 'Insert Waypoint', and press the **ENT** Key.

- Enter the identifier, facility, or city name of the departure waypoint or select a waypoint from the submenu of waypoints and press the **ENT** Key. The active flight plan is modified as each waypoint is entered.

Adding a waypoint to the active or saved flight plan using the map:

- Press the **FPL** Key.
- If an external navigator is configured, press the **INTERNAL** Softkey.
- From the Active Flight Plan Page or from the Saved Flight Plan Page, press the **USE MAP** Softkey to activate the map pointer.
- Move the **FMS** Joystick to highlight the desired flight plan leg to be modified.

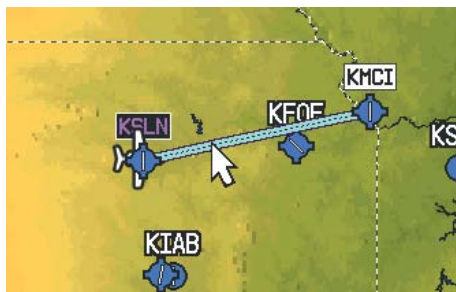

Active Flight Plan Page (Flight Plan Leg Highlighted with Map Pointer)

- With the desired flight plan leg highlighted (blue), press the **ENT** Key (the flight plan leg turns magenta). This will split the flight plan leg.
- Using the **FMS** Joystick, drag the flight plan leg to highlight the desired waypoint to be added.

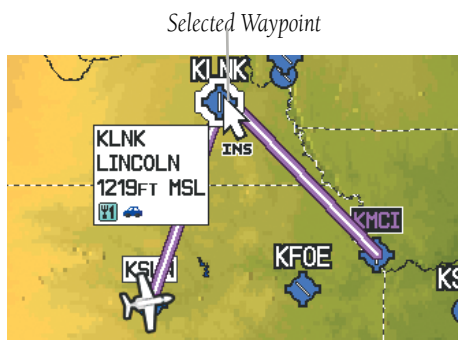

Active Flight Plan Page (Waypoint Selected with Map Pointer)

- 7) With the desired waypoint highlighted, press the **ENT** Key. The flight plan is now modified to include the added waypoint.
- 8) Press the **DONE** Softkey (from the Flight Plan List Page only).

EDITING FLIGHT PLAN SPEED, FUEL, AND/OR NAME



NOTE: If a fuel flow sensor is configured, the user-entered 'Plan Fuel' value is used while on the ground. In the air, the 'Plan Fuel' field is hidden and the fuel calculations are based on the actual measured fuel flow.

Adjusting the Active Flight Plan fuel:

- 1) Press the **FPL** Key and turn the **FMS** Joystick to display the Active Flight Plan Page.
- 2) If an external navigator is configured, press the **INTERNAL** Softkey.
- 3) Press the **FMS** Joystick to activate the cursor, and move the **FMS** Joystick to highlight the 'Plan Fuel' field.
- 4) Using the **FMS** Joystick, enter the desired plan flow, and press the **ENT** Key.

Plan Fuel Field



Plan Fuel (Active Flight Plan Page)

Adjusting the Saved Flight Plan speed and fuel:

- 1) Press the **FPL** Key and turn the **FMS** Joystick to display the Flight Plan List Page.
- 2) Press the **FMS** Joystick to activate the cursor, and turn or move the **FMS** Joystick to highlight the desired flight plan, and press the **ENT** Key. The Saved Flight Plan Page is displayed.
- 3) Move the **FMS** Joystick to the 'Plan Speed' field.
- 4) Using the **FMS** Joystick, enter the desired speed, and press the **ENT** Key.
- 5) Repeat steps 3 and 4 for 'Plan Fuel', and press the **DONE** Softkey.

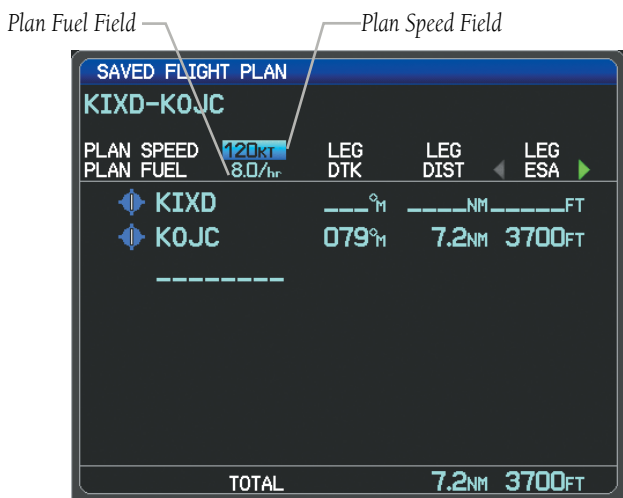

Plan Speed and Plan Fuel (Saved Flight Plan Page)

Editing the Saved Flight Plan name:

- 1) Press the **FPL** Key and turn the **FMS** Joystick to display the Flight Plan List Page.
- 2) Press the **FMS** Joystick to activate the cursor, and turn or move the **FMS** Joystick to highlight the desired flight plan, and press the **ENT** Key. The Saved Flight Plan Page is displayed.
- 3) Move the **FMS** Joystick to highlight the Flight Plan Name field.
- 4) Using the **FMS** Joystick, enter the flight plan name, and press the **ENT** Key.



Editing the Saved Flight Plan Name

COPYING FLIGHT PLANS

The G3X allows copying a flight plan into a new flight plan memory slot, allowing editing, etc., without affecting the original flight plan. This can be used to duplicate an existing stored flight plan for use in creating a modified version of the original stored flight plan.

Copying a stored flight plan:

- 1) Press the **FPL** Key and turn the **FMS** Joystick to display the Flight Plan List Page.
- 2) Press the **FMS** Joystick to activate the cursor, and turn or move the **FMS** Joystick to highlight the desired flight plan.
- 3) Press the **MENU** Key, using the **FMS** Joystick highlight 'Copy Flight Plan', and press the **ENT** Key.

DELETING FLIGHT PLANS

Individual or all stored flight plans can be deleted from the G3X memory.

Deleting a stored flight plan:

- 1) Press the **FPL** Key and turn the **FMS** Joystick to display the Flight Plan List Page.
- 2) Press the **FMS** Joystick to activate the cursor, and turn or move the **FMS** Joystick to highlight the desired flight plan.
- 3) Press the **CLR** Key; or press the **MENU** Key, highlight 'Delete Flight Plan', and press the **ENT** Key.
- 4) With 'Yes' highlighted, press the **ENT** Key to delete the flight plan. To cancel the request, press the **CLR** Key, the **FMS** Joystick, or highlight 'No' and press the **ENT** Key.

Deleting all stored flight plans:

- 1) Press the **FPL** Key and turn the **FMS** Joystick to display the Flight Plan List Page.
- 2) Press the **MENU** Key, highlight 'Delete All', and press the **ENT** Key.
- 3) With 'Yes' highlighted, press the **ENT** Key to delete all saved flight plans. To cancel the request, press the **CLR** Key, the **FMS** Joystick, or highlight 'No' and press the **ENT** Key.



NOTE: The changes made to the active flight plan affect navigation as soon as they are entered. Editing the active flight plan does not affect any saved flight plans. Waypoints in the final approach segment (such as the FAF or MAP) can not be deleted individually.

Deleting the Active Flight Plan:

- 1) Press the **FPL** Key to display the Active Flight Plan Page.
- 2) If an external navigator is configured, press the **INTERNAL** Softkey.
- 3) Press the **MENU** Key.
- 4) With 'Stop Navigation' highlighted, press the **ENT** Key.

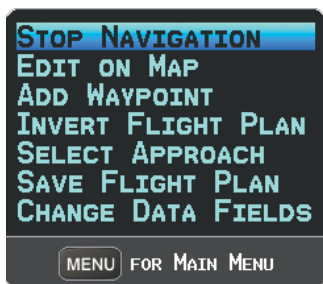

Active Flight Plan Page Menu

Deleting an individual waypoint from the active flight plan:

- 1) Press the **FPL** Key to display the Active Flight Plan Page.
- 2) If an external navigator is configured, press the **INTERNAL** Softkey.
- 3) Press the **FMS** Joystick to activate the cursor and turn or move the **FMS** Joystick to highlight the waypoint to be deleted.
- 4) Press the **CLR** Key or press the **MENU** Key and highlight 'Remove Waypoint'. The 'Remove XXXXX From Flight Plan?' window is displayed.



Remove Waypoint Window

- 5) With 'Yes' highlighted, press the **ENT** Key. To cancel the request, press the **CLR** Key, the **FMS** Joystick, or highlight 'No' and press the **ENT** Key.

Deleting an individual waypoint from a saved flight plan:

- 1) Press the **FPL** Key.
- 2) Turn the **FMS** Joystick to display the Flight Plan List Page if necessary.
- 3) Press the **FMS** Joystick to activate the cursor and turn or move the **FMS** Joystick to highlight the flight plan to be edited and press the **ENT** Key.
- 4) Move the **FMS** Joystick to highlight the waypoint to be deleted.
- 5) Press the **CLR** Key or press the **MENU** Key and highlight 'Remove Waypoint'. The 'Remove XXXXX From Flight Plan?' window is displayed.
- 6) With 'Yes' highlighted, press the **ENT** Key. To cancel the request, press the **CLR** Key, the **FMS** Joystick, or highlight 'No' and press the **ENT** Key.

INVERTING A FLIGHT PLAN

Any flight plan may be inverted (reversed) for navigation back to the original departure point.

Inverting the active flight plan:

- 1) Press the **FPL** Key to display the Active Flight Plan Page.
- 2) If an external navigator is configured, press the **INTERNAL** Softkey.
- 3) Press the **MENU** Key, turn or move the **FMS** Joystick to highlight 'Invert Flight Plan', and press the **ENT** Key. An "Invert the Active Flight Plan?" confirmation window is displayed.
- 4) With 'Yes' highlighted, press the **ENT** Key to invert the active flight plan. To cancel, press the **CLR** Key, the **FMS** Joystick, or highlight 'No' and press the **ENT** Key.

Inverting a saved flight plan:

- 1) Press the **FPL** Key and turn the **FMS** Joystick to display the Flight Plan List Page.
- 2) Press the **FMS** Joystick to activate the cursor.
- 3) Move the **FMS** Joystick to highlight the desired flight plan, and press the **ENT** Key. The Saved Flight Plan Page is displayed.
- 4) Press the **MENU** Key, highlight 'Invert Flight Plan?', and press the **ENT** Key.
- 5) With 'Yes' highlighted, press the **ENT** Key. To cancel the request, press the **CLR** Key, the **FMS** Joystick, or highlight 'No' and press the **ENT** Key.

IMPORTING/EXPORTING FLIGHT PLANS

Importing flight plans:

- 1) With a flight plan saved to the SD Card, press the **FPL** Key and turn the **FMS** Joystick to display the Flight Plan List Page.
- 2) Press the **IMPORT** Softkey.
- 3) Using the **FMS** Joystick highlight the desired flight plan to import.
- 4) Press the **IMPORT** Softkey again and press the **ENT** Key.

Exporting flight plans:

- 1) Press the **FPL** Key and turn the **FMS** Joystick to display the Flight Plan List Page.
- 2) Press the **FMS** Joystick to activate the cursor, and turn or move the **FMS** Joystick to highlight the desired flight plan.
- 3) Press the **EXPORT** Softkey and press the **ENT** Key.

6.6 APPROACHES (WITHOUT EXTERNAL NAVIGATOR CONFIGURED)



WARNING: Do not use the approach information provided by the VFR navigation database residing within the G3X as a means of navigating any instrument approach. The G3X VFR navigation database is limited to present only the waypoints for the final approach leg of a published procedure. These waypoints and associated course line are made available for monitoring purposes only.



NOTE: This section is not applicable if an external GPS navigator is configured. Approach configuration is handled via the external GPS navigator's controls only. Refer to the external GPS navigator's Pilot's Guide for more information.

An approach can be loaded at any airport that has one available, and provides situational awareness for non-precision and precision approaches to airports with published instrument approach procedures. Only one approach can be loaded at a time in a flight plan. If an approach is loaded when another approach is already in the active flight plan, the new approach replaces the previous approach.

Whenever an approach is selected, the choice to either “Load Approach” or “Activate Approach” is given. “Load Approach” adds the approach to the end of the flight plan without immediately using it for navigation guidance. This allows continued navigation via the intermediate waypoints in the original flight plan, but keeps the procedure available on the Active Flight Plan Page for quick activation when needed. “Activate Approach” also adds the procedure to the end of the flight plan but immediately begins to navigate to the first waypoint in the approach.



Select Approach Window (Split-Screen)

SELECTING AN APPROACH

When selecting an approach, it replaces the destination airport with the sequence of waypoints for the selected approach. Keep in mind that the airport must have a published approach (GPS, RNAV, VOR, NDB, localizer, or ILS) and only the final course segment (final approach fix to missed approach point) of the published approach is available (unless an external navigator is configured).

An approach can be selected from the Direct-to Window, Waypoint (WPT) Page, Active Flight Plan Page, and the Saved Flight Plan Page.

Loading an approach from the active or saved flight plan page:

- 1) Press the **FPL** Key.
- 2) Turn the **FMS** Joystick to display the Active Flight Plan Page or Saved Flight Plan Page.

- 3) Press the **SEL APPR** Softkey; or press the **MENU** Key, highlight 'Select Approach' by turning or moving the **FMS** Joystick, and press the **ENT** Key. The Select Approach Window is displayed.
- 4) Turn the **FMS** Joystick to access a list of available approaches. Turn or move **FMS** Joystick to highlight the desired approach and press the **ENT** Key.
- 5) With 'Load Approach' highlighted, press the **ENT** Key. To cancel the request, press the **CLR** Key or the **FMS** Joystick.

Viewing a chart for the selected approach:

- 1) With an approach selected in the Select Approach Window, press the **MENU** Key. The Show Chart Menu is displayed.



Select Approach Menu

- 2) Press the **ENT** Key. A chart displaying the selected approach is displayed.
- 3) Press the **EXIT** Softkey to return to the Select Approach Window.

Activating an approach on the Active Flight Plan Page:

- 1) Press the **FPL** Key.
- 2) Turn the **FMS** Joystick to display the Active Flight Plan Page (if necessary).
- 3) Press the **SEL APPR** Softkey; or press the **MENU** Key, highlight 'Select Approach' by turning or moving the **FMS** Joystick, and press the **ENT** Key. The Select Approach Window is displayed.
- 4) Turn the **FMS** Joystick to access a list of available approaches. Turn or move the **FMS** Joystick to highlight the desired approach and press the **ENT** Key.
- 5) With 'Activate Approach' highlighted, press the **ENT** Key. To cancel the request, press the **CLR** Key or the **FMS** Joystick.

Or:

- 1) With an approach loaded on the Active Flight Plan Page, press the **MENU** Key.

- Turn or move the **FMS** Joystick to highlight 'Activate Approach', and press the **ENT** Key.

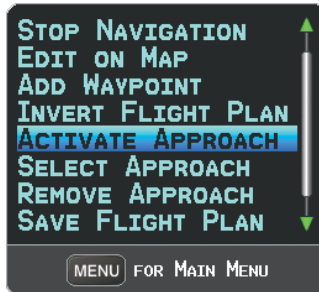

Active Flight Plan Page Menu

Or:

- With an approach loaded on the Active Flight Plan Page, press the **FMS** Joystick to activate the cursor.
- Move the **FMS** Joystick to highlight the approach, and press the **ENT** Key. "Activate XXXXX Approach?" window is displayed.
- With 'Yes' highlighted, press the **ENT** Key.

Loading/Activating an approach from the Direct-to Window or Waypoint Page:

- Press the **Direct-to** Key or select the Waypoint Page.
- Press the **MENU** Key.
- Turn or move the **FMS** Joystick to highlight 'Select Approach', and press the **ENT** Key. If an approach is not already loaded or activated, the cursor is displayed in the Approach Field. If an approach is already loaded or activated, 'Activate' is highlighted.
- With 'Activate' highlighted press the **ENT** Key, or select an approach, highlight 'Load Approach' or 'Activate Approach', and press the **ENT** Key.

Removing an approach:

- Press the **FPL** Key.
- Turn the **FMS** Joystick to display the Active Flight Plan Page or Saved Flight Plan Page.
- Press the **RMV APPR** Softkey; or press the **MENU** Key, highlight 'Remove Approach' by turning or moving the **FMS** Joystick, and press the **ENT** Key.

ACTIVATING VECTORS-TO-FINAL

After an approach has been activated, the **VECTORS** Softkey is used when being vectored to the final approach course by Air Traffic Control (ATC).

If the **VECTORS** Softkey is pressed, the G3X creates an extension of the final course, beyond the final approach waypoint in the database (final approach fix [FAF]). On the Active Flight Plan Page, a Vector to Final symbol appears beside the first approach waypoint.

The screenshot shows the 'ACTIVE FLIGHT PLAN' page with the following data:

FUEL FLOW	8.0/hr	LEG DTK	LEG DIST	LEG FUEL
ENROUTE				
◆ KOJC	___M	___NM		
APPROACH - KMKC ILS 03 (VECTORS TO FINAL)				
▲ FENEN	033°M	7.1NM	0.6	
▲ RW03	033°M	5.0NM	0.4	
TOTAL		12.1NM	1.0	

At the bottom of the screen, the 'VECTORS' softkey is highlighted. A label 'VECTORS Softkey' points to it. A label 'Vectors-to-Final Symbol' points to the '▲' symbol next to the 'FENEN' waypoint.

**Vectors-to-Final (Active Flight Plan Page)
(Split-Screen)**

The screenshot shows the 'MAP PAGE' with a terrain map. A magenta line extends from the 'FENEN' waypoint towards the 'RW03' runway, representing the 'Final Course Extension'. A label 'Final Course Extension' points to this magenta line. The 'VECTORS TO FINAL' symbol is visible near the 'RW03' waypoint.

**Vectors-to-Final (Map Page)
(Split-Screen)**

The G3X does not provide guidance to the inbound course. The course deviation needle on the graphic HSI remains off-center until established on the final approach course. The map shows an extension of the final approach course using a bold magenta line.

If the **VECTORS** Softkey is not pressed, the G3X creates a straight-line course directly to the first waypoint in the approach.

Loading the approach cancels the Direct-to and initiates a route to the FAF.

Cancelling Vectors-to-Final:

From the Active Flight Plan Page (with an approach activated), press the **VECTORS** Softkey.

Or:

- 1) From the Active Flight Plan Page, press the **MENU** Key.
- 2) Turn or move the **FMS** Joystick to highlight 'Cancel Vectors-to-Final' and press the **ENT** Key.

- System Overview
- Flight Instruments
- EIS
- CNS Interface
- GPS Navigation
- Flight Planning**
- Hazard Avoidance
- Additional Features
- Integrated Autopilot
- Annun/Alerts
- Appendix
- Index

Blank Page

SECTION 7 HAZARD AVOIDANCE

7.1 SIRIUSXM WEATHER



NOTE: See the G3X Installation Manual for SiriusXM activation instructions.



NOTE: SiriusXM Weather is only available with the optional GDU 375.

SIRIUSXM DATALINK WEATHER ADVISORY

Each time the system powers-up, the pilot is prompted to acknowledge an XM datalink weather advisory.

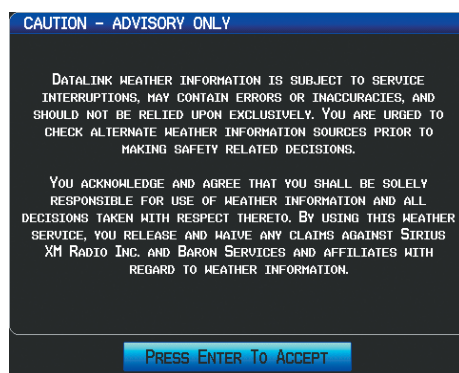

Datalink Weather Advisory

Press the **ENT** Key to acknowledge this information.

ACTIVATING SERVICES

Before SiriusXM Weather can be used, the service must be activated. Service is activated by providing SiriusXM Satellite Radio with a Radio ID.

SiriusXM Satellite Radio uses the Radio ID to send an activation signal that allows the G3X to display weather data and/or entertainment programming.

XM WEATHER INFORMATION

- Radio ID—Eight-digit ID number used for activation.
- Service Level—SiriusXM Weather subscription plan purchased.
- Weather Products—List of weather features and age of weather data in minutes.

Accessing SiriusXM Weather information:

From the Weather (WX) Page press the **INFO** Softkey.

Or:

From the (XM) Audio Page press the **INFO** Softkey.

SIRIUSXM WEATHER PRODUCTS

NEXRAD

NEXRAD (NEXT-generation RADar), is a network of 158 high-resolution Doppler radar systems that are operated by the National Weather Service (NWS). NEXRAD data provides centralized meteorological information for the continental United States and selected overseas locations. The maximum range of a single NEXRAD radar site is 250 nm. In addition to a wide array of services, the NEXRAD network provides important information about severe weather and air traffic safety.

NEXRAD data is not real-time. The lapsed time between collection, processing, and dissemination of NEXRAD images can be significant and may not reflect the current radar synopsis. Due to the inherent delays and the relative age of the data, it should be used for long-range planning purposes only. Never use NEXRAD data or any radar data to penetrate hazardous weather. Rather, use it in an early-warning capacity of pre-departure and enroute evaluation.

Composite data from all the NEXRAD radar sites in the United States is shown. This data is composed of the maximum reflectivity from the individual radar sweeps. The display of the information is color-coded to indicate the weather severity level.

The display of radar coverage is always active when NEXRAD is selected. Areas where NEXRAD radar coverage is not currently available or is not being collected are indicated in grayish-purple (Weather (WX) Page Only). Radar capability exists in these areas, but it is not active or is off-line.

NEXRAD ABNORMALITIES

There are possible abnormalities regarding displayed NEXRAD images. Some, but not all, of those include:

- Ground clutter
- Strokes and spurious radar data
- Sun strobes, when the radar antenna points directly at the sun
- Military aircraft deploy metallic dust (chaff) which can cause alterations in radar scans
- Interference from buildings or mountains, which may cause shadows

NEXRAD LIMITATIONS

Certain limitations exist regarding the NEXRAD radar displays. Some, but not all, are listed for the user's awareness:

- NEXRAD base reflectivity does not provide sufficient information to determine cloud layers or precipitation characteristics (hail vs. rain). For example, it is not possible to distinguish between wet snow, wet hail, and rain.
- NEXRAD base reflectivity is sampled at the minimum antenna elevation angle. An individual NEXRAD site cannot depict high altitude storms at close ranges, and has no information about storms directly over the site.
- Radar coverage only extends to 55°N.
- Any precipitation displayed between 52°N and 55°N is unknown.

NEXRAD INTENSITY

Colors are used to identify the different NEXRAD echo intensities (reflectivity) measured in dBZ (decibels of Z). "Reflectivity" (designated by the letter Z) is the amount of transmitted power returned to the radar receiver. The dBZ values increase as returned signal strength increases. Precipitation intensity is displayed using colors corresponding to the dBZ values.

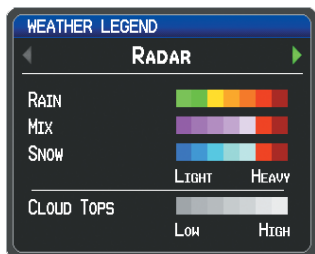

RADAR Legend

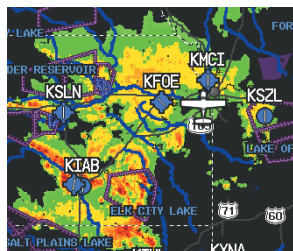

NEXRAD Data

SATELLITE MOSAIC

Satellite Mosaic displays infrared composite images of cloud cover taken by geostationary weather satellites. The Satellite Mosaic provides up to seven levels of cloud cover.

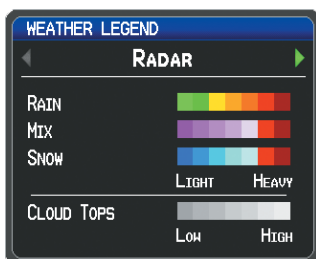

RADAR Legend

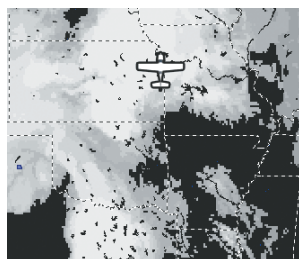

Satellite Mosaic/Cloud Tops Data

ECHO TOPS

Echo Tops are derived from NEXRAD radar and indicate the highest altitude at which precipitation is falling. Echo Tops at or above the altitude you select are displayed, in 5,000 foot increments up to 70,000 ft. Echo Tops can be helpful in determining the severity of thunderstorms.

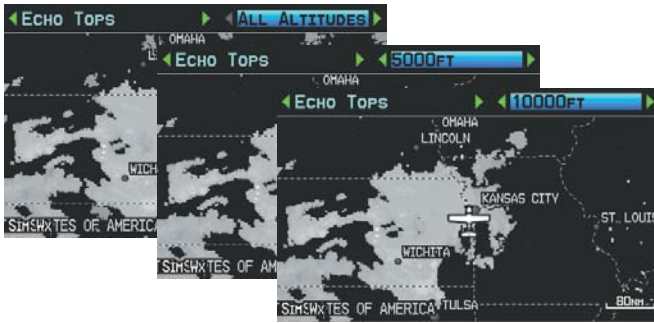

Echo Tops Data (Split-Screen)

WINDS ALOFT

Winds Aloft data shows the forecasted wind speed and direction at the surface and at selected altitudes. Altitudes can be displayed in 3,000-foot increments up to 42,000 feet MSL.

Winds Aloft are displayed using wind barbs or a wind streamline depending on the selected range. The wind barbs indicate wind speed and direction. The wind streamline indicates wind direction with arrows.

The wind barbs always point in the direction that the wind is coming from. The wind speed is depicted using flags at the end of the wind barb. A short wind flag is 5 knots, a long wind flag is 10 knots, and a triangle flag is 50 knots.



Winds Aloft Data (Split-Screen)

- System Overview
- Flight Instruments
- EIS
- CNS Interface
- GPS Navigation
- Flight Planning
- Hazard Avoidance
- Additional Features
- Integrated Autopilot
- Annun/Alerts
- Appendix
- Index

- System Overview
- Flight Instruments
- EIS
- CNS Interface
- GPS Navigation
- Flight Planning
- Hazard Avoidance
- Additional Features
- Integrated Autopilot
- Annun/Alerts
- Appendix
- Index

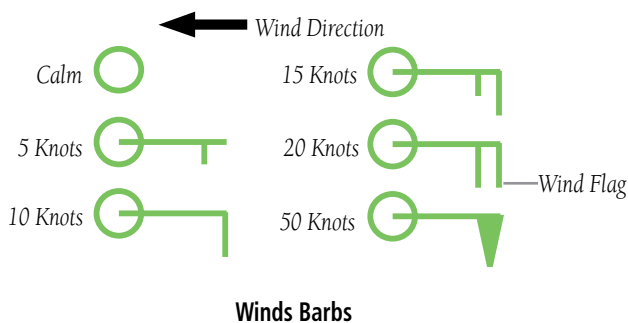

SURFACE PRESSURE

This feature displays pressure isobars and pressure centers. The isobars connect points of equal pressure. Pressure readings can help determine weather and wind conditions. High pressure areas are generally associated with fair weather. Low pressure areas are generally associated with clouds and the chance of precipitation. Isobars that are packed closely together show a strong pressure gradient. Strong gradients are associated with areas of stronger winds. Pressure units can be displayed in Millibars (mb) and Inches of Mercury (in).

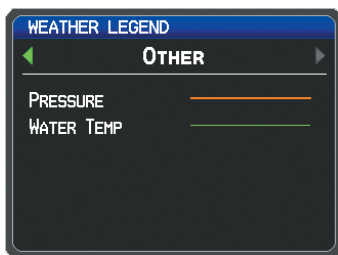

Other Legend

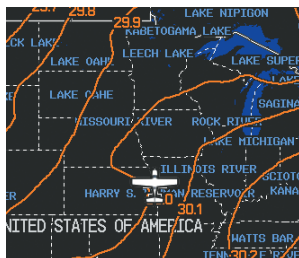

Surface Pressure Data

XM LIGHTNING

Lightning data shows the approximate location of cloud-to-ground lightning strikes. A strike icon represents a strike that has occurred within a two-kilometer region and within the last seven minutes. The exact location of the lightning strike is not displayed.



Lightning Data (Split-Screen)

STORM CELLS

The Storm Cells feature displays storms as well as the storm’s projected path in the immediate future.

The direction of the storm is displays by an arrow (at a range of 20 nm or less). The tip of the arrow indicates where the storm should be in 15 minutes. Critical information about the storm cell (tops and intensity) can be viewed by selecting the storm cell with the map pointer. Pressing the **ENT** Key will display additional information.



Storm Cell Data (Split-Screen)

METARS AND TAFS



NOTE: METAR information is only displayed within the installed aviation database service area.

METAR (METeorological Aerodrome Report) is an international code used for reporting weather observations. METARs are updated hourly or as needed. METARs typically contain information about the temperature, dewpoint, wind, precipitation, cloud cover, cloud heights, visibility, and barometric pressure. They can also contain information on precipitation amounts, lightning, and other critical data. If METAR data is available for an airport, a color-coded flag is shown next to the airport.

TAF (Terminal Area Forecast) is the standard format for 24-hour weather forecasts. TAFs may contain some of the same code as METAR data. It typically forecasts significant weather changes, temporary changes, probable changes, and expected changes in weather conditions.

METAR and TAF text data is displayed on the Map Page and the Weather (WX) Page. An abbreviated version can be viewed by panning over the METAR flag. Pressing the **ENT** Key will display additional information. METAR and TAF data can be displayed as raw or decoded text.





Changing METAR and TAF text:

- 1) Using the Map Pointer, select the desired METAR and press the **ENT** Key; or from the Waypoint (WPT) Page press the **WEATHER** Softkey. The Weather Information Page is displayed.
- 2) Press the **MENU** Key.
 - a) Select 'Show Decoded Text' or 'Show Raw Text'.
 - b) Press the **ENT** Key.

Or:

 - a) Select 'Change Text Size' and press the **ENT** Key.
 - b) Select 'Small', 'Medium', or 'Large' and press the **ENT** Key.

The METAR flag color is determined by the information in the METAR text.

-  VFR (ceiling greater than 3000 feet AGL and visibility greater than 5 miles)
-  Marginal VFR (ceiling 1000-3000 feet AGL and/or visibility 3-5 miles)
-  IFR (ceiling 500 to below 1000 feet AGL and/or visibility 1 mile to less than 3 miles)
-  Low IFR (ceiling below 500 feet AGL or visibility less than 1 mile)
-  METAR text does not contain adequate information to determine flight conditions

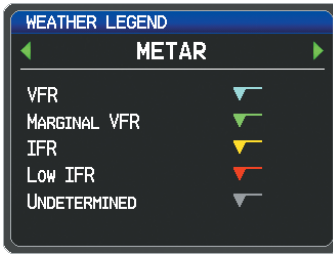

METAR Legend

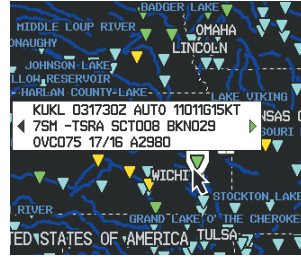

METAR Selected With Map Pointer

AIRMETS

An AIRMET (AIRmen’s METeological Information) can be especially helpful for pilots of light aircraft that have limited flight capability or instrumentation. An AIRMET must affect or be forecast to affect an area of at least 3,000 square miles at any one time. AIRMETS are routinely issued for six-hour periods and are amended as necessary due to changing weather conditions. AIRMETS are displayed as colored, dashed lines.

SIGMETS

A SIGMET (SIGnificant METeological Information) advises of weather that is potentially hazardous to all aircraft. In the contiguous United States, the following items are covered: severe icing, severe or extreme turbulence, volcanic ash, dust storms, and sandstorms that lower visibility to less than three statute miles.

A Convective SIGMET is issued for the following conditions: thunderstorms, isolated severe thunderstorms, embedded thunderstorms, hail at the surface, and tornadoes.

A SIGMET is widespread and must affect or be forecast to affect an area of at least 3,000 square miles. SIGMETs are displayed as a yellow-dashed line.

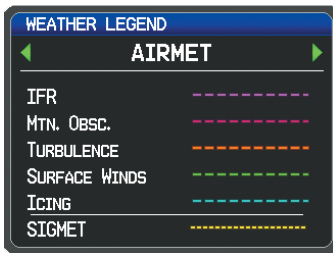

AIRMET/SIGMET Legend

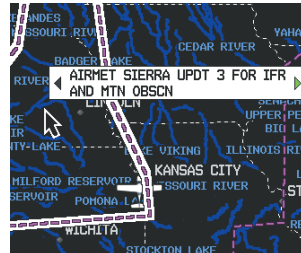

AIRMET Selected With Map Pointer

- System Overview
- Flight Instruments
- EIS
- CNS Interface
- GPS Navigation
- Flight Planning
- Hazard Avoidance**
- Additional Features
- Integrated Autopilot
- Annun/Alerts
- Appendix
- Index

TEMPORARY FLIGHT RESTRICTIONS (TFRS)

Temporary Flight Restrictions or TFRs temporarily restrict all aircraft from entering the selected airspace unless a waiver has been issued. TFRs are routinely issued for occurrences such as sporting events, dignitary visits, military depots, and forest fires. TFRs are represented as an area highlighted by red (active) or yellow (not yet active).

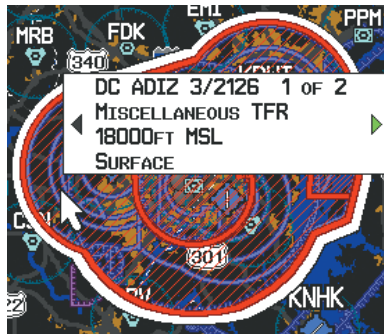

TFR Data

PIREPS

Pilot Weather Reports (PIREPs) provide timely weather information for a particular route of flight. When significant weather conditions are reported or forecast, Air Traffic Control (ATC) facilities are required to solicit PIREPs. A PIREP may contain unforecast adverse weather conditions, such as low in-flight visibility, icing conditions, wind shear, and turbulence. PIREPs are issued as either Routine (UA) (blue) or Urgent (UUA) (yellow).



PIREP Data

- System Overview
- Flight Instruments
- EIS
- CNS Interface
- GPS Navigation
- Flight Planning
- Hazard Avoidance
- Additional Features
- Integrated Autopilot
- Annun/Alerts
- Appendix
- Index

FREEZING LEVELS

Freezing Level shows contours for the lowest forecast altitude where icing conditions are likely to occur.

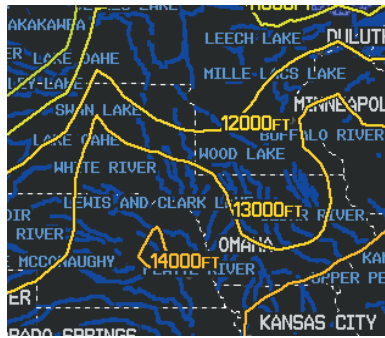

Freezing Level Data

TURBULENCE FORECAST

Turbulence data identifies the potential for erratic movement of high-altitude air mass associated winds. Turbulence is classified as light, moderate, severe, or extreme. Turbulence data is intended to supplement AIRMETs and SIGMETs.

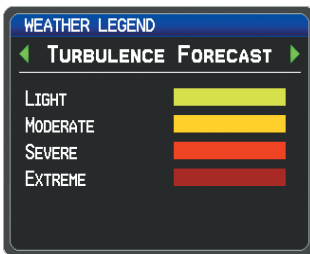

Turbulence Forecast Legend

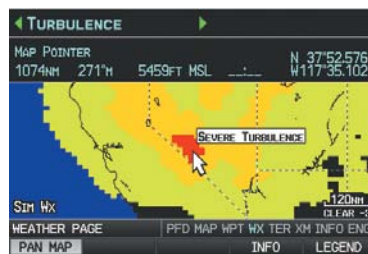

Severe Turbulence Selected With Map Pointer (Split-Screen)

- System Overview
- Flight Instruments
- EIS
- CNS Interface
- GPS Navigation
- Flight Planning
- Hazard Avoidance
- Additional Features
- Integrated Autopilot
- Annun/Alerts
- Appendix
- Index

ICING FORECAST (CIP & SLD)

Current Icing Product (CIP) data shows a graphical view of the current icing environment. Icing severity is displayed in four categories: light, moderate, severe, and extreme (not specific to aircraft type). The CIP product is not a forecast, but a representation of the current conditions at the time of the analysis.

Supercooled Large Droplet (SLD) icing conditions are characterized by the presence of relatively large, super cooled water droplets indicative of freezing drizzle and freezing rain aloft. SLD threat areas are depicted as magenta dots over the CIP colors.

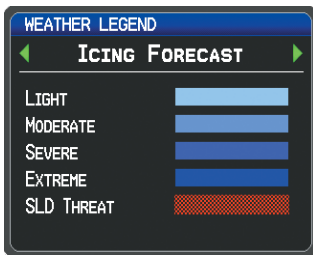

Icing Forecast Legend

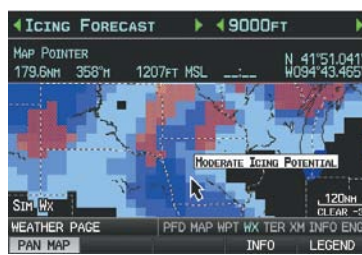

Moderate Icing Selected With Map Pointer (Split-Screen)

FORECAST

Forecast information is available for current and forecast weather conditions. Forecasts are available for intervals of 12, 24, 36, and 48 hours.

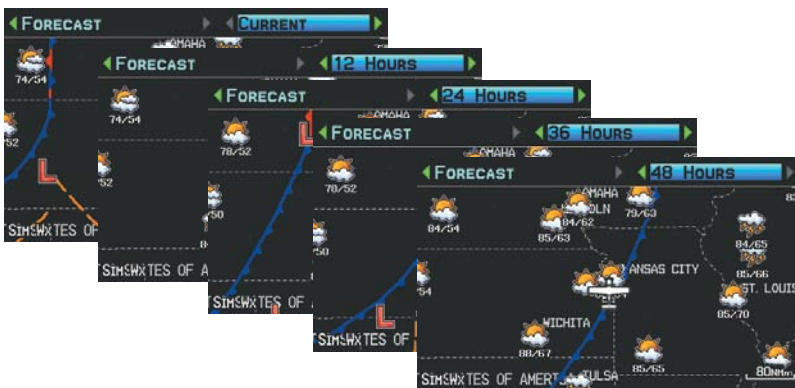

Forecast Data (Split-Screen)

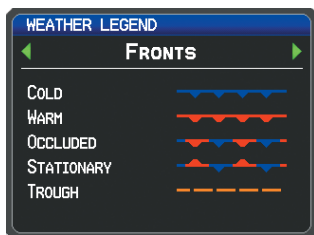

Fronts Legend

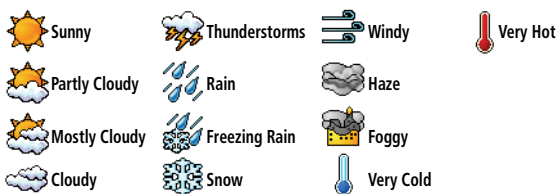

Forecast Legend

WATER TEMPERATURE

The surface temperatures of coastal and large inland bodies of water are displayed.

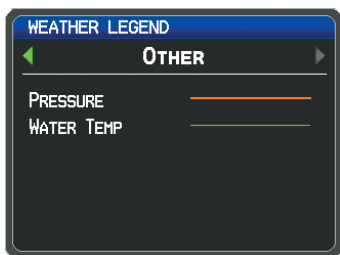

Other Legend



Water Temperature Data (Split-Screen)

USING SIRIUSXM WEATHER PRODUCTS

SiriusXM Weather Products can be displayed on the Map Page and individually on the Weather (WX) Page.

The setup menu for the Map Page controls the map range settings above which weather products are decluttered from the display. If a map range larger than the weather product map range setting is selected, the weather product data is removed from the map. For weather products such as Lightning, and Storm Cells, the weather product is displayed when a map range “smaller” than the weather product map range setting is selected (Satellite Mosaic works inversely). The menu also provides a means for enabling/disabling display of ‘Airmets’, ‘Sigmet’, ‘Weather Data’, ‘NEXRAD’, and/or ‘Fronts’ on the Map Page.

Additional information about the following can be displayed by panning over the display on the Weather Page or the Map Page:

- Storm Cells
- METARs
- SIGMETs
- TFRs
- AIRMETs

Additional information is also available for the following weather products on the Weather Page (not displayed on the Map Page):

- Forecast
- PIREPs

Viewing SiriusXM Weather products on the Map Page:

- 1) Select the Map Page.
- 2) Select the **WEATHER** Softkey to display the XM weather products.

Or:

- a) Press the **MENU** Key.
- b) Select 'Show Weather' and press the **ENT** Key.
- 3) Press the **FMS** Joystick to activate the Map Pointer.
- 4) Use the **FMS** Joystick to highlight the desired weather product with the Map Pointer.
- 5) With the desired weather product highlighted, press the **ENT** Key to get detailed information (if available).

Viewing SiriusXM Weather products on the Weather (WX) Page:

- 1) From the WX Page press the **FMS** Joystick to highlight the weather product field.
- 2) Turn the **FMS** Joystick to select and automatically display the desired weather product.
- 3) If necessary, move the **FMS** Joystick to highlight the type field and turn the **FMS** Joystick to scroll through a list of available options.
- 4) Press the **PAN MAP** Softkey to get abbreviated information about the selected weather product or map feature (if available).
- 5) With the desired weather product selected press the **ENT** Key to get detailed information (if available).

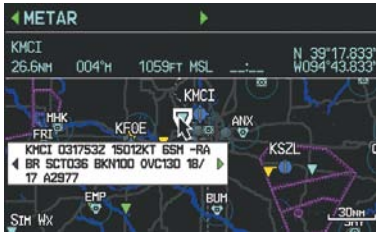

Abbreviated Weather Product Information (Split-Screen)



Detailed Weather Product Information (Split-Screen)

Setting up and customizing weather data for the Map Page:

- 1) From the Map Page press the **MENU** Key.
- 2) Turn or move the **FMS** Joystick to highlight 'Set Up Map' and press the **ENT** Key.
- 3) Turn the **FMS** Joystick to select the 'Weather' or 'WX Reports' Category from the horizontal list.
- 4) Move the **FMS** Joystick to select the desired weather product.
- 5) Turn the **FMS** Joystick to access a list of options for each product (On/Off, Auto, range settings).
- 6) Press the **ENT** Key to select an option.
- 7) Press the **FMS** Joystick, the **CLR** Key, or the **EXIT** Softkey to return to the Map Page with the changed settings.

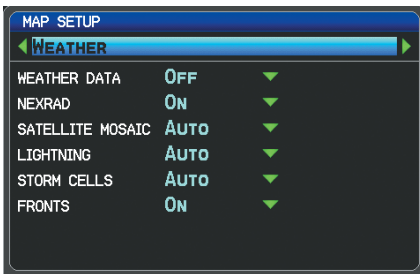

Map Setup Page (Weather Category)



Map Setup Page (WX Report Category)

Restoring default weather data for the Map Page:

- 1) From the Map Page press the **MENU** Key.
- 2) Turn or move the **FMS** Joystick to highlight 'Set Up Map' and press the **ENT** Key.

- 3) Turn the **FMS** Joystick to select 'Weather' or 'WX Reports'.
- 4) Move the **FMS** Joystick to select the desired weather product.
- 5) Press the **MENU** Key.
- 6) With 'Restore Default' or 'Restore All Map Defaults' selected, press the **ENT** Key.
- 7) Press the **FMS** Joystick, the **CLR** Key, or the **EXIT** Softkey to return to the Map Page with the restored settings.

Viewing legends for displayed weather products:

- 1) From the Map Page press the **MENU** Key to access the Map Page Menu.
- 2) Turn or move the **FMS** Joystick to select 'Weather Legend' and press the **ENT** Key to display the Weather Legend Window.
- 3) Turn the **FMS** Joystick to view the desired weather legend (Radar, Fronts, METAR, AIRMET, Turbulence Forecast, Icing Forecast, or Other).
- 4) With '**DONE**' highlighted, press the **ENT** Key to return to the Map Page.

Or:

- 1) From the Weather (WX) Page press the **LEGEND** Softkey to display the Weather Legend Window.
- 2) Turn the **FMS** Joystick to view the desired weather legend (Radar, Fronts, METAR, AIRMET, Turbulence Forecast, Icing Forecast, or Other).
- 3) Press the **FMS** Joystick, **CLR** Key, or **LEGEND** Softkey to return to the Weather (WX) Page.

Animating SiriusXM weather:

- 1) From the Map Page press the **MENU** Key to access the Map Page Menu.
- 2) Turn or move the **FMS** Joystick to select 'Animate Weather' and press the **ENT** Key.
- 3) To stop animation, press the **MENU** Key again, turn or move the **FMS** Joystick to select 'Stop Animation', and press the **ENT** Key.

Or:

- 1) Select the Weather (WX) Page.
- 2) Using the **FMS** Joystick select either the 'NEXRAD Radar' or 'Satellite Mosaic' weather product.
- 3) Select the **ANIMATE** Softkey to begin animation.

Or:

- a) Press the **MENU** Key.
 - b) Select 'Animate Weather' and press the **ENT** Key to begin animation.
- 4) To stop animation, deselect the **ANIMATE** Softkey.

Or:

Press the **MENU** Key, turn or move the **FMS** Joystick to select 'Stop Animation', and press the **ENT** Key.

7.2 TERRAIN



WARNING: Do not use Terrain information for primary terrain avoidance. Terrain information is intended only to enhance situational awareness.



NOTE: Terrain data is not displayed when the aircraft is outside the installed terrain database coverage area.



NOTE: Terrain depicted in the Profile View is always "ahead" of the aircraft, and will change as ground track changes.

The Terrain Page displays altitudes of terrain and obstructions relative to the aircraft position and altitude with reference to a database that may contain inaccuracies. Terrain and obstructions are shown only if they are in the database. Terrain and obstacle information should be used as an aid to situational awareness. They should never be used to navigate or maneuver around terrain.

Note that all obstructions may not be available in the terrain and obstacle database. No terrain and obstacle information is shown without a valid 3-D GPS position.

The G3X GPS receiver provides the horizontal position and altitude of the aircraft. Aircraft GPS altitude is derived from satellite position. GPS altitude is then converted to a mean sea level (MSL)-based altitude (GPS-MSL altitude) and is used to determine terrain and obstacle proximity. GPS-MSL altitude accuracy is affected by satellite geometry, but is not subject to variations in pressure and temperature that normally affect pressure altitude sensors. GPS-MSL altitude does not require local altimeter settings to determine MSL altitude. It is a widely-used MSL altitude source.

Terrain and obstacle databases are referenced to MSL. Using the GPS position and altitude, the Terrain feature portrays a 2-D picture of the surrounding terrain and obstacles relative to the position and altitude of the aircraft. GPS position and GPS-MSL altitude are used to calculate and predict the aircraft's flight path in relation to the surrounding terrain and obstacles. In this way, the pilot can view predicted dangerous terrain and obstacle conditions.

Alert windows appear on all pages (except the Terrain (TER) Page) to inform the pilot of proximity to the terrain and obstacles, as well as an unsafe descent rate. These alerts depend on user-defined parameters in the Terrain Page setup.

SYNTHETIC VISION

Terrain is integrated within Synthetic Vision (when active) to provide land contours (colors are consistent with those of the topographical map display), large water features, towers, obstacles over 200' AGL, as well as visual and auditory alerts to indicate the presence of terrain and obstacle threats relevant to the projected flight path. Synthetic Vision terrain information is displayed in red and yellow shading on the PFD. Refer to section 8.1 (Synthetic Vision) for more information.

TERRAIN INFORMATION

The areas of the terrain shaded red are predicted to be within 100 feet below or above the aircraft. The yellow terrain areas are between the user-defined Caution Elevation and 100 feet below the aircraft. By default, the Caution Elevation is 1,000 feet; therefore, the areas in yellow are between 1,000 feet and 100 feet below the aircraft. The black areas are further than the Caution Elevation. A projected point of impact is marked with an "X" symbol.

Enabling/Disabling Terrain Shading on the Map Page:

From the Map Page with the VFR Map displayed, press the **TERRAIN** Softkey.

Or:

- 1) From the Map Page, press the **MENU** Key.
- 2) Turn or move the **FMS** Joystick to highlight 'Set Up Map', and press the **ENT** Key.

- 3) Turn the **FMS** Joystick to highlight the 'Map' Category from the horizontal list.
- 4) Move the **FMS** Joystick to highlight the 'Terrain Shading' field.
- 5) Turn the **FMS** Joystick to select 'On' or 'Off', and press the **ENT** Key.

TERRAIN VIEWS

Two views are displayed on the Terrain (TER) Page: the Map View, and the Profile View.

Press the **MAP** or **PROFILE** Softkeys to toggle between views (split-screen only).

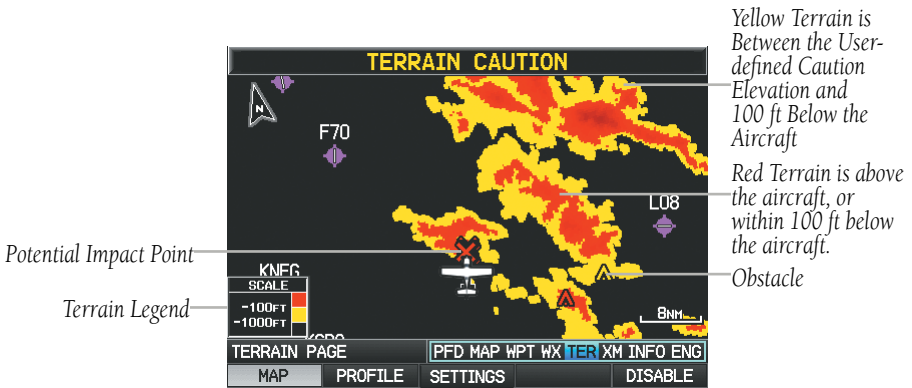

Terrain (TER) Page (Map View) (Split-Screen)

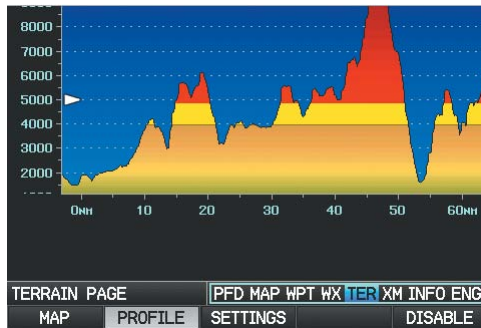

Terrain (TER) Page (Profile View) (Split-Screen)

OBSTACLE INFORMATION

Obstacles are shown on the Terrain Page at or below the map range of 12 nm. Obstacles are also shown on the Map Page when the map range is set to 3 nm or below.

Standard aeronautical chart symbols are used for lighted or unlighted obstacles taller than 200 feet Above Ground Level (AGL). Refer to the Obstacle Icons legend below.

Each obstacle is labeled with the altitude of the top of the obstacle, or Mean Sea Level (MSL). Each obstacle also lists, in parentheses, the actual height of the obstacle, or Above Ground Level (AGL).

Unlighted Obstacle		Lighted Obstacle		Potential Impact Points	Obstacle Location
< 1000' AGL	> 1000' AGL	< 1000' AGL	> 1000' AGL		
					WARNING: Red obstacle is above or within 100' below current aircraft altitude
					CAUTION: Yellow obstacle is between 100' and 1000' (default) below current aircraft altitude

Terrain Obstacle Colors and Symbology

TERRAIN SETTINGS

Use the terrain settings to set levels for terrain alerts as well as obstacles in or near your flight path.

- Caution Elevation—The G3X will provide an alert if the terrain or obstacle is within the default Caution Elevation or user-defined Caution Elevation.

- **Look Ahead Time**—Determines the maximum time when an alert annunciation occurs. For example, if 120 seconds is selected, the G3X provides an alert up to 120 seconds before you reach the terrain or obstacle.
- **Alert Sensitivity**—The three Alert Sensitivity settings (Terrain, Obstacle, and Descent Rate) determine what level of alerts are annunciated. The G3X defaults to 'High' sensitivity, which annunciates all red and yellow alerts at the time set in Look Ahead Time. 'Medium' sensitivity annunciates all of the red and the highest priority of yellow alerts. 'Low' only annunciates red alerts. 'Off' disables the alert.

Accessing the terrain settings:

- 1) On the Terrain Page, press the **SETTINGS** Softkey.
- 2) Move the **FMS** Joystick to highlight the desired field.
- 3) Turn the **FMS** Joystick to make changes to the highlighted field.
- 4) With 'Done' highlighted press the **ENT** Key, or press the **CLR** Key to accept the changes and exit the Terrain Setup window.

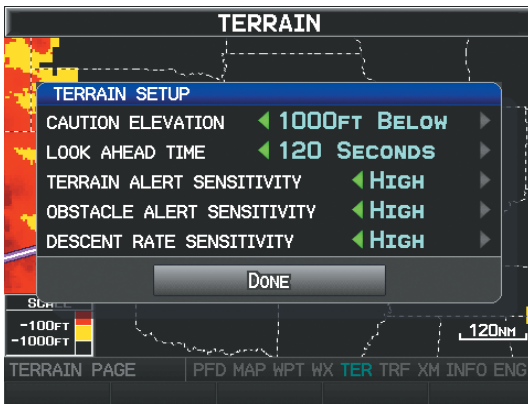

Terrain Setup

TERRAIN ALERTS

Terrain, Obstacle, and Descent Rate Alerts are issued when flight conditions meet parameters that are set within the software algorithms. Terrain alerts typically employ a CAUTION or a WARNING alert severity level, or both. When an alert is issued, visual annunciations are displayed and aural alerts are simultaneously issued. When the aircraft descends through 500 feet above the destination airport an audible “Five Hundred” altitude reminder occurs.

If the Terrain Page is not displayed, a pop-up alert appears in the lower left corner of the page. The Range Rings on the pop-up alert are spaced every whole mile/kilometer/nautical mile. Press the **CLR** Key to acknowledge the pop-up and/or aural alert.

Terrain and obstacle annunciations appear on the PFD and PFD Page in the upper left corner of the Attitude Indicator. Arrows are depicted on the terrain and obstacle annunciations if terrain is outside the Synthetic Vision field of view.

Arrows indicate the terrain is outside the Synthetic Vision field of view.



Terrain Annunciation on PFD

Enabling/Disabling terrain alerts:

From the Terrain Page, press the **DISABLE** Softkey.

Or:

- 1) From the Terrain Page, press the **MENU** Key to access the Page Menu.
- 2) Turn or move the **FMS** Joystick to highlight ‘Disable Alerts’ or ‘Enable Alerts’ and press the **ENT** Key. Disabling terrain alerts is only temporary. Terrain alerts are automatically enabled when the unit is powered on.



Terrain Page - Alerts Enabled (Split-Screen)

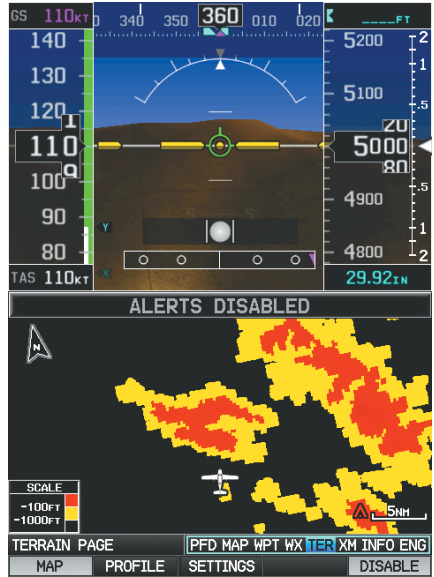

Terrain Page - Alerts Disabled (Split-Screen)

AURAL ALERTS

- “Five Hundred”—when the aircraft descends through 500 feet above the destination airport.

The following aural terrain alerts are issued when flight conditions meet parameters that are set within the software algorithms, and are dependent on the sensitivity level set in the Terrain Setup Menu.

Alert Severity	Terrain	Obstacle	Descent Rate
Caution	“caution, terrain” “caution, terrain ahead”	“caution, obstacle” “caution, obstacle ahead”	“caution, sink rate”
Warning	“terrain ahead! pull up!” “terrain! terrain! pull up! pull up!”	“obstacle ahead! pull up!” “obstacle! obstacle! pull up! pull up!”	“sink rate, pull up!” “pull up!”

Aural Alerts Summary

- System Overview
- Flight Instruments
- EIS
- CNS Interface
- GPS Navigation
- Flight Planning
- Hazard Avoidance**
- Additional Features
- Integrated Autopilot
- Annun/Alerts
- Appendix
- Index



PFD Page Terrain Alerts

7.3 TRAFFIC SYSTEMS

TRAFFIC INFORMATION SERVICE (TIS) (OPTIONAL)





NOTE: Refer to Appendix E for general information regarding Traffic Information Service (TIS).

The G3X supports Traffic input from a Garmin Mode S transponder, such as the GTX 330 or GTX 23.

SYSTEM STATUS

The traffic system status is annunciated in the upper right corner of the Map Page.

System Status	Traffic Icon
Operating	
No Traffic Data Available	

If a Traffic Icon is not displayed, check the Map Page range and/or the Traffic Display Range on the Map Set Up menu.

Traffic Modes



TRAFFIC SYMBOLOGY

Traffic is shown on the G3X according to TCAS symbology, graphically shown on the Traffic Page (Optional), Map Page, and in the Traffic Warning Window.

A Proximity Advisory (PA) indicates that the intruding aircraft is within ± 1200 feet and is within a 5 nm range, but is still not considered a threat. \pm

A Traffic Advisory (TA) symbol appears as a solid yellow circle. All other traffic within range is shown as a hollow white diamond. Altitude deviation from own aircraft altitude is shown above the target symbol if traffic is above own aircraft altitude, and below the symbol if they are below own aircraft altitude. Altitude trend is shown as an up arrow ($>+500$ ft/min), down arrow (<-500 ft/min), or no symbol if less than 500 ft/min rate in either direction.

- System Overview
- Flight Instruments
- EIS
- CNS Interface
- GPS Navigation
- Flight Planning
- Hazard Avoidance**
- Additional Features
- Integrated Autopilot
- Annun/Alerts
- Appendix
- Index

TIS Symbol	Description
	Non-Threat Traffic
	Proximity Advisory (PA)
	Traffic Advisory (TA)

Traffic Symbols

TRAFFIC ANNUNCIATIONS

The G3X displays traffic symbolically on the Map Page, and the Traffic Warning Window (Inset Map) in the lower left corner of the display(s).

When a traffic advisory (TA) is detected, the following automatically occur:

- The Traffic Warning Window (Inset Map) is enabled and displays traffic.
- A flashing black-on-yellow 'TRAFFIC' annunciation will appear in the upper right corner of the Attitude Indicator for five seconds and remains displayed until no TAs are detected in the area.
- A single "Traffic" aural alert is generated



Traffic Alerts

Arrows are depicted on the traffic message if traffic is outside the Synthetic Vision field of view. The arrow points in the direction of the traffic.



Traffic Outside the Synthetic Vision Field of View (PFD)

- System Overview
- Flight Instruments
- EIS
- CNS Interface
- GPS Navigation
- Flight Planning
- Hazard Avoidance
- Additional Features
- Integrated Autopilot
- Annun/Alerts
- Appendix
- Index

TRAFFIC AUDIO ALERTS

A traffic audio alert is generated whenever the number of Traffic Advisories on the G3X screen increases from one scan to the next. Limiting Traffic Advisories only reduces the “nuisance” alerting due to proximate aircraft. For example, when the first Traffic Advisories appear on the TIS display, the user is alerted audibly. So long as a single aircraft remains on the traffic display, no further audio alert is generated. If a second (or more) aircraft appears on the screen, a new audio alert is sounded.

If the number of Traffic Advisories on the traffic display decreases and then increases, a new audio alert is sounded. The traffic audio alert is also generated whenever traffic becomes available. The following traffic audio alerts are available:

- “Traffic”—Traffic alert received.
- “Traffic Not Available”—Traffic service is not available or out of range.

Enable/disable ‘Traffic Not Available’ audio alert:

- 1) Press the **MENU** Key twice to display the Main Menu.
- 2) Turn or move the **FMS** Joystick to highlight ‘System Setup...’ and press the **ENT** Key.
- 3) Turn or move the **FMS** Joystick to highlight ‘Sound’, and press the **ENT** Key.
- 4) Move the **FMS** Joystick to highlight the Traffic N/A Alert field.
- 5) Turn the **FMS** Joystick to highlight ‘On’ or ‘Off’.
- 6) Press the **FMS** Joystick, the **CLR** Key, the **EXIT** Softkey or the **MENU** Key to return to the previous page.

TRAFFIC WARNING WINDOW

When a traffic threat is imminent, the Traffic Warning Window is shown. The Traffic Warning Window shows a small pop-up thumbnail map in the lower left corner. The Range Rings on the pop-up alert are spaced every whole mile/kilometer/nautical mile. Press the **CLR** Key to remove the Traffic Warning Window.



NOTE: The Traffic Warning Window is disabled when the aircraft ground speed is less than 30 knots or when on the approach leg of a route.

TRAFFIC GROUND TRACK

Traffic ground track is indicated on the G3X screen by a “target track vector”, a short line shown in 45-degree increments, extending in the direction of target movement.

DISPLAYING TRAFFIC DATA

Traffic is displayed by default on the Map Page and the Traffic Warning Window.

Traffic information is also displayed on the PFD when Synthetic Vision is enabled. See the ‘Additional Features’ Section for more information.

Displaying Traffic information using the map pointer:

- 1) With traffic displayed on the Map Page, press the **FMS** Joystick. The Map Pointer is activated.
- 2) Move the **FMS** Joystick to highlight the desired traffic.

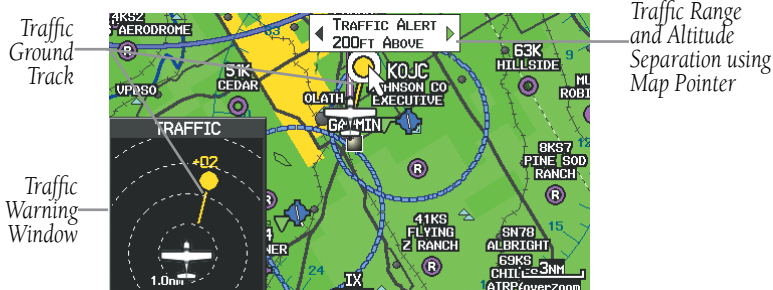

Traffic (Map Page)

Enabling/disabling traffic data on the Map Page:

- 1) From the Map Page, press the **MENU** Key.
- 2) Turn or move the **FMS** Joystick to highlight ‘Set Up Map’, and press the **ENT** Key.
- 3) If necessary, turn the **FMS** Joystick to highlight the ‘Map’ Category from the horizontal list.
- 4) Move the **FMS** Joystick to highlight the ‘Traffic Data’ field.
- 5) Turn the **FMS** Joystick to select ‘ON’ or ‘OFF’ from the menu, and press the **ENT** Key.

Enabling/disabling traffic on the Synthetic Vision display:

- 1) From the full-screen PFD and/or the split-screen PFD Page, press the **MENU** Key.
- 2) Move the **FMS** Joystick to highlight the 'TRAFFIC' field.
- 3) Turn the **FMS** Joystick to highlight 'On' or 'Off'.

DEDICATED TRAFFIC PAGE (TRF)

Displaying/Removing the Traffic Page:

- 1) Press the **MENU** Key twice to display the Main Menu.
- 2) Turn or move the **FMS** Joystick to highlight 'System Setup...' and press the **ENT** Key.
- 3) Turn or move the **FMS** Joystick to highlight 'Display', and press the **ENT** Key.
- 4) Move the **FMS** Joystick to highlight the Traffic Page field.
- 5) Turn the **FMS** Joystick to highlight 'Show' or 'Hide'.
- 6) Press the **FMS** Joystick, the **CLR** Key, the **EXIT** Softkey or the **MENU** Key to return to the previous page.

Disabling/Enabling the traffic alerts:



NOTE: Traffic alerts are reset to 'enabled' on the next power cycle.

- 1) Display the dedicated Traffic (TRF) Page as described in the procedure above.
- 2) From the Traffic (TRF) Page touch the **DISABLE** Softkey to enable/disable traffic alerts.

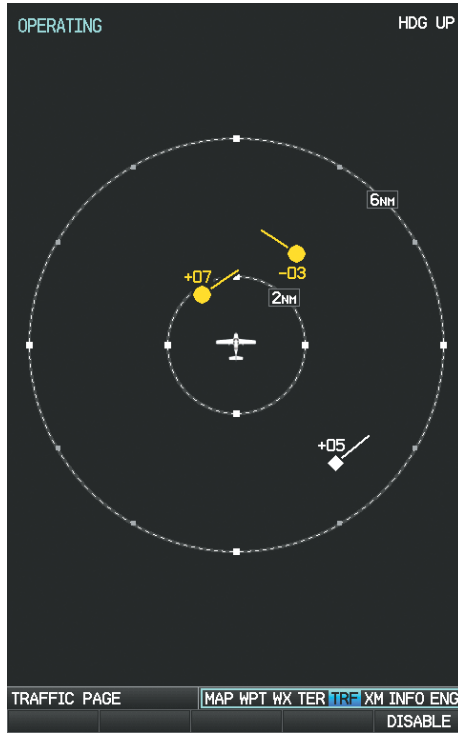

Traffic Page
Full-Screen MFD

System
Overview

Flight
Instruments

EIS

CNS
Interface

GPS
Navigation

Flight
Planning

Hazard
Avoidance

Additional
Features

Integrated
Autopilot

Annun/Alerts

Appendix

Index

GARMIN GTS 800 TRAFFIC



WARNING: *The GTS 800 Traffic Advisory System (TAS) is intended for advisory use only to aid the pilot in visually acquiring traffic. No avoidance maneuvers should be based solely upon TAS traffic information. It is the responsibility of the pilot in command to see and maneuver to avoid traffic.*



NOTE: *Pilots should be aware of TAS system limitations. TAS systems require transponders of other aircraft to respond to system interrogations. If the transponders do not respond to interrogations due to phenomena such as antenna shading or marginal transponder performance, traffic may be displayed intermittently, or not at all. Aircraft without altitude reporting capability are shown without altitude separation data or climb descent indication. Pilots should remain vigilant for traffic at all times.*



NOTE: *TIS is disabled when TAS installed.*

The optional Garmin GTS 800 is a Traffic Advisory System (TAS). It enhances flight crew situational awareness by displaying traffic information for transponder-equipped aircraft. The system also provides visual and aural traffic alerts including voice announcements to assist in visually acquiring traffic.

The GTS 800 is capable of tracking up to 45 intruding aircraft equipped with Mode A or C transponders, and up to 30 intruding aircraft equipped with Mode S transponders. A maximum of 30 aircraft with the highest threat potential can be displayed simultaneously. No TAS surveillance is provided for aircraft without operating transponders.

THEORY OF OPERATION





When the GTS 800 is in Operating Mode, the unit interrogates the transponders of intruding aircraft while monitoring transponder replies. The system uses this information to derive the distance, relative bearing, and if reported, the altitude and vertical trend for each aircraft within its surveillance range. The GTS 800 then calculates a closure rate to each intruder based on the projected Closest Point of Approach (CPA). If the closure rate meets the threat criteria for a Traffic Advisory (TA), visual and aural alerting is provided.

TAS SURVEILLANCE VOLUME

The GTS 800 surveillance system monitors the airspace within $\pm 10,000$ feet of own altitude. Under ideal conditions, the GTS 800 unit scans transponder traffic up to 12 nm in the forward direction. The range is somewhat reduced to the sides and aft of own aircraft due to the directional interrogation signal patterns. In areas of greater transponder traffic density or when TCAS II (Traffic Alert and Collision Avoidance System II) systems are detected, the GTS 800 automatically reduces its interrogation transmitter power (and therefore range) in order to limit potential interference from other signals.

TAS SYMBOLOGY

The GTS 800 uses symbology to depict intruding traffic using the symbols shown below.

Symbol	Description
	Traffic Advisory.
	Traffic Advisory out of the selected display range. Displayed at outer range ring at proper bearing.
	Proximity Advisory.
	Non-Threat Traffic.

GTS 800 Traffic Symbols

A Traffic Advisory (TA), displayed as a yellow circle or triangle, alerts the crew to a potentially hazardous intruding aircraft, if the closing rate, distance, and vertical separation meet TA criteria. A Traffic Advisory that is beyond the selected display range (off scale) is indicated by a half TA symbol at the edge of the screen at the relative bearing of the intruder.

A Proximity Advisory (PA), displayed as a solid white diamond or triangle, indicates the intruding aircraft is within ± 1200 feet and is within a 6 nm range, but is still not considered a TA threat.

A Non-threat Advisory, shown as an open white diamond or triangle, is displayed for traffic beyond 6 nm that is neither a TA or PA.

Relative altitude, when available, is displayed above or below the corresponding intruder symbol in hundreds of feet. When this altitude is above own aircraft, it is preceded by a '+' symbol; a minus sign '-' indicates traffic is below own aircraft.

A vertical trend arrow to the right of the intruder symbol indicates climbing or descending traffic with an upward or downward-pointing arrow respectively.

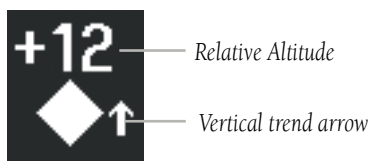

Intruder Altitude and Vertical Trend Arrow

Flight IDs may also be displayed with traffic symbols; see the Flight IDs discussion in this section for more information.

- System Overview
- Flight Instruments
- EIS
- CNS Interface
- GPS Navigation
- Flight Planning
- Hazard Avoidance**
- Additional Features
- Integrated Autopilot
- Annun/Alerts
- Appendix
- Index

TA ALERTING CONDITIONS

The GTS 800 automatically adjusts its TA sensitivity level to reduce the likelihood of nuisance TA alerting during flight phases likely to be near airports. The system uses Level A TA sensitivity when the groundspeed is less than 120 knots; Level B TA sensitivity applies in all other conditions.

Sensitivity Level	Intruder Altitude Available	TA Alerting Conditions
A	Yes	Intruder closing rate provides less than 20 seconds of vertical and horizontal separation. Or: Intruder closing rate provides less than 20 seconds of horizontal separation and vertical separation is within 600 feet. Or: Intruder range is within 0.2 nm and vertical separation is within 600 feet.
A	No	Intruder closing rate provides less than 15 seconds of separation.
B	Yes	Intruder closing rate provides less than 30 seconds of vertical and horizontal separation. Or: Intruder closing rate provides less than 30 seconds of horizontal separation and vertical separation is within 800 feet. Or: Intruder range is within 0.55 nm and vertical separation is within 800 feet.
B	No	Intruder range is less than 20 seconds.

TA Sensitivity Level and TA Alerting Criteria

TAS ALERTS

When the GTS 800 detects a new TA, the following occur:

- A single "Traffic!" voice alert is generated, followed by additional voice information about the bearing, relative altitude, and approximate distance from the intruder that triggered the TA. The announcement "Traffic! 12 o'clock, high, four miles," would indicate the traffic is in front of own aircraft, above own altitude, and approximately four nautical miles away.
- A TRAFFIC Annunciation appears at the top right of the airspeed on the PFD, flashing for five seconds and remains displayed until no TAs are detected in the area.

If the bearing of TA traffic cannot be determined, a yellow text banner will be displayed in the center of the Traffic Map Page and in the lower-left of the PFD inset map instead of a TA symbol. The text will indicate "TA" followed by the distance, relative altitude, and vertical trend arrow for the TA traffic, if known.

Bearing	Relative Altitude	Distance (nm)
"One o'clock" through "Twelve o'clock" or "No Bearing"	"High", "Low", "Same Altitude" (if within 200 feet of own altitude), or "Altitude not available"	"Less than one mile", "One Mile" through "Ten Miles", or "More than ten miles"

TA Descriptive Voice Announcements

System Overview

Flight Instruments

EIS

CNS Interface

GPS Navigation

Flight Planning

Hazard Avoidance

Additional Features

Integrated Autopilot

Annun/Alerts

Appendix

Index

SYSTEM TEST



NOTE: *Traffic surveillance is not available during the system test. Use caution when performing a system test during flight.*

The GTS 800 provides a system test mode to verify the TAS system is operating normally. The test takes ten seconds to complete. When the system test is initiated, a test pattern of traffic symbols is displayed on the Traffic Map Page. If the system test passes, the aural announcement "TAS System Test Passed" is heard, otherwise the system announces "TAS System Test Failed." When the system test is complete, the traffic system enters Standby Mode.

Testing the traffic system:

- 1) Turn the **FMS** Joystick to the Traffic Page.
- 2) Press the **RNG** Key to set the range to 2/6 nm to allow for full test pattern to be displayed during test.
- 3) Press the **MENU** Key to display the page menu.
- 4) With **SELF-TEST** highlighted press the **ENT** Key to start the self-test.



Traffic Page Menu

OPERATION



NOTE: *The GTS 800 automatically transitions from **STANDBY** to **OPERATE** mode eight seconds after takeoff. The unit also automatically transitions from **OPERATE** to **STANDBY** mode 24 seconds after landing.*

After power-up, the GTS 800 is in Standby Mode. The GTS 800 must be in Operating Mode for traffic to be displayed and for TAs to be issued.

Pressing the OPERATE Softkey allows the traffic unit to switch from Standby Mode to Operating Mode as necessary. Pressing the STANDBY Softkey forces the unit into Standby Mode.

Switching from operating mode to standby mode:

On the Traffic Page, select the **STANDBY** Softkey

Switching from standby mode to operating mode:

On the Traffic Page, press the **OPERATE** Softkey

Changing the altitude range:

- 1) On the Traffic Page, select the **ALT MODE** Softkey.
- 2) Press one of the following Softkeys:
 - **ABOVE:** Displays non-threat and proximity traffic from 9000 feet above the aircraft to 2700 feet below the aircraft. Typically used during climb phase of flight.
 - **NORMAL:** Displays non-threat and proximity traffic from 2700 feet above the aircraft to 2700 feet below the aircraft. Typically used during enroute phase of flight.
 - **BELOW:** Displays non-threat and proximity traffic from 2700 feet above the aircraft to 9000 feet below the aircraft. Typically used during descent phase of flight.
 - **UNREST** (unrestricted): All traffic is displayed from 9900 feet above and 9900 feet below the aircraft.
- 3) To return to the Traffic Page, press the **BACK** Softkey.

FLIGHT ID DISPLAY

The Flight IDs of other aircraft (when available) can be enabled for display on the Traffic Map Page. When a flight ID is received, it will appear above or below the corresponding traffic symbol on the Traffic Map Page when this option is enabled.

Enabling/Disabling Flight ID Display:

On the Traffic Map Page, press the **FLT ID** Softkey.

TRAFFIC PAGE

The Traffic Page shows surrounding TAS traffic data in relation to the aircraft's current position and altitude, without basemap clutter. It is the primary page for viewing traffic information. Aircraft orientation is always heading up unless there is no valid heading. Map range is adjustable with the **RANGE** Key, as indicated by the map range rings.

The traffic mode and altitude display mode are annunciated in the upper left corner of the page.

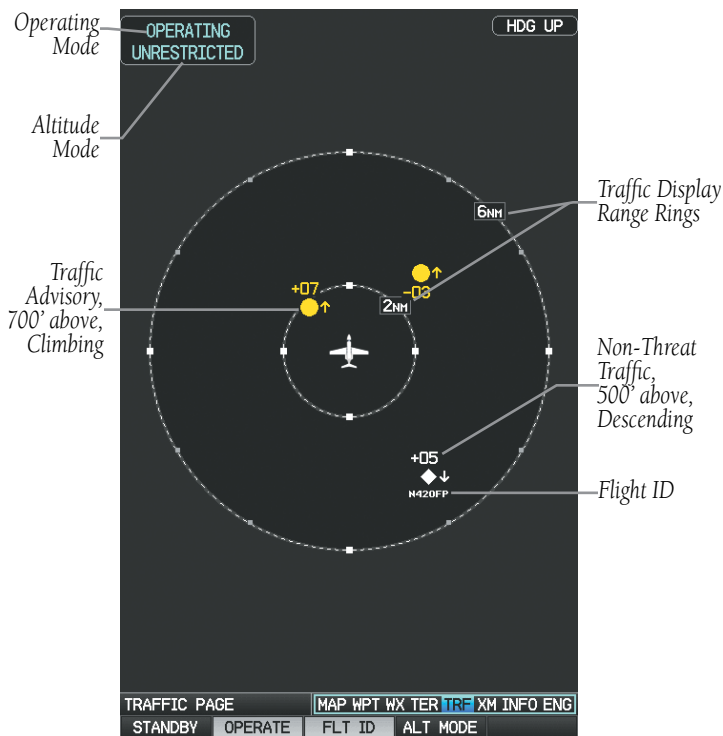

Traffic Page Full-Screen MFD

- System Overview
- Flight Instruments
- EIS
- CNS Interface
- GPS Navigation
- Flight Planning
- Hazard Avoidance**
- Additional Features
- Integrated Autopilot
- Annun/Alerts
- Appendix
- Index

Blank Page

SECTION 8 ADDITIONAL FEATURES



NOTE: *With the availability of SafeTaxi, FliteCharts, and ChartView in electronic form, it is still advisable to carry another source of charts on board the aircraft.*

Additional features of the system include the following:

- Synthetic Vision (SVX)
- SafeTaxi®
- ChartView and FliteCharts® electronic charts
- Airport Directory Data (AOPA , AC-U-KWIK, etc.)
- SiriusXM Radio entertainment (Optional)
- Electronic Checklists (Optional)
- Flight Data Logging

Synthetic Vision provides a three-dimensional forward view of terrain features on the PFD. Synthetic Vision imagery shows the pilot's view of relevant features in relation to the aircraft attitude, as well as the flight path pertaining to the active flight plan.

SafeTaxi diagrams provide detailed taxiway, runway, and ramp information at more than 1000 airports in the United States.

ChartView and FlightCharts provide on-board electronic terminal procedure charts. Electronic charts offer the convenience of rapid access to essential information. Either ChartView or FliteCharts may be used at one time, but not both. For example, if ChartView is on the SD Card and FliteCharts is on the system's internal memory, ChartView will always take precedence (FliteCharts may be used once the SD Card containing ChartView is ejected).

The Airport Directory contains airport statistics such as pattern altitudes, noise abatement information, FBO phone numbers, hours of operation, local attractions, ground transportation, lodging, and services.

The optional SiriusXM Radio entertainment audio feature offers more than 170 channels of music, news, and sports.

Optional checklists help to quickly find the proper procedure on the ground or during flight.

The Flight Data Logging feature automatically stores critical flight and engine data on an SD data card. A 2 GB SD card can store over 1,000 hours of flight data or up to 1,000 files (whichever comes first).

8.1 SYNTHETIC VISION (SVX)



WARNING: Use appropriate primary systems for navigation, and for terrain, obstacle, and traffic avoidance. Synthetic Vision is intended as an aid to situational awareness only and may not provide either the accuracy or reliability upon which to solely base decisions and/or plan maneuvers to avoid terrain, obstacles, or traffic.

Synthetic Vision is a visual enhancement to the G3X. Synthetic Vision depicts a forward-looking attitude display of the topography immediately in front of the aircraft. Synthetic Vision information is shown on the Primary Flight Display (PFD). The depicted imagery is derived from the aircraft attitude, heading, GPS three-dimensional position, and databases of terrain, obstacles, and other relevant features. Loss of any of the required data, including temporary loss of the GPS signal, will cause Synthetic Vision to be disabled until the required data is restored.

The Synthetic Vision terrain display shows land contours (colors are consistent with those of the topographical map display), large water features, towers, and other obstacles over 200' AGL that are included in the obstacle database. Cultural features on the ground such as roads, highways, railroad tracks, cities, and state boundaries are not displayed even if those features are found on the Navigation Map. The terrain display also includes a north-south east-west grid with lines oriented with true north.

Terrain is integrated within Synthetic Vision to provide visual and auditory alerts to indicate the presence of terrain and obstacle threats relevant to the projected flight path. Terrain alerts are displayed in red and yellow shading on the PFD.

The terrain display is intended for situational awareness only. It may not provide the accuracy or fidelity on which to base decisions and plan maneuvers to avoid terrain or obstacles. Navigation must not be predicated solely upon the use of the terrain or obstacle data displayed by Synthetic Vision.

The following Synthetic Vision enhancements appear on the PFD:

- Pathways
- Flight Path Marker
- Traffic Display
- Airport Signs
- Runway Display
- Terrain Alerting
- Obstacle Alerting
- Zero-Pitch Line



Synthetic Vision Imagery (PFD or PFD Page)

SYNTHETIC VISION OPERATION

Synthetic Vision is activated from the PFD or PFD Page Option Menu. When Synthetic Vision is enabled, the pitch scale increments are reduced.

Activating and deactivating synthetic vision:

- 1) From the full-screen PFD and/or split-screen PFD Page, press the **MENU** Key.
- 2) Move the **FMS** Joystick to highlight the 'Synthetic Vision' field.
- 3) Turn the **FMS** Joystick to highlight 'On' or 'Off'.

- System Overview
- Flight Instruments
- EIS
- CNS Interface
- GPS Navigation
- Flight Planning
- Hazard Avoidance
- Additional Features
- Integrated Autopilot
- Annun/Alerts
- Appendix
- Index



Synthetic Vision on PFD

PATHWAYS



NOTE: Pathways and terrain features are not a substitute for standard course and altitude deviation information provided by the CDI, VSI, and VDI.



NOTE: Pathways boxes may not be displayed for holding patterns, procedure turns and certain portions of the flight plan being received from an external GPS navigator.

Pathways provide a three-dimensional perspective view of the selected route of flight shown as colored rectangular boxes representing the horizontal and vertical flight path of the active flight plan. The box size represents 700 feet wide by 200 feet tall during enroute, oceanic, and terminal flight phases. During an approach, the box width is 700 feet or one half full scale deviation on the HSI, whichever is less. Other than the descending portion of an ILS or WAAS GPS approach (starting from the leg leading into the FAF), pathways boxes are shown at the level of the altitude bug.

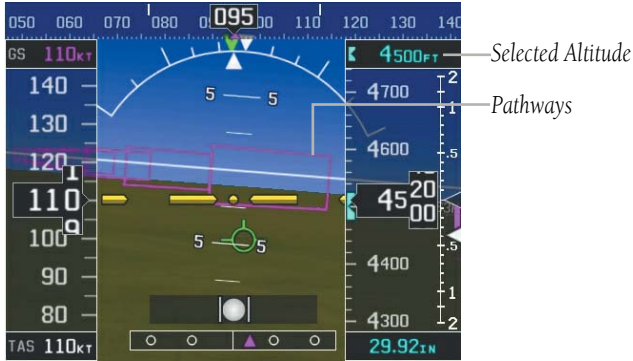

Pathways (PFD or PFD Page)

The color of the rectangular boxes may be magenta, green, or white depending on the route of flight and navigation source selected. The active GPS or GPS overlay flight plan leg is represented by magenta boxes that correspond to the Magenta CDI. A localizer course is represented by green boxes that correspond to a green CDI. An inactive leg of an active flight plan is represented by white boxes corresponding to a white line drawn on the Navigation Map indicated an inactive leg.

Pathways provide supplemental glidepath information on an active ILS, LPV, LNAV/VNAV, and some LNAV approaches. Pathways are intended as an aid to situational awareness and should not be used independent of the CDI, VDI, glide path indicator, and glide slope indicator. They are removed from the display when the selected navigation information is not available. Pathways are not displayed beyond the active leg when leg sequencing is suspended and are not displayed on any portion of the flight plan leg that would lead to intercepting a leg in the wrong direction.

Activating and deactivating pathways:

- 1) From the full-screen PFD and/or the split-screen PFD Page, press the **MENU** Key.
- 2) Move the **FMS** Joystick to highlight the 'Pathways' field.
- 3) Turn the **FMS** Joystick to highlight 'On' or 'Off'.

- System Overview
- Flight Instruments
- EIS
- CNS Interface
- GPS Navigation
- Flight Planning
- Hazard Avoidance
- Additional Features
- Integrated Autopilot
- Annun/Alerts
- Appendix
- Index

DEPARTURE AND ENROUTE

Prior to intercepting an active flight plan leg, pathways are displayed as a series of boxes with pointers at each corner that point in the direction of the active waypoint. Pathways are not displayed for the first leg of the flight plan if that segment is a Heading-to-Altitude leg. The first segment displaying pathways is the first active GPS leg or active leg with a GPS overlay. If this leg of the flight plan route is outside the SVX field of view, pathways will not be visible until the aircraft has turned toward this leg. While approaching the center of the active leg and prescribed altitude, the number of pathway boxes decreases to a minimum of four.

Pathways are displayed along the flight plan route at the selected altitude for the leg. Climb profiles cannot be displayed due to the variables associated with aircraft performance. Flight plan legs requiring a climb are indicated by pathways displayed at a level above the aircraft at the altitude selected.

DESCENT AND APPROACH



NOTE: During the final segment of an ILS or WAAS GPS approach, the pathways boxes automatically adjust to correspond with the localizer/glideslope (ILS) or horizontal/vertical (GPS) deviation signals received from the external navigator.

When an approach providing vertical guidance is activated, Pathways are shown level at the selected altitude. Pathways are shown level at the selected altitude up to the point along the final approach course where the altitude intercepts the extended vertical descent path or glideslope. From the vertical path descent or glideslope intercept point, the pathways are shown inbound to the Missed Approach Point (MAP) along the published lateral and vertical descent path.

During an ILS approach, the initial approach segment is displayed in magenta at the segment altitudes if GPS is selected as the navigation source on the CDI. When switching to the localizer inbound with LOC selected as the navigation source on the CDI, pathways are displayed in green along the localizer and glideslope.

If GPS is the selected navigation source on the HSI, the pathways boxes are magenta. If LOC is the selected navigation source on the HSI, the pathways boxes are green for the ILS. Pathways boxes are not displayed for segments such as heading legs or VOR radials.

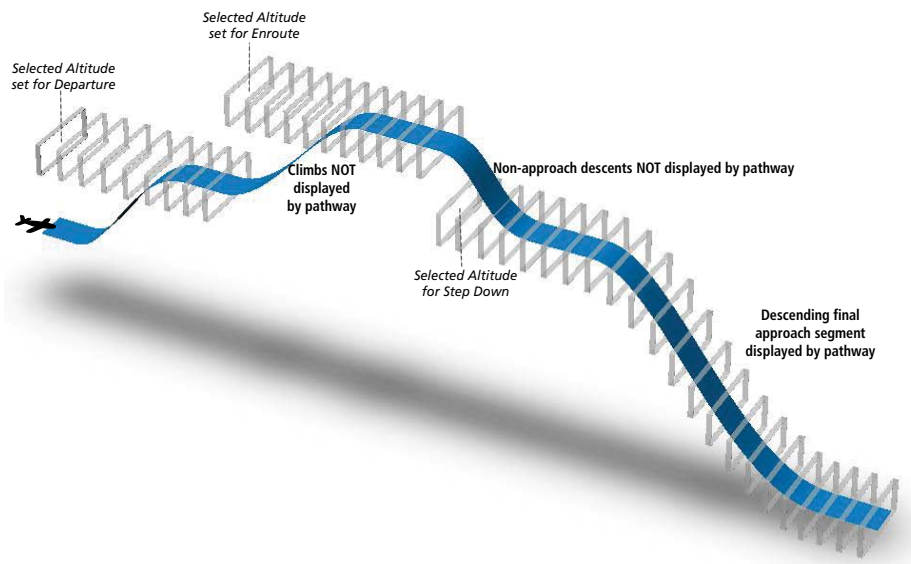

Pathways - Enroute, Descent, and Approach

MISSED APPROACH

Pathways are displayed at the selected altitude upon activating the missed approach on the external GPS navigator.

FLIGHT PATH MARKER

The Flight Path Marker (FPM), also known as a Velocity Vector, is displayed on the PFD at groundspeeds above 30 knots. The FPM depicts the approximate projected path of the aircraft accounting for wind speed and direction relative to the three-dimensional terrain display.

The FPM is always available when the Synthetic Vision feature is in operation. The FPM represents the direction of the flight path as it relates to the terrain and obstacles on the display, while the airplane symbol represents the aircraft heading.

The FPM may be used to identify a possible conflict with the aircraft flight path and distant terrain or obstacles. Displayed terrain or obstacles in the aircraft's flight path extending above the FPM could indicate a potential conflict, even before a terrain alert is issued. However, decisions regarding terrain and/or obstacle avoidance should not be made using only the FPM.

- System Overview
- Flight Instruments
- EIS
- CNS Interface
- GPS Navigation
- Flight Planning
- Hazard Avoidance
- Additional Features
- Integrated Autopilot
- Annun/Alerts
- Appendix
- Index



Flight Path Marker (PFD or PFD Page)

Activating and deactivating the flight path marker:

- 1) From the full-screen PFD and/or split-screen PFD Page, press the **MENU** Key.
- 2) Move the **FMS** Joystick to highlight the 'Flight Path Marker' field.
- 3) Turn the **FMS** Joystick to highlight 'On' or 'Off'.

ZERO PITCH LINE

The Zero Pitch Line is drawn completely across the display and represents the aircraft attitude with respect to the horizon. It may not align with the terrain horizon, particularly when the terrain is mountainous or when the aircraft is flown at high altitudes.

TRAFFIC



WARNING: Intruder aircraft at or below 500 ft. AGL may not appear on the Synthetic Vision display or may appear as a partial symbol.

Traffic symbols are displayed in their approximate locations. Traffic symbols are displayed in three dimensions, appearing larger as they are getting closer, and smaller when they are further away. Traffic within 250 feet laterally of the aircraft will not be displayed on the Synthetic Vision display. Traffic symbols and coloring are consistent with that used for traffic displayed on the Inset Map or Map Page. If the traffic altitude is unknown, the traffic will not be displayed on the Synthetic Vision display. For more details refer to the Traffic Information Service (TIS) discussion in the Hazard Avoidance section. Arrows are depicted on the traffic message if traffic is outside the Synthetic Vision field of view.

Enabling/disabling traffic on the Synthetic Vision display:

- 1) From the full-screen PFD and/or split screen PFD Page, press the **MENU** Key.
- 2) Move the **FMS** Joystick to highlight the 'TRAFFIC' field.
- 3) Turn the **FMS** Joystick to highlight 'On' or 'Off'.



Synthetic Vision Traffic (PFD)



Traffic Outside the Field of View

AIRPORT SIGNS

Airport Signs provide a visual representation of airport location and identification on the synthetic vision display. Airport Signs appear on the display when the aircraft is approximately 15 nm from an airport and disappear at approximately 4.5 nm. Airport signs are shown without the identifier until the aircraft is approximately eight nautical miles from the airport.



Airport Signs

RUNWAYS



WARNING: Do not use Synthetic Vision runway depictions as the sole means for determining the proximity of the aircraft to the runway or for maintaining the proper approach path angle during landing.



NOTE: Not all airports have runways with endpoint data in the database, therefore, these runways are not displayed.

Runway data provides improved awareness of runway location with respect to the surrounding terrain. All runway thresholds are depicted at their respective elevations as defined in the database. In some situations, where threshold elevations differ significantly, crossing runways may appear to be layered. As runways are displayed,

those within 45 degrees of the aircraft heading are outlined in white. Other runways (those NOT aligned with the aircraft heading) are outlined in gray. When an approach for a specific runway is active, that runway appears brighter and is outlined with a white box, regardless of the runway orientation as related to aircraft heading. As the aircraft gets closer to the runway, more detail such as runway numbers and centerlines are displayed.

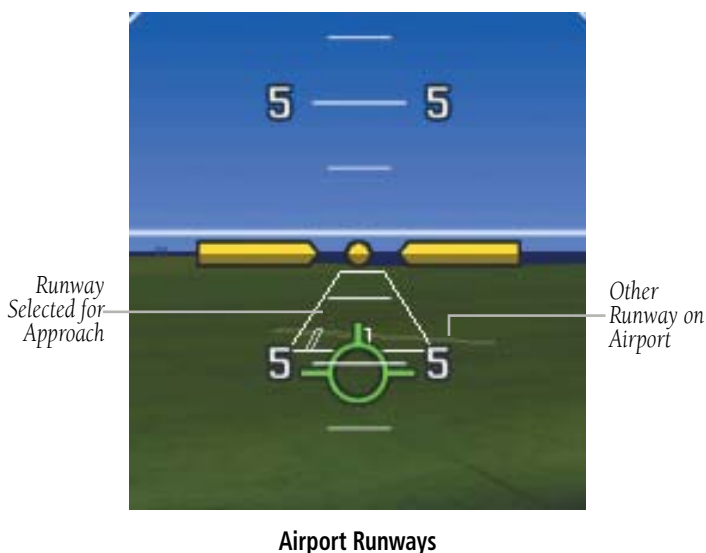

SYNTHETIC VISION TERRAIN AND OBSTACLE DATA

Terrain alerting on the synthetic vision display corresponds to the red and yellow X symbols on the Inset Map and Navigation Map. For more detailed information regarding Synthetic Vision Terrain and Obstacle Data, refer to the Hazard Avoidance Section.

In some instances, a terrain or obstacle alert may be issued with no conflict shading displayed on the synthetic vision. In these cases, the conflict is outside the Synthetic Vision field of view and the alert will have arrows indicating the direction of the alert.

- System Overview
- Flight Instruments
- EIS
- CNS Interface
- GPS Navigation
- Flight Planning
- Hazard Avoidance
- Additional Features
- Integrated Autopilot
- Annun/Alerts
- Appendix
- Index

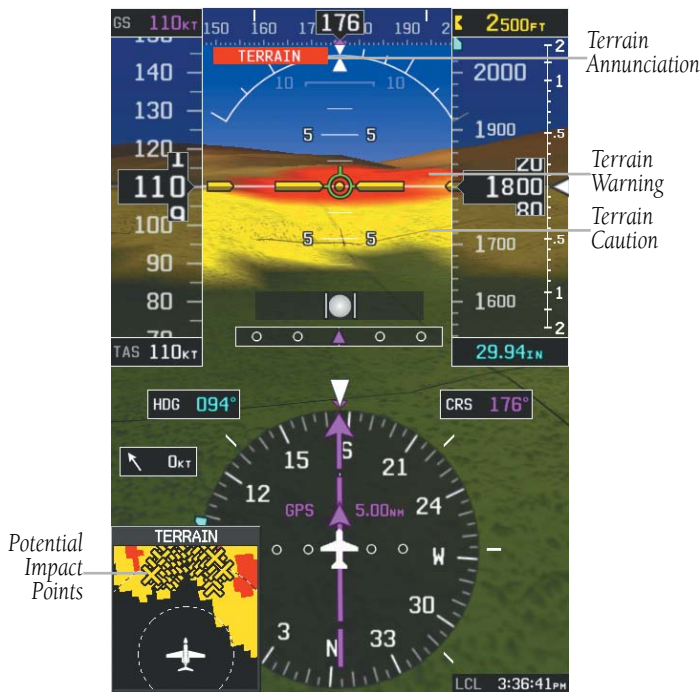

Synthetic Vision Terrain Alerts

Obstacles are represented on the synthetic vision display by standard two-dimensional tower symbols found on the Inset Map and Navigation Map. Obstacle symbols appear in the perspective view with relative height above terrain and distance from the aircraft. Unlike the Inset Map and Navigation Map display, obstacles on the synthetic vision display do not change colors to warn of potential conflict with the aircraft's flight path until the obstacle is associated with an actual terrain alert. Obstacles greater than 1000 feet below the aircraft altitude are not shown. Obstacles are shown behind the airspeed and altitude displays.

Arrows indicate the obstacle is outside the Synthetic Vision field of view.



Obstacle Outside the Synthetic Vision Field of View



Synthetic Vision Obstacle Alerts

During unusual attitude conditions or when the terrain gradient is great enough to completely fill the display, a brown (earth) or blue (sky) colored bar at the top or bottom of the screen is displayed to prevent the pilot from losing sight of the horizon.



Blue Sky Bar with Full Display Terrain

- System Overview
- Flight Instruments
- EIS
- CNS Interface
- GPS Navigation
- Flight Planning
- Hazard Avoidance
- Additional Features
- Integrated Autopilot
- Annun/Alerts
- Appendix
- Index

SYNTHETIC VISION FIELD OF VIEW

The PFD field of view can be represented on the MFD Navigation Map Page. Two dashed lines forming a V-shape in front of the aircraft symbol on the map, represent the forward viewing area shown on the PFD.

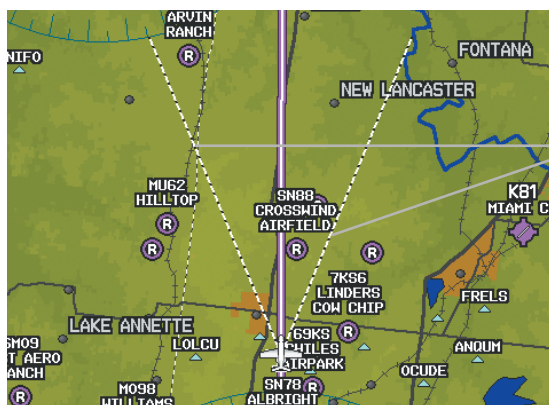

Synthetic Vision Field of View

Configuring field of view:

- 1) From the Map Page press the **MENU** Key.
- 2) Turn or move the **FMS** Joystick to highlight 'Set Up Map' and press the **ENT** Key.
- 3) Turn the **FMS** Joystick to select the 'Miscellaneous' from the horizontal list.
- 4) Move the **FMS** Joystick to highlight 'Field of View'.
- 5) Turn the **FMS** Joystick to select 'On' or 'Off', and press the **ENT** Key.

8.2 SAFETAXI®

SafeTaxi is an enhanced feature that gives greater map detail when viewing airports at close range. When viewing at ranges close enough to show the airport detail, the map reveals taxiways with identifying letters/numbers, runway incursion “Hot Spots”, and airport landmarks including ramps, buildings, control towers, and other prominent features. Resolution is greater at lower map ranges. The SafeTaxi feature can be seen on the Map Page and the Waypoint Page

Designated Hot Spots are recognized at airports with many intersecting taxiways and runways, and/or complex ramp areas. Airport Hot Spots are outlined to caution pilots of areas on an airport surface where positional awareness confusion or runway incursions happen most often. Hot Spots are defined by a red shaded area.

During ground operations the aircraft’s position is displayed in reference to taxiways, runways, and airport features. When panning over the airport, features such as runway holding lines and taxiways are shown at the cursor.

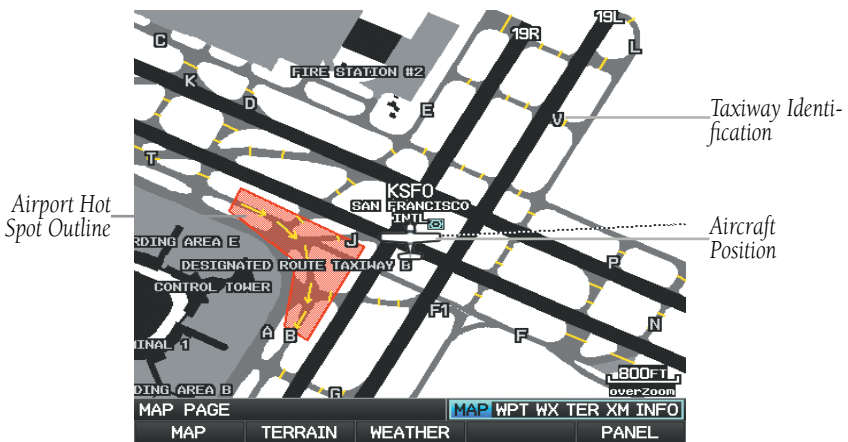

SafeTaxi Depiction on the Map Page

Enabling/disabling SafeTaxi:

- 1) With the Map Page displayed, press the **Menu** Key. The Map Page Menu is displayed.
- 2) Turn or move the **FMS** Joystick to highlight ‘Set Up Map’ and press the **ENT** Key.
- 3) Turn the **FMS** Joystick to highlight the ‘Airport’ Category from the horizontal list.

- System Overview
- Flight Instruments
- EIS
- CNS Interface
- GPS Navigation
- Flight Planning
- Hazard Avoidance
- Additional Features
- Integrated Autopilot
- Annun/Alerts
- Appendix
- Index

- 4) Move the **FMS** Joystick to highlight the 'Safe Taxi' Field.
- 5) Turn the **FMS** Joystick to access the menu options.
- 6) Turn or move the **FMS** Joystick to select 'On' or 'Off', and press the **ENT** Key.

SAFETAXI CYCLE NUMBER AND REVISION

SafeTaxi database is revised every 56 days. SafeTaxi is always available for use after the expiration date. The Power-up Page indicates whether the databases are current, out of date, or not available. The Power-up Page shows the SafeTaxi database is current when the SafeTaxi Expires date is shown in white. When the SafeTaxi cycle has expired, the SafeTaxi Expires date appears in yellow.

The SafeTaxi Region, Version, Cycle, Effective date, and Expiration date of the database cycle can also be found in the Main Menu, under 'Database Information'.

The SafeTaxi database is provided by Garmin. Refer to Appendix C for instructions on updating the SafeTaxi database.

8.3 CHARTVIEW



WARNING: Do not use the approach information provided by the VFR navigation database residing within the G3X as a means of navigating any instrument approach. The G3X VFR navigation database is limited to present only the waypoints for the final approach leg of a published procedure. These waypoints and associated course line are made available for monitoring purposes only.

ChartView resembles the paper version of Jeppesen terminal procedure charts. The MFD depiction displays the aircraft position on the moving map in the plan view of the approach charts and on airport diagrams.

ChartView database is revised every 14 days. Charts are still viewable during a period that extends from the cycle expiration date to the disables date. ChartView is disabled 70 days after the expiration date and is no longer available for viewing. When turning on the system, the Power-up Page displays the current status of the ChartView database.

The ChartView database subscription is available from Jeppesen, Inc. Available data includes:

- Arrivals (STAR)
- Departure Procedures (DP)
- Approaches
- Airport Diagrams
- NOTAMs

Displaying ChartView:

- 1) With the Waypoint (WPT) Page displayed, press the **CHART** Softkey.
- 2) Press the **FMS** Joystick to activate the cursor.
- 3) Move the **FMS** Joystick to highlight the Airport Identifier Field and use the **FMS** Joystick to begin entering the desired airport.

Or:

- a) Move the **FMS** Joystick to highlight the Chart Field.
- b) Turn the **FMS** Joystick to access a drop-down menu of available charts.
- c) Turn or move the **FMS** Joystick to select the desired chart, and press the **ENT** Key.

Or:

- 1) From the Active Flight Plan Page (with a waypoint entered), press the **SEL APPR** Softkey. The 'Select Approach Window' is displayed.
- 2) Press the **MENU** Key.
- 3) Turn or move the **FMS** Joystick to select 'Show Chart', and press the **ENT** Key. The selected chart is displayed.
- 4) Press the **EXIT** Softkey to return to the previous page.

Or:

- 1) From the Map Page or Active Flight Plan Page, use the Map Pointer to highlight the desired airport and press the **ENT** Key. The Airport Information Window is displayed.
- 2) Press the **CHART** Softkey.
- 3) With the 'Chart' Field highlighted, turn the **FMS** Joystick to access a drop-down menu of available charts.
- 4) Turn or move the **FMS** Joystick to select the desired chart, and press the **ENT** Key.

When a terminal procedure chart is not available for the requested airport or there is an error rendering the data, the banner “CHART NOT AVAILABLE” appears on the screen. The “CHART NOT AVAILABLE” banner does not refer to the ChartView subscription, but rather the availability of a particular airport chart selection or procedure for a selected airport.

CHART NOT AVAILABLE

Chart Not Available Banner

AIRCRAFT SYMBOL

The aircraft symbol is shown in magenta on the chart only if the chart is to scale and the aircraft position is within the boundaries of the chart. The aircraft symbol is not displayed when the Aircraft Symbol Not Shown Icon (X over the aircraft symbol) appears in the lower right corner. The Aircraft Symbol Not Shown Icon may appear at certain times, even if the chart is displayed to scale.

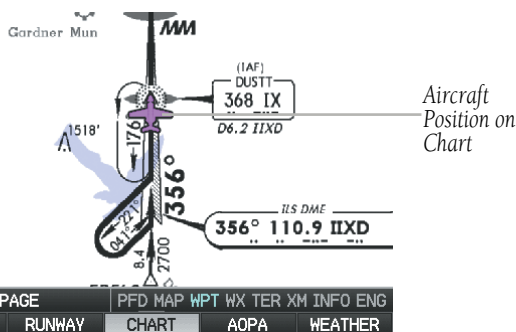

Aircraft Symbol Displayed on Chart (Waypoint Page)
(Split-Screen)



Aircraft Not Shown Icon (Waypoint Page)
(Split-Screen)

Showing/Hiding the aircraft symbol on the chart:

Press the **CLR** Key to show/hide the aircraft symbol. The Aircraft Symbol Hidden Icon (circle with a line) is displayed in the lower right corner when the aircraft symbol is hidden.



Aircraft Hidden Icon (Waypoint Page)
(Split-Screen)

CHART RANGE

Changing the chart range:

Use the down arrow on the **RNG** Key to zoom in (decreasing), or the up arrow to zoom out (increasing). Move the **FMS** Joystick to scroll the chart up, down, left, or right.

Or:

To quickly zoom all the way out, press the **CHART** Softkey. Press it again to return to the previous range (only available from the Waypoint Page).

JEPPESEN DATABASE-PUBLISHED NOTAMS



NOTE: Only NOTAMs for the selected airport is shown (when available). There may be other NOTAMs available pertaining to the flight that may not be displayed. Contact Jeppesen for more information regarding Jeppesen database-published NOTAMs.

Recent NOTAMs applicable to the current ChartView cycle are included in the ChartView database. If NOTAMs are available for the selected airport, a 'Chart NOTAMs' option will be displayed at the bottom of the drop-down menu of available charts. Select the 'Chart NOTAMs' option from the chart menu to display the applicable NOTAM information.

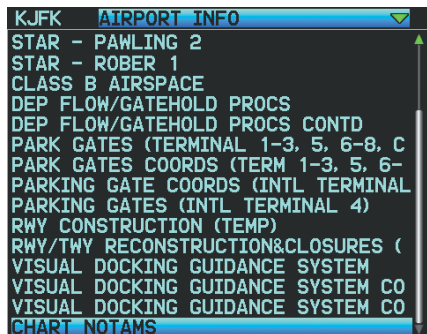

Drop-down Chart Menu

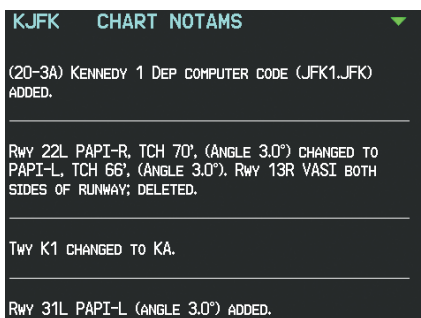

Chart Notams

8.4 FLITECHARTS®



WARNING: Do not use the approach information provided by the VFR navigation database residing within the G3X as a means of navigating any instrument approach. The G3X VFR navigation database is limited to present only the waypoints for the final approach leg of a published procedure. These waypoints and associated course line are made available for monitoring purposes only.

FliteCharts resemble the paper version of National Aeronautical Charting Office (NACO) terminal procedures charts. The charts are displayed with high-resolution and in color for applicable charts. FliteCharts database subscription is available from Garmin. Available data includes:

- Arrivals (STAR)
- Departure Procedures (DP)
- Approaches
- Airport Diagrams
- Takeoff Minimums
- Alternate Minimums

Displaying FliteCharts:

- 1) With the Waypoint (WPT) Page displayed, press the **CHART** Softkey.
- 2) Press the **FMS** Joystick to activate the cursor.
- 3) Move the **FMS** Joystick to highlight the Airport Identifier Field and use the **FMS** Joystick to begin entering the desired airport.

Or:

- a) Move the **FMS** Joystick to highlight the Chart Field.
- b) Turn the **FMS** Joystick to access a drop-down menu of available charts.
- c) Turn or move the **FMS** Joystick to select the desired chart, and press the **ENT** Key.

Or:

- 1) From the Active Flight Plan Page (with a waypoint entered), press the **SEL APPR** Softkey. The 'Select Approach Window' is displayed.
- 2) Press the **MENU** Key.
- 3) Turn or move the **FMS** Joystick to select 'Show Chart', and press the **ENT** Key. The selected chart is displayed.
- 4) Press the **EXIT** Softkey to return to the previous page.

Or:

- 1) From the Map Page or Active Flight Plan Page, use the Map Pointer to highlight the desired airport and press the **ENT** Key. The Airport Information Window is displayed.
- 2) Press the **CHART** Softkey.
- 3) With the 'Chart' Field highlighted, turn the **FMS** Joystick to access a drop-down menu of available charts.
- 4) Turn or move the **FMS** Joystick to select the desired chart, and press the **ENT** Key.

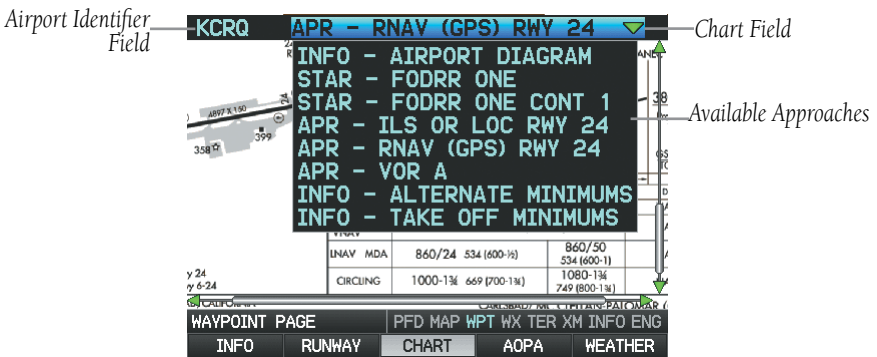

FliteCharts (Waypoint Page)
(Split-Screen)

- System Overview
- Flight Instruments
- EIS
- CNS Interface
- GPS Navigation
- Flight Planning
- Hazard Avoidance
- Additional Features
- Integrated Autopilot
- Annun/Alerts
- Appendix
- Index

When a terminal procedure chart is not available for the requested airport or there is an error rendering the data, the banner “CHART NOT AVAILABLE” appears on the screen. The “CHART NOT AVAILABLE” banner does not refer to the FliteCharts subscription, but rather the availability of a particular airport chart selection or procedure for a selected airport.



Chart Not Available Banner

AIRCRAFT SYMBOL

The aircraft symbol is shown in magenta on the chart only if the chart is to scale and the aircraft position is within the boundaries of the chart. The aircraft symbol is not displayed when the Aircraft Not Shown Icon appears. The Aircraft Not Shown Icon may appear at certain times, even if the chart is displayed to scale.

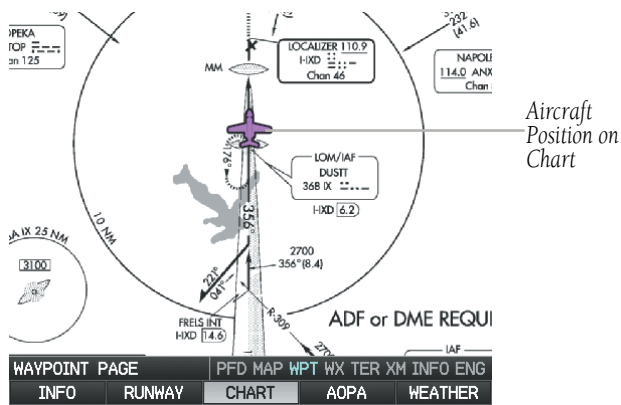

Aircraft Symbol Displayed on Chart (Waypoint Page)
(Split-Screen)

System Overview

Flight Instruments

EIS

CNS Interface

GPS Navigation

Flight Planning

Hazard Avoidance

Additional Features

Integrated Autopilot

Annun/Alerts

Appendix

Index

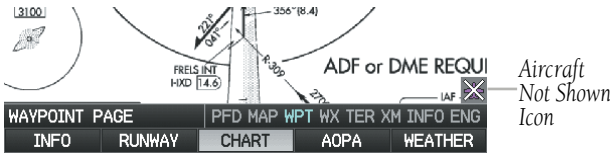

**Aircraft Not Shown Icon (Waypoint Page)
(Split-Screen)**

CHART RANGE

Changing the chart range:

Use the down arrow on the **RNG** Key to zoom in (decreasing), or the up arrow to zoom out (increasing). Move the **FMS** Joystick to scroll the chart up, down, left, or right.

Or:

To quickly zoom all the way out, press the **CHART** Softkey. Press it again to return to the previous range (only available from the Waypoint Page).

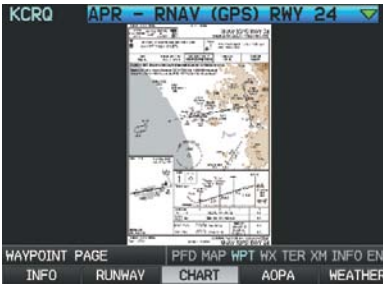

**FliteCharts (Zoomed Out)
(Split-Screen)**

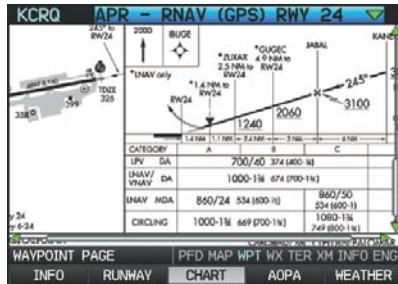

**FliteCharts (Zoomed In)
(Split-Screen)**

Scroll Arrow

Scroll Bar

FLITECHARTS CYCLE NUMBER AND EXPIRATION DATE

FliteCharts data is revised every 28 days. FliteCharts do not expire and will remain viewable after the expiration date. The Power-up Page indicates any of four different possible criteria for chart availability. These indications are whether the databases are not configured, not available, current or out of date.

8.5 AIRPORT DIRECTORY DATA

The Airport Directory contains airport statistics such as pattern altitudes, noise abatement information, FBO phone numbers, hours of operation, local attractions, ground transportation, lodging, and services.

The AOPA Airport Directory provides data on airports and heliports throughout the U.S. and it is updated on a 56-day cycle. Detailed information for over 5,300 U.S. airports, along with the names and phone numbers of thousands of FBOs can be viewed. This service allows the pilot to plan an overnight, choose fuel stops, find ground transportation, etc.

Optional airport directory databases such as AC-U-KWIK are also supported. AC-U-KWIK provides complete listings of FBOs, charter companies, fuel suppliers, ground transportation, maintenance and catering services at public airports across the world.

If the AOPA database is in use, the **AOPA** Softkey is displayed on the Waypoint (WPT) Page. If another airport directory database is in use, such as AC-U-KWIK, the **DIRECTORY** Softkey is displayed on the Waypoint (WPT) Page.

Viewing Airport Directory information:

From the Waypoint (WPT) Page, press the **AOPA** or **DIRECTORY** Softkey.

Or:

- 1) From any map highlight an airport using the Map Pointer, and press the **ENT** Key. The Airport Information Window is displayed.
- 2) Press the **AOPA** or **DIRECTORY** Softkey.
- 3) To return to the map, press the **ENT** Key, the **CLR** Key, or the **FMS** Joystick.

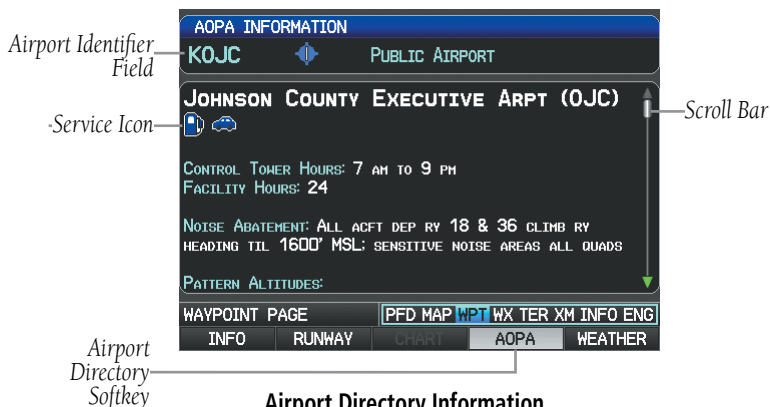

Airport Directory Information
(Waypoint (WPT) Page)
(Split-Screen)

Icon	Description
	Restaurant on Field
	Self Serve Fuel
	Courtesy Car

Airport Directory Service Icons

8.6 SIRIUSXM RADIO ENTERTAINMENT (OPTIONAL)



NOTE: See the G3X Installation Manual for SiriusXM activation instructions.



NOTE: SiriusXM Radio is only available with the optional GDU 375.



NOTE: Refer to the Hazard Avoidance Section for information about XM Weather products.

SiriusXM Satellite Radio offers a variety of radio programming over long distances without having to constantly search for new stations. Based on signals from satellites, coverage far exceeds land-based transmissions. SiriusXM Satellite Radio services are subscription-based.

ACTIVATING SIRIUSXM SATELLITE RADIO SERVICES

The service is activated by providing SiriusXM Satellite Radio with a coded ID (Radio ID).

To access the Radio ID from the XM Audio Page press the **INFO** Softkey.

Accessing the Radio ID:

From the XM Audio Page press the **INFO** Softkey.

Or:

From the XM Audio Page select Channel '0' in the 'All Channels' Category.

Or:

- 1) From the WX Page press the **MENU** Key to display the WX Page Menu.
- 2) Turn or move the **FMS** Joystick to highlight 'Weather Products' and press the **ENT** Key.

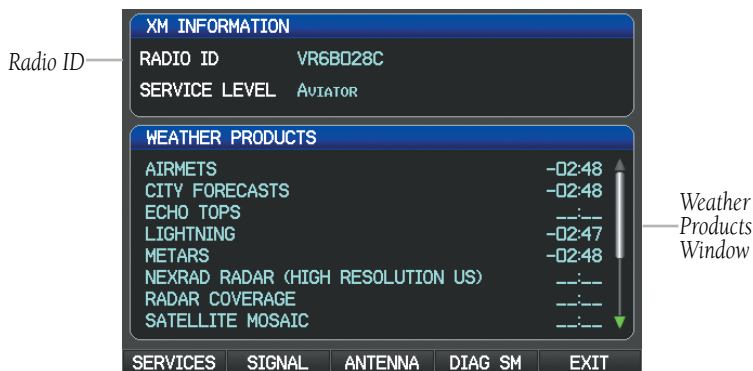

XM Information Page
(Split-Screen)

USING SIRIUSXM RADIO

The XM Audio Page provides information and control of the audio entertainment features of the SiriusXM Satellite Radio.

Selecting the XM Audio Page:

- 1) If necessary, press the **FMS** Joystick to interact with the page navigation bar.
- 2) Turn the **FMS** Joystick to select the XM Audio Page.



XM Audio Page
(Split-Screen)

CATEGORY

The Category Field of the XM Audio Page cycles through a horizontal list of categories such as jazz, rock, or news.

Selecting a category:

- 1) Press the **CATEGORY** Softkey on the XM Audio Page. The Category Field is highlighted.



Category Field (Split-Screen)

- 2) Turn the **FMS** Joystick to highlight the desired category.

Or:

- 1) Press the **FMS** Joystick to activate the cursor. Move the **FMS** Joystick to highlight the Category Field (if necessary).
- 2) Turn the **FMS** Joystick to highlight the desired category.

Press and hold the **CATEGORY** Softkey to view the 'All Channels' Category.

ACTIVE CHANNEL AND CHANNEL LIST

The Channels List of the XM Audio Page shows a list of the available channels for the selected category. The currently selected channel will flash blue. The Active Channel is denoted by an arrow.



Active Channel

The Active Channel Box (split-screen) or the Now Playing Box (full-screen) shows the currently selected channel, signal strength, and volume.

Selecting a channel:

- 1) From the XM Audio Page, press the **CHANNEL** Softkey. The Channel Field is highlighted.
- 2) Turn the **FMS** Joystick to highlight the desired channel and press the **ENT** Key.

Or:

- 1) Press the **FMS** Joystick. Move the **FMS** Joystick to highlight the Channel Field (if necessary).
- 2) Turn the **FMS** Joystick to highlight the desired channel and press the **ENT** Key.

Or:

- 1) From the XM Audio Page, press the **MENU** Key.
- 2) Turn or move the **FMS** Joystick to highlight 'Enter Channel' and press the **ENT** Key.
- 3) Turn the **FMS** Joystick to enter the desired channel and press the **ENT** or **CLR** Key.

USING FAVORITES

Favorites is a customized category of up to 30 of your SiriusXM Radio favorites.

Adding a channel to Favorites:

- 1) With the favorites channel selected, press the **MENU** Key.
- 2) With 'Add To Favorites' selected, press the **ENT** Key.
- 3) With 'Yes' selected, press the **ENT** Key.



Adding a Channel to Favorites

Selecting Favorites:

- 1) Press the **FAVORITE** Softkey on the XM Audio Page. The Favorites category is displayed.
- 2) Press the **FMS** Joystick to activate the cursor.
- 3) Move the **FMS** Joystick to select the desired channel and press the **ENT** Key.

Or:

- 1) Press the **FMS** Joystick to activate the cursor. Move the **FMS** Joystick to highlight the Category Field (if necessary).
- 2) Turn the **FMS** Joystick to highlight the Favorites category.
- 3) Move the **FMS** Joystick to select the desired channel and press the **ENT** Key.

Deleting a channel from Favorites:

- 1) With the Favorites channel selected, press the **MENU** Key.
- 2) With 'Remove Favorite' selected, press the **ENT** Key.

Or:

Highlight 'Remove All Favorites' and press the **ENT** Key to delete all channels from your Favorites list.

VOLUME

Radio volume is shown in the Now Playing Box in the lower right corner of the display. Volume level is controlled by pressing the **VOLUME** Softkey, which brings up the **MUTE** Softkey, and the volume increase (**VOL +**) and decrease (**VOL -**) softkeys.

Adjusting the volume:

- 1) With the XM Audio Page displayed, press the **VOLUME** Softkey.
- 2) Press the **VOL -** Softkey to reduce volume or press the **VOL +** Softkey to increase volume.
- 3) Press the **MUTE** Softkey to mute the audio. Press the **MUTE** Softkey again to unmute the audio.

Or:

Press and hold the **VOLUME** Softkey to mute and unmute the audio.

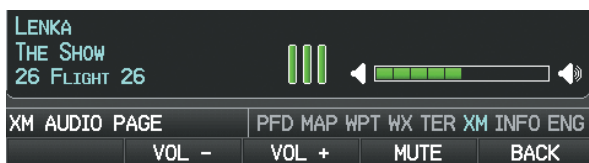

Volume Control (Split-Screen)

8.7 VERTICAL POWER (OPTIONAL)

The Vertical Power electronic circuit breaker (VP-X) integrates with the G3X system to provide a visual display of the aircraft's electrical system. From the Vertical Power (VP-X) Page pilots control, view and respond to electrical faults. The Vertical Power (VP-X) Page only appears when a VP-X is connected, configured and operational.

When an electrical device is selected, device sensitive softkeys appear, which provide the pilot with control of the device from the GDU. Devices connected to the VP-X can be controlled via dedicated switches or via softkeys on a GDU. The Vertical Power system can be connected to the PFD or MFD, but the associated softkeys will only appear on the GDU to which the Vertical Power system is connected.

Device Softkeys	Description
ON/OFF	Device sensitive softkeys for devices such as; Fuel Pump, Landing light, or anything else that would have an on/off type function.
TRIM UP/TRIM DN	Device sensitive softkeys for Pitch Trim devices.
TRIM L/TRIM R	Device sensitive softkeys for Roll Trim devices.
FLAPS UP/FLAP DN	Device sensitive softkeys for a Flap motor.
AUTO	Only appears when the landing light(s) have been configured to 'wig-wag'. When AUTO (default) is selected the VP-X will automatically pulse (wig-wag) the landing lights based on the current phase of flight. When AUTO is not selected the landing lights will remain steady-on (no wig-wag).
RESET	Only appears when the selected device is in a fault condition. By selecting 'RESET' the VP-X will attempt to clear the fault (similar to resetting the circuit breaker).

Device Sensitive Softkeys

Selecting and controlling an electrical device from the list:

- 1) With the VP-X Page displayed, press the **FMS** Joystick to activate the cursor.
- 2) Move the **FMS** Joystick to highlight the desired device.
- 3) Using the device sensitive softkeys select the desired function.

Or:

Select 'RESET' to reset a faulted device.

- System Overview
- Flight Instruments
- EIS
- CNS Interface
- GPS Navigation
- Flight Planning
- Hazard Avoidance
- Additional Features
- Integrated Autopilot
- Annun/Alerts
- Appendix
- Index

The screenshot displays the 'ELECTRICAL SYSTEM STATUS' page. At the top, it shows flight parameters: GS 0.0KT, TRK 360°H, MSA 3700FT, VSR. Below are gauges for MAN IN (7.9) and RPM (730), and fuel gauges for FUEL PSI (6.4) and FUEL QTY. Temperature gauges for OIL (67 PSI, 208 °F) and EGT (1490 °F) are also present. The main section is a schematic showing an ALTERNATOR (ON) connected to a BATTERY (13.9v) via a VP-X unit (27.0A). Below the schematic is a list of devices with their power consumption:

Device Status	Device Name	Power Consumption
ON	EFIS	2.7A
ON	GPS	0.5A
ON	LAND LT	3.2A
ON	NAV LT	4.1A
OFF	SEC ALT	
OFF	STARTER	
ON	STROBE LT	8.2A
Fault	TAXI LT	No CURRENT
ON	XPONDER	2.7A

Annotations on the image include: 'System Schematic' pointing to the electrical diagram; 'Device ON' pointing to the checked boxes; 'Device OFF' pointing to the unchecked boxes; and 'Fault Description' pointing to the 'No CURRENT' status for the TAXI LT.

Vertical Power (VP-X) Page

8.8 ELECTRONIC CHECKLISTS (OPTIONAL)



NOTE: The information described in this section is not intended to replace the checklist information described in the AFM.



NOTE: Garmin does not create, modify, or update G3X checklists and thus cannot be responsible for the availability and/or content.



NOTE: Checklists cannot be edited from within the system.

The G3X is capable of displaying checklists (if available from the aircraft manufacturer) which allow a pilot to quickly find the proper procedure on the ground and during each phase of flight. The G3X accesses the checklist file (*.ace) from the root directory (/*.ace) of the SD card. If a checklist file is available on the SD card, the 'Checklists' Main Menu Option will appear.

8.9 FLIGHT DATA LOGGING

The flight data logging feature automatically stores flight and engine data to an SD card. Data is recorded to the SD card every second. A data file is created each time the system is powered on with an SD card inserted, or each time an SD card is inserted after power on. A 2 GB SD card can store over 1,000 hours of flight data or up to 1,000 files (whichever comes first). The data files stored on the SD card have an extension of .csv. This file format can be opened using a spread sheet application on a personal computer. Garmin recommends using a 2 GB SanDisk or Toshiba SD card.

- System Overview
- Flight Instruments
- EIS
- CNS Interface
- GPS Navigation
- Flight Planning
- Hazard Avoidance
- Additional Features**
- Integrated Autopilot
- Annun/Alerts
- Appendix
- Index

Blank Page

SECTION 9 INTEGRATED AUTOPILOT (OPTIONAL)



NOTE: The approved Pilot's Operating Handbook (POH) always supersedes the information in this Pilot's Guide.



NOTE: Refer to the approved Pilot's Operating Handbook (POH) for emergency procedures.



NOTE: Refer to the G3X Installation Manual and the third-party autopilot vendor documentation for information on installing and configuring the G3X Integrated Autopilot.



NOTE: This section covers the operation of the G3X when configured with specific third-party autopilot models. Refer to the third-party autopilot vendor documentation for standalone autopilot functionality and control features.



NOTE: VOR, LOC, and GS modes are all GPS-aided. You must have a GPS position and a valid navigation database to use VOR, LOC, or GS modes.

The G3X can communicate with various third-party external autopilot units. With an appropriate third-party external autopilot installed and the G3X Integrated Autopilot configured (refer to the G3X Installation Manual), the G3X issues pitch and roll steering commands to the external autopilot unit. The external autopilot unit is then responsible for moving the flight controls.

This section contains the following terminology:

- External Autopilot Unit: Refers to the third-party autopilot box.
- Integrated Autopilot: Refers to the functionality available when the External Autopilot Unit and the G3X are working together.



NOTE: In a multiple display configuration, the external autopilot unit is connected to a single GDU (most likely the PFD). In the event that the GDU connected to the external autopilot unit fails, the integrated autopilot capability will be lost; however, the external autopilot unit will retain any standalone functionality it may support on its own.

9.1 INTEGRATED AUTOPILOT OPERATION

CONTROLS

INTEGRATED AUTOPILOT SPLIT-SCREEN PFD PAGE & FULL-SCREEN PFD SOFTKEYS



NOTE: Unless otherwise specified, all mode softkeys are alternate action (i.e., press on, press off).

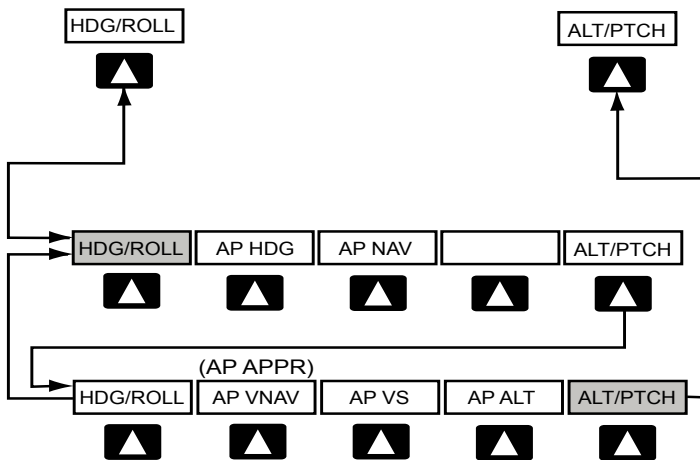

HDG/ROLL Softkey selected

HDG/ROLL	Initial press allows the pilot to adjust the heading bug and displays lateral mode softkeys; subsequent press returns to top-level softkeys
AP HDG	Selects/deselects heading mode
AP NAV	Selects/deselects navigation mode. Cancels GS Mode if LOC Mode is either active or armed. Cancels GP Mode if GPS Mode is either active or armed. Cancels LOC Mode if GPS Mode is active and LOC Mode is armed.
ALT/PTCH	Initial press allows the pilot to adjust the selected altitude and displays the vertical mode softkeys; subsequent press returns to top-level softkeys

ALT/PTCH Softkey selected

HDG/ROLL	Initial press allows the pilot to adjust the heading bug and displays lateral mode softkeys; subsequent press returns to top-level softkeys
AP VNAV	Selects/deselects vertical navigation
or	
AP APPR	Selects/deselects approach mode
AP VS	Selects/deselects vertical speed mode
AP ALT	Selects/deselects altitude hold mode
ALT/PTCH	Initial press allows the pilot to adjust the selected altitude and displays the vertical mode softkeys; subsequent press returns to top-level softkeys

FMS JOYSTICK

Moving the **FMS** Joystick up/down adjusts the mode reference for Vertical Speed (VS), Altitude Hold (ALT), and Pitch Hold (PIT) modes.

Moving the **FMS** Joystick left/right adjusts the mode reference for Roll Hold (ROL) mode. The **FMS** Joystick cannot be used to increase the roll reference bank angle, only to drive the aircraft towards wings-level.

ENGAGING THE INTEGRATED AUTOPILOT

An initial press of a softkey listed below (when the Integrated Autopilot is not engaged) will engage the Integrated Autopilot with the listed lateral and vertical modes (some modes may require an external navigator or NAV receiver):



NOTE: The External Autopilot Unit's "engage" button will activate the Integrated Autopilot in its default modes. Refer to the appropriate vendor documentation for more information.

Control Pressed	Modes Selected			
	Lateral		Vertical	
	Mode/Annunciation		Mode/Annunciation	
External Autopilot Unit	Roll Hold	ROL	Pitch Hold	PIT
CWS Button (if equipped) (press and hold)	Roll Hold	ROL	Pitch Hold	PIT
AP HDG Softkey	Heading	HDG	Pitch Hold	PIT
AP NAV Softkey	Navigation	GPS VOR LOC	Pitch Hold	PIT
AP ALT Softkey	Roll Hold	ROL	Altitude Hold	ALT
AP VS Softkey	Roll Hold	ROL	Vertical Speed	VS
AP VNAV Softkey	Roll Hold	ROL	Vertical Navigation	VNAV
AP APPR Softkey	Approach	GPS LOC	Glidepath Glideslope	GP GS

Engaging the Integrated Autopilot

The **AP NAV** and **AP APPR** Softkeys must have a valid VLOC signal or an active GPS course to activate the integrated autopilot.

The **AP VNAV** Softkey must have an active flight plan and VNAV enabled to activate the integrated autopilot.

DISENGAGING THE INTEGRATED AUTOPILOT

The Integrated Autopilot is manually disengaged by pushing the disconnect button on the external autopilot unit, or by pressing the autopilot disconnect button on the control stick or yoke. Manual disengagement is indicated by a five-second flashing yellow 'AP' annunciation and an aural alert.

Automatic disengagement is indicated by a flashing red 'AP' annunciation and an aural alert. The flashing indication continues until acknowledged by pressing the **ENT** Key. Automatic disengagement occurs due to:

- System failure
- Invalid sensor data
- Inability to compute default autopilot modes

CONTROL WHEEL STEERING (CWS) (OPTIONAL)



NOTE: *Not all external autopilot units support Control Wheel Steering (CWS).*

Control Wheel Steering allows the aircraft to be hand-flown without disengaging the Integrated Autopilot. Press and hold the external autopilot unit's CWS Button (if equipped) to temporarily disengage the pitch and roll servos from the flight control surfaces and hand-fly the aircraft. The G3X autopilot control is synchronized to the aircraft attitude during Control Wheel Steering. The green 'AP' annunciation is temporarily replaced by a white 'CW' for the duration of Control Wheel Steering maneuvers.

In most scenarios, releasing the CWS Button reengages the Integrated Autopilot with a new reference. Refer to Sections 9.2 (Vertical Modes) and 9.3 (Lateral Modes) for Control Wheel Steering behavior in each mode.

G3X AUTOPILOT STATUS BOX

Autopilot (AP) status and Integrated Autopilot mode annunciations are displayed on the G3X Autopilot Status Box, located on the PFD. When the external autopilot unit is engaged and the G3X is issuing commands to it, lateral and vertical modes are displayed. When the external autopilot unit is engaged but it is operating in a standalone mode (i.e., not responding to the G3X commands), the Autopilot status (AP) is displayed; however, the lateral/vertical modes are not displayed.

Autopilot (AP) status is displayed on the far left of the G3X Autopilot Status Box. Lateral modes are displayed in the center, and vertical modes are displayed on the right. Armed modes are displayed in white and active in green. Active modes are displayed in green and armed modes are displayed in white.

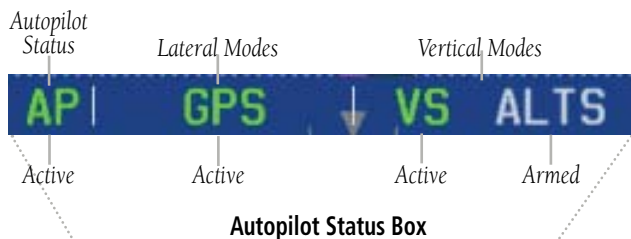

Autopilot Display (PFD)

INTEGRATED AUTOPILOT MODES

Integrated Autopilot modes are normally selected independently for the pitch and roll axes. Unless otherwise specified, all mode keys are alternate action (i.e., press on, press off). In the absence of a specific mode selection, the Integrated Autopilot reverts to the default pitch and/or roll mode(s).

Armed modes are annunciated in white and active modes are annunciated in green on the G3X Autopilot Status Box. Under normal operation when the softkey for the active mode is pressed, the Integrated Autopilot reverts to the default mode(s) for the axis(es). Automatic transition from armed to active mode is indicated by the white armed mode annunciation moving to the green active mode field and flashing for 10 seconds.

If the information required to compute a mode becomes invalid or unavailable, the Integrated Autopilot automatically reverts to the default mode for that axis. A flashing yellow mode annunciation and annunciator light indicate loss of sensor (AHRS/air data) or navigation data (VOR, LOC, GPS, WAAS) required to compute commands. When such a loss occurs, the system automatically begins to roll the wings level (i.e., enters Roll Hold Mode) or maintains the pitch angle (i.e., enters Pitch Hold Mode), depending on the affected axis. The flashing annunciation stops when the **ENT** key is pressed or another mode for the axis is selected. If after 10 seconds no action is taken, the flashing annunciation stops.

The Integrated Autopilot is automatically disabled if the attitude information required to compute the default lateral/vertical modes becomes invalid or unavailable.



Integrated Autopilot Manually Disengaged

9.2 VERTICAL MODES



NOTE: Glidepath (GP) Mode is available only in installations that include an external GPS navigation source (e.g. GTN or GNS Series). Glideslope (GS) Mode is available only in installations that include an external ILS receiver (e.g. SL30, GTN Series, or GNS Series).



NOTE: Arming Glidepath (GP) Mode also arms GPS Mode, and arming Glideslope (GS) Mode also arms LOC Mode.

Vertical Mode	Description	Control	Annunciation
Pitch Hold	Holds the current aircraft pitch attitude; may be used to climb/descend to the Selected Altitude	(default)	PIT
Selected Altitude Capture	Captures the Selected Altitude	*	ALTS
Altitude Hold	Holds current Altitude Reference	AP ALT Softkey	ALT nnnnn FT
Vertical Speed	Holds aircraft vertical speed; may be used to climb/descend to the Selected Altitude	AP VS Softkey	VS nnnn FPM
Vertical Navigation	Captures and tracks the Vertical Navigation (VNAV) profile.	AP VNAV Softkey	VNAV
VNAV Target Altitude Capture	Captures the Vertical Navigation (VNAV) Target Altitude	**	ALTV
Glidepath	Captures and tracks a WAAS approach glidepath	AP APPR Softkey	GP
Glideslope	Captures and tracks the ILS glideslope on approach		GS

* ALTS is armed automatically when PIT or VS is active, and under VNAV when the Selected Altitude is to be captured instead of the VNAV Target Altitude.

** ALTV is armed automatically under VNAV when the VNAV Target Altitude is to be captured instead of the Selected Altitude.

Integrated Autopilot Vertical Modes

PITCH HOLD MODE (PIT)

When the Integrated Autopilot is activated, Pitch Hold Mode is selected by default. Pitch Hold Mode is indicated as the active vertical mode by the green annunciation 'PIT'. This mode may be used for climb or descent to the Selected Altitude (shown above the altimeter), since Selected Altitude Capture Mode is automatically armed when Pitch Hold Mode is activated.

In Pitch Hold Mode, a constant pitch attitude (the pitch reference) is maintained. The pitch reference is set to the aircraft pitch attitude at the moment of mode selection. If the aircraft pitch attitude exceeds the configured pitch command limitations, a pitch angle equal to the nose-up/down limit is maintained.

Changing the pitch reference while in Pitch Hold (PIT) Mode:

Move and hold the **FMS** Joystick (PFD) up or down. This causes the nose of the aircraft to slowly pitch in the direction that the **FMS** Joystick is held. The current pitch attitude is held when the joystick is released.

Or:

Hold the Control Wheel Steering (CWS) Button (if equipped, and the external autopilot unit supports CWS), establish the desired pitch attitude, then release the CWS Button.

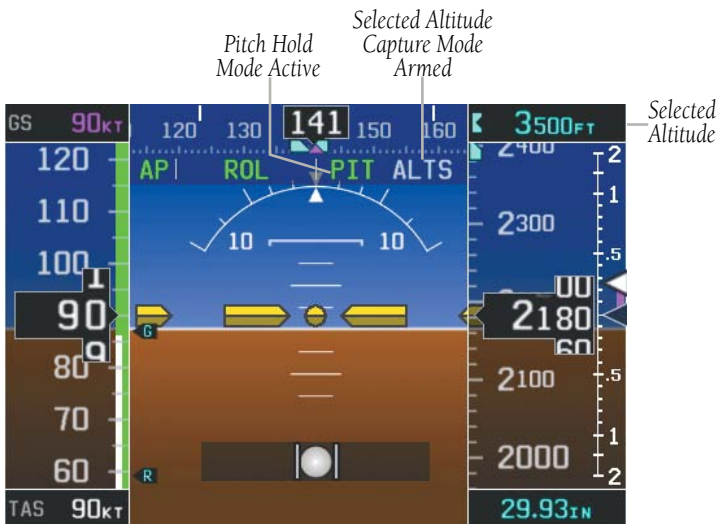

Pitch Hold & Selected Altitude Capture Modes

- System Overview
- Flight Instruments
- EIS
- CNS Interface
- GPS Navigation
- Flight Planning
- Hazard Avoidance
- Additional Features
- Integrated Autopilot
- Annun/Alerts
- Appendix
- Index

SELECTED ALTITUDE CAPTURE MODE (ALTS)



NOTE: Selected Altitude Capture Mode is not armed if the Selected Altitude has not been set.

- 1 Selected Altitude Capture Mode is automatically armed with the activation of Pitch Hold, Vertical Speed, or VNAV (if the Selected Altitude is to be captured instead of the VNAV Target Altitude) Modes. The white 'ALTS' annunciation indicates Selected Altitude Capture Mode is armed.
- 2 As the aircraft nears the Selected Altitude, Selected Altitude Capture Mode is automatically activated with Altitude Hold Mode armed. The green 'ALTS' annunciation flashes for up to 10 seconds and a white 'ALT' annunciation appears.
- 3 At 50 feet from the Selected Altitude, Altitude Hold Mode is automatically activated and the Selected Altitude is held (shown as the Altitude Reference). As Altitude Hold Mode becomes active, the white 'ALT' annunciation moves to the active pitch mode field and flashes green for 10 seconds to indicate the automatic transition. The Altitude Reference is displayed beside the 'ALT' annunciation.



Automatic transition to ALTS Mode with ALT Mode armed



Automatic transition from ALTS to ALT Mode



ALTITUDE HOLD MODE (ALT)

Altitude Hold Mode can be activated by pressing the **AP ALT** Softkey; the Integrated Autopilot maintains the current aircraft altitude (to the nearest 10 feet) as the Altitude Reference. The Altitude Reference, shown in the G3X Autopilot Status Box, is independent of the Selected Altitude, displayed above the Altimeter. Altitude Hold Mode active is indicated by a green 'ALT' annunciation in the G3X Autopilot Status Box.

Altitude Hold Mode is automatically armed when in Selected Altitude Capture Mode. Selected Altitude Capture Mode automatically transitions to Altitude Hold Mode when within 50 feet of the Selected Altitude. In this case, the Selected Altitude becomes the Altitude Reference.

CHANGING THE ALTITUDE REFERENCE

When operating in Altitude Hold Mode, the Altitude Reference can be adjusted in the following ways:

- The Altitude Reference can be adjusted up or down in 10-foot increments by pressing the **FMS** Joystick up or down. Using this method, up to 200 feet of altitude change can be commanded. To change the Altitude Reference by more than 200 feet, use the CWS button (if equipped) as described below, or climb/descend using another vertical mode (PIT, VS) to capture the desired Selected Altitude.
- If the aircraft is equipped with a CWS Button, pressing the CWS Button allows the aircraft to be hand-flown to a new Altitude Reference. When the CWS Button is released at the desired altitude, the new altitude is established as the Altitude Reference.



NOTE: While operating in Altitude Hold Mode, using the FMS Joystick to change the Selected Altitude does NOT affect the autopilot (i.e., does not change the Altitude Reference, and does not cancel the mode).

- System Overview
- Flight Instruments
- EIS
- CNS Interface
- GPS Navigation
- Flight Planning
- Hazard Avoidance
- Additional Features
- Integrated Autopilot
- Annun/Alerts
- Appendix
- Index



Altitude Hold Mode

CHANGING THE SELECTED ALTITUDE



NOTE: Holding the CWS Button (if equipped) while in Selected Altitude Capture Mode does not cancel the mode.

Setting the selected altitude:

- 1) From the PFD Page (one display) or PFD (two display), press the **ALT/PTCH** Softkey.
- 2) Turn the **FMS** Joystick to set the Selected Altitude in 100-ft increments

Use of the **FMS** Joystick to change the Selected Altitude while Selected Altitude Capture Mode is active causes the Integrated Autopilot to revert to Pitch Hold Mode with Selected Altitude Capture Mode armed for the new Selected Altitude.

VERTICAL SPEED MODE (VS)

In Vertical Speed Mode, the Integrated Autopilot acquires and maintains a Vertical Speed Reference. Current aircraft vertical speed (to the nearest 100 fpm) becomes the Vertical Speed Reference at the moment of Vertical Speed Mode activation. This mode may be used for climb or descent to the Selected Altitude (shown above the altimeter) since Selected Altitude Capture Mode is automatically armed when Vertical Speed Mode is selected.

When Vertical Speed Mode is activated by pressing the **AP VS** Softkey, 'VS' is annunciated in green in the G3X Autopilot Status Box. The current Vertical Speed Reference is displayed in the G3X Autopilot Status Box for 10 seconds after a change is made. The Vertical Speed Reference is also displayed on the vertical speed indicator with a light blue vertical speed bug whenever Vertical Speed mode is active.

CHANGING THE VERTICAL SPEED REFERENCE

The Vertical Speed Reference may be adjusted in the following ways:

- Move the **FMS** Joystick up or down to adjust the Vertical Speed Reference in increments of 100 fpm. The current Vertical Speed Reference is displayed in the G3X Autopilot Status Box for 10 seconds after a change is made. To dismiss the Vertical Speed Reference display, press **ENT**.
- Press the CWS Button (if equipped) and hand-fly the aircraft to a new Vertical Speed Reference. When the CWS Button is released, the aircraft's vertical speed (to the nearest 100 fpm) is established as the new Vertical Speed Reference.

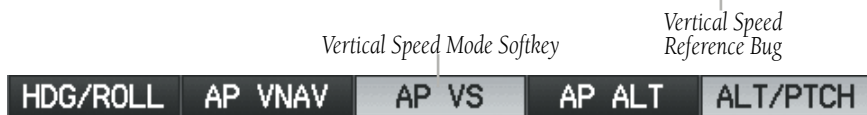
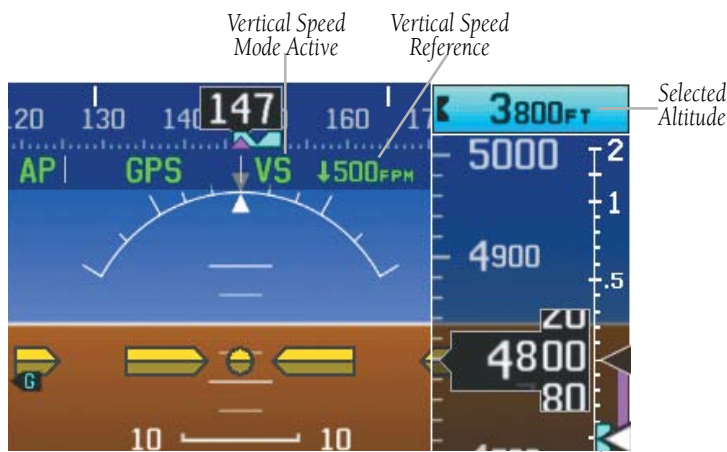

Vertical Speed Mode

System Overview
Flight Instruments
EIS
CNS Interface
GPS Navigation
Flight Planning
Hazard Avoidance
Additional Features
Integrated Autopilot
Annun/Alerts
Appendix
Index

VERTICAL NAVIGATION MODE (VNAV)



NOTE: If another vertical mode softkey is pressed while VNAV Mode is selected, VNAV Mode reverts to armed.



NOTE: Pressing the CWS Button (if equipped) while VNAV Mode is active does not cancel the mode. The Integrated Autopilot guides the aircraft back to the descent path upon release of the CWS Button.

Vertical Navigation (VNAV) Mode is available for enroute/terminal cruise and descent operations any time that VNAV flight planning is available. Refer to Section 2.3 (Vertical Navigation) for more information.

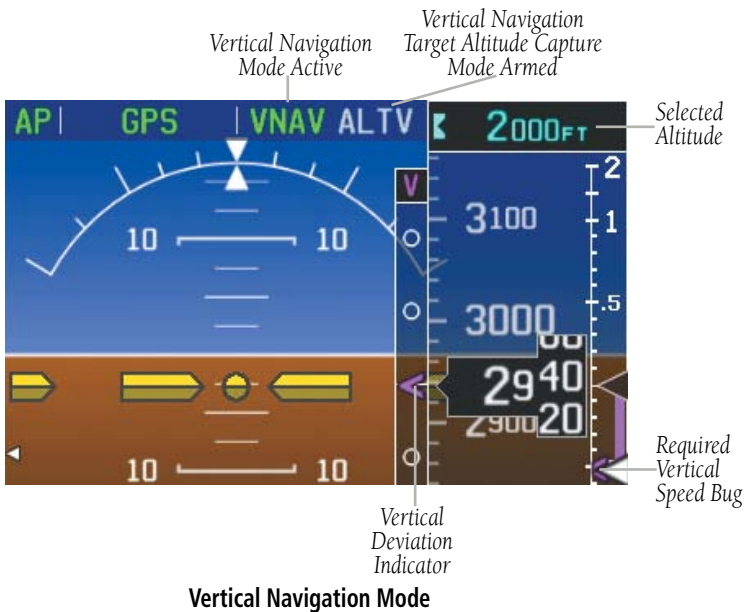

Activating Vertical Navigation Mode:

- 1 When a flight plan is active, VNAV data is valid, and the **AP VNAV** Softkey is pressed, VNAV mode is armed in preparation for descent path capture. 'VNAV' is annunciated in white in the G3X Autopilot Status Box. If applicable, the appropriate altitude capture mode is armed for capture of the VNAV Target Altitude (ALTV) or the Selected Altitude (ALTS), whichever is greater.
- 2 When a descent leg is captured (i.e., vertical deviation becomes valid), VNAV Mode is activated and tracks the descent profile. An altitude capture mode (ALTS or ALTV) is armed as appropriate.
- 3 When approaching the VNAV Target Altitude (or Selected Altitude) the system automatically transitions to ALTS or ALTV Mode with ALT Mode armed.

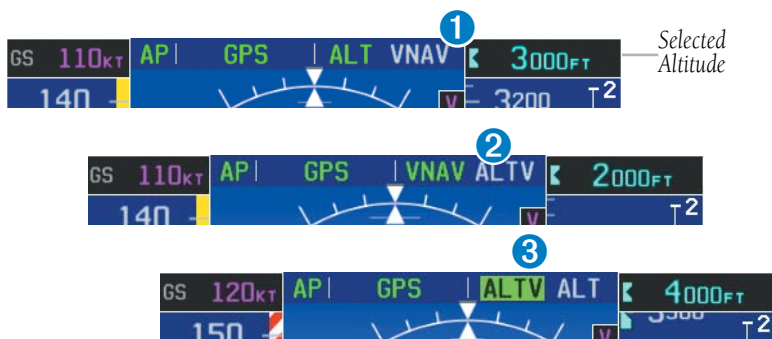

If the altimeter's barometric setting is adjusted while VNAV mode is active, the Integrated Autopilot increases/decreases the descent rate by up to 500 fpm to re-establish the aircraft on the descent path (without commanding a climb). For large changes, it may take several minutes for the aircraft to reestablish on the descent path. If the change is made while nearing the VNAV waypoint, the aircraft may not reestablish on the descent path in time to level off at the VNAV Target Altitude. In this case, the Integrated Autopilot will revert to Pitch Hold mode upon passing the VNAV waypoint, and Selected Altitude Capture (ALTV) mode will be automatically armed.

AUTOMATIC REVERSION TO PITCH HOLD MODE

Several situations can occur while VNAV Mode is active which cause the Integrated Autopilot to revert to Pitch Hold Mode:

- Vertical deviation exceeds 200 feet during an overspeed condition.
- Vertical deviation becomes invalid (the Deviation Indicator is removed from the PFD).

Following a reversion to Pitch Hold Mode, VNAV Mode and the appropriate altitude capture mode become armed to allow for possible profile recapture.

VNAV TARGET ALTITUDE CAPTURE MODE (ALTV)

VNAV Target Altitude Capture is analogous to Selected Altitude Capture Mode and is armed automatically after the **AP VNAV** Softkey is pressed if the VNAV Target Altitude is to be intercepted before the Selected Altitude. The annunciation 'ALTV' indicates that the VNAV Target Altitude is to be captured. Refer to Section 2.3 (Vertical Navigation) for more information on setting up the VNAV target altitude.

As the aircraft nears the VNAV Target Altitude, the Integrated Autopilot automatically transitions to VNAV Target Altitude Capture Mode with Altitude Hold Mode armed. This automatic transition is indicated by the green 'ALTV' annunciation flashing for up to 10 seconds and the appearance of the white 'ALT' annunciation.

At 50 feet from the VNAV Target Altitude, the Integrated Autopilot automatically transitions from VNAV Target Altitude Capture to Altitude Hold Mode and selects the VNAV target altitude as the new Integrated Autopilot Altitude Reference. As Altitude Hold Mode becomes active, the white 'ALT' annunciation moves to the active vertical mode field and flashes green for 10 seconds to indicate the automatic transition.

- System Overview
- Flight Instruments
- EIS
- CNS Interface
- GPS Navigation
- Flight Planning
- Hazard Avoidance
- Additional Features
- Integrated Autopilot
- Annun/Alerts
- Appendix
- Index

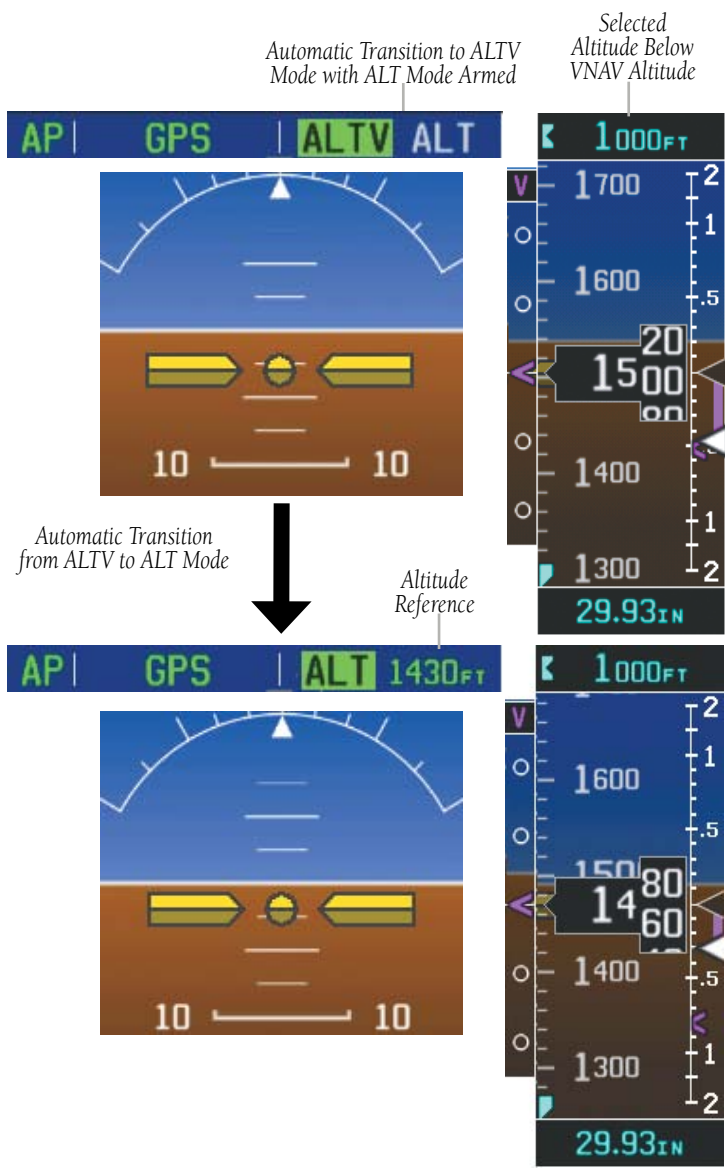

Automatic Mode Transitions During Altitude Capture

GLIDEPATH MODE (GP) (WAAS ONLY)



NOTE: Press the CWS Button (if equipped) while Glidepath Mode is active does not cancel the mode. The Integrated Autopilot guides the aircraft back to the glidepath upon release of the CWS Button.



NOTE: The integrated autopilot will not capture a glidepath or glideslope from above.

Glidepath Mode is available only in installations with an external GPS navigation source (i.e., GTN or GNS Series) configured. Glidepath Mode is used to track the WAAS-based glidepath only. When Glidepath Mode is armed, 'GP' is annunciated in white in the G3X Autopilot Status Box.

Selecting Glidepath Mode:

- 1) Ensure a GPS approach with vertical guidance (LPV, LNAV/VNAV, LNAV+V) is loaded into the active flight plan.
- 2) Ensure that GPS is the selected navigation source (use the **CDI SRC** Softkey to cycle through external navigation sources if necessary).
- 3) Press the **ALT/PTCH** Softkey to access the autopilot pitch modes and press the **AP APPR** Softkey (only available when an external GPS navigation source (i.e., GTN or GNS Series) is configured).



NOTE: Some RNAV (GPS) approaches provide a vertical descent angle as an aid in flying a stabilized approach. These approaches are NOT considered Approaches with Vertical Guidance (APV). Approaches that are annunciated on the HSI as LNAV or LNAV+V are considered Nonprecision Approaches (NPA) and are flown to an MDA even though vertical glidepath (GP) information may be provided.



WARNING: When flying an LNAV approach (with vertical descent angle) with the Integrated Autopilot coupled, the aircraft will not level off at the MDA even if the MDA is set in the altitude preselect. The baro minimums feature can still be used as a reminder to check altitude when approaching the MDA.

When Glidepath Mode is armed or activated, GPS Mode is also armed/activated.

Upon reaching the glidepath, the autopilot transitions to Glidepath Mode and begins to capture and track the glidepath.



Glidepath Mode Armed

Once the following conditions have been met, the glidepath can be captured:

- The active waypoint is at or after the final approach fix (FAF).
- Vertical deviation is valid.
- The CDI is at less than full scale deviation.

If Glidepath Mode is active and any of the following occurs, the Integrated Autopilot reverts to Pitch Hold Mode:

- The active navigation source is manually or automatically switched.
- WAAS glidepath data from the external GPS navigator fails or becomes invalid.

GLIDESLOPE MODE (GS)



NOTE: Pressing the CWS Button (if equipped) while Glideslope Mode is active does not cancel the mode. The autopilot guides the aircraft back to the glideslope upon release of the CWS Button.



NOTE: The integrated autopilot will not capture a glidepath or glideslope from above.

Glideslope Mode is available only in installations with a navigation receiver configured. Glideslope Mode is available for LOC/ILS approaches with lateral and vertical guidance to capture and track the glideslope. When Glideslope Mode is armed (annunciated as 'GS' in white), LOC Mode is armed as the lateral autopilot mode.

Selecting Glideslope Mode:

- 1) EXTERNAL NAVIGATOR: Tune and activate the desired localizer frequency.
- 2) EXTERNAL NAVIGATOR: Ensure that LOC is the selected navigation source (use the **CDI SRC** Softkey to cycle through external navigation sources if necessary).
- 3) G3X: Press the **ALT/PTCH** Softkey to access the autopilot pitch modes and press **AP APPR** Softkey. This simultaneously selects LOC and GS (Glideslope) Modes.

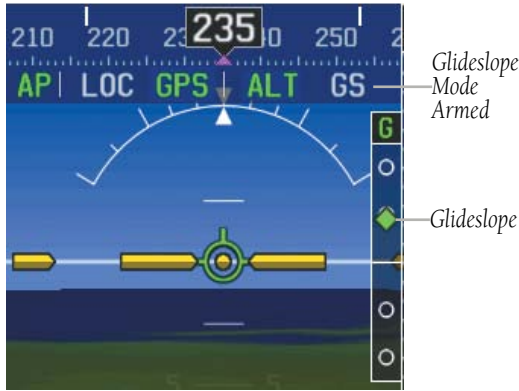

Glideslope Mode Armed

Or:



NOTE: The following procedure is useful for arming the ILS while using the GPS to fly a procedure turn. Configuration of an external GPS navigation source (i.e., GTN or GNS Series) is required.

- 1) EXTERNAL NAVIGATOR: Tune and activate the desired localizer frequency.
- 2) EXTERNAL NAVIGATOR: Load the approach (LOC, ILS, LDA, SDF, etc) into the flight plan.
- 3) G3X: While GPS is still the selected navigation source on the external navigator, press the **AP APPR** Softkey to arm LOC and GS (Glideslope) Modes even with GPS Mode still active. The external navigator will switch from GPS to VLOC automatically and the G3X will capture the localizer and then the glideslope.



ILS Armed and GPS Mode Active

Once LOC is the navigation source, the localizer and glideslope can be captured. Upon reaching the glideslope, the autopilot transitions to Glideslope Mode and begins to intercept and track the glideslope.



9.3 LATERAL MODES

The following table lists the lateral modes with their corresponding controls and annunciations:

Lateral Mode	Description	Control	Annun
Roll Hold	Holds the current aircraft roll attitude or rolls the wings level, depending on the commanded bank angle	(default)	ROL
Heading	Captures and tracks the Selected Heading (heading bug)	AP HDG Softkey	HDG
Navigation, GPS	Captures and tracks the selected navigation source (GPS, VOR, LOC)	AP NAV Softkey	GPS
Navigation, VOR Enroute & Approach Capture/Track			VOR
Navigation, LOC Capture/Track (No Glideslope)			LOC
Navigation, Backcourse Capture/Track			BC
Approach, GPS	Captures and tracks the selected navigation source (GPS, LOC) GPS Mode is automatically armed in conjunction with GP Mode.	AP APPR Softkey	GPS
Approach, LOC Capture/Track	Captures and tracks the selected navigation source (GPS, LOC) LOC Mode is automatically armed in conjunction with GS Mode.		LOC

Lateral Modes

The CWS Button (if equipped) does not change lateral references for HDG or NAV modes. The Integrated Autopilot guides the aircraft back to the Selected Heading/Course upon release of the CWS Button.

ROLL HOLD MODE (ROL)



NOTE: If Roll Hold Mode is activated as a result of a mode reversion, the Integrated Autopilot rolls the wings level.

When the Integrated Autopilot is activated, Roll Hold Mode is selected by default. This mode is annunciated as 'ROL' in the G3X Autopilot Status Box. Roll Mode maintains a constant bank angle, the roll reference, which is subject to the following bank angle conditions:



Roll Hold Mode Annunciation

Initial Bank Angle	Autopilot Roll Reference
Less than 6°	Rolls wings level
6° to Maximum Bank Setting	Maintains current aircraft bank angle
Greater than Maximum Bank Setting	Limits bank angle to maximum bank setting

Roll Hold Mode Responses

CHANGING THE ROLL REFERENCE

When operating in Roll Hold Mode, the roll reference can be adjusted in the following ways:

- To decrease the roll reference, move **FMS** Joystick (PFD) to the left or right and hold. The Integrated Autopilot slowly decreases the bank angle. The current bank angle as the **FMS** Joystick is released is held (if the bank angle exceeds 6°). If the bank angle is less than 6° as the **FMS** Joystick is released, the Integrated Autopilot will roll the aircraft wings level. The roll reference cannot be increased using the **FMS** Joystick.
- Hold the CWS Button (if equipped), establish the desired bank angle, then release the CWS Button.

HEADING MODE (HDG)

Heading Mode is activated by pressing the **AP HDG** Softkey. Heading Mode acquires and maintains the Selected Heading. The Selected Heading is shown by a light blue bug on the HSI and Heading Tape and in the box to the upper left of the HSI.



Heading Mode Annunciation

CHANGING THE SELECTED HEADING



NOTE: Press and hold the FMS Joystick (on the PFD or PFD Page) to synchronize the Selected Heading to the current heading.

Changing the selected heading (integrated autopilot configured):

- 1) From the PFD Page (one display) or PFD (two display), press the **HDG/ROLL** Softkey (if necessary). The Heading Box is highlighted.
- 2) Turn the **FMS** Joystick to select the desired heading, and press the **FMS** Joystick. The Selected Heading is shown to the left of the HSI.

Holding the CWS Button (if equipped) and hand-flying the aircraft does not change the Selected Heading. The Integrated Autopilot guides the aircraft back to the Selected Heading upon release of the CWS Button.

Turns are commanded in the same direction as Selected Heading Bug movement, even if the Bug is turned more than 180° from the present heading (e.g., a 270° turn to the right). However, Selected Heading changes of more than 330° at a time result in turn reversals.

CHANGING THE SELECTED COURSE

The Selected Course is controlled by pressing the **OBS CRS** Softkey, **VOR CRS** Softkey, or **LOC CRS** Softkey, (while in OBS, VOR, LOC, or BC Mode) and turning the **FMS** Joystick on the G3X PFD (or PFD Page) to select the desired course (or press **XPDR/CRS** > **OBS CRS** / **VOR CRS** / **LOC CRS** from the PFD (or PFD Page) if a transponder is configured). Pressing the CWS Button (if equipped) and hand-flying the aircraft does not change the Selected Course while in Navigation Mode. The Integrated Autopilot guides the aircraft back to the Selected Course (or GPS flight plan) when the CWS Button is released.

GPS, VOR & LOC MODES



NOTE: VOR, LOC, and GS modes are all GPS-aided. You must have a GPS position and a valid navigation database to use VOR, LOC, or GS modes.



NOTE: When intercepting a flight plan leg, the Integrated Autopilot gives commands to capture the active leg at approximately a 45° angle to track between the waypoints defining the active leg. The Integrated Autopilot does not give commands to fly to the starting waypoint of the active leg unless a direct-to course to the first flight plan waypoint is entered.

Pressing the **AP NAV** Softkey acquires and tracks the selected navigation source (GPS, VOR, LOC). The integrated autopilot follows GPS roll steering commands when GPS is the selected navigation source. When the navigation source is VOR or LOC, the autopilot creates roll steering commands from the Selected Course and deviation. Navigation Mode can also be used to fly non-precision GPS and LOC approaches where glideslope capture is not required.

If the Course Deviation Indicator (CDI) shows greater than one dot when the **AP NAV** Softkey is pressed, the selected mode is armed. If the CDI is less than one dot, Navigation Mode is automatically captured when the **AP NAV** Softkey is pressed. The armed annunciation appears in white to the left of the active lateral mode.

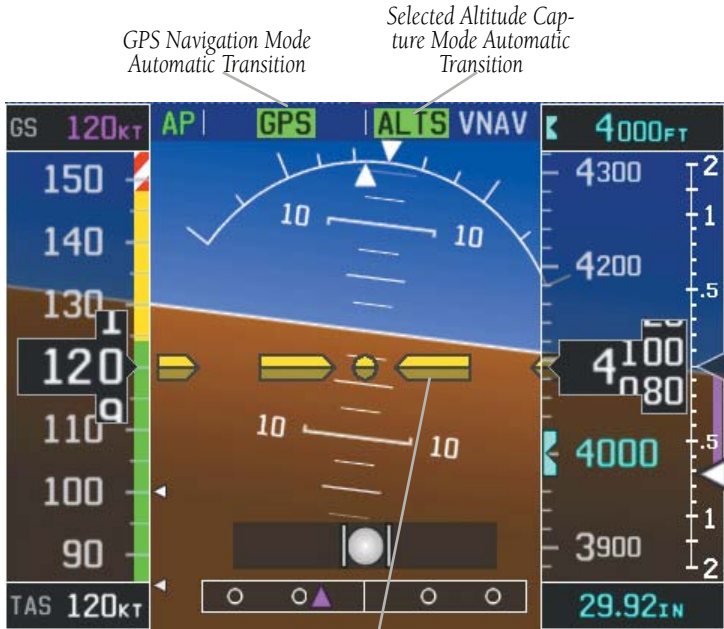

Aircraft Symbol Indicates Left Turn to Track GPS Course and Descent To Intercept Selected Altitude

Navigation Softkey



Navigation Softkeys (PFD)

LOC Mode is activated when the automatic navigation source switch takes place. If the **AP APPR** Softkey is pressed prior to the automatic navigation source switch, LOC Mode is armed.

In the right circumstances, LOC and GS Modes can be armed while GPS Mode is still active and the external navigator is set to GPS (not VLOC).

- System Overview
- Flight Instruments
- EIS
- CNS Interface
- GPS Navigation
- Flight Planning
- Hazard Avoidance
- Additional Features
- Integrated Autopilot
- Annun/Alerts
- Appendix
- Index

Arming LOC & GS Modes while GPS Mode is still active:

- 1) EXTERNAL NAVIGATOR: Tune and activate the desired localizer frequency.
- 2) EXTERNAL NAVIGATOR: Load the approach (LOC, ILS, LDA, SDF, etc) into the flight plan.
- 3) G3X: While GPS is still the selected navigation source on the external navigator, press the **AP APPR** Softkey to arm LOC and GS (Glideslope) Modes even with GPS Mode still active. The external navigator will switch from GPS to VLOC automatically and the G3X will capture the localizer and then the glideslope.

If Navigation Mode is active and either of the following occur, the Integrated Autopilot reverts to Roll Hold Mode (wings rolled level):

- Different VOR tuned while in VOR Navigation Mode (VOR Navigation Mode reverts to armed)
- Active navigation source manually switched (with the **CDI SRC** Softkey on the PFD/PFD Page, or the CDI Key on the external navigator)
- Active flight plan is deleted (only GPS-based modes)
- GPS reception is lost

If VOR Navigation Mode is active and the VOR signal is lost, the Integrated Autopilot reverts to Roll Hold Mode (wings rolled level) and reverts VOR Mode to armed in the event the VOR signal is reestablished.

OBS MODE

In OBS Mode the Selected Course is controlled using the **OBS CRS** Softkey. Or press **XPDR/CRS** > **OBS CRS** when a transponder is configured.

Enabling/disabling OBS Mode (without external GPS navigator):

- 1) From the Active Flight Plan Page, press the **MENU** Key while navigating a flight plan or Direct-to.
- 2) With 'Set OBS and Hold' highlighted, press the **ENT** Key. The OBS Mode Box is highlighted.
- 3) Turn the **FMS** Joystick to select the desired course to/from the waypoint.
- 4) To cancel OBS Mode and return to automatic waypoint sequencing, press the **MENU** Key, with 'Release Hold' highlighted, press the **ENT** Key.

Enabling/disabling OBS Mode (with external GPS navigator configured):

- 1) EXTERNAL NAVIGATOR: Press the **OBS** Key. The 'Set OBS and Hold' Active Flight Plan Page menu option is now available.
- 2) G3X: Turn the **FMS** Joystick to select the desired course to/from the waypoint.

VOR MODE FOR NAVIGATION

VOR Mode can be used for navigation when an external navigation receiver is configured.



- System Overview
- Flight Instruments
- EIS
- CNS Interface
- GPS Navigation
- Flight Planning
- Hazard Avoidance
- Additional Features
- Integrated Autopilot
- Annun/Alerts
- Appendix
- Index

Tracking Direct-to a VOR:

- 1) EXTERNAL NAVIGATOR: Tune and activate the desired VOR frequency. If a GTN or GNS series unit is not configured skip to Step 3.
- 2) EXTERNAL NAVIGATOR (GTN or GNS series units only): Ensure the 'VLOC' indication is showing in the lower-left corner. If not, press the CDI Key.
- 3) G3X: Ensure that VOR1 or VOR2 is the selected navigation source (use the **CDI SRC** Softkey on the PFD or PFD Page to cycle through external navigation sources if necessary). It should say 'VOR1' or 'VOR2' on the HSI and the needle should be green.
- 4) G3X: From the PFD or PFD Page, press the **VOR CRS** Softkey (or press **XPDR/CRS > VOR CRS** if a transponder is configured) and turn the **FMS** Joystick until the CDI is centered with a 'TO' indication.

Or:

From the PFD or PFD Page press the **VOR CRS** Softkey (or press **XPDR/CRS > VOR CRS** if a transponder is configured), then press and hold the **FMS** Joystick to automatically center the CDI.

- 5) G3X: From the PFD or PFD Page, press the **HDG/ROLL** Softkey to access the autopilot lateral modes and then press the **AP NAV** Softkey to activate VOR Mode. A green 'VOR' indication is displayed in the autopilot status bar and the autopilot tracks the selected course to the VOR.

Intercepting and tracking a VOR radial:

- 1) EXTERNAL NAVIGATOR: Tune and activate the desired VOR frequency. If a GTN or GNS series unit is not configured skip to Step 3.
- 2) EXTERNAL NAVIGATOR (GTN or GNS series units only): Ensure the 'VLOC' indication is showing in the lower-left corner of the. If not, press the CDI Key.
- 3) G3X: Ensure that VOR1 or VOR2 is the selected navigation source (use the **CDI SRC** Softkey on the PFD or PFD Page to cycle through external navigation sources if necessary). It should say 'VOR1' or 'VOR2' on the HSI and the needle should be green.

- 4) **G3X:** From the PFD or PFD Page, press the **VOR CRS** Softkey (or press **XPDR/CRS > VOR CRS** if a transponder is configured) and turn the **FMS** Joystick to select the desired radial.
- 5) **G3X:** From the PFD or PFD Page, press the **HDG/ROLL** Softkey to access the autopilot lateral modes and then press the **AP NAV** Softkey. If there is less than half-scale deviation when the **AP NAV** Softkey is pressed, VOR Mode will activate (green text), intercept, and track the selected radial. If there is more than half-scale deviation when the **AP NAV** Softkey is pressed, VOR Mode will arm (white text) first, then activate when closer to the radial.



Navigation Softkeys

APPROACHES WITHOUT VERTICAL GUIDANCE



NOTE: For the autopilot to enter a VLOC mode, the G3X must have GPS reception, a valid navigation database, and the external navigation receiver must have a valid signal (VOR or LOC).

Press the **AP NAV** Softkey to arm/activate VOR, LOC/BC, and GPS (LNAV only) lateral modes. Lateral modes acquire and track the selected navigation source (GPS, VOR, or LOC), depending on the loaded approach. These modes use the selected navigation receiver deviation and desired course inputs to fly the approach. Press the **AP NAV** Softkey when the CDI is greater than one dot to arm the selected modes (annunciated in white). Press the **AP NAV** Softkey when the CDI deviation is less than one dot to activate, capture and track the selected navigation source (GPS, VOR, or LOC).

Example	Control	Lateral Mode	Annunciation	Description
LNAV	AP NAV Softkey	Approach, GPS	GPS	Captures and tracks the selected navigation source (GPS, VOR, LOC)
VOR		VOR Approach Capture/Track	VOR	
LOC		LOC Capture/Track (No Glideslope)	LOC	
BC		Backcourse Capture/Track	BC	Captures and tracks a localizer signal for backcourse approaches

Approaches without Vertical Guidance

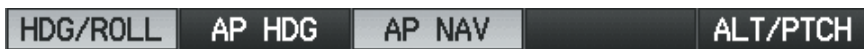

Navigation Softkeys

GPS APPROACH WITHOUT VERTICAL GUIDANCE

A GPS approach without vertical guidance (LNAV) is flown using GPS NAV Mode.

Selecting a GPS Approach without vertical guidance:

- 1) EXTERNAL NAVIGATOR: Ensure a GPS approach without vertical guidance (LNAV) is loaded into the active flight plan.
- 2) EXTERNAL NAVIGATOR: Ensure the 'GPS' indication is showing in the lower-left corner. If not, press the CDI Key.
- 3) G3X: Ensure that GPS1 is the selected navigation source on the PFD or PFD Page (use the **CDI SRC** Softkey to cycle through external navigation sources if necessary).
- 4) EXTERNAL NAVIGATOR: Select and activate the GPS approach using the PROC Key.
- 5) G3X: From the PFD or PFD Page, press the **HDG/ROLL** Softkey to access the autopilot lateral modes and then press the **AP NAV** Softkey to activate GPS Mode.
- 6) Adjust the aircraft's pitch axis as required.

VOR APPROACH

A VOR approach is flown using VOR Mode.

Selecting a VOR Approach:

- 1) EXTERNAL NAVIGATOR: Tune and activate the desired VOR frequency. If a GTN or GNS series unit is not configured skip to Step 3.
- 2) EXTERNAL NAVIGATOR (GTN or GNS series units only): Ensure the 'VLOC' indication is showing in the lower-left corner of the. If not, press the CDI Key.
- 3) G3X: Ensure that VOR1 or VOR2 is the selected navigation source (use the **CDI SRC** Softkey on the PFD or PFD Page to cycle through external navigation sources if necessary). It should say 'VOR1' or 'VOR2' on the HSI and the needle should be green.
- 4) G3X: From the PFD or PFD Page, press the **VOR CRS** Softkey (or press **XPDR/CRS > VOR CRS** if a transponder is configured) and turn the **FMS** Joystick to select the inbound approach course (radial).
- 5) G3X: From the PFD or PFD Page, press the **HDG/ROLL** Softkey to access the autopilot lateral modes and then press the **AP NAV** Softkey. If there is less than half-scale deviation when the **AP NAV** Softkey is pressed, VOR Mode will activate (green text), intercept, and track the selected radial. If there is more than half-scale deviation when the **AP NAV** Softkey is pressed, VOR Mode will arm (white text) first, then activate when closer to the radial.
- 6) Adjust the aircraft's pitch axis as required.

LOCALIZER APPROACH (NO GS)

LOC Mode is used to fly a localizer only approach (no glideslope).

Selecting LOC Mode for a localizer only approach:

- 1) EXTERNAL NAVIGATOR: Tune and activate the desired LOC frequency,
- 2) G3X: Ensure that LOC1 is the selected navigation source (use the **CDI SRC** Softkey on the PFD or PFD Page to cycle through external navigation sources if necessary). The HSI should automatically slew the needle to the correct course.
- 3) G3X: From the PFD, press the **HDG/ROLL** Softkey to access the autopilot lateral modes and then press the **AP NAV** Softkey to activate LOC Mode. If the localizer deviation is less than half-scale when the **AP NAV** Softkey is pressed, the autopilot will activate LOC Mode and track the localizer, otherwise LOC Mode is armed and the pilot is responsible for intercepting the localizer. In some cases it may be necessary to use HDG Mode with LOC Mode armed to follow a vector to the localizer.

BACKCOURSE APPROACH



NOTE: When making a backcourse approach, set the Selected Course to the localizer front course.



NOTE: 'BC' will not be displayed on the G3X HSI.

Backcourse Mode captures and tracks a localizer signal in the backcourse direction. Backcourse is indicated by 'BC' in the autopilot status box.

If GS and LOC Mode are armed, the autopilot can only capture the localizer front course, indicated by 'LOC' in the autopilot status box. If only LOC Mode is armed (not GS Mode), the autopilot will capture either the front course or the backcourse based on the angle at which the aircraft intercepts the localizer.

Selecting BC Mode:

- 1) EXTERNAL NAVIGATOR: Tune and activate the desired LOC frequency.
- 2) G3X: Ensure that LOC1 is the selected navigation source on the (use the **CDI SRC** Softkey on the PFD or PFD Page to cycle through external navigation sources if necessary). The HSI should automatically slew the needle to the correct course.

- 3) **G3X**: From the PFD or PFD Page, press the **HDG/ROLL** Softkey to access the autopilot lateral modes and then press the **AP NAV** Softkey. If the aircraft heading is within 75° of the localizer backcourse then BC Mode will be armed. If the aircraft heading is within 105° of the localizer front course, LOC Mode will be armed.

If BC mode is armed and the heading exceeds 75° of the localizer backcourse for 20 seconds, the autopilot will switch from BC to LOC mode. If LOC mode is armed and the heading exceeds 105° of the localizer front course for 20 seconds, the autopilot will switch from LOC mode to BC mode. Once BC mode or LOC mode become active, the autopilot will not switch between LOC and BC modes regardless of the heading.

APPROACHES WITH LATERAL + VERTICAL GUIDANCE

Press the **AP APPR** Softkey to arm/activate both lateral and vertical modes for approach. When Glidepath (GP) Mode is armed for a GPS approach with vertical guidance, GPS Mode is automatically armed. When Glideslope (GS) Mode armed for an ILS approach, LOC Mode is automatically armed. Press the **AP APPR** Softkey when the CDI is greater than one dot to arm the selected modes (annunciated in white). Press the **AP APPR** Softkey when the CDI deviation is less than one dot to activate, capture and track the selected navigation source.

Example	Control	Modes	Annunciation	Description
LPV, LNAV/VNAV, LNAV+V	AP APPR Softkey	Lateral: GPS	GPS	Captures and tracks the lateral portion of a GPS approach
		Vertical: Glidepath	GP	Captures and tracks a WAAS approach glidepath
LOC, ILS, LDA, SDF	AP APPR Softkey	Lateral: Localizer	LOC	Captures and tracks the localizer
		Vertical: Glideslope	GS	Captures and tracks the glideslope

Lateral + Vertical Approaches

GPS APPROACH WITH VERTICAL GUIDANCE



NOTE: To cancel Glidepath (GP) Mode without cancelling GPS Mode, press the **AP NAV** Softkey once. Pressing it a second time cancels GPS Mode.

When Glidepath (GP) Mode is armed for a GPS approach with vertical guidance, GPS Mode is automatically armed.

Selecting a GPS approach with vertical guidance:

- 1) EXTERNAL NAVIGATOR: Ensure a GPS approach with vertical guidance (LPV, LNAV/VNAV, LNAV+V) is loaded into the active flight plan.
- 2) EXTERNAL NAVIGATOR: Ensure the 'GPS' indication is showing in the lower-left corner. If not, press the CDI Key.
- 3) G3X: Ensure that GPS1 is the selected navigation source on the PFD or PFD Page (use the **CDI SRC** Softkey to cycle through external navigation sources if necessary).
- 4) EXTERNAL NAVIGATOR: Select and activate the GPS approach using the PROC Key.
- 5) G3X: From the PFD or PFD Page, press the **ALT/PTCH** Softkey to access the autopilot pitch modes and then press the **AP APPR** Softkey.

HDG/ROLL

AP APPR

AP VS

AP ALT

ALT/PTCH

Approach Softkeys

LOCALIZER WITH GLIDESLOPE

LOC Mode (lateral) and GS Mode (vertical) are both armed by pressing the **ALT/PTCH** Softkey and then the **AP APPR** Softkey from the G3X PFD. LOC/ILS approach captures are inhibited if the difference between aircraft heading and localizer course exceeds 105°.



- System Overview
- Flight Instruments
- EIS
- CNS Interface
- GPS Navigation
- Flight Planning
- Hazard Avoidance
- Additional Features
- Integrated Autopilot
- Annun/Alerts
- Appendix
- Index



NOTE: To cancel Glideslope (GS) Mode without cancelling LOC Mode, press the **AP NAV** Softkey once. Pressing it a second time cancels LOC Mode.

Selecting LOC Mode with GS Mode:

- 1) **EXTERNAL NAVIGATOR:** Tune and activate the desired LOC frequency.
- 2) **G3X:** Ensure that LOC1 is the selected navigation source (use the **CDI SRC** Softkey on the PFD or PFD Page to cycle through external navigation sources if necessary). The HSI should automatically slew the needle to the correct course.

- System Overview
- Flight Instruments
- EIS
- CNS Interface
- GPS Navigation
- Flight Planning
- Hazard Avoidance
- Additional Features
- Integrated Autopilot
- Annun/Alerts
- Appendix
- Index



- 3) **G3X**: From the PFD or PFD Page, press the **ALT/PTCH** Softkey to access the autopilot pitch modes and then press the **AP APPR** Softkey. This simultaneously selects LOC Mode and GS (Glideslope) Mode. If the localizer deviation is less than half-scale when the **AP APPR** Softkey is pressed, the autopilot will activate LOC Mode and track the localizer, otherwise LOC Mode is armed and the pilot is responsible for intercepting the localizer.



Approach Softkeys

If the following occurs, the autopilot reverts to Roll Hold Mode (wings rolled level):

- Approach Mode is active and the Navigation source is manually switched
- The localizer signal is lost

If the Glideslope signal is lost , GS Mode will revert to Pitch Hold Mode and hold the last pitch attitude.

COUPLED APPROACH



NOTE: Configuration of a GNS 430 or GNS 530 is required for a coupled ILS approach.

The external navigator (GNS 430/530), G3X, and autopilot can be used to fly a full ILS approach with procedure turn, from the enroute environment to the missed approach point.

Setting up a coupled ILS approach:

- 1) **EXTERNAL NAVIGATOR:** Ensure the 'GPS' indication is showing in the lower-left corner. If not, use the CDI Key.
- 2) **G3X:** Ensure that GPS1 is the selected navigation source on the PFD or PFD Page (use the **CDI SRC** Softkey to cycle through external navigation sources if necessary).
- 3) **EXTERNAL NAVIGATOR:** Select and activate the ILS approach using the PROC Key.
- 4) **G3X:** From the PFD or PFD Page, press the **HDG/ROLL** Softkey to access the autopilot lateral modes and then press the **AP NAV** Softkey to activate GPS Mode. The autopilot should start navigating to the IAF (Initial Approach Fix).

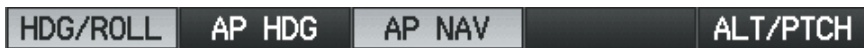

Navigation Softkeys

- 5) **EXTERNAL NAVIGATOR:** Tune and identify the localizer frequency by pressing the VLOC Flip-flop Key. (Note: The external navigator should have automatically loaded the localizer frequency into the standby VLOC slot.)
- 6) **G3X:** From the PFD or PFD Page, press the **ALT/PTCH** Softkey to access the autopilot pitch modes and then press the **AP APPR** Softkey to arm LOC and GS modes. Press the **AP ALT** Softkey. GPS Mode is now active and LOC Mode is armed in the roll axis. ALT Mode is active and GS is armed in the pitch axis. The autopilot should now navigate the entire approach from the IAF (Initial Approach Fix) to the MAP (Missed Approach Point) with the only adjustment being the throttle.

- System Overview
- Flight Instruments
- EIS
- CNS Interface
- GPS Navigation
- Flight Planning
- Hazard Avoidance
- Additional Features
- Integrated Autopilot**
- Annun/Alerts
- Appendix
- Index

HDG/ROLL	AP APPR	AP VS	AP ALT	ALT/PTCH
----------	---------	-------	--------	----------

Approach Softkeys



NOTE: Check step #5 if the external navigator doesn't automatically switch from GPS to VLOC Mode shortly after turning inbound on the final approach course.

9.4 INTEGRATED AUTOPILOT ALERTS

Refer to Section 10.4, 'PFD Annunciations and Alerting Functions'.

SECTION 10 ANNUNCIATIONS & ALERTS

10.1 MISCELLANEOUS MESSAGE ADVISORIES

Message	Comments
Approaching Target Altitude	Within 200 feet of final VNAV target altitude.
Approaching VNAV Profile	The aircraft is within one minute of reaching the initial VNAV decent point.
Arriving at XXX	The aircraft is nearing the destination.
Can't Unlock Maps	No applicable unlock code for one or more maps was found. All MapSource maps are not accessible.
Database Error	Internal problem with the system. Contact your dealer or Garmin Product Support to have the unit repaired.
Fuel Tank	A reminder for switching fuel tanks. The reminder message repeats at the specified interval after the beginning of each trip.
Lost Satellite Reception	The system is unable to receive satellite signals.
Memory Full	System memory is full, no further data can be saved.
Proximity Alarm XXXXX	You have reached the distance set for a proximity waypoint.
Next DTK XXX	The aircraft is nearing a turn in a route.
No XM Signal	The XM antenna is not receiving a signal.
Proximity Alarm Memory Full	No additional proximity waypoints can be saved.
Proximity Waypoints Overlap	The radius of two proximity waypoints overlap.
Route Already Exists	A route name that already exists has been entered.
Route Memory Full	No additional routes can be saved.
Route Truncated	Uploaded route from another device has more than 300 waypoints.
Route Waypoint Memory Full	No additional route waypoints can be saved.

System Overview

Flight Instruments

EIS

CNS Interface

GPS Navigation

Flight Planning

Hazard Avoidance

Additional Features

Integrated Autopilot

Annun/Alerts

Appendix

Index

MISCELLANEOUS MESSAGE ADVISORIES (CONT.)

Message	Comments
Saving XM Program Information	An XM Radio channel lineup change has occurred and the unit is saving the channel lineup to memory.
Steep Turn Ahead	Approaching a turn that requires a bank angle in excess of 25 degrees to stay on course.
Track Already Exists	A saved track with the same name already exists.
Track Log Full	The track log is full and track recording was turned off. To record more track points, you need to clear the track log and turn track recording on.
Track Memory Full	No more track data can be stored. Delete the old track data to store the new data.
Track Truncated	A complete uploaded track will not fit in memory. The oldest track log points have been deleted.
Transfer Complete	Data transfer was completed.
VNAV Cancelled	VNAV function has been cancelled due to a change in the active route.
Waypoint Already Exists	A waypoint with the same name already exists.
Waypoint Memory Full	The unit has stored the maximum number of waypoints.

AIRSPACE MESSAGES

Message	Comments
Inside Airspace	Inside the boundaries of the airspace.
Airspace Near and Ahead	Within two nautical miles of an airspace and your current course takes you inside the airspace.
Airspace Ahead, Within 10 Minutes	The projected course takes you inside an airspace within the next 10 minutes or less.
Airspace Near, Within 2 nm	Within two nautical miles of an airspace but not projected to enter it.

10.2 SYSTEM STATUS MESSAGES (INFO PAGE)

The 'INFO' Page on the Navigation Bar will flash yellow if there is a System Status Message (split-screen and full-screen MFD).

A yellow **MSG** (Message) alert will flash in the bottom right corner of the split-screen PFD Page or full-screen PFD to alert the pilot of System Status Messages on the **INFO** Page.



System Status Message Alert
(Split-Screen PFD Page &
Full-Screen PFD)



System Status Message Alert
(Split-Screen and Full-Screen MFD)

Accessing the Info Page system status messages:

- 1) When the 'INFO' Page on the Page Navigation Bar is flashing, use the **FMS** Joystick to access the Info Page.
- 2) Press the yellow **MESSAGES** Softkey. The Messages Page is displayed.



System Status Message Alert (Info Page)
(Split-Screen)

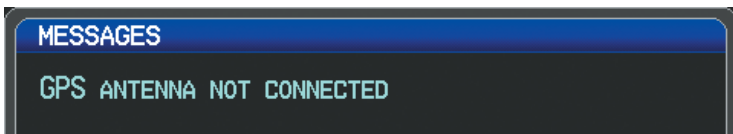

Messages Page (Split-Screen)

- 3) To return to the Info Page, press the **FMS** Joystick, **CLR** Key, or **EXIT** Softkey. The Info Page will stop flashing, but remain yellow until the message is resolved.

The following system status messages may appear on the Info Page.

SYSTEM STATUS MESSAGES

Message	Comments
AHRS extended operation in no-GPS mode	The AHRS is operating exclusively in no-GPS mode. The G3X system should be serviced.
AHRS fault detected	A fault has been detected in the AHRS. The G3X system should be serviced.
AHRS magnetic-field model out of date	The AHRS Earth magnetic field model is out of date. Update magnetic field model when practical.
AHRS not calibrated	The AHRS is either not calibrated or requires post installation calibration procedures to be conducted. The G3X system should be serviced.
AHRS not receiving airspeed data	The AHRS is not receiving true airspeed from the air data computer. The AHRS relies on GPS information in the absence of true airspeed. The G3X system should be serviced.
AHRS not receiving GPS information	The AHRS is not receiving any or any useful GPS information. The G3X system should be serviced.
AHRS too far north/south for magnetic heading	The aircraft is outside geographical limits for approved AHRS operation. Heading is flagged as invalid.
ARINC 429 receiver error	Data received on an ARINC 429 input does not match the expected configuration.
Autopilot fault detected	The remote autopilot unit has detected an internal fault and needs service.
Check XM antenna	The display that is configured for a XM antenna connection does not have an XM signal.
Config module error	The GDU has encountered unexpected configuration settings. The G3X system should be serviced.
Config module missing	The PFD config module is not connected.

Message	Comments
Demo Mode - Do not use for navigation	The system is in demo mode, do not use for navigation.
GDU software version mismatch	The PFD and MFD do not have the same software version installed. Display crosstalk is disabled. Ensure all installed display software matches.
GPS antenna not connected	The display that is configured for a GPS antenna connection does not detect any antenna current draw from the GPS antenna RF connector.
GPS antenna shorted to ground	The display that is configured for a GPS antenna connection detects the GPS antenna RF connector is shorted to ground.
GPS receiver needs service	The internal GPS receiver in the specified GDU is not responding. The affected GDU should be serviced.
GSU 73 configuration error	The GSU configuration settings do not match the configuration settings stored in backup memory. The G3X system should be serviced.
GSU 73 needs service	The GSU should be serviced when possible.
GSU 73 not responding	The GDU has lost communication with the GSU.
GSU 73 software update required	A software update for the GSU 73 is required. Consult the install manual for instructions on performing a GSU 73 software update.
GSU 73 temperature too low	The GSU temperature is too low. If the problem persists, the G3X system should be serviced.
Hardware fault detected	Send your GDU in for service.
Mag cal incomplete - repeat mag cal	The magnetic calibration is incomplete or improperly calibrated. Repeat the magnetic calibration.

Message	Comments
Magnetic anomaly - Check mag installation	An anomaly has been detected in the magnetometer data. Heading may or may not be flagged invalid.
Magnetometer data invalid	The data being communicated by the GMU is invalid. Heading is flagged invalid and the AHRS will use GPS for backup mode operation. The G3X system should be serviced.
Magnetometer failure	Communication has been lost or a fault has been detected in the GMU. Heading is flagged invalid and the AHRS will use GPS for backup mode operation. The G3X system should be serviced.
Navigation database mismatch	The PFD and MFD have different navigation database versions installed. Install the correct navigation database on all displays for proper operation.
Navigation database missing	The navigation database is missing. Install the correct navigation database on all displays for proper operation.
Network fault - Duplicate GDU detected	A duplicate GDU has been detected on the CAN bus. If the problem persists, the G3X system should be serviced.
Network address changed	One or more GDUs on the CAN bus have an indeterminate network address. This likely indicates a wiring issue or an intermittent connector pin. If the problem persists, the G3X system should be serviced.
Not receiving autopilot RS-232 data	Not receiving RS-232 data from integrated autopilot unit.
Not receiving external GPS RS-232 Aviation data	Not receiving RS-232 data from external GPS navigator.

Message	Comments
Not receiving data on ARINC 429 channel 'X'	Data is not being received on the specified GSU 73 ARINC 429 input ('x' can be 1-4).
Not receiving SL30 RS-232 data	Not receiving RS-232 data from the SL30.
Not receiving TIS RS-232 data	Not receiving RS-232 data from TIS.
Obstacle database mismatch	The PFD and MFD have different obstacle database versions installed. Install the correct obstacle database on all displays for proper terrain/obstacle alerting.
Obstacle database missing	The obstacle database is missing. Install the correct obstacle database on all displays for proper terrain/obstacle alerting.
SL30 communication error	Incorrect OBS value received from SL30. Check SL30 OBS resolver setup (see Installation Manual guidance).
Terrain database mismatch	The PFD and MFD have different terrain database versions installed. Install the correct terrain database on all displays for proper terrain/obstacle alerting.
Terrain database missing	The terrain database is missing. Install the correct terrain database on all displays for proper terrain/obstacle alerting.
Using internal flight plan for navigation	Communication with the external GPS navigation source has failed. The G3X internal flight plan is being used for navigation.
Using external GPS position data	The display that is configured for a GPS antenna connection is not available; the remaining displays are using 2D GPS position data from an external GPS navigator.
XM receiver needs service	The display should be serviced when possible.

10.3 AURAL ALERTS

- “Five Hundred”—when the aircraft descends through 500 feet above the destination airport.

The following aural terrain alerts are issued when flight conditions meet parameters that are set within the software algorithms, and are dependent on the sensitivity level set in the Terrain Setup Menu.

Alert Severity	Terrain	Obstacle	Descent Rate
Caution	“caution, terrain” “caution, terrain ahead”	“caution, obstacle” “caution, obstacle ahead”	“caution, sink rate”
Warning	“terrain ahead! pull up!” “terrain! terrain! pull up! pull up!”	“obstacle ahead! pull up!” “obstacle! obstacle! pull up! pull up!”	“sink rate, pull up!” “pull up!”

Aural Alerts Summary

10.4 PFD ANNUNCIATIONS AND ALERTING FUNCTIONS

The following annunciations and alerting functions are displayed on the PFD.

UNCERTAIN HEADING

If the G3X senses that the magnetic heading measurement is valid, but possibly outside of the internal accuracy limits, the numeric heading value on the PFD is display in yellow. When the system heading is uncertain, features that use heading data may not be available (e.g., autopilot HDG mode or PFD wind calculations). An uncertain heading value can be caused by magnetic anomalies or installation/calibration issues. Refer to the G3X installation manual for installation and calibration information for the magnetometer



Uncertain Heading

EXTERNAL NAVIGATOR MESSAGES (OPTIONAL)

When an external navigator has a pending message, a yellow 'MSG' annunciation will appear in the bottom left quadrant of the HSI.

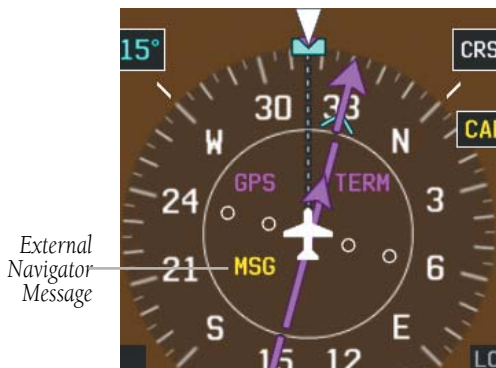

External Navigator Message

External Navigator Messages (HSI)

CAS MESSAGES (OPTIONAL)

The CAS messages displayed depend upon the current configuration, and will vary from the examples listed below. Refer to the G3X Installation Manual for more information on configuring CAS messages (if applicable).

CAS Messages are grouped by criticality (warning, caution, advisory, and safe):

- **WARNING (red):** Requires immediate attention. Warning messages will flash until acknowledged by pressing the **ENT** Key.
- **CAUTION (yellow):** Requires pilot awareness and possible future corrective action.
- **ADVISORY (white):** Provides general information.
- **SAFE (green):** Indicates a safe condition (i.e., GEAR DOWN).

Warning annunciation text is shown in red in the CAS Annunciation Window on the full-screen PFD and/or split-screen PFD Page.

CAS Messages will appear to the right of the Horizontal Situation Indicator (dependent on number of CAS messages configured) on the full screen PFD and/or the split-screen PFD Page.



CAS Warning Example

Important CAS Messages may not be visible at all times (e.g., split-screen PFD Page is not displayed, or FPL or NRST Pages are displayed on the full-screen PFD). In that case a Check Alerts Triangle is displayed to the right of the Airspeed Indicator as a reminder to check the CAS Messages.



CAS Warning Example (Check Alerts Triangle)

If less than four CAS Messages are configured for the system, the CAS Messages are displayed to the right of the Airspeed Indicator and the Check Alerts Triangle is not displayed.

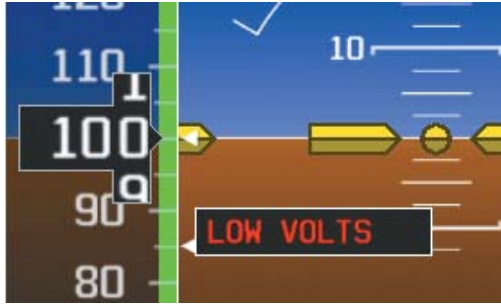

CAS Warning Example

TERRAIN ANNUNCIATIONS

In addition to the Terrain Pop-up Alert in the lower left corner of the page, terrain and obstacle annunciations appear on the PFD and/or PFD Page in the upper left corner of the Attitude Indicator. Refer to the Hazard Avoidance Section for more details.



Terrain Alerts
(PFD and/or PFD Page)

- System Overview
- Flight Instruments
- EIS
- CNS Interface
- GPS Navigation
- Flight Planning
- Hazard Avoidance
- Additional Features
- Integrated Autopilot
- Annun/Alerts
- Appendix
- Index

TRAFFIC ANNUNCIATIONS

The G3X displays traffic symbolically on the Map Page, and the Traffic Warning Window (Inset Map) in the lower left corner of the display(s). Refer to the Hazard Avoidance Section and the Annunciations and Alerts section for more details.



Traffic Alerts

INTEGRATED AUTOPILOT ALERTS (OPTIONAL)

Integrated Autopilot Alert



Integrated Autopilot Alerts

STATUS ALERTS

If the commanded operation cannot be achieved due to the limitations configured, the following messages can be displayed over the pitch ladder. The annunciation is removed once the condition is resolved.

Alert Condition	Annunciation	Description
Up-elevator Trim Required	↑ TRIM UP ↑	The autopilot does not have the required elevator authority to reach the desired flight condition.
Down-elevator Trim Required	↓ TRIM DOWN ↓	

Status Alerts

The following messages are displayed in the G3X Autopilot Status Box.

Alert Condition	Annunciation	Description
System Failure	AP	Autopilot inoperative
Manual Disengagement	AP	Autopilot Disengaged

Integrated Autopilot System Alerts

SPEED ALERTS

If the remote autopilot unit supports speed alerts and the airspeed limitations configured have been reached, the following messages can be displayed over the pitch ladder. The annunciation is removed once the condition is resolved.

Alert Condition	Annunciation	Description
Overspeed Protection	MAX SPEED	External autopilot unit will raise the nose to limit the aircraft's speed.
Underspeed Protection	MIN SPEED	External autopilot unit will lower the nose to prevent the aircraft's speed from decreasing.

Speed Alerts

VERTICAL POWER FAULT INDICATIONS

Device Fault	Description
OVER VOLTAGE	Voltage too high (only appears for alternator devices).
OVER CURRENT	Device current too high.
NO CURRENT	Device not drawing current (possible open circuit).
SHORT CIRCUIT	Short circuit detected.
RUNAWAY	Flap or trim runaway condition detected.
SWITCH DISABLED	Flap or trim switch disabled.
FAULT CODE XX	XX indicates an internal VP-X fault code (consult Vertical Power for details).
ERROR	Unable to clear fault or other error occurred.

Device Faults

SECTION 11 APPENDICES

APPENDIX A: DATA FIELD OPTIONS

DATA BAR FIELD OPTIONS

Data Bar Field	Definition
BRG - Bearing to Waypoint	The compass direction from the present position to the next waypoint.
CLG - Climb Gradient (Percent)	Current climb gradient (climb rate divided by groundspeed) in percent.
CLM - Climb Gradient (ALT/NM)	Current climb gradient (climb rate divided by groundspeed) in altitude per nautical mile.
DA - Density Altitude	Pressure Altitude adjusted for non-standard temperature.
DST - Distance to Waypoint	The distance to the next waypoint in the Active Flight Plan.
DTK - Desired Track	The desired course between the active "from" and "to" waypoints.
ECO - Fuel Economy	This value is calculated by dividing the current ground speed by the current fuel flow.
EDR - Fuel Endurance	This value is obtained by dividing the amount of fuel on board by the current fuel flow (endurance to empty - no reserve included).
ESA - En Route Safe Altitude	The recommended minimum altitude within ten miles left or right of the desired course on an active flight plan or direct-to.
ETA - Estimated Time of Arrival	The estimated time at which the aircraft should reach the next waypoint, based upon current ground speed and track.
ETE - Estimated Time En Route	The estimated time it takes to reach the next waypoint from the present position, based upon current ground speed.

DATA BAR FIELD OPTIONS (CONT.)

Data Bar Field	Definition
FLT - Flight Time	The total time in flight.
FF - Fuel Flow	The current fuel flow.
G - G-Meter	The amount of positive or negative G's.
GS - Ground Speed	The velocity that the aircraft is traveling relative to a ground position.
LCL - Time of Day (Local)	The current time and date in 12-hour or 24-hour format.
MACH - Mach Number	A unit of speed that measures the ratio of the speed of an airplane to the speed of sound in the same atmospheric conditions.
MSA - Minimum Safe Altitude	Uses Grid MORAs to determine a safe altitude within ten miles of the aircraft's present position.
REM - Fuel Remaining	The current fuel remaining (gal) adjusted for fuel burn and based on fuel flow.
TRK - Ground Track	Direction of aircraft movement relative to a ground position.
USD - Fuel Used	The quantity of fuel used (gal) based on fuel flow.
UTC - Time	The current time and date in Universal (UTC) time.
VSR - Vertical Speed Required	The vertical speed necessary to descend/climb from the current position and altitude to the previously selected VNAV position and altitude, based upon current ground speed.
WPT - Next Waypoint	The next waypoint in the flight plan or direct-to route.
XTK - Crosstrack Error	The distance the aircraft is from a desired course in either direction, left or right.

INFO PAGE DATA FIELD OPTIONS (FULL-SCREEN)

Info Page Data Field Option	Definition
Accuracy	The current accuracy of the GPS determined location.
Altitude (GPS ALT)	The current altitude in geometric height above Mean Sea Level (MSL).
Bearing (BRG)	The compass direction from the present position to a destination waypoint.
Climb Gradient (Percent) (CLG)	Current climb gradient in (climb rate divided by groundspeed) in percent.
Climb Gradient (ALT/NM) (CLM)	Current climb gradient (climb rate divided by groundspeed) in altitude per nautical mile.
Course to Steer (CTS)	The recommended direction to steer in order to reduce cross-track error and return to the course line.
Crosstrack Error (XTK)	The distance the aircraft is off a desired course in either direction, left or right.
Density Altitude (DENSITY ALT)	Pressure Altitude adjusted for non-standard temperature.
Desired Track (DTK)	The desired course between the active "from" and "to" waypoints.
Distance (Destination) (DIST DEST)	The distance to the destination waypoint in the Active Flight Plan.
Distance (Next) (DIST NEXT)	The distance to the next waypoint in the Active Flight Plan.
En Route Safe Altitude (ESA)	The recommended minimum altitude within ten miles left or right of the desired course on a active flight plan or direct-to.
Estimated Time En Route (Destination) (ETE DEST)	The estimated time it takes to reach the destination waypoint from the present position, based upon current ground speed.

INFO PAGE DATA FIELD OPTIONS (FULL-SCREEN) (CONT.)

Info Page Data Field Option	Definition
Estimated Time En Route (Next) (ETE NEXT)	The estimated time it takes to reach the next waypoint from the present position, based upon current ground speed.
Estimated Time of Arrival (Destination) (ETA DEST)	The estimated time at which the aircraft should reach the destination waypoint, based upon current speed and track.
Estimated Time of Arrival (Next) (ETA NEXT)	The estimated time at which the aircraft should reach the next waypoint, based upon current speed and track.
Estimated Time to VNAV (VNAV TIME)	The estimated time it takes to reach the VNAV waypoint from the present position, based upon current ground speed.
Flight Timer (FLT TIMER)	Total time in-flight (HH:MM).
Fuel Economy (ECONOMY)	Current Mile Per Gallon (MPG), based upon ground speed and fuel flow.
Fuel Endurance (ENDURANCE)	This value is obtained by dividing the amount of fuel on board by the current fuel flow (endurance to empty - no reserve included).
Fuel Flow (FUEL FLOW)	The current fuel flow.
Fuel Remaining (FUEL REM)	The current fuel remaining (gal) adjusted for fuel burn and based on fuel flow.
Fuel Tank Timer (FUEL TIMER)	Elapsed time since the Fuel Tank Reminder Alarm was last issued (HH:MM).
Fuel Used (FUEL USED)	The quantity of fuel used (gal) based on fuel flow.
Glide Ratio (G/R)	The estimated distance an aircraft will move forward for any given amount of lost altitude.
Ground Speed	The velocity that the aircraft is traveling relative to a ground position.
Ground Track (TRK)	The direction of aircraft movement relative to a ground position.

INFO PAGE DATA FIELD OPTIONS (FULL-SCREEN) (CONT.)

Info Page Data Field Option	Definition
Mach Number (MACH)	A unit of speed that measures the ratio of the speed of an airplane to the speed of sound in the same atmospheric conditions.
Minimum Safe Altitude (MSA)	Uses Grid MORAs to determine a safe altitude within ten miles of the aircraft's present position.
Next Waypoint	The next waypoint in the flight plan or direct-to route.
Sunrise	The time at which the sun rises on this day (current location).
Sunset	The time at which the sun sets on this day (current location).
Time (UTC)	The current time and date in Universal (UTC) time.
Time of Day (Local)	The current time and date in 12-hour or 24-hour format.
Vertical Speed (VS)	The rate of climb or descent (GPS-derived).
Vertical Speed Required (VSR)	The vertical speed necessary to descend/climb from the current position and altitude to the previously selected VNAV position and altitude, based upon current ground speed.
Weather (Altimeter) (WX ALTIM)	The altimeter setting at the nearest METAR reporting station.
Weather (Dew Point) (WX DEW PT)	The dew point at the nearest weather reporting station.
Weather (Rel. Humidity) (WX HUMIDITY)	The relative humidity at the nearest weather reporting station.
Weather (Temperature) (WX TEMP)	The temperature at the nearest weather reporting station.
Weather (Wind) (WX WIND)	The wind speed and direction at the nearest weather reporting station.

System Overview

Flight Instruments

EIS

CNS Interface

GPS Navigation

Flight Planning

Hazard Avoidance

Additional Features

Integrated Autopilot

Annun/Alerts

Appendix

Index

- System Overview
- Flight Instruments
- EIS
- CNS Interface
- GPS Navigation
- Flight Planning
- Hazard Avoidance
- Additional Features
- Integrated Autopilot
- Annun/Alerts
- Appendix**
- Index

Blank Page

APPENDIX B: UTILITIES



NOTE: The *Flight Log* option is not available from the full-screen PFD Main Menu.

FLIGHT LOG

The Flight Log shows a list of any recorded flights, including date, route of flight, and flight time. The G3X saves up to 50 recorded flights. Entries on this list are automatically created for each flight.

Recording begins when the aircraft reaches 250 feet of altitude. When the aircraft's groundspeed drops below 30 knots, the flight entry is saved and a new entry is recorded when departing the airport. A touch-and-go or brief stop of less than 10 minutes appends to the current flight record, rather than starting a new entry.

VIEWING THE FLIGHT LOG

Select any listed entry in the log to view additional information, including a map displaying the actual path flown.

Viewing details for a flight:

- 1) From the split-screen or full-screen MFD, press the **MENU** Key twice to display the Main Menu. (The 'Flight Log' option is not available from the full-screen PFD Main Menu).
- 2) Turn or move the **FMS** Joystick to select 'Flight Log', and press the **ENT** Key. (Hours and minutes can be displayed by pressing the **MENU** Key and selecting 'Show Hours and Minutes').
- 3) Turn or move the **FMS** Joystick to select the desired flight from the list, and press the **ENT** Key. Route, date, hours, distance, and actual flight path is displayed (full-screen). Use the **MAP** and **INFO** Softkeys to toggle between the Flight Log Map Page and the Flight Log Information Page (split-screen).
- 4) With 'Done' selected, press the **ENT** Key to return to the previous page.

- System Overview
- Flight Instruments
- EIS
- CNS Interface
- GPS Navigation
- Flight Planning
- Hazard Avoidance
- Additional Features
- Integrated Autopilot
- Annun/Alerts
- Appendix
- Index

FLIGHT LOG		
11-JUN	KMCI-KSTJ	0.2 Hours
11-JUN	K50-KEGT	0.1 Hours
11-JUN	51K-K34	0.4 Hours
10-JUN	KOJC-KLWC	0.2 Hours

Flight Log List (Split-Screen)

FLIGHT LOG	
FROM	KLWC - LAWRENCE MUN
TO	(LOCAL)
DATE	03-SEP-08
HOURS	1.2
DISTANCE	124.8NM
DONE	
INFO	MAP

Flight Log Information (Split-Screen)



Flight Log Map (Split-Screen)

DELETING FLIGHT RECORDS

You can delete the highlighted flight record or delete all flight records from the Flight Log.

Deleting flight records:

- 1) From the split-screen and/or full-screen MFD, press the **MENU** Key twice to display the Main Menu. (The 'Flight Log' option is not available from the full-screen PFD Main Menu).
- 2) Turn or move the **FMS** Joystick to select 'Flight Log', and press the **ENT** Key.
- 3) Select the desired flight (if applicable), and press the **MENU** Key.
- 4) Turn or move the **FMS** Joystick to select 'Delete Flight' or 'Delete All', and press the **ENT** Key.

TRACK LOG



NOTE: The Track Log option is not available from the full-screen PFD Main Menu.

The G3X draws an electronic breadcrumb trail or "track log" on the Map Page. The track log contains points along its path, including time and location for each point.

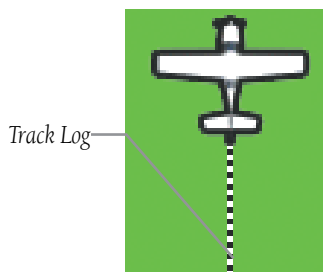

Track Log (Map Page)

The track log starts recording as soon as the G3X gets a location fix. For the best results, clear the track log before each flight. When the track log is full, new track points overwrite the oldest track points (if set to 'Wrap' in the Track Log Settings).

The percentage of memory used by the current track log appears at the top of the Track Log Window. After the track log is cleared, it shows zero percent. When the screen reaches 100%, the most recent track points start to overwrite the least recent track points (if 'Wrap' is selected in the Record Mode Field). To avoid losing track points, save the track log when it approaches the 99% mark.

The Save feature allows storage of up to 15 track logs.

Displaying/removing the track log on the Map Page:

- 1) From the Map Page, press the **MENU** Key. The Map Page Menu is displayed. (The 'Track Log' option is not available from the full-screen PFD Main Menu).
- 2) Turn or move the **FMS** Joystick to select 'Set Up Map' from the Map Page Menu, and press the **ENT** Key.
- 3) Turn the **FMS** Joystick to highlight the 'Line' options from the horizontal list.
- 4) Move the **FMS** Joystick to highlight the 'Track Log' field.
- 5) Turn the **FMS** Joystick to select 'On' or 'Off', and press the **ENT** Key.
- 6) Press the **FMS** Joystick, the **CLR** Key, or the **EXIT** Softkey to return to the Map Page.



Map Page Menu
(Split-Screen)

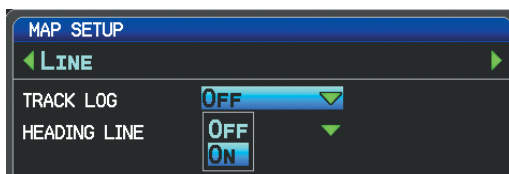

Map Setup Page

Changing track log settings:

- 1) From the split-screen or full-screen MFD, press the **MENU** Key twice. (The 'Track Log' option is not available from the full-screen PFD Main Menu).
- 2) Turn or move the **FMS** Joystick to select 'Track Log' from the Main Menu, and press the **ENT** Key.

- 3) Move the **FMS** Joystick to highlight the desired field.
- 4) Turn the **FMS** Joystick to select the desired setting.

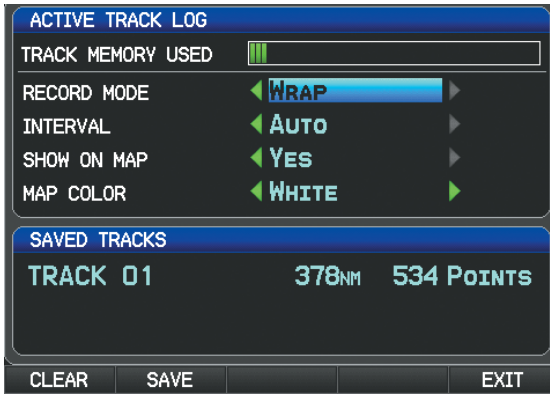

Track Log Window (Split-Screen)

- Record Mode—'Wrap' records over the oldest tracks when the track log reaches 100%. 'Fill' records a track log until the track log is full (100%).
- Interval—'Distance' records track points after a specified distance has been traveled. 'Time' creates track points after a specified time has elapsed.
- Show On Map—Select 'Yes' to display the track log on the map.
- Map Color—Select a color for the track when it appears on the map.

Clearing the track log:

- 1) From the split-screen or full-screen MFD, press the **MENU** Key twice. (The 'Track Log' option is not available from the full-screen PFD Main Menu).
- 2) Turn or move the **FMS** Joystick to select 'Track Log' from the Main Menu, and press the **ENT** Key.
- 3) Move the **FMS** Joystick to highlight the desired saved track, and press the **CLEAR** Softkey. (Or press the **MENU** Key, with 'Clear Active Track' selected, press the **ENT** Key.) The 'Clear Active Track Log?' window is displayed.
- 4) With 'Yes' selected, press the **ENT** Key.

Saving a track log:

- 1) From the split-screen or full-screen MFD, press the **MENU** Key twice. (The 'Track Log' option is not available from the full-screen PFD Main Menu).
- 2) Turn or move the **FMS** Joystick to select 'Track Log' from the Main Menu, and press the **ENT** Key.
- 3) Press the **SAVE** Softkey. (Or press the **MENU** Key, with 'Save Active Track' selected, press the **ENT** Key.) The 'Save Active Track?' window is displayed.
- 4) Turn the **FMS** Joystick to select 'Entire Active Track', 'Past 24 Hours', 'Past 7 Days', or 'Specify Dates'.
- 5) Move the **FMS** Joystick to highlight 'Save' and press the **ENT** Key.

Editing a track log:

- 1) From the split-screen or full-screen MFD, press the **MENU** Key twice. (The 'Track Log' option is not available from the full-screen PFD Main Menu).
- 2) Turn or move the **FMS** Joystick to select 'Track Log' from the Main Menu, and press the **ENT** Key.
- 3) Move the **FMS** Joystick to highlight the desired saved track, and press the **ENT** Key.
- 4) Move the **FMS** Joystick to highlight the desired field.
- 5) Turn the **FMS** Joystick to make the desired changes.
- 6) With 'Done' selected, press the **ENT** Key.

Exporting a track log:

- 1) From the split-screen or full-screen MFD, press the **MENU** Key twice. (The 'Track Log' option is not available from the full-screen PFD Main Menu).
- 2) Turn or move the **FMS** Joystick to select 'Track Log' from the Main Menu, and press the **ENT** Key.
- 3) Using the **FMS** Joystick highlight the desired track log to export.
- 4) With an SD card inserted, press the **EXPORT** Softkey.

HEADING LINE

The G3X draws an electronic “heading line” on the Map Page. The heading line can be set to time or distance.

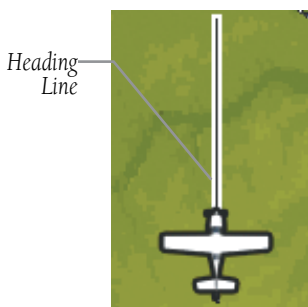

Heading Line (Map Page)

Changing the heading line settings on the Map Page:

- 1) From the Map Page, press the **MENU** Key. The Map Page Menu is displayed.
- 2) Turn or move the **FMS** Joystick to select 'Set Up Map' from the Map Page Menu, and press the **ENT** Key.
- 3) Turn the **FMS** Joystick to highlight the 'Line' options from the horizontal list.
- 4) Move the **FMS** Joystick to highlight the 'Heading Line' field.
- 5) Turn the **FMS** Joystick to select 'On/Off', 'Distance', or 'Time' and press the **ENT** Key. If necessary, move the **FMS** Joystick to set the desired time or distance, and press the **ENT** Key.

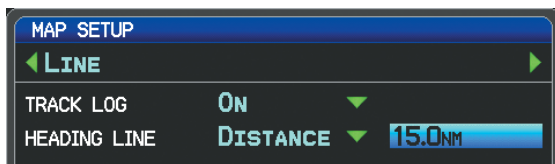

Heading Line Settings (Map Setup Page)

- 6) Press the **FMS** Joystick, the **CLR** Key, or the **EXIT** Softkey to return to the Map Page.

WEIGHT & BALANCE



NOTE: Refer to the G3X Installation Manual for information on configuring the Weight & Balance Page.

Weight & Balance may be used during pre-flight preparations to verify the weight and balance conditions of the aircraft. By entering the weight values on this page, the G3X can calculate the total weight, moment, and center of gravity (CG).



Weight & Balance Page (C.G. in Range)
(Split-Screen)



Weight & Balance Page (C.G. Out of Range)
(Split-Screen)



NOTE: This information is only for flight planning purposes. Consult the aircraft's pilot operating handbook for the official weight and balance data.

Performing weight and balance calculations:

- 1) Press the **MENU** Key twice to open the Main Menu.
- 2) Turn or move the **FMS** Joystick to highlight 'Weight & Balance', and press the **ENT** Key.
- 3) Move the **FMS** Joystick to select the desired station.
- 4) Turn the **FMS** Joystick to enter the desired weight and press the **ENT** Key.
- 5) Repeat Steps 3 and 4 using the **FMS** Joystick to enter the desired weights. Press the **ENT** Key after each entry. The calculated moment, weight, and CG figures appear at the bottom of the page.
- 6) To empty the aircraft, press the **MENU** Key and select 'Empty Aircraft', or press the **EMPTY** Softkey.

Resetting weight & balance page:

- 1) From the Weight & Balance page, press the **MENU** Key.
- 2) Turn or move the **FMS** Joystick to highlight 'Empty Aircraft', and press the **ENT** Key. "Empty All Stations?" window is displayed.



Weight & Balance Page Menu

Or:

Press the **EMPTY** Softkey. "Empty All Stations?" window is displayed.

- 3) With 'Yes' highlighted, press the **ENT** Key.

If the Loading Limit for a particular station is exceeded, the station name will turn yellow.

	WEIGHT	ARM
AIRCRAFT EMPTY	829.1LBS	+131.70
FUEL	20.0GAL	+144.00
PILOT	165.0LBS	+142.10
CO-PILOT	125.0LBS	+142.10
BAGGAGE	55.0LBS	+172.00

Loading Limit Exceeded

- System Overview
- Flight Instruments
- EIS
- CNS Interface
- GPS Navigation
- Flight Planning
- Hazard Avoidance
- Additional Features
- Integrated Autopilot
- Annun/Alerts
- Appendix
- Index

EPE CIRCLE

Estimated Position Error (EPE) indicates the accuracy of the position fix. EPE uses Dilution of Precision (DOP) and other factors to calculate a horizontal position error. DOP measures satellite geometry quality (i.e., number of satellites received and where they are relative to each other).

Setting up and customizing the EPE circle for the map page:

- 1) From the Map Page press the **MENU** Key.
- 2) Turn or move the **FMS** Joystick to highlight 'Set Up Map' and press the **ENT** Key.
- 3) Turn the **FMS** Joystick to select the 'Miscellaneous' from the horizontal list.
- 4) Move the **FMS** Joystick to highlight the desired feature.
- 5) Turn the **FMS** Joystick to select 'On' or 'Off', and press the **ENT** Key.

PROXIMITY WAYPOINTS

The Proximity Waypoints Page allows the pilot to define an alarm circle around a waypoint location.

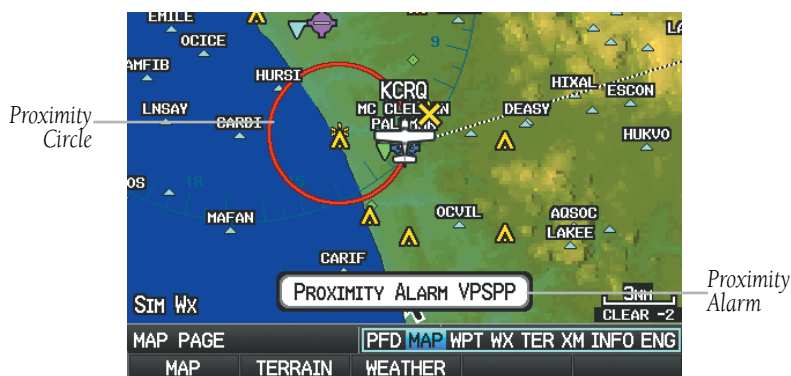

Proximity Waypoint Alarm

Defining proximity waypoints:

- 1) Press the **MENU** Key twice to open the Main Menu.
- 2) Turn or move the **FMS** Joystick to highlight 'User Waypoints', and press the **ENT** Key.

- 3) Press the **PROXIMITY** Softkey. The Proximity Waypoints Page is displayed.
- 4) Press the **NEW** Softkey. The New Proximity Waypoint Window is displayed.
- 5) Select 'Use Map' or 'Use Identifier', and press the **ENT** Key.
- 6) Select the desired waypoint using the Map or Select Waypoint Window, and press the **ENT** Key. The 'Distance' field is highlighted.
- 7) Using the **FMS** Joystick, enter the desired distance and press the **ENT** Key.

Setting up and customizing proximity waypoints for the map page:

- 1) Press the **MENU** Key twice to open the Main Menu.
- 2) Turn or move the **FMS** Joystick to highlight 'User Waypoints', and press the **ENT** Key.
- 3) Press the **PROXIMITY** Softkey. The Proximity Waypoints Page is displayed.
- 4) Turn the **FMS** Joystick to select 'On' or 'Off', and press the **ENT** Key.

Or:

- 1) Press the **MENU** Key twice to open the Main Menu.
- 2) Turn or move the **FMS** Joystick to highlight 'System Setup...', and press the **ENT** Key.
- 3) Turn or move the **FMS** Joystick to highlight 'Alarms', and press the **ENT** Key.
- 4) Move the **FMS** Joystick to highlight the 'Proximity Alarm' Field.
- 5) Turn the **FMS** Joystick to select 'On' or 'Off', and press the **ENT** Key.

Or:

- 1) From the Map Page press the **MENU** Key.
- 2) Turn or move the **FMS** Joystick to highlight 'Set Up Map' and press the **ENT** Key.
- 3) Turn the **FMS** Joystick to select the 'Point' from the horizontal list.
- 4) Move the **FMS** Joystick to highlight the 'Proximity Circle' Field.
- 5) Turn the **FMS** Joystick to access a list of options for each feature (On/Off, Auto, or range settings).
- 6) Highlight the desired setting and press the **ENT** Key.

Deleting proximity waypoints:

- 1) Press the **MENU** Key twice to open the Main Menu.
- 2) Turn or move the **FMS** Joystick to highlight 'User Waypoints', and press the **ENT** Key.
- 3) Press the **PROXIMITY** Softkey. The Proximity Waypoints Page is displayed.
- 4) Select the desired waypoint to be deleted.
- 5) Press the **CLR** Key or the **MENU** Key and select 'Remove Selected Waypoint' or 'Remove All Waypoints'.
- 6) Press the **ENT** Key. The 'Remove Proximity Waypoint for XXXX' Window is displayed.
- 7) With 'Yes' highlighted, press the **ENT** Key.

APPENDIX C: SD CARD USE AND DATABASES

The G3X uses an SD Card for software updates, database updates, MapSource® data, checklist files, Chartview, Flight Data Logging, exporting Track Logs/User Waypoints, importing/exporting Flight Plans and user-downloaded vehicles. Garmin recommends using a 2 GB SanDisk or Toshiba SD Card.

MapSource detailed maps are available from your local Garmin dealer. Refer to the Garmin website (www.garmin.com) for instructions on downloading and installing software updates.

INSTALLING AND REMOVING SD CARDS



NOTE: *SD Cards are not waterproof. They should not be exposed to moisture or excessive static charges, and should be stored in the case supplied with the card.*



SD Card Slot(s)

Installing an SD Card:

- 1) Insert the card into the slot on the top, right, front of the bezel. Be sure the SD Card contacts are facing the display.

- 2) Firmly push the card into the unit. It is not necessary to force the card.
- 3) The unit takes a few seconds to read the card. When the data card has been properly installed and accepted, a summary screen noting the card details appears. Press **ENT** Key to acknowledge.

If you insert an SD Card and get a card format not recognized message, try removing the card and reinserting it. If the card is still not recognized, contact Garmin Product Support or your Garmin dealer.

Removing an SD Card:

- 1) Push the card into the unit until it stops.
- 2) Release the card. The card should eject for easy removal.
- 3) With the card ejected, pull the card out of the slot.

G3X DATABASES

The following databases are included with the G3X depending on the unit (Americas, Atlantic, or Pacific). See the Additional Feature section for information on Airport Directories, FliteCharts[®], and SafeTaxi[®]. See the Hazard Avoidance section for information on Obstacles and Terrain.

Database	Americas	Atlantic	Pacific
Worldwide Basemap	+	+	+
Airport Directory (AOPA)	+		
Jeppesen [®] Navigation Database	+	+	+
FliteCharts [®]	+		
SafeTaxi [®]	+		
Obstacle	+	+	
Terrain	+	+	+

Included Databases

BASEMAP

The basemap database contains data for the topography and land features, such as river, lakes, and towns. It is updated only periodically, with no set schedule. There is no expiration date.

AIRPORT DIRECTORY DATABASES

The AOPA Airport Directory provides data on airports and heliports throughout the U.S. and it is updated on a 56-day cycle. Detailed information for over 5,300 U.S. airports, along with the names and phone numbers of thousands of FBOs can be viewed. This service allows the pilot to plan an overnight, choose fuel stops, find ground transportation, etc.

Optional airport directory databases such as AC-U-KWIK are also supported. AC-U-KWIK provides complete listings of FBOs, charter companies, fuel suppliers, ground transportation, maintenance and catering services at public airports across the world.

JEPPESEN® NAVIGATION DATABASE (NAVDATA™)



NOTE: After performing a Jeppesen database update, verify all flight plans (routes) are current. If there is an obsolete Jeppesen aviation point in a saved route, the route is locked and unusable. A new route with current Jeppesen database points will need to be created.

The Jeppesen Navigation Database (NavData) is updated on a 28-day cycle. The following information is provided from the Jeppesen database:

- Airport—identifier, facility name, city/state/country, latitude/longitude, field elevation, available fuel types, runway designations and layout, runway surface, runway length, runway width, runway lighting, communication frequencies, and published approaches.
- Weather—frequencies associated with an airport (ASOS, ATIS, and AWOS).
- VORs—identifier, facility name, city/state/country, location (latitude/longitude), frequency, service volume (high, low, terminal), and type (such as VOR-DME, TACAN, and VORTAC).
- NDBs—identifier, facility name, city/state/country, location (latitude/longitude), and frequency.

- Intersections—identifier, nearest VOR, radial and distance from nearest VOR, location (latitude/longitude), and region/country.
- ARTCC—Air Route Traffic Control Centers.
- Airspace—boundaries (Class B, Class C, Control Zones, SUAs, and MOAs), controlling agency, and vertical boundaries.
- FSS—Flight Service Stations.

FLITECHARTS

The FliteCharts database contains procedure charts for the United States only. This database is updated on a 28-day cycle.

CHARTVIEW

ChartView database is revised every 14 days. Charts are still viewable during a period that extends from the cycle expiration date to the disables date. ChartView is disabled 70 days after the expiration date and is no longer available for viewing. The ChartView database is always on the SD Card and is not copied to the GDU's internal memory.

SAFETAXI

The SafeTaxi database contains detailed airport diagrams for selected airports. These diagrams aid in following ground control instructions by accurately displaying the aircraft position on the map in relation to taxiways, ramps, runways, terminals, and services. This database is updated on a 56-day cycle.

OBSTACLE

The obstacle database contains data for obstacles, such as towers, that pose a potential hazard to aircraft. Obstacles 200 feet and higher are included in the obstacle database. It is very important to note that not all obstacles are necessarily charted and therefore may not be contained in the obstacle database. This database is updated on a 56-day cycle.

TERRAIN



NOTE: The data contained in the terrain and obstacle databases comes from government agencies. Garmin accurately processes and cross-validates the data, but cannot guarantee the accuracy and completeness of the data.

The terrain database is updated periodically and has no expiration date.

UPDATING G3X DATABASES



NOTE: The databases are stored internally on each GDU. When updating a system with multiple GDUs, each GDU will need to be updated individually using the same SD card.

The G3X database updates can be obtained by visiting the 'flyGarmin' website (www.fly.garmin.com). The 'flyGarmin' website requires the unit's System ID to update databases. This allows the databases to be encrypted with the unit's unique System ID when copied to the SD Card.

Obtaining the System ID:

- 1) Press the **MENU** Key twice to access the Main Menu.
- 2) Select 'System Setup' and press the **ENT** Key.

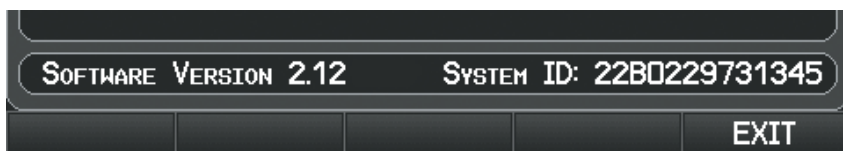

System Setup Page

Or:

Select 'Database Information' and press the **ENT** Key.

System ID

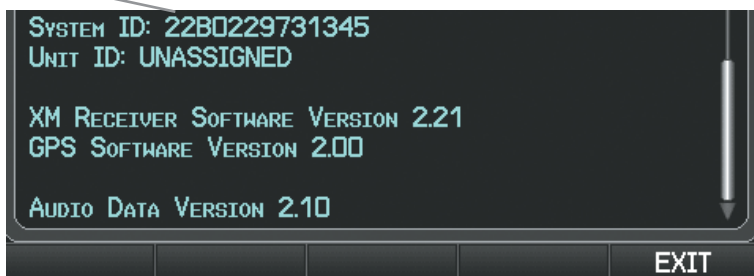

Database Information Page

Updating G3X Databases:

Equipment required to perform the update:

- Windows-compatible PC computer (Windows 2000 or XP recommended)
 - Verbatim 96504 SD Card Reader or equivalent
 - Updated database obtained from the flyGarmin website
 - SD Card, 2 GB recommended (Garmin recommends Verbatim 96504)
- 1) After the data has been copied to the SD Card, insert the SD card in the SD card slot of the display.
 - 2) Power on the display. The Update Databases Page is displayed. A green checkbox indicates that the database already installed on the G3X is up to date. An empty checkbox indicates that the database on the SD card is more current and should be installed.



Update Databases Page

- 3) With 'Update All' highlighted, press the **ENT** Key. The database status is updated.



Update Databases Page

Or:

Move the **FMS** Joystick to highlight a single database to update, and press the **ENT** Key. The database status is updated.



Update Databases Page
(Database Status Updated)

- 4) Press the **RESTART** Softkey. Once the database(s) have been successfully updated, the SD Card can be removed from the unit.



Update Databases Page

- 5) Repeat steps 1-4 for the remaining GDUs if applicable.

EXPORTING TRACK LOGS AND USER WAYPOINTS

Exporting a track log:

- 1) From the split-screen or full-screen MFD, press the **MENU** Key twice. (The 'Track Log' option is not available from the full-screen PFD Main Menu).
- 2) Turn or move the **FMS** Joystick to select 'Track Log' from the Main Menu, and press the **ENT** Key.
- 3) Using the **FMS** Joystick highlight the desired track log to export.
- 4) With an SD card inserted, press the **EXPORT** Softkey.

Exporting User Waypoints:

- 1) From the split-screen or full-screen MFD, press the **MENU** Key twice.
- 2) Turn or move the **FMS** Joystick to select 'User Waypoints' from the Main Menu, and press the **ENT** Key.
- 3) With an SD card inserted, press the **Menu** Key.
- 4) Turn or move the **FMS** Joystick to select 'Export Waypoints' from the Option Menu, and press the **ENT** Key.

IMPORTING/EXPORTING FLIGHT PLANS

Importing flight plans:

- 1) With a flight plan saved to the SD Card, press the **FPL** Key and turn the **FMS** Joystick to display the Flight Plan List Page.
- 2) Press the **IMPORT** Softkey.
- 3) Using the **FMS** Joystick highlight the desired flight plan to import.
- 4) Press the **IMPORT** Softkey again and press the **ENT** Key.

Exporting flight plans:

- 1) Press the **FPL** Key and turn the **FMS** Joystick to display the Flight Plan List Page.
- 2) Press the **FMS** Joystick to activate the cursor, and turn or move the **FMS** Joystick to highlight the desired flight plan.
- 3) Press the **EXPORT** Softkey and press the **ENT** Key.

FLIGHT DATA LOGGING

The G3X also has the ability to log flight data. Refer to the Additional Features section for more information.

APPENDIX D: MAP DATUM AND LOCATION FORMATS

MAP DATUMS

A datum is a mathematical model of the Earth that approximates the shape of the Earth and enables calculations to be carried out in a consistent and accurate manner. The datum is physically represented by a framework of ground monuments (such as trig. stations) whose locations have been accurately measured and calculated on this reference surface. Lines of latitude and longitude on a chart are referenced to a specific map datum. Every chart has a map datum reference and the G3X can be set to match most of those commonly used.

LOCATION FORMATS

Your current location can be viewed on the GPS in the form of coordinates. Since different charts use different location formats, Garmin GPS units allow you to choose the correct coordinate system for the type of chart you are using. The most common format is latitude and longitude, which is used by all Garmin units. You can change the location format to use with other coordinate systems.

Map Datum and Location Format selection can be performed on the Position Setup Page.

Changing position settings:

- 1) Press the **MENU** Key twice to display the Main Menu.
- 2) Turn or move the **FMS** Joystick to highlight 'System Setup...' and press the **ENT** Key.
- 3) Turn or move the **FMS** Joystick to highlight 'Position' and press the **ENT** Key.
- 4) Move the **FMS** Joystick to highlight the desired field, and select the desired option by turning the **FMS** Joystick.
- 5) Press the **FMS** Joystick, the **CLR** Key, the **EXIT** Softkey or the **MENU** Key to remove the menu.

- System Overview
- Flight Instruments
- EIS
- CNS Interface
- GPS Navigation
- Flight Planning
- Hazard Avoidance
- Additional Features
- Integrated Autopilot
- Annun/Alerts
- Appendix**
- Index

Blank Page

APPENDIX E: GENERAL TIS INFORMATION



NOTE: Aircraft without an operational transponder are invisible to TIS.



NOTE: TIS is not intended to be used as a collision avoidance system and does not relieve the pilot of the responsibility to “see and avoid” other aircraft. TIS should not be used for avoidance maneuvers during instrument meteorological conditions (IMC) or when there is no visual contact with the intruder aircraft.

The Traffic Information Service (TIS) provides traffic advisory information to non-TAS/TCAS-equipped aircraft. TIS is a ground-based service providing the relative locations of all ATCRBS (Air Traffic Control Radar Beacon System) Mode-A and Mode-C transponder equipped aircraft within a specified service volume. The TIS ground sensor uses real-time track reports to generate traffic notification. The G3X displays TIS traffic information on the Map Page. Surveillance data includes all transponder-equipped aircraft within the coverage volume. The G3X displays up to eight traffic targets within a 7.5-nm radius, from 3,000 feet below, to 3,500 feet above the requesting aircraft.

TIS VS. TAS/TCAS

The main difference between the Traffic Information System (TIS) and Traffic Advisory (TAS) or Traffic Collision Avoidance Systems (TCAS) is the source of surveillance data. TAS/TCAS uses an airborne interrogator with a half-second update rate, while TIS utilizes the terminal Mode-S ground interrogator and accompanying data link to provide a five-second update rate. TIS and TAS/TCAS have similar ranges.

TIS LIMITATIONS

TIS relies on surveillance of the Mode-S radar system, which is a “secondary surveillance” radar system similar to that used by ATCRBS. Many limitations are inherent in secondary radar surveillance. Information provided by TIS is neither better nor more accurate than the information used by ATC. TIS is intended only to assist in visual acquisition of other aircraft in visual meteorological conditions (VMC). While TIS is a useful aid for visual traffic avoidance, system limitations must be considered to ensure proper use. No recommended avoidance maneuvers are given, nor authorized, as a direct result of a TIS intruder display or TIS advisory.

- TIS operation may be intermittent during turns or other maneuvering.
- TIS is dependent on two-way, line-of-sight communications between the aircraft and the Mode-S radar antenna. Whenever the structure of the aircraft comes between the transponder antenna and the ground-based radar antenna, the signal may be temporarily interrupted.



NOTE: Refer to the *TIS Limitations* section of the *Aeronautical Information Manual (AIM)* for a more comprehensive explanation of limitations and anomalies associated with TIS.



NOTE: TIS is unavailable at low altitudes in many areas of the United States. This is often the case in mountainous regions.



NOTE: Garmin is not responsible for Mode S geographical coverage. Operation of the ground stations is the responsibility of the FAA. Refer to the AIM for a Terminal Mode S radar site map.

TIS information is collected during a single radar sweep. Collected information is then sent through the Mode S uplink on the next radar sweep. Because of this, the surveillance information is approximately five seconds old. TIS ground station tracking software uses prediction algorithms to compensate for this delay. These algorithms use track history data to calculate expected intruder positions consistent with the time of display. Occasionally, aircraft maneuvering may cause variations in this calculation and create slight errors on the Map Page which affect relative bearing information and the target track vector and may delay display of the intruder information. However, intruder distance and altitude typically remain relatively accurate and may be used to assist in spotting traffic. The following errors are common examples:

- When the client or intruder aircraft maneuvers excessively or abruptly, the tracking algorithm may report incorrect horizontal position until the maneuvering aircraft stabilizes.
- When a rapidly closing intruder is on a course that intercepts the client aircraft course at a shallow angle (either overtaking or head-on) and either aircraft abruptly changes course within 0.25 nm, TIS may display the intruder aircraft on the incorrect side of the client aircraft.

These are rare occurrences and are typically resolved within a few radar sweeps once the client/intruder aircraft course stabilizes.

Pilots using TIS can provide valuable assistance in the correction of malfunctions by reporting observations of undesirable performance. Reports should identify the time of observation, location, type and identity of the aircraft, and describe the condition observed. Reports should also include the type of transponder and transponder software version. Since TIS performance is monitored by maintenance personnel, not ATC, malfunctions should be reported in the following ways:

- By telephone to the nearest Flight Service Station (FSS) facility
- By FAA Form 8000-7, Safety Improvement Report (postage-paid card can be obtained at FAA FSSs, General Aviation District Offices, Flight Standards District Offices, and General Aviation Fixed Base Operators)

- System Overview
- Flight Instruments
- EIS
- CNS Interface
- GPS Navigation
- Flight Planning
- Hazard Avoidance
- Additional Features
- Integrated Autopilot
- Annun/Alerts
- Appendix**
- Index

Blank Page

APPENDIX F: ABNORMAL OPERATION

LOSS OF GPS POSITION

When the G3X loses the GPS signal for any reason, the following will occur:

- A blinking red question mark will appear over the airplane icon on the map.
- The 'Lost Satellite Reception' message will display.
- Any GPS dependent data fields will not be available.



GPS Signal Lost

HAZARD DISPLAY WITH LOSS OF GPS POSITION

If the Terrain Page doesn't have at least a 3D fix (i.e. altitude unknown), a Red X will be displayed.

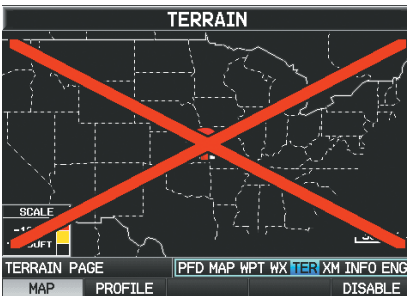

Terrain Page Red X (Split-Screen)



Map Page Red X (Terrain) (Split-Screen)

G3X SYSTEM FAILURE ANNUNCIATIONS

When an LRU or an LRU function fails, a large red 'X' is typically displayed over the instrument(s) or data experiencing the failure. Upon G3X power-up, certain instruments remain invalid as equipment begins to initialize. All instruments should be operational within one minute of power-up. If any instrument remains flagged, the G3X should be serviced.



NOTE: Refer to the Pilot's Operating Handbook for additional information regarding pilot responses to these annunciations.

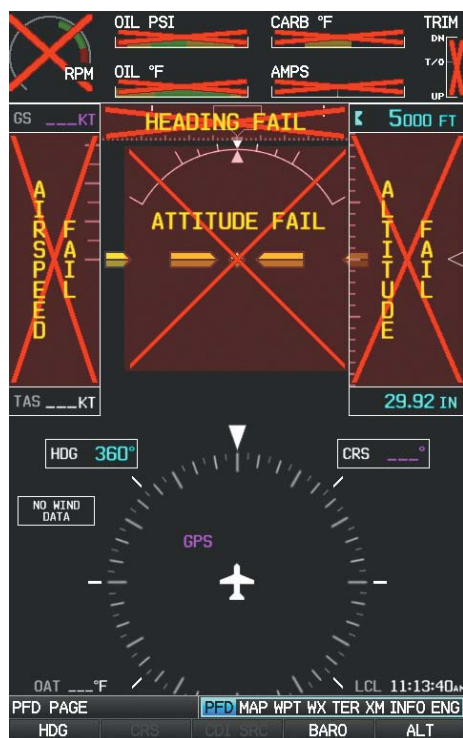

G3X System Failure Annunciations
(Split-Screen)

UNUSUAL ATTITUDES

When the aircraft enters an unusual pitch attitude, red chevrons pointing toward the horizon warn of extreme pitch and data fields are decluttered (removed) from the display. The chevrons are displayed on the Attitude Indicator, starting at 50° above and 30° below the horizon line.

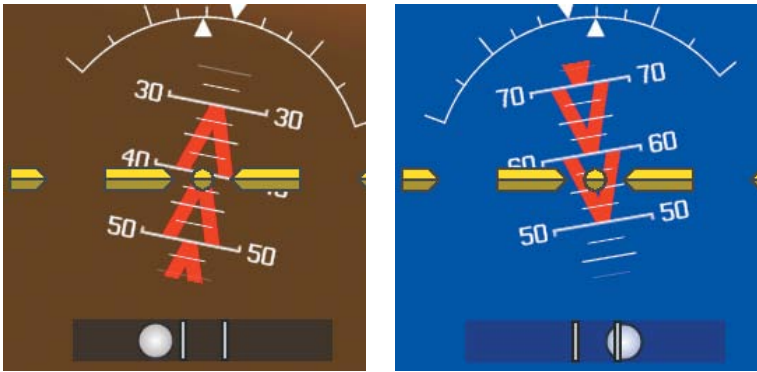

Pitch Attitude Warnings

REVERSIONARY MODE (FULL-SCREEN)

In the event of a display failure, the G3X System automatically switches to reversionary (backup) mode. In reversionary mode, the information is presented on the remaining display in the split-screen configuration.

If a display failure occurs with the GDU 375, the **WX** and **XM** Pages will no longer be available since the XM receiver resides in the GDU 375.



G3X Full-Screen Reversionary Mode (Failed PFD)

FAILURE OF THE EXTERNAL GPS NAVIGATION SOURCE

If the external GPS navigation source fails, the system reverts to the internal GPS navigation source and 'REV' is shown in yellow in the upper left corner of the Data Bar as well as the lower left quadrant of the HSI.

External
GPS Failure.
Reverted to
Internal GPS



REV: External Navigation Source failed. Reverted to internal VFR GPS for navigation.

External GPS Navigation Failure

- System Overview
- Flight Instruments
- EIS
- CNS Interface
- GPS Navigation
- Flight Planning
- Hazard Avoidance
- Additional Features
- Integrated Autopilot
- Annun/Alerts
- Appendix
- Index

SYNTHETIC VISION TROUBLESHOOTING

Synthetic Vision is intended to be used with traditional attitude, heading, obstacle, terrain, and traffic inputs (in most areas). Synthetic Vision is disabled when valid attitude or heading data is not available for the display. In case of invalid Synthetic Vision data, the PFD display reverts to the standard blue-over-brown attitude display.

Synthetic Vision becomes disabled without the following data resources:











- Attitude data
- Heading data
- GPS position data
- Terrain data
- The position of the aircraft exceeds the range of the terrain database

REVERSIONARY MODE WITH SYNTHETIC VISION







Synthetic Vision can be displayed on the remaining display(s) in Reversionary Mode. If it is enabled when the system switches to Reversionary Mode, Synthetic Vision may take up to 30 seconds to display. The standard display will be shown in the interim.

APPENDIX G: DISPLAY SYMBOLS

VFR SYMBOLS









Item	Symbol
Unknown	
Non-towered, Non-serviced	
Towered, Non-serviced	
Non-towered, Serviced	
Towered, Serviced	
Soft Surface, Non-serviced	
Soft Surface, Serviced	
Soft Surface, Private	
Paved, Private	
Seaplane Base	
Heliport	

Americas/Pacific Database Airports





Item	Symbol
Civilian, Non-serviced	
Military, Non-serviced	
Civilian, Serviced	
Military, Serviced	
Civilian, Soft/Unknown Surface, Non-serviced	
Civilian, Soft/Unknown Surface, Serviced	

Atlantic Database Airports

- System Overview
- Flight Instruments
- EIS
- CNS Interface
- GPS Navigation
- Flight Planning
- Hazard Avoidance
- Additional Features
- Integrated Autopilot
- Annun/Alerts
- Appendix
- Index



Item	Symbol
Intersection	
Visual Reporting Point	
LOM (compass locator at outer marker)	
NDB (non-directional radio beacon)	
VOR	
VOR/DME	
ILS/DME or DME only	
VORTAC	
TACAN	

Nav aids



Item	Symbol
Interstate Highway	
US Highway	
State Highway	
National Highway	
Small City	
Medium City	
Large City	

Miscellaneous











IFR SYMBOLS

Item	Symbol
VFR, Soft/unknown Surface, Non-serviced	
VFR, Soft/unknown Surface, Serviced	









Atlantic Database Airports

Item	Symbol
Low-Altitude	
High-Altitude	

Airways

Item	Symbol
Unknown	
VFR Airport, Non-serviced	
IFR Airport, Non-serviced	
VFR Airport, Serviced	
IFR Airport, Serviced	
VFR, Soft Surface, Non-serviced	
VFR, Soft Surface, Serviced	
VFR, Soft Surface, Private	
VFR, Paved, Private	
VFR Seaplane Base	
VFR Heliport	

Americas/Pacific Database Airports

Item	Symbol
Intersection	
LOM (compass locator at outer marker)	
NDB (non-directional radio beacon)	
VOR	
VOR/DME	
ILS/DME or DME Only	
VORTAC	
TACAN	

Nav aids

- System Overview
- Flight Instruments
- EIS
- CNS Interface
- GPS Navigation
- Flight Planning
- Hazard Avoidance
- Additional Features
- Integrated Autopilot
- Annun/Alerts
- Appendix
- Index

AIRSPACE SYMBOLS



- System Overview
- Flight Instruments
- EIS
- CNS Interface
- GPS Navigation
- Flight Planning
- Hazard Avoidance
- Additional Features
- Integrated Autopilot
- Annun/Alerts
- Appendix
- Index

Item	Symbol
Class B, Class E, CTA	
Class A, Class C, TMA	
Class D	
Mode C Veil	
TRSA	
MOA	
Danger, Alert, or Training Area	
Restricted, Prohibited, or Warning Area	
Radar Area	
ATZ, TIZ	
MATZ	
ADIZ	
Misc/Unknown	

VFR Americas/Pacific Database

Item	Symbol
Class B, Class E, CTA	
Class A, Class C, TMA, TRSA	
Class D	
MOA	
Danger, Alert, or Training Area	
Restricted, Prohibited, or Warning Area	
Radar Area	
ATZ, TIZ	
Misc/Unknown	

IFR Americas/Pacific Database

Item	Symbol
Danger or Alert Area	
Restricted, Prohibited, or Warning Area	
Training Area	

VFR Atlantic Database Exceptions

Item	Symbol
Training Area	

IFR Atlantic Database Exceptions

- System Overview
- Flight Instruments
- EIS
- CNS Interface
- GPS Navigation
- Flight Planning
- Hazard Avoidance
- Additional Features
- Integrated Autopilot
- Annun/Alerts
- Appendix**
- Index

Blank Page

APPENDIX H: GLOSSARY

ADIZ	Air Defense Identification Zone	System Overview
AGL	Above Ground Level	Flight Instruments
AIM	Airman’s Information Manual	EIS
AIRMET	Airman’s Meteorological Information	CNS Interface
APT	airport	GPS Navigation
ASPC	airspace	Flight Planning
ARTCC	Air Route Traffic Control Center	Hazard Avoidance
ASOS	Automated Surface Observing System	Additional Features
ATC	Air Traffic Control	Integrated Autopilot
ATIS	Automatic Terminal Information Service	Annun/Alerts
AWOS	Automated Weather Observing System	Appendix
Bearing	The compass direction from the present position to a destination waypoint.	Index
°C	degrees Celsius	
Calibrated Airspeed	Indicated airspeed corrected for installation and instrument errors.	
cm	centimeter	
COM	communication radio	
Course	The line between two points to be followed by the aircraft.	
Course to Steer	The recommended direction to steer in order to reduce course error or stay on course. Provides the most efficient heading to get back to the desired course and proceed along the flight plan.	
Crosstrack Error	The distance the aircraft is off a desired course in either direction, left or right.	
CTS	Course to Steer	

System Overview	dBZ	decibels 'Z' (radar return)
	deg	degree
Flight Instruments	Desired Track	The desired course between the active "from" and "to" waypoints.
	DIS	distance
EIS	Distance	The 'great circle' distance from the present position to a destination waypoint.
	DME	Distance Measuring Equipment
CNS Interface	DTK	Desired Track
GPS Navigation	Enroute Safe Altitude	The recommended minimum altitude within ten miles left or right of the desired course on an active flight plan or direct-to.
Flight Planning	ENT	enter
	ESA	Enroute Safe Altitude
Hazard Avoidance	Estimated Time of Arrival	The estimated time at which the aircraft should reach the destination waypoint, based upon current speed and track.
Additional Features	Estimated Time Enroute	The estimated time it takes to reach the destination waypoint from the present position, based upon current ground speed.
	ETA	Estimated Time of Arrival
	ETE	Estimated Time Enroute
Integrated Autopilot	°F	degrees Fahrenheit
	FAA	Federal Aviation Administration
Annun/Alerts	FAF	Final Approach Fix
	FCC	Federal Communication Commission
Appendix	FPL	flight plan
	fpm	feet per minute
	FSS	Flight Service Station
Index	ft	foot/feet

gal	gallon(s)
Glide Ratio, G/R	The estimated distance an aircraft will move forward for any given amount of lost altitude.
GND	ground
gph	gallons per hour
GPS	Global Positioning System
Grid MORA	Grid Minimum Off-Route Altitude; one degree latitude by one degree longitude in size and clears the highest elevation reference point in the grid by 1000 feet for all areas of the grid
Groundspeed	The velocity that the aircraft is travelling relative to a ground position.
Ground Track	see Track
GS	Ground speed
Heading	The direction an aircraft is pointed, based upon indications from a magnetic compass or a properly set directional gyro.
Hg	mercury
hPa	hectopascal
hr	hour
HSI	Horizontal Situation Indicator
Hz	Hertz
IAF	Initial Approach Fix
IAT	Indicated Air Temperature
ICAO	International Civil Aviation Organization
IFR	Instrument Flight Rules
ILS	Instrument Landing System
IMC	Instrument Meteorological Conditions
in	inch

- System Overview
- Flight Instruments
- EIS
- CNS Interface
- GPS Navigation
- Flight Planning
- Hazard Avoidance
- Additional Features
- Integrated Autopilot
- Annun/Alerts
- Appendix
- Index

System Overview	Indicated	Information provided by properly calibrated and set instrumentation on the aircraft panel.
	in HG	inches of mercury
Flight Instruments	kg	kilogram
	kHz	kilohertz
EIS	km	kilometer
	kt	knot
CNS Interface	LAT	latitude
	lb	pound
GPS Navigation	Leg	The portion of a flight plan between two waypoints.
	LON	longitude
Flight Planning	m	meter
	MAP	Missed Approach Point
Hazard Avoidance	METAR	Meteorological Aviation Routine
	MHz	megahertz
Additional Features	Minimum Safe Altitude	Uses Grid MORAs to determine a safe altitude within ten miles of the aircraft present position.
	MOA	Military Operations Area
Integrated Autopilot	MSA	Minimum Safe Altitude
	MSL	Mean Sea Level
Annun/Alerts	NAVAID	NAVigation AID
	NDB	Non-directional Beacon
Appendix	NEXRAD	Next Generation Radar
	nm	nautical mile(s)
Index	NRST	nearest

OAT	Outside Air Temperature	System Overview
OBS	Omni Bearing Selector	
psi	pounds per square inch	Flight Instruments
QTY	quantity	EIS
rpm	revolutions per minute	CNS Interface
SBAS	Satellite-Based Augmentation System	GPS Navigation
SD	Secure Digital	
sec	second(s)	Flight Planning
SIGMET	Significant Meteorological Information	
TACAN	Tactical Air Navigation System	Hazard Avoidance
TAF	Terminal Aerodrome Forecast	
TAS	True Airspeed	Additional Features
TER	terrain	
TFR	Temporary Flight Restriction	Integrated Autopilot
TOPO	topographic	
Track	Direction of aircraft movement relative to a ground position; also 'Ground Track'	Annun/Alerts
TRSA	Terminal Radar Service Area	
UTC	Coordinated Universal Time	Appendix
VFR	Visual Flight Rules	
VHF	Very High Frequency	Index
VNAV	vertical navigation	

System Overview	VOL	volume
	VOR	VHF Omni-directional Range
Flight Instruments	VORTAC	very high frequency omnidirectional range station and tactical air navigation
	VSI	Vertical Speed Indicator
	VSR	Vertical Speed Required
EIS	VTF	vector to final
	WAAS	Wide Area Augmentation System
CNS Interface	WPT	waypoint
	WX	weather
GPS Navigation		
Flight Planning		
Hazard Avoidance		
Additional Features		
Integrated Autopilot		
Annun/Alerts		
Appendix		
Index		

APPENDIX I: LICENSE AGREEMENT AND WARRANTY

CONTACT GARMIN

Contact Garmin if you have any questions while using your G3X. In the USA contact Garmin Product Support by phone: (913) 397-8200 or (800) 800-1020, Monday–Friday, 8 AM–5 PM Central Time; or go to www.garmin.com/support.

In Europe, contact Garmin (Europe) Ltd. at +44 (0) 870.8501241 (outside the UK) or 0808 2380000 (within the UK).

SOFTWARE LICENSE AGREEMENT

BY USING THE G3X, YOU AGREE TO BE BOUND BY THE TERMS AND CONDITIONS OF THE FOLLOWING SOFTWARE LICENSE AGREEMENT. PLEASE READ THIS AGREEMENT CAREFULLY.

Garmin grants you a limited license to use the software embedded in this device (the “Software”) in binary executable form in the normal operation of the product. Title, ownership rights, and intellectual property rights in and to the Software remain with Garmin.

You acknowledge that the Software is the property of Garmin and is protected under the United States of America copyright laws and international copyright treaties. You further acknowledge that the structure, organization, and code of the Software are valuable trade secrets of Garmin and that the Software in source code form remains a valuable trade secret of Garmin. You agree not to decompile, disassemble, modify, reverse assemble, reverse engineer, or reduce to human readable form the Software or any part thereof or create any derivative works based on the Software. You agree not to export or re-export the Software to any country in violation of the export control laws of the United States of America.

LIMITED WARRANTY

The Garmin G3X LRU's that comply with TSO (Technical Standard Order) requirements for certification (GMU 44 and GTP 59) are warranted to be free from defects in materials or workmanship for two years from the date of purchase. The Garmin G3X LRU's that do not comply with TSO requirements for certification (GDU 370, GDU 375, and the GSU 73) are warranted to be free from defects in materials or workmanship for one year from the date of purchase. Within the specified period, Garmin will, at its sole option, repair or replace any components that fail in normal use. Such repairs or replacement will be made at no charge to the customer for parts and labor, provided that the customer shall be responsible for any transportation cost. This warranty does not cover failures due to abuse, misuse, accidents, or unauthorized alterations or repairs. In addition, Garmin reserves the right to refuse warranty claims against products or services that are obtained and/or used in contravention of the laws of any country.

THE WARRANTIES AND REMEDIES CONTAINED HEREIN ARE EXCLUSIVE AND IN LIEU OF ALL OTHER WARRANTIES EXPRESS OR IMPLIED OR STATUTORY, INCLUDING ANY LIABILITY ARISING UNDER ANY WARRANTY OF MERCHANTABILITY OR FITNESS FOR A PARTICULAR PURPOSE, STATUTORY OR OTHERWISE. THIS WARRANTY GIVES YOU SPECIFIC LEGAL RIGHTS, WHICH MAY VARY FROM STATE TO STATE.

IN NO EVENT SHALL GARMIN BE LIABLE FOR ANY INCIDENTAL, SPECIAL, INDIRECT OR CONSEQUENTIAL DAMAGES, WHETHER RESULTING FROM THE USE, MISUSE, OR INABILITY TO USE THIS PRODUCT OR FROM DEFECTS IN THE PRODUCT. Some states do not allow the exclusion of incidental or consequential damages, so the above limitations may not apply to you.

Garmin retains the exclusive right to repair or replace the unit or software, or to offer a full refund of the purchase price, at its sole discretion. SUCH REMEDY SHALL BE YOUR SOLE AND EXCLUSIVE REMEDY FOR ANY BREACH OF WARRANTY.

Products sold through online auctions are not eligible for rebates or other special offers from Garmin. Online auction confirmations are not accepted for warranty verification. To obtain warranty service, an original copy of the sales receipt from the original retailer is required. Garmin will not replace missing components from any package purchased through an online auction.

To obtain warranty service, contact your local Garmin Authorized Service Center. For assistance in locating a Service Center, visit the Garmin website at www.garmin.com or contact Garmin Customer Service at one of the numbers listed below.

Garmin International, Inc., 1200 East 151st Street, Olathe, Kansas 66062, U.S.A.

Toll free: 800/800.1020 or 866/739.5687

Tel: 913/397.8200

Fax: 913/397.8282

Garmin AT, Inc., 2345 Turner Road SE, Salem, OR 97302, U.S.A.

Toll free: 800/525.6726

Tel: 503/391.3411

Fax: 503/364.2138

Garmin (Europe) Ltd., Liberty House, Bulls Copse Road, Hounslow Business Park, Southampton, SO40 9RB, U.K.

Toll free (within U.K.): 0808 238 0000

Tel: 44/0870.8501241

Fax: 44/0870.8501251

Refer to the G3X Installation Manual for warranty registration instructions.

AOPA AIRPORT DIRECTORY NOTICE

AOPA MEMBERSHIP PUBLICATIONS, INC. AND ITS RELATED ORGANIZATIONS (HEREINAFTER COLLECTIVELY "AOPA") EXPRESSLY DISCLAIM ALL WARRANTIES, WITH RESPECT TO THE AOPA INFORMATION INCLUDED IN THIS DATA, EXPRESS OR IMPLIED, INCLUDING, BUT NOT LIMITED TO, THE IMPLIED WARRANTIES OF MERCHANTABILITY AND FITNESS FOR A PARTICULAR PURPOSE. THE INFORMATION IS PROVIDED "AS IS" AND AOPA DOES NOT WARRANT OR MAKE ANY REPRESENTATIONS REGARDING ITS ACCURACY, RELIABILITY, OR OTHERWISE. UNDER NO CIRCUMSTANCES INCLUDING NEGLIGENCE, SHALL AOPA BE LIABLE FOR ANY INCIDENTAL, SPECIAL OR CONSEQUENTIAL DAMAGES THAT RESULT FROM THE USE OR INABILITY TO USE THE SOFTWARE OR RELATED DOCUMENTATION, EVEN IF AOPA OR AN AOPA AUTHORIZED REPRESENTATIVE HAS BEEN ADVISED OF THE POSSIBILITY OF SUCH DAMAGES. USER AGREES NOT TO SUE AOPA AND, TO THE MAXIMUM EXTENT ALLOWED BY LAW, TO RELEASE AND HOLD HARMLESS AOPA FROM ANY CAUSES OF ACTION, CLAIMS OR LOSSES RELATED TO ANY ACTUAL OR ALLEGED INACCURACIES IN THE INFORMATION ARISING OUT OF GARMIN'S USE OF THE INFORMATION IN THE DATASETS. SOME JURISDICTIONS DO NOT ALLOW THE LIMITATION OR EXCLUSION OF IMPLIED WARRANTIES OR LIABILITY FOR INCIDENTAL OR CONSEQUENTIAL DAMAGES SO THE ABOVE LIMITATIONS OR EXCLUSIONS MAY NOT APPLY TO YOU.

AC-U-KWIK LICENSE AGREEMENT

AC-U-KWIK AND ITS RELATED ORGANIZATIONS (HEREINAFTER COLLECTIVELY “AC-U-KWIK ORGANIZATIONS”) EXPRESSLY DISCLAIM ALL WARRANTIES WITH RESPECT TO THE AC-U-KWIK INFORMATION INCLUDED IN THIS DATA, EXPRESS OR IMPLIED, INCLUDING, BUT NOT LIMITED TO, THE IMPLIED WARRANTIES OF MERCHANTABILITY AND FITNESS FOR A PARTICULAR PURPOSE. THE INFORMATION IS PROVIDED “AS IS” AND AC-U-KWIK ORGANIZATIONS DO NOT WARRANT OR MAKE ANY REPRESENTATIONS REGARDING ITS ACCURACY, RELIABILITY, OR OTHERWISE. LICENSEE AGREES NOT TO SUE AC-U-KWIK ORGANIZATIONS AND, TO THE MAXIMUM EXTENT ALLOWED BY LAW, TO RELEASE AND HOLD HARMLESS AC-U-KWIK ORGANIZATIONS FROM ANY CAUSES OF ACTION, CLAIMS OR LOSSES RELATED TO ANY ACTUAL OR ALLEGED INACCURACIES IN THE INFORMATION ARISING OUT OF GARMIN’S USE OF THE INFORMATION IN THE DATASETS. SOME JURISDICTIONS DO NOT ALLOW THE LIMITATION OR EXCLUSION OF IMPLIED WARRANTIES OR LIABILITY FOR INCIDENTAL OR CONSEQUENTIAL DAMAGES SO THE ABOVE LIMITATIONS OR EXCLUSIONS MAY NOT APPLY TO LICENSEE.

SIRIUSXM SATELLITE RADIO SERVICE AGREEMENT

SiriusXM Satellite Radio Inc.

Hardware and required monthly subscription sold separately. Subscription fee is consumer only. Other fees and taxes, including a one-time activation fee may apply. All programming fees and weather data subject to change. XM WX weather data displays and individual product availability vary by hardware equipment. Reception of the SiriusXM signal may vary depending on location. Subscriptions subject to Customer Agreement included with the SiriusXM Welcome Kit and available at xmradio.com. Available only in the 48 contiguous United States. XM WX is a trademark of SiriusXM Satellite Radio Inc.

Contact SiriusXM Satellite Radio by phone at 800.985.9200 to subscribe to XM WX Weather and/or SiriusXM Radio.

WEATHER DATA WARRANTY

THE WEATHER DATA SOFTWARE PRODUCT IS PROVIDED “AS IS.” ALL OTHER WARRANTIES, EXPRESSED OR IMPLIED, INCLUDING ANY WARRANTY OF MERCHANTABILITY OR FITNESS FOR A PARTICULAR PURPOSE OR OF NON-INFRINGEMENT ARE HEREBY EXCLUDED.

USER SAFETY

If you use XM Services it is your responsibility to exercise prudent discretion and observe all safety measures required by law and your own common sense. You assume the entire risk related to your use of the Services. XM and Garmin assume no responsibility for accidents resulting from or associated with use of the Services. Your Radio Service includes traffic and weather information, and you acknowledge that such information is not for “safety for life”, but is merely supplemental and advisory in nature, and therefore cannot be relied upon as safety-critical in connection with any aircraft, sea craft or automobile usage. This information is provided “as is” and XM and Garmin disclaim any and all warranties, express and implied, with respect thereto or the transmission or reception thereof. XM and Garmin further do not warrant the accuracy, reliability, completeness or timeliness of the traffic and weather information disclosed on the Radio Service. In no event will XM and Garmin, their data suppliers, service providers, marketing/distribution, software or Internet partners or hardware manufacturers be liable to you or to any third party for any direct, indirect, incidental, consequential, special, exemplary or punitive damages or lost profits resulting from use of or interruptions in the transmission or reception of the Services.

LIMITS ON OUR RESPONSIBILITY

a) DISCLAIMERS.

EXCEPT AS EXPRESSLY PROVIDED HEREIN, WE MAKE NO WARRANTY OR REPRESENTATION, EITHER EXPRESS OR IMPLIED, REGARDING THE RADIO SERVICE. YOUR USE OF THE SERVICE IS AT YOUR SOLE RISK. THE CONTENT AND FUNCTIONALITY OF THE SERVICE IS PROVIDED "AS IS" WITHOUT ANY WARRANTY OF ANY KIND, EXPRESS OR IMPLIED. ALL SUCH WARRANTIES OR REPRESENTATIONS (INCLUDING, WITHOUT LIMITATION, THE IMPLIED WARRANTIES OF MERCHANTABILITY, FITNESS FOR A PARTICULAR PURPOSE, TITLE AND NON-INFRINGEMENT) ARE HEREBY DISCLAIMED.

b) LIMITATIONS OF LIABILITY.

WE ARE NOT RESPONSIBLE FOR ANY SPECIAL, INCIDENTAL, OR CONSEQUENTIAL DAMAGES OR LOSSES RELATING TO THE USE OF THE RADIO SERVICE, WHETHER BASED ON NEGLIGENCE OR OTHERWISE. OUR TOTAL LIABILITY TO YOU AND ANY OTHER PERSONS RECEIVING OUR SERVICES, REGARDLESS OF THE CAUSE, WILL IN NO EVENT EXCEED THE AMOUNTS THAT YOU HAVE PAID TO US FOR THE SERVICE THAT YOU RECEIVED DURING THE SIX (6) MONTH PERIOD IMMEDIATELY PRIOR TO THE SPECIFIC EVENT THAT GAVE RISE TO THE APPLICABLE DAMAGE OR LOSS. THIS ALLOCATION OF RISK IS REFLECTED IN OUR PRICES. YOU MAY HAVE GREATER RIGHTS THAN DESCRIBED ABOVE UNDER YOUR STATE'S LAWS

This product was developed using DAFIF™, a product of the National Geospatial-Intelligence Agency.

This product has not been endorsed or otherwise approved by the National Geospatial-Intelligence Agency, or the United States Department of Defense (10 U.S.C. 425)

a. Under 10 U.S.C. 456, no civil action may be brought against the United States on the basis of the content of a navigational aid prepared or disseminated by either the former Defense Mapping Agency (DMA), National Imagery and Mapping Agency (NIMA), or the National Geospatial-Intelligence Agency (NGA).

b. The DAFIF™ product is provided "as is," and no warranty, express or implied, including, but not limited to the implied warranties of merchantability and fitness for particular purpose or arising by statute or otherwise in law or from a course of dealing or usage in trade, is made by NGA as to the accuracy and functioning of the product.

c. Neither NGA nor its personnel will be liable for any claims, losses, or damages arising from or connected with the use of this product. The user agrees to hold harmless the United States National Geospatial-Intelligence Agency. The user's sole and exclusive remedy is to stop using the DAFIF product.

A

- Acquiring Satellites 42
- Air Data Computer (ADC) 2
- AIRMET 189
- Airport
 - Criteria 57
 - Nearest 142
 - Review 138
 - Weather 143
- Airspace 124, 151
 - Alerts 152
 - Selecting and Viewing 151
 - Smart 152
- Airspeed Indicator 62
- Airways 134
 - Reviewing 135
- Alarms 55
- Alerts 295
- Altimeter 61, 65–68
- Altitude Alerting 68
- Altitude Hold Mode (ALT) 265
- Ammeter 95
- AOPA 244
- Approach 174
 - Activating Vectors-to-Final 178
 - Chart 176
 - Loading 175
 - Removing 177
 - Selecting 175
- Attitude and Heading Reference System (AHRS) 2, 18
- Attitude Indicator 64
- Aural Alerts 302
- Automatic Reversion 271
- Autopilot 255
- Auto-Slewing 83

B

- Barometric setting, Altimeter 61, 66–67
- Basemap 329
- Bearing/Distance, Measuring 128
- Bearing Pointers 73
- Bearing source 74

C

- Carburetor Temperature Indicator 95
- CDI source 73
- Chart Not Available 238, 242
- Check Engine Triangle 107
- Color Mode 50
- Communication (COM) Frequency Box 61
- Compass Arc 119
- Control Wheel Steering (CWS) 259
- Course Deviation Indicator (CDI) 73
- Crew Alerting System (CAS) 97, 101, 106, 303
- Current Icing Product (CIP) 192
- Cylinder Head Temperature 95

D

- Data Bar Fields 47, 309
- Databases 328
 - Updating 331
- Data Entry 21–22
- Date & Time 52
- Delete
 - Flight Plans 168, 171
 - Flight Records 317
 - Individual Waypoint 172
- Direct-to 153
 - Cancelling 156

- System Overview
- Flight Instruments
- EIS
- CNS Interface
- GPS Navigation
- Flight Planning
- Hazard Avoidance
- Additional Features
- Integrated Autopilot
- Annun/Alerts
- Appendix
- Index

- Display
 - Backlighting 45
 - Color Mode 50
 - Dual 14, 16
 - Operation 13
 - Overview 8
 - Single 14
 - Symbols 347
- E**
- Echo Tops 184
- Engine/Airframe Unit 2
- Engine Indication System (EIS) 93
- Engine Manifold Pressure 95
- ENG Page 93
- EPE Circle 324
- Estimated Position Error (EPE) 324
- Exhaust Gas Temperature 95
- External Navigator 76
- F**
- Field of View 234
- Flight Instruments 59
- Flight Log 315
- Flight Plan 157
 - Activation 165
 - Active 162
 - Adding Waypoints 166
 - Approaches 174
 - Copying 171
 - Creation 162
 - Data Fields 158
 - Editing 166
 - Fuel Flow 168
 - Inverting 173
 - Name 168
 - Speed 168
 - Waypoints, Adding 166
- Flight Plan (FPL) Pages 25
- FliteCharts 240
 - Expiration 243
 - Range 239, 243
- FMS Joystick 10
- Forecast 192
- FPL Key 11
- Freezing Levels 191
- Frequencies 109
- Fuel Calculator 101
- Fuel Flow Indicator 95
- Fuel Pressure Indicator 95
- Fuel Quantity Indicator 95
- Fuel Range Ring 128
- G**
- Garmin Display Unit (GDU) 57
- Garmin Sensor Unit (GSU) 2
- GDU 370 1
- GlidePath Mode (GP) 273
- GMU 44 3
- GPS Receiver Status 40
- GSU 73 2
- GTP 59 3
- H**
- Hazard Display 264, 341
- Heading 61
- Heading Line 321
- Heading Mode (HDG) 279
- Heading Strip 85
- Horizontal Situation Indicator (HSI) 61, 71
 - Annunciations 73
- I**

Icing Forecast 192
 INFO Page
 Data Fields 44, 311
 Layout 45
 Show/Hide Lat/Lon 44
 Information Window 73
 Integrated Autopilot 255
 Alerts 306
 Disengaging 259
 Engaging 258
 Modes 261
 Intersections 144
 Inverting, Flight Plan 173

J

Jeppesen® Aviation Database 329

L

Lateral Modes 277
 Lean Assist 97
 Legends 196
 License Agreement 359
 Lightning 186
 Limited Warranty 359
 Line Replaceable Unit (LRU) 1
 Location Formats 55, 335
 Loss of GPS 256

M

Magnetometer 3
 Main Pages 23
 Map
 Airways 135
 Customizing 123
 Detail 133
 Displays 120
 Orientation 121
 Panning 127

Range 125
 Satellite View 131, 132
 Setup 121
 Symbols 132, 347
 Map Datum 335
 MAP Page
 Defaults 195
 XM Weather 194
 Map Range 125
 Map Symbols 132
 Measuring
 Bearing 129
 Distance 129
 MENU Key 11
 Menus 19
 Main Menu 20
 Navigating 16, 19
 Page Menu 19
 Messages
 Airspace 296
 Miscellaneous 295
 System 297
 METAR 187
 Flag Color 188
 Text 188

N

Navigation Mode (GPS) 280
 Navigation Source 7, 76
 NDBs 145
 Nearest
 Airport 142
 Airspace 151, 152
 NDB 145
 VORs 145
 Nearest Information 141
 Nearest (NRST) Pages 25
 Nearest Type
 Changing 43

- System Overview
- Flight Instruments
- EIS
- CNS Interface
- GPS Navigation
- Flight Planning
- Hazard Avoidance
- Additional Features
- Integrated Autopilot
- Annun/Alerts
- Appendix
- Index

System Overview
 Flight Instruments
 New Location 42
 NEXRAD 182, 184
 Normal Mode 14, 16
 NRST Key 11

O

EIS
 CNS Interface
 OBS Mode 86
 Obstacles 200
 Oil Pressure Indicator 95
 Oil Temperature Indicator 95
 Outside Air Temperature (OAT) 61, 87

P

GPS Navigation
 Flight Planning
 Pages 22
 Flight Plan (FPL) 25
 Information (INFO) 39
 MAIN 23
 Nearest (NRST) 25
 Panning 127
 PFD
 Annunciations 302
 PFD Page 59
 PIREP 190
 Pitch Hold Mode (PIT) 263
 Position 43
 Settings 55
 Power-up 12
 Proximity Waypoints 324

R

Annun/Alerts
 Appendix
 Red X 17, 341
 Reversionary Mode 15, 16, 294
 RNG Key 10
 Roll Hold Mode (ROL) 278
 Runway Extension line 122
 Runway Number 122

S

SafeTaxi 222, 236
 Satellite Information 42
 Satellite Mosaic 184
 Satellite View 131, 132
 Secure Digital (SD) Cards 9, 327
 Installing 9
 Selected Altitude 61
 Selected Altitude Bug 61
 Selected Altitude Capture mode (ALTS) 264
 Selected Heading 71
 Settings 45
 SIGMET 189
 SiriusXM 181, 182, 193, 194, 196, 221, 245, 246, 247, 249, 361
 Smart Airspace 152
 Softkeys 27, 38
 Softkey Selection Keys 11
 Sound 52
 Storm Cells 187
 Supercooled Large Droplet (SLD) 192
 Surface Pressure 186
 Symbols 132
 Synthetic Vision (SVX) 221
 System
 Annunciations 17
 Controls 10
 Date & Time 53, 54
 Functionality 19
 Initialization 12
 Power-up 12
 Settings 45
 System ID 331

T

- Tachometer (RPM) 95
- TAFs 187
- TAS 337
- TCAS 337
- Temperature Probe 3
- Temporary Flight Restrictions (TFRS) 190
- Terrain 197
 - Alerts 200, 202
 - Annunciations 305
 - Obstacle Information 200
 - Shading 198
 - Views 199
- Topography 130
- Track Log 317
- Traffic Information Service (TIS) 205, 337–338
 - Annunciations 206, 306
 - Audio Alerts 208
 - General Information 337
 - Ground Track 209
 - Limitations 337
- Traffic Warning Window 208
- Transponder
 - Status Box 61
- True Airspeed (TAS) 61, 62
- Turbulence Forecast 191
- Turn Rate Indicator 61, 85

U

- Unusual Attitudes 277
- User Waypoints 146
 - Creating 146
 - Deleting 149
 - Editing 149
 - Nearest 149
 - Renaming 149

V

- Vectors 178
- Vectors-to-Final 178
- Vertical Deviation Indicator (VDI) 69
- Vertical Modes 262
- Vertical Navigation (VNAV) 89
 - Capturing 91
 - Configuring 90
 - Indicator 91
- Vertical Power 23, 24, 36, 250, 252, 308
- Vertical Speed Indicator (VSI) 69
- Vertical Speed Mode (VS) 267
- VNAV Target Altitude Capture Mode (ALTV) 271
- Voltmeter 95
- VORs 145
- VP-X 24, 36, 250
- Vspeed Reference 49, 50, 56, 63

W

- Warranty 359
- Water Temperature 193
- Waypoints 136, 146
 - Creating 146
 - User 146
- Weather Information 143
- Weight & Balance 322
- Wind Data 88
- Winds Aloft 185
- Wings level 278

X

- XM
 - Accessing 182
 - XM Satellite Radio 245, 253
- XM Lightning 186
- X Symbol 198

System Overview

Flight Instruments

EIS

CNS Interface

GPS Navigation

Flight Planning

Hazard Avoidance

Additional Features

Integrated Autopilot

Annun/Alerts

Appendix

Index

Blank Page



Garmin International, Inc.
1200 East 151st Street
Olathe, KS 66062, U.S.A.
Toll free: 800.800.1020 or
866.739.5687
p: 913.397.8200
f: 913.397.8282

Garmin AT, Inc.
2345 Turner Road SE
Salem, OR 97302, U.S.A.
Toll free: 800.525.6726
p: 503.391.3411
f: 503.364.2138

Garmin (Europe) Ltd
Liberty House, Bulls Copse Road
Hounslow Business Park
Southampton, SO40 9RB, U.K.
Toll free (within U.K.) 0808.2380000
p: 44/0870.8501241
f: 44/0870.8501251

Garmin Corporation
No. 68, Jangshu 2nd Road
Shijr, Taipei County, Taiwan
p: 886/2.2642.9199
f: 886/2.2642.9099

www.garmin.com