

## INSTRUCTION MANUAL

JVCKENWOOD Corporation

### MONITOR WITH DVD RECEIVER

---

**DDX7018BT** (Region 3 – DVD Region Code 3 Area)

**DDX7018BTM** (Region 2 – DVD Region Code 2 Area)

**DDX718WBT** (Region 3 – DVD Region Code 3 Area)

**DDX718WBTM** (Region 2 – DVD Region Code 2 Area)

### MONITOR WITH RECEIVER

---

**DMX7018BT** (For Australia and New Zealand)

**DMX7018BT** (For Southeast Asia)

**DMX7018BTM**

**DMX718WBT** (For Australia and New Zealand)

**DMX718WBT** (For Southeast Asia)

**DMX718WBTM**

This instruction manual is used to describe the models listed above. Model availability and features (functions) may differ depending on the country and sales area.

# Important Notice

To ensure proper use, please read through this manual before using this product. It is especially important that you read and observe WARNINGS and CAUTIONS in this manual.

Please keep the manual in a safe and accessible place for future reference.

## WARNINGS

### To prevent accidents and damages

- DO NOT install any unit or wire any cable in a location where;
  - it may obstruct the steering wheel and gearshift lever operations.
  - it may obstruct the operation of safety devices such as air bags.
  - it may obstruct visibility.
- DO NOT raise the volume level too much, as this will make driving dangerous by blocking outside sounds, and may cause hearing loss.
- DO NOT operate the unit while driving. If you need to operate the unit while driving, be sure to look around carefully.
- Stop the car before performing any complicated operations.
- The driver must not watch the monitor while driving.

## CAUTIONS

### To care for the unit

- If you have parked the car for a long time in hot or cold weather, wait until the temperature in the car becomes normal before operating the unit.

### To care for the monitor

- The monitor built into this unit has been produced with high precision, but it may have some ineffective dots. This is inevitable and is not considered defective.
- Do not expose the monitor to direct sunlight.
- Do not operate the touch panel using a ball-point pen or similar tool with a sharp tip.
  - Touch the keys on the touch panel with your finger directly (if you are wearing a glove, take it off).
- When the temperature is very cold or very hot...
  - Chemical changes occur inside, causing malfunction.
  - Pictures may not appear clearly or may move slowly. Pictures may not be synchronized with the sound or picture quality may decline in such environments.

### On the volume setting

- Digital devices produce very little noise compared with other sources. Lower the volume before playing these digital sources to avoid damaging the speakers by sudden increase of the output level.

For DDX7018BT/DDX7018BTM/DDX718WBT/DDX718WBTM:



### The marking of products using lasers

The label is attached to the chassis/case and says that the component uses laser beams that have been classified as Class 1. It means that the unit is utilizing laser beams that are of a weaker class. There is no danger of hazardous radiation outside the unit.

## Important Notice

For DDX7018BTM/DMX7018BTM/DDX718WBTM/  
DMX718WBTM:

### For Turkey

Bu ürün 28300 sayılı Resmi Gazete'de yayımlanan Atık Elektrikli ve Elektronik Eşyaların Kontrolü Yönetmeliğe uygun olarak üretilmiştir.

### Eski Elektrik ve Elektronik Ekipmanların İmha Edilmesi Hakkında Bilgi (ayrı atık toplama sistemlerini kullanan ülkeleri için uygulanabilir)



Sembollü (üzerinde çarpı işareti olan çöp kutusu) ürünler ev atıkları olarak atılamaz. Eski elektrik ve elektronik ekipmanlar, bu ürünleri ve ürün atıklarını geri dönüştürebilecek bir tesiste değerlendirilmelidir. Yaşadığınız bölgeye en yakın geri dönüşüm tesisinin yerini öğrenmek için yerel makamlara müracaat edin. Uygun geri dönüşüm ve atık imha yöntemi sağlığımız ve çevremiz üzerindeki zararlı etkileri önlerken kaynakların korunmasına da yardımcı olacaktır.

For DDX7018BTM/DMX7018BTM/DDX718WBTM/  
DMX718WBTM:



### Declaration of Conformity with regard to the RE Directive 2014/53/EU Declaration of Conformity with regard to the RoHS Directive 2011/65/EU

#### Manufacturer:

JVC KENWOOD Corporation  
3-12, Moriya-cho, Kanagawa-ku, Yokohama-shi,  
Kanagawa, 221-0022, Japan

#### EU Representative:

JVCKENWOOD Europe B.V.  
Amsterdamseweg 37, 1422 AC UITHOORN,  
THE NETHERLANDS

### English

Hereby, JVCKENWOOD declares that the radio equipment "DDX7018BTM/DMX7018BTM/DDX718WBTM/DMX718WBTM" is in compliance with Directive 2014/53/EU.

The full text of the EU declaration of conformity is available at the following internet address:  
<http://www.kenwood.com/cs/ce/eudoc/>

### Turkish

Burada, JVCKENWOOD "DDX7018BTM/DMX7018BTM/DDX718WBTM/DMX718WBTM" radyo ekipmanının 2014/53/AB Direktifine uygun olduğunu bildirir. AB uyumluluk deklarasyonunun tam metni aşağıdaki internet adresinde mevcuttur.  
<http://www.kenwood.com/cs/ce/eudoc/>

## About this manual

The displays and panels shown in this manual are examples used to provide clear explanations of the operations. For this reason, they may be different from the actual displays or panels.

Illustrations of **DDX7018BT** are mainly used for explanation.

This manual mainly explains operations using the buttons on the monitor panel and keys on the touch panel. For operations using the remote controller, see page 43.

< > indicates the various screens/menus/operations/settings that appear on the touch panel.

[ ] indicates the keys on the touch panel.

Indication language: English indications are used for the purpose of explanation. You can select the indication language from the **<SETUP>** menu. (Page 40)

## Contents

<b>Component Names and Operations .....</b>	<b>3</b>	<b>Bluetooth® .....</b>	<b>26</b>
<b>Basic Operations .....</b>	<b>4</b>	Information .....	26
Turning on the power .....	4	Preparation .....	26
Turning off the power/turning off the AV source .....	4	Connection .....	26
Putting the unit in standby .....	4	Bluetooth mobile phone .....	29
Turning off the screen .....	4	Bluetooth audio player .....	32
Adjusting the volume .....	5	Bluetooth mobile phone settings .....	32
Attenuating the sound .....	5	<b>Settings .....</b>	<b>33</b>
Monitor panel operations .....	5	Audio settings .....	33
<b>Getting Started .....</b>	<b>6</b>	AV settings .....	37
Initial settings .....	6	Display settings .....	38
Setting the security function .....	6	User interface settings .....	39
Calendar/clock settings .....	7	Camera settings .....	40
<b>Various Screens and Operations .....</b>	<b>7</b>	Special system settings .....	41
Touch screen operations .....	7	Bluetooth settings .....	42
Home screen .....	8	Security settings .....	42
Source control screen .....	9	Navigation settings .....	42
List/setting screen .....	11	<b>Remote Controller .....</b>	<b>43</b>
<b>Disc .....</b>	<b>12</b>	Preparation .....	43
<b>Video .....</b>	<b>14</b>	Basic operations for RC-DV340 (supplied) .....	43
<b>USB .....</b>	<b>15</b>	Basic operations for KNA-RCDV331 (optionally purchased) .....	45
<b>iPod/iPhone .....</b>	<b>17</b>	<b>Installation and Connection .....</b>	<b>46</b>
<b>Apps—WebLink™ .....</b>	<b>18</b>	Before installation .....	46
<b>Radio .....</b>	<b>19</b>	Installing the unit .....	48
<b>Spotify .....</b>	<b>22</b>	Connecting external components .....	48
<b>Other External Components .....</b>	<b>23</b>	Wiring connection .....	49
View camera .....	23	<b>References .....</b>	<b>53</b>
AV-IN .....	24	Maintenance .....	53
Watching TV .....	24	More information .....	53
Using the external navigation unit .....	25	<b>Troubleshooting .....</b>	<b>56</b>
		<b>Specifications .....</b>	<b>59</b>
		Trademarks and licenses .....	62

# Component Names and Operations

## DDX7018BT/DDX7018BTM

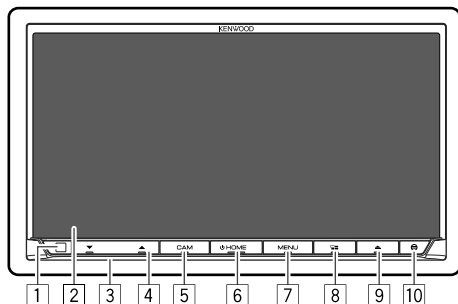

## DMX7018BT/DMX7018BTM

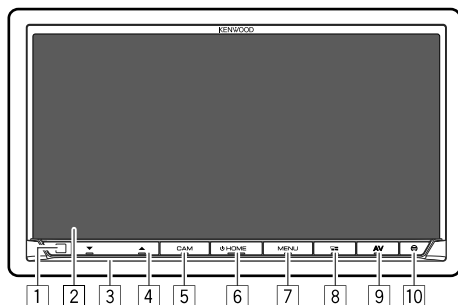

1 Remote sensor\*1

2 Screen (touch panel)

3 Monitor panel

4 **VOLUME** ▼/▲ button

5 **CAM/DISP OFF** button

- **CAM** (Press): Displays the picture from the connected rear view camera.
- **DISP OFF** (Hold): Turns off the screen.

6 **HOME** button

- **HOME** (Press): Turns on the power.
- **HOME** (Hold): Turns off the power or AV source.\*2
- **HOME** (Press): Displays the Home screen while the power is on.

7 **MENU/ATT** button

- **MENU** (Press): Pops up the short-cut menu.
- **ATT** (Hold): Attenuates the sound.

8 **APP/VOICE** button

- **APP** (Press): Displays the App screen. (Page 18)
- **VOICE** (Hold): Activates the voice dialing.

9 **DDX7018BT/DDX7018BTM**: ▲ button

Displays the **<Angle Adjust>** screen. (Page 5)

**DMX7018BT/DMX7018BTM**: **AV** button

Switches the screen between the navigation and the current source.

10 Built-in Bluetooth microphone\*3

## DDX718WBT/DDX718WBTM/DMX718WBT/DMX718WBTM

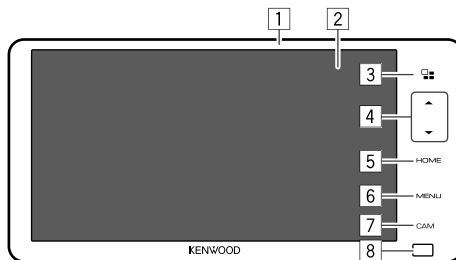

1 Monitor panel

2 Screen (touch panel)

3 **APP** button

- Press: Displays the App screen. (Page 18)
- Hold: Activates voice dialing.

4 Volume ▲/▼ buttons

5 **HOME** button

- Turns on the power. (Press)
- Displays the Home screen while the power is on. (Press)
- Turns off the power or AV source.\*2 (Hold)

6 **MENU** button

- Pops up the short-cut menu. (Press)
- Attenuates the sound. (Hold)

7 **CAM** button

- Displays the picture from the connected rear view camera. (Press)
- Turns off the screen. (Hold)

8 Remote sensor\*1

\*1 **DO NOT** expose the remote sensor to bright light (direct sunlight or artificial lighting).

\*2 The function of the button when held varies depending on the **<Manual Power OFF>** setting on the **<Special>** screen. (Page 41)

\*3 Only for DDX7018BT/DMX7018BT Southeast Asian models/DMX7018BT Indonesian models.

# Basic Operations

## Turning on the power

DDX7018BT  
DDX7018BTM  
DMX7018BT  
DMX7018BTM



DDX718WBT  
DDX718WBTM  
DMX718WBT  
DMX718WBTM



## Turning off the power/turning off the AV source

- This function varies depending on the <Manual Power OFF> setting. (Page 41)

DDX7018BT  
DDX7018BTM  
DMX7018BT  
DMX7018BTM



DDX718WBT  
DDX718WBTM  
DMX718WBT  
DMX718WBTM



## Putting the unit in standby

### 1 Display the source/option selection screen.

On the Home screen, touch as follows:



### 2 Put the unit in standby.

On the source/option selection screen, touch as follows:



## Turning off the screen

### On the monitor panel

DDX7018BT  
DDX7018BTM  
DMX7018BT  
DMX7018BTM

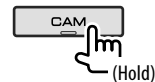

DDX718WBT  
DDX718WBTM  
DMX718WBT  
DMX718WBTM

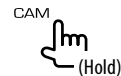

**To turn on the screen:** Press the same button on the monitor panel or touch the screen.

### On the pop-up short-cut menu

#### 1 Display the pop-up short-cut menu.

DDX7018BT  
DDX7018BTM  
DMX7018BT  
DMX7018BTM

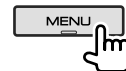

DDX718WBT  
DDX718WBTM  
DMX718WBT  
DMX718WBTM



#### 2 On the pop-up short-cut menu, touch as follows:

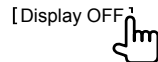

**To turn on the screen:** Touch the screen.

## Basic Operations

### Adjusting the volume

DDX7018BT  
DDX7018BTM  
DMX7018BT  
DMX7018BTM

DDX718WBT  
DDX718WBTM  
DMX718WBT  
DMX718WBTM

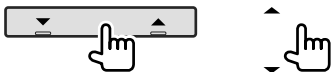

You can adjust the volume (00 to 40) by pressing ▲ to increase and pressing ▼ to decrease.

- Holding ▲ increases the volume continuously to level 15.

### Attenuating the sound

DDX7018BT  
DDX7018BTM  
DMX7018BT  
DMX7018BTM

DDX718WBT  
DDX718WBTM  
DMX718WBT  
DMX718WBTM



(Hold)



(Hold)

The ATT indicator lights up.

**To cancel attenuation:** Press and hold the same button again.

### Monitor panel operations

#### 1 Display the <Angle Adjust> screen.

DDX7018BT/DDX7018BTM:



DMX7018BT/DMX7018BTM/DDX718WBT/  
DDX718WBTM/DMX718WBT/DMX718WBTM:

Press **MENU** on the monitor panel to display the pop-up short-cut menu, then touch **[Angle]**.

#### 2 Perform the adjustment or operation.

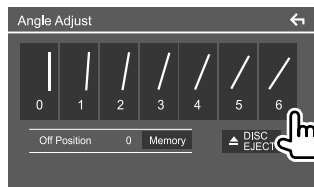

E.g. Angle adjust screen for DDX7018BT

[0] – [6]

Selects a monitor angle.  
(The monitor panel will stay in this angle when you turn on the unit.)

<Off Position>

Sets the angle of the monitor panel you want when you turn off the unit or the ignition switch of the vehicle.

- Select the monitor angle, then touch **[Memory]**.

[▲ DISC EJECT]

(Only for DDX7018BT/  
DDX7018BTM/DDX718WBT/  
DDX718WBTM)

(Touch) Ejects the disc.

To return the monitor panel to the selected angle:

Press ▲ on the monitor panel.

- To return to the previous screen, touch [←] on the setting screen.

# Getting Started

## Initial settings

When you power on the unit for the first time, the <Initial SETUP> screen appears.

### Perform the initial settings.

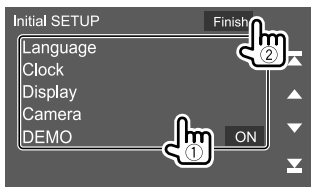

E.g. Initial settings screen for DDX7018BT

Once completed, a warning message appears. Touch **[Agree]** to display the Home screen.

### [Language]\*

Select the text language used for on-screen information.

Touch **[Language Select]**, then select the language.

- **American English (en)/British English (en)** (Initial)/**Nederlands (nl)/Français (fr)/Deutsch (de)/Italiano (it)/Español (es)/(ar) العربية/Ελληνικά (el)/Português (pt)/Čeština (cs)/Polski (pl)/Magyar (hu)/Русский (ru)/ไทย (th)/Türkçe (tr)/简体中文 (zh)/繁體中文 (zh)/(he) עברית/(fa) فارسی/Bahasa Melayu (ms)/Bahasa Indonesia (id)**

### [Clock] (Page 7)

Set the calendar and clock time.

Make the settings for **[Clock]**, **[Time Zone]** or **[Clock Adjust]**.

### [Display] (Page 38)

Make the settings to adjust the display.

### [Camera] (Page 40)

Make the settings to display the picture from the connected view camera.

### [DEMO]

- **ON** (Initial): Activates the display demonstration.
- **OFF**: Deactivates the display demonstration.

\* Only for DDX7018BT/DDX7018BTM/DDX718WBT/DDX718WBTM:

“Please Power Off” appears when the setting is changed. To enable the change:

For DDX7018BT/DDX7018BTM:

- When <Manual Power OFF> is set to [AV OFF], turn off the ignition switch, then turn on the ignition switch.
- When <Manual Power OFF> is set to [Complete OFF], turn off the power of the unit, then turn on the power of the unit.

For DDX718WBT/DDX718WBTM:

- Turn off the ignition switch, then turn on the ignition switch.

## Setting the security function

### ■ Registering a security code

You can set a security code (four-digit number of your choice) to protect your receiver system against theft. Once you set the security code, you are required to input the security code when the power is on to reconnect the battery.

#### 1 Display the Home screen.

DDX7018BT  
DDX7018BTM  
DMX7018BT  
DMX7018BTM

DDX718WBT  
DDX718WBTM  
DMX718WBT  
DMX718WBTM



#### 2 Display the <Security Code Set> screen.

On the Home screen, touch as follows:



Then, on the <SETUP> screen, touch as follows:

**[Security]** → **[Security Code Set]**



## Getting Started

- 3 Enter a four-digit number (①), then confirm the entry (②).

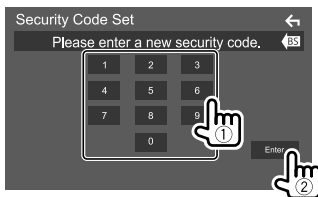

- To clear the last entry, touch [BS].
- To cancel the setting, touch [←].

- 4 Enter the four-digit number entered in step 3 and touch [Enter] again to confirm your security code.

**To change the security code:** Touch [Security Code Change] on the <Security> screen on step 2, then repeat steps 3 and 4.

**To clear the security code:** Touch [Security Code Cancellation] on the <Security> screen on step 2, then repeat step 3.

### Calendar/clock settings

- 1 Display the Home screen.

DDX7018BT  
DDX7018BTM  
DMX7018BT  
DMX7018BTM

DDX718WBT  
DDX718WBTM  
DMX718WBT  
DMX718WBTM



- 2 Display the <User Interface> screen.

On the Home screen, touch as follows:



Then, on the <SETUP> screen, touch [User Interface].

- 3 Set the date and clock.



#### [Clock]

Select the method to set the date and clock.

- **RDS-SYNC** (Initial): Synchronizes the clock with the FM Radio Data System.
- **Manual**: Sets the date and clock manually.

For Indonesian models, [Manual] is selected initially.

#### [Time Zone]\*

Select the time zone for your area.

#### [Clock Adjust]\*

Set the date and clock manually when [Clock] is set to [Manual].

Touch [▲]/[▼] to adjust the date (year/month/date), then clock (hour/minute). To finish setting, touch [Set].

\* Available when [Clock] is set to [Manual].

## Various Screens and Operations

You can display or change to other screens at any time to show information, change the AV source, change the settings, etc.

### Touch screen operations

To perform operations on the screen, you need to touch, touch and hold, flick or swipe to select an item, display setting menu screen or to change the page, etc.

#### Touch

Touch the screen gently to select an item on the screen.



#### Touch and hold

Touch the screen and keep your finger in place until the display changes or a message is displayed.



#### Flick

Slide your finger to the left or right on the screen to change the page.



#### Swipe

Slide your finger up or down on the screen to scroll the screen.



## Various Screens and Operations

### Home screen

When you turn on the power for the first time, the Home screen appears.

- You can customize the Home screen.
- To display the Home screen from other screens, press **HOME** on the monitor panel.



E.g. Home screen for DDX7018BT

Touching the operation keys performs the following actions:

- 1 Displays the current playing source control screen
- 2 Clock/date
- 3 Current source information
- 4 Displays all playback sources and options
- 5 Short-cut playback source keys
- 6 Displays the phone control screen

### Available playback sources and options

Touch [4] to display the source/option selection screen.

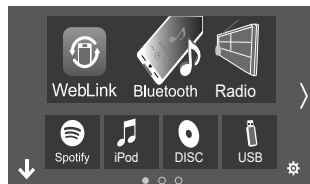

E.g. Source/option selection screen for DDX7018BT

Touching the operation keys performs the following actions:

[WebLink]	Switches to the WebLink™ application.
[Bluetooth]	Plays a Bluetooth audio player.
[Radio]	Switches to the radio broadcast.
[Spotify]	Switches to the Spotify application.
[iPod]	Plays an iPod/iPhone.
[DISC]*	Plays a disc.
[USB]	Plays files on a USB device.
[AV-IN]	Switches to an external component connected to the AV-IN input terminal.

[Audio]	Displays the sound adjustment screen.
[STANDBY]	Puts the unit in standby.
[NAV]	Displays the navigation screen when a navigation unit is connected.
[⚙️]	Displays the <SETUP> screen.

**To change the page:** Touch [◀]/[▶]. Current page is shown by the page indication on the bottom of the screen.

**To return to the Home screen:** Touch [⏪] on the source/option selection screen.

\* Only for DDX7018BT/DDX7018BTM/DDX718WBT/DDX718WBTM.

# Various Screens and Operations

## ■ Customizing the source/option selection screen

You can arrange the items to display on the source/option selection screen.

### 1 Select an item to move.

Touch and hold the item you want to move until boxes appear around the icons.

### 2 Drag the selected item to the position you want to move it to.

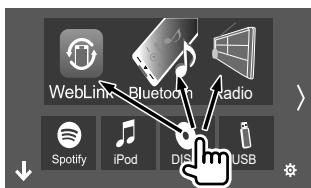

E.g. Source/option selection screen for DDX7018BT

## About short-cut playback source keys on the Home screen

The three items displayed on the top of the source/option selection screen with large icons are also shown on the Home screen as the short-cut playback source keys. You can set the source keys which you use frequently and access quickly from the Home screen.

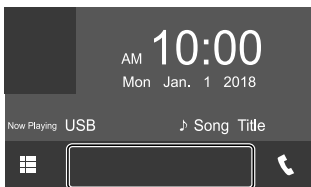

## Source control screen

You can perform the playback operation from the source control screen during playback.

- The operation keys and information displayed vary depending on the selected source/disc type/file type being played.
- If the operation keys are not displayed on the screen, touch the screen to show them.

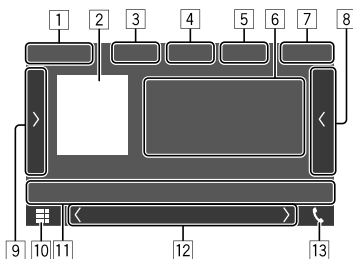

E.g. Common audio playback source screen for DDX7018BT

- 1 Playback source or media type
- 2 Picture data/artwork (shown if the file contains artwork except for disc playback)
- 3 For video: Hides the operation buttons on the screen while video is played
  - Touch the screen to restore the operation buttons.
- 4 Repeat/random playback mode keys\*1
- 5 Information about connected device
  - For Bluetooth device: Signal strength and battery level (only when the information is acquired from the device)

- 6 Track/file/song/video information
  - Touching [←] scrolls the text if not all of the text is shown.
- 7 Clock display
- 8 Displays the track/file/station/channel list
- 9 Displays/hides other available operation keys\*1
- 10 Displays the source/option selection screen
- 11 Operation keys\*1
- 12 Secondary screen

Each time you touch [⏪/⏩], the items shown on the secondary screen change as follows:

- Indicators: Displays the current source conditions, etc.

The followings are the common indicators:

- **ATT**: The sound is attenuated.
- **LOUD**: The loudness is active.
- **IN**: A disc is inserted.\*2
- **MUSIC/VIDEO**: Music/video file is played back.

- Short-cut buttons: Changes the source from those you have located on the Home screen.
  - Current source information while the navigation screen is displayed: Touching the information area displays the source control screen.
- 13 Displays the phone control screen

\*1 See “Common operation keys on source control screen” on page 10.

\*2 Only for DDX7018BT/DDX7018BTM/DDX718WBT/DDX718WBTM.

## Various Screens and Operations

### Common operation keys on source control screen

- The appearance of the operation keys may differ, however the similar operation keys have the same operations.
- Available operation keys differ depending on the selected source or connected device.

Touching the operation keys performs the following actions:

[4]

[🔄]\*

Selects repeat playback mode.

- 🔄: Repeat one
- 🔄📁: Repeat folder
- 🔄ALL: Repeat all
- 🔄CAP: Repeat chapter
- 🔄TIT: Repeat title
- 🔄(gray): Off

[🔀]\*

Selects random playback mode.

- 🔀📁: Random folder
- 🔀ALL: Random all
- 🔀(gray): Off

[9]

[>]

Displays other available operation keys besides those shown on [11].

- To hide the window, touch [◀].

[◀◀][▶▶]

Reverses/forwards search during playback.

[◀|▶]

Plays in slow-motion.

[■]

Stops playback.

[SETUP]

Displays the setting screen of the current playback source.

[MENU CTRL]

Displays the video menu control screen. (Page 14)

[📁][+]

Selects a folder.

[Audio]

Changes the audio output channel of VCD.

[11]

[🔊]

Attenuates/restores the sound.

[Q]

Displays the folder list/track list/audio menu/video menu.

[◀◀]/[▶▶]

- (Touch) Selects an item (chapter/folder/track/audio file/video file).
- (Hold) Reverses/forwards search.
- (Hold) Plays in slow-motion while paused for video playback.

[▶||]

Starts/pauses playback.

\* About playback mode:

- Available playback mode differs depending on the source, disc/file type, connected device, etc.
- You cannot activate repeat playback mode and random playback mode at the same time.

### Using the pop-up short-cut menu

While displaying the source control screen, you can jump to another screen by touching the operation keys on the pop-up short-cut menu.

#### 1 Display the pop-up short-cut menu.

DDX7018BT  
DDX7018BTM  
DMX7018BT  
DMX7018BTM

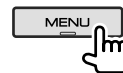

DDX718WBT  
DDX718WBTM  
DMX718WBT  
DMX718WBTM



## Various Screens and Operations

### 2 Select an item to jump.

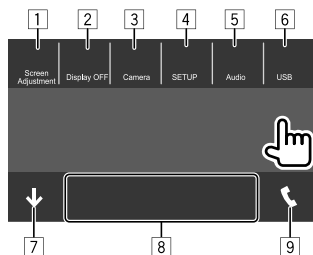

E.g. Pop-up short-cut menu screen for DDX7018BT

- 1 Displays the picture adjustment screen. (Page 15)
- 2 Turns off the screen.
- 3 **Camera** (for DDX7018BT/DDX7018BTM): Displays the picture from the connected rear view camera. (Page 23)  
**Angle** (for DMX7018BT/DMX7018BTM/DDX718WBT/DDX718WBTM/DMX718WBT/DMX718WBTM): Displays the **<Angle Adjust>** screen. (Page 5)
- 4 Displays the **<SETUP>** screen. (Page 37)
- 5 Displays the sound adjustment screen.
- 6 Displays the current source control screen.
- 7 Closes the pop-up short-cut menu.
- 8 Changes the playback source.
  - The three short-cut playback source keys displayed on the Home screen are displayed on the short-cut menu.
- 9 Displays the phone control screen. (Page 30)

### ■ Using touch screen operation during playback

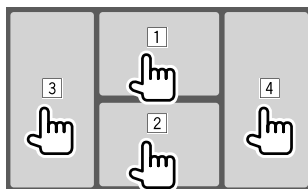

Touching the areas performs the following actions:

- 1 Displays the video control menu while playing a video.
- 2 Displays the source control screen.
- 3 Goes to the previous chapter/track.\*
- 4 Goes to the next chapter/track.\*

\* Not available for video from an external component (AV-IN).

### List/setting screen

The followings are the common operation keys which appear on the list/settings screen.

- The appearance of the operation keys may differ, however the similar operation keys have the same operations.
- Available operation keys differ depending on the setting screens. Not all the following operation keys are shown on every screen.

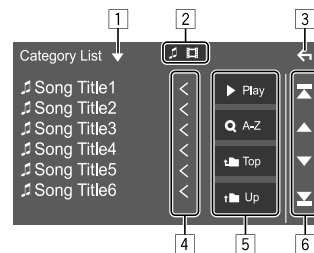

Touching the operation keys performs the following actions:

- 1 Displays list type selection window.
- 2 Selects the file type ([🎵]: audio/[📺]: video).
- 3 Exits from the current screen or returns to the previous screen.
- 4 Scrolls the text if not all of the text is shown.
- 5 Play/search keys
  - **[▶ Play]**: Plays all tracks in the folder containing the current track.
  - **[Q A-Z]**: Enters alphabet search to list the items in alphabetical order. When a keypad appears, touch the first letter you want to search for.
  - **[🏠 Top]**: Returns to the root folder.
  - **[📁 Up]**: Returns to the upper layer.
- 6 Changes the page to display more items.
  - **[▲]/[▼]**: Scrolls the page.
  - **[⏪]/[⏩]**: Jumps to the top or bottom page.

# Disc (Only for DDX7018BT/DDX7018BTM/DDX718WBT/DDX718WBTM)

- If a disc does not have a disc menu, all tracks on it will be played repeatedly until you change the source or eject the disc.
- For playable disc types, file types and other information, see pages 53 and 54.
- If “⊘” appears on the screen, the unit cannot accept the operation you have tried to do.
  - In some cases, without showing “⊘”, operations will not be accepted.
- When playing back a multi-channel encoded disc, the multi-channel signals are downmixed.

## Inserting a disc

DDX7018BT/DDX7018BTM: Press ▲ on the monitor panel to display the <Angle Adjust> screen, touch [▲ DISC EJECT] to open the monitor panel, then insert a disc.

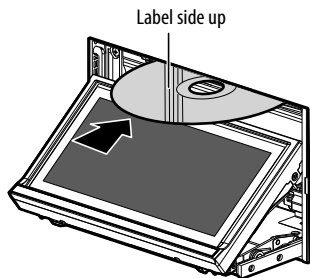

E.g. Inserting a disc for DDX7018BT

DDX718WBT/DDX718WBTM: Press **MENU** on the monitor panel, touch [Angle] on the pop-up short-cut menu to open the monitor panel, then insert a disc.

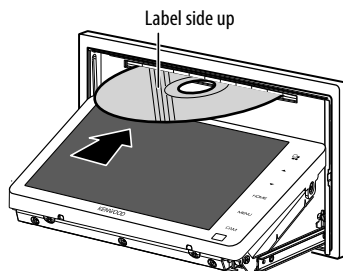

E.g. Inserting a disc for DDX718WBT

- After the disc is loaded, the monitor panel closes automatically.

The source changes to “DISC” and playback starts.

- The IN indicator lights up while a disc is inserted.

## Ejecting a disc

### 1 Display the <Angle Adjust>.

DDX7018BT/DDX7018BTM: Press ▲ on the monitor panel.

DDX718WBT/DDX718WBTM: Press **MENU** on the monitor panel, then touch [Angle] on the pop-up short-cut menu.

### 2 Eject a disc.

On the <Angle Adjust> screen, then touch as follows:



- When removing a disc, pull it out horizontally.
- You can eject a disc while playing another AV source.
- If the ejected disc is not removed within 15 seconds, the disc is automatically inserted again into the loading slot to protect it from dust.

### To close the monitor panel:

On the touch panel: After removing the disc, touch [▲ DISC EJECT] on the <Angle Adjust> screen.

On the monitor panel (only for DDX7018BT/DDX7018BTM): After removing the disc, press ▲.

## Playback operations

### ■ Audio playback information and key operation

- For playback information, see “Source control screen” on page 9.
- For key operations on the touch panel, see “Common operation keys on source control screen” on page 10.

### ■ Selecting a folder/track on the list

#### 1 Display the folder/track list.

On the source control screen, touch as follows:



#### 2 Select the item in the selected folder.

- For details about the list operation, see page 11.



Select an item in each layer until you reach and select the desired file.

## Settings for disc playback

- Available items shown on the <DVD SETUP> screen differ depending on the type of disc/file being played back.

#### 1 Display the <DVD SETUP> screen.

On the source control screen, touch as follows:



#### 2 Make the settings.



#### [Menu Language]\*

Select the initial disc menu language. (Initial:

**English**)

#### [Subtitle Language]\*

Select the initial subtitle language or turn subtitles off (**OFF**). (Initial: **English**)

#### [Audio Language]\*

Select the initial audio language. (Initial: **English**)

#### <Dynamic Range Control>

You can change the dynamic range while playing Dolby Audio encoded discs.

- **Wide:** Reproduces powerful sound at a low volume level with its full dynamic range.
- **Normal:** Reduces the dynamic range a little.
- **Dialog** (Initial): Reproduces movie dialog more clearly.

#### <Screen Ratio>

Select the monitor type to watch a wide screen picture on the external monitor.

**16:9** (Initial)    **4:3 LB**    **4:3 PS**



\* You can change these settings only while DVD is inserted. Select the language on the window, then touch [Close] to finish.

# Video

## Playback operations

### ■ Video playback information on the source control screen

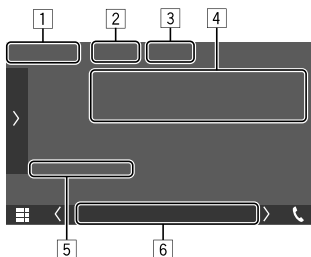

E.g. Video playback source control screen for DDX7018BT

- 1 Media type
- 2 Hides the operation buttons on the screen.
  - Touch the screen to restore the operation buttons.
- 3 Repeat/random playback mode keys
- 4 Current playback item information/audio format
- 5 Playback status/playing time
- 6 Indicators
  - **IN**: Lights up when a disc is inserted.
  - **VIDEO**: Lights up when video is played.

### ■ Video menu control operations

(Only for DDX7018BT/DDX7018BTM/  
DDX718WBT/DDX718WBTM)

You can display the video menu control during video playback.

- Available operation keys differ depending on the selected disc type and file type.

#### 1 Display the video menu control screen.

On the source control screen, touch as follows:



#### 2 Perform the video operations.

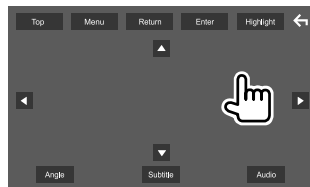

E.g. Video menu control screen for DDX7018BT

Touching the operation keys performs the following actions:

[Top]	Displays the top menu (DVD).
[Menu]	Displays the disc menu (DVD).
[Return]	Returns to the previous screen.
[Enter]	Confirms the selection.
[Highlight]	Switches to the direct disc menu selection mode. Touch the target item to select. <ul style="list-style-type: none"><li>• The menu screen disappears when no operation is done for 5 seconds.</li></ul>
[←]	Returns to the playback screen.
[Angle]	Selects the view angle.
[Subtitle]	Selects the subtitle type.
[Audio]	Selects the audio type.
[▲] [▼] [◀] [▶]	Selects an item.



## ■ Adjusting the picture

### 1 Display the pop-up short-cut menu.

DDX7018BT  
DDX7018BTM  
DMX7018BT  
DMX7018BTM

DDX718WBT  
DDX718WBTM  
DMX718WBT  
DMX718WBTM

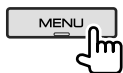

### 2 Display the picture adjustment screen.

On the pop-up short-cut menu, touch as follows:

[Screen Adjustment]



### 3 Adjust the picture.

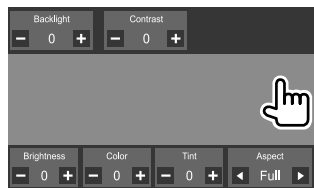

<Backlight>	Adjusts the brightness of the backlight. (-4 to +4)
<Contrast>	Adjusts the contrast. (-4 to +4)
<Brightness>	Adjusts the brightness. (-4 to +4)
<Color>*1	Adjusts the color. (-4 to +4)
<Tint>*2	Adjusts the tint. (-4 to +4)
<Aspect>	Selects the aspect ratio. <ul style="list-style-type: none"> <li>• <b>Full</b>: Changes the aspect ratio of video and displays fully on the screen.</li> <li>• <b>Normal</b>: Displays the video in the aspect ratio of 4:3.</li> <li>• <b>Auto</b>*3: <ul style="list-style-type: none"> <li>– For discs: Video of 16:9 ratio is displayed in the aspect ratio of &lt;Full&gt; setting. Video of 4:3 ratio is displayed in the aspect ratio of &lt;Normal&gt; setting.</li> <li>– For USB: Displays the video fully on vertical or horizontal with no ratio change.</li> </ul> </li> </ul>

- Adjustable items are different depending on the current source.
- You can perform this function only when you have applied the parking brake.

\*1 Adjustable only during playback.

\*2 Available only when the "AV-IN" or camera screen is displayed.

\*3 Selectable only when video from a disc or USB device is played back.

# USB

You can connect a USB mass storage class device such as a USB memory, digital audio player, etc. to the unit.

- For playable file types and other information, see pages 53 and 55.
- You cannot connect a PC or portable HDD to the USB input terminal.
- You cannot connect a USB device via a USB hub.

## Connecting a USB device

- Use CA-U1EX for extending the cable if necessary. (Max 500 mA, 5V)

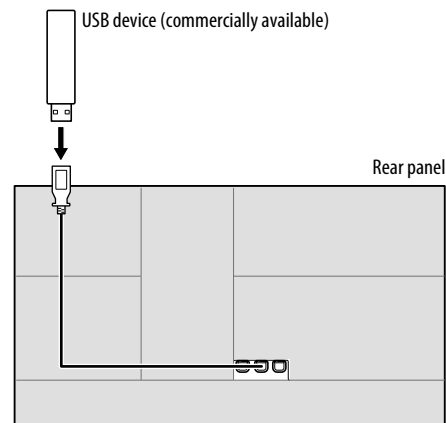

- Only for DMX7018BT/DMX7018BTM/DMX718WBT/DMX718WBTM: The unit is equipped with two USB input terminals. You can connect two USB devices.

## Playback operations

### ■ Playback information and key operation

- For playback information, see “Source control screen” on page 9.
- For key operations on the touch panel, see “Common operation keys on source control screen” on page 10.
- All tracks in the USB device will be played repeatedly until you change the source or disconnect the USB device.

Additional keys operations: Touching the operation keys performs the following actions.

**[USB DEVICE CHANGE]\*** Switches to another USB device when two USB devices are connected.

\* Only for DMX7018BT/DMX7018BTM/DMX718WBT/DMX718WBTM.

### ■ Selecting a folder/track on the list

#### 1 Display the folder/track list.

On the source control screen, touch as follows:



#### 2 Select the list type.



#### 3 Select the desired track.

- Repeat the procedure until you select the desired track.
- For details about the list operation, see page 11.

#### From <Category List>:

- ① Select the file type ([🎵]: audio/[📺]: video).
- ② Select a category, then the item in the selected category.

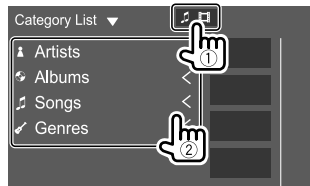

#### From <Link Search>:

- ① Select the file type ([🎵]: audio/[📺]: video).
- ② Select the tag type to display a list of contents that contains the same tag as the track/file currently being played, then select the item.

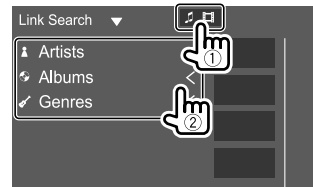

#### From <Folder List>:

Select the folder, then the item in the selected folder.



# iPod/iPhone

## Connecting an iPod/iPhone

- For playable iPod/iPhone types and other information, see page 55.
- You cannot watch video.

### Wired connection

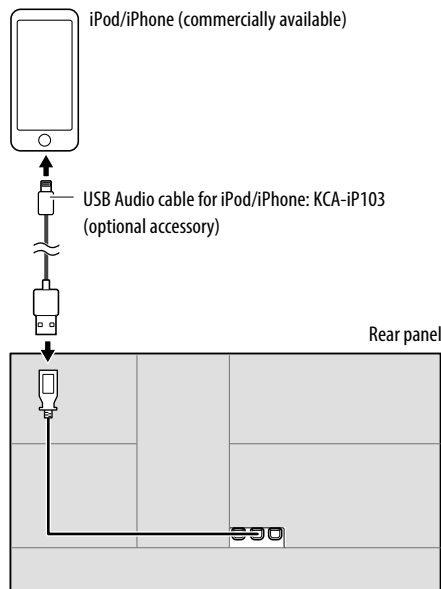

- For DMX7018BT/DMX7018BTM/DMX718WBT/DMX718WBTM: You cannot connect two iPod/iPhone at the same time.

### Bluetooth connection

Pair the iPod/iPhone with this unit via Bluetooth. (Page 26)

## Playback operations

### Playback information and key operation

- For playback information, see “Source control screen” on page 9.
- For key operations on the touch panel, see “Common operation keys on source control screen” on page 10.

### Selecting an audio file from the menu

#### 1 Display the list.

On the source control screen, touch as follows:



#### 2 Select the list type.



#### 3 Select the desired track.

- Repeat the procedure until you select the desired track.
- For details about the list operation, see page 11.

#### From <Category List>:

Select a category, then the item in the selected category.

- Available categories differ depending on the type of iPod/iPhone.

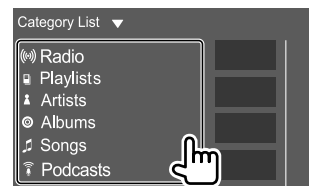

#### From <Link Search>:

Select the tag type to display a list of contents that contain the same tag as the track/file currently being played, then select the item.

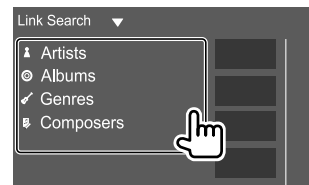

# Apps—WebLink™

You can display and control the App on the unit while your smartphone is connected to the USB input terminal.

**Preparation:** Be sure to ground the PRK SW lead. (Pages 49 – 52)

## Available Apps

You can use the following Apps on this unit. Install the WebLink™ App on your smartphone beforehand.

### WebLink™

WebLink™ enables you to use the following Apps with the unit.

- Media Player
- Yelp
- YouTube
- OpenWeatherMap

For DMX7018BT/DMX7018BTM/DMX718WBT/DMX718WBTM

To use WebLink™ App on iPhone, connect the iPhone to USB1 input terminal.

- WebLink™ App does not work on iPhone connected to USB2 input terminal.

## Connecting a smartphone

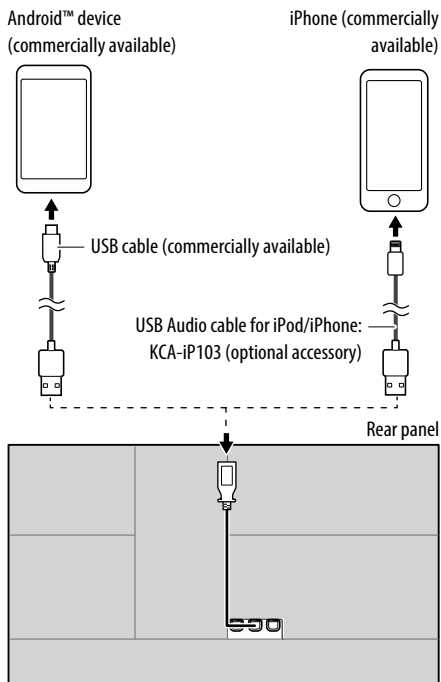

- When the smartphone is connected to the unit and “WebLink” is selected as the source, a confirmation message to communicate with each other appears on the smartphone. Touch **[Allow]** to establish connection, or **[Ignore]** to cancel the connection.
- You can check the connection status on the WebLink™ screen on your smartphone.

## Start playback

### 1 Select “WebLink” as the source.

### 2 Operate on the unit to select App.

- On the “WebLink” source screen, you can also operate on the touch panel as follows:



- Displays the main menu of the “WebLink” source screen.
- Exits the current App.



- Returns to the previous screen.
- Exits the current App.

### 3 Operate on your smartphone.

- When you are asked to communicate between your smartphone and the unit, touch **[Allow]** to proceed.
- If App does not start while using “WebLink”, start the App on your smartphone.

## Switching to the App screen while listening to the another source

You can display the App screen while listening to the other source.

DDX7018BT  
DDX7018BTM  
DMX7018BT  
DMX7018BTM

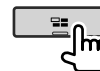

DDX718WBT  
DDX718WBTM  
DMX718WBT  
DMX718WBTM



# Radio

## Listening to the radio

### Playback information on the source control screen

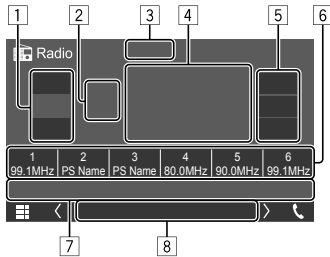

E.g. Radio source control screen for DDX7018BT

- 1 Selects the band (AM/FM1/FM2/FM3)
- 2 Current band/preset no.
- 3 Changes the seek mode for [◀◀]/[▶▶]
  - **AUTO1** (Initial): Auto search
  - **AUTO2**: Tunes in preset stations one after another
  - **MANUAL**: Manual search
- 4 Frequency/PS name
- 5 Tuner reception operation keys (TI/MONO/PTY)\*
- 6 Preset list
- 7 Operation keys\*

- 8 Indicators
  - **NEWS**: Lights up when News Standby Reception is activated.
  - **AF**: Lights up when Network-Tracking Reception is activated.
  - **TI**: Lights up in white when receiving the traffic information, and lights in orange when Traffic Information Reception is on standby.
  - **LO.S**: Lights up when Local Seek is activated.
  - **ST**: Lights up when receiving a stereo broadcast.
  - **MONO**: Lights up when receiving stations in monaural forcibly.
  - **RDS**: Indicates the status of the Radio Data System station reception when the Network-Tracking Reception is activated. (Page 21)
    - Lights in white: Radio Data System station is being received.
    - Lights in orange: Radio Data System station is not being received.
  - **EON**: Lights up when a Radio Data System station is sending EON signals.

\* See the following "Operation keys on source control screen".

#### Operation keys on source control screen

- The appearance of the operation keys may differ, however the similar operation keys have the same operations.
- See also "Common operation keys on source control screen" on page 10.

Touching the operation keys performs the following actions:

5

[TI]\*

(For FM Radio Data System features)  
Activates TI standby reception mode.

- When TI is activated, the unit is ready to switch to traffic information if available. The TI indicator lights up in white.
- If the TI indicator lights up in orange, tune into a station providing Radio Data System signals.
- The volume adjustment for traffic information is automatically memorized. The next time the unit switches to traffic information, the volume is set to the memorized level.
- To deactivate, touch [TI] again.

[MONO]\*

Activates monaural mode for better FM reception (stereo effect will be lost).

- The MONO indicator lights up while monaural mode is activated.
- To deactivate, touch [MONO] again.

[PTY]\*

(For FM Radio Data System features)  
Enters PTY search mode.

- ① Touch a PTY code.
  - ② Touch [Search] to search for.
- If there is a station broadcasting a program of the same PTY code as you have selected, that station is tuned in.
- You can set language displayed for the PTY search on the <RADIO SETUP> screen. (Page 21)

\* Appears only when FM is selected as the source.

## Radio

7

- [🔊] Attenuates the sound.
  - To restore the sound, touch the button again, or adjust the volume.
- [⏪/⏩] Searches for a station.
  - The search method differs according to the selected seek mode.
- [AME] Presets stations automatically.
- [📶] Displays the <RADIO SETUP> screen.

### Storing preset stations in the memory

You can preset 18 stations for FM and 6 stations for AM.

#### Automatic presetting — AME (Auto Memory)

On the source control screen, touch as follows:

[AME] 

A confirmation message appears. Touch [Yes].  
The local stations with the strongest signals are found and stored automatically.

#### Manual presetting

##### 1 Select the band, then tune in to a station you want to store.

- See “Playback information on the source control screen” on the page 19 for details.

##### 2 Select a preset number to store into.

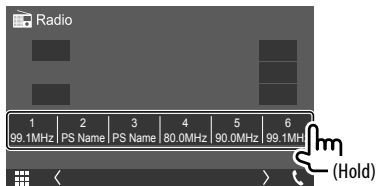

The station selected in step 1 is stored into the preset number you have selected.

### Selecting a preset station

Select the band (①), then select a preset station (②).

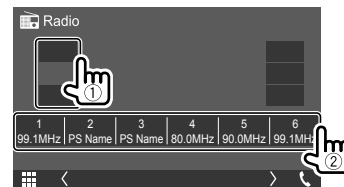

# Radio

## Settings for tuner reception

### 1 Display the <RADIO SETUP> screen.

On the source control screen, touch as follows:



### 2 Make the settings.

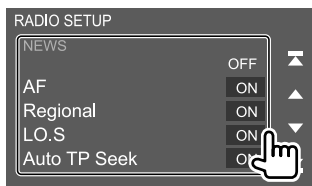

#### [NEWS]\*1

- **00min to 90min:** Activates New Standby Reception by selecting the period of time to disable the interruption. The NEWS indicator lights up.
- **OFF (Initial):** Deactivates the function.

#### [AF]

When driving in an area where FM reception is not sufficient enough, this unit automatically tunes in to another FM Radio Data System station of the same network with stronger signals— Network-Tracking Reception (AF: Alternative Frequencies).

- **ON:** Switches to another station. The program may differ from the one currently received.\*2
- **OFF (Initial):** Deactivates the function.

#### [Regional]

When driving in an area where FM reception is not sufficient enough, this unit automatically tunes in to another FM Radio Data System station of the same program with stronger signals— Network-Tracking Reception (Regional).

- **ON:** Switches to another station broadcasting the same program.\*2
- **OFF (Initial):** Deactivates the function.

#### [LO.S]

You can tune in FM stations only with strong signals—Local Seek.

- **ON:** Tunes in only to FM stations with sufficient signal strength. The LO.S indicator lights up.
- **OFF (Initial):** Deactivates the function.

#### [Auto TP Seek]

When traffic information station reception is poor, the unit automatically searches for another station that can be received better—Auto TP Seek.

- **ON (Initial):** Automatically searches for a station with better reception for traffic information if the current reception of current station is poor.
- **OFF:** Deactivates the function.

#### [Language Select]

Select the language to display for PTY search.

- **British English (en) (Initial)/Español (es)/ Français (fr)/Nederlands (nl)/Norsk (no)/ Portugues (pt)/Svenska (sv)/Deutsch (de)**

To close the setting window, touch **[Close]**.

#### [Aerial Control]\*3

- **ON (Initial):** Keeps the antenna extended even when “Radio” is not selected as the current source.
- **OFF:** Stores the antenna automatically when the source is changed from “Radio” to another source.

- \*1 The volume adjustment for Traffic Information is automatically memorized. The next time the unit switches to Traffic Information, the volume is set to the previous level.
- \*2 The RDS indicator lights up when the Network-Tracking Reception is activated.
  - Lights in white: Radio Data System station is being received.
  - Lights in orange: Radio Data System station is not being received.
- \*3 Only for DDX718WBT/DMX718WBT.

# Spotify

With Spotify, your music is everywhere. Working out, partying or relaxing, the right music is always at your fingertips. There are millions of songs on Spotify—from old favorites to the latest hits. Just choose the music you love, or let Spotify surprise you.

You can stream Spotify from iPhone/iPod touch or Android devices.

- Because Spotify is a third-party service, the specifications are subject to change without prior notice. Accordingly, compatibility may be impaired or some or all of the services may become unavailable.
- Some functions of Spotify cannot be operated from this unit.
- For issues using the application, contact Spotify at <[www.spotify.com](http://www.spotify.com)>.

## Preparation

### ■ Installing the application

Your smartphone must have built-in Bluetooth and the following profiles must be supported:

- SPP (Serial Port Profile)
- A2DP (Advanced Audio Distribution Profile)

Establish an Internet connection using LTE, 3G, EDGE, or Wi-Fi.

Ensure you are logged in to your smartphone application. If you do not have a Spotify account, you can create one for free from your smartphone or at <[www.spotify.com](http://www.spotify.com)>.

Install the latest version of the Spotify application on your smartphone.

- For Android devices: Search for “Spotify” in Google Play to find and install the most recent version.
- For iPhone/iPod touch: Search for “Spotify” in the Apple iTunes App Store to find and install the most recent version.

### ■ Connecting the device

#### For Android devices

Pair the Android device with this unit via Bluetooth. (Page 26)

#### For iPhone/iPod touch

- Via USB input terminal: Connect iPhone/iPod touch with the cable KCA-iP103 (optional accessory). (Page 17)
- Via Bluetooth: Pair the iPhone/iPod touch with this unit. (Page 26)

## Playback operations

### ■ Playback information and key operation

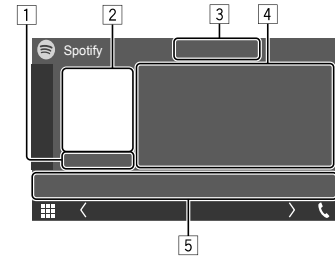

E.g. Spotify source control screen for DDX7018BT

You can also operate Spotify with a remote controller, RC-DV340\*1.

You can only control play, pause and skip with the remote controller.

- 1 Playing time
- 2 Picture data
- 3 Thumb up/down and repeat/shuffle playback mode keys\*2
- 4 Track information
  - Touching [◀] scrolls the text if not all of the text is shown.
- 5 Operation keys\*2

\*1 For DMX7018BT Australian/New Zealand models/DMX718WBT Australian/New Zealand models: Purchase optional remote controller, KNA-RCDV331.

\*2 See “Operation keys on source control screen” on page 23.



## Operation keys on source control screen

- The appearance of the operation keys may differ, however the similar operation keys have the same operations.
- See also “Common operation keys on source control screen” on page 10.

Touching the operation keys performs the following actions:

[3]

[👍]*1	Thumbs down to the current track and skips to the next track.
[👍]*1	Registers the current track as a favorite.
[🔀]*2 *3	Activates (🔀▶)/deactivates (🔀) shuffle playback mode.
[🔁]*2	Selects repeat playback mode (🔁●: repeat one*3/🔁ALL: repeat all/🔁○: repeat off).

[5]

[☰]	Displays the Spotify menu screen.
[((•))]	Creates a new station (Start Radio).
[⏮]*2 *3 [⏭]	Selects a track.
[▶][⏸]	Starts (▶)/pauses (⏸) playback.
[+]	Saves the current track/artist/album to <Your Music> or <Your Library>.

\*1 Not available for tracks in a playlist.

\*2 Not available for tracks in the Radio.

\*3 Available only for premium account users.

## ■ Creating your station (Start Radio)

Start Radio is to start a radio channel based on the currently played track.

### Create your station.

On the source control screen, touch as follows:



Station is created and playback starts automatically.

- You can personalize your station using thumb up (👍) or thumb down (👎).
- Personalizing stations may not be available depending on the track.

## ■ Selecting a track

### 1 Display the Spotify menu screen.

On the source control screen, touch as follows:



### 2 Select the list type, then select a desired item.

- The list types displayed differ depending on the information sent from Spotify.

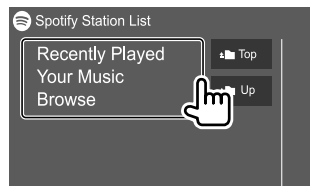

# Other External Components

## View camera

Install the view camera (separately purchased) in the appropriate position according to the instructions supplied with the view camera.

- You can use both rear view camera and front view camera.

## ■ Connecting a view camera

See page 48 for more information for connection terminals.

- To use the rear view camera, a reverse lead (REVERSE) connection is required. (Pages 49 – 52)

## ■ Using the view camera

- For view camera settings, see “Camera settings” on page 40.

### To display the rear view camera screen

The rear view camera screen is displayed by shifting the gear to the reverse (R) position when [R-CAM Interruption] is set to [ON] on the <Camera> screen. (Page 40)

- A caution message appears on the screen. To remove the caution message, touch the screen.

## Other External Components

You can also display the picture from the rear view camera manually without shifting the gear to the reverse (R) position.

On the monitor panel:

DDX7018BT	DDX718WBT
DDX7018BTM	DDX718WBTM
DMX7018BT	DMX718WBT
DMX7018BTM	DMX718WBTM



On the pop-up short-cut menu: Touch as follows (only for DDX7018BT/DDX7018BTM):



### To display the front view camera screen

- Set [Front Camera] to [ON] on the <Camera> screen beforehand. (Page 41)

While the rear camera screen is displayed, touch the area shown below.



- Each time you touch the area, the screen is switched between rear view camera and front view camera.

### To exit the camera screen

Press **HOME** on the monitor panel or touch the area shown below.



## AV-IN

### Connecting an external component

See page 48 for connection terminals.

### Starting playback

#### 1 Select "AV-IN" as the source.

On the Home screen, touch as follows:



#### 2 Turn on the connected component and start playing the source.

- For playback information, see "Source control screen" on page 9.

## Watching TV

### Connecting a TV tuner box

Connect TV tuner box to the audio/video input (AV-IN) terminal and TV tuner remote control output (REMO OUT) terminal. (Page 8)

### Displaying the TV screen

- Set [TV Tuner Control] to [ON] on the <AV> screen beforehand. (Page 37)

#### 1 Select "TV" as the source.

On the Home screen, touch as follows:



#### 2 Turn on the TV.

## Other External Components

### ■ Playback information and key operation

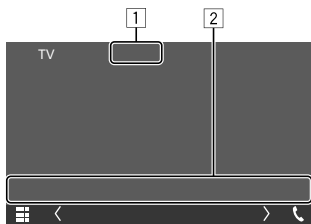

E.g. TV screen for DDX7018BT

- 1 Hides the operation buttons on the screen while video is played.
- 2 Operation keys\*

\* See the following "Operation keys on source control screen".

### ■ Operation keys on source control screen

- The appearance of the operation keys may differ, however the similar operation keys have the same operations.
- See also "Common operation keys on source control screen" on page 10.

Touching the operation keys performs the following actions:

2

[CH▲]/[CH▼] Selects the channel.

### ■ Using the external navigation unit

You can connect a navigation unit (KNA-G630: optional accessory) to the navigation input terminal so that you can view the navigation screen. (Page 48)

- The navigation guidance comes out of the front speakers even when you are listening to an audio source.

### ■ Viewing the navigation screen

- For navigation settings, see "Navigation settings" on page 42.

### Select "NAV" as the source.

On the Home screen, touch as follows:



- While the navigation screen is displayed, the touch panel operations are available only for navigation.

### ■ To exit the navigation screen

DDX7018BT  
DDX7018BTM  
DMX7018BT  
DMX7018BTM

DDX718WBT  
DDX718WBTM  
DMX718WBT  
DMX718WBTM



### ■ Switching the screen between the navigation and current source

(Only for DMX7018BT/DMX7018BTM)

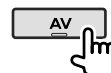

## Information

Bluetooth is a short-range wireless radio communication technology for mobile devices such as mobile phones, portable PCs and other devices. Bluetooth devices can be connected without cables and communicate with each other.

### Note

- While driving, do not perform complicated operations such as dialing numbers, using the phonebook, etc. When you perform these operations, stop your car in a safe place.
- Some Bluetooth devices may not connect to this unit depending on the Bluetooth version of the device.
- This unit may not work for some Bluetooth devices.
- Connecting conditions may vary depending on your environment.
- For some Bluetooth devices, the device is disconnected when the unit is turned off.
- If your mobile phone supports PBAP (Phone Book Access Profile), you can display the following items on the touch panel when the mobile phone is connected.
  - Phonebook: up to 1 000 entries
  - Dialed calls, received calls, and missed calls (up to 50 entries in total)

## Preparation

- Connect and install the microphone beforehand. For details, see pages 49 – 52.

For **DDX7018BT/DMX7018BT**:

– A built-in microphone is equipped with this unit.

You can also connect an external microphone to the unit. If you are looking for an external Bluetooth microphone, please contact the store where you bought the product.

– Select a microphone to use (built-in or external) via **[MIC SETUP]** on the **<Bluetooth>** screen beforehand. (Page 42)

- Set **[Bluetooth]** to **[ON]** on the **<Bluetooth>** screen. (Page 42)

## Connection

When you connect a Bluetooth device to the unit for the first time:

- ① Register the device by pairing the unit and the device.
- ② Connect the device to the unit. (Page 28)

## ■ Registering a new Bluetooth device

Pairing allows Bluetooth devices to communicate with each other.

- The pairing method differs depending on the Bluetooth version of the device.
  - For devices with Bluetooth 2.1:  
You can pair the device and the unit using SSP (Secure Simple Pairing) which only requires confirmation.
  - For devices with Bluetooth 2.0:  
You need to enter a PIN code both on the device and the unit for pairing.
- Once connection is established, it is registered in the unit even if you reset the unit. Up to 10 devices can be registered in total.
- Two Bluetooth devices for Bluetooth phone and one for Bluetooth audio can be connected at a time.
- To use the Bluetooth function, you need to turn on the Bluetooth function of the device.

### Auto pairing

When **<Auto Pairing>** is set to **[ON]** on the **<TEL SETUP>** screen, iOS (such as iPhone) devices are automatically paired when connected via USB. (Page 32)

## Registering a Bluetooth device

- 1 Search for the unit (“DDX\*\*\*” or “DMX\*\*\*”) from your Bluetooth device and operate the device to register.

### For a Bluetooth device compatible with SSP (Bluetooth 2.1):

Confirm the request both on the device and the unit.

On the device:



On the unit:

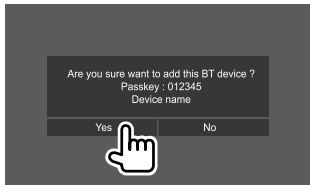

- Touch **[No]** to reject the request.

### For a Bluetooth device compatible with Bluetooth 2.0:

Select the unit (“DDX\*\*\*” or “DMX\*\*\*”) on your Bluetooth device.

- If a PIN code is required, enter the PIN code shown on the screen (initial: “0000”).  
To change PIN code, see page 28.

- 2 Determine usage as a hands free device (①), then touch [Close] (②).

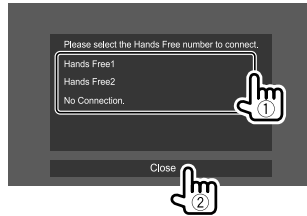

- 
- [Hands Free1]/** Select hands free number to use as the hands free device.
- [Hands Free2]**
- 
- [No Connection.]** Select this when you do not want to use as the hands free device.
- 

- 3 When your Bluetooth device is compatible with A2DP or SPP: Determine usage as an audio player or a device with Apps installed.

- 
- [Yes]** Select to use the device as an audio player.
- 
- [No]** Select this when you do not want to use the Bluetooth device as an audio player.
- 

- 4 When your Bluetooth device is compatible with PBAP: Select whether to transfer the phonebook of your Bluetooth device to the unit or not.

- 
- [Yes]** Select to transfer the phonebook from your Bluetooth device.
- 
- [No]** Select this when you do not want to transfer the phonebook.
-

## ■ Connecting/disconnecting a registered Bluetooth device

### 1 Display the <Select Device> screen.

On the Home screen, touch as follows:



Then, on the <SETUP> screen, touch [**Bluetooth**].

On the <Bluetooth Setup> screen, touch [**Select Device**].

### 2 Select the device you want to connect/disconnect.

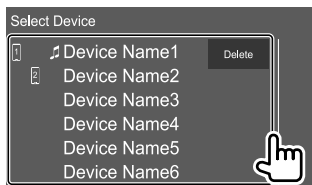

The icons beside the registered device indicate the following:

- ☎️: Connected as a mobile phone.
- 🎵: Connected as an audio player.

### 3 Select the usage of the device (①), then touch [Close] (②).

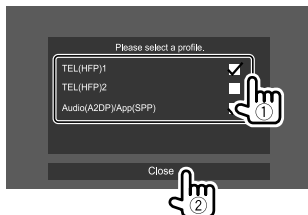

Each time you touch the selection, the usage is selected ("✓" appears) or deselected ("✓" disappears). Select to connect and deselect to disconnect the device.

[TEL (HFP)1/]	Select to use as the hands free device.
[TEL (HFP)2]	
[Audio (A2DP)/ App (SPP)]	Select to use as the audio player or device with Apps installed.

**To delete the registered Bluetooth device:** Touch [**Delete**] in step 2, select devices to delete, then touch [**Delete**]. A confirmation message appears. Touch [**Yes**].

- To select all devices, touch [ All].
- To deselect all selected devices, touch [ All].

## ■ Changing the PIN code

### 1 Display the <Change PIN Code> screen.

On the Home screen, touch as follows:



Then, on the <SETUP> screen, touch [**Bluetooth**].

On the <Bluetooth Setup> screen, touch [**PIN Code**].

### 2 Enter the PIN code (①), then confirm the entry (②).

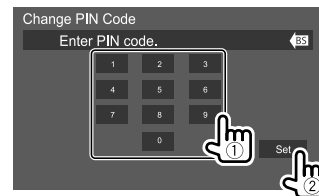

- To clear the last entry, touch [**BS**].

## ■ Changing the device name of the unit displayed on the paired device

### 1 Display the <Change Device Name> screen.

On the Home screen, touch as follows:



Then, on the <SETUP> screen, touch **[Bluetooth]**.

On the <Bluetooth Setup> screen, touch **[Device Name]**.

### 2 Enter the device name (①), then confirm the entry (②).



- To clear the last entry, touch **[BS]**.
- To move the entry position, touch **[◀/▶]**.

## Bluetooth mobile phone

### ■ When a call comes in...

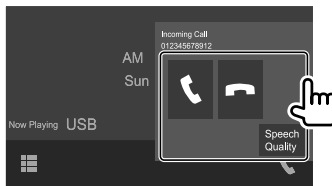

Touching the operation keys performs the following actions:

**[📞]** Answers a call.

**[📞]** Rejects a call.

**[Speech Quality]** Displays the <Speech Quality adjust> screen.

- **Microphone Level:** Adjusts the microphone volume level. (-10 to 10, initial: 0)
- **Echo Cancel Level:** Adjusts the echo volume level. (OFF, -5 to 5, Initial: 0)
- **Noise Reduction Level:** Adjusts the noise reduction volume. (OFF, -5 to 5, Initial: 0)

- Call information is displayed if acquired.
- Phone operation is not available while the picture from the view camera is displayed.

### ■ During a call...

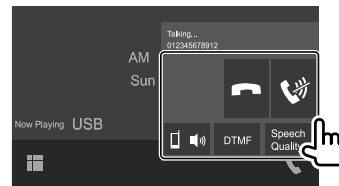

Touching the operation keys performs the following actions:

**[📞]** Ends a call.

**[📞]** Mutes the volume of the microphone.

**[📞/🔊]** / **[📞/🔊]** Switches between hands free mode and phone mode.

**[DTMF]** Enters DTMF (Dual Tone Multi Frequency), then sends text using the keypad.

**[Speech Quality]** Displays the <Speech Quality adjust> screen.

- See the left column for details.

## ■ Making a call

### 1 Display the phone control screen.

On the Home screen, touch as follows:



### 2 Select a method to make a call.

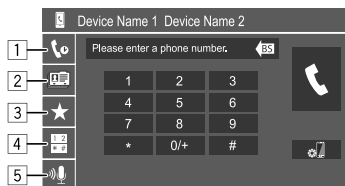

- 1 From the call history\* (missed calls/received calls/dialed calls)
- 2 From the phonebook\*
- 3 From the preset list (Page 31)
- 4 Use direct number entry
- 5 Use voice dialing

### 3 Select a contact to make a call.

Ⓐ When item **1**, **2** or **3** is selected in step 2:

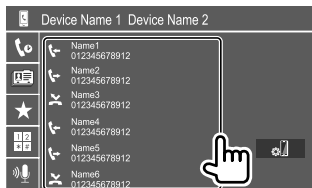

- If the selected contact has several phone numbers, the phone number list is displayed. Select a phone number to make a call.

#### To use alphabet search in the phonebook

- ① Touch [**Q A-Z**].
  - ② Touch the first letter you want to search for on the keypad.
- To search for a number, touch **[1]**.
- ③ Select a contact you want to call from the list.
- You can select a first name or last name to use when sorting the list in alphabetical order on the <TEL SETUP> screen. (Page 32)

Ⓑ When item **4** is selected in step 2:

Enter the phone number (①), then make a call (②).

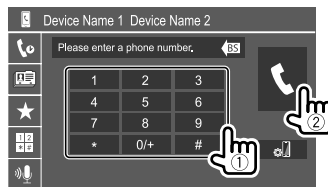

- To enter "+", touch and hold **[0/+]**.
- To clear the last entry, touch **[BS]**.

\* Applicable only for mobile phone compatible with PBAP (Phone Book Access Profile).

Ⓒ When item **5** is selected in step 2:

Say the name of the person you want to call.

- You can also make voice dialing by pressing and holding the **VOICE** on the monitor panel.
- Available only when the connected mobile phone has a voice recognition system.
- If the unit cannot find the target, "Press [Restart] to restart the voice recognition process." appears. Touch **[Restart]**, then say the name again.
- To cancel voice dialing, touch **[Stop]**.

## ■ Switching between two connected devices

You can change the device to use when two devices are connected.

On the phone control screen:



The active device is highlighted.



## ■ Presetting phone numbers

You can preset up to eight phone numbers.

### 1 Display the <Edit Preset Dial> screen.

On the Home screen, touch as follows:



Then, on the phone control screen, touch as follows:

[★] → [Edit]

### 2 Select a position to store into.



### 3 Select a method to add a phone number to preset list and register the number to the preset list (1), then touch [Close] (2).

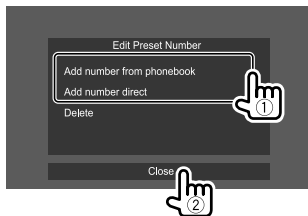

[Add number from phonebook]

Select a phone number from the phonebook.

[Add number direct]

Enter a phone number on the direct number entry screen, then touch [Set] to add to the preset list.

- To display the preset list, touch [★] on the phone control screen.

#### To delete a phone number from the preset list:

Select the phone number to delete on the <Edit Preset Dial> screen, then touch [Delete] in step 3.

#### To delete all phone numbers from the preset list:

Touch [Delete all] on the <Edit Preset Dial> screen in step 2.

## ■ Editing phonebook

### To transfer the phonebook

If the connected Bluetooth mobile phone is compatible with Phone Book Access Profile (PBAP), you can transfer the phonebook of the mobile phone to the unit.

### 1 Display the phone control screen.

On the Home screen, touch as follows:



### 2 Start phonebook data transmission.

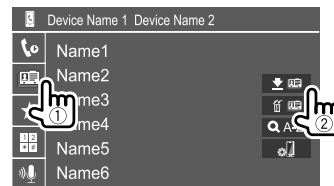

#### To delete contact from the phonebook:

Touch [Delete] in step 2 (2), select devices to delete, then touch [Delete]. A confirmation message appears.

Touch [Yes].

- To select all devices, touch [ All].
- To deselect all selected devices, touch [ All].
- Touch [Q A-Z] to search the contact by initial.

## Bluetooth audio player

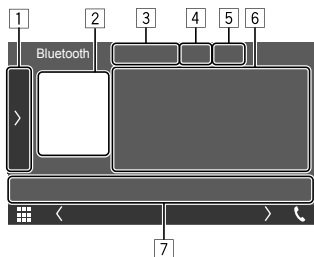

E.g. Bluetooth source control screen for DDX7018BT

- 1 Displays/hides other available operation keys\*1
- 2 Artwork (Shown if the track contains artwork)
- 3 Connected device name
- 4 Repeat/random playback mode keys\*1
- 5 Signal strength and battery level  
(Appears only when the information is acquired from the device.)
- 6 Tag data\*2 (current track title/artist name/album title)
  - Pressing [**<**] scrolls the text if not all of the text is shown.
- 7 Operation keys\*1

\*1 See “Common operation keys on source control screen” on page 10.

\*2 Available only for devices compatible with AVRCP 1.3.

## Playback information and key operation

- For playback information, see “Source control screen” on page 9.
- For key operations on the touch panel, see “Common operation keys on source control screen” on page 10.

Additional keys operations: Touching the operation keys performs the following actions.

**[BT DEVICE CHANGE]** Switches to another Bluetooth audio player.

## Selecting a track from the list

### 1 Display the music list.

On the source control screen, touch as follows:



### 2 Select the folder, then the item in the selected folder.

- For details about the list operation, see page 11.

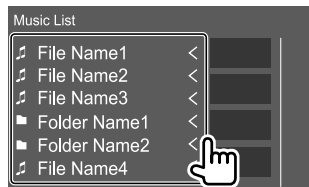

## Bluetooth mobile phone settings

You can change various settings for using Bluetooth mobile phones on the <TEL SETUP> screen.

### 1 Display the <TEL SETUP> screen.

On the Home screen, touch as follows:



Then, on the <SETUP> screen, touch **[Bluetooth]**.

On the <Bluetooth Setup> screen, touch **[TEL SETUP]**.

### 2 Make the settings.

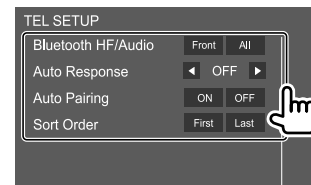

# Settings

## <Bluetooth HF/Audio>

Select the speakers used for Bluetooth mobile phones.

- **Front:** Front speakers only.
- **All (Initial):** All speakers.

## <Auto Response>

- **1 – 30** (in 5 second steps): The unit answers the incoming calls automatically. Set the calling ring time (seconds).
- **OFF (Initial):** The unit does not answer the calls automatically. Answer the calls manually.

## <Auto Pairing>

- **ON (Initial):** Establishes pairing automatically with the iOS device (such as iPhone) connected via USB. (Auto pairing may not work for some devices depending on the iOS version.)
- **OFF:** Cancels.

## <Sort Order>

Select a first name or last name to use when sorting the list in alphabetical order.

- **First:** Sorts the list in the order of first name.
- **Last (Initial):** Sorts the list in the order of last name.

## Audio settings

### 1 Display the <Audio> screen.

On the Home screen, touch as follows:



### 2 Select a setting to change.

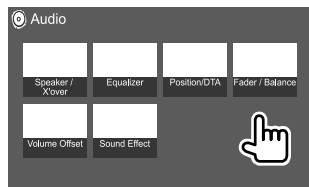

E.g. Audio settings screen for DDX7018BT

You cannot change the <Audio> screen in the following situations:

- When the AV source is turned off
- When the Bluetooth phone is used (making or receiving a call, during a call, or while voice dialing)
- During navigation guidance

## <Speaker/X'over>

### Preparation:

Before making the adjustment for <Speaker/X'over>, select the appropriate crossover network mode according to the speaker system (2-way speaker system or 3-way speaker system).

### 1 Put the unit in standby.

On the Home screen, touch as follows:



Then, on the source/option selection screen, touch [STANDBY].

### 2 Display the <X'over Network> screen.

On the monitor panel, press the following buttons at the same time:



### 3 Select the crossover network mode.

[2way] Select this when 2-way system speakers are used (front/rear).

[3way] Select this when 3-way system speakers are used (tweeter/mid range/woofer).

A confirmation message appears. Touch [Yes].

## Setting the speakers and crossover frequency

- 1 Select a car type (①), select a speaker (②) (front speakers, rear speakers, or subwoofer) to set, then location\* and speaker/tweeter size (③) of the selected speaker.

A selection window appears for each setting. Select an item, then touch **[Close]** to close the window.

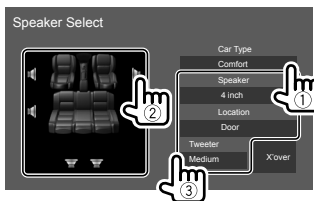

- Repeat steps ② and ③ to set all speakers.
- Adjustable items vary depending on the selected speaker type.
- When a speaker is not connected, select **[None]**.
- When setting the front speakers, also select the speaker size for **<Tweeter>**.

- 2 Touch **[X'over]** to display the **<X'over>** screen.

- 3 Select the speaker type (①), then adjust the crossover frequency (②) of the selected speaker.

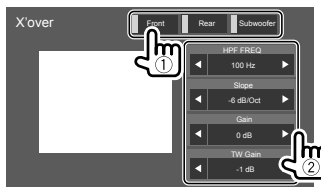

- Adjustable items vary depending on the selected speaker type/speaker size/crossover settings.

### <HPF FREQ>

Adjusts the crossover frequency for the front or rear speakers (high pass filter).

### <LPF FREQ>

Adjusts the crossover frequency for the speaker (low pass filter).

### <Slope>

Adjusts the crossover slope.

### <Gain>

Adjusts the output volume of the selected speaker.

### <TW Gain>

Adjusts the output volume of the tweeter.

### <Phase Inversion>

Selects the phase for the speaker.

\* Speaker location selection is available only when **<X'over Network>** is set to **[2way]**.

## <Equalizer>

The following adjustments are memorized for each source until you adjust the sound again. If the source is a disc, the adjustments are stored for each of the following categories.

- DVD/VCD
- CD
- Audio/video files (Page 53)

You cannot adjust the sound when the unit is in standby.

## Selecting a preset sound mode

- 1 Display the preset sound modes.

[Preset Select]

- 2 Select a preset sound mode.

- **Pops/Easy/Top40/Jazz/Powerful/Rock/Flat (Initial)/iPod/User1/User2/User3/User4**

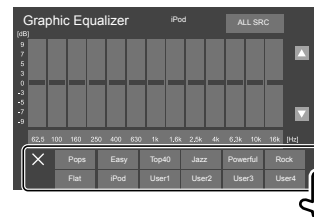

To hide the preset sound modes: Touch **[X]**.

# Settings

## ■ Store your own sound adjustments

- 1 Select a preset sound mode.
- 2 Select a band (①) and adjust the level (②), then adjust the sound (③).

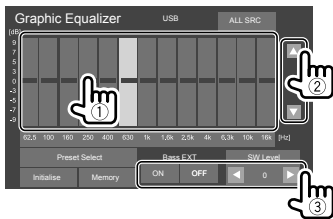

Adjust the sound as follows:

### <Bass EXT>

Activates/deactivates bass.

- ON/OFF (Initial)

### <SW LEVEL>

Adjusts the subwoofer level.\*

- -50 to +10 (Initial: 0)

- 3 Repeat step 2 to adjust the level of other bands.

- 4 Touch [Memory] to store adjustment.

A user selection window appears. Select from [User1] to [User4] to store your adjustment, then touch [Close] to close the window.

- To apply the adjusted equalizer to all playback source, touch [ALL SRC], then touch [OK] to confirm.
- To clear the adjustment, touch [Initialise].

\* Not adjustable when <None> is selected for subwoofer on the <Speaker Select> screen. (Page 34)

## <Position/DTA>

You can adjust the sound effects according to your listening position. You can also localize the sound image in front of the selected seat.

### ■ Setting the listening position

Touch [Listening Position] (①), then select the listening position ([Front L], [Front R], [Front All]\*, or [All]) (②).

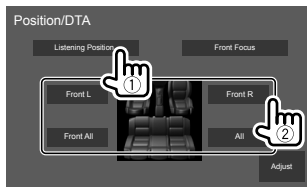

\* [Front All] is selectable only when <X'over Network> is set to [2way].

### ■ Adjusting the Digital Time Alignment (DTA)

Make fine adjustments to the delay time of the speaker output to create a more suitable environment for your car.

- 1 Touch [Adjust] on the <Position/DTA> screen to display the DTA adjustment screen.

- 2 Touch [Delay] (①), then adjust the Digital Time Alignment (DTA) value (②) for each speaker.

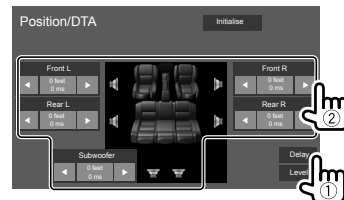

- To determine the adjustment value, see “Determining the value for <Position/DTA> adjustment” on page 36.

- 3 Touch [Level] (①), then adjust the output volume (②) for each speaker.

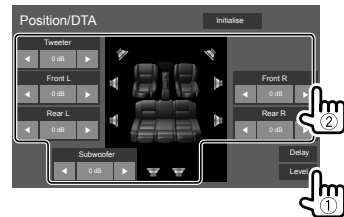

To initialize the setting value: Touch [Initialise].

## Localizing the sound image—Front Focus

- 1 Touch **[Front Focus]** (①), select the listening position (②) to set as the front position, then touch **[Adjust]** (③).

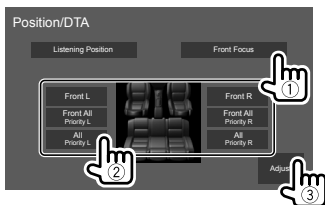

- When you are sitting on the **[Front All]** (front seats) or **[All]** (front and rear seats) position, select left ("Priority L") or right ("Priority R") to specify the position to localize the sound image.

- 2 Touch **[Delay]** (①), then adjust the sound image (②) precisely.

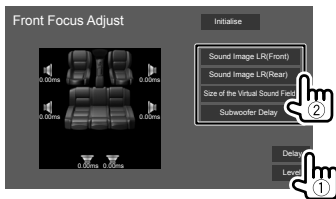

### [Sound Image LR (Front)]

Adjusts the sound image to be localized set on the front position.

### [Sound Image LR (Rear)]

Adjusts the sound image to be localized set on the rear position.

### [Size of the Virtual Sound Field]

Adjusts the virtual sound field to the desired field size.

- If the sound image moves out of the front position, adjust **[Sound Image LR (Front)]**/**[Sound Image LR (Rear)]**.

### [Subwoofer Delay]

Adjusts the delay time of the subwoofer sound.

- 3 Touch **[Level]** (①), then adjust the output volume (②) for each speaker.

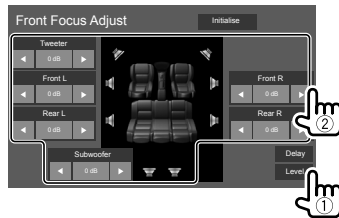

To initialize the setting value: Touch **[Initialise]**.

## Determining the value for <Position/DTA> adjustment

If you specify the distance from the center of the currently set listening position to every speaker, the delay time will be automatically computed and set.

- ① Determine the center of the currently set listening position as the reference point.
- ② Measure the distances from the reference point to the speakers.
- ③ Calculate the differences between the distance of the furthest speaker and other speakers.
- ④ Set the DTA value calculated in step ③ for individual speakers.
- ⑤ Adjust gain for individual speakers.

E.g. When **[Front All]** is selected as the listening position

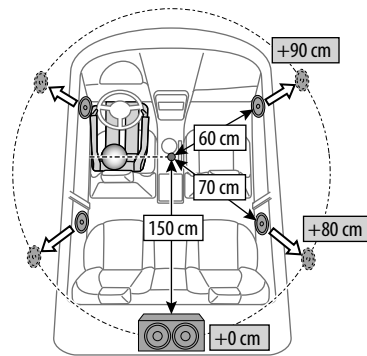

## Settings

### <Fader/Balance>

Touch [▲]/[▼]/[◀]/[▶] or drag the  mark to adjust.

#### <Fader>

Adjusts the front and rear speaker output balance.

When using a two-speaker system, set the fader to the center (0).

- **F15 to R15** (Initial: 0)

#### <Balance>

Adjusts the left and right speaker output balance.

- **L15 to R15** (Initial: 0)

**To clear the adjustment:** Touch [Center].

### <Volume Offset>

Adjust and store the auto-adjustment volume level for each source. The volume level will automatically increase or decrease when you change the source.

If you have increased the volume first, then reduced the volume using the Volume Offset, the sound generated if you suddenly switch to another source may be extremely loud.

- **-5 to +5** (Initial: 0)

**To initialize the setting value:** Touch [Initialise].

### <Sound Effect>

Adjust the sound effect.

#### <Bass Boost>

Selects the bass boost level.

- **OFF** (Initial)/1/2/3

#### <Loudness>

Adjusts loudness. (The LOUD indicator lights up when the loudness is adjusted.)

- **OFF** (Initial)/Low/High

#### <Drive Equalizer>

Reduces the driving noise by raising the bandwidth.

- **OFF** (Initial)/ON

#### <Space Enhancer>\*

Virtually enhances the sound space using the Digital Signal Processor (DSP) system. Select the enhance level.

- **OFF** (Initial)/Small/Medium/Large

#### <Supreme>

Restores the sound lost due to audio compression to a realistic sound.

- **OFF/ON** (Initial)

#### <Realizer>

Virtually makes the sound more realistic using the Digital Signal Processor (DSP) system. Select the sound level.

- **OFF** (Initial)/1/2/3

#### <Stage EQ>

Moves the localization of the sound image to the lower or higher point. Select the height.

- **OFF** (Initial)/Low/Middle/High

\* You cannot change the setting when "Radio" is selected as the source.

## AV settings

### Display the <AV> screen.

On the Home screen, touch as follows:



Then, on the <SETUP> screen, touch [AV].



E.g. Setup screen for DDX7018BT

### <TV Tuner Control>

- **ON:** Enables control of TV operation on "AV-IN".
- **OFF** (Initial): Select this to use "AV-IN" with components other than TV Tuner.

# Settings

## Display settings

### Display the <Display> screen.

On the Home screen, touch as follows:



Then, on the <SETUP> screen, touch [Display].

## <Dimmer>

- **ON:** Activates dimmer.
- **OFF:** Deactivates dimmer.
- **SYNC** (Initial): Dims the screen and button illumination when you turn on the headlights.
  - The ILLUMI lead connection is required.  
(Pages 49 – 50)\*
- **NAV-SYNC:** Activates or deactivates dimmer according to the day/night display setting of the external navigation unit.

## <OSD Clock>

- **ON** (Initial): Displays the clock while a video source is playing.
- **OFF:** Cancels.

\* Only for DDX7018BT/DDX7018BTM/DMX7018BT/DMX7018BTM.

## <Key Color>

You can change the illumination color of the buttons on the monitor panel.

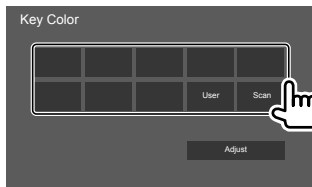

- You can also adjust the illumination color yourself. Touch [Adjust] to display the illumination color adjustment screen, then adjust the color. The adjustment is saved in [User].
- Selecting [Scan] changes the illumination color gradually.

## <Background>

You can change the background design or color.

To change the background design:

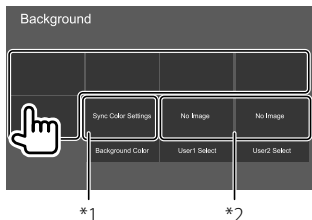

To change the background color: Touch [Background Color], then select the color on the <Background Color> screen.

- You can select same color selected in <Key Color> as the background color by touching [Sync Color Settings].
- If [Scan] is selected in <Key Color>, user cannot select [Sync Color Settings].

\*1 Selects background color in advance.

\*2 Selects a loaded favorite image in advance.

## ■ Storing your favorite image for the background

You can use your favorite image stored on the connected USB device for the background.

- Connect the USB device on which the image is stored beforehand.
- Use a JPEG/PNG/BMP file with a resolution of 800 x 480 pixels.

1 Touch [User1 Select] or [User2 Select] to store the image for the <Background> screen.

2 Select the folder, then the file for the background image in the selected folder.





- 3 Rotate the image (①) if necessary, then confirm the selection (②).

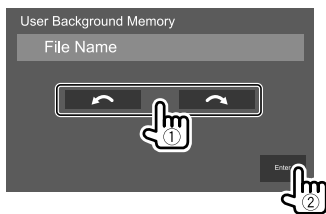

A confirmation message appears. Touch **[Enter]** to store the new image. (The existing image is replaced with the new one.)

## <Viewing Angle>

Select the viewing angle in relation to the monitor to make the image on the screen easier to see.

- 0 (Initial)/-1/-2/-3

## User interface settings

Display the <User Interface> screen.

On the Home screen, touch as follows:



Then, on the <SETUP> screen, touch **[User Interface]**.

## <Steering Remote Controller>

Assign functions to the keys on the remote controller of the steering wheel.

- This function is available only when your car is equipped with the electrical steering remote controller.
- You can only register/change the functions while you are parked.
- If your steering remote controller is not compatible, learning may not be completed and an error message may appear.

- 1 When the unit is ready for learning, press and hold a steering remote controller button for about 2 seconds to register/change.

- Refer to the message displayed to confirm whether the unit ready before proceeding.

- 2 Select a function to assign to the selected button.

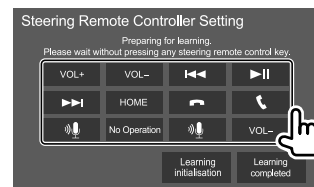

- 3 Repeat steps 1 and 2 to register other functions to other buttons.

- 4 Touch **[Learning completed]** to finish procedure.

A confirmation message appears. Touch **[Yes]**.

- The unit can register/change all of the buttons' functions at the same time. To do this, press all buttons in turn and after pressing all of them, touch **[Learning completed]** in step 2. However, new functions cannot be learned after this operation.
- When changing the functions already learned, touch the assigned function you want to change in step 2 and then touch to select the new function from the function list.
- Confirm the contents of the settable functions in the function list. You cannot edit the function list.

**To initialize the setting:** Touch **[Learning initialisation]** in step 2.

- A confirmation message appears. Touch **[Yes]**.
  - To cancel the initialization, touch **[No]**.

## Settings

### <Beep>\*1

- **ON** (Initial): Activates the key-touch tone.
- **OFF**: Deactivates the key-touch tone.

### <Language Select>

Select the text language used for on-screen information. For details, see "Initial settings" on page 6.

### <Touch Panel Adjust>

(Only for DDX7018BT/DDX7018BTM/DMX7018BT/DMX7018BTM)

Adjust the touch positions of the buttons on the screen.

Touch and hold the center of the marks at the lower left (①), then the upper right (②) as instructed.

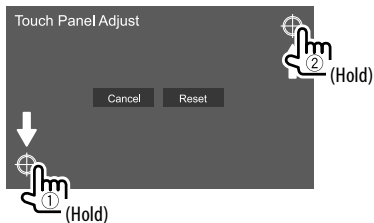

- To reset the touch position, touch **[Reset]**.
- To cancel the current operation, touch **[Cancel]**.

### <Clock>

Select the method to set the date and clock. For details, see "Calendar/clock settings" on page 7.

### <Time Zone>\*2

Select the time zone for your area. For details, see "Calendar/clock settings" on page 7.

### <Clock Adjust>\*2

Adjust the date and clock manually. For details, see "Calendar/clock settings" on page 7.

### <Travel Prayer for Safe Drive>

(Only for DDX7018BTM/DMX7018BTM/DDX718WBTM/DMX718WBTM)

- **ON**: Displays the prayer for driving safety, then plays Quran.
- **OFF** (Initial): Deactivates the function.

### <Travel Prayer for Safe Drive Volume>\*3

(Only for DDX7018BTM/DMX7018BTM/DDX718WBTM/DMX718WBTM)

Adjusts the sound volume of Quran.

\*1 Available only when <X'over Network> is set to [2way].

\*2 Available when [Clock] is set to [Manual].

\*3 Available when [Travel Prayer for Safe Drive] is set to [ON].

## Camera settings

### Display the <Camera> screen.

On the Home screen, touch as follows:

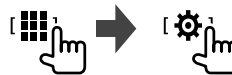

Then, on the <SETUP> screen, touch **[Camera]**.

### <R-CAM Interruption>

- **ON**: Displays the picture from the rear view camera when you shift the gear to the reverse (R) position.
- **OFF** (Initial): Select this when no camera is connected.

### <Parking Guidelines>

- **ON** (Initial): Displays the parking guidelines.
- **OFF**: Hides the parking guidelines.

## Settings

### <Guidelines Setup>

Adjust the parking guidelines according to the size of the car, parking space and so on.

When adjusting the parking guidelines, make sure to use the parking brake to prevent the car from moving.

Touch one of the  marks (①), then adjust the position of the selected  mark (②).

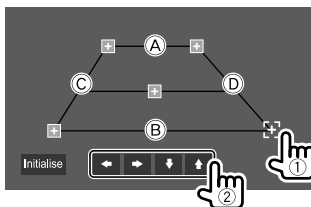

Make sure that (A) and (B) are horizontally parallel, and that (C) and (D) are the same length.

- Touch **[Initialise]** to set all the marks to the initial default position. A confirmation message appears. Touch **[Yes]**.

### <Front Camera>

- **ON**: Select this when a front view camera is connected.
- **OFF (Initial)**: Select this when no camera is connected.

### <Front Camera Mirror Image>

- **ON**: Displays the picture from the front view camera horizontally reversed.
- **OFF (Initial)**: Displays the picture from the front view camera as it is.

### Special system settings

#### Display the <Special> screen.

On the Home screen, touch as follows:



Then, on the <SETUP> screen, touch **[Special]**.

#### <DEMO>

- **ON (Initial)**: Activates the display demonstration.
- **OFF**: Deactivates the display demonstration.

#### <Manual Power Off>

(Only for DDX7018BT/DDX7018BTM/DMX7018BT/DMX7018BTM)

Assign the function of the **HOME** on the monitor panel when pressed and held.

- **AV OFF**: Turns off the screen and audio. The screen and audio restores when receiving call, inputs video signal from the rear view camera, etc.
- **Complete OFF (Initial)**: Turns off the power.

#### <SETUP Memory>

- **Lock**: Locks the <Audio SETUP Memory>/<Audio SETUP Recall>/<Audio SETUP Clear> settings.
  - The items in the <Speaker/X'over> settings cannot be adjusted when **[Lock]** is selected.
- **Unlock**: Unlocks the settings.

#### <Audio SETUP Memory>\*

Memorizes the following audio settings:

- Fader/Balance
  - Speaker/X'over
  - Equalizer (Adjustment on user preset (**[User1]** – **[User4]**)/Subwoofer level adjustment)
  - Position/DTA
  - Sound Effect
- A confirmation message appears. Touch **[Yes]**.

#### <Audio SETUP Recall>\*

Recall the settings memorized by <Audio SETUP Memory>. A confirmation message appears. Touch **[Yes]**.

#### <Audio SETUP Clear>\*

Clear the settings made on the <Audio> screen. A confirmation message appears. Touch **[Yes]**.

#### <Software Information>

Display the information of the software (such as serial number, application version, system version, etc.). You can update the software.

#### <Open Source Licenses>

Show the Open Source Licenses.

#### <Initialise>

Initialize all settings made on the unit. A confirmation message appears. Touch **[Yes]**.

- The settings memorized on the <Audio SETUP Memory> are not initialized.

\* Available only when <SETUP Memory> is set to **[Unlock]**.

## Settings

### Bluetooth settings

#### Display the <Bluetooth> screen.

On the Home screen, touch as follows:



Then, on the <SETUP> screen, touch **[Bluetooth]**.

#### <Bluetooth>

- **ON** (Initial): Activates the Bluetooth function of the unit.
- **OFF**: Deactivates the Bluetooth function of the unit.

#### <Select Device>

Connect or disconnect the paired device. (Page 28)

#### <Device Name>

Display/change the device name to be shown on the Bluetooth device. (Page 29)

#### <PIN Code>

Change the PIN code of the unit. (Page 28)

#### <Device Address>

Display the device address of the unit.

#### <TEL SETUP>

Configure the setting for using a Bluetooth mobile phone. (Page 32)

#### <MIC SETUP>

(Only for DDX7018BT/DMX7018BT Southeast Asian models/DMX7018BT Indonesian models)

Select the microphone to use for Bluetooth mobile phone.

- **Built-in Mic** (Initial): Select this when using built-in microphone.
- **External Mic**: Select this when using the external microphone connected to the MIC terminal.

### Security settings

#### Display the <Security> screen.

On the Home screen, touch as follows:



Then, on the <SETUP> screen, touch **[Security]**.

#### <Security Code Set>

Register the security code for the unit. (Page 6)

#### <Security Code Cancellation>

Clear the security code. (Page 7)

#### <Security Code Change>

Change the security code. (Page 7)

### Navigation settings

#### Display the <Navigation> screen.

On the Home screen, touch as follows:

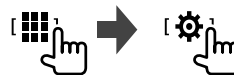

Then, on the <SETUP> screen, touch **[Navigation]**.

#### <NAV Voice Volume>

Adjust the volume of the navigation guidance. (0 to 40, Initial: 24)

# Remote Controller

- For DDX7018BT/DDX7018BTM/DMX7018BT Southeast Asian models/DMX7018BT Indonesian models/DMX7018BTM/DDX718WBT/DDX718WBTM/DMX718WBT Southeast Asian models/DMX718WBT Indonesian models/DMX718WBTM: This unit can be operated using the remote controller (RC-DV340) supplied with this unit.
- For DMX7018BT Australian/New Zealand models/DMX718WBT Australian/New Zealand models: Optional remote controller KNA-RCDV331 is designed for controlling this unit. Refer to the instruction manual that comes with the remote controller.

## ⚠ CAUTION

- Put the remote controller in a place where it will not move during braking or other operations. A dangerous situation could result if the remote controller falls down and gets wedged under the pedals while driving.
- Do not leave the battery near fire or under direct sunlight. A fire, explosion or excessive heat generation may result.
- Do not recharge, short, break up or heat the battery, or place it in an open fire. Such actions may cause the battery to leak fluid. If spilled fluid comes in contact with your eyes or clothing, immediately rinse with water and consult a physician.
- Place the battery out of reach of children. In the unlikely event that a child swallows the battery, immediately consult a physician.

## Preparation

### ■ Battery installation

Use two "AAA"/"R03"-size batteries. Insert the batteries with the + and – poles aligned properly, following the illustration inside the case.

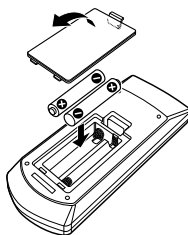

- Always insert batteries from – poles to avoid bending the springs.
- If the remote controller operates only over shorter distances or does not operate at all, it is possible that the batteries are depleted. In such instances, replace both batteries with new ones.

### ■ Remote controller mode switch

The functions operated from the remote controller differ depending on the position of the mode switch.

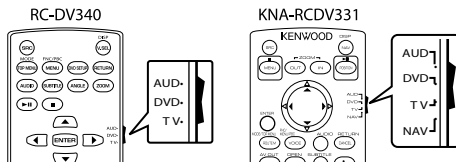

- AUD mode:** Switch to this mode when controlling a selected source or tuner source, etc.
  - When controlling a player that is not integrated in the unit, select "AUD" mode.
- DVD mode:** Switch to this mode when playing DVDs or CDs etc. with the player integrated in this unit.
- TV mode:** Not used.
- NAV mode:** Not used.
- The position of the remote control mode switch is indicated in the title of each mode, e.g., "AUD mode".

## Basic operations for RC-DV340 (supplied)

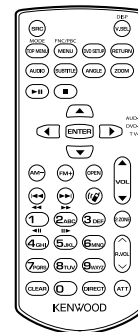

## Remote Controller

### ■ Common operations (AUD mode)

<b>SRC</b>	<ul style="list-style-type: none"><li>• Selects the source.</li><li>• Hangs up the incoming/current call.</li></ul>
<b>▲/▼VOL</b>	Adjusts the volume level.
<b>ATT</b>	Attenuates/restores the sound.
<b>DISP/V.SEL</b>	Switches to the navigation screen.
<b>ENTER</b>	Enters options.
	Answers incoming calls.
<b>FNC/PBC/MENU</b>	Switches the control screen.
<b>MODE/TOP MENU</b>	Changes the aspect ratio. <ul style="list-style-type: none"><li>• The aspect ratio changes each time you press this key.</li></ul>
<b>OPEN</b>	Adjusts the panel angle. <ul style="list-style-type: none"><li>• The panel angle changes each time you press this key.</li></ul>

### ■ DVD/VCD (DVD mode)\*

<b>▲/▼/◀/▶</b>	Moves the cursor when displaying a menu.
<b>◀◀/▶▶</b>	Selects a track.

<b>▶/  </b>	Starts/pauses playback.
<b>■</b>	Stops and memorizes the point where the disc stops.
<b>0 – 9</b>	<ul style="list-style-type: none"><li>• Specifies the number to search for in direct search.</li><li>• <b>1/2</b>: Fast forwards/backwards.<ul style="list-style-type: none"><li>– Fast forward/backward speed changes each time you press this key.</li></ul></li><li>• <b>4/5</b>: Slow forwards/backwards during pause.</li></ul>
<b>MODE/TOP MENU</b>	Shows the disc top menu.
<b>FNC/PBC/MENU</b>	Shows the disc menu.
<b>SUBTITLE</b>	Changes the subtitle language.
<b>ZOOM</b>	Changes the zoom ratio. <ul style="list-style-type: none"><li>• The zoom ratio changes each time you press this key.</li></ul>
<b>ANGLE</b>	Changes the picture angle. <ul style="list-style-type: none"><li>• The picture angle changes each time you press this key.</li></ul>
<b>AUDIO</b>	Changes the voice language. <ul style="list-style-type: none"><li>• The voice language changes each time you press this key.</li></ul>
<b>DIRECT</b>	Enters direct search mode.
<b>CLEAR</b>	Deletes a character while in direct search mode.

\* Only for DDX7018BT/DDX7018BTM/DDX718WBT/DDX718WBTM.

### ■ Music Disc/Audio file/Video file (AUD mode)

<b>AM –/FM +</b>	Selects a folder.
<b>◀◀/▶▶</b>	Selects a track/file.
<b>▶/  </b>	Starts/pauses playback.
<b>0 – 9</b>	Specifies the number to search for in direct search.
<b>DIRECT</b>	Enters direct search mode.

### ■ Radio (AUD mode)

<b>AM –/FM +</b>	Selects the band.
<b>◀◀/▶▶</b>	Searches for stations.*
<b>▶/  </b>	Changes the seek mode (AUTO1, AUTO2, MANUAL).
<b>0 – 9</b>	<ul style="list-style-type: none"><li>• Specifies preset number.</li><li>• Specifies the frequency of the station to receive to search for in direct search.</li></ul>
<b>DIRECT</b>	Enters direct search mode.

\* The search method differs according to the selected seek mode.

## Remote Controller

### ■ iPod/Android (AUD mode)

◀◀/▶▶ Selects music/videos.

▶/|| Starts/pauses playback.

### ■ USB (AUD mode)

AM -/FM + Selects a folder.

◀◀/▶▶ Selects a file.

▶/|| Starts/pauses playback.

### ■ Searching for an item directly

While listening to the radio or during disc playback, you can search for a station frequency/chapter/title/folder/file/track directly using the number buttons.

- To search for a track from the VCD menu, perform during PBC playback.

#### 1 Press DIRECT to enter the search mode.

- Each time you press **DIRECT**, the item to search for changes.

#### 2 Press a number button to select a desired item (station frequency/chapter/title/folder/file/track).

- To erase a misentry, press **CLEAR**.

#### 3 Confirm the selection.

- For station frequency: Press ◀◀/▶▶.
- For others: Press **ENTER**.

To exit the search mode: Press **DIRECT**.

### Basic operations for KNA-RCDV331 (optionally purchased)

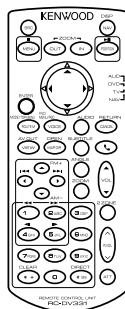

### ■ Common operations (AUD mode)

**SRC**

- Selects the source.
- Hangs up the incoming/current call.

**VOL ▲/▼** Adjusts the volume level.

**ATT** Attenuates/restores the sound.

**VOICE/FNC/ MENU/PBC** For discs/USB/iPod: Switches to the current source control screen.

**ENTER** Enters options.

 Answers incoming calls.

**ROUTE M/ MODE/ TOP MENU** Changes the aspect ratio.  
 • The aspect ratio changes each time you press this key.

**VIEW/AV OUT** Switches the AV source to be output.

**MAP DIR/OPEN** Adjusts the panel angle.  
 • The panel angle changes each time you press this key.

**NAV/DISP** Switches to the navigation screen.

**ZOOM OUT/IN** Not used for this unit.

**2 ZONE** Not used for this unit.

**R.VOL**  Not used for this unit.

### ■ Music Disc/Audio file/Video file (AUD mode)

**▲/FM+ / ▼/AM-** Selects a folder.

**◀/◀◀ / ▶▶/▶** Selects a track/file.

**POSITION/▶||** Starts/pauses playback.

**0 - 9** Specifies the number to search for in direct search.

**# BS/DIRECT** Enters direct search mode.

## Remote Controller

### ■ Radio (AUD mode)

▲/FM+ / ▼/AM- Selects the band.

◀/◀◀ / ▶▶/▶ Selects stations.\*

POSITION/▶▶ II Changes the seek mode (AUTO1, AUTO2, MANUAL).

0 - 9

- Specifies preset number.
- Specifies the frequency of the station to receive to search for in direct search.

# BS/DIRECT Enters direct search mode.

\* The search method differs according to the selected seek mode.

### ■ iPod (AUD mode)

◀/◀◀ / ▶▶/▶ Selects music/videos.

POSITION/▶▶ II Starts/pauses playback.

### ■ USB (AUD mode)

▲/FM+ / ▼/AM- Selects a folder.

◀/◀◀ / ▶▶/▶ Selects a file.

POSITION/▶▶ II Starts/pauses playback.

### ■ Searching for an item directly

While listening to the radio or during disc playback, you can search for a station frequency/chapter/title/folder/file/track directly using the number buttons.

#### 1 Press # BS/DIRECT to enter the search mode.

- Each time you press # BS/DIRECT, the item to search for changes.

#### 2 Press a number button to select a desired item (station frequency/chapter/title/folder/file/track).

- To erase a misentry, press \* +/CLEAR.

#### 3 Confirm the selection.

- For station frequency: Press ◀/◀◀ / ▶▶/▶.
- For others: Press ENTER.

To exit the search mode: Press # BS/DIRECT.

# Installation and Connection

## ⚠ WARNINGS

- DO NOT connect the ignition wire (red) and the battery wire (yellow) to the car chassis (ground), you may cause a short circuit, that in turn may start a fire.
- DO NOT cut out the fuse from the ignition wire (red) and the battery wire (yellow). The power supply must be connected to the wires via the fuse.
- Always connect the ignition wire (red) and the battery wire (yellow) to the power source running through the fuse box.

## ⚠ CAUTIONS

- Install this unit in the console of your car.
- Do not touch the metal parts of this unit during and shortly after the use of the unit. Metal parts such as the heat sink and enclosure become hot.
- When parking at a low ceiling area, turn off the unit to store the antenna. As when the unit is installed in the car with the function of auto antenna; the radio antenna extends automatically when you turn on the unit with the antenna control wire (ANT. CONT) connected. (Pages 49 - 50)

## Before installation

### ■ Precautions on installation and connection

- Mounting and wiring this product requires skills and experience. For best safety, leave the mounting and wiring work to professionals.
- Mount the unit so that the mounting angle is 30° or less.



## Installation and Connection

- Make sure to ground the unit to a negative 12 V DC power supply.
- Do not install the unit in a location exposed to direct sunlight or excessive heat or humidity. Also avoid places with too much dust or the possibility of water splashing.
- Do not use your own screws. Use only the screws provided. If you use the wrong screws, you could damage the unit.
- After the unit is installed, check whether the brake lamps, blinkers, wipers, etc. on the car are working properly.
- Do not press hard on the panel surface when installing the unit to the car. Otherwise scratches, damage, or failure may result.
- If the power is not turned on ("Miswiring DC Offset Error", "Warning DC Offset Error" is displayed), the speaker wire may have a short circuit or have touched the chassis of the car and the protection function may have been activated. In this case, the speaker wire should be checked.
- Keep all cables away from heat dissipating metal parts.
- If your car's ignition does not have an ACC position, connect the ignition wires to a power source that can be turned on and off with the ignition key. If you connect the ignition wire to a power source with a constant voltage supply, such as with battery wires, the battery may be drained.
- If the console has a lid, make sure to install the unit so that the monitor panel will not hit the lid when closing and opening.
- If the fuse blows, first make sure the wires are not touching to cause a short circuit, then replace the old fuse with one with the same rating.
- Insulate unconnected wires with vinyl tape or other similar material. To prevent a short circuit, do not remove the caps and do not let the cable out at the ends of the unconnected wires or the terminals.
- Secure the wires with cable clamps and wrap vinyl tape around the wires that comes into contact with metal parts to protect the wires and to prevent short circuit.
- Connect the speaker wires correctly to the terminals to which they correspond. The unit may be damaged or fail to work if you share the ⊖ wires or ground them to any metal part in the car.
- When only two speakers are being connected to the system, connect both connectors either to the front output terminals or to the rear output terminals (do not mix front and rear). For example, if you connect the ⊕ connector of the left speaker to a front output terminal, do not connect the ⊖ connector to a rear output terminal.

### Parts list for installation

**Note:** This parts list does not include all the package contents.

- 1 Wiring harness (× 1)
- 2 Extension parking cable, 2 m (× 1)
- 3 Round head screws, M5 × 8 mm (× 6)
- 4 Steering wheel remote input cable (× 1)

Only for DDX7018BT/DDX7018BTM/DMX7018BT/DMX7018BTM

- 5 Flat head screws, M5 × 8 mm (× 6)

Only for DMX7018BT Australian/New Zealand models

- 6 Trim plate (× 1)

Only for DDX7018BTM/DMX7018BT Australian/New Zealand models/DMX7018BTM/DDX718WBT/DDX718WBTM/DMX718WBT/DMX718WBTM

- 7 Microphone, 3 m (× 1)

### Installation procedure

**1 Remove the key from the ignition and disconnect the ⊖ battery.**

**2 Make the proper input and output wire connections for each unit.**

**3 Connect the speaker wires of the wiring harness.**

**4 Connect the wires of the wiring harness in the following order: ground, battery, ignition.**

**5 Connect the wiring harness to the unit.**

**6 Install the unit in your car.**

Make sure that the unit is installed securely in place. If the unit is unstable, it may malfunction (e.g., the sound may skip).

**7 Reconnect the ⊖ battery.**

**8 Configure <Initial Settings>. (Page 6)**

# Installation and Connection

## Installing the unit

### ■ Installing the unit using the mounting bracket removed from the car

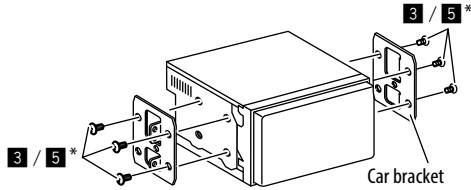

**Note:** Select the appropriate screws (supplied) for the mounting bracket.

\* Only for DDX7018BT/DDX7018BTM/DMX7018BT/DMX7018BTM.

### ■ Installing the trim plate

(Only for DMX7018BT Australian/New Zealand models)

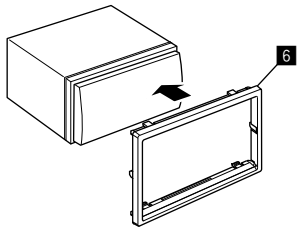

## Connecting external components

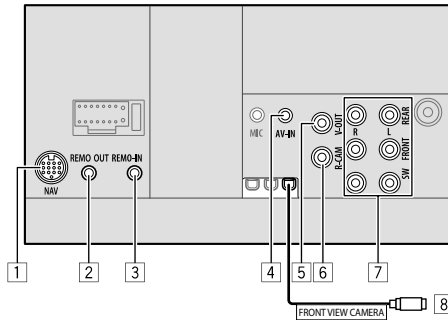

- 1 Navigation input (NAV)
- 2 TV tuner remote control output (REMO OUT)
- 3 Steering wheel remote controller input (REMO-IN)
  - Connect to the car's steering remote harness using the steering wheel remote input cable (4).
  - Contact your KENWOOD dealer for details.
- 4 Audio video input (AV-IN)
- 5 Video output (V-OUT)
- 6 Rear view camera input (R-CAM)

- 7 Output terminals\*1
    - Left output (White)
    - Right output (Red)
- REAR: Rear speaker preouts  
FRONT: Front speaker preouts  
SW: Subwoofer preouts

### For 3-way crossover:

REAR: Tweeter preouts  
FRONT: Mid range speaker preouts  
SW: Woofer preouts

- 8 Front view camera input (FRONT VIEW CAMERA)\*2

- \*1 When connecting an external amplifier, connect its ground wire to the chassis of the car; otherwise the unit may be damaged.
- \*2 Cable position differs according to the models.

# Installation and Connection

## Wiring connection

For DDX7018BT/DDX7018BTM

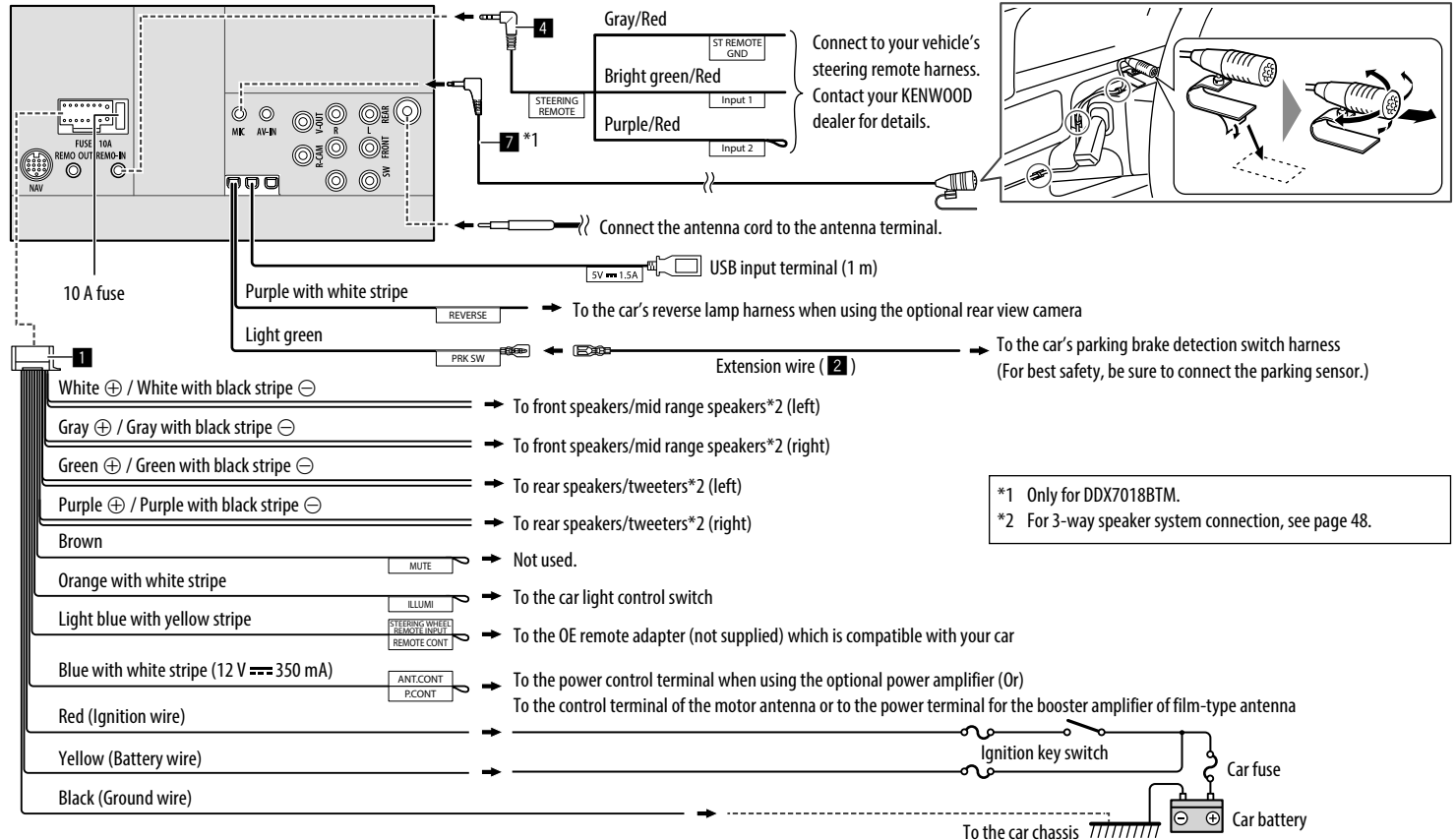

# Installation and Connection

For DMX7018BT/DMX7018BTM

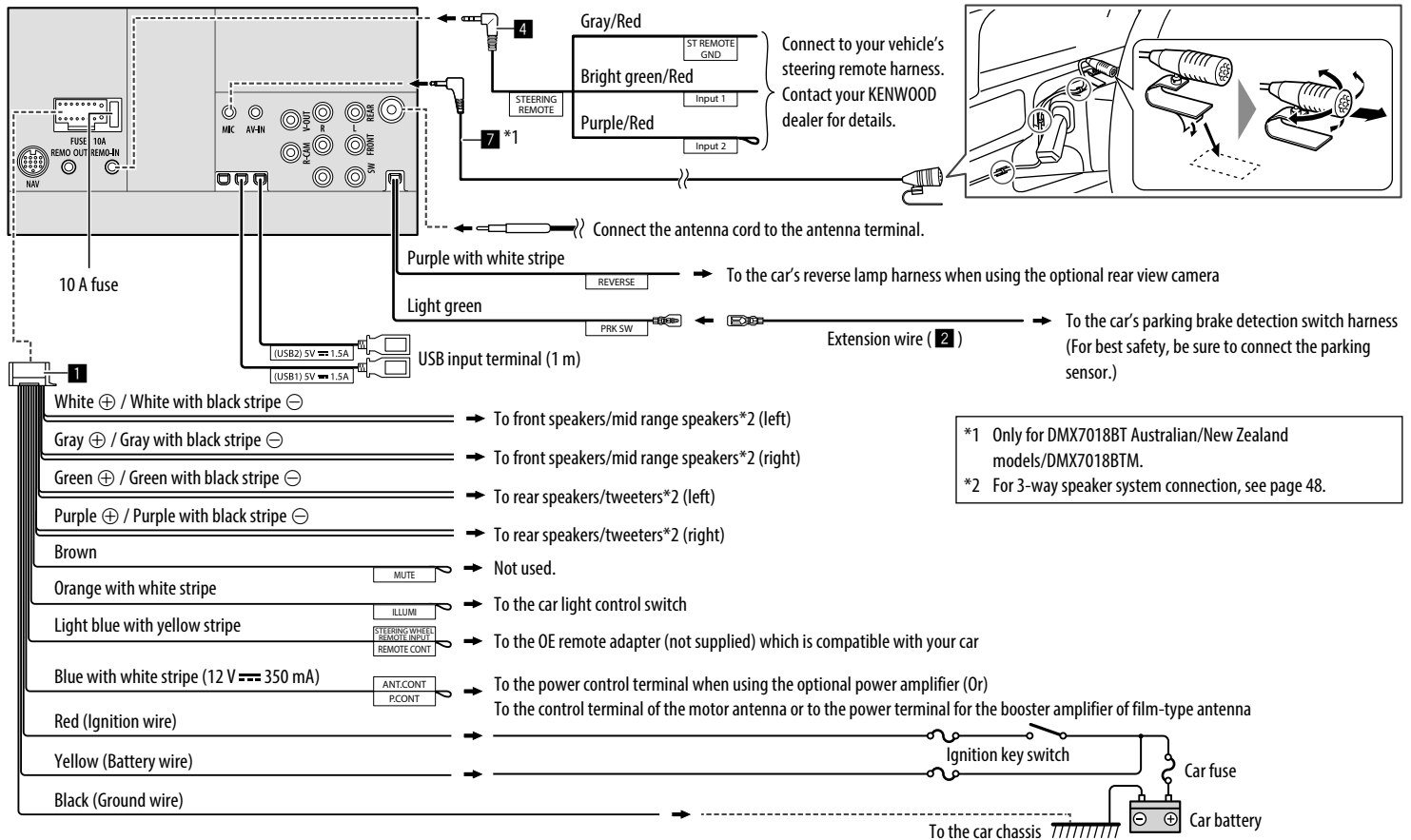

\*1 Only for DMX7018BT Australian/New Zealand models/DMX7018BTM.  
\*2 For 3-way speaker system connection, see page 48.

# Installation and Connection

For DDX718WBT/DDX718WBTM

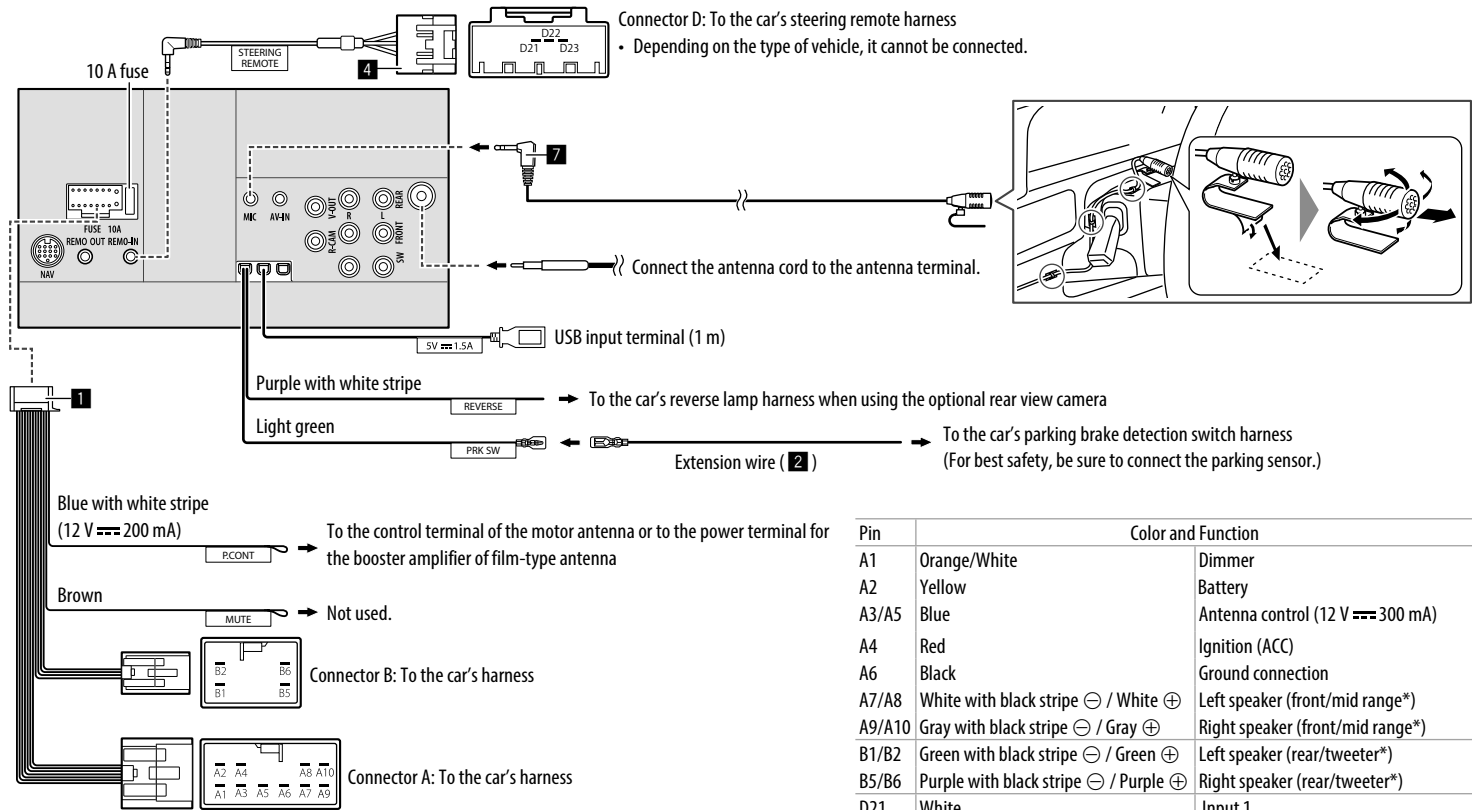

Pin	Color and Function	Color and Function
A1	Orange/White	Dimmer
A2	Yellow	Battery
A3/A5	Blue	Antenna control (12 V $\approx$ 300 mA)
A4	Red	Ignition (ACC)
A6	Black	Ground connection
A7/A8	White with black stripe ⊖ / White ⊕	Left speaker (front/mid range*)
A9/A10	Gray with black stripe ⊖ / Gray ⊕	Right speaker (front/mid range*)
B1/B2	Green with black stripe ⊖ / Green ⊕	Left speaker (rear/tweeter*)
B5/B6	Purple with black stripe ⊖ / Purple ⊕	Right speaker (rear/tweeter*)
D21	White	Input 1
D22	Red	Input 2
D23	Black	Ground

\* For 3-way speaker system connection, see page 48.

# Installation and Connection

For DMX718WBT/DMX718WBTM

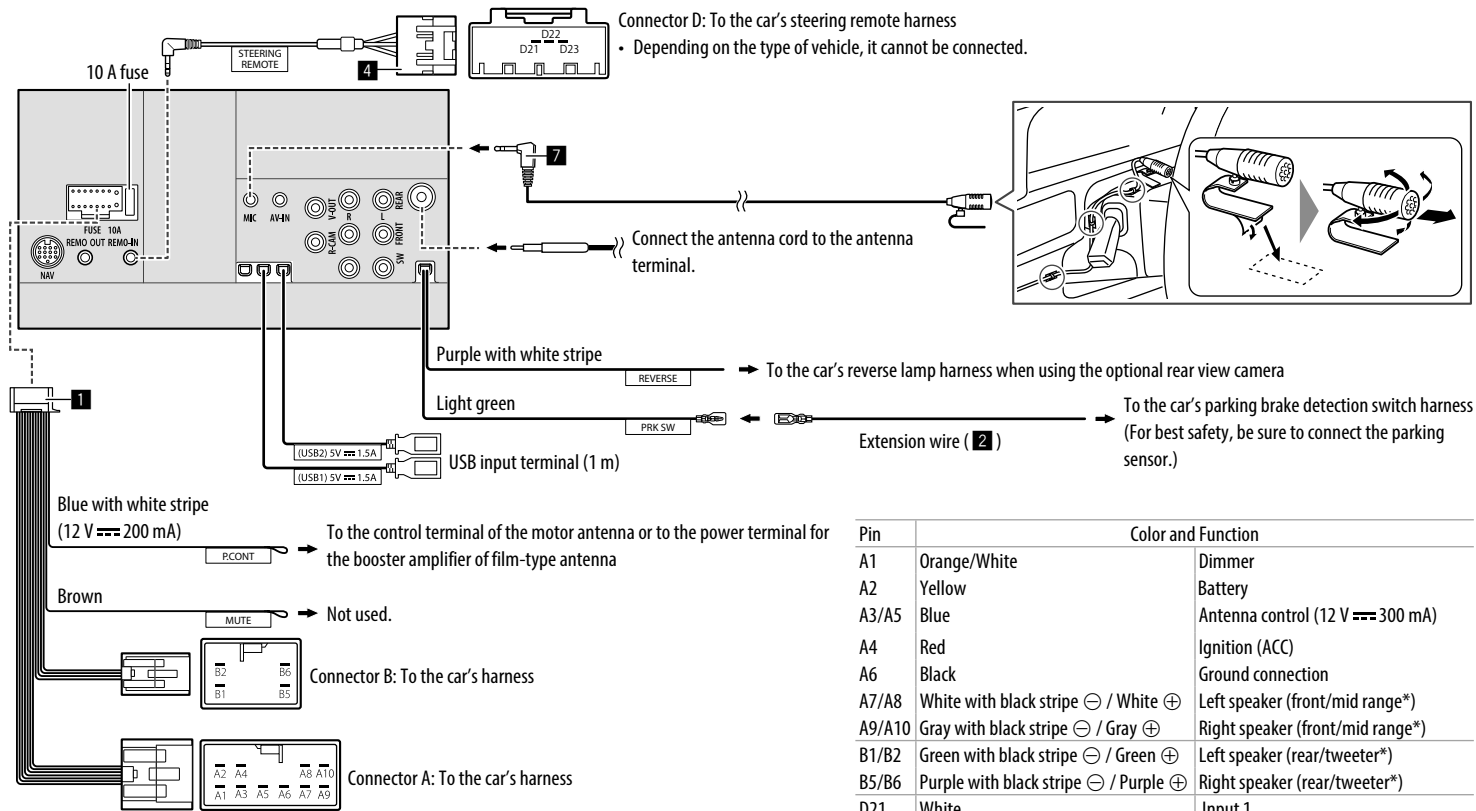

Pin	Color and Function	Color and Function
A1	Orange/White	Dimmer
A2	Yellow	Battery
A3/A5	Blue	Antenna control (12 V $\approx$ 300 mA)
A4	Red	Ignition (ACC)
A6	Black	Ground connection
A7/A8	White with black stripe ⊖ / White ⊕	Left speaker (front/mid range*)
A9/A10	Gray with black stripe ⊖ / Gray ⊕	Right speaker (front/mid range*)
B1/B2	Green with black stripe ⊖ / Green ⊕	Left speaker (rear/tweeter*)
B5/B6	Purple with black stripe ⊖ / Purple ⊕	Right speaker (rear/tweeter*)
D21	White	Input 1
D22	Red	Input 2
D23	Black	Ground

\* For 3-way speaker system connection, see page 48.

# References

## Maintenance

### Cleaning the unit

- Do not use any solvent (for example, thinner, benzene, etc.), detergent, or insecticide. This may damage the monitor or the unit.
- Gently wipe the panel with a soft, dry cloth.

### Handling discs

- Do not touch the recording surface of the disc.
- Do not stick tape etc. on the disc, or use a disc with tape stuck on it.
- Do not use any accessories for the disc.
- Clean from the center of the disc and move outward.
- Clean the disc with a dry silicone or soft cloth. Do not use any solvents.
- When removing discs from this unit, pull them out horizontally.
- Remove burrs from the center hole and disc edge before inserting a disc.

## More information

### About playable files

#### Audio files

- This unit can play back the following files with following codec and extension code:
  - For disc: MP3 (.mp3), WMA (.wma), WAV (.wav), AAC (.m4a)
  - For USB mass storage class device: MP3 (.mp3), WMA (.wma), WAV (.wav), AAC (.m4a), FLAC (.flac)

- This unit can play back files that meet the conditions below:
  - Bit Rate:
    - For disc:
      - MP3: 8 kbps – 320 kbps
      - WMA: 5 kbps – 320 kbps
      - AAC: 16 kbps – 320 kbps
    - For USB:
      - MP3/WMA/AAC: 8 kbps – 320 kbps
  - Sampling Frequency:
    - For disc:
      - MP3/AAC: 32 kHz, 44.1 kHz, 48 kHz
      - WMA: 8 kHz, 11.025 kHz, 16 kHz, 22.05 kHz, 32 kHz, 44.1 kHz, 48 kHz
    - WAV: 44.1 kHz
    - For USB:
      - MP3/WMA/AAC: 16 kHz – 48 kHz
      - WAV/FLAC: 16 kHz – 96 kHz
  - Files recorded in VBR (variable bit rate), and have a discrepancy in elapsed time indication
- This unit can show or display the following:
  - Tag:
    - MP3: ID3 Tag (version 1.0/1.1/2.2/2.3/2.4)
    - WMA Tag
    - WAV Tag
    - AAC Tag
    - FLAC Tag
  - Jacket picture:
    - Picture size: 32 × 32 to 1 232 × 672 resolution
    - Data size: less than 500 KB
    - File type: JPEG/PNG/BMP

- This unit cannot play back the following files:
  - MP3 files encoded with MP3i and MP3 PRO format.
  - MP3 files encoded with Layer 1/2.
  - WMA files encoded with lossless, professional, and voice format.
  - WMA files which are not based upon Windows Media® Audio.
  - WMA/AAC files copy-protected with DRM.
  - AAC files copy-protected with FairPlay (except those stored on an iPod/iPhone).
  - Files which have data such as AIFF, ATRAC3, etc.

#### Video files

- This unit can play back the following files with following codec and extension code:
  - For disc: MPEG1/MPEG2 (.mpg, .mpeg)
  - For USB mass storage class device: MPEG1/MPEG2 (.mpg, .mpeg), MPEG4 (.mp4, .m4v), H.264 (.mp4, .m4v, .avi, flv, f4v), WMV (.wmv), MKV (.mkv)
- Streams that conform to:
  - Audio: MP3 or Dolby Audio
  - MPEG1/MPEG2:
    - Audio: MPEG1 Audio Layer-2 or Dolby Audio
    - Video: MPEG system/program stream
- Other playable conditions:
  - MPEG1/MPEG2: File format: MP@ML (Main Profile at Main Level)/SP@ML (Simple Profile at Main Level)/MP@LL (Main Profile at Low Level)
  - Video output format: NTSC (by default)
- This unit can playback a file with the size less than 4 GB.

## References

### About disc playback

#### Playable disc types

- CD-DA: Audio CD
- DVD Video: Region code: 2 or 3 (depending on the country and sales area)
- Dual Disc: DVD side
- VCD: Video CD (PBC compatible)
- DVD Recordable/Rewritable (DVD-R/-RW, +R/+RW)
  - DVD Video: UDF bridge
  - ISO 9660 level 1, level 2, Romeo, Joliet
  - Other playable formats:
    - DVD-R recorded in multi-border format (except for dual layer discs)
    - Finalized +R/+RW (Video format only)
- CD Recordable/Rewritable (CD-R/-RW):
  - ISO 9660 level 1, level 2, Romeo, Joliet
- Other informations:
  - While playing a DVD Video, DTS sound cannot be reproduced or emitted from this unit.
  - This unit can recognize a total of 5 000 files and 250 folders (a maximum of 999 files per folder) in a recordable/rewritable disc.
  - Use only “finalized” recordable/rewritable discs.
  - This unit can play back multi-session recordable/rewritable discs; however, unclosed sessions will be skipped while playing.

#### Unplayable disc types and formats

- DVD-Audio/DVD-ROM discs
- SVCD (Super Video CD), CD Text, CD-ROM, CD-I (CD-I Ready), DTS-CD
- JPEG/PNG/BMP/MPEG4/DivX/FLAC/MKV/H.264/WMV/DVD–VR/DVD+VR/DVD-RAM recorded on DVD–R/-RW or +R/+RW
- JPEG/PNG/BMP/MPEG4/DivX/FLAC/MKV/H.264/WMV recorded on CD–R/-RW
- DVD–RW dual layer discs
- +RW double layer discs
- Non-DVD side of a “DualDisc” which does not comply with the “Compact Disc Digital Audio” standard
- Discs that are not round.
- Discs with coloring on the recording surface or discs that are dirty.
- Recordable/Rewritable discs that have not been finalized.
- 3 inch discs. Attempting to insert these discs using an adapter may cause a malfunction.
- Some recordable/rewritable discs or files may not be played back due to their characteristics or recording conditions.

#### Language codes (for DVD language selection)

AA	Afar	GD	Scots Gaelic
AB	Abkhazian	GL	Galician
AF	Afrikaans	GN	Guarani
AM	Ameharic	GU	Gujarati
AR	Arabic	HA	Hausa
AS	Assamese	HI	Hindi
AY	Aymara	HR	Croatian
AZ	Azerbaijani	HU	Hungarian
BA	Bashkir	HY	Armenian
BE	Byelorussian	IA	Interlingua
BG	Bulgarian	IE	Interlingue
BH	Bihari	IK	Inupiak
BI	Bislama	IN	Indonesian
BN	Bengali, Bangla	IS	Icelandic
BO	Tibetan	IW	Hebrew
BR	Breton	JA	Japanese
CA	Catalan	JI	Yiddish
CO	Corsican	JW	Javanese
CS	Czech	KA	Georgian
CY	Welsh	KK	Kazakh
DZ	Bhutani	KL	Greenlandic
EL	Greek	KM	Cambodian
EO	Esperanto	KN	Kannada
ET	Estonian	KO	Korean (KOR)
EU	Basque	KS	Kashmiri
FA	Persian	KU	Kurdish
FI	Finnish	KY	Kirghiz
FJ	Fiji	LA	Latin
FO	Faroese	LN	Lingala
FY	Frisian	LO	Laothian
GA	Irish	LT	Lithuanian



## References

LV	Latvian, Lettish	SM	Samoan
MG	Malagasy	SN	Shona
MI	Maori	SO	Somali
MK	Macedonian	SQ	Albanian
ML	Malayalam	SR	Serbian
MN	Mongolian	SS	Siswati
MO	Moldavian	ST	Sesotho
MR	Marathi	SU	Sundanese
MS	Malay (MAY)	SW	Swahili
MT	Maltese	TA	Tamil
MY	Burmese	TE	Telugu
NA	Nauru	TG	Tajik
NE	Nepali	TH	Thai
NO	Norwegian	TI	Tigrinya
OC	Occitan	TK	Turkmen
OM	(Afan) Oromo	TL	Tagalog
OR	Oriya	TN	Setswana
PA	Panjabi	TO	Tonga
PL	Polish	TR	Turkish
PS	Pashto, Pushto	TS	Tsonga
QU	Quechua	TT	Tatar
RM	Rhaeto-Romance	TW	Twi
RN	Kirundi	UK	Ukrainian
RO	Rumanian	UR	Urdu
RW	Kinyarwanda	UZ	Uzbek
SA	Sanskrit	VI	Vietnamese
SD	Sindhi	VO	Volapuk
SG	Sangho	WO	Wolof
SH	Serbo-Croatian	XH	Xhosa
SI	Singhalese	YO	Yoruba
SK	Slovak	ZU	Zulu
SL	Slovenian		

### About USB playback

#### Important

Make sure all important data has been backed up to avoid losing the data.  
We bear no responsibility for any loss of data stored in the devices while using this unit.

#### Playable files on a USB device

- This unit can play the following types of files stored in a USB mass storage class device.
  - MPEG1/MPEG2/MPEG4/H.264/WMV/MKV/MP3/WMA/WAV/AAC (.m4a)/FLAC
- This unit can recognize:
  - A total of 5 000 files
  - 250 folders for video files and a maximum of 9 999 files per folder
  - 250 folders for photo files and a maximum of 9 999 files per folder
  - 9 999 folders for audio files and a maximum of 1 000 files per folder
- The maximum number of characters (when the characters are 1 byte):
  - Folder names: 50 characters
  - File names: 50 characters

#### Notes on using a USB device

- Avoid using the USB device if it might affect driving safety.
- When connecting with a USB cable, use a USB 2.0 cable.

- Electrostatic shock at connecting a USB device may cause abnormal playback of the device. In this case, disconnect the USB device then reset this unit and the USB device.
- Do not pull out and connect the USB device repeatedly while “Reading” is shown on the screen.
- Operation and power supply may not work as intended for some USB devices.
- Do not leave a USB device in the car, or expose to direct sunlight or high temperatures to prevent deformation or damage to the device.

#### Unplayable USB device

- This unit may not play back files in a USB device properly when using a USB extension cable.
- USB devices equipped with special functions such as data security functions cannot be used with the unit.
- Do not use a USB device with 2 or more partitions.
- Depending on the shape of the USB devices and connection ports, some USB devices may not be attached properly or the connection might be loose.
- This unit may not recognize a memory card inserted into a USB card reader.

### About iPod/iPhone

#### Important

Make sure all important data has been backed up to avoid losing the data.  
We bear no responsibility for any loss of data stored in the devices while using this unit.

## References

### iPod/iPhone that can be connected

- Made for
  - iPod nano (7th Generation)\*
  - iPod touch (6th Generation)
  - iPod touch (5th Generation)
  - iPhone 7 Plus
  - iPhone 7
  - iPhone SE
  - iPhone 6S Plus
  - iPhone 6S
  - iPhone 6 Plus
  - iPhone 6
  - iPhone 5S
  - iPhone 5C
  - iPhone 5

\* Available only when connecting via USB input terminal.

### Notes on using an iPod/iPhone

- When operating an iPod/iPhone, some operations may not be performed correctly or as intended. In this case, visit the following KENWOOD web site: <[www.kenwood.com/cs/ce/](http://www.kenwood.com/cs/ce/)>
- When you turn on this unit, the iPod/iPhone is charged through the unit.
- The text information may not be displayed correctly.
- For some iPod/iPhone models, the performance may be abnormal or unstable during operation. In this case, disconnect the iPod/iPhone device, then check its condition.  
If the performance is not improved or slow, reset your iPod/iPhone.

## Troubleshooting

What appears to be trouble is not always serious. Check the following points before calling a service center.

- For operations with external components, refer also to the instructions supplied with the adapters used for connection (as well as the instructions supplied with the external components).

### General

#### No sound comes out of the speakers.

- Adjust the volume to the optimum level.
- Check the cords and connections.

#### No picture is displayed on the screen.

- Turn on the screen. (Page 4)

#### The remote controller\* does not work.

- Replace the battery.

\* For DMX7018BT Australian/New Zealand models/DMX718WBT Australian/New Zealand models: Purchase optional remote controller, KNA-RCDV331.

#### “No Signal”/“No Video Signal” appears.

- Start playback on the external component connected to the AV-IN input terminal.
- Check the cords and connections.
- Signal input is too weak.

#### “Miswiring DC Offset Error”/“Warning DC Offset Error” appears.

- A speaker cord has shorted or it has come into contact with the car chassis. Wire or insulate the speaker cord as appropriate, then reset the unit.

#### “Parking off” appears.

- No playback picture is shown when the parking brake is not engaged.

#### “Learning Process Failed” appears.

- Your steering remote controller is not compatible, learning may not be completed. Consult your car audio dealer for details.

#### “Panel Mecha Error” appears:

- The panel does not work properly. Turn off and on the unit.

### Discs

(Only for DDX7018BT/DDX7018BTM/DDX718WBT/DDX718WBTM)

#### Recordable/Rewritable discs cannot be played back.

- Insert a finalized disc.
- Finalize the discs with the component which you used for recording.

#### Tracks on the Recordable/Rewritable discs cannot be skipped.

- Insert a finalized disc.
- Finalize the discs with the component which you used for recording.

#### Playback does not start.

- The format of files is not supported by the unit.

#### No picture appears on the external monitor.

- Connect the video cord correctly.
- Select the correct input on the external monitor.

#### MPEG1/MPEG2/MP3/WMA/WAV/AAC discs cannot be played back.

- Record the tracks using a compatible application on the appropriate discs. (Page 54)
- Add appropriate extension codes to the file names.

## Troubleshooting

---

**Tracks on the recordable/rewritable discs are not played back as you have intended them to play.**

→ Playback order may differ from the one played back using other players.

**“Region Code Error” appears.**

→ You have inserted a DVD Video disc of an incorrect region code. Insert a correct region code disc.

### USB

---

**“Reading” does not disappear from the screen.**

→ Turn the power off and on again.

**While playing a track, sound is sometimes interrupted.**

→ The tracks are not properly copied into the USB device. Copy the tracks again, and try again.

**Tracks are not played back as you have intended them to play.**

→ Playback order may differ from the one played back using other players.

**The source does not change to “USB” when you connect a USB device while listening to another source or “USB Device Error” appears when you connect a USB device.**

→ The USB port is drawing more power than the design limit.

→ Turn the power off and unplug the USB device. Then, turn on the power and reattach the USB device.

→ If the above does not solve the problem, turn the power off and on (or reset the unit) before replacing with another USB device.

### iPod/iPhone

---

**No sound comes out of the speakers.**

→ Disconnect the iPod/iPhone, then connect it again.

→ Select another source, then reselect “iPod”.

**The iPod/iPhone does not turn on or does not work.**

→ Check the connection.

→ Update the firmware version.

→ Charge the battery.

→ Reset the iPod/iPhone.

**Sound is distorted.**

→ Deactivate the equalizer either on this unit or the iPod/iPhone.

**A lot of noise is generated.**

→ Turn off (uncheck) “VoiceOver” on the iPod/ iPhone. For details, visit <<http://www.apple.com>>.

**No operations are available when playing back a track containing artwork.**

→ Operate the unit after the artwork has loaded.

**“Authorization Error” appears.**

→ Check whether the connected iPod/iPhone is compatible with this unit. (Page 56)

### WebLink™

---

**WebLink™ cannot be started.**

→ Check whether the latest version of WebLink™ App is installed on the connected smartphone.

→ Check the connection.

→ Charge the battery.

→ Reset the smartphone.

→ Reconnect your smartphone.

### Radio

---

**AME automatic presetting does not work.**

→ Store stations manually. (Page 20)

**Static noise while listening to the radio.**

→ Connect the antenna firmly.

### AV-IN

---

**No picture appears on the screen.**

→ Turn on the video component if it is not on.

→ Connect the video component correctly.

### Navigation

---

**“No Navigation” appears.**

→ No navigation unit is connected.

## Troubleshooting

### Spotify

#### **“Check App” appears.**

- The Spotify application on the connected device has not started up.
- The Spotify application is not installed on the connected device.
- Reconnect your smartphone.
- Restart Spotify application.

#### **“Please login or sign up.” appears.**

- You have not been signed into Spotify.

#### **“Please check internet connection.” appears.**

- Check the internet connection.

#### **“Unable to start Spotify.” appears.**

- Restart Spotify application.
- Spotify application cannot be started or played in current condition.

#### **“Please update the Spotify app on the phone.” appears.**

- The Spotify application on the connected device is not the latest version. Update the application.

### Bluetooth

#### **Phone sound quality is poor.**

- Reduce the distance between the unit and the Bluetooth mobile phone.
- Move the car to a place where you can get a better signal reception.

#### **The sound is interrupted or skipped while using a Bluetooth audio player.**

- Reduce the distance between the unit and the Bluetooth audio player. Disconnect the device connected for Bluetooth phone.
- Turn off, then turn on the unit.  
(When the sound is not yet restored) connect the player again.

#### **The connected audio player cannot be controlled.**

- Check whether the connected audio player supports AVRCP (Audio/Video Remote Control Profile).

#### **The Bluetooth device does not detect the unit.**

- Search from the Bluetooth device again.

#### **The unit does not pair with the Bluetooth device.**

- For devices compatible with Bluetooth 2.1:  
Register the device using a PIN code. (Page 27)
- For devices compatible with Bluetooth 2.0:  
Enter the same PIN code for both the unit and target device. If the PIN code of the device is not indicated in its instructions, try “0000” or “1234.”
- Turn off, then turn on the Bluetooth device.

#### **Echo or noise occurs.**

- Adjust the microphone unit position.
- Adjust the echo volume or noise reduction volume. (Page 29)

#### **Microphone does not work.**

- Check the [MIC SETUP] setting. (Page 42)

#### **The unit does not respond when you try to copy the phonebook to the unit.**

- You may have tried to copy the same entries (as stored) to the unit.

#### **“Connection Error” appears.**

- The device is registered but the connection has failed. Connect the registered device. (Page 28)

#### **“Please Wait...” appears.**

- The unit is preparing to use the Bluetooth function. If the message does not disappear, turn off and turn on the unit, then connect the device again (or reset the unit).

#### **“No Voice Device” appears.**

- The connected mobile phone does not have a voice recognition system.

#### **“No Data” appears.**

- No phonebook data is contained in the connected Bluetooth phone.

#### **“Initialise Error” appears.**

- The unit has failed to initialize the Bluetooth module. Try the operation again.

#### **“Dial Error” appears.**

- Dialing has failed. Try the operation again.

#### **“Hung Up Error” appears.**

- The call has not ended yet. Park your car, and use the connected mobile phone to end the call.

#### **“Pick Up Error” appears.**

- The unit has failed to receive a call.

# Specifications

## ■ Monitor section

Picture Size (W × H)	6.95 inches (diagonal) wide 156.6 mm × 81.6 mm
Display System	Transparent TN LCD panel
Drive System	TFT active matrix system
Number of Pixels	1 152 000 (800H × 480V × RGB)
Effective Pixels	99.99%
Pixel Arrangement	RGB striped arrangement
Back Lighting	LED

## ■ DVD player section

(Only for DDX7018BT/DDX7018BTM/  
DDX718WBT/DDX718WBTM)

D/A Converter	24 bit
Audio Decoder	Linear PCM/Dolby Audio/MP3/ WMA/WAV/AAC (.m4a)
Video Decoder	MPEG1/MPEG2
Wow & Flutter	Below Measurable Limit
Frequency Response	96 kHz Sampling: 20 Hz to 20 000 Hz 48 kHz Sampling: 20 Hz to 20 000 Hz 44.1 kHz Sampling: 20 Hz to 20 000 Hz
Total Harmonic Distortion	0.010% (1 kHz)
Signal to Noise Ratio	82 dB (DVD-Video 96 kHz)
Dynamic Range	81 dB (DVD-Video 96 kHz)

Disc Format	DVD-Video/VIDEO-CD/CD-DA
Sampling Frequency	44.1 kHz/48 kHz/96 kHz
Quantifying Bit Number	16 bit/20 bit/24 bit

## ■ USB interface section

USB Standard	USB 2.0 Full Speed/High Speed
Compatible Device	Mass Storage Class
File System	FAT 16/FAT 32/NTFS
Maximum Power Supply Current	<b>DDX7018BT/DDX7018BTM/ DDX718WBT/DDX718WBTM:</b> DC 5 V $\overline{\text{V}}$ 1.5 A (× 1) <b>DMX7018BT/DMX7018BTM/ DMX718WBT/DMX718WBTM:</b> DC 5 V $\overline{\text{V}}$ 1.5 A (× 2)
D/A Converter	24 bit
Audio Decoder	MP3/WMA/AAC (.m4a)/WAV/ FLAC
Video Decoder	MPEG1/MPEG2/MPEG4/ H.264/WMV/MKV
Frequency Response	96 kHz Sampling: 20 Hz to 20 000 Hz 48 kHz Sampling: 20 Hz to 20 000 Hz 44.1 kHz Sampling: 20 Hz to 20 000 Hz

Total Harmonic Distortion	0.020% (1 kHz)
Signal to Noise Ratio	104 dB
Dynamic Range	90 dB

## ■ Bluetooth section

Technology	Bluetooth 3.0
Frequency	2.402 GHz to 2.480 GHz
Output Power	+4 dBm (MAX), 0 dBm (AVE), Power Class 2
Maximum Communication Range	Line of sight approx. 10 m (32.8 ft)
Audio Codec	SBC/AAC
Profile	HFP (Hands Free Profile) 1.6 A2DP (Advanced Audio Distribution Profile) 1.3 AVRCP (Audio/Video Remote Control Profile) 1.5 GAP (Generic Access Profile) PBAP (PhoneBook Access Profile) 1.2 SDP (Service Discovery Profile) SPP (Serial Port Profile) 1.2

## Specifications

### FM tuner section

Frequency Range	87.5 MHz to 108.0 MHz (50 kHz)
Usable Sensitivity (S/N: 30 dB, Dev. 22.5 kHz)	6.2 dBf (0.56 $\mu$ V/75 $\Omega$ )
Quieting Sensitivity (DIN S/N: 46 dB, Dev. 40 kHz)	15.2 dBf (1.58 $\mu$ V/75 $\Omega$ )
Frequency Response ( $\pm$ 3.0 dB)	30 Hz to 15 kHz
Signal to Noise Ratio	68 dB (MONO)
Selectivity ( $\pm$ 400 kHz)	> 80 dB
Stereo Separation	40 dB (1 kHz)

### AM tuner section

Frequency Range	<b>DDX7018BT/DMX7018BT</b> <b>Southeast Asian models/ DMX7018BT Indonesian models/DDX718WBT/ DMX718WBT Southeast Asian models/DMX718WBT Indonesian models:</b> 531 kHz to 1611 kHz (9 kHz) <b>DMX7018BT Australian/New Zealand models/DMX718WBT Australian/New Zealand models:</b> 531 kHz to 1701 kHz (9 kHz) <b>DDX7018BTM/DMX7018BTM/ DDX718WBTM/DMX718WBTM:</b> 531 kHz to 1602 kHz (9 kHz)
Usable Sensitivity	<b>DDX7018BT/DMX7018BT/ DDX718WBT/DMX718WBT:</b> 28.5 $\mu$ V <b>DDX7018BTM/DMX7018BTM/ DDX718WBTM/DMX718WBTM:</b> MW: 28.5 $\mu$ V/LW: 45 $\mu$ V

### Video section

Color System of	NTSC/PAL
External Video Input	
External Video Input Level (mini jack)	1 Vp-p/75 $\Omega$
External Audio Max Input Level (mini jack)	2 V/25 k $\Omega$
Video Input Level for Rear Camera (RCA jack)	1 Vp-p/75 $\Omega$
Video Input Level for Front Camera (RCA jack)	1 Vp-p/75 $\Omega$
Video Output Level (RCA jack)	1 Vp-p/75 $\Omega$
Analog RGB Input	0.7 Vp-p/75 $\Omega$

## Specifications

### Audio section

Maximum Power (Front & Rear)	50 W × 4
Full Bandwidth Power (Front & Rear)	22 W × 4 (at less than 1% THD)
Preout Level	4 V/10 kΩ
Preout Impedance	≤ 600 Ω
Speaker Impedance	4 Ω to 8 Ω
Equalizer	Band: 13 Band Frequency (Hz): 62.5/100/160/250/400/630/ 1k/1.6k/2.5k/4k/6.3k/10k/ 16k Gain (dB): -9/-8/-7/-6/-5/-4/-3/-2/ -1/0/1/2/3/4/5/6/7/8/9
2 Way X'Over	
Tweeter:	Gain (dB): -8/-7/-6/-5/-4/-3/-2/-1/0
Front/Rear (HPF):	Frequency (Hz): Through/30/40/50/60/70/ 80/90/100/120/150/180/ 220/250 Slope (dB/Oct.): -6/-12/-18/-24 Gain (dB): -8/-7/-6/-5/-4/-3/-2/-1/0

Subwoofer (LPF):	Frequency (Hz): 30/40/50/60/70/80/90/100/ 120/150/180/220/250/ Through Slope (dB/Oct.): -6/-12/-18/-24 Phase: Phase Inversion: Off/On Gain (dB): -8/-7/-6/-5/-4/-3/-2/-1/0
Position	Front/Rear/Subwoofer Delay: 0 cm to 610 cm (1.0 cm Step) Gain: -8 dB to 0 dB
Subwoofer Level	-50 dB to +10 dB

### General

Operating Voltage	14.4 V (10.5 V to 16 V allowable)
Maximum Current Consumption	10 A

Installation Dimensions (W × H × D)	DDX7018BT/DDX7018BTM/ DMX7018BT/DMX7018BTM: 178 mm × 100 mm × 162 mm DDX718WBT/DMX718WBT/ DDX718WBTM/DMX718WBTM: 178 mm × 100 mm × 162 mm 206 mm × 104 mm × 162 mm (including the sub panel part)
Operational Temperature Range	-10°C to +60°C
Weight (Main Unit)	DDX7018BT/DDX7018BTM/ DDX718WBT/DDX718WBTM: 2.4 kg DMX7018BT Southeast Asian models/DMX7018BT Indonesian models/ DMX7018BTM/DMX718WBT/ DMX718WBTM: 2.0 kg DMX7018BTM Australian/ New Zealand models: 2.0 kg (including trim plate)

Design and specifications are subject to change without notice.

### Trademarks and licenses

- Dolby, Dolby Audio and the double-D symbol are trademarks of Dolby Laboratories.
- “DVD Logo” is a trademark of DVD Format/Logo Licensing Corporation registered in the US, Japan and other countries.
- The “AAC” logo is a trademark of Dolby Laboratories.
- Microsoft and Windows Media are either registered trademarks or trademarks of Microsoft Corporation in the United States and/or other countries.
- “Made for iPod,” and “Made for iPhone” mean that an electronic accessory has been designed to connect specifically to iPod, or iPhone, respectively, and has been certified by the developer to meet Apple performance standards.  
Apple is not responsible for the operation of this device or its compliance with safety and regulatory standards. Please note that the use of this accessory with iPod, or iPhone may affect wireless performance. iTunes, iPhone, iPod, iPod classic, iPod nano, and iPod touch are trademarks of Apple Inc., registered in the U.S. and other countries.
- Lightning is a trademark of Apple Inc.
- This item incorporates copy protection technology that is protected by U.S. patents and other intellectual property rights of Rovi Corporation. Reverse engineering and disassembly are prohibited.
- Android is a trademark of Google Inc.

- The Bluetooth® word mark and logos are registered trademarks owned by Bluetooth SIG, Inc. and any use of such marks by JVC KENWOOD Corporation is under license. Other trademarks and trade names are those of their respective owners.
- THIS PRODUCT IS LICENSED UNDER THE AVC PATENT PORTFOLIO LICENSE FOR THE PERSONAL USE OF A CONSUMER OR OTHER USES IN WHICH IT DOES NOT RECEIVE REMUNERATION TO  
(i) ENCODE VIDEO IN COMPLIANCE WITH THE AVC STANDARD (“AVC VIDEO”) AND/OR (ii) DECODE AVC VIDEO THAT WAS ENCODED BY A CONSUMER ENGAGED IN A PERSONAL ACTIVITY AND/OR WAS OBTAINED FROM A VIDEO PROVIDER LICENSED TO PROVIDE AVC VIDEO. NO LICENSE IS GRANTED OR SHALL BE IMPLIED FOR ANY OTHER USE. ADDITIONAL INFORMATION MAY BE OBTAINED FROM MPEG LA, L.L.C. SEE [HTTP://WWW.MPEGLA.COM](http://www.mpegla.com)
- SPOTIFY and the Spotify logo are among the registered trademarks of Spotify AB.
- WebLink™ is a trademark of Abalta Technologies, Inc.
- YouTube and the YouTube logo are registered trademarks of Google Inc.
- libFLAC  
Copyright (C) 2000-2009 Josh Coalson  
Copyright (C) 2011-2013 Xiph.Org Foundation  
Redistribution and use in source and binary forms, with or without modification, are permitted provided that the following conditions are met:

- Redistributions of source code must retain the above copyright notice, this list of conditions and the following disclaimer.
  - Redistributions in binary form must reproduce the above copyright notice, this list of conditions and the following disclaimer in the documentation and/or other materials provided with the distribution.
  - Neither the name of the Xiph.org Foundation nor the names of its contributors may be used to endorse or promote products derived from this software without specific prior written permission.
- THIS SOFTWARE IS PROVIDED BY THE COPYRIGHT HOLDERS AND CONTRIBUTORS “AS IS” AND ANY EXPRESS OR IMPLIED WARRANTIES, INCLUDING, BUT NOT LIMITED TO, THE IMPLIED WARRANTIES OF MERCHANTABILITY AND FITNESS FOR A PARTICULAR PURPOSE ARE DISCLAIMED. IN NO EVENT SHALL THE FOUNDATION OR CONTRIBUTORS BE LIABLE FOR ANY DIRECT, INDIRECT, INCIDENTAL, SPECIAL, EXEMPLARY, OR CONSEQUENTIAL DAMAGES (INCLUDING, BUT NOT LIMITED TO, PROCUREMENT OF SUBSTITUTE GOODS OR SERVICES; LOSS OF USE, DATA, OR PROFITS; OR BUSINESS INTERRUPTION) HOWEVER CAUSED AND ON ANY THEORY OF LIABILITY, WHETHER IN CONTRACT, STRICT LIABILITY, OR TORT (INCLUDING NEGLIGENCE OR OTHERWISE) ARISING IN ANY WAY OUT OF THE USE OF THIS SOFTWARE, EVEN IF ADVISED OF THE POSSIBILITY OF SUCH DAMAGE.









For updated information (the latest Instruction Manual, system updates, new functions, etc.),  
please visit the following website:

[<www.kenwood.com/cs/ce/>](http://www.kenwood.com/cs/ce/)

