

MESA/BOOGIE[®]

SUBWAY+[®]

BASS DI-PREAMP

Owner's Manual

Greetings from the Home of Tone®

...You, smart player and intuitive human, have put your trust in us to be your amplifier company. This is something that we do not take lightly. By choosing this instrument to be part of your musical voice, you have become part of the MESA® family... WELCOME!

Our goal is to never let you down. Your reward is that you are the new owner of an amp, bred of fine heritage, benefitting from the many pioneering and patented MESA circuits as well as fresh cutting edge research and development efforts, leading to this new and exciting model. We feel confident that this amp will inspire many hours of musical satisfaction and lasting enjoyment. It was built with you in mind, by players who know the value of a fine musical instrument and the commitment it takes to make great music. The same commitment to quality, value and support we make to you... our new friend.

SUBWAY+[®]

BASS DI-PREAMP

Table of Contents

PRECAUTIONS AND SAFETY INSTRUCTIONS	
OVERVIEW _____	1

TOP PANEL (CONTROLS & FEATURES)

INPUT JACK _____	2
TUNER OUTPUT JACK _____	2
MUTE FOOTSWITCH _____	2
DEEP SWITCH _____	2
BRIGHT SWITCH _____	2
INPUT (GAIN) CONTROL _____	2
BOOST FOOTSWITCH _____	2
BOOST LEVEL CONTROL _____	2
HI-PASS FILTER _____	2-3
VOICING CONTROL _____	3
BASS CONTROL _____	3
LOW MID GAIN CONTROL _____	3
LOW MID FREQUENCY CONTROL _____	3
HIGH MID GAIN CONTROL _____	3
HIGH MID FREQUENCY CONTROL _____	3
TREBLE CONTROL _____	3
MASTER VOLUME CONTROL _____	4
POWER LED _____	4

REAR PANEL (CONTROLS & FEATURES)

POWER JACK _____	4
OPERATING POWER REQUIREMENTS _____	4
PREAMP OUT XLR JACK _____	4
PREAMP OUT GROUND LIFT SWITCH _____	4-5
PREAMP OUT ¼" (6.3mm) JACK) _____	5
EFFECTS LOOP _____	5
DIRECT OUT XLR JACK _____	5
DIRECT OUT GROUND LIFT SWITCH _____	5
DI OUT SOURCE SWITCH _____	5

TROUBLESHOOTING _____	6-7
FACTORY SAMPLE SETTINGS _____	8
USER SETTINGS _____	9
SPECIFICATIONS _____	10
BLOCK DIAGRAM _____	11

IMPORTANT SAFETY INSTRUCTIONS

- Read, keep and follow these instructions.
- Heed all warnings.
- Do not use this apparatus near water.
- Clean only with dry cloth.
- Use only with approved AC (mains) power adapters.
- Protect any power cords from being walked on or pinched, particularly at plugs, receptacles, and the point where they exit from the apparatus.
- Unplug this apparatus during lightning storms or when unused for long periods of time.
- Refer all servicing to qualified service personnel. Servicing is required when the apparatus has been damaged in any way, such as liquid has been spilled or objects have fallen into the apparatus, the apparatus has been exposed to rain or moisture, does not operate normally, or has been dropped.
- No naked flame sources, such as lighted candles, should be placed on the apparatus.
- The apparatus shall not be exposed to dripping or splashing and no objects filled with liquids, such as drinks or vases, shall be placed on the apparatus.
- **WARNING:** To reduce the risk of fire or electric shock, do not expose this apparatus to rain or moisture.
- To avoid damaging your speakers and other playback equipment, turn off the power of all related equipment before making the connections.
- Do not use excessive force when handling buttons, switches and controls. Do not use solvents such as benzene or paint thinner to clean the unit.
- Only connect to an AC power supply adapter that meets the power supply specifications listed on the rear of the unit. Make certain grounding/earthing conforms with local standards.

*Your MESA/Boogie® SUBWAY® BASS DI-PREAMP is a professional instrument.
Please treat it with respect and operate it properly.*

SUBWAY+[®]

BASS DI-PREAMP

Operating Instructions

Overview

Congratulations on your choice of the SUBWAY[®] PLUS BASS DI-PREAMP and welcome to the MESA/Boogie[®] family! First, we would like to thank you for choosing us as your amplifier company and trusting us to help create your musical voice. This is something we never take for granted and you'll find that we are here and ready to assist you should you ever need help. Our goal is to help you sound your best at all times! We feel confident that your new DI-preamp will bring you many years of reliable service, rewarding inspiration and create for you a newfound freedom to express your music.

You have chosen a product bred of a fine heritage, and this model is our testament to our legacy of tone. Its forefathers can be traced back to the very first MESA product ever built, the MESA 450 Bass Head. In fact, the first 5 MESA amplifiers built in the Lagunitas mountain shack were Bass amps... a piece of trivia little known and overshadowed by our overwhelming notoriety for guitar amplification. But we've always loved the Bass, and have—since day one—been committed to elevating its stature through our art form. The bloodline for MESA bass continued with the first rack-mount chassis bass amplifier in 1980, the D-180. The mid-eighties saw the introduction of the BASS 400 and later in 1988, the BASS 400+ with its stunning pitch, punch and power delivered by an additional 6 x 6L6s to bring the total to twelve 6L6 power tubes in the mighty power section.

The 400+ went on to become a classic used by the world's most talented bassists for two decades. Paul McCartney, Mark King, Stanley Clark, Jack Blades, Michael Anthony, Blasko and Bootsy Collins, are but a few of the international stars that put the 400+ center stage to anchor the band during its 20 year build cycle. Those iconic amps still bring top dollar when you can find one changing hands on the pre-owned market. While MESA has since pioneered an entire line of tube-driven MOSFET amplifiers (including the legendary Walkabout) that shored up our position in the bass market, changing times have encouraged us to take what we have learned over this time and create a whole new approach to the bass amp, while remaining true to our heritage and tradition of tone.

Tone Freaks Rejoice! The SUBWAY PLUS BASS DI-PREAMP is the next logical step in the MESA Bass Amp Bloodline. Based on the success of the original Subway DI-PREAMP, Subway D-800 and Subway D-800+, this new Subway series DI-preamp is a tone dripping powerhouse that's compact, lightweight, and packaged to go the distance with features, and control over the entire bass spectrum that makes it an iconic step forward in bass preamplification. Like all Mesa products, the SUBWAY PLUS BASS DI-PREAMP is made in Petaluma, California with the World's Finest Materials.

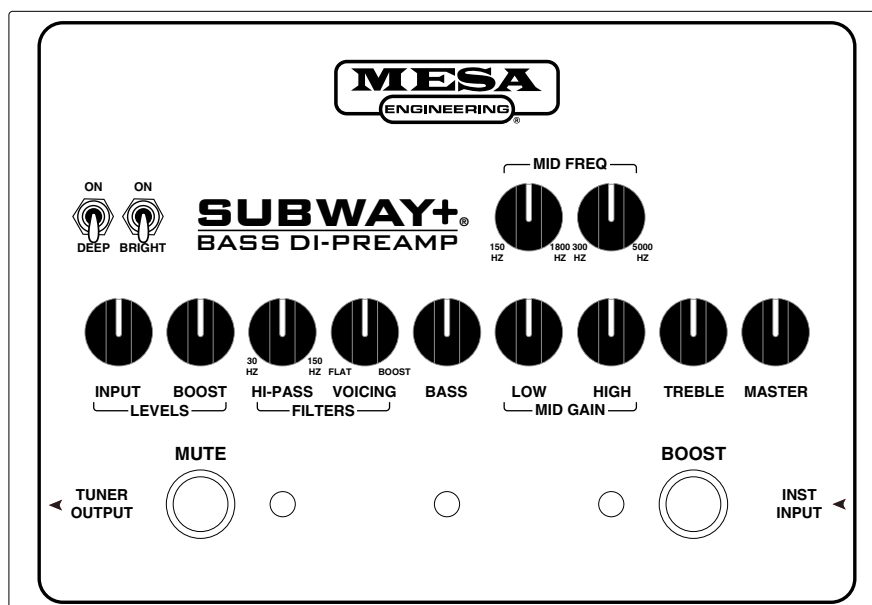

TOP PANEL (CONTROLS & FEATURES)

INPUT JACK This jack is the instrument INPUT that feeds the first stage monolithic J-FET input buffer amp of the DI-PREAMP. This stage is inherently transparent, and directly feeds the DI out when the DI out is set to the “PRE-EQ” position. The input sensitivity is adjustable via the INPUT LEVEL control, and provides enough inherent range to handle both low level passive and high level active pickups. When a standard ¼” (6.3mm) Tip-Sleeve instrument cable plug is inserted into the jack, the power is automatically turned on. Please note that it is important for the ¼” (6.3mm) plug to be of the TIP-SLEEVE type, as TIP-RING-SLEEVE type connectors may not engage the turn-on circuit properly. It is always good practice (and customary) to inform the FOH/monitor engineer that you will be turning your DI-PREAMP on or off so as to prevent any pops or unexpected signal into their system(s).

TUNER OUTPUT JACK This jack (located on the left side of the chassis) is the instrument THRU OUTPUT that is parallel to the input jack. This signal is identical to (and not isolated from) the signal from the bass itself. This input remains active when the MUTE FOOTSWITCH is engaged, allowing for silent tuning with no signal sent to the DI OUTPUT, FX SEND or either PREAMP OUTPUT jack.

MUTE FOOTSWITCH This switch mutes the audio signal being sent to all outputs except the TUNER OUT jack for silent tuning as mentioned above. When the switch is engaged, the DI-preamp is placed into mute mode, the red LED will illuminate, and NO audio will be present at the DI OUTPUT, FX SEND or PREAMP OUTPUT jacks. This switch can also be used to place the preamp into “standby mode” before and between sets without adjusting any of the controls.

DEEP SWITCH This switch engages the DEEP filter, our take on classic low frequency response enhancement and extension. Engaged, there is a mild boost in the very low frequency response while simultaneously lowering the effective high pass filter frequency slightly. This combination brings a more round, thicker, fatter response to the bottom end. When using this preamp with small (compact style) cabinets, and especially with the HPF set to below 45Hz and using large amounts of bass eq boost, be aware of the possibility of damage due to overpowering your speakers at higher volumes. Some unique tones are available with the use of the DEEP filter while at the same time rolling up the HIGHPASS CONTROL a bit.

BRIGHT SWITCH This switch engages the BRIGHT filter, which causes a rising response at higher frequencies much like the switches found on the most popular classic tube amps. Engaging this filter can bring some “brightness, presence and attack into the tone.

INPUT LEVEL CONTROL This control determines the input gain of the first gain stage and thus the level that the following electronics stages operate at. Overdriving the input gain stage may be a desirable tonal characteristic of your playing style. When using significant overdriven tones, you may find it helpful to back down on the TREBLE EQ a little bit to reduce harshness and also to reduce the BASS EQ to increase the clarity and impact.

BOOST FOOTSWITCH This footswitch engages the boost (or solo) function, the amount of boost is set by using the BOOST control on the top of the DI-PREAMP. There is a green LED indicator that illuminates when the DI-PREAMP is in BOOST mode.

BOOST LEVEL CONTROL This control sets the amount of boost (or solo) level applied when the BOOST FOOTSWITCH is engaged. Fully counterclockwise there is almost no gain increase, and fully clockwise there is about 6dB of gain increase applied to the original level.

HI-PASS FILTER This control sets the low frequency roll-off point of the DI-PREAMP, and is an important feature in maintaining control over the extreme low end, especially under high drive conditions and/or when using a lot of low EQ boost. This precision four pole filter is comprised of two cascaded two pole filters, one fixed with a turnover frequency that is set at approximately 22Hz and a second variable filter that is variable such that the overall, combined low frequency roll-off can be adjusted from 30Hz to 125Hz. While HPF's have been standard fare within the pro audio industry for decades, with a few notable exceptions this feature has only appeared in bass guitar amplifiers within the past few years. This filter also provides additional mechanical protection to the speakers being used with the amp by limiting the power to the speaker below the frequency range that the speaker cabinet cannot provide adequate acoustic loading to the drivers. This is one of the primary (and preventable) causes of premature speaker failure, especially

with compact speaker cabinet products that are driven very hard. Another valuable use for this filter is to roll off the very low end when overdriving the amp. This prevents the signal from becoming muddy, and preserves the naturally musical growl and grit of the overdriven signal. Experimentation will be helpful in such applications.

VOICING CONTROL This active eq control modifies the DI-PREAMP's response from a more flat like curve (in the counter-clockwise position) to a more voiced curve (in the clockwise position) by modifying and shifting the frequency response in all regions with a simple turn of the knob. As the control is rotated clockwise, the low and high end increase while the midrange decreases and shifts upward with a corresponding shift in the low and high frequency ranges – this is a more complex tone shaping change than a simple mid scoop. Common uses for the more voiced positions are the old school funk and slap tones, and rock tones where a rounder bottom and a little bite are needed. Experimentation is an important part of discovering the potential of this powerful tool. To initially set up your sound, gradually rotate the VOICING control clockwise and stop when you achieve the basic amp voicing that you are looking for. The more clockwise, the greater the low end boost, mid cut (frequency also shifts as the control is rotated) and mild treble boost. Once you have the basic tonal profile you are looking for, eq to taste, and don't forget that the HPF, Bright and Deep switches can also be brought into play. The DI-PREAMP is a very versatile tool when it comes to dialing in the exact sound you have in your head.

BASS CONTROL This active eq control is responsible for the amount of low frequencies present in the signal, relative to the rest of the spectrum. Low frequencies (<80Hz) are responsible for the “bottom”, “roundness”, or “feel” of the tone. This is an active control with boost and cut - the amount of boost is proportional to the clockwise rotation to the right of “flat” (12:00 straight up) position and similarly the amount of cut is proportional to the counter-clockwise rotation to the left of “flat” (12:00 straight up) position. As with everything related to EQ, generally, a little bit goes a long way and often subtracting works better than adding. Use enough to get the job done and no more. Note that if you have very compact cabinets and need high volumes, you will want to be aware that it is possible to overdrive speakers with excessive bass boost. If your speaker is not producing enough low end volume, it's possible that you do not have enough “rig for the gig”, and “more speaker” is needed. This is a shelving type filter.

LOW MID GAIN CONTROL This control is responsible for the amount (or volume) of low midrange frequencies present in the signal, relative to the rest of the spectrum. Low mid frequencies (the actual center frequency is selected with the low mid frequency control) are responsible for the “earthy”, “chesty”, “woody” character of the tone. This is an active control with boost and cut, the amount of boost proportional to the clockwise rotation to the right of “flat” (12:00 straight up) position and the amount of cut proportional to the counter-clockwise rotation to the left of “flat” (12:00 straight up) position. This is a peak-dip (or bell) type filter.

LOW MID FREQUENCY CONTROL This control is responsible for selecting the center frequency (or pitch) that the low mid gain control acts on. Rotating this control sweeps the center frequency from lower (counterclockwise) to higher (clockwise). If the low mid gain control is set at 12:00 noon, there will be no effect by the low mid frequency control because there is no boost or cut being performed. Sweep range is from 150Hz – 1800 Hz.

HIGH MID GAIN CONTROL This control is responsible for the amount (or volume) of high midrange frequencies present in the signal, relative to the rest of the spectrum. High mid frequencies (the actual center frequency is selected with the high mid frequency control) are responsible for the “boxy”, “barky”, “aggressive” character of the tone. This is an active control with boost and cut, the amount of boost proportional to the clockwise rotation to the right of “flat” (12:00 straight up) position and the amount of cut proportional to the counter-clockwise rotation to the left of “flat” (12:00 straight up) position. This is a peak-dip (or bell) type filter.

HIGH MID FREQUENCY CONTROL This control is responsible for selecting the center frequency (or pitch) that the high mid gain control acts on. Rotating this control sweeps the center frequency from lower (counterclockwise) to higher (clockwise). If the high mid gain control is set at 12:00 noon, there will be no effect by the high mid frequency control because there is no boost or cut being performed. Sweep range is from 300Hz – 5000 Hz.

TREBLE CONTROL This active eq control is responsible for the amount of high frequencies present in the signal, relative to the rest of the spectrum. High mid frequencies (>2.5kHz) are responsible for the “bright”, “airy”, “shimmery” character of the tone. This is an active control with boost and cut - the amount of boost is proportional to the clockwise rotation to the right of “flat” (12:00 straight up) position and similarly the amount of cut is proportional to the counter-clockwise rotation to the left of “flat” (12:00 straight up) position. This is a shelving type filter.

MASTER VOLUME CONTROL

This control is responsible for the level of signal being sent to the PREAMP OUTPUT jacks, and determines the overall playing volume of the DI-PREAMP. Using the MASTER VOLUME along with the INPUT GAIN control allows the optimal control over playing volume. For example, if you are using high input gain to achieve an overdriven tone, it will be likely be necessary to adjust the master volume down to obtain a reasonable playing volume and to avoid excessive overdriving of the power amp. Likewise, if you are looking for a very clean tone, you may wish to start with a lower INPUT GAIN control setting and use a higher MASTER VOLUME control setting to obtain the desired playing volume.

POWER LED

This blue LED indicates that the DI-PREAMP is connected to a power source, is switched on, and operating correctly. The SUBWAY PLUS DI-PREAMP is switched on automatically whenever a plug is inserted into the INSTRUMENT INPUT. Be sure to use a standard 1/4" (6.35mm) Tip-Sleeve (TS) instrument cable, a Tip-Ring-Sleeve (TRS) may not actuate the power switching circuitry.

REAR PANEL (CONTROLS & FEATURES)

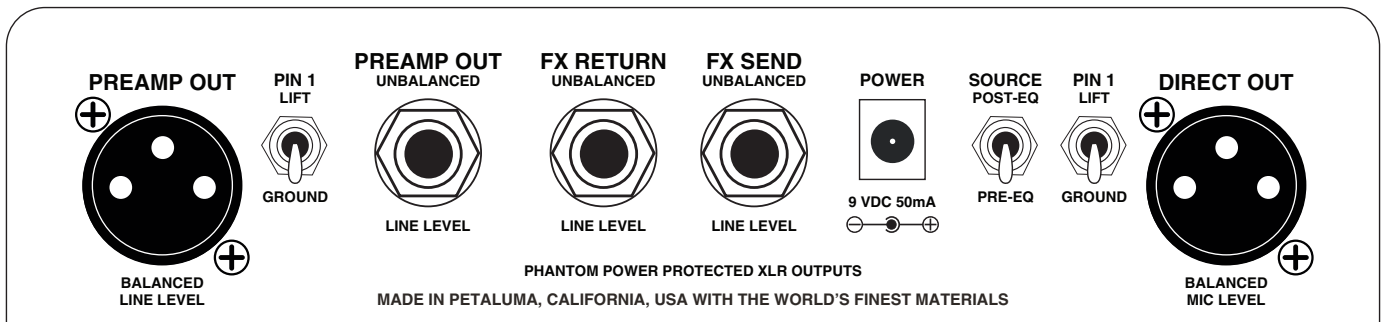

POWER JACK

The SUBWAY BASS DI-PREAMP is designed to operate from any standard 9VDC, center "-" (minus) power supply using a standard 2.1mm center pin and 5.5mm outside barrel. While the DI-PREAMP itself is tolerant of noise from outside power supplies, inadvertent ground loops can be created between pedals/effects creating noise in the instrument signal. In the event that noise is encountered, start with powering the DI-PREAMP first, and then add pedals/effects noting which one is responsible for introducing the noise.

OPERATING POWER REQUIREMENTS

The SUBWAY PLUS BASS DI-PREAMP is designed to operate from either its internal 9 volt battery (alkaline is recommended), or from any standard 9VDC center "-" (minus) power supply using a standard 2.1mm center pin and 5.5mm outside barrel. The internal battery may remain in place as there is circuitry present that will automatically select the external DC power supply when present. The internal battery is accessed by removing the cover from the battery box, located on the bottom of the unit. The internal circuitry is protected against accidental battery and external power supply reversed polarity connection attempts. Current requirements of the DI-PREAMP are less than 50mA, resulting in an expected battery life of about 12 hours. The DI-PREAMP, while tolerant of phantom power will not be powered by it.

PREAMP OUT XLR JACK

This output jack is fully balanced and can deliver a +4dBu (line level) with a maximum output level of about +12dBu. This is more than sufficient to drive any of the standard pro audio power amplifiers on the market today. The signal is derived after all voicing and EQ filters as well as after the master volume control. Even though it does not run on phantom power, the DI-PREAMP is fully phantom power protected in the event of accidental connection to an input that has phantom power present.

PREAMP OUT GROUND LIFT SWITCH

This switch connects or lifts the circuit ground/earth/common connection from pin 1 on the XLR PREAMP OUT connector only. Balanced outputs do not rely on the pin 1 (or shield) connection to transmit a signal to the amplifier. While pin 1 is almost always connected to amplifier's ground bus, often (due to differences in potential of a building's ground/earth system) currents will flow between grounds where there is a common connection resulting in hum. By lifting the ground at the sending (DI-PREAMP) end, the shielding remains in place but the ground current flow causing the hum in the signal carrying pair of conductors is eliminated. Now, the one thing that complicates this is that at very high (such as radio) frequencies, ground is not

“really” ground. To address this potential problem additional techniques are incorporated within this network that allows 2 functional grounding spectrums within the same network, providing added RFI (radio frequency interference) rejection. The general rule is to start with pin 1 lifted, and if there is noise, then try connecting it. It should also be noted that there are a lot of other possible causes for noise, this switch is primarily a solution for ground loop noise between the preamp and the power amp, but could be helpful for other causes of interference as well.

PREAMP OUT ¼” (6.35mm) JACK

This output jack is unbalanced and can deliver a +4dBu (line level) with a maximum output level of about +6dBu. This is enough to drive any of the standard MI type power amplifiers on the market today, including the power amp input jacks (or serial effects returns) present on many of the micro amps like our popular Subway series bass amps. While this output is phantom power protected, it is unlikely that phantom power would ever encountered on a ¼” (6.35mm) input as this violates industry standards.

EFFECTS LOOP

A 1/4” (6.35mm) tip-sleeve serial (series) effects loop is provided (effects send and effects return jacks) for connecting “serial”, line level outboard effects devices such as compressors and EQ’s. It may also be used with parallel outboard devices such as delays, reverbs, harmonizers and octavers, etc. by using the wet-dry mix control on the outboard device. This loop is located right before the master volume control. The effects loop’s return jack contains a “normal switch” that interrupts the signal whenever a plug is inserted into the return jack, and automatically bypasses the effects loop when the plug is removed. Because of this, the effects send jack may be used as an additional post eq (and all other tone shaping controls including the HPF), pre master volume output. This loop is line level and is not intended for use with instrument level pedals.

DIRECT OUT XLR JACK

This output jack is fully balanced and can deliver a -30dBu (microphone level) signal with a maximum output level of about -10dBu. This is fully sufficient to drive any audio console currently on the market. It is also fully phantom power protected, in the event of connection to an input that has phantom power present.

DIRECT OUT GROUND LIFT SWITCH

This switch connects or lifts the circuit ground/earth/common connection from pin 1 on the XLR DIRECT OUT connector only. Balanced outputs do not rely on the pin 1 or shield connection to transmit signal to the audio console. While pin 1 is always connected to console’s ground bus, often (due to differences in potential of a building’s ground/earth system) currents will flow between grounds where there is a common connection resulting in hum. By lifting the ground at the sending (DI-PREAMP) end, this allows the shielding to remain in place while breaking the ground current flow inducing hum into the signal carrying pair of conductors. Now, the one thing that complicates this is that at very high (such as radio) frequencies, ground is not “really” ground., To address this potential problem additional techniques are incorporated within this network that allows 2 functional grounding spectrums within the same network, providing added RFI (radio frequency interference) rejection. The general rule is to start with pin 1 lifted, and if there is noise, then try connecting it. It should also be noted that there are a lot of other possible causes for noise, this switch is primarily a solution for ground loop noise between the preamp and the console, but could be helpful for other causes of interference as well..

DI OUT SOURCE SWITCH

This switch selects the signal source routing that is used to derive the direct output signal. In the PRE position, the signal is sourced directly from the input buffer (pre gain control) and the active/passive switch sets the basic operating gain to provide a more uniform signal level to the DI OUTPUT signal. In the POST position, the signal is sourced from the output of the 4 band equalizer and before the master volume control. It therefore includes all tone shaping controls and the HPF. Generally, for PA use the FOH (front of house) engineer will probably prefer a PRE eq send. This is because the capability of the PA system may be significantly different than your stage rig and the eq that sounds perfect to you on stage may not work well to get a good band mix for the audience in a larger acoustic space than just the stage. For recording, depending on the tracking goals of the engineer, either PRE or POST might be used. There are no guaranteed right answers here, you simply need to collaborate with the sound techs and recording engineers to best use the versatility of your Mesa DI-PREAMP to complement their tools to deliver a great sound for your audience.

TROUBLESHOOTING

In the event that your SUBWAY DI-PREAMP appears not to work correctly, often enough the problem is not with the PREAMP-DI, but a related piece of equipment. In this case, it's necessary to take a deliberate, systematic approach to troubleshooting in order to effectively identify and correct the problem. Believe it or not, more often than not, the issue is something else in the rig or system, yet the amplifier is often the first consideration since its function is to amplify. We have seen all of these things below (and more) many times.

SYMPTOM

NO AUDIO OUTPUT

Is the power LED lit?

NO: Possible causes to check in this order are:

1. Verify that the power source is good (if using an external AC powered power supply).
2. If you are using an external supply, verify that it's the correct voltage and polarity and that it's actually plugged into the power source. Also check to be sure it is functioning correctly.
3. If you are using the internal battery, be sure that it is a good battery (ie. fully charged) and that it's actually present (yes, this really does happen)
4. Verify that the input cable you are using is a standard 1/4" (6.3mm) TIP-SLEEVE type. TIP-RING-SLEEVE type cables may fail to turn the unit on under conditions where the ring floats or is not solidly connected to sleeve at the other end.
5. If these do not solve your problem, it's possible that your DI-PREAMP has failed. Call our Customer Service department and we will help you get this resolved.

YES: Possible causes to check in this order are:

1. GAIN and MASTER VOLUME controls must be turned up for the PREAMP OUTPUTS to work.
2. When using the PREAMP OUTPUTS with an external power amp, the power amp's input sensitivity controls must be turned up.
3. Defective bass or cable (test with known good bass and cable)
4. Defective cable to the external device, or defective external device (ie. console, recording interface)
5. There is indeed a problem with your DI-PREAMP. Call our Customer Service department and we will help you get this resolved.

SYMPTOM

DISTORTED AUDIO OUTPUT

1. Defective battery in active bass causing instrument's onboard preamp to distort (replace battery)
2. Defective battery in PREAMP-DI causing preamp's electronics to distort (replace battery)
3. With very hot 18V basses, it's possible to overdrive the DI-PREAMP when in passive mode (switch to active mode)
4. Slightly intermittent cable in some part of the system (this can be an instrument cable, patch cable or XLR cable)
5. Defective or blown speaker(s) in cabinet (test with known good cabinet, repair cabinet as needed)
6. There is indeed a problem with your DI-PREAMP. Call our Customer Service and we will help you get this resolved.

SYMPTOM

NOISE (LOW FREQUENCY HUM) IN AUDIO

1. Defective instrument cable or problem with bass wiring. Plug a very short instrument cable into the instrument input (to turn the DI-PREAMP on), if hum is greatly reduced or eliminated, this means that the noise is entering from outside the DI-PREAMP. Try a known good instrument cable and/or bass).

2. If using the XLR outs, try switching the ground lift switch on those in use to eliminate any inadvertent ground loops between connected devices.
3. Disconnect audio feeds from the DI-PREAMP to the noisy equipment and see if the noise goes away. If it does not, the noise is being generated or introduced external to the DI-PREAMP.
4. If the volume level of the hum changes with position of the bass (rotating or general movement), the problem may be external stray magnetic field present that is coupling into the pickups, especially single coils. Possible causes are large power transformers located near the performance area. If this occurs when you get close to another instrument amp it may be due to stray field from its power supply. Moving the offending amp further from your pickups is a possible solution as the pickups and the offending amp's field is the issue, not your DI-PREAMP.

SYMPTOM

NOISE (HIGH FREQUENCY HISS AND HASH) IN AUDIO

1. Defective instrument cable or problem with bass wiring. Plug a very short instrument cable into the instrument input (to turn the DI-PREAMP on), if hum is greatly reduced or eliminated, this means that the noise is entering from outside the DI-PREAMP. Try a known good instrument cable and/or bass).
2. Defective battery in active bass or DI-PREAMP causing excessive noise (replace battery).
3. If there is neon or fluorescent lighting close by, it's possible that EMI (electromagnetic interference) is radiating into the pick-up wiring. Arcing secondary wire on neon lighting or a failing ballast or tube on fluorescent lighting may be radiating EMI into instrument pick-up. Try turning off such lighting to see if noise goes away.
4. Disconnect audio feeds from the DI-PREAMP to the noisy equipment and see if the noise goes away. If it does not, the noise is being generated or introduced external to the DI-PREAMP.
5. Tweeter turned all the way up in a quiet room, especially if the sensitivity of the tweeter greatly exceeds that of the low frequency drivers. Turn tweeter down in these conditions.

SYMPTOM

NOISE (POPPING) IN AUDIO

1. Popping while playing, especially one string. Check bass set-up to be sure there is adequate clearances between the string and pickup pole pieces.
2. Popping while just sitting there, or when touched. Under dry environmental conditions, it's possible that electrostatic discharge is the cause. Try antistatic mat on floor or a humidifier in room.
3. Popping while moving cables or connectors indicates that there might be a defect in those cables or connectors. Replace cabling with known good and working cabling.

FACTORY SAMPLE SETTINGS

GIG-READY

NOTE: Set DEEP and BRIGHT switches to taste.

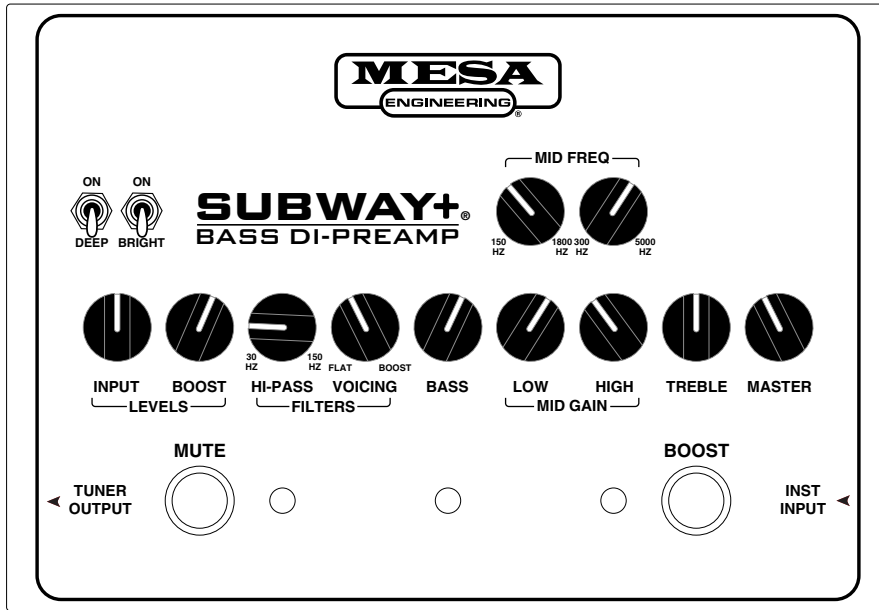

STUDIO GOLD

NOTE: Set BRIGHT switch to taste.

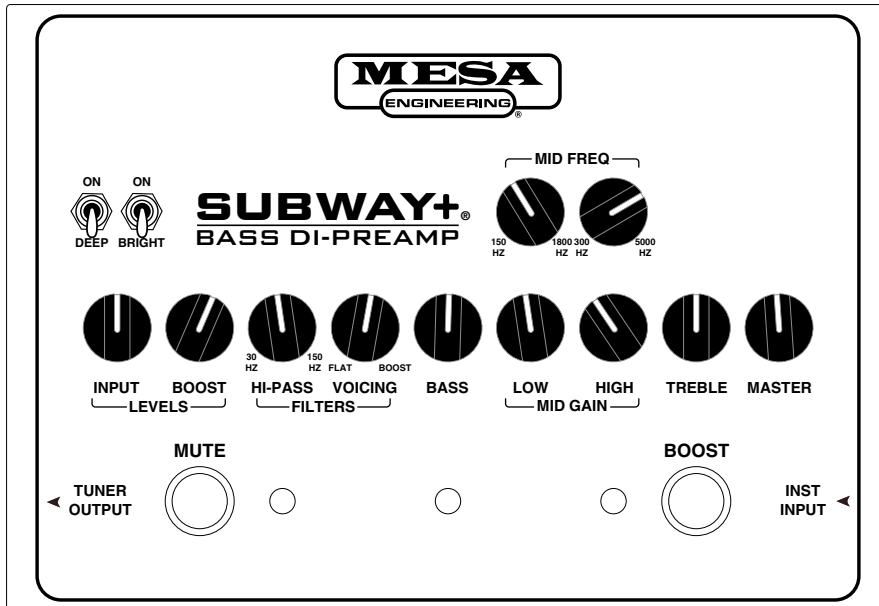

USER SETTINGS

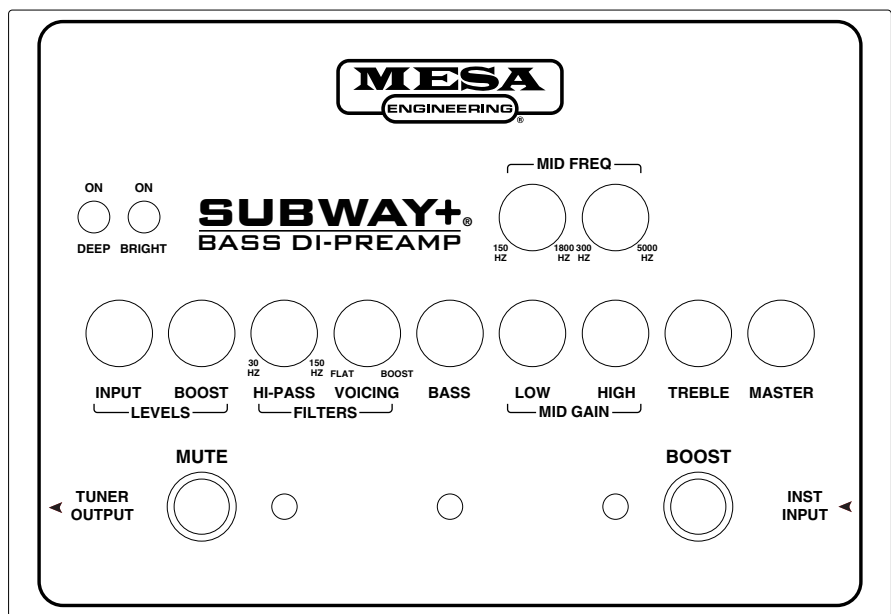

PLAYERS NOTES AND REMINDERS

A large rectangular area with rounded corners, containing ten horizontal lines for writing notes and reminders.

SUBWAY+®

BASS DI-PREAMP

Specifications

Output Levels:	Nominal	Maximum	(nominal)
Preamp Output (XLR balanced):	+4dBu	+12dBu	(line)
Preamp Output (1/4" unbalanced):	0dBu	+6dBu	(line)
DIRECT Output (XLR balanced):	-30dBu	-10dBu	(mic)
Signal to Noise Ratio:	-77dB (20-20kHz, unweighted, battery operation)		
Maximum Available Gain:	~45dB, (eq controls flat, passive mode, XLR preamp output))		
High Pass Filter:	2 pole fixed, 2 pole variable, 24dB/octave, 30Hz-125Hz		
Equalization:	Bass:	+14dB/-14dB @ 40Hz [note 1]	
	Low Mid:	+14dB/-14dB @ 150Hz-1800Hz (sweepable)	
	High Mid:	+14dB/-14dB @ 300Hz-5000Hz (sweepable)	
	Treble:	+11dB/-14dB @ 4kHz [note 1]	
Power Requirements:	9 V alkaline battery or 9 VDC external power supply (2.1mm, center negative)		
Current draw:	<50mA average		
Battery Life:	~12 hours average		
Size:	8.19" (208mm) wide x 5.50" (140mm) deep x 2.56" (65mm) high [note 2]		
Weight:	Approx. 2 lbs (0.91 kg) [note 3]		

[note 1]: measured approx. 1 octave from knee

[note 2]: including feet and controls

[note 3]: not including battery

MESA/Boogie® continually develops new products and improves existing ones. For this reason, specifications and information in this manual are subject to change without notice.

SERVICE INFORMATION

- **USA /CANADA Customer Support:**

For technical support, troubleshooting, tone questions, settings help and more...

707-778-6565 Monday-Thursday, 9AM-5PM Pacific Time

NOTE: If a Product Specialist is not available when you call (helping other customers), PLEASE leave a voice message with a phone number and a good time to call and WE'LL CALL YOU BACK!

- **INTERNATIONAL Customer Support:**

For warranty and technical support, please contact your LOCAL MESA DISTRIBUTOR.

You may use this link to search the web for your local distributor's contact information:

www.mesaboogie.com/support/locations.html



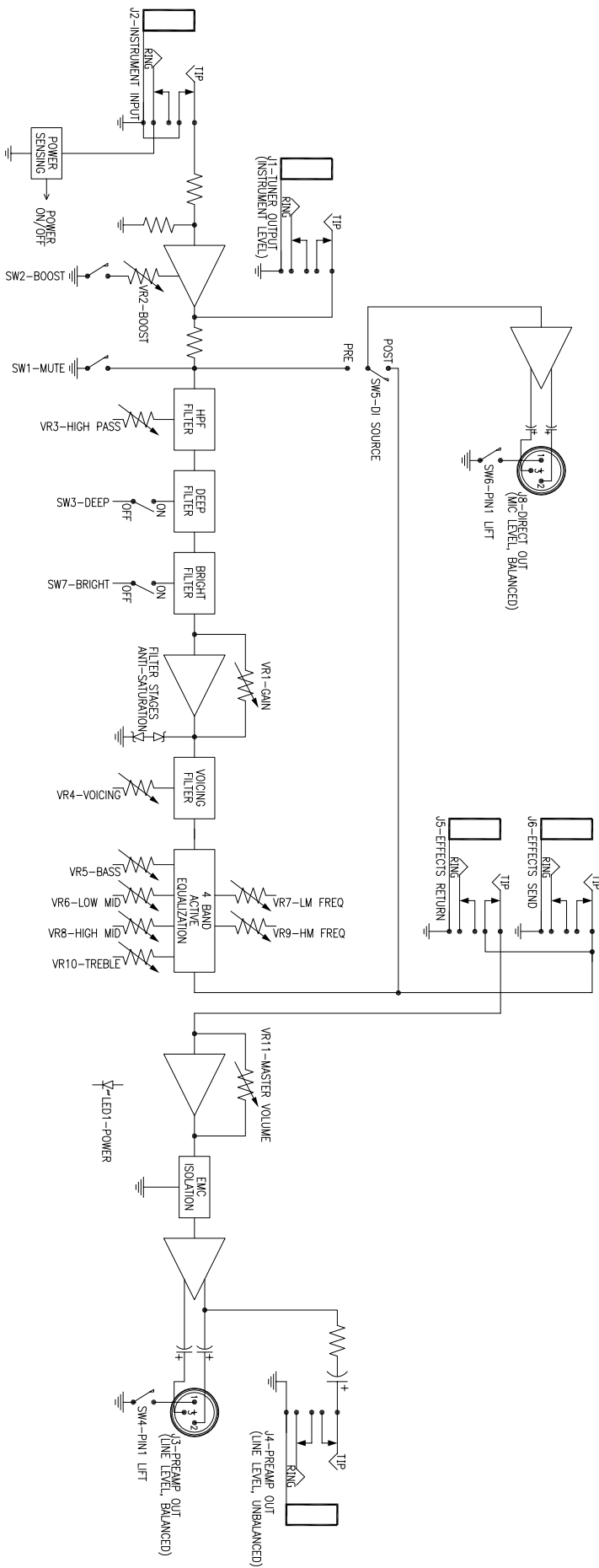



SUBWAY PLUS DI-PREAMP BLOCK DIAGRAM

MESA/BOOGIE[®]

The Spirit of Art in Technology[™]

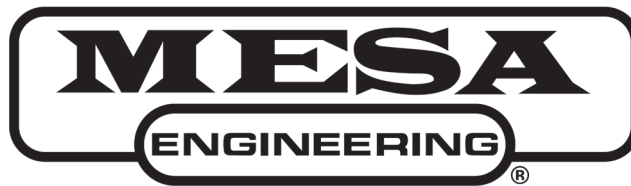
Thank you for trusting MESA/Boogie[®] to be your amplifier company and we wish you many years of toneful enjoyment from this handcrafted instrument.



 This device has been tested and found to comply with the limits for a Class B device pursuant to part 15 of the FCC rules. Operation is subject to the following two conditions: (1) This device may not cause harmful interference, and (2) this device must accept any interference received, including interference that may cause undesired operation.

The Spirit of Art in Technology™



(707) 778-6565 FAX NO. (707) 765-1503
1317 Ross Street Petaluma, CA 94954
USA