

# MACWORLD

September 1986 \$3.95

Canada \$4.95

The Macintosh™ Magazine

## More Drive for Your Dollar

*SCSI drives reviewed*

- PageMaker Tips
- Professional Design and Drafting on the Mac
- MORE than an Outliner
- All about Mac Accounting—25 Packages Compared

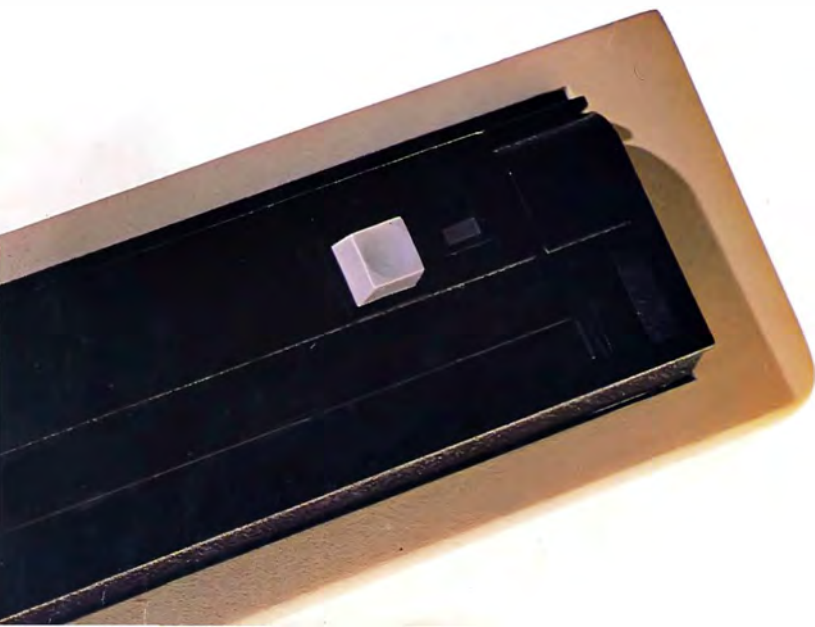
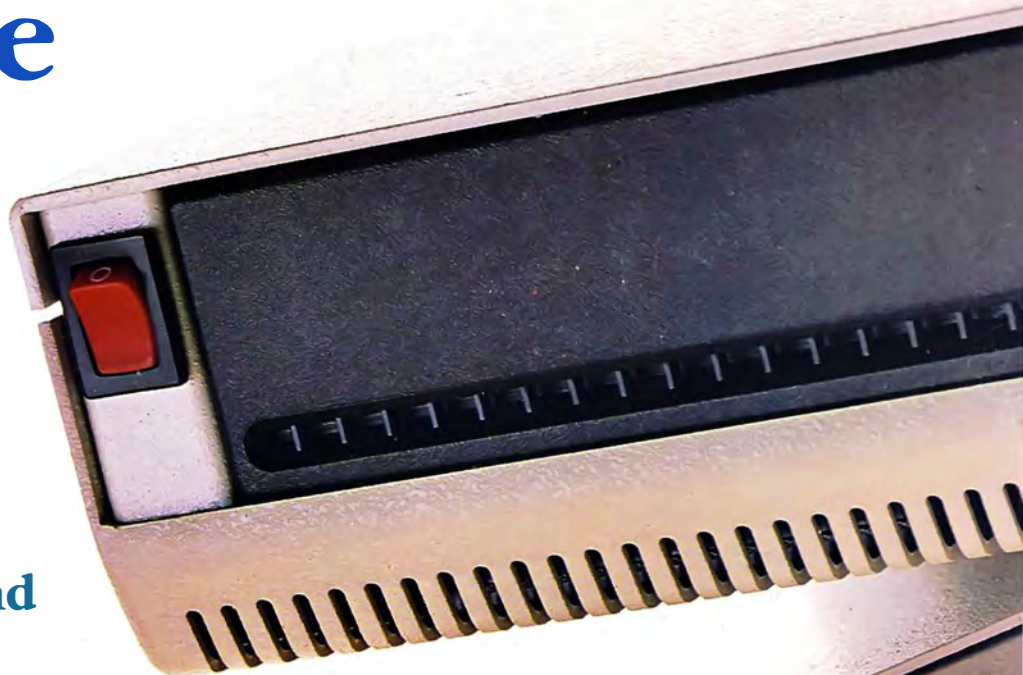

# Borland's SideKick and PhoneLink the world, and double your



## **NEW VERSION 1.1**

SideKick, The Macintosh Office Manager, now supports MacPlus (128K) and Finder 5.1 for the same low price—\$99.95. An upgrade is available from Borland for \$19.95. The upgrade is FREE if you purchased SideKick after 12/15/85. For more information, call (408) 438-8400.

Borland products include Turbo Pascal, Turbo Prolog, Turbo Database Toolbox, Turbo Lightning, Turbo Graphics Toolbox, Turbo Tutor, Turbo GameWorks, Turbo Editor Toolbox, Word Wizard, Reflex, The Analyst, SideKick, SideKick, The Macintosh Office Manager, Traveling SideKick, and SuperKey—all of which are trademarks or registered trademarks of Borland International, Inc. or Borland/Analytix, Inc.

# clear your desk, connect you to productivity for only \$99.95

**S**ideKick,® The Macintosh™ Office Manager,™ gets rid of antiques like desktop phone directories, calculators, calendars, notepads, clocks, adding machines, and similar clutter. Sweeps all that off your desk and into your Mac. You can now bring true desktop organization, information management, and telecommunications to your Mac and do all that *while you're running other programs.*

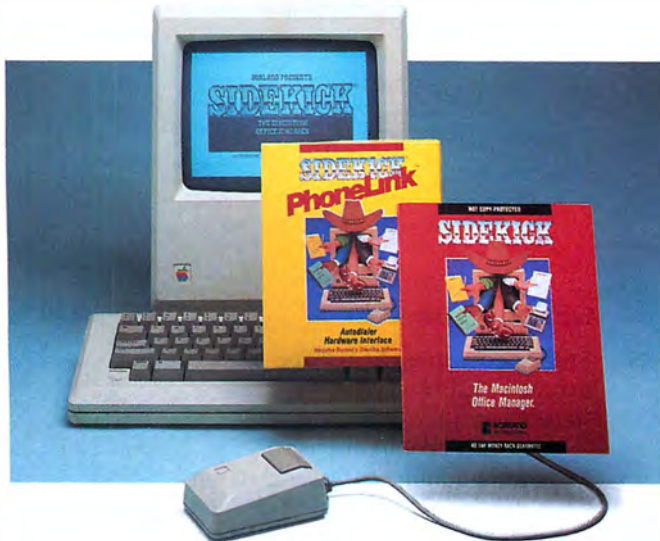

### What PhoneLink™ does for you

In true multi-tasking style, PhoneLink automatically dials for you *even while your modem is in use* on some other task, like sending or receiving a file. This one cubic-inch piece of hardware plugs into your Mac's sound port and will dial all your phone numbers for you. You can install your PhoneLink in a few seconds, and take extra pleasure in the fact that it didn't cost you anything because it came free with your new SideKick.

### What SideKick does for you

- Gives you a full-screen editor and mini-word processor that lets you jot down notes, create and edit files, and/or be used in conjunction with programs like MacWrite or MacPaint.
- Provides you with a telecommunications program that sends and receives data from any on-line network or

bulletin board *while using* other applications. (You need a modem for this feature.)

- Lets you tap into a full-featured financial and scientific calculator that will let you print out a paper tape of your work.
- Offers you a print spooler that prints any text file while you run other programs.
- Shows you an instant calendar—by day, week, or month—which you can also print out.
- Reminds you of important dates/times/appointments with a "things-to-do" file.
- Alerts you to engagements with a convenient alarm system.
- Tells you what you're spending in telephone charges by calculating the cost of every call to whatever area code or time zone.
- Keeps you aware of business and travel expenses.

- Gives you a credit card file that tracks entries, balances, and limits.
- Arms you with a report generator that prints out your mailing lists, calendar, or phone directory.
- Tells you the time with a sweep-hand analog clock.
- Gives you instant on-line "Help" with one mouse click.

### Get both SideKick, The Macintosh Office Manager and PhoneLink for only \$99.95

SideKick for the Mac is an electronic leap that projects you and your Mac into the real world. But you're getting much more than that. You're getting SideKick, you're getting PhoneLink, and you're getting our legendary 60-day money-back guarantee.\*\*

SideKick is not copy-protected. It will clear your desk and do miracles for your productivity—and do all that for only \$99.95.

“ Take my compliments as a user. When I see SideKick, I know I want it.

Jean-Louis Gassée, VP, Product Development, Apple Computer

SideKick is the first product for the Mac that begins to make real the promise of an electronic desktop.

Lawrence J. Magid, Chicago Sun Times ”

**YES!** I want the best

Rush me SideKick and PhoneLink at

**\$99.95**

To order by phone, or for a dealer nearest you, call **(800) 255-8008**  
in CA call (800) 742-1133

— SideKick/PhoneLink at \$99.95 \$ —

Outside USA add \$10 per copy.

CA and MA res. add sales tax \$ —

Amount Enclosed \$ —

Payment: VISA MC Bank Draft Check

Credit Card Exp Date \_\_\_\_ / \_\_\_\_

Card #

**NOT COPY PROTECTED  
60-DAY MONEY-BACK GUARANTEE\*\***

Name: \_\_\_\_\_

Shipping Address: \_\_\_\_\_

City: \_\_\_\_\_

State: \_\_\_\_\_ Zip: \_\_\_\_\_

Telephone: \_\_\_\_\_

CODs and purchase orders WILL NOT be accepted by Borland. Outside USA make payment by credit card or International Postal Money Order.

\*\*YES, if within 60 days of purchase this product does not perform in accordance with our claims, call our customer service department and we will gladly arrange a refund.

**Minimum System Requirements:**  
128K  
M52



4585 SCOTTS VALLEY DRIVE  
SCOTTS VALLEY, CA 95066  
(408) 438-8400 TELEX: 172373

SideKick is a registered trademark and PhoneLink is a trademark of Borland International, Inc. The Macintosh trademark is licensed to Apple Computer, Inc. MacPlus is a trademark of Apple Computer, Inc. MacWrite and MacPaint are published by Apple Computer, Inc. Copyright 1986 Borland International B1-1032B

Circle 381 on reader service card



# MACWORLD

September 1986

The Macintosh™ Magazine

## Getting Started

### 88 The Accounting Software Buyer's Guide

Steve Mann

The most comprehensive compendium of Mac accounting software ever compiled—a point-by-point comparison of 25 programs, covering over 150 criteria.

## Review

### 98 Enter the SCSI Drives

Lon Poole

Evaluations of nine of the first crop of SCSI hard disks, including timing tests and a feature-by-feature comparison.

### 108 Mac Modeling

Reese Jones

With its elegant design and visual interface, *STELLA* brings professional modeling and simulation to a nontechnical audience.

### 112 Beyond ThinkTank

Reed McManus

*ThinkTank 512*'s successor features multiple windows, graphic functions that automatically generate bullet and tree charts, a raft of utilities, and other improvements. But . . . is *More* better?

## Hands On

### 116 Proficient Pagemaking

Richard Jantz

Pick up the pace of your *PageMaker* pasteup—timesaving tips, plus 14 keyboard shortcuts.

### 120 Four Secrets of Excel

Danny Goodman

Become an *Excel* expert with this series of solutions, tutorials, and sample worksheets that guide you through some of the program's arcane but effective features.

## Community

### 124 Desktop Engineering

Paul Freiburger and Dan McNeill

A look at the Mac in its new role as part of a CAD workstation: the hardware, the programs, the problems, the future.

## Departments

### 13 The Software Storm Ahead

David Bunnell

### 23 Born-Again Enthusiast

Jerry Borrell

### 27 MIDI Life Crisis

Steven Levy

### 37 Letters

### 59 Macworld View

Add-on SCSI ports, *dBase* for the Mac, Steve Jobs's new word processor, and other news for the Macintosh community.



#### On the Cover

See "Enter the SCSI Drives," page 98, for reviews of nine new 20MB hard disks. Photograph by Fred Stimson.

## 71 Get Info

Lon Poole

*Macworld's* tutor answers questions about disk space discrepancies, changing the startup application, *MacDraw* font-handling mix-ups, and other Macintosh concerns.

## 133 Macware Reviews

- *ComicWorks* Don't laugh. For cartoonists and others who combine words and pictures, this program represents a serious advance.
- *Record Holder* No dramatic breakthrough, but at less than half the price of its major competitor, this sturdy data manager is worth a try.
- *FullPaint* Is this the Mac graphics program you've been waiting for? Draw your own conclusions.
- *MaxThink* Get organized with this full-featured—but nicely priced—outline program.
- *KidsTime* Five entertaining educational programs for three- to eight-year-olds.
- *Uninvited* A mystery-in-the-mansion text and graphics game from the maker of *Déjà Vu*.
- *MacKeymeleon* Keyboard reassignment—including your choice of 14 foreign keyboard layouts—made easy.
- *MacInker* A ribbon-recycling system for intensive ImageWriter users.

- *Orbiter* Attention space cadets: the first space shuttle simulator may not be a blast, but it is clever and realistic.
- *Maccessories Portable Modem* A mini modem for beginners or mobile communicators.
- *One on One* The Doctor faces off against Larry Bird in a blazing b-ball battle.
- *MegaTrack XL* Need an intermediate-level sequencer? This new addition to *Deluxe Music Construction Set* may be playing your

## 191 Open Window

Jim Heid

An exchange of Macintosh discoveries, including a tip for producing better boldface with *Microsoft Word*, a method of double-sided LaserWriter printing, a way to include engineering equations in *Write* or *Word* documents, and a program that lets you see lengthy file names in Open dialog boxes.

## 183 Macworld Directory

### Indexes

188 Advertisers

189 Products



Martin Marietta's Gerry Simonson with a model of the space station the Mac is helping to design. See "Desktop Engineering" on page 124.

# MACWORLD

## **David Bunnell**

Editor-in-Chief

## **J. Kelley Younger**

Executive Editor

## **Jerry Borrell**

Editor

## **Jacqueline Poitier**

Associate Publisher,  
Art and Design

## **Editorial**

*Managing Editor:* Charles Barrett

*Associate Editors:* Daniel Farber,  
Adrian Mello

*Technical Editor:* David Ushijima

*Assistant Editors:* Nancy E. Dunn,  
Joe Matazzoni, Janet McCandless

*Senior Copy Editor:*

Kathleen Christensen

*Copy Editors:* Gray Shaw,  
Katherine Ulrich

*Editorial Assistants:* Eileen Drapiza,  
Valerie L. Kuletz

*Assistant to the Executive Editor:*

Gina Vanlue

*Contributing Editors:*

Danny Goodman, Jim Heid,  
Steven Levy, Gordon McComb,  
Erfert Nielson, Lon Poole,  
Jeffrey S. Young

*Art and Design*

*Acting Art Director:*

Christopher Burg

*Designer:* Susan Howard

*Design Associates:* Leslie Barton,  
Victoria Floyd

*Design Consultant:* Spiegelman  
Design Associates, Inc.

## **Art and Design**

*Acting Art Director:*

Christopher Burg

*Designer:* Susan Howard

*Design Associates:* Leslie Barton,  
Victoria Floyd

*Design Consultant:* Spiegelman  
Design Associates, Inc.

## **Production**

*Director:* Herbert Linden

*Senior Production Managers:*

Frances Mann, Lee R. Trevino

*Editorial Production Manager:*

Ellyn L. Hament

*Ad Traffic:* Jayne Boyer

*Telecommunicators:* Mark L. Duran,  
Susan M. Ford, Virginia Weir

*Display Advertising Supervisor:*

Georgia George

*Assistant:* Otto Waldorf

## **Research**

*Associate Publisher/Director:*

Cheryl Woodard

*Manager:* Gary L. Rocchio

*Research Analyst:* Ralph Ames

*Assistant:* Steven York

## **Corporate Development**

*Manager:* Karen Wickre

*Special Projects:* Jeffrey S. Glines

*Administrative Assistant:*

Gloria C. Sundin

## **Marketing and Advertising Sales**

*Publisher:* James E. Martin

*National Advertising Manager:*

Larry Hildebrand

*Regional Advertising Manager/*

*No. California (San Francisco):*

Penny Rigby (415/861-3861)

*No. California (San Jose),*

*Northwest:* Patricia Navone

(415/861-3861)

*Midwest:* Jeff Edman (312/827-4477)

*Southeast:* Judy Sutter

(404/394-0758)

*Eastern Advertising Manager/*

*New England:* Linda Holbrook

(617/879-0700)

*New York:* Gale Paterano

(201/967-1350)

*So. California, Southwest, Texas:*

Cynthia L. Ramsey (213/201-5900)

*Directory/1/6-Page Ads:* Niki Stranz

*Advertising Services Manager:*

Ray Petsche

## **Circulation**

*Associate Publisher/Director:*

Penny Ertelt

*Single-Copy Sales Manager:*

George Clark

*Subscription Manager:* Gail Egbert

*Newsstand Manager:* Bill Cox

*Promotion Manager:*

Pamela Stevenson

*Fulfillment Coordinator:*

Doug Norde

## **Administration**

*Director:* Janet McGinnis

*Accounting:* Pat Murphy

*Facilities:* Joseph Wollenweber

*Personnel:* Shelly Ginenthal

*Technical:* Nancy Canning

*Assistant to the President:*

Christina W. Spence

*Assistant to the Publisher:*

Loretta Giglione

## **Corporate**

*PC World Communications, Inc.*

## **David Bunnell**

*Chairman*

## **Bartlett R. Rhoades**

*President & CEO*

## **Herbert Linden**

*Vice President*

## **James E. Martin**

*Vice President*

## **Jacqueline Poitier**

*Vice President*

## **Cheryl Woodard**

*Vice President*

## **Andrew Fluegelman**

1943-1985

*Founding Editor*

## **September 1986**

### **Volume 3, Number 9**

*Macworld*™ (ISSN 0741-8647) is published monthly by PC World Communications, Inc., 501 Second St., Suite 600, San Francisco, CA 94107. Subscription rates are \$30 for 12 issues, \$50 for 24 issues, and \$70 for 36 issues. Foreign orders must be prepaid in U.S. funds with additional postage. Add \$6 per year from Canada and Mexico; add \$12 per year for surface mail or \$80 per year for airmail from all other countries. For subscriber service questions call toll-free 800/525-0643 (in Colorado 303/447-9330) or write: Subscriber Services, P.O. Box 54529, Boulder, CO 80322-4529. To place new orders, call 800/524-3200. Second-class postage paid at San Francisco. POSTMASTER: Send address changes to *Macworld*, P.O. Box 54529, Boulder, CO 80323-4529. Editorial and business offices: 501 Second St., Suite 600, San Francisco, CA 94107, 415/546-7722.

*Macworld* is an independent journal, not affiliated in any way with Apple Computer, Inc. Apple is a registered trademark of Apple Computer, Inc. Macintosh is a trademark licensed to Apple Computer, Inc. The following are trademarks of PC World Communications, Inc.: Note Pad, Macware Reviews, Open Window, Macworld Gallery, Macware News, Macworld View.

Printed in the United States of America.  
Copyright ©1986 PC World Communications, Inc.  
All rights reserved.



# A disk each month delivered to you... packed with programs for your Macintosh!

**DISCOVER UPTIME.** Build an exciting library of programs for less than one dollar each. You deserve value. At UPTIME value is yours. Each month over 30,000 people just like you enjoy UPTIME. Your disk arrives with eight programs and more every month...

Enjoy eight programs including two new desk accessories on each monthly disk. Make your life easier. Get more from your Macintosh. Organize and be more productive with **home management** programs. Learn with **educational** programs. Relax and enjoy monthly **games** or **adventures**. Using your Macintosh is a snap with **tutorials** and **desk accessories**.

**It's easy, inexpensive and fun. It's UPTIME!**

Too good to be true? There's even more! Each monthly disk has reviews of the latest software, hardware and peripherals. Save time and money. Learn the strengths and weaknesses of each item we evaluate. Shop "on the disk" in our Micro Discount Mall.

**Subscribe now and save. You won't believe the low price! Satisfaction is guaranteed — or your money back.** You'll be amazed at just how much comes on every UPTIME disk. Make the very next one yours. Fill out the coupon. For **immediate service** call toll-free:

**1-800-437-0033**  
anytime, day or night.

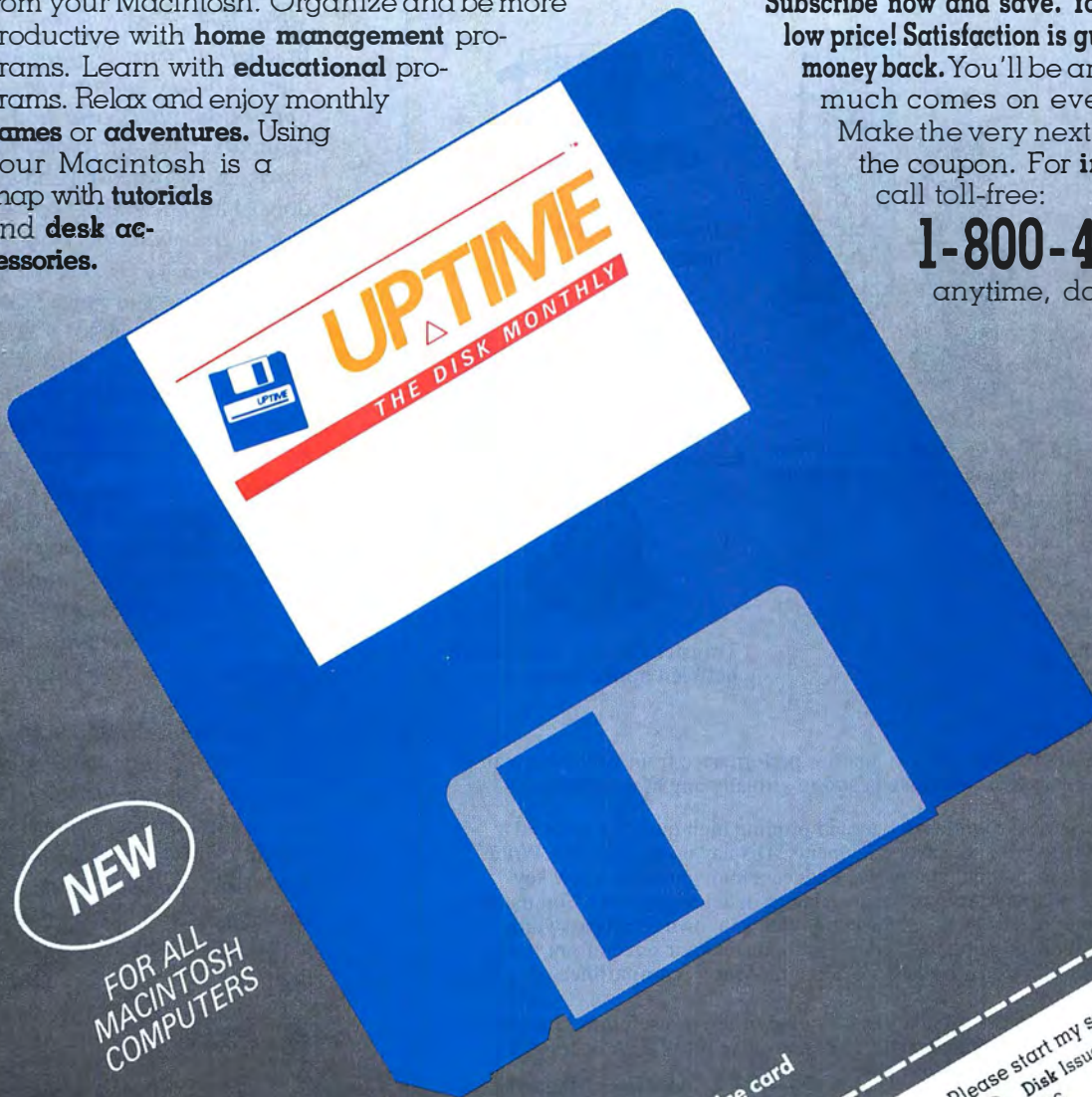

LESS THAN  
\$1 PER  
PROGRAM

NEW

FOR ALL  
MACINTOSH  
COMPUTERS

**VOLUME 1 ■ NUMBER 1**  
**Programs**

- LABEL MAGIC™
- CALENDAR DA
- FILE DOCTOR
- GINGHAM FONT
- LIVING ART
- MACSEVENS
- WE ARE THE WORD DA
- YAHTZEE

Circle 537 on reader service card

I'LL BYTE!!!

12

I'm a Macintosh enthusiast who wants more. Please start my subscription to **UPTIME** immediately.

Name \_\_\_\_\_ Address \_\_\_\_\_ City \_\_\_\_\_

6 Disk Issues \$59.50

3 Disk Issues \$36

1 Disk Issue \$14.95

Bill my:  Visa  MasterCard  Signature \_\_\_\_\_ State \_\_\_\_\_ Zip \_\_\_\_\_  
Account No. \_\_\_\_\_ Exp. Date \_\_\_\_\_

Send to:  
**UPTIME** PO Box 299  
Newport RI 02840  
(401) 849-4925

Cortland Computer Presents

# TopDesk<sup>®</sup>

## Small miracles for your Mac.



- Assign your own Command keys to *any* menu selection.



- Simplify applications with string macros.



- Protect confidential files from prying eyes.



- No more waiting for the printer. Continue to work while printing high quality text or graphics.



- View up to eight MacWrite documents from within any application.



- Prevent screen damage from image "burn-in."



- Transfer directly and quickly between applications.

**TopDesk – the different desk accessories.** Enjoy superior performance from your Mac with TopDesk, seven innovative desk accessories you can add to virtually any Mac software.

Now you can continue using your Mac while background printing high quality formatted MacWrite, MacDraw, MicroSoft Word and Excel documents. Display up to eight MacWrite and text files simultaneously for instant cut and paste. Reduce a long phrase to a few key-strokes, store up to 10,000 abbreviations. You can create, change or delete your own Command keys to any menu selection. Encrypt a 100K file in 5 seconds with your own secret password. Launch into new applications without using the finder. Even protect your screen from image burn-in for as long as your Mac stays on. TopDesk does it all. **Mac+ compatible.**

"Unique and extremely useful...This DA can't be beat for ease of use or usefulness...superb 26 page manual. It is simple and works flawlessly...This innovative set of desk accessories will make everyone's Mac an even friendlier computer."

★★★★ MacUser Magazine

"The Apple Should Have Included It as Standard Award goes to MenuKey, one of the items in Cortland Computer's TopDesk."

A + Magazine

## TopDesk. The pick to click.

Only \$59.95 Call to order today at (415) 845-1142  
Cortland Computer, Inc. P.O. Box 9916 Berkeley, CA 94709

Circle 418 on reader service card

Macworld is a member of the CW Communications/Inc. group, the world's largest publisher of computer-related information. The group publishes over 50 computer publications in more than 20 major countries. Nine million people read one or more of the group's publications each month. Members of the group include Argentina: *Computerworld/Argentina*; Asia: *Asian Computerworld*; Australia: *Computerworld Australia*, *Australian PC World*, *Macworld*; Brazil: *DataNews*, *PC Mundo*; China: *China Computerworld*, *China Computerworld Monthly*; Denmark: *Computerworld/Danmark*, *PC World*, *Run* (Commodore); Finland: *Mikro*; France: *Le Monde Informatique*, *Golden Apple*, *OPC* (IBM), *Theoreme*, *Distributive*; Germany: *Computerwoche*, *Infowelt*, *PC Welt*, *Computer Business*, *Run*; Italy: *Computerworld Italia*, *PC Magazine*; Japan: *Computerworld Japan*; Mexico: *Computerworld/Mexico*; Netherlands: *Computerworld/Netherlands*, *PC World*; Norway: *Computerworld Norge*, *PC Mikrodata*; Spain: *Computerworld/España*, *PC World*, *Commodore World*; Sweden: *ComputerSweden*, *MikroDatorn*, *Svenska PC World*; United Kingdom: *Computer News*, *PC Business World*, *Computer Business*; Venezuela: *Computerworld Venezuela*; United States: *Amiga World*, *Computerworld*, *inCider*, *InfoWorld*, *Macworld*, *Micro Marketworld*, *PC World*, *Run*, *73 Magazine*, *80 Micro*, *Focus Publications*, *On Communications*.

A PUBLICATION OF  
CW COMMUNICATIONS



# It's alive!



Now available from Human Touch Computer Products, The Three to One Touch™ board brings your Macintosh® alive with stepped-up processing speed, increased power, expandability, and upgradability.

**Speed.** How would you like to increase the speed of your Mac? with the Three to One Touch™ board, you can. It replaces your Mac's 8 MHz 68000 processor with a 12 MHz 68000 processor. This effectively doubles the system's speed because improvements are channeled to processing rather than graphics.

How about the increased speed that comes from storing frequently used programs in ROM? The Three to One Touch™ board provides that too. It can house 512KB of preprogrammed ROM—enough to store large programs permanently in your system!

**Memory.** What would an *additional* 1.5 megabytes of contiguous memory in your Mac mean to you? It would give you the ability to load the operating system, Jazz or Excel and a RAM disk, and there's still space left in memory for processing a spreadsheet twice the size of what you can now do on your current Mac!

**Expandability.** How would you like to open the Mac's architecture so that you could attach an *array* of peripherals? The Three to One Touch™ board's unique interface brings the signals from the 68000 processor to a connector outside the case. HTCP is currently developing a SCSI port and a card cage that will permit the attachment of additional devices.

**Upgradability.** What about further memory expansion? The Three to One Touch™ board can be upgraded to 3.5 megabytes of RAM as soon as the 1 megabyte chips are available *or* additional memory can be accessed via the card cage.

**Compatibility.** The Three to One Touch™ board can be installed in your Macintosh with Apple's old or new ROM. What's more, due to its ability to revert to its original untouched operation, it can run all Mac software.

**Installation.** Here's the catch, right? Wrong! The Three to One Touch™ board installs in minutes and doesn't require soldering or cutting traces. So, you can't do anything during installation that you couldn't readily undo.

Bring your Mac alive with the  
**Three to One**  
**TOUCH™ BOARD**



**Human Touch Computer Products Corp.**  
401 Rt. 70 East, Suite 200, Cherry Hill, NJ 08034  
For more information call (609) 429-6300

Macintosh is a trademark licensed to Apple Computer, Inc.  
Jazz is a trademark of Lotus Development Corporation.  
Excel is a trademark of Microsoft Corporation.

Circle 434 on reader service card

See Us at Booth #1367 at Macworld Expo

# HYPERS THE LESS



## THE WORLD'S FASTEST MACINTOSH.

But besides being a faster drive, HyperDrive is also a smarter drive.

Because it also comes with software that lets you make back-up copies of your data onto diskettes. A print spooler that lets you go on to other jobs while your printer is still turning out the one you just finished. And a security program that protects your files from unauthorized entry.

HyperDrive is far from the least expensive hard disk for the Macintosh. So you'd expect it to appeal to a relative handful of perfectionists who can afford to have high standards.

Not so: More people have bought HyperDrives than any other hard disk for the Mac.

This apparent violation of the laws of economics has a simple explanation: Any hard disk is an investment. And when it comes to choosing investments, cheaper isn't better. *Better* is better.

A line of reasoning that leads straight to HyperDrive.

## A FASTER DRIVE. AND A SMARTER DRIVE.

Ours is the fastest hard disk available for the Mac. Period. It will let you launch Microsoft's Excel, for example, two and a half times faster than one competitor. And quit MacWrite over 40% faster than another.

# DRIVE VS. HARD DRIVES.



**THE WORLD'S FASTEST-SELLING  
HARD DISK FOR THE MACINTOSH.**

You can even buy additional software (HyperNet) that lets you share HyperDrive's 10 or 20 megabytes of disk storage with other Macs on an AppleTalk network.

HyperDrive is also designed with the realization that desk space is parcelled out to each of us in very finite quantities. It's the first hard disk that's installed inside the Macintosh, taking up no more space than a Mac itself and preserving its portability.

## **COMMITMENTS & HAPPY MARRIAGES.**

Finally, since any hard disk represents a long-term commitment on the part of the buyer, we match it with a corresponding commitment of our own.

HyperDrive is backed by over a thousand dealers nationwide. Besides our ninety-day limited warranty, additional warranty coverage (HyperCare) is available for up to three years or longer. (See an authorized General Computer dealer for complete details.) And we're committed to upgrading already installed HyperDrives as refinements are made in the future.

All of which explains why *InfoWorld* judged HyperDrive "unbeatable in the current world of the Macintosh." And why *Macworld* proclaimed it "the happiest marriage of the Macintosh and a hard disk."

If that's the sort of relationship you've been looking for, call General Computer at (800) 634-9737. In Illinois, (800) 854-9737.\*



**GENERAL  
COMPUTER**

The leading edge starts here.

Circle 143 on reader service card



# OMNIS 3 PLUS.™ SAME

Industry experts already agree—  
Omnis 3 is the most powerful database  
available for micros:

*“Omnis 3 is by far the best data base  
program I’ve ever seen for either the MAC,  
other PC’s or mainframes.”*

*(MACazine)*

*“As an applications generator, Omnis 3  
knocks dBase™ and R:base™ out in the first  
round.”*

*(Business Computer Systems)*

## NOW WE’VE MADE IT EVEN BETTER

- Larger datafiles (up to 160 megabytes)
- Text fields with wordwrap
- 60+ new macro capabilities including:
  - calling any other Mac program
  - enhanced user-defined pulldown menus
  - scroll boxes
- Greater speed: access a random record out of 100,000 in .17 seconds
- Multi-user version available for virtually all hard disks

## EFFICIENCY AND CONTROL FOR YOUR BUSINESS

Whether you need a simple mail merge list manager or a complete business information system, Omnis 3 Plus can manage the information

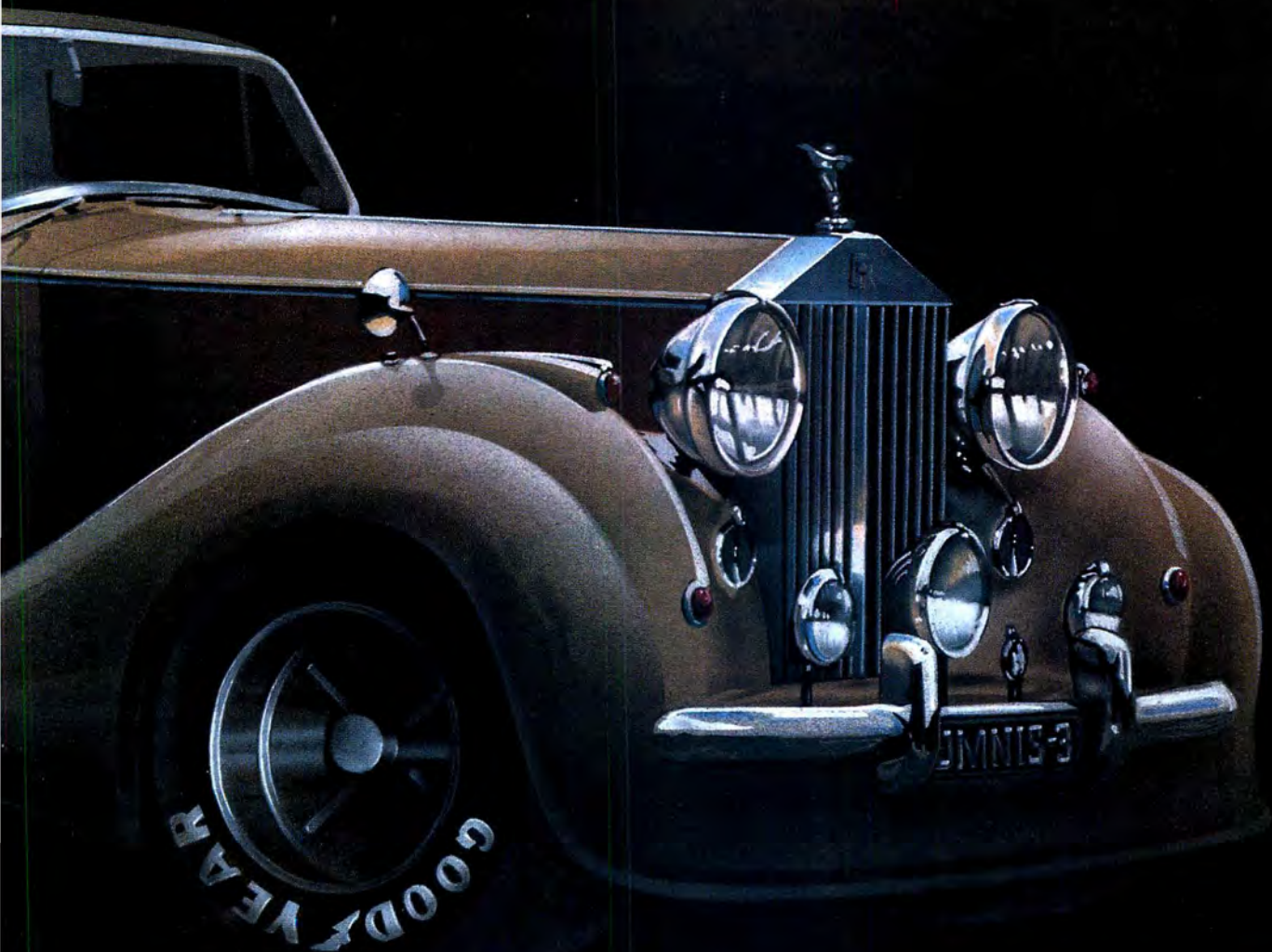

# ELEGANCE. MORE POWER.

to maximize your efficiency and help you gain control of your business decisions.

With hundreds of business applications and many unique features, Omnis 3 Plus will grow with your business. Create your own pulldown menus, or on-screen buttons as well as your own screen and report layouts. Omnis 3 Plus has multi-user capability and unsurpassed speed. It is relational and hierarchical, with full password security and record-locking.

Included with every Omnis 3 Plus system are sample applications like: Accounts Receivable, Inventory Control, Personnel Management, and Time/Cost Recording. A novice in database design can pick up the main Omnis concepts and go on to design highly customized applications for order entry and control systems, real estate management, sales management, and more.

Beginning through advanced training offered. An Omnis 3 Business Directory of current applications and consultants is available. Join the Omnis 3 Developer Program and gain additional support. Contact Blyth for further details.

## OMNIS 3 PLUS™

**ABSOLUTELY  
THE ONLY DATABASE  
YOU'LL EVER NEED.**

Blyth Software  
2929 Campus Drive, Suite 425  
San Mateo, CA 94403  
(415) 571-0222

Omnis is a registered trademark of Blyth Holdings Ltd. dBase is a registered trademark of Ashton-Tate. R-base is a registered trademark of Microrim.

Circle 38 on reader service card



# ORBQUEST

©1986 - Ed Schultz/Mike Mayer

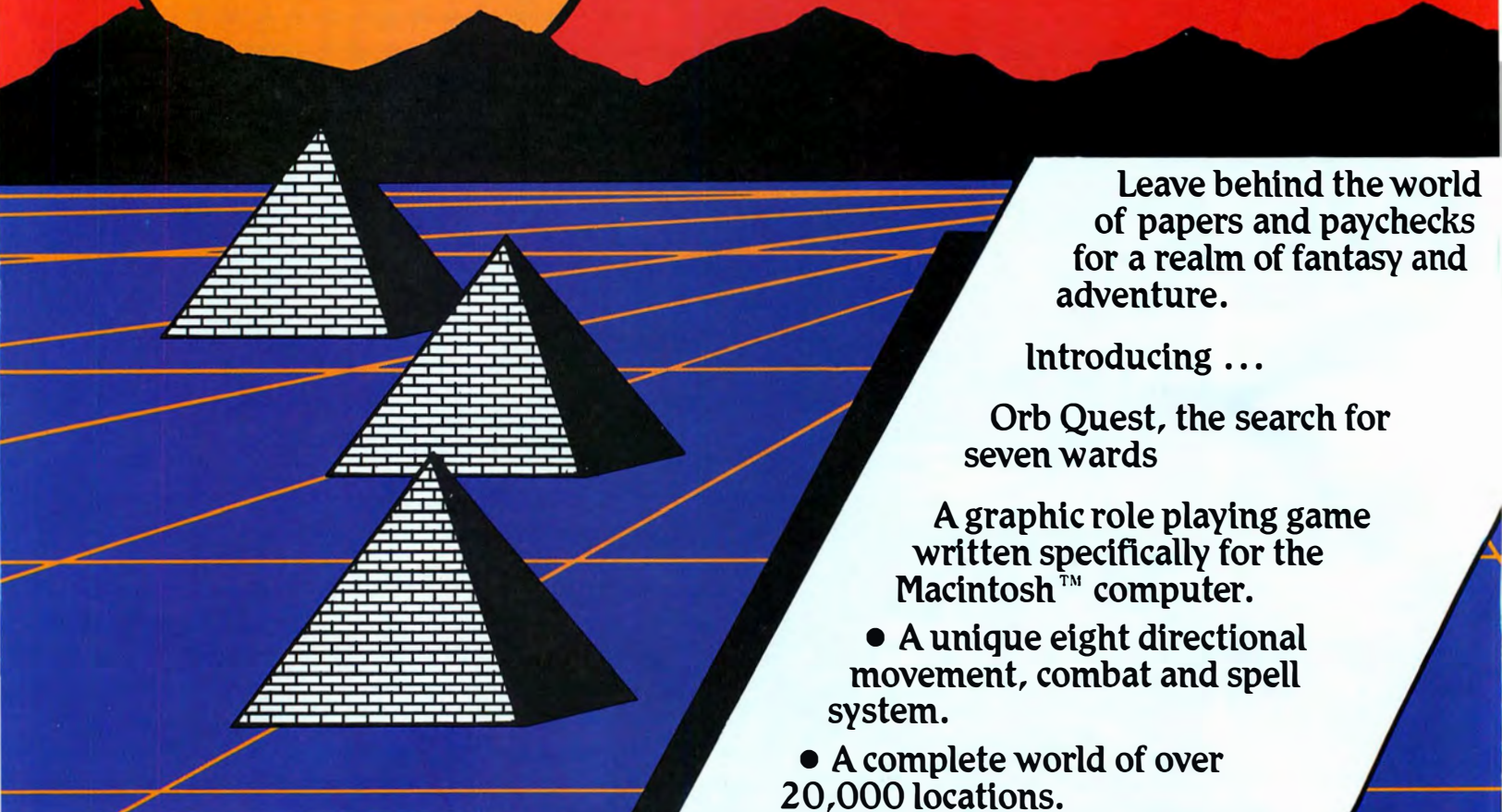

Leave behind the world of papers and paychecks for a realm of fantasy and adventure.

Introducing ...

Orb Quest, the search for seven wards

A graphic role playing game written specifically for the Macintosh™ computer.

- A unique eight directional movement, combat and spell system.
- A complete world of over 20,000 locations.
- Original graphics, including more than 60 newly designed monsters ...

Please send me \_\_\_\_\_ copies @ \$49.95 each  
(Texas residents add 5¼% sales tax)

Enclosed is a check or money order,  
payable to: Qware, Inc. or

Charge my Visa/MasterCard/Amex  
Account.  
Card No. \_\_\_\_\_  
Signature \_\_\_\_\_  
exp. date \_\_\_\_\_

Name: \_\_\_\_\_  
Address: \_\_\_\_\_  
City: \_\_\_\_\_  
St.: \_\_\_\_\_ Zip: \_\_\_\_\_

(please allow 4-6 weeks for delivery)

To Order Call  
**1-800-843-0381, in Texas 1-800-443-2495**

Or send attached form to:

See us at MACWORLD  
EXPO Boston, Booth 219  
Circle 533 on reader service card  
Dealer Inquiries Welcome

**Qware, inc.**  
P.O. Box 850415  
Richardson, TX 75085-0415

# The Software Storm Ahead

*Before the Software Curtain falls, we must do something about the proposed bill that would outlaw software rentals*



*Illegal or unauthorized copies of software often lead to legitimate sales.*

Batten down the software hatches—we're heading for a gale. A move is afoot to introduce a bill in the next session of Congress that would prohibit the rental of personal computer software.

Representative Pat Schroeder, D-Colo., with input from the Software Publishers Association, is sponsoring H.R. 4949, otherwise known as the Computer Software Rental Act of 1986. The issue is complex, problematic, and almost Catch-22 in its ramifications. Although well intentioned, the bill is fraught with danger for the software consumer and the personal computer industry alike.

Why? Because when customers have few meaningful opportunities to test software before buying it, they begin to shrink away from investing in expensive but unproven programs.

Surely we must be able to steer a creative course around the software storm the bill would create. Otherwise a lot of ships are going to go down, with all hands on board.

Schroeder sees software publishers as the sole victims: "Commercial business interests should not be allowed to reap profits from loopholes in the copyright laws or to conduct trade in copyrighted works at the expense of copyright owners."

The "loophole" she refers to is the "first sale doctrine" of the U.S. copyright law, which allows buyers of copyrighted works to dispose of them in any way they choose.

The bill's target is software rental outlets, but the real victim is you—the software user.

In my April 1986 column in *PC World* magazine, I described what I considered the real causes of the decline in personal

computer use. I observed that most software is confusing, difficult, and time-consuming to learn and that good software support is scarce. Consequently, customers become frustrated and give up computing instead of advancing further. Rather than encouraging power users, we end up with powerless users—a sad state of affairs.

Now there is an interesting but controversial way to alleviate some of that software frustration—software rental. By renting a program, potential buyers can test its capabilities to see if it really fulfills their needs, and they can try out new applications as well.

Paul Terrell has helped pioneer the software rental concept with his San Francisco Bay Area chain of five Software Emporium stores. But Paul is not new to pioneering: he started the world's second computer store, which later became the world's first computer-store chain, known as the Byte Shops.

When you walk into a Software Emporium, you can easily mistake it for a video store. Terrell has the titles displayed full-face on all four walls. He has a superb selection of software, including packages for the Macintosh, the IBM PC, the Apple II, and the Commodore 64—a much greater variety of software than you would find in most computer stores. Daily rental fees range from \$1 to \$20, with a minimum two-day rental. If you later decide to buy, you get an attractive bonus: you can apply the full rental cost to the purchase price of the software.

*(continues)*

# MORE™

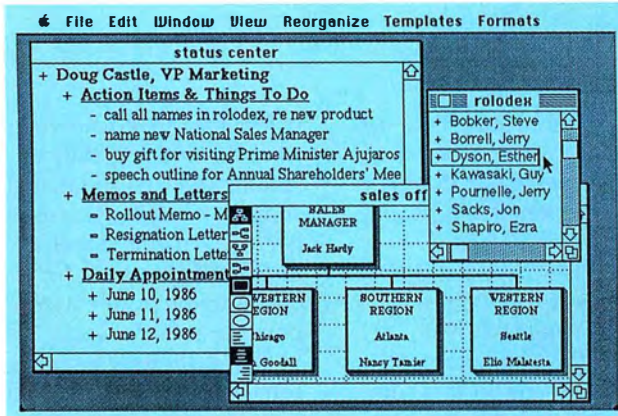

### Presentation to the Board of Directors

- Douglas B. Castle, VP-Marketing
- Price Wars - How they Affect American Tech
- American Tech's Strengths and Weaknesses
- What's the Competition Doing?
- Opportunities
- Why We're Vulnerable
- Recommendations

**1 MORE** can manage up to six 100% Mac-standard outline windows at once, so you can juggle more details, projects, more facts and ideas. Headline levels are represented **visually**, under your control, using **boldface**, *italics* and underlining (check the "status center" window). The "rolodex" window holds phone numbers which can be dialed using MORE's **autodialer**.

**2 MORE** opens a new **desktop publishing** frontier for Macintosh: automatic display and printing of **Bullet Charts**. Your presentations and overhead transparencies look like a professional spent **hours** tinkering with MacDraw.™ This leaves you with **more time** to spend developing, reorganizing and refining your ideas.

<b>MORE Intelligent Idea Processing</b>	<ul style="list-style-type: none"> <li>• hoisting - <i>focus on one section of an outline</i></li> <li>• cloning - <i>dynamic outline cross-references, change one "view," all others change</i></li> <li>• mark+gather - <i>automatic reorganization of outlines</i></li> <li>• pattern matching - <i>context-sensitive and intelligent</i></li> <li>• levels - <i>represented visually using size and style</i></li> <li>• from Living Videotext - <i>the undisputed leaders in idea processing technology</i></li> </ul>
<b>MORE Desktop Publishing</b>	<ul style="list-style-type: none"> <li>• bullet charts - <i>from outlines to overhead transparencies, in seconds</i></li> <li>• tree charts - <i>for timelines, project plans and organization charts</i></li> <li>• direct transfer to page layout programs - <i>Aldus Pagemaker,™ ReadySetGo™</i></li> </ul>
<b>MORE Desktop Productivity</b>	<ul style="list-style-type: none"> <li>• outline templates - <i>create standard outline "forms," makes routine work routine!</i></li> <li>• time management - <i>smart calendar templates, time and date stamping</i></li> <li>• auto dialer - <i>dial a phone number from any headline</i></li> <li>• word processing or graphics windows can be attached to any headline</li> </ul>
<b>MORE Macintosh™ Power</b>	<ul style="list-style-type: none"> <li>• windows - <i>up to six open at once, Macintosh standard</i></li> <li>• window tiling - <i>horizontal, vertical or diagonal</i></li> <li>• standard editing - <i>click anywhere to edit any text</i></li> <li>• transfer outlines: to MacDraw,™ MacWrite,™ Microsoft Word™</li> </ul>

# UNPRECEDENTED



From the makers of ThinkTank 512™

# Unites idea processing technology with the desktop publishing revolution

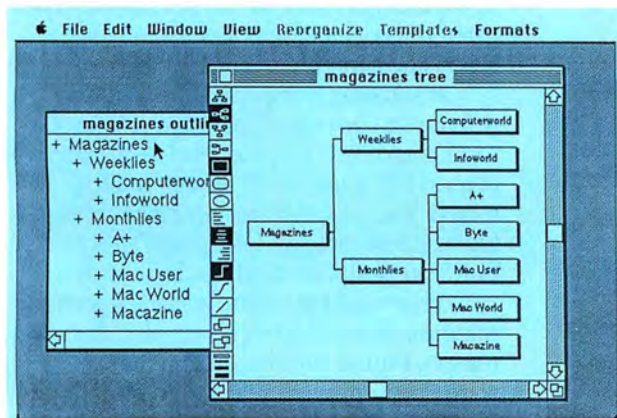

**3 MORE** can instantly transform any outline into a **Tree Chart**, providing a **graphic** way to illustrate your ideas. Tree Charts are great for presentations and organized discussions. Many people find the box-diagram format much easier to follow. Other applications: timelines, project schedules, instructions and documentation, genealogy, tournaments and contests, and of course, **organization charts**. Tree Charts and Bullet Charts **connect** the organizational power of idea processing software to the **desktop publishing revolution**.

**Not copy protected.** Compatible with Macintosh 512, Macintosh Plus, Switcher, Laserwriter, HFS, prints in color with Imagewriter II.

**Suggested retail price: \$295.**

**ThinkTank 512: \$195.**

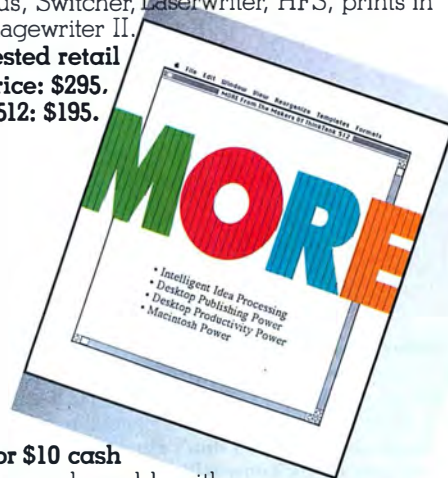
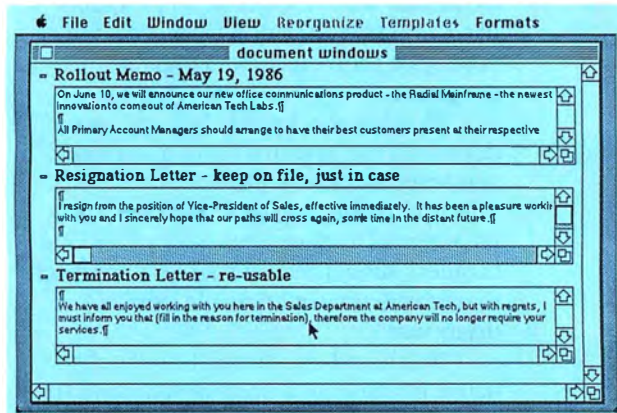

**Call today for \$10 cash rebate coupon**, redeemable with proof of purchase. Registered ThinkTank 512 and ThinkTank 128 users call for a special offer. **Limited time only.**

MORE and ThinkTank 512 and ThinkTank 128 are trademarks of Living Videotext. The names of the products above may be trademarks or registered trademarks.



**LIVING VIDEOTEXT**

*Software that people really use.*

**4 MORE** has the **third-generation** idea processing features you'd expect from Living Videotext, the undisputed leaders in idea processing technology and the company that brought you ThinkTank 128™ and ThinkTank 512™. Cloning, hoisting, mark+gather, promote, demote, **windows within windows**, intelligent pattern matching, outline templates and calendar templates are just the **tip of the iceberg**. We've been listening to your ideas and suggestions, that's why MORE has **more** idea processing, **more** desktop publishing, **more** desktop productivity, **more** word processing and **more** unprecedented power for your 512K Macintosh or Macintosh Plus. **MORE has more of what you want!**

California 800-443-4310

2432 Charleston Road, Mountain View, CA 94043

# CALL 800-822-3700

Circle 50 on reader service card

Limited Time Offer

# The Best of Word. The Best of MacWrite.™

**Word Handler™** takes the easy familiarity of MacWrite and combines the flexibility and versatility of Word for fast, professional-level word processing at the astoundingly low price of \$29.95. But you must act fast.

### Limited Offer for MacWrite Owners Only\*

This is a limited time offer direct from ALS for MacWrite owners while we're stocking dealers' shelves. After that, it will be \$79.95 at your dealer.

### Features

All new for the MAC and MAC Plus™ from the folks with over 100,000 Apple II™ word processing packages in use today:

- opens 4 windows
- horizontal scrolling
- reads MacWrite documents
- convenient utilities
- word count
- automatic abbreviations
- case changing
- on-line help
- and more

**Word Handler does not operate on the 128K Macintosh.**

### How to Order Word Handler

Put your MacWrite master disk in an envelope along with your check for \$29.95 (California residents, please add 7% sales tax) made out to ALS. Or write or phone with your Visa, MasterCard or American Express card number. DO NOT send manual. **You be the judge. If you don't agree that Word Handler is better than MacWrite, just let us know within 30 days of shipment and we will replace your MacWrite disk for just postage and handling.** Allow 6-8 weeks for delivery.

Please send this coupon, your disk, and your check for \$29.95 to:  
ALS, 1283 Reamwood Ave., Sunnyvale, CA 94089

Name \_\_\_\_\_

Address \_\_\_\_\_

City/State/Zip \_\_\_\_\_ Tel. \_\_\_\_\_

Card No./Expiration Date \_\_\_\_\_

Check one:  Visa  MasterCard  American Express



Advanced Logic Systems, Inc.  
1283 Reamwood Ave., Sunnyvale, CA 94089  
(408)747-1988

\*Offer may be withdrawn at any time without notice.

Word is a trademark of Microsoft Corporation. MacWrite and Mac Plus are trademarks of Apple Computer, Inc.

Of course, some people see rentals as an opportunity to steal software. But as a *PC World* software piracy survey showed (see the September 1985 issue of *PC World*), illegal or unauthorized copies often lead to legitimate sales. People try out unauthorized copies of software, and once they're satisfied that the software is good, they most likely purchase it. They want the documentation, the customer support, and the program updates.

Neither Schroeder nor the Software Publishers Association—which is chiefly responsible for drafting the contents of the Computer Software Rental Act—has investigated the correlation between software rental and piracy.

If software companies would allow software to be rented, perhaps rental software could be copy protected, while purchased software would remain unprotected. You could try out any program you found interesting, and if it passed inspection, you would be motivated to buy it.

This would solve the serious training dilemma associated with software. For this reason, I think Paul Terrell and his Software Emporium are really onto something.

Unfortunately, some software rental companies operate on the premise that all software renters are thieves. These stores frequently sell code-breaking programs like *Copy II PC* or *Copy II Mac*, thus encouraging their customers to pirate programs.

This unconscionable behavior is undoubtedly the impetus behind Schroeder's anti-software-rental bill.

The problem with Schroeder's bill is its potential to destroy the software rental business altogether. Paul Terrell's approach to software education would then disappear.

We should encourage Terrell's alternative because it's a positive solution to the number one cause of declining personal computer use: the almost perverse complexity of software.

In announcing her proposal, Schroeder noted the passage of similar legislation banning the rental of audio recordings.

No real parallel exists, however, between the two products. You need not test a record album to determine its value. You hear the music on the radio; then, if you like the song, you buy the album.

Software is different. No store is completely reliable. You can read reviews in

*(continues)*

Circle 525 on reader service card

# Presenting Two Drives...

## Introducing the MagNet 40/40 and the MagNet 30X.

### Speed, Storage, Security, All in One.

The MagNet 40/40 hard drive with tape backup offers speed, dependability, multiuser software, plus peace of mind. Perfect for big applications like desktop publishing, CAD, CAM and financial modeling where large storage and data integrity are crucial. The MagNet 40/40 connects directly to your Mac Plus via the SCSI port or to your Mac 512K by adding our FastPort™ option.



40 Meg Hard Storage and 40 Meg Backup at a Realistic Price

The MagNet 40/40 offers all this power at a small price. Designed to fit under your Mac and into your budget. You waste neither desk space nor dollars.

We based the MagNet 40/40 on the NEC hard drive and the 3M tape 40. Two giants in the industry. We figured it just made sense to work with the best. We added MacServe from Infosphere to give you multiuser, multitasking along with more features than ad space. The result is your hard driving with confidence.



N.E.C.,™ 3M™ and MacServe,™  
Perfect Partners

### The Power/Value Package.

The MagNet 30X with 30 Meg of storage and MacServe software is the perfect choice for users who feel their storage needs will grow. (That about covers all of us, right?) Priced only slightly higher than other 20 Meg hard drives, the 30X gives you 50% more storage.

We designed the 30X with the Seagate ST225 "engine" in mind. Seagate has over 3 million hard drives in use today and was selected by Apple as their hard drive supplier. To complete the package we have included MacServe from Infosphere, the Apple recommended networking solution. We figured why argue with success...



The MagNet 30X, 30 Megabytes  
of Storage for the Value Minded



Seagate and MacServe, Apple™'s Choice

Circle 406 on reader service card

The Macintosh Storage Specialists.

**MIRROR TECHNOLOGIES** Inc.  
**WIBBOB TECHNOLOGIES**

# ...From a Hard

Mirror Technologies. The



Magnum Tape 20

At Mirror Technologies, we've become Macintosh experts by designing storage systems and devices only for the Macintosh. The result is a line of products advanced in concept, quality and reliability. You chose the Mac for its potential as well as its performance. By choosing Mirror Technologies products, you'll finally realize that potential *and* dramatically increase your performance.

## The Tape Drive Worth Waiting For.

The Magnum Tape 20 will backup and restore data on practically any Mac-compatible hard disk. It's quiet because there's no need for a cooling fan. It's compact because we designed it to fit on your desktop with the smallest possible footprint. And it's accurate because it simply has to be. Our software update policy allows you to keep up with our latest utilities. When we improve our Magnum Tape 20, you can improve yours . . . Free.

## How'd We Put 20 Meg Into Something This Small?

It wasn't easy. But when you use our MagNet 20X™ external 20 Meg hard drive, you'll agree it was worth the effort. We packed speed, portability and great software into the most powerful single or multiuser hard drive around. Plug it straight into your Mac Plus SCSI port. Or get SCSI "Plus" performance from your 512K Mac with our FastPort option. The MagNet 20X bundled with MacServe™ features print spooling, disk cache, volume partitioning, full or incremental file backup and true multiuser/multitasking. There's no question why we did it. The only question is how.



MagNet 20 External

## The Money Saving 800K Drive

When we first introduced our Magnum 800™ Mac owners snapped it up. That's understandable. After all, it was not only the first 800K drive for the Mac, it was also very affordable. The Magnum 800 is fully compatible with your 128K, 512K or Mac Plus. It will recognize 400 or 800K formatted disks and write to them accordingly. And it's priced far less than the comparable Apple drive. Now with our new slim line cabinet!

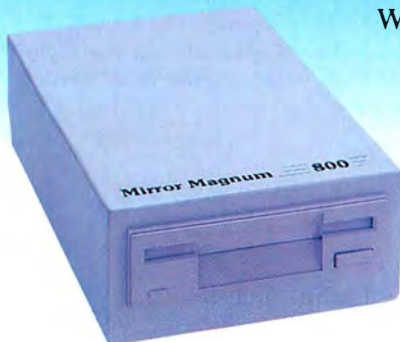

Magnum 800

## One Year Product Warranty

We warranty our drives for one full year. That kind of buyer protection is usually available only as an extended warranty, costing as much as \$300. It's our standard warranty and it doesn't cost you a thing. Naturally, we wouldn't do this if we didn't have complete confidence in everything we make. Well, we have . . . so we do.

# Drivin' Company

## Macintosh Storage Specialists

### Our MagNet 20. The Full Inside Story.

The MagNet 20 internal offers you the capability to build your Mac into a powerhouse computer by internally mounting our drive. Imagine all the speed, portability and convenience of an internally mounted hard drive for considerably less than you would expect to pay the competition. The MagNet 20 also comes bundled with MacServe to give you the power to grow into. **Now every MagNet 20 comes with our WindChill™ option to make the MagNet the coolest running, most reliable internal Mac drive available.**



MagNet 20 Internal

### Hungry For Power?

The MagNet 85 Meg and 172 Meg hard drives combine blistering speed and enormous capacity with tape backup and multiuser/multitasking software to make your Macintosh office an incredibly productive reality. Using voice coil technology, these high capacity drives are three times faster than standard hard drives. Now an entire office of Macs can share data and peripherals for maximum performance and efficiency. The MagNet 85 and 172 can satisfy your hunger for power, no matter how big your appetite.



MagNet 85/172

### Great Hard Drives Deserve Great Software.

And so do their users. That's why all our hard drive products come with MacServe™ from InfoSphere™ at no extra cost. MacServe includes some great single user features but also allows multiuser access to your Mac. With our MagNet drives and their MacServe software, you'll have the kind of power and performance you and your Mac deserve.

**See your authorized Apple dealer for a convincing demonstration of Mirror Technologies storage devices for the Macintosh. Nobody drives your Mac harder.**

The Macintosh Storage Specialists.

**MIRROR TECHNOLOGIES** Inc.  
**MIRROR TECHNOLOGIES**

2209 Phelps Road  
Hugo, Minnesota 55038  
612-426-3276

Circle 406 on reader service card

# If your Mac can't graph like this, it's not quite Cricket.

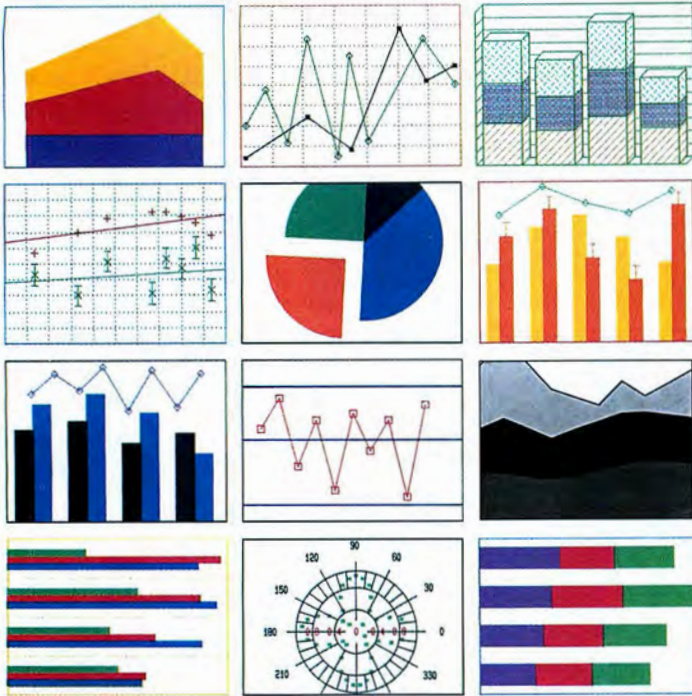

## Cricket Graph

- Get the **12 most popular business/scientific charts and graphs in one package** • Plot **2000 data points per series**. (95% more than any other Mac graphic package)
- Full color and **3-D capability** • Position up to **10 graphs on a single page** • Page layout for **desktop publishing merges graphics with text**

Only one software package arms business and science with the tremendous graphic power of the Macintosh™. Cricket Graph. The first Mac package to deliver all the impact of color presentation charts and graphs. And all the possibilities of desktop publishing. Transform data into graphics that speak louder than words. Then, print your creations out in crisp black and white or brilliant color on any of the most popular Mac-compatible printers, plotters and film recorders. Cricket Graph. Nothing else even comes close. Just \$195. Special versions available for film recorders and other high end output devices.

Requires 512K Macintosh with two disk drives, or Mac Plus with one internal drive. Macintosh is a trademark of Apple Computer Inc. Charts printed on LaserWriter™, Hewlett Packard Color Pro™, and ImageWriter II™



3508 Market Street, Suite 206  
Philadelphia, PA 19104  
(215) 387-7955  
1-800-345-8112

magazines, but they provide only a certain amount of information. You can read advertising claims, but you can never be certain how a particular package might suit you. Until you run it, you can't really tell if it will work in your computing environment.

Because of these fundamental differences, the software business needs different laws than the record business. To draft a bill for the computer industry based on record industry legislation is a critical mistake.

Schroeder expresses concern about software rentals impeding the growth of the software industry because people steal rented software.

Anyone who's involved with personal computers can easily see that software companies impede their own growth when they market programs that don't work and have poor documentation—not to mention undocumented features and substandard support.

I doubt if software rental curtails software sales by more than 1 percent, certainly a marginal amount. On the other hand, software rental enables us to find out whether a program works before we put our money down.

Why should we have to pay \$700 for a database program, only to discover that it doesn't meet our needs, that it's bug-ridden, or that we can't figure out how to use it? Why can't we test-drive it first?

Schroeder's bill assumes that the consumer is wrong and that the software company is right. Ironically, the bill's passage may prove most damaging to those it's intended to protect—the software companies.

Eventually, many software customers will begin to shrink from investing their money in expensive but iffy programs.

And that would be a great loss for everyone—customers and software publishers alike.

Surely, software vendors and legitimate software rental businesses can find a creative solution before Schroeder's Software Curtain falls.

I urge readers to write to Schroeder expressing their concern about her proposed Computer Software Rental Act of 1986: Patricia Schroeder, Congresswoman, First District, Colorado, 2410 Rayburn House Office Building, Washington, DC 20515. □

Circle 384 on reader service card

# SPELLSWELL

for MacWrite™, Word, Think Tank™, and Text documents of any length.

Only Spellswell can find all 10 errors in the following paragraph:

Spellswell is a fast accurate spelling checker for serious word processing. It has many features that no other macintosh spelling checker can match, including checking capitalization of proper nouns, correctly checking abbreviations and contractions, optionally checking homonyms, and a low price. Spellswell has a 60,000 word modifiable dictionary so it does not stop as often at words that are spelled correctly and does not make guesses. Spellswell isn't copy protected so you can easily create a back-up. You don't need a Ph.D. to use Spellswell. 512K. Mac Plus, Mac XL, and HFS compatible.

"It's a super spell checker for the Macintosh — the best out there." — John Dvorak  
 "Our highest recommendation goes to Spellswell."  
 The Macintosh Journal — May 1986

Columnist  
 InfoWorld 5/26/86

\$59.95† Visa and MasterCard accepted.

† Add \$2.50 shipping. Cal. residents add sales tax.

Trademarks: Spellswell — Greene, Johnson Inc.; Macintosh and MacWrite Apple Computer, Inc.; ThinkTank — Living Videotext, Inc.

To Order: (800) 331-4321  
 (In Cal.) (800) 851-1986

Greene, Johnson Inc.  
 15 Via Chualar • Monterey, CA 93940

For Info: (408) 375-2828

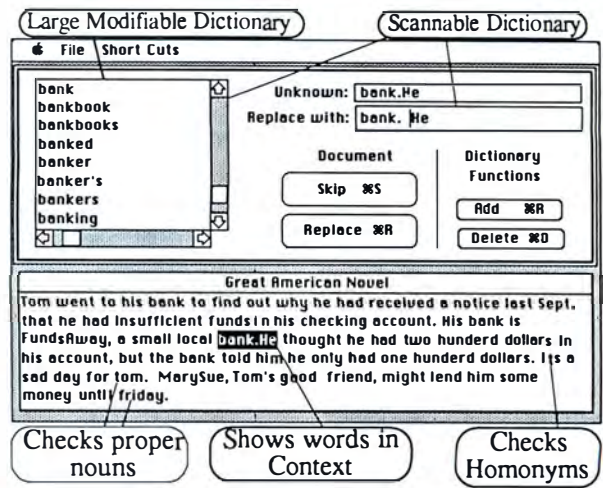

Circle 520 on reader service card

## FLUENT LASER FONTS™

<b>1</b> BODONI Italic Bold BoldItalic	<b>4</b> MONTEREY Italic MEDIUM Bold BoldItalic
<b>2</b> SANS SERIF Italic Book BookItalic DemiBold Demitalic	<b>5</b> Regency Script Calligraphy
<b>3</b> RIGHT BANK RITZ RitzCondensed Ritzitalic	<b>6</b> Prelude Script Light Slant Bold Bold Slant

Now Shipping — Auto-Downloading PostScript™ Typefaces  
 Version 1.0. Six new disks with expanded families and new styles.  
 More styles are introduced regularly—send or call for our catalogue.  
 Each Disk Comes with Screen Fonts and Printer Installation Software

THIS HALF OF THE AD IS FROM ONE PAGE OF ACTUAL LASERWRITER OUTPUT USING PAGEMAKER 1.2  
 FOR ORDERS CALL (800) 331-4321 OR IN CALIF. (800) 851-1986  
 FOR INFORMATION CALL (408) 646-4660 • MCI Mail: CASADY 272-1695

**Casady Company**

P. O. Box 223779  
 Carmel, CA 93922

TRADEMARKS: Fluent Fonts, Fluent Laser Fonts—Casady Company; Macintosh, LaserWriter, ImageWriter—Apple Computer Inc.; PostScript—Adobe Systems Inc.; PageMaker—Aldus Corporation.

Visit Us in Booth 1240 at the  
 Boston MacWorld Expo

# NOW YOU AND YOUR BUSINESS CAN DO MORE OF WHAT YOU DO BEST

## Double Helix

Double Helix is a data-based information management and decision support system—a complete application building environment. With Double Helix you can design a system to run a small business, medium office, or large departmental project.

### Works the way you do

Create a complete system according to what you know best—your own business and how it works. Double Helix will not force you to change the way you work. There are no imposed restrictions, artificial structure, or arbitrary procedures. Relational design means that information once entered can be used in any way—now or in the future. You can produce cash-flow statements, customer profiles or research summaries without having to re-enter data. Double Helix is uniquely flexible. It lets you respond to new ideas and evolving conditions as they occur—without having to rebuild your application. And no matter how much your business grows, the Helix environment expands to grow with it.

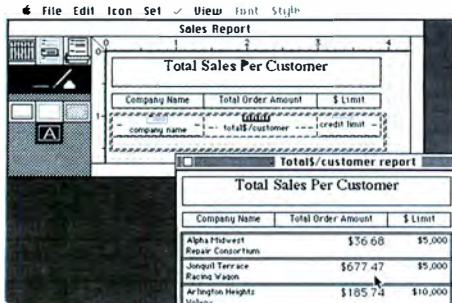

Design forms that reflect the way your business works—from mailing labels to entry forms to presentation-quality reports. All Macintosh fonts, styles and graphics capabilities are supported.

### No programming necessary

Use icons and visual design tools to create all the vital input and report forms, lists, analyses, and mail merge letters needed to run your business. No need to learn a programming language, understand arcane command codes or special formulae. Visual building blocks let you quickly set up data-based calculations to take care of any business need; from order entry, inventory control and invoicing to sales analyses, budget tracking and asset management.

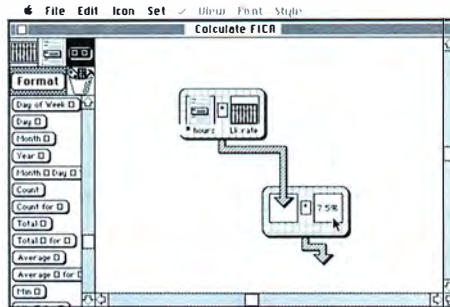

With Double Helix, you can fashion visual statements almost as easily as you can say them. Click & drag from among more than 80 calculation tiles in the list to the left. Then just drop in icons or type in constants. Connect with arrows, and you have made a powerful "program" that works automatically wherever it is placed.

### Now, applications that anyone can use

Create custom menus with Double Helix. Productive work begins immediately, without computer training or technical support. You can even set passwords to secure your sensitive information and prevent unauthorized changes.

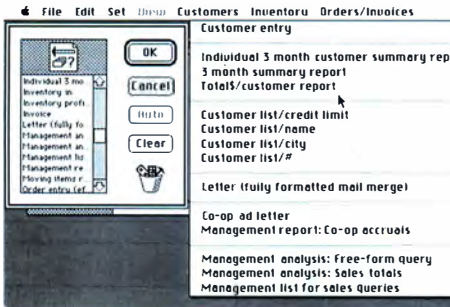

Simply type your own menu names into the Macintosh menu bar; drag form names into the menu and click OK. From then on, just pull down menus to make forms appear for entry, automatic reports, and printing.

### Full support from Odesta

This package includes: three disks (the Double Helix program disk, System disk, and Resource/Work disk with sample applications), two reference manuals, a Quick Start Manual and an 18-ring project binder with note pad. To Odesta, your business is as important as our own. Call us toll-free with technical questions or to inquire about our Consulting and Design Services.

## Key Features

- Custom menus for full tailoring of applications
- Relational capabilities including subforms to dynamically unite sets of information
- All fonts, styles and graphics supported on-screen and in printing with ImageWriters and LaserWriters
- Double Helix applications work with MultiUser Helix, RunTime Helix and Remote Helix
- Variable length fields, up to 32,500 characters each
- Length of records and files is unlimited
- Number of fields and records is unlimited
- Data stored as text, numbers, pictures, dates, or flags
- Over 80 calculation tiles representing arithmetic, date, text, and logical operators, functions and values
- Unlimited key fields and automatically updated indexes
- On-screen Help, Custom Help, and "Why" messages explaining how Double Helix works
- Export/import of data to and from minicomputers, mainframes, or other applications in any ASCII file format
- Interactive on-form and linked-form query functions
- Fast searches and lookups (1.5 second retrieval on 10,000 records)
- Built-in text formatting, including copy, cut, and paste
- Three levels of password protection
- Supports AppleTalk, HD20, and third party hard disks, digitizers and hardcoding
- Automatically utilizes up to 4 Mb of memory
- Data entry facilitated by optional use of command and cursor keys
- Graphic elements may be stored as data or used as form decoration
- Supports 17 digit precision SANETM package (a full implementation of IEEE floating point standard)

### Requirements

- Works with the Macintosh Plus, Macintosh 512K Enhanced, Macintosh 512K with external drive. Hard disk or 800K drives recommended.



Odesta Corporation 4084 Commercial Avenue Northbrook, IL 60062 U.S.A.

© 1986 Odesta Corporation. Odesta Helix and Double Helix are registered trademarks of Odesta Corporation. Macintosh is a trademark licensed to Apple Computer, Inc. by Macintosh Laboratories.

Circle 13 on reader service card



VISIT US AT  
MACWORLD EXPOSITION  
BAYSIDE EXPO CENTER, BOSTON  
AUGUST 14-16, 1986



# Born-Again Enthusiast

*New prospects for the Mac revive the spirits of a jaded computer watcher*



*'Next year will begin a halcyon period for computing.'*

After nearly a decade of work in the computer industry, I sometimes forget my original wonder with computers. Over the years my concern for the business of computers and electronics displaced my fascination with technology and its impact on society. Exuberance gave way to ennui, arising in part from the constant changes that occur in semiconductors, computers, communications, and manufacturing—enough to numb the most avid enthusiast. In part my feelings are shaped by experiences as a computer owner—feelings such as frustration with the amount of money I've invested, the recurring sense that my computer should be able to do more, and impatience with mechanical foibles.

Joining *Macworld* last November has recharged me with the same intensity I felt when microprocessors were new and personal computers were becoming a reality. For my first review of an Apple II (16K) in 1982, I had to tinker with the integrated circuits on the motherboard to attach a color monitor; fortunately the frustration level has decreased since then.

My enthusiasm has returned, not so much because of the Macintosh but because of Apple's commitment to the Macintosh product line's expandability and performance. Next year will begin a halcyon period for computing: the year 32-bit microprocessors combine with photographic-quality computer graphics, communications, and a wealth of new functionality to make the desktop computer exciting again. Not the excitement of slick ad campaigns, but the thrill that keeps us up nights learning how to do things with our computers.

The Macintosh product family will be a focal point in this era in which personal computers support advanced operating systems—such as UNIX—without causing us to resort to programming or arcane syntax. An era in which many manufacturers

*Editor Borrell joins Apple executive vice president Del Yocam for a look at the new Cray supercomputer.*



will offer computers that use the desktop, window, and icon metaphors. The Macintosh family is likely to stand in the middle ground between the mass-marketed offerings from Atari and a new generation of products from Sun Microsystems, IBM, and Apollo. The open Mac has the potential, if prices are kept low enough, to instigate another bull market like the two-year personal computer boom that began in 1982.

I hope this is the era of computing machines that allow us to grow as technology becomes more sophisticated—to graphic displays that rival nature in richness and detail, to programs that compete with the sophistication of human thought, and to communications as simple as the telephone system. We can see the rudiments of each of these: AT&T and Sun cooperating on UNIX development, implementation of advanced graphics techniques at Pixar, and the openly discussed Macintosh of this winter.

We are on the edge of a technological dream, waiting to see what appears when we open our eyes. □

# THESE EXPERTS

"As a painting program, *FullPaint* ranks at the top of the list..."  
—Frank M. Tansey,  
Review Board, InfoWorld.

"*FullPaint* is absolutely the only choice in Macintosh graphics generation, bar none."  
—Alan Stevens, MacTimes

"One of the best programs out for the Macintosh in a long time."  
—Dan Kohn, Learning Center, Ltd.

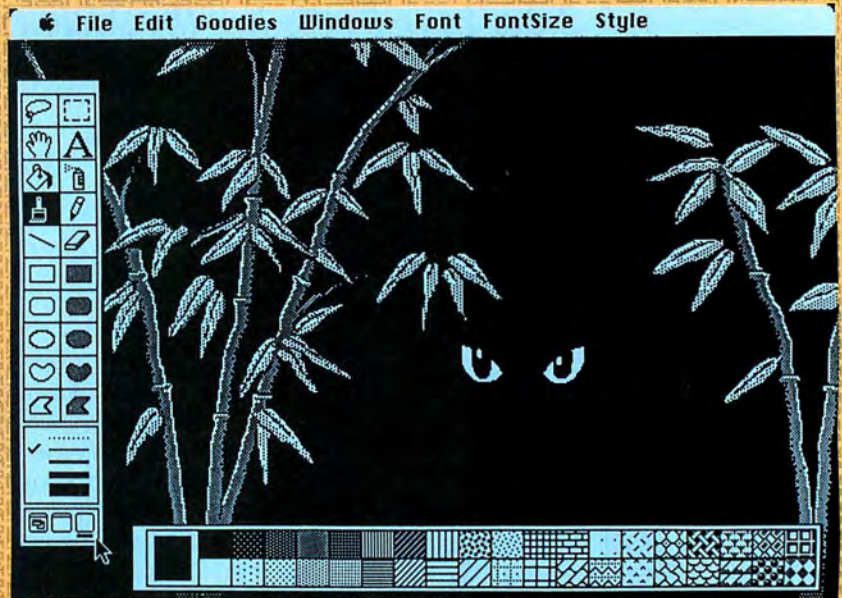

# HERE'S

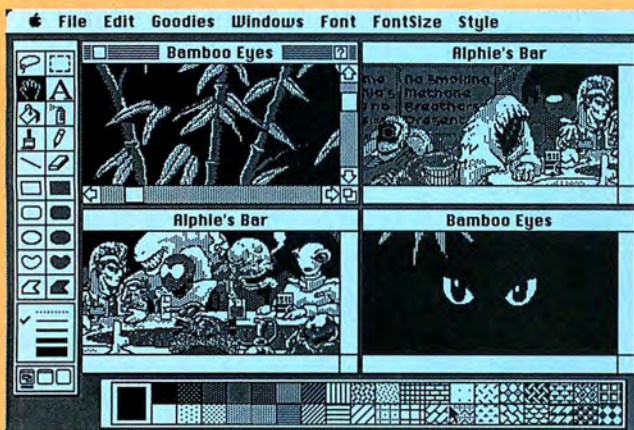

Edit four documents with FULL cutting and pasting between them and FULL compatibility with MacPaint documents and clip-art.

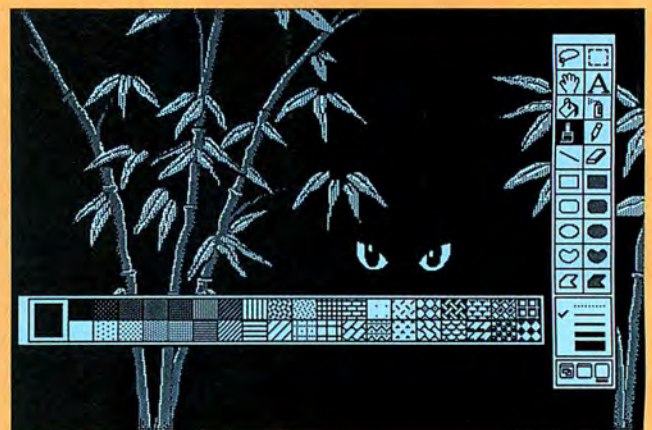

FULL screen editing capability, with tools and palettes that can be moved and/or hidden.

The reviews have been nothing short of fantastic, and we think well deserved, too. Features like automatic scrolling of tools in FatBits, editable brush shapes, LaserWriter support, poster and banner printing capability, custom font sizes, special effects tools to skew, rotate, and distort images as well as giving a 3-D perspective to drawings, are just some of the many powerful features built in to *FullPaint*.™ Features that make graphics production faster, simpler and more productive.

# CHOOSE FULLPAINT.™

"If you bought a Mac Plus, you should purchase *FullPaint* instead of MacPaint."

—David Biedny, MacUser

"*FullPaint*...it's the hottest and most powerful graphics software for the Mac ever created."

—Icon Review

"*FullPaint* is the very definition of an excellent value."

—Frank M. Tansey,  
Review Board, InfoWorld.

"There is no other product today that puts this much power into the hands of Mac owners."

—Ingram Update,  
Ingram Software

"*FULLPAINT*, from Ann Arbor Softworks, Inc., is the most appropriately named new product that we've come across this year. It is an enhanced, extended MacPaint, which should now probably be more logically called Halfpaint."

—Computer Shoptalk

## WHY:

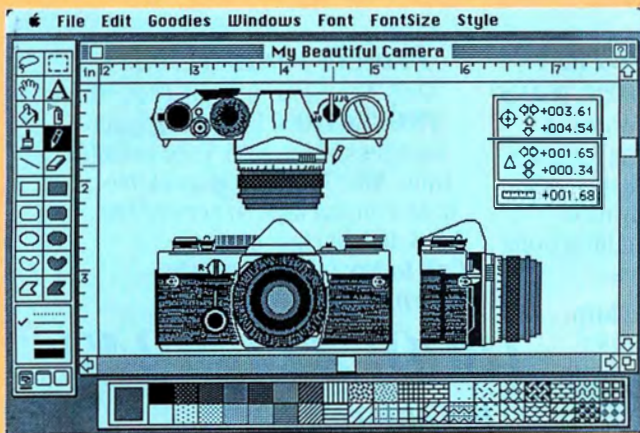

MouseSpot™ Pop-Up rulers and MouseCrawl™ for precision drawing and painting.

Compare *FullPaint*™ with MacPaint™ side by side at your local dealer.

We're sure you'll agree with us when we say that a two year old program can be an antique.

Circle 204 on reader service card

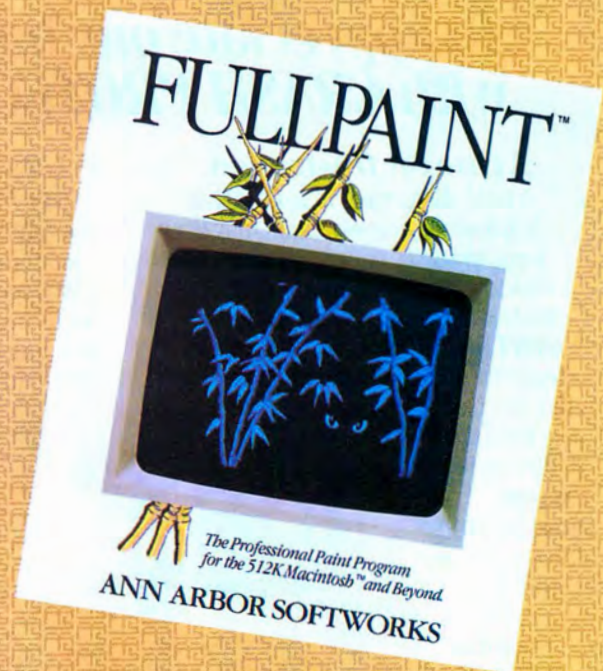

## Ann Arbor Softworks Inc.

308½ S. State St. Ann Arbor, MI 48105 313-996-3838

FullPaint, MouseSpot and MouseCrawl are registered trademarks of Ann Arbor Softworks. MacPaint is a registered trademark of Apple Computer Inc. Macintosh is a trademark licensed to Apple Computer Inc.

# You don't have to experience a disk crash



## To appreciate our hard disk with **CRASH PROTECTION**.

### **A cure for frustration.**

A hard disk crash is frustrating. You lose all your work and may even want to throw your system out the window. But now there's an alternative. The new MacSlimLine™ with **CRASH PROTECTION** protects data files—and pedestrians below—from the frustration of disk crashes.

**CRASH PROTECTION** is an *exclusive* MacSlimLine feature that **puts an end to data loss due to hard disk crashes**. Total data protection!



Univation's MacSlimLine is a 20, 30, or 43 megabyte, high speed SCSI hard disk/file server with **CRASH PROTECTION** built in.

### **CRASH PROTECTION protects you three ways:**

- **AWS™** (Advance Warning System). Unique in the industry, AWS monitors hard disk operations and provides advance warning of common malfunctions that lead to disk failures.

- **Tape Backup.**

Proven on larger systems, magnetic tape duplicates all MacSlimLine files quickly and easily. And,

- **Automatic Backup.** Programmed memory guarantees that MacSlimLine data is backed up at preset times, every day.

### **Protect yourself today**

Only MacSlimLine has **CRASH PROTECTION**. It can save your business, your data, your valuable time. MacSlimLine is available in streaming tape or removable hard disk backup options.

**Call today for immediate information:**

**(800) 221-5842**

**In California:**

**(408) 263-1200**

 **UNIVATION**  
System Solutions for Business

1231 California Circle  
Milpitas, CA 95035  
(408) 263-1200

TRADEMARKS: MacSlimLine, AWS, Univation—Univation, Inc.

**Circle 549 on reader service card**

# MIDI Life Crisis

*Can a columnist turn into a rock superhero with a boost from the Mac?*

Early in my fourth decade of life, it began to dawn on me that I would never become a rock 'n' roll star. Though I had done little during the past 20 years to advance my musical career—occasionally strumming some coffeehouse tunes on a Martin D-28—this revelation was a dark milestone. You see, I had considered this writing thing a time killer. Something to turn a buck until I could get to the real work: headlining America's great arenas, whipping 20,000 fans into spasms of madness and temporary deafness.

I had just about conceded the field to Bruce Springsteen and Johnny Rotten when I visited some rock record producers. They told me that computer technology had dramatically transformed the recording studio, in the process opening the field to a new class of musician-composer-performer. Someone with good musical ideas but little skill in performing—even a person who can't read music—now has the power to create a “demo” tape that fleshes out ideas into a listenable form.

So when a representative from an electronics company boasted that “anyone can make a hit record in half an hour,” I immediately volunteered. And though I did not make a hit record, I did produce a decently funky rock-fusion ditty using state-of-the-art recording equipment.

## Synthful

But how many people have state-of-the-art recording equipment? Not me, to be sure. But recently I acquired an amazing toy—a Casio CZ-101. Retailing at under \$500 and available at some discount outlets for half that price, the 101 is quickly becoming

the Volks-synthesizer. Though you might not find it in Herbie Hancock's keyboard armada, it is a real synthesizer, allowing users to construct sounds by manipulating the elements of sound itself. It can make fairly convincing imitations of almost every instrument imaginable. And by using something called a MIDI interface, the CZ-101 can hook up to my Macintosh and make real magic. As well as some music.

Instead of launching into an explanation of MIDI and its significance in changing modern music, let me get to the bottom line. Can the combination of Macintosh and Casio make me a rock 'n' roll star? To the mental accompaniment of Ray Davies singing “Low Budget Man,” I decided to try an experiment: how much music power can a synthesizer-ignorant Macintosh owner obtain by spending only a few hundred dollars on equipment and software?

The first requirement is the device that allows the synthesizer to communicate with the Mac. Several are available, and I settled on the Assimilation MIDI Conductor, which lists for \$89. I had no problems with it, but not long into my new career as a digital musician, I purchased a Mac Plus and discovered that none of the MIDI interfaces then available worked on the Plus, due to Apple's inexplicable fiddling with the serial port. (Just recently, Opcode Systems released a Mac Plus MIDI interface that lists for \$175.) So I had to forego the ample memory of the Plus and keep using my old Mac.

*(continues)*

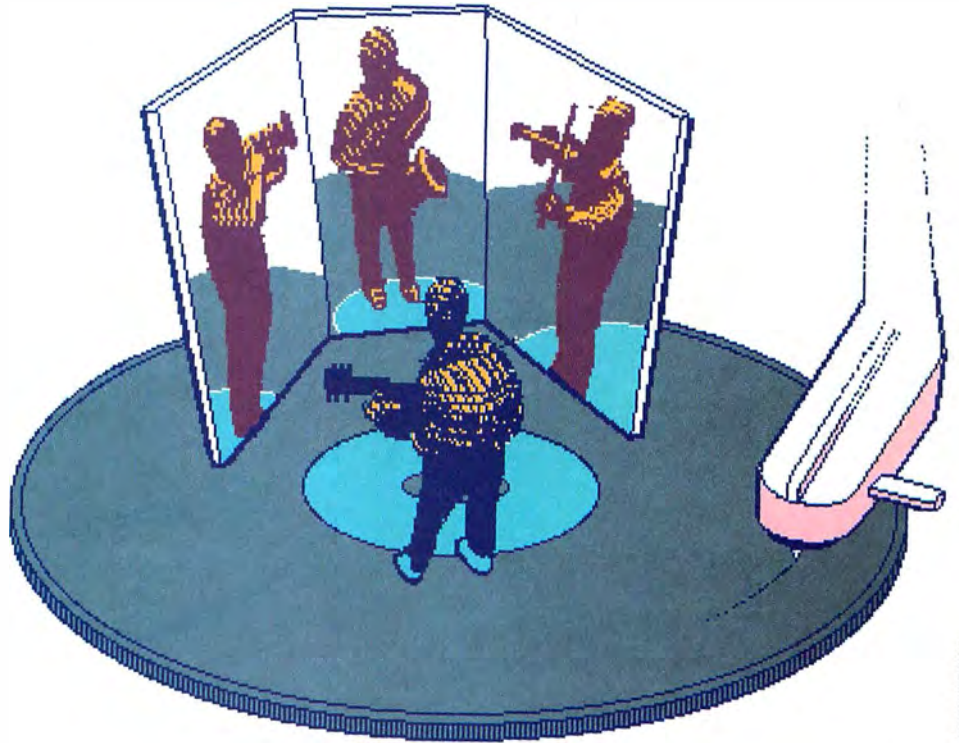

MICK WIGGINS

CONSTANT COMMITMENT

# JAZZ

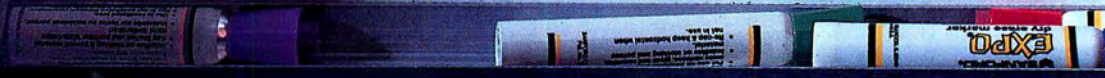
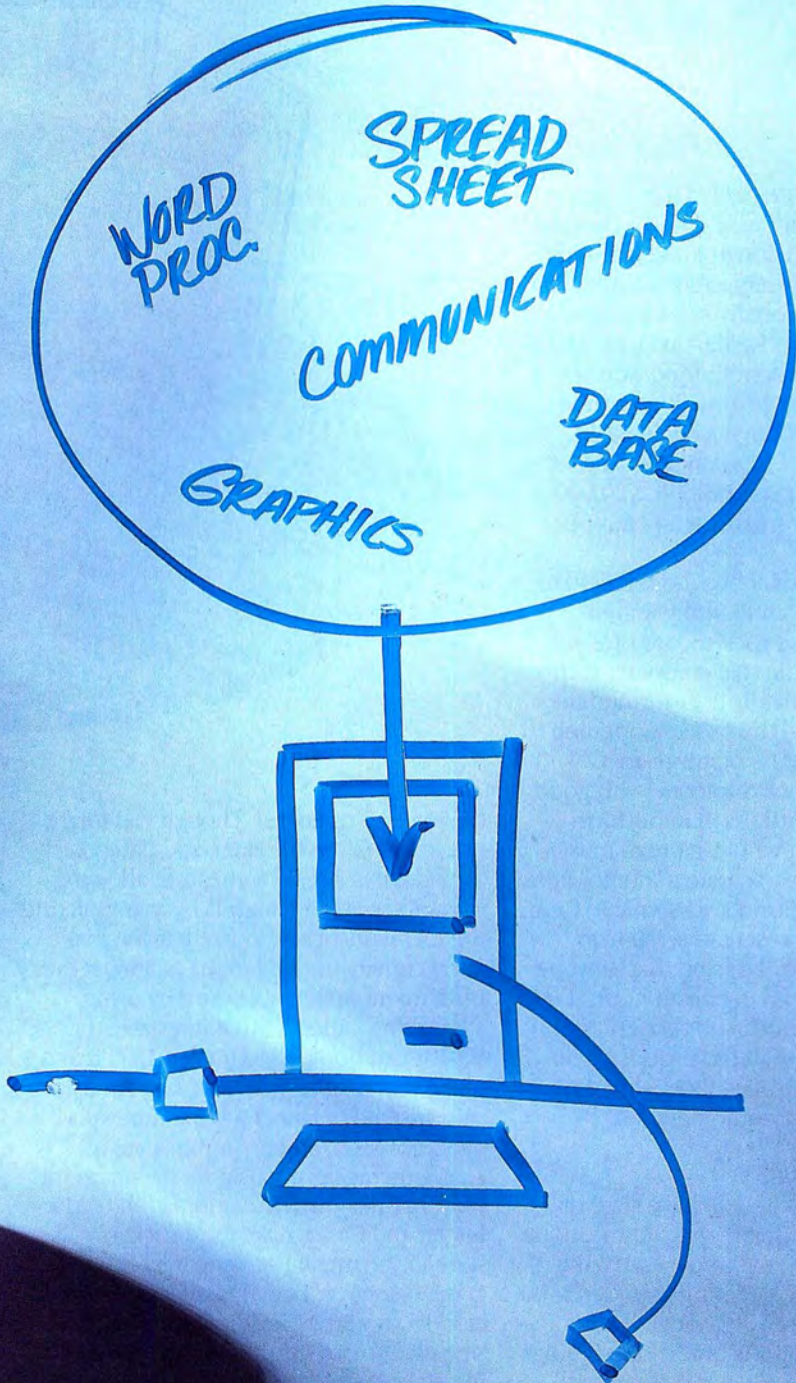

CONTINUOUS  
INNOVATION

# MORE THAN A SPREADSHEET!

You do more than spreadsheet calculations. Jazz® does more than that, too. Five times more than that. More than any other single piece of software made for your Apple® Macintosh™ personal computer.

Five powerful functions—not just a smattering of this and that—but five functions deep enough to stand alone: spreadsheet, database, word processing, graphics and communications.

All five so thoroughly integrated that they work beautifully together through a unique Jazz feature called HotView.

With Jazz you can direct your attention to many projects—or many parts of the same project—without changing programs. With Jazz you can revise or update information in one document or several documents instantly. With Jazz you can work the way you work best.

All of which simply means this: you can be more productive, more effective—you can do more, with Jazz, than you can with any other piece of software.

Go ahead. Get a demonstration at a Lotus authorized dealer.

Your Macintosh is capable of doing a lot more than spreadsheets. For that matter, so are you.

## Lotus Jazz

*Business software for the Apple Macintosh integrating spreadsheet, graphics, word processing, database and communications.*

© 1986 Lotus Development Corporation. Lotus and Jazz are registered trademarks of Lotus Development Corporation. Macintosh is a trademark of McIntosh Laboratory, Inc. and is used with expressed permission of its owner. Apple is a registered trademark of Apple Computer, Inc.

THE POWER DESK

JAZZ  
+  
MAC



The interface plugs into the modem port and comes with the proper cables to hook into the Casio. The ease of the connection only heightened the uneasy feeling I had about hooking up a musical instrument to my computer. Even though I knew that the musical instrument in question was a computer (a digital synthesizer has more chips than a bag of Fritos), it seemed impious. Not the kind of thing that Beethoven might try. But then I recalled that the initial response to the electric guitar was horror and ridicule. Like B. B. King and Bob Dylan, I embraced the marriage of music and technology.

**Sounds Right**

The first piece of software I tried was *Patch Librarian*, by Opcode Systems. *Patch* is synthesizer lingo for a sound, be it one that emulates a violin or a cat being stepped on. The Casio has 16 preset patches in ROM—standard stuff like organ, trumpet, and bass—and room for 16 “internal” patches in RAM. The preset sounds are there for eternity; the internal ones can be programmed by a hideously tedious process of fixing parameters, wave envelopes,

and other Theory of Acoustics esoterica. Once you create the patches, you store them on a RAM cartridge that holds 16 patches and costs \$35. Or at about a hundred dollars a shot, you can buy additional preprogrammed patches. The synthesizer may be cheap, but the sounds aren't.

The solution is *Patch Librarian*. For a mere \$50, this program gives you over a hundred sounds and allows you to store hundreds more on a Mac disk. I spent a few hours merely testing the sounds, everything from a soothing acoustic guitar to something that sounded like Jimi Hendrix orchestrating the closing scene of *Apocalypse Now*. I can't imagine anyone with a Casio and a Mac not taking advantage of this software. (Opcode is also about to release a patch editor, which will greatly simplify the process of programming your own patches; at \$125, *The MIDIMAC Patch Editor* will include *Librarian*.)

Armed with proper sounds, I was ready to do the hard work of recording. I gave myself a modest challenge—to produce a version of Rockin' Sidney's great zydeco hit, “(Don't Mess with) My Toot-Toot,” with several instruments going at once. One handicap was my near-complete

inability to play keyboard instruments. But I figured that technology could easily compensate for that.

Using traditional sound studio technology, I'd have to record my performance track-by-track on a tape recorder. The computer equivalent of a multitrack tape recorder is a sequencer: it does the job of a tape machine but stores music digitally. Several good under-\$200 sequencer programs are available for the Mac. I tried Opcode's *MIDI Mac* sequencer and the *Mega-Track* sequencer, by Musicworks. Both employ tape-recording metaphors, and their screen displays include record and playback “buttons.”

I played a few chords on the synthesizer and chose Playback. It was startling to hear my fumbling progression precisely echoed. I realized that using the computer as a sequencer forces you to rethink your concept of music. Musicians generate information. So when I press three keys on the Casio, the cable labeled MIDI Out tells the Macintosh not only which keys are being pressed but also the characteristics of the

*(continues)*

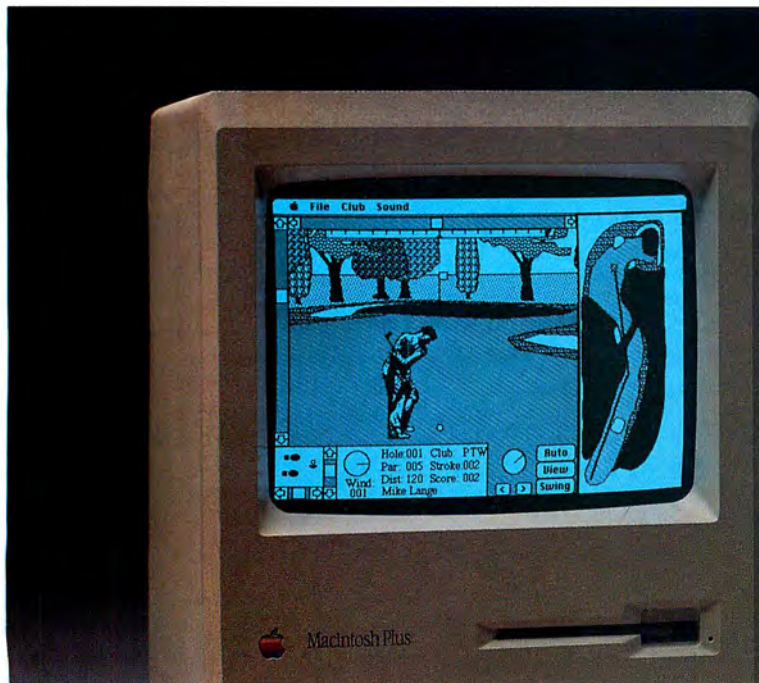

# The MacGolf™ Challenge.

Sit down, boot up and find yourself surrounded by the sights and sounds of the fair way – with MacGolf, the premier simulation golf game for Macintosh™ users.

MacGolf challenges beginners and experts with 3-dimensional animated

golfers and graphics, realistic (digitized) sound effects, and two 18 hole golf courses. Up to four people can play.

MacGolf works on a 512K or Macintosh Plus and costs only \$59.95. Get MacGolf at your nearest dealer

today. Or call Practical Computer Applications at (612) 427-4789.

## MacGolf™

Macintosh is a trademark licensed to Apple Computers, Inc. MacGolf is a trademark of Practical Computer Applications, Inc.





Perfection of both form and function. Scandinavian designers tolerate no less. Thus, MacTable. Perfect form and function for your Macintosh.

### Largest Macintosh peripheral.

Use MacTable just once and you'll think of it as a peripheral, not furniture. Because it's designed exclusively to match the unique dimensions and features of your Mac.



Scandinavian steel support bars make MacTable as sturdy as it is attractive. A full carton of printer paper is hidden from view.

Dimensions  
large: 60" W x 30" D x 27" to 29" H. 137 lbs.  
small: 42" W x 30" D x 27" to 29" H. 101 lbs.

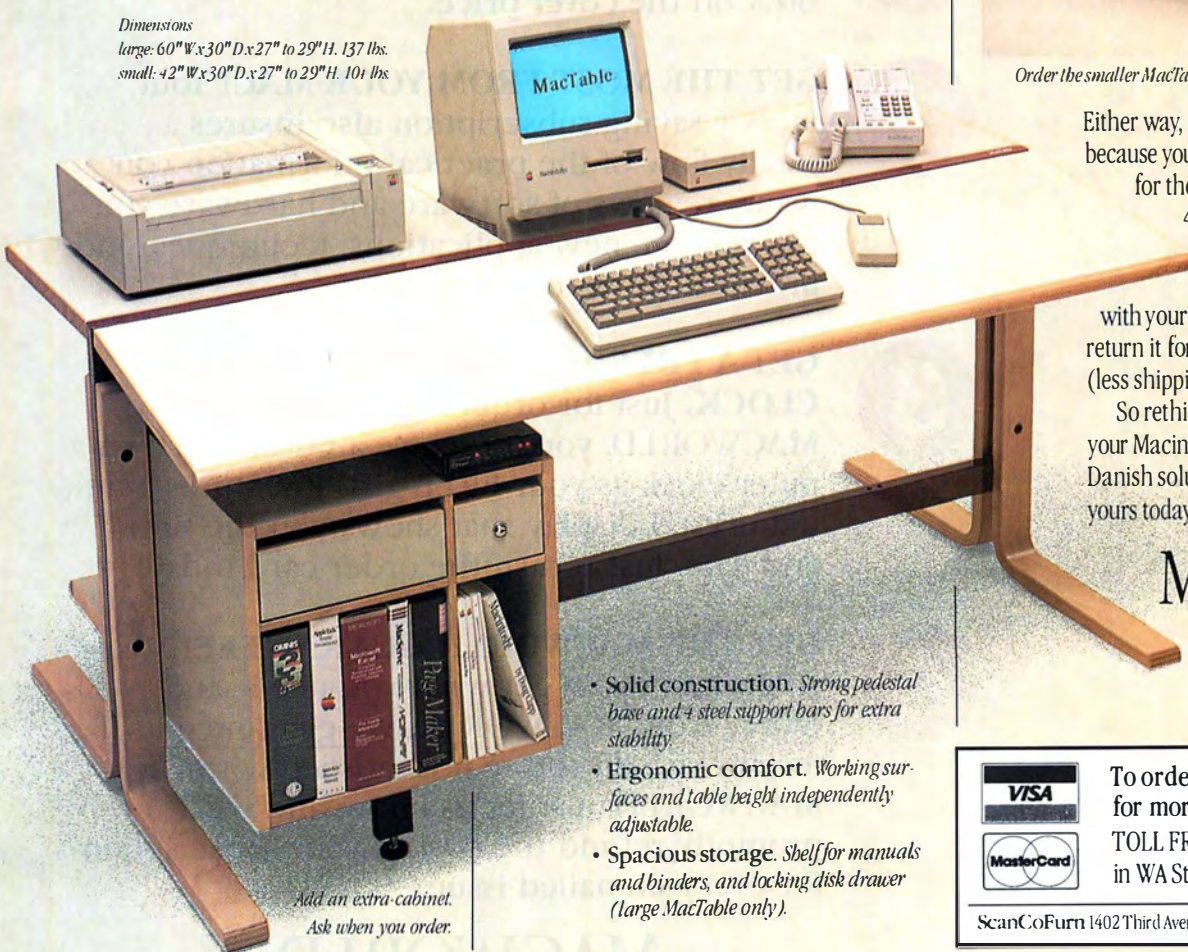

Add an extra cabinet. Ask when you order.

- **Solid construction.** Strong pedestal base and 4 steel support bars for extra stability.
- **Ergonomic comfort.** Working surfaces and table height independently adjustable.
- **Spacious storage.** Shelf for manuals and binders, and locking disk drawer (large MacTable only).

# Denmark rethinks the computer table.

It has a place for everything. Disk drive, modem, keyboard, mouse, plus an imagewriter, and a full carton of paper. Yet even with a full complement of gear, there's room to spread out for serious work.

### Comfort means productivity.

MacTable provides the comfort necessary to do your best work. The steel frame can be adjusted from 27" to 29" high. And each of its four surfaces are independently adjustable planes. You can even lower the Macintosh shelf to accommodate a hard disk. Without changing your most comfortable viewing position.

### Stands the test of time.

MacTable is meticulously built by Danish craftsmen, using pure beech wood, durable laminates, and carefully-enameled 14-gauge Scandinavian steel.

Its sturdy construction and striking European looks will last a lifetime.

### Fits your office and budget.

Choose the 60-inch MacTable, large enough to be your stand-alone desk. Or select the compact 42-inch MacTable if space is limited, or to use as a second desk.



Order the smaller MacTable if your space is limited.

Either way, you save with MacTable because you buy direct. Just \$399 for the 60" table, \$339 for the 42" (prices plus shipping & handling). And if you're not satisfied with your MacTable for any reason, return it for a prompt refund (less shipping).

So rethink the desk you use for your Macintosh. Then switch to the Danish solution. MacTable. Order yours today.

## MacTable®



To order your MacTable or for more information call:  
TOLL FREE 1-800-722-6263  
in WA State (206) 621-7911

ScanCoFurn 1402 Third Avenue, Suite 1414, Seattle, WA 98101

MacTable design Patent Pending. MacTable is a registered trademark of Scandinavian Computer Furniture, Inc. Apple is a trademark of, and Macintosh is a trademark licensed to Apple Computer, Inc.

Circle 400 on reader service card

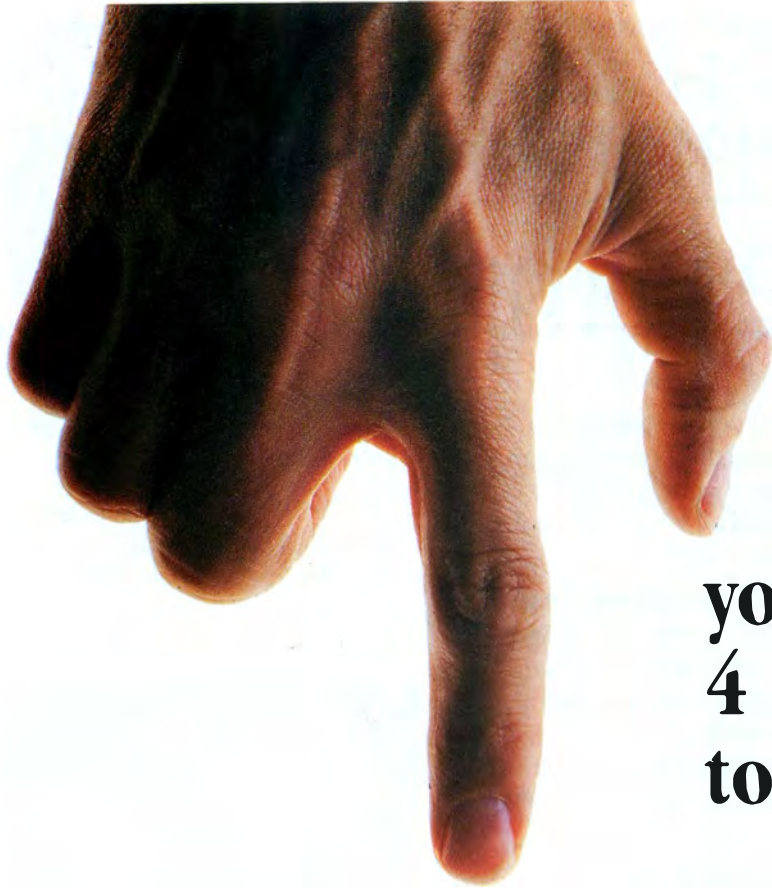

## You've put your finger on 4 key reasons to subscribe . . .

**1**

**SAVE OVER \$27 A YEAR!** Your subscription means handsome savings for you—almost 60% off the cover price.

**2**

**GET THE MOST FROM YOUR MAC!** Your money-saving subscription also insures a steady flow of the practical information you want—reviews of software and hardware you can rely on, new applications, techniques, and practical “how-to” tutorials.

**3**

**GET A FREE MACWORLD COMPUTER CLOCK.** Just for ordering a subscription to MACWORLD, you'll receive a miniature computer clock as your FREE gift. It features a liquid crystal display that shows you the time and date. Just return the order card today!

**4**

**GET THE MACWORLD GUARANTEE!** We're so certain you'll get what you need—and more—from MACWORLD, we guarantee it! If for any reason you're not satisfied with MACWORLD, just let us know, and we'll promptly refund the cost of your subscription for every unmailed issue.

**MACWORLD**  
*The Macintosh® Magazine*

Save

\$27.45

off the

~~\$47.40~~

cover price



**Order Now to Take Advantage of These Special Savings and Receive Your FREE Computer Clock. Limited-Time Offer!**

**Call TOLL FREE:  
800/524-3200**

**Visa and MasterCard Accepted!**

**SUBSCRIBE NOW**

- YES!** Please send me one year (12 monthly issues) of *Macworld* for only \$19.95, and the FREE computer clock. I'll save \$27.45 off the annual cover price of \$47.40, a savings of almost 60%. (That's over \$10 off the regular subscription rate of \$30.)

**SAVE EVEN MORE!**

- \$37.90 for 2 years (24 monthly issues)  
 Payment enclosed     Bill me later

Name \_\_\_\_\_

Company \_\_\_\_\_

Address \_\_\_\_\_

City, State, Zip \_\_\_\_\_

Please allow 6 to 8 weeks for delivery of your first issue. Offer good in U.S. only. Offer expires February 28, 1987.

4A7A5

**MACWORLD**

*The Macintosh Magazine*

**SUBSCRIBE NOW**

- YES!** Please send me one year (12 monthly issues) of *Macworld* for only \$19.95, and the FREE computer clock. I'll save \$27.45 off the annual cover price of \$47.40, a savings of almost 60%. (That's over \$10 off the regular subscription rate of \$30.)

**SAVE EVEN MORE!**

- \$37.90 for 2 years (24 monthly issues)  
 Payment enclosed     Bill me later

Name \_\_\_\_\_

Company \_\_\_\_\_

Address \_\_\_\_\_

City, State, Zip \_\_\_\_\_

Please allow 6 to 8 weeks for delivery of your first issue. Offer good in U.S. only. Offer expires February 28, 1987.

4A7A5

**MACWORLD**

*The Macintosh Magazine*



NO POSTAGE  
NECESSARY  
IF MAILED IN  
UNITED STATES

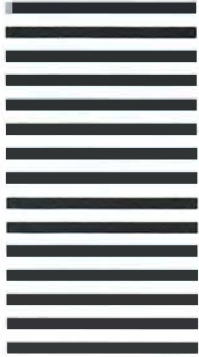

**BUSINESS REPLY MAIL**  
FIRST CLASS PERMIT NO. 1262 BOULDER, CO

POSTAGE WILL BE PAID BY ADDRESSEE

**Macworld**  
**Subscription Department**  
**P.O. Box 51666**  
**Boulder, Colorado 80321-1666**



NO POSTAGE  
NECESSARY  
IF MAILED IN  
UNITED STATES

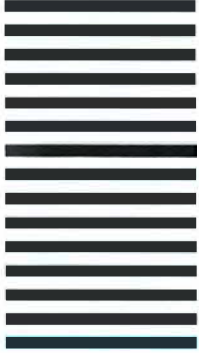

**BUSINESS REPLY MAIL**  
FIRST CLASS PERMIT NO. 1262 BOULDER, CO

POSTAGE WILL BE PAID BY ADDRESSEE

**Macworld**  
**Subscription Department**  
**P.O. Box 51666**  
**Boulder, Colorado 80321-1666**



sound, the volume, and the length of time I'm pressing the keys, and all this is stored in the Mac's RAM (or, if I save it, on a disk). During playback, the computer sends the information back through the MIDI Out cable, and the synthesizer translates it into sound. Just like the information that's stored in the form of a spreadsheet or word processing document, the musical data held by the sequencer is malleable. Once you record something, you can edit it, change the vibrato, make it louder, even transpose it to another key.

**Instant Replay**

Though I spent a lot of time playing with these functions, when I got down to playing "My Toot-Toot," I ran into some problems, especially in figuring out how to get two instrument sounds going at the same time. Eventually I concluded that while *MegaTrack* and *MIDI Mac* offer a variety of features that professionals need, Casio CZ-101 beginners might be frustrated by the resulting complexity. After talking to executives from both companies, I realized that the limitations of the Casio are part of the problem. The CZ-101, unlike its expensive counterparts, supports only a few

patches at once. In fact, if you want to record a song with four tracks playing at the same time, you must use the synthesizer's solo mode, which means you can sound only one note at a time. So much for fancy chording.

Then I booted another sequencer program, the \$139 *ConcertWare+MIDI*, by Great Wave Software. The program has three components: Music Writer, Music Player, and Instrument Maker. I first tried Music Player; I loaded one of the pre-recorded selections, Beethoven's Fifth Symphony, put my earphones on, and waited.

I see a lot of Macintosh software, much of it very good. But only a few programs a year pass the Jaw Drop Test. When something so wonderful occurs that my mouth involuntarily gapes, the test is passed. When *ConcertWare+MIDI* played Beethoven's Fifth in four parts, it was impressive, and it was cute that the screen had a little picture of a conductor surrounded by icons of four instruments. But when the instruments began changing—viola to piccolo, tuba to flute—and the icons switched along with them... well that was so Mac-like, in the best sense, that my chin almost hit my neck. I determined to produce a "Toot-Toot" on this software.

*ConcertWare+MIDI* was a felicitous choice because its default settings are geared specifically to the Casio CZ-101. It was easier to do multitracking than with the other sequencers, which really weren't happy unless paired with something like a \$2000 Yamaha DX-7. Another benefit of this choice: in the Music Writer mode, in which recording and composing occur, the keyboard input is translated to musical notation. This, I figured, would be very helpful when I was a rock 'n' roll star writing hit tunes so fast I would need instant transcription for my publishers.

Since *ConcertWare+MIDI* is actually an enhanced version of a program that is designed without MIDI (the plain old *ConcertWare+* program requires no synthesizer, though it does accept input from the low-cost MacNifty keyboard), some parts of the program were superfluous for my task. Also, I found that the manual bordered on cryptic when I sought instructions for some things I wanted to attempt. But since the program followed the Macintosh interface so well, I was able to experiment, and it didn't take long before I was

*(continues)*

# This is all it takes to get IBM, Apple, Tandy, Macintosh and Compaq talking to each other.

## And it's simple and inexpensive.



Now a powerful **GridNet™** Local Computer Communications Network is as close as your nearest electrical outlet.

Thanks to GridComm's Communicators, virtually any

office can create its own high speed, error-free **GridNet™**... instantly! There's no need to purchase special system software. And there's none of the expense and inconvenience of installing additional wiring. Because a **GridNet™** utilizes your existing electrical grid as a highly-effective data transmission medium.

And a **GridNet™** will support IBM PC, XT, AT, and all IBM compatibles, Apple and Macintosh, Hewlett-Packard, Tandy, AT&T, Epson, NEC... all the most popular

micros and peripherals, in the same network. Freely sharing data, with complete connectivity and effective compatibility.

The cost? As much as 60% below that of specially-wired systems.

Find out just how easy it is to increase your office's productivity. See your local dealer, or contact "The Great Communicator" for more information.



For information call 203-790-9077. P.O. Box 2779, Danbury, Connecticut 06813-2779

Trademarks: IBM, PC, XT, AT/International Business Machines Corp - Apple/Apple Computer Inc - Macintosh/McIntosh Laboratory Inc - Tandy/Tandy Corp - Compaq/Compaq Computer Corp - Hewlett-Packard/Hewlett-Packard Co - Epson/Epson America Inc - AT&T/American Telephone and Telegraph Co - NEC/NEC Home Electronics (USA) Inc

Circle 517 on reader service card

# OverVUE. Best Database of the Year.



Choosing a database manager is no easy task. It's by far the most confusing and fiercely competitive field in Mac software. But now your buying decision is crystal clear, because the editors of MacUser and the readers of MACazine have both selected OverVUE as the Best Database of the Year.

Said MacUser (Jan. 1986), in selecting OverVUE for its **Editors Choice Award**: "OverVUE 2.0 is a deceiving program in that the more you use it, the more you realize what it can do.

Power, speed and logical menus make this a dream database."

When MACazine (Jan. 1986) bestowed OverVUE with its **Readers' Choice Award**, they wrote: "We selected OverVUE because of its ease of use, clairvoyance and statistical capabilities. The fact that OverVUE was subsequently selected by our readers as Best Database simply confirms our original assessment: the product is a jewel and the customer support a bonus!"

OverVUE's clean sweep of these two prestigious awards only confirms what everyone else has been saying all along:

Infoworld (July 8, 1985): "... it is Macintosh software done right."

Icon Review (Fall 1985): "OverVUE 2.0 is our favorite database workhorse ... it simply offers the best balance of power and ease-of-use available on the market today."

Nibble Mac (Oct. 1985): "OverVUE is not only easy to set up, it's the easiest for data entry. Its tools for entering repetitive data minimizes typing time."

Online Today (electronic version—Nov. 1985): "OverVUE 2.0 is a heavy-duty data management tool ... It does all the things a good relational database manager should."

OverVUE's features and power make it the ultimate database choice. Clearly, users and editors alike think OverVUE is something special. We think you will, too.

So visit your nearest software dealer and purchase your very own copy of OverVUE, the Best Database of the Year.

Write for information concerning our new Mail Management and Personal Finance Templates.



ProVUE Development Corp.  
222 22nd Street • Huntington Beach, CA 92648 • 714/969-2431

Circle 77 on reader service card

able to lay down the basic "Toot-Toot" melody, which I had painstakingly picked out.

Since the heart of zydeco music is the accordion, I used the preset accordion patch, taking advantage of the editing capabilities to correct my numerous mistakes. For track two, I produced a simple percussion beat; it was easy, since I could hear the first track playing while I recorded the drum sound. On track three I recorded a simple bass line, using the synthesizer bass setting on the Casio. I wanted to add some guitar fills on track four, but that sound wasn't in my Casio. So I closed the program, found a good guitar sound in *Patch Librarian*, loaded it into the synthesizer, went back to *ConcertWare*, and, after some trial and error, composed some simple "guitar" lines to embellish the song.

### Rockin' Steven

On playback, I realized that the bass part wasn't so great. So I turned off track three and repeated the song until I created a more suitable one-finger bass line. When I thought I had it, I rerecorded that track.

My finished product will not cause Rockin' Sidney sleepless nights. But it was a four-track, four-instrument rendition that was recognizably "My Toot-Toot." Of my subsequent experiments, I had the most success with jazzlike improvisations layered over some basic chord progressions. The nice thing about improvisations recorded this way is that you can go over them later and clean them up.

At least one of my questions was answered: the Macintosh and very little money can give you astonishing power. If my work were accomplished enough, I could take the disk files I created on the Mac straight to Electric Ladyland studios and put my instrumental parts on a hit record—all the recording studios use MIDI these days. If you buy a little MIDI synthesizer, the capabilities of a recording studio are yours.

The answer to my second question, concerning my future as a pop star, was less clear. After all, it's a long road from "Don't Mess with My Toot-Toot" to "Born to Run." And I have yet to actually compose any tunes to set the whole world humming. Until I do, don't look for me in the Who's Hot issue of *Rolling Stone*.

Macworld *Contributing Editor* Steven Levy wrote *Hackers: Heroes of the Computer Revolution* and is a *contributing editor* of *Rolling Stone*. □



**All the Performance, Reliability and Speed of SCSI from Peripheral Land, The SCSI Experts.**

**PL SERIES**

**SCSI HARD DISK**

These are the fastest SCSI hard disks available for Macintosh Plus or Macintosh 512. The main features include plated media hard disks for long reliable use. The PL hard disk is auto-booted either from the Macintosh Plus or the Macintosh 512/E with our Macport+. Each unit comes equipped with its own fan for optimum operation and extended product life. Also the PL series comes with a complete set of utilities to format and park the disk. Each PL drive can be placed either underneath, next to the Macintosh, or up to 20 feet away, how's that for versatility? The PL can be daisy-chained with 6 other peripherals, and is available in various capacities.

**PL 20**, 21meg formatted drive/**PL 30**, 32meg formatted drive/**PL 80**, 80meg unformatted drive/**PL 172**, 172meg unformatted drive.

**MacBack+**

**SCSI TAPE BACK-UP**

MacBack+ SCSI tape back-up units are what every SCSI hard disk has been waiting for. The SCSI experts from Peripheral Land deliver again. The wait is over! Now, finally, a fast, easy, and reliable way to back up your

Peripheral Land hard disk drives, or anybody's SCSI hard disk.

Say goodbye to floppies and hello to 22 megabyte 1/4" tape cartridge. The MacBack+ can either back-up or restore 20 megabytes in 8 minutes. Now that's how you spell relief and security for your precious data. The MacBack+ is available in either 22 or 60 megabytes of awesome capacities.

**MacBack Plus 20/MacBack Plus 60**

**The MacFast**

**High-performance Series SCSI Hard Disk**

The MacFast SCSI series is our top of the line hard disk for the ultimate Macintosh power user who demands speed from the hard disk. What makes the MacFast hard disk superior? An 8k buffer that maximizes raw data transfer on the SCSI bus to its fullest potential. A Turbo-Stream disk/tape controller that has its own Zilog Z-8 micro-processor with DMA that optimizes data transfer at a phenomenal 5 megabytes non-stop per minute between the MacFast disk and MacBack tape unit. The MacFast runs HFS and MFS volumes simultaneously when formatted with partitions. No competitor can come close to our MacFast performance. In fact, we challenge our competition to beat our capabilities, because we know no one will . . . Remember, We Are the SCSI Experts.

**MacFast 20**, Formatted/**MacFast 30** Formatted/**MacFast 80**, unformatted/**MacFast 172**, unformatted

**MacBack**

**(QIC-02) High-performance Tape Back-up Unit**

Our companion tape back-up system for the Mac Plus. Our Turbo-Stream technique has the ability to back-up and restore 20 megabytes of data in a blistering 4 minutes. In the 5 megabyte volume mode, MacBack will back-up or restore in exactly one minute, incredible but true.

**MACPORT Plus**

**Auto-booting SCSI Adaptor for the Macintosh 512 and 512/E**

Here's where Peripheral Land expertise really shines. An auto-booting SCSI adaptor for the Macintosh 512 or 512/E with the new 128k rom. This easy, convenient upgrade provides full SCSI compatibility with our hard disk or any other SCSI hard disk. Now, you can boot directly from the hard disk, just like the Macintosh plus, without modifications to your Mother Board or cabinet. The Macport adaptor snaps on to the Mother board without any soldering, or special modifications.



**Peripheral Land**  
3677 Enochs Street  
Santa Clara, CA 95051  
(408) 733-7600

Macintosh Plus, Macintosh 512, and Macintosh 512/E are trademarks of Apple Computer, Inc.

# Guide takes the hype out of Hypertext

Guide is the first hypertext system designed specifically for the Macintosh. Now you can direct the power of the Mac with the most innovative principles of hypermedia for your personal information management.

## Move through information at the speed of thought.

Guide provides virtually limitless flexibility in storing, retrieving and assembling electronic information.

Unlike outline processors that force you to structure information according to a rigid format, Guide allows you to flow naturally through stored text.

Rather than emulating a printed page, Guide is designed to take advantage of the computer screen by allowing any number of windows containing graphics and text to be displayed. When windows are resized, graphics are automatically proportioned and text is reformatted instantly. Any displayed window can be activated and worked from.



## Information management that's as flexible as you are.

A click of the mouse at any user-defined point in a body of text and a more comprehensive level is created on the screen for storage or retrieval of information, cross references and notes. If your Guide document cross references another document, Guide automatically opens a new window for it. Guide lets you tailor your information system to suit you...not some programmer.

### With Guide you can...

- build a scheduling calendar with whatever level of detail you require. Cross reference meetings with relevant documents. Click on any date and see your agenda for that day along with other pertinent information.
- create a graphics Guideline with MacDraw or MacPaint. Click on different parts of your graphic and create new levels of information or open other documents containing cross-referenced information.

Use Guide for product specifications, research reports, personal information, legal documents, technical documents, electronic correspondence and a lot more.

## Enhancement for desktop communications.

Guide brings a new dimension to desktop communications. Use Guide to create any type of electronic document for desktop publishing, electronic mail, creative writing, researching, etc. Guide supports MacWrite, MacPaint and MacDraw. You can print anything that can be configured on your screen.

## Easy to learn...easy to use...easy to buy.

Guide is a program that you can learn while you use it. Four cursor patterns and six screen devices are all you need to know. It is 100% Mac honest. You can start using Guide immediately for your information management.



Suggested retail for Guide is \$134.95 but if you respond before Nov. 15, you can put Guide to work for only \$99.95 (includes Mini-Guide desk accessory).



**OWL**  
International,  
Inc.  
14218 NE 21st Street  
Bellevue, WA 98007  
(206) 451-2286



Yes, I want to do more with my Macintosh!

Please send me \_\_\_\_\_ copies of Guide at the introductory price of \$99.95.

Total amount: \_\_\_\_\_

Payment by:  VISA  MC  AMEX  Enclosed Check

Card Number \_\_\_\_\_

Name \_\_\_\_\_

Address \_\_\_\_\_

City \_\_\_\_\_ State \_\_\_\_\_ Zip \_\_\_\_\_

To place an order, call 206-451-2286 or enclose a check with this coupon. Please add \$2.50 for shipping within the U.S. Mail to OWL International, Inc., 14218 NE 21st Street, Bellevue, WA 98007  
Foreign orders add \$10. Washington State residents please add appropriate sales tax.

To Order:  
206-451-2286



# Letters

*Readers sound off on printing, word processing, financial modeling, and more*

## Cause and Effect

Although impressed by the quality of *my-DiskLabeler* from Williams and Macias, I found the copy protection a real hindrance. In a moment of frustration, I wrote a letter suggesting that the authors improve a very good product by removing the copy protection.

I expected the usual reply: "Unfortunately at this time our policy. . . ." Today one of the authors called to say they had received enough similar feedback from users that they are removing all copy protection from future releases. Here's a company that not only listened but responded both with a phone call and with real action.

*Rudy Rugerbrecht  
Santa Clara, California*

*Monogram, publisher of Dollars and Sense, also dropped copy protection recently. Because copy protection generally obstructs the efficient use of a hard disk, the clamor of user complaints has grown to a din. This year in the IBM PC arena, in fact, software publishers seem to be responding to pressure in the marketplace by backing away from copy protection. Microsoft, for example, has removed copy protection from all of its PC-DOS products, though Mac products remain locked up tightly.*

*By the way, the telephone number for Williams and Macias was incorrect in some recent ads; the correct number is 800/752-4400.—Ed.*

## Learning by Doing

In his letter "A Learning Experience" in the *May Macworld*, Frank D. Mathon expressed regret and surprise that not much

educational software has been written for the Macintosh. I hope that by now Mr. Mathon has realized that just using the Macintosh is an educational experience.

Writing as a former computer science teacher, I feel that students are usually happier and learn more when they use application programs (such as word processors or spreadsheets) rather than drill-and-practice programs.

*Sue Knopf  
La Crosse, Wisconsin*

## Straight from the Printer

I enjoyed your article about the ImageWriter II. It was well written and covered the product's features quite thoroughly. However, all ten of the ImageWriter II printers where I work print crookedly; the fonts look as if they were being viewed through water, especially in Standard quality. This is most obvious on printed borders, such as those used in *Microsoft File*, in which the dots do not line up.

*Vicky Jo Varner  
Los Angeles, California*

*Users say that version 2.2 of the ImageWriter driver clears up the problem. Apple reports that the earlier printer drivers had the ImageWriter print bidirectionally in Standard quality, which might account for the misalignment.—Ed.*

## A Monkey Wrench in the Network

Earlier this month our newspaper completed installation of a network system consisting of six Macintosh computers, a LaserWriter, a Corvus hard disk, and Omninet network hardware and software.

Although the Macintosh Office has worked well for all aspects of our publishing, you can imagine my chagrin when I learned that Aldus's *PageMaker* program



does not complete a print operation over the Omninet system. That's why we set up the system in the first place.

*Eric Petermann  
Delavan, Wisconsin*

*Omninet's print spooling does not work with PageMaker. You can attach your six Macs with Omninet, but to send a Page-*

*(continues)*

# Hot Problem

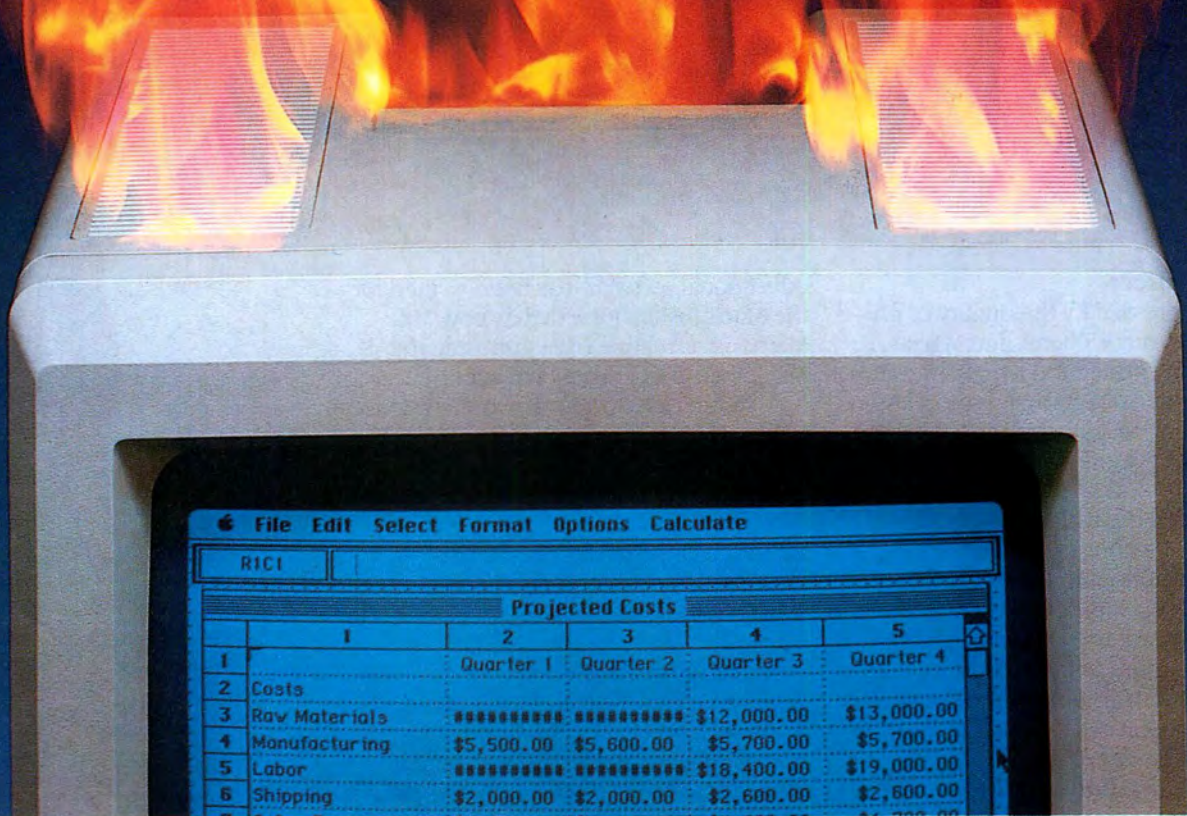

## Introducing System Saver Mac.

Ever put your hand on top of your Macintosh™ after it's been running a while? Pretty hot, isn't it? And that's a problem.

High temperature conditions can affect your computer's circuitry. Even shorten its lifespan. That's why we developed the System Saver Mac.

### System Saver Mac keeps your Macintosh cool.

The System Saver Mac's quiet fan draws a breath of fresh air in through the ventilation slots on the bottom left and right sides of the Mac, across the circuit board, over the power supply (the primary source of heat), and out the top

ventilation slot (the one hidden under your Mac's handle) at the rate of 17 cubic feet per minute. It leaves your Mac cool, calm and running at top speed.

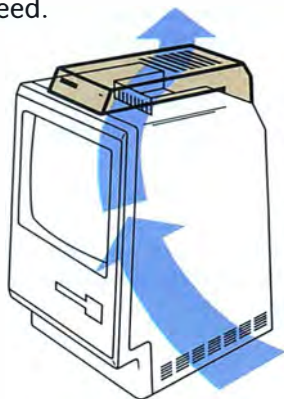

### System Saver Mac stops the scramble for power.

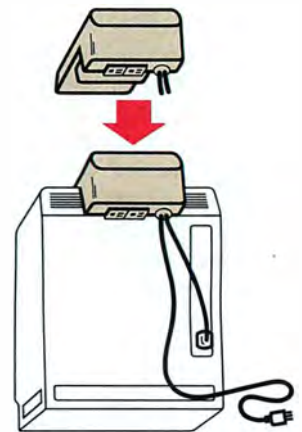

No more reaching around to the back of your Macintosh to turn it on. No more fumbling for spare outlets. System Saver Mac organizes all your power needs. It provides outlets for two peripherals (like your printer and modem), while replacing the Mac's power cord.

# Cool Solution

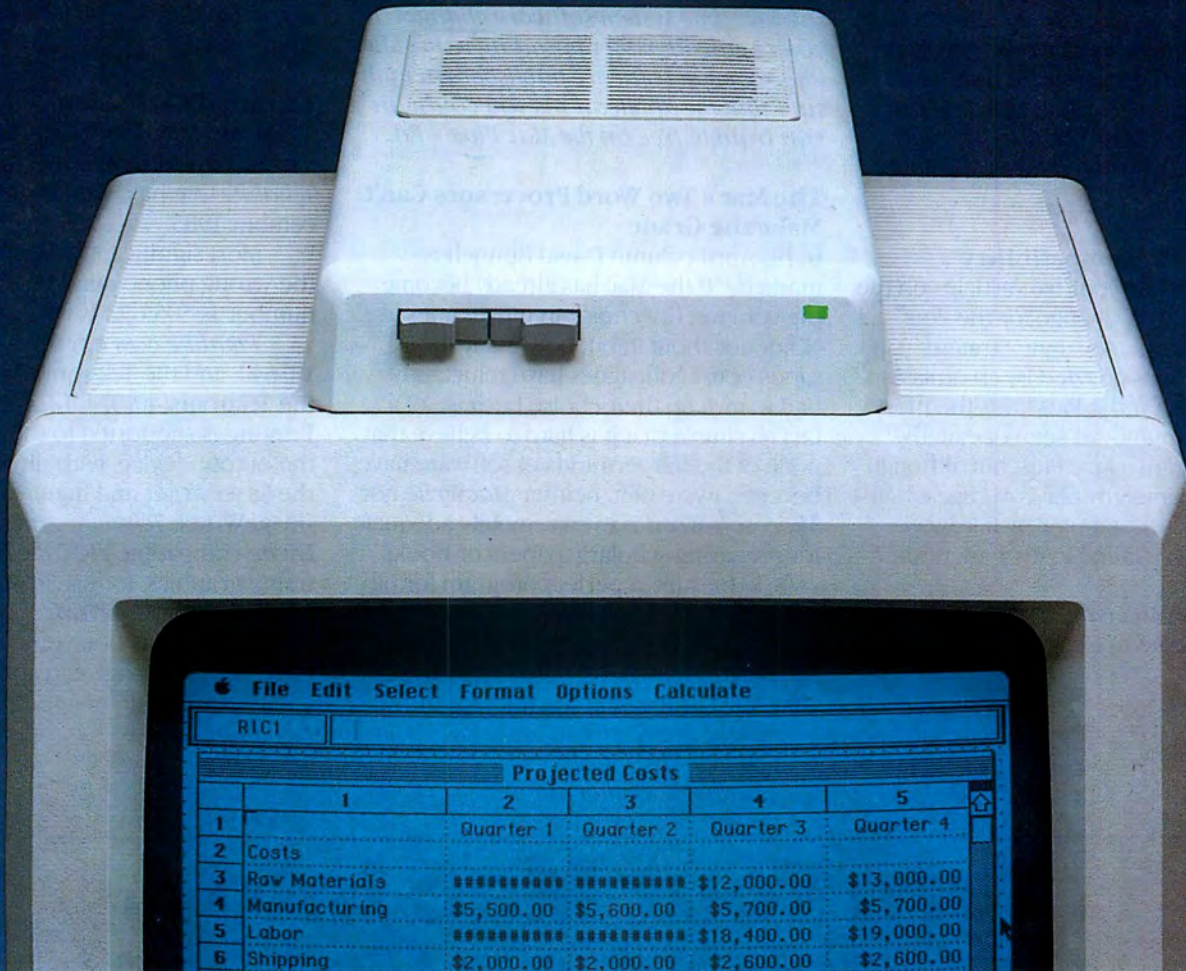

© 1986 Kensington Microwave L

## System Saver Mac has a great switch play.

System Saver Mac comes equipped with two switches - important for those of you who want to power one of your peripherals separately. For example, if you use a Hard Disk 20, you have to power up your hard disk first, before you turn on your computer. Just use one of the System Saver Mac's switches to control your hard disk and the other for the rest of your system.

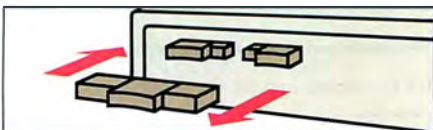

Of course, we realize that many of you would prefer the convenience of a single switch to control your entire system. That's why every System Saver Mac also comes with a special single switch cap. Just pop off the two separate switches and pop on the single one provided.

"See Us at Macworld Expo Booth #532"

## System Saver Mac provides pure power.

70-90% of all microcomputer malfunctions can be traced to impurities in the electrical current. Line noise can be interpreted as data, confusing your Macintosh and causing annoying system errors. Power surges and spikes can do costly damage to its delicate circuitry.

System Saver Mac clips surges and spikes at a safe level and filters out line noise. It provides pure power to make your Macintosh more accurate, efficient and reliable.

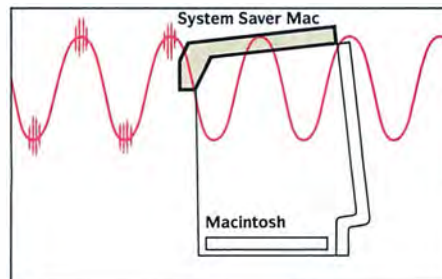

## System Saver Mac is not a completely new idea.

Clever, yes. Versatile, convenient and useful, yes. But not completely new. After all, we've been making the original System Saver for years. It's the best selling accessory ever made for the Apple II—chosen by over 1/4 million Apple II owners. We thought you'd agree—Macintosh owners deserve the best, too.

System Saver Mac, \$99.95, is available from Apple dealers everywhere. For the dealer nearest you, or to speak to a Kensington sales representative, call toll-free 800-535-4242. In NY 212-475-5200.

Circle 11 on reader service card

**KENSINGTON** 

Maker document from one of the networked Macs to the LaserWriter, you have to connect the Corvus OmniDrive to the LaserWriter via AppleTalk. Print spooling for the LaserWriter does work with PageMaker on 3Com's 3Server. In addition, the current version of PageMaker is not meant as a multiuser product; a multiuser update is scheduled for release this year. —Ed.

**HFS Software Incompatibility**

I was impressed by your two articles on the new Macintosh ("A Change for the Plus" and "Developing a Megabyte Strategy") in April 1986 but was puzzled by an omission.

"A Change for the Plus" was the most thorough treatment I've seen of exactly what you get with a Mac Plus, but although it was accompanied by fair coverage of support for the new computer by hardware manufacturers, it failed to even mention software.

Donald F. McLean  
APO San Francisco, California

Take a look at the follow-up article, "Order out of Chaos," in the May 1986 Macworld. Software compatibility is an issue any time system software changes. If you're considering upgrading to the Mac Plus, consult software publishers to make sure that the applications you count on run trouble-free on the Mac Plus. —Ed.

**The Mac's Two Word Processors Can't Make the Grade**

In his April column David Bunnell remarked, "If the Mac has already become the computer of choice in universities. . . ." No doubt about it, but how many thousands of my colleagues have reluctantly had to give up their choice because of a fact so simple that it is hard to believe that none of the masterminds of software have become aware of it: neither *MacWrite* nor *Microsoft Word* is even remotely adequate for preparing scholarly papers or books.

To be sure, a perfect program for bibliography (*Professional Bibliographic System*) has now been adapted to the Mac. But it's expensive. When can we expect suitable word processing software for the Mac?

Blake Lee Spabr  
University of California  
Berkeley, California

More word processing variety is on the way, as reported in *Macworld View*, July 1986. Next month we'll go into greater detail on the new writing tools for the Mac. —Ed.

**Terminal Confusion**

"Mini and Mainframe Connections" (*Macworld*, July 1986) reviewed a version of *Tekalike* that has been obsolete since December 1985.

Most significantly, *Macworld* printed the wrong phone number. The correct number is 505/672-1998.

*Tekalike* now emulates the VT-100, the VT-640, and the Tektronix 4105 as well as the Tektronix 4010, 4012, 4014, and 4016. Printing is supported to the resolution of the output device, with direct support for the LaserWriter and high resolution for the ImageWriter. *Tekalike* generates *MacDraw*-compatible PICT files from mainframe graphics, for use in *PageMaker*, *MacDraw*, or *MacDraft*.

Plotting has been enhanced with multiple plots on a page and additional plotter

(continues)

# Turn Your Mac Into A Presentation Center

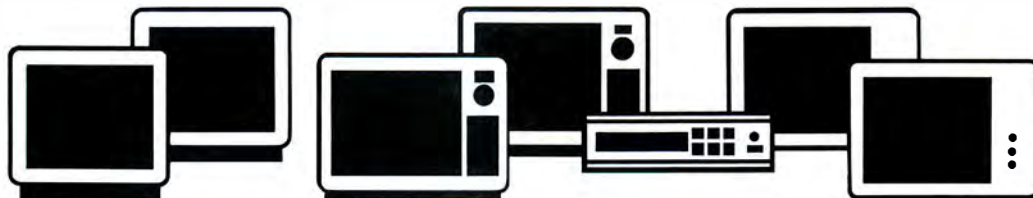

NTSC Compatible Monitor

TV Monitor

VCR  
(VHS & Beta)

IBM Compatible Monitor

The Mac Video Scan Converter enables video data from the Mac or Mac Plus to be simultaneously presented on a variety of low cost or high performance displays including NTSC or IBM monitors, TVs and VCRs.

It is intended for use in audio/visual displays such as classroom demos or to provide a convenient portable demo by storing the presentation on a video tape for use with a VCR.

An easy installation kit is available and requires no soldering. Installation will not void Apple Warranty.

The unit features:

- Freeze-frame screen memory
- Video frame advance
- Inverse video
- Compatibility with all Mac Software

Display Device	Video Output	Typical number of devices per output*
NTSC Compatible Monitor	Composite/NTSC Video	10 Monitors
TV Monitor**	Composite/NTSC Video	10 Monitors
VCR** (VHS & Beta)	Composite/NTSC Video	1 VCR
IBM Compatible Monitor	IBM Compatible Video	5 Monitors
High Speed Compatible Monitor (22.25 KHZ Horizontal scan rate)	High Speed Composite Video	10 Monitors
Color Monitor (RGB)	RGB Video	5 Monitors

\*Maximum number of devices per output is a function of device type and impedance.

\*\*May require use of RF Modulator.

Note: The two Composite/NTSC outputs are identical.

Each output will drive a number of specific display types (please see chart on the left) and will operate simultaneously.

**Distributor and Dealer inquiries invited.**

For further information please call:

**N<sup>2</sup> PRODUCTS, INC.**

2401 Qume Dr.  
San Jose, CA 95131  
408 434-6488 619 243-3632



Control Center, \$99.95



Printer Stand, \$29.95



Surge Suppressor, \$49.95



Tilt/Swivel, \$34.95



Mouse Cleaning Kit with Pocket, \$24.95



Mouse Pocket, \$9.95

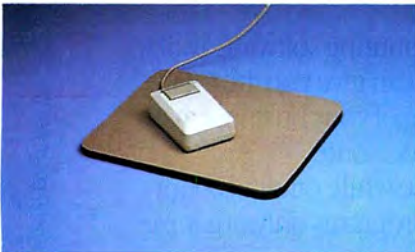

Mouseway, \$9.95



A-B Box, \$99.95



Disk Case with Disk Pocket, \$29.95



Circular Polarizing Filter, \$49.95



Disk Drive Cleaning Kit, \$29.95



Dust Covers, \$9.95 to \$13.75

# Kensington has a solution for every Macintosh™ problem. Maccessories

A whole family of enhancement products for the Macintosh™

You'll find the perfect solution for every problem. From the complete power organization of a Control Center to the simple, portable protection of a Surge Suppressor. From the convenience of an A-B Box or Printer Stand to the comfortable relief of a Tilt/Swivel or Polarizing Filter.

Of course, the best way to solve problems is to prevent

them. That's why we make a complete line of Cleaning Kits and Dust Covers for your Mac.

That's also why we've just introduced the System Saver® Mac! Turn back a page to see this important new peripheral.

For a Maccessories dealer near you, for a free 12 page brochure, or to speak to a Kensington sales representative, call toll-free (800) 535-4242. In New York (212) 475-5200.



# Introducing Insight.

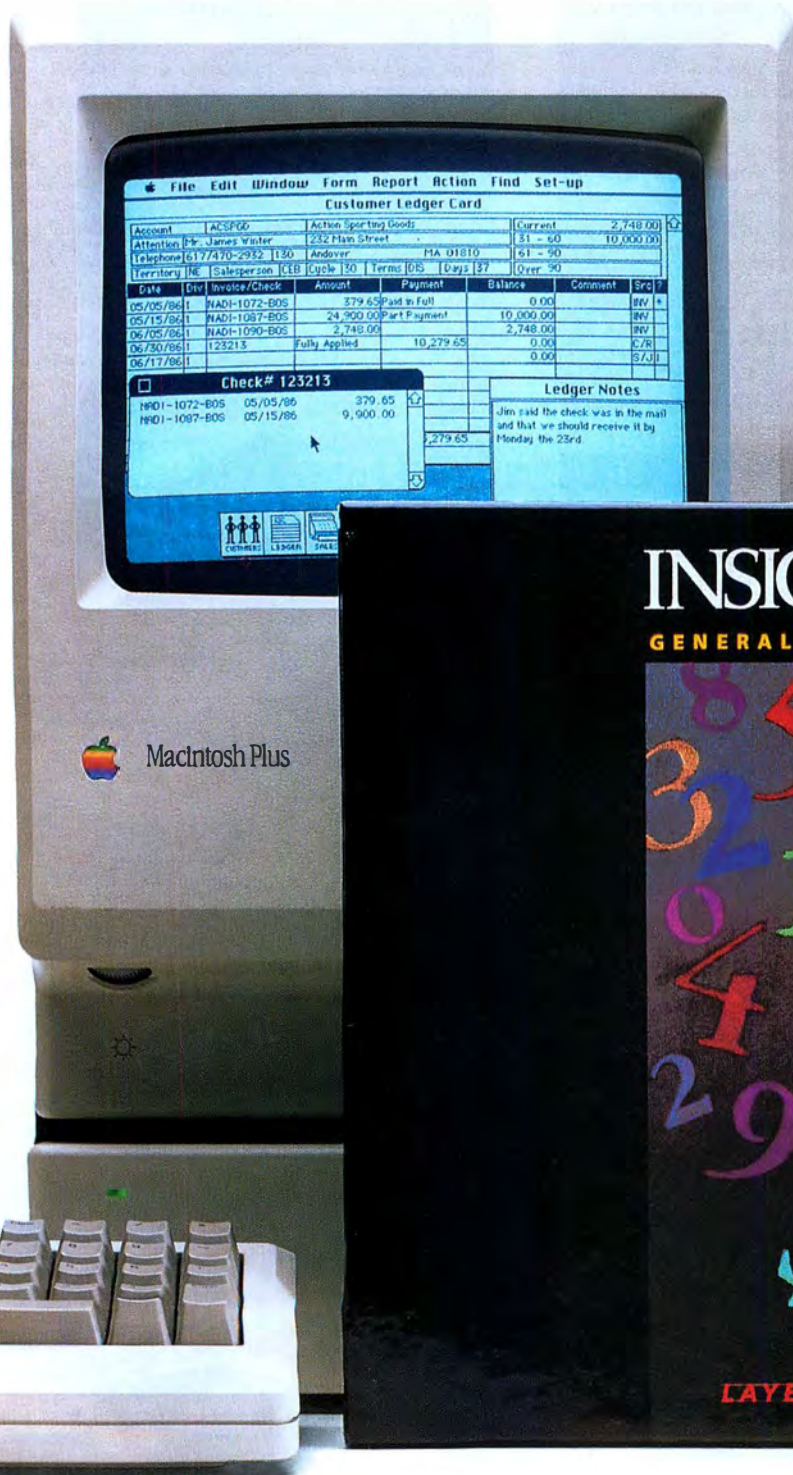

No accounting software available anywhere can give you the total understanding of your business that Insight delivers. None.

Because while other accounting software programs only organize

*Insight General Ledger, Accounts Receivable, and Accounts Payable modules run on Macintosh 512k and Macintosh Plus.*

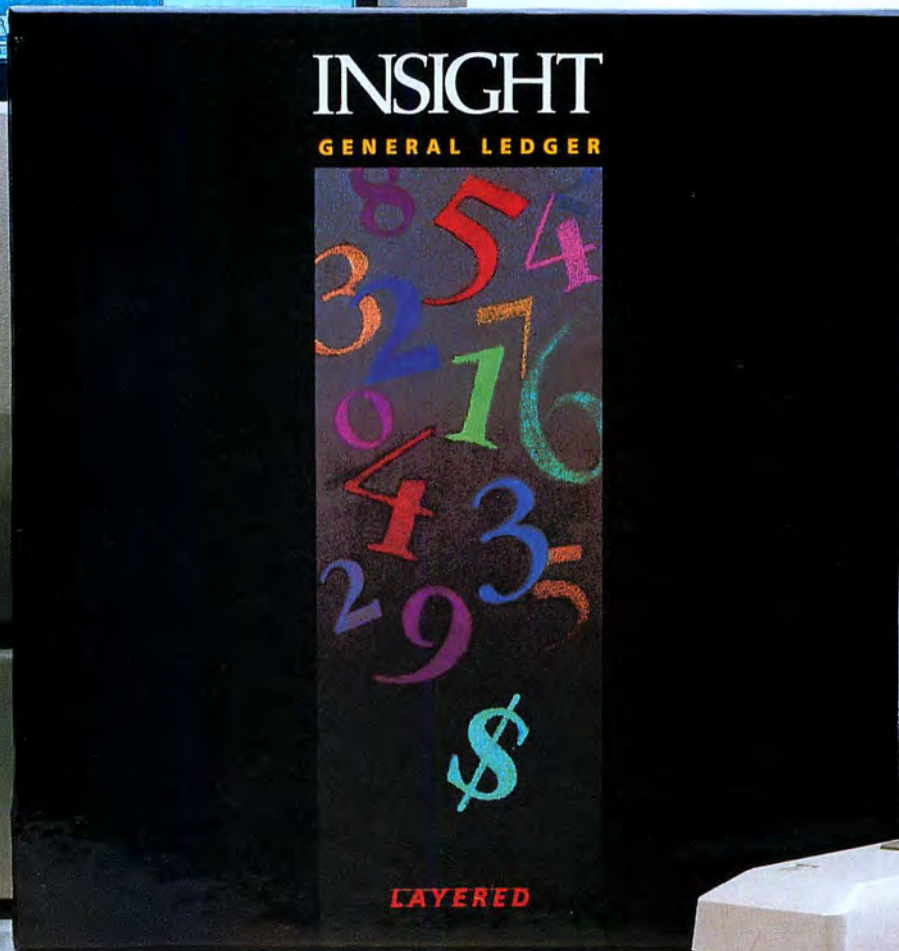

# The accounting software IBM wishes it could offer.

your numbers, Insight analyzes and interprets them for you. So you can make critical decisions that determine your company's destiny. Easier. Faster. More accurately.

Insight achieves this through Expert Reports. A unique process developed by Layered that analyzes and explains information such as current ratios, quick ratios, inventory turns and cash flow. Viewed right on the screen, they let you compare last

costs, and expenses. So you can better manage and project revenue, expenses, assets and liabilities. Assess

accounting power you need today. And by simply changing the appropriate switches, you'll get all the power you could possibly need tomorrow.

Obviously, there's a whole lot more to know about Insight. So contact us directly, or see your local dealer for a demonstration like no other you've seen before.

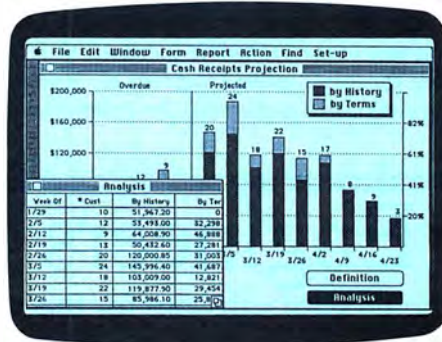
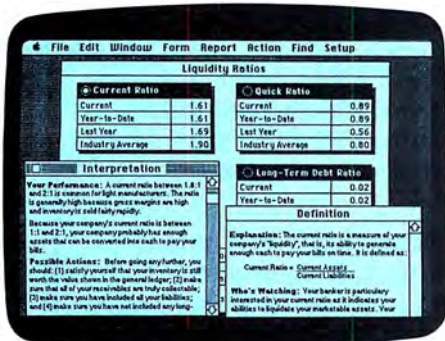

*Insight projects cash receipts "intelligently," based on when your customers actually pay you, not when they're supposed to. You can zoom from the big picture graph to a weekly list of payments to individual customer invoices. And Insight's analytical report summarizes all this for you—so you can meet your banker with confidence.*

your needs to borrow. Evaluate savings from lower inventory costs. And more.

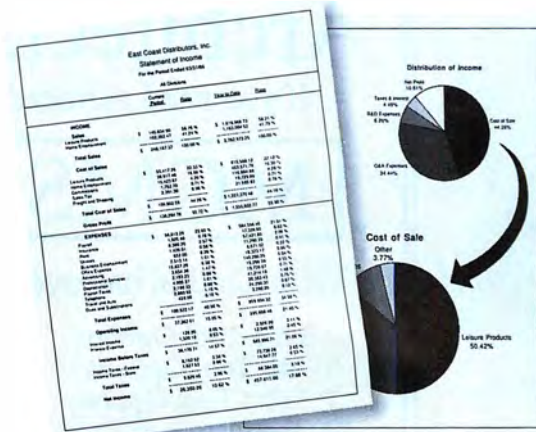

*Insight has the power and flexibility of a spreadsheet, so you can generate any financial statement you need when you need it. Then, you can view key relationships that you might otherwise miss with Insight's built-in graphics package.*

*Insight not only analyzes your results, it explains who is watching them and why. Insight interprets your performance, describes business factors affecting it, and finally recommends actions you can take.*

year's performance, current year-to-date, and even how you're doing compared to your industry.

All this allows you to quickly understand where your company is, project where it's going, and what adjustments you should consider.

Insight's Expert Reports calculate and interpret trends in your sales,

Insight gives you everything other accounting software packages only promise. Insight's Billing and Accounts Receivable, General Ledger, and Accounts Payable packages deliver power and flexibility that has never been available before on any micro system. Including IBM.®

What's more, Insight is so flexible it will grow as you grow. But won't overwhelm you if you start small. Because by using a unique series of "set-up" switches you get all the

It will take just a few minutes for you to realize that when a business has Insight, a business knows exactly where it's going.

Call Toll Free 1-800-262-6620.

## LAYERED

85 Merrimac Street, Boston, MA 02114

## Letters

support: Hewlett-Packard ColorPro and Houston Instrument DMP51/52.

*Tekalike* is hard disk compatible and supports the Macintosh File System, the Hierarchical File System, and *Switcher*.

James E. George  
President, Mesa Graphics  
Los Alamos, New Mexico

### Letter-Quality Bomb

Since letter-quality correspondence is crucial to my business, I wanted to make sure the Macintosh Plus was compatible with the Brother printer I use with my 512K and *Microsoft Word*. The local dealer brought a Mac Plus to my office, along with a copy of *Word* he said Microsoft had requested accompany the new Mac. To my astonishment, the program bombed when I set it to Brother printer. How can Microsoft have the audacity to supply free of charge an application that does not work properly?

C. Claude Dawson II  
Greensboro, North Carolina

A Microsoft representative explained that the *Word* on the disks dealers supply with the Plus is the same version (1.05) that works so well on your 512K. Microsoft

*says the problem lies with Apple's system software for the Plus. System 3.2 and Finder 5.2 should solve the problem. —Ed.*

### Can This Marriage Be Saved?

Some marriages are made in heaven, but the match of the Mac to a Hewlett-Packard LaserJet is certainly not one of them. In fact, the two immediately present the user with irreconcilable differences. I didn't realize that I'd need special software to make the LaserJet work. After buying a copy of Softstyle's *Laserstart*, I finally was able to print. However, the quality was disappointing—inconsistent spacing between words, descenders of letters inexplicably cut off, and ragged letters even in high quality. I was naive and made a costly mistake, but now I'm trying to arrange a divorce through classified ads in the newspaper.

Barbara Slater  
St. Louis, Missouri

*Bob Canaday, of technical support at Softstyle, says that most, if not all, of your problems could be avoided by taking pains to compose your document on the screen in a font that is compatible with the font you intend to print in. Match point size to point size, proportional type*

*to proportional type, and so on. To simplify the matchup, Softstyle is issuing an upgrade to Laserstart that provides four screen fonts that translate directly to LaserJet printing. —Ed.*

### Another Dimension to MacSpace

Some of the strongest points of our *MacSpace* program were not mentioned at all in "3-D In Depth" [*Macworld*, June 1986].

*Moves*. Because the program creates vector-based documents, you must specify an origin and an endpoint for objects moved. The review says this is a nuisance, but professional draftspeople are accustomed to working with vectors.

*Rotation*. True, in the case of a complex object it becomes difficult to rotate parts independently, but the table made it appear that no rotations are possible. In fact, the program offers rotations in any increment.

*Accuracy*. Drawings are done in real dimensions, with an accuracy of up to six digits to the right of the decimal point.

*Zoom*. An unlimited zoom allows users to work accurately on very small details or very large structures.

(continues)

# Architects ♦ Engineers ♦ Draftsmen

If you need Autocad™ Equivalent software for the Macintosh, you need....

## MGMStation

by Micro CAD/CAM, Inc.

ONLY \$799!

Demo Disk & Tutorial: \$29

Demo VHS VCR: \$29

(Refundable w/ Purchase)

MGMStation has over 140 powerful functions including:

- |   |                       |                             |
|---|-----------------------|-----------------------------|
| 10 Line Tool Options                      | 8 Mirror Tool Options | 8 Intersection Tool Options |
| 9 Arc Tool Options                        | 7 Point Tool Options  | 26 Plotters, Imagewriter,   |
| 7 Fillet Tool Options                     | 6 Group Menu Options  | and Laserwriter Supported   |
| 10 Translation & Rotation<br>Tool Options | 4 Spline Tool Options | 6 Hatch Menu Options        |
|   | 7 Zoom Menu Options   | 12 Dimension Tool Options   |

- Splining produces complex smooth curves passing through multiple points.
- X, Y and Polar Coordinate Axis Origins may be moved at will.
- Cross hatching may be applied to any closed area regardless of its shape.
- Symbols may be given their own "Origin Points" for precise Automatic Insertion.
- Zoom up to 100 times the original size. Enlarge or reduce objects at any increment.
- Snap to Grids available at any spacing desired. ■ Accuracy to 4 decimal places.



How much time and money are you wasting designing & drafting with less powerful software?

System required: 512K Macintosh, Mac Plus or Mac XL and a External Drive

Distributed by:  
Dealer inquires welcome.

CompServCo 800-272-5533

800 Freedom Lane  
Slidell, LA 70458  
USA (504) 649-0484

Autocad is a trademark of Autodesk, Inc. MGMStation is a trademark of Micro CAD/Cam, Inc.



# PRICED FAIR! SHIPPED FAST!

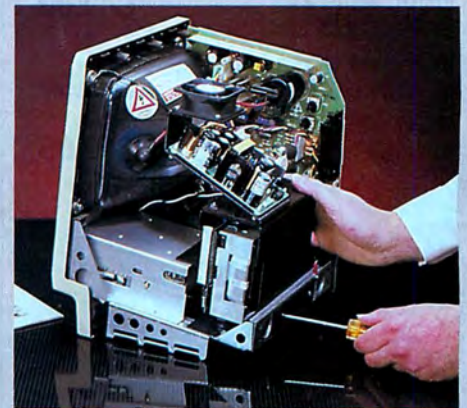

## INTERNAL HARD DRIVE WARP 20

A 20 megabyte hard drive that installs inside either a 512K or a Mac Plus. Like the Photon 20, the Warp 20 has its own cooling fan and power supply. Also, both drives are equipped with an automatic head lifting/locking mechanism for safe and secure data storage wherever your Mac travels. The Warp 20 is carefully designed to be installed by any Mac owner, regardless of experience or technical expertise.

**\$895**  
Mac 512 K

**\$949**  
Mac Plus

EXTERNAL HARD DRIVE

## PHOTON 20

Compact, yet powerful, the Photon 20 unleashes the true potential of the Mac Plus by allowing you to put all your data and software on one hard disk. And if that's not enough, the Photon 20 allows you to daisy chain up to eight devices. Mac 512K owners can get the same results by ordering the Photon 20/512, an upgrade that adds an SCSI port to a Mac 512K.

**\$945**  
Photon 20/512

**\$795**  
Mac Plus

### Compare for Yourself and Save

	Photon 20	Mac Bottom	Data Frame	Apple HD 20	Warp 20	Hyper-Drive	MicahDrive AT 20
Capacity	21	21	20	20	21	20	20
Internal/External	External	External	External	External	Internal	Internal	Internal
HFS Compatible	Yes	Yes	Yes	Yes	Yes	Yes	Yes
Mac Plus Compatible	Yes	Soon	Yes	Yes	Yes	Yes	Yes
Data Transfer Rate, Mb	5.0	5.0	5.0	0.5	5.0	5.0	5.0
Avg. Drive Seek Time, ms	65	85	63	85	65	66-85	70
Price	\$795	\$1495	\$1299	\$1195	\$949	\$1699	\$1695

**FULL FACTORY WARRANTY** All WARP NINE drives are covered by a 90 day factory warranty. A full one year warranty is also available.

**30 DAYS TO LOVE IT** We are so confident that you will like the WARP NINE drives that we will give you 30 days to use it. If at the end of that time you don't think it's a great buy, send it back for a full refund.

**IT'S EASY TO ORDER** Simply call us today toll-free. We accept MasterCard, Visa, or C.O.D. orders. Don't delay, call WARP NINE today!



**WARP NINE  
ENGINEERING INC.**

1751 W. COUNTY ROAD B, SUITE 107, ROSEVILLE, MN 55113



3.5" - FLOPPY DRIVE

## PHASER 800

Double your floppy drive capacity with the Phaser 800, a double sided disk drive compatible with the 128K, 512K, Mac Plus and HFS. The Phaser 800 can distinguish both 400K and 800K diskettes and will read/write to them accordingly. Designed to operate whisper-quiet day after day, the Phaser 800 also features an auto eject mechanism. No Mac owner should be without a Phaser... especially at this great price.

**\$229**

## MAC INKER™

Re-ink Any Fabric Ribbon  
Automatically for less than  
5 cents.

Dedicated Image-  
writer 1 and 2  
(MAC INKER IM) **\$42.00**  
shipping \$3.00

Universal Cartridge  
MAC INKER **\$68.50**

Universal Spool  
MAC INKER **\$66.95**



Lubricated, Dot Matrix Ink  
\$3.00/bottle available in black/  
brown/red/green/yellow/purple/  
orange and gold. Also available:  
Heat transfer cartridges \$9.00, in  
black/red/green and blue.

Over 50,000 MAC INKER(s) in the  
field.

Over 7500 printers supported.

## MERCURY MODEM

Really 100% Hayes\* Compatible.

- 300/1200 baud.
- audio monitor/front panel lights.
- 18 months warranty.



shipping \$4.00

**\$205.00**

\*Hayes is a trademark of Hayes Microproducts.

## DATA SWITCHES (any type)

MACINTOSH MULTIPORT  
SWITCH (9 pin). Connect up to 4  
peripherals to your printer or  
modem port.



**\$50.00**

shipping \$3.00

MAC-to-SWITCH cable \$10.00

## SUPERCHROMA™ SuperColor for the MACINTOSH.

SUPERCHROMA™ gives your  
MACINTOSH (all versions) full  
color capability, with all the per-  
formance, high resolution graphics  
and simplicity of use, which are  
exclusive to the MACINTOSH.

SUPERCHROMA consists of 3  
components, besides the  
MACINTOSH:

- 1) Colorpaint Software
- 2) Color Engine
- 3) High Resolution Monitor.

Draw directly on the RGB monitor  
or load a MAC PAINT™ file and  
color it, with 512 colors on screen,  
selectable from a palette of 16.8  
million. Plus... automatic shading  
between any 2 colors, up to 7 illu-  
mination points on any picture, 3-D  
drawing and much, much more.

If you know MAC PAINT, you will  
be immediately able to use  
COLORPAINT. And due to the ex-  
clusive and built-in grey scaling,  
the colors look real and the  
SUPERCHROMA screen is a true  
pleasure and comfort to the eye.

Applications range from Art to  
Scientific Modeling, Education,  
Business, Cartography, etc.

SUPERCHROMA™ Syst. **\$5690.00**

Colorpaint™ SW **350.00**

Omnipaint™ SW **350.00**

RASCAL™ Devel.  
System **250.00**

Immediate Delivery

A picture is worth a 1000 words. To obtain a high quality, unretouched printout from Superchroma send \$1.00 and choose from these subjects:

Botany - Anatomy - Art - Landscape.

Or just request the free brochure with complete specifications. Come and see us at MACWORLD in Boston. MAC PAINT is a trademark of Apple. Superchroma is a trademark of Computer Friends, Colorpaint & Omnipaint are trademarks of The Reed Institute, Portland, OR.

Order Toll Free.

Call or write for free brochure.

**1-800-547-3303**

In Oregon 503-297-2321 (24 hours line)

# Computer Friends®

6415 SW Canyon Ct., #10, Portland, OR 97221  
telex 4949559

Dealer inquiries welcome.

## Letters

*Coordinates.* X, y, and z coordinates are always available. Users enter absolute and relative coordinates with the mouse or the keyboard and input angles in the same fashion.

*Existing point.* MacSpace allows the user to position the origin of a vertex exactly on a point that has already been drawn; this procedure lets the user place one object precisely next to another without trial and error.

*Perspective.* The program offers true perspective with three vanishing points—the same type of perspective used in isometric drawing.

We try to produce professional CAD programs that novices can use. Perhaps your reviewer failed to mention assets of our program because he did not fully understand our product.

J. Louis Martin  
President, Abvent  
Santa Monica, California

*When we condense our experience with a product into a review, we are often forced to omit mention of some features. On moving and rotation, your point is well taken; our table oversimplified matters by saying neither was possible, though the text of the review stated moves sometimes require painstaking effort.*

*When a product is directed to both novices and pros, ease of use is important. Vector-based design may be familiar to professionals who have worked on high-end CAD workstations, but the Mac brings 3-D drawing tools within reach of users who lack such experience.*

*An upgrade of the program is now available (\$20 for registered owners) that removes hidden lines, supports high-resolution printing with the LaserWriter, and adds editing options. Another version (available at a discount to registered owners of MacSpace) is on the way for professionals; it includes features such as six layers of drawing, the ability to enter text, a library of objects, real-time rotation, and a way to convert free-hand drawings to elevations. —Ed.*

## Don't Desert the Apple Corps

David Bunnell's concern ["The Macintosh Today and Tomorrow," April 1986] that Apple may have been considering dropping the 512K Mac to concentrate on pushing the Apple II was frightening to say the

(continues)

Circle 271 on reader service card

# The secret is out!

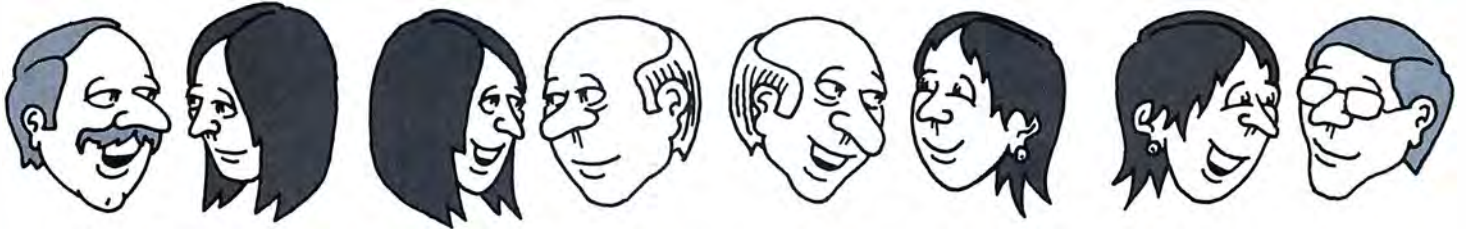

People are discovering **Record Holder™**,  
— the first high-quality, low-priced  
data manager for the Mac.

**\$49.95**  
Introductory price\*

## Talk about value!

"Don't let the \$50 price fool you. This program outclasses most other programs selling for three or four times as much."

*The Desktop Journal*, a publication of the Yale Macintosh User's Group, Winter, 1986

"There's a lot here, far more than its low price would seem to promise."

*MacUser*, April, 1986

"Record Holder met all our performance expectations . . . It's a very good value."

*InfoWorld*, March 24, 1986

## Talk about performance!

"... A powerful data manager"

*MacUser*, April, 1986

"A true file manager that offers many of the features and performance of more expensive and better known products."

*InfoWorld*, March 24, 1986

"It's the best I've seen at organizing files and allowing for real custom printouts."

User Bob Trim, Salt Lake City, UT

"Very fast on 128K Mac."

User Jim R. Hardin, Santa Ana, CA

## Talk about ease of use!

"The manual is written for users who are not data base pros. It's nice to see a manual so well planned . . ."

*MacUser*, April, 1986

"I mastered the program in one sitting."

User Ted Roeser, Dickinson, TX

"I had Record Holder running in 15 minutes."

User Peter Oppenheimer, New Haven, CT

"Record Holder is easy to use . . . help screens are well designed."

*InfoWorld*, March 24, 1986

"I have used just about every database available. Record Holder is by far the easiest to use for many applications, with a great deal of power."

User Joe Bayer, Hermitage, PA

Use **Record Holder** for: · Mailing labels · Customer and prospect files · Doctors' patient files · Personnel records · Invoicing · Quotations · Telephone/address directory · Investment records · Organizing hobby collections · Hundreds more uses!

**R**ecord Holder is a full function data manager that stores, organizes and retrieves all kinds of information and data. It also does calculations and prints out reports.

**You can store huge amounts of text** — up to 32,000 characters in each record of your file. You can be as wordy as you want with Record Holder.

**Unique Table of Contents Window** allows global view of your data base — provides instant access to records.

**Powerful searching capability.** You can search for the occurrence of any word or character string in any field.

**Need not define length of your fields.** All fields are variable in length.

**Designing both Screen and Report** is as easy as clicking and dragging with the mouse.

**Allows calculated or Computed fields.** Use Record Holder to figure out your sales tax or discounts.

**Allows Totals, Averages and Counts** for report generation.

**Allows Date, Numeric and Money formats.**

**Up to 124 sort levels** for Report generation.

**Allows unlimited number of Report Formats per file.**

**Automatic SAVE feature** to ensure data integrity.

**Use with LaserWriter™**

**Compatible with 128 K Macintosh, the 512K, the Mac XL and Mac Plus.**

"Record Holder is a gem: quick, easy, inexpensive, flexible. Buy it!"  
User L. Page Maccubbin, Washington, D.C.

To order, call toll free  
7 days a week, 24 hrs. a day,  
or return coupon today



**1-800-437-5200** operator 229

In Maryland, call: 1-800-638-8890, op. 229

For more information, call: (203) 872-1024



**Software Discoveries, Inc.**  
99 Crestwood Road, Tolland, CT 06084

Mail this coupon with your credit card number, check or money order for \$49.95 plus \$5 for shipping and handling. CT residents add \$3.75 sales tax.

Check or Money Order  VISA  MASTERCARD

Expires \_\_\_\_\_ Account # \_\_\_\_\_

Name \_\_\_\_\_

Company Name \_\_\_\_\_

Address \_\_\_\_\_

City \_\_\_\_\_ State \_\_\_\_\_ Zip \_\_\_\_\_

Phone \_\_\_\_\_

Signature \_\_\_\_\_

## Money Back Guarantee

If after trying out Record Holder you are not 100% satisfied, you may return it within 30 days for a refund of the full purchase price.

\*Price valid through Sept. 30, 1986

Record Holder is a trademark of Software Discoveries, Inc. Macintosh and LaserWriter are licensed trademarks of Apple Computer, Inc. © Software Discoveries, Inc., 1986.

Visit us at Booth 642, MACWORLD EXPO, Boston

Circle 435 on reader service card

Choose from our Collection of Select Macintosh Products

# The Icon Review Showcase

**MaxPlus**  
From MacMemory Inc. **\$399**

Now you can carry the power of your Macintosh Plus even further with MaxPlus from MacMemory Inc. Expand to 2 megabytes today without modifying your Mac, and tomorrow you're still free to expand to the Mac Plus' full 4-megabyte potential.

MaxPlus lets you run huge spreadsheets, databases, and memory-hungry programs like

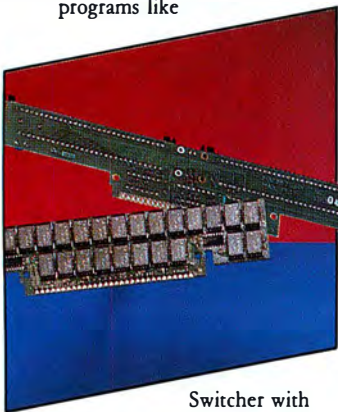

Switcher with room to spare for RAM disks and disk cache utilities. And you can use all your current Mac Plus software and external peripherals without modification. Since MaxPlus was designed for low power consumption, it works with all Mac power supplies.

Order MaxPlus today so that you can run your Mac to the Max, and you will receive MaxChill (an internal fan for the Mac) and MaxRAM/MaxPrint (RAM disk and print spooler software) FREE!



**MagNet 20x**  
From Mirror Technologies

**Y**ou'll be excited by the versatile features and quality engineering of the MagNet 20x SCSI

drive the Volvo of the computer world. Add speed, power, and 20 megs of storage to your Mac 512 or Mac Plus with this uniquely portable drive from Mirror Tech. To further expand your Mac's versatility, MacServe networking software (a \$250 value) is bundled free with the MagNet 20x, allowing several Macs to share data and peripherals and providing other key features that include volume partitioning, print spooling, password protection, and disk cache.

If you have a Mac Plus, simply plug the MagNet 20x into the SCSI port; if you use a 512K, order the MagNet 20x/FastPort Bundle and have a qualified technician install the FastPort Interface for easy connection to the MagNet 20x Drive.

The MagNet 20x is packed with features. Add this drive to your Mac system to make the most of the equipment you already own.

MagNet 20X Drive **\$ 999**

MagNet 20x/FastPort Bundle **\$1099**



**MacLightning 2.0** **\$54**  
From Target Software

MacLightning's new 2.0 version includes Merriam Webster's 80,000-word Ninth New Collegiate Dictionary, making it the most comprehensive Mac spelling checker. Only MacLightning watches your keystrokes and beeps when you misspell a word; or, work in silence and use MacLightning later to check selected text or an entire document.

Installed



as a desk accessory, MacLightning works in MacWrite, MS-Word, Jazz, ReadySetGo, and most Mac software. Expand MacLightning's scope by adding one of the new-supplemental "libraries" now available.

Requires 512 K & 2 drives or Mac Plus

Thesaurus **\$33**  
Legal Dictionary **\$69**  
Medical Dictionary **\$69**

Supplemental libraries require MacLightning

**CALL TOLL FREE & GIVE US A CHANCE TO MATCH ANY ADVERTISED PRICE!**

ORDERS  
**800/228-8910**

IN CALIFORNIA  
**800/824-8175**

MONDAY THRU SATURDAY 6 A.M. TO 8 P.M.  
SUNDAYS 9 A.M. TO 5 P.M. (Pacific Time)

SEND MAIL ORDERS TO:  
ICON REVIEW, P.O. BOX 2566, MONTEREY, CA 93942

Circle 272 on reader service card

**Icon Review**

## Color Chart

From I/O Design

**\$32**

Add color to your Mac with ColorChart, a stand-alone business graphics program that plots and prints charts and graphs in full color. Enter data directly or cut and paste from other applications. Color Chart has more than 2000 data points and will create more than 100 different charts and graphs. Print finished



charts in color on any Image Writer, or plot them on the Apple Color Plotter or several Hewlett-Packard plotters. ColorChart runs on any Mac, and it supports up to nine colors on the ImageWriter I, seven colors on the ImageWriter II, and eight colors on plotters. Order ColorChart today and add pizzazz to your presentations.

## Easy3D

From Enabling Technologies

**\$59**

Whether you're an engineer, designer, animator, or doodler, Easy3D lets you draw with dimension and depth, creating shapes and objects with true perspective. Working with solid rather than wire-frame

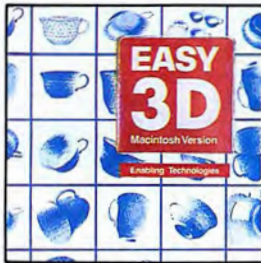

shapes, you can rotate, move, distort, glue together, cut apart, compress, and stretch any image. And use Easy3D's multiple lighting effects, including custom lighting, to make further alterations. A special print mode command lets you create MacPaint files for easy transfer to page layout or animation programs. A few hours with Easy3D and you'll wonder why you've limited yourself to two dimensions for so long.

Requires 512K or Mac Plus

## TurboCharger 2.0

From Nevins Microsystems

**\$39**

Here's the perfect product for anyone who's tired of staring at the wristwatch icon while the Mac thinks. TurboCharger 2.0 uses a disk cache to speed up the Mac's performance, making it a must for the Mac 512. And TurboCharger's expandable library of optimum cache sizes allows it to automatically size its cache for the application you're using, making it



more convenient for Mac Plus users than the disk cache Apple included on the Mac Plus. TurboCharger 2.0 is compatible with hard disks, networks, HFS, and the 128K ROM. Cut down waiting time - "cache" in on TurboCharger 2.0.

Requires 512K or Mac Plus

### Imega

- Bernoulli Boxes **NEW**
  - 10 Meg Hard Drive **\$1499**
  - 10 Meg + 10 Meg Hard Drive **\$2094**
  - 20 Meg Hard Drive **\$1899**
  - 20 Meg + 20 Meg Hard Drive **\$2699**
- Cartridge drives add flexibility

### LoDOWN

- For Mac Plus
- 20 Meg SCSI **\$895**
- 40 Meg SCSI **\$1795**
- Tape Backup 20 Meg **\$795**
- Tape Backup 60 Meg **\$CALL**

### Mirror Technologies

**SPECIALS**

- MagNet 20x SCSI Drive **\$999**
  - MagNet 20x SCSI Drive **\$1099**
- with FastPort
- MagNet 30x SCSI Drive **\$CALL**
  - Magnum Ext. 800K Drive **\$249**
  - Mirror 20 Tape Backup **\$949**
  - Mirror 40/40 **NEW \$2495**

40 meg hard drive, w/40 meg tape backup, MacServe included

### Paradise Systems

- Mac 20 Hard Disk **SPECIAL \$549**

### PCPC

- MacBottom 20 Meg Drive SCSI **SPECIAL \$949**

## ACCESSORIES

- Beck-Tech**
- Fanny Mac **SPECIAL \$79**
- Fan fits in Mac's handle
- Blowhard**
- MacFan **\$119**
- Caribbean Enterprises**
- THE Bag **SPECIAL \$109**
- Quality leather tote for your Mac
- Computer Friends**
- MacInker for ImageWriter **\$44**
- Re-inks ImageWriter cartridges only—includes ink!

### Eichner

- Disk Holder **\$25**
- Disk Holder with Lock **\$33**

### Environmental Software

- Dust Covers **\$CALL**
- For Mac, Mac Plus, ImageWriter I & II, etc. Available in gray, navy, or burgundy

### Ergotron

- MacTilt **\$75**
- Swivel stands for Mac & 2nd drive

### Icon Review

- MacCracker **\$20**

Long-handled torx screwdriver and cover pry tool for qualified technicians

- New Owner's Kit for 128/512K Macs **\$132**

- New Owner's Kit for MacPlus **\$142**

- New Owner's Kit for 128/512K w/Drive **\$320**

- New Owner's Kit for Mac Plus w/Drive **\$330**

### Imega

- Bernoulli Box Cartridges
- 10 Meg (3 pk) **\$169**
- 20 Meg (3 pk) **\$219**
- Bernoulli Box Head Cleaning Kit **\$75**

### Kensington

- Control Center **\$65**
- Polarizing Filter **SPECIAL \$31**

### Kelte Group

- MacNifty A-B Switch **SPECIAL \$27**
- MacNifty A-B-C-D Switch **\$45**

### MacHELP

- MacHELP Reference Cards **\$12**
- Cards perch on Mac or keyboard providing quick reference. Choose from Jazz, MS-Word, Multiplan, Excel, MacPaint/MacWrite.

### MicroStore

- disk•book **SPECIAL \$22**
- Highest quality, notebook-sized carrier for 32 diskettes—made in U.S.A.

- disk•book Plus **\$22**

Holds 16 diskettes plus appt. calendar, note pad & pen

- Small disk•book **\$14**

Holds 10 diskettes

### Mountain Equipment, Inc.

- ImageWriter Carrying Case **\$59**
  - ImageWriter II Carrying Case **\$69**
  - Mac Carrying Case **\$79**
  - Mac Plus Carrying Case **\$89**
- The best! Heavy-duty and stylish

### Mouse Systems Corp.

- A+ Mouse (optical) **\$39**
- Optical tracking adds speed, dexterity

### Mousetrak

- 9" x 11" Mouse Pad **\$9**
- 7" x 9" Mouse Pad **\$8**

### N<sup>2</sup> Products—Cables

- MacPlus-to-DB9 Adapter Cable **\$17**
- Adapts MacPlus serial port to Mac 512/128 standard

- Mac-to-ImageWriter II Cable **\$18**

Mac to ImageWriter III/Apple Personal Modem

- MacPlus-to-ImageWriter II Cable **\$18**

Also works with Apple Personal Modem

- Mac Printer Cable **\$18**

Mac to serial printer

### Smith & Bellows

- Mahogany Disk Case **\$28**

Holds 90 diskettes

## DISKETTES

- Sony 3 1/2" (10) SS/DD **SPECIAL \$17**

- Sony 3 1/2" (10) DS/DD **SPECIAL \$27**

The Best!

## SUMMER CATALOG!

With details on more than 130 exciting Mac products our catalog can help you make more informed buying decisions—while saving you time and money! Ordering from us is the most convenient and reliable way to get the Macintosh hardware and software you need.



MONDAY THRU SATURDAY 6 A.M. TO 8 P.M.  
SUNDAYS 9 A.M. TO 5 P.M. (Pacific Time)

ORDERS  
**800/228-8910**  
IN CALIFORNIA  
**800/824-8175**

Order by mail:  
P.O. Box 2566  
Monterey, CA 93942

CUSTOMER SERVICE 408/625-0465

NATIONAL ACCOUNTS 408/625-1957

Icon Review is dedicated to supplying top-rated Macintosh software, accessories, and peripherals; quick service; and discounted prices. Order toll free or by mail.

## OUR POLICIES

- We accept MasterCard and VISA with no added service charge. Private and company checks accepted; for faster delivery, send certified check, cashier's check, or money order.
- Sorry, we cannot accept C.O.D.'s.
- We accept corporate or school purchase orders from qualified institutions. Mail purchase orders to Icon Review P.O. Box 2566, Dept. MW096, Monterey, CA 93942.
- California residents add 6% sales tax.
- All goods are new and guaranteed to work, but we do not guarantee machine compatibility. Due to software copyright laws, all sales are final. Defective products replaced immediately; call for a Return Authorization Number, 408/625-1931.
- Most orders ship within 24 hours.

Macintosh is a trademark licensed to Apple Computer, Inc. • Icon Review is a division of MindWork Enterprises, Inc. • MindWork and Icon Review are trademarks of MindWork Enterprises, Inc. • Icon Review, published by MindWork Enterprises, Inc. 6750 Mid Valley Center, Carmel, CA 93923 • © 1986 MindWork Enterprises, Inc.

## NATIONAL ACCOUNTS

Call today to find out how our National Accounts Program gives organizations like yours the benefit of Icon Review's unique brand of service and support. For more information, call 408/625-1957.





### Hard Disks

From LoDOWN

Here's our pick for the best value in a SCSI drive for the Mac Plus! Available in sizes to fit your needs and prices to fit your budget, LoDOWN drives are fast, reliable, and economical. LoDOWN has a well-ventilated case that needs no fan, and it contains a built-in surge suppressor.

Daisy-chain as many as eight LoDOWNs for nearly unlimited storage.

Add LoDOWN's T20 or T60 Tape Backup to ensure efficient, dependable backup.

Requires Mac Plus

20 Meg SCSI Drive	\$895
40 Meg SCSI Drive	\$1795
T20 Tape Backup	\$795
T60 Tape Backup	\$CALL

**T-Maker Graphics**  
ClickOn Worksheet *SPECIAL* \$45  
Great for casual spreadsheet use

### UTILITIES

**Affinity Microsystems**  
Tempo *SPECIAL* \$79  
Powerful macros with logic branching

**Central Point Software**  
Copy II Mac *SPECIAL* \$18  
Includes hard disk install

**FWB Software**  
Hard Disk Backup \$39  
Hard Disk Utility \$59  
Removes software copy protection to install on hard disk

**Greene, Johnson Inc.**  
Spellswell \$45  
New spelling checker catches capitalization & homonym errors too

**Ideaform**  
MacLabeler \$29  
Enhanced version!

**MacMemory, Inc.**  
MaxRAM/MaxPrint Disk *NEW* \$33  
Save 11me w/ RAM disk & print spooler

**Macromind**  
Macromind Utility Disk *NEW* \$29

**Micro Analyst**  
MacZap \$39  
Hacker's backup utility and more!

**Neveins Microsystems**  
TurboCharger 2.0 \$39  
New, more powerful DiskCache works with hard disks

**New Canaan MicroCode**  
MacDiskCatalog II *SPECIAL* \$33  
Organizes your disk library

**PBI Software**  
Hard Drive Backup *NEW* \$39  
HFS Locator *NEW* \$29

### COMMUNICATIONS

**CompuServe**  
Starter Kit \$25  
FREE with Hayes Bundle

**DataViz**  
MacLink w/8' Cable *SPECIAL* \$109  
Transfers and converts files between Mac and IBM

**TopDesk**  
From Cortland Computer, Inc. *\$39*  
TopDesk contains seven easily installed desk accessories that add power and versatility to any Mac software. TopDesk lets you print high-quality text and graphics in the background while you work; see up to eight MacWrite documents at one time from within



any application for instant cut and paste; create macros for recalling long paragraphs and even entire Command-key sequences; define your own Command-key assignments for Menu selections; and much more. If you're looking for one answer to many needs, order TopDesk today.

Requires 512K, Mac Plus, or Mac XL

**Hayes**  
Interbridge \$CALL  
SmartCom II *SPECIAL* \$89

Smartmodem 1200 \$CALL  
Smartmodem 2400 \$CALL  
Smartmodem-to-Mac Cable \$18  
Please specify either 1200 or 2400

1200 Smartmodem, SmartCom & Cable (Bundled) *SPECIAL* \$449  
We add FREE CompuServe Starter Kit!

Transet 1000 *SPECIAL* \$279  
Multi-function buffer and switch—Incredible!

Transet 1000 512K *SPECIAL* \$379  
Transet Mac Accessory Kit \$29

**Infosphere**  
MacServe \$CALL  
Partitions hard disk, network disk server, print spooler & more!

**ProAPP**  
ProAPP Modem *NEW* \$CALL

**Fanny Mac**  
From Beck-Tech *\$79*  
Why risk losing valuable data by letting your Mac overheat when it's so easy and inexpensive to install Fanny Mac? Fanny Mac keeps your Mac cool and your data safe by reducing the operating temperature of your Mac as much as 50 degrees. Its compact design is elegant; Fanny Mac fits almost invisibly into your Mac's handle. And it installs in seconds with no tools. Its "pass through" power assembly means you



need only one power socket for both your Mac and Fanny Mac. And surge suppression for your Mac is built right in. Remember, the more memory and peripherals you have, the more heat your Mac generates. Get Fanny Mac to avoid system burnout.

**Software Ventures**  
MicroPhone *NEW* \$65  
Best communications software!

**Think Technologies**  
In-Box Starter Kit *NEW* \$219  
Includes 3 connections; send electronic mail over AppleTalk

In-Box Personal Connection \$65

**USRobotics, Inc.**  
Courier 2400 Modem *NEW* \$419  
Combines power, ease of use, and many special features

### HARDWARE

**Cuesta**  
90 Watt Datasaver \$299  
200 Watt Datasaver \$399  
Protection from power blackouts

**Record Holder**  
From Software Discoveries, Inc. *\$75*  
Record Holder is a full-function file/data manager with more power than packages costing far more. The



concise manual and 100+ on-line help screens make Record Holder easy to learn and use. Flexible report formatting makes this database ideal for small- to medium-size businesses. Searches are fast and versatile; an unlimited number of fields or records are allowed in any file; and a unique Table of Contents allows instant access to all records in a file. Generate invoices and mailing labels with a click of the mouse. Another plus: Record Holder works on any Mac with any drive. Put Record Holder to work for you today.

**Ergotron**  
MacBuffer 256K \$249  
MacBuffer 512K \$375  
MacBuffer 1024K \$575  
Hot new print buffer

**Kensington**  
Surge Suppressor \$34

**Koala Technology**  
MacVision *SPECIAL* \$169  
Puts images from your video camera into Mac

**MacMemory, Inc.**  
The MaxPlus \$399  
Upgrade your Mac Plus memory to 2 meg. Plugs into standard SIM sockets; includes Max Chill fan and software

**Summagraphics**  
MacTablet 6"x9" \$299  
MacTablet 12"x12" \$399

Absolute pointing device, great for tracing and drawing

### New Owner's Kits

From Icon Review

If you're serious about getting the most from your Mac, these kits offer all the accessories you'll need. Save yourself time and money by ordering one of the comprehensive kits we've assembled. Each kit includes:

- **Eichner Disk Holder**—Model 1032 holds a total of 60 diskettes, two across. Internal dividers make it easy to organize disks.

- **Sony Diskettes**—A box of 10 disks, the best available for the Mac. Double-sided disks are shipped with the Mac Plus kit.

- **Mouspad**—Give your mouse nine lives with this 7" x 9" anti-static, foam-backed desktop mouse pad.

- **Dust Covers**—For Mac and keyboard. These well-tailored waterproof ripstop nylon covers offer important protection from dust and static.

- **MacTilt**—This ergonomic stand lets you adjust the height, angle, and rotation of your Mac with ease.



New Owner's Kit for 128/512K Macs with SS/DD disks \$132

New Owner's Kit for Mac Plus with DS/DD disks \$142

Buy a New Owner's Kit and save on the Ehman 800K External Drive a \$199 value.

New Owner's Kit for 128/512K Macs w/Ehman Drive \$320

New Owner's Kit for Mac Plus w/Ehman Drive \$330

**Systems Control**  
Mac Gard *SPECIAL* \$55  
Protect your Mac from power surges

**Thunderware**  
ThunderScan *SPECIAL* \$175  
ThunderScan Adapter Kit *NEW* \$89  
For MacPlus

### DISK DRIVES

**AST**  
AST-2000 \$2195  
20 meg Winchester; 20 meg tape backup

AST-4000 \$4900  
74 meg Winchester; 60 meg tape backup

**Ehman Engineering**  
800K External Drive \$199

**CALL TOLL FREE**      **ORDERS**      **800/228-8910**  
**CALIFORNIA**      **800/824-8175**



### MacTablet

From Summagraphics

MacTablet is the closest thing to a natural input device you can find for the Mac. It's ideal for graphics, perfect for sketching or tracing, and it's more precise and more comfortable to use than either a mouse or trackball. In fact, it's not unlike the expensive graphics systems long available only for large computers.

MacTablet can be connected to either the printer or modem port, and it includes easy-to-use 3.0 Version software. MacTablet works with all Mac software and comes in two sizes. The 6" x 9" size has a resolution of 500 lines/inch; the 12" x 12" size has a resolution of 1000 lines/inch.

6" x 9" MacTablet \$299  
12" x 12" MacTablet \$399



## Fact Finder **\$49**

From MindWork Software  
Factfinder is one of our favorite, indispensable tools. Unlike database programs, Factfinder is designed to store and organize text, notes, and other free-form information that might otherwise clutter your desk with scraps of paper. While taking notes, for example, you simply type a note into a factsheet, name the factsheet, select the keywords by which you will retrieve it, and save it to disk. Later Factfinder can sort through all your note factsheets and retrieve them individually by name, keyword, or date created or modified. Factfinder is a must for every researcher, writer, student, teacher, and professional.

## BUSINESS

- Aegis**  
Doug Clapp's Word Tools \$45  
Checks text for punctuation, wordiness, and more
- Blyth Software**  
Omni 3 Plus **SPECIAL** \$289  
Powerful relational database
- Borland**  
PhoneLink & SideKick \$59  
Desktop/phoneschedule organizer; dials for you, too!
- Cricket Software**  
StatWorks \$79  
Great value with best statistical graphs
- Execucom**  
MindSight \$179  
Business planning and decision analysis
- Forethought**  
FileMaker \$105
- I/O Design**  
ColorChart **NEW** \$32  
Plot & print color charts, graphs
- Layered**  
Excel Notes **SPECIAL** \$42  
Jazz Notes **SPECIAL** \$42
- Legisoft/Nolo Press**  
WillWriter **SPECIAL** \$30
- Living Videotext**  
ThinkTank 512 \$99
- Micro Planning Software**  
MicroPlanner Plus \$295  
Enhanced version; requires 512K
- Microsoft**  
BASIC \$89  
Excel \$229  
Multiplan **SPECIAL** \$107  
Word **SPECIAL** \$112  
Works \$225
- MindWork Software**  
Factfinder \$49
- Monogram**  
Dollars and Sense **SPECIAL** \$81  
Forecast **SPECIAL** \$41
- Odesta**  
Helix 2.0 **SPECIAL** \$99  
Double Helix **SPECIAL** \$289  
Requires 512K or Mac Plus

## Bernoulli Boxes

From Iomega  
Iomega's Bernoulli Box mass storage devices for Mac Plus offer a fast, reliable, and cost-effective solution for any office. These Bernoulli Boxes work off the Mac Plus' SCSI port, allowing auto-boot, HFS support, lightning-fast speed, and daisy chaining with other SCSI devices. Average access time is 35 milliseconds, with a data transfer rate of 1.13 meg/sec. The unlimited data storage and efficient backup provided by 10- or 20-megabyte removable data cartridges put the Bernoulli Boxes in a class by themselves. While your drive stays in place, the data is highly portable and easily stored for optimum flexibility.

- 10 Meg Single-Cartridge Drive \$1499
- 10 Meg + 10 Meg Dual-Cartridge Drive \$2099
- 20 Meg Single-Cartridge Drive \$1899
- 20 Meg + 20 Meg Dual-Cartridge Drive \$2699
- 10 Meg Cartridges (3pk) \$169
- 20 Meg Cartridges (3pk) \$219
- Head Cleaning Kit \$75

## Electric Checkbook

From State of the Art **\$29**  
Electric Checkbook is a personal financial manager that handles up to five bank accounts on a 128K Mac or ten on a 512K. Define categories for income, expenses, assets, and liabilities. Reconcile bank statements and checkbooks, calculate profit and loss, and determine net worth. Use a special "What If?" feature to see the effect of a payment schedule before



implementing it. You can even print your checks on continuous forms. (Sample checks and order forms are included.)

## Mac Zap **\$39**

From Micro Analyst  
If you mistakenly throw a file and empty the Trash, Mac Zap



can retrieve it! It can even resurrect your hard disk or a crashed floppy that the Mac wants to reinitialize. And Mac Zap is a superior disk copy and software-backup program - copying master disks and moving protected programs to hard disk. Use Mac Zap to plumb the depths of your Mac - it disassembles applications, searches memory or disk blocks, compares disks, analyzes disk structure, and performs full-screen edits.

Mac Plus compatible

## ORDERS CALIFORNIA

**800/228-8910**  
**800/824-8175**

- Peachtree**  
Back to Basics  
• General Ledger \$89  
• Accounts Payable \$89  
• Accounts Receivable \$89

## GRAPHICS

- Advent**  
MacSpace \$249  
Professional 3D CAD for Mac
- Altsys Corp**  
Fontastic Font Editor \$25
- Ann Arbor Software**  
FullPaint \$59
- Casady Company**  
Fluent Fonts **SPECIAL** \$29  
Fluent Laser Fonts \$49  
Six types disks available; call for details
- Challenger Software**  
Mac 3D **SPECIAL** \$119
- Cricket Software**  
Cricket Graph \$129  
Plots 20 times more data points than Excel!
- Datafood Software**  
DrawForms **SPECIAL** \$30  
Requires MacDraw
- MacForms** **SPECIAL** \$42  
Requires MacPaint
- Desktop Graphics**  
DrawArt **NEW** \$29
- Electronic Publisher**  
MacMatbook **NEW** \$CALL  
Indexed clipart accessed as Desk Accessory
- Enabling Technologies**  
Easy3D **SPECIAL** \$59
- Innovative Data Design**  
MacDraft **SPECIAL** \$139  
Most powerful drafting tool for the Mac

- I/O Design**  
ColorPrint \$25  
Print your graphics in color!

- Living Videotext**  
More **NEW** \$CALL  
Outlining with presentation graphics

- Manhattan Graphics**  
ReadySetGo 2.1 **SPECIAL** \$99  
Best value in page processing—fast, flexible, and powerful!

- Silicon Beach Software**  
Accessory Pak #1 \$21
- Silicon Press** **SPECIAL** \$42  
Makes color labels on your ImageWriter II

- SoftStyle**  
Colormate \$59  
Print MacPaint, other documents in color
- Colormate Art** \$29  
Colorful clipart library

- Springboard Software, Inc.**  
Art a la Mac **NEW** \$29  
More than 600 clipart pictures

- Symmetry**  
PictureBase **SPECIAL** \$48  
Organize your picture files for easy access!

- T/Maker**  
ClickArt Effects \$27  
Add tools to MacPaint
- ClickArt Letters** \$27  
**ClickArt Personal Graphics** \$27  
**ClickArt Publications** **NEW** \$27

## MUSIC

- Kette Group**  
MacNifty Sound Digitizer \$99  
MacNifty Stereo System \$75  
New version—better sound—includes speakers
- MacNifty Studio Session** \$69

## HOME

- Rubicon**  
Dinner at Eight \$35  
Silver Palate Collection \$29  
Now Mac plans gourmet meals

- X-10**  
Powerhouse **NEW**

- Computerize appliances for convenience & security
- Appliance, Lamp & Wall Modules \$15 each
  - Burglar Alarm Interface \$26
  - Computer Interface \$69
  - Controller \$9
  - Thermostat Control Set \$69

## Double Helix **\$289**

From Odesta  
Double Helix packs double the punch you've come to expect from Odesta. Expanded power, flexibility, and ease of use make this the relational database for professional information management.

Double Helix features: the ability to create customized pull-down menus; three levels of password protection; subforms for easy in-voices and powerful reports; expanded data import/export; many new user-oriented additions and modifications; global delete; speed and statistical optimization; compatibility with the Mac Plus, LaserWriter Plus, and HFS; and Odesta's excellent technical support. Requires 512K or Mac Plus and external drive



## EDUCATION

- First Byte**  
Kid Talk **SPECIAL** \$39  
SmoothTalker **SPECIAL** \$49  
Speller Bee **SPECIAL** \$39
- Great Wave**  
KidsTime \$35
- QED Information Services**  
Typing Made Easy \$35

## GAMES

- Too many games to list all! Please call for prices of your favorites.
- Broderbund**  
Ancient Art of War \$29
- Electronic Arts**  
Pinball Construction Set \$27
- Microsoft**  
Flight Simulator **NEW** \$33
- Psion**  
Psion Chess \$31
- Simon & Schuster**  
Paper Airplane Construction \$23
- Spectrum Holobyte**  
Orbiter **SPECIAL** \$26

## DESK ACCESSORIES

- Cortland**  
Top Desk \$39
- Dubl-Click Software**  
Calculator Construction Set \$32  
New low price!
- Imagine Software**  
Smart Alarms \$39  
Integrates appointment book with alarms—flashes timely reminders for appointments
- Target Software**  
MacLightning 2.0 **SPECIAL** \$44  
THE breakthrough design in spelling checkers; requires two drives
- Legal Dictionary \$69
  - Medical Dictionary \$69
  - Merriam Webster Thesaurus \$33  
Dictionary supplements require MacLightning

## The Mouse Is Out!

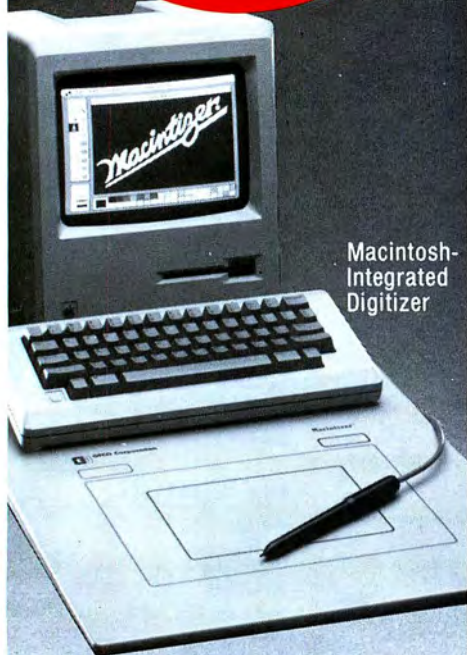

Macintosh-Integrated Digitizer

The Macintizer is *better* than a mouse: its stylus gives you precise control for drawing, you can trace original artwork, and it won't clog or skip.

PLUS, the Macintizer plugs directly into the mouse port for 100% compatibility with all your programs—no software modifications required.

Turn your Macintosh into the graphics machine it was meant to be—with the Macintizer.

Contact your dealer or GTCO Corporation for more details. Ask About Our Macintizer XL



**GTCO Corporation**

1055 First Street, Rockville, MD 20850  
Phone: (301)279-9550 Telex: 89-8471

Circle 323 on reader service card

## Letters

least, but the remark, "the smart thing would have been to phase out the Apple II" is so cavalier that I must respond.

No matter how great the Macintosh is, Apple cannot afford to intentionally alienate the base it has built up in the Apple II. A company like IBM may get away with canning the PCjr, but I cannot believe Apple will be tolerated in regularly repeating such behavior. Why should users or developers bother to support an Apple III or a Lisa or a Mac if it costs them dearly to do so?

William Clarke  
Missoula, Montana

### Get More File Finders

In the May 1986 *Get Info*, Lon Poole wrote about desk accessories that allow file deletion. Our *FileFinder* was not mentioned, though it was featured in the April *Macworld View*. In addition to letting you delete files, *FileFinder* lets you copy, rename, and get info about files without having to quit an application.

Like the other desk accessories you mentioned, *FileFinder* version 1.1 is not compatible with the Hierarchical File System (HFS). Those interested in an HFS version may write to us, and we will notify them when this version becomes available. *FileFinder* can be ordered directly from us for \$24.95: Nashoba Systems Inc., 175 Sudbury Rd., Concord, MA 01742, 800/842-4250, 617/371-2029 in Massachusetts.

Don Warren  
Nashoba Systems  
Concord, Massachusetts

*We have also learned about a file finder that works with the HFS: PBI Software's HFS Locator, which finds files by name or date, no matter how deeply nested in folders. Once it locates the files, the desk accessory can move, delete, launch, copy, rename, or get info about them. The program, which retails for \$24.95, is available from PBI Software, 1111 Triton Dr. #201, Foster City, CA 94404, 415/349-8765. —Ed.*

### Fedit Gone Astray?

Last November I sent a money order for \$30 to John Mitchell to become a registered user of his *Fedit* 3.0 file editing program (mentioned in the November 1985 *Macworld* article "Recovering a Damaged Disk").

The program itself is available at no charge via CompuServe. Users are free to try the program and, if they wish, pay the

fee to become registered users, who receive the instruction manual for the program and any updated versions as they are produced.

Five months later I had still not received a reply or a refund.

Brian L. Warbey  
Saskatoon, Saskatchewan  
Canada

*John Mitchell informs us you've already been issued a refund check. Mitchell delayed sending updates while he prepared a version that would work with the HFS—thinking that it would take only another week... and then another... The new version was nearing completion at this writing; call 408/773-9834 about availability. —Ed.*

### A New Angle on Shareware

In the spirit of the shareware concept, I am offering my booklet of Macintosh hints. As long as the supply lasts, in exchange for a 6- by 9-inch self-addressed envelope with 39¢ postage, I will send any *Macworld* reader a copy. The indexed booklet includes a number of the undocumented ⌘-key and Option-key combinations for the desktop, *MacPaint*, *MacWrite*, *MacDraw*, and many other programs. In turn, I encourage the recipient to send me \$3 or whatever seems fair.

Ken Knecht  
1340 W. Third St. #130  
Yuma, Arizona 85364

### Not the Model Program

Keith Thompson's review of *Mindsight* ["Beyond Spreadsheets"] in your April 1986 issue touched a sore point.

*Mindsight* is unusable as a financial modeling program, mainly because it has no command language (macro) capability. If you prepare a model of 500 rows and need to print 70 rows for financial statements, you have to individually choose each row and format a report every time you want to print a different case. It is surprising that your reviewer should think so highly of such a crippled package. The same publisher's MS-DOS program, *IFPS*, does have command language capability.

The Macintosh is still crying out for a financial modeling language. I hope the people at Apple are listening.

M. Alland  
Potomac, Maryland

(continues)





# The C for the Macintosh

*"Library handling is very flexible...documentation is excellent... the shell a pleasure to work in...blows away the competition for pure compile speed...an excellent effort."*

COMPUTER LANGUAGES, 4/85

## Why Professionals Choose Aztec C

Professionals choose Manx Aztec C development systems because they are the most powerful, portable, and professional microcomputer C development systems available. Professionals know that Manx Aztec C offers the features, dependability, and performance required for producing professional results.

Applications implemented with Aztec C development systems range from real time control of robot arms used in manufacturing, to message switching systems, to games, languages, operating systems, and business systems.

Much of the commercial software for the Apple Macintosh including top selling titles from software publishers Broderbund, Hayden Software, and Spinnaker is developed using Manx Aztec C.

## Value, Performance, and Flexibility

Manx Aztec C68k for the Macintosh is available as a line of three upgradable development systems: Manx Aztec C68k-p, Manx Aztec C68k-d, and Manx Aztec C68k-c. Student, non-commercial, and small business discounts are available. Whatever your budget and requirements, there is a Manx Aztec C68k development system that offers you the best value and performance for your investment.

## New Macintosh Mouse Interface

The highly acclaimed, powerful, and professional Manx Aztec SHELL development environment now includes a mouse interface. Developers unfamiliar with UNIX or MS-DOS can work entirely with the mouse interface. Those interested in learning the advanced features of the SHELL can do so at their leisure. Developer's familiar with UNIX or MS-DOS can ignore the mouse, if they so choose, and work entirely in a familiar command driven environment.

## Aztec C, The Most Portable C.

Manx Aztec C Development Systems are available for the Apple Macintosh, AppleII, IBM PC, PC compatibles, CP/M-80 systems, Radio Shack Systems, and the Commodore 64/128. Manx Aztec C is also compatible with UNIX and UNIX ports. Manx currently is developing systems for the Amiga and other microcomputer systems. No other C Development System for the Macintosh comes close to the portability of Manx Aztec C.

## Power To Spare

In benchmark after benchmark, Manx Aztec C appears in column after column as the clear winner.

The following sieve benchmark timings are reprinted with permissions of Computer Languages, 131 Townsend Sr, San Francisco, CA 94107 from a Macintosh review that appeared in the April, 1985 issue:

compiler	compile/link	run	size
Manx Aztec	49	7	13,274
Megamax	114	7	13,816
Softworks	201	9	46,914
consular	152	10	17,654
Hippo 2	102	13	30,648

The following sieve benchmark timings are reprinted with permission of Macworld, 555 De Harro St., San Francisco, CA 94107, from the May, 1985 issue from "Mac Wins By a Length" in the Open Window column.

Language	Run Time
Aztec C 1.06C	6.55
McFORTH 2.0	20.01
Modula-II	71.60
MBASIC 2.00	1170.00
Pascal	1270.00

## Sieve timings for Manx Aztec C68k 1.06g:

with register variables 3.37 secs 5,007 bytes  
without register variables 6.02 secs 5,140 bytes

## Manx Aztec C68k - Professional Tools

Manx Aztec C68k is bundled with a rich abundance of tools to help produce superior results in reasonable time frames. The following is a list of features and facilities included in Aztec C68k-d, the Developer's System, and Aztec C68k-c, the Commercial system. Items that are marked -c are unique Aztec C68k-c.

Optimized C	Mouse Enhanced SHELL
UNIX-like SHELL	Creates desk Accessories
Macro Assembler	Creates Clickable Applications
Smart Overlay Linker	Phone Support
C-PASCAL Interface	PASCAL-C Interface
Resource Compiler	UNIX Library Functions
Debuggers	Terminal Emulator (Source)
Object Librarian	Easy Access to Mac Toolbox
Mouse Editor	unlimited code size
IEEE floating point	six register variables
Inline assembly	extensive sample programs
600 page manual	hard disk support
no license fees	PASCAL type strings
MacirqTalk support	AppleTalk support
code optimizer	symbolic debugger (512k)-c
MacRam Disk-c	UniTools (ul, make grep, diff)-c
Library Source-c	One Year Of Updates-c

## Summary

If you plan to program in C on the Macintosh or are currently doing so using a brand x C compiler, there is a Manx Aztec C68k system for you that offers the best value and the greatest degree of portability, power, and professional quality available.

Look around, evaluate, and compare. The more you look, the more you compare, the more you will see that Manx Software Systems has succeeded in its objective to provide you with the best C development system available at the best possible price. Then, give us a call, and join the 25,000 users who already know and enjoy the Manx Aztec C advantage.

## Products and Prices

Aztec C68k-c Commercial System	\$499
Aztec C68k-d Developer's System	\$299
Aztec C68k-p Personal System	\$199
C-tree database (with source)	\$399
Lisa Kit	\$ 99
MS-DOS → Macintosh Cross	\$750

## Discounts

Discounts are available for professors, students, independent developers, hobbyists, and small businesses.

## How To Become an Aztec C User

To become an Aztec C user call 1-800-221-0440 or call 1-800-832-9273 (800-TEC WARE). In NJ or outside the USA call 201-530-7997. Orders can be telexed to 4995812.

Payment can be by check, COD, American Express, VISA, Master Card, or Net 30 to qualified customers.

Orders can also be mailed to Manx Software Systems, Box 55, Shrewsbury NJ, 07701.

## How To Get More Information

To get more information on Manx Aztec C and related products, call 1-800-221-0440 or 201-530-7997, or write to Manx Software Systems.

## 30 Day Return Policy

Manx has a 30 day return policy. If you don't like your Manx Aztec C development system, return it within thirty days for a refund. Refunds do not include shipping costs, and might incur a small restocking charge.

## Distribution Of Manx Aztec C:

In the USA, Manx Software Systems is the sole and exclusive distributor of Aztec C. Any telephone or mail order sales other than through Manx are unauthorized. Aztec C is available from qualified retail outlets under license to Manx Software Systems.

Circle 112 on reader service card

# MANX

To order or for information call:

## 800-221-0440

UNIX is a registered TM of Bell Laboratories, Lattice TM Lattice Inc., C-tree TM Faircom, Inc., PHACT TM PHACT ASSOC., CI Optimizing C86 TM Computer Innovations, Inc., MACINTOSH, APPLE TM APPLE, INC., Pre-C, PLINK 86, TM PHOENIX, HALD TM Media Cybernetics, Inc., C-terp, PC-link TM GIMPLE Software, Windscreens, SunScreen TM Suntec, PANEL TM Roundhill Computer Systems Ltd., WINDOWS FOR C TM Creative Solutions, XENIX, MS TM MICROSOFT INC., CP/M TM DRI, AMIGA, C64, C128 TM COMMODORE Int.

See Us at Macworld Expo Booth # 236

# Until dMac III, knocking out your customized business applications was a real fight.



When you used to put your Macintosh up against tough, custom business applications, it was nearly always an unfair bout.

Now with dMac III, your Macintosh possesses the swiftness and power of a top-ranked champion.

- *dMac III's nearly limitless range of power includes:*
  - \* Up to 7 index files per database
  - \* Up to 100 different indices per index file
  - \* Up to 10 database files in use simultaneously
  - \* Up to 2,000 fields per record
  - \* Up to 253 characters per field
- *dMac III features a powerful programming language that offers Macintosh users the ability to create professional business applications*
- *dMac III shares data with other major Macintosh software packages... in both directions*
- *dMac III is fully compatible with dBase III*
- *To run dMac III you need:*
  - \* Apple Macintosh or Macintosh plus with 512 KB RAM
  - \* Two disc drives or one disc drive and a hard disc
- *All for the suggested retail price of \$495*

For your authorized dMac III dealer contact:

**FORMAT SOFTWARE, INC.**  
11770 Bernardo Plaza Ct. Suite 217  
San Diego, CA 92128  
(619) 487-6946

Macintosh is a trademark licensed to Apple Computer, Inc. dBase III is a trademark of Ashton-Tate, Inc. The gloves used in this photograph were worn by Archie Moore when he defended his light heavyweight title by defeating Bobo Olson in June, 1955 at Los Angeles. Format Software, Inc. wishes to thank Mr. Archie Moore and the Hall of Champions, Balboa Park, San Diego, CA. For information and membership, call: (619) 234-2544.

## dMac III... Macintosh and database. An exciting match.

Dealers circle 535 on reader service card  
End Users circle 536 on reader service card

## Letters

### Reinventing the Typo

You're right. In many ways, *MacSpell+* [*Macware Reviews*, March 1986, and "Letter-Perfect Documents," July 1986] is a slick product—but with a serious problem: its dictionary contains misspelled words.

Back in the dim days of prehistory when I spent several hours per day with my Osborne 1, I used a spelling checker that contained all sorts of useful utilities, including the ability to remove words from the dictionary.

In this business, the wheel really is reinvented from time to time, and sometimes new versions are flat on one side.

Gary Johnson  
White Bear Lake, Minnesota

### Burned Up over Parts Policy

The flyback transformer burned out on my Mac's video controller board. When I took it to a dealer, I was given the option of purchasing a new board at \$515 or doing a board swap for \$195. I could not purchase just the new transformer because Apple sells those only to dealers. Again the little guy takes it in the shorts. I don't sell computers, I just happen to own one.

Jerry Stidham  
APO Miami, Florida

*Technically competent users find the policy exasperating, but it's typical throughout the personal computer industry that manufacturers discourage users from tinkering with the power supply, as a safety precaution. Though you may dispute the wisdom of absolutely restricting the distribution of parts—not even authorized service centers can obtain some parts individually—it does guarantee a standard quality of repair and prevent the intrepid but untrained from suffering injury or expensive fixes. —Ed.*

### Correction

An outdated telephone number was published for DPEX, maker of the Mac/2392 terminal emulator, in "Mini and Mainframe Connections," *Macworld*, July 1986. The current number is 408/734-5932.

Also, the correct number for Mesa Graphics, producer of the Tekalike terminal emulator, is 505/672-1998.

*Letters should be mailed to Letters, Macworld, 555 De Haro St., San Francisco, CA 94107, or sent electronically to CompuServe 70370,702 or The Source BCW440. We reserve the right to edit letters. All published letters become the property of Macworld. □*

# HERE'S THE LoDOWN .....



The fastest  
Hard Disk  
Tape Back-up  
for the  
Macintosh™

LoDOWN Hard Disk and Tape Back-up connects to the Macintosh via the ultra high speed SCSI Bus providing the **fastest** Mass Storage devices ever! For your 512 Mac LoDOWN offers an easily installed SCSI Interface Kit, providing the 512 Mac with the speed of the Mac Plus. And you can even boot directly from the LoDOWN Hard Disk. For the Mac Plus simply connect the SCSI cable and you are off and running.

### How fast is fast???

Software	Time in Seconds
MacWrite	3.8
MacDraw	3.2
MacPaint	2.5
Excel	5.6

Action measured to nearest .5 second with a Mac Plus using Finder V5.2 and average over 3 consecutive executions, system cache on. Timings are based on the amount of time to open application.

LoDOWN's Hard Disk has a unique head locking feature providing a rated shock force of 60 G (design for portability) and a MTBF (Mean Time Between Failure) Of 25,000 hours (power on hours) which is twice that of the competition. For your convenience LoDOWN preloads over 300 public domain programs and for an additional charge, offers a Print Spooler, Floppy Backup and Networking software. The LoDOWN products require no fan providing an extremely quiet working environment. An additional AC power outlet to your Mac is included in the price along with the required cable and terminator.

LoDOWN's Tape Back-up can back-up and restore your Apple Hard Disk 20, HyperDrive, Corvus, LoDOWN or other leading hard disk disks. You may backup and restore selected files, folders, or the whole disk volume. Tape speeds are approximately 4 Megabytes per minute, or just 5 minutes to backup or restore a 20 megabyte hard disk (times vary depending upon the hard disk).

Because LoDOWN believes you will be as excited and pleased with our products as we are, LoDOWN offers the same warranty program as Apple Computer.



Shown: LoDOWN-T20 Tape Back-up

Available Now!  
**COMBO 20/20**  
Integrated-one unit  
20 meg Tape Back-up  
20 meg Hard Disk

- Hard Disk
- LoDOWN 20/20 \$1795
- LoDOWN-20 \$995
- LoDOWN-40 \$1995
- LoDOWN-80 \$3995
- Tape Back-up
- LoDOWN-T20 \$895
- LoDOWN-T60 \$1795

In Europe, Contact:  
LoDOWN Europe DK  
45-9 91 16 19

## The fastest Hard Disk Tape Back-up for the Macintosh™ Plus!!!!



Apple, Finder are trademarks of Apple Computer, Inc.  
Macintosh Plus is a trademark licensed to Apple Computer Inc.  
HyperDrive is a trademark of General Computer Corp.

Circle 466 on reader service card

LoDOWN  
10 Victor Square  
Suite 200  
Scotts Valley, CA 95066  
(408) 438-7400  
Telex 5106007873  
Dealer Inquiry Welcome

# Now SOFTSTRIP® PROGRAMS ARE EVERYWHERE.

## PROGRAMS! PROGRAMS! PROGRAMS!

Hundreds of SOFTSTRIP data strip programs are available NOW.

All add an exciting dimension to your personal computing...and more are coming every day.

Business programs...personal finance programs...application notes...music...games...entertainment...graphics. ALL ON THE UNIQUE SOFTSTRIP DATA STRIP...ON PAPER!

## WHERE ARE THEY? WHAT ARE THEY?

You'll find SOFTSTRIP data strip programs...

- In the leading Macintosh magazines including *MACazine*,

*Mac User*, *MacA.P.P.L.E.*, *Nibble Mac* and the *Macintosh Buyer's Guide*. All are now printing data strips with many of their articles to give you complete software programs and demos.

- In *The Cauzin Effect*...our monthly newsletter.
- In our advertising...like this one.
- In selected *Cauzin StripWare™* software packages such as *MacArt for Business* and *The Financial Advisor*.

PLUS...in leading Macintosh user group newsletters such as *Yale MUG* and *Portland MUG*.

**BUT YOU NEED THE SOFTSTRIP SYSTEM READER TO USE THEM**

## CAUZIN

835 South Main Street  
Waterbury, CT 06706  
(203) 573-0150

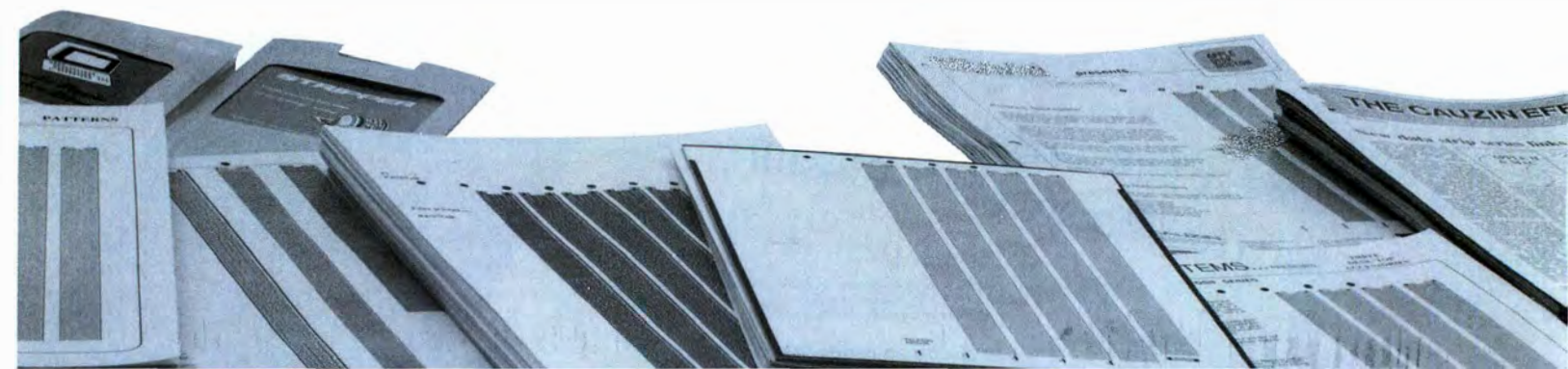



The Macintosh User's Edge

# HERE, THERE &

To Help You Make Up Your Mind We're Having a MACelebration!  
Buy a reader now... send in the warranty card and we'll immediately send you...

## MacPlenty

<b>Utility Programs</b> Utility Programs 16 programs including Banner — print large banners — and Mass Copier — simplifies disk copying.	<b>12 Desk Accessories</b> 12 Desk Accessories Including Big Ben, and Cube, a version of the famous puzzle.	<b>Clip Art™</b> Clip Art™ Valuable assortment to aid your Desktop Publishing.	<b>R Font Library</b> Font Library Featuring Apple Fonts for the Macintosh.	<b>Games and Entertainment</b> Games and Entertainment Including Backgammon and Megaroids.
--	---	--	---	--

Offer expires Sept. 30, 1986.  
May not be combined with other offers.

### PLUS — PREVIEWS!

Fully operational segments of the original program. Not just a simple demo but a full featured extract that lets you see how the 'hottest' current programs work. Useful as they stand. Sent to you regularly with our newsletter, The Cauzin Effect.

### THE SOFTSTRIP SYSTEM...READ STRIPS AND PRINT YOUR OWN.

Our unique encoding technology prints programs on paper in computer code. Anything that can be put on a disk can be put on a SOFTSTRIP data strip. Only the SOFTSTRIP SYSTEM READER can read the strips and enter the information into your personal computer.

It's as easy as can be. Simply place the reader over the data strip... Click the mouse and the reader does the rest... in a matter of seconds.

In addition to all this you can make

**DISK MEMO** (at right). Give memos a personal touch with these strips that contain an art file created with MacPaint that can be loaded into MacPaint or many of the Macintosh word processors. From the Finder, double click on the DISK MEMO icon. If MacPaint is also available, the file will be opened. Macintosh is a registered trademark of McIntosh Laboratories, Inc., and is licensed to Apple Computer, Inc.

MacPaint and The Finder are registered trademarks of Apple Computer, Inc.

Copyright © 1986 by Cauzin Systems, Inc. All rights reserved.

Reprinted with permission of John Wiley & Sons, Inc.

Cauzin and Softstrip are registered trademarks of Cauzin Systems, Inc.

StripWare is a trademark of Cauzin Systems, Inc.

your own strips using our STRIPPER™ software. STRIPPER allows you to print your own data strips on a dot matrix printer and is available for only \$19.95.

Whether your computing is all business or just for fun... or both... the SOFTSTRIP SYSTEM will add a broad new dimension to your computer system.

**ACT NOW!! Don't delay. See your local SOFTSTRIP dealer or call us at 1-800-533-7323. In Connecticut: 203-573-0150.**

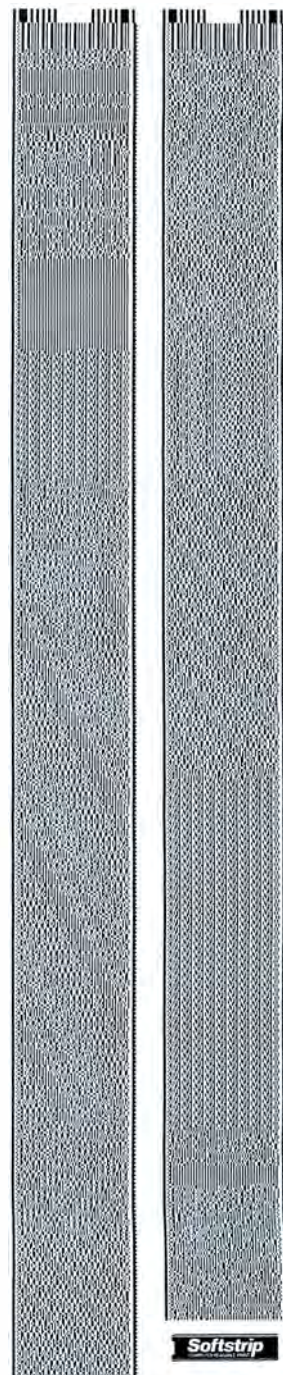

Softstrip

Macintosh is a registered trademark of McIntosh Laboratories licensed to Apple Computer Inc.

Circle 452 on reader service card

# Introducing FileMaker Plus.

Now, the only Mac database ever to get both *MacUser's* and *InfoWorld's* highest ratings does even more, with even more ease.

Humble, ordinary-but-necessary forms like mailing labels, purchase orders, invoices, credit memos or packing lists. Pain-in-the-rear forms like expense reports and insurance inventories. Hard selling forms like proposals and quotations. Indispensable forms like phone messages, address books and sales contact records.

Filemaker™ Plus lets you do these any way you want, or does them *for* you if you want. An extra disk full of templates gives you a whole set of typical formats, so all you have to do is fill in the blanks.

And in addition to doing what a database is supposed to do — calculations, summary reports, sorting — FileMaker Plus does everything you *wish* a database would do. View multiple records on a

screen. Pull information from different files together. Include graphics in your fields and reports. Print mailing labels 3 or 4-up, or more.

Your information takes much more human form. It makes more than sense. It makes an *impression*.

With FileMaker Plus, you can put information *in* any way you want, without arbitrary limitations. It automatically indexes every word, number and date. You design your output right on the screen, so you can see exactly what you (and your clients, staff, suppliers, publishers, board of directors) are going to get.

You can exchange information with other programs, like MacWrite™, MacPaint™, MacDraw™, Microsoft® Word and Microsoft Excel. You can share applications or formats you've created with other members of your team, or consolidate group efforts into one database. And FileMaker takes full advantage of the Macintosh™ family, including the Mac Plus, Mac 512, Imagewriter and LaserWriter.

So, for a mere \$295, you can watch as your data takes on all kinds of interest-

ing and profitable new forms. Call 1 800 MACWARE today for the name of your nearest dealer.

**We guarantee it.**

If FileMaker Plus doesn't completely fulfill your expectations, call 1 800 MACWARE and we'll solve your problem or arrange a refund.\* From Forethought, Inc.

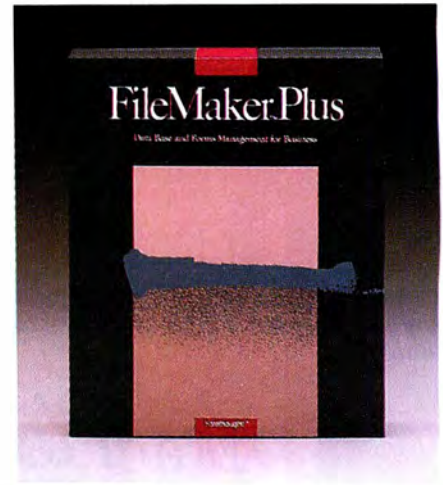

# Watch your data take human forms.

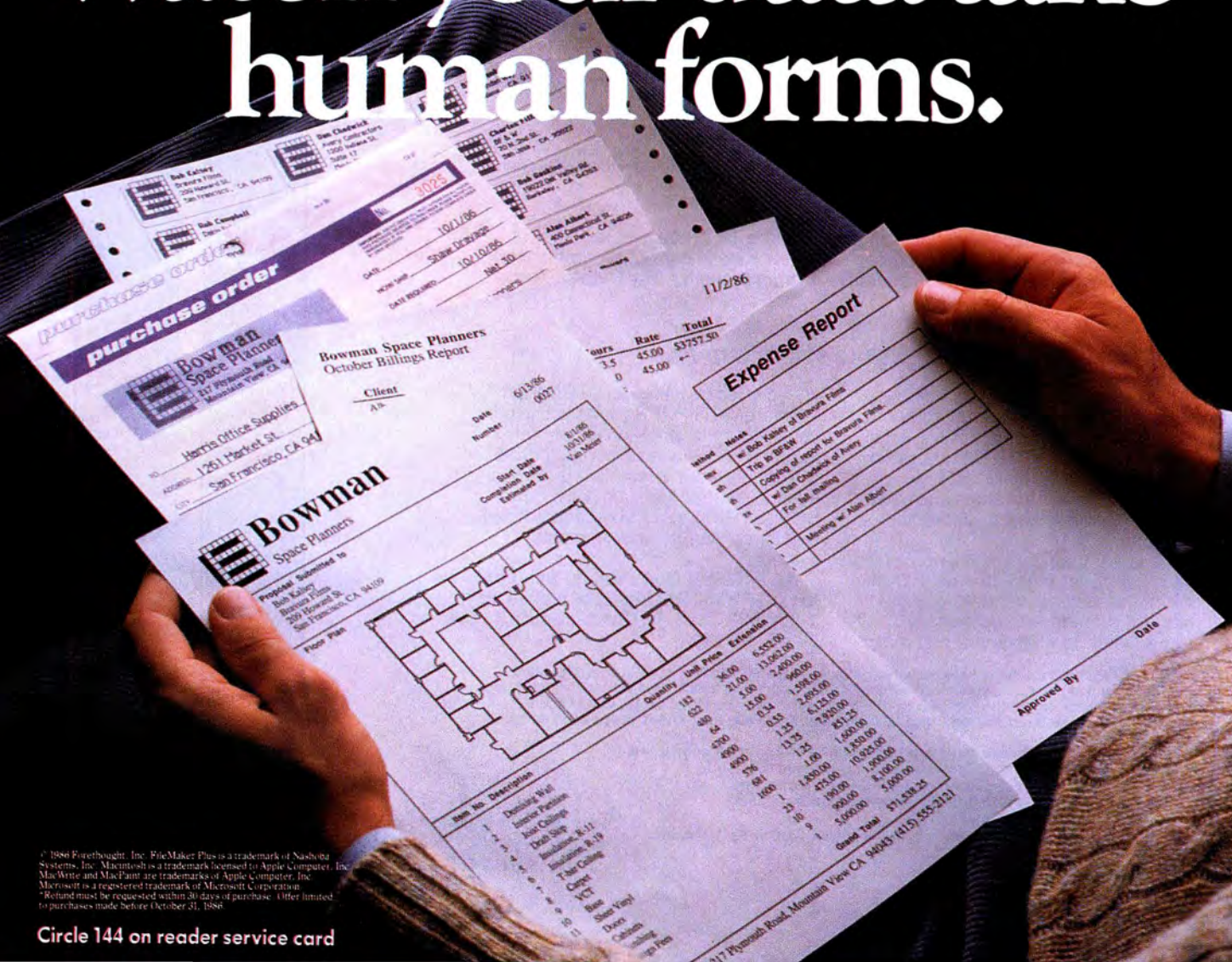

© 1984 Forethought, Inc. FileMaker Plus is a trademark of Nashoba Systems, Inc. Macintosh is a trademark licensed to Apple Computer, Inc. MacWrite and MacPaint are trademarks of Apple Computer, Inc. Microsoft is a registered trademark of Microsoft Corporation. \*Refund must be requested within 30 days of purchase. Offer limited to purchases made before October 31, 1984.

# Macworld View

*An alternative to AppleTalk, SCSI tape drives, desktop publishing, large-screen Macs, and more*

*Edited by Daniel Farber*

## Big-Screen Mac

If you want a large black-and-white screen for applications like desktop publishing, computer-aided design, or education, a few options are available. One is to install a composite video display adapter from the Macintosh to a high-resolution monitor. This converts the 22.5-kHz scan rate of the Mac to the standard TV scan rates. Mentauro Corporation (1658 IH 35 South, San Marcos, TX 78666, 512/396-1565), for example, sells a \$199.95 adapter that is compatible with a wide variety of monitors—costing from \$1000 to \$3000—and more expensive projection devices.

MacVideo Processor (MVP) from MultiVideo (4 Johnston Way, Scotts Valley, CA 95066, 408/438-3663) takes a different approach. It displays the Mac screen on standard TVs, projection TVs, and VCRs. An image processor attaches to the back

of the Macintosh with an interface board that clips onto the motherboard. You can zoom up to 16 times normal display and pan to view other sections of a magnified image. You can also freeze an image on the TV screen and continue to work on the Mac without affecting the TV image. The interlace design of TV screens results in some flickering, especially in images that contain lots of horizontal lines. Projection TVs eliminate most of the flicker, however. MVP has its own power supply and sells for \$995.

MegaScreen, from Micrographic Images (20954 Osborne St., Canoga Park, CA 91304, 818/407-0571) takes the big-screen concept one step further. The Mac screen appears on a 19½-inch, high-resolution monitor (the same one used for Sun workstations) at 1024- by 921-pixel resolution. In effect, MegaScreen displays four to six times the surface area of the standard Macintosh screen. The hardware includes a proprietary graphics control-

*(continues)*



MEL LINDSTROM

*The MacVideo Processor, which is installed on the back of the Macintosh, displays enlarged Mac images on standard TV screens.*

# This is the Only Aspiring Young Professional We Could Find That Had a Legitimate Excuse for Not Using MacLightning.

To those of you who have made MacLightning™ the nation's best-selling spell checker in just six short months, we say *thanks!*



To those of you who, for one reason or another, have not yet joined the ranks of our satisfied users we introduce **MacLightning version 2.0**. Now there can be no excuse!

When MacLightning made its debut early this year it was the **only** "interactive" spelling checker for the Macintosh. Thanks to Merriam Webster's Ninth New Collegiate Dictionary, a 45,000-word Thesaurus and a long list of upgrades, **it still is**.

Operating in either the interactive or non-interactive mode, MacLightning spell checks your work at a blazing 75 + words per second. This puts it light years ahead of the competition.

Also available from Target Software are

extensive dictionaries covering medicine, law and a host of other technical fields.

So if you'd like more information, or the name of a dealer near you, call Target Software toll-free. You'll never go wrong again.

**MacLightning Version 2.0 - \$99.95**  
**Merriam Webster Thesaurus - \$49.95**  
**Merriam Webster Medical Dictionary - \$99.95**  
**Merriam Webster Legal Dictionary - \$99.95**

**Target Software**

**National: 1-800-MAC-LITE (800-622-5483)**  
**In Fla. (305) 252-0892**

Target Software Inc. 14206 Southwest 136th Street, Miami, Florida 33186

**Circle 478 on reader service card**



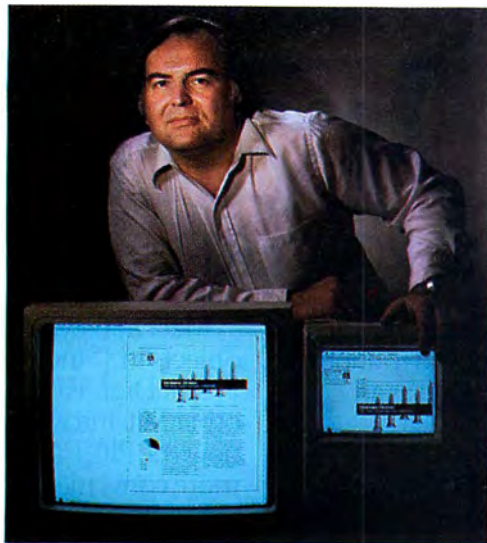

*Micrographic Images' Janek Kaliczak demonstrates the MegaScreen's ability to display a full-page PageMaker image at high resolution.*

### Big-Screen Mac (continued)

ler, a power supply, and an interface to the motherboard. MegaScreen has outputs for both TTL and NTSC composite video. Programs like *MacDraw*, *PageMaker*, *ReadySetGo*, *Pro-*

*essional CAD for the Mac*, *McCAD*, and *Quik Circuit* take advantage of the full screen and resolution without any problems. The monitor costs \$1595, and MegaScreen sells for \$1495.

## dMac III

With Ashton-Tate's *dBase* the most popular database for personal computers, it's surprising that no one has developed a *dBase* for the Mac—until recently, that is. Format Software of San Diego now publishes a programmable database that is compatible with *dBase II*, *III*, and *III+*. The program transfers data between the Mac and PC-DOS-based versions without modification. *dMac III* doesn't use the full Macintosh interface, mainly because the program's first objective is compatibility with *dBase*.

(Ashton-Tate has yet to release its database product for the Macintosh, but we expect it to follow the Macintosh user in-

terface to the letter and to be compatible with *dBase* files.)

Tom Haag, president of Format Software, has aimed the \$495 product at developers of *dBase III* programs. "This gives them the flexibility to create turnkey systems for people who want to use the Mac," he says. "*dBase III* programs already existing can easily be ported to the Mac." The company plans to develop a more Mac-like version of *dMac III* in the future. For more information, contact Format Software, 11770 Bernardo Plaza Ct. #208, San Diego, CA 92128, 619/487-6946.

## SCSI Tape Drives

As a kid you probably tried hanging on to a merry-go-round while your friends pushed it faster and faster until you either flew off or threw up. That's what life is like for information stored on a hard disk. The edge of a typical 3½-inch hard disk travels faster than 70 miles per hour; a 5¼-inch disk goes over 110 miles per hour. At those speeds, it's a miracle that information remains intact. When massive quantities of expensive programs and priceless documents go into orbit, you want to be prepared with a reliable copy of your hard disk's contents.

Sure, you can back up a hard disk on 25 or more double-sided disks, provided you have several hours and a strong wrist. If your budget exceeds your stamina, a tape drive may be the answer. Tape drives range in capacity from 20 to 60 megabytes per tape cartridge and store information at rates of up to 5 megabytes per minute.

Although most people think of tape drives as backup devices, they have other valuable uses. Imagine shipping or carrying 10 or 20 megabytes across the country, locking away sensitive information in a safe, or increasing the virtual capacity of your hard disk drive.

The advantages of tape drives are not lost on manufacturers of SCSI equipment for the Macintosh. Even Apple is widely rumored to be working on a SCSI tape drive, something Apple mass-storage product manager Al Zisser refuses to confirm or deny. At least one manufacturer is waiting to see what Apple decides to do. "We want people who use our tape drives to be able to exchange

tapes with people who use Apple's," says SuperMac Technology's president Steven Edelman.

However, the half-dozen developers who have already announced tape drives don't appear to be worrying about Apple setting a de facto standard.

Mirror Technology offers the Magnum Tape 20, which has a 20-megabyte capacity and a \$1095 list price. Another model, the \$2495 MagNet Tandem 40, puts a 20-megabyte hard disk and a 40-megabyte tape drive in one cabinet. LoDown's two tape drives, the T-20 and the T-60, have capacities of 20 and 60 megabytes, respectively. The T-20 lists for \$895, the T-60 for \$1795.

The Sun Safe-60 from Sunol Systems stores up to 60 megabytes on each tape cartridge you feed it. List price of the tape drive is \$2195. Micah offers a 40-megabyte tape drive that retails for \$1495.

AST has two SCSI product lines that include tape drives. The AST 2000 base unit contains a 20-megabyte disk drive and a 20-megabyte tape drive; it lists for \$2795. The AST 2000 with the tape drive alone costs \$1695. The higher-capacity AST 4000, with a retail price of \$6995, has a 60-megabyte tape drive and a 74-megabyte disk drive.

Peripheral Land offers the MacBack20 and the MacBack60, 20-megabyte and 60-megabyte tape drives that work only with Peripheral's MacFast line of SCSI disk drives. An intelligent link between tape drive and

(continues)

# THE EVOLUTION OF MacDraft™

## NOW EVEN MORE POWERFUL

**NOW INCLUDES**  
• Resizing of Groups  
• Cursor Position Indicators  
• Hard Disk Install

### OUR COMMITMENT

When IDD first released MacDraft a few months ago, we claimed it was the most powerful drawing tool available for the Macintosh™ and that it would evolve to be even greater. Now the evolution begins with these major enhancements.

### AUTOMATIC AREA CALCULATION

MacDraft can now automatically calculate the area of any object to scale, whether it's a simple rectangle or a 50 sided polygon.

### CUSTOMIZED FILL PATTERNS

In addition to MacDraft's palette of 64 fill and ink patterns, you can now dynamically edit and create your own patterns.



Courtesy: Bob White, Architect, Fernandina Beach, FL 32034

### UNIQUE TEXT CAPABILITIES

Auto dimension line and area calculation features now include the ability to detach text and change

MacDraft runs on a Macintosh™ 512K or XL and is compatible with the LaserWriter™. MacDraft is a trademark of Innovative Data Design, Inc. Macintosh is a trademark licensed to Apple Computer, Inc.

font, style and size. Once detached, text values can be moved to another part of the drawing, such as an information table.

### MORE SCALES TO CHOOSE FROM

The foundation of MacDraft is its ability to draw to scale and have the grids, rulers and dimensions reflect the scale of the drawing. We now offer a 4x and 10x scale. You can create a drawing at one scale then convert it to another.

### PLUS THESE CLASSIC MACDRAFT ADVANTAGES

Create circles by radius or diameter, arcs by radius or by defining 3 points. For irregular shapes, our polygon and freehand tools offer dynamic editing, auto closure and the ability to add sides to an existing object.

Zoom in and magnify a portion of your drawing up to 8x; or zoom out and see as much as 4' x 4' in a single window, maintaining full drawing capabilities at any view.

MacDraft even lets you rotate objects in 1° increments.

MacDraft is compatible with other Macintosh applications, and now the PICT format makes it even more convenient.

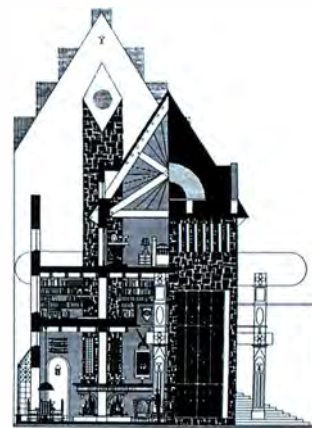

Courtesy: Trout Creek Ltd., Vail, CO 81657

### DRAW YOUR OWN CONCLUSIONS

Incredibly, MacDraft is only \$269, including a backup disk. It's a good old fashioned value that just may convince you to put away your drafting pencil forever!

**idd inc.**

Innovative Data Design, Inc.  
1975 Willow Pass Rd., Ste. 8  
Concord, CA 94520  
415/680-6818

Circle 308 on reader service card

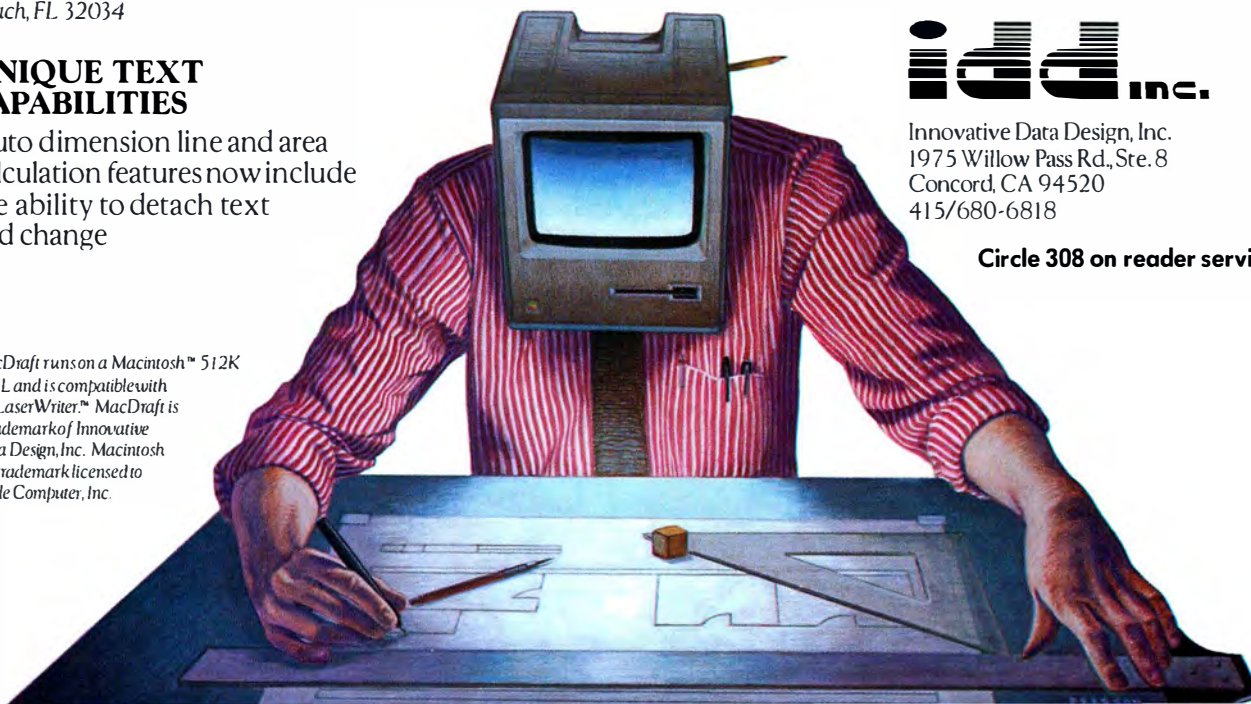

## SCSI Tape Drives (continued)

disk drive means that once information transfer has begun, the Mac's attention is no longer required. List price is \$1249 for the MacBack20 and \$1995 for the MacBack60.

Software supplied with the tape drives varies widely, and all of it is evolving rapidly. Minimal software simply dumps an entire disk or volume onto tape. Other programs let you pick folders and files to save to, or retrieve from, tape and can save and reuse lists of files and folders. Still more sophisticated software provides for automatic incremental backup: you insert a tape and click a button, and the software backs up all the files that have changed since the last backup. The best packages combine all these features, plus letting you add and remove files and folders before beginning the incremental backup. Most manufacturers provide free software updates to registered owners.

Is there a tape drive in your future? If you need removable mass storage for any reason—hard disk backup, increase storage capacity, information security, or portability—the answer may be yes.—*Lon Poole*

## PhoneNet



Farallon Computing has introduced an alternative to Apple's AppleTalk hardware. PhoneNet is a system of AppleTalk-compatible network hardware that operates over ordinary phone lines. Installing the system with existing phone lines and standard modular phone extension cables reduces wiring costs from about \$1.50 per foot with Apple's cables to 10 cents per foot, says Reese Jones, a spokesperson for the company. "PhoneNet requires only two wires between machines, whereas AppleTalk uses three. The advantage of this stems from the fact that the phone company often installs only four conductor cables in a building. The telephone uses two of the lines, still leaving two for PhoneNet," Jones explains.

Originally developed by members of the Berkeley Macintosh Users Group at the University of California, PhoneNet uses a low-resistance floating

ground circuit, which allows much longer cable lengths (3000 feet or more with a repeater, compared to AppleTalk's 1000). The system is compatible with single-line phones and Private Branch Exchange (PBX) systems, and hardware such as IBM PC/AppleTalk boards and the Kinetics Ethernet Bridge. You can add or remove devices without disturbing the network, and you can daisy chain devices. The PhoneNet works in combination with Apple's cables and connector box.

"PhoneNet is a pragmatic approach to networks," says Jones. "Wiring up a network in a large corporation or university costs from \$1000 to \$3000 per room. PhoneNet is a less expensive way to accomplish the same thing."

The cost for the PhoneNet connector is \$49. Versions are available for both the 512K Mac and the Macintosh Plus. For more information, contact Farallon Computing, 1442A Walnut St. #64, Berkeley, CA 94709, 415/849-2331.

## NextWrite



Steve Jobs may no longer carry the official flag for the Macintosh, but his new company, Next, has developed a new word processor for the Mac. The program takes over where *MacWrite* leaves off. "While useful for creating short, simple documents, the program also

has features that are invaluable for generating complex documents such as manuals and dissertations," says Dan'l Lewin, vice president of marketing at Next.

The program performs operations such as scrolling, reformatting, and repagination faster than *MacWrite* or *Microsoft Word*. It displays multiple columns of text on screen, as well as automatically numbered footnotes, headers, and footers.

Documents are limited only by memory, and you can open as many at once as memory allows. A built-in 50,000-word spelling checker and a utility that translates *MacWrite* and *Word* files to its document format are also included. At press time, Next, whose main focus is on developing scholars' workstations for higher education, had not finalized marketing plans for the product.



LEE YOUNGBLOOD

*Dr. Brown with his consulting tool: face meets interface?*

## Plastic Surgery Mac



With mouse in hand, Donald Brown, M.D., trims and reshapes the nose and chin of a face on the Macintosh screen. He then zooms into *FatBits* to sculpt a more distinct chin and refine the tip of the nose. With a few clicks of the mouse, he finishes the reconstruction, and the patient looks with satisfaction at Dr. Brown's artistry.

Brown, a San Francisco plastic surgeon, believes he has found the perfect device for improving doctor-patient communications. He scans preoperative photos of patients into the Macintosh via *ThunderScan* and then edits the photos in *MacPaint*. "The Mac serves as a blackboard for the physician and the patient. It is a great way of defining patient expectations, and it brings a closer understanding of what we will try to achieve through the surgery," says Brown. Before the Macintosh, Brown and most other plastic surgeons re-

*(continues)*

HOW TO BE  
ELOQUENT, WITTY,  
LOGICAL, FUNNY,  
PERSUASIVE  
FORCEFUL, AND EVEN  
VOCIFEROUS,  
BUT ALWAYS  
EFFECTIVE.

It's a presentation to the client, a financial report, a press release. The great American novel or a great company newsletter.

Your words are on the line. Give them the weight they deserve with one or more of the 45 classic type styles from the Adobe TypeLibrary. They work on Apple LaserWriter™ and any POSTSCRIPT™ printer or typesetter.

You get multiple versions—regular, *italic*, **bold** and **bold italic**—for ITC Garamond® Glypha® Optima® Palatino® ITC Benguiat® ITC Bookman® ITC American Typewriter® ITC Avant Garde Gothic® ITC Friz Quadrata. New Century Schoolbook. ITC Lubalin Graph® ITC Souvenir® **ITC MACHINE**® *ITC Zapf Chancery*® and ITC Zapf Dingbats.®

Type styles are licensed from the world famous libraries of Mergenthaler and International Typeface Corporation. So you're working with type the experts prefer. The stuff of which today's most effective communication is made.

Turn your next business statement into a great success story. Talk to your Apple LaserWriter dealer about the Adobe Type Library today. Or call us directly at 800-29-ADOBE for more information.

P.S. Ask your LaserWriter dealer about POSTSCRIPT, Adobe System's internationally recognized page description language.



PostScript is a trademark of Adobe Systems, Inc. LaserWriter is a registered trademark of Apple Computer, Inc. Glypha, Optima and Palatino are all registered trademarks of Allied Corporation. ITC American Typewriter, ITC Avant Garde Gothic, ITC Benguiat, ITC Bookman, ITC Garamond, ITC Lubalin Graph, ITC Machine, ITC Souvenir, ITC Zapf Chancery and ITC Zapf Dingbats are all registered trademarks of International Typeface Corporation.

Circle 552 on reader service card

Plastic Surgery Mac (continued)

lied on pencil and paper, tracing over photos on onionskin paper, and a lot of talk.

While the Mac is best suited for designing facial modifications, such as nose and chin alterations, Brown says it can give patients visual feedback about the potential results of face-lifts, breast reductions and augmentations, and fatty-tissue removal.

He now has three Macintosh Pluses networked in his office—one at the front desk for scheduling and maintaining patient records, another for accounting, and one in his own office for patient consultations. Brown's new technique has increased patient satisfaction, and consulting takes less time.

—Elinor Craig

## 512K SCSI Adapters

If you have a standard 512K Mac or a third-party megabyte Mac, and you don't want to invest \$599 or \$799 to get Apple's SCSI (and memory) upgrade, Peripheral Land's MacPort SCSI Host Adapter and SuperMac Technology's DataPort offer reasonable alternatives and cost savings. Even if you have a Macintosh 512K Enhanced, you can buy a third-party memory upgrade and one of these SCSI adapters, shaving about \$200 off Apple's upgrade price.

Both MacPort and DataPort connect to the Mac's ROM

socket and provide a connector for external devices—through the battery panel—as well as for software. Dealers perform the upgrade, but you can do it yourself if you are mechanically inclined. Neither SCSI adapter works with the HyperDrive, since both connect to the bus. Both MacPort and DataPort let you start up without floppy disks if you have the 128K ROM.

MacPort, which costs \$99, works with any SCSI device that uses the Omti controller (SuperMac, LoDown, Mirror Technologies). Peripheral Land provides a 90-day warranty for MacPort.

The DataPort Apple SCSI driver is 100 percent compatible with Apple's SCSI controller, according to SuperMac Technology. The cost of \$99 with SuperMac Technology's Data-Frame SCSI hard disk, and \$299 without it, includes a one-year warranty.

For more information, contact Peripheral Land, 3677 Enochs St., Santa Clara, CA 95051 or SuperMac Technology, 1901 Old Middlefield Way, Mountain View, CA 94040.

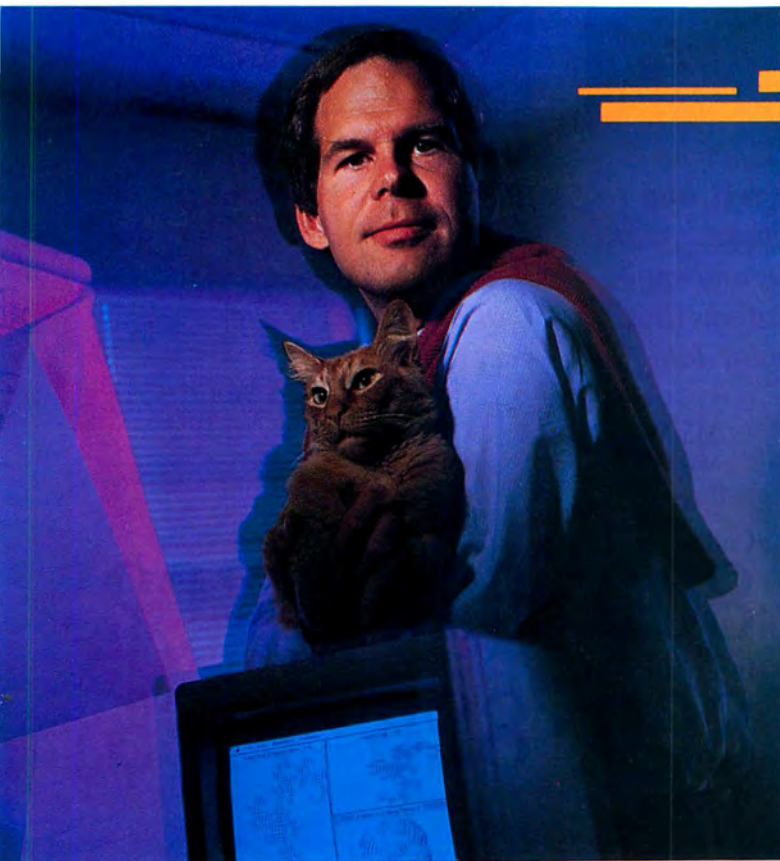

MARK HANAUER

Putting AI on the Mac: ExperTelligence president Denison Bollay—with office mascot Oliver.

## ExperTelligence

Denison Bollay, president of ExperTelligence, admits his ideas are ahead of their time. In 1980 he started the craze over computer camps—a concept that is still alive today. Bollay's real interest is now in artificial intelligence (AI), which he has been involved in since the mid-seventies—not as an esoteric science but as it applies to everyday life.

Since the coming of the personal computer, Bollay has dreamed of bringing AI applications like expert systems to PC users. But not until the advent of the Macintosh was he able to turn his concepts into reality.

Since there was no way to develop expert system tools rapidly without using LISP, the most popular AI programming language, Bollay created a version of LISP for the Macintosh—

ExperLisp. Today ExperTelligence, the publisher of ExperLisp, has the largest installed base of compiled LISP users. Not large when compared to the number of developers using C or Pascal, but Bollay and his co-workers believe that the LISP revolution is just beginning.

“Application programs have reached a threshold. To create more powerful, sophisticated ones, you must add a layer of intelligence or expertise. You can do so with Pascal or C, but LISP is specially designed for that task and is 10 to 20 times faster. There is a tremendous

(continues)

# Singular Acclaim.

*The Critics Review The INTERLACE Database.*

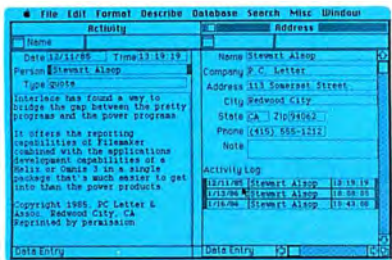

*"INTERLACE gives you a lot of freedom in report design; you can even import graphics as enhancements or backgrounds for forms."*

A+ Magazine,\*  
May, 1986

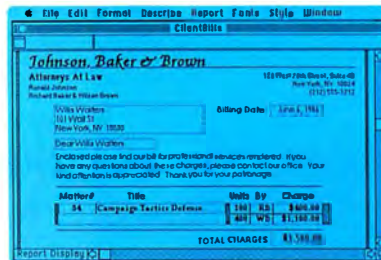

*"INTERLACE...with 49 arithmetic, text, and statistical functions... can handle business and engineering calculations that would stump most data managers."*

MacWorld,  
May, 1986

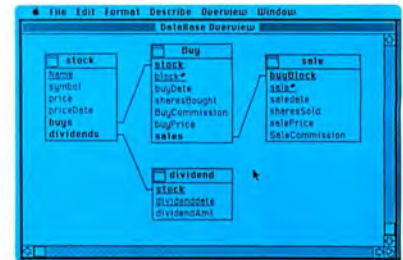

*"INTERLACE... a powerful relational database... uses a visual approach to information management that makes this power easy to manage."*

InfoWorld,  
February 10, 1986

## A Singular Solution To Managing Information. For Just \$195.

Editors are praising INTERLACE as a relational database that is, to quote *MacUser* (4/86), "a good buy for its quality, not just its price." And by the thousands, Mac owners have purchased it to help solve tough problems, fast.

What makes this popularity so easy to understand is that INTERLACE is so easy to use. Its simple spreadsheet approach makes calculations a snap. And creating database designs, forms and reports is as easy as drawing them on the screen.

Take advantage of our 60-day moneyback guarantee to review INTERLACE for yourself. Call or write today.

\*Reprinted from May 1986,  
Copyright © 1986 Ziff Communications Company

Circle 420 on reader service card

Call

**800 • 626 • 8392**

In California,

**800 • 826 • 1585**

*Singular*  
SOFTWARE, INC.

1340 Saratoga-Sunnyvale Rd., #201  
San Jose, CA 95129

**ExperTelligence (continued)**

potential for developing expert systems for the Mac or integrating them within a spreadsheet or database," says Bollay.

Bollay has also taken a step toward creating a symbiotic relationship between personal computers and dedicated AI development machines such as the Symbolics 3600. Recently, ExperTelligence entered into a comarketing agreement with Symbolics, the leading manufacturer of symbolic processing systems, and developed *ExperLink*, which allows text files to transfer between a Symbolics LISP Machine and the Macintosh running ExperLisp. Expressions can be evaluated on the more powerful Symbolics machine and the results returned to the Macintosh.

According to Bollay, serious AI users who are accustomed to \$100,000 LISP machines will find that they can do at least 75 percent of their work on a Mac Plus and then use *ExperLink* to transfer data to the Symbolics machine.

In addition, *ExperMultiOPS5*, an expert system development tool, lets you create programs that run on both the Symbolics machine and the Macintosh. You can send data from remote locations to the Macintosh and incorporate that data into expert systems running on the Symbolics machine.

Bollay hopes to break the knowledge engineering barrier in a few years so that an expert's knowledge can more easily be distilled into a set of

rules, and is looking into creating expert system links to CD ROM databases. For the near future, however, he plans to finish version 2.0 of *ExperLisp*—with a Smalltalk-like class system—to provide expert system tools to harness the intellectual powers of Mac users.

**MacCalc**



*Multiplan* and *Excel* have garnered the majority of the spreadsheet market, but that didn't stop Bravo Technologies from introducing its own number-crunching program, *MacCalc*. The program lacks many of *Excel's* powerful features, such as graphics, spreadsheet linking, and database and macro capabilities, but *MacCalc* is designed primarily for economy and speed: the \$99.95 product recalculates as fast as *Excel*, and cut and paste operations are even faster. The program also allows you to combine multiple fonts and styles within one spreadsheet and includes an annotation feature for appending notes to a cell. For more information contact Bravo Technologies, P.O. Box T, Gilroy, CA 95021-2249, 415/841-8552.

Macworld pays up to \$100 for each item published here. Mail your contributions to Macworld View, 555 De Haro St., San Francisco, CA 94107, or send them electronically via CompuServe 70370,702 or The Source BCW440. All published submissions become the property of Macworld. □

**Macworld Best-Seller Software**

This month	Business	Last month	Months on chart
1	Microsoft Excel, <i>Microsoft</i>	1	6
2	Microsoft Word, <i>Microsoft</i>	2	14
3	PageMaker, <i>Aldus</i>	4	2
4	MacDraw, <i>Apple Computer</i>	3	11
5	Microsoft Multiplan, <i>Microsoft</i>	9	14
6	Microsoft File, <i>Microsoft</i>	7	13
7	Sidekick, <i>Borland</i>	—	0
8	Dollars and Sense, <i>Monogram</i>	14	14
9	ThinkTank, <i>Living Videotext</i>	—	5
10	MacDraft, <i>Innovative Data Design</i>	—	0
11	Jazz, <i>Lotus Development</i>	5	10
12	Microsoft Chart, <i>Microsoft</i>	—	13
13	MacProject, <i>Apple Computer</i>	6	11
14	Back to Basics, <i>Peachtree</i>	14	4
15	OverVue, <i>ProVue Development</i>	—	2

Source: InfoCorp survey of over 200 retail stores

**Software Watch**

Editors' choice: other recent software of particular interest

- More, *Living Videotext*
- Presentation outliner
- SuperPaint, *Silicon Beach Graphics*
- Stat 80, *Statware Statistics*

## MEMBERS PAY WHOLESALE + 8% OR LESS AND GET 14-30 DAY SOFTWARE RENTALS

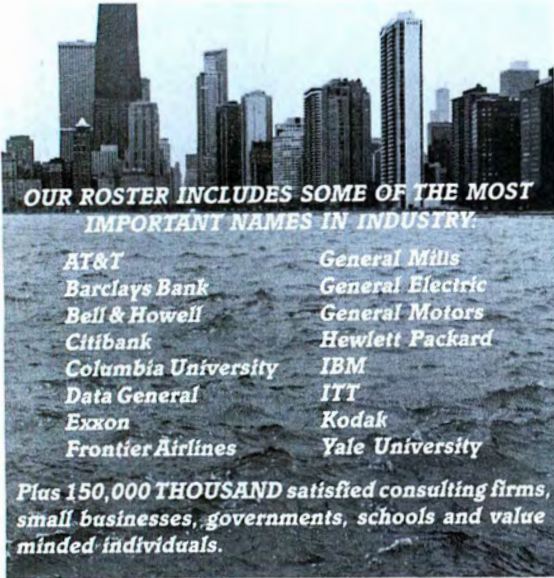

**OUR ROSTER INCLUDES SOME OF THE MOST IMPORTANT NAMES IN INDUSTRY.**

AT&T	General Mills
Barclays Bank	General Electric
Bell & Howell	General Motors
Citibank	Hewlett Packard
Columbia University	IBM
Data General	ITT
Exxon	Kodak
Frontier Airlines	Yale University

Plus 150,000 THOUSAND satisfied consulting firms, small businesses, governments, schools and value minded individuals.

**CALL TOLL FREE  
800-621-SAVE U796**

(Orders—Membership and Advice!)  
In Illinois Call (312) 280-0002  
Your Membership Validation Number

You can validate your membership number and, if you wish, place your first money-saving order over the phone by using your VISA, MASTERCARD or AMERICAN EXPRESS. Our knowledgeable sales consultants are on duty Mon.-Fri. 8:00 AM to 7:00 PM, Sat. 9:00 AM to 5:00 PM CST.

**PERSONAL COMPUTER NETWORK**  
320 West Ohio Street  
Chicago, Illinois 60610



**Macintosh**  
ALL MODELS  
AVAILABLE  
PRICES TOO LOW TO PRINT!!



**THE™ PC+**

256K RAM, IBM™ Compatible,  
360K Disk Drive, Turbo Speed,  
"AT" Style Keyboard

**\$444.00\***

APPLE 15" WIDE  
**IMAGEWRITER**

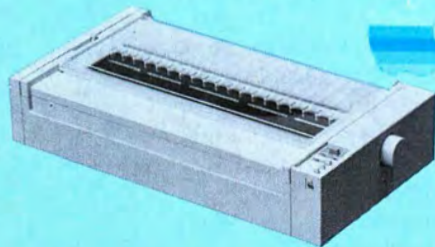

**\$475.00\***

Available for **INFOCOM**  
Apple II & Mac



\$19.75\*



\$19.75\*



\$21.50\*

**EPSON PRINTERS**

Unbelievable Low Prices!!



LX 80	80COL/100CPS .....	\$225.00*
FX 85	80COL/160CPS .....	345.00*
FX 286	132COL/200CPS .....	505.00*
LQ 1000	132COL/180CPS .....	CALL



**MICROSOFT**

(At Unheard of Prices!!)



**Flight Simulator**  
**\$27.00\***



**Excel**  
**\$197.50\***

Multiplan, File or Word ..... \$97.50  
BASIC ..... \$75.00  
Chart ..... \$62.50

**THE™ MODEMS**

100% Hayes Compatible

**BEST BUY**  
for  
the  
**MAC**

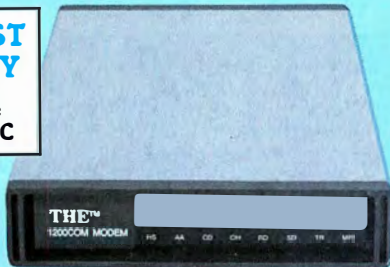

**1200 COM EXTERNAL**

Auto answer, auto dial, auto re-dial  
and a built-in speaker.

Special Wholesale Price  
**\$129.00\***

**2400 COM EXTERNAL**

Auto answer, auto dial, auto re-dial, and a  
built-in speaker with volume control.

Special Wholesale Price  
**\$277.00\***

**APPLE**

MacTerminal  
Mac's Most Popular  
Communication  
Package

**\$77.00\***

**APPLE**

MacDraw  
Apple's Most Complete  
Design Package  
for the Mac

**\$125.00\***

**MONOGRAM**

DOLLARS AND SENSE™  
for the Mac

**\$71.99\***

**First Byte®**

Smooth Talker

**\$44.00\***

**CENTRAL POINT Software**

Copy II Mac

**\$16.25\***



# YOUR MACINTOSH NEEDS!

## OVER 30,000 PRODUCTS AT EVERYDAY LOW, LOW PRICES!

### GAMES AND EDUCATIONAL SOFTWARE (Please add \$1 shipping and handling for each title ordered.)

	Wholesale		Wholesale
Aegis Mac Challenger	\$19.25*	Mark of the Unicorn Mouse Stampede	\$17.00*
Aegis Pyramid of Peril	13.50*	Microsoft Flight Simulator	27.00*
Apple MacDraw	125.00*	Miles Computing Mac the Knife	17.50*
Bluechip Baron, Millionaire, Tycoon	24.50*	Miles Computing MacAttack, Harrier Strike Mission	22.00*
Broderbund Lode Runner	20.00*	Mindscape James Bond: A View to a Kill	19.75*
Expertelligence ExperLogo	65.00*	Mindscape Rambo: First Blood Part II	19.75*
1st Byte Smooth Talker	44.00*	Palantir Mac Type	23.50*
Great Wave Concertware Plus	31.00*	Scarborough Mastertype	19.75*
Hayden Musicworks	39.97*	Sierra On-Line Championship Boxing	20.50*
Hayden Sargon III	24.75*	Sierra On-Line Frogger	20.00*
Hayden DaVinci—Houses, Interiors or Landscapes	23.00*	Silicon Beach Software Airbourne!	15.50*
Hayden Videoworks	50.00*	Simon & Schuster Typing Tutor III	28.25*
Infocom Deadline, Suspended	24.00*	Simon & Schuster Paper Airplane Construction Set	19.75*
Infocom Zork II, Witness, Planetfall, Cutthroats	19.75*	Sir-Tech Wizardy I	29.75*
Infocom Zork II, Zork III, Suspect, Infidel, Sorcerer	21.50*	Spectrum Holobyte GATO	22.00*
Infocom Hitchhiker's Guide, Ballyhoo, SeaStalker	19.75*	Telarium Amazon, Dragon World, Fahrenheit 451	20.95*
Magnum MacPic! Volume 1 or 2	24.75*	T/Maker Click Art	25.00*
Magnum The Slide Show Magician	29.75*		

### BUSINESS SOFTWARE (Please add \$2.50 shipping and handling for each title ordered.)

Apple MacTerminal, MacPascal	\$77.00*	Megahaus Megafilier	\$85.00*
Arrays Home Accountant	42.00*	Microsoft Basic	75.00*
Borland SideKick for Mac	37.50*	Microsoft Chart	62.50*
Boston Software MacPublisher	65.00*	Microsoft Excel	197.50*
BrainPower Statview	82.00*	Microsoft File, Word, Multiplan	97.50*
Central Point Copy II Mac	16.25*	Microsoft Logo	66.50*
Computer Software Design MacLion	70.00*	Odesta Helix Reg's 512K Mac	195.00*
Creative Solutions MacForth Level I	65.00*	Paladin Crunch	135.00*
Creative Solutions MacForth Level II	110.00*	Palantir G/L, A/P, INV	ea. 64.00*
Creighton MacSpell +	44.50*	Peachtree Software G/L, A/P, A/R	ea. 73.00*
Desktop Software 1st Base	82.00*	Provue Overvue	130.00*
Dilithium PC to MAC and Back w/cables	90.00*	Rio Grande Software Softmaker II	85.00*
Dow Jones Software Spreadsheet Link	43.50*	Sierra Mac One Write, A/P, A/R, G/L	ea. 116.50*
Dow Jones Software Straighttalk	37.00*	Soft Design Time Base	75.00*
Funsoft Macasm	60.00*	Softsync The Personal Accountant	42.00*
Haba Habadex	40.00*	Software Publishing PFS: File, Report	86.00*
Hayes Smartcom II	78.00*	Stoneware DB Master	90.00*
Layered Software Front Desk	66.00*	Telos Software Filevision	85.00*
Living Videotext ThinkTank (128K Ver.)	65.00*	T/Maker Click On Worksheet	33.00*
Living Videotext ThinkTank (512K Ver.)	85.00*	Tronix/Monogram Dollars & Sense	71.99*
Main Street Main Street Filer	67.00*		

### HARDWARE (Add 2% to the member price for each item for shipping and handling.)

	CALL		CALL
Apple Apple IIc, Apple IIe, Macintosh		Apple Imagewriter II 10" carriage	\$419.00*
Central Point Laser 128	\$355.00*	250 CPS/45 CPS NLQ/Color Capable	
Apple IIe and IIc Compatible		Apple Imagewriter 15" carriage w/Mac kit	475.00*
Compaq DeskPro w/256K	1,805.00*	Apple LaserWriter/Turns the Mac into a typesetter	4,895.00*
1 Floppy 20MB Hard Disk		Epson DX-35 Daisywheel 33CPS/132COL/LQ	590.00*
Compaq Hard Disk Portable	1,971.00*	Epson LX 80 10" platen/100CPS	225.00*
20MB Hard Disk w/1 Floppy w/256K		Epson FX 85 10" platen/160CPS	345.00*
IBM PC Base System	1,159.00*	Epson FX 286 15" platen/200CPS/NLQ	505.00*
2DD/DS/FDC/256K		Epson LQ 1000 180CPS/60CPS NLQ	CALL
IBM PC Professional 20MB Hard Disk	1,499.00*	Hanzon Turns your Epson into an Imagewriter	60.00*
1DD/DS/FDC/256K		NEC 3510 33CPS/Letter Quality	675.00*
IBM PC AT Base System	2,875.00*	NEC 8810 55CPS/Letter Quality	999.00*
1.2MB Floppy w/256K		Both these NEC printers are compatible with Microsoft Word!	
IBM PC AT All Configs	CALL	Okidata ML 192 10" platen/160CPS	340.00*
		Okidata ML 193 15" platen/160CPS	514.00*
		Both Okidata printers for Mac/Apple, Imagewriter Look-Alike	

### DISK DRIVES

Apple 800KB External Drive	\$349.95*	Apple Macintosh Carrying Case	\$69.00*
Corvus 5.5MB Hard Drive	675.00*	Apple Macintosh Security Kit	29.00*
Haba 800KB DS/Mac Add on Drive	215.00*	Assimilation Process MacTurboTouch	73.50*
IOmega 5MB Bernoulli Box	999.00*	Curtis Ruby Surge Protector	39.00*
IOmega 10MB Bernoulli for Mac Plus/SCSI Port	1,800.00*	Innovative Concepts Flip 'n' File II	28.08*
Paradise 10MB Hard Disk & Subsystem	525.00*	Innovative Concepts Flip 'n' File Micro (25)	6.69*
Paradise 20MB Hard Disk for the Mac	745.00*	Kensington Disk Case	15.50*
Tecmar 5MB Removable Drive or 10MB Mac Drive	999.00*	Kensington Dust Cover	6.00*

### MODEMS

Apple Modem 300	\$169.00*	Kensington Starter Pack	44.50*
Apple 1200BPS Personal Modem w/kit	275.00*	Kensington Surge Protector	27.75*
Compuable Mac to Smartmodem cable	16.00*	Koala MacVision	144.50*
Hayes Smartmodem 1200	340.00*	Maxell Mac Diskettes (Box of 10)	17.50*
Hayes Smartmodem 2400	525.00*	Mouse Systems A + Mouse	48.00*
Microcom Mac Modem	348.00*	PC Network Mac Diskettes SS/DD (Box of 10)	12.50*
Prentice Popcom Mac Pac	215.00*	PC Network Mac Diskettes DS/DD (Box of 10)	16.95*
1200 Baud, Cable, Straighttalk		Includes Free Flip 'n' File with SS/DD and DS/DD	
Prometheus Promodem 1200 w/MacPac	253.00*	PC Network Imagewriter Ribbons (Per 12)	36.00*
U.S. Robotics Password	172.00*	Thunderware Thunderscan—Turns you	150.00*
U.S. Robotics Courier 2400BPS Modem	345.00*	Imagewriter into an Optical Digitizer!	
THE™ MODEMS ARE 100% HAYES COMPATIBLE		Sony 3.5" Diskettes (Box of 10)	19.00*
THE™ 1200 Com External	129.00*	WP Printer Paper 2600 Sheets Microfine Perfs	17.00*
THE™ 2400 Com External	277.00*		

\*PCNetwork Members pay just 8% above the wholesale price, plus shipping. All prices reflect a 3% cash discount. Minimum shipping \$2.50 per order. International orders call for shipping and handling charges. Money Orders, personal and company checks please allow 10 working days to clear. All prices subject to change without notice.

**TOLL FREE (800) 621-SAVE** Orders and Memberships  
 In Illinois Call (312) 280-0002 Validation Code U796  
 Customer Service and Order Status (312) 280-1567

Circle 45 on reader service card

# PC NETWORK



## NEW! PC NETWORK ONLINE

A 24 Hour Bulletin Board and Information Service Center

- FREE SOFTWARE: Over 20,000 downloadable shareware titles.
- NEWS FLASHES AND REVIEWS: Tie into the worlds largest computer News Network. Get all the latest on Apple,™ IBM,™ Mac, Unix and related subjects.
- PLACE ORDERS, LEAVE MESSAGES FOR TECHNICAL SUPPORT—DAY OR NIGHT.
- LATEST PRICING: and Special Sales on PC Network Products.

PC Network improves on the benefits its members continue to enjoy...

- WHOLESALE + 8% PRICING.
- 10 DAY RETURN ON HARDWARE
- 600 PAGE NETWORK CATALOG
- QUARTERLY NEWSLETTER
- FREE TECHNICAL SUPPORT.
- 14-30 DAY SOFTWARE RENTAL

# TIME BILLING & MAIL LIST FOR YOUR MAC!

## LEGAL BILLING

is a time billing package designed specifically for attorneys.

Legal Billing will track time spent, costs dispersed and credits received. Client statements can be printed in several different formats. A variety of other reports can be printed including time, client and aging reports. This package is powerful enough for larger firms, yet easy enough for smaller firms.

Here is what Legal Billing can do for your professional office:

- Prints your client bills in a variety of formats
- Cuts billing time with fast and easy data entry, using up to 45 modifiable codes

- Increases office efficiency with numerous management reports
- Allows monthly or on-demand billings
- Multiple matters per client.
- Prints detailed statements in listed or paragraph format.
- Handles up to 27 lawyers or employees
- Full use of the MAC Interface
- It's so easy, you can begin using immediately
- Hard disk compatible
- **\$595.00**

Legal Billing, Professional Time Billing and Bulk Mailer are available at your local authorized dealer.



Satori Software  
2815 Second Avenue,  
Suite 590  
Seattle, WA 98121

206/443-0765

IBM and Apple II also available.

## BULK MAILER

is a powerful program specially designed for managing mail lists, large or small. Bulk Mailer does everything you want in a mail list program, including duplication elimination, zip and alpha sorts, 1 to 4 up labels printed, easy-entry defaults, multiple label format, plus much, much more. And this special Macintosh version is incredibly easy to use.

This is the only program to offer all these features:

- Duplication elimination
- Zip or alpha sort
- Car-ri sort or zip + 4

- 1 to 4 labels or roster format
- Powerful coding capabilities
- Sophisticated global editing and deleting
- Mail merge with Microsoft Word
- Envelope printing
- Easy-to-use entry defaults
- Coding and date expiration fields
- Large record capacity (up to 90,000 names)
- Hard disk compatible
- Full use of the MAC Interface
- **\$125.00** Bulk Mailer – up to 8,600 names
- **\$350.00** Bulk Mailer + – up to 90,000 names

See us at Macworld Expo

\*The Eagle Design postage meter indicia without printed information is a registered service mark of Pitney Bowes Inc.

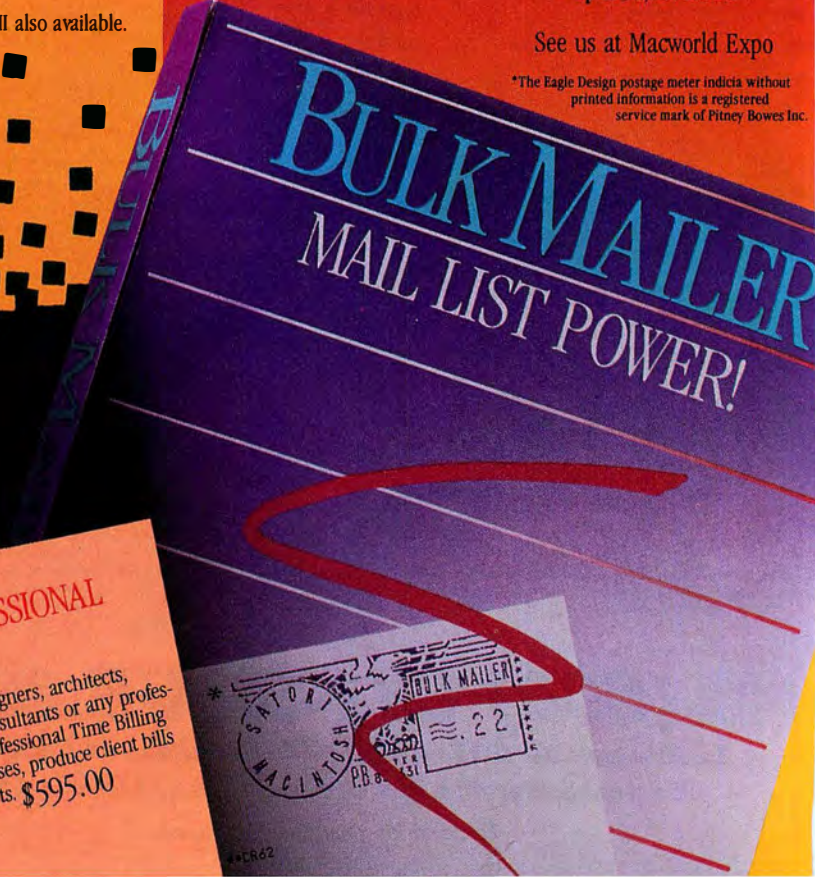
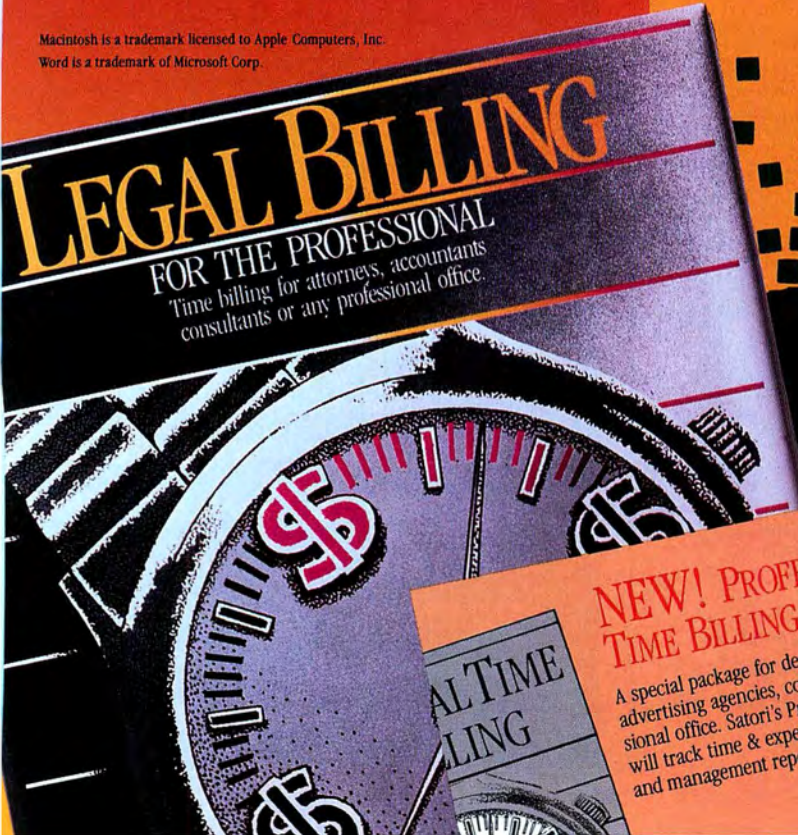

**NEW! PROFESSIONAL TIME BILLING**  
A special package for designers, architects, advertising agencies, consultants or any professional office. Satori's Professional Time Billing will track time & expenses, produce client bills and management reports. **\$595.00**

Macintosh is a trademark licensed to Apple Computers, Inc.  
Word is a trademark of Microsoft Corp.

# Get Info

*A hand decoder for system error messages, a technique for customizing date formats, and more*

Lon Poole

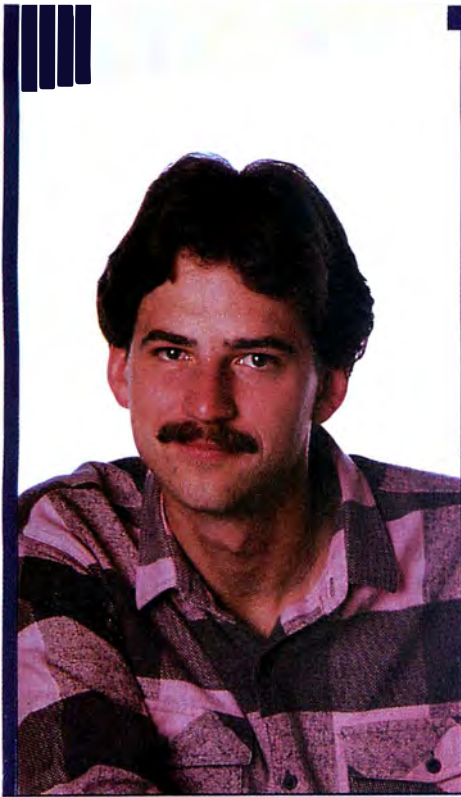

*If you've wondered why the vital statistics of a newly initialized disk don't add up, read on for an explanation. Also this month: how to change the startup application, modify date formats, and make room in a BASIC program for user input. Plus a report of flaws in MacDraw's font handling and an interpretation of system error codes.*

## Missing Disk Space

**Q.** Initializing a new double-sided disk consumes between 11K and 21K of disk space. For example, the disk's title bar may indicate that there are 0 items on the disk, 11K on disk, and 789K available. This didn't happen on 400K disks. Can you shed any light on the mysterious disappearance of the disk space?

*Chris Hagberg  
Seal Beach, California*

**A.** Although the Finder reports 0 items, one file always takes up space on a freshly initialized or erased disk—an invisible file named Desktop that contains information the Finder uses. This information includes the Get Info comments, copies of icon images for most applications and documents on the disk, the whereabouts of applications on HFS (Hierarchical File System) disks, and folder contents on non-HFS disks.

I'll bet if you look closely at the space used and available as reported by the Finder for a newly initialized or erased double-sided (800K) disk, you'll discover that the two numbers don't add up to 800K. You'll probably find 14K or 15K unaccounted for. The Mac file system uses this space for a disk directory, an allocation

map, and the "boot blocks" that contain information used at startup.

Versions 5.0 and later of the Finder likewise fail to account for all 400K on a single-sided disk, although the discrepancy is only 9K or 10K owing to a smaller disk directory. By means of a semantic trick, Finder versions 4.1 and earlier usually make space used and available add up to 400K. Finder 4.1 defines 1K as 1000 bytes, or characters, while Finder 5.0 and later defines 1K as 1024 bytes. The true capacity of a single-sided disk is 409,600 bytes. According to Finder 4.1, that's 410K, but subtracting 10K for the disk directory and so on reduces the capacity to 400K.

## Undo Startup Application

**Q.** Several software packages have a startup routine that automatically starts a specific application. If I want to use other applications on the same disk, I have to wait for the automatic start and then quit. How can I modify the startup routine?

*S. Sable  
Chino Hills, California*

**A.** The Set Startup command in the Finder's Special menu determines which application on a particular disk runs automatically when you start up the Mac with that disk. If you want the Mac to start up at the Finder's desktop, make the Finder the startup application by selecting the Finder icon (it's usually in the System Folder) and choosing the Set Startup command.

*(continues)*

*Even when the Finder reports 0 items, the Desktop file takes up space on your disk.*

Because your MAC Deserves the Best ...

# SONY®



### 3 1/2" SS Disks — Boxed in tens

100+	50+	20+
<b>1.27</b>	<b>1.29</b>	<b>1.35</b>

### 3 1/2" DS Disks — Boxed in Tens

100+	50+	20+
<b>1.99</b>	<b>2.05</b>	<b>2.09</b>

### Best Presents...

## the SONY MAC PAC

3 1/2" Disks — Boxed in 50's



	400+	100+	50+
Single Sided	<b>1.19</b>	<b>1.22</b>	<b>1.25</b>
Double Sided	<b>1.65</b>	<b>1.70</b>	<b>1.75</b>



	Boxed in tens	100+	50+	20+
3 1/2" SS	.....	1.15	1.19	1.25
3 1/2" DS	.....	1.69	1.85	1.79

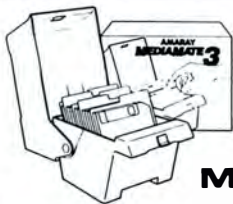

Holds 30 3.5"  
**\$8.95**  
 With Lock  
**\$10.95**

**MediaMate 3**



### Deluxe Roll-Top File

Holds 55 3.5"  
**\$15.55**  
 With Lock  
**\$17.95**

### Mouse-Pad

**\$5.95**

Red - Blue - Gray - Brown



**Imagewriter Ribbons**  
 Black (2-5) 3.45 (6+) 2.95  
 Color Packs 20.70

### Glare/Guard®

- Cuts 94% of Screen Glare
- Enhances Contrast
- Optically Coated Glass

**\$34.95**

### ORDER NOW

**1 800 351-BEST (2378)**

**1 800 451-BEST (in California)**



Visa, Mastercard, C.O.D. or Prepaid. Corporations rated 3A2 or better, government agencies and schools may send in purchase orders on a net 30 basis. Minimum order \$25.00. Shipping charges are \$3.00 per 100 diskettes (minimum shipping order \$3.00) (within the continental U.S.), APO, FPO, AK, HI, PR and Canada Orders add 10% to cover PAL and Insurance. All other countries add 20%. C.O.D. Orders Add \$4.00. No Sales Tax outside California.

**Satisfaction guaranteed on all products.**

457 McGlincey Lane  
 Campbell, CA 95008  
 (408) 559-9339

### Change Standard Date Format

**Q.** How can I change the System file, using a resource editor such as *ResEdit*, to change the system date format from MM/DD/YY to DD-MM-YY?

*Israel J. Lawrence*  
 FPO San Francisco, California

**A.** The all-numeric date format you mention is called the short date format and is part of an international resource in the System file, namely the INTL resource whose ID number is 0. You can change the order of the day, month, and year; the character that separates the different parts of the date; whether to show leading zeros for one-digit day and month numbers; and whether to show the century in four figures or two. Use Apple's *ResEdit* program (available from user groups) as follows:

- Copy your system disk; experiment on the copy, never on the original.
- Start *ResEdit* and insert a copy of the system disk. A small window appears for each inserted disk. Each window lists the applications and documents on the disk; for double-sided disks and other disks that use the Hierarchical File System (HFS), the window also lists folders. Double-click a folder's name if you want to see its contents.

• Find the System file (it may be in a folder on an HFS disk) and double-click it. Another small window opens, listing all the resources in the System file by their four-letter code names.

• Find the resource named INTL in the System window and double-click it. A window appears, listing the international resources by ID number.

• Double-click INTL resource 0. Labeled boxes in the window that opens allow you to change the formats for currency, short date, and time, as well as determine whether to use the metric system or not and specify a version number (see "Dates in Short Order").

• To reorder the date to day, month, and then year, change the box labeled dateOrder to 1 (for DD-MM-YY). In this box, 0 stands for the order MM-DD-YY and 2 for YY-MM-DD.

• Change the character that separates the different parts of the date in the dateSep box. In your case, put a hyphen in this box.

(continues)

Circle 373 on reader service card

# Why did Apple Put the SCSI on the MacPlus?

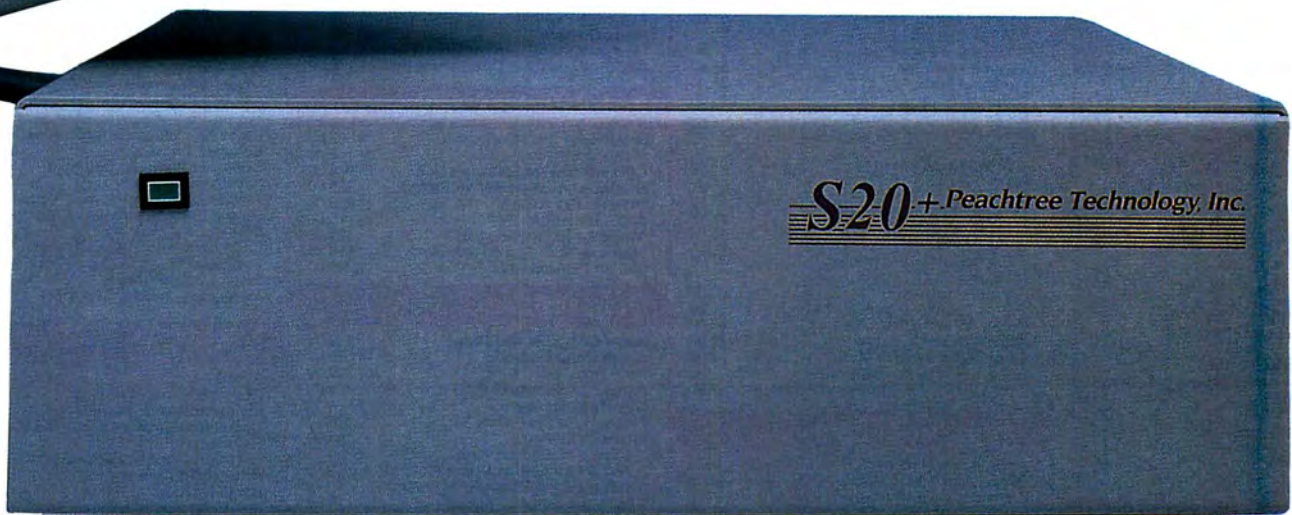

## Introducing the New S-20+ Hard Drive with SCSI Port!

**Apple had the vision.** By integrating the SCSI (small computer systems interface) on the back of the MacPlus personal computer, Apple engineers have provided the MacPlus user with the potential for fast, simple and expandable operations. **We took advantage of that vision.** Our S-20+ Hard Drive runs off the SCSI, not the floppy drive. This dynamic technological blend, offers you a communications vehicle which is:

**FAST;** Up to **ten times** the speed of the MacPlus floppy drive! Up to **six times** faster than other hard drives utilizing the floppy port! The SCSI-driven S-20+ provides rapid program loading and data transfer at 937,000 bytes per second. With the S-20+ and popular software such as Page Maker™, the MacPlus user can produce newsletters and other communications in no time.

**EASY;** Less than five minutes from box to operation! The S-20+ software allows the same simple operation of the icon as does the floppy drive for fast & easy file copying and manipulation.

**MASS STORAGE CAPACITY;** No manipulation of diskettes means increased efficiency and productivity! This 20 megabyte, formatted, external subsystem holds the equivalent of about 6,000 double-spaced pages or 25 floppy disks.

**COMPACT;** The MacPlus user can enjoy the benefits of the S-20+ without giving up valuable work space. Designed to complement the external styling of the Apple hardware, the S-20+ sits neatly under the MacPlus.

**DAISY-CHAINABLE;** The S-20+ comes with two SCSI interfaces which allow daisy-chaining of up to seven Peachtree Technology SCSI peripherals on the same bus.

**Apple had the vision.  
We took advantage of it.**

For more information, call  
Bill Daniel, Director of Sales,  
at (404) 662-5158.



The New S-20+  
(rear view)

---

---

## **Peachtree Technology, Inc.**

---

---

3120 Crossing Park, Norcross, Georgia 30071, Telephone (404) 662-5158, Sales (404) 662-5556

Macintosh Plus and MacPlus are trademarks of McIntosh Laboratory, Inc. Apple is a registered trademark of Apple Computer, Inc. S-20+ is a trademark of Peachtree Technology, Inc. Page Maker is a trademark of Aldus Corporation.

Circle 553 on reader service card

## Backup & Utility Software

<b>Apple Computer</b>	
Switcher Construction Set	12.00
<b>Central Point Software Copy II Mac</b>	19.00
<b>Dreams Of The Phoenix</b>	
Quick & Dirty Utilities Vol. 1 or 2	27.00
<b>FWB Software Hard Disk Util</b>	59.00
Hard Disk Backup	42.00
<b>Hayden</b>	
MUD (MacroMind Utility Disk)	32.00
<b>Ideaform</b>	
Mac Labeler (Version 2.2)	29.00
<b>Infosphere MacServe</b>	249.00
<b>MacMemory, Inc.</b>	
MaxRam & MaxPrint	39.00
<b>Mainstay</b>	
MacBooster, Disk Ranger, or MacSpool	32.00
N'Cryptor or PacPaint	26.00
Flashback (Hard Disk Backup Utility)	36.00
<b>Meacom Mac +</b> ] (Version 3.0)	105.00
<b>MicroAnalyst MacZap (Version 4.1)</b>	38.00
<b>Nevis Microsystems</b>	
TurboCharger (Version 2.0)	39.00
<b>New Canaan MicroCode</b>	
Mac Disk Catalog II (512K)	32.00
<b>PBI Software Icon Switcher</b>	14.00
Icon Library-Fun & Games or Business	14.00
<b>Softstyle Printworks</b>	49.00
Epstart V2.0, Jetstart or Toshstart	27.00
Laserstart	59.00
TI Start or ColorMate V2.1	49.00
ColorMate Art	25.00
PlotStart w/Cable	69.00
<b>Williams &amp; Macias</b>	
myDiskLabeler V2.1	27.00
myDiskLabeler w/Color	34.00

## Desk Accessory Programs

<b>Affinity Microsystems</b>	
Tempo (Version 1.1)	79.00
<b>Batteries Included</b>	
Battery Pak (Version 1.1)	27.00
<b>Borland</b>	
SideKick with PhoneLink (Version 1.1)	59.00
Cortland Top Desk (Version 1.4)	39.00
<b>Dubl-Click Software</b>	
Calculator Construction Set V1.03	32.00
<b>Dreams Of The Phoenix Twelve-C</b>	27.00
<b>Electronic Arts</b>	
Custom Calculator Construction Set	34.00
<b>Imagine Software Smart Alarms</b>	39.00
<b>Mainstay TypeNow</b>	26.00
SpellNow	36.00
<b>Silicon Beach Software</b>	
Accessory Pak #1	21.00
<b>T/Maker ClickOn Worksheet</b>	46.00
<b>Videx MacCalendar</b>	52.00

## Languages

<b>Apple Computer MacPascal</b>	99.00
Macintosh 68000 Development System	159.00
<b>Consular</b>	
Mac C/Mac C Toolkit (Version 4.5)	259.00
<b>Megamax, Inc. Megamax C Compiler</b>	175.00
<b>Microsoft</b>	
Microsoft Basic (Version 2.1)	89.00
Microsoft Logo (Version 1.0)	75.00
Microsoft Fortran Compiler (Version 2.1)	169.00
<b>Modula Corporation MacModula-2</b>	90.00
<b>Pecan Software</b>	
MacAdvantage: UCSD Pascal	69.00
MacAdvantage: 68000 Assembler	69.00
<b>Portable Software</b>	
PortaAPL V3.0a	199.00
<b>Softworks Ltd.</b>	
Softworks Personal Basic	69.00
Softworks Business Basic	209.00
<b>TLM Systems TLM Pascal</b>	69.00
<b>True Basic, Inc. True Basic</b>	89.00
<b>Zedcor, Inc. ZBasic</b>	65.00

## Communications Software

<b>Apple Computer MacTerminal</b>	99.00
<b>Centram Systems West</b>	
MicahTOPS for Macintosh	109.00
MicahTOPS for IBM & Compatibles	279.00
<b>Compuserve</b>	
Compuserve Starter Kit	27.00
<b>DataViz MacLink with Cable</b>	109.00
(Transfer Mac/IBM Files)	
<b>Dillithium Press</b>	
PC to Mac and Back with Cables	89.00
<b>Dow Jones</b>	
Dow Jones Membership Kit	22.00
<b>Dreams Of The Phoenix</b>	
Mouse Exchange Terminal	27.00
<b>Hayes Microcomputer Smartcom II</b>	89.00
<b>Mainstay Turbo Download</b>	25.00
<b>Palantlr inTouch (Version 2.02)</b>	79.00

## DataBase Management

<b>Blythe Software Omnis 3 Plus</b>	279.00
<b>DataPak Software Executive Office</b>	229.00
<b>Forethought Factfinder</b>	Call
Filemaker	105.00

<b>Format Software Transfer Programs and/or Databases in dBase III from the PC to Mac and run them without Modification!</b>	395.00
<b>Hayden Software</b>	
I Know It's Here Somewhere	19.00
<b>Layered Front Desk</b>	77.00
Notes For Jazz or Excel	42.00
<b>Mainstay</b>	
Micetro Information Manager	69.00
<b>Microsoft MicroSoft File 1.02</b>	110.00
<b>Odesta Helix (Version 2.0)</b>	129.00
Double Helix	289.00
<b>ProVUE Development OverVUE 2.0</b>	149.00
<b>Singular Software Interface Software Discoveries, Inc.</b>	99.00
Record Holder	42.00
<b>Telos Software</b>	
Business FileVision	199.00

## Business Software

<b>Apple Computer MacProject</b>	159.00
<b>Assimilation Process</b>	
Business Essentials	65.00
<b>Cricket Software Cricket Graph</b>	129.00
<b>Dreams Of The Phoenix</b>	
Day Keeper Calendar	27.00
<b>Electronic Arts Financial Cookbook</b>	34.00
<b>Human Edge Software</b>	
The Communications Edge or The Hiring Edge	57.00
The Management Edge or The Sales Edge	57.00
Negotiation Edge	57.00
The Mind Prober	28.00
<b>Lotus Jazz (Version 1.A)</b>	269.00
<b>Micro Planning Software</b>	
Micro Planner Plus	299.00
<b>Microsoft</b>	
Microsoft Multiplan 1.1	105.00
Microsoft Chart 1.0	72.00
Microsoft Excel 1.0	224.00
Multiplan to Excel Upgrade	150.00
<b>Legisoft/Nolo Press</b>	
WillWriter V2.0 (Includes Testimonial Trust)	32.00
<b>ODS, Inc.</b>	
Consultant (Version 1.6)	109.00
Sales Consultant (Version 2.0)	169.00
<b>Pecan Software Mail Manager</b>	69.00
<b>Paladin SuperCrunch</b>	179.00
<b>Satori Software Bulk Mailer</b>	79.00
<b>Softtechnics/Batteries Included</b>	
Time Link (Time Management System)	32.00

## Word/Idea Processors

<b>Aegis Development</b>	
Doug Clapp's Word Tools	45.00
<b>Advanced Logic Systems</b>	
Word Handler	59.00
<b>Apple Computer MacWrite</b>	99.00
<b>Haba Systems HabaWord</b>	55.00
<b>Living Videotext</b>	
More (Third Generation Idea Processing)	195.00
Think Tank 128	52.00
Think Tank 512	99.00
<b>Mainstay Think Now</b>	36.00
<b>Microsoft MicroSoft Word 1.05</b>	111.00
<b>MindWork Software MultiWrite</b>	79.00
<b>Rosetta Stone Software</b>	
Talker (Talking Word Processor)	36.00
<b>Symmetry</b>	
Acta (Outline Word Processor in DA Format)	42.00

## Spelling Checkers

<b>Assimilation Process</b>	
Mac Spell Right or The Right Word	69.00
<b>Creighton Development MacSpell+</b>	55.00
<b>DataPak Software</b>	
Liberty Spell Checker	42.00
<b>EnterSet, Inc MacGas</b>	55.00
<b>Hayden Software Hayden: Speller</b>	26.00
<b>Greene, Johnson Inc. Spellswell</b>	45.00
<b>Target Software</b>	
MacLightning w/Webster Dictionary	53.00
Additional Thesaurus Library	28.00
Medical Dictionary or Legal Dictionary	53.00

## Desktop Publishing

<b>Boston Software Publishers</b>	
The MacPublisher II	135.00
Mac-Hy-Phen	69.00
MacIndexer	62.00
<b>Manhattan Graphics</b>	
ReadySetGol (Version 2.1)	105.00
ReadySetGol Desk Design	37.00

## Overlays For Multiplan & Excel™

<b>Apropos Financial Planning or Investment Planning</b>	45.00
<b>RealData, Inc.</b>	
Overlays For Multiplan, Jazz & Excel™	
Tax Shelter Syndication Analysis	169.00
On Schedule	119.00

<b>Real Estate Investment Analysis V5.0</b>	125.00
<b>Financial Analysis</b>	62.00
<b>Commercial/Industrial Applications</b>	62.00
<b>Residential Real Estate</b>	62.00
<b>Overlays For Microsoft Excel™</b>	
Property Management Level 1	149.00
Mortgage Qualifier	119.00
<b>Listing Prospect Data Management</b>	119.00

## Accounting Packages

<b>BPI</b>	
BPI Entry Series-General Accounting	212.00
<b>Chang Labs</b>	
Rags to Riches GL, AR, AP, or Inventory	99.00
Rags to Riches Three Pack-GL/AR/AP	249.00
<b>Continental/Arrays</b>	
The Home Accountant	52.00
<b>Digital, Etc. Turbo Accountant</b>	239.00
Accountant V2.0	99.00
<b>Future Design Software</b>	
Strictly Business Accounting System: Module 1 - General Ledger	199.00
<b>Monogram Dollars &amp; Sense</b>	81.00
Forecast	41.00
<b>Open Systems Open For Business I</b>	259.00
Open For Business II	499.00
<b>Palantlr GL, AR, or Inventory Control</b>	69.00
<b>Peachtree</b>	
General Ledger or Accounts Receivable	89.00
Accounts Payable	89.00
<b>Sierra On-Line</b>	
MacOneWrite GL, AR, or Payroll	79.00
MacOneWrite Cash Disbursements	79.00

## Statistics Packages

<b>BrainPower StatView</b>	99.00
StatView 512 Plus	179.00
<b>Cricket Software Statworks</b>	79.00
<b>Northwest Analytical NWA StatPak</b>	229.00
NWA Quality Analyst	299.00
<b>StatSoft StatFast-2</b>	75.00
<b>Systat Systat (Version 3.0)</b>	399.00
<b>Statware, SLC. Stat-80 Standard</b>	159.00
Stat-80 Professional	249.00

## Graphics Software

<b>Apple Computer MacDraw</b>	149.00
<b>Aitsys Corp. Fontastic</b>	25.00
Fontographer	239.00
<b>Ann Arbor Softworks Full Paint</b>	59.00
<b>Casady Company</b>	
Fluent Fonts (Two-Disk Set)	29.00
Fluent Laser Fonts	49.00
Choice of: Bodoni, SanSerif, Ritz & Right Bank, Monterey, Calligraphy & Regency, or Prelude	
<b>Challenger Software Mac 3D</b>	119.00
<b>Desktop Graphics DrawArt</b>	29.00
<b>Electronic Publisher, Inc. (Requires PictureBase)</b>	
MacMatbook Vol. 1 thru 3	59.00
MacMatbook individual Volumes	36.00
<b>Dreams Of The Phoenix</b>	
Phoenix 3D Level One	27.00
<b>Enabling Technologies Easy 3D</b>	59.00
<b>Hayden VideoWorks</b>	59.00
Home Design w/Art Grabber	52.00
DaVinci: Building Blocks	52.00
DaVinci: Commercial Interiors	119.00
<b>Innovative Data Design</b>	
MacDraft (Version 1.2)	199.00
Paste-Ease (Volumes I & II)	35.00
<b>I/O Designs</b>	
ColorPrint Software Only	25.00
ColorPrint Starter Kit-3	39.00
<b>MicroSpot MacPalette</b>	52.00
MacPlot	119.00
MacPlot Professional	224.00
<b>Miles Computing</b>	
Mac The Knife Volume III or Volume IV	27.00
<b>Polarware The Graphics Magician</b>	32.00
Painter & Animator	32.00
<b>Silicon Beach Software SuperPaint</b>	59.00
Silicon Press	42.00
<b>Springboard</b>	
Art A La Mac Vol. 1-People & Places	23.00
Art A La Mac Vol. 2-Variety Pack	23.00
<b>Symmetry PictureBase</b>	48.00
<b>T/Maker</b>	
Click Art Letters or Personal Graphics	29.00
Click Art Publications or Effects	29.00
<b>Vamp, Inc.</b>	
McCad PCB	299.00
McCad Schematics	399.00

## Educational/Creative Software

<b>BrainPower Thinkfast</b>	23.00
Design Scope	129.00
<b>Davidson &amp; Associates</b>	
Speed Reader II	37.00
Math Blaster, or Word Attack	27.00
<b>Electronic Arts</b>	
Pinball Construction Set	27.00
<b>Deluxe Music Construction Set</b>	32.00
<b>First Byte</b>	
Smooth Talker (Version 2.0)	52.00
Kid Talk or Speller Bee	42.00

<b>Great Wave Software</b>	
ConcertWare Plus	39.00
Concertware MIDI	62.00
KidsTime	32.00
<b>Hayden MusicWorks</b>	32.00
Score Improvement System for the SAT	59.00
Score Improvement-Achievement Tests	59.00
<b>Kette Group Studio Session</b>	69.00
<b>Micro: Maps MacAtlas Volume 1 or 2</b>	49.00
<b>Microsoft Entrepreneur</b>	29.00
Hands On Excel	32.00
Learning Multiplan & Chart	39.00
<b>Mindscape Perfect Score SAT</b>	47.00
The Lucher Profile	24.00
Dick Francis' High Stakes	24.00
<b>Palantlr</b>	
MacType, MathFlash or WordPlay	26.00
<b>Queue Intellectual Software</b>	
Not Like The Others	36.00
How Many? or Early Reader	25.00
What Comes Next?	35.00
Reading & Thinking I or II	39.00
Vocabulary Adventure I or II	44.00
Spanish Grammar I, II, or III	25.00
World Geography Adventure I or II	44.00
U.S. Geography Adventure	44.00
How A Bill Becomes A Law	44.00
American History Adventure	44.00
Starting A New Business Analogies I or II	49.00
College Aptitude Reading Exercises	49.00
<b>Rosetta Stone Software Dr. Xes</b>	36.00
<b>Rubicon Publishing</b>	
Dinner at Eight	37.00
Silver Palate Collection	29.00
<b>Shaherazam</b>	
Music Type 2.0 or Mac-A-Mug	42.00
<b>Simon &amp; Schuster Mac Art Dept.</b>	24.00
Typing Tutor III	35.00
Paper Airplane Construction Set	24.00
<b>Software Concepts</b>	
Concepts Computerized Atlas	45.00
<b>Spectrum HoloByte</b>	
Tellstar Level 1 (Northern Hemisphere)	27.00
Tellstar Level 2 (Northern & Southern)	42.00
<b>Springboard</b>	
Early Games for Young Children	31.00
Easy as ABC	31.00
<b>Think Educational</b>	
MacEdge II or Mind Over Mac	28.00

## Game Software

<b>Activision</b>	
Borrowed Time or Hacker	27.00
Mindshadow or Uninvited	27.00
Championship Star League Baseball	22.00
Championship Golf Vol. 1	22.00
Alter Ego (Male or Female Version)	36.00
<b>Artworx Bridge 4.0</b>	21.00
<b>Bantam Books</b>	
Sherlock Holmes: "Another Bow"	27.00
<b>Blue Chip Software</b>	
Barron, Millionaire, Squire, or Tycoon	35.00
<b>Broderbund Ancient Art of War</b>	27.00
<b>EPYX Winter Games or Rogue</b>	24.00
Temple of Apsah Trilogy	24.00
<b>Electronic Arts</b>	
ChessMaster 2000	28.00
Seven Cities of Gold	27.00
Dr. J & Larry Bird go One-On-One	27.00
SkyFox or Archon	27.00
Software Golden Oldies Vol. 1	24.00
<b>Fortnum Software</b>	
MacNooga Choo-Choo	21.00
<b>Hayden Software Sargon III</b>	29.00
Perplex	25.00
<b>Infinity Software, LTD</b>	
Grand Slam Tennis	32.00
<b>Infocom A Mind Forever Voyaging</b>	26.00
Cutthroats, Enchanter, or Ballyhoo	23.00
Headline or Starcross	29.00
Plotchiker's Guide or Zork I	23.00
Infidel, Zork II or Zork III	26.00
Planetfall, Seastalker or Trinity	23.00
Sorcerer or Suspect	26.00
Suspended or Spellbreaker	29.00
Wishbringer or Witness	23.00
Invisiclues-Hint Booklets (ea.)	6.00
<b>Microsoft</b>	
Flight Simulator (Version 1.0)	33.00
<b>Miles Computing</b>	
MacAttack or MacWars	27.00
Harrier Strike Mission	27.00
DownHill Racer	27.00
<b>Mindscape Balance of Power</b>	30.00
Crossword Magic	30.00
Deja Vu: A Nightmare Comes True	33.00
James Bond 007: A View To Kill	24.00
James Bond 007: Goldfinger	24.00
Racter or The Halley Project	27.00
Rambo: First Blood Part II	24.00
Stephen King's: The Mist	24.00
Bratcaccas	30.00
<b>Omnitrend Software</b>	
Omnitrend's Universe II	39.00
<b>Origin Systems</b>	
Exodus: Ultima III	38.00
<b>PBI Software Strategic Conquest</b>	29.00
Fokker Triplane	35.00
<b>Polarware</b>	
Pensate, Transylvania, or Sword of Kadash	15.00
Xyphus, Coveted Mirror, Crimson Crown, or Oo-Topos	15.00

# In Connecticut Call 378-3662 or 378-8293

<b>Practical Computer Applications</b>	
MacGolf (Version 2.0)	36.00
<b>Pision</b>	
Pision Chess (3D & Multi-Lingual)	31.00
<b>Sierra On-Line</b>	
Championship Boxing or Frogger	24.00
Ultima II	35.00
<b>Silicon Beach Software</b> Airborne!	20.00
Enchanted Scepters	21.00
Dark Castle	31.00
<b>Simon &amp; Schuster</b> Star Trek	24.00
<b>Sir-Tech</b> Mac Wizardry	36.00
<b>Spectrum Holobyte</b> GATO	26.00
Orbiter	27.00
<b>Strategic Simulations</b>	
Computer Baseball	23.00
Gemstone Warrior	21.00
<b>Talarum</b>	
Amazon or Dragon World	27.00
Farenheit 451 or Rendezvous w/Rama	27.00
<b>Videx</b> MacGammon & Cribbage	28.00
MacVegas	34.00

## Disk Drives/Hard Disks/Upgrades

<b>AST Research</b> AST-4000	4899.00
74 MB External Hard Disk with 60-MB Cartridge-Tape Backup for the Macintosh Plus.	
<b>Haba Systems</b>	
HabaDisk 800 KB DS/DD External Drive	249.00
<b>Human Touch</b>	
Three To One Touch Board	999.00
<b>Imega</b>	
Bernoulli Box 2-10MB for MacPlus SCSI	2049.00
Bernoulli Box 2-20MB for MacPlus SCSI	2629.00
10MB Cartridge	48.00
Head Cleaning Kit	69.00
<b>LoDown</b>	
Hard Disks & Tape Backups for the MacPlus	
LoDown-T20 (20 Megabyte Tape Drive)	789.00
LoDown-T60 (60 Megabyte Tape Drive)	1589.00
LoDown-20 (20 Megabyte Hard Disk)	889.00
LoDown-40 (40 Megabyte Hard Disk)	1699.00
LoDown-80 (80 Megabyte Hard Disk)	3399.00
<b>MacMemory, Inc.</b>	
The MaxPlus (2MB Upgrade w/MaxRam/Max Print/MaxChill)	389.00
The MaxPlus Enhanced (2.5MB w/MaxRam/Max Print/MaxChill)	559.00
The Max 2 (512K to 2MB Expandable to 4MB)	399.00
<b>Maple Technology</b>	
MT-3002 800KB External Drive	179.00
<b>MDIdeas, Inc.</b>	
HD-20 (20MB Hard Disk For MacPlus)	819.00
HD-30 (30MB Hard Disk For MacPlus)	1189.00
<b>MICAH</b>	
Advanced Technology Internal Hard Disk Systems for the Macintosh & Macintosh Plus.	
MicahDrive AT 20 Internal Hard Drive	1199.00
MicahMemory 2/4 Card, (2MB Ram)	399.00
<b>Microtech</b>	
Auto-Eject Drive with 1 Year Warrantee	
MAC535-20 800KB External Drive	249.00
<b>Mirror Technologies</b>	
Magnum 800K External Drive	249.00
MagNet 20 (Internal 20MB Hard Drive)	1095.00
MagNet 20X (External 20MB Hard Drive)	949.00
MagNet 20X (External 20MB with FastPort)	1099.00
Magnum Tape 20 (20MB Tape Backup)	895.00
<b>Peripheral Land</b>	
PL 20-21MB Formatted for MacPlus	889.00
PL 30-32MB Formatted for MacPlus	1169.00
MacFast 20-21MB w/Tape Controller for Mac 512K or MacPlus	1269.00
MacFast 30-32MB w/Tape Controller for Mac 512K or MacPlus	1489.00
MacBack 20-27MB Tape Backup	999.00
MacStor 10-10MB Removable Cartridge Hard Disk	1799.00
10MB Removable Cartridges for MacStor 10	135.00
MacPort Host Adaptor-SCSI Interface for Mac 512K	89.00
<b>Personal Computer Peripherals</b>	
MacBottom Hard Disk 20MB (512K)	869.00
MacBottom Hard Disk 20MB (MacPlus SCSI)	869.00
<b>SuperMac</b>	
Take Full Advantage of the MacPlus SCSI Port!	
DataFrame 20MB Hard Disk for MacPlus Call	
<b>Western Automation Labs</b>	
Dasch External RAMdisk (512KB)	299.00
Dasch External RAMdisk (1024KB)	339.00
Dasch External RAMdisk (2048KB)	399.00

## Modems

<b>Anchor Automation</b>	
Signalman Express 1200 Baud	235.00
Signalman Lightning 2400 Baud	355.00
<b>Hayes Microcomputing</b>	
Interbridge	Call
Smartmodem 1200	359.00

Smartmodem 1200 Mac w/Smartcom II	429.00
Smartmodem 2400	579.00
Transet 1000-128K	269.00
Transet 1000-512K	359.00
Transet 1000 Mac Accessory Kit	31.00
<b>Novation</b>	
Cat Comm Communications Systems	315.00
<b>Prenet</b>	
Popcom X-100 Modem w/Straighttalk	259.00
<b>Prometheus</b>	
Promodem 1200M w/ProCom-M	299.00
U.S. Robotics Password 1200	199.00
Courier 2400	389.00

## Printers

<b>Brother</b>	
HR-15XL (20cps) Daisywheel/Serial	319.00
HR-25 (23cps) Daisywheel/Serial	519.00
HR-35 (35cps) Daisywheel/Serial	729.00
TwinWriter 5 Dual Head Printer/Serial	839.00
<b>Juki</b>	
6100 (18cps) Daisywheel Serial	379.00
6200 (30cps) Daisywheel Serial	559.00
6300 (40cps) Daisywheel Serial	659.00
<b>Okidata</b> ML-192 Apple Mac/Lisa	Call
ML-193 Apple Mac/Lisa	Call
<b>Toshiba</b>	
P-321 24 Pin (216cps) Par./Ser. 10"	499.00
P-341 24 Pin (216cps) Par./Ser. 10"	799.00
P-351 24 Pin (288cps) Par./Ser. 15"	1079.00

## Blank Media

<b>Single Sided 3 1/2" Diskettes</b>	
BAF 3 1/2" SS/DD Disks (box of 5)	10.00
Bulk (Sony) 3 1/2" SS/DD Disks (10)	15.00
Sony 3 1/2" SS/DD Disks (box of 10)	17.00
Centech 3 1/2" SS/DD Color Disks (box of 10)	18.00
Fuji 3 1/2" SS/DD Disks (box of 10)	18.00
Maxell 3 1/2" SS/DD Disks (box of 10)	18.00
Verbatim 3 1/2" SS/DD Disks (box of 10)	18.00
3M 3 1/2" SS/DD Disks (box of 10)	20.00
<b>Double Sided 3 1/2" Diskettes</b>	
BAF 3 1/2" DS/DD Disks (box of 5)	14.00
Bulk (Sony) 3 1/2" DS/DD (10)	24.00
Centech 3 1/2" DS/DD Color Disks (box of 10)	24.00
Sony 3 1/2" DS/DD Disks (box of 10)	27.00
Fuji 3 1/2" DS/DD Disks (box of 10)	26.00
Maxell 3 1/2" DS/DD Disks (box of 10)	28.00
Verbatim 3 1/2" DS/DD Disks (box of 10)	28.00
3M 3 1/2" DS/DD Disks (box of 10)	28.00

## Digitizers

<b>Kette Group</b>	
Capture any sound from the real world!	
MacNifty Audio Digitizer w/SoundCap	99.00
<b>Koala Technologies Corp.</b>	
KAT Graphics Tablet	135.00
MacVision	169.00
<b>New Image Technology</b>	
Magic Digitizer	249.00
Summagraphics MacTablet 6x9 size	259.00
MacTablet 12x12 size	359.00
<b>ThunderWare</b>	
Thunderscan V3.2 (Mac 128 & 512K)	175.00
Thunderscan V3.2 and Power Accessory (MacPlus)	195.00

## Accessories

<b>A.M. Products</b>	
3 1/2" Head & Computer Cleaning Kit	18.00
<b>Assimilation Process</b>	
Numeric Turbo	129.00
Mac Turbo Touch	79.00
<b>Bech-Tech</b> Fanny Mac	79.00
<b>Computer Friends</b> MacInker Universal	55.00
MacInker C.Itoh	35.00
<b>Curtis Manufacturing</b>	
Diamond-Surge Suppressor-SP1	29.00
Emerald-Surge Suppressor-SP2	36.00
Ruby-Surge Suppressor-SPF-2	55.00
Sapphire-Surge Suppressor-SPF-1	47.00
<b>Diversions, Inc.</b> Underware Ribbon	9.00
Underware Color Pens-Small	10.00
Underware Color Pens-Large	13.00
<b>Environmental Software Company</b>	
MacAttire: Available in Navy-Blue, Burgundy, or Silver-Gray.	
External Drive or Keypad Cover	7.00
ImageWriter II Cover	11.00
Wide ImageWriter Cover	13.00
Mac & Keyboard Cover	15.00
MacPlus & Keyboard Cover	15.00
MacPlus, HD-20, & Keyboard Cover	18.00
LazerWriter Cover	17.00
<b>Ergotron</b>	
MacTilt	
(Mac 128/512K or MacPlus Version)	75.00
MacBuffer 256K	249.00
MacBuffer 512K	369.00
MacBuffer 1024K	569.00
<b>Innovative Concepts</b>	
Flip 'n' File/Micro	9.00
Flip 'n' File II/Micro	18.00
<b>Innovative Technology</b>	
The Pocket Pack (holds 6 disks)	10.00
The Easel (holds 20 disks)	14.00
The Pyramid	14.00

<b>I/O Design</b> MacPlus Carrying Case	59.00
ImageWriter Carrying Case	45.00
ImageWriter II Carrying Case	49.00
ImageWriter Wide Carrying Case	49.00
<b>Kalmar Designs</b>	
Teakwood Roll-Top Disk Cases: Micro Cabinet (holds 45 3 1/2" disks)	14.00
Double Micro Cabinet (holds 60 3 1/2" disks)	21.00
<b>Kensington</b> System Saver Mac A/B Box	65.00
Disk Case (holds 36 Mac disks)	62.00
Traveling Disk Case	19.00
Disk Drive Cleaning Kit	8.00
External Disk Drive Cover	19.00
ImageWriter or ImageWriter II Cover	9.00
Macintosh Dust Cover	9.00
Mouse Cleaning Kit w/Pocket	16.00
Mouse Pocket	8.00
Circular Polarizing Filter	31.00
Starter Pack (includes Tilt/Swivel)	53.00
Surge Protector	35.00
Tilt/Swivel	22.00
Control Center	62.00
Printer Stand	17.00
<b>Kette Group</b>	
MacNifty Joystick Converter	35.00
MacNifty Stereo Music System	69.00
MacNifty A/B Switch	25.00
MacNifty A/B/C/D Switch	39.00
<b>Kraft</b> Quickstick III	55.00
<b>MacMemory, Inc.</b> MaxChill	39.00
<b>Moustrak</b> MousePad 7" x 9" Size	8.00
MousePad 9" x 11" Size	9.00
<b>MPH Computer Products</b>	
MAC-B-COOL	79.00
<b>N2 Products Inc.</b>	
MacPlus to ImageWriter II Cable (6 feet)	19.00
MacPlus to DB-9 Adaptor Cable	19.00
MacPlus to SCSI Drive Cable	24.00
<b>Optimum Computer Luggage</b>	
MacTote Mac Carry Case	60.00
PrintTote ImageWriter II Carry Case	60.00
<b>Ribbons Unlimited</b>	
Available in Black, Blue, Brown, Green, Orange, Purple, Red, Yellow, Silver & Gold	
ImageWriter Ribbon-Black	4.50
ImageWriter Ribbon-Color	5.00
ImageWriter Rainbow Pack (6 Colors)	27.00
ImageWriter II-4 Color Ribbon	6.95
<b>Smith &amp; Bellows</b>	
Hand Crafted Mahogany Disk Case: Holds up to 90 Diskettes	27.00
Hand Crafted Basswood Disk Case: Holds up to 90 Diskettes (Natural or Stain)	19.00
Software-Dust Jackets Available in Vintage Burgundy or Corporate Grey Colors:	
Mac Jacket w/Mouse & Keyboard Cover	15.00
ImageWriter I or II Cover	11.00
External Drive Cover	7.00
Wide ImageWriter Cover	13.00

<b>Systems Control</b>	
MacGard Surge Suppressor	55.00
Video 7 Mouse Stick	38.00
<b>X-10 (USA) Inc.</b>	
X-10 Powerhouse Computer Interface	65.00
Extra Modules (For Lamps, Wall Switches, & Appliances)	15.00

## Books

<b>Microsoft Press</b>	
Creative Programming in	
Microsoft Basic	14.00
Excel in Business	18.00
Inside MacPaint	14.00
Macintosh Midnight Madness	14.00
MacWork/MacPlay	14.00
Microsoft Macinations	16.00
Microsoft Multiplan: Of Mice and Menus	13.00
Presentation Graphics on Macintosh	14.00
The Apple Macintosh Book Vol. 2	15.00
The Printed Word	14.00

## Ordering Instructions

VISA AND MASTERCARD ACCEPTED  
To order, call us anytime Monday thru Friday 9:00 to 9:00, Saturday 10:00 to 6:00. For fast delivery if ordering by mail, send cashier's check, certified check or money order. Fortune 1000 & Government checks honored immediately. Personal and other company checks allow 2-3 weeks to clear. MasterCard & Visa, include card # & expiration date. Connecticut residents add 7.5% sales tax. Purchase Orders: All merchandise FOB CT. and Handling. Please call (203) 378-3662 for credit information and terms.

**Shipping Charges: Software Only** — \$3.00 Minimum charge U.S. Mainland. With C.O.D. shipments add an additional \$2.00. U.S. Postal APO, and FPO add 3% (\$5.00 Min.). Alaska or Hawaii add 6% (\$10.00 Min.). Canadian orders add 10% (\$15.00 Min.). Foreign Orders except Canada-Add 18% (\$25.00 Min.).

**Hardware** — Please call for shipping charges.  
**Our Policy** — We do not guarantee machine compatibility. All products are new and include factory warranty, therefore All sales are final. Defective software will be replaced by the same item only. Defective hardware will be replaced or repaired at our discretion. Prices & availability subject to change without notice. Products purchased in error, subject to 20% restocking fee. All returns must have an authorization number or they will not be accepted. Call (203) 378-3662 to obtain one before returning defective products for replacement.

# PROGRAMS

# PLUS

Visit Our New Showroom: Exit 32 Off I-95  
Station House Square  
2505 Main Street  
Stratford, Conn. 06497  
Telephone Hours: Monday-Friday 9-9;  
Saturday 10-6  
Showroom Hours: Monday-Friday 9-6;  
Saturday 10-6

Orders Only TOLL-FREE **1-800-832-3201**  
Circle 194 on reader service card

# Think of us as the Book of the Mind Club.

*The  
Apple®  
Macintosh™  
Book*  
SECOND EDITION

*Cary  
Lu*

EXCEL  
IN BUSINESS

DOUGLAS  
COBB  
THE COBB GROUP

MICROSOFT  
PRESS

MICROSOFT  
EXCEL WITH  
MACROS

MAXIMIZING THE POWER  
AND SPEED OF MICROSOFT EXCEL

MICROSOFT  
PRESS

L O N P O O L E ' S  
MAC INSIGHTS

Secrets,  
shortcuts  
and solutions  
for the  
Apple  
Macintosh

MICROSOFT  
PRESS



You've gone one-on-one with your Macintosh.™ Listened to the tapes. Memorized the manual. Now: Where do you go for more nourishment when you're still hungry? Easy.

Microsoft Press. The most useful books in the business.

Our parent company is Microsoft, the leading software developer for Macintosh. Our authors read like a Who's Who of What's What.

Here are four ways to boost your computer's I.Q.:



*The Apple® Macintosh Book* by Cary Lu. Everything you wanted to know about the latest Mac hardware, Mac software, Mac peripherals and Mac uses but didn't know who to ask. \$19.95. 448 pages. Softcover.



*Excel In Business* by Douglas Cobb. Lets you tap all the spreadsheet, database and graphics power of Microsoft® Excel. Quickly, completely, painlessly, \$22.95. 720 pages. Softcover.



*Microsoft Excel with Macros* by Douglas Hergert. Want to simplify recording, editing and repeating complicated commands to just a few keystrokes? Here's how. \$21.95. 288 pages. Softcover.



*Lon Poole's Mac Insights* by Lon Poole. Going from core knowledge to Mac expert is a snap. Just take Poole's tips, shortcuts and imagination to the Macs. \$18.95. 352 pages. Softcover.

Don't bob for answers. Turn to Microsoft Press. Available wherever books and software are sold. Remember: What you get out of your Macintosh depends on what you read into it.



Microsoft is a registered trademark of Microsoft Corporation. Apple is a registered trademark of Apple Computers, Inc. Macintosh is a trademark licensed to McIntosh Laboratory, Inc., and is used with its express permission.

## Get Info

INTL ID = 0 from System	
decimalPt	.
thousSep	,
listSep	;
currSym1	\$
currSym2	
currSym3	
currFmt	208
dateOrder	0
shrtDateFmt	0
dateSep	/

### Dates in Short Order

Using ResEdit to change the order of month, day, and year in dates, you open a series of windows, select the dateOrder box, and type a code for the preferred order.

- The shrtDateFmt box specifies whether to show leading zeros and whether to show the full four-digit century. To do without all of those extra characters, put a 0 in this box. For leading zeros on days below 10, add 32 to the value in the box; for leading zeros on months, add 64; and for centuries, add 128. For example, to show centuries and leading zeros in both day and month numbers, enter 224 (32 + 64 + 128).

- When you finish making changes, close all the windows, answering Yes when ResEdit asks whether you want to save your changes, and then quit ResEdit.

In addition to the short date format, there's a long date format in INTL resource 1, which—in its longest form—spells out the month and the day of the week. The resource specifies the spelling or abbreviation of the month and day names, along with the punctuation and other options you can set in the short date format. Unfortunately, the latest version of ResEdit available at this writing, version 1.0D7, does not include an editing window for INTL resource 1. Apple's Redit program (available from user groups) does, but the program doesn't work with HFS disks.

### Making Room for BASIC Input

**Q.** I am writing a program in Microsoft BASIC version 2.0 that requires the user to input long sentences. However, the cursor doesn't wrap around to a new line, and even adjusting the width of the window does not prevent the characters from dis-

appearing off the right edge of the screen. Is there any way to change the width of the screen for input?

Tommy Beller  
De Land, Florida

**A.** Use EDIT FIELD statements to define editable text fields within a window. These fields work just like editable text fields in other Mac applications, such as the comments field in the Finder's Get Info dialog box. Each EDIT FIELD statement specifies the following:

- A field ID number
- The suggested text to be edited or a blank area for entering text
- The size of the field
- Whether the field has a border
- Whether word wrap is on and Returns are not allowed as part of the entry, or word wrap is off and the user must press Return to end a line
- The format of the text—flush left, centered, or flush right.

After defining the window and edit fields, use the DIALOG function to monitor what the user does with the mouse and the keyboard. Specifically, when DIALOG(0) equals 2, the user has clicked an edit field, and DIALOG(2) identifies which one. Use an EDIT FIELD statement with just a field ID to activate the selected edit field.

When the user finishes editing the fields in the window and so signifies by

(continues)



# We'll give you and a \$5 discount MACWORLD Expo



Our exhibitors list. (As of April 1, 1986.) A who's who of people who design, develop and produce hardware, software and peripherals for Macintosh. A+/Ziff-Davis Publishing Co., Addison-Wesley Publishing, Adobe Systems, Affinity Microsystems, Ltd., Aldus Corp., Altsys Corp., Ann Arbor Softworks, Inc., Apple Computer, Inc., Applied Logic Systems, Inc., Avanteq, Inc., Avenue Software, Inc., Blackhole Technology, Inc., Blyth Software, Boston Software Publishers, Inc., Brainpower, Inc., Bridgeport Machines CMS, C. Itoh & Co., Capilano Computing Systems Ltd., Caribbean Enterprises, Casady Co., Cauzin Systems, CompServCo, Compucover, Computertown, Conceptual Instruments Co., Consulair Corp., Corvus Systems, Inc., Creighton Development Corp., Cricket Software, DataSpace Corp., Dayna Communications, DCM Data Products, Digital, Etc., Educomp, Enterset, Erez Anzel, Ergotron, Inc., Esoft Enterprises, Exper Intelligence, Inc., Ferranti-Dege, Inc., First Byte, Ford LePage, Forethought, Inc., General Computer Co., Great Wave Software, Greene, Johnson, Inc., GTCO Corp., Hayden Book Co., Hayes Microcomputer Products, High Performance Systems, I/O Design, Inc., Infosphere, Inc., Innovative Data Design, Inc., Innovative Technologies/Communications, Kette Group, Inc., Layered, Inc., Les editions Ad lib, Inc., Levco Enterprises, Lotus Development Corp., MacLord Systems, Inc., MacMemory Inc., MacPacks, Inc., MacPherson, Inc., MacTutor, MacUser Publications, MACWORLD, Manhattan Graphics, MassTech Development Labs, Inc., Micah, Inc., Micro Planning Software, USA, Micro-Design, Microsoft Corp., MicroStore, Mindwork, Model Office Co., N2 Products, Inc., National Instruments, NEC Information Systems, New Line 7, Nolo Press, Northeast Computer Supplies, Northeast Data Processing Supplies, Odesta Corp., ODS, Inc., Palantir Software, Panamax, Paradise Systems, Inc., Paragon Courseware, PBI Software, Peachtree Software, Peripheral Land, Peripheral Systems, Inc., Personal Computer Peripherals Corp., Prometheus Products, ProVUE Development Corp., Rubicon Publishing, Satori Software, Scott, Foresman & Co., SGC Computer Goods, Sierra Information Systems, Silicon Beach Software, Inc., Small Business Computers of N.E., SoftIdea, SofiView, Softworks Limited, Springboard Software, Step-Lively Software, Inc., SuperMac Technology, Summagraphics, Target Software, T/Maker Graphics, TML Systems, TPS Electronics, Unicom, UP Time/Viking Technologies, White Pine Software, Williams & Macias. And there are more to come! MACWORLD Exposition/Boston is the original Macintosh computer show. It's sponsored by MACWORLD, the Macintosh™ Magazine, a member of the CW Communications/Inc. family.

# a free McIntosh if you register for /Dallas by Oct. 1.



**MACWORLD Expo/Dallas  
comes to Market  
Hall, October 16-18.**

## **How about them apples?**

This is the original computer show for both types of people in the world. Those who own a Macintosh™. And those who soon will.

In three days, under one roof, you'll discover tips, tricks, techniques, do's, don'ts, how-to's and why-for's that would otherwise take weeks to collect.

Attend dynamic seminars and product workshops run by industry experts. Visit hundreds of exhibits. Talk to the companies you hear so much about. See, touch and test drive an extraordinary array of hardware, software and peripherals firsthand. Fine-tune your Macintosh skills — on the spot.

Do all this and more. And if you register before October 1, 1986, you can save \$5 and get a free McIntosh — the apple.

There's something for everyone. Even you, Mac.

It doesn't matter whether you're a power user or just about to take your first bite. After three days, you'll be chock full of information about Macintosh and what this remarkable computer can do to help you — in the office, at school or at home.

Find out how you can connect your Macintosh to the IBM world. Learn the innermost secrets of the industry's programming

gurus. Master new ways to unlock the potential of your Macintosh.

There's literally something for every Macintosh user. Including a special Desktop Publishing Program, Power User Seminars and an Education Forum — guaranteed to interest teachers, students and administrators. All are exclusive to MACWORLD Expo/Dallas.

## **One Macintosh deserves another.**

Avoid long lines at the door. Register now for this exciting three-day conference. You'll save \$5. And get a free McIntosh apple!

Simply fill out the coupon and send it with your check for \$30.00 (or supply credit card information) to the address listed before October 1, 1986. On-site conference admission is \$35.00. And no credit cards or checks will be accepted at Market Hall.

This low \$30 fee allows you to visit all exhibits and attend all seminars. If you just want to visit the exhibits, admission is \$15, payable only at the door.

To register additional people, just copy this form and complete it for each attendee. For group and student rates, please call 617-329-7466 by September 15th. This form must be received by October 1st. After October 1st, you must register at the show. All registrations are non-refundable.

Don't miss out on this opportunity to feast on Macintosh — the computer, not the apple.



Register by October 1. Save \$5 and get a free McIntosh apple.

Sure I want to pre-register for the MACWORLD Expo/Dallas, October 16-18, 1986 at Market Hall. I'll pick up my free McIntosh at the door. But please send my badge to:

Name \_\_\_\_\_

Title \_\_\_\_\_

Company \_\_\_\_\_

Mailing Address \_\_\_\_\_

City \_\_\_\_\_ State \_\_\_\_\_ Zip \_\_\_\_\_

Phone \_\_\_\_\_

Check enclosed (make payable to MACWORLD Exposition)  
 MasterCard  Visa  American Express

Account #                       
(Include all numbers) MW1

Expiration Date \_\_\_\_\_

Signature \_\_\_\_\_  
(Signature necessary for authorization to be valid)

Send payment and coupon to MACWORLD Expo, Mitch Hall Associates, P.O. Box 155, Westwood, Massachusetts 02090. Coupon must arrive at our offices no later than Wednesday, October 1. For further information, call Mitch Hall Associates at 617-329-7466.

MACWORLD Exposition is produced by World Expo Co., and managed by Mitch Hall Associates. MACWORLD Exposition is a registered trademark of World Expo Co., Inc. Macintosh is a trademark licensed to Apple Computer, Inc.

**MACWORLD  
EXPOSITION**  
**DALLAS**

clicking the OK button you have thoughtfully provided, the EDIT\$ function retrieves the current contents of the edit fields.

The simple program in Listing 1 illustrates these concepts. For specific information on the full range of parameter values for the EDIT FIELD statement and the DIALOG and EDIT\$ functions, see the Microsoft BASIC manual.

MacDraw Font Follies

**Q.** The System file on my HyperDrive hard disk has lots of fonts, but MacDraw's Font menu lists only nine of them. I tried a public domain program called Scroll'em, which implements scrolling menus on non-Plus Macs, but it doesn't work right with MacDraw.

(continues)

SuperMac Dealers:

AK: Anchorage: Pictures, Inc. 279-1515; Fairbanks: Empire Electronics. AL: Birmingham: AC3 Computing 942-9564; Montgomery: AC3 271-2211. AZ: Kingman: Computer Room 753-1711; Tempe: Computer Pro 829-7993. CA: Albany: ComputerLand 527-8344; Arroyo Grande: Computer Terminal 481-4860; Bakersfield: Computer Basics 339-5080; Computer Warehouse 327-3393; MicroAge 397-5864; Belmont: ComputerLand 595-4232; Berkeley: Winner's Circle 845-4814; Burlingame: ComputerLand 348-7731; Carmel: Computer Design 625-6150; Chico: Computer Center 891-1630; Concord: Infomax 689-2331; Costa Mesa: Coast Computer 646-8981; Dublin: ComputerLand 828-8090; Dublin Computers 829-8644; Fresno: OnLine Computers Plus 432-4324; Garden Grove: Inacom 898-2665; Hayward: Computer Center 538-7368; ComputerLand 538-8080; LaMiranda: ComputerLand 739-0941; Long Beach: ComputerLand 595-6683; Los Alamitos: ComputerLand 594-8813; Los Altos: ComputerLand 941-8154; Los Angeles: Computer Showcase 474-6409; ComputerLand 837-5388; Los Gatos: Wolf Computer 354-1210; Newport Beach: ComputerLand 476-8360; Oakland: ComputerLand 839-5230; Computer Store 763-7900; Palo Alto: Computer Attic 322-0639 & 328-0171; Computer Ware 323-7557; Pasadena: ComputerLand 449-3205; Palmdale: Execution 778-1242; Pleasanton: Home Business 846-3944; Rancho Cordova: AVC Computers 638-2242; Redwood City: Peninsula Office Supply 364-1333 and six other Bay Area locations; Riverside: Computer Kingdom 787-1142; Rocklin: AVC Computers 624-0601; Sacramento: Net Profit 638-0588; AVC 962-2100; Salinas: Peninsula Office Equipment 424-2103; San Diego: Byle Shop 565-8008; Computer Age 565-4042; Computer Merchants 565-2463; San Francisco: Software for Less 753-1066; Computer Connect 781-0200; Computer Attic 398-4541; ERA Electronics 398-6361; Santa Ana: ComputerLand 929-2026; San Mateo: MicroAge Computer 348-2983; Santa Clara: Affordable Computers 249-4221; ComputerLand 246-4500; Santa Cruz: Affordable Computers 458-1644; Stockton: Stockton Computers 952-2028; Sunnyvale: Fry's Electronics 733-1770; Ventura: Computer Village 644-5226; W. Los Angeles: P.C. Land 478-7709. CO: Boulder: Friendly Computers 530-5115; Denver: CW Electronics 832-1111; ComputerLand 759-4685; Lakewood: Neighborhood Computer 988-9140; Longmont: Micro Computer World 651-1177. CT: Fairfield: Computerworks 335-6316; Microage 335-3694; Hamden: Computer Factory 281-4119; New London: Computer Lab 447-1079; Norwalk: Microage Computer 947-8428; Simsbury: Logical Systems 441-0217; Stamford: Computer Factory 356-1920; Stratford: Programs Plus 278-3662; Wallingford: Computer ease 269-4440; Westport: Computer Factory 255-2822; Wethersfield: Computer Resources. FL: Fort Meyers: Microworks 936-4676; Jacksonville: Computer Kingdom 641-9042; Miami: Integrated Computer 887-4777; Kendall 274-6312. GA: Augusta: Cash Register Exchange 724-1747; Gainesville: Preferred Sys. 532-3857; Norcross: Varsity 446-3433; Computer Source 494-5166; ComputerLand 474-1410. IA: Dubuque: Computers Plus 556-6150. IL: Chicago: Golden Rule 929-2592; Highland Park: Universal Computers 433-8930; Jacksonville: Computer Oasis 245-1461; Waterloo: Computer Helper 800-235-6648. IN: Fort Wayne: Grahm Computer 42-3-3422; Marion: Computer Store 662-9994. KS: Emporia: Mr. Computer 347-4893. KY: Lexington: Lexington Computer 268-1431; Alexandria: D. M. Computer 444-0217; Maitland: Computer Shoppe 454-6600. LA: Shreveport: Compco Computer 869-1282. MA: Acton: Acton Computer Center 263-3600; Boston: Sherman Howe 423-6787; Cambridge: Tech Computer 497-0395; Chicopee: Custom Computers 594-6682; Lynn: Land of Electronics 581-2700; Newton: Micros Unlimited 964-0202; Sherman Howe 965-8970; Peabody: Computers, Etc. 535-5252. MD: Gaithersburg: MacCorner 330-9116; Laurer Computer Center 792-0600; Wheaton: Computer Crafters 933-5820. MI: Ann Arbor: Learning Center 996-1616; Farmington Hill: Retail Computer Center 626-3240. MN: Baxter: Computer One 828-4650; Hutchinson: Hutch Computer Inc. 587-2940; Manchester: United Computer 391-9409. MS: Meridian: ComputerLand 482-8523; Starkville: Teletronics 323-4614. MT: Billings: Conroy Computer 655-8100; East Haven: Computer Store 245-0092; Bozeman: Computer Lines 586-7693. NC: Charlotte: Computer Room 377-9821; Greensboro: Computer Gallery 854-2443; Leicester: Great Smokies Software 683-4128; Rocky Mount: Computer Displays 937-4781. ND: Fargo: ComputerLand 237-3069. NE: Fremont: Fremont Office 721-6436. NH: Manchester: Computer Mart of NH 624-1776; Nashua: Computer Mart of NH: 883-2386. NJ: Cranbury: Clancy-Paul Computer 655-8100; East Hanover: Computer Factory 887-5711; Englishtown: Computer Madness 462-9696; Inglewood American Business 569-0853; Fairfield: Computer Discount 882-0039; Hasbrouck: Nubs Computer 288-6827; Iselin: Computer Factory 750-8810; Mahwah: Micro Age 529-1400; Montvale: Computer Center 391-1006; Northfield: ComputerLand 646-6611; Ocean Township: Trasnet 531-7020; Paramus: ComputerLand 845-9303; Computer Factory 939-2700; Summit: Shenenge Computer 277-1020; Totowa: Computer Factory 785-0088; Union: Transnet 688-7800; ComputerLand 851-2858; Wayne: Computer Pros 256-7070. NM: Albuquerque: Rocky Mountain Computers 292-2775; Wayne: Computer Pros 256-7070; Carlsbad: Computer Network 621-0937. NY: Brooklyn: Computer Factory 377-4999; Clifton Park: Lela Computer 331-0035; Canby: Computer Factory 248-6700; Hicksville: World Computers 822-1100; Hauppauge: Computer Factory 360-7700; Huntington Sta.: B.C. Communications 549-8843; Little Neck: ComputerLand 423-5280; Manhasset: Computer Microsystems 627-5240; Melville: Computer Factory 351-8460; Merrick: Byte Shop 379-2983; Middletown: Computer Emporium 343-8740; Nanuet: Computer Factory 624-8006. NY: ComputerLand/Third Avenue 624-8006; ComputerLand/Seaport 608-2265; ComputerLand 213-1000; Olden Computers 725-1234; Software Solution 608-9595; Computer Factory/52nd St. 664-0170; Computer Factory/Lexington 687-5000; Computer Factory/Broadway 344-0733; Computer Factory/47th Street 687-5000; Computer Factory/Maiden Lane 968-0100; Computer Factory/Third Ave. 980-1700; Portchester: A World of Computers 937-6662; Reygo Park: Computer Factory 896-0700; Syosset: ComputerLand 496-4554; Vestal: MicroWorld 757-0500; White Plains: Computer Factory 681-6060; Whitesboro: Upstate Computer 768-8151; Yonkers: Computer Factory 793-1300. OH: Akron: ComputerLand 836-7800; Canton: ComputerLand 493-7786; Strongsville: CBM Computer 238-0068; Toledo: Abacus 865-1009. OK: Oklahoma City: OnLine Computers; Tulsa: ComputerLand. OR: Beaverton: Software Station 641-4667; Canby: Cleckamas Computers 650-0379; Eugene: Computer Solutions 344-9677; Medford: ComputerLand; Micro Works 773-9861; Portland: Conroy LaPoint 620-4990; Moore's Audio Visual 233-5621. PA: Allentown: General Computer 266-1880; Gladstone: T.J. Enterprises 785-5311; Monroeville: Computer Factory 856-1088; Pittsburgh: Computer Factory 359-1010; Columbia: Byte Shop 788-2525. TN: Knoxville: Educational Computing Systems 966-6731. TX: Abilene: Computer Shop 695-7320; Arlington: Hardin Computer 478-2775; Austin: ComputerLand 834-2499; Beaumont: Concept Computer 842-1163; Houston: Computer Craft 977-0247; Computer 956-7483; Laredo: ComputerLand 724-1551; Lubbock: Agriplex; Richardson: Metropolitan Computer 437-9119; Sherman: Business Computers 893-6834; Spring: Williams Computer 821-9813; Temple: Action Business Sys. 773-5351; Victoria: Computer Command 573-4305; Leesburg: Computer Solutions 777-3770. WA: Bellevue: Conroy LaPoint 455-0206; Kennewick: 783-6420. MI: Shubogyan: 452-2777. West Allis: Software Centre 545-5727. WY: Morgantown: Computer Corner 292-8298. WY: Casper: Computer Solution 265-8888.

```

true=NOT(false)
quit=false
WINDOW 2,,(125,110)-(400,215),-2 'Display window
CALL TEXTFONT(Chicago)
CALL MOVETO(5,21):PRINT "Title:" 'Display 3 edit field labels
CALL MOVETO(3,86):PRINT "Tape:"
CALL MOVETO(80,86):PRINT "Counter:"
EDIT FIELD 2, "",(40,75)-(70,90),1 'Display and activate 3 edit fields
EDIT FIELD 3, "",(140,75)-(190,90),1,3 '(this one is right justified)
EDIT FIELD 1, "",(40,10)-(260,60),1 '1st one last so it's 1st for entry
BUTTON 1,1,"OK",(210,72)-(265,96) 'Display OK button
fieldNo=1 'field 1 is 1st for entry

WHILE NOT(quit) 'Don't quit until OK clicked
  dialogEvent=0
  WHILE dialogEvent=0 'Wait for user to do something
    dialogEvent=DIALOG(0)
  WEND
  ON dialogEvent
    GOSUB ButtonClick, EditMove, NoOp, NoOp, NoOp, ReturnKey, TabKey
  WEND

WINDOW CLOSE 2
END

ButtonClick: 'User clicked the OK button
  title$=EDIT$(1) 'Get edit field entries
  tapeID$=EDIT$(2)
  tapeCount=VAL(EDIT$(3))
  GOSUB SaveRecord
  quit=true
  RETURN 'And then quit

EditMove: 'User clicked an edit field
  fieldNo=DIALOG(2) 'Find out which field
  EDIT FIELD fieldNo 'And activate it for entry
  RETURN

NoOp: 'Do nothing for some dialog events
  RETURN

ReturnKey: 'Pressing Return same as clicking OK
  GOSUB ButtonClick
  RETURN

SaveRecord: 'Saving entries to disk not
  implemented here
  RETURN

TabKey: 'User pressed the Tab key
  fieldNo=(fieldNo MOD 3)+1 'Advance to next edit field
  EDIT FIELD fieldNo 'And activate it for entry
  RETURN

```

**Listing 1**  
This short program demonstrates a technique for creating editable fields for user input in Microsoft BASIC programs.

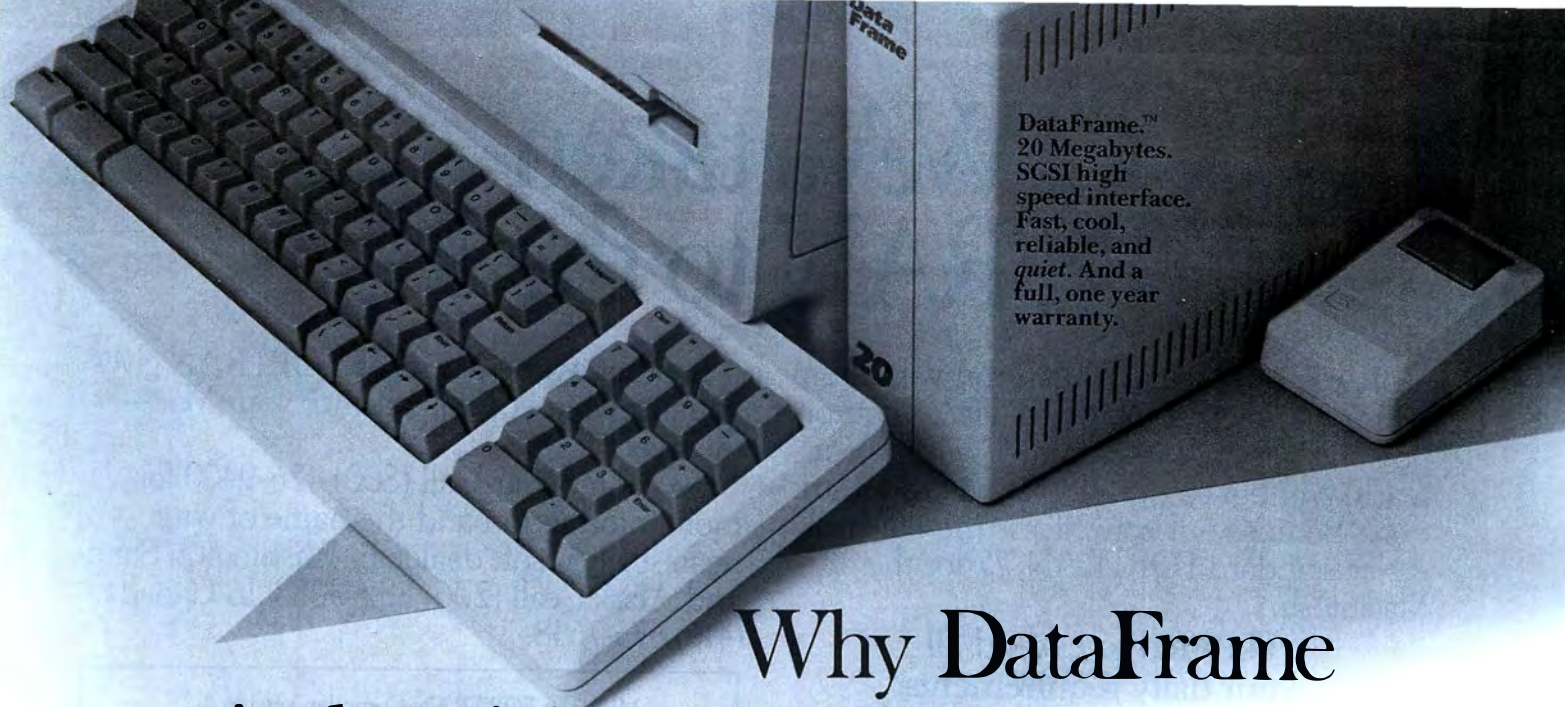

DataFrame™  
20 Megabytes.  
SCSI high  
speed interface.  
Fast, cool,  
reliable, and  
quiet. And a  
full, one year  
warranty.

# Why DataFrame is the *right* hard disk for any Mac:

*Because we looked carefully at what users need in a hard disk system for the Mac, and made the right design decisions. Decisions that give you significant benefits over any other Mac hard disk. They are:*

### Decision: Floppy disk port or SCSI?

Hard disks that use the serial or floppy disk port, such as the Apple hard disk, are *slow*. The SCSI interface (introduced with the Macintosh Plus) is considerably faster. The DataFrame uses the SCSI interface, and consequently runs *much* faster than hard drives that use slower ports. Yes, even faster than non-SCSI internal drives. It really makes your Mac *fly*.



◀ (If you own a Mac 512, you can get DataFrame performance too, with our \$99 SCSI adapter.)

### Decision: Internal drives versus external drives?

Internal drives save desktop space, but there are serious trade-offs. First, you lose your system while the drive is installed. Worse, you lose your system if the drive needs repair. (Internal drives have earned a not undeserved reputation for frequent breakdowns.)

Then there's heat—the enemy of reliability. Internal drives add heat to the system. You either use a fan—which means you listen to an annoying whine while you are working—or you use no fan, which means your system gets too hot.

DataFrame is external, so it adds no heat to the system. Because the drive is preformatted, you can take it right out of the box, plug it in, and be *working* in minutes. And if your hard disk should ever need service, you just unplug the DataFrame (you can *still*

use your Mac) and get a replacement *immediately* from your dealer.

### Decision: Under-system or beside-system?

A drive under your Mac has the same heat problems as a drive inside your Mac. The drive must either have a fan (*noisy*) or it sits under your Mac like a little hotplate (*unacceptable*).

DataFrame sits *beside* the Mac, uses a vertical 'chimney' design to vent heat, needs no fan, and therefore stays cool *silently*.

### What else?

SCSI means easy expansion—you can 'daisy chain' up to seven additional drives or other SCSI peripherals, using DataFrame's second SCSI port. Plus, DataFrame boots your system directly from disk, saving you time. And we used Apple's Hierarchical File System, so all 20 megabytes are available on line at all times. Most important, DataFrame is so reliable, we back it up with a full, one year unlimited warranty. That's confidence you can't even get from Apple.

### The result of all these decisions:

DataFrame has been chosen by more professionals, more Macintosh software developers (including many in Apple Computer, Inc.), more dealers, and in fact, *more people* than any other SCSI Macintosh drive, *by far*.

So before you commit to *any* hard disk for your Macintosh, you owe it to yourself to see DataFrame in action. You'll find it at any of the hundreds of qualified SuperMac™ dealers. They're listed next to this ad.



1901 Old Middlefield Way, Mountain View, CA 94040  
(415) 964-8884

New Price  
\$1099.

See us at MACWORLD EXPO/Boston, booth 740

New Version 2.2  
Runs on the Macintosh™ Plus

# We've taken FORTRAN to the Macs.

Now your Macintosh™ can run with the big guys. Microsoft's new FORTRAN compiler puts the power of mainframes within your reach. Without complications, without restrictions. Because our compiler is the only full, ANSI standard FORTRAN '77 for the Macintosh.

Fortified to exceed all  
your daily requirements.

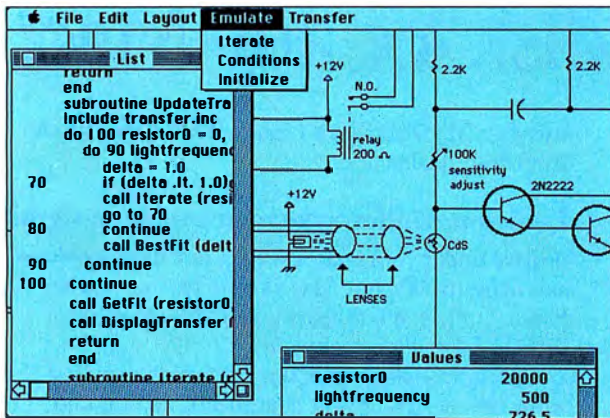

Microsoft® FORTRAN unleashes all your Mac's resources. Now your scientific and engineering programs can have access to Mac graphics. An IEEE math package. Plus huge virtual arrays for data. Boosted with the blazing speed of compiled code.

Our compiler makes the programming faster as well. FORTRAN enhancements like DO...WHILE make structured programming easy. Dynamic overlays let you run mainframe-size programs. Even in 128K of RAM. And a powerful set of utilities gives you complete library management. Not to mention dynamic linking, a program editor and an interactive source code debugger.

In other words, Microsoft FORTRAN gives you just what you'd expect for your Mac—the max.

So get moving. Call (800) 426-9400 for more information and the name of your nearest Microsoft dealer. In Washington State and Alaska, call (206) 882-8088. In Canada, (416) 673-7638.

## Microsoft FORTRAN Compiler Version 2.2

### Microsoft FORTRAN Compiler

- Full ANSI FORTRAN '77—the standard.
- Port mainframe and minicomputer applications with little or no change.
- Calculate with IEEE-standard floating-point numbers.
- Performs direct 32-bit integer arithmetic.
- Supports virtual arrays as large as available disk space.
- Compile up to 1600 lines per minute.
- Optionally compile into Apple's MDS assembly language.
- Structure your code using separately compiled modules, statement functions, block IF, block DO and SELECT CASE constructs.

### Interactive Window-Oriented Source Debugger

- View your source file while debugging.
- Single-step through your program.
- Set source-level breakpoints to control execution.
- Examine and modify your variables.
- Search source code for labels or line numbers.
- Examine file status for all units.

### Extensive Toolbox Interface

- Access over 475 built-in Macintosh toolbox functions, including windowing, cursor handling, pull-down menus, mouse tracking, event queue handling and desk accessory management.
- Draw using powerful Macintosh graphics routines: points, rectangles, ovals, arcs, polygons and regions.

### Library Manager

- Build your own libraries of useful subprograms.
- Include over 200 procedure files per library.
- Mix FORTRAN and assembly language procedures.

### Object Code Linker

- Dynamically link routines as needed while executing.
- Statically link subprograms for faster execution.

### Other Productivity Tools

- Apple's source code editor—optimized for faster programming.
- Apple's resource compiler—takes advantage of special Macintosh capabilities.

### System Requirements

- 128K Macintosh.
- One disk drive.

# Microsoft® FORTRAN for the Macintosh.™

The High Performance Software.

Microsoft is a registered trademark of Microsoft Corporation. Macintosh is a trademark licensed to McIntosh Laboratory, Inc. and is used with its expressed permission. Microsoft FORTRAN for the Macintosh was developed by Microsoft Corporation.

Also, *MacDraw* seems to identify fonts in a document by their positions on the Font menu, not by their names. Suppose, for example, I type some text in a *MacDraw* document using Chicago, which is the first font on my *MacDraw* Font menu. Then I quit *MacDraw* and use the Font/DA Mover to add the Los Angeles font

to the System file. When I reopen the *MacDraw* document, Los Angeles is at the top of the Font menu, and the text I typed in Chicago has been converted to Los Angeles.

*Bill Stewart  
Norcross, Georgia*

### System Error ID Codes

#### ID Code Meaning

1	Bus error: a memory reference problem occurred on a Mac XL or on a modified Mac or Mac Plus.
2	Address error: the program referred to an odd memory address.
3	Illegal instruction: the MC68000 microprocessor encountered a machine language instruction it did not recognize.
4	Zero divide: a machine language instruction Signed Divide (DIVS) or Unsigned Divide (DIVU) had a divisor of zero.
5	Check exception: the machine language instruction Check Register Against Bounds (CHK) failed; perhaps a Pascal "value out of range" error occurred.
6	TrapV exception: the machine language instruction Trap On Overflow (TRAPV) failed.
7	Privilege violation: the Mac always runs in privilege (supervisor) mode; perhaps an erroneous Return from Execution (RTE) machine language instruction was encountered.
8	Trace exception: the trace bit on the microprocessor's status register is set.
9	Line 1010 exception: the 1010 trap dispatcher failed, making it impossible to use the ROM.
10	Line 1111 exception: an unimplemented machine language instruction was encountered; perhaps a leftover breakpoint from program debugging.
11	Miscellaneous exception: a nonspecific error condition caught by the microprocessor.
12	Unimplemented core routine: the microprocessor encountered a nonexistent trap number, perhaps a fictitious ROM routine.
13	Spurious interrupt: the interrupt vector table entry for a particular level of interrupt is NIL; this error usually occurs with level 4, 5, 6, or 7 interrupts.
14	I/O system error: the Mac's File Manager found a bad type field in an entry on an I/O request queue, the dCtlQHead field was NIL during a Fetch or Stash call in a custom driver routine, or a needed device control entry has been purged.
15	Segment Loader error: the GetResource procedure was unable to read a segment into memory.
16	Floating-point error: the halt bit in the floating-point environment word was set.
17-24	Can't read PACK resource into memory.
25	Memory full or fragmented: the Memory Manager was unable to fill the program's request for more memory.
26	Segment Loader error: the GetResource procedure encountered a non-executable resource or was unable to read 'CODE' segment 0 into memory for some other reason.
27	File map destroyed: the volume contains a block with a block number higher than the last block or lower than the first block on the volume.
28	Stack overflow error: a memory problem occurred because the stack expanded into the heap.

**A.** Apple knows about *MacDraw*'s font troubles. Although no *MacDraw* upgrade has been officially announced, one is in the works, and I can confidently speculate that it will allow you to choose from a larger selection of fonts and that it will not mix up fonts.

Incidentally, when I use *MacDraw* (version 1.7 or 1.9) on a Mac Plus that has 15 fonts in the System file on a SCSI hard disk, I see 11 fonts (not 9) listed on *MacDraw*'s Font menu. I have to scroll the menu to choose the 48-point size at the bottom of the menu, but the menu scrolling built into the Mac Plus ROM works. However, on systems with more fonts on the Mac Plus, I have seen the screwy scrolling you report. Because the Mac Plus ROM alphabetizes Font menus, font mixup is no longer related to a font's position in the Font menu; it's the font's position in the System file that matters.

#### Bomb Error Codes

**Q.** In the course of using my Macintosh, I often encounter system errors. I don't know what I am doing wrong, but the computer gives ID numbers to most of the errors. Could you please print a list of the ID numbers and what they mean?

*Brian Kalt  
Southfield, Michigan*

**A.** When you stomp the Mac, it displays the "serious system error" alert box—the one that shows a bomb icon in the upper-left corner and a mysterious number in the lower-right corner. These numbers translate to equally esoteric phrases. In most cases only someone who is intimately familiar with the program code for the Finder or the particular application software understands why a code might have appeared. But for the curious, the table "System Error ID Codes" lists interpretations for numbers 1 through 28.

*Send questions to Get Info, Macworld, 555 De Haro St., San Francisco, CA 94107. Send electronic mail to CompuServe 70370,702 or The Source BCW440. All published submissions become the property of Macworld.*

*Lon Poolo is a Contributing Editor of Macworld. □*

# It's crazy to buy

## SOFTWARE

### Affinity Microsystems

Tempo (power user's macro utility) . . . . \$79.

### Altsys

Fontastic (create your own fonts) . . . . . 27.

### Ann Arbor

FullPaint (open four documents at once) . . . 55.

### Assimilation

MIDI Composer (music record/playback) . . . 22.

Right•Word (spell checker & thesaurus) . . . 69.

### ATI

Teach Yourself Multiplan . . . . . 39.

Jazz Training . . . . . 39.

Excel Training . . . . . 39.

### Batteries Included

The Mac BatteryPak (desk accessories) . . . 27.

### Borland International

Sidekick w/Phonelink . . . . . 59.

### BPI Systems

General Accounting . . . . . 239.

### BrainPower

Think Fast (improves recall) . . . . . 23.

Chipwits (robot simulation) . . . . . 26.

StatView (statistics package) . . . . . 52.

Designscope (electronic circuit design) . . . 129.

StatView 512+ (req. external drive, 512k) . . 179.

### CAMDE

Nutricalc (diet & nutrition analysis) . . . . 49.

### Casady Company

Fluent Fonts (two-disk set) . . . . . 29.

### Central Point Software

Copy II Mac (includes MacTools) . . . . . 20.

### Challenger Software

Mac3D (3D graphics, CAD features) . . . . . 115.

### Chang Labs

Rags to Riches Ledger . . . . . call

Rags to Riches Receivables (reqs. 512k) . . . call

Rags to Riches Payables (reqs. 512k) . . . . call

Inventory Control . . . . . call

Rags to Riches Three Pak . . . . . call

### Cortland

Top Desk . . . . . 35.

### Creighton Development

MacSpell+ (requires 512k) . . . . . 55.

### Cricket Software

Statworks . . . . . 79.

Cricket Graph . . . . . 129.

### DataViz

MacLink (transfer Mac/IBM files) . . . . . 89.

### Desktop Graphics

DrawArt (MacDraw artwork, 512k) . . . . . 27.

DrawForms (requires MacDraw) . . . . . 30.

### Digital, etc.

Turbo Maccountant . . . . . 299.

### Dow Jones

Straight Talk . . . . . 59.

Spreadsheet Link . . . . . 62.

Market Manager PLUS . . . . . 125.

### Dreams of the Phoenix

Day Keeper Calendar . . . . . 27.

Phoenix 3D . . . . . 27.

Quick & Dirty Utilities Vol. 1 . . . . . 27.

Quick & Dirty Utilities Vol. 2 . . . . . 27.

Twelve-C Financial Desk Accessory . . . . . 27.

### Electronic Arts

Financial Cookbook . . . . . 32.

Deluxe Music Construction Set . . . . . 32.

### Enabling Technologies

Easy3D (create solid 3D objects) . . . . . call

### Enterset

Quickpaint (find MacPaint files fast) . . . . \$27.

Quickset (icon-driven accessory) . . . . . 27.

Quickword (word processing tool) . . . . . 32.

MacGAS (requires 512k, external drive) . . . 55.

### 1st Byte

Speller Bee (spelling-learning tool) . . . . . 39.

KidTalk (writing-learning tool) . . . . . 39.

Smoothtalker (version 2.0) . . . . . 49.

### Forethought

Factfinder (free-form entry) . . . . . 79.

FileMaker (custom forms & reports) . . . . . 99.

### Fortnum/Southern

MacInooga Choo-Choo (reqs. 512k) . . . . . 21.

### FWB Software

Hard Disk Util . . . . . 57.

### Great Wave Software

KidsTime . . . . . 27.

ConcertWare+ (music composition) . . . . . 39.

The Art of Fugue (Bach) . . . . . 12.

### Haba/Arrays

Home Accountant (reqs. external drive) . . . 52.

### Hayden Software

I Know It's Here Somewhere . . . . . 20.

Hayden:Speller . . . . . 27.

MusicWorks . . . . . 46.

Building Blocks . . . . . 46.

Home Design . . . . . 57.

Score Improvement System for the SAT . . . 58.

VideoWorks & MusicWorks Bundle . . . . . 58.

Commercial Interiors . . . . . 114.

### Ideaform

MacLabeler (print disk labels) . . . . . 29.

### Innovative Data Design

Paste-Ease (requires MacPaint) . . . . . 35.

MacDraft (requires 512k) . . . . . 139.

### Kensington

Graphic Accents . . . . . 29.

Type Fonts for Text . . . . . 29.

Type Fonts for Headlines (reqs. 512k) . . . 42.

### Layered

Notes...For Excel . . . . . 42.

Notes...For Jazz . . . . . 42.

Front Desk (scheduling & organizer) . . . . . 69.

### Legisoft/Nolo Press

WillWriter (prepare your own will) . . . . . 27.

### Linguist's Software

Tech (1000 different symbols) . . . . . 59.

### FOREIGN LANGUAGE FONTS

MacCyrillic . . . . . 39.

SuperFrench/German/Spanish . . . . . 39.

MacArabic . . . . . 59.

MacKana/Basic Kanji . . . . . 59.

MacSemitic/Coptic/Devanagari . . . . . 59.

MacKorean . . . . . 59.

MacGreek . . . . . 59.

MacHebrew . . . . . 59.

MacHieroglyphics . . . . . 59.

LaserGreek . . . . . 79.

MacGreek/Hebrew/Phonetics . . . . . 89.

### Living Videotext

Think Tank 512k (outline processor) . . . . . 99.

### Magnum

McPic - Volume 1 . . . . . 28.

McPic - Volume 2 . . . . . 28.

The Slide Show Magician . . . . . 34.

### Manhattan Graphics

Ready Set Go (requires 512k) . . . . . 99.

### Microsoft

Flight Simulator . . . . . 32.

Learning Multiplan and Chart . . . . . \$39.

Chart 1.0 . . . . . 72.

Logo 1.0 . . . . . 75.

Basic 2.1 . . . . . 89.

Multiplan 1.1 . . . . . 105.

File 1.02 . . . . . 111.

Word 1.05 . . . . . 111.

Fortran 2.1 . . . . . 169.

Excel 1.0 . . . . . 225.

### Miles Computing

Mac the Ripper - Volume III . . . . . 27.

### Mindscape

The Luscher Profile . . . . . 24.

The Perfect Score: SAT . . . . . 47.

### Monogram

Forecast (tax planning) . . . . . 41.

Dollars & Sense . . . . . 81.

### Nevins Microsystems

Turbocharger (requires 512k) . . . . . 39.

### New Canaan MicroCode

Mac Disk Catalog II (requires 512k) . . . . . 32.

### Odesta

Helix (requires 512k, external drive) . . . . . 125.

Double Helix . . . . . special

### Palantir

MacType (supports Dvorak keyboard) . . . . 26.

MathFlash (math flash card drills) . . . . . 26.

WordPlay (crossword puzzles) . . . . . 26.

Inventory Control . . . . . 69.

inTouch (communication to emulation) . . . 79.

### PBI Software

Icon Switcher . . . . . 14.

Icon Fun & Games Library . . . . . 14.

Icon Business Library . . . . . 14.

HFS Locator . . . . . 27.

Hard Disk Backup . . . . . 29.

### Peachtree

Back to Basics General Ledger . . . . . 89.

Back to Basics Accounts Payable . . . . . 89.

Back to Basics Accounts Receivable . . . . . 89.

Back to Basics ThreePack . . . . . 239.

### Polarware

Graphics Magician . . . . . 49.

### ProVUE Development

OverVUE 2.0 (power-packed database) . . . . 149.

### QED Information Sciences

Typing Made Easy . . . . . 36.

### Rubicon Publishing

Silver Palate Collection (NY's finest!) . . . . 29.

Dinner At Eight (recipes to wines) . . . . . 32.

Dinner At Eight-Silver Palate Bundle . . . . 54.

### Satori

BulkMailer (mailing lists) . . . . . 75.

### Sierra On-Line

MacOneWrite (cash disbursements) . . . . . 137.

MacOneWrite (accounts receivable) . . . . . 137.

MacOneWrite (general ledger) . . . . . 137.

### Silicon Beach Software

Accessory Pak 1 . . . . . 21.

Silicon Press (printer utility, 512k) . . . . . 42.

### Simon & Schuster

The Mac Art Department . . . . . 24.

Paper Airplane Construction Kit . . . . . 24.

Typing Tutor III . . . . . 35.

### SMB Development

MacMate (requires 512k) . . . . . 35.

### SoftStyle

Colormate Art (color graphic images) . . . . 25.

Colormate (color printing utility) . . . . . 49.

Epstart . . . . . 27.



# We'd like to think you're even stranger.

## A walk on the weird side.

Back in prehistoric Mac times (early 1985) we held a contest to unearth strange-but-true Mac stories. Winners received \$500 worth of Mac add-ons and software, and became stars of a series of MacConnection advertisements.

The response was overwhelming. Our customers were using their Macs to run detective agencies, back up heavy metal bands, even to help explore the frozen tundra for remains of old expeditions.

## The odd get even.

Well, it's time to find out what new heights of eccentricity you've achieved. Has your Mac saved your life during a terrorist attack? Have you used a Mac to predict how many times per episode of Miami Vice Don Johnson will say the word "pal"? Have you used a Mac to create a mutant life form that will save the planet from radioactive fallout?



We're looking for adventure, romance, mystery, the occult. Mac applications that are so fascinating, far-fetched, or far-out that your fellow Mac fanatics will froth at the follicles, and feel all fuzzy around their foreheads. Oh yes.

We're talking serious strangeness here. Send along any relevant snapshots, drawings, and/or newspaper clippings with your entry. Don't forget to enclose your name, address and phone number. And keep a copy for yourself—everything you send us becomes the property of MacConnection.

## What do I win?

\$500 worth of free add-ons and software and instant fame! All entries must be received by December 31, 1986. The totally subjective decision of our judges is final. Good luck! And remember, whether you win or not, we at MacConnection are always here to fulfill your wildest Mac dreams.

# MacConnection™

14 MILL STREET, MARLOW, NH 03456 1-800/Mac&Lisa or 603/446-7711

©Copyright 1986 Micro Connection, Inc. MacConnection is a division of Micro Connection, Inc. MacConnection and Micro Connection are trademarks of Micro Connection, Inc.

# anywhere else.

## HARDWARE

<b>Assimilation</b>	
Mac•Epson•Connection . . . . .	\$40.
Mac•Port•Adaptor . . . . .	85.
Numeric•Turbo . . . . .	145.
<b>CompuCase</b>	
Mac to Hayes Smartmodem cable . . . . .	16.
Mac Plus to Hayes Smartmodem cable . . . . .	19.
Mac Plus to Imagewriter II cable . . . . .	21.
<b>Cuesta Systems</b>	
Datasaver AC Power Backup (90 watts) . . . . .	call
<b>Curtis Manufacturing</b>	
Diamond (6 outlets) . . . . .	29.
Emerald (6 outlets; 6 ft cord) . . . . .	36.
Sapphire (3 outlets; EMI/RFI filtered) . . . . .	47.
Ruby (6 outlets; EMI/RFI filtered; 6 ft cord) . . . . .	55.
<b>Epson</b>	
AP-80 printer (Imagewriter compatible) . . . . .	call
FX-85 printer . . . . .	call
FX-286 printer . . . . .	call
LQ-1000 printer (letter quality) . . . . .	call
<b>Ergotron</b>	
MacTilt (includes external drive bracket) . . . . .	75.
MacBuffer 256k . . . . .	219.
MacBuffer 512k . . . . .	319.
MacBuffer 1 Megabyte . . . . .	489.
<b>Hayes</b>	
Smartcom II (communications software) . . . . .	89.
Smartmodem 1200 . . . . .	call
Smartmodem 2400 . . . . .	call
TranSet 1000 . . . . .	call
<b>IOMEGA</b>	
Bernoulli Box (dual 10-MB w/SCSI) . . . . .	2195.
Bernoulli Box (dual 10-MB storage) . . . . .	2475.
10 Meg cartridge . . . . .	48.
<b>Kensington</b>	
External Disk Drive Cover . . . . .	8.
Mouseway . . . . .	8.
Mouse Pocket . . . . .	8.
Mac (Plus) Dust Cover . . . . .	9.
Imagewriter (II) Dust Cover . . . . .	9.
Mouse Cleaning Kit w/Mouse Pocket . . . . .	16.
Universal Printer Stand . . . . .	17.
Disk Case (holds 36 Mac disks) . . . . .	19.
Disk Drive Cleaning Kit . . . . .	19.
Tilt/Swivel . . . . .	22.
Polarizing Filter . . . . .	31.
Surge Suppressor . . . . .	35.
Starter Pack (includes Tilt/Swivel) . . . . .	53.
A-B Box (specify Mac or Mac Plus) . . . . .	62.
Control Center . . . . .	62.
System Saver Mac . . . . .	65.
<b>Koala Technologies</b>	
KAT Graphics Tablet . . . . .	139.
MacVision (digitizer) . . . . .	175.
<b>Kraft</b>	
QuickStick (Mac joystick) . . . . .	45.
<b>Micah</b>	
MicahDrive AT (20 Meg internal drive) . . . . .	1195.
<b>Mirror Technologies</b>	
FastPort ("SCSI" for your 512k Mac) . . . . .	139.
MagNet 20x External Drive w/cable . . . . .	939.
<b>Mouse Systems</b>	
A+ Optical Mouse . . . . .	59.
<b>N<sup>2</sup> Products</b>	
Mac-Modem cable (6 feet) . . . . .	19.
Mac-TranSet 1000 cable (9 feet) . . . . .	19.
Mac (Plus)-Printer cable (6 feet) . . . . .	19.
Mac Plus Adapter cable . . . . .	19.
Mac Plus-SCSI cable . . . . .	24.

<b>Paradise Systems</b>	
Mac 10 (10 megabyte hard disk) . . . . .	call
Mac 20 (20 megabyte hard disk) . . . . .	call
<b>PBI Software</b>	
Switch Box . . . . .	36.
<b>Personal Computer Peripherals</b>	
MacBottom 20 Hard Disk Drive . . . . .	949.
<b>PKI</b>	
McD 800k External Drive . . . . .	249.
<b>Summagraphics</b>	
MacTablet 6" x 9" . . . . .	269.
MacTablet 12" x 12" . . . . .	369.
<b>Systems Control</b>	
MacGard (surge protection) . . . . .	55.
<b>Thunderware</b>	
ThunderScan (high-resolution digitizer) . . . . .	175.
Mac Plus Power Accessory . . . . .	29.
<b>Western Automation</b>	
DASCH RAMdisk 500k . . . . .	299.
DASCH RAMdisk 1000k . . . . .	359.
DASCH RAMdisk 2000k . . . . .	435.

## DISKS

### Single-sided Diskettes

<b>BASF</b> 3 1/2" Disks (box of 5) . . . . .	10.
<b>Memorex</b> 3 1/2" Disks (box of 10) . . . . .	17.
<b>Sony</b> 3 1/2" Disks (box of 10) . . . . .	17.
<b>Verbatim</b> 3 1/2" Disks (box of 10) . . . . .	17.
<b>MAXELL</b> 3 1/2" Disks (box of 10) . . . . .	18.
<b>Fuji</b> 3 1/2" Disks (box of 10) . . . . .	18.
<b>3M</b> 3 1/2" Disks (box of 10) . . . . .	21.

### Double-sided Diskettes

<b>Fuji</b> 3 1/2" Double-sided Disks (10) . . . . .	26.
<b>Sony</b> 3 1/2" Double-sided Disks (10) . . . . .	26.
<b>Verbatim</b> 3 1/2" Double-sided Disks (10) . . . . .	26.
<b>MAXELL</b> 3 1/2" Double-sided Disks (10) . . . . .	28.
<b>3M</b> 3 1/2" Double-sided Disks (10) . . . . .	29.

## INFORMATION SERVICES

<b>CompuServe</b>	
CompuServe Information Service . . . . .	27.
<b>Dow Jones</b>	
Dow Jones News/Retrieval Membership Kit . . . . .	19.
<b>Source Telecomputing</b>	
The Source (subscription & manual) . . . . .	30.

## ACCESSORIES

<b>Automation Facilities</b>	
Floppiclone Drive Care Kit . . . . .	15.
MacPak Complete Care System . . . . .	29.
<b>Clean Image Ribbon Co.</b>	
Clean Image Ribbon Kit . . . . .	12.
<b>Computer Coverup</b>	
External Disk Drive Cover . . . . .	4.
Imagewriter (II) Cover . . . . .	8.
Mac (Plus) & Keyboard (two covers) . . . . .	10.
<b>Diversions</b>	
Underware Ribbon . . . . .	9.
Colorpens . . . . .	10.
Jumbo Colorpens . . . . .	13.
ColorPack (includes Colorpens) . . . . .	19.
<b>Environmental Software Company</b>	
The Clutch (holds 8 disks) . . . . .	9.
<b>MACATTIRE</b> (Rip-stop nylon covers)	
External Drive Cover (400k or 800k) . . . . .	7.
Numeric Keypad Cover . . . . .	7.

Numeric Turbo Cover . . . . .	\$8.
Imagewriter (II) Cover . . . . .	11.
Wide Imagewriter Cover . . . . .	13.
Mac (Plus) & Keyboard Cover . . . . .	15.
Laserwriter Cover . . . . .	17.
Mac (Plus) & HD20 & Keyboard Cover . . . . .	18.
<b>I/O Design</b>	
Imageware (Imagewriter case) . . . . .	39.
Imageware II (Imagewriter II case) . . . . .	49.
Imageware wide . . . . .	49.
Macinware Plus (Mac Plus carrying case) . . . . .	59.
<b>Innovative Concepts</b>	
Flip & File Micro (holds 25 disks) . . . . .	9.
Flip & File (holds 40 disks) . . . . .	18.
<b>Innovative Technologies</b>	
The Pocket Pak (holds 6 disks) . . . . .	9.
The Easel (holds 20 disks) . . . . .	12.
The Disk Directory (holds 32 disks) . . . . .	18.
<b>Kalmar Designs</b>	
Teakwood Roll-top Case (holds 45 disks) . . . . .	14.
Teakwood Roll-top Case (holds 90 disks) . . . . .	21.
Teakwood Printer Stand 24" . . . . .	29.
<b>Magnum</b>	
Mouse Mover (let your mouse ride!) . . . . .	14.
<b>Moustrak</b>	
Moustrak Pad (standard 7" x 9") . . . . .	8.
Moustrak Pad (large 9" x 11") . . . . .	9.
Imagewriter Pad . . . . .	12.
<b>Ribbons Unlimited</b>	
Imagewriter Color Ribbons . . . . .	5.
Imagewriter Ribbons Six Pack . . . . .	25.
Imagewriter Rainbow Six Pack . . . . .	25.
<b>Smith &amp; Bellows</b>	
Mahogany Disk Case (holds 90 disks) . . . . .	28.

## OUR POLICY

- We accept VISA and MASTERCARD. (Only on U.S. & Canadian orders.)
- No surcharge added for charge orders.
- Your card is not charged until we ship.
- If we must ship a partial order, we never charge freight on the shipment(s) that complete the order.
- No sales tax.
- All shipments insured; no additional charge.
- Allow 1 week for personal and company checks to clear.
- UPS Next-Day-Air available.
- COD max. \$1000. Cash or certified check.
- 120 day limited guarantee on all products.\*
- To order, call us anytime Monday thru Friday 9:00 to 9:00, or Saturday 9:00 to 5:30. You can call our business offices at 603/446-7711 Monday through Friday 9:00 to 5:30.

## SHIPPING

Accounts on net terms pay actual shipping. **Continental US:** For printers and drives add 2% for UPS ground shipping (call for UPS Blue or UPS Next-Day-Air). For all other items, add \$2 per order to cover UPS shipping. We will automatically use UPS 2nd-Day-Air at no extra charge if you are more than 2 days from us by UPS ground. **Hawaii:** For printers and drives, actual UPS Blue charge will be added. For all other items, add \$2 per order. **Alaska and Outside Continental US:** Call 603/446-7711 for information.

# Mac products and

Jetstart	\$27.
Laserstart	59.
Decision Map	75.
<b>Software Discoveries</b>	
Record Holder	35.
<b>Springboard</b>	
Art a la Mac Vol. 1-People and Places	23.
Art a la Mac Vol. 2-Variety Pack	23.
Easy as ABC	29.
Early Games	29.
<b>State of the Art</b>	
Electric Checkbook	39.
<b>Symmetry</b>	
Acta (outline/writing desk accessory)	39.
PictureBase (clip art manager, 512k)	45.
<b>T/Maker</b>	
Click Art Personal Graphics	29.
Click Art Publications	29.
Click Art Letters	29.
Click Art Effects	29.
Click On Worksheet	46.
<b>Target Software</b>	
MacLightning (reqs. 512k, external drive)	53.
<b>Telos Software</b>	
Business Filevision (512k, external drive)	199.
<b>Think Educational</b>	
MacEdge II (math & reading)	28.
<b>TML Systems</b>	
TML Source Code Library	59.
TML Pascal	69.
<b>TrueBasic</b>	
True BASIC	89.
Algebra Utility	36.
Calculus Utility	36.
3D Graphics Utility	36.
<b>Videx</b>	
MacCalendar (incl. reminder system)	52.

## GAMES

<b>Activision</b>	
Championship Star League Baseball	22.
Hacker (you're on your own!)	27.
Mind Shadow (Who am I?)	27.
Borrowed Time (murder mystery)	27.
Alter Ego (become someone else)	36.
<b>Ann Arbor Softworks</b>	
Grid Wars (3D graphic arcade)	22.
<b>Artworx</b>	
Bridge 4.0	21.
<b>Bantam Electronics</b>	
Sherlock Holmes: Another Bow	27.
<b>Blue Chip</b>	
Millionaire (stock market)	35.
Tycoon (commodities)	35.
Baron (real estate)	35.
Squire (personal finance, reqs. 512k)	35.

### MacConnection Special of the Month

through September 30, 1986

#### ODESTA

##### Double Helix

Powerful relational database for your 512k Mac or Mac Plus. Supports HFS and includes the following features:

- Password protection
- Free-form text & forms design
- Custom menus
- Unlimited number of records, fields and files

External drive required. \$249.

#### Broderbund Software

- |  |     |
|--|-----|
| Lode Runner (you'll never sleep!)      | 24. |
| Ancient Art of War (military strategy) | 27. |

#### CBS

- |  |     |
|--|-----|
| Murder by the Dozen (twelve mysteries) | 25. |
|--|-----|

#### Electronic Arts

- |  |     |
|--|-----|
| Golden Oldies Vol. 1 (software classics)   | 24. |
| Skyfox (3D graphics)                       | 27. |
| One on One/Dr J vs Larry Bird (reqs. 512k) | 27. |
| Pinball Construction Set                   | 27. |

#### Epyx

- |                                     |     |
|-------------------------------------|-----|
| Rogue (the mainframe classic!)      | 24. |
| Temple of Apshei Trilogy (4 levels) | 24. |
| Winter Games (Olympic events)       | 24. |

#### Hayden Software

- |                                |     |
|--------------------------------|-----|
| Perplexx (scrabble-like game)  | 24. |
| Sargon III (9 levels of chess) | 29. |

#### Infinity Software

- |                                 |     |
|---------------------------------|-----|
| Grand Slam (tennis, reqs. 512k) | 28. |
|---------------------------------|-----|

#### Infocom

- |                            |          |
|----------------------------|----------|
| Seastalker                 |          |
| Junior level of difficulty | each 23. |

- |                              |                    |            |
|------------------------------|--------------------|------------|
| Ballyhoo                     | Wishbringer        | Planetfall |
| Enchanter                    | Zork I             | Cutthroat  |
| The Witness                  | Hitchhiker's Guide |            |
| Standard level of difficulty |                    | each 23.   |

- |                              |          |          |
|------------------------------|----------|----------|
| Zork II                      | Sorcerer | Infidel  |
| Zork III                     | Suspect  |          |
| A Mind Forever Voyaging      |          |          |
| Advanced level of difficulty |          | each 26. |

- |                            |              |           |
|----------------------------|--------------|-----------|
| Deadline                   | Spellbreaker | Suspended |
| Starcross                  |              |           |
| Expert level of difficulty |              | each 29.  |
| Invisicues (hint booklets) |              | each 6.   |

#### Miles Computing

- |   |       |
|---|-------|
| Fusillade (arcade-maze)                       | \$21. |
| MacAttack (3D tank simulation)                | 27.   |
| Harrier Strike Mission (3D flight simulation) | 27.   |
| MacWars (3D space simulation)                 | 27.   |

#### Mindscape

- |                                    |     |
|------------------------------------|-----|
| Rambo: First Blood Part II         | 24. |
| James Bond 007: "A View to a Kill" | 24. |
| Stephen King's "The Mist"          | 24. |
| Racter (converse with your Mac!)   | 27. |
| Balance of Power (world politics)  | 30. |
| Brataccus (requires 512k)          | 30. |
| Uninvited (mystery adventure)      | 30. |
| Deja Vu (murder mystery)           | 33. |

#### Origin Systems

- |  |     |
|--|-----|
| Exodus: Ultima III (fantasy adventure) | 38. |
|--|-----|

#### PBI Software

- |                                   |     |
|-----------------------------------|-----|
| Strategic Conquest (war strategy) | 29. |
| Fokker TriPlane Flight Simulator  | 35. |

#### Polarware

- |  |     |
|--|-----|
| Transylvania (rescue Princess Sabrina) | 15. |
| Crimson Crown (sequel to above)        | 15. |
| Sword of Kadash (fantasy adventure)    | 15. |
| The Quest (beware of the dragon!)      | 15. |
| Xyphus (role playing adventure)        | 15. |

#### Practical Computer Applications

- |                         |     |
|-------------------------|-----|
| MacGolf (requires 512k) | 36. |
|-------------------------|-----|

#### Psion

- |                                    |     |
|------------------------------------|-----|
| Psion Chess (3D and multi-lingual) | 31. |
|------------------------------------|-----|

#### Sierra On-Line

- |                                      |     |
|--------------------------------------|-----|
| Frogger (classic video game)         | 24. |
| Championship Boxing (knock 'em out!) | 24. |
| Ultima II (role playing adventure)   | 35. |

#### Silicon Beach Software

- |                                      |     |
|--------------------------------------|-----|
| Airborne! (digitized-sound war game) | 20. |
| Enchanted Scepters (text & graphics) | 21. |

#### Simon & Schuster

- |                                   |     |
|-----------------------------------|-----|
| Star Trek—The Kobayashi Adventure | 24. |
|-----------------------------------|-----|

#### Sir-Tech

- |                        |     |
|------------------------|-----|
| Mac Wizardry (fantasy) | 36. |
|------------------------|-----|

#### Spectrum Holobyte

- |                                     |     |
|-------------------------------------|-----|
| GATO (submarine simulation)         | 26. |
| Orbiter (requires 512k)             | 27. |
| Tellstar North Level I (reqs. 512k) | 27. |

#### Unicorn

- |  |     |
|--|-----|
| Futura (sci-fi adventure)                | 24. |
| Animal Kingdom (ages 6-12)               | 27. |
| Decimal Dungeon (math, ages 9 and up)    | 27. |
| Fraction Action (arcade style math game) | 27. |
| Mac Robots (pre-school program)          | 27. |
| Read-A-Rama (reading, ages 5-8)          | 32. |

#### Videx

- |                             |     |
|-----------------------------|-----|
| FunPak (Solitaire and more) | 25. |
| MacCheckers/Reversi         | 25. |
| MacGammon/Cribbage          | 25. |
| MacVegas (7 casino games)   | 25. |

1-800/Mac&Lisa

620C

# MacConnection™

MacConnection, 14 Mill Street, Marlow, NH 03456 800/622-5472 603/446-7711



Copyright 1986 Micro Connection, Inc. MacConnection is a division of Micro Connection, Inc. MacConnection and Micro Connection are trademarks of Micro Connection.

All items subject to availability. Prices subject to change without notice.

\*Defective software replaced immediately. Defective hardware replaced or repaired at our discretion. Some items have warranties up to five years.

Circle 4 on reader service card

# The Accounting

**Steve Mann**

*Here it is: the most comprehensive comparison of Macintosh accounting software ever prepared. The capabilities, the characteristics, the problems, the prices—over 150 evaluation criteria for 25 programs. If you're trying to make sense of the crowded Mac accounting market, let this survey be your guide.*

Considering accounting's relative simplicity, the profusion of accounting software is overwhelming. The accompanying table, which pulls together information on over two dozen Mac accounting packages, provides an easy way to compare programs and sort out your options.

## Using the Table

To select an accounting package, you have to know how your business works—what types of accounting transactions regularly occur, how the business is structured, what types of reporting requirements you have, and so on. First, determine what type of accounting you use—cash, accrual, or fund accounting. Most small businesses use either cash or accrual accounting or a combination of the two.

Next, to determine which modules you need, ask yourself what functions drive your business. For instance, almost all businesses need a general ledger, but only certain kinds of companies, like manufacturers and distributors, need an inventory module. Keep in mind that you can track almost any type of financial transaction with a general ledger. If you're not sure about a particular module, you probably don't need it. Those offered with each package are listed at the top of the Overall Information section.

Finally, for each module you need, list the features you think you must have and those that would be useful but not essential. A variety of factors will influence your choice of features. Here are a few of the most important considerations:

**Organization.** Most small businesses have simple organizational structures. You may, however, want to track profitability for different departments or profit centers. The Overall Information and General Ledger sections list a number of organizational considerations you should address.

If you have separate departments for accounting functions like accounts payable and accounts receivable, you probably need a multiuser package or one that offers separate modules. A single-user product with separate modules can often be used by two or more people with individual Macintoshes. The different sets of data can then be merged when necessary.

**Transaction volumes.** Pay careful attention to table entries indicating maximum volumes and transaction sizes. You should have a rough idea of how many account numbers you currently need, how many transactions you generate, and how many customers, vendors, and employees you have. Make sure you select a package that can handle those volumes for each module, and be sure to consider the growth you expect over the next few years.

**Dollar limits.** Most accounting products limit the size of dollar entries. Make sure that each module you buy can handle your largest single number and your largest year-to-date cumulative amount.

A word of caution: for some programs, the maximum number of digits per dollar entry is also the maximum number the program can handle, period. Also, a limit of 11 digits may not mean a program can handle entries as large as 999,999,999.99. Some programs may allow a maximum entry of only 222,222,222.22, for example. If you have any doubt, be sure to ask the vendor.

**Transaction types.** Different accounting modules enable you to enter specific types of transactions. For instance, the basic purpose of an accounts receivable module is to bill customers and track the receipt of payments.

Within each type of module, special transaction types may or may not be available. For instance, the Accounts Receivable section of the table includes information on sales commission and sales tax calculations, finance charges, partial payments, and so on. Browse through each section looking for any special transaction types you may need.

**Reports.** While the table provides information on certain types of printed output, such as invoices, mailing labels, W2 forms, and checks, listing all the reports and formatting options of each program would have

# Software Buyer's Guide

required a whole table in itself. Contact vendors for specific information about the report types and format options you require.

In addition, check the report formatting and custom reports information in each section of the table. You may be able to create your own reports or modify the standard reports to meet your needs. Also check the data export entry in the Overall Information section, as you may be able to export data from a module into a spreadsheet or database program to create special reports.

After examining the tables for the best possible fit between your requirements and the features of each program, you should be able to isolate those programs that are most likely to fulfill your accounting needs. Your next step is to contact the vendors or your dealer and ask for more detailed information. Also, because

every program has subjective qualities that can be evaluated only by hands-on experience, ask for a demonstration disk, if one is available, or a dealer demonstration.

## Caveats

Every attempt has been made to ensure the accuracy of all the information in the table. Unfortunately, because of the magnitude of the data collected, and because upgrades may have come out after this article went to press, the table may contain some inaccuracies. Accordingly, we advise you to verify a program's capabilities before making a purchase.

In addition, because of the table format's limitations, certain entries may not tell the whole story. For

*(continues)*

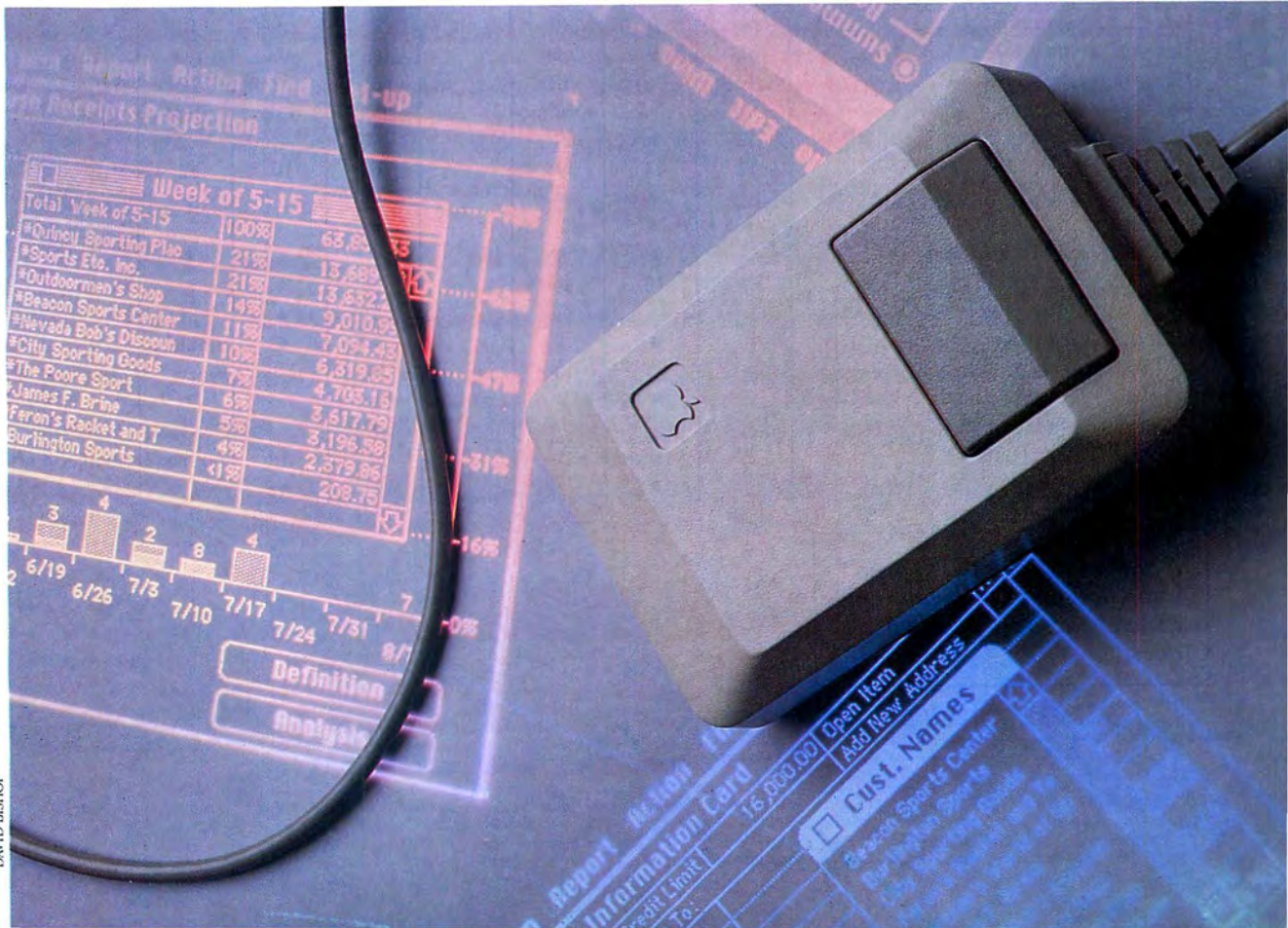

	Accountant Inc.	AMS General Ledger/ Checkmark Payroll	Back to Basics	dbbPay	Dollars and Sense	Gallery Finance	General Accounting	General Ledger for the Macintosh	Great Plains Hardisk Accounting Series	Insight	Maccountant
<b>Overall Information</b>											
Modules <sup>1</sup>	GL/AR/ AP/IN	GL/PR	GL/AR/ AP	PR	GL/CD/ CR	GL/AR/ AP/CD	GL/AR/ AP/PR	GL	GL/AR/ AP/PR/IN	GL/AR	GL/AR/ AP
Version	1	2.02/1.0	1.02	2	2	2.0	1		3.03	1	2
Multiple programs		•	•								
Cash/accrual/fund	c/a	c/a	c/a	c	c	c/a	c/a	c/a	a	a	c/a
One-write/double-entry	double	double	double	n/a	double	one	double	double	double	double	double
Passwords	•	•				•	•	•			
Copy protected											
Help screens		•			•	some					
Tutorials in manual	•	•	•		•	•	•				
Multiuser									•		
Max # of companies	disk	disk	1	1	disk	disk	disk	1	1	disk	1
Sample data included	•	•			•	some	•	•	•	•	some
Data export	•	•			•						
Macintosh interface	•	•			•	•	•	•			
Required RAM	512K	512K	128K	128K	128K	512K	512K	128K	512K	512K	128K
Hard disk required									•		
Toll-free calls			• <sup>3</sup>				•		• <sup>3</sup>		
Price	\$300	\$195/mod	\$175/mod	\$395	\$149	\$229	\$425	\$245	\$495/mod	\$95/mod	\$150
<b>General Ledger</b>											
				n/a							
Max # of accounts	99,999	1000	254		120		8000	disk	2000	disk	1000
Digits per account #	5	10	4		3	9	4	5	10	11	4
Max # of departments	n/a	9	10		3	n/a	10	n/a	n/a		
Max # of profit centers	n/a	9	n/a		n/a	n/a	n/a	n/a	999	999	n/a
Max # of fiscal periods	12	12	12		12	12	12	varies	12	varies	12
Max # of transactions	disk	disk	4000/mo		2000	disk	disk	disk	disk	disk	disk
Max lines per transaction	12	no max	21		100	1	12	1	10	no max	no max
Max # of digits per \$ entry <sup>4</sup>	12	11	9		6	10	12	11	10	10	10
Automatic recurring entries		•	•		•		•		•	•	
Budgeting	•	•			•				•		
Predefined account # ranges		•	•				•				
# of predefined reports	7+	10			7	3	8	8	12	7+	8
Report formatting						•				•	
Financial statement formatting		•			•	•	limited	•	•	•	
Custom reports											
Automatic reversals											
Produces graphs											
Max # of bank accounts	2	no max	3		12	1	no max	no max	no max	no max	5
Flexible posting		•									

*A bullet indicates that a program does have the feature in question; a space means it doesn't.*

MacOneWrite	MacStore/ AP with GL	Open for Business I	Open for Business II	Palantir Financial Series	Personal Accountant	Plains & Simple	Rags to Riches	ShopKeeper	Strictly Business	Timecard	Turbo Macaccountant	Versa Series	WOS Fund Accounting System
AR/CD	GL/AR/ AP/IN	GL/AR/ CD	GL/AR/ AP/IN	GL/AR/ IN	GL/CD/ CR	GL/AR/ AP	GL/AR/ AP/IN	AR/IN	GL	PR/CD	GL/AR/ AP/PR	GL/AR/ AP/PR/IN	GL/PR/ FA
2	1/1.03	1	1	3.1	2.3	1	2.6/1.0	1.33	1.85	1.82	1	2.02	1.0
•	•	•	•	•	•	•	•	•	•	•	•	•	•
c/a one	c/a double	c double	a double	c double	c double	c/a one	c/a double	a n/a	c/a double	c n/a	c/a double	c/a double	f double
•	•	•	•	•	•	•	•	•	•	•	•	•	•
•	•	•	•	•	•	•	some •	•	•	•	•	•	•
1	1	disk	disk	1	disk	disk	disk	disk	disk	disk	disk	1	1
•	•	•	•	some •	•	•	•	•	•	•	•	some •	•
•	partial	•	•	•	•	•	•	•	•	•	•	partial	•
512K	512K	512K	512K	128K	128K	512K	512K	512K	512K	512K	512K	512K	512K
varies	•	•	•	•	•	•	•	•	•	•	•	•	•
\$250	\$450/AR&	\$495	\$995	\$145/mod	\$100	\$695	\$200/mod	\$80	\$395	\$200	\$495	\$99/mod	\$4995
\$130/mod	IN \$500/ AP&GL											\$150 GL	
n/a				MBASIC				n/a		n/a		MBASIC	
	disk	disk	disk	disk	disk	500	5000		disk		8000	disk	disk
	10	9	9	3	n/a	3-6	n/a		5		4	6	21
	n/a	99	99	n/a	n/a	n/a	99		99		99	100	disk
	n/a	n/a	n/a	n/a	n/a	n/a	n/a		99		n/a	n/a	disk
	12	12	12	12	1	varies	12		12		12	varies	12
	disk	disk	disk	disk	disk	3000/mo	10,000		disk		disk	disk	disk
	1	98	98	1	1	1	no max		n/a		no max	no max	no max
	11	10	10	11	10 <sup>5</sup>	10	16		12		10	11	13
	•	•	•	•	•	•	•		•		•	•	•
	•	•	•	•	•	•	•		•		•	•	•
	10	10	15	10	5	8	10		15		9	9	2
	•	limited	limited	•		limited	limited		•		•	•	•
	•	•	•	•	•	•	•		•		•	•	•
	5	1 active	1 active	no max	no max	no max	no max		no max		5	1	no max
	•	•	•	•	•	•	•		•		•	•	•

<sup>1</sup> GL = general ledger, AR = accounts receivable, AP = accounts payable, IN = invoice, PR = payroll, CD = cash disbursements, CR = cash receipts, FA = fund accounting.

<sup>2</sup> Hard disk not supported.

<sup>3</sup> For paid support only.

<sup>4</sup> Includes cents.

<sup>5</sup> Maximum dollar amount = \$20,000,000.00.

	Accountant Inc.	AMS General Ledg r/ Checkmark Payroll	Back to Basics	dbspay	Dollars and Sense	Gallery Finance	General Accounting	General Ledger for the Macintosh	Great Plains Hardisk Accounting Series	Insight	Maccountant
<b>Accounts Receivable</b>		n/a		n/a				n/a			
Max # of customers	99,999	400		n/a	disk	8000		3000	disk	1000	
Digits per customer #	5	6		n/a	4	4		7	10	4	
Max # of transactions	disk	3500/mo		2000	disk	disk		disk	disk	disk	
Max # of lines per transaction	12	10		100	1	16		16	no max	no max	
Max # of digits per \$ entry <sup>1</sup>	8	9		6	10 <sup>2</sup>	12		10	10	10	
# of aging periods	4	4		n/a	4	2		4	3	4	
Separate prod. svc. table	•				•						
Tracks salespeople											
Calculates sales tax	•	•									
Calculates commissions											
Handles payment terms	3 types	•									
Calculates discounts	•					•					
Supports sales territories									•		
Open item/balance forward	both	bal		open	both	bal		both	both	n/a	
Calculates finance charges	•	•									
Handles invoice adjustments	•	•		•	•	•					
Handles partial payments	•	•		•	•	•					
Automatic invoice numbering		•				•		n/a	•	n/a	
Separate bill-to/ship-to	•					•					
# of predefined reports	10+	9		2	2	7		24	34+	2	
Report formatting					•						
Prints invoices/statements	both	st		inv		inv		st	both		
Produces custom reports				•							
Prints mailing labels	•	•						•			
Credit limit processing	•	•									
Handles one-time customers				•		•				•	
Produces graphs				•					•		
<b>Accounts Payable</b>		n/a		n/a				n/a		n/a	
Max # of vendors	99,999	300		disk	disk	8000		3000		1000	
Digits per vendor #	5	6		n/a	3	4		7		4	
Max # of transactions	disk	2000/mo		2500	disk	disk		disk		disk	
Max # of lines per transaction	12	15		100	1	16		16		no max	
Max # of digits per \$ entry <sup>1</sup>	8	9		6	10 <sup>2</sup>	12		10		10	
Automatic recurring payments				•							
Voucher adjustments	•	•		•	•	•					
Calculates discounts	•	•						•			
Manual checks	•	•		•	•	•					
Selective voucher payment	•	•		•	•						
Partial voucher payment	•	•		•	•						
User-assigned check numbers	•	•		•		•					
# of predefined reports	10+	12		2	2	7		21		3	
Report formatting											
Prints checks	•	•		•		•					
Produces custom reports				•							
Handles payment terms	•	•									
Credit limit processing	•										
Handles one-time vendors		•		•		•				•	
Produces graphs				•							
Prints mailing labels	•	•						•			



MacOneWrite	MacStore/ AP with GL	Open for Business I	Open for Business II	Palantir Financial Series	Personal Accountant	Plains & Simple	Rags to Riches	ShopKeeper	Strictly Business	Timecard	Turbo Maccountant	Versa Series	WOS Fund Accounting System
					n/a				n/a	n/a			
disk 6	disk 25	disk n/a	disk n/a	disk 4		700 n/a	5000 n/a	disk 10			8000 4	1500 5	disk 21
disk 9	disk no max	disk 98	disk 98	disk 20		2500/mo 1	10,000 no max	disk 10			disk 10,000	10,000 no max	disk no max
9	7	9	varies	11		10	16	8			10	9 <sup>3</sup>	13
4	0	4	4	4		4	4	4			4	4	1
	•		•	•				•			•	•	•
	•		•	•				•			•	•	•
	•		•	•		• <sup>4</sup>		•			•	•	n/a
						• <sup>4</sup>					•	•	n/a
						• <sup>5</sup>					• <sup>5</sup>	•	n/a
						• <sup>6</sup>		multiple			• <sup>5</sup>	•	n/a
both	open	both	both	both		both	open	open			both	both	both
•	•	•	•	•		•	•	•			•	•	n/a
•	•	•	•	•		•	•	•			•	•	•
•	•	•	•	•		•	•	•			•	•	n/a
•	•	•	•	•		•	•	•			•	•	n/a
6	10+	10	8	5		8	9	8			5	8	5
st	inv	st	both	st		limited st	limited both	both			both	both	n/a
•	•	•	•	•		•	•	•			•	•	n/a
						•	•	•			•	•	n/a
						•	•	•			•	•	n/a
						•	•	•			•	•	n/a
					n/a	n/a		n/a	n/a				
disk n/a	disk 3	disk n/a	disk n/a			300 n/a	5000 n/a			disk n/a	8000 4	1000 4	disk 6
disk 1	disk 3	disk 98	disk 98			2500/mo 1	10,000 no max			disk 1	disk 10,000	10,000 1	disk no max
9	11	10	10			10	16			8	10	10	13
	•		•			•	•			n/a	•	•	•
	•		•			•	•			•	•	•	•
	•		•			•	•			•	•	•	•
	•		•			•	•			n/a	•	•	•
	•		•			•	•			n/a	•	•	•
	•		•			•	•			•	•	•	•
6	8+	4	7			9	10			5	3	6	14
•	•	•	•			•	limited •	•		•	•	•	•
	•		•			•	•			•	•	•	•
						•	•			n/a	•	•	•
						•	•			n/a	•	•	•
						•	•			•	•	•	•

<sup>1</sup>Includes cents.

<sup>2</sup>Maximum dollar amount = \$20,000,000.00.

<sup>3</sup>Maximum dollar amount = \$1,000,000.00.

<sup>4</sup>With difficulty.

<sup>5</sup>One per customer.

<sup>6</sup>One per invoice.

	Accountant Inc.	AMS General Ledger/ Checkmark Payroll	Back to Basics	dbsPay	Dollars and Sense	Gallery Finance	General Accounting	General Ledger for the Macintosh	Great Plains Hardisk Accounting Series	Insight	Maccountant
<b>Payroll</b>	n/a		n/a		n/a	n/a		n/a		n/a	n/a
Max # of employees		100		2500			8000		250		
Digits per employee #		n/a		n/a			4		7		
Max # of transactions		disk		disk			disk		disk		
Max transaction lines per employee		1		24			10		20		
Max # of deductions per employee		9		12			n/a		24		
Pay period types		4		many			n/a		8		
# of deduction types		3		15			n/a		999		
Max # of pay categories per employee		9		16			n/a		26		
Handles manual checks				only			•				
# of state tax tables		6		1			n/a		50		
User-updated tax tables		•		•			n/a		•		
Calculates fed withholding		•		•					•		
Handles vacation and sick pay		•							•		
Tracks labor distribution									•		
# of predefined reports		5		10			4		42		
Prints W-2 forms		•							•		
Prints state tax reports		•							•		
Report formatting											
Prints checks		•					•		•		
Custom reports											
Produces graphs											
<b>Inventory</b>		n/a	n/a	n/a	n/a	n/a	n/a	n/a		n/a	n/a
Max # of items	99,999								6000		
# of digits per item code	5								15		
Max # of transactions	disk								disk		
# of flow assumptions	0								34		
Costing methods	avg, last								std, last		
Max # of digits, quantity on hand	5								8		
Max # of digits, cost per item <sup>1</sup>	9								10		
Max # of digits, price per item <sup>1</sup>	9								11		
Max # of suppliers per item	no max								no max		
Max # of price types per item	1								5		
Max # of costs per item	1								2		
Handles inventory adjustments	•								•		
Handles subassemblies	•								•		
Reports reorder point	•								•		
Prints purchase orders	•								•		
Max # of decimals per cost	6								4		
Max # of decimals per price	6								4		
Calculates cost of goods sold	•								•		
Tracks freight	•								•		
Handles sales returns	•								•		
Multiple units of measure									•		
Supports standard costs									•		
Custom reports											
Supports inventory transfers	•								n/a		
# of predefined reports	1+								29		
Report formatting											
Interfaces to sales/purchases	both								both		

MacOneWrite	MacStore/ AP with GL	Open for Business I	Open for Business II	Palantir Financial Series	Personal Accountant	Plains & Simple	Rags to Riches	ShopKeeper	Strictly Business	Timecard	Turbo Maccountant	Versa Series	WOS Fund Accounting System
n/a	n/a	n/a	n/a	n/a	n/a	n/a	n/a	n/a	n/a				
										disk	8000	800	disk
										n/a	4	n/a	8
										disk	8000	800	disk
										0	1	3	no max
										7	10	7	15
										7	none	4	6
										4/person	10	8	6
										4	4	3	5
											•		•
										1	0	50	50
											•		•
											•		•
													•
										17	2	6	10
											•		•
											•		•
											•		•
n/a		n/a		n/a	n/a			n/a	n/a	n/a			n/a
	disk		disk	disk			3000	32,000					disk
	25		10	4			n/a	5					15
	disk		disk	disk			50/day	disk					disk
	0		0	0			0	0					0
	avg		avg	avg			actual	avg					last, avg
	4		5	11			5 <sup>2</sup>	5					10
	7		9	11			10 <sup>3</sup>	5					10
	7		9	11			10 <sup>3</sup>	5					10
	no max		n/a	n/a			n/a	n/a					1
	1		1	2			1	1					2
	1		1	1			1	1					2
	•		•	•			•	•					•
	•		•	•			•	•					•
	•		•	•			•	•					•
	6		2	2			2	2					2
	6		2	2			2	2					2
	•		•	•			•	•					•
	•		•	•			•	•					•
	•		•	•			•	•					•
	n/a		•	•			•	n/a					n/a
	10+		7	7			22	7+					7
	both		sales	sales			sales	sales					both

<sup>1</sup>Includes cents.

<sup>2</sup>Maximum-quantity-on-hand entry=32,000.

<sup>3</sup>Maximum dollar entry per item = \$21,000,000.00.

<sup>4</sup>Weighted average; first in, first out; last in, last out.

## Phone Support Information

Product	Company	Phone Support	Phone
<b>Accountant, Inc.</b>	Softsync Inc.	Unlimited free support	212/685-2080
<b>AMS General Ledger/Checkmark Payroll</b>	Checkmark Software, Inc.	Unlimited free support	303/484-3541
<b>Back to Basics</b>	Peachtree Software	45 days free, then \$20/call + \$1/min. after 20 min.	800/554-8900, 404/564-5700
<b>dbspay</b>	Summit Systems Inc.	Unlimited free support	617/344-1251
<b>Dollars and Sense</b>	Monogram	Unlimited free support	213/215-0355
<b>Gallery Finance</b>	Haba Systems	30 days free, then \$50/quarter	818/994-1899
<b>General Accounting</b>	BPI Systems	60 days free, then \$20/call or \$75/5 calls or \$295/yr.	800/531-5236, 512/328-5400
<b>General Ledger for the Macintosh</b>	Lake Avenue Software	30 days free, then \$10/call or \$200/yr.	818/792-1844
<b>Great Plains Hardisk Series</b>	Great Plains Software	30 days free, then \$25/call or \$650/yr. + \$50 reg.	800/345-3276, 701/281-0550
<b>Insight</b>	Layered Inc.	30 days free, then \$60/hr. or \$125/10 hr. or \$300/yr.	617/423-9041
<b>Maccountant</b>	Digital Etc., Inc.	Unlimited free support	213/452-5636
<b>MacOneWrite</b>	Sierra On-Line, Inc.	90 days free, then \$30/yr./module or \$100/yr.	800/344-7448, 209/683-6858
<b>MacStore/AP with GL</b>	Vertical Business Software Inc.	Unlimited free support	800/992-9914, 914/632-8305
<b>Open for Business I</b>	Open Systems, Inc.	\$2.95/min.	800/328-2276, 612/829-0032
<b>Open for Business II</b>	Open Systems, Inc.	\$2.95/min.	800/328-2276, 612/829-0032
<b>Palantir Financial Series</b>	Palantir Software	90 days free support	800/368-3797, 713/955-8880
<b>Personal Accountant</b>	Softsync Inc.	Unlimited free support	212/685-2080
<b>Plains &amp; Simple</b>	Great Plains Software	30 days free, then \$25/call or \$200/yr. + \$50 reg.	800/345-3276, 701/281-0550
<b>Rags to Riches</b>	Chang Labs	90 days free, then \$75/yr.	800/972-8800, 800/831-8080 in CA
<b>ShopKeeper</b>	Woodtec	Unlimited free support	316/441-0187
<b>Strictly Business</b>	Future Design Software	Unlimited free support	714/891-9796
<b>Timecard</b>	Varo Design Group, Inc.	Unlimited free support	617/643-6135
<b>Turbo Accountant</b>	Digital Etc., Inc.	45 days free, then \$150/yr.	213/452-5636
<b>Versa Series</b>	H&E Computronics	60 days free, then \$75/yr. or \$50/6 mo.	800/431-2818, 914/425-1535
<b>WOS Fund Accounting System</b>	WOS Data Systems, Inc.	Unlimited free support	913/462-7581

instance, an entry might indicate that the number of general ledger accounts is limited only by disk space. However, this doesn't tell you just how many accounts you can enter before system performance degrades. Most vendors do not list that kind of information, so be sure to ask.

It's impossible to fully explain how to select accounting software in a thousand words or less. If you have any doubts, it might be a good idea to have your accountant or an independent consultant guide you through this process. Selecting a product and then converting from a manual to an automated system can require as little as a few hours to as much as several days. Once you have your system up and running, however, the time savings and flexibility you'll enjoy will more than make up for the effort. □

### Acknowledgment

*The author would like to thank several Peat Marwick colleagues without whom this article could not have been completed: Beth Gordon, Laura Doane, Doug Griscom, Debra Jackson, Doug Martin, and Jim Pierre.*

■■■■■■■■■■ Steve Mann is a micro-computer and accounting systems specialist employed by the San Francisco office of Peat, Marwick, Mitchell, & Co., the largest corporate user of Macintoshes in the world.



# Enter the SCSI Drives

**Lon Poole**

*Hot on the heels of Apple's Mac Plus announcement, nine manufacturers announced hard disk drives that attach to the Plus's SCSI port. With so many drives to choose from, deciding which one to buy is a challenge even for an experienced disk drive shopper.*

For this review I tested nine SCSI drives: the AST 4000, the Bernoulli Box 10 + 10, the LoDown-20, the MDIdeas HD-20, the MagNet 20X, the MacFast20, the Sun Streak SCSI-21, the DataFrame, and the SlimLine 1010-2R. By the time I completed my tests, five other manufacturers had announced SCSI drives (see "SCSI Drive List" for a complete list of SCSI drive offerings).

Arriving at trouble-free performance is an evolutionary process with pioneer products. The first SCSI drives were no exception to the rule. Almost every drive had problems worthy of criticism. In addition, Apple's implementation of the SCSI interface caused some drive manufacturers trouble. However, during the two-month test period for this article, all the manufacturers corrected their drive malfunctions, worked around the SCSI port idiosyncrasies, issued improved utility software, and distributed better documentation. And at the end of the test period, Apple was about to release System 3.2. The new System reportedly includes fixes to the Mac's SCSI software, but I was unable to test the drives with it.

## **On Your Mark**

Setting up a SCSI drive is a snap; plug the data cable into the drive and the Mac and plug the power cord into an outlet. All drives include both power cables and data cables, except the Bernoulli Box 10 + 10, the Sun Streak, the DataFrame, and the MagNet 20X, which lack data cables.

*None of the  
drives tested require  
initialization,  
formatting, or other  
preparation.*

None of the drives tested require initialization, formatting, or other preparation. Unless a floppy disk is inserted or an Apple Hard Disk 20 is attached to the floppy disk port, the Mac Plus uses the SCSI drive as the startup disk.

I ran each drive heavily for four or five days, with a sizable mixture of applications. The hard disks contained 13 megabytes of application programs and documents along with System 3.1.1, Finder 5.2, ImageWriter 2.2, and LaserWriter 3.0.

The Bernoulli 10 + 10, the LoDown-20, the MacFast20, and the DataFrame all require a special file from Apple, usually named SCSI Helper. If that file isn't present in the System Folder of the initial startup disk, the Mac sporadically locks up while starting applications and copying or duplicating files with the Finder.

*(continues)*

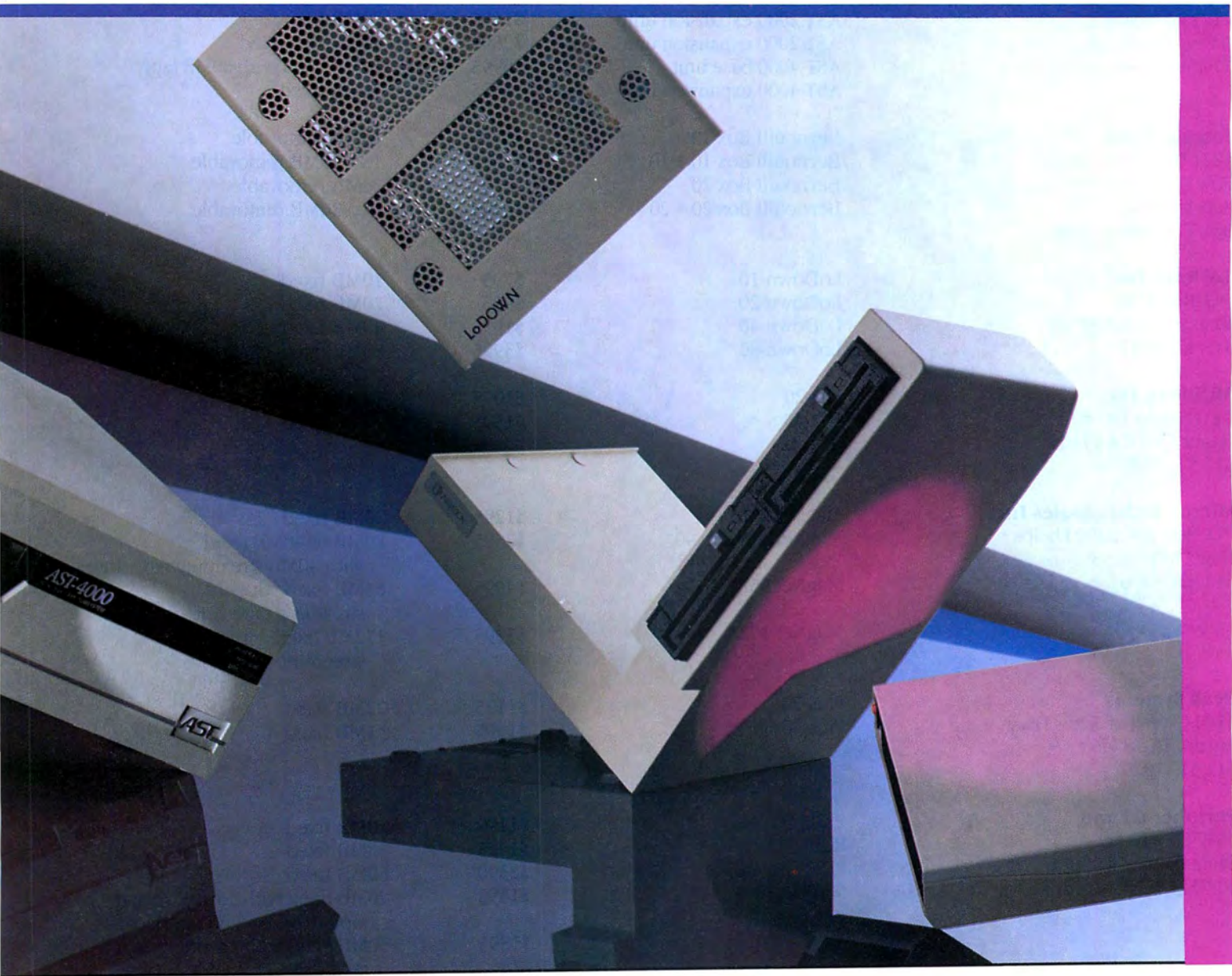

## SCSI Drive List

Manufacturer	Model	Price	Capacity
<b>AST Research, Inc.</b> 2121 Alton Ave. Irvine, CA 92714 714/553-0340	AST 2000 base unit	\$2795	20MB fixed with 20MB tape
	AST 2000 expansion unit	\$1595	20MB fixed
	AST 2000 expansion unit	\$2695	Two 20MB fixed
	AST 4000 base unit	\$6995	74MB fixed with 60MB tape
	AST 4000 expansion unit	\$3595	74MB fixed
<b>Iomega Corp.</b> 1821 West 4000 South Roy, UT 84067 800/446-6342, 801/778-3000 in Utah	Bernoulli Box 10	\$1795	10MB removable
	Bernoulli Box 10 + 10	\$2695	Two 10MB removable
	Bernoulli Box 20	\$2395	20MB removable
	Bernoulli Box 20 + 20	\$3495	Two 20MB removable
<b>LoDown Inc.</b> P.O. Box 5146 Pleasanton, CA 94566 415/426-1747	LoDown-10	\$795	10MB fixed
	LoDown-20	\$995	20MB fixed
	LoDown-40	\$1995	40MB fixed
	LoDown-80	\$3995	80MB fixed
<b>MDIdeas, Inc.</b> 1111 Triton Dr. #205 Foster City, CA 94404 415/573-0580	HD-20	\$1095	20MB fixed
	HD-30	\$1595	30MB fixed
<b>Mirror Technologies Inc.</b> P.O. Box 304, 2209 Phelps Hugo, MN 55038 612/426-3276	MagNet 20X	\$1295	20MB fixed
	MagNet Tandem 40	\$2595	20MB or 40MB fixed with 40MB streaming tape drive
	MagNet 85X	\$4995	85MB fixed with 40MB streaming tape drive
	MagNet 172X	\$5995	172MB fixed with 40MB streaming tape drive
<b>Peak Systems</b> 1120 Capital of Texas Hwy. Austin, TX 78746 512/329-1020	Plus-20	\$1195	22MB fixed
	Plus-30	\$1595	31MB fixed
<b>Peripheral Land</b> 3677 Enochs St. Santa Clara, CA 95051 408/733-7600	PL20	\$1195	20MB fixed
	PL30	\$1495	30MB fixed
	PL80	\$2390	80MB fixed
	MacFast20	\$1595	20MB fixed with partitions and tape drive backup interface
	MacFast30	\$1895	30MB fixed with partitions and tape drive backup interface
	MacFast80	\$2890	80MB fixed with partitions and tape drive backup interface
	MacFast170	\$4995	170MB unformatted
	MacFast2020T	\$2495	20MB fixed, 20MB tape backup
	MacStor10	\$2195	10MB removable



Manufacturer	Model	Price	Capacity
<b>Personal Computer Peripherals Corp.</b> 6204 Benjamin Rd. Tampa, FL 33614 800/622-2888, 813/884-3092 in Florida	MacBottom SCSI	\$1195	21MB fixed
<b>ProApp, Inc.</b> 1475 S. Bascom Ave. Campbell, CA 95008 800/424-2425, 408/559-3552 in California	ProApp10	\$795	10MB fixed
	ProApp20	\$995	20MB fixed
<b>Rabbit Industries</b> 206 W. 38th St. #224 Austin, TX 78705 512/473-2935	Magic20	\$1050	20MB fixed
	Magic30	\$1250	30MB fixed
	Magic40	\$1450	40MB fixed
	Magic186	\$4995	186MB fixed, ultra high performance
<b>Softworks Limited</b> 2944 N. Broadway Chicago, IL 60657 312/975-4030	SD11A	\$995	11MB fixed
	SD22A	\$1275	22MB fixed
	SD30A	\$1595	30MB fixed
	SD60A	\$2750	60MB fixed
	SD140X	\$6400	140MB fixed
	SD170X	\$7400	170MB fixed
	SD4000	\$4895	60MB with 60MB tape backup
<b>Sunol Systems, Inc.</b> 1777 Quarry Ln. Pleasanton, CA 94566 415/484-3322	Sun Streak SCSI-21	\$2195	21MB fixed
	Sun Streak SCSI-45	\$4595	45MB fixed
	Sun Streak SCSI-70	\$5295	70MB fixed
	Sun Streak SCSI-110	\$6995	110MB fixed
	Sun Streak SCSI-160	\$8795	160MB fixed
<b>SuperMac Technology, Inc.</b> 1901 Old Middlefield Way Mountain View, CA 94040 415/964-8884	DataFrame	\$1299	20MB fixed
<b>Univation</b> 1231 California Circle Milpitas, CA 95035 408/263-1200	SlimLine 10R	\$2195	10MB removable
	SlimLine 1010-2R	\$3495	Two 10MB removable
	SlimLine 20	\$1795	20MB fixed
	SlimLine 30	\$1995	30MB fixed
	SlimLine 40	\$2995	40MB fixed
	SlimLine 2010R	\$2995	20MB fixed and 10MB removable
	SlimLine 3010R	\$3295	30MB fixed and 10MB removable
	SlimLine 4010R	\$4495	40MB fixed and 10MB removable

## Gauging SCSI Performance

Hard disks that attach to the high-speed SCSI port on a Mac Plus all operate faster than drives connected to a serial port or a disk port. Theoretically, SCSI drives should operate even faster than they do, but the Mac Plus cannot accept and process information as fast as a hard disk can send it through the SCSI port. The disparity between theoretical and actual transfer rates occurs because the Mac Plus periodically interrupts the flow of information to arrange the incoming program or document file in its memory.

Curiously, actual performance varies tremendously depending on file and folder organization and on what kind of information is being transferred. For example, a typical SCSI drive takes about 9 seconds to start the 372K *Microsoft Excel* application. In contrast, the same drive takes nearly 60 seconds to open a 300K *Excel* document.

To measure performance, I timed the nine SCSI drives, Apple's Hard Disk 20, and the Mac Plus 800K internal floppy disk drive to see how long each took to start *Excel* from the Finder and to open a 300K

worksheet document from *Excel* (see "On the Test Track"). In each case, I made three timings and averaged them. All the hard disks had the same set of 1090 files organized in identical HFS folders. On most disks, they occupied just over 12 megabytes. The AST 4000, however, allocated disk space in larger chunks due to its high capacity and required about 13 megabytes for the same files. On the Bernoulli Box and SlimLine, both drives that utilize removable disk cartridges, the files were spread across two cartridges.

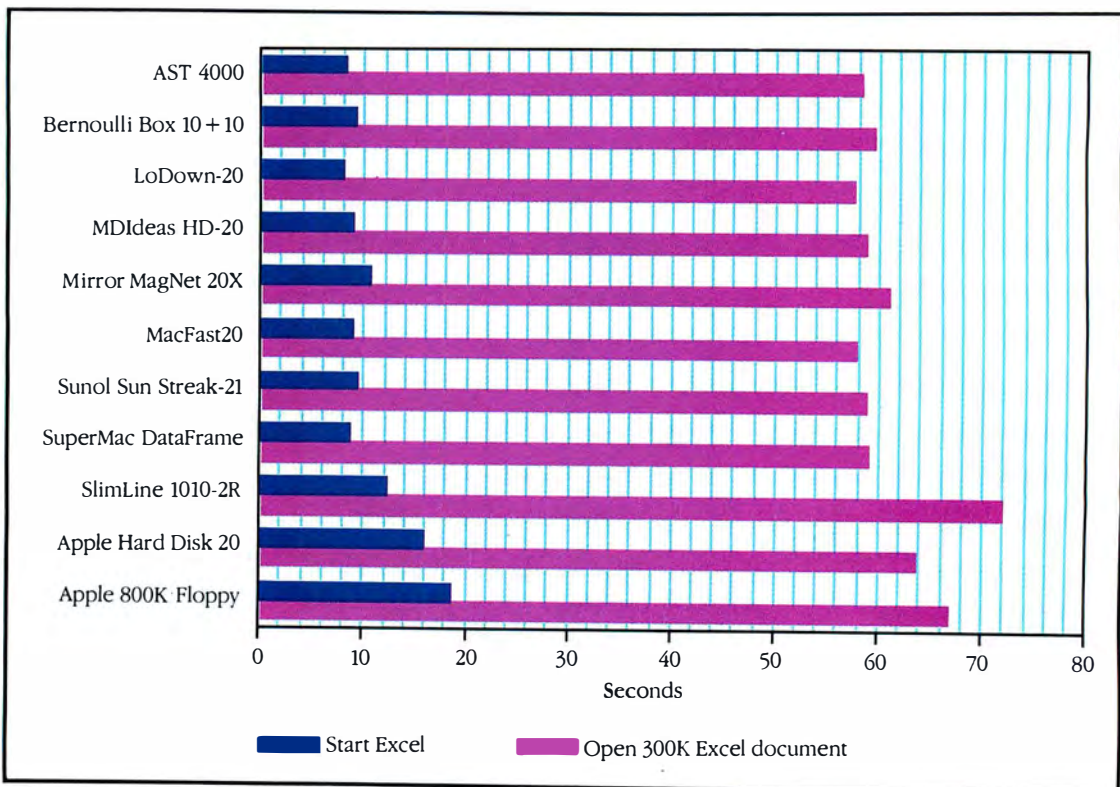

### On the Test Track

The measured times for starting *Excel* or opening a 300K *Excel* worksheet were comparable for all of the drives I tested. In everyday use, a 1-second difference is inconsequential.

(System 3.2 reportedly circumvents the need for the SCSI Helper file.) The MagNet 20X requires a special version of the System file to work correctly.

During the test period, the disks all seemed to perform at about the same speed. To measure performance, I ran a series of timing tests, the results of which appear in "Gauging SCSI Performance." Many of

*'What's that sound?' callers asked when the Bernoulli Box was idling in the background.*

the differences between drives, however, are most apparent when you compare the drives feature by feature (see "SCSI Drives at a Glance"). The following synopsis covers each drive's performance during the test period.

#### **AST 4000**

The 74-megabyte AST 4000 is best suited for sharing among several Macs on an AppleTalk network with disk- or file-server software such as Infosphere's *MacServe* or Centram's *TOPS*. It was the largest and the loudest drive I tested. The smaller, quieter AST 2000 stacks neatly under the Mac Plus and is more appropriate as a personal hard disk drive than the AST 4000. However, it was unavailable for testing at press time.

Using the versions of the System file, Finder, and AST 4000 Install File application that came with the drive, I occasionally had startup trouble that was easy to work around. After I installed System file 3.1.1, Finder 5.2, and AST's Install File 1.04, the drive worked faultlessly.

One unique feature of the AST 4000 is its built-in 60-megabyte tape drive. The included backup software dumps the entire 74 megabytes—whether it's all in use or not—onto two tapes in about half an hour, or it backs up individual files you select one by one. The software does not allow selection by folder, date, or file type. The AST 2000 also includes a built-in tape drive that reportedly backs up 20 megabytes in under 9 minutes and reads and writes individual files like a disk drive.

#### **Bernoulli Box 10 + 10**

"What's that sound?" callers always asked on the telephone when the Bernoulli Box was idling in the background. The drive ticks like a grandfather clock because the read/write head moves randomly to avoid wearing out one place on the disk.

With the Bernoulli Box you get the most flexible backup application program I have seen to date. For example, you can build a list of files to be backed up by name, date and time, kind, or a progressive combination of those criteria, and you can add or remove individual files from the list. You can have the program back up all files on the list or only those files that have changed since the last backup.

No problems turned up during the five days of heavy use. Because the Bernoulli Box was the easiest to daisy chain with all the other drives, I kept using it to copy a standard set of application and document folders to whatever drive I was about to test. Once, however, as I was about to copy files to another drive, the red light on the back of the Bernoulli Box went on, indicating an internal fuse had blown. Iomega product manager Greg Brashear explained that the internal fuse protects the SCSI bus's 5-volt line, which the Bernoulli Box augments. According to Brashear, Iomega is modifying the drive's design to correct the problem.

#### **LoDown-20**

The LoDown-20 performed well except for one problem: a bad spot developed on the disk. The disk error rendered an application unopenable and uncopyable. While I was able to discard the damaged application and recopy it from a floppy disk, the problem could have occurred in a more critical location that might have meant reformatting the entire disk.

#### **March of the SCSI Soldiers**

*(Left to right) Bernoulli Box 10 + 10, DataFrame, and MDIdeas HD-20. The Bernoulli Box features two 10-megabyte removable cartridges. The quiet DataFrame sits next to the Mac, while the MDIdeas HD-20 fits nicely beneath the computer.*

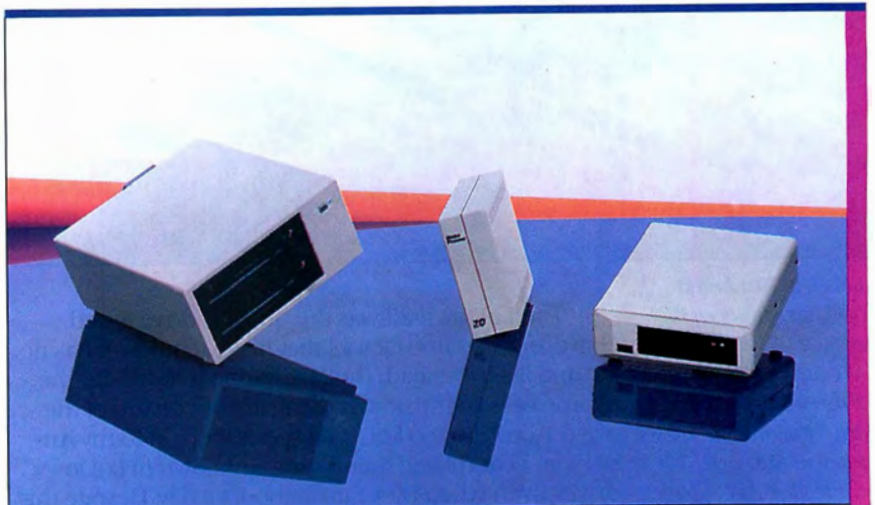

# SCSI Drives at a Glance

	AST Research AST 4000	Omega Bernoulli Box 10+10	LoDown LoDown-20	MDIdeas HD-20	Mirror Technologies MagNet 20X
Capacity of sample unit (formatted) <sup>1</sup>	73,350 bytes	19,218 bytes	20,334 bytes	21,670 bytes	21,496 bytes
Noise level (subjective) <sup>2</sup>	loud	loud	quiet	medium	medium
Number of ports	1	2	2	1	1
Type of connector	Amphenol 50-pin	Amphenol 50-pin	DB-25	Amphenol 50-pin	Amphenol 50-pin
Data cable included	yes	no	yes	yes	no
Convenience AC outlet	yes	yes	yes	no	no
Dimensions (H x W x D in inches)	5.5 x 14.5 x 17.25	6.25 x 12.5 x 17	3.5 x 10.25 x 11.75	3.75 x 10 x 12	3 x 5.375 x 9.25 <sup>4</sup>
Backup software	limited <sup>6</sup>	elaborate	unavailable for test	adequate	unavailable for test
Standard warranty	180-day limited	90-day limited	90-day limited	90-day full	90-day limited
Price	\$6995	\$2695	\$995	\$1095	\$1295
Additional features	60MB tape drive; dual voltage (120 VAC 60Hz or 240 VAC 50Hz)	removable disks	includes more than 300 public domain programs		includes MacServe file server and print spooler



**Last but Not Least**  
 (Left to right) Peripheral Land MacFast20, AST-4000, MagNet 20X. Peripheral Land's drive includes an intelligent tape drive controller. AST's drive stores 74 megabytes and includes a 60-megabyte tape drive. The MagNet 20X comes with InfoSphere's MacServe disk server software.

The LoDown-20 was the quietest drive tested. However, the same factors that make it quiet—it has no fan and it sits beneath the Mac—appear to hinder the escape of hot air through the grillwork on top of the drive. According to LoDown spokesperson Kathy Anderson, heat-related failures are unknown in LoDown drives even when they run 24 hours a day. Despite this reassurance, I suspect that keeping the Mac and all other objects off the LoDown would enhance the drive's reliability and longevity.

In addition to the usual disk format and mount utilities, the LoDown-20 includes an interesting extra: 300 public domain applications, fonts, and desk accessories. A backup application is available from LoDown for \$40.

### MDIdeas HD-20

The MDIdeas HD-20 worked without a hitch. The moderately quiet, fan-cooled HD-20 resides in a cabinet that gives you several placement options, including stacking the Mac atop it. The HD Backup program included with the drive gives you two options: back up the entire hard disk onto floppy disks or copy just the files that have changed since the last backup.

The drive I received came with very little documentation, just a one-page instruction sheet. MDIdeas now ships a more complete manual, but I did not see it prior to press time.

### MagNet 20X

The MagNet 20X from Mirror Technologies has the smallest cabinet of any drive tested. It also has a small remote power supply designed to sit up to 4 feet away from the drive. The first MagNet 20X that I tested, which had no fan, failed after a few hours of use. Mirror Technologies shipped a replacement unit that included a fan. Joel Ronning, president of Mirror Technologies, explained that although their test showed that the temperatures measured inside the cabinet

Peripheral Land MacFast20	Sunol Systems Sun Streak SCSI-21	SuperMac Technology DataFrame	Univation SlimLine 1010-2R	
21,379 bytes	20,574 bytes	20,468 bytes	21,755 bytes	<sup>1</sup> Capacity may vary slightly among different units of the same model due to different number of defective sectors.
medium	loud	quiet	loud	<sup>2</sup> Noise varies markedly from one unit of the same drive to the next. If noise is a factor, try the individual unit before buying.
2 <sup>3</sup>	1	2	1	<sup>3</sup> Second port is for smart tape drive.
Amphenol 50-pin	Amphenol 50-pin	Amphenol 50-pin	DB-25	<sup>4</sup> Plus power supply cabinet, 2.625 × 4.125 × 6.5.
yes	no	no	yes	<sup>5</sup> Cabinet size of test unit was 3 × 6.875 × 15.25.
no	no	no	yes	<sup>6</sup> Backup software works only with the built-in tape drive.
3 × 9.5 × 9.5	3.375 × 7.5 × 14.5	8 × 3 × 9.5	15.75 × 12 × 10.75	<sup>7</sup> Backup software comes with companion tape drive (not tested).
none <sup>7</sup>	none <sup>7</sup>	unavailable for test	unavailable for test	
180-day full	6-month limited	1-year full	1-year limited	
\$1595	\$2195	\$1299	\$3495	
smart tape drive port; optional fixed-size MFS and HFS volume partitions			removable disks	

were well below the drive's published limits, a fan was added for insurance. Mirror claims that since adding the fan, it has had no reports of heat-related failures.

I experienced some additional heat-related problems with early versions of the software. Chuck Thiesfield, who wrote the Mirror software, explained that versions 1.61 and above make allowances for normal temperature changes as the drive warms up. In my tests the fan-equipped MagNet 20X with version 1.61 performed well.

The MagNet 20X comes with the *MacServe* disk and print server software created by Infosphere (see "Expanding Your Network Options," *Macworld*, June 1986). *MacServe* enables other Macs in an AppleTalk local area network to share the MagNet 20X. What's more, *MacServe* allocates part of the MagNet 20X for a print spooler so that you can continue working while printing documents.

### MacFast20

Peripheral Land's MacFast20 can be set up as four 5-megabyte Mac File System (MFS) or Hierarchical File System (HFS) volumes or as a single 20-megabyte HFS volume. The MacFast20 also has a built-in provision for a smart external tape backup unit, Peripheral Land's MacFast20 Tape. Once a transfer between disk and

tape begins, the Mac is free to do anything that does not require the disk or tape. I did not test the tape unit or the backup application supplied with it, but Peripheral Land claims the tape drive backs up 20 megabytes in under 5 minutes.

During the test period, Peripheral Land made a minor change to the drive's controller electronics and sent out Apple's revised SCSI Helper software to solve some performance problems with the MacFast20. With these changes, the MacFast20 performed reliably. Plans were also well underway to change the cabinet so that the MacFast20 would match the Mac Plus's footprint.

### Sun Streak SCSI-21

The Sun Streak SCSI-21 I tested was a preproduction model, but there was nothing premature about its performance. It performed ably during the test period.

The Sun Streak cabinet is too narrow to stack under the Mac. You have to put this drive alongside the Mac or in some more remote location. The prototype's noisy fan made me favor a remote location, but Virginia Wurts, Sunol Systems' sales manager, assured me that production units would have quieter fans.

Because the Sun Streak was a prototype, it came with no manual and no utility software. Wurts says that a brief manual and formatting and diagnostic software will accompany the drive. Backup software comes only with Sunol's tape backup unit, the Sun Safe-60.

**DataFrame**

The DataFrame was the first drive I received and one of the few drives I tested that was completely trouble-free during the entire test period. Although it came with just a single instruction sheet, four weeks later that was replaced by a well-written, comprehensive manual. The DataFrame's greatest deficiency was scant utility software. Recognizing this, SuperMac plans to ship free backup, file security, and background printing utilities to all DataFrame owners by the time you read this review. I did not see any of the new software in time to test it.

The DataFrame runs hotter than the fan-cooled drives. However, the DataFrame uses the same time-tested cooling mechanism as a double-hung window. Hot air inside the cabinet rises, escapes through vents near the top of the cabinet, and sucks cooler air in through vents near the bottom. To check its cooling capability, I left the DataFrame running for four weeks straight, and it worked fine during that time.

**SlimLine 1010-2R**

The SlimLine I tested was a preproduction unit with two removable 10-megabyte hard disk cartridges. The drive worked fine as long as I inserted both cartridges and let them come up to speed before switching on the Mac. However, the drive wouldn't recognize any cartridges I inserted after startup, including those

I ejected and later reinserted. According to Mike Higgins, Univation's director of marketing, the prototype contained a prerelease version of the drive's controller electronics. He assured me that production units would properly handle cartridge removal and insertion from the Finder. But you won't be able to swap cartridges quite as freely as you swap floppy disks.

The L-shaped Univation SlimLine drive cabinet wraps around a Mac Plus so that the two units look like one. The actual drives are stacked lengthwise in the

**And Three Makes Six**

*(Left to right) LoDown-20, SlimLine 1010-2R, and Sun Streak SCSI-21. LoDown's drive comes with 300 public domain programs. The SlimLine 1010-2R's two drives are housed in an unusual L-shaped cabinet that wraps around the Mac. Sunol's drive sits alongside the Mac.*

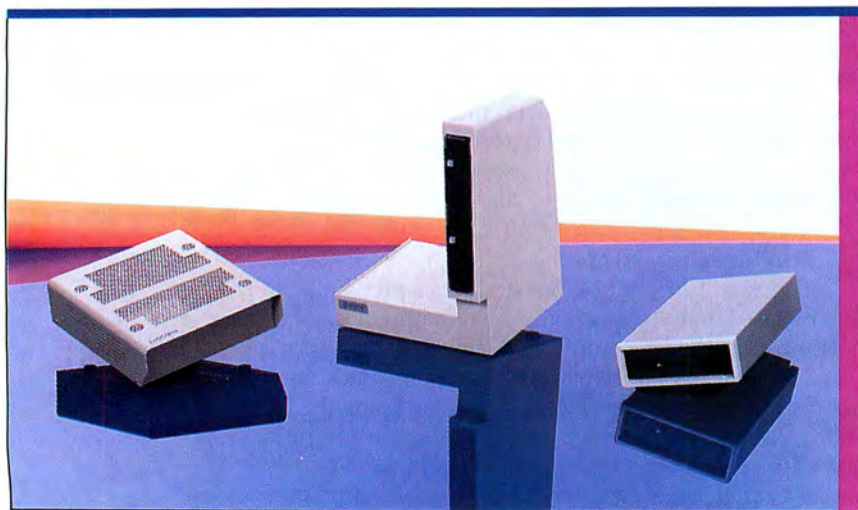

*The DataFrame was one of the few completely trouble-free drives tested.*

upright part of the SlimLine cabinet on the right side of the Mac. The Mac-and-SlimLine combination stands only 2¾ inches taller and 2¼ inches wider than the Mac alone. Space conservation has its price, however. You give up peace and quiet to a moderately loud fan in the base of the SlimLine cabinet. Also, the SlimLine partly blocks the vents on the right side of the Mac. In spite of this, Higgins reports that the slight temperature rise inside the Mac presents no problem.

**Shopping for Megabytes**

In evaluating SCSI disk drives, consider the capacity, size, shape, noise level, warranty, and price that best suit your needs. Reliability is difficult to ascertain by testing a single unit. However, with the latest software, all the drives seemed reasonably reliable. Surprisingly, performance isn't a major comparison point because all the SCSI drives are limited by the Mac and run at nearly the same speed when performing everyday tasks.

Four drives seem particularly suited to the individual user who is concerned about price: the LoDown-20, the MDIdeas HD-20, the SuperMac DataFrame, and the Mirror MagNet 20X. Businesses and other users who are more concerned with data security than price may prefer a drive with removable disk cartridges, namely the Iomega Bernoulli Box 10 + 10 or the Univation SlimLine 1010-2R. The Peripheral Land MacFast20 satisfies both the price-conscious and the security-conscious user; it costs a bit more than the low-priced drives but offers a couple more features, notably a provision for adding a smart tape backup. At the high end of the scale, the AST 4000 is ideal for businesses with large databases or AppleTalk networks. □

◆◆◆◆◆◆◆◆◆◆ Lon Poole is a Contributing Editor of Macworld.



**The inventors of the 3.5" drive  
recommend only one floppy disk.  
Theirs.**

If your computer has 3.5" drives, it has a little bit of Sony. Because Sony invented the 3.5" drive technology that has taken floppy disk memory all the way to two megabytes.

So nobody knows better than Sony how important high standards are for producing 3.5" floppy disks. But then, Sony invented those, too, as well as the most demanding methods for making 3.5" disks.

Such as the Sony Vivax™ magnetic medium, with the high coercive force necessary to suppress the "noise" that can cause disk error. And the Sony DDL™ binder system for incredibly even dispersion of magnetic particles on the disk surface. Then there's Sony's burnishing expertise that eliminates microscopic projections as small as 1/1,000,000th of a millimeter.

But the best reason to trust only Sony is your irreplaceable data. After all, you'll be storing six times the information on a disk that's one-third smaller than a 5.25" floppy. That's why we recommend only one floppy disk for our 3.5" drives. The Sony.

**SONY®**  
THE ONE AND ONLY®

© 1986 Sony Corporation of America. Sony, Vivax, DDL and The One and Only are trademarks of Sony.

Circle 255 on reader service card

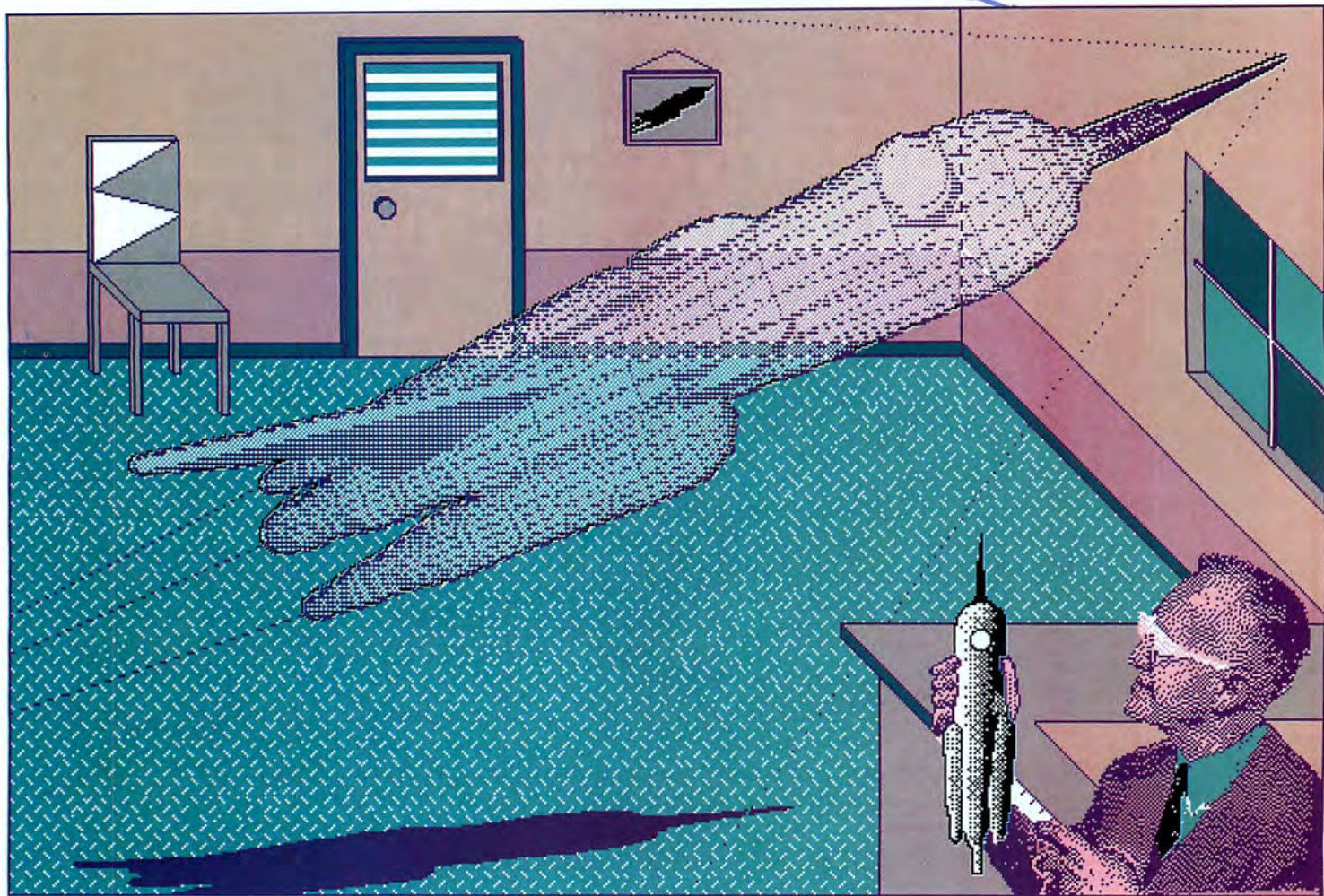

JOHN HERSEY



# Mac Modeling

Reese M. Jones

*STELLA brings professional computer simulation and modeling to the Macintosh*

*Modeling and simulation* may sound like arcane, information-age practices, but really they're as common and as old as thinking. Every time you put ideas together to figure out how something works, you're creating a mental model. When you use your ideas about how things work to make a prediction, you're engaging in simulation. The formal discipline of explicit modeling is no different—just more rigorous.

An explicit model is an abstract system that uses equations to describe the parts and behavior of a real system. Explicit modeling has long been performed on mainframes and minicomputers in the physical and biological sciences, business, economics, public policy, and many other fields. But in the personal computer world, modeling software has been restricted to very limited applications, such as spreadsheet programs and project managers. Now a new program from High-Performance Systems, *STELLA*, enables the Macintosh to be used for modeling applications as varied as evaluating airplane designs, estimating the effects of rent control on a local economy, or predicting the casualties from a nuclear disaster.

*STELLA* (*Structural Thinking, Experiential Learning Laboratory with Animation*) is a relatively complete environment for constructing and experimenting with explicit models. With its elegant, visual interface, it represents the first of a new type of modeling program that's accessible to relatively nontechnical users yet powerful enough to build substantial models with real-world applications.

## The Diagram Window

*STELLA*'s visual orientation makes it unique among modeling programs. You begin constructing a model by outlining its structure in the Diagram window (see Figure 1). *STELLA* diagrams have four main elements: The boxes, called *stocks* or *accumulators*, represent quantities that can grow or shrink as the model runs. The hollow arrows, known as *flows*, indicate movement in and out of the stock boxes. The circles attached to the flows are called *converters* or *logic receptacles*; these contain the decision rules that control the flows and, ultimately, the model's behavior.

The fourth element, the curved arrows, are the *input links*, or *signals*. Signals show logical connections between a model's components. In Figure 1, for example, revenues and expenses are both linked to profits.

*STELLA* is capable of handling complex models with multiple, convoluted feedback loops and numerous interacting factors. Models can extend beyond the edge of the screen; the display zooms out to show the overall structure of the model or in to enlarge a particular section. Also, when dealing with a complex diagram, you can search for a model's components by name.

## Making the Rules

After you have pieced together your model on the Diagram window, it's time to define the contents of each stock box and

logic receptacle. *STELLA*'s defining dialog boxes are one of its most powerful features. The algebra box (shown at the top of Figure 2) tells you which parts of your model you must include in the current definition. The Required Inputs list is determined by the links you have drawn in your structural diagram and is one of the ways in which *STELLA* ensures that you maintain a one-to-one correspondence between your diagram and your equations. If you leave anything out of your equation, the program won't accept your definition.

The algebra box also shows a menu of built-in mathematical and logical functions that you can include in a definition simply by clicking on them. An on-line error-checking feature tells you when you have entered an equation incorrectly; unfortunately, you can't query the error checker to find out the correct format for a function before you enter it.

In addition to defining elements algebraically, the graph dialog box (shown at the bottom of Figure 2) lets you easily define a nonlinear response for a logic receptacle by specifying its input and output values. You can also use the mouse to draw a plot representing the relationship between the values. The combination of these defining tools gives you great flexibility when constructing complicated models with many feedback controls and nonlinearities. At the same time, you don't have to know calculus, solve sets of nonlinear partial differential equations, or do any programming.

**Simulation**

An important requirement for a simulation program is the ability to control the step size and numerical precision of the simulation. *STELLA* allows for great flexibility in setting these parameters. You can also choose simulation start and stop times, the ranges within which variables will be scaled for plotting or animation, and combinations of fixed or floating-point values with different precisions. The program even offers a selection of numerical-integration algorithms, including Euler's method and second- and fourth-order Runge-Kutta, that enable you to trade off speed and precision and deal with instabilities. This combination of features allows you to debug your model with a series of quick, approximate simulation runs before you do a longer, more precise calculation.

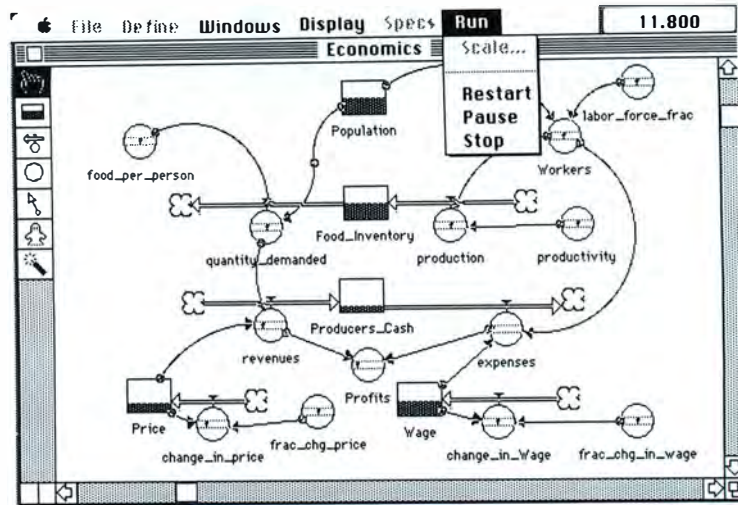

**Figure 1**  
A diagram of a complex economic model with extensive interconnections and feedback-control loops. You construct a diagram by dragging elements from the toolbox on the left and arranging them in the window.

**Required Inputs**

- Population
- food\_per\_person

**Builtins**

- ARCTAN
- EHP
- LOGN
- RANDOM
- NORMAL
- IF

quantity\_demanded = Population \* food\_per\_person

**Become Graph** **Cancel** **OK**

**Input** **Output**

0.0	0.0
0.20	412.50
0.40	795.00
0.60	907.50
0.80	907.50
1.00	660.00
1.20	1237.50
1.40	1342.50
1.60	1410.00
1.80	1455.00
2.00	1492.50

**Become Algebra** **Cancel** **OK**

**Figure 2**  
*STELLA* offers two alternatives for defining the elements in a model: the algebra dialog box at top indicates which terms of your model you must include in your current definition and offers built-in mathematical and logical functions; the graph box lets you define nonlinear responses by either drawing a curve or entering values.

Another important feature for a simulation program is the ability to produce graphic—even animated—output. Responses that are difficult to see in tables of numbers are often obvious in plots. Animation enables you to observe cycling phenomena and recognize early on if your simulation needs adjustments.

*STELLA*'s output features are another of its strengths. You can plot the change in any value over time and watch as the program produces an animated graph (see

Figure 3). *STELLA* can plot up to four independently scaled variables, and you can plot any variable against any other over time to display their relationship.

To set up a plot, you simply open the Graph Pad window and select the variables you want from a menu. To scale the graph, you can determine the ranges for every variable automatically by running through

a simulation cycle, or you can save time by letting the program determine the range for a single variable of particular interest. *STELLA* also lets you set plot-display ranges manually. This unusual variety of options makes it easy to compare the behavior of very different components of a model.

One stunning output feature is *STELLA*'s ability to animate the components of the structural diagram in the Diagram window. As the program runs, stock boxes fill up or empty to show changes in stock quantities over time. *STELLA* indicates the relative value of an equation in a logic receptacle by means of a moving speedometer needle (see Figure 1). You set the relative scaling of each variable for this animation in the same manner as you set the ranges for the plots.

Simulation results can also be displayed and printed in a traditional table format (see the Table window in Figure 3). However, *STELLA* cannot transfer tabular output to other programs—a serious drawback. *STELLA* does not support the Mac's Copy and Paste commands or provide a facility for printing a table to disk. This means you can't, for example, generate a data curve in *STELLA* and then move the data to a *Microsoft Excel* or FORTRAN program for analysis, or to *Cricket Graph* to make a presentation-quality graph. The only way to move a table, a diagram, or a plot from *STELLA* to *MacWrite* or *MacDraw* is to create a *MacPaint* bit map via a  $\text{⌘-Shift-3}$  screen dump. A business version of *STELLA* that addresses many of these shortcomings is in the works.

### Documenting and Data Fitting

*STELLA*'s model-documenting abilities are limited. You can display the equations used in a model in the Equations window, which is useful for debugging the model (see Figure 3). But *STELLA* automatically displays equations in order by type and then alphabetically within types—a scheme that most likely bears no relation to the structure of your model. Mainframe simulation programs often provide more flexible equation-listing capabilities, allowing you to add comments to equations and to sort and group equations based on the model's structure. Such features can be important when you're working with large, complicated models.

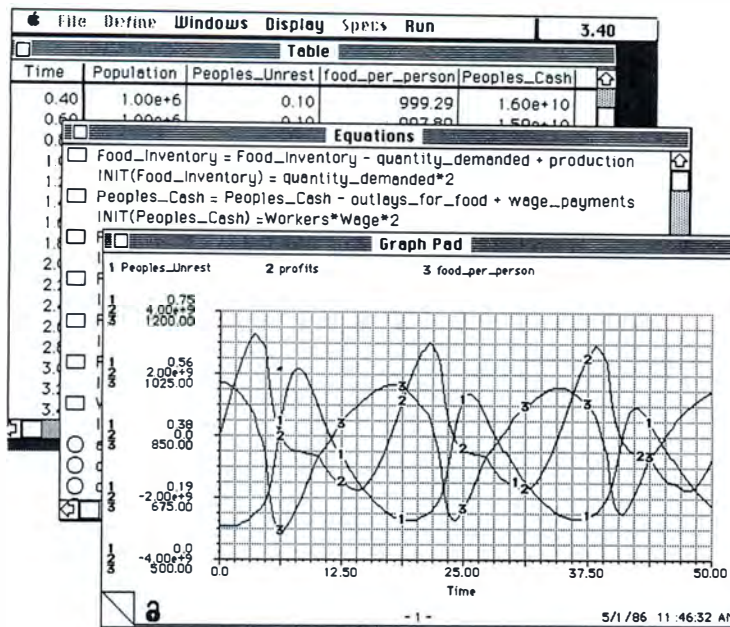

**Figure 3**  
Three of *STELLA*'s output windows. The Graph Pad displays an animated plot of up to four components of your model. The Equations window shows a model's algebraic structure. And the Table window gives the numerical values of model components over time (the number in the upper-right corner indicates elapsed time).

Once a model has been constructed and tested, it's often necessary—particularly for applications in the physical and biological sciences—to fit the model to a set of experimentally observed data to determine the exact quantities of unknown parameters in the model. *STELLA* is very useful for getting the structure and parameters of a model qualitatively correct, but its ability to determine the real-world value of variables is limited.

### Evaluation

*STELLA*'s documentation is structured as a series of tutorials that take several hours—and some effort—to complete. While this manual is well written and presents interesting insights into modeling theory and logical thinking, it lacks some key elements. There is no systematic overview of the program's features and, worse, no index. These omissions leave you with no way of answering specific questions; instead, you must thumb through the tutorials until you find the information you need.

The size of a model in *STELLA* is limited to the number of components that fit on one worksheet, which is partly a function of available RAM. *STELLA* version 1.2 works on a Mac Plus or a 512K Macintosh, but for most professional applications 512K will probably be unsatisfactory.

*STELLA* is an exciting and powerful tool that can be used in a variety of fields, from physics and biochemistry to psychology and public policy.

It is well suited for modeling and simulating dynamic systems and deals grace-

fully with the particularly difficult modeling task of multiple feedback loops. The program's graphic interface, animation, and sophisticated simulation-control features allow you to concentrate on the structure of your model rather than on the logistics of programming or mathematics.

If you have a model to develop, seriously consider *STELLA*. If you are interested in learning more about modeling and simulation, this program represents a relatively easy and inexpensive way to do so. □

▲▲▲▲▲ Reese M. Jones is doing research in neurochemistry and brain imaging at Lawrence Berkeley Laboratory while working toward a Ph.D. in biophysics at the University of California, Berkeley. He is also president and founder of the Berkeley Macintosh Users Group.

▲▲▲▲▲  
*STELLA*, version 1.1  
High-Performance Systems  
13 Dartmouth College Hwy.  
Rte. 1, Box 37  
Lyme, NH 03768  
603/795-4122  
List price: \$200

# Beyond ThinkTank

Reed McManus

*Does More really give you more for your money?*

Who needs a \$300 outliner? That's the question I asked myself when I first saw *More*, the successor to Living Videotext's *ThinkTank 512*. To its popular "idea processor," Living Videotext has added several disk utilities, a number of new outline-organization features, multiple windowing, graphics functions that enable you to generate bullet and tree charts automatically, and other improvements.

The not-too-surprising answer, as it turned out, is that *More* is a program for intensive outline users—people for whom conceptualization and organization are major job components and who like the outline format. *More* is not likely to replace *ThinkTank* in the near future among authors, researchers, teachers, and others who regularly use outlines. But it could be a key program for managers and other business professionals, helping them to coordinate their hectic workdays and to plan, present, and execute projects.

I looked at a prerelease version of *More*. The program's substantial features were up and running, but some disk utilities and file transfer functions were not. *More* requires 512K and two disk drives. It is not copy protected.

## ThinkTank Plus

Those familiar with *ThinkTank 512* will immediately recognize *More*'s structure: headings with subheads are preceded by a plus symbol, and headings without, by a minus symbol. Flush-left or indented headlines can be created anywhere in an outline, and existing headlines can be moved anywhere, along with their subheads, simply by clicking and dragging.

You can collapse an outline to study relationships between topics at the same hierarchical level or expand the outline to take in the details. Word processing or graphics windows can be attached to any headline.

*More*'s outliner offers several organizing features not found in *ThinkTank 512*. Hoist lets you focus on a selected topic and work with it apart from the rest of the outline. Promote and Demote let you change the status of all subtopics below a selected heading without clicking on and dragging individual headings.

Cloning creates a cross-referenced copy of a headline; changes made to a heading are automatically reflected in its clone. For example, if you modify an entry in an alphabetical list of company names, the entry's clone in a list sorted by geographic region changes automatically.

Mark and Gather allow you to tag topics as you scroll through your outline and then move, copy, or clone the entire group. These features let you reorganize an outline without cutting and pasting items one by one. *More*'s Search function adds a wild-card capability and is useful for finding topics slated for gathering.

## More Windows

*More*'s multiple windows are its most significant outlining enhancement. Instead of trying to stuff all your ideas or projects into one outline, or closing an outline and opening a new file for each project, you can keep six windows cooking at one time (see Figure 1). This windowing ability en-

ables you not only to keep "desktop" outlines—address files, daily to-do lists, memo files—alongside project outlines, but to readily switch among them.

Windows can be overlaid or displayed side by side. Click on a window, and its outline becomes active; select Zoom In, and all other windows disappear. Data, including graphics, can easily be transferred between outlines and documents with the Clipboard or the Scrapbook.

### Working with Words

*More* can handle all but the most intensive word processing tasks. Unlike *ThinkTank 512*'s word processing capabilities, *More*'s are neatly integrated into the outliner. You can attach a document window to any heading and use the Clipboard or the Scrapbook to transfer data between any document window and outline.

*More*'s editing functions allow you to delete characters to the right of the cursor

and to use keyboard commands for all editing. However, the program lacks an Undo command. In document mode, you can select any font and size in the System file, but you are restricted to plain text. (For outlines you can also choose among six font styles: plain, bold, underline, italic, outline, and shadow.) You can set tabs and choose either fixed-width or word-wrapped text. Page breaks are not shown on screen.

### Instant Presentations

*More*'s classiest act is its ability to automatically generate bullet and tree charts from an outline. When you select any outline heading, it and its subheads (including document and graphics windows) become a series of bullet charts or a tree chart suitable for presentations or desktop publishing.

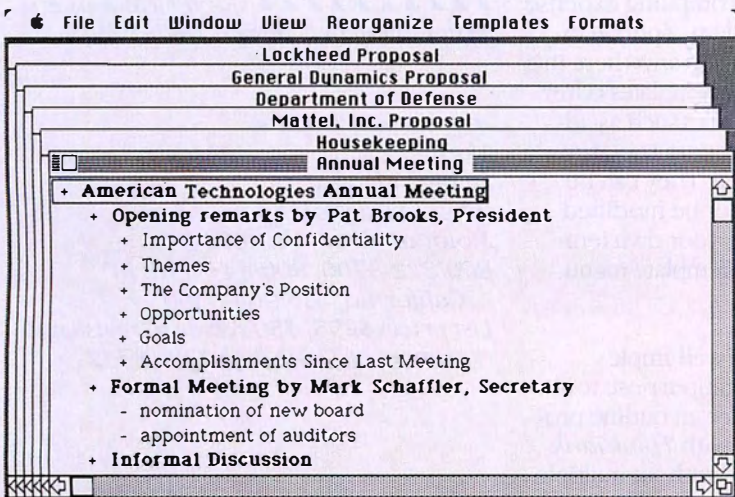

**Figure 1**  
*Multiple windows let you organize projects into separate but easily accessible outlines. Here, project proposals, annual meeting presentation plans, and daily organization files are each just a mouse click away. When you start More, you can select a group of outlines from the desktop for the program to open at once.*

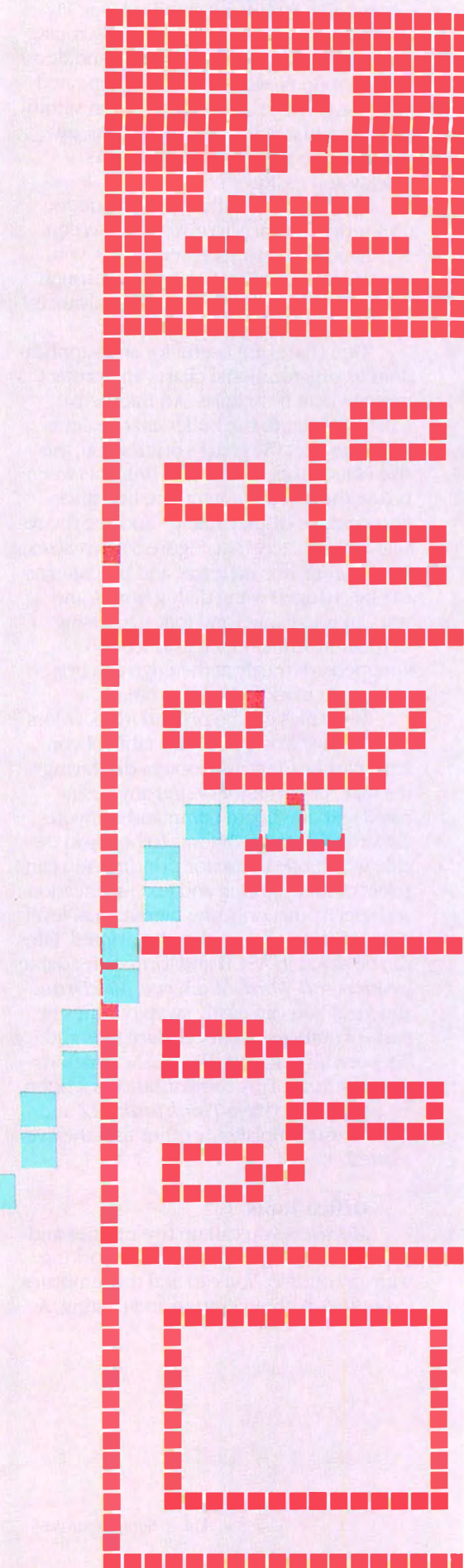

The bullet chart features a unique interactive palette that could be the forerunner of a new Macintosh standard (see Figure 2). To design a chart, you simply rotate through a variety of font, spacing, and decorative options, without making repeated selections. This instant visualization significantly speeds up the design process, enabling you to try a variety of options quickly and easily.

You can print bullet charts or queue up a series of charts to give an on-screen presentation. During presentations, you can let *More* scroll automatically through the slides at a designated pace or advance slides manually with a mouse click.

Tree charts are useful for such applications as organizational charts and project management flowcharts. An interactive palette similar to the bullet chart palette lets you select the chart's orientation, the size of its boxes, the style of links between boxes, the text alignment, the line thickness, and the display sizing—and see the results immediately (see Figure 3). Box sizes, box spacing, line patterns, and fill patterns can be changed using dialog boxes, and you can rotate fonts and font sizes using keyboard commands. Text is word-wrapped arbitrarily at the edge of a box unless you mark forced line breaks.

*More* files can be printed in six colors on an ImageWriter II, with a table of contents plus headers and footers displaying the date, page numbers, and any designated text. Keyboard commands let you view the full range of fonts to help you decide which one to use for printing. You can select outline spacing and text justification and specify that only one hierarchical level or subsection of an outline be printed. Files can be saved in ASCII and formats readable by *Microsoft Word*, *MacWrite*, *MacDraw*, and *Jazz*. You can easily swap outlines or parts of outlines between *More* files and between all Mac and IBM PC incarnations of *ThinkTank*. This compatibility is a boon for people who have *ThinkTank 512* and want to use templates or other files they've created.

**Office Tools**

*More* lets you call up five utilities and 11 preformatted templates while working with any outline. You can add the templates to outlines without cutting and pasting. A

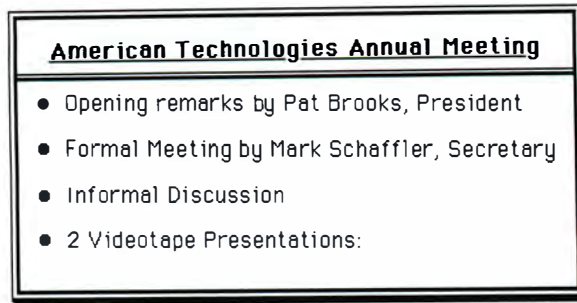

**Figure 2**  
Bullet charts turn outlines into presentations automatically. By clicking on any of the options in the palette, you can instantly preview a different font size or style, spacing, or arrangement of decorative elements.

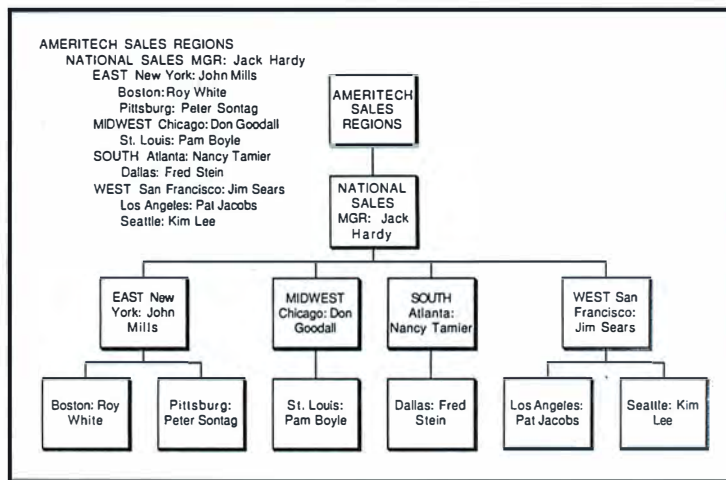

**Figure 3**  
Tree charts can be created automatically from outlines simply by changing views. The hierarchical relationships of the outline (left) are graphically depicted in the tree chart (right).

time-and-date-stamping facility lets you organize outlines by date and keep logs of meetings and phone calls. A calendar through the year 2039 generates appointment books covering any number of days with user-selected time intervals. A calculator adds up the figures in all subheads of a selected heading and is useful for simple applications such as compiling expense reports. If you use a modem, a phone dialer calls a number recorded anywhere in a selected headline. *More's* templates cover routine record-keeping tasks such as address files, sales leads, order entries, travel expenses, and time billing. They can be added to an outline as is or be modified and saved. You can create your own template and install it in the Template menu.

**More or Less**

*More* is a clever and well-implemented but expensive multipurpose tool. If you're simply looking for an outline processor, consider sticking with *ThinkTank 512*—unless you can't live without multiple windows and *More's* improved text pro-

cessing abilities. However, if you juggle many projects during your workday and can take advantage of *More's* presentation graphics, desk accessories, and templates, this jack-of-all-trades might easily become your office command post. □

▲▲▲▲▲▲▲▲▲▲ *Reed McManus is a writer living in Oakland, California.*

▲▲▲▲▲▲▲▲▲▲  
*More*  
*Living Videotext, Inc.*  
2432 Charleston Rd.  
Mountain View, CA 94043  
800/822-3700, 800/443-4310 in  
California, 415/964-6300  
List price: \$295, \$50 rebate to registered  
owners of *ThinkTank 128* or *512*

# Now with BPI Systems™, you've got a full-time accountant on hand.



When BPI Systems introduced General Accounting, it revolutionized the way businesses automate their accounting. When Apple® introduced Macintosh™, it revolutionized automation with one-touch personal computing.

Now BPI introduces General Accounting for Macintosh, so Mac users can point and click their way to automated, one-touch accounting.

To take full advantage of Mac's easy-to-use features, BPI General Accounting uses everyday business language and pull-down menus, with an interface consistent with Mac's. And it supports Mac's Mouse functions, so you've got a full-time accountant right at your finger tip.

Of course, General Accounting includes all of the features that made BPI a leader in business

accounting software—Accounts Payable, Accounts Receivable and Payroll subsidiary ledgers, plus a flexible chart of accounts, automatic check writing, and comprehensive financial reports.

But hurry. BPI is offering General Accounting for Macintosh at an introductory retail price of \$425.

So with a touch of a button you can find out exactly how your business is doing, instead of how it was.



**BPI**  
SYSTEMS™

3001 Bee Cave Road, Austin, Texas 78746, 1-800-531-5252.

Apple is a trademark of Apple Computer, Inc. Macintosh is a trademark of Macintosh Laboratories, Inc.

**Circle 481 on reader service card**





# Proficient Pagemaking

**Richard Jantz**

*A pasteboard of time-saving tips and practical techniques for using PageMaker*

So you joined the legion of desktop publishers. Armed with a Macintosh, the LaserWriter, and *PageMaker*, one of the popular page-makeup programs, you're willing to try whatever the job calls for: newsletters, reports, brochures, ads, marketing materials, magazines, books. As long as you don't run out of paper or cartridge toner, you're ready. . . .

Or are you? Just how adept are you at controlling your desktop publishing system? Have you mastered *PageMaker's* sophisticated capabilities, or do you still squander hours trying to get page layouts just right?

This collection of tips will help you get the most out of *PageMaker* (see "Keyboard Shortcuts"). Whether you're a veteran or novice user, these tips turn pedestrian page navigation into streamlined sailing.

**Ad-Lib Eraser** You can produce a crude but functional "eraser" with the toolbox. Select the None and White options in the Lines and Shades menus, respectively. Then use the box or circle tool to draw an invisible object large enough to cover an unwanted page element.

**Cut and Paste with Caution** Cutting or copying with one tool and pasting with another can generate a file-corruption error. Don't mix the arrow and text tools during cut and paste operations.

**Create Precision Art** Augment *PageMaker's* drawing abilities with *MacDraw*, which offers features such as curves, freehand shapes, and polygons; or *MacDraft*, which features precision-controlled drawing, object rotation, and scaling. Save *MacDraw*

# Keyboard Shortcuts

 Mouse click

## Placing Documents

Place  

Place text with original line breaks   with text icon

Stop text flow  anywhere on page



## Typing Text

Discretionary hyphen  



Em dash   

Page number marker   

Opening quotation mark  



Closing quotation mark  

Single opening quotation mark   

Apostrophe   

## Selecting Text



Line   

Paragraph  



Text block   

Word  

## Changing Views

Actual size  

Fit in window  

Go to "Actual Size" from other view   at new center

Go to "Fit in window" from "Actual Size"  

Go to "200% Size" from any view    at new center

## Changing Graphics

Resize proportionally  while dragging

Return a "placed" graphic to original proportions   handle

Change a rectangle to a square   handle

Change an oval to a circle   handle

## Using Tools

Show/hide guides  

Show/hide rulers  

Show/hide toolbox  

Use grabber hand  while dragging

*The mouse and keyboard shortcuts in this list provide quick operation and some special functions.*

graphics in PICT format, and place *MacDraft* drawings into *PageMaker* via the Clipboard or the Scrapbook or by turning them into *MacPaint* files.

**Condense and Stretch Type** You can use *MacDraw* in conjunction with *PageMaker* to embellish type. Type the text into *MacDraw* in a laser font and save the file in PICT format. Open *PageMaker* and place the *MacDraw* file. Eight handles surround the type; drag one in any direction to stretch or compress the type (see Figure 1).

**Save Unplaced Text** Avoid the loss of unplaced text when you close a file in the middle of a layout. Click the plus (+) handle at the bottom of the unfinished text block and place the remaining text on the pasteboard instead of the publication window before saving the file.

**Form-Fitting Headlines** Sometimes it's difficult to fit a long headline or a logo that spans multiple columns at the top of a page. Keep in mind that line length is determined by where you click the text insertion point. Inside the publication window, new text must conform to the column guides; therefore, type large text or headlines on the pasteboard and then drag them into place on the page.

**Tighten Up Big Heads** Because *PageMaker* lacks automatic or manual kerning features, it's difficult to tighten up large headlines. Although this method is imprecise, the program's text editor can divide a major headline into separate text blocks at points where you want kerning. For example, a large headline like "Winston Wins" might consist of three

separate text blocks: "W," "inston W," and "ins." Use Actual size or 200 percent to position each text block.

**Save Disk Space** Customize *PageMaker* backup disks to gain as much free space as possible and avoid swapping disks. Remove the Quicktour, Quicktour Text & Graphics, and Help Screens folders. Also remove either the ImageWriter and Aldus Prep folders or the LaserWriter folder, depending on which system you intend to use. Finally, remove any unneeded fonts or desk accessories from the System Folder with the Font/DA Mover.

**Creating Em and En Spaces** Create alternative spaces with special keyboard commands. Make an em space by pressing Option-Shift-hyphen. Make an en space with Option-hyphen.

**Zoom with Precision** You may lose track of your page position when you focus in on a layout's detail by selecting the 200 percent Page option. Keep your bearings by holding down both the ⌘ and Option keys, then click with the arrow at the point you wish to zoom in on.

**Switch to the Fast Lane** Use *Switcher* to move quickly and easily between programs such as *MacWrite*, *Microsoft Word*, *MacPaint*, and *MacDraw*—as long as your Macintosh has enough memory. Although 512K is recommended, you can allot 256K to a customized *PageMaker* disk that contains only essential files. The amount of memory remaining dictates how many other programs you can install. Two megabytes of RAM give you room to create an integrated desktop publishing system: load *PageMaker* along with design programs, a picture library or a clip art manager, a word processor, and digitizing software.

**Diagonal Scrolling** Scroll diagonally or in any direction by holding down the Option key while dragging the mouse. This is often more efficient than the scroll bars because it lets you move directly to a new page position with the tool known as the *grabber band*.

**Smooth Those Jaggies** Bit-mapped graphics, like those produced by *MacPaint*, are slightly distorted when printed on a LaserWriter. For best results, both printer and graphics should have the same resolution; however, a LaserWriter (300 dots per inch) has more than four times the resolution of bit-mapped graphics (72 dots per inch). To enable the printer to fill in the jagged edges, use the Print dialog box to select the Smooth option. Then reduce the Scaling to 96 percent to enable the printer to add dots and produce an exact multiple of the bit-mapped resolution.

**Bleeding Graphics** Normally, you can't print graphics or text that extends, or "bleeds," to the page's outside edges on the LaserWriter. This holds true even

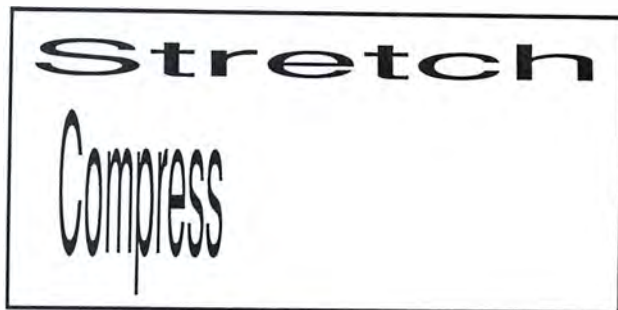

**Figure 1**

Use *PageMaker* with *MacDraw* to stretch or condense type—a technique that adds flair to headlines and initial capitals.

after setting up 0.00-inch margins or trying to print an enlargement, because the LaserWriter automatically creates a 3/4-inch border. However, you can create bleed effects on the top and bottom of letter-sized pages by printing on longer paper than you want for the final publication and trimming off the excess with the following procedure.

- Open a new file, choose Page Setup from the File menu, and select U.S. legal paper (8½ by 14 inches) in the dialog box. Use *PageMaker*'s default margin settings.
- Choose Actual size from the Page menu and drag two horizontal ruler guides to mark off 11 inches. Add dotted lines to provide a guide for trimming the excess paper off the printout.
- During the layout process, let the text and graphic elements you want to bleed overlap the top and bottom edges of the 11-inch document (delineated by the ruler guides). If you wish to shorten text blocks that extend too far over the dotted line, select and drag the bottom plus (+) handle upward.
- Print the final copy on legal-sized paper and cut off the excess. □

*Richard Jantz, based in Berkeley, California, is a freelance writer and the principal author of Creating the Best Impression: All about Business Graphics Software (Hayden Book Company, 1986).*

*PageMaker, version 1.0  
Aldus Corp.  
411 Second Ave. S  
Seattle, WA 98104  
206/622-5500  
List price: \$495*

# Four Secrets of Excel

**Danny Goodman**

*Learn how to make your spreadsheets sizzle with four efficient techniques for linking, opening, printing, and moving within spreadsheets*

Anyone can be an accomplished *Excel* user and still be unable to come up with what should be simple solutions. One problem that crops up frequently concerns *Excel's* spreadsheet-linking abilities, particularly in relation to updating external references to nonresident worksheets. I'll explain how to smooth these linking operations while demonstrating how to

- set up multiple-document *Excel* systems you can open as a single document from the Finder or from within *Excel* (for example, a system containing a worksheet, a macro sheet, and graphs)
- create a "living" table of contents for a large worksheet
- print irregularly shaped (nonrectangular) worksheets without printing all the blank pages in between.

## Secret #1: Linking Spreadsheets

Linking *Excel* worksheets is a real asset in many business situations. Linking lets you consolidate information from several worksheets into a summary worksheet. In a budget forecast, for instance, you can combine expense figures forecast by each department head to determine the company's total cash requirements.

In *Excel* parlance, the department worksheets are called *supporting* documents. The summary worksheet is called a

*dependent* document because it contains formulas that retrieve values directly from one or more supporting documents. When you open a summary worksheet, its formulas seek information from supporting documents named in those formulas, even if the supporting documents are not open at the time. Whether or not you can retrieve values from closed documents, however, depends on the way the formulas are constructed.

### Simple versus Complex

*Excel* can retrieve values in closed supporting documents if the formulas in the summary worksheet contain "simple external references" but not if they contain "complex external references." A simple reference refers to a specific cell or range of cells in a supporting document. This can be an absolute cell or range reference, such as "Department1!\$C\$14," or a range name, such as "Department1!January\_Total."

A simple reference must also refer to only one such cell or range name in a formula at a time. Consequently, you can't add, subtract, or perform any function on two or more external references within a formula without creating a complex reference. The formula "= Department1!\$C\$14 + Department1!\$C\$15" is a complex external reference.

Once opened, a summary worksheet attempts to update the supporting documents. If they're closed, a dialog box asks whether you wish to update references to nonresident (that is, not open, or not resident in memory) worksheets. The updating process will be successful if the formulas linking the summary worksheet to

the dependent documents contain only simple references, but not if complex references are used. So much for theory. Let's look at some examples.

### The Problem

Figure 1 illustrates two simple supporting worksheets that list sales, expenses, and profits for each month of the first calendar quarter. Figure 2 shows two different methods of referencing external cells after *Excel* has attempted to update those references without opening the supporting documents. Notice the #REF! error message in cell B19. This message indicates that *Excel* had trouble with the reference in the formula. That formula, “= sheet1!\$B\$3 + sheet2!\$B\$3,” attempted to add the January sales figures from two nonresident worksheets, making it a complex external reference (see Figure 3). This formula would work only if the two supporting documents and the summary document are open simultaneously.

### The Solution

The second method solves this problem by using formulas containing only simple references, namely, “= sheet1!\$B\$3” in cell B10 and “= sheet2!\$B\$3” in cell B14. Each formula refers to a specific absolute reference cell in one external sheet. With the simple references working fine on the summary worksheet, you can go ahead and use the imported values in the summary sheet's own calculations. Therefore, in cell B4, the formula “= B10 + B14” adds the values fetched by *Excel* in cells B10 and B14.

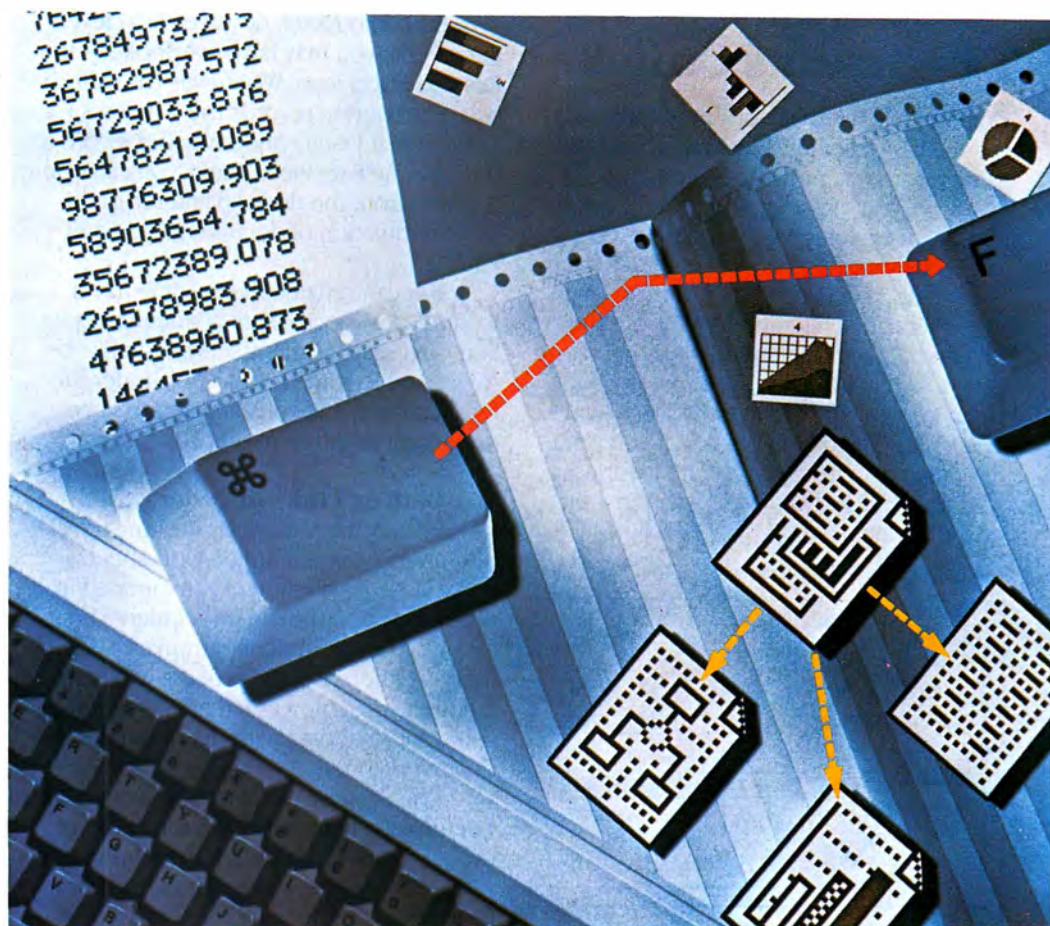

MARK FARRIN

The formulas referring to nonresident worksheets must be either absolute references (indicated by dollar signs on both sides of the cell references) or range names. A relative reference in the formula (for example, “= sheet1!B3”) would make this a complex reference. Therefore, if you think you might rearrange cell locations on a supporting worksheet, you should define as many cells as possible with range names (using the Define Name choice on the Formula menu) and refer to cells by name rather than by cell number. Since *Excel* considers a reference to a nonresident worksheet's range name to be a simple reference, you won't lose track of supporting cells as you adjust the supporting document's layout.

### Saving Memory

All of the foregoing have a significant impact on the way you organize your linked worksheets and use memory. Complex references, as it turns out, allow you to accomplish much more on the summary worksheet with as few cells as possible—

you can perform calculations that refer directly to external cells. Your summary document, therefore, will be compact, but all supporting documents must be open at the same time.

If you use simple references, however, you must essentially replicate the data cells from the nonresident sheets on the summary sheets to perform calculations on those values. While this may require a large summary sheet, it still may be more parsimonious with memory than using complex references, because you need only the extra room on the summary worksheet for the raw values. Since you'll likely be totaling or performing other calculations on the data, you don't need to import the totals from the nonresident sheets. Therefore, by using simple external references, you may very well use less total memory to achieve the same results of linking the data.

(continues)

## Secret #2: Documents Unite!

Creating macros that work independently of specific worksheets lets you reuse the same macro in a number of situations. However, you must remember to open the macro sheet along with the worksheet. You can usually open several documents from the desktop at once by Shift-clicking each document and choosing Open from the File menu. Opening linked documents can be problematic because you must open them in a specific order. Otherwise, you risk having the dialog box ask if you want to update data from nonresident worksheets; you're only allowed to open a single document.

	A	B	C	D	E
1	DEPARTMENT 1				
2		January	February	March	Q1 Total
3	Sales	1000	2000	2500	5500
4	Expenses	200	600	1000	1800
5	Net Profit	800	1400	1500	3700

	A	B	C	D	E
1	DEPARTMENT 2				
2		January	February	March	Q1 Total
3	Sales	300	500	1200	2000
4	Expenses	100	750	500	1350
5	Net Profit	200	-250	700	650

**Figure 1**  
With department profit figures used as supporting documents, and the same spreadsheet layout for each department, values can be easily linked to a dependent document (see Figure 2).

	A	B	C	D	E
1	SUMMARY				
2		January	February	March	Q1 Total
3	Sales	1300	2500	3700	7500
4	Expenses	300	1350	1500	3150
5	Net Profit	1000	1150	2200	4350
6	-----				
7	Simple:				
8	From	1000	2000	2500	
9	Sheet 1	200	600	1000	
10	From	300	500	1200	
11	Sheet 2	100	750	500	
12	Complex:				
13	From Both	#REF!			

**Figure 2**  
A dependent document can retrieve information from nonresident supporting documents when the references to those unopened documents are simple references. A complex reference generates a #REF! error, as shown in cell B19.

## The Resume Excel Icon

Built into *Excel*, however, is a clever device that you may have overlooked—the Resume Excel icon. Whenever you quit *Excel*, the program records the windows open at that instant and saves the record as the Resume Excel icon. Later, you can open the icon from the desktop and return to the combination of documents you quit earlier.

You can rename the Resume Excel icon to save specific sets of documents. You can create as many sets as you like by saving the Resume Excel icons under different names, and you can use the same document in different sets.

## Getting Links in Order

Be careful when your Resume Excel documents contain linked worksheets; make sure the documents are opened in order. Open supporting documents first, followed by dependent (summary) documents. Otherwise, the process will be curtailed by the dialog box that asks whether you want to update with data from nonresident worksheets.

The Resume Excel icon first opens the document whose window was on top of the stack when you quit. If the summary worksheet is on top, you'll have to "bury" its window before you quit. Choosing **Alt-M** quickly places the topmost window at the bottom of the stack. Conversely, **Shift-Alt-M** brings a buried window to the top.

	A	B	C	D	E
1	SUMMARY				
2		January	February	March	Q1 Total
3	Sales	=B10+B14	=C10+C14	=D10+D14	=SUM(B4:D4)
4	Expenses	=B11+B15	=C11+C15	=D11+D15	=SUM(B5:D5)
5	Net Profit	=B4-B5	=C4-C5	=D4-D5	=SUM(B6:D6)
6	-----				
7	Simple:				
8	From	=sheet1!\$B\$3	=sheet1!\$C\$3	=sheet1!\$D\$3	
9	Sheet 1	=sheet1!\$B\$4	=sheet1!\$C\$4	=sheet1!\$D\$4	
10	From	=sheet2!\$B\$3	=sheet2!\$C\$3	=sheet2!\$D\$3	
11	Sheet 2	=sheet2!\$B\$4	=sheet2!\$C\$4	=sheet2!\$D\$4	
12	Complex:				
13	From Both	=sheet1!\$B\$3+sheet2!\$B\$3			

**Figure 3**  
A simple external reference fetches data from only one nonresident cell. Math operations can then be performed on that data, as shown in B4:E6. The formula in cell B19 attempts to retrieve data from two external cells at once. Both supporting documents must be open for the summary sheet to "see" this data.

## Secret #3: Spreadsheet Rapid Transit

Large worksheets usually consist of several small, distinct areas that are interrelated. A construction proposal, for example, might contain several subsections for calculating estimated cost and schedule details. The information in the subsections provides backup material for another subsection—a one-page summary contained elsewhere on the worksheet.

Large worksheets present two difficulties: moving between subsections is slow; and when you do move, it's easy to lose your bearings. By creating a simple macro, you can point to any cell in the summary sheet and issue a keyboard command, and you'll be moved directly to the related backup material on the worksheet. A second macro returns you to the summary page. Figure 4 shows a worksheet with a summary page that represents a 1040 tax form. In another section of the worksheet, several backup forms represent different tax schedules.

## The Reference Section

To make a single macro work regardless of the cell you select, you must create a new section in the worksheet, such as the area called "Replica" in Figure 4. This section, located 100 rows below the 1040 form, holds the references to the

names of the backup forms. After placing the *Excel* cell pointer on a cell containing the amount extracted from a supporting form, choose Option-⌘-f (or another keyboard equivalent you've specified), and the short macro will look in the cell in the same column, 100 rows down, where it will find the name of the desired schedule's cell range. The formula immediately scrolls to that schedule. Pressing Option-⌘-x initiates the second macro, restoring the view of Form 1040.

### Creating the Macro

The macro listings are shown in Figure 5. To create the macros, perform the following operations:

1. Choose New from the *Excel* File menu.
2. In the resulting dialog box, click the macro sheet button and OK.
3. Type in the listings on the macro sheet just as they are shown in Figure 5. Pay particular attention to location of parentheses.
4. Select cell A1 on the macro sheet and choose Define Name from the Format menu.
5. The name of the macro ("jump") will already appear in the Define Name dialog box. Click on the button to the left of the word *Command*. This will activate the small text box in the lower-right corner of the dialog box.
6. Press the Tab key twice to advance the text pointer to that small box, and type the letter you wish to use as a keyboard macro ⌘ equivalent. Then click OK.

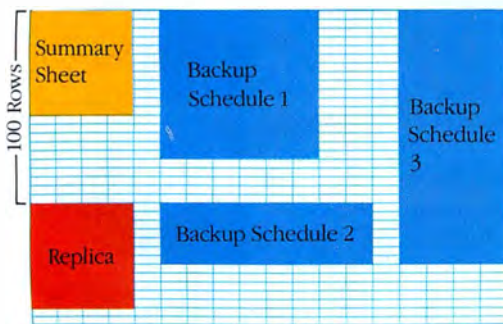

**Figure 4**  
In a large worksheet, a summary sheet area may rely on values calculated in several supporting subsections on the sheet. The cell range for each form is defined with a recognizable name, such as "SchedB." By placing the range names of the backup areas in the Replica area, a simple macro zips the desired backup area into view.

7. Select cell A5 on the macro sheet, and choose Define Name from the Format menu.
8. As in step 5, click on the ⌘ button.
9. Tab the text pointer to the small text box and type any lowercase letter as a keyboard command to return to the main form. Then click OK.
10. Choose Save As from the File menu and assign an easily recognizable name to this macro sheet (if you're using HFS, save the macro in the same folder as the worksheet).

In the 1040 form you can add more cells linked to other worksheet areas without revising the macro. Simply type the range name of the supporting worksheet area into a cell 100 rows below its value on the 1040 form.

You can also use this macro to create a table of contents for an *Excel* document that is divided by pages. After listing the page titles and page numbers as they might appear in a book's table of contents, select the cell containing the page number and issue the macro, and *Excel* will bring that page to the screen in an instant.

If you are creating an *Excel* environment for inexperienced users, you might want the macro to summon instructions for particular entry cells. When unsure about the kind of data to put in a cell, the user could issue the macro, which would then shift the view to a context-sensitive help screen from elsewhere on the worksheet.

## Secret #4: Print No Blanks

As the previous document demonstrates, *Excel* worksheets (or interesting areas thereof) can grow to nonrectangular proportions. When you print large worksheets, however, you may often produce

blank or unnecessary pages that make the document unwieldy and difficult to read. This problem is caused by blank areas of the spreadsheet and areas used for calculation that are unnecessary for the final report.

The good news is that *Excel* lets you bypass the pages you don't want to print, even if the resulting print area is oddly shaped. Print areas must be contiguous, and you cannot specify more than one print area at a time.

### Selecting a Print Area

Selecting a nonrectangular print area is easy. Simply choose contiguous rectangles while holding down the ⌘ key until you build up the shape you want.

When you have marked the area, release the ⌘ key, pull down the Options menu, and choose Set Print Area. This action creates a named range on your worksheet called Print\_Area just as if you had selected those cells and named them yourself with the Define Name menu command. In fact, if you choose Define Name from the Format menu, you will see that the Print\_Area range has been named for you automatically.

Now when you print, only the areas selected and assigned to Print\_Area will be printed. Later, if you want to print a different section, select the appropriate cells on the worksheet and choose Set Print Area again. But if you want to print the entire worksheet, then be sure to delete Print\_Area from the Define Name dialog box.

These four tips should keep you going for a while. Try them in your *Excel* work, and let us know how you're doing. □

**Danny Goodman**  
is a Contributing Editor to *Macworld* and author of *Hands-On Excel* (1986; Scott, Foresman & Co.).

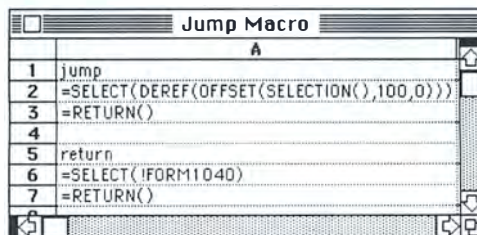

**Figure 5**  
The top macro, "jump," looks for the name of the desired backup area in a cell 100 rows below the location of the cell cursor. Return always returns the view to the summary sheet.

*Excel*  
Microsoft Corp.  
16011 N.E. 36th Way  
Redmond, WA 98052  
206/882-8080  
List price: \$395

*The Macintosh tackles the final frontier at Martin Marietta, where engineers are using it to design the space station and shuttle. Pictured is Gerry Simonson at the company's Denver Aerospace Facility.*





# Desktop Engineering

**Paul Freiberger and Dan McNeill**

*The Macintosh is helping design the space station. It started when an engineer at Martin Marietta took a Lisa computer to work. Others liked it, and soon the company ordered more. When the Macintosh appeared, project managers began supplying them to engineers' desks in bulk.*

*The story is typical. Over the last few years, thousands of Macintoshes have quietly filtered into the engineering departments of companies like Hughes Aircraft and McDonnell Douglas. And for every one of those, there are probably ten more in smaller environments.*

While administrators have tended to favor IBM, the Macintosh has won acceptance mainly from the engineers themselves. "Many corporations say they swear by IBM, but what you see when you walk in are Macs," says Marvin Kreithen of Bridgeport Machines. Apple intends to promote desktop engineering—primarily in the area of CAD (computer-aided design)—much as it previously pushed the concept of desktop publishing. This commitment greatly heartened third-party developers, and several first-rate Macintosh CAD programs are already available.

## **The Macintosh Edge**

The Macintosh is a newcomer in the engineering design and drafting domain, but it has some distinct advantages. One is price. The least expensive Apollo workstation now costs around \$9000. An IBM PC AT with an enhanced graphics board and an enhanced monitor sells for about \$4500, and *AutoCAD*, the reigning prince of IBM PC CAD software, ranges from \$1000 to \$2500. A Macintosh with a second disk drive sells for around \$2495, and CAD programs cost between \$400 and \$2495—bringing the price of a Mac design station to no more than \$4990.

Another advantage is the Macintosh user interface, which allows engineers new to the Mac to start

working in a few hours and become fluent in two weeks. You need days of training to use *AutoCAD* and weeks or months to become fluent.

A third Macintosh advantage is that it lets you move designs easily from program to program at different stages of a project. For instance, you could easily shift a CAD drawing via the Clipboard to *MacPaint* for touching up, then transfer the drawing to *PageMaker* and print a high-quality technical document.

## **CAD Fundamentals**

Creating, editing, transmitting, and storing drawings are completely electronic processes with CAD. CAD programs give you instant erasure and numerous special aids for structured drawing. For creating designs with specific lengths, widths, and depths, most CAD programs display a grid and automatically calculate and draw tangents, fillets, circles, perpendiculars, and different views of an object. They also have multiple layers, which you display as you choose.

For adding cross-hatching and labels, most programs offer several fonts and fill patterns, as well as automatic dimensioning. This last feature is essential because manually calculating height and width outside a drawn item is such a time-consuming process.

Lower-level programs like *MacDraw* and *MacDraft* are relatively inexpensive and can help conceptualize floor plans and machine parts. But they don't offer multilayering, perspective views, or rotation from one plane to another, nor do they support large plotters. Programs like *Mac3D*, *Easy3D*, and *MacSpace* let you draw and manipulate objects in three-dimensional space (see "3-D In Depth," *Macworld*, June 1986), but they lack the features needed to solve sophisticated engineering problems.

### The New CAD Programs

Among Macintosh CAD programs, *EZ-Draft* and *Professional CAD for the Mac* appeal to mechanical engineers, who need a rather rigid format; *Dimension* appeals to designers and architects, who like the numerous fonts and fills, the ability to stretch circles and squares on the screen, and the greater freehand capacity.

Bridgeport Machines' *EZ-Draft*, the first of the Macintosh CAD packages, permits six views of an object—top, bottom, and four sides—and lets you project from one to another. With what Bridgeport calls *dynamic dimensioning* you create dimensions with or without tolerancing data and move and edit the dimensions easily. *EZ-Draft* has 256 layers, an IGES (International Graphics Exchange Standard) interface for communicating with mainframes, a macro capacity, and good documentation. An upgrade, which at press time was slated for release in mid-August, includes an Undo command, fonts and fillets for architects, and a tenfold increase in speed. *EZ-Draft* was originally ported from VAX and Apollo machines; future releases will follow the Macintosh user interface more closely. Bridgeport is also developing a translator that allows *EZ-Draft* to read *AutoCAD* files.

*EZ-Draft* is clearly the most complete CAD program available on the Macintosh, but the new version will require 1 megabyte of RAM and cost \$2495.

*Professional CAD for the Mac*, from Micro CAD/CAM, is a smaller, less expensive package that fits onto a single 400K disk and sells for \$800. Like *EZ-Draft*, *Professional CAD* addresses mainly mechanical engineers and has good preliminary notices. The program offers 40 layers, mirroring, adjustable grids,



Glowing globes created in Visual Information's *Dimension* via ray tracing and displayed on the VMI Intelligent Monitor.

splines, and an interface to most plotters. *Professional CAD* also works with the company's CAM software. To fit *Professional CAD* onto a 400K disk and get the program to run efficiently on a 512K Mac, Micro CAD/CAM had to sacrifice 3-D capability, an Undo command, and a macro language. However, *Professional CAD* sells for a third of the price of, runs faster than, and follows the Mac user interface better than *EZ-Draft*. Future plans for the product include 3-D projection, an IGES interface, and additional architectural fills.

*Dimension*, a \$750 program from Visual Information, specializes in conceptual design. The program lets you create surface-sculptured solid models and is the first Macintosh CAD program with a true 3-D database. *Dimension* rotates the perspective and manipulates up to 16 simultaneous views; the program includes mirroring, infinite nested groups, and color options. *Dimension* should appeal mainly to architects, engineers, and others preparing technical documents. Ideally, *Dimension* should let you move designs to 2-D programs to create more precise renderings. To that end, Visual Information is working with 2-D program developers so that files can be exchanged.

*Minicad*, from Diehl Graphsoft, began as a one-person project at the Johns Hopkins Applied Physics Lab. After several incarnations, it became a two-dimensional CAD system with a three-dimensional designer. Objects can transfer freely between the 2-D and 3-D modules, with no size restriction. The 2-D portion is *MacDraw*-like but with higher precision, 15 layers, and color capacity. And the program formats for standard A, B, C, D, E, and F plotter sheets. However, the \$395 *Minicad* still lacks a macro language and fill capacity and doesn't yet support IGES.



Professor William R. Dale at Cal Poly, Pomona. Cal Poly's computer-aided design program is one of the largest in the country, with over 1200 architecture, landscape architecture, and planning students.

## Templates

Like *MacPaint*, CAD programs can be supplemented by templates—clip-art-like drawings that plug right into a design. Architects, for instance, require illustrations of items such as gates, doors, windows, and trees. The number of templates available for a CAD program can greatly affect its value. *AutoCAD* on the IBM PC is no longer the most efficient CAD software around, but it benefits greatly from the number of templates written for it. This fall CompServCo expects to introduce one architectural and two engineering templates for both *EZ-Draft* and *Professional CAD for the Mac*. The company already offers *MacCAD*, a collection of 12 libraries of three to four disks each for *Mac-Draw* and *MacDraft*.

## Specialty Software

A great variety of specialty programs are also available. For example, SolarSoft offers *Sumpas* to help engineers and architects calculate indoor temperatures for buildings. A different kind of specialty program aids printed circuit board (PCB) designers. Vamp sells *McCAD*, a series of sophisticated integrated CAD modules that automates the PCB design-and-analysis process. *McCAD* modules are currently in use at companies like Hughes, Motorola, and RCA. Bishop Graphics' *Quik Circuit* helps engineers to create products efficiently for the Macintosh itself. With this program Micrographic Images designed and laid out its first 1-megabyte upgrade board in a day and a half.

Two more specialty programs deserve mention here: *DesignScope*, from BrainPower, allows an engineer to take a block diagram, assign parameters, and run a simulation to see if the design works; *Frame-Mac* is a structural engineering package that Erez Anzel distributes for designing and analyzing two-dimensional frames or trusses with any number of nodes and prismatic elements. Anzel also developed *Beamac II*, a program for analyzing and designing continuous (indeterminate, multispans) or simply supported beams.

## Configurations of Macintosh CAD

The Macintosh is most often used for CAD in conjunction with other computers. In the space station program at Martin Marietta, where some engineers have IBM PCs, Centram's *TOPS* network connects all the computers. However, the Mac generally links to larger machines, either as a complement or as a terminal.

Given the cost of minicomputer workstations, companies often buy Macs for simple work and reserve their minis for more complex tasks. Other companies tie the Mac, as a terminal, to a larger system. At Alcoa's Technical Center near Pittsburgh, Macs act as VT-100 and Tektronics graphics terminals for engineers seeking to improve metalworking processes.

Academia is also advancing the idea of connecting the Mac to other computer systems. At the University of Michigan, the MacApollo Project is developing a distributed computing environment to serve more than 6000 students and teachers. The project has al-

ready achieved its first milestone: an RS-232 connection between a Mac and an Apollo. This product is available in the public domain through the Apollo Domain Users Society. Eventually the MacApollo Project should connect several Macs on a network to a gateway for an Apollo network.

## The Mac's Future

The Macintosh is not yet the dream machine for desktop engineering, but it's making headway. For designers who prefer a larger CRT, the MegaScreen, from Micrographic Images, offers 1024- by 921-pixel resolution and increases the Mac's display size by four to six times. MegaScreen currently works with most CAD programs, with the major exception of *EZ-Draft*.

Colors make the layers of a complex drawing much more distinct, a real plus for applications such as floor plans and topographical maps. Fortunately, a full-color, 640- by 480-pixel screen is available for the Mac from Vermont Microsystems. The company also makes "smart" boards that convert CAD specifications to screen images displaying up to 256 colors at once, out of a palette of 250,000. However, programs must be written specifically for these boards; thus far, only *EZ-Draft* and *Dimension* work with them. The monitors retail at \$2195 for the 13-inch model and \$4495 for the 19-inch model. When Apple comes out with its new Macintosh next year, the Vermont Microsystems graphics boards should plug right in.

Since CAD programs perform many calculations over and over, a 68881 floating-point coprocessor, which handles over 40 complex mathematical functions, speeds up the design process considerably. Four upgrades substantially increase the Mac's processing power: Novy Systems' Floating Point Accelerator; Qesse Computer's Maccelerator; the HyperDrive 2000, from General Computer; and the Levco Prodigy 4. All four boards supply the Mac with a floating-point coprocessor; in addition, the Levco and General Computer products replace the Mac's 68000 processor with



VAMP's George Soluk waits while a plotter rolls out a printed circuit design created in *McCAD*.

## A Sampling of CAD Products for the Mac

### DesignScope

BrainPower  
818/884-6911  
List price: \$249.95

### Dimension

Visual Information, Inc.  
818/918-8834  
List price: \$750, Dimension/  
Color \$1250, solid shading  
add-on module \$995

### Easy3D

Enabling Technologies, Inc.  
312/427-0408  
List price: \$99

### EZ-Draft

Bridgeport Machines  
215/659-5055  
List price: \$2495, \$1995 limited-  
time introductory offer

### Floating Point Accelerator

Novy Systems Inc.  
904/427-2358  
List price: \$449

### Frame-Mac, Beamac II

Erez Anzel  
212/884-5798  
List price: Frame-Mac \$495,  
Beamac II \$295

### HyperDrive 2000

General Computer Corp.  
800/422-0101, 617/492-5500  
List price: \$3195

### Intelligent Monitor

Vermont Microsystems, Inc.  
800/354-0055, 802/655-3800 in  
Vermont  
List price: 13-inch \$2195, 19-  
inch \$4495

### MacCAD

CompServCo  
800/272-5533, 504/649-0484  
List price: \$69 to \$169 per tem-  
plate package

### Maccelerator with Quick- SANE software

Quesse Computer Co., Inc.  
206/392-7701  
List price: \$495, \$995 bundled  
with the Consulair Direct Ac-  
cess C Compiler and installa-  
tion kit

### MacDraft

Innovative Data Design, Inc.  
415/680-6818  
List price: \$239

### MacDraw

Apple Computer, Inc.  
408/996-1010  
List price: \$195

### MacSpace

Abvent  
213/659-5157  
List price: \$395

### McCAD

Vamp Inc.  
213/466-5533  
List price: \$395 to \$595 per  
module

### McNET

Argus Software  
617/475-8952  
List price: \$250, Components  
Library Builder \$100, demo  
disk \$50

### MegaScreen

Micrographic Images Corp.  
818/407-0571  
List price: \$2995, without  
monitor \$1495

### Minicad

Diehl Graphsoft  
301/461-9488  
List price: \$395

### Prodigy 4

Levco  
619/457-2011  
List price: \$7000

### Professional CAD for the Mac

Micro CAD/CAM Inc.  
213/838-7851  
List price: \$800

### Quik Circuit

Bishop Graphics CAD  
Systems Corp.  
818/991-2600  
List price: \$695, \$15 for  
demo disk

### Sunpas

SolarSoft, a division of Kinetic  
Software, Inc.  
415/342-3338  
List price: \$189

a faster chip. (For a thorough discussion of these up-grades see "New Ways to a Faster Mac," *Macworld*, August 1986.)

Many observers think Apple's next Mac or Mac-like machine will feature a 68020 CPU and a 68881 coprocessor. It may also have UNIX, which has become a standard in the technical world. Such a computer would spread the CAD revolution even further and faster. To that end, Apple recently acquired rights to Cadmus Computer Systems' proprietary software, which is based on a UNIX workstation that runs on the 68020 microprocessor and has the graphics user inter-

face of the Macintosh and a distributed file system for Macs and IBM PCs.

But even without such a super-CAD device, the Macintosh is well poised to shape the contours of desktop engineering and perhaps become one of engineers' premier machines. □

●●●●●●●●●● *Paul Freiburger and Dan McNeill are coauthors of Computer Sense (Bantam, 1986) and other books and contributors to MacOffice (Compute! Publications, 1985).*

# INTRODUCING TOPS<sup>®</sup>

## The Macintosh<sup>™</sup> Network that teaches IBM<sup>®</sup> how to share.



**N**ow, for the first time, your Macintosh can share files, even peripherals with your IBM PC or compatible. So, for the first time, it's not necessary to have an all Mac or all PC office.

TOPS is the only local area network that connects the Macintosh with PCs. And it's the only one to provide direct real time communications between these operating systems.

### TOPS in Compatibility

TOPS is 100% AppleTalk<sup>™</sup> compatible. For the first time, you can access and work on files stored on remote drives, exactly as if they were in your own computer. Regardless of operating system.

For example, you can access your IBM Lotus 1-2-3<sup>™</sup> files and modify them on your Macintosh under MicroSoft Excel.<sup>™</sup> Then save them on your remote IBM hard disk!

### TOPS in Versatility

TOPS is three networks in one: Mac to Mac, Mac to PC, PC to PC. TOPS is the only Mac to Mac distributed file server network. And TOPS works with all Macintosh hard disks. Plus TOPS is the only network to offer Mac users real record and file locking.



TOPS makes IBM PCs transparent to Macs and vice versa. Users never even know TOPS is there because it operates invisibly with no disruption in computer functions. No special procedures are needed to access remote programs or files. And as a full function network, TOPS is the easiest to set up and use.

### TOPS in Price Performance

TOPS eliminates the need for an expensive file server. Any Mac or PC can be a file server or user at the same time. TOPS for the Macintosh consists of one piece of software for each Macintosh



on the network, and costs just \$149@. TOPS for the PC consists of software and a board for each PC, together priced at a low \$389. Networks that don't even come close in performance can cost three times as much.

Whether you're using all Macs, all PCs or Macs and PCs, we're so convinced that TOPS is the best network you can buy that Centram is offering a special introductory 30-day money back guarantee. Don't waste a minute. Call and order TOPS today.

And get your IBM on speaking terms with your Macintosh.

For inquiries, call 415/644-8244 or write Centram Systems West, 2372 Ellsworth Ave., Berkeley, CA 94704.

**Introductory 30-Day  
Money Back Guarantee**  
For orders, call

# 800-227-3900

in California call 800-632-2122

 **Centram**  
systems west

Macintosh is a trademark licensed to Apple Computer, Inc. IBM is a registered trademark of the International Business Machines Corp. AppleTalk is a registered trademark of Apple Computer, Inc. Lotus 1-2-3 is a trademark of Lotus Development Corp. Excel is a trademark of MicroSoft Corp. TOPS is a registered trademark of Centram Systems West, Inc.



TOPS for the PC, \$389

TOPS for the Macintosh, \$149

Circle 524 on reader service card

# Microsoft Excel. For those who

You may speak more softly now.  
For we are delivering into the hands of  
business, a very big stick.

Microsoft® Excel for the Macintosh.™ A  
financial analysis tool of unprecedented  
power.

First and foremost,  
Microsoft Excel  
is the most

formidable spreadsheet ever to run on a  
personal computer.

A spreadsheet which is in turn linked  
with an extraordinary graphics program and  
a highly capable data filing application.

These already consider-  
able powers are magnified  
geometrically by Macros.

Which give Microsoft Excel

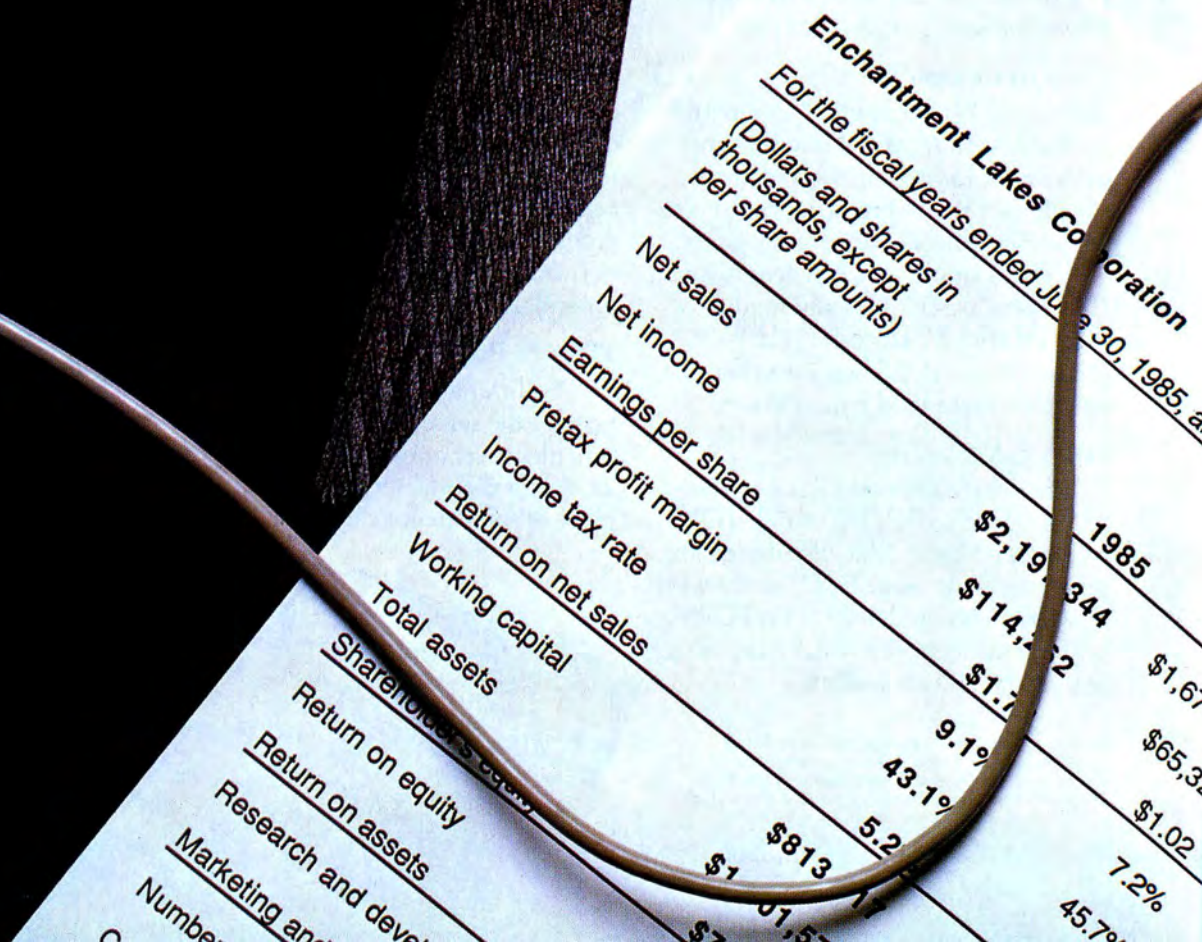

**Enchantment Lakes Corporation**  
*For the fiscal years ended June 30, 1985, and 1984*  
(Dollars and shares in thousands, except per share amounts)

	1985	1984
<u>Net sales</u>	\$2,190,344	\$1,670,000
<u>Net income</u>	\$114,352	\$65,300
<u>Earnings per share</u>	\$1.75	\$1.02
<u>Pretax profit margin</u>	9.1%	43.1%
<u>Income tax rate</u>	5.2%	7.2%
<u>Return on net sales</u>	5.2%	45.7%
<u>Working capital</u>	\$813	\$1,015
<u>Total assets</u>	\$1,015	\$1,015
<u>Shareholders' equity</u>	\$1,015	\$1,015
<u>Return on equity</u>	5.2%	45.7%
<u>Return on assets</u>	5.2%	45.7%
<u>Research and development</u>	\$1,015	\$1,015
<u>Marketing and advertising</u>	\$1,015	\$1,015
<u>Number of shares outstanding</u>	125,000	125,000

# appreciate the uses of power.

the capacity to learn your most complex routines. And activate them with a single keystroke.

Yet for all its ability, Microsoft Excel is simple to learn, simple to use. No complex commands to memorize. No classes to take. The only thing complicated about Microsoft Excel is the problems it can solve.

See your Microsoft dealer for a demon-

stration of the powers of Microsoft Excel.

In the right hands, a potent weapon, indeed, in the cause of commerce.

We trust you will use it responsibly.

## Microsoft Excel

The rest are history.

You can upgrade to Microsoft Excel from Microsoft Multiplan® (Macintosh version) for a suggested retail price of just \$200. See any participating Microsoft dealer. For the name of the nearest one, call (800) 426-9400. In Washington State and Alaska, (206) 882-8088. In Canada, call (416) 673-7638. The upgrade offer is good only in the United States and expires on 12/31/86.

Microsoft is a registered trademark of Microsoft Corporation.  
Macintosh is a trademark licensed to Apple Computer, Inc.





# HOW TO EXPAND YOUR MEMORY WITHOUT LOSING YOUR MIND.

**MAC SNAP** If choosing a memory upgrade for your Macintosh is threatening your sanity, bring your problems to the silicon shrinks at Dove Computer. Our new MacSnap™, MacSnap 2™ and MacSnap+™ will give your Mac more RAM, and let you work up to 60% faster, without driving you or your machine crazy.

All you do is give your local computer dealer ten minutes to literally "snap" our RAM expansion board into your Macintosh. No trace cutting. No soldering. In fact, you can even do it yourself with a MacSnap User Kit, also available from your dealer.

Using all the extra speed and capability is a snap, too, because you get complete, easy-to-understand documentation and a quality upgrade designed to improve your productivity. MacSnap is fully compatible with all Macintosh system software, but it doesn't stop there. It comes with its own performance software package that includes Switcher, a user-configurable RAMdisk and a print spooler.

With up to 60 percent more speed than a 512K Mac, MacSnap speeds up those normally cumbersome programs

like EXCEL and JAZZ and even allows them to run simultaneously with only a single disk drive. In addition, MacSnap's print spooling capability lets you print one document while working on another.

MacSnap is fully compatible with HyperDrive and Apple's 128K ROM, too.

The original MacSnap comes in three models: 128K to 1.5 megs, 512K to 1.0 megs, and 512K to 2.0 megabytes.

MacSnap 2 takes your 512K Mac all the way to 4.0 megabytes, and includes the new SCSI. It's the sane way for 512K Macowners to get better than Mac Plus performance.

MacSnap+ takes a Macintosh Plus from 1.0 to 4.0 megs, to give you more of the performance and speed you bought it for.

So go ahead. Before you lose *your* mind, call Dove Computer toll free, for the name of your nearest dealer. Or visit your dealer, and ask for MacSnap.

**1-800-MAC-SNAP**

In NC, call (919)763-7918



**DOVE**

COMPUTER CORPORATION  
P.O. Box 7008  
Wilmington, NC 28406

## PC Productivity Enhancement Products

Macintosh is a trademark licensed to Apple Computer Inc. Switcher, EXCEL, JAZZ and HyperDrive are registered trademarks of Apple Computer Inc., Microsoft, Inc., Lotus Development Corp., Inc., and General Computer Corp., respectively. MacSnap, MacSnap 2 and MacSnap+ are registered trademarks of Dove Computer Corp.

Circle 498 on reader service card



# Macware Reviews

*ComicWorks, Record Holder, FullPaint, MaxThink, KidsTime, Uninvited, MacKeymeleon, MacInker, and Orbiter*

*Edited by Erfert Nielson*

## Comic Relief

Considering the levity of the Sunday comics, it's sometimes difficult to appreciate the amount of work that goes into them. But as anyone who has ever drawn a comic strip knows, cartooning is a labor-intensive art. **ComicWorks** promises some relief from the drudgery of creating repetitive panels by providing a cartoonist's wish list of features specifically geared to producing comic strips and comic books. *Macworld* examined a prerelease version of this exciting new program, which was developed by MacroMind and published by Mindscape.

**ComicWorks** combines the capabilities of bit-mapped programs like *MacPaint* with the object-oriented approach of programs like *MacDraw*. If you're not a cartoonist, **ComicWorks** doubles as a limited desktop publishing program, allowing for the easy integration of text and art in greeting cards, short newsletters, and flyers.

### A Panel Discussion

Whether you're drawing a daily strip or a monthly comic book, the steps are usually the same: ruling panel borders, lettering dialog balloons, and drawing the same characters over and over—often in recurring poses. Creating a comic strip with **ComicWorks** is similar to drawing a strip by hand. To start making panels, click on the New Panel tool, select a spot on the screen, and drag the panel to the size you want. Resize and reshape a panel by dragging its handles.



You then use the New Easel tool to produce a drawing area, an *easel*, within a panel. All the familiar *MacPaint* drawing tools work within this easel (see "Launching a Cartoon"). Unlike a *MacPaint* drawing, however, each easel—and the drawing it holds—exists as an autonomous, movable object, which you can move without disturbing other easels and place in front of or behind them. Numerous easels fit in a single panel to illustrate individual elements such as characters, objects, and background. The Easel Switcher tool lets you find a buried easel by flipping through a panel's stack of easels one by one.

*(continues)*

# Mac Disks

Sony Boxed Disks	
SS	13.90
DS	19.90
Sony Bulk (min. 50)	
SS	1.28
DS	1.85
Verbatim After Rebate	
SS	9.90
DS	15.90
Verbatim disks come with a \$12 rebate on 2 boxes	

## Upgrades

128K-512K	139
512K-1024K	219
128K-1024K	339
SCSI Port	99/125
68020	695

180 Day warranty on all Upgrades

## SCSI Hard Drives

by Rabbit Industries

Magic20 795

Magic30 995

Print Spooling Password Security  
HFS Compatible Backup Software  
*Its So Fast You'll Think It's Magic*

## The Keeper

by Reach Technologies

20 MB	2695
40 MB	3695

## Hardware

MacBottom 20 MB	995
800K Disk Drive	239
Avatex 1200 Baud Modem	100
(Free Compuserve Starter Kit)	
Numeric Turbo	109
Turbo Touch	89

## Ribbons

	1-5	6 or more
Black	3.95	3.00
Colored	4.95	4.00
Multicolored	14.00	13.00

## Accessories

MagicPad	10.95
(the ultimate mouse pad)	
Mouse Mover	12.95
Pocket Pak (holds 12)	7.95
Easel (holds 20)	12.95
Disc Directory (holds 32)	18.95
MacTote	69.00
Print Tote	69.00
Phone Net	38.00
(the Appletalk Alternative)	

## Software

HabaWord 89	MS Flight Sim.	34
FullPaint 68	One on One	29
Mac Golf 35	My Disk Labeler	33
Orbitor 29	Mac Lightning	54
Copy II Mac 20	Hard Disk Utilities	66

## Vision Technologies

\$30 minimum on all orders.  
Shipping minimum \$3 additional.  
Visa, MC, C.O.D., P.O.s, Checks  
Texas Residents add sales tax.

1 (800) MAC-DISK

In Texas or for information:

1-512-473-8393  
2200 Guadalupe Street  
Austin, TX 78705  
Dealer Inquiries Welcome

Circle 459 on reader service card

### Launching a Cartoon

The ComicWorks screen resembles MacPaint, with a few exceptions. Four new tools occupy the top of the tool rack. The palette of dialog balloons, along with the tool rack and other palettes, can be hidden for full-screen drawing.

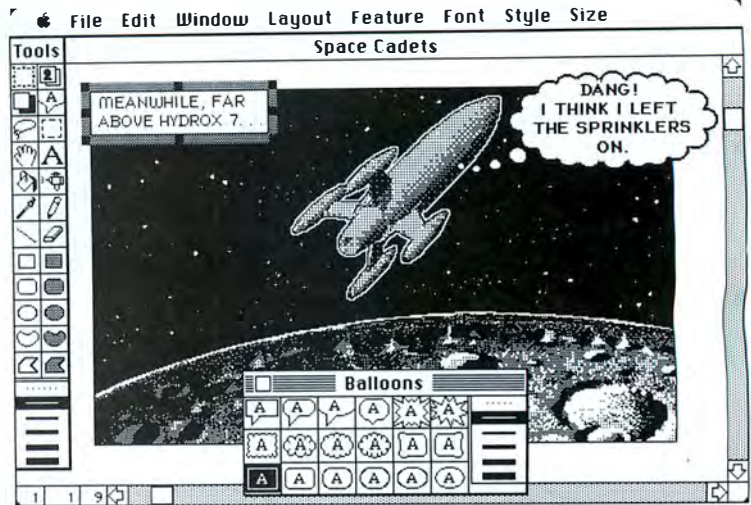

### Meaningful Dialog

The words of comic characters most often appear within the whimsical confines of dialog balloons. You create balloons by dragging a balloon style from a specialized palette containing balloon-style icons and begin typing in the dialog. Unlike with *MacPaint*, text automatically wraps around to fit within the balloon. You can later change the balloon's shape or size; text reshapes itself to match the new balloon's dimensions. Moreover, you can edit a balloon's text at any time, changing fonts, type sizes, styles, and justification. This word processing capability, combined with the ability to place balloons of any shape or size anywhere on a page, allows *ComicWorks* to double as a page-makeup program. A text-filled rectangular balloon with an invisible border can also be interpreted as a column of text.

You can type text in custom comic fonts such as Crypt and Commando or stick to tamer fare like New York and Geneva (or their LaserWriter equivalents, Times and Helvetica) or add fonts with Apple's Font/DA Mover.

### Drawing in Detail

If you thought *MacPaint*'s spray can was pretty good, wait until you see the action on the *ComicWorks* airbrush. You can alter the airbrush's spray size from tiny to large in ten increments by pressing the ten number keys. Then it's up to the plus and minus keys to fine-tune these changes in one-pixel increments. You can also vary the spray density.

Several sizes of FatBits are available, making detail work much easier. And a unique ThinBits feature places a miniature version of the current page next to the full-size page. All of *ComicWorks*' tools and

commands work on both pages. Drawing on the full page lets you sketch a large figure or lay out a page without constantly moving the drawing window. The Show Pages command displays a reduced version of two adjacent pages.

Detail work is further facilitated by buttons that let you move in sequence from page to page, panel to panel, or easel to easel and a grid that resizes to inches, centimeters, or pixels. *ComicWorks* also lets you draw in eight kinds of "ink," which are similar to the special effects in *VideoWorks*. These menu choices let one drawing show through another, reverse blacks and whites when drawings overlap, and so on.

### Print and Paste Extras

Art Grabber+ and PosterMaker are two additional programs that come with *ComicWorks*, along with a disk of clip art by Mike Saenz, creator of *Shatter*, the first comic book produced with the Macintosh. The ArtGrabber+ desk accessory provides easy access to *MacPaint* files from within *ComicWorks*. PosterMaker divides documents into printable subsections for enlarging comic strips or *MacPaint* documents to poster or billboard size. Pasting printed subsections together produces posters as large as 26 feet by 21 feet.

As far as printing goes, *ComicWorks* was designed primarily with the ImageWriter in mind. The program supports the LaserWriter to a certain extent, but printing is slow when bit-mapped graphics and LaserWriter fonts are combined in a document. Like *MacPaint*, *ComicWorks* doesn't

(continues)

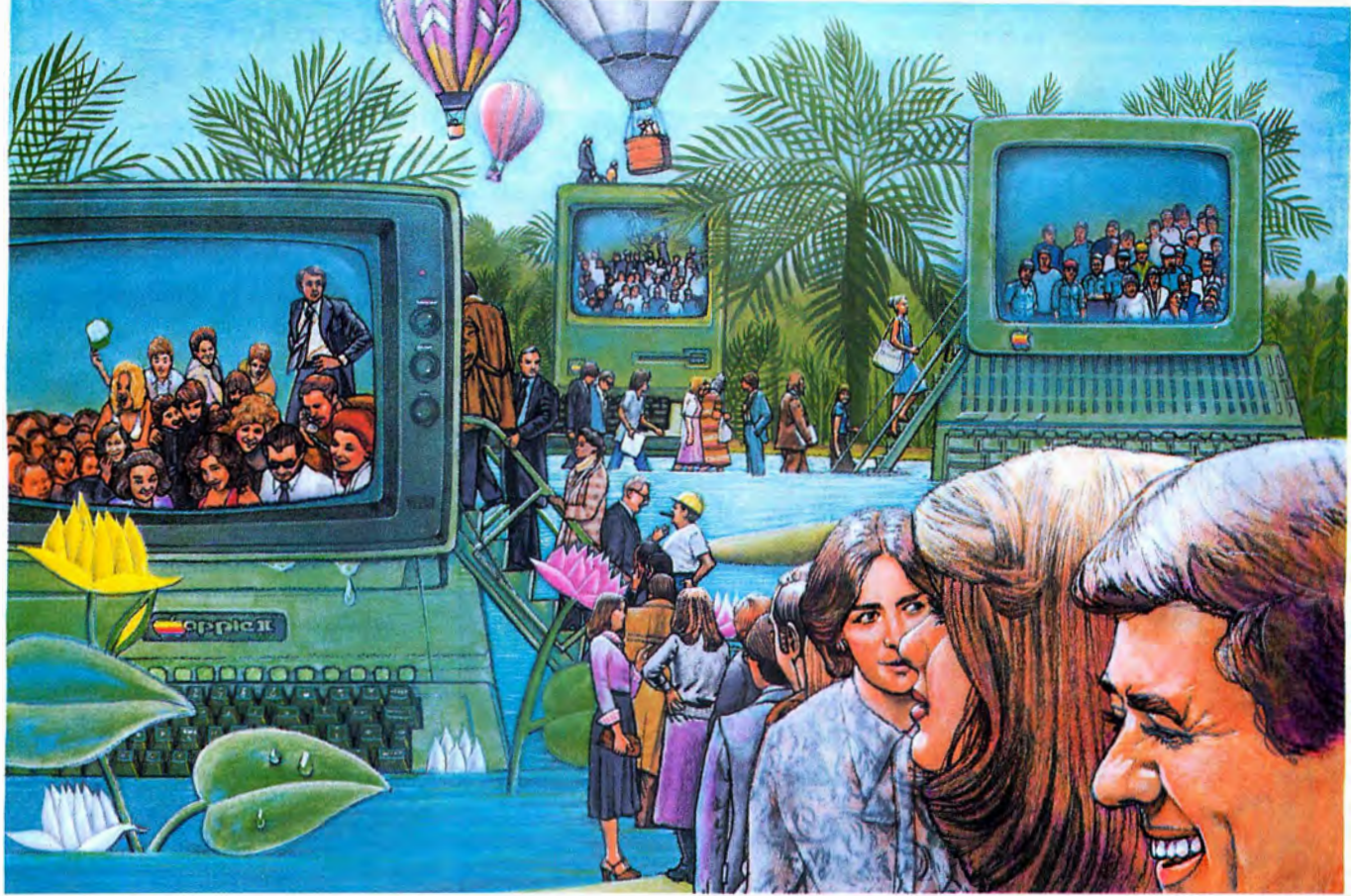

# USE THE BRAINS YOUR APPLE WASN'T BORN WITH.

## Right at your fingertips in CompuServe's Apple® Forums.

Join the CompuServe **Apple II and III Forum** to swap everything from tall tales to short cuts with other users, and explore thousands of classic programs stockpiled since 1979.

Swap programs and files with fellow Mac owners in our **Macintosh® Users Forum**. Questions? You'll get answers from the experts here!

Visit the **Macintosh Developers Forum**. Get updates to the "Inside Macintosh Software Supplement." Interact with the Mac "team" in Cupertino.

The **Apple User Groups Forum**, supported by Apple Computer, unites officers of Apple user groups—"ambassadors" for hundreds of thousands of Apple-active enthusiasts worldwide.

### Easy access to free software.

- Download *First-rate, non-commercial, user-supported software and utility programs.*
- Take advantage of *CompuServe's*

*inexpensive weeknight and weekend rates (when Forums are most active, and standard online charges are just 10¢ a minute).*

- Go online in most major metropolitan areas with a local phone call.
- And receive a **\$25.00 Introductory Usage Credit** with purchase of your *CompuServe Subscription Kit*.

### Information you simply can't find anywhere else.

Use the *Forum Message Board* to send and receive electronic messages, and pose specific questions to Apple owners.

Join ongoing, real-time discussions in a *Forum Conference*—with Apple luminaries like Bill Atkinson, Doug Clapp, Dan Cochran, Jean-Louis Gasse, Mark Pelczarski, John Sculley and Steve Wozniak.

Search *Forum Data Libraries* for free software, user tips, transcripts of previous CompuServe online conferences and more.

### Enjoy other useful services like:

- **Popular Computer Magazines**—electronic editions, for your reading pleasure. Including **Apples Online**, which reprints

Circle 330 on reader service card

*articles from leading user group newsletters nationwide and other Apple-related publications.*

- **Other CompuServe Forums**—supporting *Jazz™* and other *LOTUS®* products. *Microsoft®, MicroPro®, Borland International®, Ashton-Tate®* and other software. Also *Pascal, Basic, C, Forth, Assembly* and other programming languages.

### All you need is your Apple computer and a modem ... or almost any other personal computer.

To buy your *Subscription Kit*, see your nearest computer dealer. Suggested retail price is \$39.95. To receive our free brochure, or to order direct, call 800-848-8199 (in Ohio, call 614-457-0802). If you're already a CompuServe subscriber, type **GO MAUG** (Micronetworked Apple Users Group) at any ! prompt to see what you've been missing.

## CompuServe®

Information Services, P.O. Box 20212  
5000 Arlington Centre Blvd., Columbus, Ohio 43220

**800-848-8199**

In Ohio, Call 614-457-0802

An H&R Block Company

## Levco's Prodigy 4™ Transforms Your Macintosh™ Into a Mini-Mainframe.



### Levco introduces a Macintosh expansion board with twice the speed of a DEC VAX™ 11/780 and three times faster than an IBM PC AT™.

The Levco Prodigy 4 couples a 16MHz processor, a floating-point math co-processor, an intelligent, on-board SCSI controller, and four megabytes of fast RAM with your Mac, producing a powerful personal work station.

#### 68020 PROCESSOR:

With its 16MHz clock and 32-bit data path, the Prodigy's 68020 processor runs at double the speed and fetches twice as much data as the 68000 found on the Mac. As a result, standard applications run at least 400-500% faster on the Prodigy 4.

#### 68881 CO-PROCESSOR:

The optional co-processor, directly supported by the 68020 instruction set, is compatible with Standard Apple Numeric Environment (SANE) used by most Mac applications. Programs optimizing the floating-point chip can crunch numbers up to 100 times faster.

#### COMPATIBILITY:

Despite its revolutionary leap in performance, the Prodigy 4 is fully compatible with the latest Macintosh system, HFS and 128K ROMs.

Mounted internally, the upgrade board clips onto a 128K, 512K, or Macintosh Plus™ motherboard, and also features an emulation mode that allows your Mac to operate exactly as it did prior to the upgrade.

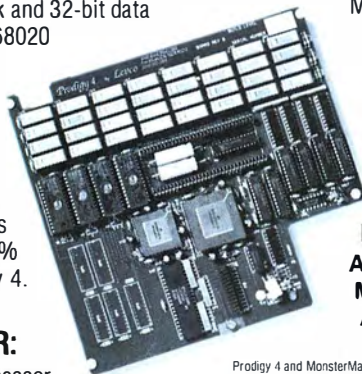

**Prodigy 4:**  
A quantum leap in  
Macintosh technology.  
Available now.

Prodigy 4 and MonsterMac are trademarks of Levco. Macintosh and Macintosh Plus are trademarks licensed to Apple Computer, Inc. DEC VAX is a trademark of Digital Equipment Corporation. IBM PC AT is a trademark of International Business Machines Corporation.



6160 Lusk Blvd.  
Suite C-203  
San Diego, CA 92121  
(619) 457-2011

From the creators of  
MonsterMac™

Circle 493 on reader service card

make full use of the LaserWriter's high-resolution potential, and laser-printed art still has the familiar "jaggies."

Setting up a comic strip by hand can have a soothing, meditative effect that provides a chance to finalize the artist's feel for the art to come. By eliminating the drudgery associated with creating comics, *ComicWorks* also eliminates the ritual. Apart from this loss, *ComicWorks* is an exciting program with great potential for creating sophisticated art. *ComicWorks* needn't be confined to comics. Even if you never touch the balloon icon, features such as the airbrush, the ability to move objects, and the inclusion of word processing make *ComicWorks* a worthwhile program.

—Jay Kinney

*ComicWorks*, prerelease  
Mindscape, Inc.

3444 Dundee Rd.

Northbrook, IL 60062

800/221-9884

List price: \$79.95

## Filing for Less

Software Discoveries' *Record Holder* is a plain and functional program that breaks no new data-management ground. However, accompanied by a clearly written manual, it works well for simple filing applications—mailing lists, expense accounts, and other index-card tasks. And it also costs less than its main competitors, *Microsoft File* and Forethought's *FileMaker*. (For reviews of those products, see "File, Macintosh Style," *Macworld*, May 1985, and *Macware Reviews*, *Macworld*, December 1985.)

In the data department, *Record Holder* lacks the picture fields that make *File* ideal for storing digitized images, and it does not allow you to paste a picture into a form layout, as does *FileMaker*. *Record Holder* handles only text, number, currency, and date values. You can designate computed fields to process values according to a user-specified formula, but *Record Holder* cannot display data as flexibly as its competitors can. For example, dates appear in only one format, and you cannot change a field's alignment to center or right-justify its contents.

(continues)

*The Authoritative  
New Magazine  
From the Publishers  
Of PC World and  
Macworld*

# Publish!

*The Magazine of Desktop and Personal Computer Publishing*

If you use a Macintosh or PC system to publish reports, newsletters, books, ads, brochures, or any other printed material, then you need *Publish!*, the Magazine of Desktop and Personal Computer Publishing.

## **Act Now for Charter Subscriber Savings— 33% Off!**

*Publish!* is a new magazine that is written, edited, and produced on personal computer-based systems. Because *Publish!* is on the cutting edge of this exciting new technology, you can depend on us for the expert information you need to set up and manage your own personal publishing operation.

Each colorful, feature-filled issue is easy to read and understand, yet comprehensive and authoritative. *Publish!* will answer all your questions about how to use personal computers with laser printers and page makeup software—and even how to drive commercial typesetters with a personal computer. What's more, *Publish!* covers both stand-alone systems and networks.



*Publish!* shows you the shortcuts and tricks of the trade that can help you get the most from the hardware and software available. You'll learn fundamentals of graphic design and other publishing basics, and you'll save time and money, too.

### **In coming issues of Publish!...**

- Getting the manufacturer support you need
- Advice on designing your pages for maximum impact
- Major New York graphic designers discover desktop publishing
- Cost-saving ways to prepare pages for outside printing
- Hardware and software reviews
- Hundreds of new product listings

All this and more comes to you in *Publish!*, six times a year—and at a low Charter Subscriber price if you act now.

### **Fast action saves you money!**

For a limited time, Charter Subscriptions are available for just \$19.95 for a full year (six bimonthly issues). You save 33% off the basic subscription price others will pay when the Charter offer closes.

Take advantage of this limited-time Charter Subscriber offer now and get the full benefit of *Publish!*'s expertise as soon as possible. Mail the attached postpaid card or the coupon below. Or for faster service, call TOLL-FREE (800) 222-2990.

### **Charter Subscription Savings**

**YES**, I want to be among the first to take advantage of **Publish!**. Enter my Charter Subscription for 1 year—6 bimonthly issues—at only \$19.95. I save 33% off the basic subscription price.

Payment enclosed    Bill me later  
Charge my    Visa    MasterCard

Card no. (please print)

Expiration date

Name

Company (if applicable)

Street

City

State

Zip

Mail to: **Publish!**, Subscription Department, P.O. Box 51966, Boulder, Colorado 80321-1966

*Guarantee: If you're ever dissatisfied with **Publish!**, let us know, and we'll promptly refund you for every issue remaining on your subscription. No questions, no problems. We guarantee it.*

*Offer valid in the U.S. only. Premier issue will be mailed in August 1986.*

# SONY

## 3 1/2" DISKETTES ■ Boxed in tens

	30+	50+	100+
SS	1.34	1.30	1.28
DS	2.04	1.99	1.95



**FREE!**  
One VHS or BETA Sony blank tape with every 30 Sony boxed disks purchased from this ad.

## MAC-PAK 3 1/2" Disks Packaged in 50's

	50+	100+	400+
Single Sided	1.24	1.20	1.15
Double Sided	1.74	1.70	1.65

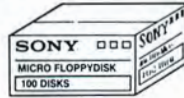

## maxell



### 3 1/2" SS Disks ■ Packed in 50's

50+	100+	400+
1.30	1.25	1.20

### 3 1/2" SS Disks ■ Boxed in tens

30+	50+	100+
1.38	1.32	1.29

## Nashua



### 3 1/2" SS Disks ■ Boxed in tens

30+	50+	100+
1.32	1.26	1.20

### 3 1/2" SD Disks ■ Packed in 50's

30+	50+	100+
1.76	1.72	1.66

## ROLLTOPS

**\$17.49**



Genuine teak, holds 50 3 1/2" disks.

**\$15.49**



The original in buff and oak. Holds 55 disks.

## RIBBONS

Apple  
Imagewriter **\$2.35** each,  
Qty. 6

Color  
6 packs **\$3.05** each,  
Qty. 6

(one each red, green, blue, brown, purple, yellow)



## PORTABLE MODEM

- 300 baud
- Connects directly to the wall telephone jack
- Battery powered
- Weights 12 oz.
- Full/Half duplex select switch.

**ONLY \$69.00**

Compare to the exact same modem advertised in this magazine at **over \$80.00!!**

**CALL TOLL FREE**

**1 800 USA FLEX**

(1 800 872-3539)

In Illinois 1 800 FOR FLEX (1 800 367-3539)

7 to 7 Central Time  
10 to 3 Saturdays

Shipping/handling additional. Minimum order \$50.00. Visa, MasterCard and Prepaid orders accepted. Corporations rated 3A2 or better and government accounts are accepted on a net 30 basis. C.O.D. orders add an additional \$5.00 special handling charge. APO, FPO, AK, HI, & PR orders add an additional 5% to the total order amount to cover PAL and insurance. No sales tax outside of Illinois.



*Record Holder* does shine in one crucial area in which *File* and *FileMaker* fall flat. You can specify any field as "required," meaning that it must contain data before *Record Holder* accepts a record. Specifying important fields as required helps ensure that a record is complete.

### Forms, Finds, and Reports

*Record Holder's* form-design facility adequately creates simple data entry and retrieval screens. With the drag function you can position fields anywhere, and all Mac fonts, sizes, and styles are available. A horizontal ruler appears when you're designing a form, but it doesn't allow the precise positioning provided by *FileMaker's* T square. *Record Holder* also lacks *FileMaker's* line- and box-drawing tools for sprucing up forms.

Unlike *File* and *FileMaker*, a *Record Holder* database can have only one form layout. Both *File* and *FileMaker* can create a virtually limitless array of forms and switch between them quickly, letting you specify precise entry or retrieval requirements. Also, unlike *File*, *Record Holder* can't show a database in table form, a format useful for quick browsing and proofreading.

*Record Holder's* form features may be limited, but its data entry and searching talents aren't. A complete set of ⌘-key shortcuts lets you zip through data entry sessions without having to reach for the mouse. You can even move the cursor left and right using the arrow keys on a numeric keypad or by pressing Option- $\leftarrow$  and Option- $\rightarrow$ . And to cut down on repetitive typing, *Record Holder* lets you specify that fields not be cleared when a record is added.

*Record Holder* makes it easy to locate data. Menu commands and an icon in the form window let you browse through a database one record at a time (see "Browsing Records"). To locate specific records, you can type search criteria in the What to Find window. *Record Holder* allows more specific search specifications than either *File* or *FileMaker*. Along with relational operators (greater-than, less-than, equal-to), you can use logical operators (AND, OR, NOT) to create very specific search specifications (for example, all employees earning less than \$20,000 or more than \$30,000 who do not work in the accounting department).

(continues)

MacVision

# Live Action to Newsletter ...in Seconds

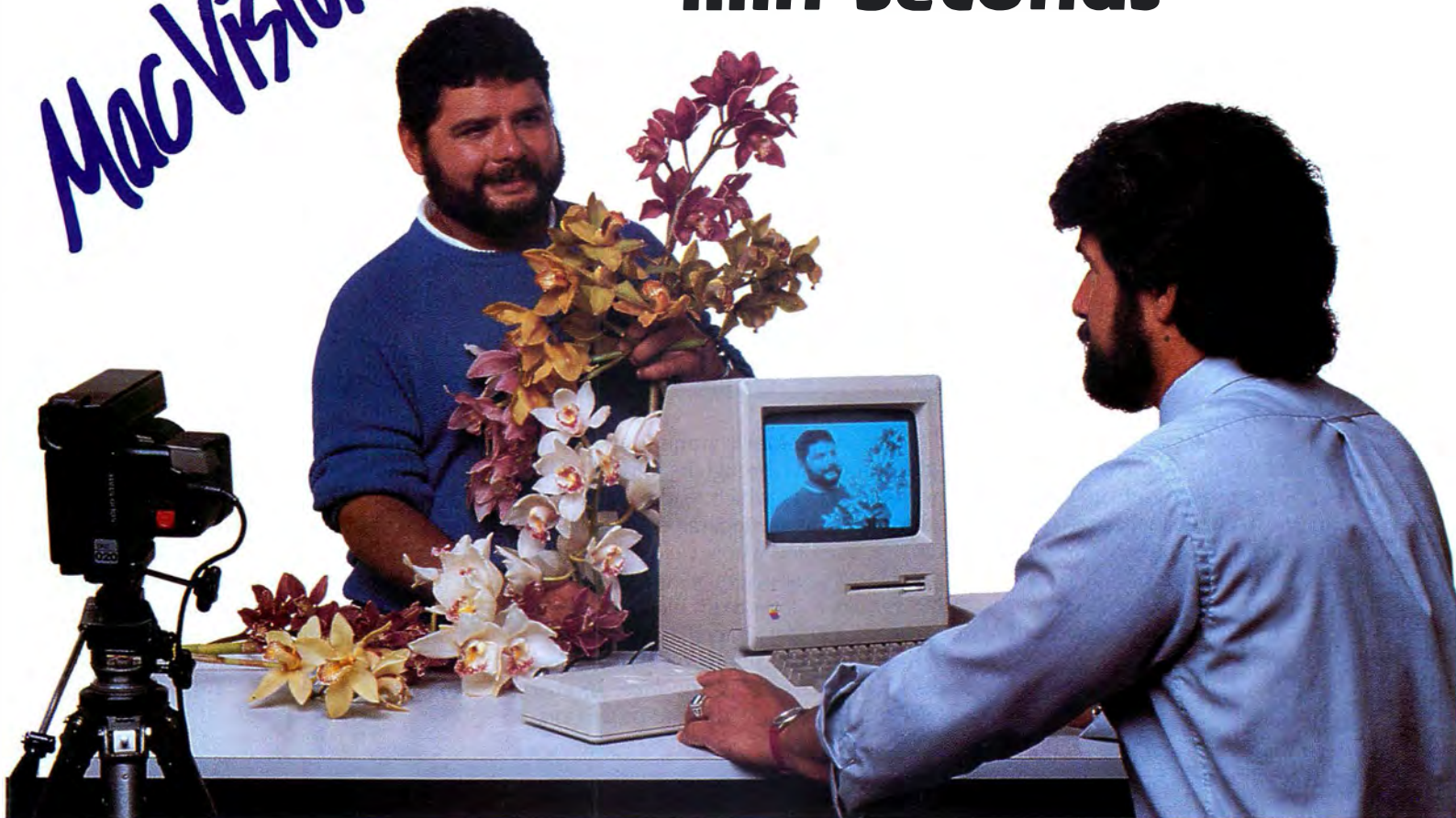

Ted Benhari is Public Information Officer at Dominican Hospital in Santa Cruz, CA. He is very much into Desktop Publishing. He produces numerous publications for the hospital, including "The Dominigram," a magazine for the general public, "The Scanner," a newsletter for employees, and a catalog promoting various classes at the hospital's Education Center. Ted likes having the ability to digitize

three-dimensional objects. **He can go from live action to his newsletter in seconds.** MacVision™ saves him time and money and gives him tremendous creative flexibility in his publishing efforts. If you need to image three-dimensional objects (buildings, displays, people, products, etc. as well as flat art) you will need MacVision™. It's that simple. And **each MacVision™ package contains valuable coupons** for special discounts on color and black-and-white cameras so you can go from live action to print in seconds. **Save \$366 on a Panasonic Camcorder and \$85 on a black and white camera.** MacVision™ is available at leading computer dealers everywhere.

Retail \$349.95

**The Scanner**  
DOMINICAN HOSPITAL EMPLOYEE NEWSLETTER  
VOLUME 1, NUMBER 7  
AUGUST, 1986

**Alphonse Castaneda...Blooming Genius**

The gorgeous orchid corsages at the Hospital's Employee Service Award Dinner came not from some South American jungle, but from the carefully tended plants grown locally by Alphonse Castaneda, the instrument technician in the Surgery Department.

Alphonse has been growing orchids for seven years. Blossomed from a hobby into a part-time vocation, his orchids are in great demand by local flower marts for retailing to the public.

Orchids' delicate beauty belies their durability. They make great gifts - a cut stem

lasts with flowers, called a spray, can last for one to two months, Alphonse says.

He grows his plants by cloning them in peat dishes, or crosses varieties through hybridization. The work is exacting, as is his delicate adjustments of the sophisticated surgical equipment.

"My gift herein is to make sure everything used in an operation is working properly," says Alphonse. "It requires great care and the ability to troubleshoot during a procedure if something isn't working as well as it should.

Alphonse's expertise goes beyond mere

maintenance. He redesigned a surgical saw used for cutting by one block of vertebrae fusions. "The improvement makes the procedure go a lot faster," Alphonse says with justifiable pride.

Alphonse was a prime mover in organizing the Hospital softball team, although his schedule doesn't permit him to play this year. "The team's boost morale by helping people from different departments get to know each other as people," he says, "not just as functions."

This is very important to Alphonse, who, as anyone who knows him will affirm, is a real "people person," with a well-deserved reputation for kindness and generosity.

 **Koala**

PTI Industries • 269 Mt. Hermon Rd. • Scotts Valley, CA 95066 • (408) 438-0946

Circle 541 on reader service card

Newsletter created with the Macintosh™ using PageMaker™ MacWrite™ MacDraw™ and MacVision™

MacVision is a trademark of PTI Industries; Macintosh is a trademark licensed to Apple Computer; MacWrite is a trademark of Apple Computer, Inc.; PageMaker is a trademark of Aldus Corporation.

*Record Holder's* unique Table of Contents window lets you locate a specific record by selecting its table-of-contents entry, a less technical way of referring to a database's index fields—the fields on which a database is sorted. You can see roughly 18 table-of-contents entries at once, meaning you have one-click access to 18 records. As the Mac's Open dialog box does, *Record Holder* scrolls to the first file that begins with a typed character.

*Record Holder's* reporting features let you put data on paper easily and effectively. You can create tabular reports with headers (no footers, however) and generate free-form reports such as invoices or forms. Like its competition, *Record Holder* prints totals and averages, though the minimum, maximum, and standard deviation functions available in *File* are missing. Unlike its peers, *Record Holder* can print more than one mailing label across the page, giving you more choices when shopping for labels. *Record Holder* also lets you preview a report on screen before printing, compensating somewhat for the lack of a tabular display.

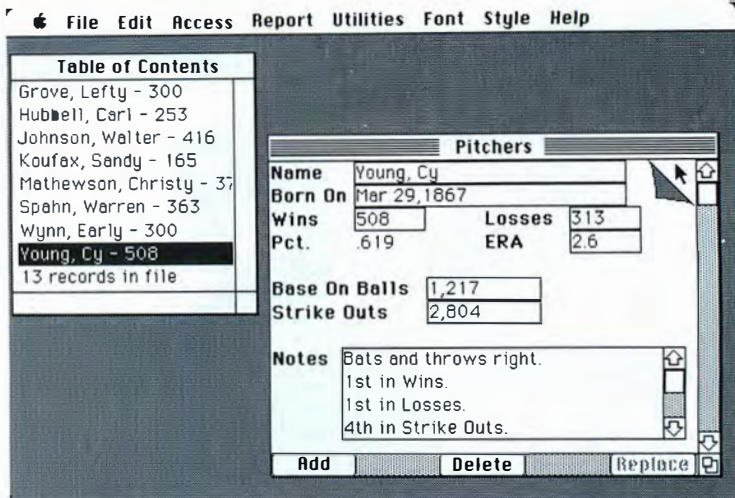

**Browsing Records**  
With *Record Holder* you can leaf through a database by clicking the browse icon. You can also jump to a given record by clicking its entry in the Table of Contents window or by typing its first few characters. Also noteworthy are the vertical scroll bars that *Record Holder* adds to lengthy text fields.

*Record Holder* communicates with other programs through its Import and Export commands, which read or save files whose records are separated by carriage return codes and whose fields are separated by tab characters or commas. *Record Holder* can't access SYLK files as can *File-Maker*, but its data-interchange features are sufficient for exchanging files with other data managers such as *Interlace*, *Microsoft File*, and *Helix*—or with word processors.

**Not Lost in the Crowd**

Despite some shortcomings—only one form layout per file, no graphics capabilities, and few functions for analyzing data in reports—*Record Holder* commands a place in the crowded market of Mac data managers. Its searching and browsing skills are strong, its manual and help screens are

(continues)

# PUT CHECKMARK ON YOUR PAYROLL.

A complete payroll system that calculates employee and employer payroll taxes, generates W-2's, paychecks, employee earnings and other reports. Use as a stand-alone system or interface with our General Ledger. \$195.



P.O. Box 860  
Fort Collins, Colorado 80522

To Order Call:

**1-800-426-2466 ext. 338**

MASTERCARD and VISA accepted  
30 day Money Back Guarantee



Circle 148 on reader service card





Running like crazy and getting nowhere?

# Try the new quadLYNX Trackball.

We understand. You're attached to your mouse. But it takes up a lot of precious desk space, gets into all kinds of dirt, and those little feet have a tendency to wear out. That can make the mouse erratic and unusable.

Just like your mouse, the new quadLYNX trackball handles all Macintosh™ software, and plugs directly into your mouse port. Its stationary base is ergonomically designed for almost effortless use. And think of all the desk space you'll save!

The quadLYNX uses a non porous phenolic ball that is perfectly round and impervious to dust and dirt.



Overall quality construction means incredibly precise cursor manipulation. We think you'll agree, the mouse is just no match for quadLYNX versatility, reliability and ease-of-use.

Interested? The quadLYNX price of only \$129 includes a full year warranty — nine months longer than the warranty offered by Apple.™ For a limited time we're even offering a \$20 rebate when you send in your old mouse. This offer expires Friday, November 7, 1986, Midnight. So call us today. Or talk to one of our dealers. Then, get your hands on a quadLYNX, and quit mousing around.

Macintosh and Apple are trademarks of Apple Computer Inc.

**Honeywell**  
Disc Instruments Subsidiary

102 East Baker Street • Costa Mesa, CA 92626  
714-979-5300 800-824-3522



Dealer Inquiries  
Welcome  
**quadLYNX**

Circle 529 on reader service card

# Plot-It



Now for  
**MacDraw**  
**MacDraft**  
**MacProject !**

Plot-It...plots MacDraw, MacDraft, MacProject, any Pict document, or MacPaint on Apple, Hewlett-Packard, and Houston Instruments color plotters.

- Control scale for MacDraw or MacDraft plotter output.
- Add color to MacDraw, MacDraft or MacPaint.

Price: \$125  
 Upgrade from  
 Version 1: \$30

## TEKALIKE Terminal Communications

TEK4014	VT100
TEK4105	VT640
TEK4010	
TEK4006	

Tekalike lets you use your Macintosh as a graphic terminal with mainframe applications from Issco Graphics, Molecular Design, Chemical Abstracts Service, Precision Visuals, SAS Institute...

- Save mainframe graphics for MacDraw, MacPaint, Pagemaker.
- LaserWriter, Imagewriter, and plotters supported.
- Macplus and INTERNATIONAL keyboards supported.

Price: \$250

**Mesa Graphics, Inc.**  
 P.O. Box 600  
 Los Alamos, NM  
 87544 (USA)  
 (505) 672-1998  
 Telex II: 5101003099

Circle 97 on reader service card



MARK ULRICH

clear and concise, and it's only a bit harder to use than a notebook or index card file. And at \$49.95, it isn't much more expensive, either. Software Discoveries plans to up the ante to \$69.95 in October, but even that beats the competition. *Record Holder* brings simple, effective filing within anyone's reach. Maybe it does break new ground after all. —Jim Heid

*Record Holder, version 2.1*  
 Software Discoveries, Inc.  
 99 Crestwood Rd.  
 Tolland, CT 06084  
 800/437-5200 ext. 229, 800/638-8890  
 ext. 229 in Maryland, 203/872-1024  
 List price: \$49.95, \$69.95 after  
 September 30

## Paint Your Bandwagon

Although *MacPaint* is an excellent program, most of us have lists of features we wish it had. Several companies have recently come up with their own piecemeal solutions: T/Maker Graphics' *ClickArt Effects* rotates and slants objects, while Silicon Beach Software's *Paint Cutter* takes care of cutting and pasting large sections of drawings.

The first company to transform its wish list into a stand-alone program was Ann Arbor Softworks. Its program, **FullPaint**, is a significant improvement on *MacPaint*, combining the features of several *MacPaint* add-ons with a number of other good ideas. *FullPaint* is not a revolutionary advance in Macintosh graphics software. Indeed, at first glance *FullPaint* looks just like *MacPaint*. But a keen eye will quickly discern a few additions to the *MacPaint* screen: a menu called Windows, scroll bars and a grow box in the document window, and three new icons at the bottom of the tool palette. Together they comprise *FullPaint's* two major advances: the ability to access up to four documents simultaneously and the ability to work on a document that fills the entire screen.

### Windows and Views

After opening two or more windows, you can cut and paste sections of one document into another without having to close any files or use a desk accessory like *QuickPaint* or *Art Grabber*. You can arrange the windows any way you like by resizing them with the grow box and moving them with the title bar. Double-click on the title bar, and a window expands to the edges of the screen. Double-click again, and it shrinks to its previous size. With the

(continues)

# How To Make Your Macking Faster, Easier, and a Lot More Fun!



## Tempo macros speed your work or play on the Macintosh.

Record any series of Macintosh commands or keystrokes and Tempo will play them back, at top speed, every time you need them. With a single key code, you can execute a macro that replays an unlimited number of commands.



## Add intelligence to your Macintosh software

If a macro needs to be performed 27 times in a row or every 15 minutes, Tempo will do that. If it depends on whether a number starts with a "\$" or if a name is greater than "Jones," Tempo will read it and decide which way to branch. Tempo can even determine if it needs to *branch to another program*. Tempo will close the program you're in, open the other, and continue replaying your commands. Automatically. Exactly as you require.



## Edit your macros for changes or corrections

You may edit Tempo macros the same way you create them - click to edit, click to change, click to save. Tempo has no complex programming language, simply step-by-step menu commands and dialog boxes.



## What you can do with Tempo

- Reduce complex commands to a single keystroke.
- Automate moving information from one program to another.
- Have Tempo wait until the time you specify, then perform multiple tasks on your Macintosh - unattended.
- Guide new users through programs, prompting them with dialog boxes along the way.
- Distribute time-saving macros to other members of your company.
- Customize programs to work the way you need them to.
- Simplify, automate, customize, modify, design, and create in a million different ways!



## Intelligent macros for the Macintosh.



## Other Tempo features...

- Pause during a macro replay to enter text or make a selection.
- Record macros up to the limits of your disk space - hard drive or floppy.
- Assign up to 450 keyboard commands in each application.
- Use Command key codes or Option key codes.
- Replay in slow motion, in real time, or at high speed.
- Connect macros together, nested, branched or sequentially.
- Repeat the macro *if* or *until* it sees the specified text, or *for* a required number of times.
- Tempo works with nearly every Macintosh program.
- For the 512K or larger Macintosh and Macintosh XL.
- Works with all hard disk drives.
- Tempo is not copy-protected, so you can easily install it on your hard drive.
- If you're not absolutely happy with what Tempo can do for you and your Mac, return it within 90 days for a complete refund. We guarantee your satisfaction. For \$99, you get more macro power than a micro has ever had before.

Call 1-800-367-6771 right now, today!

Call us for the dealer nearest you, or you can order directly from us.

# Tempo™



Affinity Microsystems Ltd.  
1050 Walnut Street, Suite 425  
Boulder, Colorado 80302

Macintosh is a trademark licensed to Apple Computer, Inc. Tempo and Affinity are trademarks of Affinity Microsystems, Ltd.

Circle 274 on reader service card

Windows menu you can bring hidden windows into view or rearrange them neatly on the screen. Unlike *MacPaint*, *FullPaint* lets you keep desk accessory windows open for reference while you work.

The three icons at the bottom of the tool palette represent the program's three view options. Clicking the left-hand icon produces a view similar to *MacPaint*'s screen layout. The central icon expands a document so that it fills the screen up to the menu bar; scroll bars and title bar are missing, and the tool and pattern palettes sit on top of the document (see "The Big Screen"). The icon on the right provides a full-screen view that obliterates the menu bar (although many commands and the menu bar itself are still accessible through  $\mathbb{C}$ -key combinations). In all three viewing modes, the palettes can be dragged anywhere on the screen and can even be removed or recalled by pressing the space bar.

**Improved Tools**

Although the three view icons are the only additions to the tool palette itself, *FullPaint* has enhanced the functions of



many existing tools. For example, not only can you choose a brush shape but you can create your own brushes as well. The Option, Shift, and  $\mathbb{C}$  keys play a much wider (and often more consistent) role in the use of several tools. For instance, many *MacPaint* masters know that pressing Option while using the pencil changes the pencil into the hand, allowing them to move the drawing area. In *FullPaint*, this time-saving technique also works with the eraser. Other tool and keystroke combinations al-

low you to select areas larger than the window, type white letters on a black background, and perform other useful operations. And the program provides enough  $\mathbb{C}$ -key equivalents to use up almost every letter in the alphabet. In addition, *FullPaint* tops *MacPaint* in the docu-

(continues)

**The Big Screen**

In *FullPaint*'s full-screen view, the active document fills the entire screen, and the palettes float above it. The palettes can be placed anywhere on the screen or erased by pressing the space bar, and many tools can pass "underneath" the palettes as if they weren't there.

# TRY NEW EZ-DRAFT™ SOFTWARE AND DRAW YOUR OWN CONCLUSION.

PC-based mainframe power in a CAD system. ONLY \$2495.\*

EZ-DRAFT is a full-featured, professional CAD/Drafting system for the Apple Macintosh™. It's ideal for every kind of drawing. Now both casual users and experts can...

- Select from a wide variety of forms, like boxes, hexheads, slots and B-splines.
- Make projections from a designated workview to any other orthogonal or isometric view.
- Down-load drawings from most mainframe CAD systems using IGES, including geometry, text, dimensions and views.
- Dynamically reposition dimension sets.
- Create high-quality technical documentation by using



EZ-DRAFT drawings with Macintosh desktop publishing software.

- Use in EZ-DRAFT text and pictures that have been created with MacWrite™ and MacDraw™.
  - Use plotters like HP and Calcomp and plot high-quality drawings on the Apple LaserWriter™.
- EZ-DRAFT's the surefire way to increase efficiency and boost profits! Call today for complete details.

Applications support readily available.  
Bridgeport Machines  
Bridgeport, CT  
1-800-242-2404



\*Price for software only. Requires minimum 512Kb ram and one external drive.

Apple is a trademark of Apple Computer, Inc. Macintosh is a trademark licensed to Apple Computer, Inc.

Circle 479 on reader service card



## Many Questioned Whether The Macintosh™ Would Really Succeed In The Office. MICAH Offers Them Real Answers:

**Q:** Can you supply the large-capacity mass storage that business users need?

**A:** MICAH provides 30 megabytes (mb) of hard disk storage, either as an internal upgrade or a compact external drive. There is also a 60mb version, the industry's price/performance leader in mass storage. These units use MICAH's sophisticated data-management software that ensures high-speed performance and document security.

**Q:** Our office cannot afford to lose data. Do you offer backup protection?

**A:** MICAH provides a safe and simple 60mb tape backup that plugs into the Macintosh Plus™. In the 60mb external hard disk, the tape backup is already built-in. This error-free system uses low-cost media cartridges and will automatically back up your valuable data.

**Q:** Even if you can store and back up my data, how do I share that information with others in my office?

**A:** MICAH offers the first true network for the Macintosh—MICAHTOPS™—which allows any hard disk running on an AppleTalk network to become a true distributive file server, with efficient MS-DOS/Macintosh file transfers.

**Q:** We depend on our computers to work all the time. What about reliability and service?

**A:** MICAH has been providing highly reliable hardware and software products for more than eight years and is backed by nationwide servicing dealers. MICAH stands behind all its products with a full one-year warranty, which can be extended to three years. You can trust the quality built into every MICAH product.

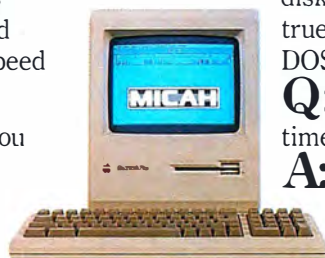

**MICAH**  
REAL ANSWERS

For More Information And The Location Of Your Nearest MICAH Dealer. Call (800) 523-9394. In California, call (415) 331-6422. Telex: TWX 510 600 1221.  
If You Have A Macintosh With A Modem, Log On To MICAHLINK™: (415) 771-1119

Macintosh, Macintosh Plus and AppleTalk are registered trademarks of Apple Computer, Inc. TOPS is a registered trademark of Centram West, Inc. MS-DOS is a registered trademark of Microsoft Corp. MICAHLINK is a registered trademark of MICAH Inc.

Circle 352 on reader service card

mentation department; the program's 94-page manual far exceeds *MacPaint*'s skimpy one.

*FullPaint* adds a number of bells and whistles likely to be found on many people's *MacPaint* wish lists. These include four special-effects commands similar to those found in *ClickArt Effects*: Free Rotate, Distort, Perspective, and Skew. You can add a custom font size (from 1-point to 127-point) to the FontSize menu, although most of the resulting fonts are not too attractive. One convenient option lets you double-click on an object to lasso it, rather than painstakingly surround it with the lasso. FatBits AutoScroll scrolls the window when you reach the edge, allowing you to continue drawing without jumping in and out of FatBits.

Several *FullPaint* features prove helpful for precision work. The program contains rulers that can measure inches, picas, centimeters, or pixels. The Mouse Crawl option restricts drawing tools to one-pixel increments. Mouse Crawl makes the most sense combined with MouseSpot, a small window that displays the current pointer

location and the dimensions of any object created by dragging, such as a rectangle or a circle.

### On Compatibility, Printing, and Life

*MacPaint* is an eminently compatible program that allows you to transfer illustrations into documents produced by other programs; *FullPaint* shares this ability. I combined *FullPaint* documents with those of several other applications, including *PageMaker*, *PictureBase*, *MacWrite*, and *Microsoft Word*, and encountered no compatibility problems.

When you're ready for some hard copy, *FullPaint* offers a range of printing options. An ImageWriter can print an entire document or a section at normal, half, double, or quadruple size (enlarged documents are printed on more than one page, if necessary). A LaserWriter can produce copy anywhere between 25 and 400 percent of original size. *FullPaint* also includes LaserPrint, a program that enhances a document's appearance for high-resolution (150 and 300 dots per inch) printing.

A final note: a *FullPaint* goody that probably never graced anyone's wish list

but that is entertaining nonetheless is the Game of Life. If you're experiencing illustrator's block and want to while away a few minutes, surround an area with the marquee and press ⌘-Option-L repeatedly. Select Undo to restore your drawing.

### Full Enough?

With such an abundance of new features, what could anyone find to complain about? Not much, actually, but enough to make at least a few people think twice before buying *FullPaint*. The most serious drawbacks? It lacks full-page drawing capability and a horizontal, or landscape, mode. In addition, *FullPaint* is clearly geared to the new, Mac Plus generation. That's no concern for the growing number of Mac Plus owners, but it can be for the rest of us. For example, you can use *FullPaint* with *Switcher*, but not on a 512K Mac (unless you enjoy shifting from *Switcher* to *FullPaint* and back). Also, on a 512K Mac

(continues)



**Macinware Plus™** - \$99.95  
for  
Mac Plus™ System  
w/wo HD20™

*MacLuggage*

Made in the U.S.A.  
of  
Cordura™ Nylon

**Imageware II™** \$89.95  
for  
Imagewriter II™

**Call 1-800-241-2122**  
I/O Design, Inc. • P.O. Box 156 • Exton, PA 19341

See Us at Macworld Expo Booth #719    **Circle 530 on reader service card**

All Trademarks Acknowledged



# LESS BULK MORE STATISTICS!

## Now on the Macintosh...

### Mac Features:

- Pull-down menus
- Clipboard
- Cut, Paste, Scroll
- Mouse control of spreadsheet
- Desk Accessories
- 400K, 800K, HFS compatibility

### SYSTAT Capabilities:

- Full screen spreadsheet data editor
- Missing data, arrays, character variables
- Unlimited cases
- Process hierarchical files and variable length records
- Rectangular and triangular files
- Relational database management and report generation
- Character, numeric, and nested sorts
- Merge and append large files
- Unlimited numeric and character transformations
- Interactive or batch
- Read and write text and external files
- Subgroup processing in statistical modules with SELECT and BY
- Value labels
- RECODE statements for quick multiple codes
- Scatterplots, contours, histograms, stem-and-leaf, boxplots, bar charts, quantile, probability plots
- Basic statistics, frequencies
- T-tests
- Multi-way crosstabs with log-linear modeling, association coefficients, PRE statistics, asymptotic standard errors
- Pairwise/listwise missing value correlation, SSCP, covariance, Spearman, Gamma, Kendall Tau, Euclidean distances

- Linear, polynomial, multiple, stepwise, weighted regression
- Extended regression diagnostics
- Multivariate general linear model
- Multi-way ANOVA, ANOCOVA, MANOVA, repeated measures
- Post-hoc tests
- Principal components with rotations and scores
- Multidimensional scaling
- Multiple and canonical discriminant analysis, Bayesian classification
- Canonical correlation
- Cluster analysis (hierarchical, single, average, complete median, centroid linkage, k-means, cases, variables)
- Nonparametric statistics (sign, Runs, Wilcoxon, Kruskal-Wallis, Friedman two-way ANOVA, Mann-Whitney U, Kolmogorov-Smirnov, Lilliefors, Kendall coefficient of concordance)
- Time Series (smoothing, seasonal and nonseasonal ARIMA, ACF, PACF, Cross-correlation function, transformations, forecasting, Fourier analysis)
- Nonlinear estimation (non-linear regression, least absolute values regression, logit, probit, maximum likelihood estimation, iteratively reweighted least squares)

SYSTAT operates on the following machines: IBM-PC/XT/AT,™ Apple II,™ Apple Macintosh,™ Kaypro,™ HP 150,™ HP 9000,™ DEC Rainbow,™ VAX,™ Alpha Micro,™ MS-DOS,™ CP/M™ and UNIX.™

Single copy price:  
\$595 USA and Canada  
\$695 Foreign  
Site licenses and quantity prices available

Call or write for additional information

**SYSTAT, Inc.**  
2902 Central Street  
Evanston, IL 60201  
312 864.5670



The system for statistics

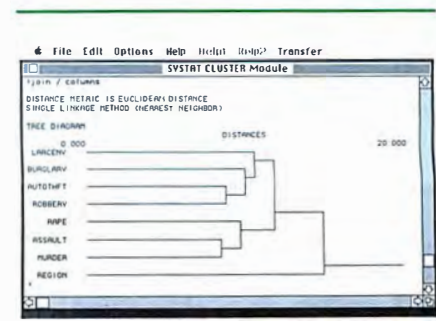
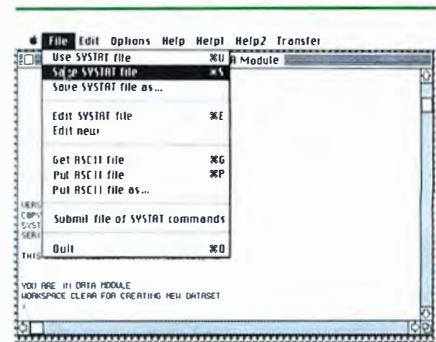
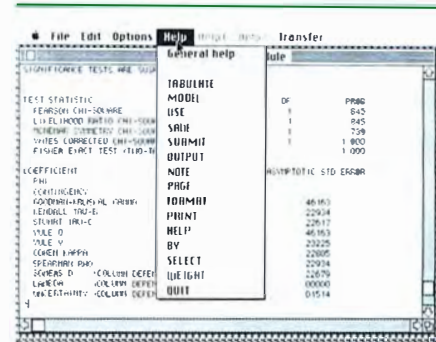
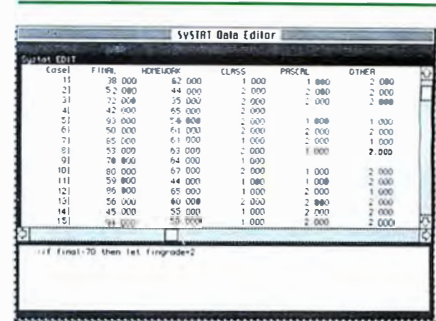

Circle 491 on reader service card

# COPY II MAC™

## BACKS UP PROTECTED SOFTWARE.

Copy II Mac does more than just sector copy. Its bit copy program has the built-in power and flexibility to handle most protection schemes automatically and supports single and double-sided drives. (We update Copy II Mac as often as needed to handle new protections; you as a registered owner may update at any time for \$15 plus \$3 s/h.)

## RUNS PROTECTED SOFTWARE FROM YOUR HARD DISK.

Copy II Mac makes using your hard disk (including the Apple hard disk-20) as convenient as it should be. No longer will you have to use the 3 1/2" disk with some of the most popular business software. Call for current list.

## GIVE YOUR MAC MORE MUSCLE.

Copy II Mac can even repair some damaged disks and recover accidentally deleted files.

System Requirements: Macintosh or Macintosh Plus, 1 drive. (2 drives, all available memory and hard disks fully supported.)

Call 503/244-5782, M-F, 8-5:30 (West Coast time) with your   in hand. Or send a check for \$39.95 U.S. plus \$3 s/h, \$8 overseas.

**\$39.95**

*Central Point  
Software*

INCORPORATED  
9700 S.W. Capitol Hwy., #100  
Portland, OR 97219

*Winner of A+ Readers' Choice Awards!*

Backup utilities also available for the IBM, Apple II, Atari ST, and Commodore 64/128.

## Now available!!!

800K drives for Macintosh: \$195.00 (plus \$10 shipping/handling). Plugs directly into Mac & Mac Plus!

Circle 175 on reader service card

## Macware Reviews

it's impossible to open four documents at once—the program allows you access to only three. But the program's worst sin may be its key disk copy-protection scheme (hard disk owners get two hard disk installs that do not require a key disk), which results in unnecessary aggravation and a black mark on an otherwise respectable program.

*FullPaint* is a powerful tool that transcends the features you can get by souping up *MacPaint* with various add-ons. But the program is, as they say, evolutionary, not revolutionary. Mac Plus owners are the logical candidates for a *FullPaint* purchase, since *MacPaint* is not bundled with the Plus and is more expensive and less versatile than *FullPaint*. Owners of 512K Macs who already have *MacPaint* should think carefully before buying *FullPaint*, especially if they already own *MacPaint* add-ons.—Robert C. Eckhardt

*FullPaint, version 1.0*  
Ann Arbor Softworks, Inc.  
308 1/2 S. State St.  
Ann Arbor, MI 48104  
313/996-3838  
List price: \$99.95

## Mac Owners — Meet the Market Pro™

The First Fully-Integrated Portfolio Management System For The Mac

- Save valuable analysis time
- Gain access to greater market information
- Increase your investment decision-making confidence
- Easily track the performance of your securities

"An indispensable resource for anyone interested in the stock market!"

Not Copy-Protected!  
Communications Included!  
512k, external drive required

### Software Package Includes:

- Portfolio Manager
- Technical Analysis
- Fundamental Analysis

### Also Available:

- Commodity Analysis (Individual Module Only)

### 30 Day, No Risk, Money Back Guarantee!

If not completely satisfied simply return for a full refund.

Macintosh is a trademark licensed to Apple Computer, Inc.  
Mac is a trademark of Apple Computer Inc.

Complete Fully-Integrated Package . . . . . \$395\*  
Individual Modules . . . . . \$195\*  
Demo Disk . . . . . \$10\*

TO ORDER THE MARKET PRO™ CALL TODAY!

1-800-992-2919

In Arizona 1-830-8835

Visa/MasterCard/American Express Orders Accepted

\*Add \$5.00 for shipping. Arizona residents add 6% sales tax

Exclusively offered by



Pro Plus Software, Inc.

2830 E. Brown Rd. Suite C-12, Mesa, Arizona 85203

Circle 516 on reader service card

## Order out of Chaos

Outline processors let you toss ideas onto your computer screen and shunt them around until they make sense. *MaxThink*, by MaxThink, closely follows the format set by its sole competitors in the Mac outline marketplace—Living Videotext's *ThinkTank* and *ThinkTank 512*. The program's underlying hierarchical structure organizes topics into headings with subtopics, prefaced by a plus sign, and headings without subtopics, indicated with a minus sign (see "A MaxThink Screen"). A few keystrokes or mouse clicks change a topic to a subtopic or reorder existing headings. Unlike *ThinkTank*, *MaxThink* lets you expand a single entry into several pages of text, but you can't add graphics to an outline. *MaxThink* provides the essential tools for creating coherent outlines and includes on-screen tutorials, all for just \$89—less than half the price of *ThinkTank 512*.

### Movers and Shapers

Although you'll find more ways to organize headlines using *MaxThink* than with *ThinkTank*, *MaxThink*'s default mode for moving headlines is a slow, four-

(continues)



See Us at  
Macworld Expo Booth



# PC MacBridge™

Bridges your IBM® PC with the Apple® Macintosh™ Office Network™ and LaserWriter™.

Now you can bridge the IBM-Apple gap.

PC MacBridge from Tangent Technologies is a PC enhancement card that puts you on the AppleTalk Personal Network. The PC user can now tap the power of the Macintosh Office and the LaserWriter printer.

And with the LaserWriter, a whole new dimension in printing immediately opens up to you. Our LaserScript software turns PC word processors, like WordStar and MultiMate, into page processors. And the PostScript output gets you near-typeset quality printing on the LaserWriter.

For graphics, we give you LaserGraph. You get presentation

quality graphics from Lotus 1-2-3. Where pie-charts look like pies, not eggs. LaserGraph also lets you generate your own high-resolution business graphics.

Plus with our MailBox software, you get electronic mail and file transfer capabilities. You can send mail or transfer your PC-generated Lotus 1-2-3 files to Mac-based Lotus Jazz or Microsoft Excel.

Bridge the Mac-to-PC gap with PC MacBridge.

For complete details, call your local dealer or call us direct. This is one bridge you'll want to cross as soon as you can.



**TANGENT TECHNOLOGIES**

5720 Peachtree Parkway • Suite 100 • Norcross, Georgia 30092 • (404) 662-0366

In Canada, call McKENZIE BROWN LTD (416) 593-6880

Circle 461 on reader service card

**MICROTECH**

MAC535

The 800K  
DISK DRIVE

for all  
Macintosh™  
Computers

featuring  
AUTO EJECT  
ONE YEAR WARRANTY

Complete and Ready to Use with  
128k, 512k and MacPlus  
Computers

EXPO  
SPECIAL \$259<sup>00</sup>

**Trade In Offer:**

Send us your old 400K and receive  
\$50 off on a new Microtech 800K

**User Group Discounts:**

Call for quantity discounts



800-325-1895

Dealer Inquiries Call 800-626-4276

**MICROTECH**  
PERIPHERALS, INC.

29 Business Park Drive  
Branford, CT USA 06405  
203/488-8993

Macintosh™ is a trademark of Apple Computer, Inc.

Circle 470 on reader service card

step process: click on a heading, cut it to the Clipboard, click on a destination heading, and select Paste, Paste After, or Paste Before from the Edit menu. A more direct method, Fast-Move, cuts the steps in half but must first be invoked through keyboard commands or a menu selection. Click on a topic, and it disappears; click on a second topic, and the hidden topic reappears above the current one or as a subtopic, depending on where you're positioned. In contrast to *ThinkTank*, *MaxThink* also streamlines operations on a range of headings: simply stretch a rectangle around desired topics and choose a command such as Cut or Copy. Select All instantly captures the entire outline as a range.

*MaxThink*'s Sort menu provides five separate functions for reorganizing headings. Prioritize lets you click on headings one by one to create a newly ordered outline. Binsort lets you designate any number of topics as categories, or "bins," and then assign separate headings to each. Both are good features, but you must leave the main outline to perform them. The other three sort functions alphabetize headings, remove all indentations, and randomly reorder headings (to produce "new patterns of thought," according to the manual).

Other organizing functions include Toggle Expand, which suppresses or expands all subtopics under a selected range of topics; it is especially useful for developing consistency among headlines at equal levels. The Markers function, which works like a telephone's auto-dial, finds up to eight preselected topics automatically. Use it for permanent headings like phone numbers, schedules, and daily to-do lists. Unfortunately, if you change a topic's text, the marker text associated with it does not change.

**A MaxThink Screen**

*Topics without subheads are preceded by minus signs, and topics with subheads, by plus signs. When printed, headings are numbered and lettered consecutively. If you want a command to affect more than one topic, stretch a rectangle around the desired range and select the command.*

Some *MaxThink* functions have limited value. Search finds only the first occurrence of designated text, Join combines separate entries into one long heading, and Divide separates a multiple-line text entry into individual headings. Join can be useful for combining several topics into one, but you must usually edit the joined headline to have it make any sense. Divide does not let you determine where text will be split. Reclaim resurrects erased headings, starting with the most recent deletion. It works well with topics you have deleted with Clear, but not with the more commonly used Cut command.

**From Topic to Text**

Unlike *ThinkTank*, *MaxThink*'s word processing features are fully integrated into the outline—you can stretch a single entry into several pages of text without calling up a separate function. However, this is no-frills text editing, offering basic word-wrap and cut-and-paste but no formatting functions. For any substantive writing, you will undoubtedly prefer *MaxThink*'s Write command to create a text file readable by a word processor. Such files created with a word processor can be opened as a *MaxThink* outline; all incoming text appears as a single outline entry.

Printing involves choosing from the Page Setup menu among ten print format options covering margins, indentations, and spacing. The default line numbering scheme replaces the outline's plus and minus signs with consecutive letters and numbers. You can change the scheme and view your formatted outline before saving it or sending it to the printer.

(continues)

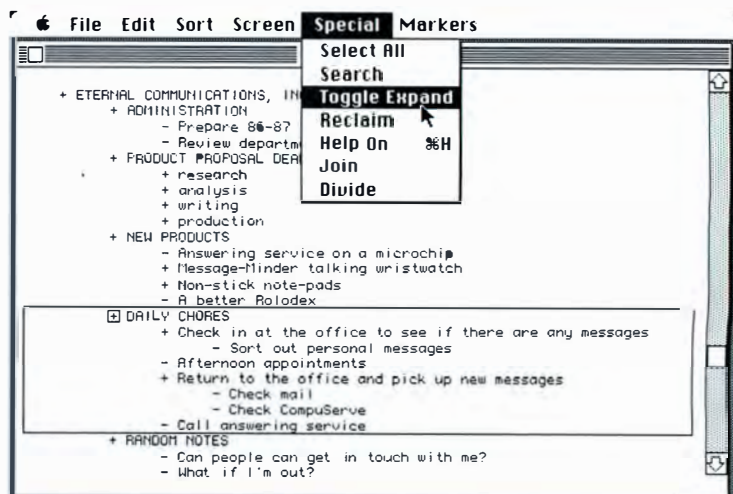

# A POWERFUL PAIR

Having trouble sleeping nights, can't understand why those sheep keep appearing night after night after night! Well stop worrying! We've got the solution!

Introducing the BIG MACK TWIN PACK, the POWERFUL PAIR that ends those sleepless nights worrying about Head Crashes and Data Security. THE BIG MACK TWIN PACK contains a 20MB HARD DISK for your MACINTOSH PLUS as well as a powerful 20MB CASSETTE TAPE BACK-UP for all those files that somehow vanish from your disk. By utilizing the STATE OF THE ART SCSI INTERFACE, the BIG MACK TWIN PACK allows for High Performance Transfer Rates to your

MACINTOSH PLUS. The Tape Back-up, in addition to Streaming Back-up, can be used as a Random Access Device that allows file by file back-up and restore operations. So stop counting sheep and start counting on the reliability of a POWERFUL PAIR of STATE OF THE ART Data Storage Devices . . . THE BIG MACK TWIN PACK.



## THE RIGHT PRODUCT AT THE RIGHT TIME



For Information on the Dealer Nearest You, Please Contact:

**Western Computer**

17781 MITCHELL, IRVINE, CALIFORNIA 92714  
(714) 553-1611 • FAX (714) 553-0236  
TELEX 756731 ANSWER BACK: WESTERN COMP.

Prices and Availability Subject to Change Without Notice

Macintosh Plus is a Registered Trademark of Apple Computer Corp.  
Big Mack Twin Pak is a Trademark of Western Computer Corp



**BIG MACK  
TWINPACK**

Circle 539 on reader service card

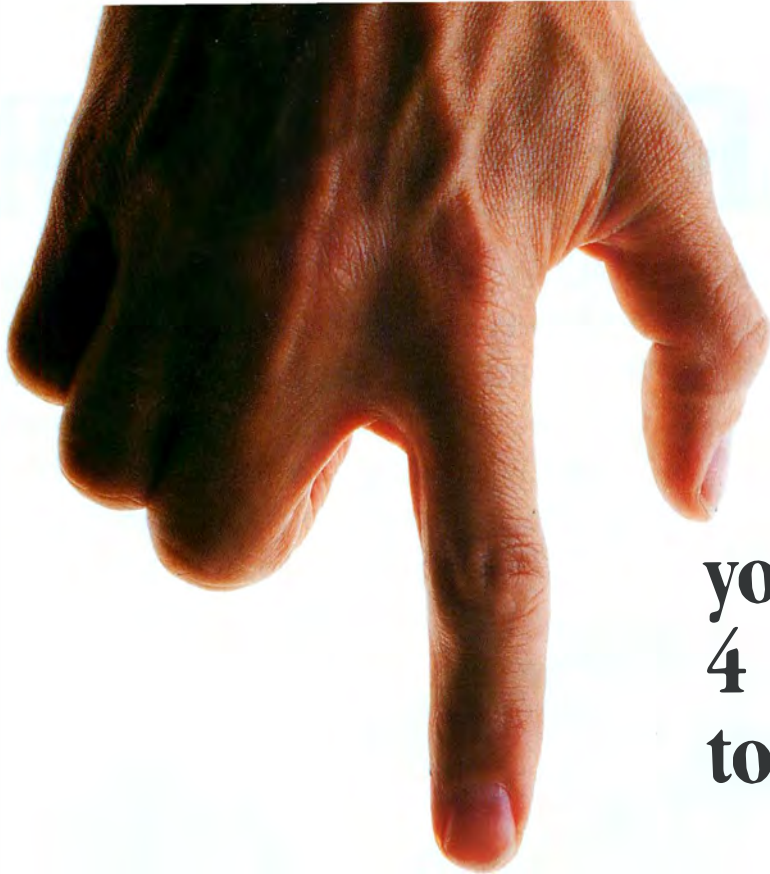

## You've put your finger on 4 key reasons to subscribe . . .

**1**

**SAVE OVER \$27 A YEAR!** Your subscription means handsome savings for you—almost 60% off the cover price.

**2**

**GET THE MOST FROM YOUR MAC!** Your money-saving subscription also insures a steady flow of the practical information you want—reviews of software and hardware you can rely on, new applications, techniques, and practical “how-to” tutorials.

**3**

**GET A FREE MACWORLD COMPUTER CLOCK.** Just for ordering a subscription to MACWORLD, you'll receive a miniature computer clock as your FREE gift. It features a liquid crystal display that shows you the time and date. Just return the order card today!

**4**

**GET THE MACWORLD GUARANTEE!** We're so certain you'll get what you need—and more—from MACWORLD, we guarantee it! If for any reason you're not satisfied with MACWORLD, just let us know, and we'll promptly refund the cost of your subscription for every unmailed issue.

**MACWORLD**  
*The Macintosh® Magazine*

Save

\$27.45

off the

~~\$47.40~~

cover price



Order Now to Take Advantage of These Special Savings and Receive Your FREE Computer Clock. Limited-Time Offer!

Call TOLL FREE:  
800/524-3200

Visa and MasterCard Accepted!

**SUBSCRIBE NOW**

- YES!** Please send me one year (12 monthly issues) of *Macworld* for only \$19.95, and the FREE computer clock. I'll save \$27.45 off the annual cover price of \$47.40, a savings of almost 60%. (That's over \$10 off the regular subscription rate of \$30.)

**SAVE EVEN MORE!**

- \$37.90 for 2 years (24 monthly issues)  
 Payment enclosed     Bill me later

Name \_\_\_\_\_

Company \_\_\_\_\_

Address \_\_\_\_\_

City, State, Zip \_\_\_\_\_

Please allow 6 to 8 weeks for delivery of your first issue. Offer good in U.S. only. Offer expires February 28, 1987.

4A7A5

**MACWORLD**

*The Macintosh Magazine*

**SUBSCRIBE NOW**

- YES!** Please send me one year (12 monthly issues) of *Macworld* for only \$19.95, and the FREE computer clock. I'll save \$27.45 off the annual cover price of \$47.40, a savings of almost 60%. (That's over \$10 off the regular subscription rate of \$30.)

**SAVE EVEN MORE!**

- \$37.90 for 2 years (24 monthly issues)  
 Payment enclosed     Bill me later

Name \_\_\_\_\_

Company \_\_\_\_\_

Address \_\_\_\_\_

City, State, Zip \_\_\_\_\_

Please allow 6 to 8 weeks for delivery of your first issue. Offer good in U.S. only. Offer expires February 28, 1987.

4A7A5

**MACWORLD**

*The Macintosh Magazine*



NO POSTAGE  
NECESSARY  
IF MAILED IN  
UNITED STATES



**BUSINESS REPLY MAIL**

FIRST CLASS PERMIT NO. 1262 BOULDER, CO

POSTAGE WILL BE PAID BY ADDRESSEE

**Macworld**  
**Subscription Department**  
**P.O. Box 51666**  
**Boulder, Colorado 80321-1666**



NO POSTAGE  
NECESSARY  
IF MAILED IN  
UNITED STATES



**BUSINESS REPLY MAIL**

FIRST CLASS PERMIT NO. 1262 BOULDER, CO

POSTAGE WILL BE PAID BY ADDRESSEE

**Macworld**  
**Subscription Department**  
**P.O. Box 51666**  
**Boulder, Colorado 80321-1666**



**Three Gripes**

Although my general complaints about *MaxThink* aren't earthshaking, they aren't trivial either. First, *MaxThink* takes minimal advantage of the Mac's graphics capabilities. Text appears in a bland 9-point Monaco font with no optional typefaces, and graphics cannot be included in an outline. Second, programming oversights make file management confusing: *MaxThink* asks if you want to save changes when quitting or closing files even if you've done no editing, and opening a new file without returning to the desktop forces you to stare at the previous outline's title until you've saved your new outline. Third, the poorly edited *MaxThink* manual takes some getting used to: only 18 of its 78 pages explain how to use the program, and complex program functions are given short shrift. My advice: read the short "how-to" section and ignore the rest.

*MaxThink* has a free upgrade program. The current version, 2.2, appears bug-free, although our tests determined it won't work on a 128K Mac. The developers claim they're working on that one. *MaxThink* isn't as elegant as *ThinkTank*, but it is a full-featured outliner that gives *ThinkTank 512* a run for its money. —Reed McManus

*MaxThink*, version 2.2  
*MaxThink*  
 230 Crocker Ave.  
 Piedmont, CA 94610  
 800/227-1590, 800/642-2406 in  
 California  
 List price: \$89

**Hey Kids!**

Apple may be marketing the Macintosh as a business machine, but anyone who's watched a five-year-old playing with *MacPaint* knows that the Mac can also be a wonderful toy and a fine teacher. Although the Mac's graphic interface is easy for children to understand, few programs have been available for them to use. The number of educational programs is slowly growing, however. Great Wave Software recently introduced *KidsTime*, a package specifically aimed at three- to eight-year-olds. *KidsTime* includes five programs that teach numbers, the alphabet, and basic music skills. Dollar for dollar, it's hard to find software that offers more educational value and fun.

(continues)

1 / 2 / 4 • M E G • U P G R A D E

**BRAINSTORM**

*The upgrade to end all Mac upgrades is available now!*

**INTERCHANGEABLE MEMORY MODULES:**

- 512K to 1 Meg -- \$379
- 128K to 1 Meg -- \$428
- 512K to 2 Meg -- \$733
- 128K to 2 Meg -- \$782
- 4 Meg Add On -- \$559

**One Year  
 Warranty;  
 Lifetime on  
 Memory**

Credit for Mac Doctor 512: \$89

Rebate on 1 Meg Module: \$65

Take off \$49 if you have Apple's new ROMs.

**HARDWARE/SOFTWARE COMPATIBLE**

BRAINSTORM™ installs on any 128K or 512K Macintosh. It provides CONTIGUOUS memory, not banked memory, making it 100% compatible with all Macintosh software. It requires no special startup disk, with either the old or new Apple ROMs. And because BRAINSTORM™ is both ultra-low-power and ultra-low-profile, it is 100% compatible with all Mac hardware, including the Apple 800K disk drive, HyperDrive, and the SCSI Port.

**POWERSAVER™**

BRAINSTORM™ contains a custom PowerSaver™ chip which reduces the power to memory by over 50%. So the 1 MEG runs as cool as a 512K, and a 2 MEG with the new CMOS chips runs COOLER THAN THE ORIGINAL 128K. With PowerSaver™, your Mac runs safer--no overheating or power supply overloading--and without a noisy fan.

**SCSI Port \$129**

**512 K • U P G R A D E**

OUR AD MAY BE  
 BLACK AND WHITE  
 BUT OUR SOCKETS ARE

**GOLD**

Before you buy an upgrade from anyone with a fancy color ad, put them to the test: Ask them if they use sockets. Then ask what kind. Are they tin or gold? Closed or open frame? With four contacts or one?

At Mac Doctor we use the best sockets money can buy. OPEN FRAME, FOUR-CONTACT, GOLD sockets. That means your memory chips will stay cool, stay in place, and stay in good electrical contact--a few features worth their weight in gold.

120-day warranty. Free software. No down time. Dealers welcome.

**512 K  
 \$169**

Hobbyist's Kit \$99. Exchange Kit available.



**Mac Doctor Electronics**

1145 Terra Bella Ave, Mountain View, CA 94043 (415) 964-2131

Circle 395 on reader service card

# THE NEW PLUS SERIES™

Quality, Versatility, and Protection for your MacPlus™



**MacPlusBag**

Soft protective, easy to carry bag for new keyboard and external hard disc drive with room for a second disc drive.

**PrintPak™ II**

Take your printer along, with this soft protective bag; made especially for the new Image Writer II.



**MacFreighter™ Plus**



A sturdy, solidly built, all purpose shipping case. You can tote your keyboard and disc drives knowing they are safe and protected. Can be checked as luggage.

**MacCovers™, MacPak, and MacCase™ are now available for the Plus Series.**

FOR ADDITIONAL INFORMATION  
PLEASE CALL TOLL FREE  
**1-800-228-7042**

Quality Products From  
**LINEBACKER**

643 Industry Drive Seattle, Washington 98188  
(206) 575-1180

## Macware Reviews

### Dot-to-Dot

Young children will learn the alphabet and numbers by playing Dot-to-Dot, the Mac version of the classic coloring-book activity. The screen shows a sequence of numbered or lettered dots. When all the dots are connected with the mouse, a picture appears. A new puzzle is just a mouse click away. The program comes with ten ready-made puzzles and a puzzle editor that lets you turn *MacPaint* drawings or digitized images into custom dot puzzles.

### Match-It

Match-It is really several games, all of which require players to match up cards by dragging them to empty boxes on the screen. Some of the games involve simple matching operations, such as pairing pictures with corresponding letters. Others involve arranging picture fragments into a completed puzzle. The most complex puzzles require the child to fill a two-dimensional matrix, matching shapes with sizes or patterns. Although it wasn't available for this review, a MatchMaker program is promised in the manual that will allow *KidsTime* owners to create their own Match-It puzzles to supplement those that come on the disk.

### ABKey

In ABKey, letters and/or pictures appear on the screen. When a child presses the key that corresponds to a letter or a word, it disappears while the computer pronounces it (for example, "uppercase A" or "Apple"). While ABKey is a good teaching tool, the keyboard's QWERTY layout may prove confusing to children who have just learned the alphabet. A big improve-

ment would be an ordered set of alphabet buttons at the bottom of the screen that could be clicked to select letters.

### Story Writer

Once children are able to find their way around the keyboard, they can graduate to Story Writer, a sort of mini *MacWrite* that includes a voice. Typed words appear in a text window, and a special Storybook font makes each key into a picture (see "Every Picture Tells a Story"). A Key Caps window at the bottom of the screen shows the locations of letters and pictures. Also at the bottom of the screen are several tools, including a potentially dangerous eraser that can instantly clear away hours of creative effort. Fortunately, the eraser is undoable, but only if the child knows where to find Undo in the Edit menu. Younger kids will enjoy listening to stories being read aloud, but they may have trouble finding the Read All menu option. A read icon would be helpful.

### KidsNotes

Finally, there's KidsNotes, a program that allows children to create simple melodies using an on-screen piano keyboard or the Mac's keyboard. Once notes are entered on the musical staff, you can change the time values by clicking on note icons located in a second window, but you can't enter the notes onto the staff by dragging them from the icon window. The staff's main purpose seems to be allowing simple editing of songs before they're saved to disk. As with Story Writer, most pre-

(continues)

### Every Picture Tells a Story

In *KidsTime's Story Writer*, pressing the Shift and Option keys reveals a set of pictures hidden beneath the letter keys on the screen. Pictures inserted into the text are read aloud by the computer when Read All is selected from the Voice menu.

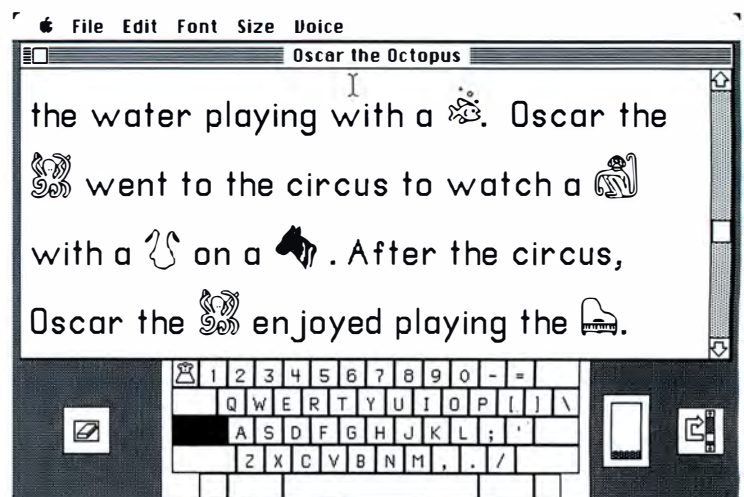

Circle 28 on reader service card





# If They've Told Us Once, They've Told Us A Dozen Times.

The Bernoulli Box disk cartridge subsystem is now the proven standard in PC mass storage solutions. But don't take our word for it.

"Bernoulli Box ranks as the almost perfect tool."

*PC WEEK*

"Omega's Bernoulli Box is a no-compromise disk drive that solves the problems of floppy and hard disks, offering their benefits while eliminating their shortcomings."

*PC Magazine*

"An add-on storage device that combines rugged durability with high speed, it offers the portability and low cost for which floppies are noted plus the huge storage capacity and snappy access speed that are the hallmarks of hard disks."

*New York Times*

"...we now have unlimited storage capacity with greater performance than that available on the IBM XT."

*Datapro Research Report*

"The Bernoulli Box operated flawlessly during my long evaluation period."

*PC Tech Journal*

"Attached to an AT, the Bernoulli Box is faster than the AT's own hard disk. Attached to an XT, it is faster than an XT hard disk and even a smidgen faster than an AT. If you install a Bernoulli Box on a standard PC, its performance will make you forget any thoughts you had of eventually upgrading to an XT."

*PC News*

"When you add the convenience of the removable cartridge, with its instant backup potential and easy swapping of data files, the speed of data access and transfer, and the reduced risk of head crashes, you've got what could amount to a 'best buy' in mass storage systems."

*Popular Computing*

"World Class Hard Disk Storage Award."

*PC World*

"Omega's success has proven to computer makers that its disk drives work and that it can produce them reliably."

*Business Week*

"...megabytes of fast, reliable, removable on-line storage in such a compact configuration are practically irresistible."

*PC News*

"It's the best form of PC storage I know."

*PC WEEK*

"They're tough too—"

*PC Magazine*

THE BERNOULLI BOX AND CARTRIDGES.

AVAILABLE FOR IBM, IBM-COMPATIBLES  
AND APPLE MACINTOSH.

For information,  
call 1-800-255-5550,  
Extension 466.



**OMEGA**  
BERNOULLI TECHNOLOGY

Omega Corporation, Holly Pond Plaza, 1281 Main Street, Stamford, CT 06902

Circle 171 on reader service card

release 2.1

# STATFAST-2™ STATISTICAL PACKAGE

- Menu driven, very easy to use, even for novices
- Speed is a crucial issue in statistics: STATFAST is a professionally designed superfast stand-alone application (it completes in seconds what takes BASIC or Pascal program 20 minutes or more)
- Double precision calculations. Unlimited size of data files!
- Descriptive Statistics, t-tests (indep./dep. samples), Correlations, Crosstabulation, Frequency, 10 Nonparametric Statistics, Multifactor Analysis of Variance/Covariance (up to 5 factors [including a covariate], Repeated Measures, Unbalanced Designs, Contrasts), Multiple Regression (up to 50 predictors, Durbin-Watson statistic, autocorrelation of residuals, forecasting subprogram, plots of residuals, and more), Significance Tests, and much more
- User defined (multiple) conditional selection of subsets of cases, various ways of treating missing data
- Two flexible Data Editors: easy entering/editing, "copying", "pasting" of data, complex (conditional) transformations, sorting, and more
- Can also access files created by spreadsheets (e.g. Multiplan, Jazz), data bases, and from mainframes
- Graphics, clear comprehensive output, can be "pasted" into MacWrite or MacPaint documents
- Clear, comprehensive manual, with step by step examples
- Runs on Macintosh 128/512/Plus

To order send check or money order for \$119 (plus \$5.00 sh/h) to:

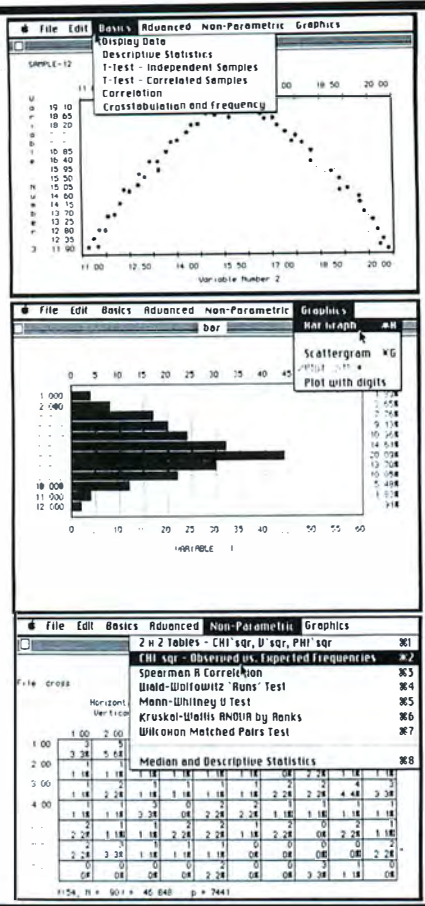

Circle 225 on reader service card

## There's A DEC™ Graphics Terminal Trapped Inside Your Macintosh™

# Release it with Mac 240™

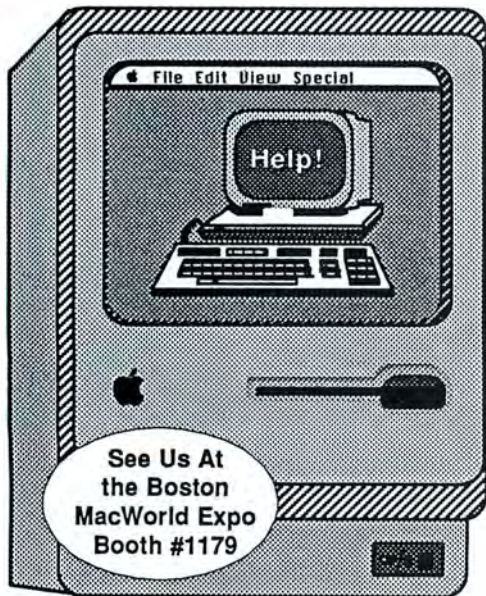

- VT100/220/240 compatible
- ReGIS graphics
- Function key emulation
- File transfer
- Autodialing
- Copy text and graphics
- Printing

**\$199** postpaid  
**CALL TODAY**  
**(603)673-8151**

**WHITE PINE SOFTWARE**  
75 Rte. 101A, PO Box 1108  
Amherst, NH 03031

™DEC & VT are trademarks of Digital Equipment Corp., Macintosh is a trademark licensed to Apple Computer, Inc.

Circle 538 on reader service card

schoolers will need some help with this program. Unfortunately, kids who can handle KidsNotes by themselves will probably find it of limited interest.

### All the Trimmings

The *KidsTime* disk has a special software safety lock that prevents anything from being saved or changed unless a special file is present. Users familiar with the Mac may be frustrated if they dive into *KidsTime* without reading the manual, spend time writing a story or composing a song, and then find out that their composition can't be saved; however, this feature is a wise precaution given the intended users of the program.

*KidsTime* comes with a thoroughly readable manual that includes a beginner's guide, a discussion of the educational theory, complete instructions for all the games, and tips for advanced use. All in all, the manual is an excellent guide for parents. The only thing missing is a set of instructions aimed at the kids themselves.

### Grade Card

Although *KidsTime* is for the most part a well-designed program, young children may have problems using the scroll bars, the pull-down menus, and the keyboard. The designers should have relied more heavily on icons, which even the youngest children can understand. A fully functional Clipboard in Story Writer and Dot-to-Dot would allow parents or children to enhance stories and pictures with other programs, such as *MacWrite* or *Art Grabber*.

But *KidsTime* has so much going for it that these complaints seem minor. The package has so many diverse activities, levels, and features that just about any kid under 12 can enjoy it for hours or days. Simple animation adds reinforcement for young learners, and the computer voice is an effective and exciting teaching tool. The open-ended nature of the program allows parents to create new puzzles, making the games continually fresh, personal, and creative. *George Beekman*

*KidsTime*  
Great Wave Software  
104 Gilbert Ave.  
Menlo Park, CA 94025  
415/325-2202  
List price: \$49.95

(continues)

# Freedom for Your Laserwriter

The First Amendment provides for freedom of the Printed Word,

but without LaserWorks™ you can only exercise your Freedom with Helvetica, Times, Courier and limited symbols. Now you can create professional fonts, logos or character graphics using this unique and complete workshop. If you need special scientific characters, Greek, Arabic, Chinese, Japanese, your company logo or just your monogram, they can be quickly and simply made with a minimum of graphic skills.

The characters created are laserfonts and can be used exactly as you presently use the "built-in" fonts on the LaserWriter. You can even choose the option to save the fonts as a special "Laser Dictionary" which will remain in the Laserwriter as long as the power is not shut off. The "Liberty Bell", logo and sample letters have all been created in minutes, using LaserWorks™. It is simpler, more direct, and easier to use than MacPaint™.

To help you in your work you can use all the normal Macintosh™ fonts as templates and then trace the edges to make the lines and curves that the Laserwriter understands. You may also choose to take a template from the "Scrapbook" which widely extends the use. They can be created by hand, using MacPaint™ and then transferred to LaserWorks™. (The characters in this ad were made by using this method). To make your work even easier while editing, you can automatically test your work on the Laserwriter!!

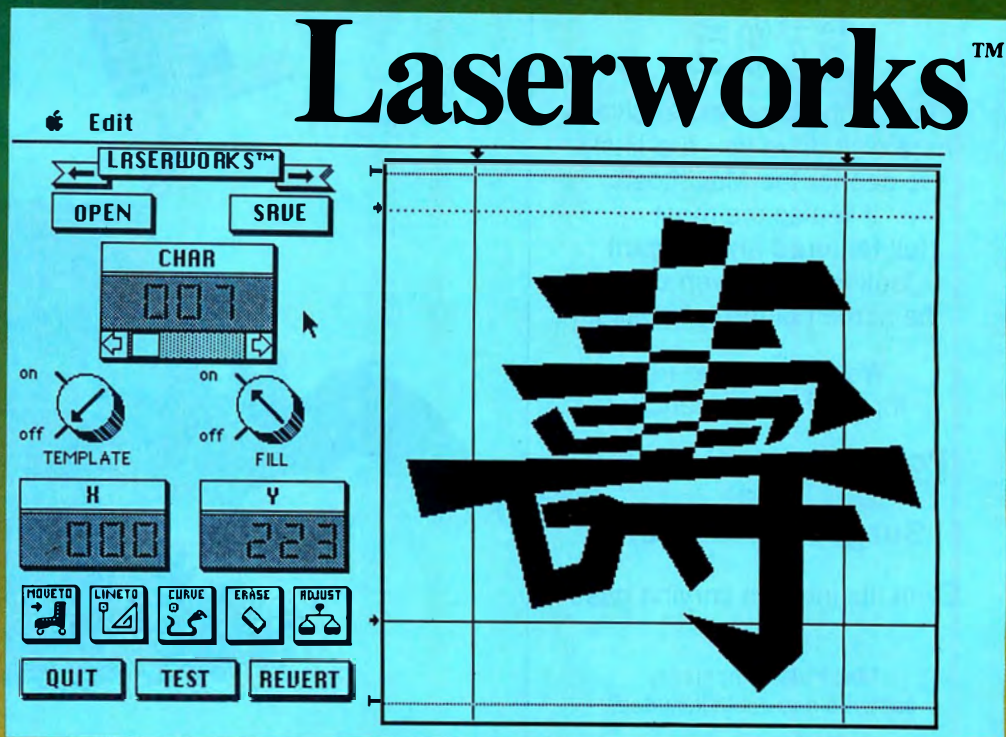

This is the main screen of LaserWorks™ where all the editing gets done. The additional screens of "Goodies" and "LaserExpert" give all the possible tools you will need and even more!! Rotated, italics, light, bold and medium characters are all made in "Goodies". Everything is done using the mouse and all our special controls are designed so that the user can work with the minimum amount of skill. If you need help, at any time, you can click on a button and get all the explanations necessary. This is why we say "Excessively Macintosh™".

Laser Works™ is the perfect companion for your Laserwriter and is a completely professional workshop which does not require professional skills.

**Laserwriter without LaserWorks™ is like the liberty bell Without a Crack.**

In the U.S.A. contact:  
**E.D.O. Communications**  
63 Arnold Way  
West Hartford, CT. 06119  
Tel: 203 233-5850

In Europe contact:  
**D.O.S. Ltd.**  
Glansevin LLangadog  
Dyfed, Wales SA199HY  
United Kingdom  
Tel: 0550-777121

Visa, and MasterCard accepted  
\$299.00

Circle 485 on reader service card

**MACWORLD EXPOSITION**  
Booth #1180

VISIT US AT  
MACWORLD EXPOSITION  
BAYSIDE EXPO CENTER, BOSTON  
AUGUST 14-16, 1986

## 20 Megabyte SCSI Hard Drive.

**\$795**

This is the least expensive hard disk drive you are likely to see for the Macintosh.

It is also the most full featured and elegant looking. We even use the same paint Apple uses.

We have included, for your convenience:

**Power Control, Noise and Surge Supression.**

Even fits into the carrying case

Mac Plus compatible, software and cable included.



**FAST DELIVERY.**

90 day warranty.

VISA / Master Card.

Toll Free.

**(800) 826-5178**

(602) 884-7402

**Spectra  
Micro Development**

P.O. Box 41795  
Tucson, AZ. 85717

Circle 554 on reader service card



MARK ULRICH

## Ghoul Diggers of '86

If you boot up *Uninvited* and have an uncanny feeling you've been there before, it's probably just a touch of *Déjà Vu*—last year's text and graphics adventure game that let Mac owners manipulate objects with the mouse rather than enter Cro-Magnon commands such as "Get book" or "Drop torch" (see *Macware Reviews*, January 1986). Mindscape's latest game is also created by ICOM Simulations, the developer of *Déjà Vu*. *Uninvited* shares *Déjà Vu*'s format, including the ability to move objects, some delightfully sarcastic commentary, and an intriguing and challenging plot.

As the game begins, you awaken at the wheel of your wrecked automobile, discover that your little brother has disappeared, and clamber out of the wreckage and into an adventure that starts out in a Gothic mansion. The object of *Uninvited* is to find your little brother and escape with your lives—not an easy task.

### Who Invited You?

Once inside the mansion, you'll encounter a host of unpleasant creatures, but only a few signs of your host's existence. You'll wander through dozens of dilapidated rooms, each artfully illustrated, collecting clues and encountering more than one red herring (see "A Room with a Clue"). You'll find magical incantations in ancient books bearing the sign of the pentagram, but you must figure out how and where to use them. It's quite a thrill the first time you utter a spell and see the results. *Uninvited* surpasses *Déjà Vu* in the use of digitized sounds—thunderclaps, barking dogs, and creaking doors, to name a few—as well as animation. Scuttling spiders, flapping bats, and a most annoying little demon who periodically scampers across the screen all add excitement to the game.

I found myself vacillating between fascination and frustration. Some of the puzzles are quite tricky, and I felt foolish interrogating every chair in the house in an attempt to gain information. In the end I

had to swallow my pride and resort to peeking at a few clues; Mindscape will send a free hint sheet to registered owners upon request.

### Save Yourself Some Trouble

If you know what's good for you, you'll save early and often—a single slip can end the game and wipe out a good deal of work. The game's quick reference card advises you not to save games on either of the program's two disks, which are filled with the files necessary to run the game, but to use a separate disk (the easiest method is to eject Disk One and insert a game storage disk). Not a big fan of disk swapping, I discarded the ImageWriter file on Disk One to create ample room for at least one game. (If you want to print out the certificate that appears at the successful conclusion of a game, however, you should leave the ImageWriter file intact.)

Saving games avoids wasted time and effort when you experience an untimely demise, and you should also map the game's terrain, both inside the house and out. Like its text-adventure ancestors, *Uninvited* subjects players to a maze. However, this puzzle exists not only in the imagination, but as a seemingly endless series of illustrations, each with a chamber nearly identical to the last. Adventure game veterans already know this, but I had to learn the hard way: you must draw a map of the maze as you traverse it. And watch out for the zombies!

If you like a good mystery, you should enjoy *Uninvited*. The graphics are skillfully drawn and plentiful, the plot is intricate and amusing (although at times frus-

trating), and the imaginative sound effects and animation make this game a winner.

—Erfert Nielson

### Uninvited

Mindscape, Inc.

3444 Dundee Rd.

Northbrook, IL 60062

800/221-9884, 800/942-7315 in Illinois

List price: \$49.95

## Across-the-Keyboard Customization

If you use your Macintosh to write in a language other than English, you've experienced the frustrating delay caused by pressing the Option key, pressing the appropriate key for an accent or a diacritical mark, and then typing the accented letter (Option-i, for example, produces a circumflex). Worse yet, you may have to open the Key Caps desk accessory to find out where an accent resides. Now you can customize your keyboard, thanks to *MacKeymeleon*, from Avenue Software.

*MacKeymeleon* saves you the trouble of remembering keystroke combinations by letting you assign accented letters to infrequently used keys. For example, you could assign the letter é to the percent sign, ô to the asterisk, and so on.

In addition to allowing you to assign accented characters to any key you wish,

(continues)

### A Room with a Clue

One of the many rooms you'll tour in *Uninvited*, the master bedroom provides clues in the guise of wheelchair, book, and candle.

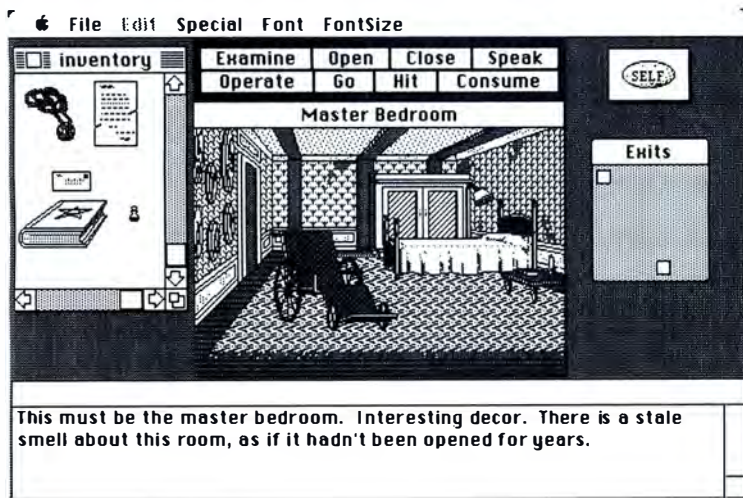

# VersaTerm

## Terminal Emulation\* and Communications Programs for the Macintosh™

The Professional VersaTerm Line of Software has a solution for your needs.

### VersaTerm-PRO New!

The most Complete and Powerful Tektronix 4105 Macintosh Terminal Emulator on the market today!

#### Terminal Emulation

- Tektronix 4105
- DEC VT100
- Tektronix 4014
- Data General D200

#### File Transfer

- TEXT
- MacTerminal™ XModem
- Text XModem Protocol
- MacBinary XModem
- Text/Binary Kermit Protocol

Version 1.10 now supports 132 Columns and MacBinary Kermit!

#### Features

- Create TekPrint, MacDraw, MacPaint and MacWrite documents from memory.
- True Interactive Zoom and Pan In memory with either the 4105 or 4014 graphics.
- Fully supports all text and graphics features of the Tektronix 4105.
- The 4105 dialog can either be a separate window or text overlaying the graphics.
- Very high quality, full page graphics may be printed on either the ImageWriter or LaserWriter.
- Color output supported with ImageWriter II.
- Supports 4105 host and keyboard Macros.
- Copy either text or graphics to the Clipboard.

Requires a 512K Mac, Mac-XL or Mac Plus, and optionally an ImageWriter(II) or LaserWriter printer and numeric keypad.

List Price \$295

Special upgrade price for registered VersaTerm Owners.

### VersaTerm

Terminal Emulations

- DEC VT100
- Tektronix 4014
- DataGeneral D200

This solid program (VersaTerm) should be looked at by all power users, especially those with VT100 and Tektronix emulation needs. — MacUser, Premiere Issue '85

File Transfer

- TEXT
- MacTerminal™ XModem
- Text XModem Protocol
- MacBinary XModem
- Text/Binary Kermit Protocol

Create TekPrint, MacPaint and MacWrite documents.

NEW! Version 2.20 now supports 132 Columns and MacBinary Kermit!

Graphics and Text terminal emulation and communications.

- Copy a text selection to the Clipboard.
- Up to 384 lines of text saved in memory.
- Supports ALL Auto-Dial Modems.
- Supports the Hard Disk 20 with HFS.
- Very High character throughput, up to 9600 baud.
- Log text directly to a printer.
- Move the cursor within an editor using the mouse.
- Full screen Tek cross-hairs.

Requires a 128K or 512K Mac, Mac-XL or Mac Plus.

List Price \$ 99

### TekPrint

Requires a 128K or 512K Mac, Mac-XL or Mac Plus and VersaTerm or VersaTerm-PRO.

NEW! Version 2.00 now supports Tektronix 4105 Vectors and HP Pen Plotters!

Zoom, Pan, Rotate and Print High Resolution Tektronix Graphics on the ImageWriter or LaserWriter Printer. Create MacDraw Documents. Use VersaTerm to preview and create TekPrint documents. Print several files at once.

List Price \$ 79

### VersaTerm-HP

Requires a 128K or 512K Mac, Mac-XL or Mac Plus.

Same general features as standard VersaTerm, except the VT100 emulation is replaced with a Hewlett Packard 2621 emulation.

List Price \$ 99

Published and Distributed by:



Developed by:



PCS Inc.  
2457 Perklomen Avenue  
Mt. Penn, PA 19606  
(215) 779-0522

Circle 304 on reader service card

**NEW**

# Williams & Macias myDiskLabeler™

myDiskLabeler™, the finest disk labeling product available, lets you design and print unique, high quality, removable labels for your 3 1/2" disks.

## New, Version 2 With Icon Grabber

The advanced, Version 2 myDiskLabeler™ lets you grab application icons and modify them. Create your own distinctive icons with the Icon Editor or with Macpaint.™ Seven windows provide editing of text and graphics: Disk Name, Edge Title, Back Title, Contents, Picture, Owner, and Date. myDiskLabeler™ also reads and sorts disk directories. Saves labels for easy updates. myDiskLabeler™ supports HFS, Apple's new Hierarchical Filing System.

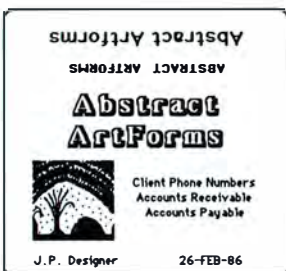

\*Washington State residents add 7.8% sales tax. Macintosh, Imagewriter, & Macpaint are trademarks of Apple Computer, Inc.

### Color Printing

Design and print color labels with our color option and Imagewriter II.™ Option is just \$10.00 more.

### Precision Printing

Print single or multiple labels. Graphics interface makes alignment of Smart Labels™ quick and easy.

### Smart Labels™

myDiskLabeler™ comes with 54 die-cut Smart Labels™ designed specifically for the Imagewriter.™ Labels wrap around the disk edge, have a matte finish, and are removable. Refills are \$5.00 for 54 labels, \$9.50 for 108, or \$18.00 for 216.

Call today, or ask your Apple dealer. Shipping to 48 states is \$3.00 (\$1.00 for each add'l. item). myDiskLabeler™ is for Macintosh™ (MacPlus, 128, 512, or XL) and Imagewriters.™

Version 2, Only \$44.95\*  
With Color, Only \$54.95\*  
Call Toll-free: 1-800-752-4400  
M—F 8:00 a.m. to 5:00 p.m. PST  
Washington & Alaska, call (509) 458-6312



Spokane International Airport Business Park  
P.O. Box 19206, Spokane, Washington 99219

Circle 374 on reader service card

# Verbatim® DataLife™



## 3 1/2" SINGLE SIDED DISKS

FOR AS LOW AS **99¢**\* each

\*With manufacturer's rebate, as outlined below.

Description	40+	100+
3 1/2" Single Sided	1.24	1.19
3 1/2" Double Sided	1.85	1.78
5 1/4" Double Sided/Double Density	1.11	1.07

CALL TOLL FREE **1 800 USA-FLEX**

IN ILLINOIS 1 800 FOR-FLEX  
(1 800 367-3539)



135 N. Brandon Dr. Glendale Hts., IL 60139

7 to 7 Central Time  
10 to 3 Saturdays

### MANUFACTURER'S COUPON

It's easy. Buy your Verbatim DataLife 10-pack(s), and send us this coupon with your proofs of purchase and receipt(s). Please, only one redemption per name and address.

Please send me the DataLife 10-pack I've indicated below.

I have enclosed my fully completed coupon, three (3) UPC symbols and dated cash register receipts(s) with purchase price(s) circled. Select only one:

- 5 1/4" Single Sided/Double Density
- 5 1/4" Double Sided/Double Density
- 3 1/2" Single Sided/Double Density
- 3 1/2" Double Sided/Double Density

Please send my \$12 Cash Rebate Check. I have enclosed my fully completed coupon, two (2) UPC symbols, and dated cash register receipt(s) with purchase price(s) circled.

Please send my \$5 Cash Rebate Check. I have enclosed my fully completed coupon, one (1) UPC symbol, and dated cash register receipt with price circled.

Name \_\_\_\_\_

Address \_\_\_\_\_

City \_\_\_\_\_

State \_\_\_\_\_ Zip \_\_\_\_\_

Send complete coupon and proofs of purchase to:  
Verbatim 1-2-3 FREE Offer, P.O. Box 8966, Clinton, Iowa 52736  
Limit one choice per name and address. Offer void if correct and valid proofs of purchase and complete return name and address are not included. Mechanical reproductions of this coupon or UPC symbols will not be honored. Offer rights not assignable or transferable. Allow eight (8) weeks for delivery.  
Void where taxed, prohibited or otherwise restricted by law. Requests must be received no later than November 1, 1986.

Circle 134 on reader service card

## Macware Reviews

MacKeymeleon lets you customize the keyboard layout. For example, the standard French keyboard is arranged differently than the QWERTY layout to which American typists are accustomed. You can choose from among 14 standard setups, including standard, French, Italian, and Dvorak. The program offers two fonts, Hénédine 12 and Grondines Bold 24.

The process of designing a keyboard is not difficult, and the program's manual covers the installation procedures well, leading you through a number of examples. You can install several customized keyboards on a word processing disk and have one of these layouts automatically install itself when you insert the disk.

When you add a MacKeymeleon keyboard to a disk, the program adds a desk accessory called Keymeleon to your word processor's Apple menu. When you select Keymeleon, a new menu appears on the menu bar. This menu allows you to change from one keyboard layout to another during a word processing session and to select fonts and font sizes. (The developers of MacKeymeleon are French-speaking Québécois, so the program's menus are available in French as well as English.)

MacKeymeleon uses the Key Caps desk accessory to remind you of the locations of your custom keys. If you leave the Key Caps window open below your word processing document window, you'll have a handy map of your keyboard layout.

I encountered a few glitches in MacKeymeleon, but nothing that seriously affected the program's performance. For example, the Key Caps desk accessory tends to lag behind your typing, occasionally highlighting keys at random as you type. The manual is generally informative, but the differences between the standard and international keyboards aren't well documented—the inclusion of extra keys on the international keyboards isn't mentioned in the documentation.

On the whole, however, MacKeymeleon is an extremely useful program. Now you can have your gâteau and eat it too. —Emil Flock and Miriam Flock

MacKeymeleon 1.1  
Avenue Software Inc.  
1173 Charest Blvd. #250  
Québec City, Québec G1N 2C9  
Canada  
418/682-3088  
List price: \$49.95

(continues)

# FOR THE BEST IN MAC GRAPHICS, ONE PRODUCT SCANS ALONE.

"Best Peripheral Device"  
*MacUser*

The editors of *MacUser* named ThunderScan the Best Peripheral Device of 1985. Here's what they said: "ThunderScan from Thunderware is an astonishing device that transfers images to the Mac by scanning them using a snap-in device that replaces the ImageWriter ribbon...Easy to hook up and use, relatively inexpensive, this device should be owned by anyone who uses graphic images on the Mac."

"Best Graphics"  
*MACazine*

Based upon their personal use, the readers of *MACazine* voted ThunderScan the Best Graphics System of 1985.

"Best Hardware Product"  
*MACazine*

We didn't finish first here, but in this case we don't object to second best. Of all the hardware products on the market, ThunderScan finished second only to the Mac 512 as the Year's Best Hardware Product.

**WORKS WITH  
MAC PLUS!** For adapter, see your  
dealer or call us.



To get the best graphics from the world's most graphic computer, experts and users agree: Nothing works like ThunderScan. Because only ThunderScan replaces ImageWriter's ribbon cartridge, scans printed images and turns them into high-resolution MacPaint documents. Just \$229 complete including our powerful image enhancement software (no video camera required). Get yours today. Or contact us for more information and sample ThunderScanned images.

*ThunderScan, as shipped, is compatible with the 128K or 512K Macintosh, ImageWriter I & II and LaserWriter. Compatibility with the wide-carriage ImageWriter and Mac Plus requires accessories. Contact us directly for answers to your compatibility questions.*



Thunderware®, Inc.  
21 Orinda Way  
Orinda, CA 94563  
(415) 254-6581

**ThunderScan**

## In the Black

Black ImageWriter ribbons range in price from \$3.95 to \$10.50, depending on where you buy them. When they become old and gray, they're usually thrown away. However, there are alternatives. If you use a considerable number of ribbons, you should investigate **MacInker** from Computer Friends.

### I Ink, Therefore I Am

MacInker is a small plug-in device that reinks fabric ribbons. The model I tested—MacInker 234IM—is designed for ImageWriter I and II ribbons; also available is a Universal Cartridge model that accommodates some 200 cartridge types. The package includes the reinking machine, a felt roller with an ink reservoir, and a bottle of ink. Additional ink (in black, brown, red, green, yellow, purple, orange, gold, and silver) is available for \$3 a bottle, \$8 for gold or silver. Computer Friends claims that one bottle will reink 25 to 40 ribbons.

MacInker is easy to operate, although becoming a proficient reinker takes some practice. A plastic platform with a spindle turns the ribbon, which in turn loops around the ink-saturated felt roller. To re-

ink a ribbon, you fill the roller's reservoir with ink, place the ribbon cartridge on the platform, pull out a section of ribbon and place it around the roller, and turn on the machine. An ImageWriter ribbon takes about 15 minutes to reink. Ideally, you should let the ribbon sit overnight before using it, to ensure even absorption. According to Computer Friends, a ribbon can be reinked 60 to 100 times, depending on the quality of the fabric and the other components of the ribbon cartridge.

Reinking is not without its frustrations. The first time I used MacInker I applied too much ink, producing a very dark and slightly smudgy printout. Following the instructions in a page of tips included in the package, I reinserted the cartridge in MacInker and wrapped the ribbon around a roll of paper towels to absorb excess ink. The second printout was crisper, but still a bit too dark for my liking. The manufacturer suggested a technique for obtaining a somewhat lighter ribbon: fill the roller's ink reservoir only halfway, then run MacInker for two or three hours. Using this method I finally got satisfactory results.

With a little practice, you should be able to reink ribbons effortlessly. You will, of course, get ink on your hands, but it

washes off surprisingly easily. If you use only a few ribbons a year, MacInker is not worth the expense and effort involved. But businesses with heavily used ImageWriters, or even individuals who are prolific users of printers, should consider investing in a MacInker.

### Would You Like a Refill?

If you're not the do-it-yourself type, you might want to use the services of American Inc. Products, which manufactures ribbons in black, green, blue, brown, purple, yellow, orange, and silver. Mail a worn-out ribbon cartridge to the company and it will refill the cartridge with a new ribbon for \$3.25 (\$3.75 for colored ribbons) plus \$2.25 shipping. Because of mailing charges, the refills are no bargain if you send only one or two cartridges. But it can be economical for larger orders, since these are good-quality ribbons comparable to those sold in computer stores. And if you don't mind getting your hands dirty, the company also sells ribbons separately for \$2.65 for installation in your own cartridges. —*Erfert Nielson*

(continues)

ONLY \$49.95\*  
Not copy protected!

## BEST DESK ACCESSORY AWARD! A+ Magazine

SAVE TIME AND GET ORGANIZED WITH THESE MACINTOSH ACCESSORIES. ALL ON ONE DISK, FOR ONE LOW PRICE!

- 1 Calendar with Daytimer: keeps track of appointments, deadlines, important dates. Includes global search, automatic dial, and Calendar Manager with print command.
- 2 250-page Phonepad: stores and retrieves phone numbers instantly. Includes mini-wordprocessor for taking notes, free-form database, and Print Contents.
- 3 Automatic Modem/Phone Dialer: dials any phone number listed in Phonepad or Calendar.
- 4 Scientific Calculator: Hewlett-Packard RPN notation, statistical, logarithmic and trigonometric functions, and much more.
- 5 RPN Calculator: simplified and streamlined for everyday calculating. Continuous memory and full display control.
- 6 9-function Disk Utility: from within any application you can trash, copy, find, move and rename files, lock/unlock files, change default drive, access disk and file size/date information.
- 7 High-Speed Launcher: transfer to any other application — without going through the Finder.
- 8 Print Text: prints hardcopy of any document or program — while you keep working. Many formatting options.
- 9 Windows: gives a complete listing of every window in your system, and lets you bring any window to front of screen.



BATTERYPAK WORKS WITH ANY 128K MACINTOSH AND THE NEW MACINTOSH PLUS! ALSO INSTALLS ON ALL HARD DISK DRIVES.

**BATTERIES INCLUDED**

30 Mural Street, Richmond Hill, Ontario L4B 1B5 Canada (416) 881-9941 Teles: 06-989-266. If you can't find Battery Pak at your local retailer, you can order it direct from us for \$49.95\* (plus \$5.00\* for shipping and handling). Call 1-800-387-5707 (U.S. only). New enhanced version 1.2 now available! Update your disk for only \$10.00\* with the return of your original disk. \*Suggested U.S. list price. All prices shown are in U.S. funds. — BATTERIES INCLUDED. APPLE, ATARI, COMMODORE AND IBM ARE REGISTERED TRADEMARKS RESPECTIVELY OF APPLE COMPUTERS INC., ATARI INC., COMMODORE BUSINESS MACHINES INC., AND IBM BUSINESS MACHINES INC. WRITE TO US FOR OUR FULL COLOR CATALOG OF SOFTWARE FOR ATARI, ATARI ST, APPLE, MACINTOSH, COMMODORE, AMIGA AND IBM SYSTEMS.



"A 'WISH LIST' OF DESK UTILITIES." (A 4 DISK RATING) — Tom Neudecker/InfoWorld "HANDS DOWN WINNER!" — Sharon Aker/A + Magazine "PACKED WITH ACCESSORIES" — Gordon McComb/MacWorld "SIMPLE TO USE AND GETS THE JOB DONE" — Steven Schwartz/Macazine "WORTH EVERY PENNY" — L. Kutten/Computer Shopper "THE BEST WE'VE SEEN!" ("five mouse" rating). — Steven Bobker/Macuser



# TimeWand™ - Keeping track of time...

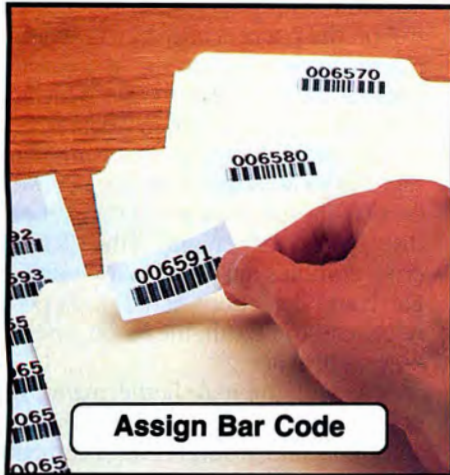

**Assign Bar Code**

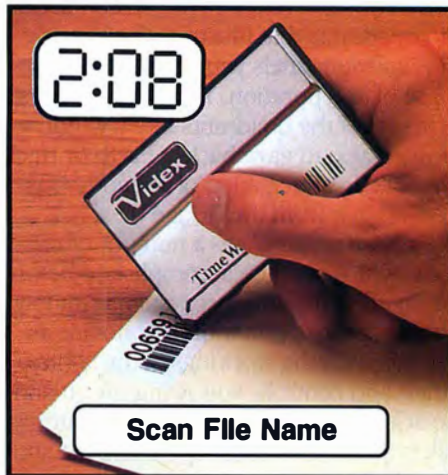

**Scan File Name**

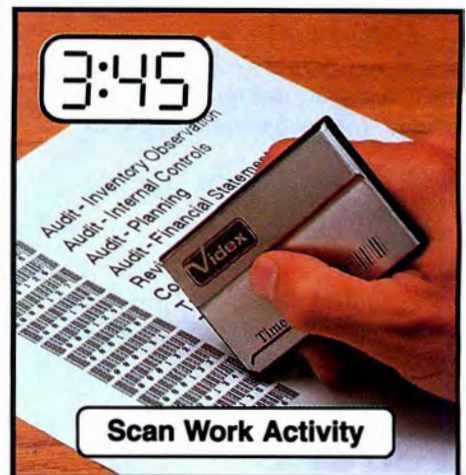

**Scan Work Activity**



**Transfer Scan Data**

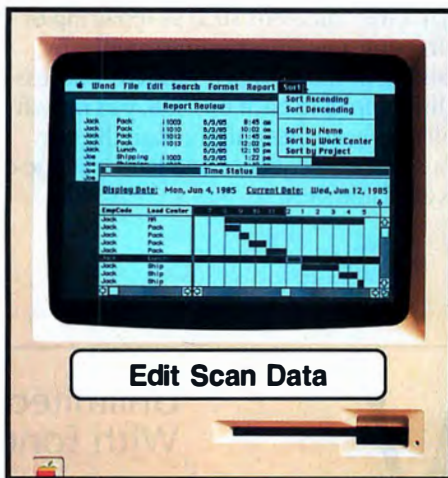

**Edit Scan Data**

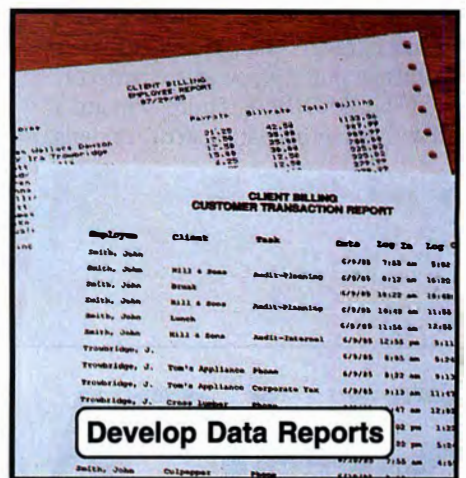

**Develop Data Reports**



## Six easy steps to time management!



The Videx TimeWand™ is an intelligent yet inexpensive bar code system for your business needs. Small enough to fit easily into a shirt pocket and weighing in at less than two ounces, TimeWand gives a new dimension to the concept of fully portable bar code readers.

Versatility is the hallmark of the TimeWand system. With its built-in microprocessor, TimeWand puts the power of a computer into the palm of your hand. Power that lets you actually change how TimeWand works. Whether you want to read different types of bar codes or program the wand to read bar codes in a certain order, TimeWand can accommodate your needs.

Available in three different memory configurations, TimeWand can store from 2,000 to 16,000 characters in its internal memory. This means you can hold from a few hundred to a few thousand bar codes in the TimeWand before transferring the information to a host computer system.

TimeWand time-stamps *each* bar code as it's read. This lets you know not only what the bar code says, but *when* the code was read.

The TimeWand's recharging/download station uses a standard RS232C serial connector that allows you to communicate with the wand through a variety of host computer systems. Since the communication is keyless, the scan information is sent quickly and error free. Currently, software packages are available for the IBM PC (and compatibles), Apple //, and Apple Macintosh personal computers.

Put the power of TimeWand in your own hands... and let it work for you.

**TimeWand (2K version) - \$198**

**Recharger - \$149**

**TimeWand Manager Software (Macintosh) - \$499**

**TimeWand Communications Software (IBM) - \$299**



1105 N.E. Circle Blvd., Corvallis, OR 97330  
503-758-0521

Videx is a registered trademark and TimeWand is a trademark of Videx, Inc.

Circle 383 on reader service card

### MacInker

Computer Friends

6415 S.W. Canyon Ct. #10

Portland, OR 97221

800/547-3303, 503/297-2321 in Oregon

List price: ImageWriter model \$42,

Universal Cartridge model \$68.50

American Inc. Products Co.

527 Howard St.

San Francisco, CA 94105

415/982-0161

List price: refills \$3.25 (\$4.23 for color)

plus shipping, ribbons \$2.65 (\$3.45 for color)

## Star Struck

If you own a 512K Mac, you can get an idea of what space travel is like, thanks to Spectrum HoloByte putting you at the helm of the Space Shuttle Orbiter. There, you are greeted with an intimidating array of dials,

buttons, toggle switches, and CRTs that make up the Shuttle's forward control panel. During a mission, the screen divides into quadrants that illustrate the specific CRTs and subpanels you need for each phase of an operation. You can also transform one of the quadrants into a window, allowing you to gaze back at Earth or track a satellite in anticipation of a rendezvous (see "A View from the Bridge").

**Orbiter** simulates a number of missions, which must be accomplished before the Shuttle's life-support systems run low. A training mission familiarizes novice astronauts with the workings of the vehicle's panels and controls. Following lift-off and the achievement of a stable orbit, your first task is to launch a telescope using the shuttle's mechanical arm. Later, you must perform other missions such as repairing or retrieving a malfunctioning satellite by walking in space. When you have successfully completed each mission, you must finally navigate the craft through the perilous reentry sequence and land it at one of six available sites.

### Technology Triumphs

**Orbiter** is an impressive programming achievement. Every gauge, switch, and control on the panel is fully functional. Each minute movement through the cosmos is tracked on one of three CRTs, which provide the accurate telemetry data necessary to successfully complete your mission. Messages from Mission Control are delivered by a synthesized voice and simultaneously displayed as text on one of the CRTs. The crisp graphics include a "map" view of the Earth and depictions of the ship's position relative to the Earth, the Moon, and other objects in space.

As with the real shuttle, many aspects of your mission are controlled by on-board autopilots and ground control computers. You can disable these fail-safe systems, however, and instead use manual control to get a firsthand taste of space flight.

(continues)

# SHOW ANY FACE WITH PRIDE.

## Unlimited Fonts For Laser Writing With Fontographer.

Only Fontographer™ can give you the superior quality of laser writing with an unlimited number of fonts. Allowing you to go far beyond the restricted number available before.

Fontographer's powerful design tools make it easy to create custom characters in any size. Use graphic effects, like drop shadows, slants and rotations. Plus you can build Macintosh™ screen fonts automatically.

Create your own fonts\* from anything you draw. Logos, signatures, line drawings, or any scanned inputs. All with full laser writing resolution and complete convenience.

Fontographer. The professional font editor that lets you show your face with pride. Any face. With exclusive laser writing compatibility.

# ALTSYS

C O R P O R A T I O N

720 Avenue F, Suite 108 • Plano, TX 75074 • (214) 424-4888

\*If you design a font using Fontographer you particularly like, send it to us. We might add it to our Font Library. And pay you the royalty on every sale!

Macintosh is a trademark of Apple Computer, Inc.  
Fontographer is a trademark of Altsys Corporation.

Circle 227 on reader service card

# Coming Soon for the Macintosh



Clip Art  
at your Fingertips!

Thousands of pieces of top-flight clip art are now as accessible as your nearest mouse!

From the copyrighted files of SCW Services, Inc. (A Scripps Howard Company), supplier to newspaper and magazine publishers, comes problem-solving PC Quik-Art. The perfect complement to such versatile graphics programs as PC Paintbrush (from Z-SOFT) or FONTRIX and PRINTRIX (from Data Transforms).

Make full use of today's desk-top publishing possibilities by incorporating PC Quik-Art into your program right away.

Available on a monthly basis (200 "clips") in 5.25" IBM-PC compatible disk format . . . or on a quarterly basis in CD ROM format.

Thousands of dollars worth of top-of-the-line art for only \$59.95 per release (in 5.25" diskette form). CD ROM versions available for volumes of 5,000 or more "clips." You can even get custom PC Quik-Art volumes on a subject matter basis. Call for special pricing.

With PC Quik-Art, you can turn your mouse's squeak into a lion's roar. The change is only a phone call away. (Dealer inquiries also welcome.)

## PC QUIK-Art™

50 Gaines School Road  
Athens, Georgia 30605  
(404) 354-1911

PC Quik-Art is a trademark of PC Quik-Art, Inc. PC Paintbrush is a trademark of Z-SOFT Corp. All images copyrighted by SCW Services, Inc. FONTRIX and PRINTRIX are trademarks of Data Transforms, Inc.

Circle 558 on reader service card



**Lost in Space**

Maneuvering the shuttle requires precision and practice and at least a basic understanding of space physics. Because you are operating in a vacuum, you must get used to the concept of inertia. Also, you must take into account the curvature of the shuttle's orbit before you can overtake other objects in space.

These and other basic principles of space flight are outlined in *Orbiter's* manual, but beyond a detailed training mission and an adequate explanation of how to set up display quadrants and access menus, documentation is somewhat limited. For example, it tells you how to retrieve a satellite once you're within docking range but offers few directions for getting that close.

The manual is also rather inadequate when trouble arises. When the Shuttle burned up the first two times I attempted reentry, I was shown a dialog box explaining that my acceleration rate was too high. Unfortunately, I found no suggestions for solving that problem in future missions.



**A View from the Bridge**

*Orbiter's* screen is divided into quadrants: Control, Engines, CRT, and Forward Main Station. The panel in the lower right lets you select subpanels such as the view outside the shuttle shown here.

**Reality Strikes**

*Orbiter's* designers have gone to great lengths to accurately simulate all aspects of shuttle operation. Ironically, the very realism that makes the simulation so impressive is also responsible for its major weakness: *Orbiter* is ultimately somewhat boring. In his now classic book, *The Right Stuff*, Tom Wolfe describes the test pilots who became our first astronauts as "Spam in a can." The astronauts didn't "fly" their

spacecraft—they merely pushed buttons or monitored the activities of on-board and ground computers.

Similarly, when at the controls of *Orbiter*, you simply push buttons and check readouts under the guidance of Mission Control. While my first few missions were entertaining, educational, and challenging,

*(continues)*

Concerned about the damaging effects of excessive heat and power line disturbances?

# MACBCOOL™

**Not just another fan!**

Cooling is essential for optimum Mac operation. MACBCOOL™ cools your Mac better. Its whisper quiet fan circulates more than 20 cubic feet of air per minute through your Mac utilizing all top vents. That's plenty of cooling... even if you pack your Mac with hard disks and tons of RAM!

Surge energy protection is a must for your Mac too! MACBCOOL™ offers premium quality surge suppression and line filtering as protection against power line disturbances which can cause permanent damage to sensitive computer components.

And, MACBCOOL™ gives you added convenience with its easy to reach, front mounted switches to power up your Mac and up to two peripherals.

To order, see your local dealer or call:  
**1-800-231-2401**  
 Inside California:  
**818-442-7829**

MPH COMPUTER PRODUCTS

Circle 291 on reader service card

# Moving?

Be sure your Macworld subscription goes with you!

Use the coupon here for your convenience to change the mailing address on your Macworld subscription.

Be sure to include the mailing label from a recent issue if possible or, if a label is not available, please send us your complete former address including the zip code. Allow 6-8 weeks for this change to be effective.

SAVE TIME: Call our toll-free service number for immediate service:  
 800-525-0643 (In Colorado, Alaska, Hawaii 303-447-9330).

New address:

Name \_\_\_\_\_  
 Company \_\_\_\_\_  
 Address \_\_\_\_\_  
 City, State, Zip \_\_\_\_\_

Former address:

Attach mailing label here ▶

Send coupon and mailing label to Macworld Subscription Dept. P.O. Box 55029  
 Boulder, CO 80322-5029.

# UNLEASH THE COLOR IN YOUR MACINTOSH.



Color from your Macintosh? Yes, indeed.

The Macintosh is truly a remarkable machine, and now it's even more so. By attaching a Vermont Microsystems intelligent color monitor and using one of the new color graphics software programs, color will bloom from your Mac.

The color images are vivid and flicker-free. 256 colors can be displayed simultaneously from a palette of 4,096. Just connect either the VM-8860 13" monitor or the VM-8861 19" monitor to your Mac (512 or Plus versions), load the color graphics software and you've

turned your Mac into a real professional design workstation.

So, if you need to do business graphics, or are an artist who is tired of working in shades of gray, or you are a design engineer who loves the ease of using the Mac, a Vermont Microsystems intelligent monitor is what you need.

Believe what you see on this page. The image on the screen was produced using Visual Information, Inc. M.C.A.D. color graphics software and the VM-8861 intelligent color monitor. It was then transferred onto film using

the N.I.S.E. Rembrandt film recorder. The resultant photographic image was color separated for use in this ad. It is unretouched. To prove it we'll send you a copy of the slide. Just write to us requesting the Mac slide.

No more shades of gray for the Mac. Brilliant beyond belief, the Mac has become a true professional design station. So, get colorful with Vermont Microsystems and Apple.



**Vermont Microsystems, Inc.**

Setting the standard to help the professional.

**Circle 556 on reader service card**

# NORTHEASTERN

## Software

7 Trap Falls Rd. Shelton, Connecticut 06484

- Tap our unmatched selection and inventory of software/hardware for the Mac and Apple (as well as the IBM PC and Commodore Amiga).
- School and corporate purchase orders are welcomed. CALL 1-800-874-1108.
- Special/rush orders. If something you need is not listed, hard to find, or needed in a hurry, CALL 1-800-874-1108.
- Order Status. CALL (203) 375-3860.
- FREQUENT PURCHASER PROGRAM. Any repeat customer will automatically receive \$1 off any order he or she places with us. Please mention to your operator that you are a repeat customer. We value your continuing business. Send in \$1,000 worth of invoices (representing previous purchases) and you will receive a coupon worth 1% off any future purchase. With \$5,000 worth of invoices, receive a coupon worth 5% off any future purchase.
- Ask for System Sales when ordering a complete system.
- No additional charges for credit card orders.
- Technical experts on duty.
- Convenient hours. 7 days/week: 9AM-11 PM EST.
- FREE AIR EXPRESS SHIPPING. Purchase \$150 or more of software and for no additional charge we will ship your products by air courier. Mention this to your operator as you place your order.
- FURTHER DISCOUNTS BY MAIL. Circle the items in our ad you want, send the ad in with the coupon below and receive \$ .50 off each item! Cut out a competitor's ad with a lower price and we will give you \$1 off his price (subject to the conditions below).

IF ORDERING AT THE LAST MINUTE, OUR AIR EXPRESS SERVICE CAN RUSH YOUR SOFTWARE/HARDWARE TO YOU.



Send coupon and list of items desired to:  
**DISCOUNT BY MAIL DEPARTMENT**  
 Northeastern Software, 88 Ryders Lane, Stratford, CT 06497

To be eligible for the \$1.00 per item discount you must:  
 1. Fill out all items. 2. Send in our ad with the items you desire circled.

Name \_\_\_\_\_

Address \_\_\_\_\_  
(Include Company Name)

City \_\_\_\_\_ State \_\_\_\_\_ Zip \_\_\_\_\_

Phone No. at above address \_\_\_\_\_

Check form of payment  
 Visa  MasterCard  C.O.D.  Personal Check  
 Certified Check  Money Order

Card No. \_\_\_\_\_ Exp. Date \_\_\_\_\_

Computer Model \_\_\_\_\_

Personal and company checks allow 3 weeks to clear. For faster delivery, send cashier's check, certified check, or money order. Shipping—Software (\$3.00 minimum). Shipping—Hardware (please call 203-375-3860). COD—Add an addition \$2.00. Alaska, Hawaii, Canada, PD, APO, and FPO \$5.00 minimum. Foreign orders—\$15.00 minimum and 15% of all orders over \$100. Mastercard and Visa (please include card no. and expiration date). Connecticut residents add 7.5% sales tax. Prices subject to change without notice. All returns must have a return authorization number. Call 203-375-3860 to obtain one before returning goods for replacement. Defective merchandise replaced with same item only. We do not guarantee compatibility. All sales are final. "Comparable advertised price" does not include typographical errors on the part of other vendors or prices that do not reflect higher shipping costs, credit card charges, or membership fees. The \$1 off offer only applies to items where Northeastern's price is not already the lowest. Final judgment remains with the manager on duty.

Circle 215 on reader service card

# WE WILL BEAT

(See Below)

## SPECIALS

Copy II Mac	17.75
Excel	221.00
Flight Simulator	32.00
Full Point	54.00
Gato	25.00
The Graphics Magician	51.00
Hobo 800K Drive	248.00
Harrier Strike Mission	26.00
Imagewriter Ribbons	4.25
Mac Golf	34.00
Mac Lightning	52.50
Microsoft Word	109.00
Quick and Dirty Vol 2	24.00
Ready Set Go	98.50
Sidekick with Phone Link	51.00
System Saver	64.00
Thinktank 512K	98.50
Thinktank (New Version)	174.00
True Basic W/3-D Graphics	95.00
Turbo Charger	35.00
Wizardry I	35.00

## SILICON BEACH SOFTWARE

Accessory Pack 1	20.50
VIDEX	
Mac Calendar	48.50

## GRAPHICS SOFTWARE

ALTSYS	
antographer	238.00
antostic	23.50
ANN ARBOR SOFTWARE	
Advanced Animation Toolkit I	44.00
Animation Toolkit II	88.00
Animation Toolkit I	32.00
In Motion	88.00
Full Point	54.00
AXLON	
Card Shoppe	37.50
Art Portfolio	35.50
Art Portfolio II	49.50
CASSADY COMPANY	
Fluent fonts	28.50
Fluent Laser Fonts	
CENTURY SOFTWARE	
Laser font Patomac	19.00
Laser font Willamette	19.00
Ultrafonts	19.00
Ultrafonts/Technical & Business	32.00
Technical & Business fonts	19.00
DIABLO VALLEY DESIGN	
Mac Grid	25.00
CHALLENGER SOFTWARE	
Mac 3D	114.50
CRICKET SOFTWARE	
Cricket Graph	128.00
DESKTOP GRAPHICS	
Draw Art	28.00
DIVERSION INC	
Jumbo Color Pens	13.00
Underware Pens	9.00
Underware Ribbon	9.00
DRUID	
Classic fonts	25.00
Graphic Letters	25.00
ENABLING TECHNOLOGIES	
Easy 3D	58.00
ENTERSET	
Quick Point	26.00

## HAYDEN SOFTWARE

DoVinci Commercial Interiors	113.50
DoVinci Interiors	28.50
DoVinci Houses	28.50
Video Works	56.00
DoVinci Building Blocks	45.50
DoVinci Landscapes	28.50
Home Design	47.00
Art Grabber W/Body Shop	28.50

## INNOVATIVE DATA DESIGN

Mac Draft	138.00
Paste Ease	34.50

## KENSINGTON

Professional Type fonts-Headln	41.00
Graphic Accents	28.50
Professional Type fonts-Text	28.50

## MAGNUM SOFTWARE

Slide Show Magician	33.50
Mac Pic Volume 1	27.50
Mac Pic Volume 2	27.50

## MANHATTAN GRAPHICS

Ready Set Go	98.50
MESA GRAPHICS	
Plot II	58.50

## MICRO MAPS

Mac Atlas World	48.50
Mac Atlas USA	48.50

## MICROSPOT

Mac Plot	117.00
SILICON BEACH SOFTWARE	
Silicon Press	41.00

## SOFTSTYLE

Calormate	57.00
SUMMAGRAPHICS	
Mac Tablet 9x6	257.00
Mac Tablet 12x12	357.00

## SUNCOM INC

Macfont 1	18.00
T MAKER	
Click Art Publications	26.75
Click Art Effects	26.75
Click Art Letters	26.75
Click Art Personal Graphics	26.75

## ACCOUNTING SOFTWARE

ARRAYS/CONTINENTAL	
Home Accountant	CALL

## DESK ACCESSORY PROGRAMS

AFFINITY MICROSYSTEMS	
Tempa	69.00
BATTERIES INCLUDED	
Battery Pack	26.50
BORLAND	
Sidekick with Phone Link	51.00
DREAMS OF THE PHOENIX	
Day Keeper Calendar	24.00
Twelve-C Financial Desktop	24.00
DUBL-CLICK SOFTWARE	
Calculator Const. Set	62.00
ELECTRONIC ARTS	
Custom Calc Set	33.50
ENTERSET	
Quick Set	26.00
Quick Point	26.00
MAINSTAY	
Type Now	25.75
HARVARD ASSOCIATES	
Desk Toppers	28.50

I soon tired of flying the shuttle. Even with the autopilot disengaged, you encounter long interludes with little to do but languidly cruise through the vastness of space. *Orbiter's* time-compression feature helps somewhat but doesn't alleviate the monotony altogether.

There is much to like about *Orbiter*. For dedicated students of space travel, it's a must. However, if you want excitement as well as a realistic simulation, you may be happier with a faster-paced program such as Microsoft's *Flight Simulator* or PBI's *Fokker Triplane Flight Simulator*. Unfortunately, many people will find they lack the patience for extended space travel. —Walter C. Burns

*Orbiter, version 1.0*  
Spectrum HoloByte Inc.  
1050 Walnut #325  
Boulder, CO 80302  
303/443-0191  
List price: \$49.95

## Making Tracks

Although there are almost as many styles of music programs as there are styles of music, none is more magical to me than the sequencer. Attach a synthesizer to the Macintosh through a Musical Instrument Digital Interface (MIDI) adapter, start up a sequencer program, and the Mac lets you record one track, play it back while recording another, and so on until you've created a complete arrangement. And because the Mac stores not sounds but digital information, each playback is an original performance (for background on music products for the Mac, see "Musical Wares," *Macworld*, February 1986).

Macintosh musicians can choose from several sequencers, from beginner-oriented products like Creative Solutions' *Studio Mac* to professional-caliber products like Southworth Systems' *Total Music* and Mark of the Unicorn's *Professional Performer*.

Also near the high end is *MegaTrack XL*, from Musicworks of Boston (not to be confused with Hayden Software's *MusicWorks* program). *MegaTrack XL* is part of Musicworks' *Professional Musician* sys-

tem, which includes Musicworks' Mac MIDI Star MIDI adapter hardware and Electronic Arts' *Deluxe Music Construction Set* for transcribing sequences into sheet music.

### Simple and Straightforward

*MegaTrack XL's* greatest strength is its intuitive design. Many other sequencers litter the screen with windows, each devoted to a particular function. *MegaTrack XL*, in contrast, divides its functions between menu commands, dialog boxes, and windows, resulting in an uncluttered display and a straightforward, easy-to-use program. Each track you create is shown in the Tracks window, while another window contains four buttons corresponding to the tape controls on a tape deck. To add a track, you simply choose New Track from the Track menu, type a track name, click the Run button, and start playing.

Recorded tracks can be played back as is or altered using numerous track-manipulation features. Looped tracks, which repeat continuously, are useful for bass lines or other repetitive parts. You can *quantize* a track, causing *MegaTrack XL* to correct

(continues)



## APPLE HARD DISK UPGRADES. ONE SIZE FITS ALL.

FULLY COMPATIBLE WITH APPLE® MACINTOSH™ 128 AND 512, MACINTOSH PLUS, IIe™ AND IIc™

Finding a reliable and affordable hard disk for your Apple is easier than you think thanks to the new ProAPP™ 10 and 20 megabyte hard disk systems.

- Everything is supplied—cables, manuals and software.
- Simply plug in and run—there's no complicated setup.
- Supports IIe/IIc ProDOS™, DOS 3.3 or Pascal 1.3; \* Macintosh MFS or HFS systems.
- One year limited warranty.
- Toll-free hotline support.
- "No risk" money-back guarantee —use it for up to 10 days.

10MB HARD DISK SYSTEM—\$795.\*  
20MB HARD DISK SYSTEM—\$995.\*

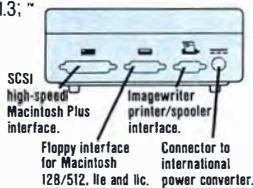

**PROAPP™ ORDER TODAY. CALL 800-424-2425.**  
10005 Muirlands, Suite 0, Irvine, CA 92718

\*Includes shipping, handling and sales tax. †registered trademarks, licensed trademarks and ‡trademarks of Apple Computer, Inc., and ProAPP, Inc. All disk capacities are listed as formatted. ©1986 ProAPP, Inc.

Circle 508 on reader service card

## MAC SOFTWARE AT LOW PRICES

85 Disk Library of Public Domain Software for Mac

<b>Art</b>		<b>Utilities (continued)</b>	
58 Make posters any size	\$9	6 ResEd/ReEd edit fonts, icons	\$9
80 Users draw Bloom City cartoons	\$9	25 Banner prints to 8" letters	\$9
<b>Business</b>		47 Check drive speed, screen edit	\$9
76 Accts rec invoicing system	\$9	73 Calendar-personalize	\$9
<b>Communication</b>		79 Utilities for Mac Appletalk program	\$9
29 Red Ryder-latest version w/doc	\$9	<b>VideoWorks</b>	
<b>Desk Accessories</b>		77 MacMelt: Oceania, Jupiter II, erotica	\$9
24 24 progs Mockterm, RPN calc	\$9	<b>Book</b>	
36 Save Screen, H-P calculator	\$9	<i>The Best Mac Deal</i>	\$795
45 Compact Memory term emul	\$9	160 pg paperback directory of disks	
<b>Education</b>		<b>Macintosh Public Domain Library</b>	
75 Quizzes French, geog., metrics, etc	\$9	Complete Set of 85 diskettes	\$595
<b>Fonts</b>		<b>SPECIAL OFFER</b>	
56 33 fonts Cursive, Boston, Omega	\$9	<b>Any 4 Disks &amp; directory</b>	
81 18 fonts Elexis, Cavanaugh	\$9	<b>Only \$39.95</b>	
82 17 fonts McCloud, Oblique	\$9	Add \$4 (\$10 foreign) shipping for disk orders, or \$2 (\$5 foreign) if ordering directory only. CA orders add sales tax	
<b>Games</b>			
19 Othello, Space Bubble, Orbit	\$9	Enclosed \$ _____ by <input type="checkbox"/> check <input type="checkbox"/> VISA <input type="checkbox"/> MC	
67 Billiards, Volleyball, Juggling	\$9	Card no. _____	
78 Cap'n Magneto, MacBugs!	\$9	Exp. _____ Signature _____	
<b>Home/Business</b>		Name _____	
1 Clock, lease/buy decision, budget	\$9	Address _____	
2 Rolodex, screenmaker, error codes	\$9	City _____ State _____ Zip _____	
33 Multiplan templates bus., nutrition	\$9	<b>The Public Domain Exchange</b>	
<b>Music</b>		2076C Walsh Ave., Santa Clara, CA 95050	
35 20 songs needs Musicworks	\$9	(408) 496-0624 #103	
40 Compose, Smooth Talker demo	\$9		
60 Concertware songs	\$9		
<b>Nudes</b>			
66 MacNudes digitized photos—x-rated	\$9		
<b>Programming</b>			
44 XLISP 15 AI language	\$9		
51, 52, 53 Modula2 language w/doc	\$27		
<b>Spelling</b>			
70 SpellCheck for MacWrite 2.2. doc	\$9		
<b>Utilities</b>			
5 Code Cracking w/doc	\$9		

Circle 334 on reader service card

# THE MOST EXTENSIVE SELECTION AT THE

## ANY COMPARABLE ADVERTISED PRICE

<b>CHANG LABS</b>	<b>ARTSCI</b>	<b>GREENE, JOHNSON INC.</b>	<b>MICRO PLANNING SOFTWARE</b>	<b>SOFTWARE PUBLISHING</b>
Rags to Riches GL ..... 94.00	Softforms ..... 23.00	Spellswell ..... 32.00	Micro Planner ..... CALL	PFS File/Report Combo ..... 98.00
Rags to Riches AP ..... 94.00	Magic File ..... 57.00	<b>HABA SYSTEMS</b>	Micro Planner Plus ..... CALL	PFS Report ..... 69.00
Rags to Riches AR ..... 94.00	<b>ASSIMILATION PROCESS</b>	Quartet ..... 125.00	<b>MICROSOFT</b>	PFS File ..... 69.00
Rags to Riches Inventory ..... 94.00	Business Essentials ..... CALL	Haba Wills ..... 30.50	Excel ..... 223.50	<b>SOUTHEASTERN SOFTWARE</b>
<b>DIGITAL ETC.</b>	Mac Spell Right ..... CALL	Haba Business Forms ..... 30.50	Chart ..... 71.00	Mac Transfer ..... 28.00
Mac Accountant ..... 78.00	Right Word The ..... CALL	Haba Business Letters ..... 30.50	Multiplan ..... 109.00	<b>STATSOFT</b>
<b>INTERMATRIX</b>	<b>BLYTH SOFTWARE</b>	<b>HARRIS TECHNICAL SYSTEMS</b>	File ..... 109.00	Data Fast ..... 38.50
Chequebook ..... 26.00	Omnis III ..... 275.00	Profit Projection/Breakeven An ..... 46.50	Word ..... 109.00	<b>STONEWARE</b>
<b>MONOGRAM</b>	<b>BOSTON SOFTWARE</b>	<b>HAYDEN SOFTWARE</b>	<b>NEW CANNAN MICRO</b>	OB Master Mac ..... 104.00
Dollars & Sense ..... 79.00	Mac Publisher II ..... 125.00	I Know Its Here Somewhere ..... 34.00	Mac Disk Catalog II ..... 31.50	<b>SUPEREX</b>
Forecast ..... 39.50	<b>BRAINPOWER</b>	Ensemble ..... 55.00	<b>NOLO LEGAL SOFTWARE</b>	Mac Notes ..... 37.00
<b>PAIANTIR</b>	Stat View ..... 125.00	Hayden Speller ..... 58.00	Will Writer ..... 24.50	<b>TELOS</b>
Accounts Receivable-Palantir ..... 68.00	Stat View 512 ..... 215.00	Hayden Chart ..... 58.50	<b>OOESTA</b>	Television ..... 94.00
Accounts Payable-Palantir ..... 68.00	<b>CHANG LABS</b>	<b>HAYES MICROCOMPUTING</b>	Helix ..... 218.00	Business Television ..... 198.00
Inventory Control-Palantir ..... 68.00	Three Pack ..... 227.00	Please ..... 122.00	<b>ODS INC.</b>	<b>WARNER</b>
General Ledger-Palantir ..... 68.00	<b>COMPUTER: APPLICATION INC.</b>	HEYDEN & SON.	Consultant ..... 108.50	Desk Organizer ..... 54.00
<b>PEACHTREE</b>	II in a Mac ..... 51.50	Stat Works ..... 78.00	Sales Consultant ..... CALL	
Accounts Payable-Peachtree ..... 86.50	<b>CREIGHTON SOFTWARE</b>	<b>HOWARD SOFT</b>	<b>PALADIN</b>	
General Ledger-Peachtree ..... 86.50	Mac Office ..... 27.50	Howard Tax Preparer ..... CALL	Crunch ..... 77.00	<b>LANGUAGES</b>
Accounts Receivable-Peachtree ..... 86.50	Mac Spell + ..... 54.00	<b>HUMAN EDGE SOFTWARE</b>	Supercrunch ..... 164.00	<b>APPLE COMPUTER</b>
<b>SIERRA INFO SYSTEMS</b>	Mac Home ..... 25.00	Mind Prober ..... 29.50	<b>PALANTIR</b>	Mac Pascal ..... CALL
Accountants Choice Each ..... CALL	<b>CRICKET SOFTWARE</b>	<b>LAZER SOFTWARE</b>	In Touch ..... 78.00	Macintosh 68000 Development ..... CALL
Mac One Write ..... 136.00	Cricket Graph ..... 133.00	Layered ..... 58.50	<b>PROVUE DEVELOPMENT</b>	<b>CONSULAIR</b>
Mac One Write Payroll ..... 136.00	<b>CRYSTAL CANYON</b>	Front Desk ..... 76.00	Overview ..... 148.00	Mac C W Tool Kit ..... 258.00
<b>SOFTSYNC</b>	Mac Librarian ..... 29.00	<b>LIGHTYEAR</b>	<b>PROTEKT-IT SOFTWARE</b>	<b>CREATIVE SOLUTIONS</b>
Personal Accountant ..... 53.00	<b>QATAFOOD</b>	Lightyear ..... CALL	Pracopy/Pracedit ..... 27.00	Mac Forth level I ..... 72.00
<b>SIMON AND SCHUSTER</b>	Drawforms ..... 29.50	<b>LIVING VIDEOTEXT</b>	<b>REAL DATA</b>	<b>EXPERTELLIGENCE</b>
J.K. Lassers Money Manager ..... 57.00	Mac Forms ..... 41.00	Think Tank 128K ..... 49.50	Residential Real Estate ..... 58.50	Exper Lisp ..... 238.00
<b>UNITED SOFTWARE</b>	<b>CATALOGICA</b>	Think Tank 512K ..... 98.00	Financial Analysts ..... 58.50	Exper Ops 5 ..... 168.00
In House Accountant ..... 109.00	dMAC III ..... CALL	<b>LOTUS DEVELOPMENT</b>	Tox Shelter Syndication Analyst ..... 168.00	Exper Logo ..... 78.00
	<b>QATAPACK SOFTWARE</b>	Jazz ..... CALL	Real Estate Investment Analysis ..... 88.00	<b>HIPPOPOTAMUS</b>
<b>BUSINESS SOFTWARE</b>	Executive Office ..... 198.00	<b>MACNIFTY</b>	Mortgage Qualifier ..... 118.00	Hippo C level I ..... 74.00
<b>ADVANCED LOGIC SYSTEMS</b>	My Office ..... 78.00	Studio Session ..... 68.00	On Schedule ..... 118.00	Hippo C level II ..... 191.00
Mighty Mac ..... 35.00	<b>DOW JONES SOFTWARE</b>	<b>MAINSTAY</b>	Commercial Industrial App. .... 58.50	<b>KRIYA SYSTEMS INC</b>
<b>AEGIS</b>	Spreadsheet Link ..... 61.00	Turbo Download ..... 24.75	<b>SATORI SOFTWARE</b>	Neon ..... 118.00
Housekeeper, The ..... 31.50	Straight Talk ..... 55.50	<b>MAIN STREET SOFTWARE</b>	Bulk Mailer ..... 74.00	<b>MAINSTAY</b>
Bug Clapp's Word Tools ..... 44.00	Dow Jones Membership Kit ..... 17.00	Main Street Writer ..... 52.00	<b>SIMON &amp; SCHUSTER</b>	Macosm ..... 74.00
<b>ALLÉGRÒ SOFTWARE</b>	Market Manager + ..... 113.00	Main Street Filer ..... 52.00	Construction Estimator ..... 41.00	<b>MANX</b>
Multiplan Templates-Busns Anal ..... 32.00	<b>DREAMS OF THE PHOENIX</b>	<b>MEACOM</b>	Market Link ..... 53.00	Aztec C68K-C ..... 355.00
Multiplan Templates-Pers Finan ..... 32.00	Quick and Dirty Utilities 1 ..... 26.50	Mac + II ..... 68.50	Stock Portfolio System ..... 141.00	<b>MICRO ANALYST</b>
<b>APPLE COMPUTER</b>	Quick and Dirty Utilities 2 ..... 26.50	<b>MEGAHAUS</b>	<b>SOFT DESIGN</b>	Mac Zap ..... 29.50
Mac Project ..... CALL	<b>ELECTRONIC ARTS</b>	Megafile ..... 98.00	Timebase ..... 83.00	<b>MICROMOTION</b>
<b>APPLIED LOGIC SYSTEMS</b>	Financial Cookbook ..... 31.50	Megamerge ..... 64.00	<b>SOFTSTYLE</b>	Masterforth ..... 88.00
Mac Math Pac ..... 279.00	<b>EMERGING TECHNOLOGIES</b>	Megafarm ..... 148.00	Decision Map ..... 74.00	<b>MICROSOFT</b>
<b>APROPOS</b>	Macafix ..... 78.00	<b>MEGAMAX, INC</b>	<b>SOFTTECH MICROSYSTEMS</b>	Basic-Microsoft ..... 85.00
Financial Planning ..... 43.00	<b>ENTERSET</b>	Megamax C Compiler ..... 199.00	Mail Manager ..... 49.00	Fortran Compiler-Microsoft ..... 168.00
Investment Planning ..... 43.00	Quick Word ..... 31.50	<b>MESA GRAPHICS</b>	<b>SOFTVIEW</b>	Logo-Microsoft ..... 74.00
Tax Planner ..... 27.00	<b>FORETHOUGHT</b>	Tekalke ..... 150.00	Macintax 85 ..... 48.00	
	Factfinder ..... 83.00			
	Filemaker ..... 104.00			



# SIVE MACINTOSH E BEST PRICES!!!

## PRICE BY \$1

### BOOKS

<b>MICROSOFT PRESS</b>	
Mac Work Mac Play	13.00
Macinations-Microsoft	15.00
Apple Macintosh Book	14.00
Inside Macpoint	13.00
Presentation Graphics	13.00
Lotus Guide to Jazz	13.00
Printed Word The	13.00
Macintosh Software Book of	13.00
Multiplan Book-Microsoft	12.50

### EDUCATIONAL SOFTWARE

<b>ADDISON WESLEY</b>	
Smart Eyes	35.00
<b>ATI</b>	
How to Use Multiplan	38.50
Mac Coach	38.50
Teach Yourself Excel	38.50
Teach Yourself Jazz	38.50
<b>BRAINPOWER</b>	
Powermath	51.00
Chipwits	25.50
Thinkfast	21.50
<b>CADME</b>	
Nutricalc	46.50
<b>DAVIDSON AND ASSOCIATES</b>	
Spell It	26.75
Word Attack	26.75
Math Blaster	26.75
Speed Reader II	36.00
<b>FIRST BYTE</b>	
Smooth Talker	48.00
Kidtalk	38.50
Speller Bee	38.50
<b>FORETHOUGHT</b>	
Typing Intrigue	28.50
<b>FORTHUM SOFTWARE</b>	
Mac Chemistry	88.00
<b>GREATWARE SOFTWARE</b>	
Concertware +	35.50
<b>HARVARD ASSOCIATES</b>	
Mac Manager	35.50
<b>HARVARD ASSOCIATES</b>	
MAC Manager	28.50

<b>HAYDEN SOFTWARE</b>	
Music Works	44.00
Turbo Turtle	34.00
<b>HIPPOPOTAMUS SOFTWARE</b>	
Hippo Computer Almanac	19.00
<b>MARK OF THE UNICORN</b>	
Professional Composer	238.00
<b>MICROSOFT</b>	
Entrepreneur	28.50
Learning Multiplan & Chart	36.00
<b>PALANTIR</b>	
Mac Type	25.50
Word Play	25.50
Math Flash	25.50
<b>QUEUE INTELLECTUAL SOFTWARE</b>	
Starting a New Business	43.00
<b>RUBICON PUBLISHING</b>	
Song Painter	CALL
Dejo Vu-Rubicon	21.75
<b>SCARBOROUGH</b>	
MasterType	22.00
Run for the Money	1.40
Make Millions	28.50
<b>SIMON &amp; SCHUSTER</b>	
Mac Art Department	23.00
Typing Tutor III	31.00
Paper Airplane Construction SE	22.00
<b>SPECTRUM HOLOBYTE</b>	
Tellstar Astronomy Program	26.00
Tellstar Astronomy Level II	41.00
<b>SPRINGBOARD</b>	
Art a la Mac People + Places	22.00
Art a la Mac Variety Pock	22.00
<b>TERRAPIN</b>	
Mac Logo	64.00
<b>THINK EDUCATIONAL</b>	
Mac Edge II	27.50
Mind O' ve Mac	27.50
Mac Edge +	27.50
<b>TIMWORKS</b>	
Evelyn Wood Dynamic Reader	40.00

### ENTERTAINMENT

<b>ACTIVISION</b>	
Alter Ego-Male	34.50
Mindshadow	26.00
Borrowed Time	26.00
Championship Star Baseball	20.00

<b>AEGIS</b>	
Pyramid of Peril	22.00
Mac Challenger	22.00
<b>ANN ARBOR SOFTWARE</b>	
Grid Wars	21.00
Lunar Explorer	29.00
<b>AXLON</b>	
Mac Match	32.00
<b>BLUE CHIP SOFTWARE</b>	
Squire	29.00
Starcrass	29.00
Suspect	29.00
Suspended	29.00
Wishbringer	29.00
Witness	22.00
Zark I	27.00
Zark II	23.50
Zark III	26.50
<b>KASTEL TECHNOLOGY</b>	
Trivia Savant	22.50
<b>MAGNUM SOFTWARE</b>	
Gypsy	23.00
<b>MARK OF THE UNICORN</b>	
Mouse Stampede	26.50
<b>MILES COMPUTING</b>	
Mac Wars	17.50
<b>ELECTRONIC ARTS</b>	
Mac Attack	26.00
Fusillade	31.00
Horrier Strike Mission	25.00
<b>MINDSCAPE</b>	
James Bond A View to a Kill	CALL
Rambo	23.00
Balance of Power	29.00
Brotocuss	28.50
Ractor	23.00
Dejo Vu-Mindscope	26.50
Stephen Kings The Mist	32.00
Goldfinger	23.50
Dick Francis-High Stakes	23.50
<b>MIRAGE CONCEPTS</b>	
Trivia	11.50
<b>NEWSOFT</b>	
New Gammon	19.00
<b>ORIGIN SYSTEMS</b>	
Ultimo III	36.00
<b>PBI SOFTWARE</b>	
Fokker Triplane	34.50
Strategic Conquest	28.50
Feathers & Space	20.75
<b>PENGUIN</b>	
Crimson Crown	23.00
A Mind Forever Voyaging	25.00
Graphics Magician	445.0

Cutthroats	22.00
Deadline	28.00
Enchanter	23.00
Hitchhikers Guide to the Galaxy	22.00
Infidel	25.00
Planetfall	22.00
Seastalker	22.00
Sorcerer	25.00
Spellbreaker	28.00
Starcrass	28.00
Suspect	25.00
Suspended	28.00
Wishbringer	22.00
Witness	22.00
Zark I	22.00
Zark II	25.00
Zark III	25.00
<b>KASTEL TECHNOLOGY</b>	
Trivia Savant	22.00
<b>MAGNUM SOFTWARE</b>	
Gypsy	22.75
<b>MARK OF THE UNICORN</b>	
Mouse Stampede	21.00
<b>MILES COMPUTING</b>	
Mac Wars	26.00
Mac Attack	26.00
Fusillade	20.50
Horrier Strike Mission	26.00
<b>MINDSCAPE</b>	
James Bond A View to a Kill	23.00
Rambo	23.00
Balance of Power	29.00
Brotocuss	28.50
Ractor	26.50
Dejo Vu-Mindscope	32.00
Stephen Kings The Mist	23.50
Goldfinger	23.50
Dick Francis-High Stakes	23.00
<b>MIRAGE CONCEPTS</b>	
Trivia	11.50
<b>NEWSOFT</b>	
New Gammon	19.00
<b>ORIGIN SYSTEMS</b>	
Ultimo III	36.00
<b>PBI SOFTWARE</b>	
Fokker Triplane	34.50
Strategic Conquest	28.50
Feathers & Space	20.75
<b>PENGUIN</b>	
Crimson Crown	23.00
Graphics Magician	445.0

Pensate	23.00
Transylvania	23.00
Xyphus	23.00
Quest	2.00
<b>PRACTICAL COMPUTER APPLICATIONS</b>	
Mac Golf	34.00
<b>PROFESSIONAL SOFTWARE</b>	
Trivia Fever Volume II	13.00
Super Sports Trivia	16.00
Trivia Fever	21.00
<b>PSION</b>	
Psion Chess	30.50
<b>PRIORITY SOFTWARE</b>	
Forbidden Quest	23.00
Gateway	24.00
<b>SIERRA ON LINE</b>	
Ultimo II	34.00
Frogger	23.00
Championship Boxing	23.00
<b>SILICON BEACH SOFTWARE</b>	
Enchanted Scepters	20.50
Airborne	19.00
<b>SIR TECH</b>	
Wizardry I	33.00
<b>SOFT LIFE</b>	
Mac Slots	28.00
<b>SPECTRUM HOLOBYTE</b>	
6to	24.50
Orbiter	25.00
<b>STRATEGIC SIMULATIONS</b>	
Gemstone Warrior	20.00
Computer Baseball	22.00
<b>SYNAPSE</b>	
Brimstone	26.00
Essex	26.00
Mindwheel	26.00
<b>TELARIM</b>	
Dragon World	25.00
Amazon	25.00
Fahrenheit 451	25.00
Rendezvous with Rama	26.00
<b>UNICORN SOFTWARE</b>	
Futurio	23.00
Utopia	23.00
<b>VIDEX</b>	
Mac Checkers & Reversi	27.50
Mac Vegas	33.00
Funpak	22.00
Mac Gammon & Cribbage	27.50

# CALL TOLL FREE 1-800-382-2242

## Connecticut Orders Call (203) 929-8522

### IN CANADA 1-800-843-0074

#### ACCESSORIES

<b>AMERICAN TOURISTER</b>	
Mac Carrying Case-Amer Tourist	54.00
<b>APPLE COMPUTER</b>	
Mac Security Kit	CALL
<b>ASSIMILATION PROCESS</b>	
Mac Numeric Turbo	CALL
Mac Part Adaptor	CALL
Mac Turbo Touch	CALL
Mac Daisy Wheel Connection	CALL
Mac Epson Connection	CALL
<b>AST RESEARCH</b>	
Ramstack 1.5 MB	995.00
Ramstack 512K	550.00
Ramstack 2 MB	1575.00
Ramstack 1 MB	795.00
<b>AUTOMATION FACILITIES</b>	
Micro Clean	CALL
Floppyclean Refill	CALL
Floppyclean 3 1/2	CALL
CRT Work Station Kit	CALL
Printer Keyboard Kit	CALL
<b>CREIGHTON DEVELOPMENT</b>	
Proprint W/Cable	51.00
Proprint	38.00
Proprint W/Ab Switch & 2 Cable	134.00
<b>CURTIS MANUFACTURING</b>	
Ruby Surge Suppressor	49.00
Emerald Surge Suppressor	33.00
Sapphire Surge Suppressor	43.00
Diamond Surge Suppressor	27.00
<b>DIVERSIONS INC.</b>	
Underware Color Ribbon	9.00
Underware Jumbo Pens	13.00
Underware Colarpens	9.00
Underware Colarpack	15.00
Underware Black Ribbons	9.00
<b>ENVIRONMENTAL SOFTWARE</b>	
Mac Cover Complete-Environment	14.00
Dust Cover Laserwriter-Mac Att	16.00
Dust Cover Keypad-Mac Attire	6.00
Dust Cover Printer 15-Mac Atti	12.00
Dust Cover Disk Drive-Environm	6.00
Dust Cover Printer 10-Mac Atti	10.00
<b>ERGOTRON</b>	
Mac Tilt	73.00
Mac Buffer 256K	CALL
Mac Buffer 512K	CALL
Mac Buffer 1024K	CALL
<b>GTCO CORPORATION</b>	
Macintizer	459.00
<b>HABA SYSTEMS</b>	
Hobo Window Dialer	19.00
<b>HANZON CORPORATION</b>	
Honzon Board & Cable	75.00
<b>INNOVATIVE CONCEPTS</b>	
Flip N File W/Micro	17.00
Flip N File I/Micro	7.00
<b>INNOVATIVE TECHNOLOGIES</b>	
Easel The	11.00
Pocket	8.25
<b>I/O DESIGN</b>	
Mac Carrying Case-I/O	CALL
Imagewriter Carrying Case-I/O	48.00

<b>KALMAR DESIGNS</b>	
Microcabinet-Double	20.00
Microcabinet	13.00
<b>KENSINGTON</b>	
Swivel/Tilt-Kensington	21.50
Swivel-Kensington	20.00
Disk Case-Kensington	18.50
Dust Cover Printer 15-Kensingt	7.50
Starter Pack-Kensington	52.00
Dust Cover Disk Drive-Kensingt	7.00
Control Center-Kensington	59.00
Printer Stand	16.00
Polarizing Filter	30.50
A/B Box-Kensington	59.00
Surge Suppressor-Kensington	31.50
Disk Drive Cleaning Kit	18.50
Dust Cover-Kensington	8.00
Dust Cover Printer 10-Kensingt	8.00
Mouse Cleaning Kit W/Package	15.50
Mouse Pocket	7.00
<b>KETTE GROUP</b>	
Macnify ABCD Port Switch	31.50
Macnify Stereo Music System	54.00
Macnify A/B Switch	21.50
<b>KOALA TECHNOLOGIES</b>	
Mac Visprint	167.00
Kot	134.00
<b>KRAFT</b>	
Quick Stick	44.00
<b>MAGNUM SOFTWARE</b>	
Mouse Mover	13.00
<b>MEGAHAUS</b>	
Megadeck	58.75
<b>MICROAIR</b>	
Mac Station II	70.00
<b>MJ ELECTRIC</b>	
Mac Guard	54.00
<b>MPH COMPUTERS</b>	
Mac Be Cool	98.00
<b>NEW IMAGE TECHNOLOGIES</b>	
Magic Digitizer	275.00
<b>OPTIMUM</b>	
Mac Tote	59.00
<b>SOUTH BAY SYSTEMS</b>	
Mouse Pad	8.00
<b>SUPEREX</b>	
Mac Speak	14.00
<b>T MAKER</b>	
Click On Worksheet	45.50
<b>THUNDERWARE</b>	
Thundercon	174.00
<b>VIDEO 7</b>	
Mouse Stick	35.50

#### COMMUNICATION SOFTWARE

<b>APPLE COMPUTER</b>	
Mac Terminal	CALL
<b>COMPUSERVE</b>	
Compuserve Starter Kit	18.00
<b>DATAVIZ</b>	
Mac Link W/Cable	105.00

<b>DILITHIUM PRESS</b>	
PC to Mac & Back	84.00
<b>DOW JONES SOFTWARE</b>	
Straight Talk	57.00
<b>DREAMS OF THE PHOENIX</b>	
Mouse Exchange BBS	26.00
Mouse Exchange Terminal	26.00
<b>HAYES MICROCOMPUTING</b>	
Smartcom II	85.00
<b>PALANTIR</b>	
In Touch	77.00
<b>SOURCE ON LINE</b>	
Source On-Line Info Network	22.00
<b>VIDEX</b>	
Mail Center for Six	268.00
Mail Center for Two	168.00
<b>AEGIS</b>	
Mac Mail Apple Talk	39.00
Mac Mail Telecom	34.00
<b>HABA SYSTEMS</b>	
Hobo Dialer	19.00
Hobo Dialer/Window Dialer	45.00
Hobo Cam	44.00
<b>INTERMATRIX</b>	
Phone Link	16.00
<b>SOUTHEASTERN SOFTWARE</b>	
Mac Transfer	29.00

#### BLANK DISKS

BASF 3 1/2 SS/DD	10.00
BASF 3 1/2 DS/DD	14.00
Verbatim 3 1/2 SS/DD	21.00
Elephant 3 1/2 SS/DD	19.00
Fuji 3 1/2 SS/DD	17.50
Fuji 3 1/2 DS/DD	22.50
Maxell 3 1/2 SS/DD	17.50
Memorex 3 1/2 SS/DD	22.00
Sony 3 1/2 SS/DD	16.00
Sony 3 1/2 DS/DD	26.00

#### MODEMS

<b>APPLE COMPUTER</b>	
Apple Personal Modem 300/1200	CALL
<b>COMPUABLE</b>	
Cable Mac to Hayes	15.50
<b>HAYES MICROCOMPUTING</b>	
Interbridge	CALL
Smartmodem 1200	358.00
Smartmodem 2400	570.00
Smartmodem 300	133.00
Transet	257.00
Transet 1000 512K	350.00
Transet/Mac Acc. Kit	28.00
<b>KENSINGTON</b>	
Portable Modem 300 Baud	85.00
<b>MICROCOM</b>	
Mac Modem 2400 W/Software	553.00
Mac Modem 1200 W/Software	395.00
<b>NOVATION</b>	
Cat Comm Communication System	295.00
Novation 2400 Baud	CALL

<b>PRENTICE</b>	
Papcom X 100	257.00
<b>PROMETHEUS</b>	
Promodem 1200 W/Mac Software	299.00
<b>US ROBOTICS</b>	
Courier 2400	385.00
Password 1200	195.00

#### PRINTERS

<b>APPLE COMPUTER</b>	
Laserwriter	CALL
Imagewriter	CALL
Imagewriter 15	CALL
Imagewriter II 32K Buffer	CALL
Imagewriter II Cut Sheet Feed	CALL
<b>BROTHER</b>	
Hr 35	CALL
Hr 25	CALL
Hr 15 XL	CALL
<b>EPSON</b>	
AP-80	CALL
DX 10	CALL
LX 80	205.00
LX 90	CALL
DX 20	CALL
LQ 800	CALL
LQ 1000	CALL
LQ 1500	CALL
SQ 2000	CALL
<b>JUKI</b>	
6100S	375.00
5510S	449.00
6300S	654.00
<b>NEC</b>	
Elf 360	395.00
<b>OKIDATA</b>	
1935 Mac/Aliso	CALL
1925 Mac/Aliso	CALL
<b>TOSHIBA</b>	
351	1069.00
351 Tractor	150.00

#### DISK DRIVES

<b>APPLE COMPUTER</b>	
Macintosh Hard Disk 20MB	CALL
Mac 512K	CALL
Mac 4/1 Meg	CALL
Mac External BOOK Drive-Apple	CALL
<b>CORVUS</b>	
5.5 MB Mac Omnidrive	979.00
Omni Talk	275.00
45.1 MB Mac Omnidrive	3399.00
11.1 MB Mac Omnidrive	1379.00
21.6 MB Mac Omnidrive	1959.00
<b>HABA SYSTEMS</b>	
Habo Disk BOOKB	245.00
<b>IOMEGA</b>	
5 MB Cartridge-Iomega	40.00
Head Cleaning Kit-Bernoulli	56.75
Bernoulli Box 5MG	1350.00



# MAC CLASSIFIEDS

ORDERS ONLY **CALL TOLL FREE 1-800-468-9044** INFORMATION AND PA ORDERS 814-234-2236

## SOFTWARE

### BUSINESS & PRODUCTIVITY

Infinity	
mpo	\$64.00
<b>propos</b>	
Multiplan and Excel Templates	
Financial Planning	\$49.00
Investment Planning	\$49.00
ix Planner '85-'86	\$39.00
<b>rrays</b>	
Time Acct.	\$51.00
<b>ssimilation</b>	
ork-n-Print	\$22.00
acTracks	\$22.00
acMemory Disk	\$22.00
I.D.I. Composer	\$22.00
acSpell Right	\$67.00
Business Essentials	\$62.00
e Right Word	\$67.00
ac Daisywheel Connection	\$39.00
ac Epson Connection	\$39.00
<b>yth Software</b>	
inis 3+	\$289.00
<b>erland</b>	
neral Accounting	\$219.95
ekick w/phonelink	\$call
<b>eighton</b>	
icSpell +	\$57.00
<b>icket</b>	
cket Graph	\$129.95
atworks	\$79.95
<b>esktop Software</b>	
st Base	\$94.00
st Merge	\$47.00
st Port	\$call
st Base, Merge, Port bundle	\$177.00
<b>igital, Etc.</b>	
ccountant 2.0	\$99.00
rbro Accountant (incl. free video)	\$call
ce)	\$call

<b>Dubl-click</b>	
Calculator construction set	\$59.00
<b>ESOFT</b>	
Color Print	\$24.95
Color Chart	\$CALL
<b>Expertelligence</b>	
Exper Logo	\$77.00
Experisp	\$call
ExperOPSS	\$169.00
<b>Forethought</b>	
Filemaker	\$105.00
Factfinder	\$82.00
<b>Hayden</b>	
Ensemble	\$59.00
Art Grabber w/Body shop	\$29.00
Speller	\$45.00
<b>Kensington</b>	
Fonts	\$29.00
Fonts for Headlines	\$40.00
<b>Layered</b>	
Front Desk	\$call
<b>Living Videotext</b>	
Thinktank 128	\$59.95
Thinktank 512	\$97.95
<b>Manhattan Graphics</b>	
Ready Set Go V2.1	\$99.00
<b>Megahaus</b>	
Call for our low price on all Megahaus products!!!	
<b>Microsoft</b>	
Excel	\$219.00
Multiplan	\$105.00
File	\$109.00
Word	\$109.00
Basic	\$87.00
Fortran	\$call
Chart	\$72.00
Logo	\$call
Mac Enhancer	\$149.00

<b>Miles Software</b>	
Mac The Knife — 1	\$23.00
Mac The Knife — 2	\$28.00
Mac The Knife — 3	\$call
<b>Monogram</b>	
Dollars & Sense	\$80.00
Forecast	\$40.00
<b>Odesta</b>	
Helix	\$CALL
Double Helix	\$CALL
<b>Paladin</b>	
Crunch 512	\$99.00
Supercrunch	\$call
<b>Palantir</b>	
Mactype	\$26.00
Mathflash	\$26.00
A/R, GL, Inventory account. modules	\$call
<b>Peachtree</b>	
GL/AP/AR	\$83.95
<b>Sartori</b>	
Bulk Mailing	\$77.00
<b>Sierra Information Systems</b>	
Accountant's Choice	\$call
<b>Sierra-on-line</b>	
Mac OneWrite acct. modules	\$133.00
<b>Silicon Beach Software</b>	
Silicon Press	\$call
Accessory Pak 1	\$23.00
<b>Softstyle</b>	
DecisionMap	\$79.00
<b>Softsync</b>	
Personal Acct.	\$52.00
<b>Software Publishing</b>	
PFS File & Report	\$97.00
<b>Telos</b>	
Filevision	\$104.00
<b>T/Maker</b>	
ClickOn Worksheet	\$45.00
Click Art-Effects	\$27.95
Click Art-Publications	\$27.95
Click Art-Letters	\$27.95
Click Art-Pers. Graphics	\$27.95

OPEN 9-8 Mon-Fri; 10-5 Sat EAST COAST TIME

Software orders over \$50.00 will be shipped FEDERAL EXPRESS (yes, even with these prices)

You only pay TCP's standard shipping charge of \$4.00 per order. This offer also valid on peripherals and accessories under 8 pounds. Orders arriving before 11:00 AM our time will be shipped out same day.\*



**MICROSOFT®**  
The High Performance Software.

Excel .....\$219.00 File .....\$109.00  
Multiplan.....\$105.00 Word .....\$109.00

**cricket SOFTWARE**

Cricket Graph .....\$129.95  
Statworks .....\$87.95

**Tempo** from Affinity .....\$64.00

OMNIS 3+ .....\$289.00

DOUBLE HELIX .....\$CALL

## MACINTOSH HARD DRIVES

**HERE'S THE LoDOWN ...**

10 Meg Hard .....\$649 20 Meg Hard ...\$CALL  
SCSI Interface

**MIRROR TECHNOLOGIES**

Magnet 20x SCSI Interface .....\$CALL

**PARADISE**  
SYSTEMS INC

MAC 10 .....\$537  
MAC 20 .....\$779



**MAC BOTTOM**

PCPC MACBOTTOM 20 HARD DRIVE .....\$879  
SCSI Version Now Available  
CALL FOR PRICE!!!

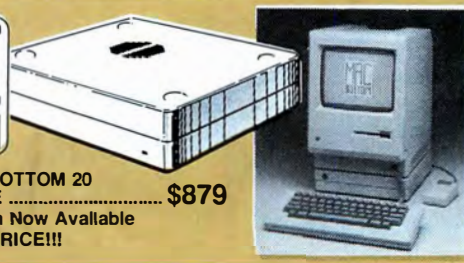

## HARDWARE

<b>ssimilation</b>	
ic Port Adapter	\$75.00
ic Turbo Touch	\$77.00
imeric Turbo	\$129.00
<b>ack-Tech</b>	
enny Mac	\$79.95
<b>MICROSOFT</b>	
inter Enhancer	\$149.00
<b>ODEMS</b>	
rometheus	
omodem 1200m	\$327.00
cludes Software)	
<b>rentice</b>	
opcon X-100	\$251.00
<b>ensington</b>	
0 Baud Portable	\$84.00

<b>EPSON</b>	
All models in stock	
CALL FOR LOWEST PRICES!!!	
<b>PANASONIC</b>	
1091	\$229.00
1092	\$329.00
1592	\$CALL
<b>STAR</b>	
A NEW STAR IS BORN .... NX-10	
SCALL FOR PRICE AND AVAILABILITY	
Star to Mac Interface	\$call
SG-10, SD-15, SR-10, SR-15	\$call
SD-10	\$323.95
SG-15	\$364.00
<b>TAPE DRIVE BACKUP</b>	
<b>LoDOWN</b>	
T20, T-60	\$call
Mirror Tech. 20 meg tape backup	\$call

## GAMES AND EDUCATIONAL

<b>HAYDEN</b>	
SAT	\$55.00
Sargon III	\$29.95
<b>Infocom</b>	
Zork II or III	\$26.00
Zork I, SeaStalker, Enchanter, Hitchhikers guide, Planetfall, Wishbringer, The Witness, Cuthroats	\$23.00
<b>Microsoft</b>	
Entrepreneur	\$31.00
Flight Simulator	\$32.95
<b>Miles Software</b>	
Harrier Strike Mission	\$29.00
Macatack	\$29.00
Overloads	\$call
Fusillade	\$call
Macwars	\$call
<b>Mindscape</b>	
SAT	\$45.00
Deja Vu	\$29.00
Racler	\$26.00
Balance of Power	\$30.00
Rambo	\$24.00
The Mist	\$24.00
View to a kill	\$24.00
<b>PBI</b>	
Feathers & Space	\$21
Strategic Conquest	\$29
Fokker	\$35
<b>Silicon Beach</b>	
Airborne	\$19.95
ENCHANTEDSCPTRE	\$22.00
<b>Spectrum Holobyte</b>	
GATO	\$28.00
Orbiter	\$34.95
Tellstar L1	\$28.00
Tellstar L2	\$44.95

## ACCESSORIES

<b>IO Design</b>	
MAC+ Bag	\$69.95
magewriter Bag	\$49.95
magewriter II Bag	\$54.95
<b>NOVATIVE CONCEPTS</b>	
ip-n-File Macro (holds 25)	\$7.95
ip-n-File (holds 40)	\$15.95
<b>Innovative Technologies</b>	
asel (holds 20 disks)	\$14.00
ask Directory (holds 32)	\$19.95
ocket Pack	\$9.95
ibrary	\$29.95
ompubag for Mac 512, 128	\$54.00
as enough space for hard drive)	
ompubag for Mac +	\$call
ousepad	\$5.95

<b>Kensington</b>	
swivel	\$20.00
filter	\$29.00
control center	\$59.00
A-B box	\$59.00
surge suppressor	\$32.00
Accessories starter pak	\$53.00
Mouse cleaning kit & pocket	\$16.00
<b>N2 Cables</b> . \$call for price and configuration	
<b>DISKS</b>	
<b>SONY</b> (10) SS/DD	\$17.95
DS/DD	\$26.95
<b>MAXELL</b> (10) SS/DD	\$16.95
DS/DD	\$24.95
<b>FUJI</b> (10) SS/DD	\$15.95
DS/DD	\$23.95

OD orders will be shipped UPS second day air. Orders under \$100.00 will be shipped UPS ground. Call for shipping charges on hardware.

Order by Mail: We accept money order, certified check, personal check. Allow 2 weeks for personal check to clear.

Shipping: \$4.00 per order for software and accessories. Add \$3.00 per box shipped COD. Call for shipping charges on Hardware. Additional shipping required on APO, FPO, AK, HI,

and foreign orders.  
Terms: ALL PRICES REFLECT CASH DISCOUNT, ADD 1.9% FOR MASTERCARD OR VISA. Manufacturer's warranty honored with copy of our invoice. Due to software piracy and our guarantee of factory fresh merchandise, ALL SALES ARE FINAL. Defective software replaced upon receipt. Defective hardware replaced or repaired at our discretion. Please call for an RA#. PA delivers add 6% sales tax. Prices and terms subject to change without notice.

■ If through some oversight we don't have the lowest price, we would appreciate the opportunity to beat it. If we can, you will still get the benefit of our Federal Express shipping on software orders over \$100.00

■ We accept MasterCard, Visa, COD and mail orders.

■ Purchase orders accepted from qualified corporations and institutions. Minimum order of \$500.00 required.

■ No sales tax on orders outside PA

■ Buy with confidence. We honor manufacturer's warranty.



# TUSSEY COMPUTER PRODUCTS

P.O. BOX 1006  
STATE COLLEGE, PA 16804  
Circle 483 on reader service card

timing errors by rounding off note values to the nearest beat; change the playback speed; merge several tracks into one; and change the MIDI channel on which the track is played back.

**Graphic Editing**

Most exciting, however, is *MegaTrack XL*'s track-editing feature, which lets you graphically view and alter notes. Notes in a track are shown in proportional form—with longer notes appearing wider than shorter ones—on a musical staff (see "Changing Notes"). When a track is initially displayed, you see its entire contents. By selecting an area, then double-clicking it, you can zoom in on a particular section to more easily see and edit short notes. This zooming process is infinite; you can continue selecting and double-clicking until even the shortest note is wider than the Mac's screen. *MegaTrack XL*'s graphic editing is easy to use, but it lacks the precise control over a track's contents offered by other sequencers, such as *Professional Performer*.

**A Slow Jump**

*MegaTrack XL* has other shortcomings. While you can zoom in on a track for detailed editing, you can't zoom out one or

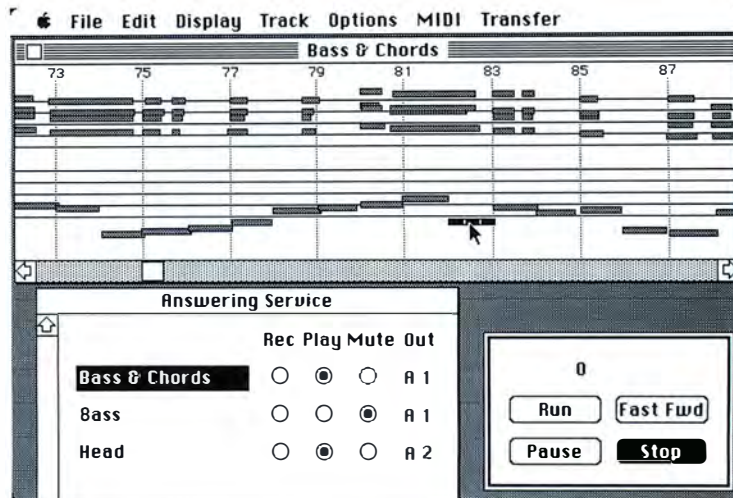

two steps to see the larger picture. You must revert to the full-track view, then zoom in again. Worse, you can't jump to a given point in a piece. To reach the middle of a *MegaTrack XL* sequence, you must use the fast-forward button, which plays the piece at eight times normal speed, until you reach the desired point. The current version of *MegaTrack XL* doesn't let you

edit MIDI data such as pitch bends, synthesizer patch changes, and mode changes, although Musicworks representatives told me a future version will offer enhanced editing capabilities as well as the ability to jump to specific points in a score.

To its credit, *MegaTrack XL* does a great deal while taking up a remarkably small 30K of disk space, and it runs on a 128K Mac, while *Professional Performer*,

(continues)

**Changing Notes**  
*MegaTrack XL*'s editing feature lets you alter individual notes in a recorded performance. You can alter a note's length, pitch, and position in time. You can also copy, delete, and create new notes.

# IF THE WORLD WERE FLAT YOU WOULDN'T NEED EASY3D.

The world isn't flat.

And you shouldn't have to restrict your artistic skills to the flat world of simple draw and paint programs. That's why we designed Easy3D... a program that enables you to draw in three dimensions as easily as two.

Easy3D is a serious program already being used by thousands of graphic designers, architects, and engineers.

But that doesn't mean that it's hard to learn. With a 512K Mac, or Plus, simple icon

commands enable you to build complex 3D shapes, then rotate them, change perspective...even assign custom lighting effects at the click of a mouse!

At \$149.00 it's easy to understand why so many users have found Easy3D one of the most valuable drawing tools they've ever used! Easy3D is distributed by the Ashton-Tate Publishing Group, and is available at your dealer now. For further information call us at 312-427-0408.

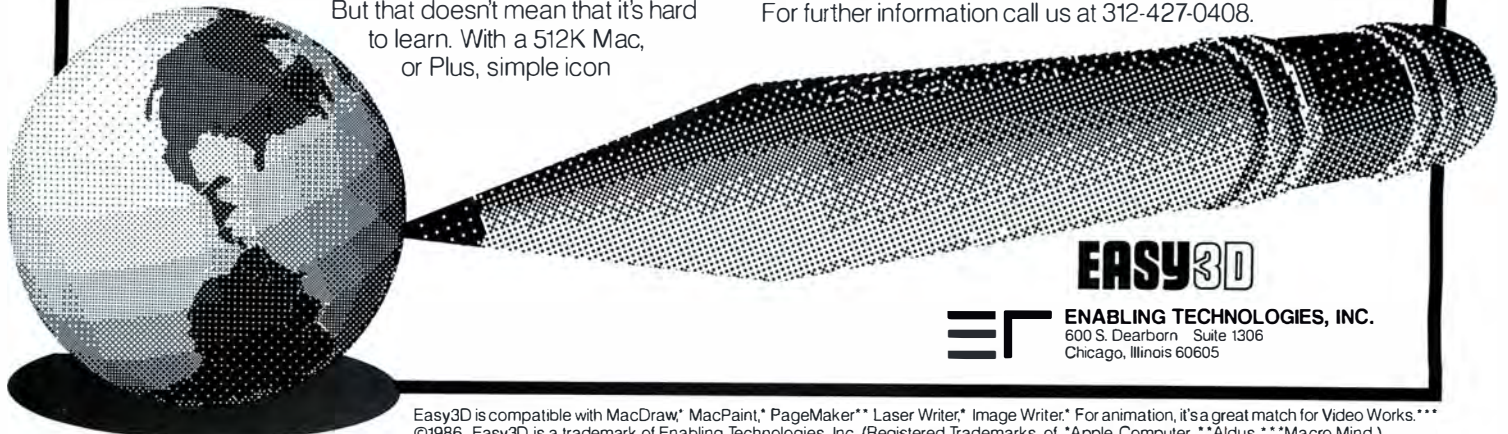

**EASY3D**  
**ENABLING TECHNOLOGIES, INC.**  
 600 S. Dearborn Suite 1306  
 Chicago, Illinois 60605

Easy3D is compatible with MacDraw,\* MacPaint,\* PageMaker\*\* Laser Writer.\* Image Writer.\* For animation, it's a great match for Video Works.\*\*\* ©1986. Easy3D is a trademark of Enabling Technologies, Inc. (Registered Trademarks of \*Apple Computer \*\*Aldus \*\*\*Macro Mind)

Circle 403 on reader service card

# How to make networking the Macintosh as easy as using one.

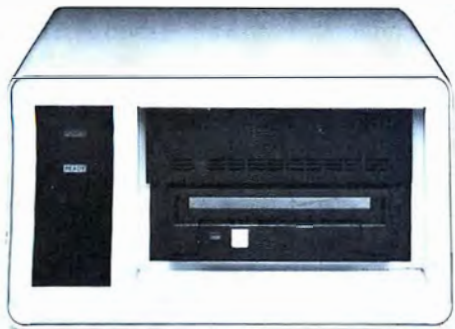

## Introducing the all new Keeper™ Plus.

THE ONLY TRUE FILE SERVER  
BUILT FOR THE MACINTOSH™  
APPLETALK™ NETWORK.

It's a simple fact. The all-new Keeper Plus is the only true file server that allows multiple Macintosh users access to the same file at the same time. Period. And it does it without dedicating an additional Macintosh. No other file server is smart enough to make that claim. And no other has the built-in intelligence, power, and easy user interface of the Keeper Plus. It makes a network full of Macs run as simply as one.

### Alone. Or in a crowd.

The Keeper Plus performs just as well for

a single Macintosh. It greatly expands your storage capacity—up to 80 MB. Provides flexible partitioning. But unlike other storage devices, the Keeper Plus provides you a growth path. As your business expands, you can add more Macintoshes to share the power of the Keeper Plus. There's no additional software needed.

### All it takes is a connection.

If you can plug in a cable, you can set up the Keeper Plus. All it takes is a single AppleTalk cable. That's it. No additional software to learn. No complicated start-up functions to perform.

Instantly, you'll have access to 64 disk volumes. With up to 2,000 files per disk drive. And 32 disk volumes that can be active at one time.

The Keeper Plus files expand and contract automatically. You'll never have to set parameters. Or calculate confusing disk volume sizes.

### The one and only.

There is no other shared storage device that can match the Keeper Plus

for versatility and power. As a print server and print spooler, you won't have to wait for a document to print before resuming work. And back-up options are available to protect your valuable files.

The new Keeper Plus is manufactured and supported by REACH Technologies Incorporated. And every new Keeper Plus has been designed by REACH to provide the reliability you need to keep your network

up and running. Operating the Keeper Plus is as easy as operating the Mac.

The Keeper Plus. The easiest, most efficient way to store and share information for the Macintosh AppleTalk network. No other file server even comes close.

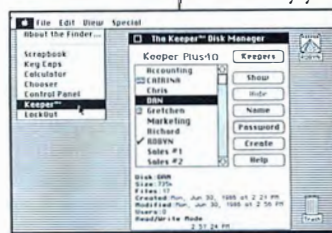

The Keeper Disk Manager makes access to all 64 disk volumes a one-screen operation.

The Keeper Plus is available from Authorized Resellers of REACH Technologies Incorporated. Call 1-800-523-8392 (512-280-1977 in Texas) for the Reseller nearest you.

**REACH**  
TECHNOLOGIES INCORPORATED  
P.O. BOX 9802, SUITE 925, AUSTIN, TEXAS 78766

The best networking solutions within reach.

Circle 551 on reader service card

The Keeper Plus is a trademark of REACH Technologies Incorporated. Apple is a registered trademark, and AppleTalk is a trademark of Apple Computer, Inc. Macintosh is a trademark of McIntosh Laboratory, Inc. and is used with its express permission.

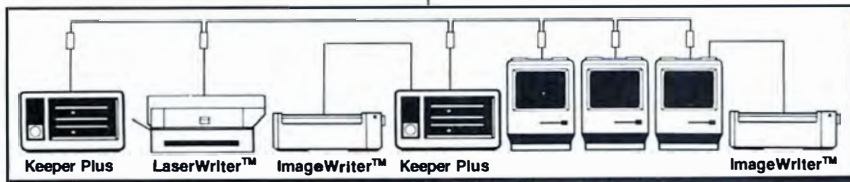

REGISTER TO WIN A KEEPER™ PLUS AT MACWORLD EXPO Booth #733.

Opcode Systems' *Sequencer*, and Southworth's *Total Music* each require 512K. I'd like to see Musicworks sell *MegaTrack XL* separately, without *Deluxe Music Construction Set*, at a lower price. In my opinion, *Professional Performer* is the better program for professional musicians, while *MegaTrack XL* is an ideal sequencer for beginners and intermediate-level musicians.  
-Jim Heid

*MegaTrack XL, version 2.1*

Musicworks  
18 Haviland St.  
Boston, MA 02115  
617/266-2886

List price: \$495 (includes MIDI adapter, Deluxe Music Construction Set, and MIDIWorks utility for translating files between programs)

*Professional Performer, version 1.21*

Mark of the Unicorn, Inc.  
222 Third St.  
Cambridge, MA 02142  
617/576-2760

List price: \$295

## Modemette

In today's world of 2400-bps, auto-everything modems, a 300-bps, manual-dial modem is as anachronistic as black-and-white home movies and poodle skirts. Nonetheless, alongside my Mac is a 300-bps, manual-dial modem: Kensington Microware's **Maccessories Portable Modem.**

The Maccessories modem does differ from its ancestors: it's smaller (roughly the size of a paperback novel), and it's powered (supposedly for up to two years) by a 9-volt battery. A 20-inch cable connects it to the Mac, and the cables going to the phone line and a telephone plug into two modular jacks. The modem comes with a well-written manual.

### Dialing by Hand

The Maccessories modem is a manual-dial; to establish a link, you first start your communications program, then dial the number on a telephone. When you hear the remote computer's carrier tone, you flick a switch on the modem from "Phone" to "Apple." The manual-dial Maccessories modem doesn't use modem commands for dialing, answering the phone, or hanging up. That means you need not worry if it's incompatible with your communications

software. The trade-off is losing the capabilities that make auto-dial modems appealing: the ability to redial busy numbers and to conduct unattended communications.

I won't say that the Portable Modem is comparable to other modems I've used; after all, it wasn't designed to replace the Hayes Smartmodem. However, the Maccessories modem works well and won't drain a power outlet. It also hooks up to the Apple IIc, and Kensington wisely includes a list of the modem's pin signals in the manual, enabling you to wire a cable for using the modem with battery-powered portable computers like the NEC 8201. Travelers will appreciate the modem's in-a-briefcase portability, but its use may be restricted, since the phones in most hotel rooms are wired directly into the wall, making it impossible to use direct-connect modems. It's a good second or backup modem for the frequent communicator and an inexpensive way for beginners to try their hand at telecommunications.

But even beginners should evaluate their future communications needs before buying the Maccessories modem. Commu-

(continues)

# This publication is available in microform.



University Microfilms International reproduces this publication in microform: microfiche and 16mm or 35mm film. For information about this publication or any of the more than 13,000 titles we offer, complete and mail the coupon to: University Microfilms International, 300 N. Zeeb Road, Ann Arbor, MI 48106. Call us toll-free for an immediate response: 800-521-3044. Or call collect in Michigan, Alaska and Hawaii: 313-761-4700.

Please send information about these titles:

\_\_\_\_\_

Name \_\_\_\_\_

Company/Institution \_\_\_\_\_

Address \_\_\_\_\_

City \_\_\_\_\_

State \_\_\_\_\_ Zip \_\_\_\_\_

Phone ( ) \_\_\_\_\_

University  
Microfilms  
International

# Publishing Power

## MacPublisher

## II

The Pioneer in Macintosh Publishing Is Now  
The Desktop Publishing Power Leader

### The 1984 Original

The year Apple introduced Macintosh, we introduced MacPublisher for the Macintosh and ImageWriter. The first Macintosh Electronic Publishing System was designed for laying out newsletters with text and graphics in multiple columns. Articles were measured with a unique transparent Ruler, clipped with a Scissors tool, and dropped into columns on the layout MiniPage. Graphics were cropped to size with a Camera tool.

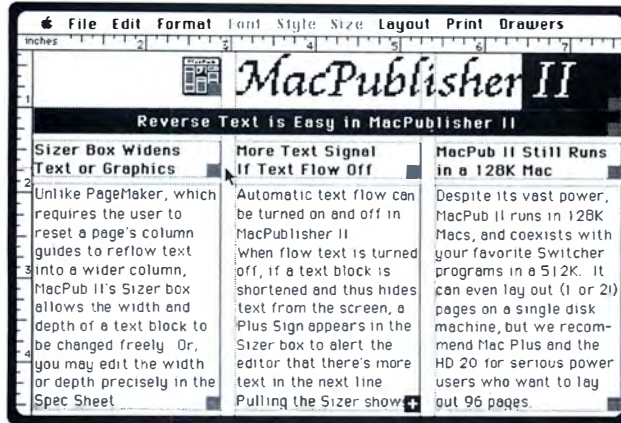

Page Designers seeking perfection in their display type require **Kerning** to change spacing between letterpairs —sometimes even making them touch or over-lap. Kerning is critical for control of LaserWriter spacing idiosyncracies. MacPublisher's kerning is also user-adjustable, instead of being determined by the font.

## NAVAL

kerns to

## NAVAL

MacPublisher introduced advanced typographic features like leading and micro-justification, Automatic Save and a Table of Contents generator.

### Has Now Been Redesigned With...

MacPublisher II is the first of the second-generation Mac Publishing products. It's easy enough to use for "the rest of us" to intermix text and graphics — for newsletters, calendars, price lists or catalogs, etc. Yet it has the power needed by professionals — technical documentors, page designers, advertising specialists, and graphic artists.

Artists can design thousands of decorative rules and borders with the Graphics Palette which features three pens (each in any of 7 colors and any thickness), 9 shades of gray, and an amazing 99 fill patterns.

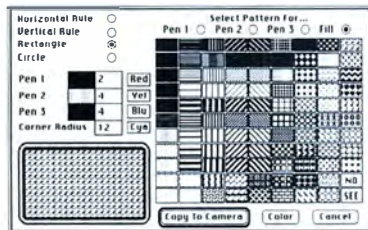

### The Best Ideas of the Competition

MacPublisher II now includes all the best features of PageMaker and ReadySetGo — a full-size layout page, horizontal and vertical rules, auto text flow, resizing and scaling graphics in the layout, style changes on a line, type and picture Spec Sheets that let you position and size precisely, facing pages, snap-to guides, grid lines, variable column widths & margins, page margins, page numbering, custom font sizes, repeating elements, and direct opening of MacWrite, Word, MacPaint, and MacDraw (pict) files.

### Plus Unequaled Power... and Color.

MacPublisher II has gone far beyond the competition with features like **Kerning**, optional batch **hyphenation**, vertical Depth Justification, a 48-column **Grid** system, multiple alternating left/right **Master Pages**, 96-Page issues, twenty Page Sizes including tabloid/broadsheet (21" x 28"), automatic Continued lines, Zoom views to 900%, built-in **Telecommunications** for sending/receiving stories, an amazing **Graphics Palette**, and a Macintosh first — **Color** printing of text and graphics on ImageWriter II.

### Other Professional Publishing Tools for The Rest of Us from BSPI include...

**MacIndexer™** — takes a keywords list and indexes a MacWrite or Word document in a few minutes. Renumbers, merges chapter indexes, filters noisewords, and does word counts. **\$79.95**

**Mac-Hy-phen™** — a dictionary batch hyphenation program that inserts discretionary hyphens throughout a block of text. Also works with Microsoft® Word and PageMaker™. **\$89.95**

**Designs for MacPublishing™** — publication clip-art, rules & borders, initial alphabets. **\$39.95**

**Boston Software Publishers, Inc.**

**Professional Publishing Tools  
For the Rest of Us.**

1260 Boylston Street  
Boston, MA 02215  
(617) 267-4747



**\$195**

**Toll-Free Order Line 1-800-556-0027**

Circle 199 on reader service card



# DISK DEAL!

## Save on Sony Disks!!

(SS) boxed \$1.40 bulk \$1.27  
 (DS) boxed \$2.20 bulk \$1.87

*Here's the only way to see if that program really is the right one.*

Choose that program from more than 400 titles, and run it yourself. You decide whether it's worth buying. If it fits, keep it, and pay the difference. If it doesn't, send it back, and if you wish, try something else. Manuals are included, too!

Don't buy a pig in a poke. Call us, and be sure you get software that fits.

### FREE catalogue!

Remember, we have more than 400 software titles in stock, so call and order the one you've been thinking about. Get a hands-on tryout for a fraction of the purchase price...if you decide to keep it, all you pay is the difference.

Save on disk drives and ribbons, too! Why Pay More? Call us.

## 1-800-972-3018

in Texas (713) 360-4649

### MacRENTALS™

P.O. Box 6093 • Kingwood, TX 77325

### Software That Fits

Circle 368 on reader service card

	try	then, buy
Easy 3D	\$14.85	\$44.55
Excel	\$55.85	\$167.45
Full Paint	\$14.85	\$44.45
Mac 3D	\$26.35	\$78.95
MacDraft	\$30.65	\$91.95
MacLightning	\$14.85	\$44.55
ReadySetGo	\$24.75	\$74.25
Tempo	\$13.35	\$40.05

We carry hundreds more of the most popular Macintosh programs. If there's one you've been wanting to try, call us for prices.

nicating at 300 bps is four to eight times slower than using today's standard 1200- and 2400-bps modems; you may see your initial savings eaten up by high telephone and connect time charges. And with manual dialing you have to redial when the number you're calling is busy. Finally, remember that 1200-bps, Hayes-compatible modems are available for between \$300 and \$400 (Apple's 300/1200 Personal Modem and the Prometheus ProModem are my choices). That isn't much more when you consider the advantages offered by such fast, smart modems. —Jim Heid

*Maccessories Portable Modem Kensington Microware Ltd.*

*251 Park Ave. S*

*New York, NY 10010*

*800/535-4242, 212/475-5200*

*List price: \$140*

## One on One

Julius Erving and Larry Bird going head to head would be a basketball confrontation to take your breath away. In **One on One**, Electronic Arts' programmer Eric Hammond brings this dream match to the Mac screen. Hammond studied hundreds of game films and action photos and consulted with both athletes to reproduce the players' styles and strategies in their digital counterparts.

### Jump Ball

*One on One* offers four levels of competition: Park and Rec, Varsity, College, and Pro. You can assume the role of either player while the computer takes the other, or two people can play against each other. The game includes a 24-second clock, a referee who calls fouls, and instant replays. Animation of the athletes and sound effects, such as the squeak of rubber-soled shoes, add a degree of authenticity. For further realism, a fatigue bar for each player indicates his condition; if your man has expended a lot of energy running and jumping, he slows down, and his shooting and defensive skills wilt. You can reenergize him by dribbling in place or by taking a time-out.

Both players shoot with either hand and execute realistic reverse lay-ups, jump shots, and a variety of dunks. They have,

*(continues)*

## DrawArt™ MacDraw™ Art Library

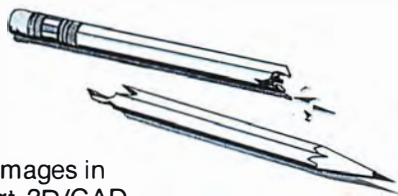

More than 150 "publishing-quality" images in the categories of Publishing, Clip-Art, 3D/CAD, Cartoons, Drafting and Drawings.

*"Highest quality art for your Mac—Superior to anything you've seen for MacPaint™—Make your documents sparkle—You'd be smart to get DrawArt™ today"—Icon Review*



*"DrawArt™ can take better advantage of (the LaserWriter™) than images created for MacPaint™"—InfoWorld*  
*"First-rate product... sure to be highly prized by anyone involved in desktop publishing"—Macazine*

### Desktop Graphics

Requires 512K and MacDraw™

400 Country Drive • Suite H • Dover, Delaware 19901

\$49.95 each. Order direct, 30-day money back guarantee, if not satisfied.

To order: 302/736-9098. VISA/MC accepted. Write, call or see your dealer.

Imagewriter, LaserWriter, MacDraw, MacWrite and MacPaint are trademarks of Apple Computer, Inc. DrawArt is a trademark of Desktop Graphics.

Circle 546 on reader service card



# WE BACK-UP WHAT WE SAY!

They claim they can do it in 4 minutes. We say prove it...

Tired of the claims manufacturers make about their tape back-up units that aren't true? Ever call the manufacturer and quiz him about the performance of his unit? Can he back-up his words with actions? Well, we've had enough. Some tape drive manufacturers advertise that they are able to back-up 20 meg drives in 4 minutes. We challenge them to PROVE IT!! At MDIdeas, we don't make claims we can't "back-up."

## Introducing TDBK-20+, the SCSI Tape Back-up for the Mac Plus

TDBK-20+ is the best performing SCSI tape drive for your money. The TDBK-20+ will back-up and restore MDIdeas' HD-20 and HD-30, Apple's Hard Disk 20,<sup>TM</sup> Hyperdrive,<sup>TM</sup> Corvus,<sup>TM</sup> and virtually any other Macintosh hard disk or volume. Not only will the TDBK-20+ back-up HFS volumes but even volumes across networks under MacServe. With a mechanism that has a tape speed rated at 90 inches/sec., back-ups are fast and reliable. Data is read and verified with each back-up and restoration; even sensitive software such as Excel<sup>TM</sup> can be backed-up and restored. Restores complete mirror images, no thought...no mistakes. If your drive's capacity has more than the tape's 22 meg capacity, such as MDIdeas' HD-30—a 30 megabyte hard disk drive—no

problem. The TDBK-20+ will back-up the first 20 megabytes from the drive and will then ask for just an additional tape. No need to buy a larger capacity tape unit. BONUS: Extra tape is supplied. The price of the TDBK-20+, \$1095.

## HD-20<sup>TM</sup> & HD-30<sup>TM</sup> SCSI Hard Disk Drives

MDIdeas also offers SCSI Hard Disk Drives for the Macintosh Plus. Add incredible speed and storage capacity to your Macintosh Plus with the HD-20 and HD-30, 20 and 30 megabyte hard disk drives. Place them underneath your Mac to save desk space. Connect them to the SCSI port and you can transfer data up to 16 times faster. Turn them on and they automatically boot up. Comes complete with the necessary cables and a bonus; HD Back-up, a floppy back-up utility from PBI Software, is included (a \$50.00 value).

Expand your horizons, go see MDIdeas' TDBK-20+, HD-20, and HD-30 at your local authorized Apple dealer.

MDIdeas, Inc.



1111 Triton Drive, Suite 205  
Foster City, CA 94404  
(415) 573-0580

## Macware Reviews

however, no hook shots in their repertoire. And regrettably, you cannot control the type of shot your man takes.

Occasionally play is halted by a slam dunk that disintegrates the backboard. A little man shuffles out, sweeps away the broken glass, and utters some unintelligible phrase. Slow-motion instant replays sometimes appear, but like the foul calls and backboard-exploding dunks, they occur randomly. After seeing these gimmicks a few times, you'll wish for a way to terminate them forever.

### Mouse versus Joystick

Your opponent, whether Bird or Erving, is a deadly shooter from anywhere on the court. And maneuvering with the mouse, rather than a joystick, has serious limitations. You can't move your player to the basket for rebounds after missing an outside shot, for example. Instead, you flounder helplessly in the backcourt while your opponent dunks the ball with impunity. The offensive player cannot beat the defender to the basket; in fact, from Varsity level and beyond, I was unable to

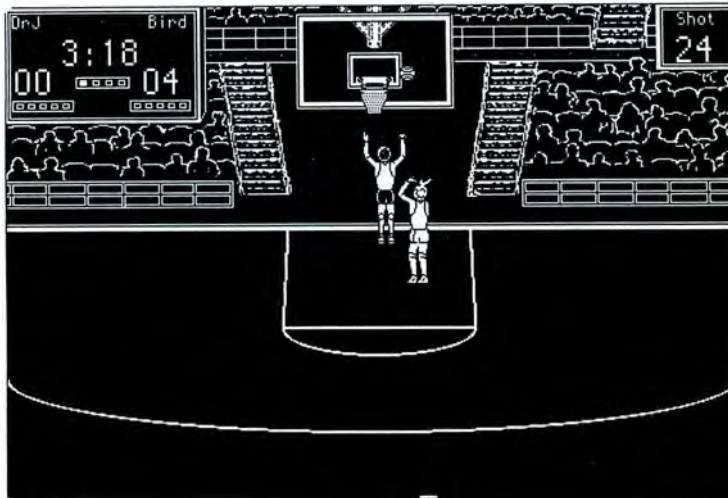

**Take It to the Hoop**  
Dr. J goes baseline against Larry Bird in Electronic Arts' One on One.

move past my opponent and drive to the basket. Forget playing against Erving or Bird at the higher levels with the mouse—you'll get crushed. However, with a little experience and the joystick, your chances for scoring improve.

### The Coach's Advice

The game offers a sense of NBA magic. Hammond captures the styles of both superstars, even though you experience only a few facets of their true talents—those that can be statistically represented. I found the

game absorbing because of the degree of realism, but unless you use a joystick, you will be at an unfair disadvantage. —Richard Miller

*One on One*  
Electronic Arts  
1820 Gateway Dr.  
San Mateo, CA 94404  
800/245-4525, 800/562-1112 in California  
List price: \$39.95 □

# Max Production



## MaxRAM™ MaxPrint™

**RAM disk and print spooler software.**

MaxRAM automatically creates an adjustable RAM disk that runs ten times faster than a floppy.

MaxPrint lets you work and print at the same time—even high quality text and graphics.

\$49.95



## MaxChill™

**Whisper quiet internal fan for the Macintosh™.**

MaxChill's piezo-electric element moves air so quietly you won't even hear it.

And it fits *inside* your Mac to enhance the Mac's natural convection currents.

\$49.95

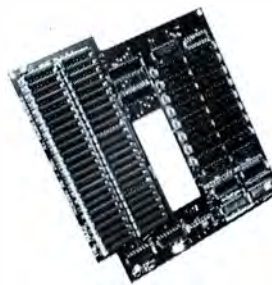

## TheMax2™

**2Mb expansion for the 128K and 512K Mac™.**

TheMax2 gives you twice as much memory as the Apple™ upgrade for a lower price.

- Expandable to 4Mb.
- New Apple ROM compatible.
- Includes MaxRAM/MaxPrint.

\$545 (\$695 from 128K)

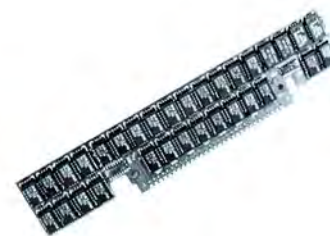

## MaxPlus™

**2Mb expansion for the Macintosh Plus.**

Plug MaxPlus into your memory expansion sockets to get 2Mb of memory available to all your programs without modification.

- Expandable to 4Mb.
- Includes MaxRAM, MaxPrint and MaxChill.

\$499

# MacMemory Inc

473 Macara, Suite 701 Sunnyvale, CA 94086 (800) 862-2636, Inside California (408) 773-9922

Macintosh is a trademark licensed to Apple Computer Inc. Apple and Mac are trademarks of Apple Computer Inc. MaxRAM, MaxPrint, MaxPlus, TheMax2, and MaxChill are trademarks of MacMemory, Inc.

# Give us your slow, your fragmented, your run-down disks...

ALSoft introduces **DiskExpress™** to keep your drives at peak performance.

The more you use your floppy or hard disk the slower it becomes. Why? Because as you use a disk, the files on it become more and more fragmented. All disks are divided into a number of areas called blocks with each block holding as little as 1/2K of data. A 400K floppy disk has 400 blocks while a 20 megabyte hard disk can have over 40,000 blocks. The Macintosh stores files by breaking them into block-size pieces and writing them into unused blocks wherever they are available. Over time, virtually every file can be scattered around in different places. Starting applications, opening documents, sorting databases, and compiling programs all become slower and slower because your drive has to move its head from block to block as it retrieves the pieces of your files. It actually takes longer for a drive to move its head than it does to read or write data. In addition, all that additional movement puts extra wear and tear on your drive.

Now, DiskExpress puts maximum performance back into your disk. It gathers all the pieces of files and puts them into contiguous blocks. Then your drive head need only move to the beginning of a file where it can continue to read sequentially. All the unused blocks are also placed together so that MacServe users will no longer suffer from the "disk too fragmented" message when attempting to create new volumes. DiskExpress will optionally organize your files by usage to reduce future fragmentation. It supports floppy and hard disks with both MFS and HFS directories.

### Bonus Features

**DeskTop file compacting:** The Finder stores application and document icons in a hidden DeskTop file on every disk. Old icons no longer needed are never removed. DiskExpress will optionally dispose of those "unneeded" icons without losing any file comments or leaving any documents with "plain generic" icons. This not only recovers space but also speeds up the time it takes to return to the Finder from an application. **Discarded data security:** Deleting a file only removes the file name, not the information. DiskExpress will optionally erase all information in blocks of deleted files so that it cannot be recovered by unauthorized individuals.

### Easy to use

If you know how to use the Finder then you already know how to use DiskExpress. The familiar Finder icons and desktop display allow you to work with all available disks.



**\$29<sup>95</sup>**

plus \$3 s/h add \$2 for COD. Texas add 5 1/8 %. Sorry, no P.O.s can be accepted  
Special Introductory Price



ALSoft, Inc.  
(713) 353-4090  
P.O. # 927  
Spring, Tx 77383-0927

Circle 557 on reader service card

# OUR COMMUNITY NEEDS MORE CORPORATE HEROES.

The United Way volunteer gives a gift that's hard to measure. Because without his or her contribution of time, energy and dedication, the community services and local programs of United Way simply cannot exist.

United Way has much to do in our community. From day care for the young to services for the elderly.

So this year, be generous. Give yourself.



**United Way**  
THANKS TO YOU IT WORKS FOR ALL OF US



ONLY \$89.95

### CHOOSE MAC 'N FROST FOR THE FOLLOWING ENHANCEMENTS

- Quiet, Reliable Cooling
- Safe Surge Protection (More Than 100 Joules)
- Power Distribution Center
- Innovative Diskette Storage
- Touch Me Static Discharge Plate
- 1 Year Warranty
- Optional Modem Line Protector

Mac 'N Frost offers a new standard in cooling and protection for your Macintosh by complementing the existing convection air cooling system. Enjoy major cost savings by alleviating expensive maintenance and repairs. Mac 'N Frost is engineered for high efficiency cooling which

reduces premature internal component failure, while also maintaining constant line filtering and surge suppression. No tools required for installation or removal.

**RHELECTRONICS, INC.**  
566 Trejan Dr., Buellton CA 93427  
PST (805) 688-2047

Circle 554 on reader service card

# 512K

U P G R A D E S

# \$159<sup>00</sup>

- Visa and Master Card Accepted •
- No Down Time •
- Free Software •
- Free Shipping •

TO ORDER DIAL

## 800 8MAC MEM

Inside California  
408-773-9922

MACMEMORY INC.  
473 Macara Ave., Suite 701  
Sunnyvale, CA 94086

### MacPerspective™

makes perspective drawings fun



- For
- Architects
  - Draftsmen
  - Engineers
  - Commercial Artists

Constructs accurate "wire-frame" perspective drawings of complex objects such as houses and buildings from dimensioned drawings. Viewpoint can be changed. Drawings can be printed or transferred to other Macintosh™ programs in any desired size.

- Enter dimensions in feet & inches or decimal units
- Move/Duplicate objects in 3-D
- Cut/Copy/Paste objects in 3-D
- Zoom capability
- Orthographic views

Call B. Knick Drafting at (305) 727-8071.  
313 Marlin Place  
Melbourne Beach, Florida 32951

Circle 550 on reader service card

## MDC II™

MAC DISK CATALOG II



THE BEST JUST GOT BETTER!

MDC II for the 512K Mac, Plus and XL has the features you've been looking for: • Insert Disks to Catalog them • Fully indexed database • Find and Select files and volumes • 4000 to 6000 entries on a 512K • Volume IDs • 16 Standard and 16 User definable Categories • Category Learn Mode • Edit all fields • Print Reports, Diskette Labels and 3X5 Cards.

### New Version for HD20 & HFS

MDC II - \$49.95 • Mac Disk Catalog™ for the 128K - \$39.95 • Pinfeed MDCLabels™ Red, Blue, Green, Yellow, Gray or mixed 150 - \$11.95 • 250 - \$19.95 • 500 - \$39.95. Shipping & Handling \$3.00 (\$5.00 foreign) per order. Visa & MasterCard Accepted.

new canaan  
**MicroCode**

136 Beech Rd. New Canaan, CT 06840 (203) 966-6969

Circle 284 on reader service card

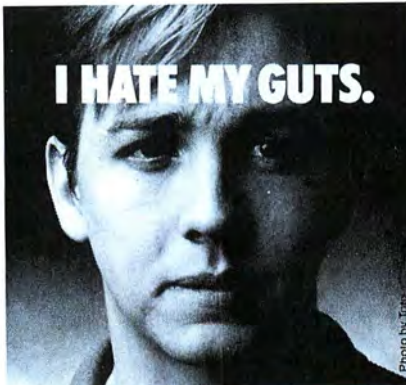

### I HATE MY GUTS.

Imagine what it would be like to live with painful stomach cramps and terrible diarrhea. Forever.

More than 2 million men, women and children do just that. They have Ileitis and Ulcerative Colitis, intestinal diseases that strike at any age, and often require hospitalization for weeks—even months.

Please help us in our fight to find a cure for these devastating and misunderstood diseases.

Because when you suffer from something that many people acknowledge with only snickers and whispers, it's easy to mistakenly begin hating yourself as much as you hate your disease.

## The National Foundation for Ileitis & Colitis

To send your tax-deductible contribution or for more information, please write: N.F.I.C., P.O. Box 2020, Murray Hill Station, New York, NY 10156

## MACINTOSH PUBLIC DOMAIN SOFTWARE

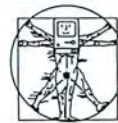

The most complete, quality MAC public domain software available. Over 1,000 programs to choose from. Average price of a program is 65 cents! Constantly updated catalog. Instructions included. Many programs are better than those available commercially. Why pay more?

- Fonts by the dozen
- Essential desk accessories
- Multiplan templates for home and business finance, real estate, etc.
- Terrific games
- RAM disk & hacker's tools
- Disk backup utilities, even protected
- Statistics programs
- Font editor and font tools
- Bill Atkinson's PaintMover pgm.
- Spell check & word count
- Items we can't tell you about here

**SONY DISKS s.s. and d.s.**  
Prices from \$1.07 per disk

To order our recent catalog, send \$1.00 to cover postage & handling to:

**EDUCOMP**  
(619) 942-3838  
2431 Oxford Street, Cardiff, CA 92007

Circle 410 on reader service card

## COMPUCOVER®



### COVER YOUR INVESTMENT

#### DUST COVERS

Macintosh CRT & Keyboard	12.95
Macintosh CRT & Keyboard & Mouse	13.95
Macintosh Disk Drive or Floppy Drive	5.95
Macintosh Plus Keyboard	8.95
Macintosh CRT & MAC Bottom Disk	15.95
Macintosh Laser Jet Printer	10.95

#### DISK WALLETS

3 1/2" Disk for 20 Disks	16.95
3 1/2" Disk for 10 Disks	14.95
3 1/2" Disk for 6 Disks	9.95

Anti-Static-different colors



ORDER LINE  
1-800-874-6391  
FLORIDA ORDER LINE  
1-800-342-9008



Dealer Inquiries Invited



CompuCover  
P.O. Box 310 Dept. M  
Mary Esther, FL 32569

Customer Service  
(904) 243-5793  
Telex 469783

Circle 496 on reader service card

# Macworld Directory

The Macworld Directory is a comprehensive listing, by category, of products and services available for the Apple Macintosh. It provides advertisers with a low-cost advertising alternative and our readers with an easy reference guide.

**FORMAT:** The standard format includes a product ID, a 300-character descriptive ad, and a company name, address, and telephone number.

Advertisers may choose among categories already in use, or they may create their own. Display advertisers can cross-reference their current ad to the Macworld Directory for increased exposure.

**RATES:** Listings are accepted for a three-time consecutive insertion at a rate of \$726. We offer a six-time insertion at \$1230 that reflects a 15% frequency discount. Listings must be prepaid (except for established display advertisers) upon submission of ad copy. Checks, money orders, Visa, and MasterCard are accepted.

**DEADLINE:** For copy deadlines and further information please contact Niki Stranz, your Macworld Directory Account Manager, at 415/861-3861 or 800/435-7766 (800/435-7766 in California). Please send copy and prepayment to the Macworld Directory, 555 De Haro St., San Francisco, CA 94107.

## ■ Accessories

### ○ Cables

#### Mac Lock/Mac Cables

Mac Lock, finest security kit for Mac/+, secures Mac, keyboard, mouse, 2nd drive, modem, & printer. Attractive red vinyl-covered steel 1/16" cables. Lock included. No tools req. Money-back guarantee. \$40. Mac Cables provide any length custom cables for Mac/+ (incl. keyboard) or almost any computer need. \$20 & up. *Mac Products, 20231 San Gabriel Valley Dr., Walnut, CA 91789, 714/595-4838*

## ■ Artificial Intelligence

### ExperTelligence:

Is the world leader in the field of artificial intelligence products for the Mac. ExperTelligence is the only AI company that offers a full line of AI-related products. ExperLisp-Plus (full developers version), ExperLisp-Talker, ExperOPS5-Plus, ExperFacts, Prolog2 (the original Prolog developed by Marseilles University), ExperLogo, and ExperLisp 3600. For FREE info. call or write: *ExperTelligence, Inc., 559 San Ysidro Rd., Santa Barbara, CA 93108, 805/969-7871*

## ■ Business Opportunities

### Make Money with your Mac

Start your own business printing "Time Scrolls," histories of what happened on any birth date. News, sports, prices, other famous births, etc., are included. A proven money-

maker—great for fairs, conventions, bazaars, etc. (512K Mac with external disk drive req.) *Time Scroll software \$200.*

*Accurate Computer Search, 993C S. Santa Fe Ave., Vista, CA 92083, 619/726-7136*

## ■ Expert Systems

### MacKIT™ Version 2.0

The Knowledge Integration Toolkit for Building Expert Systems. This shell is written in FORTH as a turn-key application... FORTH not required. *MacKIT* features a production rule compiler, back-chaining inference engine, certainty factors. Not copy protected. 512K req. \$149, demo disk \$10. MC/Visa.

*Knowledge System Environments Inc., P.O. Box 261, Dept. M3, Grantham, PA 17027, 717/766-4496*

## ■ Hardware

### ○ Bar Code

#### Bar Code/MagCard Readers

The PC-380 Bar Code & PC-580 Magnetic Stripe (credit card) Readers have been designed to interface with the Apple Macintosh, are easily connected between the keyboard and the CPU, and require neither additional software nor an RS-232 port. A powerful but simple program for printing Code 39 bar codes is also available.

*TPS Electronics, 4047 Transport St., Palo Alto, CA 94303, 415/856-6833*

### ○ Data Acquisition

#### "Real World" Access

Add measurement and control capabilities to your Mac with the ADC-1. This easy-to-use RS-232 peripheral includes 16 analog inputs (13-bit), 4 digital inputs, 6 outputs, and a BSR controller. Use for laboratory, industrial, and home monitoring. \$449. ADControl software \$45. Sensors available.

*Remote Measurement Systems, 2633 Eastlake Ave. #200, Seattle, WA 98102, 206/328-2255*

### ○ Memory Upgrade

#### Memory Enhancements

Upgrade your Mac to 512K, 1024K, or 2048K of contiguous memory. SCSI port & fans available. Factory flow-solder techniques used for high reliability. 120-day warranty. Local 20-minute installation or mail order. Dealer inquiries welcome. Call for pricing and information.

*Ehman Engineering, 2721 La Gran Via, Carlsbad, CA 92008, 800/227-2400 ext. 949*

### ○ Video

#### MacMonitors/Projectors

17- & 23-inch hi-res monochrome monitors w/ antiglare, white phosphor, vari-scan. When your Mac must be seen in the classroom, trade show, office, etc. Only \$1095 & \$1295. Projector Systems w/ white phosphor, hi-gain screen, stand, cables. A complete system for the ultimate in Mac viewing pleasure. Only \$5295. Dealer inquiries welcome.

*National Data Systems, 2419 Rutland Dr., Austin, TX 78758, 512/837-1760, 800/531-5143, 800/252-8286 in Texas*

## Mentauris Corp.

Specialists in Macintosh video interfacing for over two years. Mentauris offers a wide range of products to satisfy any Mac or Mac Plus video interfacing need: our original, high-res Composite Video Adapter; our new, "no-drill" CVA; monochrome and color NTSC scan converters; Mac disassembly hand tools.  
*Mentauris Corp., 1658 IH 35 S, P.O. Box 1467, San Marcos, TX 78666, 512/396-1565*

## Special Offer:

\$99.95 video adapter. Julian Systems is proud to announce its new composite video adapter for the Mac. Great for meetings, shows, other large displays. Hook your Mac to large screens, projectors, etc. Why pay more for less? Won't void warranty! Order yours today! Call or mail *chik/MO* to:

*Julian Systems, Attn: DVA Offer, 4345 Fairwood Dr., Concord, CA 94521, 415/686-4400, 800/447-2300 in CA*

## Insurance

### Safeware

If your computer is important to you, insure it! SAFEWARE provides full replacement of hardware, media, & purchased software. As little as \$39 a year covers fire, theft, power surges, earthquake, water damage, auto accident. Call 8 a.m. to 8 p.m. Mon. thru Fri.; Sat. 9 a.m. to 5 p.m.

*Safeware, The Insurance Agency Inc., 2929 N. High St., P.O. Box 02211, Columbus, OH 43202, 800/848-3469 (Natl), 614/262-0559 (OH)*

## Publications

### Microcomputer Books

- *Mac Midnight Madness* \$17.95
  - *Mac Spreadsheets. Using Microsoft Multiplan, Chart & File* \$15.95
  - *Microsoft File* \$17.95
  - *Microsoft Macinations* \$18.95
  - *Planning Big with MacProject* \$15.95
  - *Presentation Graphics on the Apple Mac* \$17.95
  - *The Printed Word* \$16.95
- MC/Visa/AE. FREE Directory.

*Micro Books, P.O. Box 4068, West Richland, WA 99352, 800/547-9755 ext. 8, 509/967-5084 in Washington*

## Mac Artist Wanted!

Do you miss *Macworld Gallery*? Do you have patterns or drawing tips to share? I am putting together a portfolio of computer artists. Send a self-addressed stamped envelope and a disk with your artwork on it, and it will be printed and published. Prizes awarded to top entries. For a copy of *Mac Artist* send \$5 to:  
*Mac Artist, 12 Calvin Ct., Walnut Creek, CA 94595, 415/935-2270*

## Mac Tricks

Only \$14.95 postpaid, a handbook of hundreds of helpful tips to make your Mac more useful, fast, and fun. If you read ALL of the magazines, you've seen many, if you could only remember where?! Full table of contents and index, information arranged by application. Probably the best \$15 you'll ever spend on your Mac. MC/Visa accepted.  
*Digi-Graphics, 764 E. Village Way, Kaysville, UT 84037, 801/544-2009*

## Services

### ○ Data Conversion

#### Electronic Data Conversion

Conveniently translate data files from mainframes, minis, dedicated word processors, typesetters, & PCs (word processing embedded codes, database structures & spreadsheet reports & formulas) to Mac or almost any system. Ultimate technology. Nation's leading firms use our invaluable services!

*CompuData Translators, Inc., 6565 Sunset Blvd. #301, Hollywood, CA 90028, 213/462-6222*

### ○ Graphics/Printing

#### Save \$\$

Allied Linotype L100 output \$4 per page (volume discount) from Mac/IBM disks. LaserWriter \$1 per page. Disk/modem service 24-hr. return. Send \$5 to become registered user & receive Laserscreen fonts disk. In-house offset printing & bindery services available. As our user you can buy Sony disks at the lowest prices. 400K \$1.60, 800K \$2.80.

*Laser Printing Services, 26058 W. 12 Mile Rd., Southfield, MI 48034, 313/356-1004*

## Laser Typesetting

Use your Mac for desktop publishing! Newsletters, brochures, and other graphics output at professional quality using your Mac and our Linotype™ typesetter or Apple LaserWriter. Great savings and 24-hour turnaround via disk or modem. Graphic design also available from our staff artists. Write or call:  
*Spectrum Arts, Ltd., 1823 Eutaw Pl., Baltimore, MD 21217, 301/225-7372*

### ○ Publishing

#### MacTypeNet™

Mac/PC typesetting. Disk or modem. 300-dot LaserWriter™ output; 635-, 1270-, or 2540-line Linotype™ L300P output. Composition, page makeup, printing/bindery services. Hardware/software sales, services, and support; beginning and advanced training and seminars for Macintosh, PC, and Linotype 100/300 users.  
*MacTypeNet™, P.O. Box 52188, Livonia, MI 48152-0188, 313/477-2733*

## Software

### ○ Accounting

#### PoOs/Mac

- Point-of-sale software. Includes:
- Invoicing w/ multipayment types, sales tax, & credit/debit tracking
  - Inventory w/ commission, serial numbers, floor planning, bundles, service items
  - Accounts Receivable with credit limit, auto discount, tax exemption
  - Price quotes • Full reporting
  - Multiuser—\$995.

*Software Complement, P.O. Box 1123, Milford, PA 18337, 717/686-5592*

#### Time-Saver Payroll System

*Calculate* salaried & hourly wages, state, federal tax & FICA. Many other optional deductions provided for in the system. *Accumulates* employee wages & deductions for year-end W2 reporting. *Creates* req. monthly & quarterly state & federal tax reports. *Easy to Use!* Req. *Excel*. \$35. MC/Visa/Chk.

*Western Software Assoc., 110 El Dorado Rd., Walnut Creek, CA 94595, 415/935-3673*

### ○ Apple Emulator

#### II in a Mac™ Version 2.0

AT LAST!... Run Apple II +/e/c software on your Macintosh, easily and without modification! *II in a Mac* INCLUDES DOS 3.3, ProDOS, Integer/AppleSoft BASIC, transfer software, & supports:

- 80 cols. • Hi/low-res. graphics,
  - Joystick • UniDisk™ format
  - Hard Disk • 4 MEG RAM!
  - Desk accessories • Switcher™ BELIEVE it—STILL only \$89.95!
- Computer Applications Inc., 12813 Lindley Dr., Raleigh, NC 27614, 919/846-1411*

### ○ Backup/Restore

#### HFS Backup™

Program to "back up" (archive) data from hard disks. The entire disk, selected files, or all changes since the last backup may be saved or restored. A backup template may be created. Program is optimized for efficient use of both user time and backup space. Files may be viewed hierarchically by folder or alphabetically by file. \$39.95. MC/Visa or at your dealer.

*Personal Computer Peripherals Corp., 6204 Benjamin Rd., Tampa, FL 33614*

### ○ Billing

#### Invoicing/Job Costing

*Office Productivity System™ (OPS)*. For professionals that bill based on time-use. Includes invoicing, time-keeping/productivity reports, job budget/cost tracking, client database with mail merge and accounts receivable. Multiuser capable. 512K Mac with hard or external drive. Avail now for \$475.

*Applied Micrometics, 1078 Carol Ln. #202, Lafayette, CA 94549, 415/283-4498*

#### MacFill-In™

Create on-line forms with *MacFill-In*. Fill in blanks manually by typing or automatically with date, time, or other defaults, or computed values. File forms on disk, or print if paper is required. Includes 18 standard forms that you can customize, or create your own. Requires 512K Mac \$39. Check/MC/Visa OK.

*Cognitive Concepts, 1219 Phelps Ave., San Jose, CA 95117, 408/243-6886*

## ○ Data Acquisition

### Macontrol-IDAC/1000

Macontrol, a \$695 software package that makes data acquisition + control as simple as using a spreadsheet (*Excel* or *Multiplan*). The IDAC/1000, a new high-performance \$995 data acquisition peripheral—8 analog inputs (3600 samples/sec), 16 digital points, 19.2KB serial port connection with pass-thru port.

*International Data Acquisition + Control, Inc., 4 Limbo Ln., P.O. Box 387, Amherst, NH 03031, 603/673-0765*

## ○ Educational

### Test Generation/Grade Book

*MICROTEST II*—Create, update, generate, & store exam materials. Easy question entry, large database; print multiple versions. *MICROGRADE*—Research-based, includes most-wanted features! Flexible course & grading structure, complete statistical pkg.; create variety of reports. Free brochures, demo pkgs. \$5 each. *Chariot Software Group, 3659 India St. #MD-1, San Diego, CA 92103, 619/298-0202*

### Religious & Graphics Series

- *Scripture Bits* (Bible calendar) \$22
  - *MacConcord* (N.T. concordance) \$42.95
  - *MacScripture* (Old & N.T.) \$140
  - *Religious Art Portfolio* \$24.95
  - *Electro Bits* (circuit graphics) \$24.95
  - *Orlando à la Carte!* (dining guide) \$19.95
  - *MacMundo* (newsletter disk in Spanish) \$8
  - English or Spanish
- Medina Software, Inc., 2008 Las Palmas Circle, Orlando, FL 32822, 305/281-1557*

### Educational Measurement

measureUP™ is a revolutionary new personnel testing system. Uniquely combining *graphics*, word processing, and database management, measureUP enables you to develop personnel tests more easily and better than ever—we guarantee it! Call today and learn how measureUP can dramatically improve your testing program!

*Logic eXtension Resources, 9651 Business Center Dr., Rancho Cucamonga, CA 91730, 714/980-0046, Telex: 508581 LXR*

## ○ Engineering

### Digital Logic Design Aid

*LogiWorks* is an interactive digital logic drawing and simulation package for the Macintosh. Features:

- built-in library of common gates, flip-flops, etc.
  - user-defined devices, PROMs and PLAs
  - adjustable device delays
  - 3-state and open-collector devices
  - produces timing diagram of selected signals
  - \$159.95 (U.S.) ● 128K version (no user-defined devices) \$79.95 (U.S.)
- Capilano Computing, 548 Beatty St., Vancouver, B.C. V6B 2L3 Canada, 604/669-6343*

### Structural

Analysis & design programs. Any # of nodes, elements, loads. Structure, load, tension, shear, moment & deflected shape diagrams, in & out text, section table, more. Full mac interface. FRAME-MAC (2-D frames) \$495; BEAMAC II (continuous beams) \$295; BEAMAC (simple beams) \$95. \$-back guarantee. Free support. *Erez Anzel, 5800 Arlington Ave. #5T, Riverdale, NY 10471, 212/884-5798*

## ○ Financial

### MacMoney™

Gain control of your finances with this record keeper & financial planner designed for the Macintosh™ with your needs in mind. Easy transaction entry. Print checks, multiple reports, & graphs. Transfer data to a text file for extra benefits from *Excel*™ or other programs. Introductory price \$74.95 + s/h. Req. 512K. *Survivor Software Ltd./u, 11222 La Cienega Blvd. #450, Inglewood, CA 90304, 213/410-9527*

## ○ Fonts

### Downloadable Laser Fonts

Specialized fonts for the LaserWriter. Classical Greek (SMK™ or WSU format) \$85. Serif/sans-serif for scientific texts \$75. Font of 100 chemical structures \$125 (with scientific text fonts \$160). Polish serif or sans-serif \$85 each (4 styles). Soon: small caps and modern Greek. MC/Visa. As mentioned in July '86 issue. *Allotype Typographics, 1600 Packard Rd. #5, Ann Arbor, MI 48104, 313/663-1989*

## Laser Perfect/Custom Fonts

We want fine typography for the Mac. Our downloadable fonts were designed especially for LaserWriter/Linotronic printers & put others to shame: good fit, kerned letters, old-style numerals, thin/em space; *MacSlab* (square-serif) & *MacSans* (sans-serif), with ital, bold, bold ital \$95 each. *LaserHebrew*, \$145. Next: Devanagari, Bembo. Custom characters/fonts. MC/Visa. *NeoScribe International, P.O. Box 6533-MD, Hamden, CT 06517, 203/782-2200*

## ○ Genealogy

### MacGene™

Ideal for beginners and advanced users, the program was designed specifically for the Macintosh. One menu bar gives you complete control over data entry, search, select, list, and chart. Displays include Descendant, Pedigree, Family Group, Birthday, Surname. Supports user-defined fields, tailored reporting, linked files, etc. Exchange data w/ genealogist across town or across the world. Compatible w/ *MacWrite*, *Microsoft File*, etc. \$145. *Applied Ideals, Inc., P.O. Box 3225, Manhattan Beach, CA 90266*

## ○ Graphics

### Mac-Art Library

Mac-Art Library is 11 full disks of professional quality *MacPaint* art files. At \$29.95/disk, choose from *Animals*, *Plants*, *Transportation*, *Sports*, *The Farm*, *Tools*, *The Kitchen*, *Buildings*, *Signs/Symbols*, *Greeting Card Art*, *Geography*. Or get all for \$200. Also available: a Library Sampler for \$39.95. *CompuCRAFT, P.O. Box 3155, Englewood, CO 80155, 303/850-7472*

### Magic Slate—Version 2.0

A dynamic graphics program that brings to the Mac environment an exciting art medium stimulating untapped artistic talent. Slate provides features typically found in expensive systems. Since you have a state-of-the-art computer, it makes sense to support it with similar software that opens the door to a fulfilling new personal experience. *Devionics, P.O. Box 2126, Covina, CA 91722, 714/779-7193*

## MGMStation

by Micro CAD/CAM, Inc., is a high-powered, easy-to-use CAD program for the Mac, similar in performance to *AutoCAD* for the IBM PC. *MGMStation* boasts over 140 powerful functions, including XY coordinate, polar, or digital data input; 100 × zoom; accuracy to 4 decimals; & much more! Demo disk &/or VCR tape available. \$799. *CompServCo., 800 Freedom Ln., Slidell, LA 70458, 800/272-5533, 504/649-0484*

## EZ-Draft™ Software

Now you can have mainframe CAD power at a fraction of the usual cost! *EZ-Draft* is a full-feature professional drafting system for the Macintosh™ Plus. Ideal for the casual user. Lets the expert outdraw any other PC drafting system available. Perfect for any kind of drawing. A surefire way to boost profits. *Bridgeport Machines, P.O. Box 32, Bridgeport, CT 06606, 800/242-2404*

## MacPlot & MacCAD

*MacPlot* by Microspot is a powerful plotter driver that will plot any object-oriented graphics produced on the Mac in up to 30 colors/pens. Supports over 45 plotters. *MacCAD* is a series of 12 separate architectural & engineering template libraries for use with either *MacDraw* or *Mac-Draft* (specify which). *CompServCo., 800 Freedom Ln., Slidell, LA 70458, 800/272-5533, 504/649-0484*

## ○ Languages

### Pascal Extender/C Extender

Compiled library routines provide fast, flexible, modifiable Mac interface (windows, menus, scrolling, etc.) PLUS graphics printing, text editing, zooming, picture "grabber." 220-pg. manual, demos. Mac Pascal 2.0, TML Pascal versions: \$89.95. Megamax, Aztec C versions: \$129.95. Consular, Lightspeed C: call. *Inventions Software Corp., P.O. Box 3168, Ann Arbor, MI 48106, 313/996-8108*

### Multitasking for the Mac

*Mach1™*, a multitasking FORTH83 development system, is THE language for interactive Mac programming: COMPLETE toolbox access, MDS-format assembler, unlimited

terminal/background tasks, FAST execution, text files, clickable applications (no lic.), *Switcher/*Edit, 400-p. manual. \$99.95 (+ s/h, CA tax). MC/Visa.

*Palo Alto Shipping Company, P.O. Box 7430, Menlo Park, CA 94026, 415/854-7994, 800/44FORTH*

## MacScheme™ —A Mac Lisp

A LISP environment that makes a Mac feel like a LISP machine. MacScheme™ features a fast, reliable byte code interpreter, debugger, trace facility, and QuickDraw graphics. Its Smalltalk-like interface offers multiple windows and an editor that understands LISP syntax. Supports HFS, 512K or more RAM. \$125. *Semantic Microsystems, 4470 S.W. Hall St. #340, Beaverton, OR 97005, 503/643-4539*

## ○ Printer Drivers

### The Print-Link™

A printer driver program, complete with cable, allowing choice of dot matrix, daisy wheel, and ink jet printers for the Macintosh. Mfrs. supported are Epson, Okidata, Panasonic, Citizen, Olympia, Brother, Juki, Dynex, C. Itoh, Diablo, Siemens, and still adding. \$84.95. *GDT Softworks Inc., P.O. Box 1865, Point Roberts, WA 98281-1865, 604/291-9121 or 800/663-MACC*

## ○ Public Domain

### Public Domain Disks \$9

Have access to 1500 public domain programs by mail! Members pay \$9 per disk plus \$1 postage & handling. Send \$20 for 1-year subscription. Includes intro disk with ten neat programs, plus listing of all disks in library, plus quarterly newsletter describing latest public domain software.

*PD Mac, Dept. U, P.O. Box 5626, Sherman Oaks, CA 91423*

### Public Domain Disks \$5

Hundreds of public domain and shareware programs available for \$5/disk ppd USA; no membership fees. Monthly newsletter reviews public domain and commercial software and technical issues of interest to Mac users: \$14/yr. subscription. Send for free sample issue and disk catalog.

*MacKey Mouse Club, P.O. Box 4561, Lincoln, NE 68504, 402/466-0252*

## PD Software Club

The best in proven up-to-date PD Software with complete documentation. Choose from our extensive library. 800K of fonts & DAs free with \$20 annual dues. 2 new disks a month—one technical, one for general users. Monthly newsletter with complete description of new disks. 400K & SSD at \$8.95 or 800K DSD at \$12.95 + \$1 s/h. Current catalog \$2. *Translatum International, 1730 E. Oltorf St. #127, Austin, TX 78741, 512/442-0266*

## 1,000s of Titles!

The very best of Mac public domain software, shareware, and original clip art, by mail! Send \$1 for catalog. Each disk only \$9, plus \$1 s/h. Our optional membership plan includes special \$8 disk price, our catalog, free sampler disk, and quarterly newsletter, all for only \$14/yr. *The Mac Group, P.O. Box 85152, MB231, San Diego, CA 92138*

## ○ Publishing

### DrawArt™

A library of "publishing-quality" graphics in *MacDraw* files. More than 150 images in the categories of Publishing, Clip Art, 3-D/CAD, Drafting, Cartoons, & Drawings. *DrawArt™* is "Smart-Art." Customize sizes, scales, patterns, borders & still retain image quality using *ImageWriter* or *LaserWriter*. Req. *MacDraw* & 512K. Save \$10; order from us. List \$49.95. Special \$39.95. Visa/MC. *Desktop Graphics, 400 Country Dr., Ste. H, Dover, DE 19901, 302/736-9098*

## ○ Real Estate

### Property Management

Comprehensive program for managing residential and commercial properties. Many management reports including: operating statement, delinquent rent, lease expiration, and transaction register. Provides check writing, check reconciliation, posting late fees, recurring expenses—\$395. Investment analysis—\$245.

*Yardi Systems, 3324 State St. Ste. O, Santa Barbara, CA 93105, 805/687-4245*

## Investment Analysis

From *RealData*, the leader in real estate software. Latest tax rules included in this powerful sensitivity analysis for income property. Ten-year pro forma of cash flows, financing, resale, tax consequences, IRR/FMRR, and more. Flexible and easy to use. Requires *Multiplan™*, *Jazz™*, or *Excel™*. \$195.

*RealData, Inc., 78 N. Main St., South Norwalk, CT 06854, 203/255-2732*

## Property Management

From *RealData*, the leader in real estate software. Manage up to 70 residential or commercial units. Receipts/disbursements ledgers, extensive property profile, receivables and billing, check-writing, financial statement, and many more features. Completely macro driven for easy use. Requires *Excel™*. \$250. *RealData, Inc., 78 N. Main St., South Norwalk, CT 06854, 203/255-2732*

## More Real Estate Tools . . .

From *RealData*, the leader in real estate software. Products for investors, commercial and residential developers, syndicators, mortgage lenders, brokers, and closing attorneys. Programs for the Macintosh and the IBM PC available for immediate delivery. AMEX, Visa, MasterCard welcome.

*RealData, Inc., 78 N. Main St., South Norwalk, CT 06854, 203/255-2732*

## ○ Security

### Advanced Copy Protection

The leading software manufacturers depend on *Softguard* copy protection. Introducing the *MACLOCK Kit™*, a complete copy protection system that runs on the Macintosh.

- Stops all copybusters
- FULL HARD DISK support
- No source code changes
- Compatible with all Macintosh systems.

Free demo disk.

*Softguard Systems, Inc., 2840 San Tomas Expwy. #201, Santa Clara, CA 95051, 408/970-9240*

## ○ Spelling Checkers

### Spellswell™

A better spelling fixer for *MacWrite™*, *Word™*, *ThinkTank™* and text documents.

- Catches mistakes the others don't, like "insufficient funs"

- Checks homophones, e.g., there/their
- Handles hyphens/abbreviations
- Maintains capitalization
- Add/remove words from dictionary
- Separate document dictionaries
- \$59.95

*Greene, Johnson, Inc., 15 Via Chualar, Monterey, CA 93940, 408/375-2828*

## MacGAS™

The top-rated spell-checker w/ Glossary & Thesaurus

- works on-line with *MacWrite™*, *Word™*, *Jazz™*, & others
- 35,000- & 85,000-word dictionaries
- automatically replaces misspelled words, preserving style of text
- synonyms & antonyms

"MacGAS is fast, straightforward, & easy to use . . . outstanding glossary" —*July Macworld*.

*Enter-Set, Inc., 410 Townsend St., San Francisco, CA 94107, 415/543-7644*

## ○ Statistics

### Number Cruncher Stat Sys

Integrated, menu-driven, Mac statistical system including: Multiple and stepwise regression, t-tests, correlation, scatter plots, up to 4-way ANOVA, principal components, cross tabulation, transformation, non-parametrics and much more. Complete Mac interface. Transfer data to/from clipboard. \$79. Requires 2dd. *NCSS-Mac, 865 E. 400 N., Kaysville, UT 84037, 801/546-0445*

## STATEFAST

Professional but easy-to-use, SUPERFAST statistical package. Unlimited size of data files. Incl. two flexible data editors (can access *Multiplan* & other files), descriptive stats, t-tests, correlations, cross-tabulation, non-parametric stats, general multifactor ANOVA/ANCOVA, multiple regression, charts, plots, and more. \$119. Req. 128K, 1cld. *Statsoft, 2832 E. Tenth St. #4, Tulsa, OK 74104, 918/583-4149*

## CLR ANOVA

Analysis of variance program that can compute up to a 10-way design with repeated measures and unequal *n*. Marginal means, plots of interactions, simple effects, range tests, contrasts, and more. Full Mac interface. Two data editors provided. Can read



text files w/entries separated by spaces, commas, or tabs. \$75 + \$3 s/h.

*Clear Lake Research, 5615 Morningside #127, Houston, TX 77005, 800/835-2246 ext. 199, 800/362-2421 ext. 199 in Kansas*

### WormStat™

A statistical package designed for teachers, students, and occasional statistics users. The program uses a *MacPaint*™-like format. 16 statistical tools to choose from. One of the easiest to use and most intuitive packages available. \$79 each, educational price \$39 each. Site License \$1500.

*Small Business Computers of New England, Inc., P.O. Box 397, 4 Limbo Ln., Amberst, NH 03031, 603/673-0228*

### ○ Stock Market

#### Portfolio/Market Link

● *Stock Portfolio System*, a complete portfolio manager, incl. 9 reports, tie to Dow Jones or manual update. Handles diversified investments.

● *Market Link*, auto fetch up to 120 quotes up to 8 times in unattended mode. Tie to DJ or Source. Bridge quotes to *Excel*.

Free brochure + 100% rebate offer. *Smith Micro Software, Inc., P.O. Box 7137, Huntington Beach, CA 92615, 714/964-0412*

### ○ Tax

#### Mac Tax Software

*Multiplan* or *Excel*, extensive corporate tax planning, complete individual tax plan or prep. *Highly rated* individual or prof. use. Full customer support. Corp. tax planner \$295. Individual tax planner \$95. *Tax-Prep*™ individual tax prep. \$99.95. Specify your spreadsheet, add \$3 s/h or CALL NOW for free info. MC/Visa/Amex.

*EZWare Corp., Dept. 5, P.O. Box 620, Bala Cynwyd, PA 19004, 800/543-1040 or 215/667-4064 in PA*

### ○ Typesetting

#### Type/Setting Net/Work™

*Stylo-Type 1* is a quality true typesetting program for the Mac. Program drives the Mergenthaler CRTronic™ or Linotronic™ via its DENSY command language or Image/W & Laser-

Writer™ printers. 4-186 pt. range, actual typesetter width values. *Stylo-Type 1* can access the Merg 1500 font library & outputs the typesetter language. PostScript not req. Screen VIEW w/ size & positioning, picas/pts. or inches. *Stylo-Type 1*™ \$495. *Type/Setting Net/Work, Inc., P.O. Box 5279, Reno, NV 89513, 702/322-1884*

### ○ Utilities

#### GRIDS™ Tools for MacPaint

Know where the window is! 2 disks of utility templates for MacPaint for producing professional-looking drawings and charts. A collection of various grids, scales, rulers, protractors and charts with instruction manual. Use it once and wonder how you did without it! \$40 ppd. To order or request information:

*Soft Wares Inc., 19 Monroe Dr., Williamsville, NY 14221, U.S. 800/848-5500, NY 800/447-5500, Ext. 50*

#### Copy II Mac

Backs up nearly all protected software quickly, easily! Includes Copy II Hard Disk, which copies many protected programs direct to your hard disk so you can run them without a key disk. Great disk utilities (Mac Tools) also included. For Mac/Mac Plus, 1 or 2 drives. All 3 for \$39.95 + \$3 s/h. Visa/MC/Chk.

*Central Point Software, Inc., 9700 S.W. Capitol Hwy. #100, Portland, OR 97219, 503/244-5782*

### ○ Word Processing

#### MacΣqn/Equation Processor

MacΣqn is a desk accessory equation processor that lets you include complicated mathematical equations in your technical documents. MacΣqn supports: integrals, sums, products, multi line expressions, roots, super- & subscripts on the same character. Automatic character sizing, etc. \$44.95. Educational discount avail. *Software for Recognition Technologies, 110 University Park, Rochester, NY 14620, 716/461-0923*

## We RENT Mac Software !!

**MacStore**™

28 Tealwood  
New Braunfels  
Texas 78130

National **1-800-847-0026**

Ask about our frequent renter program!

**We'll match any software rental price in this issue.**

We have hundreds of other titles available for the Mac. **If you don't see what you want - call us!**

Accessory Pak 1	8.90	Mac Golf	9.45
Art Grabber	8.90	Mac Labeler	8.90
Back to Basics G.L., A.P. or A.R. (each)	26.66	Mac Muscle	8.90
Battery Pak	8.90	Mac Project	26.29
Bulk Mailer	21.60	Mac Publisher & Mac Publisher II	Call
Business Filevision	56.25	Mac Spell Right or Mac Spell +	13.85
Click Art, Effects, Letters, Publications (each)	8.90	Mac Stronomy	13.20
Click-on Worksheet	13.33	Mac Terminal	26.14
Consultant	30.80	Mac 3 D	27.80
Copy II Mac	8.90	Mac Tracks	8.90
Championship Boxing or Baseball	8.90	Mac the Knife 1, 2, or 3 (Art, Fonts, Ripper)	Call
Crickit Graph	29.90	Management Edge, Sales Edge	Call
Da Vinci (We have them all!)	Call	MegaFiler, MegaForm, MegaMerge	Call
Dollars and Sense	18.70	Mind Prober	8.90
Excel	52.75	Musicworks or Videoworks	13.19 & 14.15
Factfinder	22.95	My Office & Executive Office	Call
Filemaker	29.20	Omnis III	70.95
Filevision & Business Filevision	Call	Overview	36.80
Fluent Fonts, Fontastic, Font Explorer,	Call	Picture Base or Postermaker	8.90
Laser Fonts, Superfonts, UltraFonts...	Call	Pinball Construction Set	8.90
Flight Simulator (Microsoft)	8.90	Professional Composer	76.45
Gato, Orbitor, or Gridwars	8.90	Quick Disk, Quick Word, Quick Paint (each)	8.90
Helix	49.50	Ready Set Go	Call
Infocom games	Call	Smooth Talker	15.36
Jazz	49.45	Tempo	14.70
Keystroke	64.68	Think Tank 128 & 512	Call
Languages (Asm, Basic, Z Basic, C, Cobol,	Call	TurboCharger	15.91
Experisp, Fortran, TML Pascal, etc.)	Call	Willi Writer	8.90
Microsoft Chart, File, Multiplan, Word	Call	Word Play	8.90
Mac Attack	8.90	<b>Accessories</b>	
Mc Cad	62.56	Sony Disks (10)	13.95
Mac Challenger or Mac Command	8.90	800k External Drives (double sided)	269.00
Mac Draft	34.45	1200 Baud Modem	186.00
Mac Draw	32.47	Mac Bottom 20 Meg Hard Disk	879.50

No membership fee • 16 day rentals • Rental applies to purchase

The store logo is a trademark of MacStore, Inc., the apple logo a trademark of Apple Comp. Inc.



In Texas **1-800-222-1537** After tone ask operator for extension 993265

or dial direct **512-629-5419**



Circle 16 on reader service card

## Multiply your customers by Magic.

### The Magic Hard Disk Drive

- SCSI—16 times faster than conventional hard drives
- Dependable performance
- Print spooling, password security, and backup software at no charge
- List Prices: Magic 20 \$895, Magic 30 \$1095



#### Rabbit Industries

- Sales referrals
- Dealer discounts
- Sales and hotline support
- Fast, dependable service

For information on dealer pricing and support, contact:



P.O. Box 49859 Austin, Texas 78765 512-473-2935

Circle 459 on reader service card

Macworld 187

# MAC PLOTS II™

Business Version-\$195

Drafting Version-\$295

MacPlots II™ is a software package that turns your Macintosh® or MacPlus into a CAD system with color plotting from a full range of plotters.....up to "E" size. Can plot files saved in PICT format. Not just a plotter utility, but alot more! See your dealer today for a demonstration.

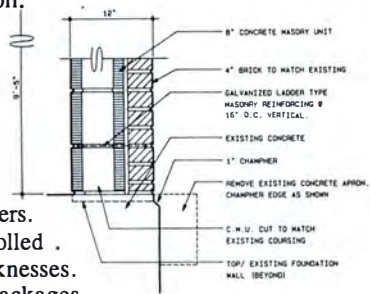

**Features include:**

- \* Easy to use
- \* Fast loading of files.
- \* Faster Bit Image support
- \* Supports full range of plotters.
- \* Plot position can be controlled .
- \* Supports variable line thicknesses.
- \* Supports popular drafting packages.
- \* Optimization of file for faster plotting.
- \* Dashed line support for both MacDraft and MacDraw.
- \* **Bold, Italics, & Underline** text supported in all type sizes.

**Additional Drafting Version features:**

- \* Clipping (hidden line removal) \* Requires 512K Mac
- \* Quick Plot (one pass overview) \* "E" size plotter support
- \* Line Specifications (for Circuit Board design)

**Computer Shoppe**  
(919) 299-4843

P.O. Box 18344  
Greensboro NC 27419

Circle 548 on reader service card

## dbSPay \$395

The powerful, yet so easy to use, Payroll system . . . for 5 to 500 employees. Design your own Payroll forms using the mouse then print the results from the dbSPay information.

*Payroll . . . the Macintosh way*

-Optional external disk drive  
(required for more than 50 employees)

### SUMMIT SYSTEMS, INC.

1050 TURNPIKE ST., P.O. BOX 91, STOUGHTON, MA 02072

call or write for additional information at no obligation

**(617) 344-1251**

dbSPay is the trademark of Deverill Business Systems. Macintosh is the trademark of Apple Computer, Inc.

Circle 542 on reader service card

## Advertiser Index

Reader Service Number

Reader Service Number

- |  |  |
|--|--|
| <p>552 Adobe, 64<br/>525 Advanced Logic Systems, 16<br/>274 Affinity Microsystems, 143<br/>557 Alsoft, 181<br/>227 Altsys Corp., 164<br/>204 Ann Arbor Softworks, 24-25<br/>550 B. Knick Drafting, 182<br/>481 BPI Systems, 115<br/>380 Batteries Included, 162<br/>490 Beale Tech, 195<br/>373 Best Computer Supplies, 72<br/>38 Blyth Software, 10-11<br/>381 Borland Int'l., IFC-1<br/>199 Boston Software Publishers, 177<br/>479 Bridgeport Machines, 144<br/>— Casady Co., 21<br/>452 Cauzin Systems, 56-57<br/>175 Central Pt. Software, 148<br/>524 Centram Systems West, 129<br/>148 CheckMark Software, 140<br/>458 CompServCo, 44<br/>496 CompuCover, 182<br/>330 CompuServe, 135<br/>271 Computer Friends, 46<br/>548 Computer Shoppe, 188<br/>418 Cortland Computer, 6<br/>384 Cricket Software, 20<br/>485 D.O.S., 157<br/>523 Data Graphics, 193<br/>546 Desktop Graphics, 178<br/>498 Dove Computer Corp., 132<br/>193 Echo Data Services, 189<br/>410 Educomp, 182<br/>403 Enabling Technologies, 174<br/>144 Forethought, 58<br/>535 Format Software, 54<br/>536 Format Software, 54<br/>323 GTCO Corp., 52<br/>143 General Computer, 8-9<br/>520 Greene, Johnson, 21<br/>517 GridComm, 33<br/>257 Hayes, BC<br/>529 Honeywell/Disc Instruments, 141<br/>434 Human Touch Computer Products, 7<br/>530 I/O Design, 146<br/>272 Icon Review, 48-51<br/>249 Infosphere, IBC<br/>308 Innovative Data Design, 62<br/>171 Iomega, 155<br/>11 Kensington, 38-39, 41<br/>489 LM Software, 192<br/>543 Layered, 42-43<br/>493 Levco, 136<br/>28 Linebacker, Inc., 154<br/>50 Living Videotext, 14-15<br/>466 LoDown, 55<br/>250 Lotus Development Corp., 28-29<br/>467 MDideas, 179<br/>291 MPH Computer Products, 166<br/>395 Mac Doctor Electronics, 153<br/>4 MacConnection, 84-87<br/>— MacMemory, 180, 182<br/>368 MacRentals, 178<br/>16 MacStore, 187<br/>— Macworld Expo, 78-79<br/>112 Manx Software, 53<br/>97 Mesa Graphics, 142</p> | <p>352 Micah, 145<br/>— Microsoft, 82, 130-131<br/>— Microsoft Press, 76-77<br/>470 Microtech Peripherals, Inc., 150<br/>406 Mirror Tech, 17-19<br/>353 N2 Products, 40<br/>284 New Canaan MicroCode, 182<br/>215 Northeastern Software, 168-171<br/>13 Odesta, 22<br/>547 Owl Int'l., 36<br/>4 PC Connection, 84-87<br/>558 PC Quick-Art, 165<br/>45 PC Network, 68-69<br/>541 PTI Industries, 139<br/>450 Panamax, 196<br/>553 Peachtree Technology, 73<br/>509 Peripheral Land, 35<br/>304 Peripherals Computers &amp; Supplies, 159<br/>— Practical Computer Applications, 30<br/>516 Pro Plus Software, 148<br/>508 ProAPP, 172<br/>77 ProVUE Development, 34<br/>194 Programs Plus, 74-75<br/>334 Public Domain Exchange, The, 172<br/>533 QWare, 12<br/>544 RH Electronics, 181<br/>459 Rabbit Industries, 187<br/>551 Reach Tech, 175<br/>— Satori Software, 70<br/>400 ScanCoFurn, 31<br/>420 Singular Software, 66<br/>435 Software Discoveries, 47<br/>545 Software Library, 196<br/>500 Software Ventures, 97<br/>255 Sony, 107<br/>554 Spectra Micro Development, 158<br/>225 StatSoft, 156<br/>542 Summit Systems, 188<br/>— SuperMac, 80-81<br/>491 Systat, 147<br/>471 TML, 194<br/>461 Tangent Technology, 149<br/>478 Target Software, 60<br/>522 Template Systems, 190<br/>— Thunderware, 161<br/>483 Tussey Computer Products, 173<br/>134 USA-Flex, 138, 160<br/>549 Univation, 26<br/>537 Uptime, 5<br/>556 Vermont Microsystems, 167<br/>383 Videx, 163<br/>459 Vision Technologies, 134<br/>439 Warp Nine Engineering, 45<br/>539 Western Computer, 151<br/>538 White Pine Software, 156<br/>374 Williams &amp; Macias Microcomputer Products, 160</p> |
|--|--|

Get more data on products you're interested in—  
simply return this card today.  
There's no cost.  
And no obligation.

It's easy to get more information on products advertised in Macworld.  
Here's how:

- Print or type your name and address in the spaces provided, and answer the questions that apply to you or your company. (These questions help us to better meet your needs and the needs of our advertisers.)
- Circle the number(s) on the card that corresponds to the reader service number(s) for the product(s) in which you're interested. For your convenience, the reader service number appears in the ad and in the Advertiser Index.
- Detach the card from the magazine, fold, seal with tape (please do not staple), apply first-class postage, and mail. Literature on the products you're interested in will be mailed to you directly from the manufacturer, free of charge.

## Free Product Information Service

Please print or type all information.

Name \_\_\_\_\_

Company \_\_\_\_\_

Address \_\_\_\_\_

City, State, Zip (Zip code needed to insure delivery) \_\_\_\_\_

Phone: Area Code/Number \_\_\_\_\_

PLEASE NOTE: This card is for your convenience in obtaining information on products advertised in *Macworld*. Please send editorial comments or inquiries to: The Editor, *Macworld*, 555 De Haro St., San Francisco, CA 94107. Thank you.

### 1. Your primary job function:

- (A) Corporate or general management  
 (B) Department manager  
 (C) MIS manager  
 (D) Professional  
 (E) Other \_\_\_\_\_

### 2. Number of employees in your company:

- (1) 25 or less       (4) 500-999  
 (2) 26-99       (5) 1000 +  
 (3) 100-499

### 3. Information requested for:

- (A) Business applications  
 (B) Home applications

### 4. Reason for inquiring:

- (1) Plan to buy—next 3 months  
 (2) Plan to buy—4-6 months  
 (3) Plan to buy—7-12 months  
 (4) Plan to buy—beyond 12 months  
 (5) Reference only

### 5. For how many personal computers do you buy products? (Include both company and personal units, please.)

- (A) 1       (C) 5-9  
 (B) 2-4       (D) 10 or more

### 6. How many of the above are Macintoshes?

- (1) 1       (3) 5-9  
 (2) 2-4       (4) 10 or more

### 7. How much do you plan to spend in the next 12 months for peripherals and other add-ons for the Macintosh(es)?

- Less than \$250       \$500-\$999  
 \$250-\$499       \$1000 or more

### 8. How much do you plan to spend in the next 12 months on software for the Macintosh(es)?

- Less than \$250       \$500-\$999  
 \$250-\$499       \$1000 or more

Please bill me \$30 for a 1-year (12-issue) subscription to *Macworld* (U.S. only). 4A7X3      W[1]      Sept 86

Valid through 12/3/86

1 2 3 4 5 6 7 8 9 10 11 12  
 13 14 15 16 17 18 19 20 21 22 23 24  
 25 26 27 28 29 30 31 32 33 34 35 36  
 37 38 39 40 41 42 43 44 45 46 47 48  
 49 50 51 52 53 54 55 56 57 58 59 60  
 61 62 63 64 65 66 67 68 69 70 71 72  
 73 74 75 76 77 78 79 80 81 82 83 84  
 85 86 87 88 89 90 91 92 93 94 95 96  
 97 98 99 100 101 102 103 104 105 106 107 108  
 109 110 111 112 113 114 115 116 117 118 119 120  
 121 122 123 124 125 126 127 128 129 130 131 132  
 133 134 135 136 137 138 139 140 141 142 143 144  
 145 146 147 148 149 150 151 152 153 154 155 156  
 157 158 159 160 161 162 163 164 165 166 167 168  
 169 170 171 172 173 174 175 176 177 178 179 180  
 181 182 183 184 185 186 187 188 189 190 191 192  
 193 194 195 196 197 198 199 200 201 202 203 204

205 206 207 208 209 210 211 212 213 214 215 216  
 217 218 219 220 221 222 223 224 225 226 227 228  
 229 230 231 232 233 234 235 236 237 238 239 240  
 241 242 243 244 245 246 247 248 249 250 251 252  
 253 254 255 256 257 258 259 260 261 262 263 264  
 265 266 267 268 269 270 271 272 273 274 275 276  
 277 278 279 280 281 282 283 284 285 286 287 288  
 289 290 291 292 293 294 295 296 297 298 299 300  
 301 302 303 304 305 306 307 308 309 310 311 312  
 313 314 315 316 317 318 319 320 321 322 323 324  
 325 326 327 328 329 330 331 332 333 334 335 336  
 337 338 339 340 341 342 343 344 345 346 347 348  
 349 350 351 352 353 354 355 356 357 358 359 360  
 361 362 363 364 365 366 367 368 369 370 371 372  
 373 374 375 376 377 378 379 380 381 382 383 384  
 385 386 387 388 389 390 391 392 393 394 395 396  
 397 398 399 400 401 402 403 404 405 406 407 408

409 410 411 412 413 414 415 416 417 418 419 420  
 421 422 423 424 425 426 427 428 429 430 431 432  
 433 434 435 436 437 438 439 440 441 442 443 444  
 445 446 447 448 449 450 451 452 453 454 455 456  
 457 458 459 460 461 462 463 464 465 466 467 468  
 469 470 471 472 473 474 475 476 477 478 479 480  
 481 482 483 484 485 486 487 488 489 490 491 492  
 493 494 495 496 497 498 499 500 501 502 503 504  
 505 506 507 508 509 510 511 512 513 514 515 516  
 517 518 519 520 521 522 523 524 525 526 527 528  
 529 530 531 532 533 534 535 536 537 538 539 540  
 541 542 543 544 545 546 547 548 549 550 551 552  
 553 554 555 556 557 558 559 560 561 562 563 564  
 565 566 567 568 569 570 571 572 573 574 575 576

# MACWORLD

## Free Product Information Service

Just return the card—  
to get more facts on the products that interest you!

PLACE  
FIRST-CLASS  
POSTAGE HERE.  
(POST OFFICE  
WILL NOT DELIVER  
WITHOUT STAMP)

Macworld  
Product Information Service  
P.O. Box 92844  
Rochester, NY 14692

# Product Index

Reader Service Number

## Software

### Business

- 274 Affinity Microsystems, 143
- 481 BPI Systems, 115
- 381 Borland Int'l., IFC-1
- 148 CheckMark Software, 140
- 458 CompServCo, 44
- 418 Cortland Computer, 6
- 384 Cricket Software, 20
- 546 Desktop Graphics, 178
- 144 Forethought, 58
- 536 Format Software, 54
- 535 Format Software, 54
- 249 Infosphere, IBC
- 489 LM Software, 192
- 50 Living Videotext, 14-15
- 250 Lotus, 28-29, 42-43
- Microsoft, 130-131
- 547 Owl Int'l., 36
- 516 Pro Plus Software, 148
- Satori Software, 70
- 225 StatSoft, 156
- 542 Summit Software, 188
- 537 Uptime, 5
- 383 Videx, 163

### Vertical

- Satori Software, 70

### Data Management

- 38 Blyth Software, 10-11
- 381 Borland Int'l., IFC-1
- 144 Forethought, 58
- 250 Lotus, 28-29
- 13 Odesta, 22
- 77 ProVUE Development, 34
- 420 Singular Software, 66
- 435 Software Discoveries, 47
- 383 Videx, 163

### Word Processing

- 525 Advanced Logic Systems, 16
- 520 Greene, Johnson, 21
- 489 LM Software, 192
- 478 Target Software, 60

### Communications

- 524 Centram Systems West, 129
- 249 Infosphere, IBC
- 304 Peripherals Computers & Supplies, 159
- 500 Software Ventures, 97
- 538 White Pine Software, 156

### Educational

- 537 Uptime, 5

### Entertainment

- Practical Computer Applications, 30
- 533 QWare, 12

### Graphics/Desktop Publishing

- 552 Adobe, 64
- 227 Altsys Corp., 164
- 204 Ann Arbor Softworks, 24-25
- 550 B. Knick Drafting, 182
- 479 Bridgeport Machines, 144
- Casady Co., 21
- 458 CompServCo, 44
- 384 Cricket Software, 20
- 485 D.O.S., 157
- 546 Desktop Graphics, 178
- 530 I/O Design, 146
- 308 Innovative Data Design, 62
- 50 Living Videotext, 14-15

Reader Service Number

- 97 Mesa Graphics, 142
- 547 Owl Int'l., 36
- 558 PC Quick-Art, 165
- 374 Williams & Macias Microcomputer Products, 160

### Personal Business/Home

- 381 Borland Int'l., IFC-1
- 418 Cortland Computer, 6
- 547 Owl Int'l., 36
- 374 Williams & Macias Microcomputer Products, 160

### Languages/Development Systems

- 112 Manx Software, 53
- Microsoft, 82
- 471 TML Systems, 194

### Utilities

- 557 Alsoft, 181
- 175 Central Pt. Software, 148

### Miscellaneous

- 380 Batteries Included, 162
- 199 Boston Software Publishers, 177
- 175 Central Pt. Software, 148
- 330 CompuServe, 135
- 548 Computer Shoppe, 188
- 523 Data Graphics, 193
- 410 Educomp, 182
- 403 Enabling Technologies, 174
- 284 New Canaan MicroCode, 182
- 334 Public Domain Exchange, The, 172
- Satori Software, 70
- 491 Systat, 147
- 522 Template Systems, 190
- 537 Uptime, 5
- 374 Williams & Macias Microcomputer Products, 160

## Hardware

### Digitizers/Scanners

- 541 PTI Industries, 139
- Thunderware, 161

### Display

- 556 Vermont Microsystems, 167

### Modems

- 271 Computer Friends, 46
- 257 Hayes, BC

### Hard Disks/Storage

- 498 Dove Computer Corp., 132
- 143 General Computer, 8-9
- 171 Iomega, 155
- 493 Levco, 136
- 466 LoDown, 55
- 467 MDIdeas, 179
- 352 Micah, 145
- 406 Mirror Technologies, 17-19
- 553 Peachtree Technology, 73
- 509 Peripheral Land, 35
- 508 ProApp, 172
- 459 Rabbit Technologies, 187
- 551 Reach Tech, 175
- 554 Spectra Micro Development, 158
- SuperMac, 80-81

Reader Service Number

- 549 Univation, 26
- 439 Warp Nine Engineering, 45
- 539 Western Computer, 151

### Miscellaneous

- 452 Cauzin Systems, 56-57
- 271 Computer Friends, 46
- 323 GTCO Corp., 52
- 517 GridComm, 33
- 529 Honeywell/Disc Instruments, 141
- 434 Human Touch Computer Products, 7
- 395 Mac Doctor Electronics, 153
- MacMemory, 180, 182
- 470 Microtech Peripherals, 150
- 353 N<sup>2</sup> Products, 40
- 509 Peripheral Land, 35
- 544 RH Electronics, 181
- SuperMac, 80-81
- 383 Videx, 163

## Accessories

### Floppy Disks/holders

- 193 Echo Data Services, 189
- 255 Sony, 107

### Miscellaneous

- 490 Bede Tech, 195
- 373 Best Computer Supplies, 72
- 496 CompuCover, 182
- 11 Kensington, 38-39, 41
- 28 Linebacker, Inc., 154

Reader Service Number

- 291 MPH Computer Products, 166
- Microsoft Press, 76-77
- 353 N<sup>2</sup> Products, 40
- 450 Panamax, 196
- 400 ScanCoFurn, 31

## Mail Order

- 373 Best Computer Supplies, 72
- 272 Icon Review, 48-51
- 4 MacConnection, 84-87
- 368 MacRentals, 178
- 16 MacStore, 187
- 215 Northeastern Software, 168-171
- 4 PC Connection, 84-87
- 45 PC Network, 68-69
- 194 Programs Plus, 74-75
- 334 Public Domain Exchange, The, 172
- 545 Software Library, 196
- 483 Tussey Computer Products, 173
- 134 USA-Flex, 138, 160
- 459 Vision Technologies, 134

*The Product Index is published as a service to our advertisers and may be discontinued at the publisher's discretion. Every reasonable effort is made to categorize advertisers correctly. If a listing should be changed, please write us at Macworld, 555 De Haro Street, San Francisco, CA 94107, so that we have the opportunity to change it.*

**It's a Huge *Disk War!***  
and Echo is taking no prisoners!

**3.5" Disk Sale!**  
**Maxell-3M-Sony-Dysan**

Bulk Packs	<b>50</b>	<b>500</b>	<b>1000</b>
<b>SS</b>	<b>\$1.50</b>	<b>\$1.45</b>	<b>\$1.40</b>
<b>DS</b>	<b>\$1.70</b>	<b>\$1.65</b>	<b>\$1.60</b>

**P.S. We're also the best software duplicators on the East Coast !!!!**

**CALL: 800-533-4188**  
**or 215-363-2400**

**DATA SERVICES, INC.**  
Marsh Creek Corp Center  
Lionville, Pennsylvania 19353

Circle 193 on reader service card

# Everything Business ... the proven solutions!

Order Processing & A/R \* Inventory \* Purchase Order & A/P

TELEX & Electronic Mail \* Mailing Lists \* Merged Letters

Mainframe/Micro Communications \* File Conversion

Custom Design: Sales/Marketing/Pricing/Job Order

NEW

20 PAGE

CATALOG

Note: Available Direct from Template Systems® or your "Authorized" Apple® Dealer Only

	<p><b>Template Systems</b> originated as an in-house effort to develop a stand-alone PC system for the MicroGroup® when they outgrew their inflexible, unreliable multi-user microcomputer.</p>	<p><b>Order Processing &amp; A/R:</b> Up to 25000+ orders/year Prints: Packing Slip, Label, Invoice, Backorder, Credit Memos, etc. Printed Reports Re. Everything!</p>
\$259	<p>The prototype met all the goals and provided a bonus...SPEED. The system is now managed by clerical personnel!</p>	<p><b>Inventory:</b> Up to 60000 items by lot, item, both Printed Reports Re. Everthing!</p>
	<p>The packages contain USER MODIFIABLE Templates used with Microsoft FILE® that can manage all the needs of distributors</p>	<p><b>Purchase Order &amp; A/P:</b> Similar to Order Processing Prints checks, aging, etc. Printed Reports Re. Everything!</p>
\$99	<p>manufacturers and some retail items such as furniture, furs and jewelry (a great way to send reminders, thanks, appraisals, etc).</p>	
	<p>Can easily "import" data from other Macs providing multi-user computer power and flexibility (with or without networking).</p>	
\$199	<p>Supports multi-company and/or divisions in the same file.</p>	
	<p>With <b>1stBASE</b> you can use the Macintosh mouse, menus and other tools to create files of your own design, enter and edit data, sort multiple fields and produce reports from single or joined files. <b>1stBASE</b> allows computing of up to 25 new fields with arithmetic and IF...THEN...ELSE logic, storing of reports and the programs used to generate them, mailmerge functions, up to 5-ACROSS LABELS, multiple line headings Reports saved as "text" can be "UPLOADED" into most data bases and spreadsheets.</p>	<p>Up to 100 fields per record Up to 100 list fields per report Up to 10 sort fields per report Up to 25 computed fields per report Up to 5000 characters per record Up to 16 megabyte files Relational joining of files IF-THEN-ELSE logic Hard and ram disc compatible</p>
\$195	<p>The easiest to learn relational data base.</p>	
	<p>With <b>1stPORT</b> your Macintosh can function as a terminal and can communicate with with other micros, mainframes, TELEX and on-line data base services. You can send and receive ASCII and binary data. Auto-dial &amp; auto-log on are provided. <b>1stPORT</b> provides a totally unique file conversion system that allows transfer of data between text, Clipboard, DIF, SYLK and 1stBASE, but can redefine the the number, length, position and type of fields within a record and actually and UPLOAD the data back to the original program or most any other spreadsheet, data base, word processing or communications program.</p>	<p><b>COMMUNICATIONS:</b> ASCII terminal emulation Auto Dial and auto-log on Apple &amp; Hayes compatible <b>FILE TRANSFER:</b> ASCII or binary either direction Supports XMODEM® protocol <b>FILE CONVERSION:</b> Tabular data can be transferred among text, DIF, CLIPBOARD and 1st BASE formats... FIELDS AND RECORDS CAN BE REDEFINED</p>
\$125	<p><b>1stPORT</b> is the ideal solution to routinely convert data between various brands of computers and data formats.</p>	
	<p>With <b>1stMERGE</b> you create a form letter in MacWrite using "[:]" to define the field insertion points (you can use the same field any number of times). The data can be in <b>1stMERGE</b>, 1st Base or converted from any data source; modem file, any Macintosh or other computer database (converted using <b>1stPORT</b>&gt;<b>1stBASE</b>). <b>1stMERGE</b> allows the maximum flexibility and use of the Mac features by applying "cut&amp;paste", MacPaint graphics and all MacWrite fonts and type styles. Can produce up to 5- up labels including the standard 4-up Cheshire mailing label format.</p>	<p>Up to 100 fields per MacWrite letter Up to 40 pages per MacWrite letter Up to 1000 paragraphs per letter Up to 100 fields per record Up to 50 characters per field Up to 16 megabyte files Hard and ram disc compatible Can directly use 1st BASE files Requires MacWrite®</p>
\$125		

Microsoft® & Microsoft File® are reg. TM of Microsoft Corp®. \*\*Macintosh® is a reg. TM licensed to Apple Computer  
Apple&MacWrite are reg TM of Apple Computer\*\*1stBASE®, 1st PORT®, 1stMERGE® are reg. TM of Template Systems

**Template Systems, Inc.**

7 Industrial Park Medway, Mass. 02053

1-800-522-2286

(617) 533-2203(Ma.)

# Open Window

*An exchange of Macintosh discoveries*

**Edited by Jim Heid**

*This month, a hint that will put you on better terms with your Brother: a modification of the Microsoft Word printer driver that improves the printer's bold-face text. Also, tips on laser-printing both sides of the paper, selecting paper, writing equations with MacDraw, and stretching MacDraw text for special effects. A MacPaint trick improves shadow text, and a reader's clever adaptation of the Finder and the MiniFinder lets you switch between programs quickly. Of interest to Microsoft Chartographers: a reader uncovers a LaserWriter printing problem and offers a solution. But first, news of a shareware utility that modifies programs to show long file names when you open and save documents.*

## Looking at Long Names

One advantage the Mac has over many computers is that it lets you give documents long names: 1986 Budget Forecast instead of BUDG86.WKS, or Sales Memo to Duncan instead of MEMDUN.DOC. Often, however, this benefit backfires. If you begin more than one file with the same text—May Sales Forecast Memo and May Sales Forecast Report, for example—you may not see enough of the name in an Open dialog box to tell which is which.

You can tell documents apart by remembering that they're listed alphabetically (for example, the May memo before the May report), but a simple solution resides in the stacks of a MAUG data library

on CompuServe. It's a \$5 shareware application called *Window Changer*, which modifies Open and Save boxes to show document names as long as 56 characters. *Window Changer* modifies over a dozen of the most popular Mac applications, and its version 1.0 is stored in MACUS DL3 (Programming) as BIGWIN.BIN. For important information about which programs can be modified, download the documentation (BIGWIN.DOC), too. —Ed.

## A Better Brother Bold

With my Mac and *Microsoft Word*, I use Brother electronic typewriters and the Brother printer driver included with *Word*. The bold text looks anemic to me, however. The Brother prints bold by double-printing the text, displacing the second pass by  $\frac{1}{80}$  inch. Shadow text works the same way: the second pass is displaced  $\frac{1}{20}$  inch, resulting in bolder text. I used John Mitchell's *Fedit* disk-editing utility to modify *Word*'s Brother driver, changing bold text to shadowed text.

- Make a backup of the Brother driver, start *Fedit*, and open the backup. Make sure the display is in hexadecimal (choose Display Sector in Hex from the Display menu).

- Choose Hex Search from the Options menu and type **1B4F** (the codes that activate bold text) and then click Find.

*Fedit* positions the cursor at the bytes you need to change.

- Choose Hex Modify from the Edit menu and type **1B57**. Double-check your work and then choose Write Sector from the Edit menu and OK from the dialog box.

*Ismail bin Mustapha  
Petaling Jaya, Malaysia*

## Two Sides to Every Page

I've figured out how to collate the paper in the LaserWriter's paper cassette so that documents can be printed on both sides, with pages in the right order. It seems trivial, but you'd be surprised how much paper you can waste until you know the secret.

- Print half the number of final copies you'll need. If you need ten copies, for example, print five. If you need seven copies, print four; you'll wind up with eight copies, but an extra is often handy.

- Arrange the printed pages so that all the copies of page 2 are on top, followed by all the copies of page 1, then of page 4, page 3, page 6, page 5, and so on (see "Two-Sided Printing"). If the last page of your document is odd-numbered, set aside the printed copies of that page and replace them on the stack with blank paper. Place the pages in the LaserWriter's tray with the printed side up and the top edge of the pages feeding into the printer.

- Again, print half the number of copies you'll need, then collate the pages from both printings into the proper order. If you end with an odd-numbered page, remember to include the single-sided copies from the first printing.

*Brian Lyngaas  
Fond du Lac, Wisconsin*

*This approach works for Microsoft Word documents, but MacWrite throws a wrench into things by printing documents in reverse order so that pages*

*(continues)*

## Open Window

stack up in the proper order in the LaserWriter's output tray. To collate the first printing for a MacWrite document, start with all the copies of page 2 on the bottom and add all the copies of page 1 on top, followed by page 4 and then 3, 6, 5, and so on. —Ed.

### Solving the Equation Problem

Despite the variety of software available for the Mac, I haven't found a word processor that lets me include engineering equations in reports. Until someone solves this admittedly complex problem, I've resorted to the following procedure to get acceptable results.

I set up *Switcher* to run *MacWrite* (or *Microsoft Word*) and *MacDraw*, with the Always Convert Clipboard option active. When I get to an equation, I switch from *MacWrite* to *MacDraw* and put together the equation. I then select the entire equation, copy it to the Clipboard, and switch back to *MacWrite* to paste the equation in the report (see "Drawing Equations"). This approach requires patience but allows me to align super- and subscript numbers, super-superscripts, sub-subscripts, and

(continues)

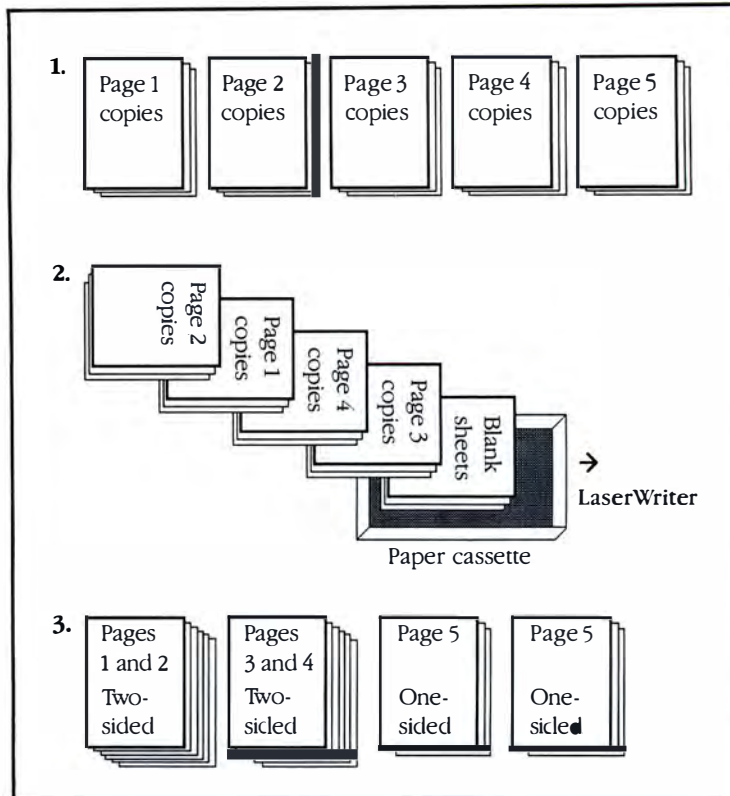

### Two-Sided Printing

To laser-print a Word document on both sides of the paper, first print half the number of final copies you'll need (1). Next, rearrange the pages in the order shown: page 2 copies on top of page 1 copies, then pages 4 and 3, and so on (2). Print the document again on the blank sides and then collate the pages (3). See the text for the order for MacWrite documents.

# New

# MacSpec™

# Version 2

## MacSpec™ now supports graphics!

**MacSpec™**  
will automatically:

- Indent and number sections
- Re-number & align sections when moved
- Build table of contents with page numbers
- Generate page headers and footers
- Number pages
- \$199.95

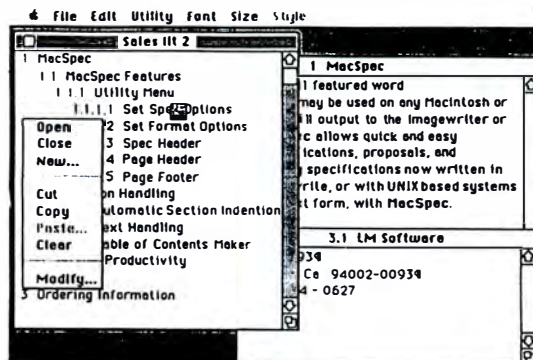

Section Handling



LM Software™  
P.O. Box 93  
Belmont, CA 94002  
(415) 594 - 0627

**MacSpec™** is a new full featured word processor/editor. It may be used on any Macintosh™ or Macintosh Plus™ and will output to the Imagewriter™ or Laserwriter™. **MacSpec™** allows quick and easy composition of specifications, proposals, and technical papers. Any specs now written in Microsoft Word™, Macwrite™, or with UNIX™ based systems are compatible, in text form, with **MacSpec™**. Graphics can be pasted into your specification.

Macintosh, Macintosh Plus, Imagewriter, Laserwriter are trademarks licensed to Apple Computer.  
Microsoft Word is a trademark licensed to Microsoft. UNIX is a trademark licensed to AT&T Bell Labs.

Circle 489 on reader service card



# PRICE BREAKTHROUGH!

# Sr. Accountant

by DATA GRAPHICS, INC.

# Only \$69.95\*

30 Day Money Back Guarantee \* Price includes

ACC # 1020 CASH BANK

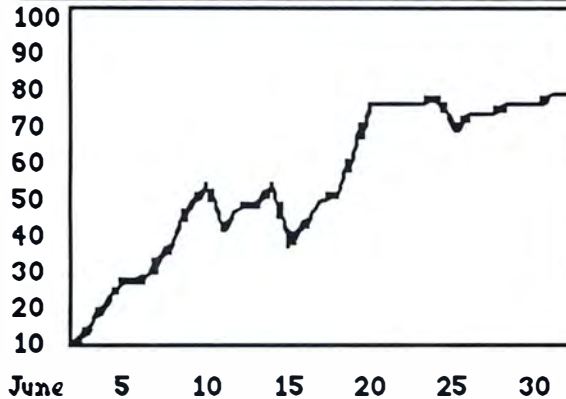

Graph of Cash Account

ALL EIGHT MODULES!!

**Sr. Accountant** is an easy to use accounting software for the Macintosh that features a full graphics routine for analyzing each account. With **Sr. Accountant** you can graphically display expenses, sales, cash or any other account on the trial balance. Graphs can be displayed on the screen or printed on the Image Writer. Each account can be graphed by the month, quarter or year. All scales are automatic, you just select the account number and the period to graph.

**Sr. Accountant** includes *eight full feature accounting modules* each instantly selected for the main menu.

- |                  |                      |                       |
|------------------|----------------------|-----------------------|
| • General Ledger | • Accounts Payable   | • Accounts Receivable |
| • Inventory      | • Monthly Statements | • Job Costing         |
| • Graphics       | • Custom Reports     | • Trial Balance       |
| • Aging Reports  | • Cost Centers       | • Full Audit Trails   |

You can generate hundreds of custom reports with the above integrated modules. The software is designed to be used with either a service or product-based business.

**Sr. Accountant** checks each and every entry against the trial balance – if the operator tries to enter data that upsets the trial balance the data is rejected with an error message allowing the operator to correct the mistake.

Job Costing allows you to track costs on any job and print a report listing income and expenses by job. This is an excellent management tool that will allow you to control costs and increase profits.

### First Accounting Program To Use Artificial Intelligence

*Will not allow errors* on the trial balance. Most offsetting entries are *automatic*. Full audit trails using GAAP standards are built into the software.

**Minimum System Requirements:** 128K with external drive, 512K or more & Hard Disks fully supported.

### Money Back Guarantee

Try it for 30 days – If you don't agree, send it back for a full refund (less postage and handling.) There is a \$10 restocking fee if the program disk has been used. Non Copy Protected. Comes with excellent documentation. The software is machine language coded for the fastest possible speed.

**Sr. Accountant** performs the same accounting functions of software costing \$500 to \$2000 and more.

**DATA GRAPHICS, INC.** guarantees Full Management Reports including – Aging Reports, Job Costing – Tracking, Simple Menu Driven Operation, Graphics for any account, Full Audit Trails and *much more*.

Call toll-free or mail the coupon below now!

**1-800-822-1160** or 614-863-0694

Mail to: **DATA GRAPHICS, INC.**  
4480 Refugee Rd. • Suite 208 • Columbus, Ohio 43232

**YES!** Please rush me \_\_\_\_\_ copies of **Sr. Accountant** at \$69.95 per copy. I've enclosed \$7.50 postage and handling. In Ohio, add 5.5% sales tax (\$3.85 for each copy). U.S. prices only.

Name \_\_\_\_\_

Company \_\_\_\_\_

Address \_\_\_\_\_

City \_\_\_\_\_ State \_\_\_\_\_ Zip \_\_\_\_\_

Check enclosed.  VISA   MasterCard 

Acct. No. \_\_\_\_\_ Exp. Date \_\_\_\_\_

Signature \_\_\_\_\_

Circle 523 on reader service card

## Open Window

$$F_{T_{fail}}(t_{fail}) = \int_0^{t_{fail}} 1 - \exp\left\{-\frac{\delta_{ij}^2(\tau)\sqrt{2\pi}}{\sigma(\tau)}\right\} d\tau \quad (\text{Eq.1})$$

### Drawing Equations

To add complex equations to documents, create an equation with MacDraw, then select the equation, copy it to the Clipboard, switch to the word processor, and paste.

anything else you can imagine. The Send to Back and Bring to Front commands are more and more useful as the equation grows; choose the No Fill background to avoid obscuring the bottom layers. Finally, enter the equation number on the same line in MacDraw, too.

Richard J. Nielsen  
Menlo Park, California

### Text Stretching

Text pasted from MacDraw into word processing documents behaves differently depending on the copying method. If you se-

lect the text with the I-beam pointer, it's copied as text and can be edited once it's pasted. If you select text with the arrow pointer, the type is treated as a graphic object you can stretch by dragging its handles to achieve special effects for banners or signs.

Jess Dorsey  
Lubbock, Texas

Stretching type is even more useful for LaserWriter fonts. Stretched or otherwise resized MacDraw text looks ragged on the screen but, through the magic of PostScript, prints beautifully on the LaserWriter, making this an excellent technique for customizing condensed or expanded headline type styles. This trick doesn't work with stretched MacPaint text, since MacPaint creates bit-mapped graphics, while MacDraw creates QuickDraw images—mathematical descriptions of an object's appearance. (For more information on cutting and pasting Macintosh graphics, see "A Clipboard Collage," Macworld, January 1986.)

Don't go overboard with text stretching, however; a typeface is designed to look best in its original proportions, and

the more it's altered, the less attractive it becomes. Generally, don't expand or condense a font more than 10 or 15 percent. —Ed.

### Swapping MiniFinder and Finder

Previous Open Window columns described two MiniFinder shortcuts: pressing the Enter key to start the Finder, and holding an Option key while quitting an application to bypass the MiniFinder and go straight to the Finder. I found the tips useful, but for file management, I'd rather quit to the Finder most of the time, with the option of quitting to the MiniFinder when I want to move quickly between applications. My solution: I change the Finder's name to MiniFinder and the MiniFinder's name to Finder, so that I quit to the Finder unless I hold down an Option key while quitting. The following procedure lets you swap the two files' names:

- Install the MiniFinder, then duplicate both the Finder and the MiniFinder (because the Finder doesn't let you change the original files' names).

(continues)

# Pascal for the Mac!

Only \$99.95

## TML Pascal. NEW VERSION 2.0!



Pascal

- Create double-clickable applications
- Create desk accessories
- Create definition procs, FKEYs, etc.

### New TML Pascal v2.0 Language Features

- Separate compilation of Units
- Object Pascal for object-oriented programming
- Complete support for Lisa style type casting and qualification
- Complete access to all extended SANE operations
- Universal parameter types, and much much more

### Complete access to:

- QuickDraw
- Print Manager
- Packages
- MacinTalk Speech
- AppleTalk LAN
- Toolbox
- Operating System
- Serial Drivers
- 3D Graphics
- SCSI & List Managers

### Two Compilation Modes:

- Compile to Object code (MDS .Rel files)
- Compile to Assembly source code (MDS .Asm files)

## The TML Source Code Library. NEW PRODUCT!



GrafMDEF

- 18 source code examples (over 1Mb on 3 disks)
- Complete User Manual documenting each example

### Example programs demonstrate how to program...

- Print Manager
- Serial Drivers
- Standard File Dialog
- Split-scrollable windows
- MacinTalk Speech
- Pop-up Menus
- Function Keys
- Menu Definitions
- Window Definitions
- Desk Accessories
- Control Definitions
- List Definitions

All for Only \$79.95

### Other TML Pascal Development Tools:

Database Toolkit	\$89.95
MiniEdit Source Code example	\$19.95
MacExpress™	\$195.00

Please enclose \$5.00 shipping and handling with all orders

# TML Systems

And now at our  
New Address: 4241 Baymeadows Rd. Suite 23  
Jacksonville, FL 32217

To order by VISA, Mastercard or COD call  
(904) 636-8592

Circle 471 on reader service card

# MAX YOUR MAC

**WITH BEDE TECH**  
**800 / 772-4536**



**WOULD YOU PAY \$49 FOR A LIFETIME RIBBON SUPPLY? MAC ImageWriter Ribbon RE-INKER**

Motorized Ribbon Re-Inker silently re-inks all ImageWriter I and II fabric ribbons again and again. Better print quality than new ribbons. Our special lubricated black ink actually extends print head life. Built to last. Simple to run. Saves a bundle.  
MAC ImageWriter Ribbon Re-Inker **Bede Tech Bonus • 4 Oz. Bottle Black Ink, Roller & Roller Cover. BEDE TECH DIRECT \$49.00**  
Reg. \$67 Value  
Call for Epson Inker.

## INK AND RIBBON SAVINGS

- 4 Oz. Bottle Black Ink \$ 4.50
- 2 Oz. Bottle Colored Ink \$ 4.50
- Pint of Black Ink \$16.50
- Gallon of Black Ink \$75.00
- Color Ink Kits (2 Oz. ink, uninked roller, roller cover) \$ 8.00
- Uninked Roller w/Cover \$ 3.50
- ImageWriter Ribbon Cartridge (box of 2 uninked ribbons) \$10.00
- ImageWriter Ribbon Cartridge (box of 2 inked ribbons) \$12.00
- ImageWriter II Multi-Color Ribbon Call
- Print Head Cleaning Kit \$ 9.95
- Re-Inker Shut-Off Timer (for high volume users) \$24.00
- ImageWriter Silence Pad \$11.25

## MOUSE PAD



Your mouse will work faster and live longer. Anti-static, designer blue surface, 9-3/8" x 7-1/8" with thick foam pad.  
**BEDE TECH DIRECT \$6.95**  
Reg. \$9.95 Value

Circle 490 on reader service card

## COOLER COMPUTERS LIVE LONGER

Built without its own fan, your MAC is prone to overheating. High temperatures can cause component failure or even burn out your power supply circuit board. Tests show our fan significantly reduces the temperature inside your MAC. It installs into the recessed Macintosh handle in one second. It runs whisper quiet. Intelligently designed by **Steve Beck's Beck-Tech**, with built-in surge protector and top-mounted switch that controls both fan and MAC. PATENT PENDING

**BEDE TECH DIRECT \$79.00**  
Reg. \$129.95 Value

Temperature measured inside left and right side of MAC with LM35 temperature sensor. 75° average ambient air temperature during test.

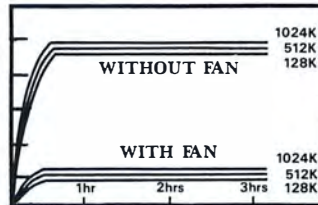

## EXTERNAL 800K MAC DRIVE

The McD-800 sets the standards for micro-floppy disc drives. It works with ALL Macs. It's completely compatible with Apple's single sided 400K and double sided 800K disk format. Soft landing function. Auto and manual eject mechanisms. Unbeatable specifications.

**BEDE TECH DIRECT \$247.00**  
Reg. \$459 Value

## KEYBOARD COVERS

Sturdy, Mac-colored, hard covers protect your MAC or MAC PLUS keyboard and number pad from dust, dirt, spills and damage. Specify MAC or MAC PLUS.

**Bede Tech Bonus • MAC Keyboard Command Reference Charts! BEDE TECH DIRECT \$9.95**



## DISC ORGANIZER • SAVE BIG WITH FOUR-PAK

Each extra sturdy 200 lb. test corr. bd. disk organizer holds up to 100 3.5" or 5.25" disks. Comes with removable dividers, cover. Glossy white dirt-resistant surface. Stackable!

**BEDE TECH DIRECT Save! Four-Pak \$27.95 • Reg. \$39.80 Value**  
**BEDE TECH DIRECT Single Disk File \$7.95 • Reg. \$9.95 Value**

MADE IN AMERICA • 30-DAY SATISFACTION MONEY-BACK GUARANTEE

QTY.	ITEM	TOTAL	Send check, money order or charge it
_____	\$ _____		<input type="checkbox"/> VISA <input type="checkbox"/> MasterCard Exp. Date _____
_____	\$ _____		Card No. _____
_____	\$ _____		Signature _____
_____	\$ _____		Name _____
_____	\$ _____		Address _____
_____	\$ _____		City _____
_____	\$ _____		State/Zip _____
PURCHASE TOTAL		\$ _____	
Shipping and Handling Charge		\$ 1.50	
(Canada, Hawaii, Alaska, \$4.50 S&H)			
Ohio residents add 6.5% Sales Tax		\$ _____	
TOTAL ORDER		\$ _____	

ImageWriter is a registered trademark of Apple Computer, Inc.  
Macintosh and MAC are trademarks licensed to Apple Computer, Inc.

mw9

**brown**  
*d i s c*



**TWO-FOR-ONE LIFETIME WARRANTY + FREE DISC ORGANIZER**

Brown Disc has built a reputation for superior quality and error-free performance among OEM customers. Discs are 100% certified and exceed ANSI standards! These are the finest discs in the world. We prove it with a two-for-one lifetime warranty: If any Brown Disc diskette fails to perform due to defects in materials or workmanship, Brown Disc will replace the defective diskette with two diskettes of the same type.

**NEW LOW DISC PRICES**

**Bede Tech Bonus • All orders of 50 or more discs are shipped in FREE Disc Organizer, Reg. \$9.95 Value.**

**Call for our current disc prices for all bulk and packaged 3.5" and 5.25" Brown discs.**

**We offer the absolutely best disc value you can find.**



**bede tech**

**CALL TOLL FREE**  
**800-772-4536**  
In Ohio 216-631-4214  
8327 Clinton Road  
Cleveland, Ohio 44144

© 1986 Bede Tech

**Go for the MAX™**

**SuperMAX™. The MAXimum in Surge Suppression, Noise Filtration, Under Voltage detection and protection, PLUS Telecommunication Line protection.**



- Quality Power Line AND Data Line Protection
- Exceeds IEEE 587
- Status Lights
- Reset Switch
- Five Year Warranty
- Made In U.S.A.

**PANAMAX**  
Toll Free 1-800-472-5555  
In California 1-800-4-P.A.N.A.M.A.X  
(1-800-472-6262)  
150 Mitchell Boulevard, San Rafael, CA 94903

See Us at Boston Macworld Expo Booth #1377

Circle 450 on reader service card

**FREE \$20 MEMBERSHIP**

**SOFTWARE LIBRARY** 

**RENT**

**TRY IT FIRST.**  
RENTAL APPLIES TO PURCHASE

**We Carry All Available Mac Software Complete With Manuals.**

SONY 3 1/2" SS/DD	1.44 ea.
MICAH AT 20 Meg	1285.
MAC TURBO TOUCH	86.18
MAC BUFFER 256	215.96

Texas Residents & Information  
**(713) 622-1100**  
P.O. Box 66754 • Houston, Tx 77266

**ORDER HOTLINE 1-800-847-5775**

Circle 545 on reader service card

## Open Window

- While running with a different disk as the startup disk, throw away the original Finder and MiniFinder. To avoid the "Are you sure..." queries, hold down an Option key while dragging the files to the trash.

- Change the name Copy of Finder to MiniFinder, and Copy of MiniFinder to Finder.

Shut down and then restart the Mac with the modified disk. The Finder appears as usual, although the Mac thinks it's running the MiniFinder, since that's the Finder's new name.

R. W. Zehr  
Sausalito, California

*A slick trick, but a caveat is in order: once you've switched the names, you can't use the MiniFinder's Finder button to start the real Finder because the Mac thinks it's already running the Finder. Also, you can't use the Open Other button to start the Finder, since the MiniFinder file doesn't appear in the scroll box. To get to the real Finder, you have to start an application and then quit.*

*The fact that the Mac always looks for a program called MiniFinder upon quitting has another benefit. Once you've renamed a program MiniFinder, it starts automatically after every quit unless you hold down an Option key to bypass it. For the most flexibility, check out a desk accessory called Launch (stored on CompuServe's MAUG Data Library 1 as LAUNCH.BIN), which lets you quit one application and directly start another.*  
—Ed.

Open Window welcomes your contributions. Please send submissions on disk (which we will return) along with a brief description on paper to Open Window, Macworld, 555 De Haro St., San Francisco, CA 94107. Or send your contribution electronically to CompuServe 70370,702 or The Source BCW440. We pay \$25 to \$100 for each Open Window item published. All published submissions become the property of Macworld.

Jim Heid is a Contributing Editor of Macworld. □

# MacServe. For those who understand the power of sharing.

It's called teamwork—everyone benefits from sharing knowledge and resources. MacServe's safe-fail

resource management lets your team get the most from your choice of hard disks and printers. Your choices expand to PCs and compatibles, when you add Tangent's PC MacServe. Imagine what MacServe can do for the prosperity and morale of your operation!

## Productivity increases

You'll enjoy direct access to shared databases (such as multi-user Omnis 3 Plus) and libraries of documents. And save time with MacServe's printer spooler, because your team can share a

printer and still get back to work sooner.

## Safe-fail convenience

MacServe lets you divide hard disks into segments or "volumes" with noticeable speed advantages and the comfort of password protection—even for lone Macs. It's faster than accessing a whole disk (even under HFS) and more reliable than any file serving scheme

yet devised. Your team won't scream if a server crashes—because MacServe is the *only* solution that automatically reconnects all users without any loss of data!

## The complete Apple network

MacServe networking software and Apple's Hard Disk 20 finally make Apple networking a reality. Your team can share any of the leading hard disks—all at the same time—because MacServe does not limit you to Apple's hard disks and printers. MacServe requires no special or dedicated hardware. And there's no extra charge for user nodes!

## Call your Apple dealer now

Leading Apple dealers have delivered over 15,000 safe-fail networking solutions from Infosphere since June 1985. Ask your favorite dealer for MacServe!

## MacServe™

Sharing Resources through AppleTalk



Infosphere, Inc. is a trademark of Infosphere, Inc. Macintosh is a trademark licensed to and AppleTalk is a trademark of Apple Computer, Inc. Omnis is a trademark of Blyth Holdings, Ltd.

# AppleTalk™ networks communicate better after a little bridgework.

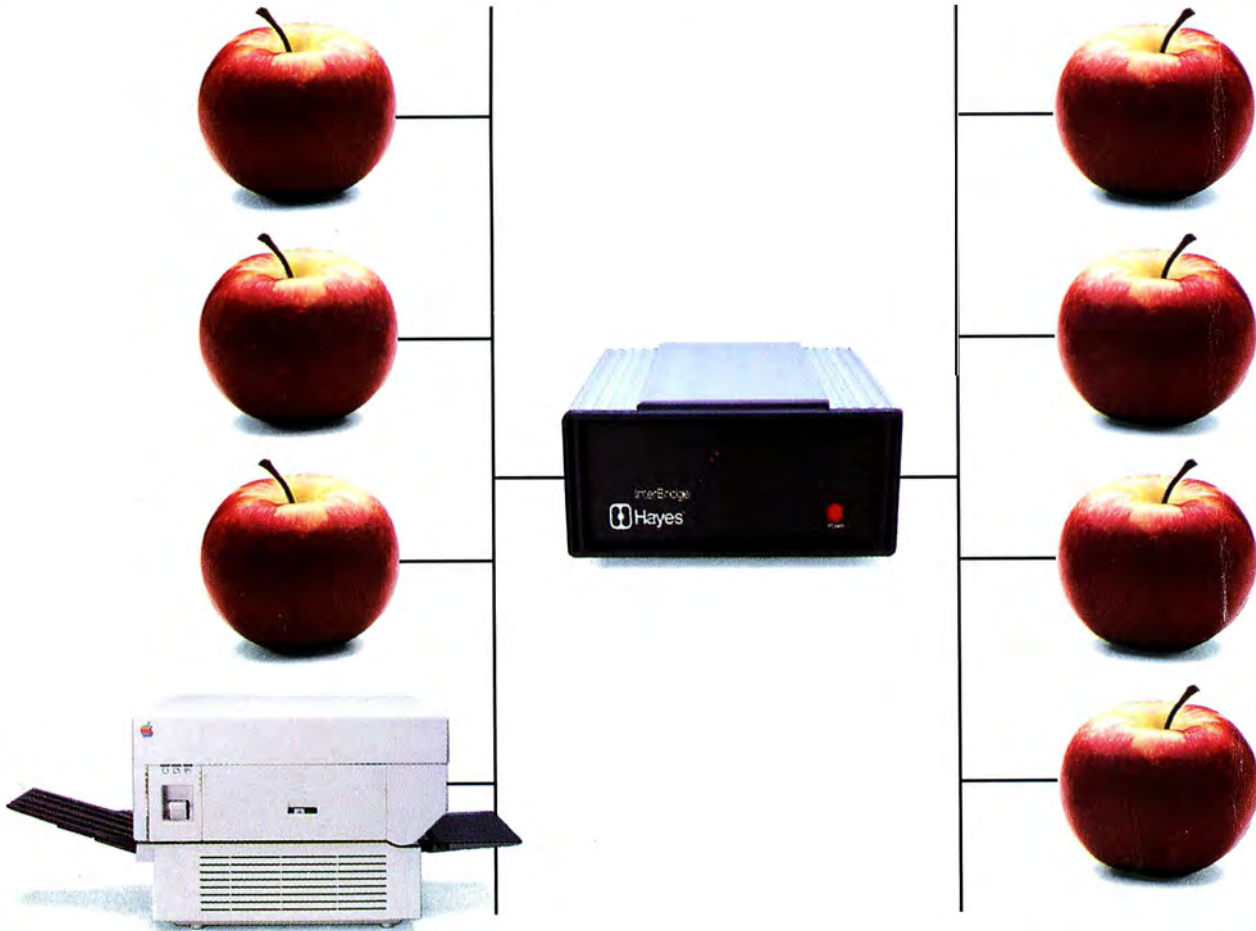

© 1986 Hayes Microcomputer Products, Inc.

It took Hayes, the PC communications leader, to bridge the gap between AppleTalk networks.

Introducing Hayes InterBridge.™ There's nothing like it!

Now one AppleTalk network can communicate with another. Across the hall. Across town. Or across the country.

It's a local bridge, that lets you share information with other AppleTalk networks in your company. Or, if one network becomes overloaded, InterBridge allows you to split that network and split the workload.

It's a remote bridge, that lets you share information with AppleTalk networks everywhere. All it takes is one InterBridge and one Hayes Smartmodem 2400,™ on each end.

And it permits casual access to expensive peripherals by both local and remote AppleTalk networks. InterBridge allows you to access a LaserWriter,™ file servers and gateways on another network,

even if they're thousands of miles away.

This feature alone can save thousands of dollars you'd otherwise spend on dedicated peripherals for each of your AppleTalk networks!

No matter how you look at it, or how you use it, Hayes InterBridge is quite a bargain. Now you can get a lot of fancy bridgework, without a fancy price.

See your authorized Hayes dealer for details. Or contact Hayes at 404/441-1617.

Hayes Microcomputer Products, Inc., P.O. Box 105203, Atlanta, Georgia 30092.

## Hayes®

Say yes to the future

Circle 257 on reader service card