

# MultiHop Radios

## Instruction Manual

Original Instructions  
151317 Rev. E  
27 July 2016



151317

# Contents

|   |    |
|---|----|
| 1 MultiHop Radio Overview .....   | 4  |
| 1.1 MultiHop Application Modes .....  | 4  |
| 1.1.1 Modbus Mode .....   | 4  |
| 1.1.2 Transparent Mode .....  | 6  |
| 2 Radio Features .....  | 7  |
| 3 Setting Up Your MultiHop Network .....  | 8  |
| 3.1 Configure the MultiHop Radios .....   | 8  |
| 3.1.1 Wiring for MultiHop Radios .....  | 8  |
| 3.2 Set the MultiHop Radio (Slave) ID .....   | 8  |
| 3.3 Bind the MultiHop Radios to Form Networks .....   | 9  |
| 3.3.1 Slave and Repeater LED Behavior .....   | 9  |
| 3.3.2 Master LED Behavior .....   | 10 |
| 3.4 Conduct a Site Survey .....   | 10 |
| 3.4.1 Conduct a MultiHop Site Survey (from the LCD Menu System) .....                       | 10 |
| 3.5 Installing Your Sure Cross® Radios .....  | 11 |
| 3.5.1 Mounting SureCross Devices Outdoors .....   | 11 |
| 3.5.2 Other Installation Requirements .....   | 12 |
| 3.5.3 Installation Quick Tips .....   | 13 |
| 3.5.4 Basic Remote Antenna Installation .....   | 14 |
| 4 Modbus Register Configuration .....   | 19 |
| 4.1 00000s Standard Physical Inputs .....   | 19 |
| 4.1.1 00400s Extra Inputs .....   | 19 |
| 4.2 00500s Standard Physical Outputs .....  | 19 |
| 4.2.1 00900s Extra Outputs .....  | 19 |
| 4.3 01000s Input Parameters .....   | 19 |
| 4.3.1 Switch Power Input Parameters .....   | 20 |
| 4.4 02000s Output Parameters .....  | 20 |
| 4.5 02950s Default Output Parameters .....  | 21 |
| 4.6 03000s Discrete Input Parameters .....  | 21 |
| 4.7 03300s Analog Input Parameters .....  | 22 |
| 4.8 03500s Counter Input Parameters .....   | 24 |
| 4.9 03600s H-Bridge Output Parameters .....   | 25 |
| 4.9.1 03600s Switch Power Output Parameters .....   | 26 |
| 4.10 03700s Discrete Output Parameters .....  | 26 |
| 4.11 04000s Analog Output Parameters .....  | 27 |
| 4.12 04150s Initialization Controls .....   | 27 |
| 4.13 04400s Output Flash Pattern Parameters .....   | 28 |
| 4.14 04500s M-GAGE Parameters .....   | 28 |
| 4.15 04800s Ultrasonic Input Parameters .....   | 29 |
| 4.16 06050s Battery Monitoring Parameters .....   | 31 |
| 4.17 Configure the SDI-12 Inputs .....  | 31 |
| 4.17.1 Basic SDI-12 Interface Parameters .....  | 32 |
| 4.17.2 Result Registers Configuration Parameters .....                                      | 32 |
| 4.17.3 SDI-12 Device Result Registers .....   | 35 |
| 4.17.4 SDI-12 Device Settings .....   | 36 |
| 4.17.5 Configuring for Acclima SDI-12 Sensors .....   | 37 |
| 4.17.6 Configuring for Decagon 5T3 SDI-12 Sensors .....                                     | 37 |
| 4.18 Manufacturer Parameter Registers .....   | 37 |
| 4.19 Device and System Parameters .....   | 38 |
| 4.19.1 08200s Sample On Demand .....  | 39 |
| 5 Certified For Use in the Following Countries .....  | 40 |
| 5.1 FCC Certification, 900 MHz, 1 Watt Radios .....   | 41 |
| 5.2 FCC Certification, 2.4GHz .....   | 42 |
| 6 Dimensions .....  | 44 |
| 6.1 DX80...E Housings .....   | 45 |
| 7 Advanced Setup .....  | 46 |
| 7.1 MultiHop Radio Menu System .....  | 46 |
| 7.2 Binding Mode: What Does MultiHop Binding Do? .....                                      | 47 |
| 7.2.1 Manually Bind the MultiHop Radios to Create the Network (using Menu Navigation) ..... | 48 |
| 7.3 Conduct a Site Survey using Modbus Commands .....                                       | 48 |
| 7.4 Using 10 to 30V dc to Power the MultiHop Radio and a Gateway .....                      | 49 |
| 7.5 Using the Solar Supply to Power the MultiHop Radio and a FlexPower Gateway .....        | 49 |
| 8 Accessories .....   | 50 |

|       |  |    |
|-------|--|----|
| 8.1   | Selecting an Enclosure                       | 50 |
| 8.1.1 | Enclosures                                   | 50 |
| 8.2   | Selecting an Antenna                         | 52 |
| 8.2.1 | Antennas: Rubber RP-SMA                      | 53 |
| 8.2.2 | Antennas: Dome                               | 53 |
| 8.2.3 | Antennas: Other                              | 53 |
| 8.2.4 | Antennas: Fiberglass N-Type                  | 54 |
| 8.2.5 | Antennas: Yagi N-Type                        | 54 |
| 8.2.6 | Antenna Cables: RP-SMA to RP-SMA             | 54 |
| 8.2.7 | Antenna Cables: RP-SMA to N-Type             | 55 |
| 8.2.8 | Antenna Cables: N-Type                       | 55 |
| 8.2.9 | Surge Suppressors                            | 55 |
| 8.3   | Power Supplies                               | 55 |
| 8.3.1 | DC Power Supplies                            | 55 |
| 8.3.2 | FlexPower Supplies and Replacement Batteries | 56 |
| 8.4   | Relays                                       | 57 |
| 8.5   | Brackets and Mounting Options                | 57 |
| 8.6   | Other Accessories                            | 59 |
| 8.6.1 | Other Accessories                            | 59 |
| 8.6.2 | DX85 Modbus RTU Remote I/O Devices           | 59 |
| 8.6.3 | Sensors                                      | 60 |
| 8.6.4 | Cables                                       | 62 |
| 8.6.5 | Hardware and Replacement Parts               | 65 |
| 8.6.6 | Cable Glands and Plugs                       | 65 |
| 8.6.7 | Metal Housing Accessories                    | 66 |
| 9     | Copyright Notice                             | 67 |
| 9.1   | Banner Engineering Corp Limited Warranty     | 67 |
| 9.2   | Contact Us                                   | 67 |

# 1 MultiHop Radio Overview

MultiHop networks are made up of one master radio and many repeater and slave radios.

The MultiHop networks are self-forming and self-healing networks constructed around a parent-child communication relationship. A MultiHop Radio is either a master radio, a repeater radio, or a slave radio.

- The master radio controls the overall wireless network.
- The repeater radios extend the range of the wireless network.
- The slave radios are the end point of the wireless network.

At the root of the wireless network is the master radio. All repeater or slave radios within range of the master radio connect as children of the master radio, which serves as their parent. After repeater radios synchronize to the master radio, additional radios within range of the repeater can join the network. The radios that synchronize to the repeater radio form the same parent/child relationship the repeater has with the master radio: the repeater is the parent and the new radios are children of the repeater. The network formation continues to build the hierarchical structure until all MultiHop radios connect to a parent radio. A MultiHop radio can only have one designated parent radio. If a radio loses synchronization to the wireless network it may reconnect to the network through a different parent radio.

For the simple example network shown below, the following relationships exist:

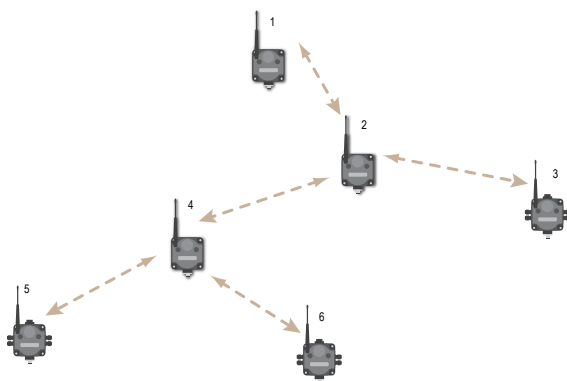

- Radio 1 is the master radio and is parent to radio 2 (repeater).
- Radio 2 (repeater) is child to radio 1 (master), but is parent to radios 3 (slave) and 4 (repeater).
- Radio 4 (repeater) is child to radio 2 (repeater), but is parent to radios 5 and 6 (both slaves).

On the LCD of each device, the parent device address (PADR) and local device address (DADR) are shown.

**MultiHop Master Radio.** Within a network of MultiHop data radios, there is only one master radio. The master radio controls the overall timing of the network and is always the parent device for other MultiHop radios. The host system connects to this master radio.

**MultiHop Repeater Radio.** When a MultiHop radio is set to repeater mode, it acts as both a parent and a child. The repeater receives data packets from its parent, then re-transmits the data packet to the children within the repeater's network. The incoming packet of information is re-transmitted on both the radio link and the local serial link.

**MultiHop Slave Radio.** The slave radio is the end device of the MultiHop radio network. A radio in slave mode does not re-transmit the data packet on the radio link, only on the local serial (wired) bus.

## 1.1 MultiHop Application Modes

The MultiHop radios operate in Modbus mode or transparent mode. Use the internal DIP switches to select the mode of operation. All MultiHop radios within a wireless network must be in the same mode.

### 1.1.1 Modbus Mode

Modbus application mode provides additional functionality to optimize RF packet routing performance and allows register-based access and configuration of various parameters on the MultiHop radio. Modbus application mode requires that the system host device be running a Modbus master program and that the master radio is connected directly to the host.

#### 1.1.1 Packet Routing

In Modbus application mode, the master radio first discovers all connected Modbus slaves in the network, then uses the Modbus slave ID contained in the incoming Modbus message to wirelessly route the packet only to the radio attached to the target Modbus slave. The packet is then passed via the radio's serial interface to the Modbus device where it is processed. This is entirely transparent to the user. Direct packet by packet routing offers an advantage over broadcast addressing with MultiHop paths because each hop in the path can be retried independently in the event of a packet error. This results in significantly more reliable packet delivery over MultiHop paths.

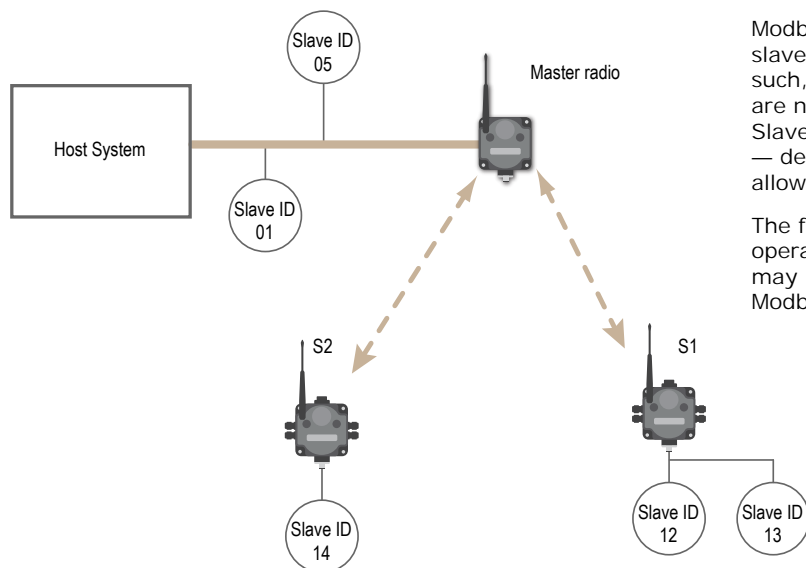

Modbus Slave IDs 01 through 10 are reserved for slaves directly connected to the host (local I/O). As such, polling messages addressed to these devices are not relayed over the wireless link. Use Modbus Slaves IDs 11 through 60 for remote Modbus slaves — devices serially connected to a data radio — allowing a maximum of 50 attached devices.

The figure illustrates a basic wireless network operating in Modbus application mode. Slave devices may be any Modbus slaves, including Banner's DX85 Modbus RTU Remote I/O devices or DX80 Gateways.

### 1.1.1 MultiHop Radio Registers and Radio IDs

The Modbus application mode also enables the host to access a radio's internal Modbus registers to access radio configuration and status information.

To enable access of a radio's internal Modbus registers, the radio itself must be assigned a Modbus Slave ID, or MultiHop Radio ID, using the rotary dials on the front of the device. The left rotary dial acts as the tens unit while the right rotary dial acts as the ones unit. To set the slave ID to 12, set the left dial to 1 and the right dial to 2.

#### SureCross Radio Rotary Dials

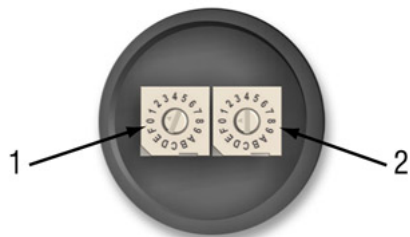

- 1 Left dial - Represents the tens unit of the slave or device ID.
- 2 Right dial - Represents the ones unit of the slave or device ID.

When a Modbus message is received by the radio, the packet's slave ID is compared to its own rotary dial address. If it matches, the radio accesses its internal Modbus registers. If it does not match, the radio delivers the packet to the serial interface thereby interrogating a connected Modbus slave. The range of acceptable Modbus Slave/MultiHop Radio IDs is from 11 to 60; a Slave ID setting of 0xFF disables access to the MultiHop radio's internal registers but still delivers addressed messages to Modbus slaves that are serially connected to the radio. Detailed information about the contents and functions of the radio's Modbus registers is provided in table 2.

All MultiHop Radio internal registers are defined as 16-bit holding registers (4xxxx). To access the internal registers, set the radio to operate in Modbus mode (using the DIP switches) and set a valid MultiHop Radio ID (11 through 60).

\*Note: The radio's rotary dial address must not be a duplicate of an attached Modbus slave ID.

- Rotary dial positions 11 through 60. Valid wireless Modbus Slave IDs or MultiHop Radio IDs
- Rotary dial position FF. Devices set to FF are not directly addressed by the Modbus host system but can deliver the message to the serially connected Modbus slaves

## MultiHop Radios

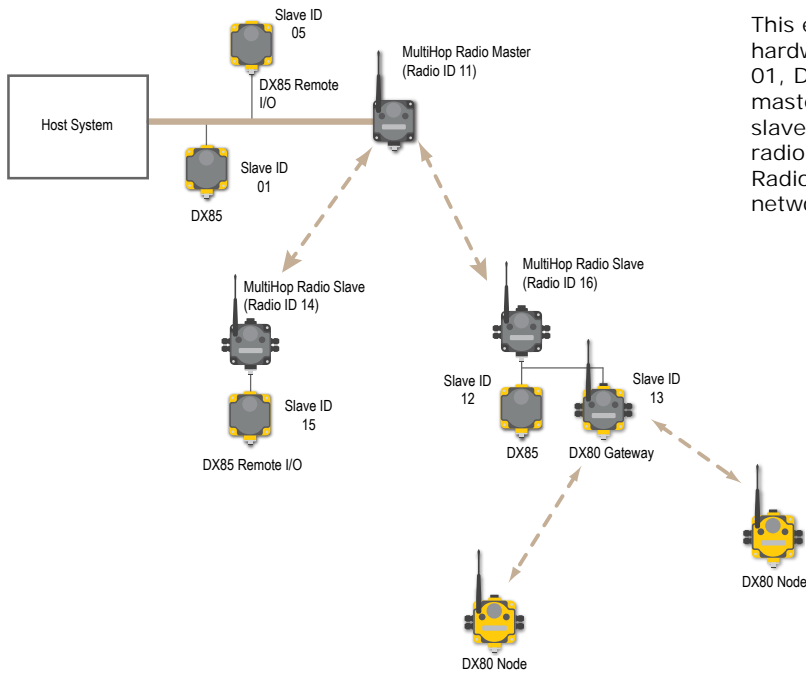

This example host system is connected to three hardwired devices: DX85 Remote I/O Modbus slave 01, DX85 Remote I/O Modbus slave 05, and the master MultiHop Radio. Host messages for Modbus slaves 01 through 10 are ignored by the master radio. Messages for Modbus Slaves or MultiHop Radios 11 through 60 are sent out the wireless network.

### 1.1.2 Transparent Mode

Use transparent mode for communication protocols other than Modbus.

In transparent mode, the MultiHop radio packetizes data received from the hardwired serial connection and transmits the packet to all radios within range. A wireless system by definition is a lossy link. It is up to the host system protocol to guarantee the data integrity. For reliable packet transmission, follow all rules for packet size and inter-character timing listed in the specifications and allow sufficient time between packets to avoid overloading the MultiHop radio network. The time between packets varies based on the size of the network.

## 2 Radio Features

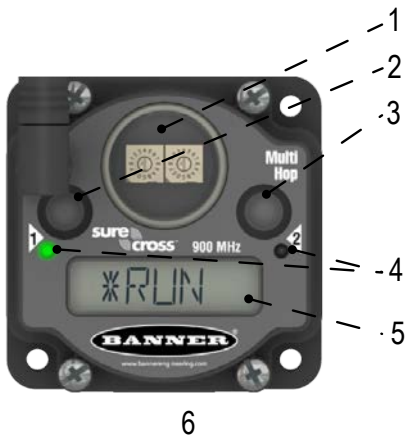

- 1 Rotary Dials. Set the Modbus Slave ID when operating in Modbus mode. (Not used on the Ethernet Data Radio.)
- 2 Push Button 1. Single-click to advance across all top-level data radio menus. Single-click to move down interactive menus, once a top-level menu is chosen. (See MultiHop Radio Menu System.)
- 3 Push Button 2. Double-click to select a menu and to enter manual scrolling mode. Double-click to move up one level at a time. Triple click to enter binding mode.
- 4 LED 1 and 2. Provide real-time feedback to the user regarding RF link status, serial communications activity, and the error state.
- 5 LCD Display. Six-character display provides run mode user information such as the number of packets sent and received. This display allows the user to conduct a site survey.
- 6 5-pin M12 Euro-style Quick-disconnect Port. The Euro-style power is used for serial connections and power. (Not available on the Ethernet Data Radio.)

## 3 Setting Up Your MultiHop Network

To set up and install your wireless MultiHop network, follow these steps:

1. If your radios have DIP switches, configure the DIP switches of all devices. For DIP switch configurations, refer to the product's datasheet.
2. Connect the sensors to the MultiHop radios if applicable. For available I/O, refer to the product's datasheet.
3. Apply power to all devices.
4. If your MultiHop radio has rotary dials, set the MultiHop Radio (Slave) ID. If your MultiHop radio has no rotary dials, continue to the next step.
5. Form the wireless network by binding the slave and repeater radios to the master radio.
6. Observe the LED behavior to verify the devices are communicating with each other.
7. Conduct a site survey between the MultiHop radios.
8. Install your wireless sensor network components.

### 3.1 Configure the MultiHop Radios

Before configuring the devices, disconnect the power to all MultiHop radios.

MultiHop Radios use the master device identification number to form groups of radios that communicate with each other. Follow the procedure outlined below for binding radios to a particular master radio.

1. Access the DIP switches by removing the four screws that mount the cover to the bottom housing.
2. Remove the cover from the housing without damaging the ribbon cable or the pins the cable plugs into.
3. Using the master/repeater/slave DIP switches, set one unit to be the master radio. By default, the MultiHop radios ship from the factory configured to be repeater radios.
4. Using the same DIP switches, set the other data radios to be repeaters or slaves.
5. Set any additional DIP switches now. (See the DIP Switches section in the data sheet for the positions and descriptions.) By default, the MultiHop radios ship from the factory in Modbus mode. If you need the radio to be in Transparent mode, configure that DIP switch now.
6. Apply power to the MultiHop radios to activate the DIP switch changes.

#### 3.1.1 Wiring for MultiHop Radios

Connecting dc power to the communication pins will cause permanent damage. For FlexPower devices, do not apply more than 5.5 V to the gray wire.

The FlexPower Multihop radios will operate equally well when powered from the brown or gray wire. It is not necessary to supply both. The power for the sensors can be supplied by the radio's SPx terminals or from the 10 to 30 V dc used to power the radio.

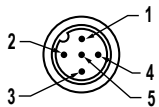
|   | Pin | Wire Color | Models powered by 10 to 30 V dc with RS-485 | FlexPower models with RS-485 | FlexPower models with RS-232 |
|---|-----|------------|---|------------------------------|------------------------------|
|  | 1   | brown      | 10 to 30 V dc                               | 10 to 30 V dc                | 10 to 30 V dc                |
|   | 2   | white      | RS-485 / D1 / B / +                         | RS-485 / D1 / B / +          | RS-232 Tx                    |
|   | 3   | blue       | dc common (GND)                             | dc common (GND)              | dc common (GND)              |
|   | 4   | black      | RS-485 / D0 / A / -                         | RS-485 / D0 / A / -          | RS-232 Rx                    |
|   | 5   | gray       | -   | 3.6 to 5.5 V dc              | 3.6 to 5.5 V dc              |

### 3.2 Set the MultiHop Radio (Slave) ID

On a MultiHop radio, use the rotary dials to set the device's MultiHop Radio ID.

Modbus Slave IDs 01 through 10 are reserved for slaves directly connected to the host (local I/O). Polling messages addressed to these devices are not relayed over the wireless link. Use Modbus Slave IDs 11 through 60 for MultiHop master, repeater, and slave radios. Up to 50 devices (local slaves and remote slaves) may be used in this system.



With the left dial acting as the left digit and the right dial acting as the right digit, the MultiHop Radio ID can be set from 01 through 60.



### 3.3 Bind the MultiHop Radios to Form Networks

To create your MultiHop network, bind the repeater and slave radios to the designated master radio.

1. Apply power to all MultiHop radios and place the MultiHop radios configured as slaves or repeaters at least two meters away from the master radio.
2. Put the MultiHop master radio into binding mode.
  - For two button master radios, triple-click button 2.
  - For one button master radios, triple-click the button.

For the two LED/button models, both LEDs flash red and the LCD shows \*BINDNG and \*MASTER. For single LED/button models, the LED flashes alternatively red and green.

3. Put the MultiHop repeater or slave radio into binding mode.
  - For two button radios, triple-click button 2.
  - For one button radios, triple-click the button.

The child radio enters binding mode and searches for any Master radio in binding mode. While searching for the Master radio, the two red LEDs flash alternately. When the child radio finds the Master radio and is bound, both red LEDs are solid for four seconds, then both red LEDs flash simultaneously four times. For M-GAGE Nodes, both colors of the single LED are solid (looks orange), then flash. After the slave/repeater receives the binding code transmitted by the master, the slave and repeater radios automatically exit binding mode.

4. Repeat step 3 for as many slave or repeater radios as are needed for your network.
5. When all MultiHop radios are bound, exit binding mode on the master.
  - For two button master radios, double-click button 2.
  - For one button master radios, double-click the button.

All radio devices begin to form the network after the master data radio exits binding mode.

#### Child Radios Synchronize to the Parent Radios

The synchronization process enables a SureCross radio to join a wireless network formed by a master radio. After power-up, synchronization may take a few minutes to complete. First, all radios within range of the master data radio wirelessly synchronize to the master radio. These radios may be slave radios or repeater radios.

After repeater radios are synchronized to the master radio, any radios that are not in sync with the master but can "hear" the repeater radio will synchronize to the repeater radios. Each repeater "family" that forms a wireless network path creates another layer of synchronization process. The table below details the process of synchronization with a parent. When testing the devices before installation, verify the radio devices are at least two meters apart or the communications may fail.

#### 3.3.1 Slave and Repeater LED Behavior

All bound radios set to slave or repeater modes follow this LED behavior after powering up.

| Process Steps | Response   | Two Button/LED Models           |                       | Single Button/LED Models        |
|---------------|--|---------------------------------|-----------------------|---------------------------------|
|               |  | LED 1                           | LED 2                 | LED                             |
| 1             | Apply power to the radio   | -                               | Solid amber (briefly) | Amber                           |
| 2             | The slave/repeater searches for a parent device.   | Flashes red                     | -                     | Flashes red (1 per 3 sec)       |
| 3             | A parent device is detected. The slave/repeater searches for other parent radios within range. | Solid red                       | -                     | Solid red                       |
| 4             | The slave/repeater selects a suitable parent.  | -                               | Solid amber           | Solid amber                     |
| 5             | The slave/repeater attempts to synchronize to the selected parent.                             | -                               | Solid red             | Solid red                       |
| 6             | The slave/repeater is synchronized to the parent.  | Flashes green                   | -                     | Flashes green                   |
| 7             | The slave/repeater enters RUN mode.  | Solid green, then flashes green |                       | Solid green, then flashes green |
|               | Serial data packets begin transmitting between the slave/repeater and its parent radio.        | -                               | Flashes amber         | Flashes amber                   |

### 3.3.2 Master LED Behavior

All bound radios set to operate as masters follow this LED behavior after powering up.

| Process Steps | Response   | Two Button/LED Models |               | Single Button/LED Models |
|---------------|--|-----------------------|---------------|--------------------------|
|               |  | LED 1                 | LED 2         | LED                      |
| 1             | Apply power to the master radio  | -                     | Solid amber   | Solid amber              |
| 2             | The master radio enters RUN mode.  | Flashes green         | -             | Flashes green            |
|               | Serial data packets begin transmitting between the master and its children radios. | -                     | Flashes amber | Flashes amber            |

## 3.4 Conduct a Site Survey

A site survey analyzes the radio signal between a MultiHop child radio and its parent and reports the number of data packets missed or received at relative signal strengths.

### 3.4.1 Conduct a MultiHop Site Survey (from the LCD Menu System)

Perform the site survey before permanently installing your network to pre-screen a site for its radio communication potential, compare link quality in different locations in a factory, or assist with final antenna placement and aiming.

Site surveys can be conducted from either the master, repeater, or slave radios. A master radio is always a parent and the slave radios are always children radios within the radio communication relationship. A repeater radio, however, may be both a child radio to the master or another repeater and a parent radio to other repeater or slave radios. For a more detailed description of the parent-child relationships, refer to the device data sheets.

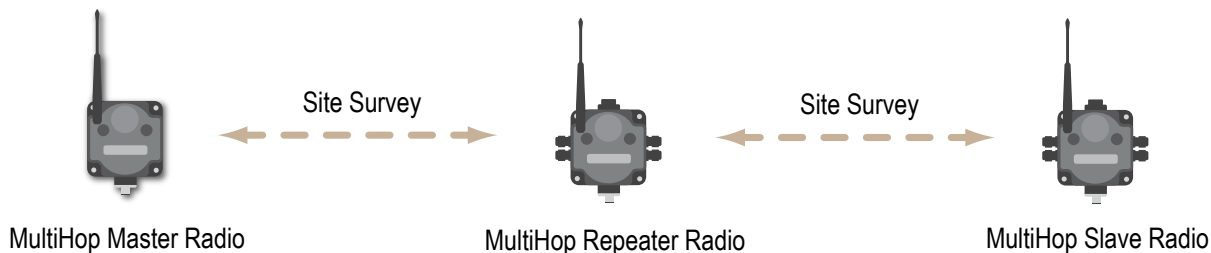

Other radios bound within the same network remain synchronized to the network, but are blocked from sending data while the site survey is running. The site survey analyzes the signal strength between the selected child and its parent radio only. Disable site survey on one radio before initiating it from another.

Radios in site survey mode have a solid green LED for the duration of the site survey and the LCD display scrolls the results. Because the statistics represent the lesser of the round-trip results, one person can ascertain the link quality from either device.

Single-click button 2 to pause or resume autoscrolling the site survey results. While paused, button 1 single-step advances through the four signal strength categories: green, yellow, red, and missed. Double-click button 2 to exit the results display. (Refer to the data sheet for the menu structure.)

1. On a MultiHop radio, press button 1 until the display reads \*SITE.  
When the site survey runs, serial and I/O data radio communication between that parent and its children stops.
2. Single-click button 2 to enter the Site Survey menu.  
Master radio: The display reads CHLDRN. Repeater radio: The display reads PARENT. Slave radio: The display reads PARENT.

## 3. Select the MultiHop radio to analyze.

|                         |   |
|-------------------------|---|
| MultiHop Model          | Select the radio to analyze:  |
| From the master radio   | Single-click button 2 to display the child radio's device address. (A radio's device address is displayed under its *RUN menu). Single click button 1 to scroll between all the master radio's children. When you reach the child radio you want to run the site survey with, single-click button 2.  |
| From the repeater radio | Single-click button 1 to cycle between PARENT and CHLDRN. Single-click button 2 to select PARENT or CHLDRN. If conducting the site survey with one of the repeater's children, single-click button 1 to scroll among a repeater's children radios. (Each data radio's device address is displayed under its *RUN menu.) Single-click button 2 at the device address screen to select the child or parent and begin the site survey. |
| From the slave radio    | Single-click button 2 to display PARENT. Single-click button 2 to begin the site survey.  |

The site survey begins. LED 2 on both the parent and child radios flash for every received RF packet. To indicate the parent is in site survey mode, LED 1 is a solid green. The data radio analyzes the quality of the signal between the parent and child by counting the number of data packets received and measuring the signal strength (green, yellow, and red).

- Examine reception readings (G, Y, R, M) of the devices at various locations. M displays the percent of missed packets while G, Y, and R display the percent of received packets at those signal strengths. These values are continuously updated as long as the site survey is running.  
GRN = GREEN excellent signal strength; YEL = YELLOW good signal strength; RED = RED marginal signal strength; MIS = Percentage of missed packets. When possible, install all devices to optimize the percentage of YELLOW and GREEN data packets received.
- While the site survey is in process, single-click button 2 to pause or resume autoscrolling the site survey results. While paused, button 1 single-step advances through the four signal strength categories: green, yellow, red, and missed. Double-click button 2 to exit the results display.
- Double-click button 2 on either the child or the parent device.  
Site survey ends and the devices automatically resume operation.

## Interpreting the MultiHop Site Survey Results

Site survey mode works by having two radios (one child and one parent) repeatedly exchange data packets. For every round-trip exchange of data, the child data radio keeps track of the weaker of the two paths. Both units report the statistics as a percentage on their LCD display.

The reports consists of sorting the data into one of four categories: Green, Yellow, Red, or Missed Packets.

- Green indicates strong signal,
- Yellow is less strong but still robust,
- Red means the packet was received but has a margin of less than 15 dB, and
- A missed packet means the data did not arrive or contained a checksum error. (During normal operation, missed packets are re-tried until they are received without errors. During a site survey, missed packets are not re-tried.)

For applications with only a few hops, the system can tolerate up to 40% missed packets without serious degradation, but situations with more missed packets should be reviewed for proper antenna selection and placement, cabling, and transmit power levels. If your application includes many hops, modify the installation and antenna placement to reduce the missed packet count.

Any radio can initiate a site survey. Other radios on the same network ID remain synchronized to the network, but are blocked from sending data while the site survey is running. In installations with multiple child radios, the site survey analyzes the signal strength between the selected child and its parent radio only. Disable site survey on one radio before initiating it from another.

Radios in site survey mode have a solid green LED for the duration of the site survey and the LCD display scrolls the results. Because the statistics represent the lesser of the round-trip results, one person can ascertain the link quality from either device.

## 3.5 Installing Your Sure Cross® Radios

Follow these recommendations to install your wireless network components.

### 3.5.1 Mounting SureCross Devices Outdoors

Use a Secondary Enclosure. For most outdoor applications, we recommend installing your SureCross devices inside a secondary enclosure. For a list of available enclosures, refer to the *Accessories* list.

**Point Away From Direct Sunlight.** When you are not using a secondary enclosure, minimize the damaging effects of ultra-violet radiation by mounting the devices to avoid facing intense direct sunlight.

- Mount under an overhang or other source of shade,
- Install indoors, or
- Face the devices north when installing outside.

For harsh outdoor applications, consider installing your radio inside a secondary enclosure. For a list of available enclosures, refer to the *Accessories* list.

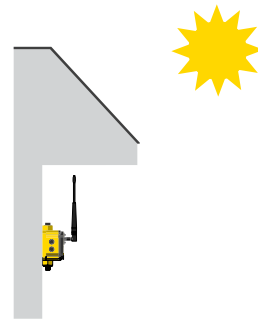

**Mount Vertically to Avoid Collecting Rain.** When possible, mount the devices where rain or snow will drain away from the device.

- Mount vertically so that precipitation, dust, and dirt do not accumulate on permeable surfaces.
- Avoid mounting the devices on flat or concave surfaces, especially if the display will be pointing up.

**Remove Moisture and Condensation.** If condensation is present in any device, add a small desiccant packet to the inside of the radio. To help vent the radios, Banner also sells a vented plug (model number BWA-HW-031) for the 1/2-inch NPT port of the SureCross radios.



## Watertight Glands and NPT Ports

To make glands and plugs watertight, use PTFE tape and follow these steps.

1. Wrap four to eight passes of polytetrafluoroethylene (PTFE) tape around the threads as close as possible to the hexagonal body of the gland.
2. Manually thread the gland into the housing hole. Never apply more than 5 in-lbf of torque to the gland or its cable clamp nut. <sup>¶</sup>



Seal any unused PG-7 access holes with one of the supplied black plastic plugs. To install a watertight PG-7 plug:

1. Wrap four to eight passes of PTFE tape around the plug's threads, as close as possible to the flanged surface.
2. Carefully thread the plastic plug into the vacant hole in the housing and tighten using a slotting screwdriver. Never apply more than 10 in-lbf torque to the plastic plug.

Seal the 1/2-inch or 3/4-inch NPT port(s) if it is not used. To install a watertight NPT plug:

1. Wrap 12 to 16 passes of PTFE tape evenly across the length of the threads.
2. Manually thread the plug into the housing port until reaching some resistance.
3. Using a crescent wrench, turn the plug until all the plug's threads are engaged by the housing port or until the resistance doubles. Do not over-tighten as this will damage the Sure Cross unit. These threads are tapered and will create a waterproof seal without over-tightening.

## 3.5.2 Other Installation Requirements

### 3.5.2 Reduce Chemical Exposure

Before installing any devices in a chemically harsh environment, contact the manufacturer for more information regarding the life-expectancy. Solvents, oxidizing agents, and other chemicals will damage the devices.

### 3.5.2 Minimize Mechanical Stress

Although these radio devices are very durable, they are sophisticated electronic devices that are sensitive to shock and excessive loading.

<sup>¶</sup> This is not a lot of torque and is equivalent to the torque generated without using tools. If a wrench is used, apply only very light pressure. Torquing these fittings excessively damages the device.

- Avoid mounting the devices to an object that may be shifting or vibrating excessively. High levels of static force or acceleration may damage the housing or electronic components.
- Do not subject the devices to external loads. Do not step on them or use them as handgrips.
- Do not allow long lengths of cable to hang from the glands on the Gateway or Node. Cabling heavier than 100 grams should be supported instead of allowed to hang from the housing.
- Do not crack the housing by over-tightening the top screws. Do not exceed the maximum torque of 4 in-lbf.

It is the user's responsibility to install these devices so they will not be subject to over-voltage transients. Always ground the devices in accordance with local, state, or national regulations.

### 3.5.2 When Installing Performance or MultiHop 1-Watt Radios

Notice: This equipment must be professionally installed. The output power must be limited, through the use of firmware or a hardware attenuator, when using high-gain antennas such that the +36 dBm EIRP limit is not exceeded.

### 3.5.3 Installation Quick Tips

The following are some quick tips for improving the installation of wireless network components.

#### Create a Clear Communication Path

Wireless communication is hindered by radio interference and obstructions in the path between the transmitter and receiver. To achieve the best radio performance, carefully consider the installation locations for the Gateways and Nodes and select locations without obstructions in the path.

For more information about antennas, please refer to the *Antenna Basics* reference guide, Banner document p/n 132113.

#### Increase the Height of the Antennas

Position the external antenna vertically for optimal RF communication. If necessary, consider changing the height of the SureCross radio, or its antenna, to improve reception. For outdoor applications, mounting the antenna on top of a building or pole may help achieve a line-of-sight radio link with the other radios in the network.

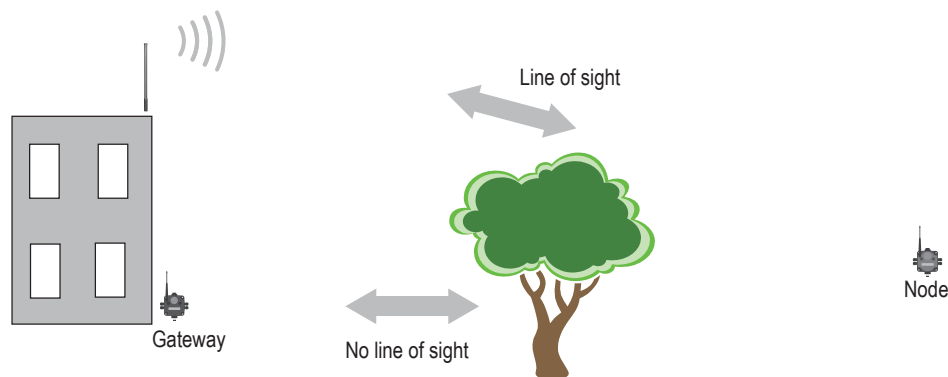

#### Collocated Radios

When the radio network's master device is located too close to another radio device, communications between all devices is interrupted. For this reason, always assign a unique Network ID to your wireless networks. The Network ID (NID) is a unique identifier you assign to each wireless network to minimize the chances of two collocated networks interfering with each other. Assigning different NIDs to different networks improves collocation performance in dense installations.

#### Be Aware of Seasonal Changes

When conducting the initial Site Survey, the fewest possible missed packets for a given link is better. However, seasonal changes may affect the signal strength and the total signal quality. Radios installed outside with 50% missed packets in the winter months may have 80% or more missed packets in the summer when leaves and trees interfere with radio reception.

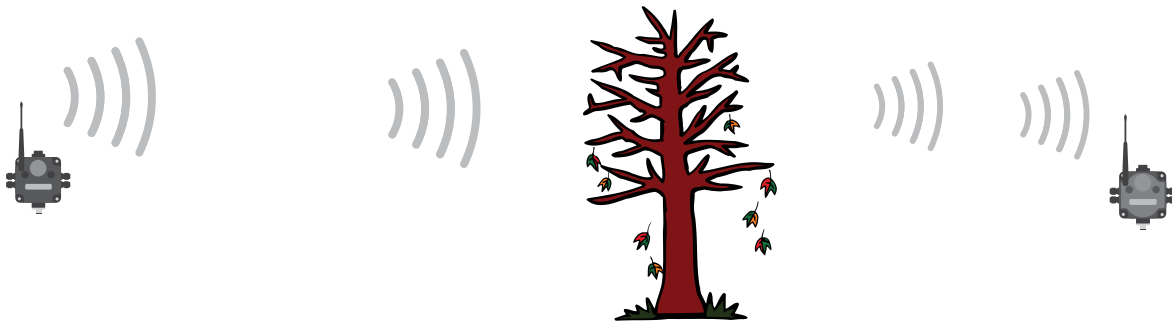

Figure 1. A good signal in winter doesn't always mean you will get the same signal strength the rest of the year.

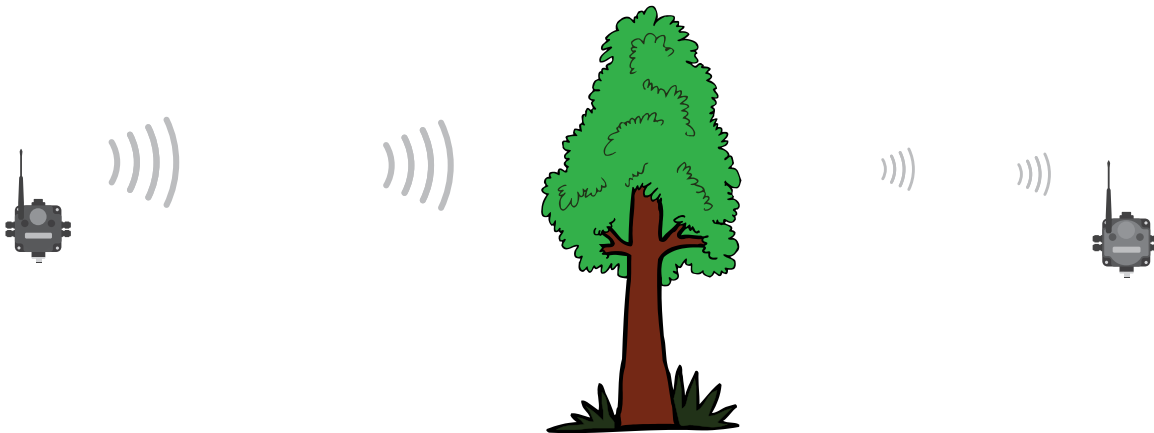

Figure 2. During spring and summer, leaves may block more of the radio signal.

### 3.5.4 Basic Remote Antenna Installation

A remote antenna system is any antenna system where the antenna is not connected directly to the radio; coaxial cable connects the antenna to the radio.

When installing a remote antenna system, always include a lightning arrester or coaxial surge suppressor in the system. Remote antenna systems installed without surge protection invalidate the warranty of the radio devices.

Surge suppressors should be properly grounded and mounted at ground level near where the cabling enters a building. Install the surge suppressor indoors or inside a weatherproof enclosure to minimize corrosion or component deterioration. For best results, mount the surge suppressor as close to the ground as possible to minimize the length of the ground connection and use a single-point ground system to avoid creating ground loops.

For more detailed information about how antennas work and how to install them, refer to [Antenna Basics](#) (p/n 132113) (also included as a chapter within the product manual).

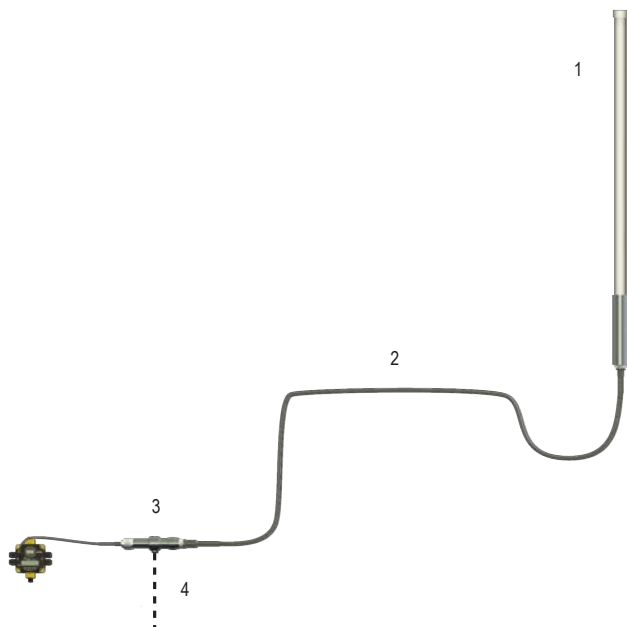

1. Antenna mounted remotely from the radio device.
2. Coaxial cable
3. Surge suppressor
4. Ground wire to a single-point ground system

I/O Isolation. When connecting analog and discrete I/O to external equipment such as VFDs (Variable Frequency Drives), it may be appropriate to install interposing relays and/or loop isolation devices to protect the DX80 unit from transients, noise, and ground plane interference originating from devices or the environment. Contact Banner Engineering Corp. for more information.

### Weatherproof Remote Antenna Installations

Seal the connections with rubber splicing tape and electrical tape to prevent water damage to the cable and connections.

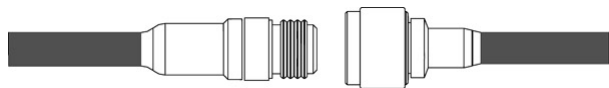

Step 1: Verify both connections are clean and dry before connecting the antenna cable to the antenna or other cable. Hand-tighten the cable connections.

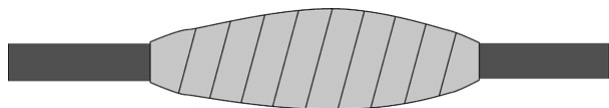

Step 2: Tightly wrap the entire connection with rubber splicing tape. Begin wrapping the rubber splicing tape one inch away from the connection and continue wrapping until you are one inch past the other end of the connection. Each new round of tape should overlap about half the previous round.



Step 3: Protect the rubber splicing tape from UV damage by tightly wrapping electrical tape on top of the rubber splicing tape. The electrical tape should completely cover the rubber splicing tape and overlap the rubber tape by one inch on each side of the connection.

### Installing Remote Antennas

Install and properly ground a qualified surge suppressor when installing a remote antenna system. Remote antenna configurations installed without surge suppressors invalidate the manufacturer's warranty. Keep the ground wire as short as possible and make all ground connections to a single-point ground system to ensure no ground loops are created. No surge suppressor can absorb all lightning strikes; do not touch the Sure Cross® device or any equipment connected to the Sure Cross device during a thunderstorm.

## Mount a Dome Antenna to the Enclosure

Use a -D dome antenna when mounting an antenna directly to the outside of the enclosure.



1. Dome antenna
2. DIN rail and DIN rail bracket
3. Enclosure

The -D dome antennas come with an 18-inch RP-SMA extension cable connected to the antenna. Use this extension cable to connect the antenna directly to the radio.

To mount, drill a hole in the enclosure and insert the antenna.

| Models    | Description   | List Price |
|-----------|---|------------|
| BWA-902-D | Antenna, Omni, 900 MHz, 2 dBd, Dome, RP-SMA MALE Box mount, 18-inch antenna cable | \$95       |
| BWA-202-D | Antenna, Omni, 2.4 GHz, 2 dBd, Dome, RP-SMA MALE Box mount, 18-inch antenna cable | \$95       |



### Use an N-Type, Pole-Mounted Antenna

This antenna mounts remotely from the box, with the SureCross device mounted inside the box.

Ground the surge suppressor and antenna. Keep the ground wire as short as possible and make all ground connections to a single-point ground system to ensure no ground loops are created.

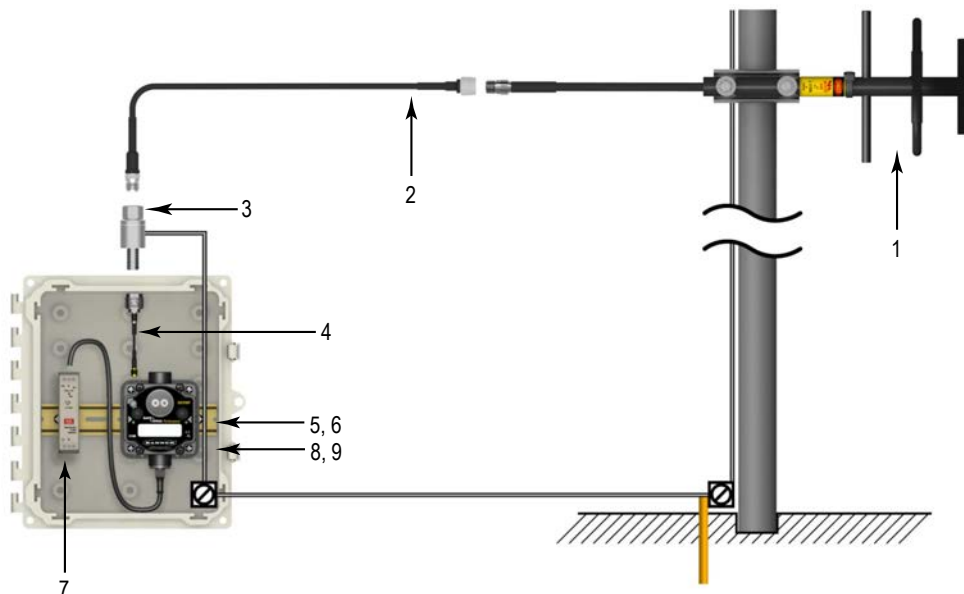

- 1. N-type Yagi antenna
- 2. N-Type to N-Type antenna cable
- 3. Surge suppressor
- 4. RP-SMA to N-Type male antenna cable
- 5 and 6. DIN rail and DIN rail bracket
- 7. Power supply
- 8 and 9. Enclosure and enclosure cover/plate, etc

| Models                     | Frequency | Description                      | List Price |
|----------------------------|-----------|----------------------------------|------------|
| <a href="#">BWA-9Y6-A</a>  | 900 MHz   | 6.5 dBd, 6.8 × 13 inches Outdoor | \$135      |
| <a href="#">BWA-9Y10-A</a> |           | 10 dBd, 6.8 × 24 inches Outdoor  | \$150      |



| Models                     | Frequency | Description  | List Price |
|----------------------------|-----------|--|------------|
| <a href="#">BWA-9O6-A</a>  | 900 MHz   | 6 dBd, Fiberglass, Full wave, 71.5 inches                | \$355      |
| <a href="#">BWA-2O8-A</a>  | 2.4 GHz   | 8.5 dBi, Fiberglass, 24 inches                           | \$200      |
| <a href="#">BWA-2O6-A</a>  |           | 6 dBi, Fiberglass, 16 inches (shown)                     | \$125      |
| <a href="#">BWA-9O6-AS</a> | 900 MHz   | 6 dBi, Fiberglass, 1/4 Wave, 23.6 inches (1.3 inch dia.) | \$120      |
| <a href="#">BWA-9O8-AS</a> |           | 8 dBi, Fiberglass, 3/4 Wave, 63 inches (1.5 inch dia.)   | \$215      |

Use the LMR400 cables to connect the surge suppressor to the antenna.

| Models      | Description                               | List Price |
|-------------|---|------------|
| BWC-4MNFN3  | LMR400 N-Type Male to N-Type Female, 3 m  | \$77       |
| BWC-4MNFN6  | LMR400 N-Type Male to N-Type Female, 6 m  | \$92       |
| BWC-4MNFN15 | LMR400 N-Type Male to N-Type Female, 15 m | \$156      |

MultiHop Radios

| Models      | Description                               | List Price |
|-------------|---|------------|
| BWC-4MNFN30 | LMR400 N-Type Male to N-Type Female, 30 m | \$296      |

| Model         | Description                                     | Connection                 | List Price |   |
|---------------|---|----------------------------|------------|---|
| BWC-LMRSFRPB  | Surge Suppressor, Bulkhead, RP-SMA Type         | RP-SMA to RP-SMA           | \$111      |  |
| BWC-LFNBMN-DC | Surge Suppressor, bulkhead, N-Type, dc Blocking | N-Type Female, N-Type Male | \$120      |  |

Use the RP-SMA to N-Type male cables to connect the radio to the surge suppressor.

| Model        | Description                         | List Price |
|--------------|-------------------------------------|------------|
| BWC-1MRSMN05 | LMR100 RP-SMA to N-Type Male, 0.5 m | \$40       |
| BWC-1MRSMN2  | LMR100 RP-SMA to N-Type Male, 2 m   | \$50       |

## 4 Modbus Register Configuration

Change the factory default settings for the inputs, outputs, and device operations using the device Modbus registers. To change parameters, set the data radio network to Modbus mode and assign the data radio a valid Modbus slave ID.

Generic input or output parameters are grouped together based on the device input or output number: input 1, input 2, output 1 etc. Operation type specific parameters (discrete, counter, analog 4 to 20 mA) are grouped together based on the I/O type number: analog 1, analog 2, counter 1, etc. Not all inputs or outputs may be available for all models. To determine which specific I/O is available on your model, refer to the Modbus Input/Output Register Maps listed in the device's datasheet. For more information about registers, refer to the [MultiHop Product Manual](#) (p/n 151317).

### 4.1 00000s Standard Physical Inputs

Registers 1 through 16 are the results registers for inputs 1 through 16.

For a list of the active results registers for your MultiHop radio, refer to your product's datasheet.

#### 4.1.1 00400s Extra Inputs

Registers 401 through 500 are the results registers for extra inputs 1 through 100.

For a list of the active results registers for your MultiHop radio, refer to your product's datasheet.

### 4.2 00500s Standard Physical Outputs

Registers 501 through 516 are the results registers for outputs 1 through 16.

For a list of the active results registers for your MultiHop radio, refer to your product's datasheet.

#### 4.2.1 00900s Extra Outputs

Registers 901 through 1000 are the results registers for extra outputs 1 through 100.

For a list of the active results registers for your MultiHop radio, refer to your product's datasheet.

### 4.3 01000s Input Parameters

Data radio inputs have the following generic parameters. These are not global parameters but are associated only with a particular input.

There are currently 16 separate inputs possible; the factory default settings are defined in the I/O specifications. Parameters for Input 1 are at 1001 through 1008. Parameters for input 2 are at 1051 through 1058. Each following input is offset from the previous one by 50 registers.

| Parameter Registers for Inputs (4xxxx) |      |      |      |      |      |      |      |      |                             |
|--|------|------|------|------|------|------|------|------|-----------------------------|
| 1                                      | 2    | 3    | 4    | 5    | 6    | 7    | 8    | 9    | Parameters                  |
| 1001                                   | 1051 | 1101 | 1151 | 1201 | 1251 | 1301 | 1351 | 1401 | Enable                      |
| 1002                                   | 1052 | 1102 | 1152 | 1202 | 1252 | 1302 | 1352 | 1402 | Sample Interval (high word) |
| 1003                                   | 1053 | 1103 | 1153 | 1203 | 1253 | 1303 | 1353 | 1403 | Sample Interval (low word)  |
| 1008                                   | 1058 | 1108 | 1158 | 1208 | 1258 | 1308 | 1358 | 1408 | Out-of-Sync Enable          |

#### Enable

A 1 enables the input and a 0 to disable the particular input.

#### Out-of-Sync Enable

Set to one (1) to enable the input to continue operating when the device is out of sync with the master radio. Set to zero (0) to disable the input when the device is not synchronized to the master radio. The default value is one (1).

#### Sample Interval (High Word)

The sample interval (rate) is a 32-bit value (requires two Modbus registers) that represents how often the data radio samples the input. The register value is the number of time units. For example, a Modbus register value of 125 (for a 900 MHz device) represents a sample interval of 5 seconds (125 x .040 seconds = 5 seconds). A unit of time for a 900 MHz data radio is 40 milliseconds. A unit of time for a 2.4 GHz data radio is 20 milliseconds.

#### Sample Interval (Low Word)

See Sample Interval (High Word).

1xx4 through 1xx7

See *Switch Power Input Parameters*.

### 4.3.1 Switch Power Input Parameters

The switch power input parameters are not global parameters but are associated only with a particular input.

There are currently 16 separate inputs possible; the factory default settings are defined in the I/O specifications. Switch power parameters for Input 1 are at 1004 through 1007. Switch power parameters for input 2 are at 1054 through 1057. Each following input is offset from the previous one by 50 registers.

| Parameter Registers for I Inputs (4xxxx) |      |      |      |      |      |      |      |      |                      |
|--|------|------|------|------|------|------|------|------|----------------------|
| 1  | 2    | 3    | 4    | 5    | 6    | 7    | 8    | 9    | Parameters           |
| 1004                                     | 1054 | 1104 | 1154 | 1204 | 1254 | 1304 | 1354 | 1404 | Switch Power Enable  |
| 1005                                     | 1055 | 1105 | 1155 | 1205 | 1255 | 1305 | 1355 | 1405 | Switch Power Warm-up |
| 1006                                     | 1056 | 1106 | 1156 | 1206 | 1256 | 1306 | 1356 | 1406 | Switch Power Voltage |
| 1007                                     | 1057 | 1107 | 1157 | 1207 | 1257 | 1307 | 1357 | 1407 | Extended Input Read  |

#### Extended Input Read

The Extended Input Read is a bit field parameter that allows multiple inputs to be sampled with the same switch power parameters. If the bit field is set to 0x000F, the first four inputs are sampled after the switch power parameters are satisfied. If this parameter is set in the input 1 configuration registers, set inputs 2 through 4 to zero.

#### Switch Power Enable

The bit mask can select any number of switch power outputs 1 through 4. Switch power enable works with the warm-up and voltage parameters to define the switch power output. Some devices have only two switch power outputs. Refer to your model's datasheet to confirm which switch power outputs are active for your MultiHop radio.

- 0x0 - No switch power enabled
- 0x1 - Enable SP1
- 0x2 - Enable SP2
- 0x3 - Enable SP1 and SP2
- 0x4 - Enable SP3
- 0x8 - Enable SP4
- 0xC - Enable SP3 and SP4

#### Switch Power Voltage

The Switch Power Voltage parameter defines the output voltage of the switch power output. This parameter applies only to inputs using switched power. If switch power is not used with an input, use the Continuous Voltage parameter to control the voltage.

| Output Voltage | Parameter Value | Output Voltage | Parameter Value |
|----------------|-----------------|----------------|-----------------|
| 0 V            | 255             | 15 V           | 32              |
| 5 V            | 204             | 20 V           | 12              |
| 7 V            | 125             | 24 V           | 03              |
| 10 V           | 69              |                |                 |

#### Switch Power Warm-up

When the data radio supplies power to external sensors, the Switch Power Warm-up parameter defines how long power is applied to the external sensor before the input point is examined for changes. The register value is the number of time units.

A unit of time for a 900 MHz data radio is 40 milliseconds. A unit of time for a 2.4 GHz data radio is 20 milliseconds.

## 4.4 02000s Output Parameters

The following characteristics are configurable for each output.

Parameters for Output 1 start at 2001 through 2004. Parameters for output 2 start at 2051 through 2054. Each following output is offset from the previous one by 50 registers.

| Parameter Registers for Outputs (4xxxx) |      |      |      |      |      |      |      |      |                     |
|---|------|------|------|------|------|------|------|------|---------------------|
| 1                                       | 2    | 3    | 4    | 5    | 6    | 7    | 8    | 9    | Parameters          |
| 2001                                    | 2051 | 2101 | 2151 | 2201 | 2251 | 2301 | 2351 | 2401 | Enable              |
| 2002                                    | 2052 | 2102 | 2152 | 2202 | 2252 | 2302 | 2352 | 2402 | Flash Output Enable |
| 2003                                    | 2053 | 2103 | 2153 | 2203 | 2253 | 2303 | 2353 | 2403 | Flash Index         |
| 2004                                    | 2054 | 2104 | 2154 | 2204 | 2254 | 2304 | 2354 | 2404 | Out of Sync Enable  |

#### Enable

Set to 1 to enable the output; set to 0 to disable the output.

#### Flash Index

The Flash Index can have values 1, 2, 3, or 4. For a particular output, the Flash Index 1 through 4 select a certain output pattern as defined in registers 4401, 4411, 4421, or 4431.

#### Flash Output Enable

The Flash Output Enable, Flash Index, and Output Flash Pattern registers are all used to set up flashing patterns for indicator lights connected to the data radio. Set the Flash Output Enable register to 1 to enable the ability to select an output flash pattern; set to 0 to disable this feature. Select the output pattern using the Flash Index and Output Flash Pattern registers.

#### Out of Sync Enable

Set to one (1) to enable the output to continue operating when the device is out of sync with the master radio. Set to zero (0) to disable the output when the device is not synchronized to the master radio. The default value is one (1).

## 4.5 02950s Default Output Parameters

Several device conditions may be used to send outputs to their default state. Use these properties to define the device's default output conditions.

#### 2951 Enable Default Out Of Sync

When a radio is "out of sync," it is not communicating with its parent radio.

Set this value to 1 to enable the default condition when the device is not communicating with its parent radio. Set to 0 to disable.

#### 2952 Enable Default Communication Timeout

A "communication timeout" refers to the communication between the host system and this radio. Set this register to 1 to enable the default condition when the host has not communicated with this radio for the period of time defined by the Communication Default IO Timeout.

#### 2953 Communication Default I/O Timeout (100 ms/Count)

This parameter defines the host timeout period in 100 millisecond increments. If a host does not communicate within this timeout period, the device outputs are set to the default values.

#### 2954 Enable Default on Power Up

Setting this parameter to 1 sends the device outputs to their default condition when the radio is powered up. Set to 0 to disable this feature.

## 4.6 03000s Discrete Input Parameters

The Discrete Input Configuration parameters configure certain aspects of the data radio's discrete inputs.

Parameters for Discrete Input 1 start at 3001 through 3004. Parameters for Discrete Input 2 start at 3021 through 3024. Each following input is offset from the previous one by 20 registers.

| Parameter Registers for Discrete Inputs (4xxxx) |      |      |      |   |
|---|------|------|------|---|
| IN 1  | IN 2 | IN 3 | IN 4 | Parameters                                |
| 3001  | 3021 | 3041 | 3061 | PNP/NPN                                   |
| 3002  | 3022 | 3042 | 3062 | Sample High                               |
| 3003  | 3023 | 3043 | 3063 | Sample Low                                |
| 3004  | 3024 | 3044 | 3064 | Enable Latch on Change of State           |
| 3007  | 3027 | 3047 | 3067 | Enable Discrete Input Time Active Counter |
| 3008  | 3028 | 3048 | 3068 | Discrete Input Time Active Count          |
| 3009  | 3029 | 3049 | 3069 | Discrete Input Time Active Count          |

| Parameter Registers for Discrete Inputs (4xxxx) |           |           |           |                       |
|---|-----------|-----------|-----------|-----------------------|
| IN 1  | IN 2      | IN 3      | IN 4      | Parameters            |
| 3013  | 3033      | 3053      | 3073      | Enable Rising Edge    |
| 3014  | 3034      | 3054      | 3074      | Enable Falling Edge   |
| 3015-3016                                       | 3035-3036 | 3055-3056 | 3075-3076 | Digital Counter Value |

#### Digital Counter Value

The 32-bit counter results are placed in registers 3015 and 3016 for input #1. To clear or preset the counter value, write a zero value or the preset value into registers 4015 and 4016.

Cycling the power sets the counter values back to zero. The host system is responsible for saving the counter values in case of a power failure or power reset condition.

A discrete input will not count when the device is not in sync with a parent MultiHop device. To allow for counting when out of sync, set configuration register 1008 to 1 for input #1.

| Out of Sync Actions |      |      |      |   |
|---------------------|------|------|------|---|
| IN 1                | IN 2 | IN 3 | IN 4 | Description   |
| 1008                | 1058 | 1108 | 1158 | Enable out-of-sync action. Set to 1 to enable, set to 0 to disable. |

#### Discrete Input Time Active Count

These two registers contain the counter value. Register 3xx8 contains the high portion of the active counter and 3xx9 contains the low portion of the active counter. The counter stores a time value in 100 ms increments. This value is reset to zero when the power cycles off.

#### Enable Discrete Input Time Active Counter

The time active counter counts the time a discrete input is in the active state. Set to one (1) to enable the time counter; set to zero (0) to disable the counter. By default, this counter is enabled.

#### Enable Latch on Change of State

Writing a 1 to this register causes a data "push" (data transmitted to the master radio) on Change of State.

#### Enable Falling Edge

Enables the sync counter falling edge. Set to 1 to enable, set to 0 to disable.

#### Enable Rising Edge

Enables the sync counter rising edge. Set to 1 to enable, set to 0 to disable. To count on both rising and falling edges, set both the configuration registers to 1 to enable.

#### PNP or NPN

Set to 1 to define the input as a PNP (sourcing) input. Set to 0 to define the input as an NPN (sinking) input.

#### Sample High

The default value is 0, which disables this feature. The value range is 1 through 255. The Sample High parameter refers to the number of samples (1 through 255) a discrete input must be detected high (1) before it is considered to be a change of state.

#### Sample Low

The default value of 0 disables this feature. The value range is 1 through 255. The Sample Low parameter refers to the number of samples (1 through 255) a discrete input must be detected low (0) before it is considered to be a change of state.

## 4.7 03300s Analog Input Parameters

The following characteristics are configurable for each of the analog inputs.

Analog input parameters for input 1 start at 3301. Analog input parameters for input 2 start at 3321. Each following input is offset from the previous one by 20 registers.

| Registers for Analog Parameters (4xxxx) |                  |                     |                     | Parameters                 |
|---|------------------|---------------------|---------------------|----------------------------|
| IN 1<br>(3301-3320)                     | IN 2 (3321-3340) | IN 3<br>(3341-3360) | IN 4<br>(3361-3380) |                            |
| 3301                                    | 3321             | 3341                | 3361                | Maximum Analog Value       |
| 3302                                    | 3322             | 3342                | 3362                | Minimum Analog Value       |
| 3303                                    | 3323             | 3343                | 3363                | Enable Register Full Scale |
| 3304                                    | 3324             | 3344                | 3364                | Temperature Degrees C/F    |

| Registers for Analog Parameters (4xxxx) |                  |                     |                     | Parameters                  |
|---|------------------|---------------------|---------------------|-----------------------------|
| IN 1<br>(3301-3320)                     | IN 2 (3321-3340) | IN 3<br>(3341-3360) | IN 4<br>(3361-3380) |                             |
| 3305                                    | 3325             | 3345                | 3365                | Temperature Scaling         |
| 3306                                    | 3326             | 3346                | 3366                | Thermocouple Type           |
| 3307                                    | 3327             | 3347                | 3367                | Temperature Resolution      |
| 3308                                    | 3328             | 3348                | 3368                | Threshold                   |
| 3309                                    | 3329             | 3349                | 3369                | Hysteresis                  |
| 3310                                    | 3330             | 3350                | 3370                | Delta                       |
| 3311                                    | 3331             | 3351                | 3371                |                             |
| 3312                                    | 3332             | 3352                | 3372                |                             |
| 3313                                    | 3333             | 3353                | 3373                |                             |
| 3314                                    | 3334             | 3354                | 3374                |                             |
| 3315                                    | 3335             | 3355                | 3375                |                             |
| 3316                                    | 3336             | 3356                | 3376                | Sample High                 |
| 3317                                    | 3337             | 3357                | 3377                | Sample Low                  |
| 3318                                    | 3338             | 3358                | 3379                | Change of State Push Enable |
| 3319                                    | 3339             | 3359                | 3379                | Median Filter Enable        |
| 3320                                    | 3340             | 3360                | 3380                | Tau Filter                  |

#### Change of State Push Enable

Set to one (1) to enable push registers for this input. When the analog input changes state, the register value will be pushed to the master radio if this register is configured to be a push register.

#### Delta

The delta parameter defines the change required between sample points of an analog input before the analog input reports a new value. To turn off this option, set the Delta value to 0.

#### Enable Register Full Scale

Set to 1 to enable a linear range from 0 to 65535 for specified input range. For a 4 to 20 mA input, a value of 0 represents 4 mA and 65535 represents 20 mA. Set this parameter to 0 to store input readings in unit-specific data. For example, the register data representing a 15.53 mA reading is 15530. For units of current (0 to 20 mA inputs), values are stored as  $\mu\text{A}$  (micro Amps) and voltage values are stored as mV (millivolts).

#### Hysteresis and Threshold

Threshold and hysteresis work together to establish the ON and OFF points of an analog input. The threshold defines a trigger point or reporting threshold (ON point) for a sensor input. Setting a threshold establishes an ON point. Hysteresis defines how far below the threshold the analog input is required to be before the input is considered OFF. A typical hysteresis value is 10% to 20% of the unit's range.

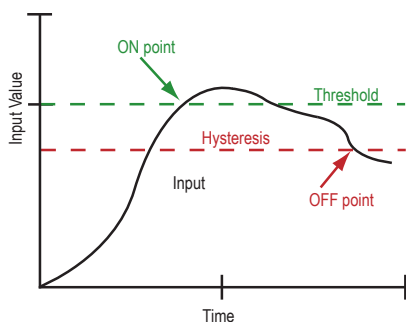

In the example shown graphically, the input is considered on at 15 mA. To consider the input off at 13 mA, set the hysteresis to 2 mA. The input will be considered off when the value is 2 mA less than the threshold.

#### Maximum Analog Value

The Maximum Value register stores the maximum allowed analog value. The specific units of measure apply to the register value. For example, the register may contain 20000, for 20 mA, or for a voltage input the register may contain 8000, for 8 volts.

#### Median Filter Enable

Set to zero (0) to turn off the median filter. Set to one (1) to turn on the median filter.

#### Minimum Analog Value

The Minimum Value register stores the minimum allowed analog value. The specific units of measure apply to the register value. For example, the register may contain 4000, for 4 mA, or for a voltage input the register may contain 2000, for 2 volts.

#### Sample High and Sample Low

For analog inputs, the sample high parameter defines the number of consecutive samples the input signal must be above the threshold before a signal is considered active. Sample low defines the number of consecutive samples the input signal must be below the threshold minus hysteresis before a signal is considered deactivated. The sample high and sample low parameters are used to avoid unwanted input transitions.

#### Tau Filter

Set to zero (0) to turn off the tau filter. Set to 1 (weakest filter) through 6 (strongest filter) to turn on the tau filter. (In the DX80 products, the Low Pass Filter is a combination of the median filter and the tau filter.)

## 4.7 Temperature Parameters

The following parameters are used to configure analog inputs involving temperature and are typically used to configure thermocouple or RTD inputs.

| Registers for Analog Parameters (4xxxx) |                  |                     |                     | Parameters              |
|---|------------------|---------------------|---------------------|-------------------------|
| IN 1<br>(3301-3320)                     | IN 2 (3321-3340) | IN 3<br>(3341-3360) | IN 4<br>(3361-3380) |                         |
| 3304                                    | 3324             | 3344                | 3364                | Temperature Degrees C/F |
| 3305                                    | 3325             | 3345                | 3365                | Temperature Scaling     |
| 3306                                    | 3326             | 3346                | 3366                | Thermocouple Type       |
| 3307                                    | 3327             | 3347                | 3367                | Temperature Resolution  |

#### Temperature Degrees C/F

Set to 1 to represent temperature units in degrees Fahrenheit, and set to 0 (default) to represent temperature units in degrees Celsius.

#### Temperature Resolution

Thermocouples and RTDs may record temperatures in either high resolution (tenths of a degree) or low resolution (whole degree).

Write a 0 to select high resolution (default) or a 1 to select low resolution. Choosing high or low resolution changes the range of temperatures that can be written to the register.

#### Temperature Scaling

Set to 1 to store temperatures the same way as the DX80 devices (measured temp × 20) represent temperature.

Set to 0 (default) to store temperature values in tenths of a degree (measured temp × 10).

For example, if the measured temperature is 20.5 degrees, using temperature scaling set to 1 would store the temperature value as 410; using temperature scaling set to 0 would store the temperature as 205.

#### Thermocouple Type

Write the listed value to this register to select a thermocouple type. The default configuration is set to a Type B thermocouple (0).

| Value | Thermocouple Type | Value | Thermocouple Type | Value | Thermocouple Type |
|-------|-------------------|-------|-------------------|-------|-------------------|
| 0     | B                 | 5     | J                 | 10    | P                 |
| 1     | C                 | 6     | K                 | 11    | R                 |
| 2     | D                 | 7     | L                 | 12    | S                 |
| 3     | E                 | 8     | M                 | 13    | T                 |
| 4     | G                 | 9     | N                 | 14    | U                 |

## 4.8 03500s Counter Input Parameters

The following parameters are configurable for the counter input.

Counter Input parameters for Counter Input 1 start at 3501 through 3505. Counter Input parameters for Counter Input 2 start at 3521 through 3525. Each following counter input is offset from the previous one by 20 registers.



| Parameter Registers for Counter Inputs (4xxxx) |                                |
|--|--------------------------------|
| IN 1   | Parameters                     |
| 3501   | Enable Frequency/Event Counter |
| 3502   | Enable Read Counter State      |
| 3503   | Set Preset Value               |
| 3504   | Counter Preset Value           |
| 3505   | Counter Preset Value           |

#### Counter Preset Value

Registers 3504 (high word) and 3505 (low word) contain the 32-bit value for presetting the counter. Write the 'Counter Preset Value' registers first, then use the 'Set Preset Value' register to execute the counter preset.

#### Enable Frequency/Event Counter

A counter input can be defined to calculate the frequency of the input in hertz or as a counter that increments with every input change (event counter) from 0 to 1 (for PNP inputs).

Set this parameter to 1 to configure the input to calculate frequency. Set to 0 to configure the counter to count input changes, for example, an event counter or totalizer. Because the counter is reset to zero when power is cycled to the device, it is up to the host system to save count data.

#### Enable Read Counter State

Manufacturing/test register only

#### Set Preset Value

Writing this value to 1 signals the data radio to preset the counter with the value stored in Modbus registers 3504 and 3505. When the task is complete, the value is written to 0.

## 4.9 03600s H-Bridge Output Parameters

The following parameters are configurable for the H-bridge outputs.

Parameters for H-bridge 1 start at 3604 through 3609. Parameters for H-bridge 2 start at 3624 through 3629. Each following H-bridge parameter set is offset from the previous one by 20 registers.

| Parameter Registers for H-Bridge Outputs (4xxxx) |                                      |
|--|--------------------------------------|
| H-Bridge 1                                       | Parameters                           |
| 3604   | Enable H-Bridge                      |
| 3605   | H-Bridge Warmup Cap Time             |
| 3606   | H-Bridge Active Current Time         |
| 3607   | H-Bridge Switches                    |
| 3608   | H-Bridge Switches                    |
| 3609   | H-Bridge Booster Enabled When Active |

#### Enable H-Bridge

Enable (1) or disable (0) the h-bridge inputs as needed. Disable the h-bridge inputs when using SDI-12 devices.

#### H-Bridge Active Current Time

Set how long, in 40 millisecond increments, the capacitor is switched into and supplying power to the solenoid circuit.

#### H-Bridge Switches

Use these two parameters as a bit mask to set the ON and OFF conditions of the h-bridge switch.

|                           | DO4 | DO3 | DO2 | DO1 | SP4 | SP3 | SP2 | SP1 |
|---------------------------|-----|-----|-----|-----|-----|-----|-----|-----|
| 3607 Rising Switch (ON)   | 0   | 0   | 1   | 0   | 0   | 0   | 0   | 1   |
| 3608 Falling Switch (OFF) | 0   | 0   | 0   | 1   | 0   | 0   | 1   | 0   |

#### H-Bridge Warm Up Cap Time

Similar to the switch power warm up time, the h-bridge capacitor warm up time is the time allotted, in 40 millisecond increments, to charge the capacitor used to activate the h-bridge and latching solenoid.

#### H-Bridge Booster Enabled When Active

To use this parameter, contact the applications engineers at Banner Engineering Corp. This parameter leaves the boost voltage on while the capacitor discharges into the solenoid. While this can supply more power to the solenoid circuit, it may also brown-out the radio device.

### 4.9.1 03600s Switch Power Output Parameters

The Power Output Configuration parameters provide the basic operation for each power output. These parameters are not associated to specific inputs.

Efficient power management technology enables some FlexPower devices to include an internal power supply, called switch power (SP), that briefly steps up to power sensors requiring 5, 10, or 15 V power (ideally, 4 to 20 mA loop-powered sensors). When the switch power output cycles on, the voltage is boosted to the voltage needed to power the sensor for a specific warmup time. This warmup time denotes how long the sensor must be powered before a reliable reading can be taken. After the warmup time has passed, the input reads the sensor, then the switch power shuts off to prolong battery life. The switch power voltage, warm-up time, and sample interval are configurable parameters.

Parameters for SP 1 start at 3601 through 3603. Parameters for SP 2 start at 3621 through 3623. Each following switch power is offset from the previous one by 20 registers.

| Parameter Registers for Switch Power Outputs (4xxxx) |      |      |      |                            |
|--|------|------|------|----------------------------|
| SP1  | SP2  | SP3  | SP4  | Parameters                 |
| 3601   | 3621 | 3641 | 3661 | Continuous Voltage Setting |
| 3602   | 3622 | 3642 | 3662 | Default Output State       |
| 3603   | 3623 | 3643 | 3663 | Hold Last State Enable     |

#### Continuous Voltage Setting

Use this voltage parameter to set the output voltage when supplying continuous power through the SP# terminals (not associated with inputs). The Continuous Voltage parameter cannot be used if any input uses switch power. To set a continuous voltage on the SP output, also turn on the default output condition "default on power up." This will turn on this continuous voltage output when the radio powers up.

| Output Voltage | Parameter Value | Output Voltage | Parameter Value |
|----------------|-----------------|----------------|-----------------|
| 0 V            | 255             | 15 V           | 32              |
| 5 V            | 204             | 20 V           | 12              |
| 7 V            | 125             | 24 V           | 03              |
| 10 V           | 69              |                |                 |

#### Default Output State

The Default Output State parameter represents the default condition of the switch power output. When communication is lost to the host or the wireless link is lost for the I/O data radio, the data radio can set the outputs and switch power outputs in this default state.

When set to 0, the switch power is turned off. When set to 1, the switch power is set to the voltage established by the Continuous Voltage Setting.

#### Hold Last State Enable

Set Hold Last State Enable to 1 to set the switch power output to its last known value when communications are lost.

Set this parameter to 0 to disable the Host Last State Enable and use the Default Output State settings.

### 4.10 03700s Discrete Output Parameters

The following characteristics are configurable for each of the discrete outputs.

Parameters for Output 1 start at 3701 through 3703. Parameters for Output 2 start at 3721 through 3723. Each following input is offset from the previous one by 20 registers.

| Parameter Registers for Discrete Outputs (4xxxx) |       |       |       |                           |
|--|-------|-------|-------|---------------------------|
| OUT 1  | OUT 2 | OUT 3 | OUT 4 | Parameters                |
| 3701   | 3721  | 3741  | 3761  | Default Output State      |
| 3702   | 3722  | 3742  | 3762  | Hold Last State Enable    |
| 3703   | 3723  | 3743  | 3763  | Enable Switch Power Logic |

#### Default Output State

The Default Output State parameter represents the default condition of the discrete output. When an error condition exists, the outputs are set to this user-defined output state, either a 0 or a 1.

#### Enable Switch Power Logic

#### Hold Last State Enable

Set the Hold Last State to 1 to set the output to its last known value before the error occurred. Set this parameter to 0 to disable the Hold Last State and use the Default Output State setting during an error condition.

## 4.11 04000s Analog Output Parameters

---

The following characteristics are configurable for each of the analog outputs.

Parameters for Analog Output 1 start at 4001 through 4005. Parameters for Analog Output 2 start at 4021 through 4025. Each following input is offset from the previous one by 20 registers.

| Parameter Registers for Analog Outputs (4xxxx) |       |       |       |                            |
|--|-------|-------|-------|----------------------------|
| OUT 1  | OUT 2 | OUT 3 | OUT 4 | Parameters                 |
| 4001   | 4021  | 4041  | 4061  | Maximum Analog Value       |
| 4002   | 4022  | 4042  | 4062  | Minimum Analog Value       |
| 4003   | 4023  | 4043  | 4063  | Enable Register Full Scale |
| 4004   | 4024  | 4044  | 4064  | Hold Last State Enable     |
| 4005   | 4025  | 4045  | 4065  | Default Output State       |

#### Default Output State

The Default Output State parameter represents the default condition of the analog output. When an error condition exists, the outputs are set to this 16-bit user-defined output state.

#### Enable Register Full Scale

Set to 1 to enable a linear range from 0 to 65535 for specified input range. For a 4 to 20 mA output, a value of 0 represents 4 mA and 65535 represents 20 mA. Set this parameter to 0 to store readings in unit-specific data. For example, the register data representing a 15.53 mA reading is 15530. For units of current (0 to 20 mA outputs), values are stored as  $\mu\text{A}$  (micro Amps) and voltage values are stored as mV (millivolts).

#### Hold Last State Enable

Set the Hold Last State to 1 to set the output to its last known value before the error occurred. Set this parameter to 0 to disable the Hold Last State and use the Default Output State setting during an error condition.

#### Maximum Analog Value

The Maximum Analog Value register stores the maximum allowed analog value. The specific units of measure apply to the register value. For example, the register may contain 20000, for 20 mA, or for a voltage output the register may contain 8000, for 8 volts.

#### Minimum Analog Value

The Minimum Analog Value register stores the minimum allowed analog value. The specific units of measure apply to register value. For example, the register may contain 4000, for 4 mA, or for a voltage output the register may contain 2000, for 2 volts.

## 4.12 04150s Initialization Controls

---

#### 4151 Reset Device

Write a 1 to this register to trigger a device reset of the parameters selected by the next three registers.

#### 4152 Default I/O Configuration

Returns all I/O configuration parameters to their factory default settings.

#### 4153 Default System Parameters

Returns all system-level parameters to their factory default settings.

#### 4154 Initialize Variables from the Serial Number

Returns all variables that are normally calculated (or seeded) from the serial number to values seeded from the serial number.

## 4.13 04400s Output Flash Pattern Parameters

Setting the flash pattern establishes an on and off pattern that can be used for a discrete output or switch power.

Flash patterns are established by selecting specific timeslots to turn the output on or off. While originally the flash pattern was designed to turn on and off an indicator light, the flash pattern can be set for any discrete output or switch power. Each slot represents one frame size, which may vary from radio to radio. The default frame is 40 milliseconds. Users may configure up to four different flash patterns.

4401-4408 Flash Pattern Index 1.

4411-4418 Flash Pattern Index 2.

4421-4428 Flash Pattern Index 3.

4431-4438 Flash Pattern Index 4.

## 4.14 04500s M-GAGE Parameters

The following characteristics are configurable for the M-GAGE devices.

### 4501 Set Baseline

Write a 1 to this register to set the baseline. The baseline function of the M-GAGE stores the ambient magnetic field values of the X, Y, and Z axes as a baseline value. Once this baseline is established, any deviation in the magnetic field represents the presence of a ferrous object and will be reflected in the M-GAGE register. The more disruption in the magnetic field, the larger the M-GAGE register value.

### 4502 Disable Axes

A bit-wise register (0000). Write a one to disable the selected axis where bit 0 is the x axis, bit 1 is the y axis, and bit 2 is the z axis.

### 4503 Disable Compensation Median Filter

Write a 1 to this register to disable the compensation median filter.

### 4504 Disable Sensing Median Filter

Write a 1 to this register to disable the sensing median filter.

### 4505 Low Pass Filter

The filters T0 through T6 are parameter settings that define the degree of input digital signal filtering for analog inputs. T0 is the least amount of filtering. T6 is the highest filter setting and has the least amount of fluctuation between readings. Write the following values to select a low pass (tau) filter.

| Low Pass (Tau) Filter | Register Value | Low Pass (Tau) Filter | Register Value |
|-----------------------|----------------|-----------------------|----------------|
| T0                    | 0              | T4                    | 4              |
| T1                    | 1              | T5                    | 5              |
| T2                    | 2              | T6                    | 6              |
| T3                    | 3              |                       |                |

### 4506 Sample High

The sample high counter parameter defines the number of consecutive samples the input signal must be above the threshold before a signal is considered active. The default value is 0, which disables this feature. The value range is 1 through 255. The Sample High parameter refers to the number of samples (1 through 255) a discrete input must be detected high (1) before it is considered to be a change of state.

### 4507 Sample Low

The default value of 0 disables this feature. The value range is 1 through 255. The Sample Low parameter refers to the number of samples (1 through 255) a discrete input must be detected low (0) before it is considered to be a change of state.

### 4509 Delta

Rate of change filter.

**4510 Threshold and 4511 Hysteresis**

Threshold and hysteresis work together to establish the ON and OFF points of an analog input. The threshold defines a trigger point or reporting threshold (ON point) for the M-GAGE™ input. The hysteresis value establishes how much below the active threshold (ON point) an analog input is required to be before the input is considered OFF. A typical hysteresis value is 10% to 20% of the unit's range.

The M-GAGE's threshold and hysteresis ranges are 0 to 65,535.

The factory default threshold setting is 150 and default hysteresis is 30 (the sensor detects an OFF condition at threshold minus hysteresis, or  $150 - 30 = 120$ ). With the default settings, once the magnetic field reading is above 150, an ON or "1" is stored in the lowest significant bit (LSB) in the Modbus register. When the M-GAGE reading drops below the OFF point (threshold minus hysteresis), the LSB of the Modbus register is set to "0."

To determine your threshold, take M-GAGE readings of the test objects at the distance they are likely to be from the sensor. For example, if a car reads 150, a bicycle 15, and a truck reads 250, setting the threshold to 200 will detect only trucks of a specific size. Magnetic field fluctuations vary based on the amount of ferrous metal present and the distance from the sensor.

**4512 Baseline (Drift) Filter Time**

Baseline filter time. When the Baseline Filter is on and the magnetic field readings are below the baseline filter threshold setting, an algorithm is used to slowly match the device's baseline to the current ambient magnetic field. This helps to account for the natural fluctuations in the magnetic field.

**4513 Baseline (Drift) Filter Threshold**

Baseline filter threshold is used with the baseline filter time to account for the natural fluctuations on the magnetic field.

**4514 Baseline (Drift) Filter Tau**

Baseline filter's low pass filter.

**4521 Baseline Difference Signal Value Total**

A combination of the x-, y-, and z-axis baseline different signal values.

**4522–4524 Baseline Difference Signal Value [x-axis]**

4522 [x-axis]—The difference between the ambient magnetic field and the current magnetic field reading for the x axis.

4523 [y-axis]—The difference between the ambient magnetic field and the current magnetic field reading for the y axis.

4524 [z-axis]—The difference between the ambient magnetic field and the current magnetic field reading for the z axis.

**4525–4527 Baseline Value**

4525 [x-axis]—Ambient magnetic field reading for the x axis.

4526 [y-axis]—Ambient magnetic field reading for the y axis.

4527 [z-axis]—Ambient magnetic field reading for the z axis.

**4528–4530 Raw Signal Value**

4528 [x-axis]—The actual magnetic field reading for the x axis.

4529 [y-axis]—The actual magnetic field reading for the y axis.

4530 [z-axis]—The actual magnetic field reading for the z axis.

## 4.15 04800s Ultrasonic Input Parameters

---

The following characteristics are configurable for the Ultrasonic input devices.

**0001 Temperature Measured**

Temperature is measured in 0.1 °C increments.

**0002 Distance Measured**

Distance is measured in mm.

The least significant bit indicates threshold status

Value 65535 or 65534: Alarm, No Reflection Detected

Value 65533 or 65532: Alarm, Reflection Mismatch

Value 65531 or 65530: Alarm, Thermistor Error

**1051 Enable**

Write a 1 to enable the ultrasonic sensor. Write a 0 to disable.

**1053 Sample Interval**

The sample interval (rate) defines how often the data radio samples the input. The register value is the number of time units. For example, a Modbus register value of 125 (for a 900 MHz device) represents a sample interval of 5 seconds ( $125 \times 0.040$  seconds = 5 seconds).

A unit of time for a 900 MHz data radio is 40 milliseconds. A unit of time for a 2.4 GHz data radio is 20 milliseconds.

**4801 Drive Pulses**

Defines the number of cycles the transducer is pulsed.

4808 Receive Pulses

Defines the number of cycles that must be seen to recognize a reflection.

4810 Max Scale Value

The Maximum Value register stores the maximum allowed analog value. The specific units of measure apply to the register value. For example, the register may contain 20000, for 20 mA, or for a voltage input the register may contain 8000, for 8 volts.

4811 Min Scale Value

The Minimum Value register stores the minimum allowed analog value. The specific units of measure apply to the register value. For example, the register may contain 4000, for 4 mA, or for a voltage input the register may contain 2000, for 2 volts.

4812 Enable Register Full Scale

Set to 1 to enable a linear range from 0 to 65535 for specified input range. For a 4 to 20 mA input, a value of 0 represents 4 mA and 65535 represents 20 mA. Set this parameter to 0 to store input readings in unit-specific data. For example, the register data representing a 15.53 mA reading is 15530. For units of current (0 to 20 mA inputs), values are stored as  $\mu$ A (micro Amps) and voltage values are stored as mV (millivolts).

4813 Threshold and 4814 Hysteresis

Threshold and hysteresis work together to establish the ON and OFF points of an analog input. The threshold defines a trigger point or reporting threshold (ON point) for a sensor input. Setting a threshold establishes an ON point. Hysteresis defines how far below the threshold the analog input is required to be before the input is considered OFF. A typical hysteresis value is 10% to 20% of the unit's range.

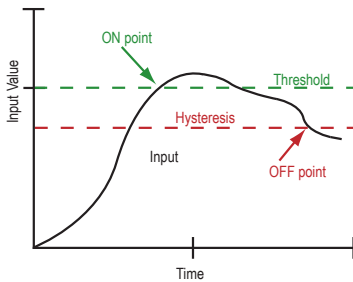

In the example shown graphically, the input is considered on at 15 mA. To consider the input off at 13 mA, set the hysteresis to 2 mA. The input will be considered off when the value is 2 mA less than the threshold.

4815 Delta

The delta parameter defines the change required between sample points of an analog input before the analog input reports a new value. To turn off this option, set the Delta value to 0.

4816 Sample High and 4817 Sample Low

For discrete inputs, the sample high parameter defines the number of consecutive samples the input signal must be high before a signal is considered active. Sample low defines the number of consecutive samples the input signal must be low before a signal is considered low. The sample high and sample low parameters are used to create a filter to avoid unwanted input transitions. The default value is 0, which disables this feature. The value range is 1 through 255.

4818 Change of State Push Enable

Set to one (1) to enable push registers for this input. When the analog input changes state, the register value will be pushed to the master radio if this register is configured to be a push register.

4819 Median Filter Enable

Set to zero (0) to turn off the median filter. Set to one (1) to turn on the median filter.

4820 Low Pass (Tau) Filter

Set to zero (0) to turn off the tau filter. Set to 1 (weakest filter) through 6 (strongest filter) to turn on the tau filter. (In the DX80 products, the Low Pass Filter is a combination of the median filter and the tau filter.) Write the following values to select a low pass (tau) filter.

| Low Pass (Tau) Filter | Register Value | Low Pass (Tau) Filter | Register Value |
|-----------------------|----------------|-----------------------|----------------|
| T0                    | 0              | T4                    | 4              |
| T1                    | 1              | T5                    | 5              |
| T2                    | 2              | T6                    | 6              |
| T3                    | 3              |                       |                |

4823 Window Range

Measured in mm.

When ultrasonic teach is active, the threshold is set to the distance measured minus the window range.

**4825 Ultrasonic Teach**

Write a 1 to initiate a threshold teach.

When ultrasonic teach is active, the threshold is set to the distance measured minus the window range.

**4826 Invert Digital Logic**

If the set distance measures below the threshold, the transition has an LSB of 1.

If the clear distance measures below the threshold, the transition has an LSB of 0.

**4827 Boost Enable**

Controls the ultrasonic transducer power level.

Set to 0 for low power level, a longer battery life, less noise, and a shorter range.

Set to 1 for higher power levels, a shorter battery life, more noise, and a longer range.

**4828 Ultrasonic Sensitivity Control**

Adjusts ultrasonic reflection sensitivity.

Write a 0 to disables the control feature

Start control at 0x8000 to match default

Control below 0x8000 is more sensitive

Control above 0x8000 is less sensitive

**4831 Set Alarm as Logic 0**

If set, an alarm is treated is if it is below the threshold.

If cleared, an alarm is treated is if it is above the threshold.

**7909-7912 Push Registers**

7909 Push Register 1 — Pushes the value of register 0002 (Distance Measured).

7910 Push Register 2 — Pushes the value of register 0001 (Temperature in 0.1 °C increments).

7911 Push Register 3 — Pushes the value of register 4813 (Current threshold setting).

7912 Push Register 4 — Pushes the value of register 4823 (Current teach window range).

## 4.16 06050s Battery Monitoring Parameters

---

Use the battery monitor parameters to monitor and set a threshold based on the incoming device voltage (on some models).

The incoming voltage is approximately 3.6 V dc from a battery input or 4.2 V dc from the 10 to 30 V dc input. These parameters allow users to determine which power source is powering the MultiHop device.

**6051 Enable Battery Read**

Set to zero to disable the battery read function. Set to 1 to enable the battery read function.

**6052 Battery Read Sample Interval**

Use this parameter to set the time interval at which the incoming voltage is read. Sample Interval (in seconds) = 0.040 seconds × 2<sup>RegValue</sup>. Default register value: 9 (20 seconds).

**6053 Battery Voltage Threshold**

Use this parameter to define the incoming voltage threshold at which register 44061 will be set to a zero or one.

Set this value in number of 100 mA increments. The default value is 38 (or 3.8 V).

**6054 Hardware Reference Select**

Use this parameter to allow for the correct calibration reference for different hardware platforms. Set to zero for 3.0 V PCB Vcc. Set to one for 3.3 V PCB Vcc. Default value is zero.

**6061 Battery Threshold Reading**

When zero (0), the incoming voltage is below the threshold defined by parameter 6053 (powered by battery).

When one (1), the incoming voltage reading is above the defined threshold (powered by a solar panel or 10 to 30 V dc).

**6062 Battery Voltage Reading**

Actual incoming voltage reading in units of 100 mV.

## 4.17 Configure the SDI-12 Inputs

---

The SDI-12 interface on the MultiHop radio can support up to five devices with (12) 32-bit register values each. The radio's SDI-12 interface can be configured to increase the number of registers per device address for devices with large register sets. The factory default enables one SDI-12 device using device address 1 with up to nine registers with a SDI-12 command of "M!".

Configure the MultiHop device by writing to non-volatile Modbus registers with configuration parameters. Read or write the device configuration parameters using standard Modbus commands.

### 4.17.1 Basic SDI-12 Interface Parameters

Up to five devices/commands can be accessed using the SDI-12 interface. There are three parameters for each device/command: Enable, Device Address, Device Command. For more information, refer to the SDI-12 Technical Notes.

**Enable.** Instructs the MultiHop Data Radio device to activate or deactivate the SDI-12 device. Write a 1 to enable, and write a 0 to disable. The factory default for device 1 is enabled; devices 2 through 5 are disabled.

**Device Address.** Each SDI-12 device must have a unique device address. This parameter is the ASCII code for the device address. Valid device addresses are 0–9 and a–z that map to ASCII codes 48–57 and 97–122, respectively. The factory default addresses are:

- SDI-12 Device 0 uses ASCII code 48
- SDI-12 Device 1 uses ASCII code 49
- SDI-12 Device 2 uses ASCII code 50
- SDI-12 Device 3 uses ASCII code 51
- SDI-12 Device 4 uses ASCII code 52

**Device Command** The SDI-12 interface supports "M!" or "C!" commands. Use the Device Command parameter to define which command to use for this device. The factory default is "M!" commands for all devices (value of 10 in the Modbus register).

| Supported M! Commands |                | Supported C! Commands |                |
|-----------------------|----------------|-----------------------|----------------|
| SDI-12 Command        | Register Value | SDI-12 Command        | Register Value |
| xM!                   | 0 or 10        | xC!                   | 1 or 20        |
| xM1!                  | 11             | xC1!                  | 21             |
| xM2!                  | 12             | xC2!                  | 22             |
| xM3!                  | 13             | xC3!                  | 23             |
| xM4!                  | 14             | xC4!                  | 24             |
| xM5!                  | 15             | xC5!                  | 25             |
| xM6!                  | 16             | xC6!                  | 26             |
| xM7!                  | 17             | xC7!                  | 27             |
| xM8!                  | 18             | xC8!                  | 28             |
| xM9!                  | 19             | xC9!                  | 29             |

The Modbus configuration registers are listed. All registers are defined as Modbus holding registers. The factory default values are shown in parentheses. All values are in decimal, unless noted otherwise.

| Device/CMD Configuration | Registers (Default Value) |                         |                |
|--------------------------|---------------------------|-------------------------|----------------|
|                          | Enable                    | Device Address          | Device Command |
| SDI-12 Device/CMD 1      | 1751 (1)                  | 11001 (48) <sup>2</sup> | 11002 (10)     |
| SDI-12 Device/CMD 2      | 1701 (0)                  | 11201 (49)              | 11202 (10)     |
| SDI-12 Device/CMD 3      | 1651 (0)                  | 11401 (50)              | 11402 (10)     |
| SDI-12 Device/CMD 4      | 1601 (0)                  | 11601 (51)              | 11602 (10)     |
| SDI-12 Device/CMD 5      | 1551 (0)                  | 11801 (52)              | 11802 (10)     |

### 4.17.2 Result Registers Configuration Parameters

There are 12 result registers allocated for each device, and each register can be individually configured to change its formatting. Use these parameters to customize the formatting for each data value coming from a SDI-12 device.

The default configuration of a floating point format works for most SDI-12 values. For each register the following parameters apply:

- **Enable.** Enable or disable for each device. To enable, set to 1. To disable, set to 0.
- **Decimal point Move:** Moves the decimal point 0 to 7 places.

<sup>2</sup> The default device addresses 48 through 52 are in ASCII.



- Decimal point Direction: To move the decimal point to the right, set to 0. To move the decimal point to the left, set to 1.
- Register Sign: For an unsigned value, set to 0. For a signed value, set to 1.
- Register Size: For a 16-bit word, set to 0. For a 32-bit word, set to 1. Select 32-bit when using floating point.
- Floating Point Enable: For an integer, set to 0. For a floating point number, set to 1.

The following tables define the Modbus configuration registers for the result registers. All registers are defined to be Modbus holding registers. The default values are shown in parentheses, factory defaults enable the first nine registers as floating point registers. The "M!" command only supports a maximum of nine registers.

| SDI -12 Device 1 / CMD 1 | Register 1 | Register 2 | Register 3 | Register 4  | Register 5  | Register 6  |
|--------------------------|------------|------------|------------|-------------|-------------|-------------|
| Result Register Enable   | 11011 (1)  | 11021 (1)  | 11031 (1)  | 11041 (1)   | 11051 (1)   | 11061 (1)   |
| Decimal Point Move       | 11012 (0)  | 11022 (0)  | 11032 (0)  | 11042 (0)   | 11052 (0)   | 11062 (0)   |
| Decimal Point Direction  | 11013 (0)  | 11023 (0)  | 11033 (0)  | 11043 (0)   | 11053 (0)   | 11063 (0)   |
| Register Sign            | 11014 (0)  | 11024 (0)  | 11034 (0)  | 11044 (0)   | 11054 (0)   | 11064 (0)   |
| Register Size            | 11015 (1)  | 11025 (1)  | 11035 (1)  | 11045 (1)   | 11055 (1)   | 11065 (1)   |
| Floating Point Enable    | 11016 (1)  | 11026 (1)  | 11036 (1)  | 11046 (1)   | 11056 (1)   | 11066 (1)   |
|                          | Register 7 | Register 8 | Register 9 | Register 10 | Register 11 | Register 12 |
| Result Register Enable   | 11071 (1)  | 11081 (1)  | 11091 (1)  | 11141 (0)   | 11151 (0)   | 11161 (0)   |
| Decimal Point Move       | 11072 (0)  | 11082 (0)  | 11092 (0)  | 11142 (0)   | 11152 (0)   | 11162 (0)   |
| Decimal Point Direction  | 11073 (0)  | 11083 (0)  | 11093 (0)  | 11143 (0)   | 11153 (0)   | 11163 (0)   |
| Register Sign            | 11074 (0)  | 11084 (0)  | 11094 (0)  | 11144 (0)   | 11154 (0)   | 11164 (0)   |
| Register Size            | 11075 (1)  | 11085 (1)  | 11095 (1)  | 11145 (1)   | 11155 (1)   | 11165 (1)   |
| Floating Point Enable    | 11076 (1)  | 11086 (1)  | 11096 (1)  | 11146 (1)   | 11156 (1)   | 11166 (1)   |

| SDI -12 Device 2 / CMD 2 | Register 1 | Register 2 | Register 3 | Register 4  | Register 5  | Register 6  |
|--------------------------|------------|------------|------------|-------------|-------------|-------------|
| Result Register Enable   | 11211 (1)  | 11221 (1)  | 11231 (1)  | 11241 (1)   | 11251 (1)   | 11261 (1)   |
| Decimal Point Move       | 11212 (0)  | 11222 (0)  | 11232 (0)  | 11242 (0)   | 11252 (0)   | 11262 (0)   |
| Decimal Point Direction  | 11213 (0)  | 11223 (0)  | 11233 (0)  | 11243 (0)   | 11253 (0)   | 11263 (0)   |
| Register Sign            | 11214 (0)  | 11224 (0)  | 11234 (0)  | 11244 (0)   | 11254 (0)   | 11264 (0)   |
| Register Size            | 11215 (1)  | 11225 (1)  | 11235 (1)  | 11245 (1)   | 11255 (1)   | 11265 (1)   |
| Floating Point Enable    | 11216 (1)  | 11226 (1)  | 11236 (1)  | 11246 (1)   | 11256 (1)   | 11266 (1)   |
|                          | Register 7 | Register 8 | Register 9 | Register 10 | Register 11 | Register 12 |
| Result Register Enable   | 11271 (1)  | 11281 (1)  | 11291 (1)  | 11341 (0)   | 11351 (0)   | 11361 (0)   |
| Decimal Point Move       | 11272 (0)  | 11282 (0)  | 11292 (0)  | 11342 (0)   | 11352 (0)   | 11362 (0)   |
| Decimal Point Direction  | 11273 (0)  | 11283 (0)  | 11293 (0)  | 11343 (0)   | 11353 (0)   | 11363 (0)   |
| Register Sign            | 11274 (0)  | 11284 (0)  | 11294 (0)  | 11344 (0)   | 11354 (0)   | 11364 (0)   |

MultiHop Radios

| SDI -12 Device<br>2 / CMD 2 | Register 1 | Register 2 | Register 3 | Register 4 | Register 5 | Register 6 |
|-----------------------------|------------|------------|------------|------------|------------|------------|
| Register Size               | 11275 (1)  | 11285 (1)  | 11295 (1)  | 11345 (1)  | 11355 (1)  | 11365 (1)  |
| Floating Point<br>Enable    | 11276 (1)  | 11286 (1)  | 11296 (1)  | 11346 (1)  | 11356 (1)  | 11366 (1)  |

| SDI -12 Device<br>3 / CMD 3 | Register 1 | Register 2 | Register 3 | Register 4  | Register 5  | Register 6  |
|-----------------------------|------------|------------|------------|-------------|-------------|-------------|
| Result Register<br>Enable   | 11411 (1)  | 11421 (1)  | 11431 (1)  | 11441 (1)   | 11451 (1)   | 11461 (1)   |
| Decimal Point<br>Move       | 11412 (0)  | 11422 (0)  | 11432 (0)  | 11442 (0)   | 11452 (0)   | 11462 (0)   |
| Decimal Point<br>Direction  | 11413 (0)  | 11423 (0)  | 11433 (0)  | 11443 (0)   | 11453 (0)   | 11463 (0)   |
| Register Sign               | 11414 (0)  | 11424 (0)  | 11434 (0)  | 11444 (0)   | 11454 (0)   | 11464 (0)   |
| Register Size               | 11415 (1)  | 11425 (1)  | 11435 (1)  | 11445 (1)   | 11455 (1)   | 11465 (1)   |
| Floating Point<br>Enable    | 11416 (1)  | 11426 (1)  | 11436 (1)  | 11446 (1)   | 11456 (1)   | 11466 (1)   |
|                             | Register 7 | Register 8 | Register 9 | Register 10 | Register 11 | Register 12 |
| Result Register<br>Enable   | 11471 (1)  | 11481 (1)  | 11491 (1)  | 11541 (0)   | 11551 (0)   | 11561 (0)   |
| Decimal Point<br>Move       | 11472 (0)  | 11482 (0)  | 11492 (0)  | 11542 (0)   | 11552 (0)   | 11562 (0)   |
| Decimal Point<br>Direction  | 11473 (0)  | 11483 (0)  | 11493 (0)  | 11543 (0)   | 11553 (0)   | 11563 (0)   |
| Register Sign               | 11474 (0)  | 11484 (0)  | 11494 (0)  | 11544 (0)   | 11554 (0)   | 11564 (0)   |
| Register Size               | 11475 (1)  | 11485 (1)  | 11495 (1)  | 11545 (1)   | 11555 (1)   | 11565 (1)   |
| Floating Point<br>Enable    | 11476 (1)  | 11486 (1)  | 11496 (1)  | 11546 (1)   | 11556 (1)   | 11566 (1)   |

| SDI -12 Device<br>4 / CMD 4 | Register 1 | Register 2 | Register 3 | Register 4  | Register 5  | Register 6  |
|-----------------------------|------------|------------|------------|-------------|-------------|-------------|
| Result Register<br>Enable   | 11611 (1)  | 11621 (1)  | 11631 (1)  | 11641 (1)   | 11651 (1)   | 11661 (1)   |
| Decimal Point<br>Move       | 11612 (0)  | 11622 (0)  | 11632 (0)  | 11642 (0)   | 11652 (0)   | 11662 (0)   |
| Decimal Point<br>Direction  | 11613 (0)  | 11623 (0)  | 11633 (0)  | 11643 (0)   | 11653 (0)   | 11663 (0)   |
| Register Sign               | 11614 (0)  | 11624 (0)  | 11634 (0)  | 11644 (0)   | 11654 (0)   | 11664 (0)   |
| Register Size               | 11615 (1)  | 11625 (1)  | 11635 (1)  | 11645 (1)   | 11655 (1)   | 11665 (1)   |
| Floating Point<br>Enable    | 11616 (1)  | 11626 (1)  | 11636 (1)  | 11646 (1)   | 11656 (1)   | 11666 (1)   |
|                             | Register 7 | Register 8 | Register 9 | Register 10 | Register 11 | Register 12 |
| Result Register<br>Enable   | 11671 (1)  | 11681 (1)  | 11691 (1)  | 11741 (0)   | 11751 (0)   | 11761 (0)   |
| Decimal Point<br>Move       | 11672 (0)  | 11682 (0)  | 11692 (0)  | 11742 (0)   | 11752 (0)   | 11762 (0)   |
| Decimal Point<br>Direction  | 11673 (0)  | 11683 (0)  | 11693 (0)  | 11743 (0)   | 11753 (0)   | 11763 (0)   |
| Register Sign               | 11674 (0)  | 11684 (0)  | 11694 (0)  | 11744 (0)   | 11754 (0)   | 11764 (0)   |
| Register Size               | 11675 (1)  | 11685 (1)  | 11695 (1)  | 11745 (1)   | 11755 (1)   | 11765 (1)   |

| SDI-12 Device 4 / CMD 4 | Register 1 | Register 2 | Register 3 | Register 4 | Register 5 | Register 6 |
|-------------------------|------------|------------|------------|------------|------------|------------|
| Floating Point Enable   | 11676 (1)  | 11686 (1)  | 11696 (1)  | 11746 (1)  | 11756 (1)  | 11766 (1)  |

| SDI-12 Device 5 / CMD 5 | Register 1 | Register 2 | Register 3 | Register 4  | Register 5  | Register 6  |
|-------------------------|------------|------------|------------|-------------|-------------|-------------|
| Result Register Enable  | 11811 (1)  | 11821 (1)  | 11831 (1)  | 11841 (1)   | 11851 (1)   | 11861 (1)   |
| Decimal Point Move      | 11812 (0)  | 11822 (0)  | 11832 (0)  | 11842 (0)   | 11852 (0)   | 11862 (0)   |
| Decimal Point Direction | 11813 (0)  | 11823 (0)  | 11833 (0)  | 11843 (0)   | 11853 (0)   | 11863 (0)   |
| Register Sign           | 11814 (0)  | 11824 (0)  | 11834 (0)  | 11844 (0)   | 11854 (0)   | 11864 (0)   |
| Register Size           | 11815 (1)  | 11825 (1)  | 11835 (1)  | 11845 (1)   | 11855 (1)   | 11865 (1)   |
| Floating Point Enable   | 11816 (1)  | 11826 (1)  | 11836 (1)  | 11846 (1)   | 11856 (1)   | 11866 (1)   |
|                         |            |            |            |             |             |             |
|                         | Register 7 | Register 8 | Register 9 | Register 10 | Register 11 | Register 12 |
| Result Register Enable  | 11871 (1)  | 11881 (1)  | 11891 (1)  | 11941 (0)   | 11951 (0)   | 11961 (0)   |
| Decimal Point Move      | 11872 (0)  | 11882 (0)  | 11892 (0)  | 11942 (0)   | 11952 (0)   | 11962 (0)   |
| Decimal Point Direction | 11873 (0)  | 11883 (0)  | 11893 (0)  | 11943 (0)   | 11953 (0)   | 11963 (0)   |
| Register Sign           | 11874 (0)  | 11884 (0)  | 11894 (0)  | 11944 (0)   | 11954 (0)   | 11964 (0)   |
| Register Size           | 11875 (1)  | 11885 (1)  | 11895 (1)  | 11945 (1)   | 11955 (1)   | 11965 (1)   |
| Floating Point Enable   | 11876 (1)  | 11886 (1)  | 11896 (1)  | 11946 (1)   | 11956 (1)   | 11966 (1)   |

### 4.17.3 SDI-12 Device Result Registers

The result registers store all information received from the SDI-12 devices.

The registers are 16-bit registers and require two registers to store a 32-bit value. The factory default configuration defines the result registers as 32-bit registers, floating point format, and the first nine result registers are enabled for use. A host system reads the SDI-12 device data from these registers.

| Result Registers                 | Register 1 | Register 2 | Register 3 | Register 4 | Register 5 | Register 6 |
|----------------------------------|------------|------------|------------|------------|------------|------------|
| SDI-12 Device/CMD 1 Result Upper | 11101      | 11103      | 11105      | 11107      | 11109      | 11111      |
| SDI-12 Device/CMD 1 Result Lower | 11102      | 11104      | 11106      | 11108      | 11110      | 11112      |
| SDI-12 Device/CMD 2 Result Upper | 11301      | 11303      | 11305      | 11307      | 11309      | 11311      |
| SDI-12 Device/CMD 2 Result Lower | 11302      | 11304      | 11306      | 11308      | 11310      | 11312      |
| SDI-12 Device/CMD 3 Result Upper | 11501      | 11503      | 11505      | 11507      | 11509      | 11511      |
| SDI-12 Device/CMD 3 Result Lower | 11502      | 11504      | 11506      | 11508      | 11510      | 11512      |
| SDI-12 Device/CMD 4 Result Upper | 11701      | 11703      | 11705      | 11707      | 11709      | 11711      |
| SDI-12 Device/CMD 4 Result Lower | 11702      | 11704      | 11706      | 11708      | 11710      | 11712      |
| SDI-12 Device/CMD 5 Result Upper | 11901      | 11903      | 11905      | 11907      | 11909      | 11911      |
| SDI-12 Device/CMD 5 Result Lower | 11902      | 11904      | 11906      | 11908      | 11910      | 11912      |

| Result Registers                 | Register 7 | Register 8 | Register 9 | Register 10 | Register 11 | Register 12 |
|----------------------------------|------------|------------|------------|-------------|-------------|-------------|
| SDI-12 Device/CMD 1 Result Upper | 11113      | 11115      | 11117      | 11119       | 11121       | 11123       |

| Result Registers                 | Register 7 | Register 8 | Register 9 | Register 10 | Register 11 | Register 12 |
|----------------------------------|------------|------------|------------|-------------|-------------|-------------|
| SDI-12 Device/CMD 1 Result Lower | 11114      | 11116      | 11118      | 11120       | 11122       | 11124       |
| SDI-12 Device/CMD 2 Result Upper | 11313      | 11315      | 11317      | 11319       | 11321       | 11323       |
| SDI-12 Device/CMD 2 Result Lower | 11314      | 11316      | 11318      | 11320       | 11322       | 11324       |
| SDI-12 Device/CMD 3 Result Upper | 11513      | 11515      | 11517      | 11519       | 11521       | 11523       |
| SDI-12 Device/CMD 3 Result Lower | 11514      | 11516      | 11518      | 11520       | 11522       | 11524       |
| SDI-12 Device/CMD 4 Result Upper | 11713      | 11715      | 11717      | 11719       | 11721       | 11723       |
| SDI-12 Device/CMD 4 Result Lower | 11714      | 11716      | 11718      | 11720       | 11722       | 11724       |
| SDI-12 Device/CMD 5 Result Upper | 11913      | 11915      | 11917      | 11919       | 11921       | 11923       |
| SDI-12 Device/CMD 5 Result Lower | 11914      | 11916      | 11918      | 11920       | 11922       | 11924       |

#### 4.17.4 SDI-12 Device Settings

The following are generic sampling, power and warmup parameters that should work for all SDI-12 devices. See the tested device table below. In most cases, parameters will not need to be adjusted but if needed there are three common SDI-12 device parameters that control the communications and power of the SDI-12 device. Contact Banner Engineering Corp support for more guidance.

- **Sample Rate.** Formed using two 16-bit parameters, a HI word and a LOW word. The sample rate is how often the SDI-12 device is powered up, then interrogated for data. The value in the registers is the number of 0.040 second counts. For example, the default value is 22,500, which calculates to  $22500 \times 0.040$ , or 15 minutes. Adjusting this value affects the battery life.
- **Warmup time.** Amount of time to wait, in 0.040 second increments, from powering on the device to the time to send communications to the device. The default value is 50, or 2 seconds. Adjusting this value affects the battery life.
- **Voltage.** The default voltage setting is 6 volts or a register value of 168. Adjusting this value affects the battery life.

| Device / Cmd Configuration | Registers (Default Value) |                         |                     |                |           |              |             |            |
|----------------------------|---------------------------|-------------------------|---------------------|----------------|-----------|--------------|-------------|------------|
|                            | Enable                    | Device Address          | Switch Power Enable | Device Command | Sample Hi | Sample Low   | Warmup Time | Voltage    |
| SDI-12 Device/CMD 1        | 1751 (1)                  | 11001 (48) <sup>3</sup> | 1754 (1)            | 11002 (10)     | 1752 (0)  | 1753 (22500) | 1755 (50)   | 1756 (148) |
| SDI-12 Device/CMD 2        | 1701 (0)                  | 11201 (49)              | 1704 (0)            | 11202 (10)     | 1702 (0)  | 1703 (22500) | 1705 (50)   | 1706 (148) |
| SDI-12 Device/CMD 3        | 1651 (0)                  | 11401 (50)              | 1654 (0)            | 11402 (10)     | 1652 (0)  | 1653 (22500) | 1655 (50)   | 1656 (148) |
| SDI-12 Device/CMD 4        | 1601 (0)                  | 11601 (51)              | 1604 (0)            | 11602 (10)     | 1602 (0)  | 1603 (22500) | 1605 (50)   | 1606 (148) |
| SDI-12 Device/CMD 5        | 1551 (0)                  | 11801 (52)              | 1554 (0)            | 11802 (10)     | 1552 (0)  | 1553 (22500) | 1555 (50)   | 1556 (148) |

These SDI-12 probes have been tested and are functional with the factory default settings.

| MFG             | Models                                    | Technical Note   |
|-----------------|---|--|
| Acclima         | SEN-SDI (TDT SDI-12 Soil Moisture Sensor) | <a href="#">SDI-12 and the Acclima TDT SDI-12 Soil Moisture Probe</a>  |
| Adcon Telemetry | HydraProbeII                              |  |
| AquaCheck       | Sub-surface Probe                         | <a href="#">SDI-12 and the AquaCheck Sub-Surface Soil Moisture Probe</a>   |
| Decagon         | MPS-2, MPS-6, 5TE, TS1, T8                | <a href="#">SDI-12 and the Decagon 5TE Soil Moisture Probe</a><br><a href="#">SDI-12 and the Decagon GS3 Soil Moisture Probe</a><br><a href="#">SDI-12 and the Decagon MPS-2 Soil Moisture Probe</a> |
| HSTI            | HydraScout                                | <a href="#">SDI-12 and the HydraScout HSTI Probe</a>   |
| Sentek          | EnviroSCAN                                | <a href="#">SDI-12 and the Sentek EnviroScan Soil Moisture Probe</a>   |

<sup>3</sup> The default device addresses 48 through 52 are in ASCII.

## 4.17.5 Configuring for Acclima SDI-12 Sensors

Table 1: Acclima SDI-12 Parameter Registers

| SDI-12 Device Register (Acclima) | Register Enable (1) | Decimal Point Move (0-7) | Move Right (0) or Left (1) | Signed (1) or Unsigned (0) | 16 bit (0) or 32 bit (1) |
|----------------------------------|---------------------|--------------------------|----------------------------|----------------------------|--------------------------|
| 1 Volumetric water content       | ON                  | 2                        | Left                       | Unsigned                   | 32 bit                   |
| 2 Temperature                    | ON                  | 1                        | Left                       | Signed                     | 32 bit                   |
| 3 Soil Permittivity              | ON                  | 2                        | Left                       | Unsigned                   | 32 bit                   |
| 4 Soil Conductivity              | ON                  | 2                        | Left                       | Unsigned                   | 32 bit                   |

Table 2: Acclima SDI-12 Results Registers

| Acclima Register No.       | Results Registers (high:low) | Integer Conversion Multiplier | Sample Reading | Actual Value |
|----------------------------|------------------------------|-------------------------------|----------------|--------------|
| 1 Volumetric water content | 11101:11102                  | ×100                          | 0:124          | 1.24%        |
| 2 Temperature              | 11103:11104                  | ×10                           | 0:238          | 23.8 °C      |
| 3 Soil Permittivity        | 11105:11106                  | ×100                          | 0:402          | 4.02         |
| 4 Soil Conductivity        | 11107:11108                  | ×100                          | 0:123          | 1.23 dS/m    |

## 4.17.6 Configuring for Decagon 5T3 SDI-12 Sensors

Table 3: Decagon SDI-12 Parameter Registers

| SDI-12 Device Register (Decagon 5T3) | Register Enable (1) | Decimal Point Move (0-7) | Move Right (0) or Left (1) | Signed (1) or Unsigned (0) | 16 bit (0) or 32 bit (1) |
|--------------------------------------|---------------------|--------------------------|----------------------------|----------------------------|--------------------------|
| 1 Volumetric water content           | ON                  | 2                        | Left                       | Unsigned                   | 32 bit                   |
| 2 Soil Conductivity                  | ON                  | 2                        | Left                       | Unsigned                   | 32 bit                   |
| 3 Temperature                        | ON                  | 1                        | Left                       | Signed                     | 32 bit                   |

Table 4: Decagon SDI-12 Results Registers

| Decagon Register No.       | Results Registers (high:low) | Integer Conversion Multiplier | Sample Reading | Actual Value |
|----------------------------|------------------------------|-------------------------------|----------------|--------------|
| 1 Volumetric water content | 11101:11102                  | ×100                          | 0:124          | 1.24%        |
| 2 Soil Conductivity        | 11103:11104                  | ×100                          | 0:123          | 1.23 dS/m    |
| 3 Temperature              | 11105:11106                  | ×10                           | 0:238          | 23.8 °C      |

## 4.18 Manufacturer Parameter Registers

The following are the device-specific and manufacturer parameters for the MultiHop radio devices. These registers are all within the 4xxxx range.

### 4.18 04100s Manufacturing Information

| Address (4xxxx) | Name                        | Format           |
|-----------------|-----------------------------|------------------|
| 4101-4104       | Serial number, digits 1-8   | ASCII, read only |
| 4111-4113       | Model number, digits 1-6    | ASCII, read only |
| 4121-4123       | Production date, digits 1-6 | ASCII, read only |

#### 4.18 04200s Device Name

| Address (4xxxx) | Name                 | Format |
|-----------------|----------------------|--------|
| 4201–4209       | Name characters 1-18 | ASCII  |

#### 4.18 04300s Software Information

| Address (4xxxx) | Name                                      | Format           |
|-----------------|---|------------------|
| 4301–4303       | RF firmware p/n                           | ASCII, read only |
| 4304–4305       | RF firmware version                       | ASCII, read only |
| 4306–4308       | RF EEPROM part number, digits 1–6         | ASCII, read only |
| 4309–4310       | RF EEPROM version number, characters 1–3  | ASCII, read only |
| 4311–4313       | LCD firmware p/n                          | ASCII, read only |
| 4314–4315       | LCD firmware version                      | ASCII, read only |
| 4316–4318       | LCD EEPROM part number, digits 1–6        | ASCII, read only |
| 4319–4320       | LCD EEPROM version number, characters 1–3 | ASCII, read only |

#### 4.18 06400s Message Parameters

Strings stored in ASCII format are read as two characters per Modbus register. The lower numbered Modbus register contains the right-most characters in the string. Within a given Modbus register, the upper byte contains the ASCII character that goes to the right of the character in the lower byte.

| Address (4xxxx) | Name           | Format         |
|-----------------|----------------|----------------|
| 6401            | Device address | Hex            |
| 6402            | Parent address | Hex, read only |

#### Storing a Model Number

For example, the model number 148691 is stored as shown below.

| Address (4xxxx) | Name                    | Modbus Register Value (in hex) | Character Representation |
|-----------------|-------------------------|--------------------------------|--------------------------|
| 4111            | Model number digits 6-5 | 0x3139                         | 1 9                      |
| 4112            | Model number digits 4-3 | 0x3638                         | 6 8                      |
| 4113            | Model number digits 2-1 | 0x3431                         | 4 1                      |

#### Parameters Stored as Numbers

Parameters stored as number values (not ASCII) read out directly as 16-bit values. Examples of parameters of this type include the Parent Address or Device Address.

| Address (4xxxx) | Name           | Value (in hex) | Value (decimal) |
|-----------------|----------------|----------------|-----------------|
| 6401            | Device address | 0x002A         | 42              |
| 6402            | Parent address | 0x0023         | 35              |

## 4.19 Device and System Parameters

### 4.19.1 08200s Sample On Demand

To Sample on Demand is to trigger inputs to immediately sample. A host system triggers this sampling by writing a specific value to the Sample on Demand registers.

After the selected inputs are sampled, the MultiHop device resets the Sample on Demand register(s) back to zero. It is up to the host system to retrieve the value of the sampled input. There are two ways to trigger a Sample on Demand.

1. Write a value to register 8201, or
2. Write a one (1) to any of the individual input's registers 8221 (input 1) through 8236 (input 16).

Do not write to both register 8201 and the registers 8221 through 8236.

#### 8201 Input 1-16 Sample on Demand Latch (bit field)

Use this bit field register to trigger a sample on demand to more than one input using a single register. For example, to trigger a sample on demand for inputs 1 and 5, write 0000 0000 0001 0001 (0x0011) to this register.

#### 8221 Input 1 Sample on Demand Latch

Write a one (1) to this register to sample input 1.

#### 8222 Input 2 Sample on Demand Latch

Write a one (1) to this register to sample input 2.

#### 8236 Input 16 Sample on Demand Latch

Write a one (1) to this register to sample input 16.

## 5 Certified For Use in the Following Countries

The Sure Cross® radio devices are approved for use in the following countries.

| Country                     | Radio Modules    |                  |                 |
|-----------------------------|------------------|------------------|-----------------|
|                             | 900 MHz (150 mW) | 900 MHz (1 Watt) | 2.4 GHz (65 mW) |
| Australia                   |                  |                  | x               |
| Austria                     |                  |                  | x               |
| Bahamas, The                | x                |                  | x               |
| Bahrain, Kingdom of         |                  |                  | x               |
| Belgium                     |                  |                  | x               |
| Brazil                      |                  |                  | x               |
| Bulgaria                    |                  |                  | x               |
| Canada                      | x                | x                | x               |
| Chile                       |                  |                  | x               |
| China, People's Republic of |                  |                  | x               |
| Colombia                    | x                |                  | x               |
| Cyprus                      |                  |                  | x               |
| Czech Republic              |                  |                  | x               |
| Denmark                     |                  |                  | x               |
| Ecuador                     |                  |                  | x               |
| El Salvador                 |                  |                  | x               |
| Estonia                     |                  |                  | x               |
| Egypt                       |                  |                  | x               |
| Finland                     |                  |                  | x               |
| France                      |                  |                  | x               |
| Germany                     |                  |                  | x               |
| Greece                      |                  |                  | x               |
| Guatemala                   | x                |                  | x               |
| Hungary                     |                  |                  | x               |
| Iceland                     |                  |                  | x               |
| India                       |                  |                  | x               |
| Ireland                     |                  |                  | x               |
| Israel                      |                  |                  | x *             |
| Italy                       |                  |                  | x               |
| Korea, Republic of (South)  |                  |                  | x               |
| Latvia                      |                  |                  | x               |
| Liechtenstein               |                  |                  | x               |
| Lithuania                   |                  |                  | x               |
| Luxembourg                  |                  |                  | x               |
| Malta                       |                  |                  | x               |
| Mexico                      | x                | x                | x               |
| Netherlands                 |                  |                  | x               |
| New Zealand                 |                  |                  | x               |
| Norway                      |                  |                  | x               |
| Oman, Sultanate of          |                  |                  | x               |
| Pakistan                    |                  |                  | x               |
| Panama                      | x                |                  | x               |
| Poland                      |                  |                  | x               |



| Country                    | Radio Modules    |                  |                 |
|----------------------------|------------------|------------------|-----------------|
|                            | 900 MHz (150 mW) | 900 MHz (1 Watt) | 2.4 GHz (65 mW) |
| Portugal                   |                  |                  | x               |
| Romania                    |                  |                  | x               |
| Saudi Arabia, Kingdom of   |                  |                  | x               |
| Singapore                  |                  |                  | x               |
| Slovakia                   |                  |                  | x               |
| Slovenia                   |                  |                  | x               |
| South Africa               |                  |                  | x               |
| Spain                      |                  |                  | x               |
| Sweden                     |                  |                  | x               |
| Switzerland                |                  |                  | x               |
| Taiwan (Republic of China) |                  |                  | x **            |
| Thailand                   |                  |                  | x               |
| Turkey                     |                  |                  | x               |
| United Arab Emirates       |                  |                  | x               |
| United Kingdom             |                  |                  | x               |
| United States of America   | x                | x                | x               |

Bulgaria - Authorization required for outdoor and public service use.

Canada- This Class A digital apparatus meets all requirements of the Canadian Interference Causing Equipment Regulations. Operation is subject to the following two conditions: (1) this device may not cause harmful interference, and (2) this device must accept any interference received, including interference that may cause undesired operation.

Cet appareil numérique de la classe A respecte toutes les exigences du Règlement sur le matériel brouilleur du Canada. Le présent appareil numérique n'émet pas de bruits radioélectriques dépassant les limites applicables aux appareils numériques de la Classe A prescrites dans le Règlement sur le brouillage radioélectrique édités par le ministère des Communications du Canada.

France - In Guyane (French Guiana) and La Réunion (Reunion Island), outdoor use not allowed.

\* Israel - DX80 and DX99 models are certified for the external antenna models only.

Italy - If used outside of own premises, general authorization is required.

Luxembourg - General authorization is required for public service.

\*\* Taiwan - Taiwan is certified to operate specific DX70, DX80, and DX99 models. For a list of specific models, refer to the certificate.

## 5 Additional Statements - 900 MHz

This device has been designed to operate with the antennas listed on Banner Engineering's website and having a maximum gain of 9 dBm. Antennas not included in this list or having a gain greater than 9 dBm are strictly prohibited for use with this device. The required antenna impedance is 50 ohms.

To reduce potential radio interference to other users, the antenna type and its gain should be so chosen such that the equivalent isotropically radiated power (EIRP) is not more than that permitted for successful communication.

## 5 Transmit Power Levels

The Sure Cross wireless products were certified for use in these countries using the standard antenna that ships with the product. When using other antennas, verify you are not exceeding the transmit power levels allowed by local governing agencies.

## 5.1 FCC Certification, 900 MHz, 1 Watt Radios

The DX80 Module complies with Part 15 of the FCC rules and regulations.

FCC ID: UE3RM1809 This device complies with Part 15 of the FCC Rules. Operation is subject to the following two conditions: (1) this device may not cause harmful interference, and (2) this device must accept any interference received, including interference that may cause undesired operation.

## 5.1 FCC Notices

**IMPORTANT:** The radio modules have been certified by the FCC for use with other products without any further certification (as per FCC section 2.1091). Changes or modifications not expressly approved by the manufacturer could void the user's authority to operate the equipment.

**IMPORTANT:** The radio modules have been certified for fixed base station and mobile applications. If modules will be used for portable applications, the device must undergo SAR testing.

**IMPORTANT:** If integrated into another product, the FCC ID label must be visible through a window on the final device or it must be visible when an access panel, door, or cover is easily removed. If not, a second label must be placed on the outside of the final device that contains the following text: Contains FCC ID: UE3RM1809.

### 5.1 Note

This equipment has been tested and found to comply with the limits for a Class B digital device, pursuant to Part 15 of the FCC Rules. These limits are designed to provide reasonable protection against harmful interference in a residential installation. This equipment generates, uses, and can radiate radio frequency energy and, if not installed and used in accordance with the instructions, may cause harmful interference to radio communications. However, there is no guarantee that interference will not occur in a particular installation. If this equipment does cause harmful interference to radio or television reception, which can be determined by turning the equipment off and on, the user is encouraged to try to correct the interference by one or more of the following measures:

- Reorient or relocate the receiving antenna,
- Increase the separation between the equipment and receiving module,
- Connect the equipment into an outlet on a circuit different from that to which the receiving module is connected, and/or
- Consult the dealer or an experienced radio/TV technician for help.

**Antenna WARNING:** This device has been tested with Reverse Polarity SMA connectors with the antennas listed in Table 1 Appendix A. When integrated into OEM products, fixed antennas require installation preventing end-users from replacing them with non-approved antennas. Antennas not listed in the tables must be tested to comply with FCC Section 15.203 (unique antenna connectors) and Section 15.247 (emissions).

### 5.1 FCC Approved Antennas

**WARNING:** This equipment is approved only for mobile and base station transmitting devices. Antenna(s) used for this transmitter must be installed to provide a separation distance of at least 20 cm from all persons and must not be collocated or operating in conjunction with any other antenna or transmitter.

DX80 Module may be used only with Approved Antennas that have been tested with this module.

| Model Number | Antenna Type                     | Maximum Gain | Minimum Required Cable/<br>Connector Loss |
|--------------|----------------------------------|--------------|---|
| -            | Integral Antenna                 | Unity gain   | 0   |
| BWA-901-x    | Omni, 1/4 wave dipole            | ≤2 dBi       | 0   |
| BWA-902-C    | Omni, 1/2 wave dipole, Swivel    | ≤2 dBi       | 0   |
| BWA-906-A    | Omni Wideband, Fiberglass Radome | ≤8.2 dBi     | 2.2 dB                                    |
| BWA-905-B    | Omni Base Whip                   | ≤7.2 dBi     | 1.2 dB                                    |
| BWA-9Y10-A   | Yagi                             | ≤10 dBi      | 4 dB                                      |

## 5.2 FCC Certification, 2.4GHz

The DX80 Module complies with Part 15 of the FCC rules and regulations.

FCC ID: UE300DX80-2400 This device complies with Part 15 of the FCC Rules. Operation is subject to the following two conditions: (1) this device may not cause harmful interference, and (2) this device must accept any interference received, including interference that may cause undesired operation.

### 5.2 FCC Notices

**IMPORTANT:** The DX80 Modules have been certified by the FCC for use with other products without any further certification (as per FCC section 2.1091). Changes or modifications not expressly approved by the manufacturer could void the user's authority to operate the equipment.

**IMPORTANT:** The DX80 Modules have been certified for fixed base station and mobile applications. If modules will be used for portable applications, the device must undergo SAR testing.

**IMPORTANT:** If integrated into another product, the FCC ID label must be visible through a window on the final device or it must be visible when an access panel, door, or cover is easily removed. If not, a second label must be placed on the outside of the final device that contains the following text: Contains FCC ID: UE300DX80-2400.

## 5.2 Note

This equipment has been tested and found to comply with the limits for a Class B digital device, pursuant to Part 15 of the FCC Rules. These limits are designed to provide reasonable protection against harmful interference in a residential installation. This equipment generates, uses, and can radiate radio frequency energy and, if not installed and used in accordance with the instructions, may cause harmful interference to radio communications. However, there is no guarantee that interference will not occur in a particular installation. If this equipment does cause harmful interference to radio or television reception, which can be determined by turning the equipment off and on, the user is encouraged to try to correct the interference by one or more of the following measures:

- Reorient or relocate the receiving antenna,
- Increase the separation between the equipment and receiving module,
- Connect the equipment into an outlet on a circuit different from that to which the receiving module is connected, and/or
- Consult the dealer or an experienced radio/TV technician for help.

Antenna Warning **WARNING:** This device has been tested with Reverse Polarity SMA connectors with the antennas listed in Table 1 Appendix A. When integrated into OEM products, fixed antennas require installation preventing end-users from replacing them with non-approved antennas. Antennas not listed in the tables must be tested to comply with FCC Section 15.203 (unique antenna connectors) and Section 15.247 (emissions).

## 5.2 FCC Approved Antennas

**WARNING:** This equipment is approved only for mobile and base station transmitting devices. Antenna(s) used for this transmitter must be installed to provide a separation distance of at least 20 cm from all persons and must not be collocated or operating in conjunction with any other antenna or transmitter.

DX80 Module may be used only with Approved Antennas that have been tested with this module.

| Model Number | Antenna Type                  | Maximum Gain |
|--------------|-------------------------------|--------------|
|              | Integral antenna              | Unity gain   |
| BWA-202-C    | Omni, 1/2 wave dipole, Swivel | ≤2 dBi       |
| BWA-205-C    | Omni, Collinear, Swivel       | ≤5 dBi       |
| BWA-207-C    | Omni, Coaxial Sleeve, Swivel  | ≤7 dBi       |

## 6 Dimensions

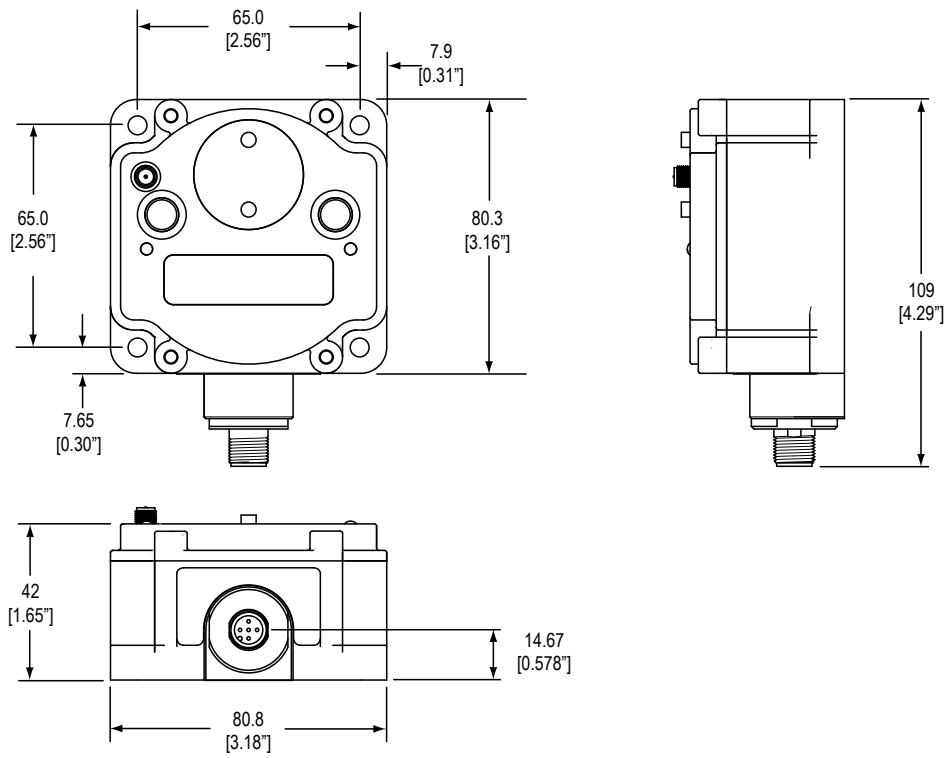

Figure 3. MultiHop Radio, Low Profile Housing

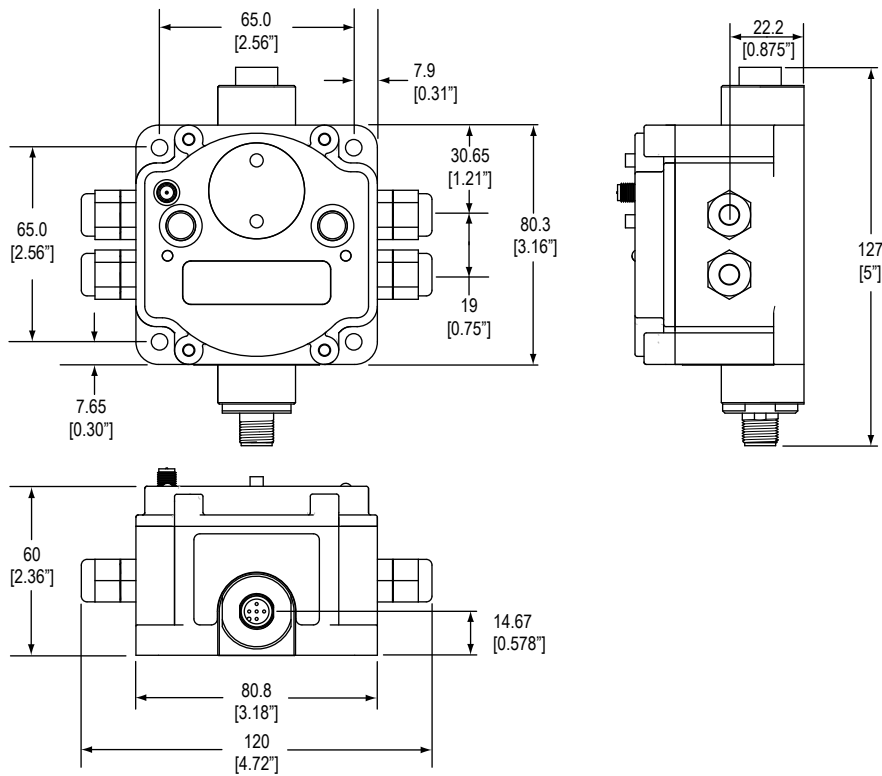
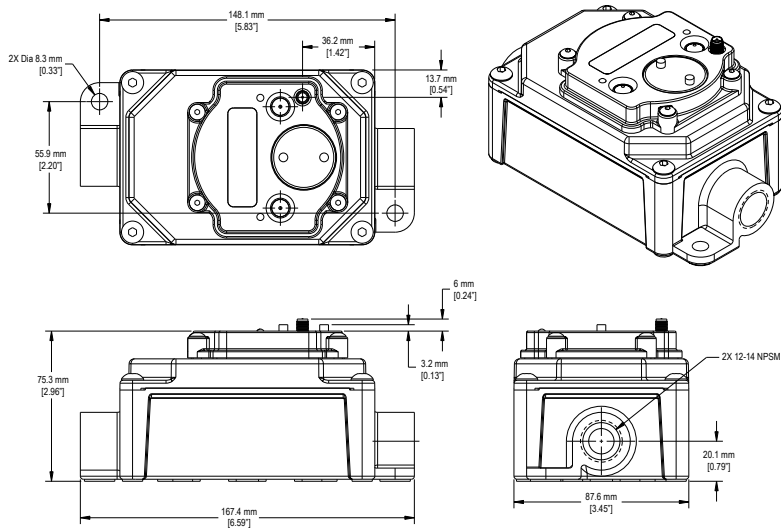

Figure 4. MultiHop Radio with I/O

## 6.1 DX80...E Housings



# 7 Advanced Setup

## 7.1 MultiHop Radio Menu System



When power is applied, the MultiHop radio begins running. The display screen autoscrolls through the \*RUN menu and communication between the devices is enabled. Autoscrolling through the \*RUN menu is the normal operating mode for all devices on the wireless network.

Access the menu system using the push buttons and the LCD.

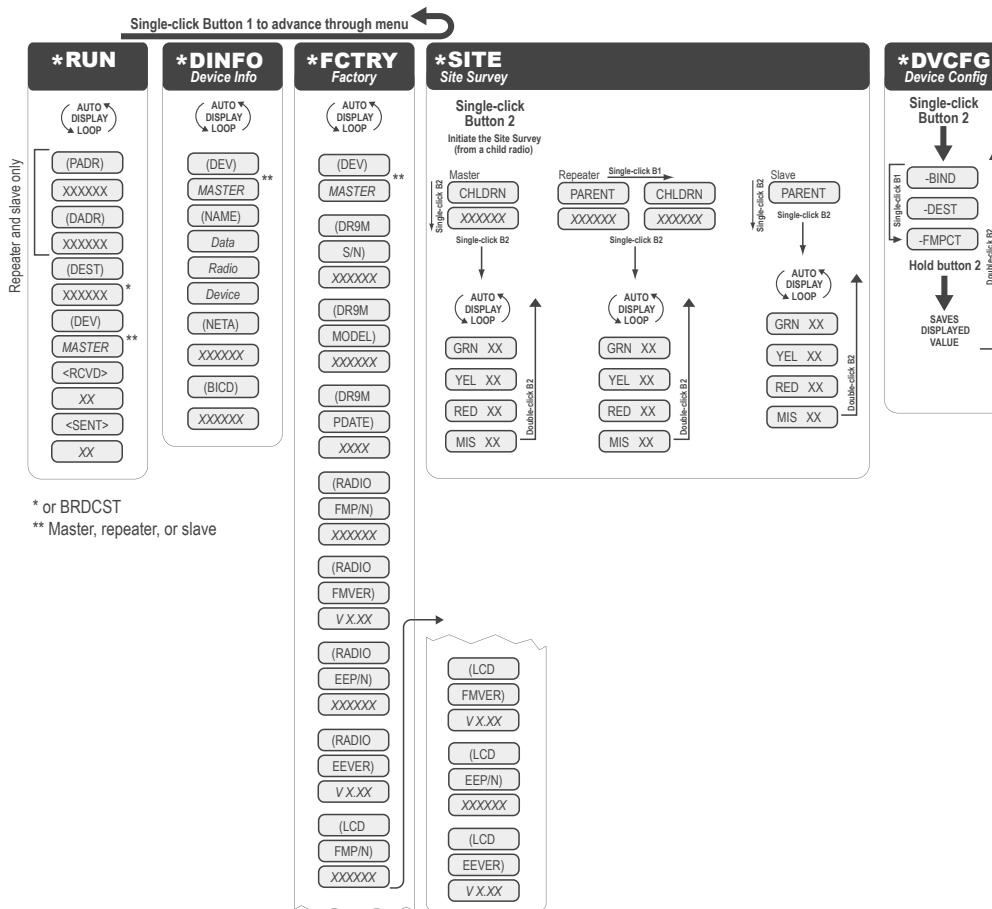

From the \*RUN Menu (or any menu), single-click button 1 to advance through the top-level menus. Top-level menus are displayed on the LCD with an asterisk (\*) in front of the menu name.

Double-click button 2 to pause or resume the auto display loop. Use button 1 to advance through the items in that menu. (Enter "auto scrolled" menus by double clicking button 2. Enter the other menus by single clicking button 2.)

### 7.1 RUN

The RUN menu displays the network ID, parent address, device address, current destination address, operational mode (master, repeater, slave), and the number of received and sent data packets.

PADR. Parent's device address, a unique number based on the parent device's serial number and assigned by the factory. The PADR is the 6-digit serial number minus 65535.

DADR. Device address, a unique number based on the serial number and assigned by the factory. The DADR is the 6-digit serial number minus 65535.

DEST. The current destination address to route messages. When this displays BRDCST, the device is either in transparent mode and is broadcasting the messages to all devices, or the device is in the early stages of Modbus mode and is broadcasting messages to determine the paths to specific device addresses.

RCVD. The number of serial messages received.

SENT. The number of serial messages sent.

## 7.1 DINFO (Device Info)

The DINFO menu displays the device information.

(NAME). An 18-character name users may assign to the device.

(NETA). Network Address (display only).

(BICD). Binding Code (display only).

## 7.1 FCTRY (Factory)

The FCTRY menu displays the factory information about the device, including the model, dates of manufacture, and version numbers.

S/N. The device's serial number.

Model #. The DX80DR9M family model number.

PDate. Production date.

Radio FMP/N. Firmware part number.

## 7.1 SITE (Site Survey)

Single-click button 2 to pause/resume the auto display loop. While paused, use button 1 to advance through the GRN, YEL, RED, and MIS displays.

## 7.1 DVCFG (Device Configuration)

Single-click button 2 to enter this menu. Use button 1 to move through the options in this menu.

-BIND. Binding Code. Single click button 2 to manually set the binding code. Once in the binding code command, use button 2 to select the digits; use button 1 to increment the selected digit. Press and hold button 2 to save the new binding code. The device asks if you want to save the new setting (button 2) or discard the new setting and reselect (button 1).

-DEST. Destination Address. To force message routing when operating in transparent mode, set a specific destination address.

-FMPCT. Formation percentage, default value of 50%. This device will not form a parent/child relationship with a parent radio that misses more than 50% of the timing beacons (approximately a 25% site survey link value). If the only option for a child is a parent with a less than a 25% site survey link value, change this value.

## 7.2 Binding Mode: What Does MultiHop Binding Do?

---

Binding MultiHop radios ensures all MultiHop radios within a network communicate only with other radios within the same network. The MultiHop radio master automatically generates a unique binding code when the radio master enters binding mode. This code is then transmitted to all radios within range that are also in binding mode. After a repeater/slave is bound, the repeater/slave radio accepts data only from the master to which it is bound. The binding code defines the network, and all radios within a network must use the same binding code.

After binding your MultiHop radios to the master radio, make note of the binding code displayed under the \*DVCFG > - BIND menu on the LCD. Knowing the binding code prevents having to re-bind all radios if the master is ever replaced.

## 7.2.1 Manually Bind the MultiHop Radios to Create the Network (using Menu Navigation)

To quickly replace radios or create ready-to-go spares in an existing network, use the manual binding feature to preset the binding code.

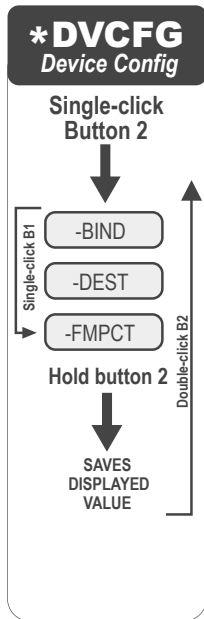

Normally, all devices are bound together before they are physically installed. In a replacement situation, the master device may not always be accessible. Using the manual binding process eliminates the need to put the master device into binding mode and allows the wireless network to remain operational.

To manually enter a binding code:

1. Single click button 1 to advance to the \*DVCFG menu.1.
2. Single click button 2 to enter the DVCFG menu.2. -BIND displays on the screen as the first option under DVCFG.
3. Single click button 2 to display the binding code. Record this number if this is the binding code you are copying.3.
4. To change this binding code, use button 1 to increment the blinking digit. Use button 2 to advance, from left to 4. right, to the next digit.
5. When you are finished making changes, press and hold down button 2 to save your changes. When the screen 5. reads SAVE, release button 2.
6. The device confirms your request to save. Press button 1 to reject your changes. Press button 2 to save your 6. changes.
7. Double-click button 2 to exit the DVCFG menu.

## 7.3 Conduct a Site Survey using Modbus Commands

When triggering a site survey from a Modbus master/host system, only the child radio is used to start the site survey. While the site survey is running, you will not be able to communicate with the radio slave. To trigger a site survey using a Modbus master/host-controlled system, follow these steps:

1. Write zeros (0) to the child radio's Site Survey Results registers: 46452 through 46455.
2. Write a one (1) to the child radio's External Site Survey Control register: 46451  
The site survey between the child radio and its parent radio begins. Unlike other site survey processes, this method of triggering a site survey results in only 100 packets sent between the parent and child.
3. Wait about 10 seconds for the site survey to complete.  
After the 100 packets are sent, the site survey shuts down automatically.
4. Read the child radio's results registers.

Register 46452 contains the green signal strength results. Register 46453 contains the yellow signal strength results. Register 46454 contains the red signal strength results. Register 46455 contains the number of missed packets.



## 7.4 Using 10 to 30V dc to Power the MultiHop Radio and a Gateway

When using 10 to 30 V dc (Outside the USA: 12 to 24 V dc,  $\pm 10\%$ ) to power both the MultiHop data radio and a Gateway, use the 4-pin Euro-style splitter cable to avoid damaging either radio.



- 1 CSB-M1240M1241. Splitter cable, 4-pin Euro-style QD, No trunk male, two female branches, yellow. Use to connect the data radio to the Gateway.
- 2 DX80DR9M-Hx. MultiHop Data Radio powered by 10 to 30 V dc (Outside the USA: 12 to 24 V dc,  $\pm 10\%$ )
- 3 DX80 Gateway, powered by 10 to 30 V dc (Outside the USA: 12 to 24 V dc,  $\pm 10\%$ )

## 7.5 Using the Solar Supply to Power the MultiHop Radio and a FlexPower Gateway

When using the FlexPower Solar Supply to power both the data radio and the FlexPower Gateway, use the 5-pin Euro-style splitter cable.



- 1 CSRB-M1250M125.47M125.73. Splitter cable, 5-pin Euro-style QD, No trunk male, two female branches, black. Most commonly used with solar and other FlexPower devices. Splitter cable, 5-pin Euro-style QD, No trunk male, two female branches, black. Most commonly used with solar and other FlexPower devices.
- 2 DX80DR9M-Hx. MultiHop Data Radio
- 3 DX80 FlexPower Gateway

## 8 Accessories

The accessories list includes FCC approved antennas, antenna cabling, surge suppressors, power supplies, replacement batteries, enclosures, cables, and other hardware.

### 8.1 Selecting an Enclosure

Select the enclosure size based on what you intend to mount inside it. Always select the largest enclosure you can to allow for future expansion.



6 × 6 inch: Fits a single DX80.

10 × 8 inch: Fits a power supply, surge suppressor, a single DX80, and a few relays. This is a popular size but can get cramped.

12 × 10 inch: This is the recommended size; provides ample room for multiple radios and accessories.

#### 8.1.1 Enclosures

##### 8.1.1 Polycarbonate Enclosures

| With Opaque Covers           |   |            |
|------------------------------|---|------------|
| Models                       | Description   | List Price |
| <a href="#">BWA-AH664</a>    | Enclosure, Polycarbonate, with Opaque Cover, 6 × 6 × 4    | \$93       |
| <a href="#">BWA-AH864</a>    | Enclosure, Polycarbonate, with Opaque Cover, 8 × 6 × 4    | \$98       |
| <a href="#">BWA-AH1084</a>   | Enclosure, Polycarbonate, with Opaque Cover, 10 × 8 × 4   | \$120      |
| <a href="#">BWA-AH12106</a>  | Enclosure, Polycarbonate, with Opaque Cover, 12 × 10 × 6  | \$166      |
| <a href="#">BWA-AH14126</a>  | Enclosure, Polycarbonate, with Opaque Cover, 14 × 12 × 6  | \$195      |
| <a href="#">BWA-AH16148</a>  | Enclosure, Polycarbonate, with Opaque Cover, 16 × 14 × 8  | \$220      |
| <a href="#">BWA-AH181610</a> | Enclosure, Polycarbonate, with Opaque Cover, 18 × 16 × 10 | \$260      |

| With Clear Covers           |  |            |
|-----------------------------|--|------------|
| Models                      | Description  | List Price |
| <a href="#">BWA-AH664C</a>  | Enclosure, Polycarbonate, with Clear Cover, 6 × 6 × 4  | \$100      |
| <a href="#">BWA-AH864C</a>  | Enclosure, Polycarbonate, with Clear Cover, 8 × 6 × 4  | \$111      |
| <a href="#">BWA-AH1084C</a> | Enclosure, Polycarbonate, with Clear Cover, 10 × 8 × 4 | \$141      |

| With Clear Covers             |  |            |
|-------------------------------|--|------------|
| Models                        | Description  | List Price |
| <a href="#">BWA-AH12106C</a>  | Enclosure, Polycarbonate, with Clear Cover, 12 × 10 × 6  | \$185      |
| <a href="#">BWA-AH14126C</a>  | Enclosure, Polycarbonate, with Clear Cover, 14 × 12 × 6  | \$204      |
| <a href="#">BWA-AH16148C</a>  | Enclosure, Polycarbonate, with Clear Cover, 16 × 14 × 8  | \$250      |
| <a href="#">BWA-AH181610C</a> | Enclosure, Polycarbonate, with Clear Cover, 18 × 16 × 10 | \$290      |

| Swing Panel Kits |  |            |
|------------------|--|------------|
| Models           | Description  | List Price |
| BWA-AH66SPK      | Swing Panel Kit, 6 × 6, Includes Mounts, Screws, and Panel   | \$54       |
| BWA-AH86SPK      | Swing Panel Kit, 8 × 6, Includes Mounts, Screws, and Panel   | \$55       |
| BWA-AH108SPK     | Swing Panel Kit, 8 × 10, Includes Mounts, Screws, and Panel  | \$60       |
| BWA-AH1210SPK    | Swing Panel Kit, 12 × 10, Includes Mounts, Screws, and Panel | \$65       |
| BWA-AH1412SPK    | Swing Panel Kit, 14 × 12, Includes Mounts, Screws, and Panel | \$70       |
| BWA-AH1614SPK    | Swing Panel Kit, 16 × 14, Includes Mounts, Screws, and Panel | \$75       |
| BWA-AH1816SPK    | Swing Panel Kit, 18 × 16, Includes Mounts, Screws, and Panel | \$80       |

| Back Panel Kits |                               |            |
|-----------------|-------------------------------|------------|
| Models          | Description                   | List Price |
| BWA-BP66A       | Back Panel, Aluminum, 6 × 6   | \$16       |
| BWA-BP86A       | Back Panel, Aluminum, 8 × 6   | \$17       |
| BWA-BP108A      | Back Panel, Aluminum, 10 × 8  | \$21       |
| BWA-BP1210A     | Back Panel, Aluminum, 12 × 10 | \$24       |
| BWA-BP1412A     | Back Panel, Aluminum, 14 × 12 | \$28       |
| BWA-BP1614A     | Back Panel, Aluminum, 16 × 14 | \$32       |
| BWA-BP1816A     | Back Panel, Aluminum, 18 × 16 | \$38       |

| DIN Rail Kits (Self-Threading Screws) |  |            |
|---------------------------------------|--|------------|
| Models                                | Description  | List Price |
| BWA-AH6DR                             | DIN Rail Kit, 6", Includes 2 Trilobular/Self-Threading Screws, and DIN Rail  | \$12       |
| BWA-AH8DR                             | DIN Rail Kit, 8", Includes 2 Trilobular/Self-Threading Screws, and DIN Rail  | \$14       |
| BWA-AH10DR                            | DIN Rail Kit, 10", Includes 2 Trilobular/Self-Threading Screws, and DIN Rail | \$16       |
| BWA-AH12DR                            | DIN Rail Kit, 12", Includes 2 Trilobular/Self-Threading Screws, and DIN Rail | \$18       |
| BWA-AH14DR                            | DIN Rail Kit, 14", Includes 2 Trilobular/Self-Threading Screws, and DIN Rail | \$20       |
| BWA-AH16DR                            | DIN Rail Kit, 16", Includes 2 Trilobular/Self-Threading Screws, and DIN Rail | \$22       |
| BWA-AH18DR                            | DIN Rail Kit, 18", Includes 2 Trilobular/Self-Threading Screws, and DIN Rail | \$24       |
| BWA-AHTBS                             | Trilobular/Self-Threading Screws, #10-32 × 0.375 PHL PH ZINC, 10 pack        | \$6        |

| DIN Rail Kits (Machine Screws and Slot Nuts) |   |            |
|--|---|------------|
| Models                                       | Description   | List Price |
| BWA-AH6DRK                                   | DIN Rail Kit, 6", Includes 2 Slot Nuts, 2 Machine Screws, and DIN Rail  | \$30       |
| BWA-AH8DRK                                   | DIN Rail Kit, 8", Includes 2 Slot Nuts, 2 Machine Screws, and DIN Rail  | \$31.50    |
| BWA-AH10DRK                                  | DIN Rail Kit, 10", Includes 2 Slot Nuts, 2 Machine Screws, and DIN Rail | \$33       |
| BWA-AH12DRK                                  | DIN Rail Kit, 12", Includes 2 Slot Nuts, 2 Machine Screws, and DIN Rail | \$35       |
| BWA-AH14DRK                                  | DIN Rail Kit, 14", Includes 2 Slot Nuts, 2 Machine Screws, and DIN Rail | \$36       |
| BWA-AH16DRK                                  | DIN Rail Kit, 16", Includes 2 Slot Nuts, 2 Machine Screws, and DIN Rail | \$38       |
| BWA-AH18DRK                                  | DIN Rail Kit, 18", Includes 2 Slot Nuts, 2 Machine Screws, and DIN Rail | \$39       |

| Accessories |  |            |
|-------------|--|------------|
| Models      | Description  | List Price |
| BWA-AHSNK   | Slot Nut Kit, Includes 2 Nuts and 2 Screws                                       | \$25       |
| BWA-AHSPM   | Swing Panel Mounts (4 per Kit)   | \$35       |
| BWA-AHLK    | Latch Kit, 2 Latches per Kit, Replacement Only                                   | \$12       |
| BWA-AHAK    | Accessory Kit, Includes all screws, inserts, and mounting feet, Replacement Only | \$15       |

### 8.1.1 Fiberglass Enclosures

| Models                      | Description                                | List Price |   |
|-----------------------------|--|------------|---|
| <a href="#">BWA-EF14128</a> | Enclosure Fiberglass Hinged 14" x 12" x 8" | \$180      |  |
| <a href="#">BWA-EF1086</a>  | Enclosure Fiberglass Hinged 10" x 8" x 6"  | \$95       |   |
| <a href="#">BWA-EF866</a>   | Enclosure Fiberglass Hinged 8" x 6" x 6"   | \$120      |   |
| BWA-PANEL-1412              | Panel, 14 x 12                             | \$26       |   |
| BWA-PANEL-108               | Panel, 10 x 8                              | \$22       |   |
| BWA-PANEL-86                | Panel, 8 x 6                               | \$10       |   |
| BWA-PM12                    | Pole Mount, 12 inch                        | \$73       |   |
| BWA-PM8                     | Pole Mount, 8 inch                         | \$55       |   |
| BWA-PM6                     | Pole Mount, 6 inch                         | \$52       |   |

## 8.2 Selecting an Antenna

Select your antenna based on your specific application needs. There are three basic antenna solutions:

- Use the supplied rubber duck antenna inside the enclosure. DX80 products come with a 2 dBi rubber duck antenna. Often simply attaching the supplied antenna to the radio provides enough radio range to meet your needs.
- Mount a dome antenna to the enclosure. The -D antennas can be mounted directly on the enclosure.
- Use an N-type pole-mounted antenna, with surge suppressor. The -A and -AS antennas can be mounted remotely from the enclosure and require the BWC-LFNBMN-DC surge suppressor.

## 8.2.1 Antennas: Rubber RP-SMA

The following rubber, or rubber duck, antennas have an RP-SMA male connection.

### Omni-Directional Antennas with RP-SMA Male Connections

| Models                    | Frequency | Description  | List Price |
|---------------------------|-----------|--|------------|
| <a href="#">BWA-902-C</a> | 900 MHz   | 2 dBi, Rubber swivel (ships with 900 MHz radios)               | \$25       |
| <a href="#">BWA-905-C</a> |           | 5 dBi, Rubber swivel   | \$60       |
| <a href="#">BWA-202-C</a> | 2.4 GHz   | 2 dBi, Rubber swivel, 3 1/4 inches (ships with 2.4 GHz radios) | \$25       |
| <a href="#">BWA-205-C</a> |           | 5 dBi, Rubber swivel, 6 1/2 inches                             | \$28       |
| <a href="#">BWA-207-C</a> |           | 7 dBi, Rubber swivel, 9 1/4 inches                             | \$37       |



| Models     | Frequency | Description                     | List Price |
|------------|-----------|---------------------------------|------------|
| BWA-902-RA | 900 MHz   | 2 dBi, Rubber fixed right angle | \$25       |



| Models      | Frequency | Description                | List Price |
|-------------|-----------|----------------------------|------------|
| BWA-201-001 | 2.4 GHz   | 1 dBi, Rubber, 1 inch tall | \$15       |



## 8.2.2 Antennas: Dome

### Omni-Directional Dome Antennas

| Models                    | Frequency | Description          | Connection                    | List Price |
|---------------------------|-----------|----------------------|-------------------------------|------------|
| <a href="#">BWA-902-D</a> | 900 MHz   | 2 dBi, 18-inch cable | RP-SMA Box Mount <sup>4</sup> | \$95       |
| <a href="#">BWA-202-D</a> | 2.4 GHz   |                      |                               | \$95       |



## 8.2.3 Antennas: Other

| Models    | Frequency | Description                               | Connection  | List Price |
|-----------|-----------|---|-------------|------------|
| BWA-205-M | 2.4 GHz   | 5 dBi, Magnetic whip antenna, 12 ft cable | RP-SMA Male | \$80       |



<sup>4</sup> For remote mounting options, use bracket SMBAMS18RA listed in the [Brackets and Mounting Options](#) on page 57 section.

## 8.2.4 Antennas: Fiberglass N-Type

The following fiberglass antennas are typically used outdoors.

### Omni-Directional Fiberglass Antennas with N-Type Female Connections

| Models                     | Frequency | Description  | List Price |
|----------------------------|-----------|--|------------|
| <a href="#">BWA-906-A</a>  | 900 MHz   | 6 dBd, Fiberglass, Full wave, 71.5 inches                | \$355      |
| <a href="#">BWA-208-A</a>  | 2.4 GHz   | 8.5 dBi, Fiberglass, 24 inches                           | \$200      |
| <a href="#">BWA-206-A</a>  |           | 6 dBi, Fiberglass, 16 inches (shown)                     | \$125      |
| <a href="#">BWA-906-AS</a> | 900 MHz   | 6 dBi, Fiberglass, 1/4 Wave, 23.6 inches (1.3 inch dia.) | \$120      |
| <a href="#">BWA-908-AS</a> |           | 8 dBi, Fiberglass, 3/4 Wave, 63 inches (1.5 inch dia.)   | \$215      |



## 8.2.5 Antennas: Yagi N-Type

### Directional (Yagi) Antennas with an N-Type Female Connection

| Models                     | Frequency | Description                      | List Price |
|----------------------------|-----------|----------------------------------|------------|
| <a href="#">BWA-9Y6-A</a>  | 900 MHz   | 6.5 dBd, 6.8 × 13 inches Outdoor | \$135      |
| <a href="#">BWA-9Y10-A</a> |           | 10 dBd, 6.8 × 24 inches Outdoor  | \$150      |



## 8.2.6 Antenna Cables: RP-SMA to RP-SMA

Use these cables to connect a radio to a bulkhead surge suppressor or a bulkhead surge suppressor to an RP-SMA antenna. These cables are typically used inside an enclosure or without an enclosure.

### RP-SMA to RP-SMA Antenna Cables

| Models         | Description  | List Price |
|----------------|--|------------|
| BWC-1MRSFRS0.2 | RG58, RP-SMA Male to RP-SMA Female Bulkhead, 0.2 m | \$29       |
| BWC-1MRSFRS1   | RG58, RP-SMA Male to RP-SMA Female Bulkhead, 1 m   | \$31       |
| BWC-1MRSFRS2   | RG58, RP-SMA Male to RP-SMA Female Bulkhead, 2 m   | \$33       |
| BWC-1MRSFRS4   | RG58, RP-SMA Male to RP-SMA Female Bulkhead, 4 m   | \$36       |



| Models        | Description                                | List Price |
|---------------|--|------------|
| BWC-2MRSFRS3  | LMR200, RP-SMA Male to RP-SMA Female, 3 m  | \$50       |
| BWC-2MRSFRS6  | LMR200, RP-SMA Male to RP-SMA Female, 6 m  | \$60       |
| BWC-2MRSFRS9  | LMR200, RP-SMA Male to RP-SMA Female, 9 m  | \$70       |
| BWC-2MRSFRS12 | LMR200, RP-SMA Male to RP-SMA Female, 12 m | \$80       |

## 8.2.7 Antenna Cables: RP-SMA to N-Type

Use an LMR100 cable to connect a radio to an N-type antenna, N-type antenna extension cable, or N-type surge suppressor. These cables may be used inside or outside the enclosure or without an enclosure.

| Model        | Description                         | List Price |
|--------------|-------------------------------------|------------|
| BWC-1MRSMN05 | LMR100 RP-SMA to N-Type Male, 0.5 m | \$40       |
| BWC-1MRSMN2  | LMR100 RP-SMA to N-Type Male, 2 m   | \$50       |



## 8.2.8 Antenna Cables: N-Type



These LMR400 cables are antenna extension cables, connecting an N-type antenna to another N-type antenna cable. These cables are usually used outside the enclosure.

| Models      | Description                               | List Price |
|-------------|---|------------|
| BWC-4MNFN3  | LMR400 N-Type Male to N-Type Female, 3 m  | \$77       |
| BWC-4MNFN6  | LMR400 N-Type Male to N-Type Female, 6 m  | \$92       |
| BWC-4MNFN15 | LMR400 N-Type Male to N-Type Female, 15 m | \$156      |
| BWC-4MNFN30 | LMR400 N-Type Male to N-Type Female, 30 m | \$296      |



## 8.2.9 Surge Suppressors

Always install and properly ground a qualified surge suppressor when installing a remote antenna system (antenna not directly connected to the SureCross radio). Remote antenna configurations installed without a surge suppressor invalidate the manufacturer's warranty.



| Model         | Description                                     | Connection                 | List Price |   |
|---------------|---|----------------------------|------------|---|
| BWC-LMRSFRPB  | Surge Suppressor, Bulkhead, RP-SMA Type         | RP-SMA to RP-SMA           | \$111      |  |
| BWC-LFNBMN-DC | Surge Suppressor, bulkhead, N-Type, dc Blocking | N-Type Female, N-Type Male | \$120      |  |

## 8.3 Power Supplies



### 8.3.1 DC Power Supplies

| Models | Description   | List Price |   |
|--------|---|------------|---|
| PS24W  | DC Power Supply, 500 mA, 24 V dc, Demo kit power supply | \$49       |  |

## MultiHop Radios

| Models                       | Description  | List Price |   |
|------------------------------|--|------------|---|
| <a href="#">PSDINM-24-04</a> | DC Power Supply, 0.4 Amps, 24 V dc, with DIN Rail Mount  | \$35       |  |
| <a href="#">PSDINM-24-10</a> | DC Power Supply, 1.0 Amps, 24 V dc, with DIN Rail Mount  | \$40       |   |
| <a href="#">PSDINM-24-17</a> | DC Power Supply, 1.7 Amps, 24 V dc, with DIN Rail Mount  | \$54       |   |
| <a href="#">PSDINM-24-25</a> | DC Power Supply, 2.5 Amps, 24 V dc, with DIN Rail Mount  | \$60       |   |
| <a href="#">PSDINP-24-06</a> | DC Power Supply, 0.63 Amps, 24 V dc, with DIN Rail Mount, Class I Division 2 (Groups A, B, C, D) Rated | \$80       |  |
| <a href="#">PSDINP-24-13</a> | DC Power Supply, 1.3 Amps, 24 V dc, with DIN Rail Mount, Class I Division 2 (Groups A, B, C, D) Rated  | \$127      |   |
| <a href="#">PSDINP-24-25</a> | DC Power Supply, 2.5 Amps, 24 V dc, with DIN Rail Mount, Class I Division 2 (Groups A, B, C, D) Rated  | \$160      |   |

## 8.3.2 FlexPower Supplies and Replacement Batteries

| Power Supplies                      |   |            |   |
|-------------------------------------|---|------------|---|
| Models                              | Description   | List Price |   |
| <a href="#">DX81-LITH</a>           | Battery Supply Module with mounting hardware  | \$75       |   |
| <a href="#">DX81H</a>               | Battery Supply Module with mounting hardware, for DX99 polycarbonate housing devices  | \$145      |   |
| <a href="#">DX81P6</a>              | Battery Supply Module, six "D" cells, with mounting hardware  | \$395      |  |
| <a href="#">BWA-SOLAR PANEL 3W</a>  | Solar Panel, 12 V, 3 W, Multicrystalline, 188 × 195 × 15, Wall/Pole clamp style mounting bracket included                               | \$60       |  |
| <a href="#">BWA-SOLAR PANEL 5W</a>  | Solar Panel, 12 V, 5 W, Multicrystalline, 270 × 222 × 17, Wall/Pole clamp style mounting bracket included                               | \$75       |   |
| <a href="#">BWA-SOLAR PANEL 20W</a> | Solar Panel, 12 V, 20 W, Multicrystalline, 573 × 357 × 30, "L" style mounting bracket included  | \$165      |   |
| <a href="#">BWA-SOLAR CNTRL-12V</a> | Solar Controller, 6 A Load Current 12 V System Voltage, recommended for 20 watts or less solar panel AND Sealed Lead Acid Battery (SLA) | \$125      |   |

| Replacement Batteries for DX81x Models |   |            |   |
|--|---|------------|---|
| Model                                  | Description   | List Price |   |
| BWA-BATT-001                           | Lithium "D" cell, single, for DX81-LITH and DX81H Battery Supply Module | \$36       |  |



| Replacement Batteries for Wireless Q45 Sensor Models |   |            |  |
|--|---|------------|--|
| Model  | Description   | List Price |  |
| BWA-BATT-006   | Lithium "AA" cell, single, for Wireless Q45 Sensors | \$24       |  |



## 8.4 Relays

| Models                 | Description   | List Price |   |
|------------------------|---|------------|---|
| <i>IB6RP</i>           | Interface Relay Box, 18 to 26 V dc inputs, isolated relay outputs (not shown) | \$233      |   |
| <i>BWA-RELAY-12V</i>   | Relay, Blade Style with Base, 12 V  | \$29       |  |
| <i>BWA-RELAY-24V</i>   | Relay, Blade Style with Base, 24 V  | \$29       |   |
| <i>BWA-RH1B-UDC12V</i> | Relay, Blade Style, No Base, 12 V (replacement part)                          | \$21       |   |
| <i>BWA-RH1B-UDC24V</i> | Relay, Blade Style, No Base, 24 V (replacement part)                          | \$21       |   |
| <i>BWA-SH1B-05</i>     | Relay Base Only (replacement part)  | \$13       |   |

## 8.5 Brackets and Mounting Options

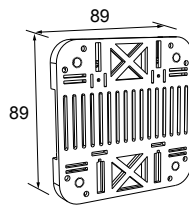
|  |  |            |
|--|--|------------|
| BWA-HW-001 Mounting Hardware Kit   |  | List Price |
| Screw, M5-0.8 x 25 mm, SS (4)<br>Screw, M5-0.8 x 16 mm, SS (4)<br>Hex nut, M5-0.8 mm, SS (4)<br>Bolt, #8-32 x 3/4", SS (4) |  | \$4        |
| Brackets   |  | List Price |
| SMBDX80DIN<br>Black reinforced thermoplastic<br>Bracket for mounting on a 35 mm DIN rail                                   |  | \$14       |

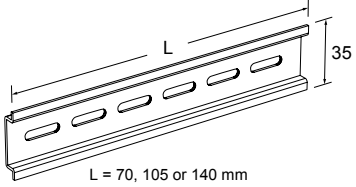

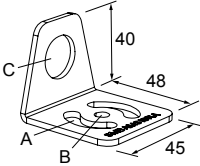
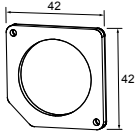
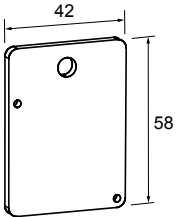
| Brackets  | List Price  |        |           |    |            |     |            |     |   |
|---|-------------|--------|-----------|----|------------|-----|------------|-----|---|
| <p>DIN-35-...</p> <p>35 mm DIN Rail</p> <table border="1" data-bbox="164 296 602 464"> <thead> <tr> <th>Model</th> <th>Length</th> </tr> </thead> <tbody> <tr> <td>DIN-35-70</td> <td>70</td> </tr> <tr> <td>DIN-35-105</td> <td>105</td> </tr> <tr> <td>DIN-35-140</td> <td>140</td> </tr> </tbody> </table>  <p>Hole center spacing: 35.1</p> <p>Hole size: 25.4 x 5.3</p>                                      | Model       | Length | DIN-35-70 | 70 | DIN-35-105 | 105 | DIN-35-140 | 140 | <p>70 mm (\$10)</p> <p>105 mm (\$11)</p> <p>140 mm (\$12)</p> |
| Model   | Length      |        |           |    |            |     |            |     |   |
| DIN-35-70   | 70          |        |           |    |            |     |            |     |   |
| DIN-35-105  | 105         |        |           |    |            |     |            |     |   |
| DIN-35-140  | 140         |        |           |    |            |     |            |     |   |
| <p>BWA-HW-034</p> <ul style="list-style-type: none"> <li>DIN rail clip, black plastic</li> </ul>    | <p>\$10</p> |        |           |    |            |     |            |     |   |
| <p>This standard Banner bracket can also be used to remotely mount dome antennas.</p> <p>SMBAMS18RA</p> <ul style="list-style-type: none"> <li>Right-angle SMBAMS series bracket with 18 mm hole</li> <li>Articulation slots for 90+° rotation</li> <li>12-ga. (2.6 mm) cold-rolled steel</li> </ul>  <p>Hole center spacing: A = 26.0, A to B = 13.0</p> <p>Hole size: A = 26.8 x 7.0, B = ø 6.5, C = ø 19.0</p> | <p>\$12</p> |        |           |    |            |     |            |     |   |
| <p>BWA-BK-001</p> <ul style="list-style-type: none"> <li>Includes magnetic mounting bracket SMB42FLM12 and 2 mounting screws</li> </ul>    | <p>\$50</p> |        |           |    |            |     |            |     |   |
| <p>BWA-BK-002</p> <ul style="list-style-type: none"> <li>Includes SMB42FL stainless steel bracket, 1/4"-28 screw mount, and 1 piece of 3M™ thermally conductive adhesive transfer tape</li> </ul>    | <p>\$25</p> |        |           |    |            |     |            |     |   |

| Brackets   | List Price |
|--|------------|
| <p>BWA-BK-004</p> <ul style="list-style-type: none"> <li>Mounts both the K50U Ultrasonic sensor and a Wireless Q45U Node or DX80 Node</li> </ul> |            |
| <p>BWA-BK-006</p> <ul style="list-style-type: none"> <li>Mounts both the K50U Ultrasonic sensor and a Wireless Q45U Node</li> </ul>              |            |

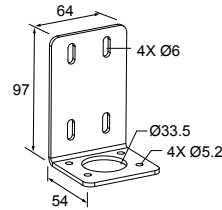
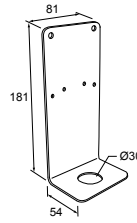

## 8.6 Other Accessories

### 8.6.1 Other Accessories

The following are other accessories available for the SureCross product line or available as stand-alone devices.

#### 8.6.1 GPS Modules

| Models        | Description  | Connection             |
|---------------|--|------------------------|
| <i>GPS50M</i> | Global Positioning System using Modbus RTU to communicate data | 2 meter integral cable |

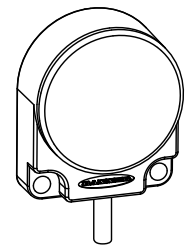

#### 8.6.2 DX85 Modbus RTU Remote I/O Devices

These remote I/O devices have a Modbus interface and are used to expand the I/O of the Gateway or the Modbus host.



DX85 IP67 Housing Model



DX85..C IP20 Housing Model

| Models                       | Description  | List Price |
|------------------------------|--|------------|
| <a href="#">DX85M6P6</a>     | DX85 Modbus RTU Remote I/O, 6 Discrete IN, 6 Discrete OUT  | \$475      |
| <a href="#">DX85M4P4M2M2</a> | DX85 Modbus RTU Remote I/O, 4 Discrete IN, 4 Discrete OUT, 2 Analog IN, 2 Analog OUT (0 to 20 mA)            | \$475      |
| <a href="#">DX85M4P8</a>     | DX85 Modbus RTU Remote I/O, 4 Discrete IN, 8 Discrete OUT  | \$475      |
| <a href="#">DX85M8P4</a>     | DX85 Modbus RTU Remote I/O, 8 Discrete IN, 4 Discrete OUT  | \$475      |
| <a href="#">DX85MOPOM4M4</a> | DX85 Modbus RTU Remote I/O, 4 Analog IN, 4 Analog OUT (0 to 20 mA)   | \$475      |
| <a href="#">DX85M-P7</a>     | DX85 Modbus RTU Remote I/O, Up to 12 sinking inputs or up to 12 NMOS sinking outputs (for a total of 12 I/O) | \$475      |
| <a href="#">DX85M-P8</a>     | DX85 Modbus RTU Remote I/O, Up to 12 sourcing inputs or up to 12 sourcing outputs (for a total of 12 I/O)    | \$475      |

Note: Add a "C" to the end of any DX85 model to order that I/O mix with an IP20 housing. The IP20 models are Class I, Division 2 certified when installed in a suitable enclosure.

### 8.6.3 Sensors

#### 8.6.3 Sensors Optimized for Use with FlexPower Devices

| Models          | Description  | Datasheet              | List Price |  |
|-----------------|--|------------------------|------------|--|
| SM312LPQD-78447 | MINI-BEAM, Low Power, 5V, Polarized Retroreflective, 3 m   | <a href="#">134420</a> | \$112      |  |
| SM312DQD-78419  | MINI-BEAM, Low Power, 5V, Diffuse, 38 cm   |                        | \$105      |  |
| QT50ULBQ6-75390 | Ultrasonic, QT50U, 200 mm to 8 m Range   |                        | \$626      |  |
| QS30WEQ         | WORLD-BEAM Photoelectric Emitter, QS30 (Max Range: 100 feet, 10x excess gain at 50 feet), 1-wire serial interface  | <a href="#">140987</a> | \$70       |  |
| QS30WRQ         | WORLD-BEAM Photoelectric Receiver, QS30 (Max Range: 100 feet, 10x excess gain at 50 feet), 1-wire serial interface |                        | \$91       |  |



| Models   | Description  | Datasheet              | List Price |   |
|----------|--|------------------------|------------|---|
| M12FTH3Q | Temperature and Humidity Sensor, RS-485 Modbus interface | <a href="#">163751</a> | \$185      |  |
| M12FT3Q  | Temperature Sensor, RS-485 Modbus interface              |                        | \$125      |   |

### 8.6.3 Other Sensors



| Models                    | Description  | List Price |
|---------------------------|--|------------|
| BWA-THERMISTOR-001        | NTC Thermistor, 2.2 KOhms, +/-0.2%C, blue bead (For models: DX80N9X2S2N2T/C, DX99N9X2S2N0T4X0A0, and DX99N9X1S2N0T4X0D0)       | \$9        |
| BWA-THERMISTOR-002        | NTC Thermistor, 10 KOhms, +/-0.2%C, black bead (For Performance models -P1/C/E, and MultiHop models M-H1/C/E), 2 pack          | \$12       |
| BWA-S612-30-100           | NoShok Series 612 Submersible Level Transmitter, model 612-30-1-1-N-100, 0 to 30 psig, 100' cable                              | \$979      |
| BWA-S612-15-100           | NoShok Series 612 Submersible Level Transmitter, model 612-15-1-1-N-100, 0 to 15 psig, 100' cable                              | \$979      |
| BWA-625-5000-1-1-8-25     | NoShok Series 625 Intrinsically Safe Pressure Transmitter, model 625-5000-1-1-8-25, 0 to 5000 psig, 1/2" NPT, 4-20mA, M12 QD   | \$753      |
| BWA-625-10000-1-1-8-25    | NoShok Series 625 Intrinsically Safe Pressure Transmitter, model 625-10000-1-1-8-25, 0 to 10000 psig, 1/2" NPT, 4-20mA, M12 QD | \$753      |
| BWA-P-RKGV 5.33T-1727-2.0 | Cable, female M12 4-pin, blue PVC, SS connector, for NoShok Series 625 IS Pressure Transmitter                                 |            |
| BWA-ACC-SEN-SDI           | Acclima SDI-12 Soil Moisture Transducer  | \$224      |

### Sensors with a Serial Interface

The following sensors are designed to be used with any of the 1-Wire Serial Interface Nodes.

| Models   | Description   | Datasheet              | List Price |   |
|----------|---|------------------------|------------|---|
| M12FTH4Q | Temperature and Humidity Sensor, $\pm 2\%$ Accuracy, 1-wire serial interface<br>(Requires a 5-pin threaded M12/Euro-style double-ended cordset less than 3 meters long, such as model DEE2R-5xD.) | <a href="#">162669</a> | \$175      |  |
| M12FT4Q  | Temperature Sensor with 1-wire serial interface<br>(Requires a 5-pin threaded M12/Euro-style double-ended cordset less than 3 meters long, such as model DEE2R-5xD.)                              |                        | \$115      |   |
| QM42VT1  | Vibration and Temperature Sensor with 1-wire serial interface   | <a href="#">186209</a> | \$195      |  |
| K50UX2RA | U-GAGE Ultrasonic Sensor with 1-wire serial interface   | <a href="#">191599</a> |            |  |

## Replacement Filters

| Replacement Filters | Description   |   |
|---------------------|---|---|
| FTH-FIL-001         | Aluminum grill filter cap (factory default, ships with M12FT*Q sensors)           |  |
| FTH-FIL-002         | Stainless steel, sintered to 10 micrometer porosity (for high dust environments.) |  |

## 8.6.4 Cables

### Ethernet Cables

Use a crossover cable to connect the GatewayPro or DX83 Ethernet Bridge to a host system without using an Ethernet switchbox or hub. When using a switchbox or hub, use a straight cable.

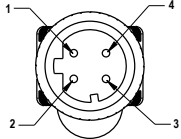
| RSCD RJ45 Ethernet to 4-Pin M12/Euro-Style Cordsets |               |                                 |            |  |
|---|---------------|---------------------------------|------------|--|
| Model   | Length        | Style                           | Dimensions | Pinout   |
| BWA-E2M   | 2 m (6.6 ft)  | Straight RSCD<br>RJ45 440       |            |  <ul style="list-style-type: none"> <li>1 = White/Orange (+Tx)</li> <li>2 = Orange (-Tx)</li> <li>3 = White/Blue (+Rx)</li> <li>4 = NIC</li> <li>5 = NIC</li> <li>6 = Blue (-Rx)</li> <li>7 = NIC</li> <li>8 = NIC</li> </ul>  <ul style="list-style-type: none"> <li>1 = White/Orange (+Tx)</li> <li>2 = White/Blue (+Rx)</li> <li>3 = Orange (-Tx)</li> <li>4 = Blue (-Rx)</li> </ul> |
| BWA-E8M   | 8 m (26.2 ft) |                                 |            |  |
| BWA-EX2M  | 2 m (6.6 ft)  | Crossover<br>RSCD RJ45CR<br>440 |            |  |

### Adapter Cables

| Models                                 | Description   | List Price |   |
|--|---|------------|---|
| <a href="#">BWA-HW-006</a>             | Adapter cable, USB to RS-485, for use with the User Configuration Tool software (UCT)   | \$132      |  |
| <a href="#">BWA-UCT-900</a><br>(shown) | Adapter cable with power, USB to RS-485, for use with the User Configuration Tool software (UCT), supplies power to 1 Watt radios | \$132      |   |



### Splitter Cables

Use CSRB-M1250M125.47M125.73 to split power between two *FlexPower* or solar powered devices. DO NOT use this cable to connect a *FlexPower* devices to a 10 to 30 V dc powered device.

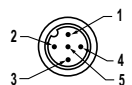
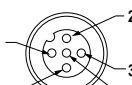
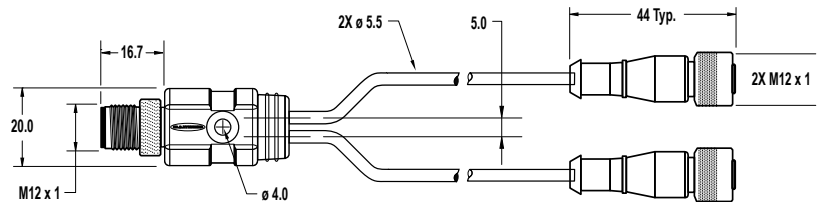
Use CSRB-M1253.28M1253.28M1253.28 to connect one *FlexPower* device (data radio, *FlexPower* Gateway, etc) to two power sources, such as the *FlexPower* Solar Supply and DX81P6 Battery Pack.

| 5-Pin Threaded M12/Euro-Style Splitter Cordsets—Rounded Junction                   |   |          |  |
|--|---|----------|--|
| Model  | Length  | Style    | Pinout   |
| CSRB-M1250M125.47M125.73   | Trunk: 0 m (male)<br>Branches: 0.14 m and 0.22 m (female) | Straight | <p>Male</p>  <p>Female</p>  <p>1 = Brown<br/>2 = White<br/>3 = Blue<br/>4 = Black<br/>5 = Gray</p> |
| CSRB-M1253.28M1253.28M1253.28  | Trunk: 1 m (female)<br>Branches: 1 m (male)               |          |  |
|  |   |          |  |

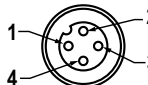
Use the following 4-pin splitter cables to split power between two 10 to 30 V dc powered devices, such as a data radio and Gateway, or between a DX85 and Gateway.

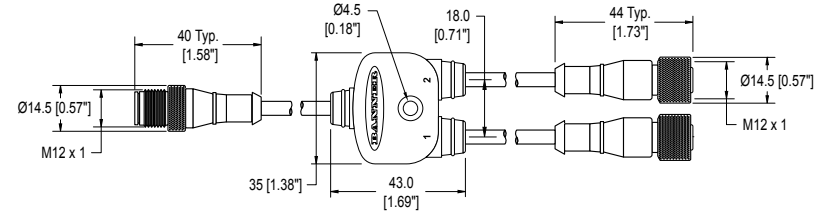
| 4-Pin Threaded M12/Euro-Style Splitter Cordsets—Flat Junction                        |                   |                             |  |
|--|-------------------|-----------------------------|--|
| Model  | Branches (Female) | Trunk (Male)                | Pinout   |
| CSB-M1240M1240   | No branch         | No trunk                    | <p>Female</p>  <p>Male</p>  <p>1 = Brown<br/>2 = White<br/>3 = Blue<br/>4 = Black</p> |
| CSB-M1240M1241   | 2 x 0.30 m (1 ft) | No trunk                    |  |
| CSB-M1241M1241   |                   | 0.30 m (1 ft)               |  |
| CSB-M1248M1241   |                   | 2.50 m (8 ft)               |  |
| CSB-M12415M1241  |                   | 4.57 m (15 ft)              |  |
| CSB-M12425M1241  |                   | 7.60 m (25 ft)              |  |
| CSB-UNT425M1241  |                   | 7.60 m (25 ft) Unterminated |  |
|  |                   |                             |  |

| Models     | Description  | List Price |   |
|------------|--|------------|---|
| BWA-HW-026 | Splitter cable, wall wart for external power split to 5-pin M12/Euro-style male and 5-pin M12/Euro-style female (to power a M-H at 1 Watt while configuring it through the MHCT) | \$75       |  |

| Other Splitter Cables          |  |            |
|--------------------------------|--|------------|
| Models                         | Description  | List Price |
| <a href="#">BWA-DRSPLITTER</a> | Splitter cable, DB9 Female (RS232) trunk to 5-pin M12/Euro-style male and female | \$43       |

### Euro-Style Cordsets - Single Ended

Right-angle cordsets are not compatible with the DX70 devices. When facing the Node or Gateway toward you and the quick disconnect connection is facing down, the right-angle cables exit to the right.

When using the FlexPower Node with integrated battery, use a double ended cordset. For a FlexPower Node with external power supply, use a single ended cordset. If using the communication lines, the cable length cannot exceed 3 meters, or 10 feet.

| 5-Pin Threaded M12/Euro-Style Cordsets—Single Ended |                 |             |            |                 |
|---|-----------------|-------------|------------|-----------------|
| Model   | Length          | Style       | Dimensions | Pinout (Female) |
| MQDC1-501.5   | 0.50 m (1.5 ft) | Straight    |            |                 |
| MQDC1-506   | 1.83 m (6 ft)   |             |            |                 |
| MQDC1-515   | 4.57 m (15 ft)  |             |            |                 |
| MQDC1-530   | 9.14 m (30 ft)  |             |            |                 |
| MQDC1-506RA   | 1.83 m (6 ft)   | Right-Angle |            |                 |
| MQDC1-515RA   | 4.57 m (15 ft)  |             |            |                 |
| MQDC1-530RA   | 9.14 m (30 ft)  |             |            |                 |

| Models      | Description  |
|-------------|--|
| BWA-QD5.5   | Prewired 5-pin M12/Euro-style quick disconnect (QD), 1/2-14 NBSM   |
| BWA-QD8.5   | Prewired, 8-pin M12/Euro-style quick disconnect (QD), 1/2-14 NBSM  |
| BWA-QD12.5  | Prewired 12-pin M12/Euro-style quick disconnect (QD), 1/2-14 NBSM  |
| FIC-M12F4   | 4-pin M12/Euro-style straight female field-wireable connector  |
| DEUR-506.6C | 1.83 m (6 ft) cordset with a 5-pin M12/Euro-style straight male quick disconnect (QD) and straight female QD                     |
| MQDMC-401   | 300 mm (12 in) cordset with a 4-pin M12/Euro-style straight male quick disconnect (QD), single ended, longer for DX80...C models |

### Euro-Style Cordsets - Double Ended

When using the FlexPower Node with integrated battery, use a double ended cordset. When using a FlexPower Node with external power supply, use a single ended cordset. If using the communication lines, the cable length cannot exceed 3 meters (10 ft).

| 5-Pin Threaded M12/Euro-Style Cordsets—Double Ended and Less Than 3 m Long |               |                                   |            |        |
|--|---------------|-----------------------------------|------------|--------|
| Model  | Length        | Style                             | Dimensions | Pinout |
| DEE2R-51D  | 0.31 m (1 ft) | Female Straight/<br>Male Straight |            | Male   |
| DEE2R-53D  | 0.91 m (3 ft) |                                   |            |        |
| DEE2R-58D  | 2.44 m (8 ft) |                                   |            |        |
|  |               |                                   |            |        |





## Other Cables

| Models         | Description                         | List Price |
|----------------|-------------------------------------|------------|
| BWA-RIBBON-001 | Ribbon cable, 20-pin DBL socket     | \$9        |
| BWA-HW-010     | Cable, FlexPower Current Monitoring | \$59       |

## 8.6.5 Hardware and Replacement Parts



| Models     | Description   | List Price |
|------------|---|------------|
| BWA-HW-002 | DX80 Access Hardware Kit<br>Plastic threaded plugs, PG-7 (4)<br>Nylon gland fittings, PG-7 (4)<br>Hex nuts, PG-7 (4)<br>Plug, 1/2-inch NPT<br>Nylon gland fitting, 1/2-inch NPT | \$25       |
| BWA-HW-003 | PTFE Tape, 1/4 inches wide, 600 inches long   | \$4        |
| BWA-HW-004 | Replacement Seals<br>O-ring, rotary access cover, PG21 (2)<br>O-ring, body gasket (2)<br>Access cover, rotary dials, clear plastic (2)  | \$5        |
| BWA-HW-009 | Solar assembly hardware pack, includes brackets, bolts, and set screws  | \$12       |
| BWA-HW-007 | Housing Kit, DX80, top and bottom, 10 pieces  | \$100      |
| BWA-HW-008 | Housing Kit, DX81, top and bottom, 10 pieces  | \$100      |
| BWA-HW-044 | Terminal header for the MultiHop Ethernet Data Radio  | \$15       |
| BWA-HW-011 | Terminal Block Headers, IP20, 2 pack  | \$22       |
| BWA-HW-012 | DX99 Antenna Extension Pack<br>Screw, M4-0.7 x 20, pan head, black steel<br>Flexible Antenna Cable, 12 inches, SMA male to SMA female   | \$42       |
| BWA-HW-032 | Access hardware for the E housing, one 1/2-inch plug, one 1/2-inch gland  | \$15       |
| BWA-HW-037 | Clear plastic retaining ring for DX99 metal housings, 10 pack   | \$20       |

## 8.6.6 Cable Glands and Plugs

| Models            | Description   | List Price |   |
|-------------------|---|------------|---|
| BWA-HP.5-10       | Dummy Hole Plugs, 1/2-inch NPT, 10 pieces   | \$5        |   |
| BWA-HW-031        | Vent Plug, 1/2" NPT, IP67   | \$50       |  |
| BWA-CG.5-10       | Cable Glands, 1/2-inch NPT, 10 pieces, Cordgrips for cable diameters 0.17" to 0.45" | \$32       |  |
| BWA-CG.5-3X5.6-10 | Cable Glands, 1/2-inch NPT, Cordgrip for 3 holes of 2.8 to 5.6 mm diam, 10 Pack     | \$32       |   |
| BWA-CG.5-2X2.5-10 | Cable Glands, 1/2-inch NPT, Cordgrip for 2 holes of 1.2 to 2.5 mm diam, 10 Pack     | \$32       |   |
| BWA-CG.5-6X4.0-10 | Cable Glands, 1/2-inch NPT, Cordgrip for 6 holes of 2 to 4 mm diam, 10 Pack         | \$32       |   |
| BWA-CG.5-6X3.0-10 | Cable Glands, 1/2-inch NPT, Cordgrip for 6 holes of 1.5 to 3 mm diam, 10 Pack       | \$32       |   |

 Shown with PTFE tape wrapping

### 8.6.7 Metal Housing Accessories

| Model No.    | Description   | List Price |   |
|--------------|---|------------|---|
| BWA-HW-016   | Antenna Feedthrough, Stainless Steel, 1/2" NPT  | \$62       |  |
| BWA-HW-017   | Antenna Feedthrough, Stainless Steel, 3/4" NPT  | \$66       |   |
| BWA-HW-012   | DX99 Antenna Extension Pack (M4-0.7 x 20 black steel pan head screw, flexible antenna cable 12" SMA male to SMA female) | \$42       |   |
| BWA-HW-037   | Clear plastic retaining ring for DX99 metal housings (10 pack)  | \$20       |   |
| BWA-AXFS0130 | AXF™ Explosion-Proof Antenna Coupler  |            |  |

| Omni-Directional Dome Antennas |           |                      |                  |            |  |
|--------------------------------|-----------|----------------------|------------------|------------|--|
| Models                         | Frequency | Description          | Connection       | List Price |  |
| BWA-902-001                    | 900 MHz   | 2 dBi, 18-inch cable | 1/2" SS NPT Port | \$140      |  |
| BWA-902-002                    |           | 2 dBi, 18-inch cable | 3/4" SS NPT Port | \$140      |  |
| BWA-202-001                    | 2.4 GHz   | 2 dBi, 18-inch cable | 1/2" SS NPT Port | \$140      |  |
| BWA-202-002                    |           | 2 dBi, 18-inch cable | 3/4" SS NPT Port | \$140      |  |

## 9 Copyright Notice

Any misuse, abuse, or improper application or installation of this product or use of the product for personal protection applications when the product is identified as not intended for such purposes will void the product warranty. Any modifications to this product without prior express approval by Banner Engineering Corp will void the product warranties. All specifications published in this document are subject to change: Banner reserves the right to modify product specifications or update documentation at any time. For the most recent version of any documentation, refer to: [www.bannerengineering.com](http://www.bannerengineering.com). © Banner Engineering Corp. All rights reserved.

### 9.1 Banner Engineering Corp Limited Warranty

Banner Engineering Corp. warrants its products to be free from defects in material and workmanship for one year following the date of shipment. Banner Engineering Corp. will repair or replace, free of charge, any product of its manufacture which, at the time it is returned to the factory, is found to have been defective during the warranty period. This warranty does not cover damage or liability for misuse, abuse, or the improper application or installation of the Banner product.

THIS LIMITED WARRANTY IS EXCLUSIVE AND IN LIEU OF ALL OTHER WARRANTIES WHETHER EXPRESS OR IMPLIED (INCLUDING, WITHOUT LIMITATION, ANY WARRANTY OF MERCHANTABILITY OR FITNESS FOR A PARTICULAR PURPOSE), AND WHETHER ARISING UNDER COURSE OF PERFORMANCE, COURSE OF DEALING OR TRADE USAGE.

This Warranty is exclusive and limited to repair or, at the discretion of Banner Engineering Corp., replacement. IN NO EVENT SHALL BANNER ENGINEERING CORP. BE LIABLE TO BUYER OR ANY OTHER PERSON OR ENTITY FOR ANY EXTRA COSTS, EXPENSES, LOSSES, LOSS OF PROFITS, OR ANY INCIDENTAL, CONSEQUENTIAL OR SPECIAL DAMAGES RESULTING FROM ANY PRODUCT DEFECT OR FROM THE USE OR INABILITY TO USE THE PRODUCT, WHETHER ARISING IN CONTRACT OR WARRANTY, STATUTE, TORT, STRICT LIABILITY, NEGLIGENCE, OR OTHERWISE.

Banner Engineering Corp. reserves the right to change, modify or improve the design of the product without assuming any obligations or liabilities relating to any product previously manufactured by Banner Engineering Corp.

### 9.2 Contact Us

#### Corporate Headquarters

Address:  
Banner Engineering Corporate  
9714 Tenth Avenue North  
Minneapolis, Minnesota 55441, USA

Phone: +1 763 544 3164  
Website: [www.bannerengineering.com](http://www.bannerengineering.com)

#### Europe

Address:  
Banner Engineering EMEA  
Park Lane Culliganlaan 2F  
Diegem B-1831, Belgium

Phone: +32 (0)2 456 0780  
Website: [www.bannerengineering.com/eu](http://www.bannerengineering.com/eu)  
Email: [mail@bannerengineering.com](mailto:mail@bannerengineering.com)

#### Turkey

Address:  
Banner Engineering Turkey  
Barbaros Mah. Uphill Court Towers A Blok D: 49  
34746 Batı Ataşehir İstanbul Türkiye

Phone: +90 216 688 8282  
Website: [www.bannerengineering.com.tr](http://www.bannerengineering.com.tr)  
Email: [turkey@bannerengineering.com.tr](mailto:turkey@bannerengineering.com.tr)

#### India

Address:  
Banner Engineering India Pune Head Quarters  
Office No. 1001, 10th Floor Sai Capital, Opp. ICC Senapati Bapat Road  
Pune 411016, India

Phone: +91 (0) 206 640 5624  
Website: [www.bannerengineering.co.in](http://www.bannerengineering.co.in)  
Email: [salesindia@bannerengineering.com](mailto:salesindia@bannerengineering.com)

#### Mexico

Address:  
Banner Engineering de Mexico Monterrey Head Office  
Edificio VAO Av. David Alfaro Siqueiros No.103 Col. Valle Oriente C.P.66269  
San Pedro Garza Garcia, Nuevo Leon, Mexico

Phone: +52 81 8363 2714 or 01 800 BANNERE (toll free)  
Website: [www.bannerengineering.com.mx](http://www.bannerengineering.com.mx)  
Email: [mexico@bannerengineering.com](mailto:mexico@bannerengineering.com)

## MultiHop Radios

### Brazil

Address:  
Banner do Brasil  
Rua Barão de Teffé nº 1000, sala 54  
Campos Elíseos, Jundiaí - SP, CEP.: 13208-761, Brasil

Phone: +1 763 544 3164  
Website: [www.bannerengineering.com.br](http://www.bannerengineering.com.br)  
Email: [brasil@bannerengineering.com](mailto:brasil@bannerengineering.com)

### China

Address:  
Banner Engineering Shanghai Rep Office  
Xinlian Scientific Research Building Level 12, Building 2  
1535 Hongmei Road, Shanghai 200233, China

Phone: +86 212 422 6888  
Website: [www.bannerengineering.com.cn](http://www.bannerengineering.com.cn)  
Email: [sensors@bannerengineering.com.cn](mailto:sensors@bannerengineering.com.cn)

### Japan

Address:  
Banner Engineering Japan  
Cent-Urban Building 305 3-23-15 Nishi-Nakajima Yodogawa-Ku  
Osaka 532-0011, Japan

Phone: +81 (0)6 6309 0411  
Website: [www.bannerengineering.co.jp](http://www.bannerengineering.co.jp)  
Email: [mail@bannerengineering.co.jp](mailto:mail@bannerengineering.co.jp)

### Taiwan

Address:  
Banner Engineering Taiwan  
8F-2, No. 308 Section 1, Neihu Road  
Taipei 114, Taiwan

Phone: +886 (0)2 8751 9966  
Website: [www.bannerengineering.com.tw](http://www.bannerengineering.com.tw)  
Email: [info@bannerengineering.com.tw](mailto:info@bannerengineering.com.tw)

# Index

## A

- analog input parameters 22, 24
- analog min/max 27
- analog output parameters 27
- antenna
  - remote installation 17
- antenna installation
  - remote 14–17

## B

- baseline 28
- baseline drift filter 28
- binding radios 9, 10

## C

- certification
  - FCC 42
- chemical exposure 12, 13
- child radio 4–6
- collocation 13
- communication timeout 21
- compensation median filter 28
- continuous voltage 20, 26
- counter input parameters 24
- counter preset 24

## D

- de 29
- default output parameters 21
- default output state
  - switch power 26
- delta 28
- device name 37, 38
- DIP switches 8
- discrete input parameters 21
- discrete output 26

## E

- enclosure 11, 12
- event/frequency counter 24
- extended input read 20
- extra inputs 19
- extra outputs 19

## F

- factory default settings 27
- flash 20
- full scale 22, 24

## G

- ground 12, 13
- ground wire 14–17

## H

- H-bridge parameters 25, 26
- hold last state
  - switch power 26
- host timeout 21
- hysteresis
  - M-GAGE 28

## I

- I/O isolation 14–17
- input parameters 19, 20
- inter-character timing 6

## L

- latch on change of state 21
- lightning arrestor 14–17
- low pass filter 28, 29

## M

- M-GAGE baseline 28
- M-GAGE baseline drift filter 28
- M-GAGE delta 28
- M-GAGE low pass filter 28
- M-GAGE parameters 28
- manufacturer parameters 37, 38
- manufacturing information 37, 38
- master radio 4–6
- max/min scale 29
- maximum value 22, 24
- mechanical stress 12, 13
- message parameters 37, 38
- minimum value 22, 24
- Modbus mode 4, 5
- Modbus registers
  - I/O parameters 19–22, 24–29, 31, 32, 35–39
- Modbus Slave IDs 4, 5
- model number register 37, 38
- MultiHop Radio ID 4, 5, 8
- MultiHop Slave ID 8

## N

- network formation 4–6

## O

- out of sync 19–21
- outdoor installations 11, 12
- output flash pattern 28
- output parameters 20

- overvoltage transients 12, 13

## P

- packet routing 4, 5
- packet size 6
- parameters
  - I/O 19–22, 24–29, 31, 32, 35–39
- parent radio 4–6
- PNP or NPN 21

## R

- repeater radio 4–6

## S

- sample high
  - M-GAGE 28
- sample high/low 29
- sample interval 19, 20
- sample low
  - M-GAGE 28
- sample on demand 39
- seasonal changes 13
- site survey
  - interpreting results 11
- slave radio 4–6
- software information 37, 38
- standard inputs 19
- standard outputs 19
- sunlight exposure 11, 12
- surge suppressors 14–17
- switch power inputs 20
- switch power output 26
- switch power voltage 20
- switch power warm-up 20

## T

- ta 29
- temperature resolution 22, 24
- temperature scaling 22, 24
- thermocouple type 22, 24
- threshold
  - M-GAGE 28
- transparent mode 6

## U

- ultrasonic input parameters 29

## V

- vibration 12, 13

W  
water exposure 11, 12

weatherproofing 15