

Modicon M221 logic controllers

Catalog

December 2015



How can you fit a 6000-page catalog in your pocket ?

Schneider Electric provides you with the complete set of industrial automation catalogs all on a handy USB key for PC or in an application for tablets



Digi-Cat, a handy USB key for PC



- > Convenient to carry
- > Always up-to-date
- > Environmentally friendly
- > Easy-to-share format

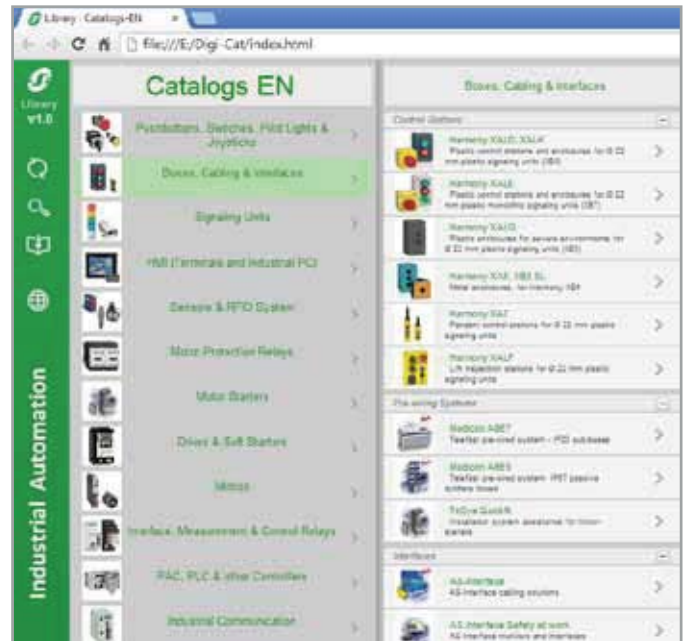

Contact your local representative to get your own Digi-Cat



e-Library, the app for tablets

If you have an iPad®:

- > Go to the App Store and search for e-Library
- > or scan the QR code



If you have an Android tablet:

- > Go to the Google Play Store™ and search for eLibrary
- > or scan the QR code

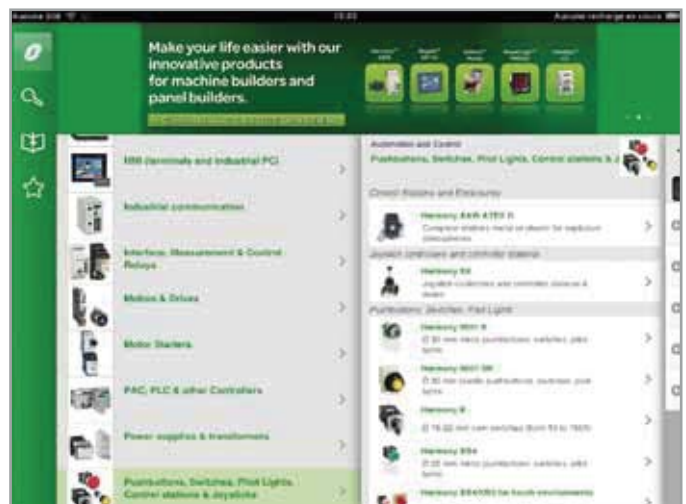

General contents

■ General presentation	2
■ Selection guide for Modicon™ M221 and Modicon™ M221 Book logic controllers	6
Modicon™ M221 and M221 Book logic controllers	
■ Presentation	
- Applications, key features.....	8
- Embedded communication, Embedded functions.....	9
- Options: memory card, cartridges.....	9
- Remote graphic display	10 and 11
- Communication via Bluetooth® wireless connection	12
- Communication via modem and router	12
- I/O extensions with Modicon TM3 expansion modules	13
- Control architecture for standalone machines.....	14
- Communication	15
■ Description	
- Modicon M221 logic controllers	16
- Modicon M221 Book logic controllers	17
- TMH2GDB Remote graphic display.....	16
■ References	
- Modicon M221 logic controllers	18
- Modicon M221 Book logic controllers	19
- Remote graphic display	20
- Options, separate parts, software, cordsets.....	21
- Telefast pre-wired system with Modicon ABE7 for Modicon M221 Book logic controllers	22
Communication bus	
■ Serial links (Modbus protocols, character mode)	
- Presentation, description.....	24
- References	25
■ Industrial Ethernet	
- General.....	26
- Main equipment supported	27
- Web server	27
- Ethernet services Description.....	28
- Transparent Ready class and Functions.....	29
- Ethernet Ports (logic controllers and Ethernet switch module).....	29
- Architecture	30
- References	31
■ Communication via modem and router	
- Presentation	32
- References	33
Compatibility	
■ Compatibility of Modicon TM2 expansion modules with Modicon M221 logic controllers	34
Products reference index	35

Maximize your business and machine performance with MachineStruxure

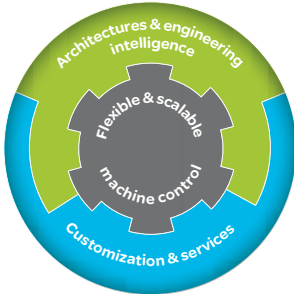

Machine builders like you are constantly looking for new ways to design and build more innovative machines in less time and at lower cost. MachineStruxure™ can help.

The NEXT generation of MachineStruxure is a complete machine automation solution that provides flexible and scalable machine control, ready-to-use architectures, efficient engineering solutions, and comprehensive customization and engineering support services. It can help you meet your challenges for improved efficiency and greater productivity, as well as allow you to deliver higher added value to your customers throughout the entire machine life cycle.

Ready-to-use architectures and function blocks

Tested, Validated, and Documented Architectures (TVDA) are just one of the ways we help you reduce design time. Whether your machines are simple or complex, Application Function Blocks (AFBs) make system design fast and easy.

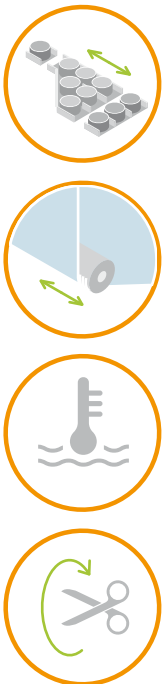

Application Function Blocks (AFB)

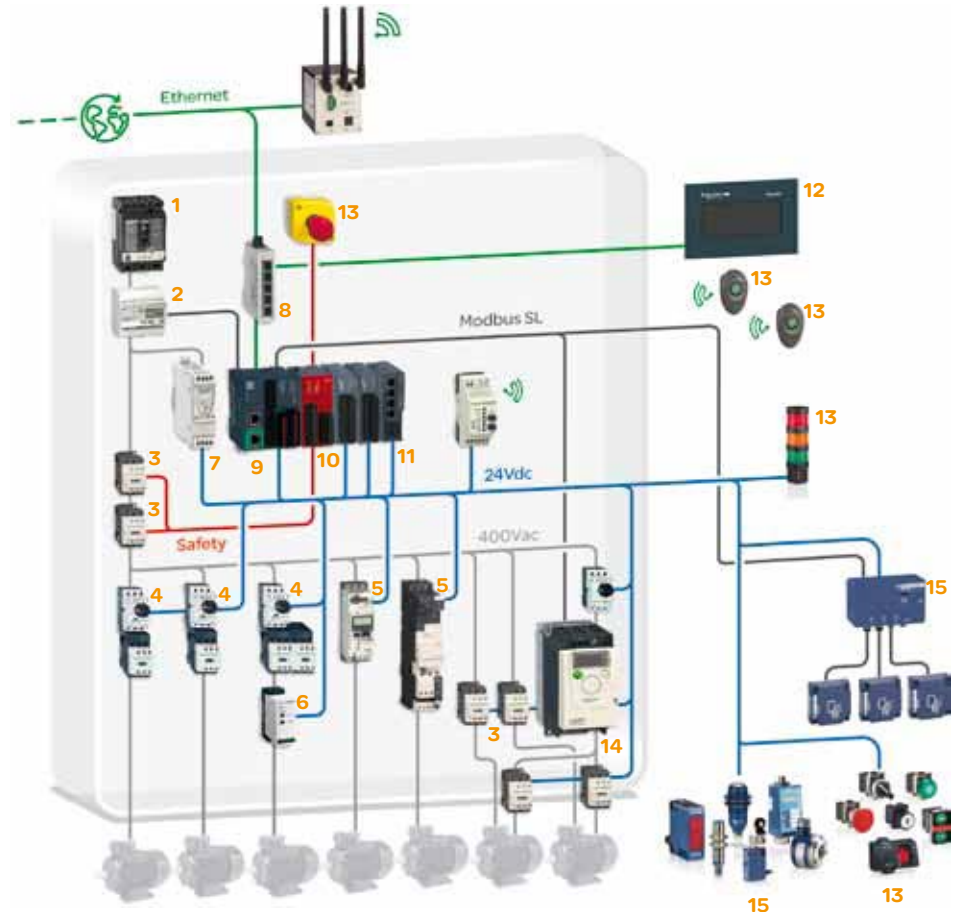

- | | |
|---|--|
| 1 POWERPACT circuit breaker | 10 Modicon TM3 safety module, Modicon TM3 digital/analog I/O modules |
| 2 Energy meter Acti9 iEM310 iEM310 | 11 Modicon TM3 TeSys motor starter module |
| 3 TeSys D contactor | 12 Magelis display |
| 4 TeSys GV2P motor circuit-breaker | 13 Harmony signalling and control devices |
| 5 TeSys U starter-controller | 14 Altivar 312 variable speed drive |
| 6 Multi9 circuit-breaker C60N | 15 OsiSense: limit switches and inductive sensors |
| 7 Phaseo power supply 24 V $\bar{\text{---}}$ | |
| 8 Ethernet switch (unmanaged) | |
| 9 Modicon M221 Book logic controller | |

Fastest and smallest logic controllers on the market

Flexible and scalable machine control

With the new range of Modicon™ logic controllers, the next generation of MachineStruxure provides flexible and scalable machine control. Ethernet connectivity, USB port for programming, and an embeded web server: it's all included.



From logic to motion control, the Modicon range offers flexibility and scalability to suit your needs

Modicon M221: the small yet powerful logic controller for hardwired solutions

Everything you need is embedded

The Modicon M221 offers best-in-class performance. Available also in book format, the Modicon M221 requires minimal installation and offers tremendous versatility.

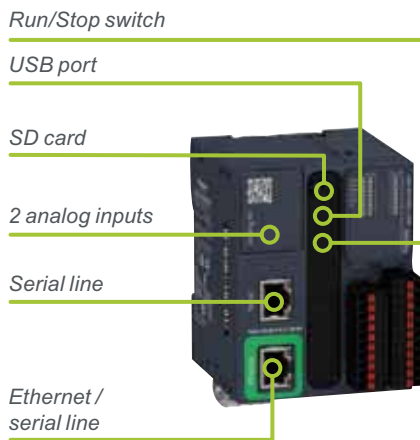

Modicon M221 Book and a broad choice of I/O extension modules

- > SD card, Run/Stop switch, USB port, 2 analog inputs, serial line, Ethernet and serial line, cartridge extension (on standard version): it's all **embedded**.
- > Thanks to its high degree of **flexibility**, it's very easy to add additional modules (safety modules, Tesys motor starter module, extensive line of analog and digital modules, ...) - and still keep everything in **just one configuration**

Modicon M221: the small yet powerful logic controller for hardwired solutions

Intuitive machine programming with SoMachine

SoMachine® is the universal programming software for machines automated by MachineStruxure controllers. Simple navigation that requires only fewer clicks delivers a more efficient engineering process.

- > In order to reduce complexity we offer SoMachine Basic, a simplified engineering tool for the new controller Modicon M221.
- > All programming, visualization, and commissioning are handled in just one intuitive tool that is available as a free download.
- > No training required



SoMachine simplifies every step in the design and commissioning of your machines

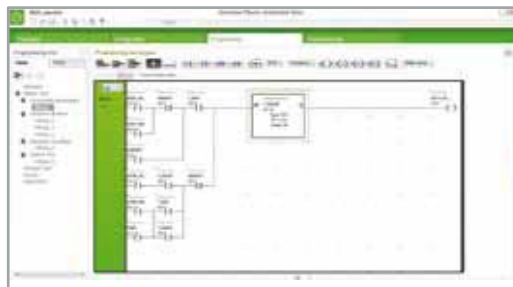

Programming



Configuration



Commissioning

Connected everywhere

For simplified maintenance, commissioning, and uploads/downloads, simply use your smartphone or tablet and connect anytime, anywhere.

- > Application for mobile phone & smartphone
- > Bluetooth® communication



Customization and services

Our experts help you every step of the way, from perfecting machine design to on-site services of the finished machine. Global support, 24/7 hotline services, and replacement parts centers around the world enable you to deliver superior customer support and satisfaction.



Achieve benchmark performance
while increasing profitability

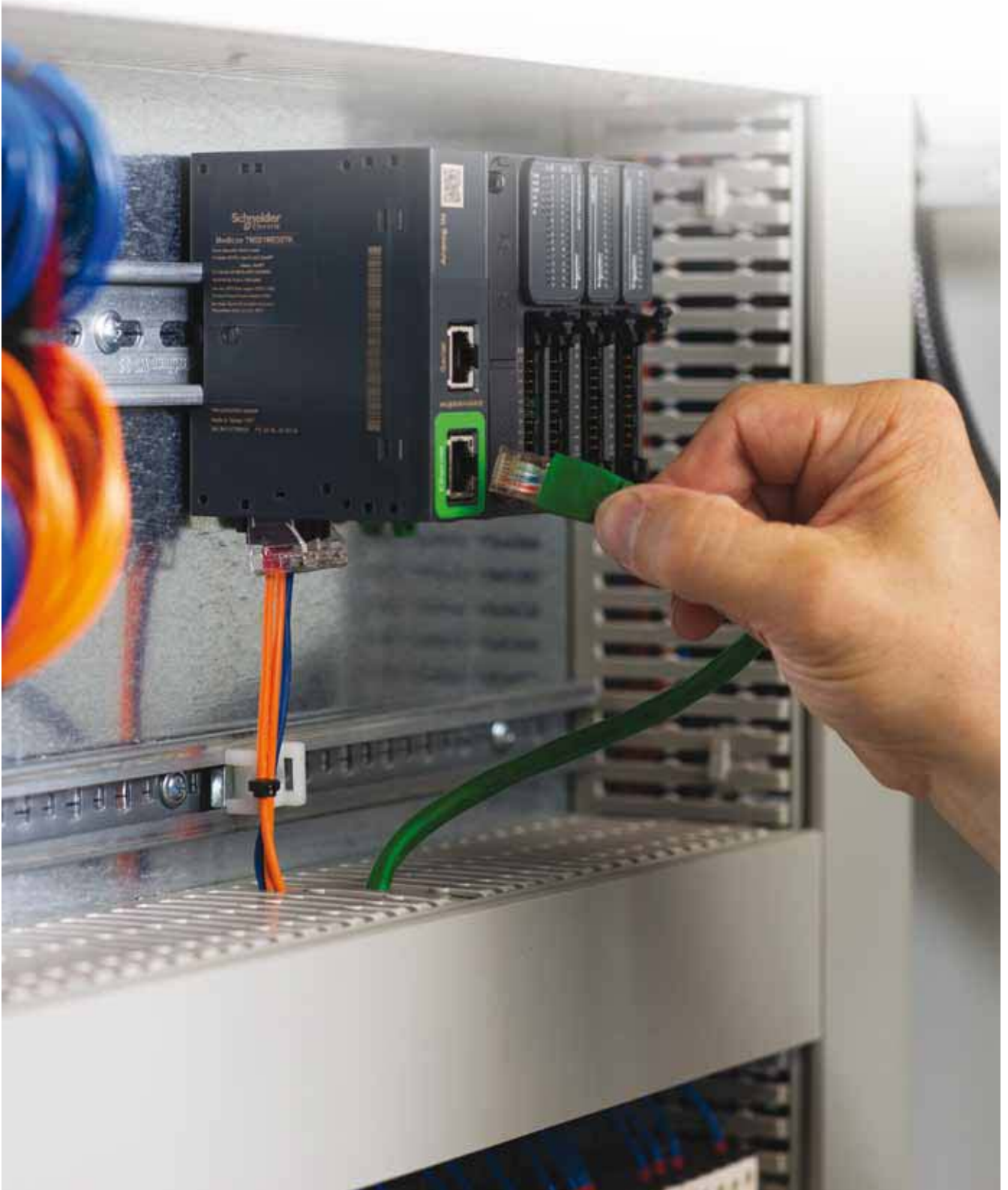

Make the most of your energySM

Applications

Control of simple machines



Supply voltage

100-240 V ~	24 V ~	24 V ~	100-240 V ~	24 V ~	24 V ~
-------------	--------	--------	-------------	--------	--------

Inputs/outputs

- Logic inputs/outputs
 - No. and type of inputs
 - No. and type of outputs
 - Connection of the logic I/O
- Analog inputs
 - Connection of analog inputs

16 logic I/O			24 logic I/O		
9 sink/source 24 V ~ inputs, inc. 4 high-speed inputs	9 sink/source 24 V ~ inputs, inc. 4 high-speed inputs	9 sink/source 24 V ~ inputs, inc. 4 high-speed inputs	14 sink/source 24 V ~ inputs, inc. 4 high-speed inputs	14 sink/source 24 V ~ inputs, inc. 4 high-speed inputs	14 sink/source 24 V ~ inputs, inc. 4 high-speed inputs
7 relay outputs	7 source transistor outputs, inc. 2 high-speed outputs	7 sink transistor outputs, inc. 2 high-speed outputs	10 relay outputs	10 source transistor outputs, inc. 2 high-speed outputs	10 sink transistor outputs, inc. 2 high-speed outputs

On removable screw terminal block

2 x 0...10 V analog inputs

On dedicated removable connector

I/O extension

Max. number of I/O expansion modules that can be connected /with bus expansion modules

- 7 Modicon TM3 expansion modules, along with limited number of outputs.
- 14 Modicon TM3 expansion modules with the use of bus expansion modules (transmitter and receiver), along with limited number of outputs.
- Possible use of Modicon TM2 expansion modules with restrictions.

Embedded communication

Ethernet link

Serial link

1 Ethernet port on TM221CE... controllers: Modbus TCP communication (client & server), slave Modbus TCP, DHCP Client dynamic configuration, programming, downloading, monitoring, EtherNet/IP adapter

1 serial link port (RJ 45 connector) RS 232/RS 485 with + 5 V supply

Embedded functions

Process control

Counting

Position control

PID

Up to 4 high-speed counter inputs (HSC), 100 kHz frequency

Position control (PTO), with trapezoidal profile and S curve able to control either:

- 2 axes in "pulse direction" (P/D) mode
- 1 axis in CW/CCW mode

Format

W x H x D

3 controller sizes:	
95 x 90 x 70 mm 3.74 x 3.54 x 2.75 in.	110 x 90 x 70 mm 4.33 x 3.54 x 2.75 in.

Options

- Cartridges

Number of cartridge slots

- Display unit

- 3 analog I/O expansion cartridges
 - 1 additional serial link communication cartridge
 - 3 application cartridges
 - for control of hoisting applications
 - for control of packaging applications
 - for control of conveying applications
- 1
- TMH2GDB remote graphic display: visualization and monitoring
- Mounting on symmetrical rail or panel with specific mounting kit TMAM2

Mounting

Software programming

With SoMachine Basic software

Logic controller type

Controllers without Ethernet port

Controllers with embedded Ethernet port

Modicon M221					
TM221C16R	TM221C16T	TM221C16U	TM221C24R	TM221C24T	TM221C24U
TM221CE16R	TM221CE16T	TM221CE16U	TM221CE24R	TM221CE24T	TM221CE24U

Pages

18

Control of simple machines



100-240 V ~ 24 V --- 24 V ---

40 logic I/O

24 sink/source 24 V --- inputs, inc. 4 high-speed inputs	24 sink/source 24 V --- inputs, inc. 4 high-speed inputs	24 sink/source 24 V --- inputs, inc. 4 high-speed inputs
16 relay outputs	16 source transistor outputs, inc. 2 high-speed outputs	16 sink transistor outputs, inc. 4 high-speed outputs



24 V ---

16 logic I/O

8 sink/source 24 V --- inputs, inc. 4 high-speed inputs

8 relay outputs



24 V ---

16 logic I/O

8 sink/source 24 V --- inputs, inc. 4 high-speed inputs

8 source transistor outputs, inc. 2 high-speed outputs



24 V ---

32 logic I/O

16 sink/source 24 V --- inputs, inc. 4 high-speed inputs

16 source transistor outputs, inc. 2 high-speed outputs

On removable screw terminal block or spring terminal block (1)

On HE 10 connector (with the Telefast Modicon ABE7 pre-wired system: connection cables and sub-bases)

2 x 0...10 V analog inputs

On dedicated removable connector

- 7 Modicon TM3 expansion modules, along with limited number of outputs.
- 14 Modicon TM3 expansion modules with the use of bus expansion modules (transmitter and receiver), along with limited number of outputs.
- Possible use of Modicon TM2 expansion modules with restrictions.

1 Ethernet port on TM221ME... controllers: Modbus TCP communication (client & server), slave Modbus TCP, DHCP Client dynamic configuration, programming, downloading, monitoring. EtherNet/IP adapter

1 serial link port (RJ 45 connector) RS 232/RS 485 with + 5V supply
1 additional serial link port on TM221M... controllers (RJ 45) RS 485

PID

Up to 4 high-speed counter inputs (HSC), 100 kHz frequency

Position control (PTO), with trapezoidal profile and S curve able to control either:

- 4 axes in "pulse direction" (P/D) mode
- 2 axes in CW/CCW mode
- 2 axes in "pulse direction" (P/D) mode
- 1 axis in CW/CCW mode

163 x 90 x 70 mm
6.41 x 3.54 x 2.75 in.

1 size only:
70 x 90 x 70 mm
2.75 x 3.54 x 2.75 in.

2

TMH2GDB remote graphic display: visualization and monitoring

Mounting on symmetrical rail or panel with specific mounting kit TMAM2

With SoMachine Basic software

Modicon M221 Book

TM221C40R TM221C40T TM221C40U

TM221M16R TM221M16T TM221M32TK

TM221CE40R TM221CE40T TM221CE40U

TM221M16RG (1) TM221M16TG (1)

TM221ME16R TM221ME16T TM221ME32TK
TM221ME16RG (1) TM221ME16TG (1)

19

(1) Spring terminal block on references ending in the letter G.



Modicon M221 and M221 Book logic controllers

General presentation

Compatibility of offers

Modicon M221 and M221 Book logic controllers

- > Modicon TM3 expansion modules
- > Modicon TM2 expansion modules
- > SoMachine Basic software



16 I/O channels



24 I/O channels



40 I/O channels

Modicon M221 logic controllers (standard format)



16 I/O channels



32 I/O channels

Modicon M221 Book logic controllers

Presentation

Applications

Modicon **M221** and **M221 Book** logic controllers are designed for simple machines. They can optimize the size of wall-mounted and floor-standing control system enclosures due to their compact dimensions.

- The controllers are available in 2 formats:
 - Modicon **M221** controllers (references TM221C●●●●) offer excellent connection capacity and customization options without increasing the controller size, using I/O, communication or application cartridges.
 - Modicon **M221 Book** controllers (references TM221M●●●) offer very small dimensions and a wide choice of connections.
- M221 and M221 Book controllers have an embedded Ethernet port meaning they can easily be integrated in control system architectures, for remote control and maintenance of machines using applications for smartphones, tablets and PCs.
- The wealth of functions embedded in M221 and M221 Book controllers minimizes the cost of the machine:
 - Functions embedded in the controller: Modbus serial link, USB port dedicated to programming and simple position control functions (high-speed counters and pulse train outputs with trapezoidal profile and S curve).
 - Functions embedded in Modicon TM3 extensions: functional safety modules, motor-starter control module and remote expansion system.
 - Functions embedded in the dedicated display unit.
- The application is created quickly thanks to the intuitive nature of the SoMachine Basic programming software, which also has embedded configuration of the display unit and extensions, including the functional safety modules. This software environment makes it easy to retrieve Twido range applications, maximizing use of the investment already made. Applications can thus easily be ported to any of the Modicon logic controllers: M241, M251 and M258.

Main functions

Modicon TM221C●●●●	Modicon TM221M●●●
w x h x d (mm/in.)	
<ul style="list-style-type: none"> □ 16 I/O: 95 x 90 x 70 / 3.74 x 3.54 x 2.75 □ 24 I/O: 110 x 90 x 70 / 4.33 x 3.54 x 2.75 □ 40 I/O: 163 x 90 x 70 / 6.41 x 3.54 x 2.75 	<ul style="list-style-type: none"> □ 16 I/O: 70 x 90 x 70 / 2.75 x 3.54 x 2.75 □ 32 I/O: 70 x 90 x 70 / 2.75 x 3.54 x 2.75
Supply voltage	
24 V $\overline{\text{---}}$ or 100..240 V \sim 50/60 Hz	24 V $\overline{\text{---}}$
Connection of the embedded I/O	
On removable screw terminal blocks at intervals of 5.08 mm (0.20 in.) 24 V/0.25 A power supply provided by the controller for sensor inputs on TM221C●●●R models	16 I/O: On removable screw or spring terminal blocks at intervals of 3.81 mm (0.15 in.) 32 I/O: On HE10 connectors with HE 10 cables/bare wires or Telefast ABE7 connection sub-bases (1)
Analog inputs	
2 embedded inputs on each TM221M●●● and TM221C●●● controller	
Embedded Ethernet communication	
Yes on TM221CE●●	Yes on TM221ME●●
Serial link	
1 embedded link	1 to 2 embedded links
Cartridges	
One slot for 1 or 2 cartridges depending on the controller model: <ul style="list-style-type: none"> □ I/O cartridge (analog inputs or outputs, temperature inputs) □ communication cartridge (serial link) or application cartridges (hoisting, conveying and packaging) 	–

Hardware characteristics

M221 and M221 Book controllers each have an embedded:

- Run/Stop switch
- slot for an industrial SD memory card
- QR code for direct access to its technical documentation

(1) Telefast Modicon ABE7 pre-wired system to be ordered separately (see page 22).



Example of a QRcode:
QRcode for access to the TM221M16R logic controller technical documentation

Modicon M221 and M221 Book logic controllers

General presentation, options for Modicon M221 and M221 Book logic controllers



SoMachine Basic software

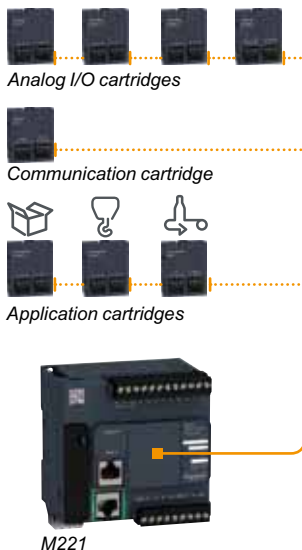
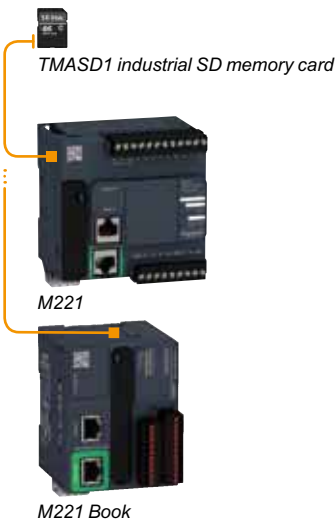

Presentation

Embedded communication (see page 15)

M221 and M221 Book logic controllers have three types of integrated communication port:

- Ethernet
- RS 232/RS 485 serial link
- USB mini-B programming port

Embedded functions

Each Modicon M221 and M221 Book logic controller has the following integrated functions:

- Analog (PID control)
- Counting: Up to 4 high-speed counters (HSC), 100 kHz frequency
- Controllers with transistor logic outputs (source or sink) are equipped with 2 or 4 high-speed counters (1) supporting pulse generation functions.
- Position control (PTO), with trapezoidal profile and S curve able to control either:
 - 2 or 4 axes in pulse direction (P/D) mode
 - 1 or 2 axes in CW/CCW mode
 These outputs can be associated with event-triggered inputs to feed back homing and capture information. A "Motiontask" function block (one per axis) associated with a command table can be used to program and preview intuitively all the movements of an axis in the SoMachine Basic software.
- Pulse width modulation (PWM)
- Pulse generator (PLS)
- Frequency generator (FREQGEN)

Processing power

- Execution speed: 0.2 μs/Boolean instruction
- Program: 10 Boolean Kinstructions
- Number of words: 8,000. Number of internal bits: 1,024
- RAM: 640 K (256 K for internal variables and 256 K for application and client data)
- Flash memory: 2 MB (including 256 K for backing up the client application and data in the event of a power outage)

Programming

M221 and M221 Book logic controllers are programmed with the SoMachine Basic software. **Please consult our website: www.schneider-electric.com**
 SoMachine Basic is an integral component of the SoMachine software. SoMachine Basic is available on CD and also as a download from our website: www.schneider-electric.com.

Options

Memory card

The **TMASD1** industrial SD memory card, with 256 MB capacity, is available for Modicon M221 and M221 Book logic controllers. It is used for:

- backing up and transferring applications
- loading firmware
- duplicating applications between controllers

Cartridges

One or two cartridges can be inserted on the front of TM221C●●● controllers without increasing the dimensions.

Three types of cartridge are offered:

- Analog I/O cartridges
 - TMC2AI2** for 2 analog inputs which can be configured as voltage or current
 - TMC2AQ2V** for 2 voltage analog outputs
 - TMC2AQ2C** for 2 current analog outputs
 - TMC2TI2** for 2 temperature inputs
- Communication cartridge
 - TMC2SL1** providing additional serial link port terminals for connection via a printer, barcode reader, etc.
- Application cartridges
 - TMC2HOIS01** for hoisting applications with two dedicated analog inputs for controlling a load cell
 - TMC2PACK01** for packaging applications with two dedicated analog inputs for controlling the temperature on a packaging machine
 - TMC2CONV01** for conveyor system applications with a serial link.
 Using an application cartridge provides direct access to application examples via the SoMachine Basic software

(1) 4 high-speed outputs on TM221C●40U, 2 high-speed outputs on TM221●●16T, TM221C●24T, TM221C●40T, TM221C●16U, TM221C●24U.

Modicon M221 and M221 Book logic controllers

Remote graphic display unit for Modicon M221 and M221 Book logic controllers

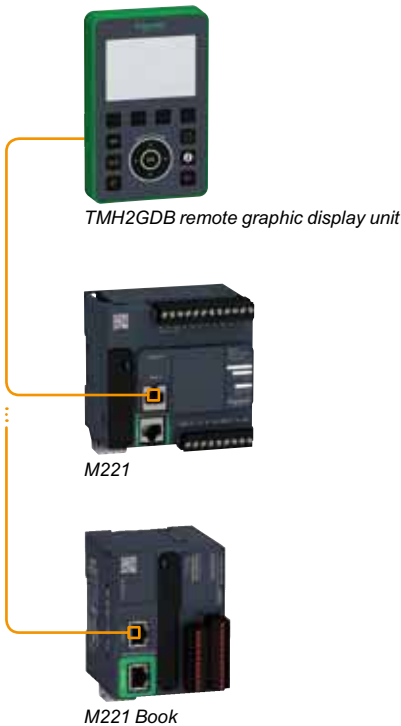

TMH2GDB remote graphic display unit

Presentation

The **TMH2GDB** remote graphic display unit is an HMI dedicated to M221 and M221 Book logic controllers. It is mounted on the front panel of a wall-mounted or floor-standing enclosure (degree of protection IP 65) or, using mounting brackets, at the back of an enclosure on a panel or symmetrical rail.

The **TMH2GDB** display unit is ready to use: the main application parameters can be accessed, with no prior programming, as soon as it is connected to the logic controller. Customized dialog pages can however easily be created using predefined templates in the SoMachine Basic software dedicated to Modicon M221 and M221 Book logic controllers.

The **TMH2GDB** remote graphic display unit is a multifunction display unit which runs alongside your machine throughout its life cycle:

- During debugging: reading the states and values of variables and providing complete diagnostics of the controller configuration
- During installation: options for setting the time and configuring the communication ports
- During runtime: an operator interface created in the SoMachine Basic software can be used to (for example):
 - display information in the form of text, values, bargraphs or gauges
 - perform machine control actions
 - enter or modify data
 - customize buttons on the front panel
- During maintenance: the page displaying alarm messages is permanently accessible by pressing a single key. Alarm messages are stored and time-tagged in a page of the log. An icon, which is always visible, flags up the presence of at least one alarm message. Access to each page and modification of its values can be protected by a password.

Main characteristics

- Backlit monochrome STN LCD 60 x 40 mm (2.36 x 1.57 in.)
- 5 lines of 20 to 35 characters, depending on the type of page
- Title block at the top of the page
- Title block at the bottom of the page
- 8 languages available: English, French, German, Italian, Spanish, Portuguese, Chinese and Turkish
- Up to 4 customizable service keys
- 100 HMI pages maximum
- Dimensions on the front panel of the machine (w x h x d): 80 x 126 x 19.2 mm (3.15 x 4.96 x 0.75 in)

Conformity

- CE, cULus Listing Mark

Environment characteristics

- Ambient operating temperature: -15...+ 50°C (5...122°F)

Supply characteristics

- 5 V $\overline{\text{DC}}$ (200 mA) directly by the controller
- Max. consumption: 1 W

Modicon M221 and M221 Book logic controllers

Remote graphic display unit for Modicon M221 and M221 Book logic controllers

Controller Info		10/02/2012 02:57:11
Device name	TM221CE24T	
Firmware version	0.3.9.1	
Last MAST cycle	0,134 ms	
Min. MAST cycle	0,134 ms	
Max. MAST cycle	0,159 ms	
Alarm		Back

Debugging: Controller information

Ethernet		10/02/2012 02:57:47
IP Mode	0	
IP address	85.21.1.24	
Mask	255.255.255.0	
Gateway	0.0.0.0	
Device name	M221	
Apply		Edit Refresh Cancel

Debugging: Configuring communication

Alarm Monitoring		26/11/2014 10:38:24
Temperature 1	23	
Temperature 2	24	
Heating	1	
Cooling	0	
AutoManu	1	
Edit Alarm		menu

HMI: Monitor

Alarm Controls		26/11/2014 10:39:40
Auto mode status		
Auto mode selected		
Oven is heating		
Cooling system is OFF		
On		Off Menu Alarm

HMI: Control panel

WATER SUPPLY		14/09/2015 20:20:10
3	10	m
9	10	m ³
Edit1 Edit2 Alarm Home		

HMI: Bargraph

Temperature		10/02/2012 02:58:14
20	25	30
22 °C		
Alarm		menu set

HMI: Gauge

Alarm Alarm History		17/09/2015 07:44:18
TANK EMPTY	17/09/2015 07:43:55	
Conveyor blocked	17/09/2015 07:43:36	
LOW BATTERY	17/09/2015 07:41:37	
TANK EMPTY	17/09/2015 07:41:00	
Alarm		Delete Back

HMI: Alarm display

Examples of screens

TMH2GDB remote graphic display unit (continued)

Installation

The **TMH2GDB** remote graphic display unit is fixed in a hole with diameter 22 mm (0.87 in.) and is connected to the SL or SL1 serial link on Modicon M221 and M221 Book logic controllers with the **XBTZ9980** and **VW3A1104R10** cable which also supplies it with power (no other Modbus slave equipment must be connected on this link) (1).

The debug screens, including those for setting the time and configuring the communication ports, are already configured and available as soon as the display unit is connected to the logic controller (2).

The HMI (runtime) pages and alarm pages are created and configured very easily in the SoMachine Basic programming software (3), from predefined pages:

- "Alarm display" template
- "Menu" template
- "Monitor"
- "Control panel" template
- "Bargraph" template (1 or 2 bars)
- "Gauge" template

These pages constitute part of the controller application. They are transferred to and stored in the M221 and M221 Book logic controller memory, no transfer is necessary between the PC and the **TMH2GDB** graphic display unit. The latter is operational as soon as it is connected to the serial port on the logic controller.

Upgrade envisaged from 2nd quarter 2016: addition of the Home page.

The Home page can be selected by programming. Each HMI and alarm page can be displayed by navigating the front panel using the keys or called by a program. In addition, the alarm pages can be displayed on a red background.

The HMI pages can be created in several languages, the language displayed on the graphic display unit can then be selected by the operator in the display configuration menu.

(1) Neither the serial link on the TMC2SL1 cartridge, nor the SL2 embedded serial link, can be used to connect the graphic display unit.

(2) When the controller has no application program, only the product reference and the controller firmware version are accessible. The controller firmware version must be V1.3 or later.

(3) Possible from version V1.3 of SoMachine Basic.

Modicon M221 and M221 Book logic controllers

Communication via Bluetooth®

Communication via modem and router

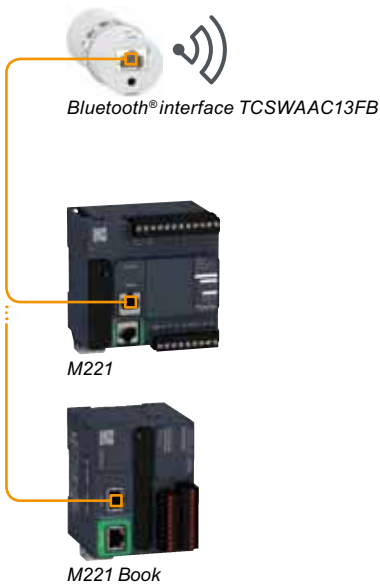

Communication via Bluetooth® wireless link

The Bluetooth® wireless link enables complete freedom of movement within a radius of 10 m (32.808 ft.) around the controller.

For its M221 and M221 Book controllers Schneider Electric offers the Bluetooth® interface **TCSWAAC13FB** so they can perform the following functions:

- Commissioning
- Monitoring
- Up/downloading

Bluetooth® interface **TCSWAAC13FB** (supplied with cordsets for connection to the controller) (see page 20).



Communication via modem and router

The communication via modem and router offer is dedicated to the following applications:

- Synchronization between remote machines; direct data exchange between controllers.
- Remote maintenance; access to the controller via the SoMachine Basic programming software.
- Remote control and monitoring of machines; receipt of information and sending commands on GSM phone.

This offer comprises 2 **Schneider Electric** modems (PSTN modem, GSM modem) and a VPN router made by **eWon**.

Modems, router and connection cables (see page 32).

Modicon M221 and M221 Book logic controllers

I/O extensions with Modicon TM3 expansion modules

I/O extensions with Modicon TM3 modules

Modicon TM3 expansion modules

Please consult our website: www.schneider-electric.com

The capacity of M221 and M221 Book logic controllers can be enhanced with the Modicon TM3 expansion module offer:

- Digital I/O modules which can be used to create configurations with up to 488 digital I/O. These modules are available with the same connections as the controllers.
- Analog I/O modules which can be used to create configurations with up to 114 analog I/O and are designed to receive, amongst other things, position, temperature or speed sensor signals. They are also capable of controlling variable speed drives or any device equipped with a current or voltage input.
- Expert module for control of TeSys motor-starters, connected with RJ 45 cables to simplify wiring up the control section.
- Functional safety modules which simplify wiring and can be configured in the SoMachine Basic software.

In addition, the TM3 expansion system is flexible due to the possibility of remotely locating some of the TM3 modules in the enclosure or another cabinet, up to 5 meters (16.404 ft.) away, using a bus expansion system.

The Modicon TM3 expansion system is common to the whole range of Modicon M221, M241 and M251 logic controllers, meaning that the controller model can be upgraded without changing extension.

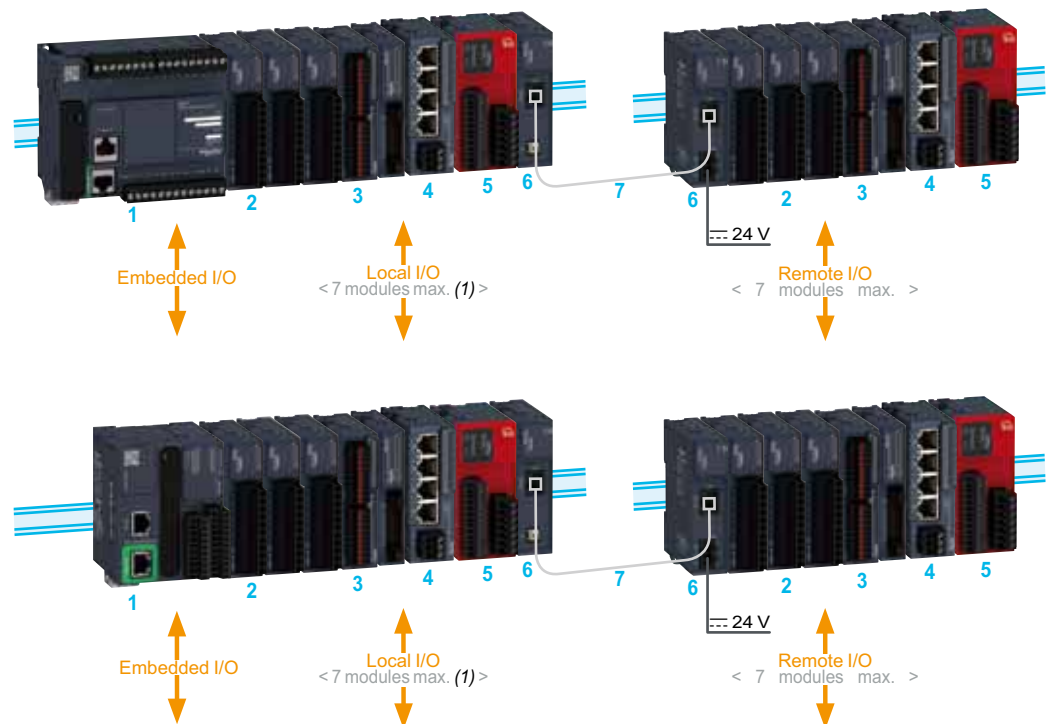

- 1 Modicon M221/M221 Book logic controller
- 2 Modicon TM3 digital I/O modules
- 3 Modicon TM3 analog I/O modules (2)
- 4 Modicon TM3 expert module: control of TeSys motor-starters
- 5 Modicon TM3 functional safety modules
- 6 Modicon TM3 bus expansion modules (transmitter and receiver)
- 7 TM3 bus expansion cable

(1) Depending on type of TM3 module used.

(2) Compatibility of expansion module offers: the majority of Modicon TM2 expansion modules can be used with M221 and M221 Book logic controllers. Nonetheless, adding a Modicon TM2 expansion module to a configuration can increase the expansion module execution times by as much as a few milliseconds. The compatibility between Modicon TM2 expansion modules and each M221 or M221 Book logic controller is specified on page 34.

Modicon M221 and M221 Book logic controllers

Control architecture

Control architecture for standalone machines

Typical applications: repetitive machines

- Packaging: recycling machines
- Textile-clothing machines
- Commercial equipment: automatic wash units, advertising hoardings, etc.
- Construction/service sector: access and entry control for automated systems
- Other sectors: woodworking, agriculture, fish farming, incubators, swimming pools, etc.

■ M221 (TM221C●●●●) controllers

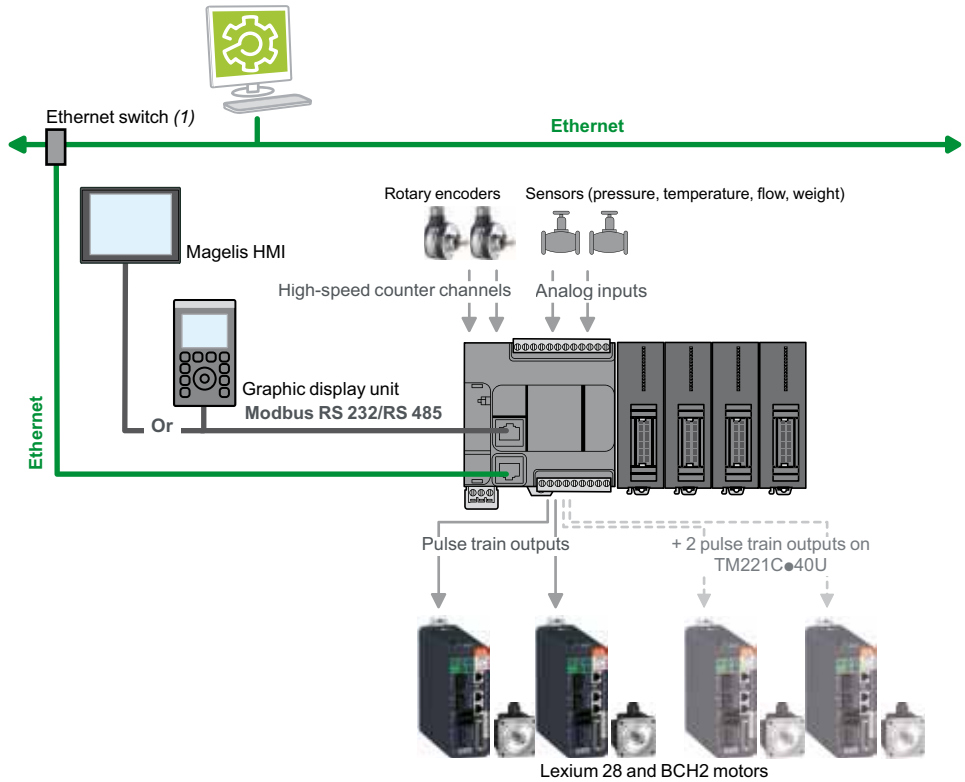

■ M221 Book (TM221M●●●) controllers

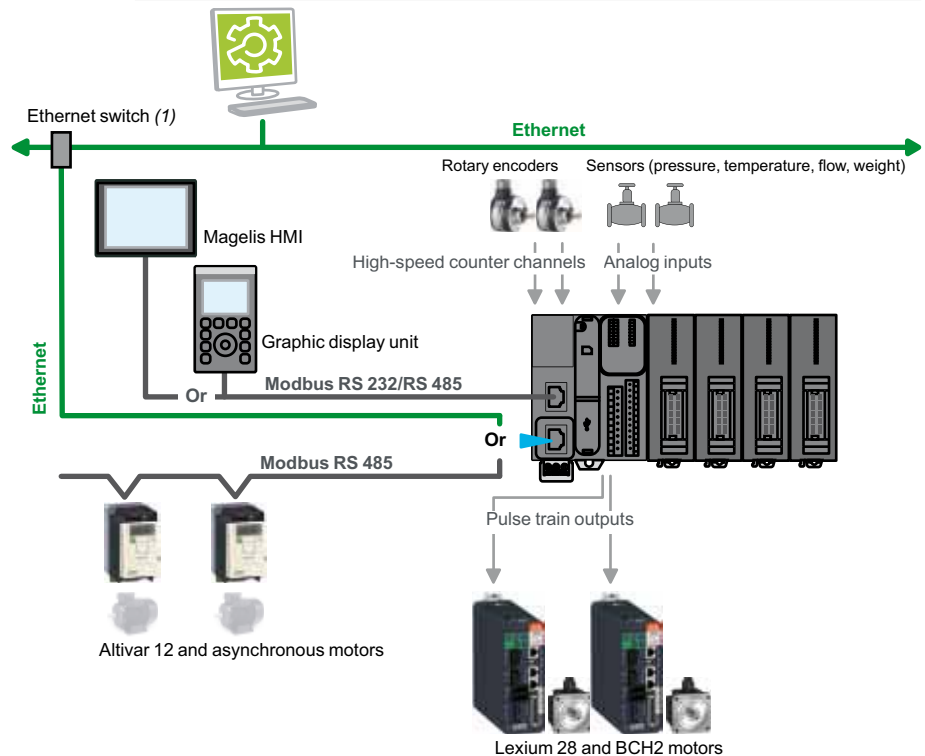

(1) Only use one switch, as Hubs are not compatible.

Modicon M221 and M221 Book logic controllers

Embedded communication, Characteristics

Embedded communication

Communication on Ethernet network

TM221CE●●● and TM221ME●●● controllers have an embedded RJ 45 Ethernet port (10/100 Mbps, MDI/MDIX) with Modbus TCP (Client/Server), EtherNet/IP (adapter), UDP, TCP protocols.

- As well as the default address based on the MAC address, it is possible to assign the controller IP address via a DHCP server or via a BOOTP server.
- The Ethernet port also offers the same application upload/download, update and debug functions when the controller is supplied with power.
- A firewall can be used to lock each communication protocol.

Connection cables and accessories for Industrial Ethernet (see page 26).

Serial links

■ Each TM221C●●● controller has an embedded serial link that can be configured as RS 232 or RS 485. A 5 V/200 mA voltage is available on the RJ 45 connector, which then supplies the **TMH2GDB** display unit, a Magelis **XBTN** or **XBTRT** HMI or the Bluetooth® **TCSWAAC13FB** communication adapter.

■ Each TM221M●●● controller has one or two embedded serial links.

- The SL1 serial link, found on each M221 Book controller, can be configured as RS 232 or RS 485. In addition, a 5 V/200 mA voltage is available on the RJ 45 connector which then supplies the **TMH2GDB** display unit, a Magelis **XBTN** or **XBTRT** HMI or the Bluetooth® **TCSWAAC13FB** communication adapter or other devices.
- The SL2 serial link, found on TM221M16●●●, TM221M24●●● and TM221M40●●● controllers only, is configured as RS 485.

Serial links also offer the same upload/download, update and debug functions when the controller is supplied with power. Embedded in both links are the two main commercially-available protocols:

- Modbus ASCII/RTU Master or Slave
- ASCII character string

Connection cables and accessories for serial link (see page 24).

Software programming with power off charging function

The programming port, equipped with a USB mini-B connector, is embedded in each M221 and M221 Book controller; it is dedicated to communication with a PC equipped with SoMachine Basic for programming, debugging, and maintenance. In addition, it offers the ability to load an application program or update the firmware without the controller being powered by another source.

Characteristics of M221 and M221 Book logic controllers

- Certifications: CE, UL Listing Mark, CSA, RCM, EAC, LR, ABS, DNV and GL (1)
- Standards: IEC/EN 61131-2 (Edition 2 2007), UL 508 (UL 61010-2-201), ANSI/ISA 12.12.01-2007, CSA C22.2 No. 213, No. 142, E61131-2 and IACS E10

Environment

- Ambient operating temperature: - 10...+ 55°C (14...+ 131°F)
- Storage temperature: - 25...+ 70°C (- 13...+ 158°F)
- Relative humidity: 10...95% (non-condensing)

Operating altitude:

- 0...2,000 m (0...6,562 ft.) : complete specification for temperature and insulation
- 2,000...4,000 m (6,562...13,123 ft.):
 - temperature derating: + 1°C/400 m (+ 1.8°F/1,312 ft.)
 - insulation losses: 150 V ---/1,000 m (150 V ---/3,280 ft.)

- Storage altitude: 0...3,000 m (0...9,842 ft.)

Immunity to mechanical stress (vibrations):

- For 1131: 5...8.4 Hz (amplitude 3.5 mm/ 0.138 in.); 8.4...150 Hz (acceleration 1 g)
- For merchant navy: 5...13.2 Hz (amplitude 1.0 mm/0.039 in.); 13.2...100 Hz (acceleration 0.7 g)

Power supply

Two power supply types are available depending on M221 controller model: 24 V --- or 100-240 V ~ 50/60 Hz

- Voltage limit (including ripple): 19.2...28.8 V ---/85...264 V ~
- Immunity to micro-cuts (class PS-2): 10 ms

Max. consumption:

- TM221 powered with AC, depending on model: 31...41 VA without expansion modules, 46...70 VA with maximum expansion module configuration
- TM221 powered with DC, depending on model: 3.2...4.9 W without expansion modules, 10...23 W with maximum expansion module configuration

(1) LR, ABS, DNV and GL marine certifications: pending.

Modicon M221 and M221 Book logic controllers

Modicon M221 logic controllers

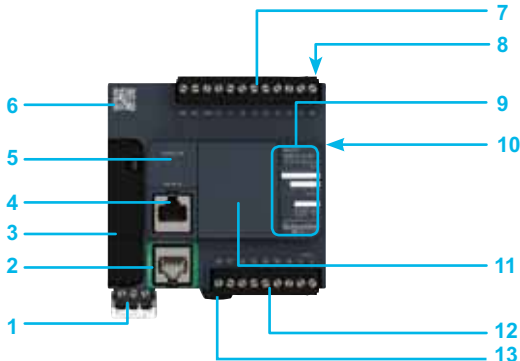

M221: 16 I/O

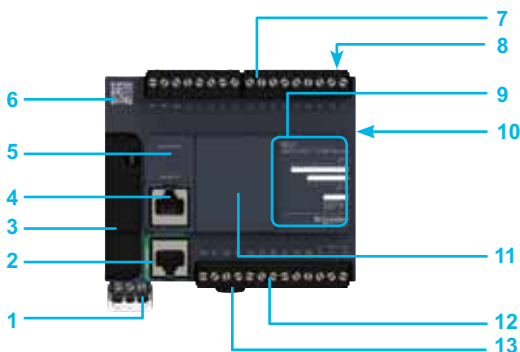

M221: 24 I/O

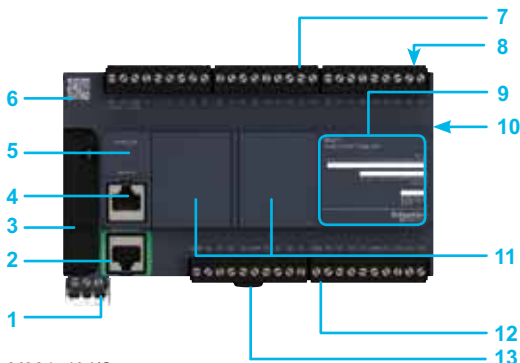

M221: 40 I/O



TMH2GDB

Description

M221 logic controllers (TM221C●●●)

- 1 Removable screw terminal block, 3 terminals for connecting the 24 V $\overline{\text{DC}}$ or 100-240 V \sim supply (depending on the model).
- 2 On TM221CE●●● controllers: RJ 45 connector for Ethernet network, with exchange and activity speed LED indicator
- 3 Behind the removable cover:
 - Mini-B USB connector for connecting a PC equipped with the SoMachine Basic software
 - Slot for the industrial SD memory card
 - Run/Stop switch
- 4 Serial link port (RS 232 or RS 485): RJ 45 connector.
- 5 Behind a flap: dedicated removable connector for two analog inputs.
- 6 QR code for access to the controller technical documentation.
- 7 Connection of 24 V $\overline{\text{DC}}$ logic inputs on removable screw terminal blocks (1).
- 8 On top of the controller: slot for backup battery.
- 9 LED display block showing:
 - the status of the controller and its components (battery, industrial SD memory card)
 - the status of the serial link
 - the status of the embedded I/O
- 10 On the side of the controller: TM3 bus connector for the link with a Modicon TM3 expansion module.
- 11 Slot(s) for I/O cartridge(s), communication cartridge or application cartridge(s): one on M221 controllers with 16 and 24 I/O, two on M221 controllers with 40 I/O.
- 12 Connection of relay/transistor logic outputs: on removable screw terminal blocks (1).
- 13 Clip for locking on \perp symmetrical rail.

(1) Removable screw terminal blocks equipped with screw terminals, supplied with M221 controller.

Graphic display unit TMH2GDB

- 1 Control screen: backlit STN graphic screen, two-tone (white/red).
 - 2 Ten command buttons, two of which can be customized with the option of identifying associated functions.
 - 3 Rotary navigation and control wheel.
- On the back of the display unit:
- 4 Mounting system consisting of locking nut, seal and anti-rotation tee.
 - 5 RJ 45 connector for the cable connecting the graphic display unit to the Modicon M221/M221 Book logic controller.

Modicon M221 and M221 Book logic controllers

Modicon M221 Book logic controllers

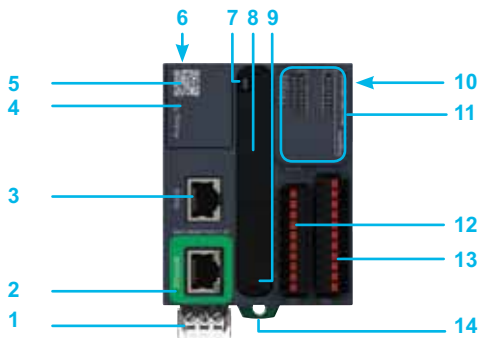

TM221ME16TG

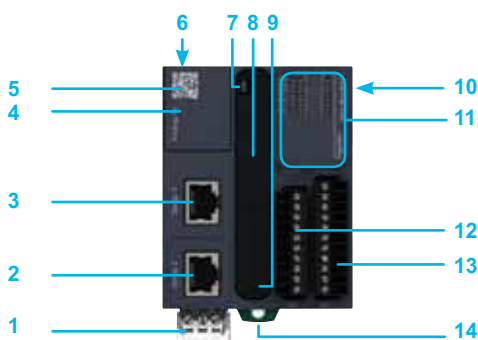

TM221M16T

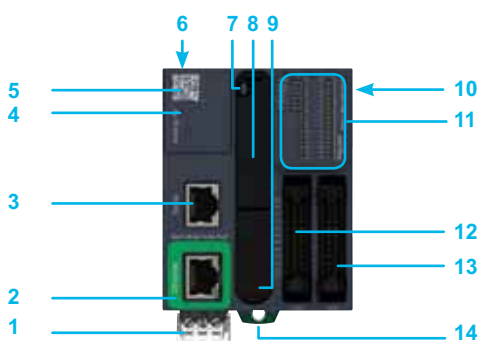

TM221ME32TK



TMH2GDB

Description

M221 Book logic controllers (TM221M●●●)

- 1 Removable screw terminal block, 3 terminals for connecting the 24 V $\overline{\text{---}}$ supply.
- 2 On TM221ME16●● and TM221ME32●● controllers: RJ 45 connector for Ethernet network, with exchange and activity speed LED indicator.
On TM221M16●● and TM221M32●● controllers: RJ 45 connector for SL2 serial link.
- 3 SL1 serial link port (RJ 45 connector).
- 4 Behind the removable cover: dedicated removable connector for two analog inputs.
- 5 QR code for identifying the controller technical documentation.
- 6 Backup battery slot.

Behind the removable cover: 7, 8 and 9

- 7 Slot for the industrial SD memory card.
- 8 Run/Stop switch.
- 9 Mini-B USB connector for connecting a PC equipped with the SoMachine Basic software.
- 10 TM3 bus connector for linking to a Modicon TM3 expansion module.
- 11 LED display block showing:
 - the status of the controller and its components (battery, industrial SD memory card)
 - the status of the serial links
 - the status of the I/O
- 12 Connection of 24 V $\overline{\text{---}}$ logic inputs:
 - on 16-channel controllers: removable screw or spring terminal blocks (1)
 - on 32-channel controllers: HE10 connector
- 13 Connection of relay/transistor logic outputs:
 - on 16-channel controllers: removable screw or spring terminal blocks (1)
 - on 32-channel controllers: HE10 connector
- 14 Clip for locking on \perp symmetrical rail.

(1) Removable terminal blocks equipped with screw terminals or spring terminals depending on the controller type. Terminal blocks supplied with M221 Book controller.

Graphic display unit TMH2GDB

Description: see page 16

Modicon M221 and M221 Book logic controllers

Modicon M221 logic controllers



TM221C16R, TM221C16T, TM221C16U



TM221CE16R, M221CE16T, TM221CE16U



TM221C24R, M221C24T, TM221C24U



TM221CE24R, TM221CE24T, TM221CE24U



TM221C40R, TM221C40T, TM221C40U



TM221CE40R, TM221CE40T, TM221CE40U



TMC2AI2



TMC2AQ2V



TMC2AQ2C



TMC2TI2



TMC2SL1



TMC2PACK01



TMC2HOIS01



TMC2CONV01

References

Modicon M221 logic controllers (1)

Number of logic I/O	Logic inputs	Logic outputs	Analog inputs	Integrated communication ports (2)		Reference	Weight kg/lb
				Ethernet (RJ 45)	Serial link (RJ 45)		
■ 100-240 V ~ power supply							
16 inputs/outputs	9 sink/source 24 V $\overline{\text{---}}$ inputs, inc. 4 high-speed inputs	7 relay outputs	2 x 0...10 V inputs	–	1	TM221C16R	0.346 0.763
				1	1	TM221CE16R	0.346 0.763
24 inputs/outputs	14 sink/source 24 V $\overline{\text{---}}$ inputs, inc. 4 high-speed inputs	10 relay outputs	2 x 0...10 V inputs	–	1	TM221C24R	0.395 0.871
				1	1	TM221CE24R	0.395 0.871
40 inputs/outputs	24 sink/source 24 V $\overline{\text{---}}$ inputs, inc. 4 high-speed inputs	16 relay outputs	2 x 0...10 V inputs	–	1	TM221C40R	0.456 1.005
				1	1	TM221CE40R	0.456 1.005
■ 24 V $\overline{\text{---}}$ power supply							
16 inputs/outputs	9 sink/source 24 V $\overline{\text{---}}$ inputs, inc. 4 high-speed inputs	7 source transistor outputs, inc. 2 high-speed outputs	2 x 0...10 V inputs	–	1	TM221C16T	0.346 0.763
				1	1	TM221CE16T	0.346 0.763
24 inputs/outputs	14 sink/source 24 V $\overline{\text{---}}$ inputs, inc. 4 high-speed inputs	10 source transistor outputs, inc. 2 high-speed outputs	2 x 0...10 V inputs	–	1	TM221C24T	0.395 0.871
				1	1	TM221CE24T	0.395 0.871
40 inputs/outputs	24 sink/source 24 V $\overline{\text{---}}$ inputs, inc. 4 high-speed inputs	16 source transistor outputs, inc. 2 high-speed outputs	2 x 0...10 V inputs	–	1	TM221C40T	0.456 1.005
				1	1	TM221CE40T	0.456 1.005
16 inputs/outputs	9 sink/source 24 V $\overline{\text{---}}$ inputs, inc. 4 high-speed inputs	7 sink transistor outputs, inc. 2 high-speed outputs	2 x 0...10 V inputs	–	1	TM221C16U	0.558 1.230
				1	1	TM221CE16U	0.626 1.380
24 inputs/outputs	14 sink/source 24 V $\overline{\text{---}}$ inputs, inc. 4 high-speed inputs	10 sink transistor outputs, inc. 2 high-speed outputs	2 x 0...10 V inputs	–	1	TM221C24U	0.770 1.698
				1	1	TM221CE24U	0.570 1.257
40 inputs/outputs	24 sink/source 24 V $\overline{\text{---}}$ inputs, inc. 4 high-speed inputs	16 sink transistor outputs, inc. 4 high-speed outputs	2 x 0...10 V inputs	–	1	TM221C40U	0.630 1.389
				1	1	TM221CE40U	0.780 1.720

Options for Modicon TM221C●●●● logic controllers (3)

Description	Function	Reference	Weight kg/lb	
I/O cartridges	2 analog inputs (12-bit resolution) configurable as: - 0...10 V voltage - 0...20 mA/4...20 mA current Screw terminal version	TMC2AI2	0.025 0.055	
	2 analog outputs (12-bit resolution) 0...10 V voltage Screw terminal version	TMC2AQ2V	0.025 0.055	
	2 analog outputs (12-bit resolution) 4...20 mA current Screw terminal version	TMC2AQ2C	0.025 0.055	
	2 temperature inputs (12-bit resolution) type K, J, R, S, B, E, T, N, C, PT100, PT1000, NI100, NI1000 Screw terminal version	TMC2TI2	0.025 0.055	
Communication cartridge	1 additional serial link on screw terminal block	TMC2SL1 (4)	0.025 0.055	
Cartridges for specific application	Hoisting application	2 analog inputs	TMC2HOIS01	0.025 0.055
	Packaging application	2 analog inputs	TMC2PACK01	0.025 0.055
	Conveyor system application	1 serial link	TMC2CONV01 (4)	0.025 0.055

(1) M221 controllers are supplied with:
- removable screw terminal blocks for connecting the I/O
- a removable screw terminal block for connecting the power supply
- a button cell backup battery (BR2032)
- a cable for connecting the analog inputs

(2) Each M221 logic controller has an embedded USB mini-B programming port.

(3) One cartridge for controllers with 16 and 24 I/O. Two cartridges maximum for controllers with 40 I/O, only one of which can be a communication cartridge.

(4) Just one cartridge per controller.

Modicon M221 and M221 Book logic controllers

Modicon M221 Book logic controllers



TM221M16RG



TM221M16T



TM221ME16RG



TM221ME16T



TM221M16TG



TM221M32TK



TM221ME32TK

References									
Modicon M221 Book logic controller (1)									
24 V $\bar{\square}$ power supply									
No. of logic I/O	Logic inputs	Logic outputs	Analog inputs	Embedded communication ports (2)		Term. block for I/O conn. Interval (mm/in.)	Reference	Weight kg/lb	
				Ethernet (RJ 45)	Serial link SL1 (RJ 45) SL2 (RJ 45)				
16 inputs/ outputs	8 sink/source 24 V $\bar{\square}$ inputs, inc. 4 high-speed inputs	8 relay outputs	2 x 0...10 V inputs	–	1	1	screw (3.81/0.15)	TM221M16R	0.264 0.582
				–	1	1	spring (3.81/0.15)	TM221M16RG	0.264 0.582
				1	1	–	screw (3.81/0.15)	TM221ME16R	0.264 0.582
				1	1	–	spring (3.81/0.15)	TM221ME16RG	0.264 0.582
16 inputs/ outputs	16 sink/source 24 V $\bar{\square}$ inputs, inc. 4 high-speed inputs	8 source transistor outputs, inc. 2 high-speed outputs	2 x 0...10 V inputs	–	1	1	screw (3.81/0.15)	TM221M16T	0.264 0.582
				–	1	1	spring (3.81/0.15)	TM221M16TG	0.264 0.582
				1	1	–	screw (3.81/0.15)	TM221ME16T	0.264 0.582
				1	1	–	spring (3.81/0.15)	TM221ME16TG	0.264 0.582
32 inputs/ outputs	16 sink/source 24 V $\bar{\square}$ inputs, inc. 4 high-speed inputs	16 source transistor outputs, inc. 2 high-speed outputs	2 x 0...10 V inputs	–	1	1	HE 10 connector	TM221M32TK	0.270 0.595
				1	1	–	HE 10 connector	TM221ME32TK	0.270 0.595

- (1) M221 Book controllers are supplied with:
- removable terminal blocks (screw or spring-type depending on controller model), for connecting the I/O
 - a removable screw terminal block for connecting the power supply
 - a button cell backup battery (BR2032)
 - a cable for connecting the analog inputs

(2) Each M221 Book logic controller has an embedded USB mini-B programming port.

Modicon M221 and M221 Book logic controllers

Options, separate parts



TMH2GDB



ZB5AZ905



A9A15151



DX1AP52



XBTZ9980



TMASD1

References

Remote graphic display unit, mounting accessories, cable

Designation	Description	Unit reference	Weight kg/lb
Remote graphic display unit	<input type="checkbox"/> For data display and modification (1) <input type="checkbox"/> Contains 1 bezel key ZB5AZ905	TMH2GDB	0.170 0.37
Tightening tool	For tightening the cover on Ø 22 mm unit	ZB5AZ905	0.016 0.04
Mounting plate for  (Sold in lots of 4)	For clipping onto 35 mm (1.378 in.) symmetrical rail (1 hole Ø 22 mm (0.87 in.))	A9A15151	0.040 0.09
Metal bracket for panel mounting, threaded (Sold in lots of 10)	1 hole Ø 22 mm (0.87 in.) Mounted using 2 screws with diameter 7 mm (0.28 in.)	DX1AP52	0.065 0.014
Connecting cables Used between TMH2GDB remote display unit and M221/M221 Book logic controller	Equipped with an RJ 45 connector at each end Length: 2.5 m (8.202 ft.)	XBTZ9980	0.230 0.51
	Equipped with an RJ 45 connector at each end Length: 1 m (3.281 ft.)	VW3A1104R10	0.050 0.110

Option

Industrial SD memory card	Application backup and program transfer Capacity: 256 MB	TMASD1	0.004 0.009
----------------------------------	---	---------------	----------------

Separate parts

Designation	Description	Unit reference	Weight kg/lb
Mounting kit Sold in lots of 10	For plate or panel mounting of M221 and M221 Book controllers	TMAM2	0.065 0.143

Replacement parts

Designation	Description	Reference	Weight kg/lb
Set of terminal blocks for connecting the power supply on M221 and M221 Book logic controllers	8 removable terminal blocks with screw terminals	TMAT2PSET	0.127 0.280
Set of terminal blocks for connecting the I/O on M221 controllers	Removable screw terminal connectors: 8 different connectors for equipping a TM221C●●●● logic controller (8 x I/O)	TMAT2CSET	0.127 0.280
Set of terminal blocks for connecting the I/O on M221 Book controllers	4 x 10-way and 4 x 11-way removable terminal blocks with screw terminals	TMAT2MSET	0.127 0.280
	4 x 10-way and 4 x 11-way removable terminal blocks with spring terminals	TMAT2MSETG	0.127 0.280

Backup battery

The battery supplied with each controller is not available as a spare part in the Schneider catalog. If a replacement part is needed, only use a Panasonic battery type BR2032.

(1) Compatible only with M221 and M221 Book logic controllers whose firmware is version V1.3 or later. HMI pages can be configured with SoMachine Basic from version V1.3.

Modicon M221 and M221 Book logic controllers

Programming software, expansion modules, connection cables



SoMachine Basic software

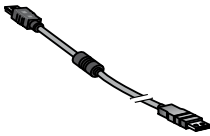

TCSXCNAMUM3P



TCSWAAC13FB

References

Programming software

Designation	For use with	Reference
SoMachine Basic	Modicon M221 and M221 Book logic controllers	Please consult our website: www.schneider-electric.com

Expansion modules

Designation	For use with	Reference
Modicon TM3 expansion modules	Modicon M221 and M221 Book logic controllers	Please consult our website: www.schneider-electric.com

Connection cables

Designation	Use	Length	Reference	Weight kg/lb
Programming cordsets	From the PC USB port to the USB mini-B port on M221 and M221 Book controllers	3 m (0.98 ft.)	TCSXCNAMUM3P (1)	0.065 0.143
		1.8 m (5.90 ft.)	BMXXCAUSBH018	0.065 0.143
Cable for connecting the analog inputs embedded in M221 and M221 Book controllers	Equipped with 1 dedicated removable connector at one end and bare wires at the other end	1 m (3.28 ft.)	TMACBL1	0.024 0.053

Connection accessory

Designation	Description	Reference	Weight kg/lb
Universal Bluetooth® interface (UBI)	Kit consisting of: <ul style="list-style-type: none"> <input type="checkbox"/> A Universal Bluetooth® interface (UBI) <input type="checkbox"/> An RJ 45/mini-DIN cable (1 m/3.28 ft long) <input type="checkbox"/> An RJ 45/RJ 45 cable (1 m/3.28 ft long) <input type="checkbox"/> A fixing clamp for installation inside the electrical enclosure <input type="checkbox"/> A CD with configuration software and user manual 	TCSWAAC13FB	0.320 0.705

(1) Unshielded, non-grounded cable. Only for use on temporary connections. For permanent connections, use cable reference BMXXCAUSBH018.

Modicon M221 and M221 Book logic controllers

Telefast pre-wired system with Modicon ABE7 for M221 Book controllers

Telefast pre-wired system with Modicon ABE 7

For 32-channel Modicon M221 Book logic controller and Modicon TM3 digital I/O expansion modules

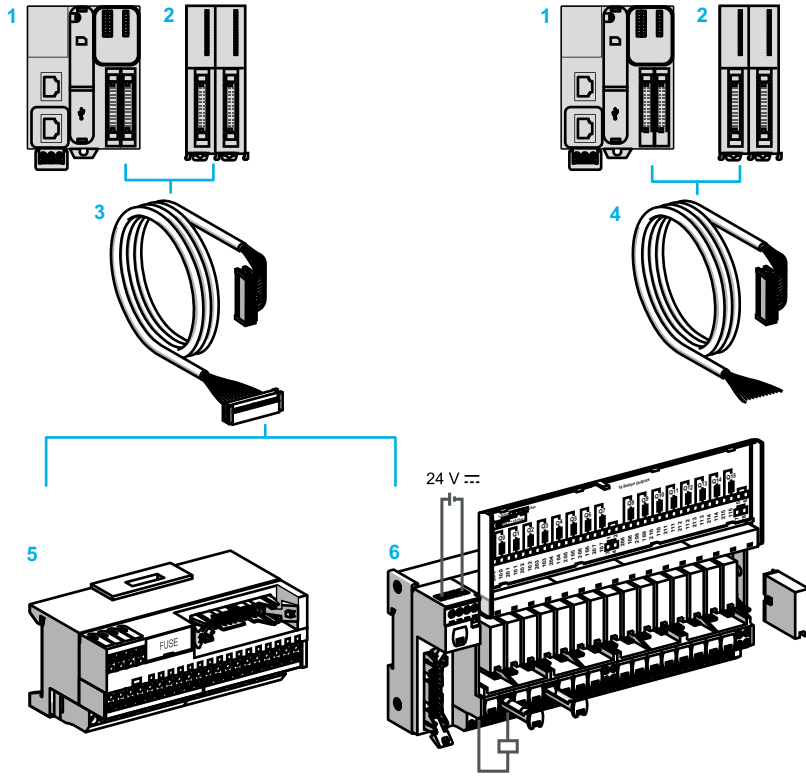

Possible combinations:

- (1 or 2) + 3 + (5 or 6)
- (1 or 2) + 4

- 1 32-channel Modicon M221 Book logic controllers (TM221M32TK, TM221ME32TK), equipped with HE 10 connectors.
- 2 Digital I/O modules (TM3D●●●●K) with 16 or 32 I/O, equipped with HE 10 connectors.
- 3 ABFTE20●●● cordsets with one HE 10 connector at each end.
- 4 TWDFCW●●● cordsets with an HE 10 connector at one end and flying leads at the other end for direct connections to sensors, preactuators and terminal blocks.
- 5 Optimum "miniature" sub-bases.
- 6 16-channel sub-base for expansion modules.

Combinations of Modicon ABE7 sub-bases with M221 Book controllers and Modicon TM3 expansion modules

Modicon Telefast sub-bases		Modicon M221 Book logic controllers		Modicon TM3 I/O expansion modules		
		TM221M32TK TM221ME32TK		TM3DI16K TM3DI32K	TM3DQ16TK TM3DQ32TK	TM3DQ16UK TM3DQ32UK
Reference	Type	Inputs	Outputs	Inputs	Outputs	Outputs
ABE7H20E000	Passive					
ABE7H16C10	Passive					
ABE7H16C11	Passive					
ABE7H16C21	Passive					
ABE7H16C31	Passive					
ABE7R16S111	2 A relay					
ABE7R16S111E	2 A relay					
ABE7R16T111	5 A plug-in relay					
ABE7P16T111	Empty sub-base for solid state or electromechanical relay					

Compatible with inputs
For use with ABF TE20EP●●●● cables

Compatible with outputs
For use with ABF TE20SP●●●● cables

Modicon M221 and M221 Book logic controllers

Telefast pre-wired system with Modicon ABE7 for M221 Book controllers



ABE7H20E000



ABE7H16C21



ABE7R16S111



ABE7P16T111

Connection sub-bases for discrete signals

Passive connection sub-bases for inputs/outputs

Sub-base type	Number of terminals		LED per chnntl	Width mm/in.	Type of connection	Reference	Weight kg/lb
	per channel	on row number					
Optimum "Economy" sub-bases	1	2	No	55/2.15	Screw	ABE7H20E000	–
Optimum "miniature" sub-bases	1	1	No	106/4.17	Screw	ABE7H16C10	0.160 0.353
	1	1	Yes	106/4.17	Screw	ABE7H16C11	0.160 0.353
	2	2	Yes	106/4.17	Screw	ABE7H16C21	0.205 0.452
	3	3	Yes	106/4.17	Screw	ABE7H16C31	0.260 0.573

Optimum and Universal output sub-bases with electromechanical relays

Number of channels	Number of contacts	Polarity distribution/operative part	Output current	Width mm/in.	Type of connection	Reference	Weight kg/lb
16 channels	1 NO	Contact common per group of 8 channels	2 A	125/4.93	Removable screw terminal block	ABE7R16S111	0.405 0.893
					Removable spring terminal block	ABE7R16S111E	0.405 0.893
	1 NO	Contact common per group of 4 channels	5 A	110/4.33	Screw	ABE7R16T111	0.600 1.323
	to be completed with relays ABR7S11 ABS7SC1B	Contact common per group of 4 channels	5 A	110/4.33	Screw	ABE7P16T111	0.550 1.213

Plug-in relays for ABE7●16T111 sub-bases

Relay type	Number of contacts	Output voltage	Output current	Width mm/in.	Reference	Weight kg/lb
Electro-mechanical	1 NO	24 V ~	5 A	5/0.197	ABR7S11	0.005 0.011
Solid state		24 V ~	2 A	5/0.197	ABS7SC1B	0.010 0.022

Connection cables between TM221M●32TK controller, TM3 modules and sub-bases

Designation	Compatibility	CSA	Connection method	Length m/ft.	Reference	Weight kg/lb
Cordsets for digital inputs	TM221M32TK, M221ME32TK, TM3DI16K, TM3DI32K	AWG 28/ 0.08 mm ²	HE10 - HE10	1/3.281	ABFTE20EP100	–
				2/6.562	ABFTE20EP200	–
				3/9.843	ABFTE20EP300	–
Cordsets for digital outputs	TM221M32TK, TM221ME32TK, TM3DQ16TK, TM3DQ32TK	AWG 28/ 0.08 mm ²	HE10 - HE10	1/3.28	ABFTE20SP100	–
				2/6.56	ABFTE20SP200	–
				3/9.843	ABFTE20SP300	–
Cordsets for digital I/O	TM221M32TK, TM221ME32TK, TM3DI16K, TM3DI32K, TM3DQ16TK, TM3DQ32TK	AWG 22/ 0.035 mm ²	HE10 - Flying leads	3/9.84	TWDFCW30K	0.405 0.893
				5/16.40	TWDFCW50K	0.670 1.477

Modicon M221 and M221 Book logic controllers

Serial links

Modbus protocols, character mode

Presentation

RS 232/RS 485 serial links offer a simple solution to the communication needs of compact machines.

Modbus and ASCII standard communication protocols are used to connect numerous equipment items such as: HMIs, printers, energy meters, variable speed drives, motor starters, remote I/O (RIO), etc. Thanks to the I/O Scanner function, this equipment is just as easy to integrate into the application as the local I/O.

Description

- Modicon M221 Book logic controllers with 16, 24 or 40 I/O have the following on the front panel:
 - 1 A serial link port with an RJ 45 connector delivering a voltage of 5 V (200 mA) to supply an HMI or Bluetooth® adapter with power.
 - 2 A slot for a 2nd serial link port (with connection on screw terminals) by inserting the **TMC2SL1** communication cartridge or the **TMC2CONV01** application cartridge (1).
- Modicon M221 Book logic controllers with 16 or 32 I/O have the following on the front panel:
 - 3 A serial link port with an RJ 45 connector delivering a voltage of 5 V (200 mA) to supply an HMI or Bluetooth® adapter with power
 - 4 A 2nd serial port also equipped with an RJ 45 connector for **TM221M16●●** and **TM221M32●●** controllers (controllers without embedded Ethernet).



TM221C●●●●



TM221M16●●
TM221M32●●



TM221ME●●●●

Controller Type	Embedded Ports		Optional Port (1 max. per controller)
	"Serial" or Serial 1" port, RJ 45 connector	"Serial 2" port, RJ 45 connector	
TM221C●●●●	RS 232/RS 485 with 5 V (200 mA) power supply for HMI or Bluetooth communication adapter (items 1/3)	–	On TMC2SL1 or TMC2CONV01 option cartridges, connection on screw terminals RS 232/RS 485 (item 2)
TM221M●●●●		RS 485 (item 4)	–
TM221ME●●●●		–	–

(1) TM221C40●●●● controllers have 2 slots for a cartridge; only one cartridge, TMC2SL1 or TMC2CONV01, can be used per controller. The other slot remains available for an analog I/O cartridge or an application cartridge.

Modbus serial link wiring system

Non-isolated bus

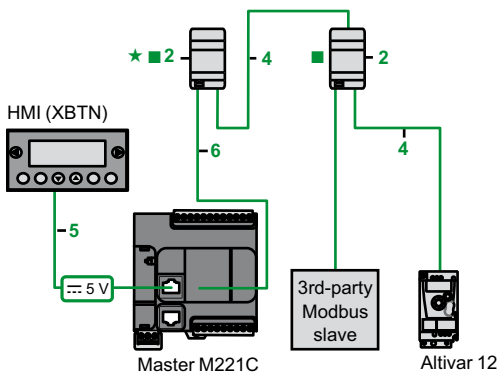



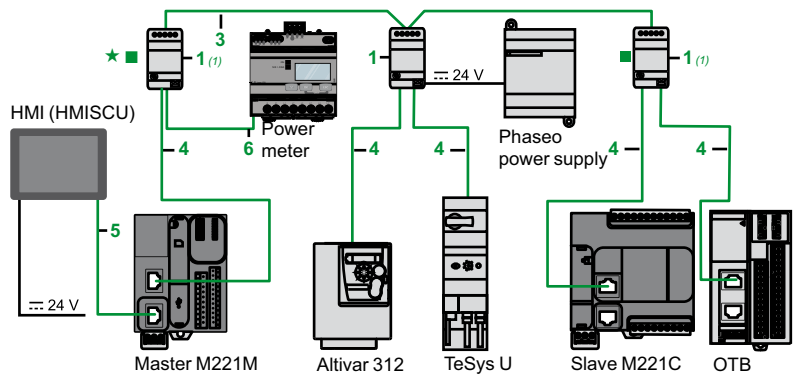







Isolated bus (recommended for bus > 10 m/32.808 ft)



- Total length of cables between M221 and ATV 12: ≤ 30 m (98.425 ft)
- Length of cable 4: ≤ 10 m (32.808 ft)
★ Line polarization active. ■ Line termination

- Total length of cables between isolation boxes 1: ≤ 1,000 m (3,280.840 ft)
- Length of drop cables 4 or 5: ≤ 10 m (32.808 ft)
★ Line polarization active. ■ Line termination
(1) Box powered by the logic controller.

References

Tap-off and adapter components for RS 485 serial link							
Designation	Description	Item	Length	Unit reference	Weight		
					kg	lb	
 TWDXCAISO	T-junction box with line isolation Screw terminal block for trunk cable 2 x RJ 45 for tap-off	<input type="checkbox"/> Isolation of the RS 485 link (1) <input type="checkbox"/> Line termination (RC 120 Ω, 1 nF) <input type="checkbox"/> Line pre-polarization (2 R 620 Ω) <input type="checkbox"/> Power supply: 24 V $\overline{\text{---}}$ (screw terminals) or 5 V $\overline{\text{---}}$ (via RJ 45) <input type="checkbox"/> Mounting on 35 mm (1.378 in.) \perp	1	–	TWDXCAISO	0.100 0.220	
	T-junction box 1 RJ 45 for trunk cable 2 x RJ 45 for tap-off	<input type="checkbox"/> Line termination (RC 120 Ω, 1 nF) <input type="checkbox"/> Line pre-polarization (2 R 620 Ω) <input type="checkbox"/> Mounting on 35 mm (1.378 in.) \perp	2	–	TWDXCAT3RJ	0.080 0.176	
 TWDXCAT3RJ	Modbus splitter box Screw terminal block for trunk cable 10 x RJ 45 for tap-off	<input type="checkbox"/> Mounting on 35 mm \perp , on plate or panel	–	–	LU9GC3	0.500 1.102	
	T-junctions 2 x RJ 45 for trunk cable	1 integrated cable with RJ 45 connector for tap-off dedicated to Altivar variable speed drive	–	0.3 m 0.984 ft 1 m 3.281 ft	VW3A8306TF03 VW3A8306TF10	– –	
 LU9GC3	Passive T-junction box	<input type="checkbox"/> 1-channel line extension and tap-off on screw terminals <input type="checkbox"/> Line termination	–	–	TSXSACA50	0.520 1.146	
	RS 232C/RS 485 line converter	<input type="checkbox"/> Max. data rate 19.2 Kbps. No modem signals <input type="checkbox"/> 24 V $\overline{\text{---}}$ /20 mA power supply <input type="checkbox"/> Mounting on 35 mm (1.378 in.) \perp	–	–	XGSZ24	0.100 0.220	
Cables and cordsets for RS 485 serial link							
 TSXSACA50	RS 485 double shielded twisted pair trunk cables	Modbus serial link, supplied without connector	3	100 m 328.064 ft	TSXSACA100	5.680 12.522	
				200 m 656.168 ft	TSXSACA200	10.920 24.074	
				500 m 1,640.420 ft	TSXSACA500	30.000 66.139	
 TSXSACA50	Modbus RS 485 cordsets	2 x RJ 45 connectors	4	0.3 m 0.984 ft	VW3A8306R03	0.030 0.066	
				1 m 3.281 ft	VW3A8306R10	0.050 0.110	
				3 m 9.840 ft	VW3A8306R30	0.150 0.331	
		1 x RJ 45 connector and 1 end with flying leads	6	1 m 3.281 ft	TWDXCAFJ010	0.060 0.132	
				3 m 9.843 ft	VW3A8306D30	0.150 0.331	
 XGSZ24	Controller to Magelis HMI cordsets	2 x RJ 45 connectors Compatible with: <input type="checkbox"/> Com Port 1 on XBTN200/N400/R400/RT500 (2) <input type="checkbox"/> Com Port 1 on XBTR511/HMISTO/STU/SCU <input type="checkbox"/> Com Port 2 on XBTGT2●●0...7●●0 and HMIGTO	5	2.5 m 8.202 ft	XBZ9980	0.230 0.507	
				5	10 m 32.81 ft	XBZ9982	–
		1 x RJ 45 connector and 1 x 25-way SUB-D connector Compatible with: <input type="checkbox"/> Com Port 1 on XBTN410/N410 and XBTR410/R411	–	2.5 m 8.202 ft	XBZ9938	0.210 0.463	
		1 x RJ 45 connector and 1 x 9-way SUB-D connector Compatible with: <input type="checkbox"/> Com Port 1 on XBTGT2●●0...7●●0	–	2.5 m 8.202 ft	XBZ9908	–	
 XGSZ24	TMC2SL1 cartridge to Magelis HMI cordsets	1 x RJ 45 connector and stripped wires Compatible with: <input type="checkbox"/> Com Port 1 on XBTR511/HMISTO/STU/SCU <input type="checkbox"/> Com Port 2 on XBTGT2●●0...7●●0 and HMIGTO	–	3 m 9.843 ft	VW3A8306D30	0.150 0.331	
 XGSZ24	Line end adapter Sold in packs of 2	For RJ 45 connector R = 120 Ω, C = 1 nF	–	–	VW3A8306RC	0.200 0.441	
Cordsets for RS 232 serial link							
 XGSZ24	Cordset for DTE terminal (printer) (3)	Serial link for DTE (2) 1 x RJ 45 connector and 1 x 9-way female SUB-D connector	–	3 m 9.843 ft	TCSMCN3M4F3C2	0.150 0.331	
 XGSZ24	Cordset for DCE terminal (modem, converter)	Serial link for point to point device (DCE) 1 x RJ 45 connector and 1 x 9-way male SUB-D connector	–	3 m 9.843 ft	TCSMCN3M4M3S2	0.150 0.331	

(1) Line isolation recommended for line distances > 10 m (32.808 ft).

(2) Can only be connected to the controller SL or SL1 ports in order to supply the Magelis terminal with power.

(3) If the terminal is equipped with a 25-way SUB-D connector, you will also need to order the 25-way female/9-way male SUB-D adapter TSXCTC07.

Modicon M221 and M221 Book logic controllers

Industrial Ethernet network

General

Industrial Ethernet is the term used to refer to industrial communication protocols using Ethernet standard physical layers such as:

- EtherNet/IP
- Modbus TCP
- TCP and UDP

On an Ethernet Industrial network, it is possible to connect:

- industrial products (industrial communication protocols) such as controllers, variable speed drives, robots, etc.
- products using TCP/UDP-based proprietary protocols

In addition, it is possible to use different Ethernet Industrial protocols on the same network simultaneously.

The EtherNet/IP protocol

EtherNet/IP is an industrial communication protocol based on CIP (Common Industrial Protocol), owned and managed by the ODVA, an independent standards organization (www.odva.org).

EtherNet/IP is the result of implementing CIP protocol on standard Ethernet.

EtherNet/IP operates on the same device and the same infrastructure as Modbus TCP, and both protocols can be activated simultaneously on the network at any time.

EtherNet/IP is a robust protocol for use with sophisticated devices such as cameras, robots, etc.

Advanced services and outstanding performance

EtherNet/IP is object-oriented. In each EtherNet/IP device, the data is arranged as objects and each device can be associated with several types of object depending on its intended use. Integration of devices is made easy thanks to predefined and standard objects.

The EtherNet/IP protocol uses an Originator/Target architecture for data exchanges.

The Modbus TCP protocol

Modbus has been the industry communication standard since 1979. During the internet revolution, Modbus was combined with Ethernet to form Modbus TCP, a completely open Ethernet protocol.

Modbus TCP, simple and open

The Modbus application layer is simple and universally familiar with its 9 million installed connections.

□ Thousands of manufacturers have already implemented this protocol. Many have already developed a Modbus TCP connection and numerous products are currently available.

□ The simplicity of Modbus TCP enables any fieldbus device, such as an I/O module, to communicate on Ethernet without the need for a powerful microprocessor or a lot of internal memory.

Modbus TCP, a standard

□ The application protocol is identical on Modbus serial link and Modbus TCP; messages can be routed from one network to the other without converting the protocol.

□ Since Modbus operates on the TCP/IP higher layer, users benefit from IP routing, thus enabling devices located anywhere in the world to communicate without worrying about the distance between them. Modbus and Modbus TCP are recognized as a fieldbus by the international standard IEC/EN 61158. They also comply with the "national Chinese standard" managed by ITEI.

The Modbus TCP protocol uses a client/server architecture for data exchanges.

Modicon M221 and M221 Book logic controllers

Industrial Ethernet network

Modicon M221, M241 and M251 logic controllers

The embedded Ethernet communication ports in Modicon M221, M241 or M251 logic controllers and in the Modicon TM4ES4 communication module optimize integration in factory network architectures.

Modicon M221, M241 and M251 controllers can easily be integrated in typical architectures:

- machine to devices (variable speed drives, remote I/O modules, operator dialogue terminals) with the I/O Scanner function
- machine to machine with the NGVL function
- machine to supervision with the Modbus Client/Server function and EtherNet/IP adapter

Ethernet also brings transparency to the factory, in particular - thanks to the firewall functions - making it possible from any point on the network to safely:

- program, monitor a controller or download an application
- access device parameters (variable speed drives for example)

A simple web browser can be used to access machines anytime anywhere, using a tablet or smartphone, for example, using the web servers embedded in Modicon M241 and M251 controllers.

Safety can be enhanced by the use of VPN modems; refer to our Partner program on our website www.schneider-electric.com > Products and Services > Automation and Control > Collaborative Automation Partner Program.

Main devices supported

Device	Protocols supported			Tools for integration in the SoMachine software (1)
	TCP/UDP	Modbus TCP	EtherNet/IP	
Altivar 32	-	<input checked="" type="checkbox"/>	<input checked="" type="checkbox"/>	FDR, DTM, TVDA
Altivar 71	-	<input checked="" type="checkbox"/>	<input checked="" type="checkbox"/>	FDR, DTM, TVDA
Lexium 32 M	-	<input checked="" type="checkbox"/>	<input checked="" type="checkbox"/>	FDR, DTM, TVDA
Lexium ILA	-	<input checked="" type="checkbox"/>	<input checked="" type="checkbox"/>	FDR, libraries, TVDA
Lexium ILE	-	<input checked="" type="checkbox"/>	<input checked="" type="checkbox"/>	FDR, libraries, TVDA
Lexium ILS	-	<input checked="" type="checkbox"/>	<input checked="" type="checkbox"/>	FDR, libraries, TVDA
OsiSense XG	-	<input checked="" type="checkbox"/>	<input checked="" type="checkbox"/>	TVDA
OsiSense XUW	-	-	<input checked="" type="checkbox"/>	TVDA
Modicon OTB1EODM9LP	-	<input checked="" type="checkbox"/>	-	Libraries
Preventa XPSMCM	-	(2)	<input checked="" type="checkbox"/>	TVDA for EtherNet/IP
Harmony XB4R, XB5R	-	<input checked="" type="checkbox"/>	-	DTM, libraries
Modicon M221, M241, M251	<input checked="" type="checkbox"/>	<input checked="" type="checkbox"/>	<input checked="" type="checkbox"/>	User parameters (only for EtherNet/IP), libraries
Device supplied with EDS file (1)	-	-	<input checked="" type="checkbox"/>	User parameters
Generic device	<input checked="" type="checkbox"/>	<input checked="" type="checkbox"/>	<input checked="" type="checkbox"/>	User parameters (only for EtherNet/IP), libraries

Web servers

Preconfigured Web server

Using a simple web browser available on PC, smartphone or tablet, this server authorizes the following "ready-to-use" functions:

- With no prior programming
 - Display of the I/O states
 - Controller diagnostics, and of its expansion and communication modules
 - Communication port diagnostics
 - I/O Scanner function diagnostics
 - Maintenance and configuration functions (EtherNet/IP, firewall, etc.)
- After configuration
 - Viewing data values
 - Viewing the evolution of these data values over time (oscilloscope function)

Viewer Web server

The SoMachine programming software is used to create customized pages for viewing and monitoring devices. These pages can also be accessed on any mobile device such as a tablet or smartphone with any operating system (iOS, Android, Windows).

(1) SoMachine configuration software: please consult our catalog [DIA3ED2140110EN.pdf](#) or our website www.schneider-electric.com

- FDR: Fast Device Replacement
- DTM: Device Type Manager
- TVDA: Tested Validated Documented Architectures

(2) Integration as a generic device.



Preconfigured Web server



Viewer Web server

Modicon M221 and M221 Book logic controllers

Industrial Ethernet network

Description of Ethernet services

Network Global Variable List (NGVL)

The NGVL protocol allows a controller to share data with other controllers on a local Ethernet network (LAN) or subscribe to data published by other controllers that support the NGVL protocol and thus allowing, for example synchronization between control platforms.

I/O Scanning (Industrial Ethernet Manager)

The Industrial Ethernet Manager service is used to manage the exchange of remote I/O states on the Ethernet network after a simple configuration operation, with no need for special programming.

I/O scanning is performed transparently by means of read/write requests in accordance with the Modbus TCP or EtherNet/IP protocol, this is called Scanner Manager on Modbus TCP or Scanner Manager on EtherNet/IP.

Slave Modbus TCP

This function can be used to create a dedicated I/O table in the controller, which can be accessed via the Modbus TCP protocol and by a controller with the Modbus TCP I/O Scanner function.

Fast Device Replacement (FDR)

This service uses standard address management technologies (BOOTP, DHCP) and the TFTP (Trivial File Transfer Protocol) file management service, in order to simplify maintenance of Ethernet products.

The FDR service is used to replace a device with a new one; the device is detected, reconfigured and automatically rebooted by the system.

Access to files via FTP (File Transfer Protocol)

This service provides access to the controller files from, for example, a PC (FTP client) and is used to exchange files such as application programs, data, etc.

This service can be accessed even if the controller has no application program in its memory.

Dynamic Host Configuration Protocol (DHCP)

This protocol can be used to assign an address to a controller (client DHCP/BOOTP) automatically. This address can be:

- fixed and determined either in the SoMachine software or included in a post-configuration file
- assigned by a controller with the DHCP server or BOOTP server function (such as the **TM251MESE** logic controller)

SNMP (Simple Network Management Protocol)

From a network management station, the SNMP protocol is used to monitor and control the Ethernet architecture components, meaning problems are diagnosed quickly.

The SNMP protocol is used to access configuration and management objects that are contained in the device MIBs (Management Information Bases).

Modicon M241 and M251 controllers support the "MIB 2 Standard" SNMP network management interface. This interface accesses a first level of network management; it enables the manager to identify the devices making up the architecture and retrieve general information about configuration and operation of the Ethernet Modbus TCP interfaces.

IP address filter (Whitelisting)

IP addresses that are authorized to access the controller can be loaded in the controller from either an SD card or an FTP client.

Locking communication protocols

Not only SoMachine, NetManage (1), SNMP communication protocols but also Modbus, WEB and FTP servers can be locked individually in the SoMachine software.

EtherNet/IP target

This function can be used to create a dedicated I/O table in the controller, that can be accessed via the EtherNet/IP protocol and by a controller with the EtherNet/IP originator function. EtherNet/IP target acts in the same way for EtherNet/IP as a Modbus TCP slave.

EtherNet/IP originator

Controllers with this function trigger exchanges with devices featuring the Ethernet/IP target function. EtherNet/IP originator acts in the same way for EtherNet/IP as a Modbus TCP master.

(1) The NetManage function can automatically detect which controllers are present on the network. It also offers the option of straightforward connection to any controller present on the network in order to identify it physically by means of a visual or audible message and modify its parameters or manage the resident application.

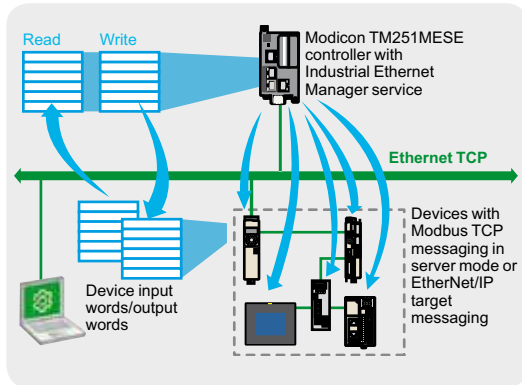

I/O scanning (Industrial Ethernet Manager)

Transparent Ready class and Functions

	Logic controllers, Ethernet switch module			
	TM221ME●●●/TM221CE●●●	TM241CE●●●, TM4ES4	TM251MESc	TM251MESE
Transparent Ready class	A10	B20		
Internet protocol version	IPV4			
Ethernet services				
Programming, downloading, monitoring				
Firmware update	–			
Modbus TCP/IP (client & server)				
Modbus TCP slave				
EtherNet/IP target				
EtherNet/IP originator	–	–	–	
Data exchange – NVGL and IEC VAR ACCESS	–			
Web server	–			
SNMP network management MIB2	–			
Scanner Manager on Modbus TCP	–	–	–	Ethernet port 2
Scanner Manager on EtherNet/IP	–	–	–	Ethernet port 2
FTP file transfer	–			
DHCP Client dynamic configuration				Ethernet port 1
DHCP Server dynamic configuration	–	–	–	Ethernet port 2
FDR faulty device replacement	–	–	–	
SMS	(1)			
Security functions				
IP address filter (Whitelisting)	–			
Locking communication protocols				
Locking IP address routing	–			

(1) With dedicated function block in the SoMachine Basic software.

Modicon M251 controller network characteristics

Topology	Daisy chain and star using switches
Bandwidth	10/100 Mbps
EtherNet/IP scanner performance	Up to 16 slave devices controlled by the controller in 10 ms
Ethernet Modbus TCP scanner performance	Up to 64 slave devices controlled by the controller in 64 ms

Note: When EtherNet/IP and Modbus TCP devices are controlled on the same network simultaneously (Ethernet 2 connector), 16 devices maximum can be controlled (EtherNet/IP + Modbus TCP).

Ethernet ports on logic controllers and the Ethernet switch module

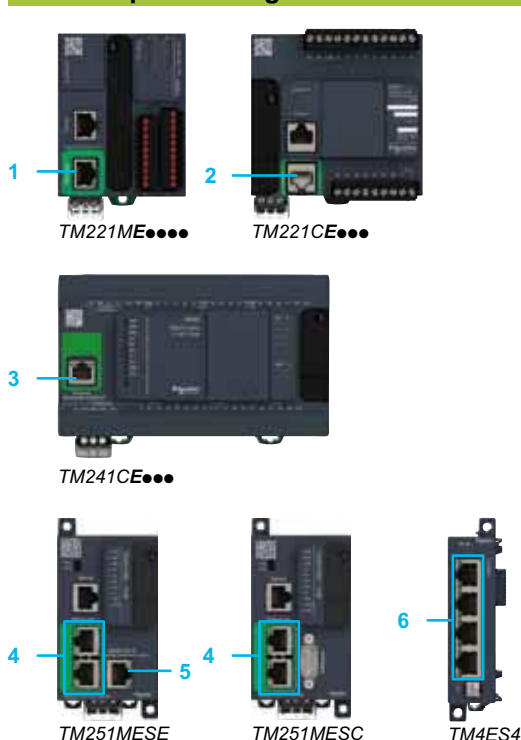

M221 logic controllers

- 1 On **TM221ME●●●●** controllers: RJ 45 connector for Ethernet network, with exchange speed and activity LED indicator.
- 2 On **TM221CE●●●●** controllers: RJ 45 connector for Ethernet network, with exchange speed and activity LED indicator.

M241 logic controllers

- 3 On **TM241CE●●●●** controllers: RJ 45 connector for Ethernet network, with exchange speed and activity LED indicator.

M251 logic controllers

- 4 On **TM251MESE** and **TM251MESc** controllers: 2 connectors connected by an RJ 45 internal switch for "Machine or Factory" Ethernet network, with exchange speed and activity LED indicator.
- 5 On **TM251MESE** controller: RJ 45 connector for "fieldbus" Ethernet network with exchange speed and activity LED indicator. This port can be used with the Industrial Ethernet Manager function.

TM4ES4 Ethernet switch communication module

- 6 4 type RJ 45 connectors for Ethernet network with exchange speed and activity LED indicator.

Industrial Ethernet architecture

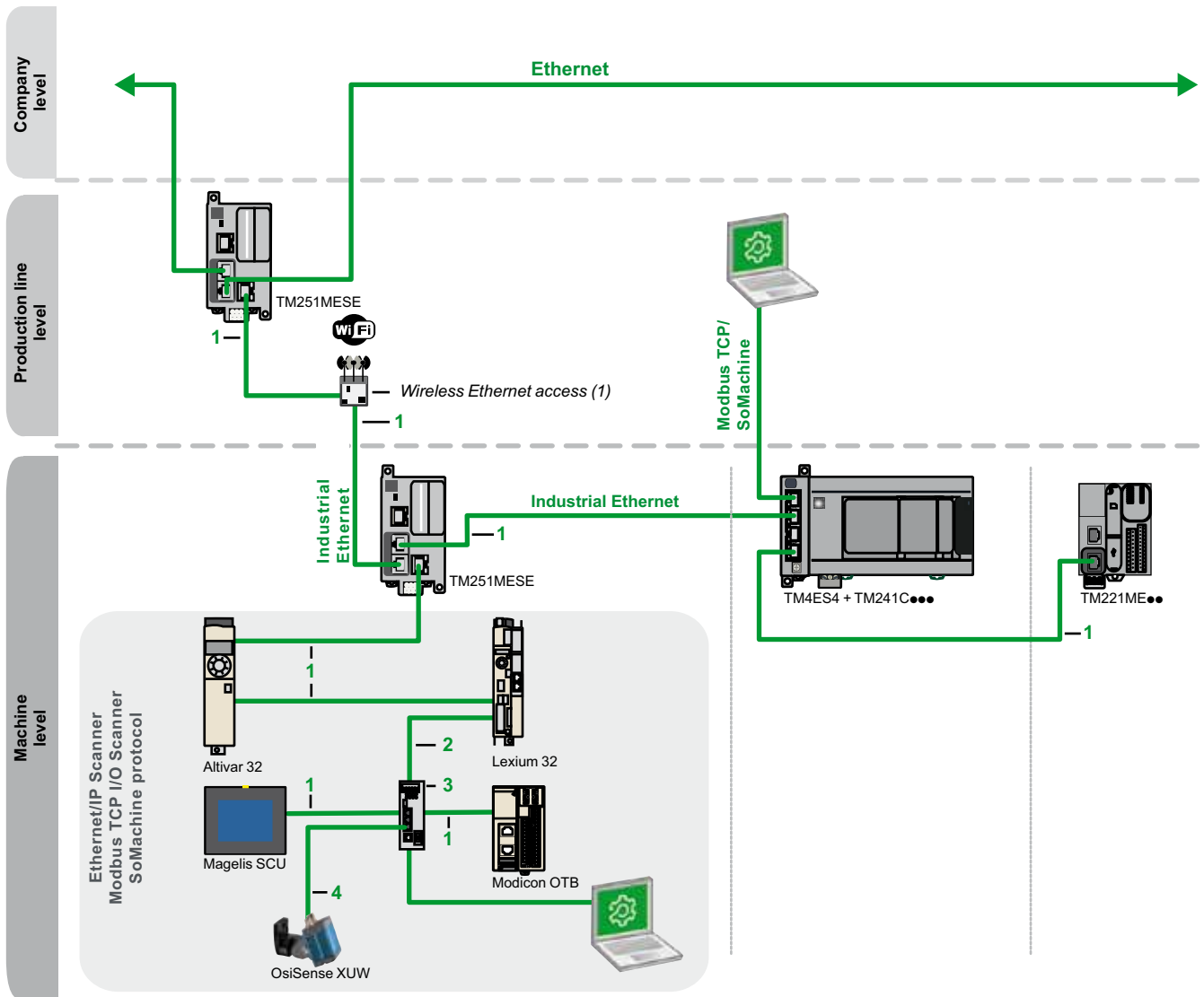

NB: The ports on M251 controllers and the TM4ES4 communication module cannot be used to create redundant architectures.

(1) Wireless Ethernet access, see our partner program.

Items 1, 2 and 3: see references on next page.

Item 4: Ethernet jumper cables XGSZ●2E45●● (M12 straight/RJ 45, shielded cable, straight cabling) for OsiSense XUW vision sensors.

More information on our partner website www.tesensors.com

Shielded copper connection cables

ConneXium shielded connection cables are available in two versions to meet the requirements of the various current standards and approvals:

■ EIA/TIA 568 shielded twisted pair cables for CE market

These cables conform to:

- EIA/TIA-568 standard, category CAT 5E
- IEC 11801/EN 50173-1 standard, class D

Their fire resistance conforms to:

- NF C32-070 standard, class C2
- IEC 322/1 standards
- Low Smoke Zero Halogen (LSZH)

■ EIA/TIA 568 shielded twisted pair cables for UL market

These cables are:

- CEC type FT-1
- NEC type CM

A new range of ConneXium fully shielded preassembled cables has been specially designed for use in harsh industrial environments. These cables combine a category 5E shielded cable and RJ 45 connectors reinforced with a metal profile.

Modicon M221 and M221 Book logic controllers

Industrial Ethernet network

References

EIA/TIA 568 shielded twisted pair cables for C€ market

Description	End fittings	Item	Type	Length m (ft.)	Reference	Weight kg
Straight-through copper cables, C€ compatible	2 RJ 45 connectors For connection to terminal devices (DTE)	1	standard	2 (6.56)	490NTW00002	–
				5 (16.41)	490NTW00005	–
				12 (39.37)	490NTW00012	–
				40 (131.23)	490NTW00040	–
				80 (262.467)	490NTW00080	–
		1	ruggedized	1 (3.28)	TCSECE3M3M1S4	–
				2 (6.56)	TCSECE3M3M2S4	–
				3 (9.84)	TCSECE3M3M3S4	–
				5 (16.40)	TCSECE3M3M5S4	–
				10 (32.81)	TCSECE3M3M10S4	–



TCSECE3M3M10S4

Shielded twisted pair cables for UL market

Description	End fittings	Item	Type	Length m (ft.)	Reference	Weight kg
Straight-through copper cables, UL compatible	2 RJ 45 connectors For connection to terminal devices (DTE)	1	standard	2 (6.56)	490NTW00002U	–
				5 (16.40)	490NTW00005U	–
				12 (39.37)	490NTW00012U	–
				40 (131.23)	490NTW00040U	–
				80 (262.47)	490NTW00080U	–
		1	ruggedized	1 (3.28)	TCSECU3M3M1S4	–
				2 (6.56)	TCSECU3M3M2S4	–
				3 (9.84)	TCSECU3M3M3S4	–
				5 (16.40)	TCSECU3M3M5S4	–
				10 (32.81)	TCSECU3M3M10S4	–

Do it Yourself copper cable and connectors

The **ConneXium** "Do it Yourself" offer consists of 2 connector references (M12 and RJ 45) and 1 cable reference - 300 m (984.25 ft) reel - enabling Ethernet 10/100 Mbps network cables to be made up in situ. The maximum length of cables made up in this way is 80 m (262.47 ft.). They are assembled using only a knife and wire cutters (no special tool is required).

Description	Characteristics	Item	Length m (ft.)	Reference	Weight kg
Ethernet copper cable 2 shielded twisted pairs 24 AWG	Conforms to the standards and approval listed above	2	300 (984.25)	TCSECN300R2	–
RJ 45 connector	Conforms to EIA/TIA-568-D	2	–	TCSEK3MDS	–



TCSESU053FN0

ConneXium unmanaged switches, 3, 4 and 5 ports, twisted pair and optical fiber

Description	Interfaces	Item	Reference	Weight kg lb
ConneXium unmanaged switches	3 x 10BASE-T/100BASE-TX ports (copper cable), RJ 45 shielded connectors	3	TCSESU033FN0	0.113 0.249
	■ 4 x 10BASE-T/100BASE-TX ports (copper cable), RJ 45 shielded connectors ■ 1 x 100BASE-FX port (multimode fiber), duplex SC connector	3	TCSESU043F1N0	0.120 0.265
	5 x 10BASE-T/100BASE-TX ports (copper cable), RJ 45 shielded connectors	3	TCSESU053FN0	0.113 0.249

Other wiring components are available, please consult the **ConneXium** offer on our website www.schneider-electric.com

Modicon M221 and M221 Book logic controllers

Communication via modem and router

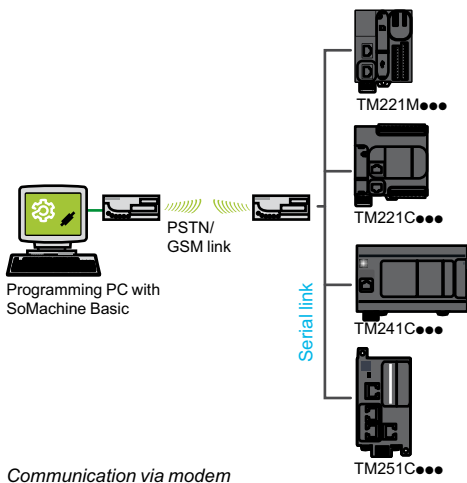

Communication via modem

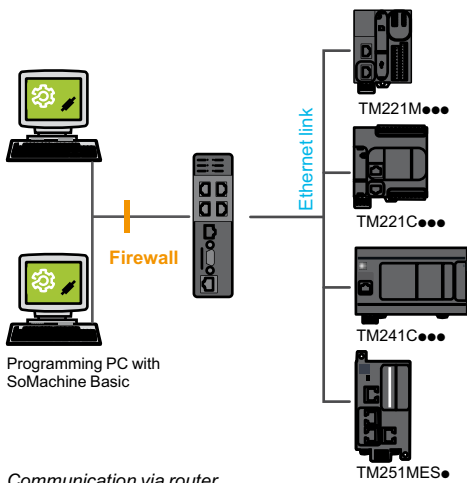

Communication via router

Presentation

The communication via modems and routers offer is dedicated to the following applications:

- Synchronization between remote machines; direct data exchange between controllers.
- Remote maintenance; access to the controller via the programming software (SoMachine or SoMachine Basic).
- Remote control and monitoring of machines; receipt of information and sending commands on GSM phone.

This offer comprises 2 Schneider Electric modems (PSTN and GSM) and a VPN router made by Ewon®.

Setting up this router requires installation of two configuration software programs.

PSTN and GSM modems

Both these modems can either be used on the machine or connected to the PC if it does not have a modem. On the machine side, they are then connected to the logic controller SL or SL1 serial port (1). On the PC side, they use a USB port.

VPN router

The eWON Cosy is an industrial VPN router designed to offer easy remote access, via the Internet.

On the machine side, it is connected to the controller Ethernet port. The router establishes a secure VPN connection via the plant LAN. This is an outgoing connection compatible with the firewalls. Remote users can only access the machine's LAN, not the customer's LAN.

(1) Modems cannot be connected to either the logic controller SL2 port or the **TMC2SL1** cartridge.

Applications

		Modems		Router
		SR2MOD01	SR2MOD03	Ewon Cosy 141
Type of connection between logic controller and modem/router		Serial link	Serial link	Ethernet
Remote maintenance	<input type="checkbox"/> Monitoring via the protocol for programming and writing variables (1) <input type="checkbox"/> Application transfer/download <input type="checkbox"/> Online program modification (writing code)	M221, M221 Book (2)	M221, M221 Book	M221, M221 Book, M241, M251
Remote data logging	File reading/writing	–	–	M241, M251
Synchronization between machines	Modbus exchanges	M221, M221 Book, M241, M251	–	–
Remote control	Receipt/sending of "SMS"	–	M221, M221 Book, M241, M251 (3)	–
	Viewer Web server (HTTP)	–	–	M241, M251
	OPC communication (4) (on Modbus protocol)	M221, M221 Book, M241, M251	–	–

Logic controller supporting the application

(1) Including Run/stop, Init.

(2) Modbus ASCII.

(3) Function blocks in SoMachine and SoMachine Basic programming software.

(4) The OPC (Object Linking and Embedding for Process Control) standard defines communication between Windows applications and the hardware/software used regularly in the field of process control (e.g.: controllers). The OPC standard describes a coherent and universal way of accessing field data in the factory devices.

Modicon M221 and M221 Book logic controllers

Communication via modem and router



SR2MOD01



SR2MOD03



Ewon Cosy 141



TSXCUSB232

Modems

Designation	Composition	Reference	Weight kg/lb
PSTN modem	<ul style="list-style-type: none"> ■ SIXNET VT-MODEM-5-WW type ■ Supplied with a telephone cable (2 m/6.562 ft long) ■ Supply voltage: 12...24 V ~ 	SR2MOD01	0.265 0.584
GSM modem	<ul style="list-style-type: none"> ■ Quad band type 900/1800 MHz, 850/1900 MHz ■ Supplied with: <ul style="list-style-type: none"> □ a power supply cable (1.5 m/4.921 ft long) □ a magnetic GSM 4-band aerial SMA-M with 2.5 m (8.202 ft) long cable ■ Mounted on 5 panel or rail ■ Supply voltage: 12...24 V ~ 	SR2MOD03	0.335 0.739

Connection components for modem link

Designation	For use Composition	Reference	Weight kg/lb
Connecting cables	<ul style="list-style-type: none"> ■ Between modem and M221, M221 Book, M241 and M251 logic controllers ■ Equipped with an RJ 45 connector and a 9-way male SUB-D connector, 3 m (9.843 ft) long Cable type: 4-wire: RX, TX, RTS, CTS 	TCSMCN3M4M3S2	0.150 0.331
	<ul style="list-style-type: none"> ■ Between Modem and PC ■ Equipped with 2 x 9-way male SUB-D connectors, 1.8 m (5.906 ft) long 	SR1CBL03	0.110 0.243
USB-RS232 converter	<ul style="list-style-type: none"> ■ For PC not equipped with a 9-way SUB-D connector ■ Equipped with a USB connector and a 9-way SUB-D connector, cable length: 0.4 m (1.31 ft) 	TSXCUSB232	0.145 0.320

Router

Designation	Composition	Reference
Ewon Cosy 141 (partner offer)	<ul style="list-style-type: none"> ■ VPN internet ■ 4 x Ethernet LAN 10/100 MB switch, 1 x Ethernet WAN 10/100 MB, 1 x RS 232/485 9-way SUB-D ■ Supply voltage: 12...24 V ~ ■ Mounted on rail 	Visit our partner's website http://www.ewon.biz/en/home.html

Connection components for router link

For connecting the router and logic controller, use Ethernet cables type 490NTW●●●● and TCSEC●●●● (see page 31).

Programming software

Designation	Compatibility with logic controllers	Reference
SoMachine Basic	M221 and M221 Book	Please consult our website: www.schneider-electric.com
SoMachine	M241 and M251	Please consult our website: www.schneider-electric.com

Modicon M221 and M221 Book logic controllers

Compatibility of Modicon TM2 expansion modules with Modicon M221, M221 Book, M241 and M251 logic controllers

Compatibility					
Modicon TM2 expansion modules		Logic controllers			
		M221	M221 Book	M241	M251
Digital modules	TM2DDI8DT				
	TM2DDI16DT				
	TM2DDI16DK				
	TM2DDI32DK				
	TM2DAI8DT				
	TM2DDO8UT				
	TM2DDO8TT				
	TM2DDO16UK				
	TM2DDO16TK				
	TM2DDO32UK				
	TM2DDO32TK				
	TM2DRA8RT				
	TM2DRA16RT				
	TM2DMM8DRT				
	TM2DMM24DRF				
	Analog modules	TM2AMI2HT			
TM2AMI2LT					
TM2AMI4LT					
TM2AMI8HT					
TM2ARI8LRJ					
TM2ARI8LT					
TM2ARI8HT					
TM2AMO1HT					
TM2AVO2HT					
TM2AMM3HT					
TM2ALM3LT					
TM2AMM6HT					
Expert modules (counter modules)		TM200HSC206DT			
	TM200HSC206DF				

Compatible

Not compatible

Note: The TWD●●●●● range of expansion and communication modules is not compatible with the Modicon M221/M221 Book/M241/M251 logic controller offer.

Configuration

- Modicon TM3 expansion modules are powered by logic controllers via the bus connector on the side of the products. This connector delivers 2 voltages, 5 V and 24 V. For the Modicon M221 and M221 Book logic controllers, you should therefore calculate the total TM3 expansion module consumption and check that it is definitely compatible with the maximum current delivered by the controller. This information is available on each product data sheet or in the hardware reference guide. This can be checked very quickly in the SoMachine Basic programming software setup page.
- For Modicon M241 and M251 logic controllers, up to 7 TM2 expansion modules can be attached regardless of these module references.

4			
490NTW00002	31	TCSESU043F1N0	31
490NTW00002U	31	TCSESU053FN0	31
490NTW00005	31	TCSMCN3M4F3C2	25
490NTW00005U	31	TCSMCN3M4M3S2	25
490NTW00012	31		33
490NTW00012U	31	TCSWAAC13FB	21
490NTW00040	31	TCSXCNAMUM3P	21
490NTW00040U	31	TM221C16R	18
490NTW00080	31	TM221C16T	18
490NTW00080U	31	TM221C16U	18
		TM221C24R	18
		TM221C24T	18
		TM221C24U	18
		TM221C40R	18
		TM221C40T	18
		TM221C40U	18
		TM221CE16R	18
		TM221CE16T	18
		TM221CE16U	18
		TM221CE24R	18
		TM221CE24T	18
		TM221CE24U	18
		TM221CE40R	18
		TM221CE40T	18
		TM221CE40U	18
		TM221M16R	19
		TM221M16RG	19
		TM221M16T	19
		TM221M16TG	19
		TM221M32TK	19
		TM221ME16R	19
		TM221ME16RG	19
		TM221ME16T	19
		TM221ME16TG	19
		TM221ME32TK	19
		TMACBL1	21
		TMAM2	20
		TMASD1	20
		TMAT2CSET	20
		TMAT2MSET	20
		TMAT2MSETG	20
		TMAT2PSET	20
		TMC2AI2	18
		TMC2AQ2C	18
		TMC2AQ2V	18
		TMC2CONV01	18
		TMC2HOIS01	18
		TMC2PACK01	18
		TMC2SL1	18
		TMC2TI2	18
		TMH2GDB	20
		TSXCSA100	25
		TSXCSA200	25
		TSXCSA500	25
		TSXCUSB232	33
		TSXSCA50	25
		TWDFCW30K	23
		TWDFCW50K	23
		TWDXCFAJ010	25
		TWDXCAISO	25
		TWDXCAT3RJ	25
		V	
		VW3A1104R10	20
		VW3A8306D30	25
		VW3A8306R03	25
		VW3A8306R10	25
		VW3A8306R30	25
		VW3A8306RC	25
		VW3A8306TF03	25
		VW3A8306TF10	25
		XBTZ938	25
		XBTZ9008	25
		XBTZ9980	20
			25
		XBTZ9982	25
		XGSZ24	25
		ZB5AZ905	20
A			
A9A15151	20		
ABE7H16C10	23		
ABE7H16C11	23		
ABE7H16C21	23		
ABE7H16C31	23		
ABE7H20E000	23		
ABE7P16T111	23		
ABE7R16S111	23		
ABE7R16S111E	23		
ABE7R16T111	23		
ABFTE20EP100	23		
ABFTE20EP200	23		
ABFTE20EP300	23		
ABFTE20SP100	23		
ABFTE20SP200	23		
ABFTE20SP300	23		
ABR7S11	23		
ABS7SC1B	23		
B			
BMXXCAUSBH018	21		
D			
DX1AP52	20		
L			
LU9GC3	25		
S			
SR1CBL03	33		
SR2MOD01	33		
SR2MOD03	33		
T			
TCSECE3M3M1S4	31		
TCSECE3M3M2S4	31		
TCSECE3M3M3S4	31		
TCSECE3M3M5S4	31		
TCSECE3M3M10S4	31		
TCSECN300R2	31		
TCSECU3M3M1S4	31		
TCSECU3M3M2S4	31		
TCSECU3M3M3S4	31		
TCSECU3M3M5S4	31		
TCSECU3M3M10S4	31		
TCSEK3MDS	31		
TCSSESU033FN0	31		

The Next Generation



Schneider Electric Industries SAS

Head Office
35, rue Joseph Monier
F-92500 Rueil-Malmaison
France

www.schneider-electric.com/msx

The information provided in this documentation contains general descriptions and/or technical characteristics of the performance of the products contained herein. This documentation is not intended as a substitute for and is not to be used for determining suitability or reliability of these products for specific user applications. It is the duty of any such user or integrator to perform the appropriate and complete risk analysis, evaluation and testing of the products with respect to the relevant specific application or use thereof. Neither Schneider Electric nor any of its affiliates or subsidiaries shall be responsible or liable for misuse of the information contained herein.

Design: Schneider Electric
Photos: Schneider Electric

DIA3ED2140106EN