



androidtv

75" SMART HDR 4K LED TV

SERIES 9 XU9210 (KALED75XU9210STA)

CONTENTS

Safety and warnings	02	Settings	12
Components	04	Overview	12
Product overview	05	Quick menu	12
Inputs	05	Global settings	13 - 14
Assembly and installation	06	PVR mode	15
Stand assembly	06	Instant recording	15
Connect to antenna	06	Schedule recording	15
Using remote / power button	07	Timeshift mode	16
Remote control overview	08	Media playback	16
First time setup	09 - 10	Wall-mount installation	17
Basic operation	11	Specifications	18
Channel Selection	11	Troubleshooting	19
Volume / mute	11		
Input Source	11		
Navigating menus	11		
Colour buttons	11		

THIS USER GUIDE COVERS THE FOLLOWING MODELS

Kogan 75" Smart HDR 4K LED TV Android TV™ (Series 9, XU9210)

SAFETY AND WARNINGS

Thank you for buying this Kogan product. Please read all safety instructions before using your TV.

WARNING

Never place a television set in an unstable location. A television set may fall, causing serious personal injury or death. Many injuries, particularly to children, can be avoided by taking simple precautions such as:

- Using cabinets or stands recommended by the manufacturer of the television set.
- Only using furniture that can safely support the television set.
- Ensuring the television set is not overhanging the edge of the supporting furniture.
- Not placing the television set on tall furniture (for example, cupboards or bookcases) without anchoring both the furniture and the television set to a suitable support.
- Not placing the television set on cloth or other materials that may be located between the television set and supporting furniture.
- Educating children about the dangers of climbing on furniture to reach the television set or its controls.

If your existing television set is being retained and relocated, the same considerations as above should be applied.

- To reduce the risk of fire or electric shock, do not expose this apparatus to rain or moisture.
- The apparatus shall not be exposed to dripping or splashing, and no objects filled with liquids, (for example, vases), shall be placed on the apparatus.
- When discarding used batteries, always be mindful of the environment. Ensure you follow any guidelines for recycling and safe disposal of batteries that apply in your local area. Don't throw used batteries in rubbish bin.
- When installing your TV, maintain a distance of at least 10 cm between the TV and other objects (walls, cabinet sides, etc.) to ensure proper ventilation. Failing to maintain proper ventilation may result in a fire or a problem with the product caused by an increase in its internal temperature.
- The openings/slots on the back of the apparatus have been provided for necessary ventilation. Ventilation should not be impeded by blocking these openings in any way (for example, newspapers, table-cloths, curtains, etc.)
- No naked flame sources, such as lit candles, should be placed on the apparatus. To prevent the spread of fire, keep candles or other open flames away from this product at all times.
- The device may malfunction when under electrostatic discharge. It can be manually resumed by switching power off completely (at wall outlet), then switching power on again.
- To avoid any injury caused by overturn of the product when installed with base stands, please always ensure the whole product is placed horizontally within the supporting surface and that the television is not overhanging the edge of the supporting furniture.
- If not using with base stands, use only a wall or ceiling mount which has been recommended by the manufacturer of the television.

SAFETY AND WARNINGS cont'd

- Keep small accessories out of reach of children so they are not mistakenly swallowed.

CAUTION: Connecting the power cord

Most appliances recommend they be placed upon a dedicated circuit; that is, a single outlet circuit which powers only that appliance and has no additional outlets or branch circuits.

Do not overload wall outlets. Overloaded wall outlets, loose or damaged wall outlets, extension cords, frayed power cords, or damaged or cracked wire insulation are dangerous. Any of these conditions could result in electric shock or fire. Periodically examine the cord of your appliance, and if appearance indicates damage or deterioration, immediately discontinue use of the appliance until the cord is replaced with an exact replacement part by an authorized servicer.

Protect the power cord from physical or mechanical abuse, such as being twisted, kinked, pinched, closed in a door, or walked upon. Pay particular attention to plugs, wall outlets, and the point where the cord exits the appliance.

The MAINS plug is used as the disconnect device, and the disconnect device shall remain readily operable.

Operating Temperature: 5°C to 35°C

Storage Temperature: -15°C to 45°C

Operating Humidity: ≤80%

Storage Humidity: ≤90%







CAUTION

Do not attempt to modify this product in any way without written authorization from supplier. Unauthorized modification could void the user's authority to operate this product.

It is not recommended to keep a certain still image displayed on the screen for a long time as well as displaying extremely bright images on screen.

Figures and illustrations in this User Manual are provided for reference only and may differ from actual product appearance. Product design and specifications may be changed without notice.

Refer to the table below as a guide to the symbols and warnings which may be on your TV.

	<p>CAUTION: TO REDUCE THE RISK OF ELECTRIC SHOCK DO NOT REMOVE COVER (OR BACK). NO USER SERVICEABLE PARTS INSIDE. REFER TO QUALIFIED SERVICE PERSONNEL.</p>
	<p>The lightning flash with arrowhead symbol, within an equilateral triangle, is intended to alert the user to the presence of uninsulated "dangerous voltage" within the products enclosure that may be of sufficient magnitude to constitute a risk of electric shock to persons.</p>
	<p>The exclamation point within an equilateral triangle is intended to alert the user to the presence of important operating and maintenance (servicing) instructions in the literature accompanying the appliance.</p>
	<p>Class II product: This symbol indicates that a safety connection to electrical earth (ground) is not required. If this symbol is not present on a product with a mains lead, the product MUST have a reliable connection to protective earth (ground).</p>
	<p>AC voltage: Rated voltage marked with this symbol is AC voltage.</p>
	<p>DC voltage: Rated voltage marked with this symbol is DC voltage.</p>
	<p>Caution. Consult instructions for use: This symbol instructs the user to consult the user manual for further safety related information.</p>

COMPONENTS

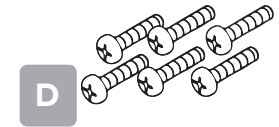
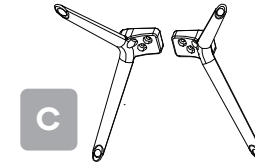

A Kogan 75" Smart HDR 4K LED TV

B Remote control

C Stand (x2)

D M6 x 20mm screw (x6)

E AAA battery (x2)

F Quick-start guide

G Warranty card

NOT INCLUDED

Phillips head screwdriver, antenna cable, broadband internet connection.

PRODUCT OVERVIEW

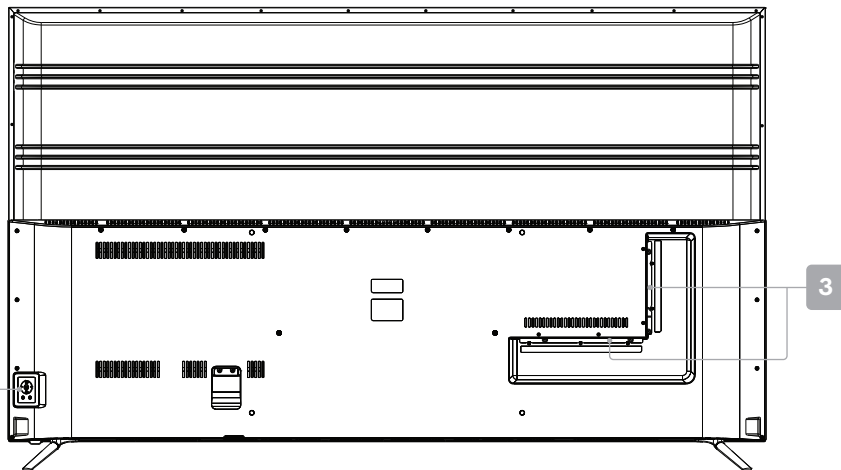
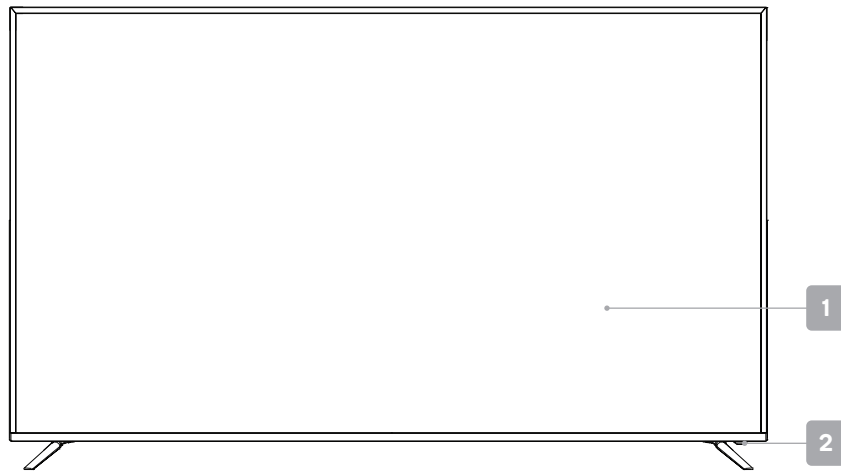

- 1 HDR 4K LED display screen
- 2 Remote sensor / Standby light
- 3 Inputs/Ports
- 4 Power button

Inputs

Audio in			Stereo (2.0) audio input.
Composite video in			Usually paired with stereo audio inputs (red and white cables), the single-wire composite cable provides video signal.
Component video in			Three cables ("Y," "Pb" and "Pr") provide a higher quality connection than the single-wire composite cable ("Y") commonly used to hook up earlier AV equipment.
HDMI			Connect an HDMI cable between the HDMI port on the TV and the HDMI port on the DVD player/Set-Top Box. Ports marked 'ARC' also support Audio Return Channel.
USB 2.0			USB storage devices can be inserted to record and pause live TV in PVR mode, or to watch media files stored on device in media mode.
VGA			Connect to a desktop or laptop computer.
ANT			For free-to-air TV, use an antenna cable (not supplied) to connect to a working antenna, either via an antenna wall socket, or directly.
LAN			For a wired internet connection via a broadband modem or router, connect an Ethernet cable to the LAN port.
Digital audio out (optical)			Audio out for digital audio devices. Port and cable may look different depending on an optical or coaxial input. Please use the cable appropriate for your device.
Digital audio out (coaxial)			Audio out for digital audio devices. Port and cable may look different depending on an optical or coaxial input. Please use the cable appropriate for your device.
3.5mm audio out			Line audio out port for use with headphones, amplifier, soundbar or any other audio device via an AUX cable (not supplied).

This is a general guide to inputs and ports, your TV may not feature all of the above.

ASSEMBLY AND INSTALLATION

BEFORE YOU GET STARTED

Spread cushioning flat to lay the TV on. This will help to prevent damage.

1. Stand assembly

- a. Attach stands to base of TV, ensuring 'L' and 'R' markings on the TV and stands match.
- b. Insert three 20mm screws for each stand and use Phillips head screwdriver (not supplied) to tighten.

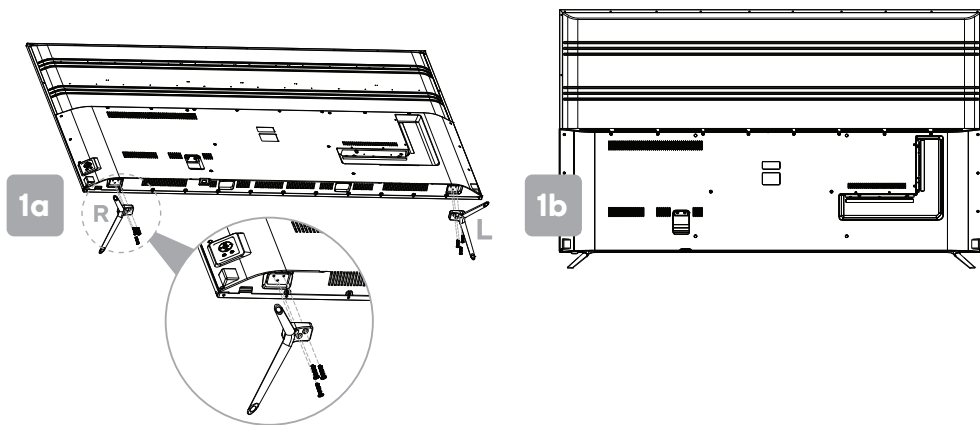

2. Connect to antenna

- a. Connect an antenna cable (not supplied) via the 'ANT' input port at the back of the TV.
- b. Ensure the antenna cable is also connected to a working antenna, either via an antenna wall socket in your home, or directly.

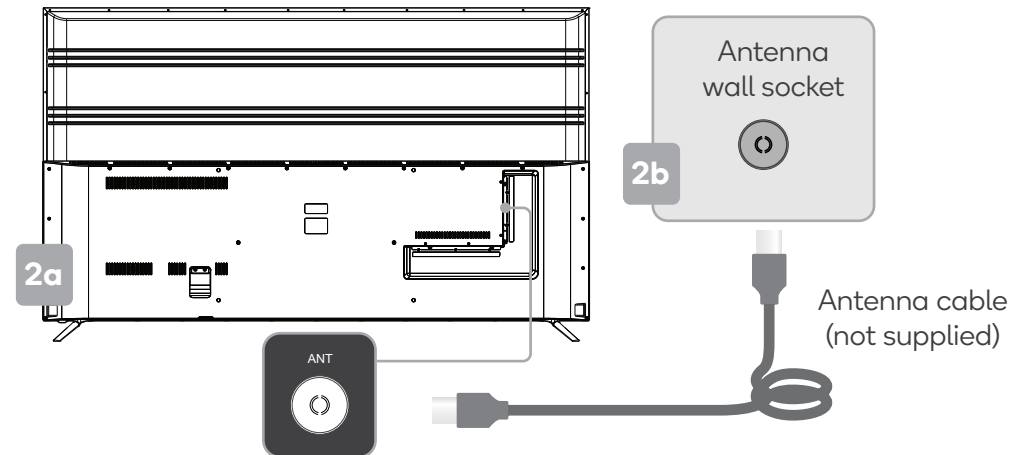

USING REMOTE CONTROL / POWER BUTTON

3. Remote control assembly

- Open the battery compartment cover on the back side.
- Insert two 1.5V AAA size batteries, making sure to match the polarity markings (+ / -) of the batteries with the diagram inside the compartment.
- Replace battery compartment cover.

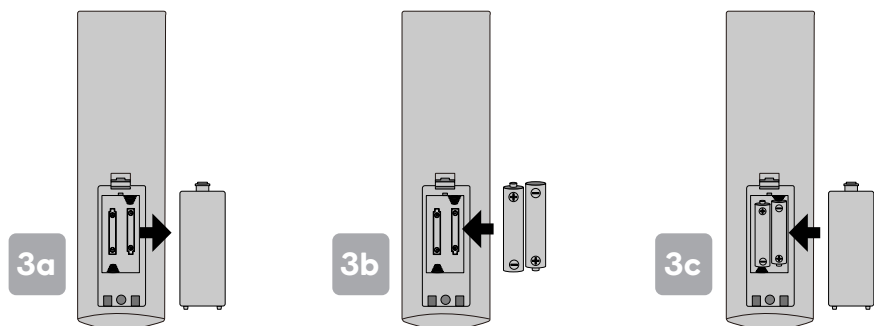

WARNINGS

- One loading of batteries will last for 1 year under normal use.
- If you do not intend to use the remote controller for a long period of time, remove them to avoid damage due to leakage.
- Do not use old and new batteries together.
- The batteries (battery pack or batteries installed) shall not be exposed to excessive heat such as sunshine, fire or the like.

4. Using remote control without bluetooth

Your Android TV remote control has bluetooth capability, but until this is paired with your TV, you will need to ensure the distance between the remote control and the TV is no greater than 8 metres, at an angle of no more than 30 degrees on either side (4a). Point the remote towards the sensor at the front of the TV (this may differ from the illustration).

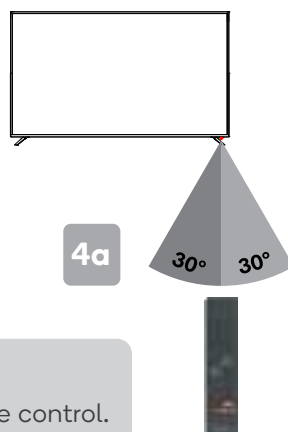

TIPS

Do not block the path between the sensor and the remote control.

5. Turning TV on

- Plug the power cord into a suitable power outlet. The standby will display a light, showing that the TV is receiving power.
- Press the POWER (⏻) button (either on your remote control or beneath the front panel on the TV) to turn the TV on.
- The standby light will turn off when the TV is on.

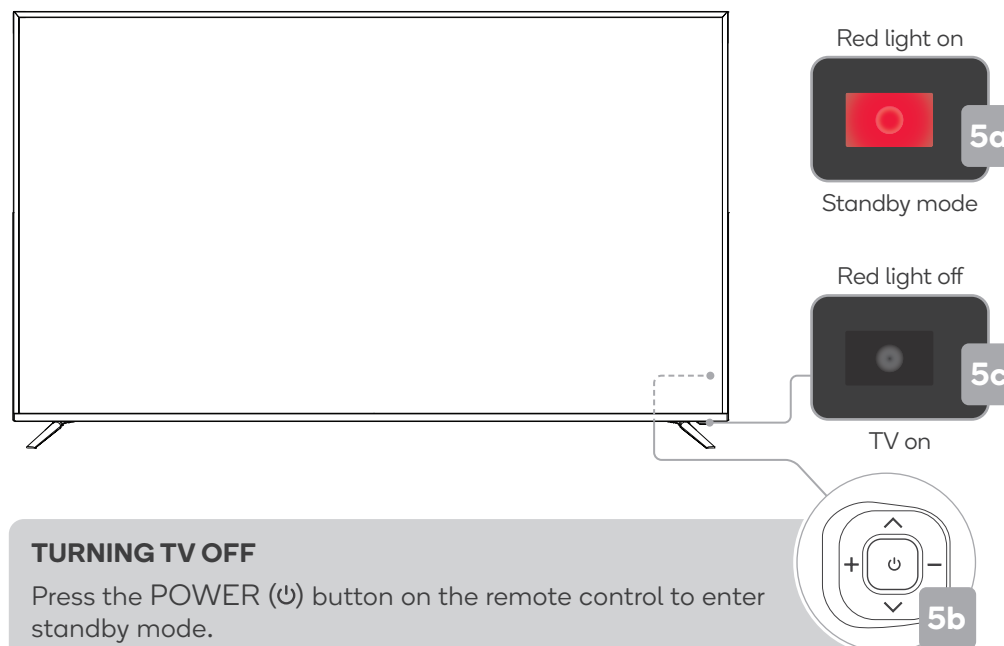

TURNING TV OFF

Press the POWER (⏻) button on the remote control to enter standby mode. To power down the TV completely, unplug the power cord from the power outlet.

Do not leave your set in standby mode for long periods of time. If you will not use the TV for a long time, it is recommended to unplug the set from both the power outlet and aerial.

REMOTE CONTROL OVERVIEW

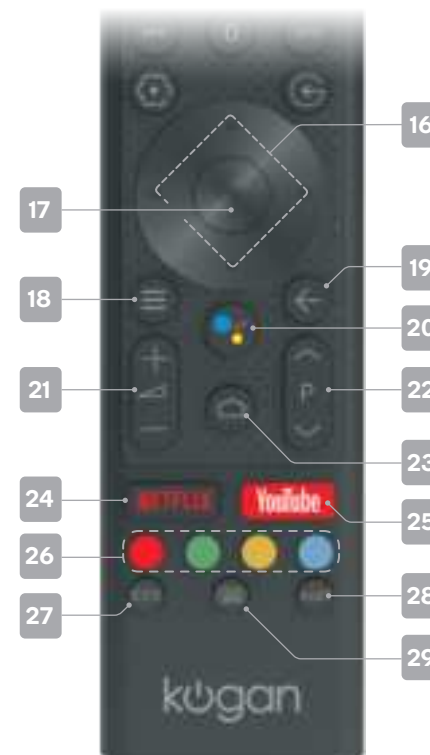
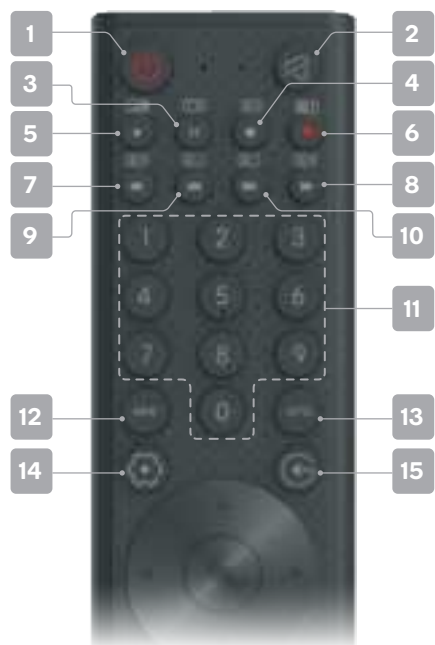

- 1 **Power**, press to enter or exit standby mode
- 2 **Mute** to toggle sound on/off
- 3 **Pause** in media/PVR mode; **Timeshift** function in DTV mode
- 4 **Stop** in media/PVR mode; **Hold** teletext page on display, press again to release
- 5 **Start** playback in media mode; **MIX mode** in teletext
- 6 **Record** in DTV mode; **Change size** of teletext screen
- 7 **Reverse playback rapidly** in media mode; **Subtitle** mode, or Submenu
- 8 **Advance playback rapidly** in media mode; **Cancel** teletext but not exit
- 9 **Skip to previous** in media mode; **Index page**
- 10 **Skip to next** in media mode; **Reveal hidden** information in some teletext pages
- 11 **Number buttons** to select channels or input passwords
- 12 **INFO** displays the current program information
- 13 **EPG Electronic Program Guide** in DTV mode
- 14 **Device preferences** to display sound and picture options
- 15 **Source** displays the list of input source channels.

- 16 **Direction buttons** for navigating menus and settings
- 17 **Enter** select the current item or confirm selection, display **Channel list** in DTV mode
- 18 **Quick Menu** to display TV options with optional, adjustable settings
- 19 **Back** to the previous menu
- 20 **Google Assistant** to launch the built-in virtual assistant for voice commands
- 21 **+/- Volume** to adjust the volume up or down
- 22 **Program** to scroll channels
- 23 **Home** to access the home page
- 24 **NETFLIX** to open app homepage
- 25 **YouTube** to open app homepage
- 26 **Colour buttons** for navigational use within apps
- 27 **Audio** to select available languages and audio channels.
- 28 **sub Subtitles** to select subtitles
- 29 **Teletext** to show/hide Teletext (Teletext not available in Australia or New Zealand)

FIRST TIME SETUP

When turning the TV on for the first time, the **Welcome** screen will appear. Use the **▲**, **▼** and **OK** buttons to navigate the following options.

Language and Location

Select your menu language, and select your country/region from the list.

Bluetooth

Your Android TV remote control has bluetooth capabilities. Follow the onscreen prompts to pair the remote with the TV, holding the **Volume** and **Back** buttons simultaneously. Your remote's LED light will flash while pairing, and the TV will display 'Remote control paired' when successful. This will allow you to use voice commands with your remote via the Google Assistant button.

Quickly set up with Android phone

If you have an Android smartphone, you can easily transfer your phone's Wi-Fi network and Google account to your TV. If not, select 'Skip'.

Select Wi-Fi network

Your Android TV will automatically scan for wireless networks nearby. Ensure the TV is within range of your wireless modem or router, and have your password handy. Follow the prompts to input your password and connect your TV to your selected network.

If you'd prefer to connect an Ethernet cable to connect to the internet, simply insert the cable (not supplied) to the 'LAN' input port at the back of the TV (**6b**, next page), and ensure that it is correctly connected to the internet.

Google Account sign-in

Linking your Google Account to your Android TV will allow you to install new apps from the Play store, as well as receive recommendations from Google.

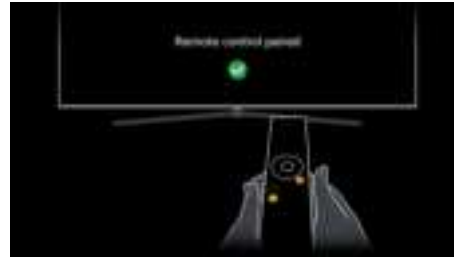

Pairing your bluetooth remote control with your Android TV will enable your remote's Google Assistant voice control function.



Connect to Wi-Fi by selecting your network and entering your password. A broadband internet connection is required for this step.

Terms of Service

This page will allow you to read each of the Google Terms of Service, Privacy Policy, and Google Play Terms of Service in full, and to accept.

Location permission

Grant permission for your Android TV to detect your location. You can adjust these permissions at any time from Settings.

Help improve Android

Grant permission for your Android TV to detect your location to automatically send diagnostic information to Google.

Choose a name for your TV

Give your TV a name to help identify it when casting or connecting to it from other devices. Select a preset option or enter a custom name.

Install additional apps

Get started with some of our handpicked selections from the Play Store. Following this you will be shown a brief overview of Android TV's features.

Password

Set a default password.

Select TV mode

The 'home mode' is optimized for efficient usage for home use. The 'retail mode' is optimized for store Demo with fixed settings.

WOL

Select on or off for the Wake On LAN function (if using Ethernet cable).



Sign in to your Google account here. If you use Gmail, you already have a Google account.



Select a name for your TV.

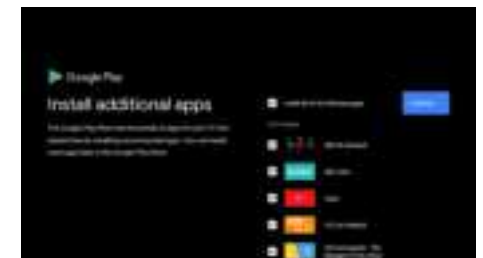

Installing additional apps from the Google Play Store.



Select 'home mode' or 'retail mode'.

FIRST TIME SETUP (cont'd)

Following these options, the **Channel Scan** screen will appear. Ensure you have an antenna cable connected to the 'ANT' input port at the back of the TV (**6a**).



The auto tuning function will search for and save all available free-to-air TV channels. After confirming your settings (the default will be set for Australia), the process will automatically begin. The number of searched channels will be displayed on the screen.

When setup is complete, you will be able to access the **Home** screen.

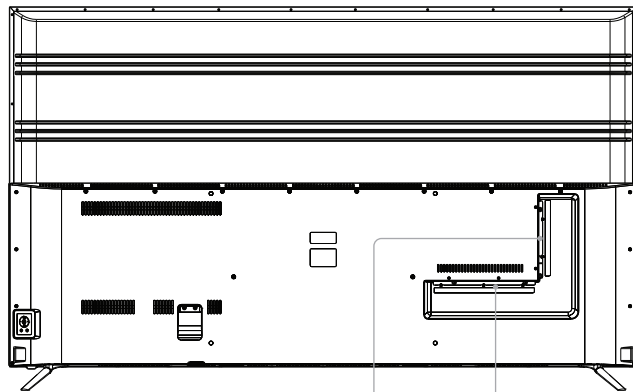

'ANT' input

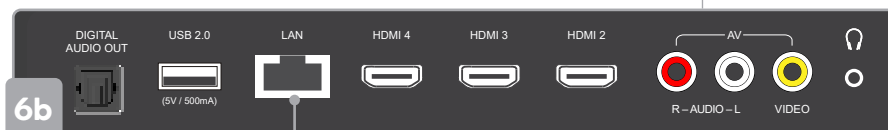

'LAN' input

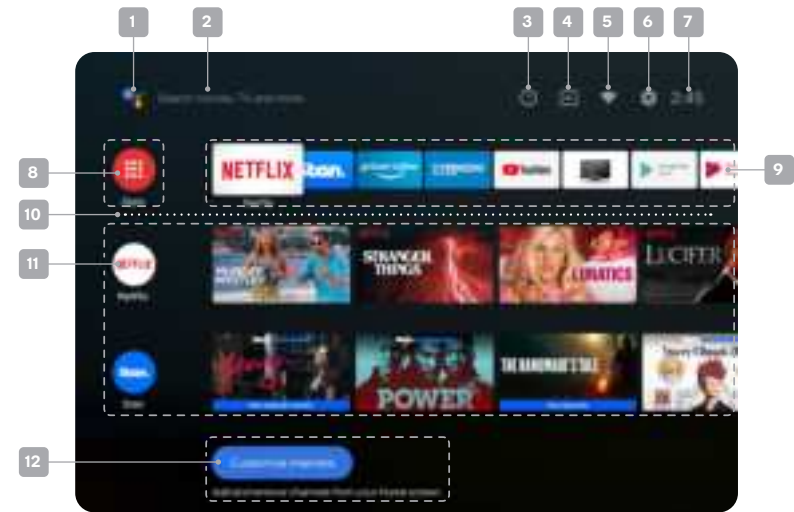

1 Google Assistant

Click to launch the built-in virtual assistant, which will begin listening for voice commands. Give it a try, ask "What's the weather today?"

2 Text search

Enter text manually to search TV apps.

3 System notifications

This option will only appear when notifications are present.

4 Source

Access free-to-air channels ('DTV') or other input source channels.

5 Internet connection

This will display as a Wi-Fi or LAN icon, depending on your connection. Select for connectivity options.

6 Settings

Access the global settings menu.

7 Clock

Time and date settings can be adjusted in the global settings.

8 Apps

Access the App Centre to display all installed apps. Free-to-air channels can be accessed under the 'Live TV' option.

9 Favourites list

A customisable list of apps available at a single click.

10 Play next

Displays the program you are watching or have queued to play next. You can add to this list by long pressing the **OK** button, then selecting "Add to play next". If the play next queue is empty, it will not be shown on the home page.

11 Pinned channels

Show the program list of pinned channels. The order of this list can be adjusted by pressing **◀** from the channel icon and selecting the "<>" icon. Empty channels will not be shown on the home page.

12 Customise channels

Add or remove pinned channels from the home page.

BASIC OPERATION

Selecting channels

There are two ways to select channel:

1. Using number buttons followed by the **OK** button on the remote control to select channel directly.
 - To select channel 5, press: **5**.
 - To select channel 21, press: **2 → 1** in quick succession.

When using the number buttons, you can directly select channels that were either not saved during the auto tuning, or manually erased.

2. Using **▲P▼** buttons on the remote control or on your TV to select channel. When you press the **▲P▼** buttons, the TV changes channels in sequence. You will see all the channels that the TV has saved, but will not see channels that were either not saved, or manually erased.

Volume adjustment and mute setup

Press **+▲/▼-** buttons on the remote control or the TV to adjust the volume of the TV.

- To increase the volume, press **▲+** button
- To decrease the volume, press **▼-** button

Press the **🔇 Mute** button to toggle TV sound on and off. The mute icon will appear in the lower-right corner of the screen. To resume sound when TV is muted, press the **🔇 Mute** button again, or simply press the **▲+** button.

Input source

Input options are accessible directly from the home screen by selecting the **📺 Source** icon. Press the **OK** button to confirm your selection.

Alternatively, you can use the **📺** button on your remote control to access the list from any channel or screen.

Colour buttons

In some menus and apps, the remote control's four colour buttons (**●●●●**) can be used.

Navigating menus

- Press the **☰ Menu** button to display the quick menu.
- Press the **▲/▼ Navigational** buttons to select the desired sub item.
- Press the **OK Enter** or **▶ Navigational** button to access the menu of the next level.
- Select **More** on quick menu list to bring up the full settings menu.
- Press the **← Back** button to return to the previous menu.

NOTE

- When a menu item is greyed out, it means that the item is not available or cannot be adjusted.
- Some items in menus may be hidden depending on modes or signal sources used.

SETTINGS

Quick menu

Options for your TV (picture, aspect ratio, speakers, etc) can be accessed by pressing the **≡ Quick Menu** button on your remote control. Use **◀ / ▶** buttons to navigate through the submenus, and **▲ / ▼** buttons to access Channel and Recording/Time Shift options **(7a)**.

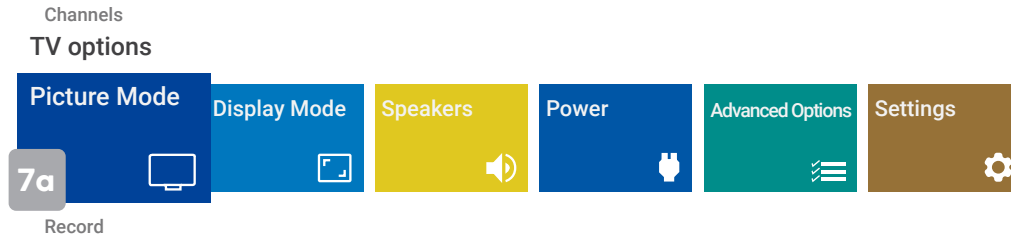

Global settings

To access the global settings menu, simply navigate to the **⚙️** icon on the Home screen. Here you will find all of the adjustable options for Android TV's interface, connectivity, and apps.

In DTV mode you can also press the **≡ Quick Menu** button on your remote control and use the **◀ / ▶** buttons to navigate to the 'Settings' option.

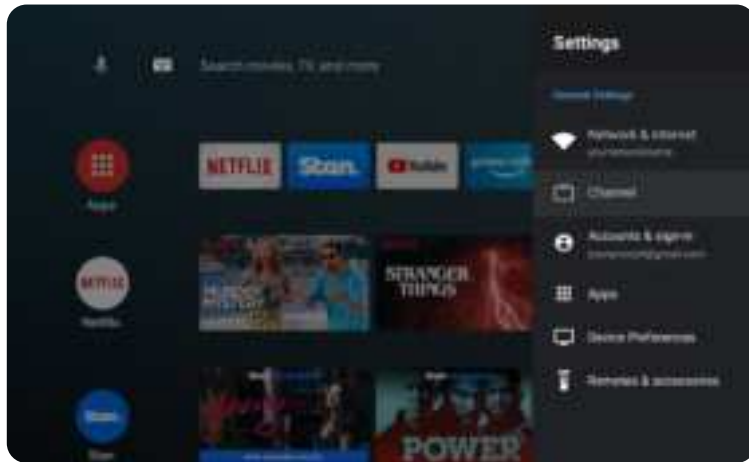

Device preferences

To open the device options submenu directly during live TV playback, press the **⚙️ Device preferences** button on your remote control.

QUICK MENU

Picture mode

Choose from the following selection of presets, or select 'User' mode to configure your own custom settings.

- **Standard**
- **Vivid**
- **Sport**
- **Movie**
- **Game**
- **Energy Saving**

Display mode

You can select the picture size which best corresponds to your viewing requirements. Sizes may differ between input sources.

Speakers

Select the desired audio output source, choosing from the built-in TV speakers or an external system.

Power

Display power usage and sleep timer options, as well as the option for picture off (audio only) playback.

Advanced options

Adjust settings for subtitles, default channel, blue mute and more. Also see system and app version information.

Settings

Selecting the settings option here will take you to the **Global Settings** menu, also accessible via the home screen.

SETTINGS (cont'd)

GLOBAL SETTINGS

Network & Internet

Here you will find the options for Wi-Fi and Ethernet internet connections.

Wi-Fi

Available Wi-Fi networks are listed, with the option to manually add a new network.

Scanning always available

Toggle on/off.

WOW

Toggle on/off for Wake On Wi-Fi function.

WOL

Toggle on/off for Wake On LAN function.

Ethernet

The TV will display whether a LAN connection is active or not. If LAN is connected, status will show IP address.

Proxy settings

HTTP proxy is used by the browser but may not be used by other apps. Select between no proxy, or manually entering proxy address details.

IP settings

Select between DHCP or static.

CHANNEL

Auto channel update

Toggle on/off.

Parental controls

Enter PIN to access. Here you will find options for blocking channels, restricting content based on ratings, and blocking inputs (TV, AV, and all four HDMI).

Audio language and Second audio language

Select primary and secondary audio languages.

ACCOUNT & SIGN-IN

Here you find the same Google account sign-in screen from the start-up wizard.

APPS

Recent

View all recently used apps.

See all apps

Display a list of all installed apps.

Permissions

View and adjust settings for app permissions, special app access, and security & restrictions.

DEVICE PREFERENCES

About

View system information.

Date & Time

Set clock and date information.

Timer

Adjust auto power-on and auto power-off settings.

Language

Interface language settings for on-screen display.

Keyboard

Adjust keyboard options. Third party keyboards can be added from the Play store. By default, Google's GBoard keyboard is installed.

Inputs

HDMI CEC (Consumer Electronic Control) settings can be adjusted here. Option to rename inputs (for example, 'HDMI 1' can be set as 'Blu-ray' or even a custom name, which will appear on the source inputs list) are also located in this submenu.

Power

Adjust power settings here.

Picture

Adjust picture settings here, in more detail than the Quick Menu's picture mode presets.

Sound

Locate settings for sound balance, equalizer, speakers, digital output, SPDIF and more in this submenu.

SETTINGS (cont'd)

Storage

View and adjust device storage information and set up external drives for use.

Home screen

Adjust options such as enabling video or audio previews, customising channels, and app order for the home screen. You can also view app licenses.

Retail mode

Toggle on/off. The 'home mode' is optimized for efficient usage for home use. The 'retail mode' is optimized for store Demo with fixed settings. By default the TV is set to home mode.

Google Assistant

Access options for Google Assistant and voice controls.

Chromecast built-in

View license details for Chromecast functionality. By default, Chromecast is enabled for your TV and does not require adjusting.

Screensaver

Adjust the screensaver usage and time settings.

Location

Enable location settings.

Usage & Diagnostics

Enable permission to share usage and diagnostic data.

REMOTES AND ACCESSORIES

All compatible Bluetooth devices will appear here. You can connect and disconnect from devices here.

PVR MODE

NOTE

- Don't connect or disconnect any USB device while in USB playback mode.
- Ensure all personal data is backed up before inserting USB device into TV. We assume no liability for any loss of data due to malfunction or misuse.
- USB device should have capacity at least 512MB.
- USB device must support USB 2.0 high-speed specification.
- Use only USB storage devices formatted to FAT32.
- You cannot change channels while recording.
- If the signal is interrupted while recording, the recording will stop until signal is regained.
- While in time-shift mode, do not turn TV off.

Setup

To use PVR and Timeshift settings, first you must prepare your USB device. Ensure you have a USB drive inserted in either of your TV's USB 2.0 input ports.

Channels

TV options

Record



Press the **≡ Quick Menu** button on your remote control, then the **▼** button to scroll down to the **Record** menu. Select **Device Info (8a)** to prepare your USB device for PVR or Timeshift functionality.

Your attached USB device will display on the Device Info list if it is prepared for PVR or Timeshift usage, or both.

You can also format your device and run speed tests from this menu.



Recording and Timeshift controls

- ▶ Play
- ⏮ Skip to start
- ⏸ Pause / Timeshift
- ⏭ Skip to end
- Stop
- ⏪ Skip backward
- Record
- ⏩ Skip forward

OK Confirm / Play / Pause

◀▶ Navigation / Skip backward & forward, Hold to skip to start & end

▲/▼ Navigation

Recording

There are two types of recording: **Instant Recording** and **Schedule Recording**. Instant recording can record current TV programmes, while schedule recording can be set to record TV programmes automatically on the day, time, and duration you choose.

Instant recording

Select the channel you want, then press the **● Record** button on the remote control to start recording. You will be prompted to confirm – press **OK** to begin recording.

To hide the information bar at the bottom of the screen, press the **● Record** button once more.

To stop the recording, press **■ Stop** and then **OK** to confirm when prompted.

Schedule recording

Select the **Schedule List** from the Record menu. Use the navigation buttons to select the desired programme, and press the **● Red** colour button to schedule a programme for recording.

You can schedule several items to record. Press the **● Yellow** colour button to view the list of currently scheduled programmes. Different schedules should not overlap and there must be at least a one-minute time gap to set up between two schedules.

NOTE

Schedule recording still works when TV is in standby mode.



PVR MODE (cont'd)

Timeshift mode

With the Timeshift turned on, you may pause and rewind normal TV viewing at any time without missing any of the live broadcast. This can also allow you to create a buffer and skip forward through commercials.

Press the **II Pause** button on the remote control while in DTV mode to activate the Timeshift function. The TV stores the channel from the point of view you want to record. **▶ Play** will resume from where you left off. Press **■ Stop** to exit Timeshift mode. If a USB device dedicated to recording is disconnected, Timeshift files that were saved will automatically be deleted.

Playing recorded files

After recording is complete, press the **≡ Quick Menu** button on your remote control, then the **▼** button to scroll down to the **Record** menu to find the **Record List**. Here you will find a complete list of your recordings. Press the **● Red** colour button to delete any files you no longer require.

MEDIA PLAYBACK

NOTE

You will need to have an app installed for media playback. We recommend **VLC for Android**, but you are welcome to choose your preferred media player from the Google Play store.

To access media playback mode, insert a USB drive containing files of the following type into the TV's USB input port. Next, from the Home page, select your preferred media player app. The following file types are supported:

Data	Format
Photo	JPEG, PNG, BMP
Audio	MP3, M4A, WAV, ASF, MP4, AAC
Video	MPEG, MPG, VOB, DAT, TS, TP, TRP, AVI, MP4, MOV, MKV, FLV, ASF, 3GP

Alongside flashdrives, the TV's USB port is also capable of reading from devices such as digital cameras and USB hard disks.

Recordings saved in PVR mode will also be playable.



Media playback controls

- ▶** Play
 - ||** Pause
 - Stop playback
 - ⏪** Skip to start
 - ⏩** Skip to end
 - ⏮** Skip backward
 - ⏭** Skip forward
-
- OK** Confirm / Play / Pause
 - ◀/▶** Navigation / Skip backward & forward, Hold to skip to start & end
 - ▲/▼** Navigation
 - ←** Back to previous menu

WALL MOUNTING

Wall mount kit not included. Steps below are provided as an optional alternative to the supplied base-mounts.

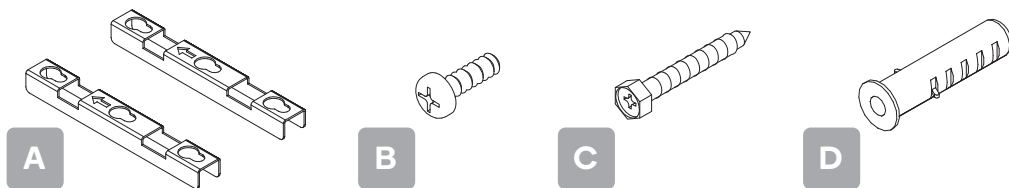

A Mounting bracket (x2)
B M8 x 50mm screw (x4)

C M6 x 60mm self-tapping screw (x4)
D Wall anchor (x4)

9. Optional wall-mounting installation

- Measure and double-check the distance of threaded holes on the back panel of the TV before creating any holes in the wall.
- Insert the 50mm screws (**B**) within the four threaded holes on the back panel of the TV and tighten.

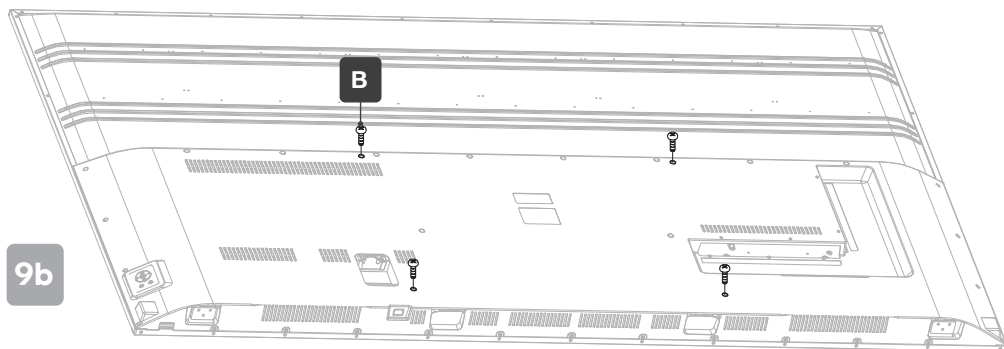

- Use a mounting bracket (**A**) as a guide to mark the positions for the four holes on the wall with a pencil.
- Using a drill, create holes in the marked positions on the wall.
- Insert the four wall anchors (**D**) into the screw holes in the wall.
- Place the mounting brackets against the wall, aligned with the wall anchors, ensuring the directional arrow is facing upwards.
- Fix the mounting brackets with the 60mm self-tapping screws.
- Attach the TV to the mounting brackets by placing all four of the screws attached to the rear of the TV (**B**) into the larger openings of the brackets, then lowering the TV so that the screws “lock” into place within the brackets.

It is recommended that two people perform **step 9h** together to ensure the sleeves are properly aligned before the TV is lowered onto the brackets.

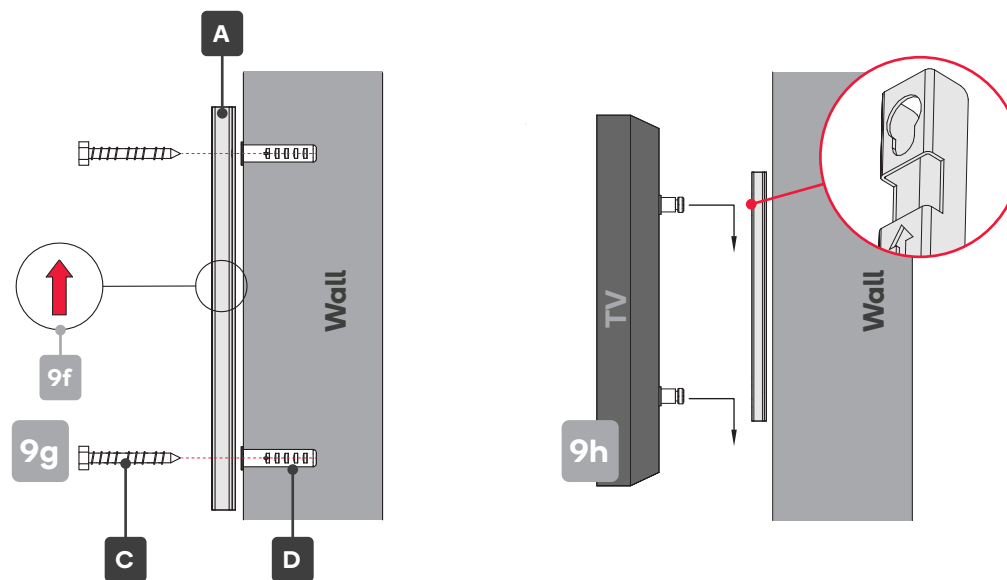

NOTE:

Only use wall-mounts that match the same size screws and fittings as those listed on this page. Other methods of wall-mounting have not been tested for this model and can not be guaranteed to safely support the TV.

SPECIFICATIONS

Audio

Speakers 2 x 10W

Connectivity

Ethernet (RJ45) Yes
 HDMI 2.0
 HDMI-ARC Yes | HDMI 1
 HDMI-CEC Yes | HDMI 1, HDMI 2, HDMI 3, HDMI 4
 USB 2 x USB 2.0
 Wi-Fi IEEE 802.11b/g/n

Dimensions

Distance Between Legs 1607mm
 Without Stand 1682 x 964 x 71mm
 With Stand 1682 x 1026 x 292.5mm
 VESA Wall Mount Pattern 600 x 400
 Weight 31kg

Display

Colours 1.07B
 Computer Supported Resolutions 640x360, 853x480, 1024x576, 1280x720, 1366x768, 1920x1080, 3840x2160 (@60Hz)
 Contrast Ratio 4000:1
 Native Aspect Ratio 16:9
 Panel Manufacturer CSOT
 Refresh Rate 60Hz
 Resolution 3840 x 2160
 Response Time 8ms
 Size 75"
 Viewing Angle 170°/170°

Features

EPG Yes
 HDCP Yes | 2.2
 TV Resolution 4K UHD

Browser Pango
 USB Media Playback Yes
 USB Media Playback Formats JPG, JPEG, PNG, BMP, MP3, DD, DD+, AAC, MPG, MPEG4, H.265, VP9 (4K@60P)

Inputs

Composite (AV) 1
 HDMI 4

Outputs

3.5mm Stereo Audio 1
 Optical Audio Out 1

Performance

CPU ARM CA55 Quad Core with TEE1.2GHz
 GPU Mali470 MP3
 OS Android 9.0
 RAM 1.5GB
 Storage Capacity 8GB

Power

Average Consumption 265W
 Energy Consumption 681kWh per year
 Energy Rating 4.5 Star

Tuning And Signal

Tuner Type DVB-T

Note:

- Design and specifications are subject to change without notice.
- Weight and dimension shown are approximate.

TROUBLESHOOTING

Common fixes

Many minor issues can be resolved by hard resetting, or power cycling the unit or upgrading the firmware.

To perform a hard reset, or power cycle, please use the following steps.

- Unplug it from the main power socket and leave it for 10-15 minutes.
- Press and hold the power button on the TV for 5 seconds.
- Connect the TV back to the power and turn it on.

Poor picture and sound quality

- Try a different channel
- Adjust the antenna
- Check all connections

No picture or sound in TV status

- Try another channel
- Press the TV/AV button
- Make sure TV is plugged in
- Check the antenna connection

No sound or sound is too low at maximum volume

- Check the volume settings on any external speakers connected to your television
- Adjust the TV volume accordingly
- Check another channel or input
- Check that MUTE hasn't been turned on

Picture rolls vertically

- Check all connections

No colour, wrong colour or tints

- Make sure the program itself is broadcast in colour
- Select the picture menu, then adjust the colour and tint submenus

Blurred or snowy picture, distorted sound

- Check direction, location and connections to your antenna
- Issues may be caused by the use of an indoor antenna (poor signal)

Remote control malfunctions

- Replace remote control batteries
- Check battery terminals
- Remote is out of range, move closer to TV
- Remove any obstructions between remote and IR sensor of TV
- Make sure the power cord to your TV is plugged in and turned on

Image is not centred on the screen

- Adjust the horizontal and vertical position

“No Signal” on HDMI source

- Test the device with a different HDMI cable
- Plug the device into another HDMI port
- Try a different device connected to the same cable and port
- Perform a factory reset on your TV

Care & maintenance

Unplug the television from the power supply before cleaning. Do not use any liquid cleaners or harsh chemicals. Always use a soft, damp cloth.

Cleaning the screen

Wet a soft cloth in a mixture of lukewarm water and a little fabric softener or dish washing detergent. Wring the cloth until it's almost dry, and then use it to wipe the screen.

Make sure the excess water is off the screen, and then let it air-dry before you turn on your TV.

Cleaning the casing

To remove dirt or dust, wipe the TV casing with a soft, dry, lint-free cloth. Please be sure not to use a wet cloth.

**For our full TV troubleshooting guide,
head online to help.kogan.com**