

ASRock



DeskMini series

User Manual

Version 1.0

Published May 2016

Copyright©2016 ASRock INC. All rights reserved.

Copyright Notice:

No part of this documentation may be reproduced, transcribed, transmitted, or translated in any language, in any form or by any means, except duplication of documentation by the purchaser for backup purpose, without written consent of ASRock Inc.

Products and corporate names appearing in this documentation may or may not be registered trademarks or copyrights of their respective companies, and are used only for identification or explanation and to the owners' benefit, without intent to infringe.

Disclaimer:

Specifications and information contained in this documentation are furnished for informational use only and subject to change without notice, and should not be constructed as a commitment by ASRock. ASRock assumes no responsibility for any errors or omissions that may appear in this documentation.

With respect to the contents of this documentation, ASRock does not provide warranty of any kind, either expressed or implied, including but not limited to the implied warranties or conditions of merchantability or fitness for a particular purpose.

In no event shall ASRock, its directors, officers, employees, or agents be liable for any indirect, special, incidental, or consequential damages (including damages for loss of profits, loss of business, loss of data, interruption of business and the like), even if ASRock has been advised of the possibility of such damages arising from any defect or error in the documentation or product.



This device complies with Part 15 of the FCC Rules. Operation is subject to the following two conditions:

- (1) this device may not cause harmful interference, and
- (2) this device must accept any interference received, including interference that may cause undesired operation.

CALIFORNIA, USA ONLY

The Lithium battery adopted on this motherboard contains Perchlorate, a toxic substance controlled in Perchlorate Best Management Practices (BMP) regulations passed by the California Legislature. When you discard the Lithium battery in California, USA, please follow the related regulations in advance.

“Perchlorate Material-special handling may apply, see www.dtsc.ca.gov/hazardouswaste/perchlorate”

ASRock Website: <http://www.asrock.com>

The terms HDMI™ and HDMI High-Definition Multimedia Interface, and the HDMI logo are trademarks or registered trademarks of HDMI Licensing LLC in the United States and other countries.



Contents

| | |
|---|-----------|
| Chapter 1 Introduction | 1 |
| 1.1 Package Contents | 1 |
| 1.2 Specifications | 2 |
| Chapter 2 Product Overview | 4 |
| 2.1 Front View | 4 |
| 2.2 Rear View | 5 |
| 2.3 Motherboard Layout | 6 |
| Chapter 3 Hardware Installation | 12 |
| 3.1 Begin Installation | 12 |
| 3.2 Installing the CPU | 13 |
| 3.3 Installing the CPU Fan and Heatsink | 15 |
| 3.4 Installing Memory Modules (SO-DIMM) | 16 |
| 3.5 Installing the WiFi Module | 17 |
| 3.6 Installing the M.2 SSD (Type 2280) | 18 |
| 3.7 Installing the 2.5-inch HDD/SSD | 19 |
| 3.8 Complete | 21 |
| 3.9 Installing the VESA Bracket (Optional) | 22 |
| 4.0 Installing the WiFi Antennas (Optional) | 24 |
| Chapter 4 Software and Utilities Operation | 26 |
| 4.1 Installing Drivers | 26 |
| 4.2 ASRock Live Update & APP Shop | 27 |
| 4.2.1 UI Overview | 27 |

| | | |
|-------|--|----|
| 4.2.2 | Apps | 28 |
| 4.2.3 | BIOS & Drivers | 31 |
| 4.2.4 | Setting | 32 |
| 4.3 | Enabling USB Ports for Windows® 7 Installation | 33 |

Chapter 5 UEFI SETUP UTILITY 36

| | | |
|-------|---|----|
| 5.1 | Introduction | 36 |
| 5.2 | EZ Mode | 37 |
| 5.3 | Advanced Mode | 39 |
| 5.3.1 | UEFI Menu Bar | 39 |
| 5.3.2 | Navigation Keys | 40 |
| 5.4 | Main Screen | 41 |
| 5.5 | OC Tweaker Screen | 42 |
| 5.6 | Advanced Screen | 50 |
| 5.6.1 | CPU Configuration | 51 |
| 5.6.2 | Chipset Configuration | 53 |
| 5.6.3 | Storage Configuration | 55 |
| 5.6.4 | Super IO Configuration | 56 |
| 5.6.5 | ACPI Configuration | 57 |
| 5.6.6 | USB Configuration | 58 |
| 5.7 | Tools | 59 |
| 5.8 | Hardware Health Event Monitoring Screen | 62 |
| 5.9 | Security Screen | 63 |
| 5.10 | Boot Screen | 64 |
| 5.11 | Exit Screen | 67 |

Chapter 1 Introduction

Thank you for purchasing DeskMini series, a reliable gaming barebone system produced under ASRock's consistently stringent quality control. It delivers excellent performance with robust design conforming to ASRock's commitment to quality and endurance.



Because the hardware specifications might be updated, the content of this documentation will be subject to change without notice. In case any modifications of this documentation occur, the updated version will be available on ASRock's website without further notice. If you require technical support related to this product, please visit our website for specific information about the model you are using. ASRock website: <http://www.asrock.com>.

1.1 Package Contents

- DeskMini series Barebone System with:
DeskMini series Chassis
Motherboard (pre-installed)
*The barebone system does not include memory, hard drive, WiFi module and M.2 SSD.
- 120W/19V Power Adapter & Power Cord
- SATA Cable
- Screws Package (HDD Screw x 6, M.2 Screw x 2pcs, Rubber Foot x 4pcs)
- Support CD
- Quick Installation Guide



If any items are missing or appear damaged, contact your authorized dealer.

1.2 Specifications

- System Model**
- DeskMini 110
 - DeskMini 110/COM
 - DeskMini 170

- Chassis**
- 1.92L (155 x 155 x 80mm)

- CPU**
- Supports 6th Generation Intel® Core™ i7/i5/i3/Pentium®/Celeron® Processors (Max. TDP 65W)

- CPU cooling**
- Supports Standard Intel Box Fan Coolers

- Mother-board**
- ASRock H110M-STX (Mini-STX) (for DeskMini 110)
 - ASRock H110M-STX/COM (Mini-STX) (for DeskMini 110/COM)
 - ASRock Q170M-STX (Mini-STX) (for DeskMini 170)

- Chipset**
- Intel® H110 Chipset (for DeskMini 110 series)
 - Intel® Q170 Chipset (for DeskMini 170 series)

- Graphics**
- Intel® HD Graphics

- Memory**
- Supports DDR4 2133MHz, 2 x SO-DIMM Slots, Max. 32GB

- Audio**
- Realtek ALC283 Codec

- LAN**
- Intel Gigabit I219V LAN (for DeskMini 110)
 - Intel Gigabit I219LM LAN (for DeskMini 170)*
- *Supports Intel® vPro™ Technology

- Expansion Slots**
- 1 x M.2 (E key/2230) Slot for WiFi + BT Module,
 - 1 x M.2 SSD Slot (Supports type 2280 M.2 PCIe Gen3 x4)*
- * SATA type M.2 module is not supported.

- Front I/O**
- Power Button, Power LED & HDD LED
 - 1 x USB 3.0, 1 x USB 3.0 (Type-C), 1 x Headphone/Headset Jack , 1 x MIC-In

- Rear I/O**
- 1 x VGA , 1 x HDMI, 1 x DP, 1 x USB 3.0, 1 x USB 2.0, 1 x LAN, 1 x DC-In Jack (for DeskMini 110 series)
 - 1 x VGA , 1 x HDMI, 1 x DP, 2 x USB 3.0, 1 x LAN, 1 x DC-In Jack (for DeskMini 170 series)

- Onboard Connectors**
- 2 x USB 2.0 Headers
 - 1 x COM Port Header (only for DeskMini 110/COM)
 - 1 x Front Panel Header
 - 1 x CPU_Fan_1 Connector (4-Pin)
 - 1 x CPU_Fan_2 Connector (5-Pin)
 - 1 x DC-In Jack (Supports 19V 120W Power Adapters)
 - 1 x MONO Speaker Header (4-Pin)

- Drive Bays**
- 2 x 2.5" HDD or SSD

- Power Adapter**
- 120W/19V Power Adapter

- Operation Temp.**
- 0~35°C

- OS**
- Microsoft® Windows® 10 64-bit / 8.1 64-bit / 7 32-bit / 7 64-bit

* For detailed product information, please visit our website: <http://www.asrock.com>



Please realize that there is a certain risk involved with overclocking, including adjusting the setting in the BIOS, applying Untied Overclocking Technology, or using third-party overclocking tools. Overclocking may affect your system's stability, or even cause damage to the components and devices of your system. It should be done at your own risk and expense. We are not responsible for possible damage caused by overclocking.

Chapter 2 Product Overview

This chapter provides diagrams showing the location of important components of the Beebox series.

2.1 Front View

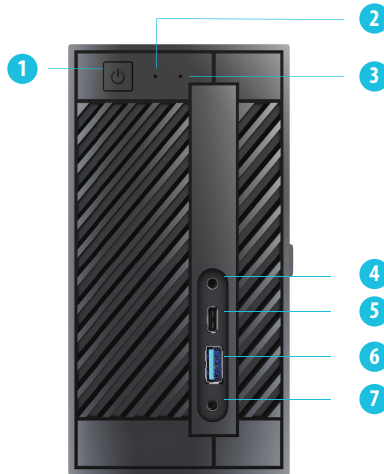

| No. | Description |
|-----|---------------------|
| 1 | Power Button |
| 2 | Power LED |
| 3 | HDD LED |
| 4 | MIC-In |
| 5 | USB 3.0 Type-A Port |
| 6 | USB 3.0 Type-C Port |
| 7 | Headphone/Headset |

2.2 Rear View

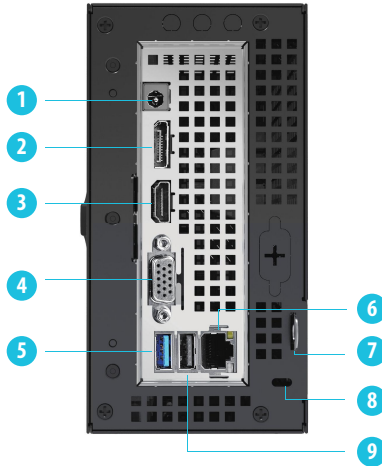

| No. | Description |
|-----|--|
| 1 | DC Jack (Supports 19V 120W Power Adapters)* |
| 2 | Display Port |
| 3 | HDMI Port |
| 4 | D-Sub Port |
| 5 | USB 3.0 Port |
| 6 | LAN RJ-45 Port** |
| 7 | Key Lock |
| 8 | Kensington Lock |
| 9 | USB 2.0 Port (for DeskMini 110 series) USB 3.0 Port (for DeskMini 170 series) |

*Specification for DC plug

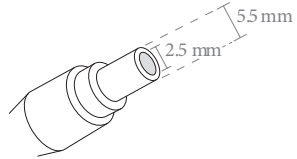

** There are two LEDs on the LAN port. Please refer to the table below for the LAN port LED indications.

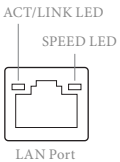

| Activity / Link LED | | Speed LED | |
|---------------------|---------------|-----------|--------------------|
| Status | Description | Status | Description |
| Off | No Link | Off | 10Mbps connection |
| Blinking | Data Activity | Orange | 100Mbps connection |
| On | Link | Green | 1Gbps connection |

Bottom View

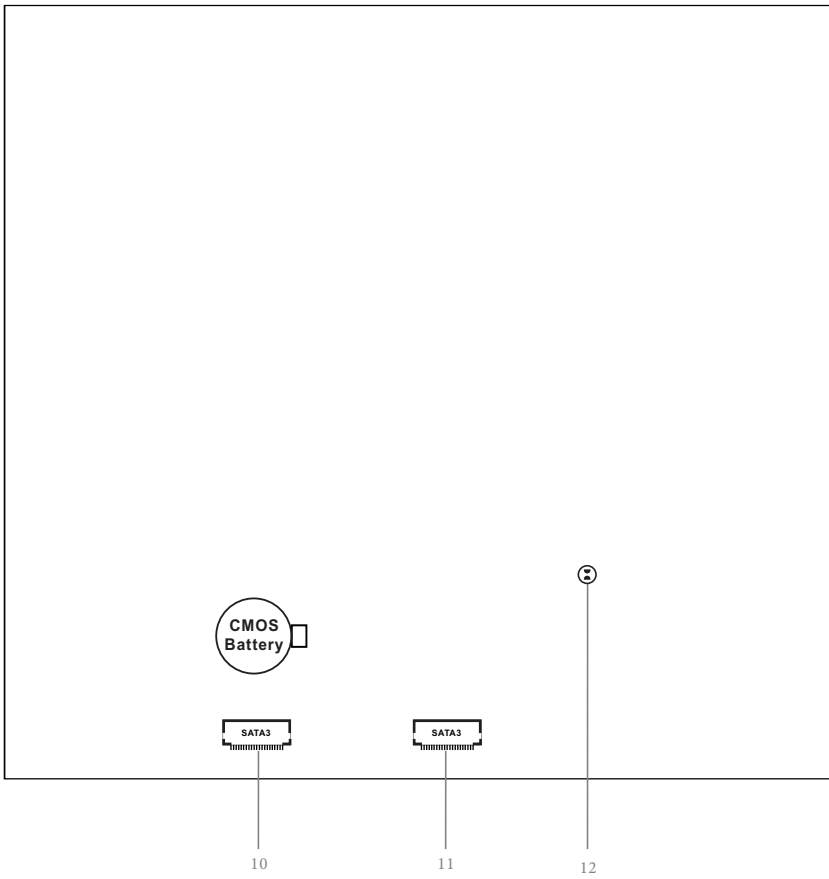

| No. | Description |
|-----|--|
| 1 | 5-Pin CPU Fan Connector (CPU_FAN2) |
| 2 | 2 x 260-pin DDR4 SO-DIMM Slots (DDR4_A1, DDR4_B1) |
| 3 | 4-Pin CPU Fan Connector (CPU_FAN1) |
| 4 | LPC Debug Header (LPC1) |
| 5 | USB 2.0 Header (USB_5_6) |
| 6 | MONO Speaker Header (SPEAKER1) |
| 7 | COM Port Header (COM1) (only for DeskMini 110/COM) |
| 8 | System Panel Header (PANEL1) |
| 9 | Chassis Intrusion Header (CI1) |
| 10 | SATA3 Connector (SATA1) |
| 11 | SATA3 Connector (SATA2) |
| 12 | Clear CMOS Pad |

Onboard Headers and Connectors



Onboard headers and connectors are NOT jumpers. Do NOT place jumper caps over these headers and connectors. Placing jumper caps over the headers and connectors will cause permanent damage to the motherboard.

System Panel Header
(9-pin PANEL1)
(see p.6, No. 8)

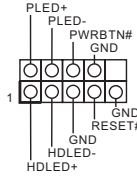

Connect the power switch, reset switch and system status indicator on the chassis to this header according to the pin assignments below. Note the positive and negative pins before connecting the cables.



PWRBTN (Power Switch):

Connect to the power switch on the chassis front panel. You may configure the way to turn off your system using the power switch.

RESET (Reset Switch):

Connect to the reset switch on the chassis front panel. Press the reset switch to restart the computer if the computer freezes and fails to perform a normal restart.

PLED (System Power LED):

Connect to the power status indicator on the chassis front panel. The LED is on when the system is operating. The LED keeps blinking when the system is in S1/S3 sleep state. The LED is off when the system is in S4 sleep state or powered off (S5).

HDLED (Hard Drive Activity LED):

Connect to the hard drive activity LED on the chassis front panel. The LED is on when the hard drive is reading or writing data.

The front panel design may differ by chassis. A front panel module mainly consists of power switch, reset switch, power LED, hard drive activity LED, speaker and etc. When connecting your chassis front panel module to this header, make sure the wire assignments and the pin assignments are matched correctly.

MONO Speaker Header
(4-pin SPEAKER1)
(see p.6, No. 6)

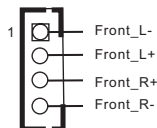

Please connect the chassis speaker to this header.

Serial ATA3 Connectors
(see p.7, No. 10 and 11)

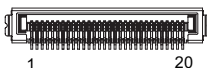

| PIN | Signal Name | PIN | Signal Name |
|-----|-------------|-----|-------------|
| 1 | GND | 11 | N/A |
| 2 | LVDS_TX+ | 12 | 5V |
| 3 | LVDS_TX- | 13 | 5V |
| 4 | GND | 14 | 5V |
| 5 | GND | 15 | 5V |
| 6 | LVDS_RX- | 16 | 5V |
| 7 | LVDS_RX+ | 17 | N/A |
| 8 | GND | 18 | GND |
| 9 | GND | 19 | GND |
| 10 | GND | 20 | GND |

These two SATA3 connectors support SATA data cables for internal storage devices with up to 6.0 Gb/s data transfer rate.
*The SATA3 connectors support 2.5-inch hard drive (+5V) and do not support 3.5-inch hard drive (+12V)

USB 2.0 Header
(9-pin USB_5_6)
(see p.6, No. 5)

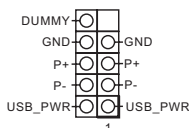

There is one header on this motherboard. This USB 2.0 header can support two ports.

CPU Fan Connector
(4-pin CPU_FAN1)
(see p.6, No. 3)

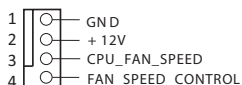

This motherboard provides a 4-Pin CPU fan (Quiet Fan) connector.
If you plan to connect a 3-Pin CPU fan, please connect it to Pin 1-3.

CPU Fan Connector
(5-pin CPU_FAN2)
(see p.6, No. 1)

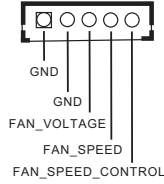

This motherboard provides a 5-Pin CPU fan connector. This connector supports Intel® 1L Thermal Modules.

Serial Port Header
(only for DeskMini 110/
COM)
(9-pin COM1)
(see p.6, No. 7)

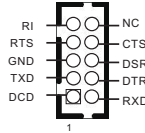

This COM1 header supports a serial port module.

Chassis Intrusion Header
(2-pin CII)
(see p.6, No. 9)

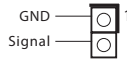

This motherboard supports CASE OPEN detection feature that detects if the chassis cover has been removed. This feature requires a chassis with chassis intrusion detection design.

Clear CMOS Pad
(see p.7, No. 12)



Clear CMOS Pad allows you to clear the data in CMOS. To clear CMOS, disconnect the power supply and short the Clear CMOS Pad.

LPC Debug Header
(13-pin LPC1)
(see p.6, No. 4)



| PIN | Signal Name | PIN | Signal Name |
|-----|-------------|-----|-------------|
| 1 | CLK | 2 | GND |
| 3 | RESET# | 4 | LFRAME# |
| 5 | LAD0 | 6 | LAD1 |
| 7 | LAD2 | 8 | LAD3 |
| 9 | LAD3 | 10 | LAD3 |
| 11 | +3V | 12 | +3V |
| 13 | No pin | 14 | +3V |

Chapter 3 Hardware Installation

3.1 Begin Installation

1. Unscrew the four screws of the back panel.

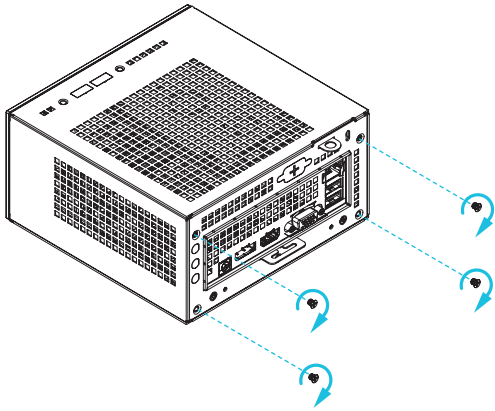

2. Pull out the motherboard tray while holding the handle .

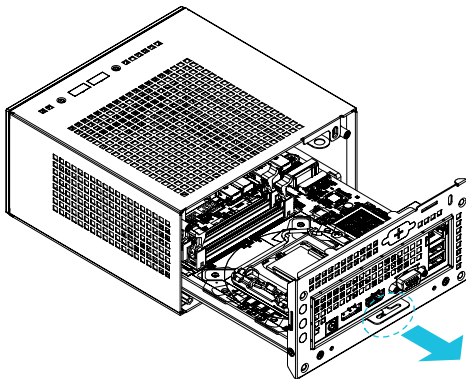

3.2 Installing the CPU

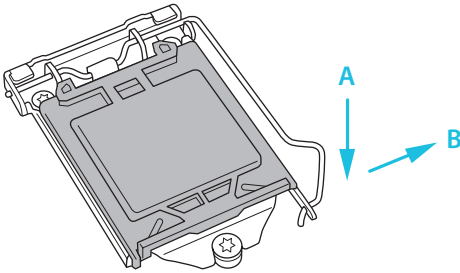
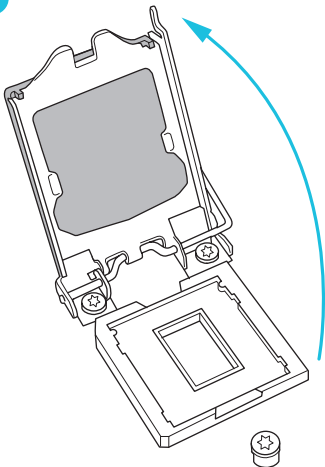

1. Before you insert the 1151-Pin CPU into the socket, please check if the **PnP cap** is on the socket, if the CPU surface is unclean, or if there are any **bent pins** in the socket. Do not force to insert the CPU into the socket if above situation is found. Otherwise, the CPU will be seriously damaged.
2. Unplug all power cables before installing the CPU.

1**2**

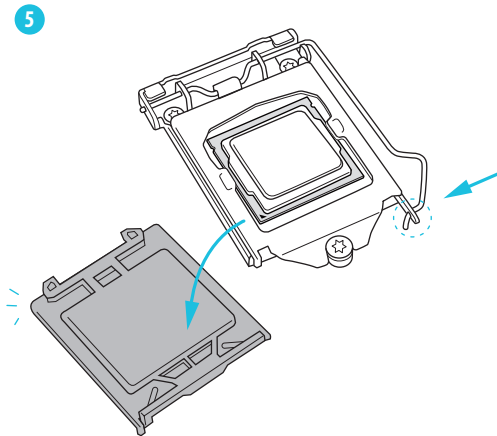
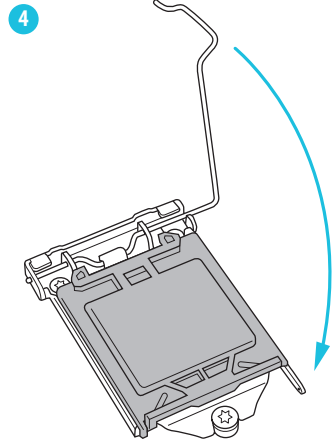
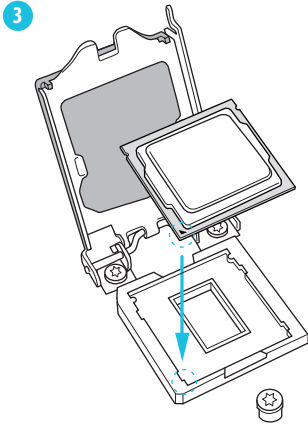

Please save and replace the cover if the processor is removed. The cover must be placed if you wish to return the motherboard for after service.

3.3 Installing the CPU Fan and Heatsink

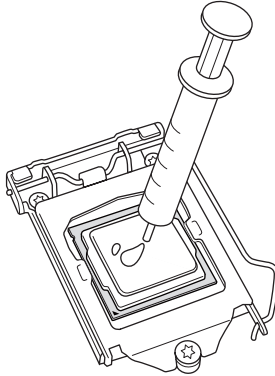
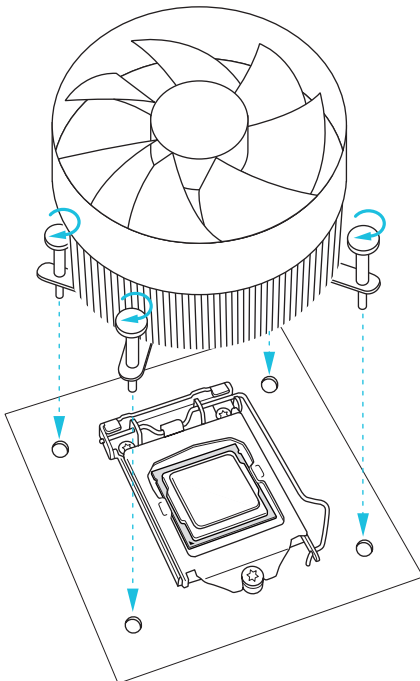
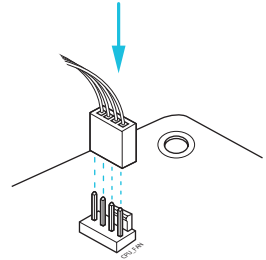

DeskMini 110 series supports both Intel CPU Box Fan (65W) and third-party CPU fan cooler. Please note that the DeskMini 110 series chassis has 52mm height limitation for the CPU fan cooler.

1**2****3**

3.4 Installing Memory Modules (SO-DIMM)

This motherboard provides two 260-pin DDR4 (Double Data Rate 4) SO-DIMM slots.



1. DeskMini 110 series requires DDR4 SO-DIMM.
2. For dual channel configuration, you always need to install identical (the same brand, speed, size and chip-type) DDR4 SO-DIMM pairs.



1. It is not allowed to install a DDR, DDR2 or DDR3 memory module into a DDR4 slot; otherwise, this motherboard and SO-DIMM may be damaged.
2. The SO-DIMM only fits in one correct orientation. It will cause permanent damage to the motherboard and the SO-DIMM if you force the SO-DIMM into the slot at incorrect orientation.

1

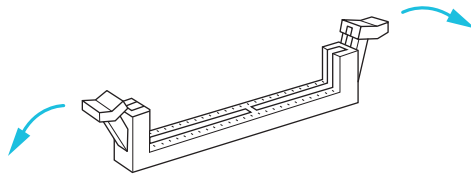

2

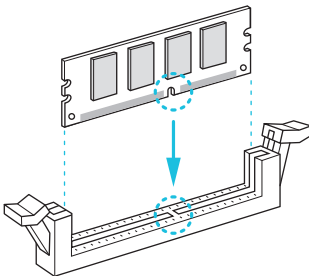

3

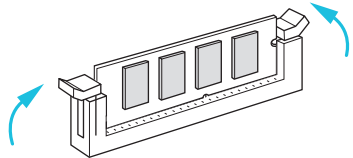

3.5 Installing the WiFi Module

1. Insert the WiFi Module Card into the M.2 Slot for WiFi + BT Module.

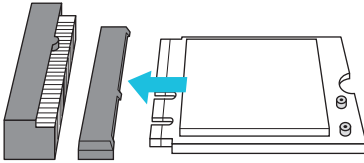

2. Tighten the screw to secure the WiFi Module Card to the motherboard.

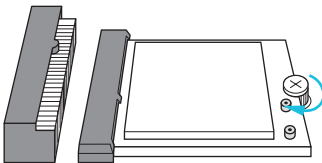

3. Attach the SMA Wi-Fi Antenna Cables to the WiFi Module.

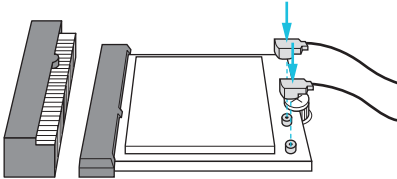

3.6 Installing the M.2 SSD (Type 2280)

1. Locate the M.2 slot on the motherboard.

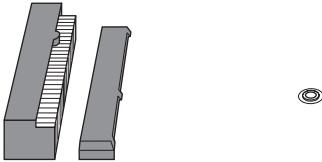

2. Carefully insert the M.2 SSD into the slot.

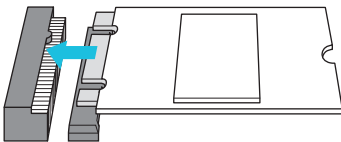

3. Tighten the screw to secure the M.2 SSD to the motherboard.

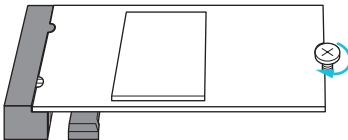

3.7 Installing the 2.5-inch HDD/SSD

1. Place another HDD/SSD on the tray B shown in Step 1. Then turn the motherboard tray upside down and secure the HDD/SSD with the four screws.

*Removing the motherboard before installing the second HDD/SSD.

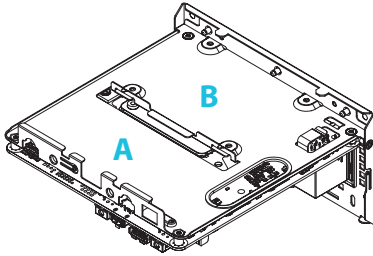

2. Connect the SATA Data and Power Cable to the HDD/SSD.

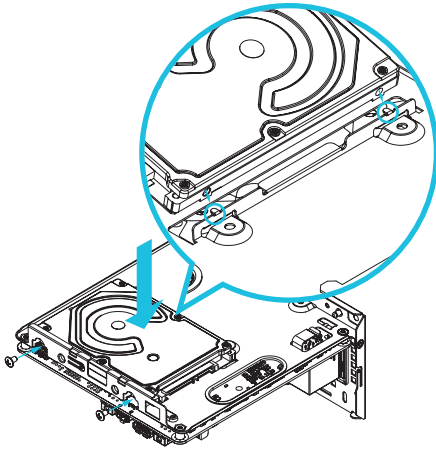

3. Connect the other end of the SATA Cables to the SATA Connectors on the motherboard.

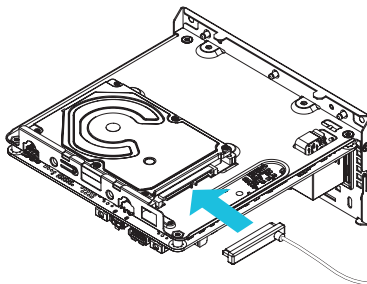

4. Place another HDD/SSD on the tray B shown in Step 1.
Then turn the motherboard tray upside down and secure the HDD/SSD with the four screws.

*Removing the motherboard before installing the second HDD/SSD.

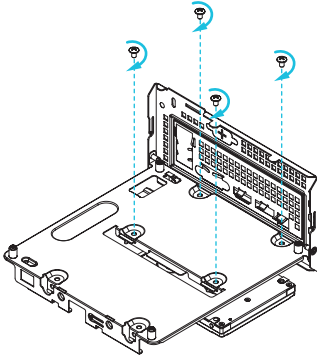

5. Connect the SATA Data and Power Cable to the HDD/SSD.

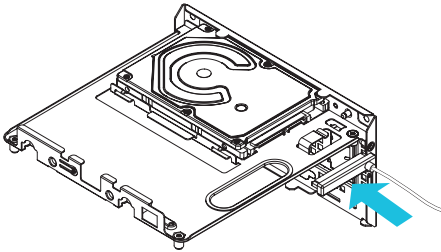

6. Connect the other end of the SATA Cables to the SATA Connectors on the motherboard.

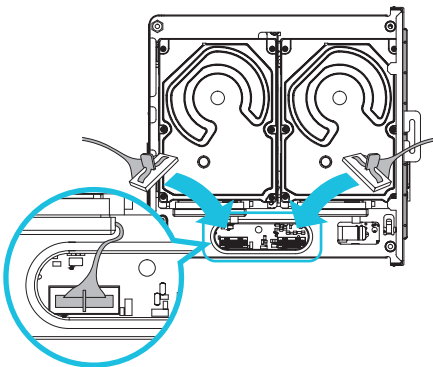

3.8 Complete

1. Connect the power button cable to the System Panel Header on the motherboard.

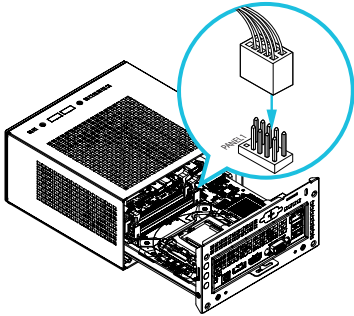

2. Align the motherboard tray with the two sliding tracks on the chassis while sliding it back to the chassis.

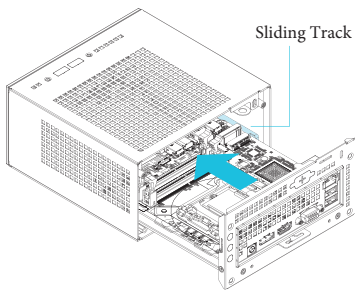

3. Then refasten the four screws that you removed earlier.

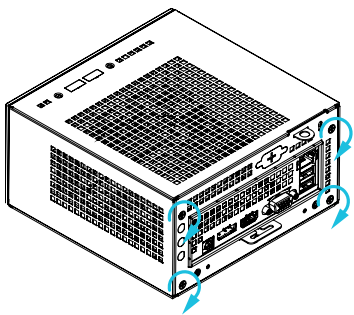

3.9 Installing the VESA Bracket (Optional)

1. Secure the VESA Bracket to the right side panel of the DeskMini 110 series by using the four screws.

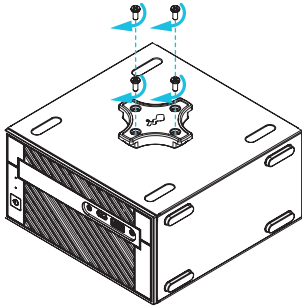

2. Attach the other VESA Bracket to the rear of a compatible display using the four screws.

*Choose mounting holes depending on the mounting hole pattern of your LCD screen (75 mm × 75 mm or 100 mm × 100 mm).

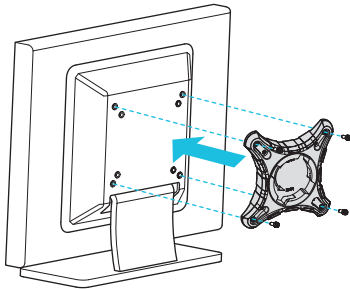

3. Mount the DeskMini 110 series by turning it counterclockwise.

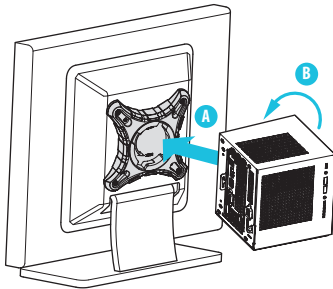

4. Complete.

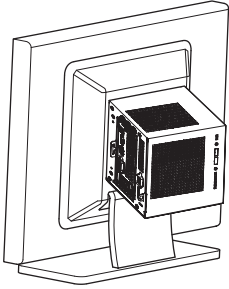

4.0 Installing the WiFi Antennas (Optional)

1. Insert the Wi-Fi Antenna Connectors to the antenna ports on the rear panel of the DeskMini 110 series

*Please make sure to align the flat surface of Wi-Fi Antenna Connectors with the flat side of holes when inserting the connectors.

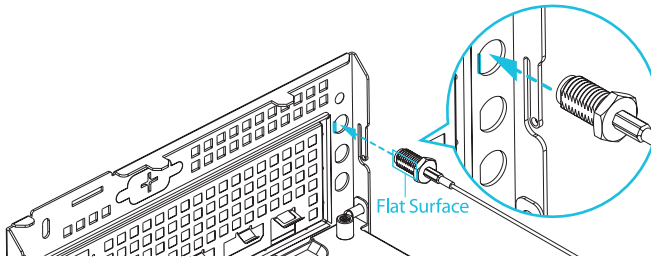

2. Fasten the screw nuts to secure the antenna connectors.

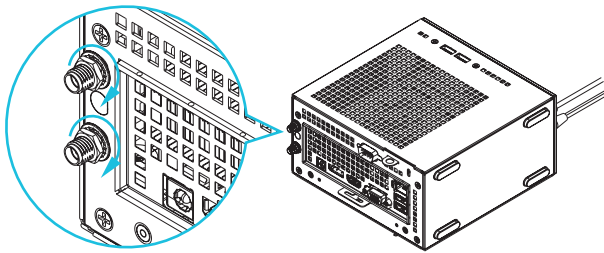

3. Connect the two WiFi 2.4/5 GHz Antennas to the antenna connectors. Turn the antenna clockwise until it is securely connected.

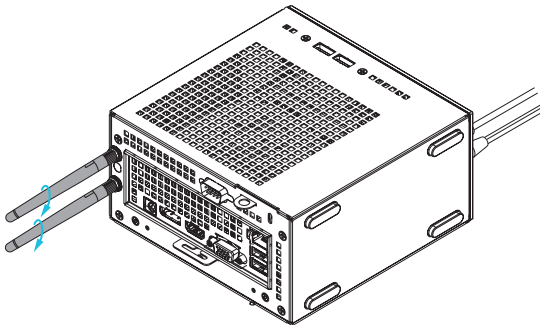

4. Set the WiFi 2.4/5 GHz Antenna at 90-degree angle.

*You may need to adjust the direction of the antenna for a stronger signal.

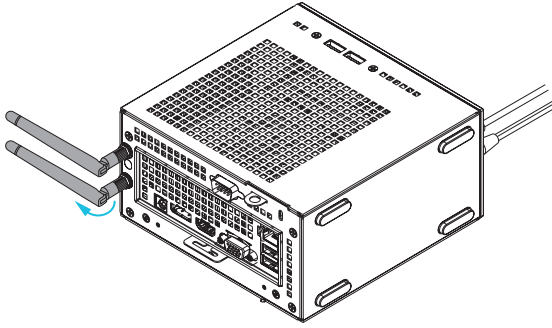

Chapter 4 Software and Utilities Operation

4.1 Installing Drivers

The Support CD that comes with the motherboard contains necessary drivers and useful utilities that enhance the motherboard's features.

Running The Support CD

To begin using the support CD, insert the CD into your CD-ROM drive. The CD automatically displays the Main Menu if "AUTORUN" is enabled in your computer. If the Main Menu does not appear automatically, locate and double click on the file "ASRSETUP.EXE" in the Support CD to display the menu.

Drivers Menu

The drivers compatible to your system will be auto-detected and listed on the support CD driver page. Please click **Install All** or follow the order from top to bottom to install those required drivers. Therefore, the drivers you install can work properly.

Utilities Menu

The Utilities Menu shows the application software that the motherboard supports. Click on a specific item then follow the installation wizard to install it.



*To improve Windows 7 compatibility, please download and install the following hot fix provided by Microsoft.
"KB2720599": <http://support.microsoft.com/kb/2720599/en-us>*

4.2 ASRock Live Update & APP Shop

The ASRock Live Update & APP Shop is an online store for purchasing and downloading software applications for your ASRock computer. You can quickly and easily install various apps and support utilities, such as USB Key, XFast LAN, XFast RAM and more. With ASRock APP Shop, you can optimize your system and keep your motherboard up to date simply with a few clicks.

Double-click  on your desktop to access ASRock Live Update & APP Shop utility.

**You need to be connected to the Internet to download apps from the ASRock Live Update & APP Shop.*

4.2.1 UI Overview

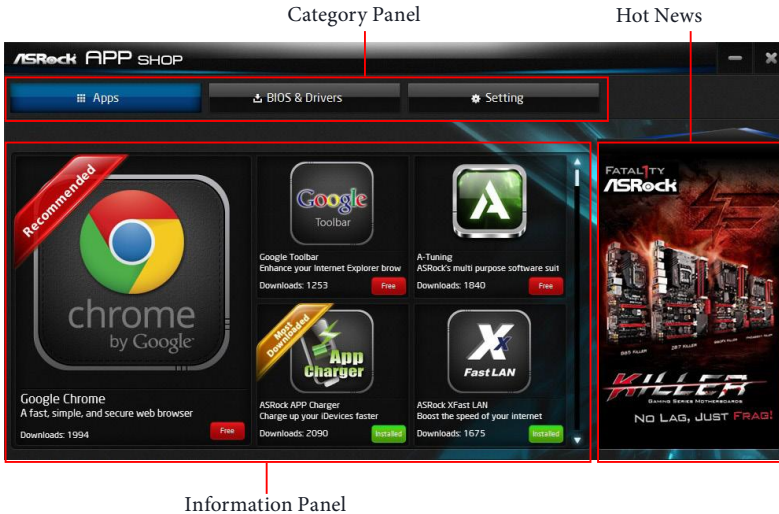

Category Panel: The category panel contains several category tabs or buttons that when selected the information panel below displays the relative information.

Information Panel: The information panel in the center displays data about the currently selected category and allows users to perform job-related tasks.

Hot News: The hot news section displays the various latest news. Click on the image to visit the website of the selected news and know more.

4.2.2 Apps

When the "Apps" tab is selected, you will see all the available apps on screen for you to download.

Installing an App

Step 1

Find the app you want to install.



The most recommended app appears on the left side of the screen. The other various apps are shown on the right. Please scroll up and down to see more apps listed.

You can check the price of the app and whether you have already installed it or not.

 - The red icon displays the price or "Free" if the app is free of charge.

 - The green "Installed" icon means the app is installed on your computer.

Step 2

Click on the app icon to see more details about the selected app.

Step 3

If you want to install the app, click on the red icon  to start downloading.

**Step 4**

When installation completes, you can find the green "Installed" icon appears on the upper right corner.

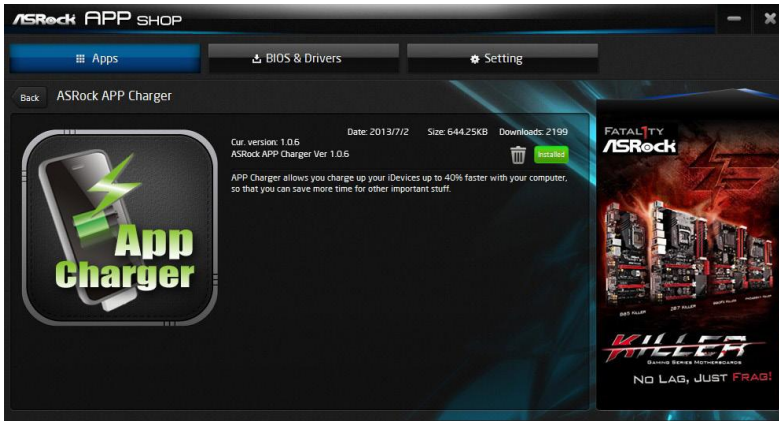

To uninstall it, simply click on the trash can icon .
*The trash icon may not appear for certain apps.

Upgrading an App

You can only upgrade the apps you have already installed. When there is an available new version for your app, you will find the mark of "New Version"  appears below the installed app icon.



Step 1

Click on the app icon to see more details.

Step 2

Click on the yellow icon  to start upgrading.

4.2.3 BIOS & Drivers

Installing BIOS or Drivers

When the "BIOS & Drivers" tab is selected, you will see a list of recommended or critical updates for the BIOS or drivers. Please update them all soon.

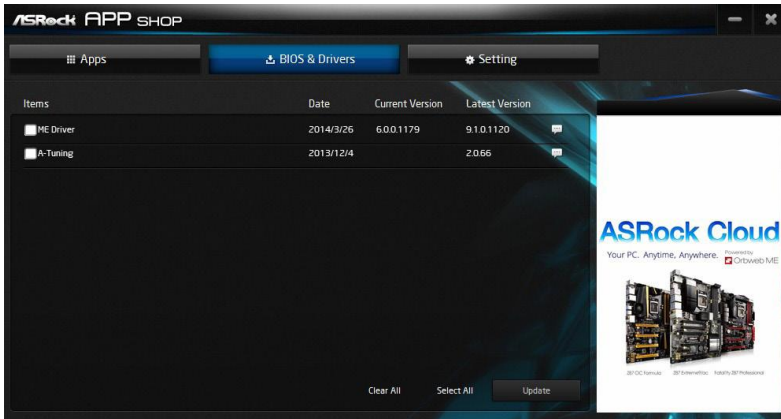

Step 1

Please check the item information before update. Click on  to see more details.

Step 2

Click to select one or more items you want to update.

Step 3

Click Update to start the update process.

4.2.4 Setting

In the "Setting" page, you can change the language, select the server location, and determine if you want to automatically run the ASRock Live Update & APP Shop on Windows startup.

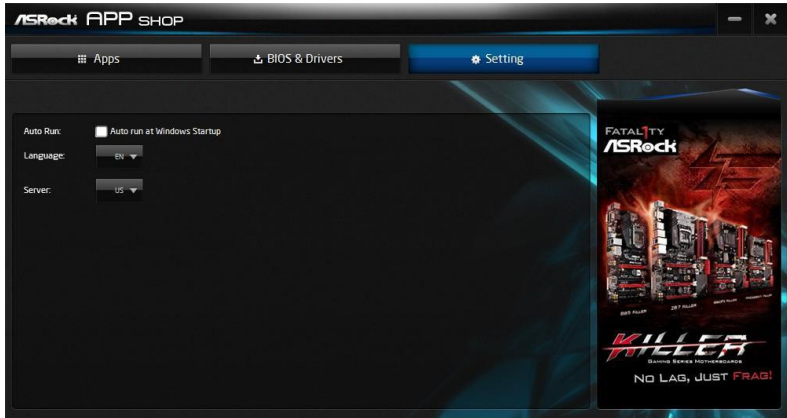

4.3 Enabling USB Ports for Windows® 7 Installation

Intel® Braswell and Skylake has removed their support for the Enhanced Host Controller Interface (EHCI – USB2.0) and only kept the eXtensible Host Controller Interface (XHCI – USB3.0). Due to that fact that XHCI is not included in the Windows 7 inbox drivers, users may find it difficult to install Windows 7 operating system because the USB ports on their motherboard won't work. In order for the USB ports to function properly, please create a Windows® 7 installation disk with the Intel® USB 3.0 eXtensible Host Controller (xHCI) drivers packed into the ISO file.

Requirements

- A Windows® 7 installation disk or USB drive
- A Windows® PC
- Win7 USB Patcher (included in the ASRock Support CD or downloaded from website)

Instructions

Step 1

Insert the Windows® 7 installation disk or USB drive to your system.

Step 2

Extract the tool (Win7 USB Patcher) and launch it.

Step 3

Select "Create a Windows 7 installation disk with a USB device".



Step 4

Locate your Win7 source folder or your ISO file.

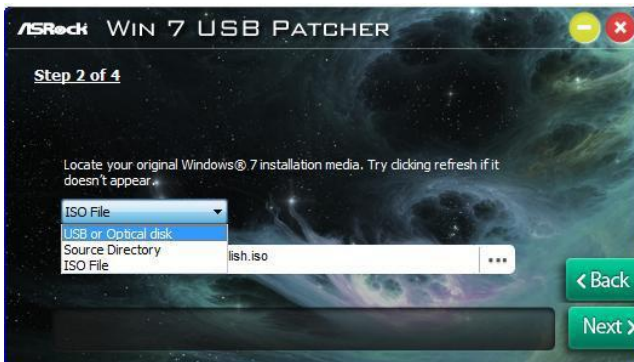

Step 5

Select the USB storage, compact disk or destination folder for the new Windows 7 installation file.

**Step 6**

Click "Start" to begin.

**Step 7**

Now you are able to install Windows® 7 on Braswell or Skylake with the new burned CD. Or please use the patched ISO image to make an OS USB drive to install the OS.

Chapter 5 UEFI SETUP UTILITY

5.1 Introduction

This section explains how to use the UEFI SETUP UTILITY to configure your system. You may run the UEFI SETUP UTILITY by pressing <F2> or right after you power on the computer, otherwise, the Power-On-Self-Test (POST) will continue with its test routines. If you wish to enter the UEFI SETUP UTILITY after POST, restart the system by pressing <Ctl> + <Alt> + <Delete>, or by pressing the reset button on the system chassis. You may also restart by turning the system off and then back on.



Because the UEFI software is constantly being updated, the following UEFI setup screens and descriptions are for reference purpose only, and they may not exactly match what you see on your screen.

5.2 EZ Mode

The EZ Mode screen appears when you enter the BIOS setup program by default. EZ mode is a dashboard which contains multiple readings of the system's current status. You can check the most crucial information of your system, such as CPU speed, DRAM frequency, SATA information, fan speed, etc.

Press <F6> or click the "Advanced Mode" button at the upper right corner of the screen to switch to "Advanced Mode" for more options.

DeskMini 110:

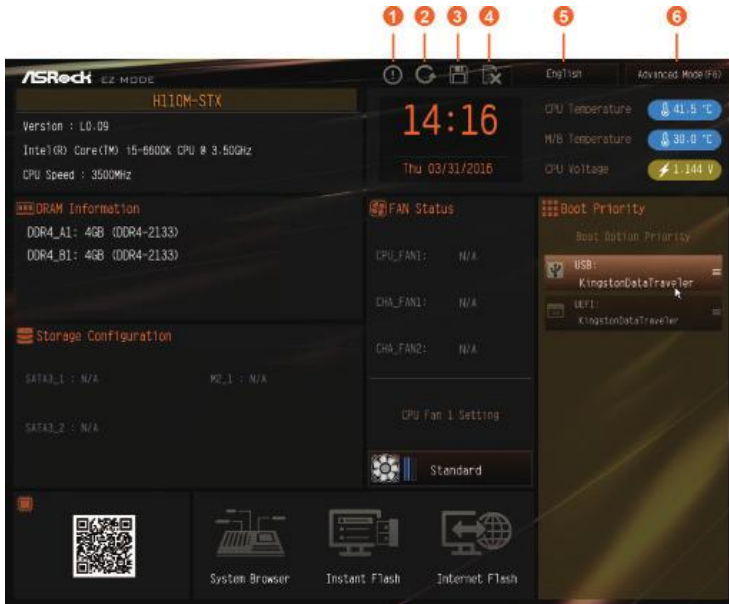

DeskMini 110/COM:



| No. | Function |
|-----|-------------------------|
| 1 | Help |
| 2 | Load UEFI Defaults |
| 3 | Save Changes and Exit |
| 4 | Discard Changes |
| 5 | Change Language |
| 6 | Switch to Advanced Mode |

5.3 Advanced Mode

The Advanced Mode provides more options to configure the BIOS settings. Refer to the following sections for the detailed configurations.

To access the EZ Mode, press <F6> or click the "EZ Mode" button at the upper right corner of the screen.

5.3.1 UEFI Menu Bar

The top of the screen has a menu bar with the following selections:

| | |
|--------------------|---|
| Main | For setting system time/date information |
| OC Tweaker | For overclocking configurations |
| Advanced | For advanced system configurations |
| Tool | Useful tools |
| H/W Monitor | Displays current hardware status |
| Boot | For configuring boot settings and boot priority |
| Security | For security settings |
| Exit | Exit the current screen or the UEFI Setup Utility |

5.3.2 Navigation Keys

Use <←> key or <→> key to choose among the selections on the menu bar, and use <↑> key or <↓> key to move the cursor up or down to select items, then press <Enter> to get into the sub screen. You can also use the mouse to click your required item.

Please check the following table for the descriptions of each navigation key.

| Navigation Key(s) | Description |
|-------------------|--|
| + / - | To change option for the selected items |
| <Tab> | Switch to next function |
| <PGUP> | Go to the previous page |
| <PGDN> | Go to the next page |
| <HOME> | Go to the top of the screen |
| <END> | Go to the bottom of the screen |
| <F1> | To display the General Help Screen |
| <F5> | Add / Remove Favorite |
| <F7> | Discard changes and exit the SETUP UTILITY |
| <F9> | Load optimal default values for all the settings |
| <F10> | Save changes and exit the SETUP UTILITY |
| <F12> | Print screen |
| <ESC> | Jump to the Exit Screen or exit the current screen |

5.4 Main Screen

When you enter the UEFI SETUP UTILITY, the Main screen will appear and display the system overview.

DeskMini 110:



DeskMini 110/COM:



My Favorite

Display your collection of BIOS items. Press F5 to add/remove your favorite items.

5.5 OC Tweaker Screen

In the OC Tweaker screen, you can set up overclocking features.



Because the UEFI software is constantly being updated, the following UEFI setup screens and descriptions are for reference purpose only, and they may not exactly match what you see on your screen.

DDR4 Non-Z OC

Please note that overclocking may cause damage to your memory DIMMs and motherboard. It should be done at your own risk and expense. Please use a better cooling solution while overclocking. The option colored in red might make your system unstable. It depends on the quality of the memory DIMMs and system environment.

CPU Configuration

Intel SpeedStep Technology

Intel SpeedStep technology allows processors to switch between multiple frequencies and voltage points for better power saving and heat dissipation.

Intel Speed Shift Technology

Enable this option to expose the Collaborative Processor Performance Control (CPPC) v2 interface to allow hardware controlled P-states.

Intel Turbo Boost Technology

Intel Turbo Boost Technology enables the processor to run above its base operating frequency when the operating system requests the highest performance state.

Long Duration Power Limit

Configure Package Power Limit 1 in watts. When the limit is exceeded, the CPU ratio will be lowered after a period of time. A lower limit can protect the CPU and save power, while a higher limit may improve performance.

Long Duration Maintained

Configure the period of time until the CPU ratio is lowered when the Long Duration Power Limit is exceeded.

Short Duration Power Limit

Configure Package Power Limit 2 in watts. When the limit is exceeded, the CPU ratio will be lowered immediately. A lower limit can protect the CPU and save power, while a higher limit may improve performance.

DRAM Configuration

DRAM Tweaker

Fine tune the DRAM settings by leaving marks in checkboxes. Click OK to confirm and apply your new settings.

DRAM Timing Configuration

DRAM Reference Clock

Select Auto for optimized settings.

DRAM Frequency

If [Auto] is selected, the motherboard will detect the memory module(s) inserted and assign the appropriate frequency automatically.

Primary Timing

CAS# Latency (tCL)

The time between sending a column address to the memory and the beginning of the data in response.

RAS# to CAS# Delay and Row Precharge (tRCDtRP)

RAS# to CAS# Delay: The number of clock cycles required between the opening of a row of memory and accessing columns within it.

Row Precharge: The number of clock cycles required between the issuing of the precharge command and opening the next row.

RAS# Active Time (tRAS)

The number of clock cycles required between a bank active command and issuing the precharge command.

Command Rate (CR)

The delay between when a memory chip is selected and when the first active command can be issued.

Secondary Timing

Write Recovery Time (tWR)

The amount of delay that must elapse after the completion of a valid write operation, before an active bank can be precharged.

Refresh Cycle Time (tRFC)

The number of clocks from a Refresh command until the first Activate command to the same rank.

RAS to RAS Delay (tRRD_L)

The number of clocks between two rows activated in different banks of the same rank.

RAS to RAS Delay (tRRD_S)

The number of clocks between two rows activated in different banks of the same rank.

Write to Read Delay (tWTR_L)

The number of clocks between the last valid write operation and the next read command to the same internal bank.

Write to Read Delay (tWTR_S)

The number of clocks between the last valid write operation and the next read command to the same internal bank.

Read to Precharge (tRTP)

The number of clocks that are inserted between a read command to a row pre-charge command to the same rank.

Four Activate Window (tFAW)

The time window in which four activates are allowed the same rank.

CAS Write Latency (tCWL)

Configure CAS Write Latency.

Third Timing

tREFI

Configure refresh cycles at an average periodic interval.

tCKE

Configure the period of time the DDR4 initiates a minimum of one refresh command internally once it enters Self-Refresh mode.

tRDRD_sg

Configure between module read to read delay.

tRDRD_dg

Configure between module read to read delay.

tRDRD_dr

Configure between module read to read delay.

tRDRD_dd

Configure between module read to read delay.

tRDWR_sg

Configure between module read to write delay.

tRDWR_dg

Configure between module read to write delay.

tRDWR_dr

Configure between module read to write delay.

tRDWR_dd

Configure between module read to write delay.

tWRRD_sg

Configure between module write to read delay.

tWRRD_dg

Configure between module write to read delay.

tWRRD_dr

Configure between module write to read delay.

tWRRD_dd

Configure between module write to read delay.

tWRWR_sg

Configure between module write to write delay.

tWRWR_dg

Configure between module write to write delay.

tWRWR_dr

Configure between module write to write delay.

tWRWR_dd

Configure between module write to write delay.

RTL Init Value

Configure round trip latency init value for round trip latency training.

IO-L Init Value

Configure IO latency init value for IO latency training.

RTL (CH A)

Configure round trip latency for channel A.

RTL (CH B)

Configure round trip latency for channel B.

IO-L (CH A)

Configure IO latency for channel A.

IO-L (CH B)

Configure IO latency for channel B.

IO-L Offset (CH A)

Configure IO latency offset for channel A.

IO-L Offset (CH B)

Configure IO latency offset for channel B.

RFR Delay (CH A)

Configure RFR Delay for Channel A.

RFR Delay (CH B)

Configure RFR Delay for Channel B.

Fourth Timing**twRPRE**

Configure twRPRE.

Write_Early_ODT

Configure Write_Early_ODT.

tAONPD

Configure tAONPD.

tXP

Configure tXP.

tXPDLL

Configure tXPDLL.

tPRPDEN

Configure tPRPDEN.

tRDPDEN

Configure tRDPDEN.

twRPDEN

Configure twRPDEN.

OREF_RI

Configure OREF_RI.

tREFIx9

Configure tREFIx9.

txSDLL

Configure txSDLL.

txs_offset

Configure txs_offset.

tZQOPER

Configure tZQOPER.

tMOD

Configure tMOD.

ZQCS_period

Configure ZQCS_period.

tZQCS

Configure tZQCS.

Advanced Setting

ODT WR (CH A)

Configure the memory on die termination resistors' WR for channel A.

ODT WR (CH B)

Configure the memory on die termination resistors' WR for channel B.

ODT PARK (CH A)

Configure the memory on die termination resistors' PARK for channel A.

ODT PARK (CH B)

Configure the memory on die termination resistors' PARK for channel B.

ODT NOM (CH A)

Use this to change ODT (CH A) Auto/Manual settings. The default is [Auto].

ODT NOM (CH B)

Use this to change ODT (CH B) Auto/Manual settings. The default is [Auto].

MRC Fast Boot

Enable Memory Fast Boot to skip DRAM memory training for booting faster.

Dll Bandwidth 0

Configure the Dll Bandwidth 0.

Dll Bandwidth 1

Configure the Dll Bandwidth 1.

Dll Bandwidth 2

Configure the Dll Bandwidth 2.

Dll Bandwidth 3

Configure the Dll Bandwidth 3.

Margin Limit

Adjust Margin Limit to get better memory margin.

Voltage Configuration

DRAM Voltage

Use this to configure DRAM Voltage. The default value is [Auto].

Save User Default

Type a profile name and press enter to save your settings as user default.

Load User Default

Load previously saved user defaults.

5.6 Advanced Screen

In this section, you may set the configurations for the following items: CPU Configuration, Chipset Configuration, Storage Configuration, Super IO Configuration, ACPI Configuration and USB Configuration.



Setting wrong values in this section may cause the system to malfunction.

UEFI Configuration

UEFI Setup Style

Select the default mode when entering the UEFI setup utility.

Active Page on Entry

Select the default page when entering the UEFI setup utility.

5.6.1 CPU Configuration



Active Processor Cores

Select the number of cores to enable in each processor package.

CPU C States Support

Enable CPU C States Support for power saving. It is recommended to keep C3, C6 and C7 all enabled for better power saving.

Enhanced Halt State (C1E)

Enable Enhanced Halt State (C1E) for lower power consumption.

CPU C3 State Support

Enable C3 sleep state for lower power consumption.

CPU C6 State Support

Enable C6 deep sleep state for lower power consumption.

CPU C7 State Support

Enable C7 deep sleep state for lower power consumption.

Package C State Support

Enable CPU, PCIe, Memory, Graphics C State Support for power saving.

CPU Thermal Throttling

Enable CPU internal thermal control mechanisms to keep the CPU from overheating.

No-Execute Memory Protection

Processors with No-Execution Memory Protection Technology may prevent certain classes of malicious buffer overflow attacks.

Intel Virtualization Technology

Intel Virtualization Technology allows a platform to run multiple operating systems and applications in independent partitions, so that one computer system can function as multiple virtual systems.

Hardware Prefetcher

Automatically prefetch data and code for the processor. Enable for better performance.

Adjacent Cache Line Prefetch

Automatically prefetch the subsequent cache line while retrieving the currently requested cache line. Enable for better performance.

Software Guard Extensions (SGX)

Enable or disable the support for Intel® Software Guard Extensions (Intel® SGX).

5.6.2 Chipset Configuration



Top of Lower Usable DRAM

Set the maximum value of TOLUD. Set this item to Dynamic to allow TOLUD to adjust automatically based on the largest MMIO length of the installed graphic controller.

VT-d

Intel® Virtualization Technology for Directed I/O helps your virtual machine monitor better utilize hardware by improving application compatibility and reliability, and providing additional levels of manageability, security, isolation, and I/O performance.

PCIE ASPM Support

This option enables/disables the ASPM support for all CPU downstream devices.

PCH PCIE ASPM Support

This option enables/disables the ASPM support for all PCH PCIE devices.

DMI ASPM Support

This option enables/disables the control of ASPM on CPU side of the DMI Link.

PCH DMI ASPM Support

This option enables/disables the ASPM support for all PCH DMI devices.

IOAPIC 24-119 Entries

Enable or disable IOAPIC 24-119 Entries to expand your PIROI-PIROX.

Share Memory

Configure the size of memory that is allocated to the integrated graphics processor when the system boots up.

Onboard LAN

Enable or disable the onboard network interface controller.

Onboard HD Audio

Enable/disable onboard HD audio. Set to Auto to enable onboard HD audio and automatically disable it when a sound card is installed.

Onboard HDMI HD Audio

Enable audio for the onboard digital outputs.

WAN Radio

Enable/disable the WiFi module's connectivity.

Deep Sleep

Configure deep sleep mode for power saving when the computer is shut down.

Restore on AC/Power Loss

Select the power state after a power failure. If [Power Off] is selected, the power will remain off when the power recovers. If [Power On] is selected, the system will start to boot up when the power recovers.

Good Night LED

By enabling Good Night LED, the Power/HDD LEDs will be switched off when the system is on. It will also automatically switch off the Power and Keyboard LEDs when the system enters into Standby/Hibernation mode.

5.6.3 Storage Configuration



SATA Controller(s)

Enable/disable the SATA controllers.

SATA Aggressive Link Power Management

SATA Aggressive Link Power Management allows SATA devices to enter a low power state during periods of inactivity to save power. It is only supported by AHCI mode.

Hard Disk S.M.A.R.T.

S.M.A.R.T stands for Self-Monitoring, Analysis, and Reporting Technology. It is a monitoring system for computer hard disk drives to detect and report on various indicators of reliability.

5.6.4 Super IO Configuration



Serial Port (for DeskMini 110/COM only)

Enable or disable the Serial port.

Serial Port Address (for DeskMini 110/COM only)

Select the address of the Serial port.

5.6.5 ACPI Configuration



Suspend to RAM

Select disable for ACPI suspend type S1. It is recommended to select auto for ACPI S3 power saving.

ACPI HEPT Table

Enable the High Precision Event Timer for better performance.

Wake From Onboard LAN

Allow the system to be waked up by the onboard LAN.

Ring-In Power On

Allow the system to be waked up by onboard COM port modem Ring-In signals.

RTC Alarm Power On

Allow the system to be waked up by the real time clock alarm. Set it to By OS to let it be handled by your operating system.

USB Keyboard/Remote Power On

Allow the system to be waked up by an USB keyboard or remote controller.

USB Mouse Power On

Allow the system to be waked up by an USB mouse.

5.6.6 USB Configuration



Legacy USB Support

Enable or disable Legacy OS Support for USB 2.0 devices. If you encounter USB compatibility issues it is recommended to disable legacy USB support. Select UEFI Setup Only to support USB devices under the UEFI setup and Windows/Linux operating systems only.

PS/2 Simulator

Enable this item for the complete USB keyboard legacy support for non-USB aware operating system.

XHCI Hand-off

This is a workaround for OSes without XHCI hand-off support. The XHCI ownership change should be claimed by XHCI driver.

5.7 Tools



OMG (Online Management Guard)

Administrators are able to establish an internet curfew or restrict internet access at specified times via OMG. You may schedule the starting and ending hours of internet access granted to other users. In order to prevent users from bypassing OMG, guest accounts without permission to modify the system time are required.

UEFI Tech Service

Contact ASRock Tech Service if you are having trouble with your PC. Please setup network configuration before using UEFI Tech Service.

Easy Driver Installer

For users that don't have an optical disk drive to install the drivers from our support CD, Easy Driver Installer is a handy tool in the UEFI that installs the LAN driver to your system via an USB storage device, then downloads and installs the other required drivers automatically.

Boot Manager

Boot Manager is specifically designed for the dual OS platform/multi-OS platform users to easily customize and manage the boot menu.

*Please connect more than one boot devices to use this tool.

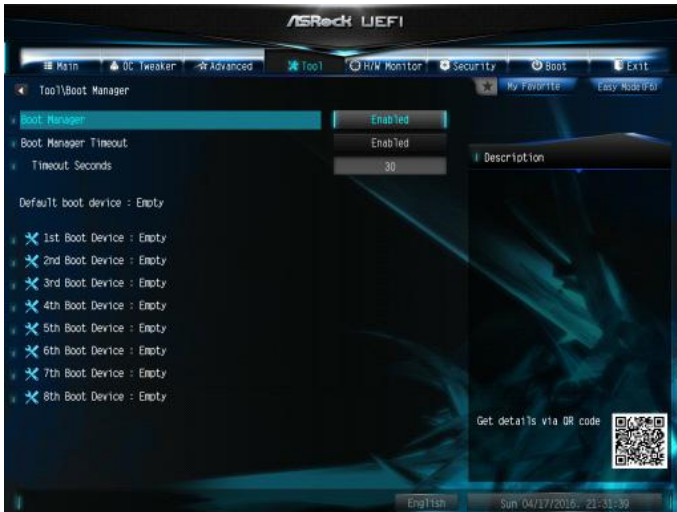

Boot Manager

Enable/disable the Boot Manager.

Boot Manager Timeout

Enable/disable the Boot Manager Timeout.

Timeout Seconds

Configure the number of seconds to wait for the Boot Manager.

Instant Flash

Save UEFI files in your USB storage device and run Instant Flash to update your UEFI.

Internet Flash - DHCP (Auto IP), Auto

ASRock Internet Flash downloads and updates the latest UEFI firmware version from our servers for you. Please setup network configuration before using Internet Flash.

*For BIOS backup and recovery purpose, it is recommended to plug in your USB pen drive before using this function.

Network Configuration

Use this to configure internet connection settings for Internet Flash.



Internet Setting

Enable or disable sound effects in the setup utility.

UEFI Download Server

Select a server to download the UEFI firmware.

5.8 Hardware Health Event Monitoring Screen

This section allows you to monitor the status of the hardware on your system, including the parameters of the CPU temperature, motherboard temperature, fan speed and voltage.



Fan-Tastic Tuning

Select a fan mode for CPU Fan, or choose Customize to set 5 CPU temperatures and assign a respective fan speed for each temperature.

CPU Fan 1 Setting

Select a fan mode for CPU Fan 1, or choose Customize to set 5 CPU temperatures and assign a respective fan speed for each temperature.

CPU Fan 2 Setting

Select a fan mode for CPU Fan 2, or choose Customize to set 5 CPU temperatures and assign a respective fan speed for each temperature.

Case Open Feature

Enable or disable Case Open Feature to detect whether the chassis cover has been removed.

5.9 Security Screen

In this section you may set or change the supervisor/user password for the system. You may also clear the user password.



Supervisor Password

Set or change the password for the administrator account. Only the administrator has authority to change the settings in the UEFI Setup Utility. Leave it blank and press enter to remove the password.

User Password

Set or change the password for the user account. Users are unable to change the settings in the UEFI Setup Utility. Leave it blank and press enter to remove the password.

Secure Boot

Use this item to enable or disable support for Windows 8.1 Secure Boot.

Intel(R) Platform Trust Technology

Enable/disable Intel PTT in ME. Disable this option to use discrete TPM Module.

5.10 Boot Screen

This section displays the available devices on your system for you to configure the boot settings and the boot priority.



Fast Boot

Fast Boot minimizes your computer's boot time. In fast mode you may not boot from an USB storage device. Ultra Fast mode is only supported by Windows 8.1 and the VBIOS must support UEFI GOP if you are using an external graphics card. Please notice that Ultra Fast mode will boot so fast that the only way to enter this UEFI Setup Utility is to Clear CMOS or run the Restart to UEFI utility in Windows.

Boot From Onboard LAN

Allow the system to be waked up by the onboard LAN.

Setup Prompt Timeout

Configure the number of seconds to wait for the setup hot key.

Bootup Num-Lock

Select whether Num Lock should be turned on or off when the system boots up.

Boot Beep

Select whether the Boot Beep should be turned on or off when the system boots up. Please note that a buzzer is needed.

Full Screen Logo

Enable to display the boot logo or disable to show normal POST messages.

AddOn ROM Display

Enable AddOn ROM Display to see the AddOn ROM messages or configure the AddOn ROM if you've enabled Full Screen Logo. Disable for faster boot speed.

Boot Failure Guard

If the computer fails to boot for a number of times the system automatically restores the default settings.

Boot Failure Guard Count

Configure the number of attempts to boot until the system automatically restores the default settings.

CSM (Compatibility Support Module)



CSM

Enable to launch the Compatibility Support Module. Please do not disable unless you're running a WHCK test. If you are using Windows 8.1 64-bit and all of your devices support UEFI, you may also disable CSM for faster boot speed.

Launch PXE OpROM Policy

Select UEFI only to run those that support UEFI option ROM only. Select Legacy only to run those that support legacy option ROM only. Select Do not launch to not execute both legacy and UEFI option ROM.

Launch Storage OpROM Policy

Select UEFI only to run those that support UEFI option ROM only. Select Legacy only to run those that support legacy option ROM only. Select Do not launch to not execute both legacy and UEFI option ROM.

Launch Video OpROM Policy

Select UEFI only to run those that support UEFI option ROM only. Select Legacy only to run those that support legacy option ROM only. Select Do not launch to not execute both legacy and UEFI option ROM.

5.11 Exit Screen



Save Changes and Exit

When you select this option the following message, “Save configuration changes and exit setup?” will pop out. Select [OK] to save changes and exit the UEFI SETUP UTILITY.

Discard Changes and Exit

When you select this option the following message, “Discard changes and exit setup?” will pop out. Select [OK] to exit the UEFI SETUP UTILITY without saving any changes.

Discard Changes

When you select this option the following message, “Discard changes?” will pop out. Select [OK] to discard all changes.

Load UEFI Defaults

Load UEFI default values for all options. The F9 key can be used for this operation.

Launch EFI Shell from filesystem device

Copy shellx64.efi to the root directory to launch EFI Shell.

Contact Information

If you need to contact ASRock or want to know more about ASRock, you're welcome to visit ASRock's website at <http://www.asrock.com>; or you may contact your dealer for further information. For technical questions, please submit a support request form at <http://www.asrock.com/support/tsd.asp>

ASRock Incorporation

2F., No.37, Sec. 2, Jhongyang S. Rd., Beitou District,
Taipei City 112, Taiwan (R.O.C.)

ASRock EUROPE B.V.

Bijsterhuizen 11-11

6546 AR Nijmegen

The Netherlands

Phone: +31-24-345-44-33

Fax: +31-24-345-44-38

ASRock America, Inc.

13848 Magnolia Ave, Chino, CA91710

U.S.A.

Phone: +1-909-590-8308

Fax: +1-909-590-1026