

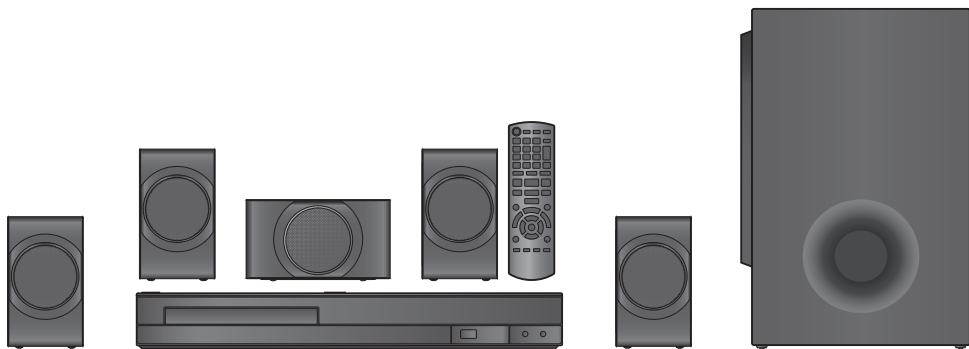









## Operating Instructions DVD Home Theater Sound System

Model No. SC-XH160  
SC-XH100  
SC-XH60



This illustration shows SC-XH100.

Thank you for purchasing this product.  
Please read these instructions carefully before using this product, and save this manual for future use.  
**The illustrations shown may differ from your unit.**

Region number		
The player plays DVD-Video marked with labels containing the region number or "ALL".		
Region	Number	Example
The Middle East and South Africa	2	  
Southeast Asia	3	  
India	5	  

Indicates features applicable to:

<b>XH160</b> : SC-XH160 only	<b>XH100</b> : SC-XH100 only	<b>XH60</b> : SC-XH60 only
------------------------------	------------------------------	----------------------------

System		SC-XH160	SC-XH100	SC-XH60
Main unit		SA-XH160	SA-XH100	SA-XH60
Speaker system	Front speakers	SB-HF75	SB-HF1001	SB-HF1001
	Center speaker	SB-HC1001	SB-HC1001	SB-HC1001
	Surround speakers	SB-HS75	SB-HS75	SB-HS75
Subwoofer		SB-HW20	SB-HW20	SB-HW600

- These operating instructions are applicable to models SC-XH160, SC-XH100 and SC-XH60 for a variety of regions. Unless otherwise indicated, illustrations in these operating instructions are of SC-XH100.
- Operations in these instructions are described mainly with the remote control, but you can perform the operations on the main unit if the controls are the same.

## Accessories

Please check and identify the supplied accessories.



- 1 Remote control (N2QAYB000853)
- 1 Remote control battery
- 1 FM indoor antenna



- 1 Video cable
- XH160** **XH100**  
1 HDMI cable
- 2 Sheets of speaker cable stickers

- For India**  
1 AC mains lead
- For Southeast Asia, the Middle East and South Africa**  
2 AC mains leads
- Speaker cables
  - XH160**
    - 1 short cable
    - 2 long cables
  - XH100** **XH60**
    - 3 short cables
    - 2 long cables
- XH160** 2 Speaker stands (with cable)
- XH160** 2 Bases
- XH160** 8 Screws

**For the Middle East and South Africa**

**(When using the moulded three pin mains plug)**

### How to replace the fuse

The location of the fuse differ according to the type of AC mains plug (figures A and B). Confirm the AC mains plug fitted and follow the instructions below. Illustrations may differ from actual AC mains plug.

1. Open the fuse cover with a screwdriver.

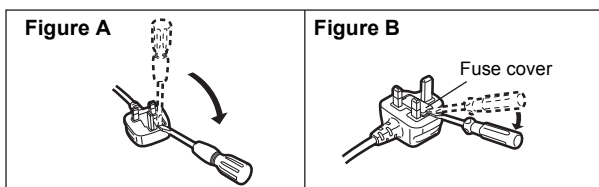

2. Replace the fuse and close or attach the fuse cover.

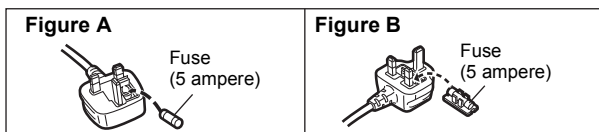

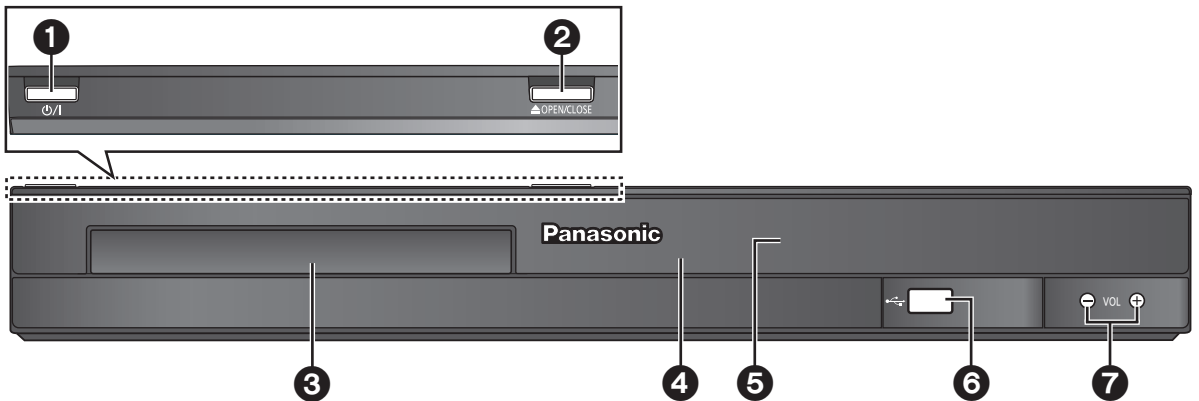
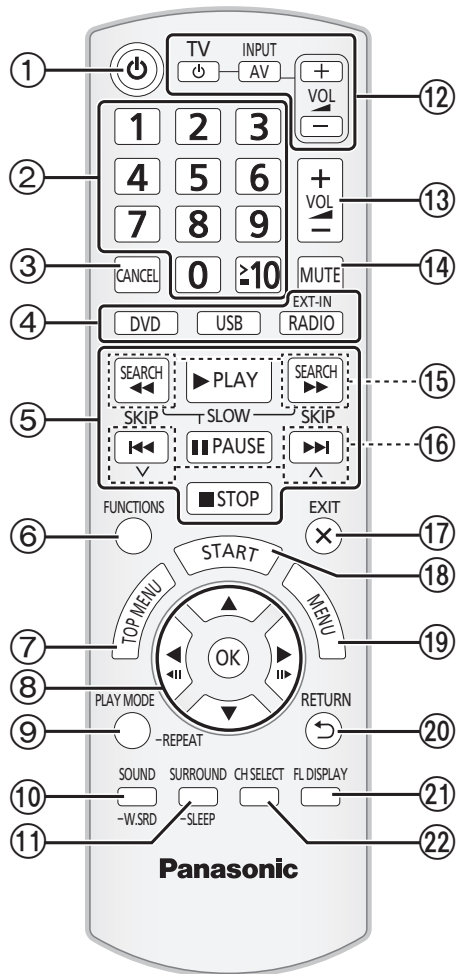

The circled numbers indicated in the operating instructions (e.g. Press [⏻]①) correspond to the circled numbers in the above.

# Control reference guide

## Remote control

- ① Turn the main unit on/off (⇒ 9)
- ② Select channels and title numbers etc. / Enter numbers (⇒ 10, 12)
- ③ Cancel (⇒ 13)
- ④ **Source select**
  - [DVD]: Select disc as the source (⇒ 12)
  - [USB]: Select USB as the source (⇒ 16)
  - [EXT-IN, RADIO]:
    - Select the FM tuner or the external audio as the source (⇒ 10)
    - FM → AUX → ARC
- ⑤ Basic operations for play (⇒ 12)
- ⑥ Show on-screen menu (⇒ 14)
- ⑦ Show a disc top menu (⇒ 13)
- ⑧ Select or confirm menu items / Frame-by-frame (⇒ 12)
- ⑨ Select the play mode / Set the repeat mode (⇒ 13, 14)
- ⑩ Select sound mode / Turn Whisper-mode Surround on/off (⇒ 12)
- ⑪ Select surround sound effects (⇒ 11)  
or  
**Set the Sleep timer**  
Press and hold [–SLEEP].  
While the time is shown on the main unit's display, press [–SLEEP] repeatedly.  
Each time you press the button:  
SLEEP 30 → SLEEP 60 → SLEEP 90 → SLEEP 120  
↑ OFF (Cancel) ↓
  - To confirm the remaining time, press and hold the button again.
- ⑫ **TV operations**  
Aim the remote control at the Panasonic TV and press the button.
  - [TV, ⏻]: Turn the TV on/off
  - [INPUT, AV]: Change the TV's video input mode
  - [+, VOL, –]: Adjust the TV volumeThis may not work properly with some models.
- ⑬ Adjust the volume of the main unit
- ⑭ **Mute the sound**
  - "MUTE" flashes on the main unit's display while the function is on.
  - To cancel, press the button again or adjust the volume.
  - Muting is cancelled when you switch the unit to standby.
- ⑮ Select radio stations manually (⇒ 10)
- ⑯ Select preset radio stations (⇒ 10)
- ⑰ Exit the display
- ⑱ Show START menu (⇒ 10)
- ⑲ Show a disc menu (⇒ 13)
- ⑳ Return to previous screen (⇒ 13)
- ㉑ Switch information on the main unit's display (⇒ 13)
- ㉒ Select speaker channel (⇒ 12)

## Avoiding interference with other Panasonic equipment

Other Panasonic audio/video equipment may start functioning when you operate the unit using the supplied remote control. You can operate this unit in another mode by setting the remote control operating mode to "REMOTE 2".

### The main unit and remote control must be set to the same mode.

- 1 Press [EXT-IN]④ to select "AUX".
- 2 Press and hold [▲ OPEN/CLOSE]② on the main unit and [2] on the remote control until the main unit's display shows "REMOTE 2".
- 3 Press and hold [OK]⑧ and [2] on the remote control for at least 2 seconds.

To change the mode back to "REMOTE 1", repeat the steps above by replacing [2] with [1].

## Main unit

### 1 Standby/on switch (⏻/⏻)

Press to switch the unit from on to standby mode or vice versa. In standby mode, the unit is still consuming a small amount of power.

### 2 Open/Close the disc tray (⇒ 12)

### 3 Disc tray

### 4 Remote control signal sensor

### 5 Display (FL display)

### 6 Connect USB device (⇒ 16)

### 7 Adjust the volume of the main unit

## POWER-SAVING FEATURES

The main unit is designed to conserve its power consumption and save energy.

### ■ Auto power-down function

- The main unit will automatically switch to standby mode after 30 minutes of inactivity.  
e.g.
  - There is no audio signal from an external device.
  - Media playback is stopped/paused.
  - The disc menu is displayed and play is not selected. (This function may not work depending on the application type of discs.)
- When the main unit is turned back on, "POWER ON FROM AUTO POWER DOWN MODE" appears on the main unit's display.

# TABLE OF CONTENTS

## Getting Started

Accessories .....	2
Control reference guide .....	4

### **POWER-SAVING FEATURES.....4**

<b>step 1 Preparing the speakers .....</b>	<b>6</b>
<b>step 2 Positioning .....</b>	<b>7</b>
<b>step 3 Connections .....</b>	<b>7</b>
Speaker connections .....	7
Radio antenna connection .....	8
Audio and video connections .....	8
<b>step 4 AC mains lead connection .....</b>	<b>9</b>
<b>step 5 Preparing the remote control .....</b>	<b>9</b>
<b>step 6 Easy setup .....</b>	<b>9</b>

Listening to the radio .....	10
Presetting stations automatically .....	10
Listening to a preset channel .....	10

Using the <b>START</b> menu .....	10
Selecting the source using the remote control .....	10

Listening to the TV or other device's audio from this unit's speakers .....	11
---	----

### **Enjoying sound effects from all speakers**

Enjoying surround sound effects .....	11
Selecting sound mode .....	12
Whisper-mode Surround .....	12
Adjusting the speaker level during playback .....	12
Adjusting the front speaker balance during playback .....	12

## Playing Discs

Basic play .....	12
Playing from the selected item .....	13
Other modes of play .....	13
Program and Random play .....	13
Repeat play .....	14
Using on-screen menus .....	14

## Other Operations

### Linked operations with the TV

(VIERA Link "HDMI Control™") .....	15
Setting the audio link .....	15
Easy control only with VIERA remote control .....	16
Playing from an USB device .....	16

## Reference

Changing the player settings .....	16
Media that can be played .....	18
Maintenance .....	19
Speaker installation option .....	19
Troubleshooting guide .....	20
Messages .....	22
Licenses .....	22
Specifications .....	23

### **Safety precautions.....24**

## step 1 | Preparing the speakers

### XH160 Front speakers

#### Preparation

- To prevent damage or scratches, lay down a soft cloth to assemble speakers.
- For assembly, use a Phillips-head screwdriver (not supplied).

Make sure you have all the indicated components before starting assembly, setup, and connection.

- Keep the screws out of reach of children to prevent swallowing.
- For optional wall mount, refer to page 19.

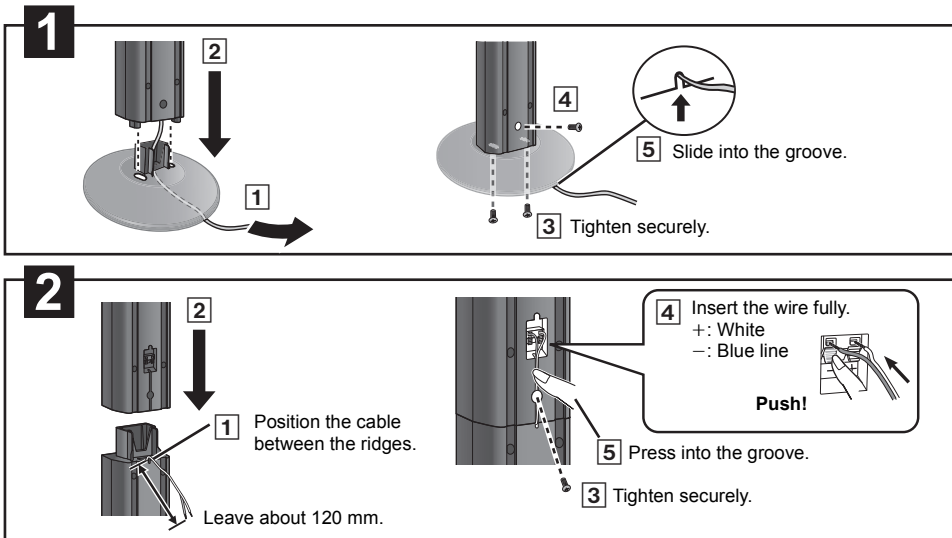

#### Speaker assembly option

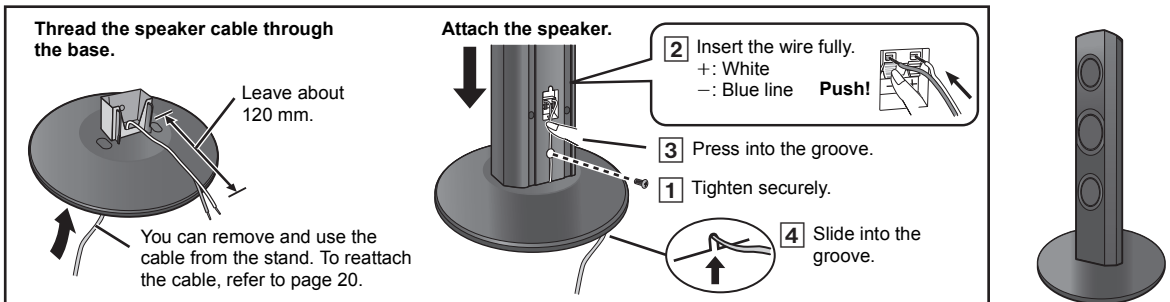

#### Preventing the speakers from falling

- You will need to obtain the appropriate screw eyes to match the walls or pillars to which they are going to be fastened.
- Consult a qualified building contractor concerning the appropriate procedure when attaching to a concrete wall or a surface that may not have strong enough support. Improper attachment may result in damage to the wall and speakers, and personal injury.
- Use a string of less than  $\varnothing 2.0$  mm, which is capable of supporting over 10 kg.

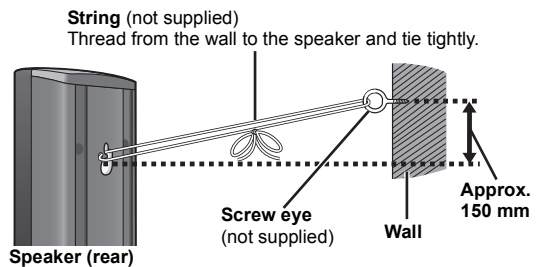

#### Caution

- Do not stand on the base. Be cautious when children are near.
- When carrying the speaker, hold the stand and base parts.

## step 2 | Positioning

How you set up your speakers can affect the bass and the sound field. Note the following points:

- Place speakers on flat secure bases.
- Keep your speakers at least 10 mm away from the system for proper ventilation.
- Placing speakers too close to floors, walls, and corners can result in excessive bass. Cover walls and windows with thick curtains.
- For optional wall mount, refer to page 19.

**Setup example ("Surround layout (Recommended)"): Standard surround placement)**

Place the front, center, and surround speakers at approximately the same distance from the seating position. The angles in the diagram are approximate.

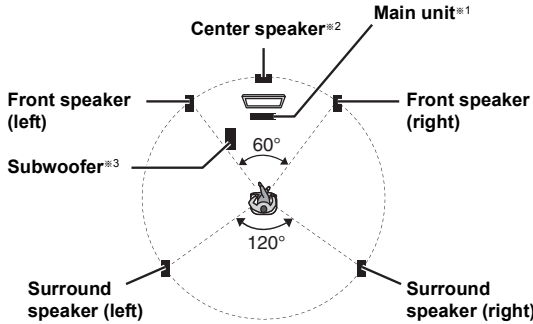

- ※1 Position with at least 5 cm of space on all sides for proper ventilation.
- ※2 Put on a rack or shelf. Vibration caused by the speaker can disrupt the picture if it is placed directly on the TV.
- ※3 Place to the right or left of the TV, on the floor or a sturdy shelf so that it will not cause vibration. Leave about 30 cm from the TV.

Depending on the room layout, you may like to use all the speakers at the front ("Front layout (Alternative)") (→ 9, Easy setup).

## Notes on speaker use

### • Use only supplied speakers

- Using other speakers can damage the unit, and sound quality will be negatively affected.
- You can damage your speakers and shorten their useful life if you play sound at high levels over extended periods.
- Reduce the volume in the following cases to avoid damage:
  - When playing distorted sound.
  - When the speakers are reverberating due to a record player, noise from FM broadcasts, or continuous signals from an oscillator, test disc, or electronic instrument.
  - When adjusting the sound quality.
  - When turning the unit on or off.
- These speakers do not have magnetic shielding. Do not place them near a TV, PC, or other device that is affected by magnetic fields.
- Keep magnetized items away. Magnetized cards, watches, etc., can be damaged if placed too close to the speaker.

### Caution

- The main unit and supplied speakers are to be used only as indicated in this setup. Failure to do so may lead to damage to the amplifier and/or the speakers, and may result in the risk of fire. Consult a qualified service person if damage has occurred or if you experience a sudden change in performance.
- Do not attempt to attach these speakers to walls using methods other than those described in this manual.

## step 3 | Connections

Turn off all equipment before connection and read the appropriate operating instructions.

**Do not connect the AC mains lead until all other connections are completed.**

### 1 Speaker connections

Cable type	Speakers	A	B
(Attached to subwoofer)	Subwoofer	6	SUBWOOFER / ENCEINTE D'EXTRÊMES-GRAVES
Short	Center speaker	5	CENTER / CENTRE
XH160 (Supplied with the speaker stand) XH100 XH60 Short	Front speaker (R)	2	FRONT / AVANT
	Front speaker (L)	1	
Long	Surround speaker (R)	4	SURROUND / AMBIOPHONIE
	Surround speaker (L)	3	

Use of the speaker cable stickers is convenient when making cable connections.

e.g., Surround speaker (L)

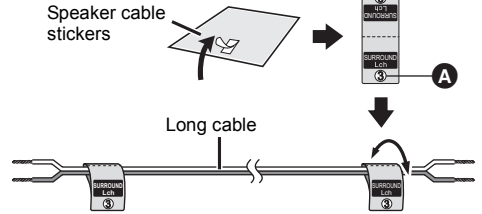

Verify the type of speaker with the label on the speaker before connecting the appropriate cable.

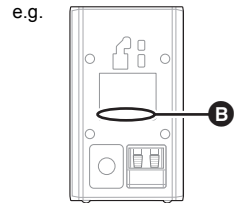

Connect the speaker cables to the appropriate speakers by referring to the above table.

Insert the wire fully, taking care not to insert beyond the wire insulation.

**Be careful not to cross (short circuit) or reverse the polarity of the speaker wires as doing so may damage the speakers.**

- + : White
- : Blue line

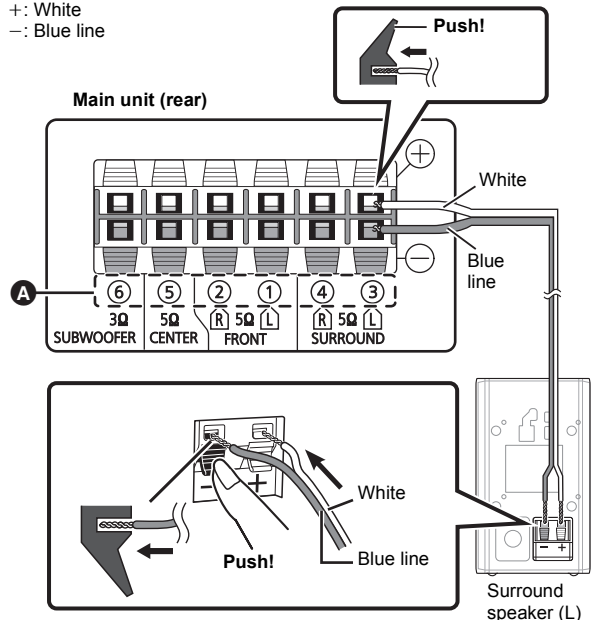

## 2 Radio antenna connection

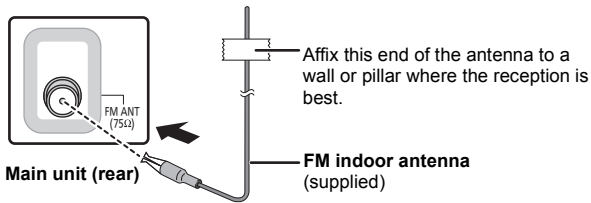

Use an FM outdoor antenna if radio reception is poor.

## 3 Audio and video connections

- To listen to the TV audio on the sound system, connect the HDMI\*1 cable or audio cable. Refer to the operating instructions of the respective devices for the settings necessary to output the audio.

\*1 Only when connecting to an ARC compatible TV. Refer to "Connection with an ARC compatible TV" for details. (⇒ right)

### Recommended connection to a TV

This connection provides the best picture and audio quality.

#### VIERA Link "HDAVI Control"

If your Panasonic TV is VIERA Link compatible, you can operate your TV synchronising with home theater operations or vice versa (⇒ 15, Linked operations with the TV).



- Use the ARC compatible High Speed HDMI cables. Non-HDMI-compliant cables cannot be utilised.  
**XH160** **XH100** The HDMI-compliant cable is supplied with this unit. Do not use any other HDMI cables except the supplied one.
- It is recommended that you use Panasonic's HDMI cable. When outputting 1080p signal, please use HDMI cables 5.0 meters or less.
- Do not make the video connections through the VCR.**  
 Due to copy guard protection, the picture may not be displayed properly.
- After connecting with the HDMI\*1 cable, make settings to suit the type of audio from your digital equipment (⇒ 11).  
 (Only Dolby® Digital and PCM can be played with this connection.)

## ■ Connection with an ARC compatible TV

### What is ARC?

ARC is an abbreviation of Audio Return Channel, also known as HDMI ARC. It refers to one of the HDMI functions. If the TV is ARC compatible, audio from the TV can be sent to this unit via the HDMI cable without the need to make an extra audio connection.

- Refer to the operating instructions of the TV for details.

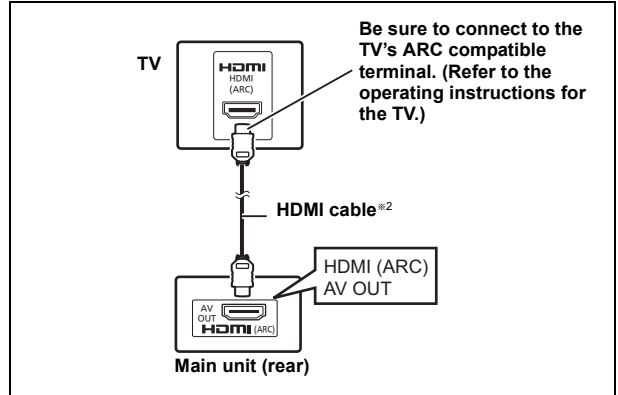

## ■ Connection without an ARC compatible TV

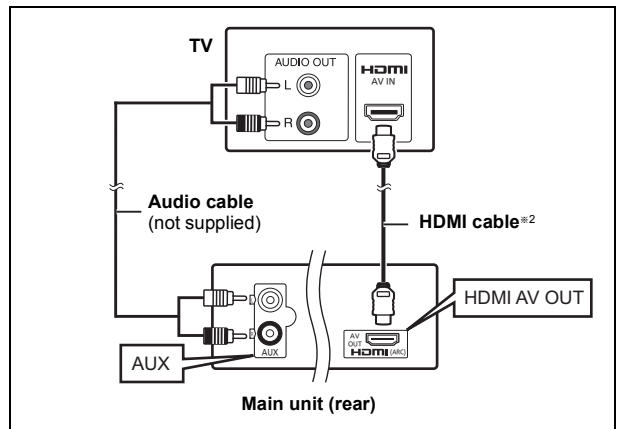

- \*2 **XH160** **XH100** : supplied  
**XH60** : not supplied

### Alternative connection to a TV

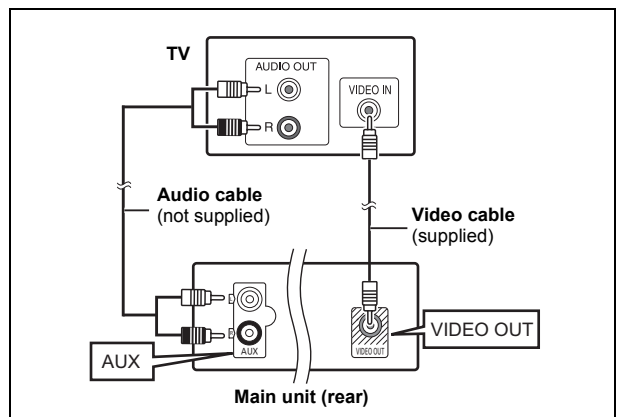

If you have various sound sources (such as Blu-ray Disc player, DVD recorder, VCR, etc.), connect them to the available inputs on the TV and the TV output should then be connected to the AUX or HDMI AV OUT terminal of the main unit.



## step 4 | AC mains lead connection

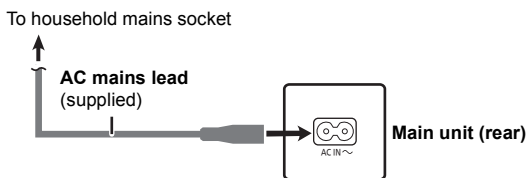

### Conserving power

The main unit consumes a small amount of power, even when it is in standby mode (⇒ 23). To save power when the unit is not to be used for a long time, unplug it from the household mains socket.

You will need to reset some memory items when plugging back the main unit.



- The supplied AC mains lead is for use with the main unit only. Do not use it with other equipment. Also, do not use cords for other equipment with the main unit.
- Please use the supplied AC mains lead suitable for the household mains socket.  
In Saudi Arabia, please use the moulded three pin mains plug.

## step 5 | Preparing the remote control

- 2 Insert so the poles (+ and -) match those in the remote control.

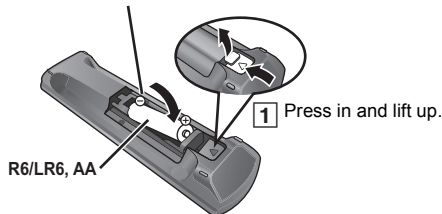

- 3 Replace the cover.

- Use alkaline or manganese batteries.

### Use

Aim at the remote control signal sensor (⇒ 4), avoiding obstacles.

Distance: Within approx. 7 m

Angle: Within approx. 20° up and down, approx. 30° to the left and right

## step 6 | Easy setup

The Easy setup screen assists you in making necessary settings.

### Preparation

Turn on your TV and select the appropriate video input mode (e.g. VIDEO 1, AV 1, HDMI, etc.) to suit the connection to this unit.

- To change your TV's video input mode, refer to its operating instructions.
- This remote control can perform some basic TV operations (⇒ 4).

### 1 Press [⏻]① to turn on the unit.

- The Easy setup screen appears automatically.

### 2 Press [▲, ▼]② to select "Yes" and press [OK]③.

### 3 Follow the messages and make the settings with [▲, ▼, ◀, ▶]④ and [OK]⑤.

#### • Language

Select the language used on menu screen.

#### • TV aspect

Select the aspect to suit your TV.

#### • Speaker layout

Select "Surround layout (Recommended)" mode or "Front layout (Alternative)" mode according to your speaker layout (⇒ 7, Positioning).

#### • Speaker check

Listen to speaker output to confirm speaker connections.

#### • Speaker output

Make surround sound setting for speaker output.

#### • TV audio

Select the audio input connection from your TV.

For AUX connection (⇒ 8): Select "AUX".

For HDMI (ARC) connection (⇒ 8): Select "ARC".

This will be the TV audio setting for VIERA Link "HDAVI Control". (⇒ 15)

### 4 Press [OK]⑥ to finish the "Easy setup".



- You can perform this setup anytime by selecting "Easy setup" in the Setup menu. (⇒ 18)
- If this unit is connected to a "HDAVI Control 3 or later" compatible TV via HDMI cable, the menu language and TV aspect information will be retrieved via VIERA Link.
- If this unit is connected to a "HDAVI Control 2" compatible TV via HDMI cable, the menu language information will be retrieved via VIERA Link.

## Listening to the radio

You can preset up to 30 channels.  
The radio settings will be shown on the unit's display. (Some settings are also indicated on the TV screen.)

### Preparation

Make sure that the FM antenna is connected. (⇒ 8)

### Presetting stations automatically

- 1 Press **[RADIO]**④ to select "FM".
- 2 Press **[MENU]**⑩ to select "LOWEST" or "CURRENT".  
**LOWEST:**  
To begin auto preset with the lowest frequency (FM 87.50).  
**CURRENT:**  
To begin auto preset with the current frequency.\*  
 ※ To change the frequency, refer to "Manual tuning and presetting".
- 3 Press and hold **[OK]**⑧.  
Release the button when "FM AUTO" is displayed.  
The tuner starts to preset all the stations it can receive into the channels in ascending order.

### Listening to a preset channel

- 1 Press **[RADIO]**④ to select "FM".
- 2 Press the numbered buttons to select the channel.  
 • To select a 2-digit number  
 e.g. 12: [ $\equiv$ 10]② ⇒ [1] ⇒ [2]  
 Alternatively, press [ $\vee$ ,  $\wedge$ ]⑬.

### Manual tuning and presetting

Select a radio broadcast.

- 1 Press **[RADIO]**④ to select "FM".
- 2 Press **[SEARCH ◀▶]**⑮ to select the frequency.  
 • To start automatic tuning, press and hold **[SEARCH ◀▶]**⑮ until the frequency starts scrolling. Tuning stops when a station is found.

To preset the channel

- 3 While listening to the radio broadcast  
Press **[OK]**⑧.
- 4 While the frequency is flashing on the display  
Press the numbered buttons to select the channel.



A station previously stored is overwritten when another station is stored in the same channel preset.

## Using the START menu

You can select desired source, change the settings, access playback/menus, etc., by using the START menu.

### 1 Press **[START]**⑩ to show the START menu.

- When using VIERA Link "HDMI Control", the TV also turns on when the START menu is displayed.

e.g.



### 2 Press **[▲, ▼]**⑧ to select an item and press **[OK]**⑧.

- To exit, press **[START]**⑩.

### 3 Press **[▲, ▼, ◀, ▶]**⑧ to make the setting and press **[OK]**⑧.

#### When "Input Selection" is selected

You can select a desired source from the menu.

- DVD/CD (⇒ 12), FM RADIO (⇒ left), AUX\* (⇒ below), ARC\* (⇒ below), USB (⇒ 16)

※ "(TV)" will appear beside "AUX" or "ARC", indicating the TV audio setting for VIERA Link "HDMI Control" (⇒ 15).

#### When "Setup" is selected

You can change the settings for this unit. (⇒ 16)

#### Other selectable items

The items that are displayed will vary depending on the media and source.

When a disc is loaded or an USB device is connected, you can also access playback or menus from the START menu.

e.g. **[DVD-V]**

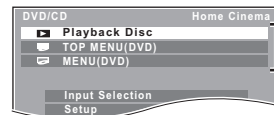

Playback/menu access

When the on-screen control panel appears

e.g. **[DVD-V]** (when "Playback Disc" is selected from the START menu)

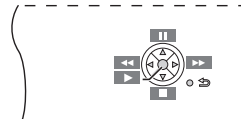

You can operate the playback with the indicated controls.

### Selecting the source using the remote control

Press	To select
<b>[DVD]</b> ④	<b>DVD/CD</b> (⇒ 12)
<b>[USB]</b> ④	<b>USB</b> (⇒ 16)
<b>[EXT-IN, RADIO]</b> ④	Each time you press the button: <b>FM:</b> (⇒ left) <b>AUX:</b> For audio input through the AUX terminal. <b>ARC:</b> For audio input through the HDMI AV OUT terminal. (⇒ 11)



Confirm the audio connection to the AUX or HDMI AV OUT terminal on the main unit when you select the corresponding sources (⇒ 8). Reduce the volume on the TV to its minimum, and then adjust the volume of the main unit.

## Listening to the TV or other device's audio from this unit's speakers

### Preparation

- Make sure that there is an audio connection between this unit and the TV or other device. (⇒ 8)
- Turn on the TV or/and other device.

Press [EXT-IN]④ to choose the source that is used to connect this unit to the TV or other device.

- To change the surround sound effects and sound mode, refer to "Enjoying sound effects from all speakers" (⇒ right).
- If your Panasonic TV is VIERA Link compatible, refer to "Linked operations with the TV" (⇒ 15) for other related functions.

### Making settings for digital audio input

Select to suit the type of audio from the HDMI AV OUT terminal on the main unit.

- Underlined items are the factory presets.

Available settings	
Mode	Setting
<b>DUAL:</b>	(Only works with Dolby Dual Mono) – <u>MAIN+SAP</u> (stereo audio) – <u>MAIN</u> – <u>SAP</u> *SAP* = Secondary Audio Program • Set PCM FIX mode to "OFF" to listen to the "MAIN" or "SAP" audio.
<b>DRC: (Dynamic Range Compression)</b>	– <u>ON</u> Adjust for clarity even when the volume is low by compressing the range of the lowest sound level and the highest sound level. Convenient for late night viewing. (Only works with Dolby Digital) – <u>OFF</u> The full dynamic range of the signal is reproduced.
<b>PCM FIX:</b>	– <u>ON</u> Select when receiving only PCM signals. – <u>OFF</u> Select when receiving Dolby Digital and PCM signals. • When receiving true 5.1-channel surround sound, select "OFF".

- 1 Press [EXT-IN]④ several times to select "ARC".
- 2 Press [PLAY MODE]⑨ and then [▲, ▼]⑧ to select the mode.
- 3 While the selected mode is displayed, press [◀, ▶]⑧ to select the desired setting.

## Enjoying sound effects from all speakers

- The following sound effects may not be available or may have no effect with some sources.
- You may experience a reduction in sound quality when these sound effects are used with some sources. If this occurs, turn the sound effects off.



When changing the surround sound effect, Whisper-mode Surround or the sound modes, the setting is displayed on the TV screen if "DVD/CD" or "USB" is the selected source during video playback.

### Enjoying surround sound effects

Press [SURROUND]⑩.

Each time you press the button:

For "Surround layout (Recommended)"\* mode

**STANDARD:**

Sound is output as it was recorded/encoded. Speaker output varies depending on the source.

**MULTI-CH:**

You can enjoy sound from the front speakers, as well as the surround speakers and center speaker even when playing stereo sources.

**MANUAL:** (⇒ below)

While "MANUAL" is displayed, press [◀, ▶]⑧ to select other surround modes.

Each time you press [◀, ▶]⑧:

**DOLBY PLII MOVIE**

Suitable for movies, or videos recorded in Dolby Surround.

**DOLBY PLII MUSIC**

Adds 5.1-channel effects to stereo sources.

**S.SRD (Super Surround)**

You can enjoy surround effect with stereo sources.

**STEREO**

Sound will only be output to the front speakers and the subwoofer from any source.

**Recommended modes to enjoy TV audio or stereo sources from all speakers:**

"MULTI-CH", "DOLBY PLII MOVIE", "DOLBY PLII MUSIC" or "S.SRD"

For "Front layout (Alternative)"\* mode

**STANDARD:**

Stereo source is output as 2.1-channel audio.

When playing surround sources, you can enjoy 5.1-channel surround-like effect even with all the speakers at the front.

**STEREO:**

You can play any source in stereo. Surround sound effect is unavailable.

**A.SRD (Advanced Surround):**

You can enjoy surround effect with any audio source.

When the signal is Dolby Digital, "DOLBY DIGITAL" will also be displayed.

\* Selected mode in "Speaker layout" (⇒ 9, Easy setup).

## Selecting sound mode

### 1 Press [SOUND]Ⓣ to select a sound mode.

Each time you press the button:

- EQ:** Equaliser
- SUBW LVL:** Subwoofer Level
- C.FOCUS:** Center Focus (Only when "Surround layout (Recommended)" mode is selected in "Speaker layout" (⇒ 9, Easy setup).)

### 2 While the selected mode is displayed, press [◀, ▶]Ⓣ to make the settings.

Refer to the following for setting details of each sound effect.

#### EQ (Equaliser)

You can select sound quality settings.

Each time you press [◀, ▶]Ⓣ:

- FLAT:** Cancel (no effect is added).
- HEAVY:** Adds punch to rock.
- CLEAR:** Clarifies higher sounds.
- SOFT:** For background music.

#### SUBW LVL (Subwoofer level)

You can adjust the amount of bass. The unit automatically selects the most suitable setting according to the type of playback source.

LEVEL 1 ↔ LEVEL 2 ↔ LEVEL 3 ↔ LEVEL 4

- The setting you make is retained and recalled every time you play the same type of source.

#### C.FOCUS (Center Focus)

(Effective when playing audio containing the center channel sound or when DOLBY PLII (⇒ 11) is selected.)

You can make the sound of the center speaker seem like it is coming from within the TV.

ON ↔ OFF

## Whisper-mode Surround

You can enhance the audio effect for low volume 5.1-channel sound. (Convenient for late night viewing.)

### Press and hold [-W.SRD]Ⓣ to show the current setting.

While the current setting is displayed, press [-W.SRD]Ⓣ to change the setting.

ON ↔ OFF

## Adjusting the speaker level during playback

Only when "Surround layout (Recommended)" mode is selected in "Speaker layout" (⇒ 9, Easy setup)

(Effective when playing 5.1-channel sound or when DOLBY PLII/"S.SRD" (⇒ 11) is selected.)

### 1 Press [CH SELECT]Ⓣ to select the speaker.

Each time you press the button:

e.g. L → C → R → RS → LS → SW

- You can adjust SW (Subwoofer) only if the disc includes a subwoofer channel.
- When "S" appears, only the surround speaker channel can be adjusted. Both surround speaker levels will be adjusted at the same time.

### 2 While "C", "RS", "LS", "SW" or "S" is selected Press [▲]Ⓣ (increase) or [▼]Ⓣ (decrease) to adjust the speaker level for each speaker.

C, RS, LS, SW, S: -6 dB to +6 dB

(L, R: Only the balance is adjustable.) (⇒ below)

## Adjusting the front speaker balance during playback

### 1 Press [CH SELECT]Ⓣ to select "L" or "R".

### 2 While "L" or "R" is selected Press [◀, ▶]Ⓣ to adjust the speaker balance.

## Basic play

### Preparation

To display the picture, turn on your TV and change its video input mode (e.g. VIDEO 1, AV 1, HDMI, etc.) to suit the connection to this unit.

### 1 Press [⏻]Ⓣ to turn on the unit.

### 2 Press [DVD]④ to select "DVD/CD".

### 3 Press [▲ OPEN/CLOSE]② to open the disc tray.

### 4 Load the disc.

- Load double-sided discs so the label for the side you want to play is facing up.

Label facing up



### 5 Press [▶ PLAY]⑤ to start play.

- Press [+ , VOL, -]Ⓣ to adjust the volume.



- When you press [▲ OPEN/CLOSE]② to close the disc tray, this unit automatically starts playing the disc in the tray.

**MP3 | JPEG | Xvid**

– Only the contents in the current group will be played.

– If there are MP3, JPEG and Xvid contents in the current group, only one content type will be played. (Priority: MP3 → JPEG → Xvid)

You can select an item of your desired content type to start play. (⇒ 13, Using navigation menu)

- **DISCS CONTINUE TO ROTATE WHILE MENUS ARE DISPLAYED.**

Press [■ STOP]⑤ when you finish to preserve the unit's motor and your TV screen.

- Total title number may not be displayed properly on +R/+RW.

## Basic controls

### Stop: [■ STOP]⑤

The position is memorised while "RESUME" is on the main unit's display.

**DVD-V | VCD | CD | MP3 | Xvid** This unit can memorise the resume position for the last 5 discs.

- Press [▶ PLAY]⑤ to resume.
- Press [■ STOP]⑤ again to clear the position.

### Pause: [|| PAUSE]⑤

- Press [▶ PLAY]⑤ to restart play.

### Skip: [SKIP ◀◀, SKIP ▶▶]⑤

**Search:** [SEARCH ◀◀, SEARCH ▶▶]⑤ (during play)

**Slow-motion:** [SEARCH ◀◀, SEARCH ▶▶]⑤ (during pause)

- Search: Up to 4 steps
- Slow-motion: Up to 3 steps
- Press [▶ PLAY]⑤ to start normal play.
- **VCD | Xvid** Slow-motion: Forward direction only.

### Frame-by-frame (during pause)

**DVD-V** : [◀◀◀, ▶▶▶]⑤

**DVD-V | VCD | Xvid** : [|| PAUSE]⑤ (forward direction only)

### On-screen item select: [▲, ▼, ◀, ▶, OK]Ⓣ

[▲, ▼, ◀, ▶]Ⓣ: Select

[OK]Ⓣ: Confirm

### Enter number: Numbered buttons

**DVD-V | VCD | CD**

e.g. To select 12: [≧10]② ⇒ [1] ⇒ [2]

**DVD-V** Show a disc top menu: [TOP MENU]⑦  
**DVD-V** Show a disc menu: [MENU]⑩

**Return to previous screen:** [RETURN]⑫

**VCD** (with playback control)  
**Show a disc menu:** [RETURN]⑫  
**Turn PBC function on/off:** [MENU]⑩

**Main unit display:** [FL DISPLAY]⑫

**DVD-V** | **MP3** | **Xvid**  
Time display ↔ Information display

**JPEG**  
SLIDE↔Content's number

## Playing from the selected item

**Using navigation menu**

**CD** | **MP3** | **JPEG** | **Xvid**

You can select to play from your desired item while the navigation menu screen is displayed.

e.g. Data disc

**Group (Folder):**

**Content (File/Track):**

: MP3/CD-DA

: JPEG

: Xvid

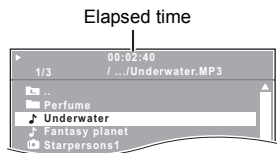

**Press [▲, ▼]⑧ to select an item and press [OK]⑧.**

• Press [◀, ▶]⑧ to skip page by page.

Play starts from the selected content.

**MP3** | **JPEG** | **Xvid**

- To return to the previous folder, press [RETURN]⑫. You can also do this by selecting "⏪ .." in the menu.
- Maximum: 16 characters for file/folder name.
- Only the contents in the current group will be played.
- If there are MP3, JPEG and Xvid contents in the current group, play will be based on the selected content type.

**Selecting the picture in Thumbnail menu**

**JPEG**

**1** While the picture is displayed, press [TOP MENU]⑦ to show the thumbnail menu.

e.g.



**2** Press [▲, ▼, ◀, ▶]⑧ to select a picture and press [OK]⑧.

• Press [SKIP ◀◀, SKIP ▶▶]⑤ to skip page by page.

**Rotating a picture**

While a picture is displayed, press [▲, ▼, ◀, ▶]⑧ to rotate the picture.

## Other modes of play

**Program and Random play**

**CD** | **MP3** | **JPEG** | **Xvid**

**Preparation**

While stopped, press [PLAY MODE]⑨ to select the play mode.

Each time you press the button:

**CD** | **MP3** Music Program menu

**JPEG** Picture Program menu

**Xvid** Video Program menu

**RND** (Random) menu

Exit program and random menus

**Program play (up to 30 items)**

**1** Press [▲, ▼]⑧ to select an item and press [OK]⑧.  
e.g. **MP3**

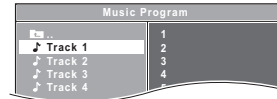

- When a content is selected, it will be programmed.
- Repeat this step to program other items.
- **MP3** | **JPEG** | **Xvid** To return to the previous folder, press [RETURN]⑫. You can also do this by selecting "⏪ .." in the menu.

**2** Press [▶ PLAY]⑤ to start play.

**To clear the selected program**

- 1 Press [▶]⑤ and then press [▲, ▼]⑧ to select the program.
- 2 Press [CANCEL]③.

**To clear the whole program**

Press [▶]⑤ several times to select "Clear All", and then press [OK]⑧. The whole program is also cleared when the disc tray is opened, the unit is turned off or another source is selected.

**Random play**

**CD** All tracks will be played in random order.

Press [▶ PLAY]⑤ to start play.

**MP3** | **JPEG** | **Xvid** The MP3/JPEG/Xvid contents of the selected group will be played in random order.

**1** Press [▲, ▼]⑧ to select the desired group and press [OK]⑧.  
e.g. **MP3**

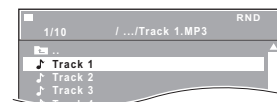

- To return to the previous folder, press [RETURN]⑫. You can also do this by selecting "⏪ .." in the menu.

**2** Press [▲, ▼]⑧ to select the desired content\* and press [OK]⑧.

Play starts from the selected content.

\* If there are MP3, JPEG and Xvid contents, random play will be based on the selected content type.

## Repeat play

This works only when the elapsed play time can be displayed. It also works with all JPEG content.

### During play, press and hold [–REPEAT]Ⓢ, to show the repeat mode.

While the repeat mode is displayed, press [–REPEAT]Ⓢ to select the item to be repeated.

e.g. **DVD-V**

Chapter → Title → Off

To cancel, select "Off".

Items shown differ depending on the type of disc and playback mode.



Random mode will be cleared when you change the repeat mode.

## Using on-screen menus

### 1 Press [FUNCTIONS]Ⓢ to show the on-screen menu.

Each time you press the button:

- Menu 1 (Disc)
- Menu 2 (Video)
- Menu 3 (Audio)
- Exit

e.g. **DVD-V** Menu 1 (Disc)

Current item

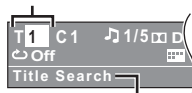

Item name

### 2 Press [▲, ▼, ◀, ▶]Ⓢ to select the item and press [OK]Ⓢ.

e.g. **DVD-V** Menu 1 (Disc)

Current setting



### 3 Press [▲, ▼]Ⓢ to make the settings and press [OK]Ⓢ.



This does not work during HD JPEG playback (⇒ 17, HD JPEG Mode **JPEG**)

Items shown will vary depending on the type of disc.

## Menu 1 (Disc)

Track Search, Title Search, Content Search, Chapter Search

To start from a specific item

e.g. **DVD-V**: T2 C5

To select 12: [≧10]Ⓢ ⇒ [1] ⇒ [2] ⇒ [OK]Ⓢ

## Audio

**DVD-V** **Xvid** (with multiple soundtracks)

To select audio soundtrack

**VCD**

To select "L", "R", "L+R" or "L R"

Actual operations depend on the disc. Read the disc's instructions for details.

## Signal type/data

LPCM/[D] D/DTS=/MP3/MPEG: Signal type

※ During playback of DTS source, there will be no sound from the speakers.

- **Xvid** It may take some time for play to start if you change the audio on a Xvid video disc.

## Play Speed

**DVD-V**

To change play speed

– from "×0.6" to "×1.4" (in 0.1-unit steps)

- Press [▶] PLAYⓈ to return to normal play.
- After you change the speed
  - Dolby Pro Logic II has no effect.
  - Audio output switches to 2-channel stereo.
  - Sampling frequency of 96 kHz is converted to 48 kHz.
- This function may not work depending on the disc's recording.

## Repeat Mode

(⇒ left, Repeat play)

**A-B Repeat** (To repeat a specified section)

Except **JPEG** **Xvid**

Press [OK]Ⓢ at the starting and ending points.

- Select "Off" to cancel.

## Subtitle

**DVD-V** (with multiple subtitles)

To select subtitle language

- On +R/+RW, a subtitle number may be shown for subtitles that are not displayed.

## Angle

**DVD-V** (with multiple angles)

To select a video angle

## Menu 2 (Video)

### Transfer Mode

To select the method of conversion for video output to suit the type of material

Auto, Video

- When the content is distorted, select "Video".
- This may have no effect with some sources.

## Zoom

To select zoom

Normal, 1, 2, 3

## Menu 3 (Audio)

### Dialog Enhancer (or Dialogue Enhancer)

To make the dialogue in movies easier to hear

**DVD-V** **Xvid** (Dolby Digital, 3-channel or higher, with the dialogue recorded in the center channel)

Off, On

# Linked operations with the TV (VIERA Link "HDAVI Control™")

## What is VIERA Link "HDAVI Control"?

VIERA Link "HDAVI Control" is a convenient function that offers linked operations of this unit, and a Panasonic TV (VIERA) under "HDAVI Control". You can use this function by connecting the equipment with the HDMI cable. See the operating instructions for connected equipment for operational details.

## Preparation

- Confirm that the HDMI connection has been made (⇒ 8).
- 1 Set "VIERA Link" to "On" (⇒ 17).  
(The default setting is "On".)
- 2 Set the "HDAVI Control" operations on the connected equipment (e.g., TV).
- 3 Turn on all "HDAVI Control" compatible equipment and select this unit's input channel on the connected TV so that the "HDAVI Control" function will work properly.

**Whenever the connection or settings are changed, repeat this procedure and reconfirm the points in "Setting the audio link" (⇒ below).**

## Setting the audio link

### ■ Setting the audio link with the TV

Select "AUX" or "ARC"<sup>\*1</sup> for TV audio link. Refer to TV audio setting in Easy setup (⇒ 9) or "TV Audio" in HDMI menu (⇒ 17).

Confirm the TV audio connection to the AUX terminal (for "AUX") or HDMI AV OUT terminal (for "ARC"<sup>\*1</sup>) on the main unit (⇒ 8).



- VIERA Link "HDAVI Control", based on the control functions provided by HDMI which is an industry standard known as HDMI CEC (Consumer Electronics Control), is a unique function that we have developed and added. As such, its operation with other manufacturers' equipment that supports HDMI CEC cannot be guaranteed.
- This unit supports "HDAVI Control 5" function. "HDAVI Control 5" is the standard for Panasonic's HDAVI Control compatible equipment. This standard is compatible with Panasonic's conventional HDAVI equipment.
- Please refer to individual manuals for other manufacturers' equipment supporting VIERA Link function.

## Auto lip-sync

(For "HDAVI Control 3 or later")

This function automatically provides synchronised audio and video output. (This works only when the source is "DVD/CD", "USB", "AUX"<sup>\*2</sup> or "ARC"<sup>\*1,2</sup>.)

- When using "DVD/CD" or "USB" as the source, set "Time Delay" in Video menu to "0ms/Auto" (⇒ 17).

## Auto input switching (Power on link)

When the following operations are performed, the TV will automatically switch the input channel and display the corresponding action.

Additionally when the TV is off, the TV will automatically turn on:

- When play starts on the unit
- When an action that uses the display screen is performed (e.g., START menu)
- When you switch the TV input to TV tuner mode, this unit will automatically switch to "AUX"<sup>\*2</sup> or "ARC"<sup>\*1,2</sup>.
- When you start disc play, the TV will automatically switch its input mode for this unit.

## Power off link

All connected equipment compatible with "HDAVI Control", including this unit, automatically turn off when you switch the TV off.

To continue audio playback even when the TV is turned off, select "Video" (⇒ 17, "Power Off Link" in HDMI menu).



When you press [⏻] [⏻], only this unit turns off. Other connected equipment compatible with VIERA Link "HDAVI Control" stays on.

For details, refer also to the operating instructions for your TV.

## Speaker selection

You can select whether audio will output from this unit's speakers or the TV speakers by using the TV menu settings. For details, refer to the operating instructions for your TV.

## Home Cinema

This unit's speakers are active.

- When you turn on this unit, this unit's speakers will be automatically activated.
- When this unit is in standby mode, changing the TV speakers to this unit's speakers in the TV menu will automatically turn this unit on and select "AUX"<sup>\*2</sup> or "ARC"<sup>\*1,2</sup> as the source.
- The TV speakers are automatically muted.
- You can control the volume setting using the volume or mute button on the TV's remote control. (The volume level is displayed on the main unit's display.)
- To cancel muting, you can also use this unit's remote control (⇒ 4).
- If you turn off this unit, TV speakers will be automatically activated.

## TV

TV speakers are active.

- The volume of this unit is set to "0".
  - This function works only when "DVD/CD", "USB", "AUX"<sup>\*2</sup>, or "ARC"<sup>\*1,2</sup> is selected as the source on this unit.
- Audio output is 2-channel audio.



When switching between this unit speakers and TV speakers, the TV screen may go blank for several seconds.

- ※1 The selection works only when using an ARC compatible TV.
- ※2 "AUX" or "ARC" works depending on the TV audio setting (⇒ left, Setting the audio link with the TV).



## Easy control only with VIERA remote control

### (For "HDAVI Control 2 or later")

You can control the playback menus of this unit with the TV's remote control. When operating the TV's remote control, refer to the below illustration for operation buttons.

- 1 Select this unit's operation menu by using the TV menu settings. (For details, refer to the operating instructions for your TV.) The START menu will be shown.  
e.g. **[DVD-V]**

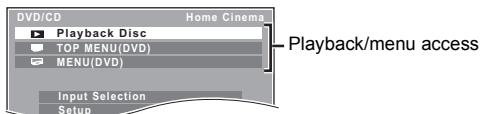

- The START menu can also be shown by using a button on the TV's remote control (e.g. [OPTION]).  
– When "DVD/CD" or "USB" is selected as the source, the TV's remote control works only during stop mode.

- 2 Select the desired item on the START menu (⇒ 10).

When the on-screen control panel appears

e.g. **[DVD-V]** (when "Playback Disc" is selected from the START menu.)

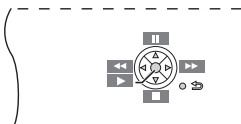

You can operate the playback with the indicated controls.

- The on-screen control panel can also be shown by using a button on the TV's remote control (e.g. [OPTION]).  
– This works only during "DVD/CD" or "USB" playback and resume modes.



- Depending on the menu, some button operations cannot be performed from the TV's remote control.
- You cannot input numbers with the numbered buttons on the TV's remote control ([0] to [9]). Use this unit's remote control to select the play list etc.

## Playing from an USB device

You can connect and play tracks or files from USB mass storage class devices (⇒ 18).

Devices which are defined as USB mass storage class:

– USB devices that support bulk only transfer.

### Preparation

- Before connecting any USB mass storage device to the unit, ensure that the data stored therein has been backed up.
- It is not recommended to use a USB extension cable. The USB device connected using the cable will not be recognised by this unit.

- 1 **Connect the USB device (not supplied) to the USB port** (↔ ⑥).

- 2 **When you press [USB]④ to select "USB", this unit automatically starts playing the contents in the USB device.**

- To playback a selected item, press **[STOP]⑤** and refer to "Playing from the selected item" (⇒ 13).
- For other operating functions, they are similar to those described in "Playing Discs" (⇒ 12 to 14).



- Maximum: 259 folders (excluding Root folder), 2600 files, 16 characters for file/folder name.
- Only one memory card will be selected when connecting a multiport USB card reader. Typically the first memory card inserted.

## Changing the player settings

- 1 Press **[DVD]④** to select "DVD/CD".
- 2 Press **[START]⑩** to show the START menu.
- 3 Press **[▲, ▼]⑧** to select "Setup" and press **[OK]⑧**.

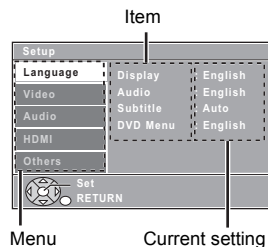

- 4 Press **[▲, ▼]⑧** to select menu and press **[OK]⑧**.

- 5 Press **[▲, ▼]⑧** to select the item and press **[OK]⑧**.

- 6 Press **[▲, ▼]⑧** to make the settings and press **[OK]⑧**.

- To return to the previous screen, press **[RETURN]⑳**.
- To exit the screen, press **[START]⑩**.
- The settings remain intact even if you switch the unit to standby.
- Underlined items are the factory settings in the following menus.

### Language menu

#### Display

Choose the language for the on-screen messages.

##### **For India, the Middle East and South Africa**

- English • Français • Español • Deutsch
- Русский • Magyar • Polski • Česky

##### **For Southeast Asia**

- English • 繁體中文 • 简体中文

#### Audio\*1

Choose the audio language.

- English • (Language options)\*2

#### Subtitle\*1

Choose the subtitle language.

- Auto • English • (Language options)\*2 • Off

#### DVD Menu\*1

Choose the language for disc menus.

- English • (Language options)\*2

- ※1 Some discs start in a certain language despite any changes you make here.

When the selected language is not available on the disc, the default language is played. There are discs where you can only switch the language from the menu screen (⇒ 13).

- ※2 Language options

##### **For India, the Middle East and South Africa**

- French • Spanish • German • Russian
- Hungarian • Polish • Czech

##### **For Southeast Asia**

- Chinese Trad. • Chinese Simp.



## Video menu

### TV Aspect

Choose the setting to suit your TV.

- **16:9**: Widescreen TV (16:9)
- **4:3 Pan&Scan**: Regular aspect TV (4:3)  
The sides of the widescreen picture are cut off so it fills the screen (unless prohibited by the disc).
- **4:3 Letterbox**: Regular aspect TV (4:3)  
Widescreen picture is shown in the letterbox style.



### Time Delay

When connected with a Plasma display, adjust if you notice the audio out of sync with the video.

- **0ms/Auto**
- **20ms**
- **40ms**
- **60ms**
- **80ms**
- **100ms**

When using VIERA Link "HDMI Control" with "HDMI Control 3 or later" compatible TV (⇒ 15), select "0ms/Auto".  
Audio and video will automatically be set in sync.

### TV System

Choose the appropriate output source when connecting to a TV (⇒ 19, Video systems).

- **NTSC**: When connected to an NTSC TV.
- **PAL**: When connected to a PAL TV.
- **Auto**: Selects the original output source when playing PAL or NTSC discs.

**For Southeast Asia** : "Auto" is the factory preset.

### Video Resolution

This works only when the HDMI connection is being used.

Select suitable picture quality with your TV.

(Video recordings will be converted to, and output as, high-definition video.)

- **Auto**
- **480i/576i**
- **480p/576p**
- **720p**
- **1080i**
- **1080p**

Ensure that your TV can support the resolution that you choose.

If a message screen appears, confirm your selection by pressing [◀, ▶]Ⓜ to select "Yes" and press [OK]Ⓜ. If the picture is distorted, wait for 15 seconds or press [◀, ▶]Ⓜ to select "No". To accept the setting, select "Yes" again.

### HD JPEG Mode [JPEG]

(This works only when using HDMI connection with "Video Resolution" (⇒ above) set to "Auto", "720p", "1080i" or "1080p".)

● **On**: HD JPEG playback is available. (JPEG images will be displayed in original resolution.)

● **Off**

During HD JPEG playback, there will be no on-screen menus (⇒ 14) and on-screen displays.

## Audio menu

Select to suit the type of equipment you connected to the HDMI AV OUT terminal.

Select "Bitstream" when the equipment can decode the bitstream (digital form of 5.1-channel data). Otherwise, select "PCM".

(If the bitstream is output to the equipment without a decoder, high levels of noise can be output and may damage your speakers and hearing.)

### Digital Output

- Bitstream
- **PCM**

When audio output is from HDMI AV OUT terminal, and the connected equipment does not support the item selected, the actual output will depend on the performance of this connected equipment.

### Dynamic Range

- **On**: Adjusts for clarity even when the volume is low. Convenient for late night viewing. (Only works with Dolby Digital)
- **Off**: The full dynamic range of the signal is reproduced.

## Speaker Settings

Select the delay time of the speakers.

(Effective only when "Surround layout (Recommended)" mode is selected in "Speaker layout" (⇒ 9, Easy setup).)

(Center and surround speakers only)

For optimum listening with 5.1-channel sound, all the speakers, except for the subwoofer, should be the same distance from the seating position.

If you have to place the center or surround speakers closer to the seating position, adjust the delay time to make up for the difference.

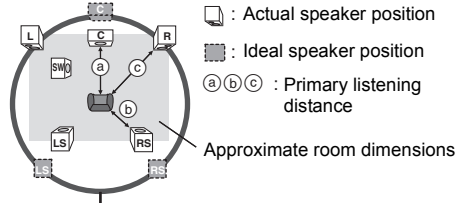

Circle of constant primary listening distance

If either distance (a) or (b) is less than (c), find the difference in the table and change to the recommended setting.

a Center speaker		b Surround speaker	
Difference (Approx.)	Setting	Difference (Approx.)	Setting
30 cm	1ms	150 cm	5ms
60 cm	2ms	300 cm	10ms
90 cm	3ms	450 cm	15ms
120 cm	4ms		
150 cm	5ms		

● **C Delay (Center Delay)**:

**0ms**, 1ms, 2ms, 3ms, 4ms, 5ms

Select the delay time for your center speaker.

● **LS/RS Delay (Left Surround/Right Surround Delay)**:

**0ms**, 5ms, 10ms, 15ms

Select the delay time for your surround speakers.

● **Test Tone**:

Use the test tone to listen to the speaker output to confirm speaker connections.

Test tone will be output to each channel in the following order.

Left, Center, Right, Surround Right, Surround Left, Subwoofer

To stop the test tone, press [RETURN]Ⓜ.

## HDMI menu

### VIERA Link

- **On**: The VIERA Link "HDMI Control" function is available (⇒ 15).
- **Off**

### Audio Out

- **On**: When audio output is from the HDMI AV OUT terminal. (Depending on the capabilities of the connected equipment, audio output may differ from the audio settings of the main unit.)
- **Off**: When audio output is not from the HDMI AV OUT terminal. (The audio is output using the settings of the main unit.)

### Power Off Link

Select the desired power off link setting of this unit for VIERA Link operation (⇒ 15). (This works depending on the settings of the connected VIERA Link "HDMI Control" compatible equipment.)

- **Video/Audio**: When the TV is turned off, this unit will turn off automatically.
- **Video**: When the TV is turned off, this unit will turn off except during the following conditions:
  - audio playback ([CD] [MP3])
  - radio mode
  - "AUX" or "ARC" mode (non-selected TV audio setting for VIERA Link)

### TV Audio

Select the TV audio input to work with the VIERA Link operations (⇒ 15).

- **AUX**
- **ARC**

**Slide Show Time**

Set the speed of the slideshow.

- 3 Seconds    ● 5 Seconds    ● 10 Seconds    ● 15 Seconds

**Easy setup**

You can execute basic settings to optimise your home theater system.  
(⇒ 9)

**FL Dimmer**

Change the brightness of the unit's display.

- Bright
- Dim: The display is dimmed.
- Auto: The display is dimmed, but brightens when you perform some operations.

**Screen Saver**

This is to prevent burn marks on the TV screen.

- Off
- Wait 5 min: If there is no operation for 5 minutes, the screen saver will be shown. The TV screen will resume when you perform some operations. (This does not work during playback.)

**Ratings**

Set a rating level to limit DVD-Video play.

Setting ratings (When level 8 is selected)

- 1 to 7
- 8 No Limit

When you select your ratings level, a password screen is shown.

The default password is "0000".

Enter the 4-digit password with the numbered buttons, and press [OK]Ⓢ. You can change the default password (⇒ below)

**Do not forget your password.**

A message screen will be shown if a DVD-Video disc exceeding the rating level is inserted in the unit.

Follow the on-screen instructions.

**Set Password**

Change the password for "Ratings".

When you change the password for the first time:

The default password is "0000".

Follow the on-screen instructions.





**Restore Default Settings**

This returns all values in the Setup menu to the default settings except the password and ratings level.



Press [◀, ▶]Ⓢ to select "Yes" and press [OK]Ⓢ.

Turn the unit off and on again.

**Media that can be played****Commercial discs**

Type of media/ Logo	Remarks	Indicated as
<b>DVD-Video</b>   	High quality movie and music discs	<b>DVD-V</b>
<b>Video CD</b>   	Music discs with video Including SVCD (Conforming to IEC62107)	<b>VCD</b>
<b>CD</b>  	Music discs	<b>CD</b>

**Recorded discs and USB devices**

Type of media/ Logo	Formats	Indicated as
<b>DVD-R/RW</b>   	<ul style="list-style-type: none"> <li>● DVD-Video Format</li> <li>● MP3 format</li> <li>● JPEG format</li> <li>● Xvid format</li> </ul>	<b>DVD-V</b> <b>MP3</b> <b>JPEG</b> <b>Xvid</b>
<b>DVD-R DL</b>  	<ul style="list-style-type: none"> <li>● DVD-Video Format</li> <li>● Xvid format</li> </ul>	<b>DVD-V</b> <b>Xvid</b>
<b>+R/+RW/+R DL</b>	<ul style="list-style-type: none"> <li>● +VR (+R/+RW Video Recording) Format</li> </ul>	<b>DVD-V</b>
<b>CD-R/RW</b>	<ul style="list-style-type: none"> <li>● CD-DA format</li> <li>● MP3 format</li> <li>● JPEG format</li> <li>● Xvid format</li> </ul>	<b>CD</b> <b>MP3</b> <b>JPEG</b> <b>Xvid</b>
<b>USB device</b>	<ul style="list-style-type: none"> <li>● MP3 format</li> <li>● JPEG format</li> <li>● Xvid format</li> </ul>	<b>MP3</b> <b>JPEG</b> <b>Xvid</b>

- Before playback, finalise the disc on the device it was recorded on.
- It may not be possible to play all the above-mentioned medias in some cases due to the type of media, the condition of the recording, the recording method, or how the files were created (⇒ 19, About MP3/JPEG/Xvid files).
- During playback of DTS source, there will be no sound from the speakers.

**Note about using a DualDisc**

The digital audio content side of a DualDisc does not meet the technical specifications of the Compact Disc Digital Audio (CD-DA) format so playback may not be possible.

**Discs that cannot be played**

Blu-ray Discs, HD DVD, AVCHD discs, DVD-RW version 1.0, DVD-Audio, DVD-ROM, DVD-VR, CD-ROM, CDV, CD-G, SACD, DTS Music Discs, WMA discs, DivX discs and Photo CD, DVD-RAM, and "Chaoyi VCD" available on the market including CVD, DVCD and SVCD that do not conform to IEC62107.

## Video systems

This unit can play PAL and NTSC, but the "TV System" (⇒ 17) of this unit must match the system of your TV.



Depending on the PAL video on the disc, the image may not be displayed correctly on an NTSC TV.

## Disc handling precautions

- Do not attach labels or stickers to discs. This may cause disc warping, rendering it unusable.
- Do not write on the label side with a ball-point pen or other writing instrument.
- Do not use record cleaning sprays, benzene, thinner, liquids which prevent static electricity, or any other solvent.
- Do not use scratch-proof protectors or covers.
- Do not use the following discs:
  - Discs with exposed adhesive from removed stickers or labels (rented discs, etc.).
  - Discs that are badly warped or cracked.
  - Irregularly shaped discs, such as heart shapes.

## About MP3/JPEG/Xvid files

### MP3 (Extension: ".MP3", ".mp3")

- Sampling frequency and compression rate:
  - 8 kHz, 11.02 kHz, 12 kHz, 16 kHz, 22.05 kHz, 24 kHz (8 kbps to 160 kbps), 32 kHz, 44.1 kHz and 48 kHz (32 kbps to 320 kbps)
- ID3 tags: version 1, 2

### JPEG (Extension: ".JPG", ".jpg", ".JPEG", ".jpeg")

- JPEG files taken on a digital camera that conform to DCF Standard (Design rule for Camera File system) Version 1.0 are displayed.
  - Files that have been altered, edited or saved with computer picture editing software may not be displayed.
- This unit cannot display moving pictures, MOTION JPEG and other such formats, still pictures other than JPEG (e.g. TIFF), or play pictures with attached audio.

### Xvid (Extension: ".XVID", ".xvid", ".AVI", ".avi")

- Xvid files greater than 2 GB or have no index may not be played properly on this unit.
- This unit supports all resolutions up to maximum of 720×480 (NTSC)/720×576 (PAL).

- There may be differences in the display order on the menu screen and computer screen.
- This unit cannot play files recorded using packet write.

## DVD-R/RW

- Discs must conform to UDF bridge (UDF 1.02/ISO9660).
- This unit does not support multi-session. Only the default session is played.

## CD-R/RW

- Discs must conform to ISO9660 level 1 or 2 (except for extended formats).
- This unit supports multi-session but if there are many sessions it takes more time for play to start. Keep the number of sessions to a minimum to avoid this.

## USB device

- This unit does not guarantee connection with all USB devices.
- This unit does not support USB device charging.
- FAT12, FAT16 and FAT32 file systems are supported.
- This unit supports USB 2.0 Full Speed.

# Maintenance

## Clean this unit with a soft, dry cloth

- Never use alcohol, paint thinner or benzene to clean this unit.
- Before using chemically treated cloth, carefully read the instructions that came with the cloth.

**Do not use commercially available lens cleaners as they may cause malfunction.** Cleaning of the lens is generally not necessary although this depends on the operating environment.

**Before moving the unit, ensure the disc tray is empty.** Failure to do so will risk severely damaging the disc and the unit.

# Speaker installation option

## Attaching to a wall

You can attach all of the speakers (except subwoofer) to a wall.

- The wall or pillar on which the speakers are to be attached should be capable of supporting 10 kg per screw. Consult a qualified building contractor when attaching the speakers to a wall. Improper attachment may result in damage to the wall and speakers, and personal injury.

### 1 Drive a screw (not supplied) into the wall.

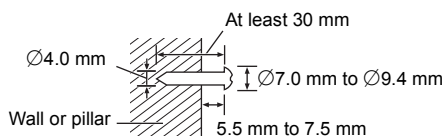

### 2 Fit the speaker securely onto the screw(s) with the hole(s).

e.g., Surround speaker	
DO NOT	DO
<ul style="list-style-type: none"> <li>• In this position, the speaker will likely fall if moved to the left or right.</li> </ul>	<ul style="list-style-type: none"> <li>• Move the speaker so that the screw is in this position.</li> </ul>

## ■ Tips

Use the measurements indicated below to identify the screwing positions on the wall.

- Leave at least 20 mm of space above the speaker and 10 mm on each side to allow enough space for fitting the speaker.

XH160 Surround speaker

Center speaker

XH100 XH60 Front/Surround speaker

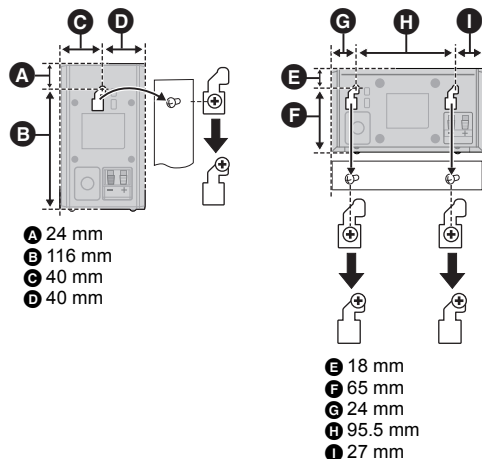

**XH160** Front speaker

Attach to a wall without the base and the stand.

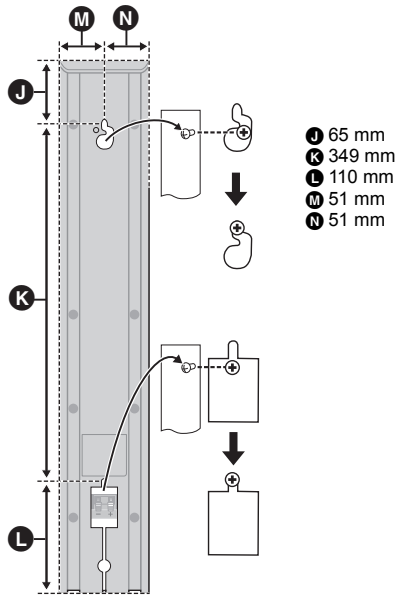

### ■ To prevent speakers from falling

Front speaker, Surround speaker, Center speaker

- You will need to obtain the appropriate screw eyes to match the walls or pillars to which they are going to be fastened.
- Use a string of less than  $\varnothing 2.0$  mm, which is capable of supporting over 10 kg.

e.g. **XH160** Front speaker

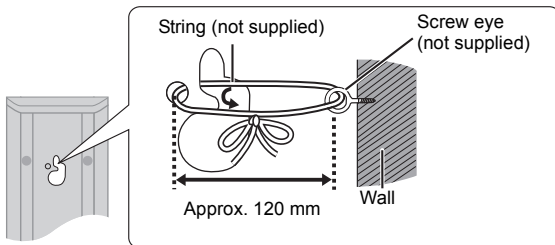

### **XH160** Reattaching the speaker cable

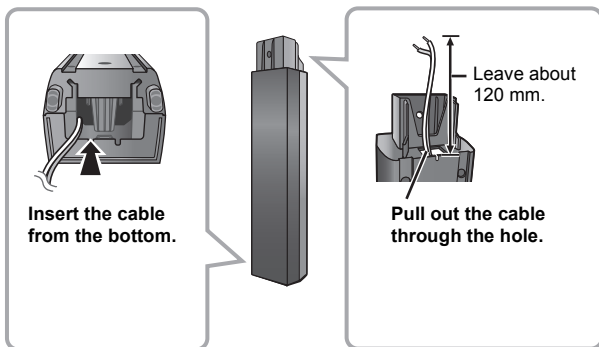

## Troubleshooting guide

Before requesting service, make the following checks. If you are in doubt about some of the check points, or if the solutions indicated in the following guide do not solve the problem, consult your dealer for instructions.

### Power

#### No power.

Insert the AC mains lead securely. (⇒ 9)

#### The unit is automatically switched to standby mode.

- The Sleep timer was working and had reached the set time limit. (⇒ 4)
- The main unit will automatically switch to standby mode after 30 minutes of inactivity. (⇒ 4)

#### Power of this unit is turned off when the input for the TV is changed.

This is normal when using VIERA Link "HDAVI Control 4 or later". For details please read the operating instructions for the TV.

### General operation

#### No response when any buttons are pressed.

- This unit cannot play discs other than the ones listed in these operating instructions. (⇒ 18)
- The unit may not be operating properly due to lightning, static electricity or some other external factor. Turn the unit off and then back on. Alternatively, turn the unit off, disconnect the AC mains lead, and then reconnect it.
- Condensation has formed. Wait 1 to 2 hours for it to evaporate.

#### No response when remote control buttons are pressed.

- Check that the battery is installed correctly. (⇒ 9)
- The battery is depleted. Replace it with a new one. (⇒ 9)
- Aim the remote control at the remote control signal sensor and operate. (⇒ 4)

#### Other products respond to the remote control.

Change the remote control operating mode. (⇒ 4)

#### Cannot display the START menu.

Remove the disc and then press [START]Ⓡ again.

#### No picture or sound.

- Check the video or speaker connection. (⇒ 7, 8)
- Check the power or input setting of the connected equipment and the main unit.
- Check that the disc has something recorded on it.
- During HD JPEG playback, there will be no video output from the VIDEO OUT terminal.

#### No on-screen menus/displays.

**JPEG** This is normal during HD JPEG playback.

#### You have forgotten your ratings password.

Reset all the settings to Factory Preset.

While "DVD/CD" is the source and there is no disc inserted, press and hold [▲ OPEN/CLOSE]Ⓢ on the main unit and [≧10]Ⓢ on the remote control until "RESET" appears on the main unit's display. Turn the unit off and on again.

All settings will return to the default values.

#### Some characters are not displayed correctly.

Characters other than English alphabet and Arabic numerals may not be displayed correctly.

#### The VIERA Link "HDAVI Control" function does not respond.

Depending on the condition of this unit or the connected equipment, it may be necessary to repeat the same operation so that the function can work correctly. (⇒ 15)

#### The setting you made in "TV Aspect" (⇒ 17, Video menu) or "Display" (⇒ 16, Language menu) does not work.

The settings for "TV Aspect"※1 and "Display"※2 will automatically follow the information from the TV. (⇒ 9, Easy setup)

※1 When using VIERA Link "HDAVI Control" with "HDAVI Control 3 or later" compatible TV

※2 When using VIERA Link "HDAVI Control" with "HDAVI Control 2 or later" compatible TV

## Disc operation

### It takes time before play starts.

- Play may take time to begin when an MP3 track has still picture data. Even after the track starts, the correct play time will not be displayed. This is normal. [MP3]
- This is normal on Xvid video. [Xvid]

### A menu screen appears during skip or search. [VCD]

This is normal for Video CDs.

### Playback control menu does not appear.

[VCD] with playback control  
Press [MENU]Ⓜ to change to PBC on and then press [RETURN]Ⓜ to return to playback.

### Play does not start.

If a disc contains CD-DA and other formats, proper playback may not be possible.

### No subtitles.

Display the subtitles. ("Subtitle" in Menu 1) (⇒ 14)

### Point B is automatically set.

The end of an item becomes point B when it is reached.

### The Setup menu cannot be accessed.

Select "DVD/CD" or "USB" as the source.

## Sound

### Sound is distorted.

The format (sampling frequency, etc.) of the digital audio input is not supported by this unit.

### Effects do not work.

Some audio effects do not work or have less effect with some discs.

### Humming is heard during play.

An AC mains lead or fluorescent light is near the main unit. Keep other appliances and cables away from the main unit.

### No sound.

- There may be a slight pause in sound when you change the play speed.
- If the input source is bitstream, set the sound setting to PCM on the external equipment.
- When using the HDMI output, audio may not output from other terminals.
- Audio may not be output due to how the files were created. [Xvid]
- During playback of DTS source, there will be no sound from the speakers. Select a different audio source (e.g. Dolby Digital). (⇒ 14)

### No sound from the TV.

- If the TV is not ARC compatible and only the HDMI connection is used, an extra audio connection is necessary. (⇒ 8)
- Confirm the audio connection. Press [EXT-IN]Ⓜ to select the corresponding source. (⇒ 8, 10)
- When using the HDMI connection, ensure that "Audio Out" in the HDMI menu is set to "On". (⇒ 17)

### No sound from the surround speakers.

- When using the "Surround layout (Recommended)" mode, press [SURROUND]Ⓜ to select "MULTI-CH". (⇒ 11)
- When using the "Front layout (Alternative)" mode, press [SURROUND]Ⓜ to select "A.SRD". (⇒ 11)

## Picture

### The picture on the TV is not displayed correctly or disappears.

- The unit and TV are using different video systems.

#### For India, the Middle East and South Africa

Use a multi-system or PAL TV.

#### For Southeast Asia

Use a multi-system or NTSC TV.

- The system used on the disc does not match your TV.
  - Change the "TV System" settings to match your TV. (⇒ 17)  
(Depending on the PAL video on the disc, the image may not be displayed correctly on an NTSC TV.)
- Ensure that the unit is connected directly to the TV, and is not connected through a VCR. (⇒ 8)
- Mobile telephone chargers can cause some disturbance.
- If you are using an indoor TV antenna, change to an outdoor antenna.
- The TV antenna wire is too close to the unit. Move it away from the unit.
- Reduce the number of connected HDMI devices.
- When using the HDMI AV OUT terminal, ensure that an incompatible video output with the connected TV is not selected. Set the "Video Resolution" in Video menu to "480p/576p". (⇒ 17)
- Video images converted to 1920×1080 resolution may look different from the true native 1080p full-HD sources. This is not a malfunction of the main unit.

### Picture size does not fit the screen.

- Change "TV Aspect" in the Video menu. (⇒ 17)
- Use the TV to change the aspect.
- Change the zoom setting. ("Zoom" in Menu 2) (⇒ 14)
- [JPEG] This is normal during HD JPEG playback. Set "HD JPEG Mode" to "Off" if you want to perform zoom function. (⇒ 17)

### Menu is not displayed correctly.

Restore the zoom ratio to "Normal". ("Zoom" in Menu 2) (⇒ 14)

### Display is distorted.

[JPEG] This is normal when the display switches to/from HD JPEG playback.

## USB

### The USB drive or its contents cannot be read.

- The USB drive format or its contents is/are not compatible with the system. (⇒ 16)
- The USB host function of this product may not work with some USB devices.
- USB devices with storage capacity of more than 32 GB may not work in some instances.

### Slow operation of the USB device.

Large file size or high memory USB device takes longer time to read and display on the TV.

## HDMI progressive video

### There is ghosting when HDMI progressive output is on.

This problem is caused by the editing method or material used on DVD-Video, but should be corrected if you use interlaced output. When using the HDMI AV OUT terminal, set "Video Resolution" in Video menu to "480i/576i". Or, disable the HDMI connection and use the other video connection. (⇒ 8, 17)

## Radio

### Distorted sound or noise is heard.

Adjust the position of the FM antenna.

### A beat sound is heard.

Try to keep a certain amount of distance between the antenna and the TV.

### If noise is excessive.

Change the audio to be output as monaural.  
Press and hold [PLAY MODE]Ⓜ to select "MONO".  
The sound becomes monaural.

- To cancel the mode, press and hold the button again until "AUTO ST" is displayed. (The mode is also cancelled when you change the frequency.)

In normal circumstances, select "AUTO ST".

## Messages

The following messages or service numbers may appear on the TV or unit's display.

### TV displays

“”

The operation is prohibited by the unit or disc.

### “ Incorrect Disc Region”

Only DVD-Video discs that include or have the same region number as the one on the rear panel of this unit can be played. (⇒ Cover page)

### Unit displays

#### “NO PLAY”

- You inserted a disc the unit cannot play; insert one it can. (⇒ 18)
- You inserted a blank disc.
- You inserted a disc that has not been finalised.

#### “NO DISC”

- You have not inserted a disc; insert one.
- You have not inserted the disc correctly; insert it correctly. (⇒ 12)

#### “USB OVER CURRENT ERROR”

The USB device is drawing too much power. Switch to “DVD/CD” mode, remove the USB and turn the unit off.

#### “F61”

Check and correct the speaker cable connections. If this does not fix the problem, consult the dealer. (⇒ 7)

#### “F76”

There is a power supply problem. Consult the dealer.

#### “DVD U11”

Disc may be dirty. Wipe it clean.

#### “SET OK”

“SET OK” is displayed when the stations are set, and the radio tunes to the last preset station.

#### “ERROR”

- Incorrect operation performed. Read the instructions and try again.
- “ERROR” is displayed when automatic presetting is unsuccessful. Preset the stations manually.

#### “TUNED/STEREO”

Displayed when receiving stereo broadcasting.

#### “TUNED”

Displayed when receiving monaural broadcasting or monaural sound is selected.

#### “DVD H□□”

#### “DVD F□□□”

□ stands for a number.

- Trouble may have occurred. The numbers following “H” and “F” depend on the status of the unit. Turn the unit off and then back on. Alternatively, turn the unit off, disconnect the AC mains lead, and then reconnect it.
- If the service numbers fail to clear, note the service number and contact a qualified service person.

#### “U70□”

□ stands for a number. (The actual number following “U70” will depend on the state of the main unit.)

- The HDMI connection acts unusually.
  - The connected equipment is not HDMI-compatible.
  - Use the High Speed HDMI Cables.
  - The HDMI cable is too long.
  - The HDMI cable is damaged.

#### “REMOTE 1” or “REMOTE 2”

Match the modes on the main unit and remote control. Depending on the number being displayed (“1” or “2”), press and hold [OK]Ⓢ and the corresponding numbered button ([1] or [2]) for at least 2 seconds. (⇒ 4)

## Licenses

Manufactured under license from Dolby Laboratories. Dolby, Pro Logic, and the double-D symbol are trademarks of Dolby Laboratories.

This item incorporates copy protection technology that is protected by U.S. patents and other intellectual property rights of Rovi Corporation. Reverse engineering and disassembly are prohibited.

HDMI, the HDMI Logo, and High-Definition Multimedia Interface are trademarks or registered trademarks of HDMI Licensing LLC in the United States and other countries.

HDAVI Control™ is a trademark of Panasonic Corporation.

“DVD Logo” is a trademark of DVD Format/Logo Licensing Corporation.

MPEG Layer-3 audio coding technology licensed from Fraunhofer IIS and Thomson.



# Specifications

## GENERAL

### Power supply

**For India** AC 220 V to 240 V, 50 Hz

**Except India** AC 220 V to 240 V, 50/60 Hz

**Power consumption** 50 W

**Dimensions (W×H×D)** 360 mm×48 mm×273 mm

**Mass** Main unit 2.0 kg

**Operating temperature range** 0 °C to +40 °C

**Operating humidity range** 35 % to 80 % RH (no condensation)

**Power consumption in standby mode** approx. 0.45 W

## AMPLIFIER SECTION

### RMS Output Power: Dolby Digital Mode

Front Ch 67 W per channel (5 Ω), 1 kHz, 30 % THD

Surround Ch 67 W per channel (5 Ω), 1 kHz, 30 % THD

Center Ch 67 W per channel (5 Ω), 1 kHz, 30 % THD

Subwoofer Ch 100 W per channel (3 Ω), 100 Hz, 30 % THD

Total RMS Dolby Digital mode power 435 W

**For India PMPO Output Power** 4000 W

## FM TUNER, TERMINALS SECTION

**Preset Memory** FM 30 stations

### Frequency Modulation (FM)

Frequency range 87.50 MHz to 108.00 MHz (50-kHz step)

Antenna terminals 75 Ω (unbalanced)

### USB Port

USB standard USB 2.0 Full Speed

Media file format support MP3 (\*.mp3)

JPEG (\*.jpg, \*.jpeg)

Xvid (\*.xvid, \*.avi)

USB device file system FAT12, FAT16, FAT32

USB Port power Max. 500 mA

Bit rate Up to 4 Mbps (Xvid)

## DISC SECTION

### Discs played (8 cm or 12 cm)

(1) DVD (DVD-Video, Xvid<sup>※4,5</sup>)

(2) DVD-R (DVD-Video, MP3<sup>※2,4</sup>, JPEG<sup>※3,4</sup>, Xvid<sup>※4,5</sup>)

(3) DVD-R DL (DVD-Video, Xvid<sup>※4,5</sup>)

(4) DVD-RW (DVD-Video, MP3<sup>※2,4</sup>, JPEG<sup>※3,4</sup>, Xvid<sup>※4,5</sup>)

(5) +R/+RW (Video)

(6) +R DL (Video)

(7) CD, CD-R/RW (CD-DA, Video CD, SVCD<sup>※1</sup>, MP3<sup>※2,4</sup>, JPEG<sup>※3,4</sup>, Xvid<sup>※4,5</sup>)

※1 Conforming to IEC62107

※2 MPEG-1 Layer 3, MPEG-2 Layer 3, MPEG-2.5 Layer 3

※3 Exif Ver 2.1 JPEG Baseline files

Picture resolution:

16:9 min. size 4×4, max. size (720×8)×(405×8);

4:3 min. size 4×4, max. size (720×8)×(540×8)

※4 The total combined maximum number of recognizable audio, picture and video contents and groups: 2600 audio, picture and video contents and 259 groups. (Excluding Root folder)

※5 Plays Xvid video.

### Pick up

Wavelength (DVD/CD) 655/790 nm

## VIDEO SECTION

**Video system** PAL, NTSC

### Composite video output

Output level 1 Vp-p (75 Ω)

Terminal Pin jack (1 system)

### HDMI AV output

Terminal 19-pin type A connector

**HDAVI Control** This unit supports "HDAVI Control 5" function.

## SPEAKER SECTION

### XH160 Front speakers SB-HF75

**Type** 1 way, 1 speaker system (Bass reflex)

**Speaker unit(s)** Impedance 5 Ω

Full range 6.5 cm Cone type

**Output sound pressure** 79 dB/W (1 m)

**Frequency range** 75 Hz to 25 kHz (−16 dB)

85 Hz to 22 kHz (−10 dB)

**Dimensions (W×H×D)** 100.5 mm×523 mm×80 mm

**Mass** 0.9 kg

### Full assembly with stand base

**Dimensions (W×H×D) max** 255 mm×1013 mm×255 mm

**Mass** 2.26 kg

**Dimensions (W×H×D) min** 255 mm×543 mm×255 mm

**Mass** 1.58 kg

### XH100 XH60 Front speakers SB-HF1001

**Type** 1 way, 1 speaker system (Bass reflex)

**Speaker unit(s)** Impedance 5 Ω

Full range 6.5 cm Cone type

**Output sound pressure** 78 dB/W (1 m)

**Frequency range** 80 Hz to 25 kHz (−16 dB)

120 Hz to 22 kHz (−10 dB)

80 mm×139 mm×70 mm

**Mass** 0.37 kg

### Surround speakers SB-HS75

**Type** 1 way, 1 speaker system (Bass reflex)

**Speaker unit(s)** Impedance 5 Ω

Full range 6.5 cm Cone type

**Output sound pressure** 78 dB/W (1 m)

**Frequency range** 80 Hz to 25 kHz (−16 dB)

120 Hz to 22 kHz (−10 dB)

80 mm×139 mm×70 mm

**Mass** 0.37 kg

### Center speaker SB-HC1001

**Type** 1 way, 1 speaker system (Bass reflex)

**Speaker unit(s)** Impedance 5 Ω

Full range 6.5 cm Cone type

**Output sound pressure** 78 dB/W (1 m)

**Frequency range** 76 Hz to 25 kHz (−16 dB)

110 Hz to 22 kHz (−10 dB)

146.5 mm×84 mm×78 mm

**Mass** 0.5 kg

### XH160 XH100 Subwoofer SB-HW20

**Type** 1 way, 1 speaker system (Bass reflex)

**Speaker unit(s)** Impedance 3 Ω

Woofer 16 cm Cone type

**Output sound pressure** 79 dB/W (1 m)

**Frequency range** 32 Hz to 220 Hz (−16 dB)

38 Hz to 180 Hz (−10 dB)

**Dimensions (W×H×D)** 189 mm×290 mm×255 mm

**Mass** 3.4 kg

### XH60 Subwoofer SB-HW600

**Type** 1 way, 1 speaker system (Bass reflex)

**Speaker unit(s)** Impedance 3 Ω

Woofer 16 cm Cone type

**Output sound pressure** 78 dB/W (1 m)

**Frequency range** 40 Hz to 220 Hz (−16 dB)

45 Hz to 180 Hz (−10 dB)

**Dimensions (W×H×D)** 145 mm×289.5 mm×259 mm

**Mass** 3 kg



1 Specifications are subject to change without notice.

Mass and dimensions are approximate.

2 Total harmonic distortion is measured by a digital spectrum analyzer.

# Safety precautions

## WARNING

### Unit

- To reduce the risk of fire, electric shock or product damage,
  - Do not expose this unit to rain, moisture, dripping or splashing.
  - Do not place objects filled with liquids, such as vases, on this unit.
  - Use only the recommended accessories.
  - Do not remove covers.
  - Do not repair this unit by yourself. Refer servicing to qualified service personnel.
  - Do not let metal objects fall inside this unit.
  - Do not place heavy items on this unit.

### AC mains lead

- To reduce the risk of fire, electric shock or product damage,
  - Ensure that the power supply voltage corresponds to the voltage printed on this unit.
  - Insert the mains plug fully into the socket outlet.
  - Do not pull, bend, or place heavy items on the lead.
  - Do not handle the plug with wet hands.
  - Hold onto the mains plug body when disconnecting the plug.
  - Do not use a damaged mains plug or socket outlet.
- The mains plug is the disconnecting device.  
Install this unit so that the mains plug can be unplugged from the socket outlet immediately.

## CAUTION

### Unit

- This unit utilizes a laser. Use of controls or adjustments or performance of procedures other than those specified herein may result in hazardous radiation exposure.
- Do not place sources of naked flames, such as lighted candles, on this unit.
- This unit may receive radio interference caused by mobile telephones during use. If such interference occurs, please increase separation between this unit and the mobile telephone.
- This unit is intended for use in tropical climates.

### Placement

- Place this unit on an even surface.
- To reduce the risk of fire, electric shock or product damage,
  - Do not install or place this unit in a bookcase, built-in cabinet or in another confined space. Ensure this unit is well ventilated.
  - Do not obstruct this unit's ventilation openings with newspapers, tablecloths, curtains, and similar items.
  - Do not expose this unit to direct sunlight, high temperatures, high humidity and excessive vibration.

### Batteries

- Danger of explosion if battery is incorrectly replaced. Replace only with the type recommended by the manufacturer.
- Mishandling of batteries can cause electrolyte leakage and may cause a fire.
  - Do not heat or expose to flame.
  - Do not leave the battery(ies) in a car exposed to direct sunlight for a long period of time with doors and windows closed.
  - Do not take apart or short circuit.
  - Do not recharge alkaline or manganese batteries.
  - Do not use batteries if the covering has been peeled off.
  - Remove the battery if you do not intend to use the remote control for a long period of time. Store in a cool, dark place.
- When disposing the batteries, please contact your local authorities or dealer and ask for the correct method of disposal.

### -If you see this symbol-

#### Information on Disposal in other Countries outside the European Union



This symbol is only valid in the European Union. If you wish to discard this product, please contact your local authorities or dealer and ask for the correct method of disposal.





