

2221
DIGITAL STORAGE
OSCILLOSCOPE
OPERATORS

*Please Check for
CHANGE INFORMATION
at the Rear of This Manual*

Copyright © 1987 Tektronix, Inc. All rights reserved.
Contents of this publication may not be reproduced in any
form without the written permission of Tektronix, Inc.

Products of Tektronix, Inc. and its subsidiaries are covered
by U.S. and foreign patents and/or pending patents.

TEKTRONIX, TEK, SCOPE-MOBILE, and  are
registered trademarks of Tektronix, Inc.

Printed in U.S.A. Specification and price change privileges
are reserved.

INSTRUMENT SERIAL NUMBERS

Each instrument has a serial number on a panel insert, tag,
or stamped on the chassis. The first number or letter
designates the country of manufacture. The last five digits
of the serial number are assigned sequentially and are
unique to each instrument. Those manufactured in the
United States have six unique digits. The country of
manufacture is identified as follows:

B000000	Tektronix, Inc., Beaverton, Oregon, USA
100000	Tektronix Guernsey, Ltd., Channel Islands
200000	Tektronix United Kingdom, Ltd., London
300000	Sony/Tektronix, Japan
700000	Tektronix Holland, NV, Heerenveen, The Netherlands

Certificate of the Manufacturer/Importer

We hereby certify that the 2221 DIGITAL STORAGE OSCILLOSCOPE

AND ALL INSTALLED OPTIONS

complies with the RF Interference Suppression requirements of Amtsbl.-Vfg 1046/1984.

The German Postal Service was notified that the equipment is being marketed.

The German Postal Service has the right to re-test the series and to verify that it complies.

TEKTRONIX

Bescheinigung des Herstellers/Importeurs

Hiermit wird bescheinigt, daß der/die/das 2221 DIGITAL STORAGE OSCILLOSCOPE

AND ALL INSTALLED OPTIONS

in Übereinstimmung mit den Bestimmungen der Amtsblatt-Verfügung 1046/1984 funkentstört ist.

Der Deutschen Bundespost wurde das Inverkehrbringen dieses Gerätes angezeigt und die Berechtigung zur Überprüfung der Serie auf Einhalten der Bestimmungen eingeräumt.

TEKTRONIX

NOTICE to the user/operator:

The German Postal Service requires that Systems assembled by the operator/user of this instrument must also comply with Postal Regulation, Vfg. 1046/1984, Par. 2, Sect. 1.

HINWEIS für den Benutzer/Betreiber:

Die vom Betreiber zusammengestellte Anlage, innerhalb derer dies Gerät eingesetzt wird, muß ebenfalls den Voraussetzungen nach Par. 2, Ziff. 1 der Vfg. 1046/1984 genügen.

NOTICE to the user/operator:

The German Postal Service requires that this equipment, when used in a test setup, may only be operated if the requirements of Postal Regulation, Vfg. 1046/1984, Par. 2, Sect. 1.7.1 are complied with.

HINWEIS für den Benutzer/Betreiber:

Dies Gerät darf in Meßaufbauten nur betrieben werden, wenn die Voraussetzungen des Par. 2, Ziff. 1.7.1 der Vfg. 1046/1984 eingehalten werden.



TABLE OF CONTENTS

	Page		Page
LIST OF ILLUSTRATIONS	iii	Section 6 BASIC APPLICATIONS	
LIST OF TABLES	v	INTRODUCTION	6-1
OPERATORS SAFETY SUMMARY	vii	OSCILLOSCOPE DISPLAYS.....	6-1
		NON STORE DISPLAYS.....	6-1
		DIGITAL STORAGE DISPLAYS	6-2
Section 1 GENERAL INFORMATION		MAKING NONSTORAGE	
INTRODUCTION.....	1-1	MEASUREMENTS	6-4
SPECIFICATION.....	1-2	AC PEAK-TO-PEAK VOLTAGE	6-4
		GROUND REFERENCED DC	
Section 2 PREPARATION FOR USE		VOLTAGE	6-5
SAFETY	2-1	ALGEBRAIC ADDITION.....	6-5
LINE VOLTAGE.....	2-1	COMMON-MODE REJECTION.....	6-6
POWER CORD.....	2-1	TIME DURATION	6-7
LINE FUSE	2-2	AMPLITUDE COMPARISON	6-7
INSTRUMENT COOLING.....	2-2	FREQUENCY	6-8
START-UP.....	2-2	RISE TIME.....	6-8
REPACKAGING.....	2-3	TIME DIFFERENCE BETWEEN TWO	
		TIME-RELATED PULSES	6-9
Section 3 CONTROLS, CONNECTORS,		TIME DIFFERENCE BETWEEN	
AND INDICATORS		REPETITIVE PULSES.....	6-10
POWER AND DISPLAY	3-1	PHASE DIFFERENCE	6-10
VERTICAL	3-1	TIME COMPARISON	6-11
HORIZONTAL.....	3-5	SLOPE	6-12
TRIGGER	3-8	TV LINE SIGNAL.....	6-13
STORAGE CONTROLS	3-10	TV FIELD SIGNAL.....	6-13
REAR PANEL	3-13	MAKING DIGITAL STORAGE	
SIDE PANEL.....	3-13	MEASUREMENTS	6-14
CRT READOUT.....	3-14	AC PEAK-TO-PEAK VOLTAGE	
		USING CURSORS	6-14
Section 4 OPERATING CONSIDERATIONS		GROUND REFERENCED DC	
GRATICULE	4-1	VOLTAGE	6-14
GROUNDING	4-1	TIME DURATION	6-15
SIGNAL CONNECTIONS	4-1	FREQUENCY	6-16
INPUT-COUPLING		RISE TIME.....	6-16
CAPACITOR PRECHARGING	4-2	WAVEFORM COMPARISON.....	6-17
PLOTTING THE GRATICULE	4-2	TIME DIFFERENCE BETWEEN	
CANCELING A PLOT	4-2	REPETITIVE PULSES.....	6-18
		TIME DIFFERENCE BETWEEN	
Section 5 OPERATOR'S CHECKS AND		TWO TIME-RELATED PULSES	6-18
ADJUSTMENTS		PHASE DIFFERENCE BETWEEN	
INITIAL SETUP.....	5-1	SINUSOIDAL SIGNALS	6-19
TRACE ROTATION		SLOPE	6-20
ADJUSTMENT.....	5-1	LOW-LEVEL SIGNAL	
PROBE COMPENSATION.....	5-2	MEASUREMENTS	6-21
		OBSERVING AND REMOVING	
		ALIASES IN STORE MODE	6-22

TABLE OF CONTENTS (cont)

	Page		Page
Section 7 OPTIONS AND ACCESSORIES		STRUCTURE.....	A-1
INTRODUCTION	7-1	TEST EQUIPMENT REQUIRED	A-1
GENERAL INFORMATION	7-1	LIMITS AND TOLERANCES.....	A-1
STANDARD ACCESSORIES.....	7-1	PREPARATION FOR CHECKS	A-1
OPTIONAL ACCESSORIES.....	7-1	INDEX TO PERFORMANCE	
INTERNATIONAL POWER CORD		CHECK STEPS.....	A-3
OPTIONS	7-2	VERTICAL	A-4
OPTION 10	7-2	INITIAL CONTROL SETTINGS.....	A-4
OPTION 12	7-2	PROCEDURE STEPS	A-4
OPTION 33	7-2	HORIZONTAL.....	A-11
COMMUNICATIONS OPTION		INITIAL CONTROL SETTINGS.....	A-11
OPERATION.....	7-2	PROCEDURE STEPS	A-11
ADVANCED FUNCTION MENU		TRIGGER.....	A-15
(for the 2230 only)	7-3	INITIAL CONTROL SETTINGS.....	A-15
NON-VOLATILE EXTENDED		PROCEDURE STEPS	A-15
MEMORY (for the 2230 only).....	7-3	EXTERNAL Z-AXIS, PROBE	
OPTION 10 GPIB OPERATORS		ADJUST, EXTERNAL CLOCK,	
INFORMATION.....	7-3	AND X-Y PLOTTER	A-18
OPTION 12 RS-232-C OPERATORS		INITIAL CONTROL SETTINGS.....	A-18
INFORMATION.....	7-10	PROCEDURE STEPS	A-18
RS-232-C PROGRAMMING.....	7-15		
COMMUNICATION AND WAVEFORM		Appendix B	
TRANSFER.....	7-17	RS-232-C DEVICE	
READOUT/MESSAGE COMMAND		INTERCONNECTION	B-1
CHARACTER SET	7-17	INTRODUCTION.....	B-1
MESSAGES AND COMMUNICATION		DETERMINING DEVICE TYPE.....	B-1
PROTOCOL.....	7-17	INTERCONNECTION RULES	B-2
WAVEFORM TRANSFERS.....	7-21	INTERCONNECTION CABLE TYPE	
COMMUNICATION COMMANDS.....	7-24	IDENTIFICATION.....	B-3
STATUS BYTES AND EVENT		RS-232-C INTERCONNECTION	
CODES	7-47	CABLE-TYPE ILLUSTRATIONS.....	B-3
2221 SPECIFIC COMMANDS	7-51	INTERCONNECTION CABLE	
		PART NUMBERS	B-7
Appendix A PERFORMANCE CHECK PROCEDURE		PRINTER/PLOTTER OPERATION	B-10
INTRODUCTION	A-1	PLOTTER TYPES.....	B-10
PURPOSE.....	A-1	QUESTIONS AND ANSWERS	B-17
PERFORMANCE CHECK INTERVAL..	A-1		
		CHANGE INFORMATION	

LIST OF ILLUSTRATIONS

Figure		Page
	The 2221 Digital Storage Oscilloscope	
1-1	Maximum input voltage vs frequency derating curve for CH 1 OR X, CH 2 OR Y, and EXT INPUT connectors	1-14
1-2	Physical dimensions of the 2221 Oscilloscope	1-15
2-1	Securing the detachable power cord to the instrument	2-1
2-2	Optional power-cord data	2-2
2-3	Fuse holder and detachable power-cord connector	2-2
3-1	Power and display controls and power-on indicator	3-2
3-2	Vertical controls and connectors	3-3
3-3	Horizontal controls	3-6
3-4	Trigger controls, connector, and indicator	3-8
3-5	Storage controls	3-11
3-6	Rear panel	3-13
3-7	Left side panel	3-14
3-8	X-Y Plotter interfacing	3-15
3-9	Crt readout display	3-16
4-1	Graticule measurement markings	4-1
5-1	Probe compensation	5-2
6-1	Peak-to-peak waveform voltage	6-4
6-2	Ground referenced voltage measurement	6-5
6-3	Algebraic addition	6-6
6-4	Common-mode rejection	6-7
6-5	Time duration	6-7
6-6	Rise time	6-9
6-7	Time difference between two time-related pulses	6-10
6-8	Time difference between repetitive pulses	6-10
6-9	Phase difference	6-11
6-10	High-resolution phase difference	6-11
6-11	Slope	6-12
6-12	Ac peak-to-peak voltage, cursor method	6-14
6-13	Ground referenced dc voltage, cursor method	6-15
6-14	Time duration, cursor method	6-16
6-15	Rise-time setup, five-division display	6-16
6-16	Rise time, cursor method	6-17
6-17	Waveform comparison	6-18
6-18	Time difference between repetitive pulses	6-18
6-19	Time difference between two time-related pulses	6-19
6-20	Phase difference between sinusoidal signals	6-20

LIST OF ILLUSTRATIONS (cont)

Figure		Page
6-21	Slope using cursors.....	6-21
6-22	Low-level signal, STORE mode	6-21
6-23	Low-level signal, AVERAGE mode	6-22
6-24	Anti-aliasing	6-22
6-25	Glitch display, ACCPEAK Store mode.....	6-23
6-26	Missing pulse, ACCPEAK Store mode.....	6-23
7-1	Option 10 side panel	7-5
7-2	SRQ, ADDR, and PLOT indicators.....	7-7
7-3	Option 12 side panel	7-11
B-1	Null Modem cable wiring	B-2
B-2	Type A Connections—DTE male to DCE female.....	B-4
B-3	Type A1 Connections—DTE female to DCE female.....	B-5
B-4	Type A2 Connections—DTE male to DCE male.....	B-6
B-5	Type B Connections—DTE male to DTE male and DCE male to DCE male	B-7
B-6	Type B1 Connections—DTE female to DTE male and DCE female to DCE male	B-8
B-7	Type B2 Connections—DTE female to DTE female and DCE female to DCE female	B-9
B-8	Option 12 RS-232-C Printer/Plotter interconnects.....	B-11
B-9	Option 12 RS-232-C communication parameters	B-11
B-10	HP 7470A and HP 7475A plotter RS-232-C switch settings.....	B-12
B-11	Option 12 PARAMETERS switch settings for HP-GL compatible plotters	B-12
B-12	Epson FX-Series printer RS-232-C switch settings	B-13
B-13	Option 12 PARAMETERS switch settings for Epson printers.....	B-13
B-14	HP ThinkJet RS-232-C switch settings	B-14
B-15	Option 12 PARAMETERS switch settings for HP ThinkJet printer.....	B-14
B-16	Option 10 GPIB Interface PARAMETERS switch.....	B-15
B-17	Option 10 PARAMETERS switch settings for compatible GPIB printers/plotters	B-15
B-18	Switch settings for compatible GPIB plotters	B-16

LIST OF TABLES

Table	Page
1-1	1-1
1-2	1-3
1-3	1-13
1-4	1-14
3-1	3-4
3-2	3-7
3-3	3-7
3-4	3-12
3-5	3-13
7-1	7-4
7-2	7-4
7-3	7-5
7-4	7-5
7-5	7-6
7-6	7-6
7-7	7-10
7-8	7-11
7-9	7-11
7-10	7-12
7-11	7-13
7-12	7-13
7-13	7-14
7-14	7-18
7-15	7-19
7-16	7-21
7-17	7-22
7-18	7-23
7-19	7-23
7-20	7-24
7-21	7-24
7-22	7-26
7-23	7-27
7-24	7-28
7-25	7-29
7-26	7-31
7-27	7-32
7-28	7-34
7-29	7-38
7-30	7-40
7-31	7-44
7-32	7-45

LIST OF TABLES (cont)

Table		Page
7-33	RS-232-C Specific Commands	7-46
7-34	Status Event and Error Categories	7-47
7-35	Event Codes	7-48
7-36	2221 Commands, Short Form List	7-51
A-1	Test Equipment Required.....	A-2
A-2	Deflection Accuracy Limits.....	A-4
A-3	Storage Deflection Accuracy.....	A-5
A-4	Settings for Bandwidth Checks	A-7
A-5	Settings for Timing Accuracy Checks	A-12
A-6	Switch Combinations for Triggering Checks	A-15
B-1	Cable-Type Identification.....	B-3
B-2	RS-232-C Transfer Rates	B-17

OPERATORS SAFETY SUMMARY

The general safety information in this part of the summary is for both operating and servicing personnel. Specific warnings and cautions will be found throughout the manual where they apply and do not appear in this summary.

Terms in This Manual

CAUTION statements identify conditions or practices that could result in damage to the equipment or other property.

WARNING statements identify conditions or practices that could result in personal injury or loss of life.

Terms as Marked on Equipment

CAUTION indicates a personal injury hazard not immediately accessible as one reads the markings, or a hazard to property, including the equipment itself.

DANGER indicates a personal injury hazard immediately accessible as one reads the marking.

Symbols in This Manual



This symbol indicates where applicable cautionary or other information is to be found. For maximum input voltage see Table 1-2.

Symbols as Marked on Equipment



DANGER — High voltage.



Protective ground (earth) terminal.



ATTENTION — Refer to manual.

Power Source

This product is intended to operate from a power source that does not apply more than 250 volts rms between the supply conductors or between either supply conductor and ground. A protective ground connection by way of the grounding conductor in the power cord is essential for safe operation.

Grounding the Product

This product is grounded through the grounding conductor of the power cord. To avoid electrical shock, plug the power cord into a properly wired receptacle before making any connections to the product input or output terminals. A protective ground connection by way of the grounding conductor in the power cord is essential for safe operation.

Danger Arising from Loss of Ground

Upon loss of the protective-ground connection, all accessible conductive parts (including knobs and controls that may appear to be insulated) can render an electric shock.

Use the Proper Power Cord

Use only the power cord and connector specified for your product.

Use only a power cord that is in good condition.

For detailed information on power cords and connectors, see Figure 2-2.

Use the Proper Fuse

To avoid fire hazard, use only a fuse of the correct type, voltage rating and current rating as specified in the parts list for your product.

Do Not Operate in Explosive Atmospheres

To avoid explosion, do not operate this instrument in an explosive atmosphere.

Do Not Remove Covers or Panels

To avoid personal injury, do not remove the product covers or panels. Do not operate the instrument without the covers and panels properly installed.

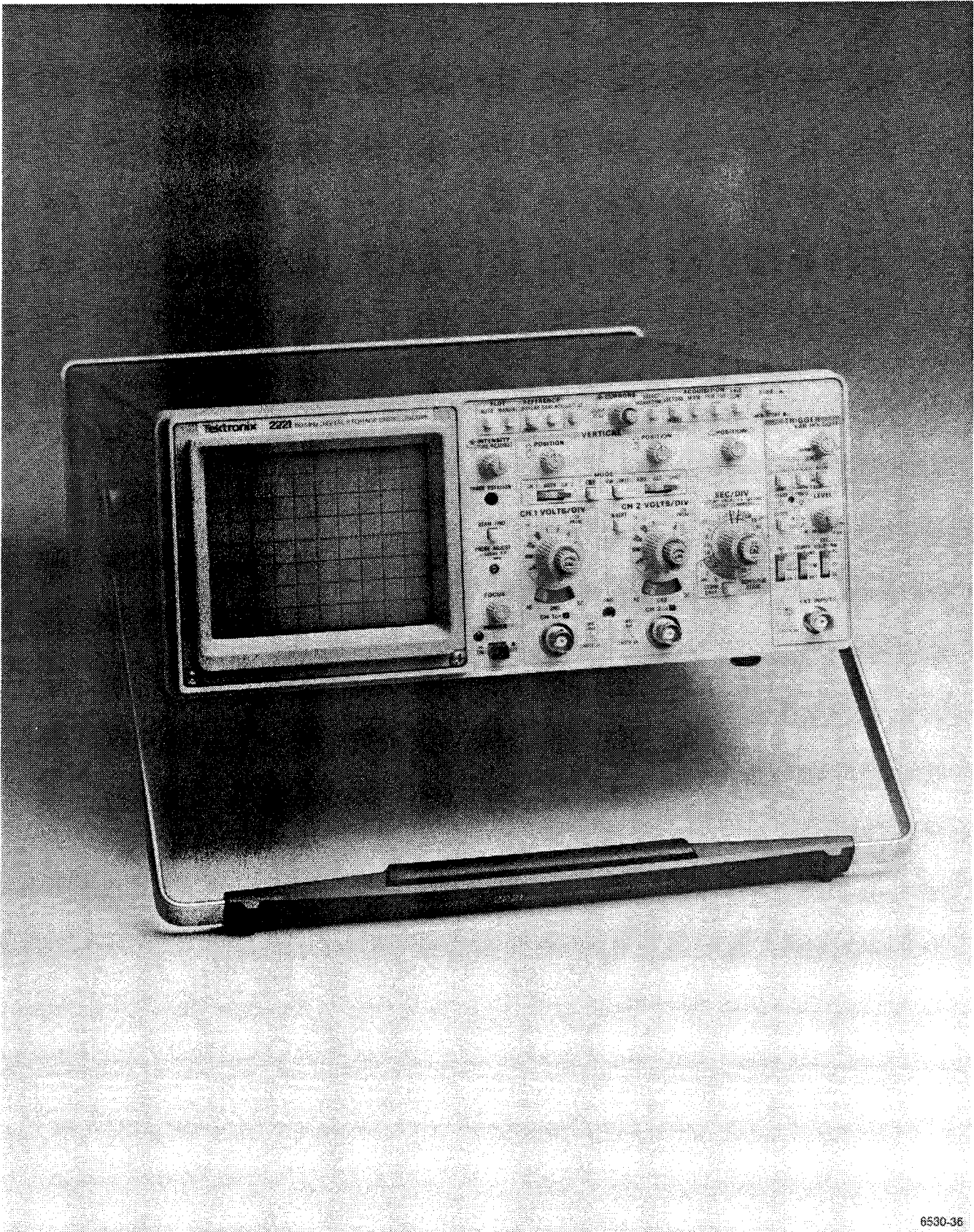

6530-38

The 2221 Digital Storage Oscilloscope.

GENERAL INFORMATION

INTRODUCTION

The TEKTRONIX 2221 Digital Storage Oscilloscope is a 60 MHz bandwidth, dual-channel, portable oscilloscope. It has both real-time analog display (NON-STORE) and digital sampling and display capabilities (STORE). The 2221 is a rugged, lightweight instrument featuring microprocessor operation, on-screen readout of the front-panel control settings and measurement results, and on-screen measurement cursors and trigger-point indicator.

The vertical system provides calibrated deflection factors from 2 mV per division to 5 V per division. The horizontal system provides calibrated sweep speeds from 50 ns per division to 0.5 s per division in both STORE and NON-STORE. Three slower sweep speeds of 1 s, 2 s, and 5 s per division are available for STORE mode operation. A X10 magnifier increases all the display sweep speeds by a factor of ten and increases the maximum sweep speed to 5 ns per division.

The STORE mode maximum digital-sampling rate is 20 megasamples per second. The digitizing system can capture waveform glitches (unwanted brief surges or false signals) that have pulse widths of at least 100 ns. There is a SAVE mode that stops the waveform acquisition in progress and freezes the display. This SAVE feature prevents the display from being updated by further acquisitions to let the user store or examine a waveform of interest.

The acquired waveform record length is 4 K samples (4096 data points) for a single applied waveform. For dual-channel storage, the record length of each waveform (in either CHOP or ALT Vertical Mode) is 2 K samples (2048 data points). The normal waveform display window is 1 K (1024 data points) in length. One waveform set of 4 K record length may be stored in the SAVE REF memory. The acquired waveforms and the SAVE REF waveforms may be displayed at the same time for making comparisons.

The CURSORS position control lets the user place the 1 K display window anywhere within a 4 K record. A bar graph is displayed on screen to tell the user where the window is located in the record. There is also a DISPLAY COMPRESS feature that lets the user reduce the waveform record to 1 K in length so that the complete acquired record may be displayed in one screen. The effect of the DISPLAY COMPRESS and the X10 magnification features on horizontal SEC/DIV, the number of displayable screens, and the acquisition record length is shown in Table 1-1.

The on-screen measurement cursors may be used to make voltage and time difference measurements on either the STORE mode waveforms being acquired or the stored SAVE REF waveforms. When both CH 1 and CH 2 are being displayed, the measurement cursors are present on both channel traces. Voltage difference (delta V) and either the time difference (delta T) or the reciprocal of the time difference (1/delta T) between the displayed cursors are displayed in the crt readout.

Table 1-1
Displayable Record Length

Effective SEC/DIV	Displayable Screens	Active Controls	Display Window (=) Additional Displayable Windows (-)
(SEC/DIV) ÷ 10	40 screens	×10	-----
(SEC/DIV) × 4 ÷ 10	10 screens	×10 and UNCAL	---=---
SEC/DIV	4 screens		----
(SEC/DIV) × 4	1 screen	UNCAL	=

General Information—2221 Operators

The instrument is shipped with the following standard accessories:

- 1 Operators Manual
- 1 Users Reference Card
- 2 Probe Packages
- 1 Accessory Pouch
- 1 Front Panel Cover
- 1 Power Cord
- 1 Fuse
- 1 DB-9 Male Connector and Connector Shell
- 1 Loop Clamp
- 1 Flat Washer
- 1 Self-Tapping Screw

For part numbers and further information about both standard and optional accessories, refer to "Options and Accessories" (Section 7) of this manual. Your Tektronix representative, local Tektronix Field Office, or Tektronix products catalog can also provide additional accessories information.

SPECIFICATION

The following electrical characteristics (Table 1-2) are valid when the instrument has been adjusted at an ambient temperature between +20°C and +30°C, has had a warm-up period of at least 20 minutes, and is operating at an ambient temperature between 0°C and +50°C (unless otherwise noted).

Items listed in the "Performance Requirements" column are verifiable qualitative or quantitative limits that define the measurement capabilities of the instrument.

Environmental characteristics are given in Table 1-3. This instrument meets the requirements of MIL-T-28800C for Type III, Class 5 equipment, except where noted otherwise.

Physical characteristics of the instrument are listed in Table 1-4.

Table 1-2
Electrical Characteristics

Characteristics	Performance Requirements	
VERTICAL DEFLECTION SYSTEM		
Deflection Factor Range	2 mV per division to 5 V per division in a 1-2-5 sequence of 11 steps.	
DC Accuracy (NON-STORE) +15°C to +35°C	Within ±2%.	
0°C to +50°C	Within ±3%. ^a For 5 mV per division to 5 V per division, the gain is set with the VOLTS/DIV switch at 10 mV per division. 2 mV per division gain is set with the VOLTS/DIV switch at 2 mV per division.	
On Screen DC Accuracy (STORE) +15°C to +35°C	Within ±2%.	
0°C to +50°C	Within ±3%. ^a Gain set with VOLTS/DIV set to 5 mV per division.	
Storage Acquisition Vertical Resolution	8-bits, 25 levels per division. 10.24 divisions dynamic range. ^a	
Range of VOLTS/DIV Variable Control	Continuously variable between settings. Increases deflection factor by at least 2.5 to 1.	
Step Response (NON-STORE Mode) Rise Time 0°C to +35°C 5 mV per division to 5 V per division	5.8 ns or less. ^a	
2 mV per division	7.0 ns or less. ^a	
+35°C to +50°C 5 mV per division to 5 V per division	7.0 ns or less. ^a	
2 mV per division	7.0 ns or less. ^a Rise time is calculated from the formula: $\text{Rise Time} = \frac{0.35}{\text{Bandwidth } (-3 \text{ dB})}$	
Step Response (STORE Mode) Useful Storage Rise Time SAMPLE	Single Trace $\frac{\text{SEC/DIV} \times 1.6}{100} \text{ s}^a$	CHOP/ALT $\frac{\text{SEC/DIV} \times 1.6}{50} \text{ s}^a$
PEAK DETECT or ACCPEAK	$\frac{\text{SEC/DIV} \times 1.6}{50} \text{ s}^a$	$\frac{\text{SEC/DIV} \times 1.6}{25} \text{ s}^a$
	Rise time is limited to 5.8 ns minimum with derating over temperature (see NON-STORE Rise Time).	

^aPerformance Requirement not checked in manual.

Table 1-2 (cont)

Characteristics	Performance Requirements						
Aberrations (NON-STORE and STORE in SAMPLE Mode) 2 mV per division to 50 mV per division	+4%, -4%, 4% p-p. 3% or less at 25°C with cabinet installed.						
0.1 V per division to 0.5 V per division	+6%, -6%, 6% p-p. 5% or less at 25°C with cabinet installed.						
1 V per division to 5 V per division	+12%, -12%, 12% p-p. ^a 10% or less at 25°C with cabinet installed. Measured with a five-division reference signal, with the top of the square wave centered vertically, from a 50-ohm source driving a 50-ohm coaxial cable terminated in 50 ohms at the input connector, and VOLTS/DIV Variable control in the CAL detent.						
NON-STORE Bandwidth (-3 dB) 0°C to +35°C 5 mV per division to 5 V per division	Dc to at least 60 MHz.						
2 mV per division	Dc to at least 50 MHz.						
+35°C to +50°C 5 mV per division to 5 V per division	Dc to at least 50 MHz. ^a						
2 mV per division	Dc to at least 50 MHz. ^a Measured with a six-division reference signal, centered vertically, from a 50-ohm source driving a 50-ohm coaxial cable terminated in 50 ohms at the input connector and the probe input, and VOLTS/DIV Variable control in the CAL detent.						
NON-STORE BW LIMIT (-3 dB)	10 MHz ± 15%.						
AC Coupled Lower Cutoff Frequency	10 Hz or less at -3 dB. ^a						
Useful Storage Performance RECORD, SCAN, and ROLL Store Modes SAMPLE Acquisition, no AVERAGE 5 μs/div to 5 s/div EXT CLOCK (up to 1 kHz)	<table border="0" style="width: 100%;"> <tr> <td style="width: 50%; text-align: center;">Single Trace</td> <td style="width: 50%; text-align: center;">CHOP/ALT</td> </tr> <tr> <td style="text-align: center;">$\frac{10}{\text{SEC/DIV}}$ Hz^a</td> <td style="text-align: center;">$\frac{5}{\text{SEC/DIV}}$ Hz^a</td> </tr> <tr> <td style="text-align: center;">$\frac{\text{EXT}}{10}$ Hz^a</td> <td style="text-align: center;">$\frac{\text{EXT}}{20}$ Hz^a</td> </tr> </table> <p>Useful storage performance is limited to the frequency where there are ten samples per sine-wave signal period at the maximum sampling rate. This yields a maximum amplitude uncertainty of 5%. Max sampling rate is 20 MHz in Single trace and 10 MHz in CHOP or ALT at a SEC/DIV setting of 5 μs per division. Accuracy at useful storage performance limit is measured with respect to a six-division 50 kHz reference sine wave.</p>	Single Trace	CHOP/ALT	$\frac{10}{\text{SEC/DIV}}$ Hz ^a	$\frac{5}{\text{SEC/DIV}}$ Hz ^a	$\frac{\text{EXT}}{10}$ Hz ^a	$\frac{\text{EXT}}{20}$ Hz ^a
Single Trace	CHOP/ALT						
$\frac{10}{\text{SEC/DIV}}$ Hz ^a	$\frac{5}{\text{SEC/DIV}}$ Hz ^a						
$\frac{\text{EXT}}{10}$ Hz ^a	$\frac{\text{EXT}}{20}$ Hz ^a						

^aPerformance Requirement not checked in manual.

Table 1-2 (cont)

Characteristics	Performance Requirements	
Useful Storage Performance (cont) PEAK DETECT Sine-Wave Amplitude Capture (5% p-p maximum amplitude uncertainty) Pulse Width Amplitude Capture (50% p-p maximum amplitude uncertainty)	Single Trace and ALT 1 MHz ^a 100 ns	CHOP 1 MHz ^a $\frac{\text{SEC/DIV}}{50}$
REPETITIVE Store Mode 0.05 μs per division 0.1 μs per division 0.2 μs per division to 2 μs per division (5% maximum amplitude uncertainty)	Single Trace 60 MHz (–3 dB) ^b 60 MHz (–3 dB) ^{a b} $\frac{10}{\text{SEC/DIV}}$ Hz ^a	ALT 60 MHz (–3 dB) ^b 50 MHz (–3 dB) ^a $\frac{5}{\text{SEC/DIV}}$ Hz ^a
AVERAGE Mode Weight of Last Acquisition	AVERAGE Mode weight is 1/16. ^a	
NON-STORE CHOP Mode Switching Rate	500 kHz \pm 30%. ^a	
STORE Chop Rate 10 μs per division 5 s per division to and including 20 μs per division	$\frac{50}{(\text{SEC/DIV})}$. ^a $\frac{25}{(\text{SEC/DIV})}$. ^a	
5 μs per division through 0.05 μs per division	No CHOP Mode; acts as in ALT. ^a	
A/D Converter Linearity	Monotonic with no missing codes. ^a	
STORE Mode Cross Talk	Less than 2%. Measured in CHOP at 10 μs per division and 10 mV per division using a 100 kHz square wave signal vertically centered and the other channel input coupling set to GND.	

^aPerformance Requirement not checked in manual.

^bSixty MHz bandwidth is derated for temperature outside 0°C to +35°C and at 2 mV per division as for NON-STORE.

Table 1-2 (cont)

Characteristics	Performance Requirements
NON-STORE Common-mode Rejection Ratio (CMRR)	At least 10 to 1 at 50 MHz. Checked at 10 mV per division for common-mode signals of six divisions or less with VOLTS/DIV Variable control adjusted for best CMRR at 50 kHz.
Input Current	1 nA or less (0.5 division or less trace shift when switching between DC and GND input coupling with the VOLTS/DIV switch at 2 mV per division. ^a)
Input Characteristics Resistance Capacitance	1 MΩ ± 2%. ^a 20 pF ± 2 pF. ^a
Maximum Safe Input Voltage (CH 1 and CH 2)  DC and AC Coupled	See Figure 1-1 for maximum input voltage vs. frequency derating curve. 400 V (dc + peak ac) or 800 V ac p-p at 10 kHz or less. ^a
NON-STORE Channel Isolation	Greater than 100 to 1 at 50 MHz.
STORE Channel Isolation	100 to 1 at 50 MHz.
POSITION Control Range	At least ±11 divisions from graticule center.
Trace Shift with VOLTS/DIV Switch Rotation	0.75 division or less; VOLTS/DIV Variable control in the CAL detent. ^a
Trace Shift as the VOLTS/DIV Variable Control is Rotated	1 division or less. ^a
Trace Shift with INVERT	1.5 division or less. ^a

^aPerformance Requirement not checked in manual.

Table 1-2 (cont)

Characteristics	Performance Requirements
TRIGGERING SYSTEM	
TRIGGER Sensitivity P-P AUTO and NORM	
Internal	10 MHz 60 MHz 0.35 div 1.0 div
External	40 mV 120 mV
	External trigger signal from a 50-ohm source driving a 50-ohm coaxial cable terminated in 50 ohms at the input connector.
HF REJ Coupling	Reduces trigger signal amplitude at high frequencies by about 20 dB with rolloff beginning at 40 kHz \pm 15 kHz. Should not trigger with a 1-division peak-to-peak 250 kHz signal when HF REJ is ON.
P-P AUTO Lowest Useable Frequency	20 Hz with 1 division internal or 100 mV external. ^a
TV LINE	
Internal	0.35 div. ^a
External	35 mV p-p. ^a
TV FIELD	\geq 1 division of composite sync. ^a
EXT INPUT	
Maximum Input Voltage 	400 V (dc + peak ac) or 800 V ac p-p at 10 kHz or less. ^a See Figure 1-1 for maximum input voltage vs frequency derating curve.
Input Resistance	1 M Ω \pm 2%. ^a
Input Capacitance	20 pF \pm 2.5 pF. ^a
AC Coupled Lower Cutoff Frequency	10 Hz or less at -3 dB. ^a
LEVEL Control Range	
TRIGGER (NORM)	
INT	May be set to any voltage level of the trace that can be displayed. ^a
EXT, DC	At least \pm 1.6 V, 3.2 V p-p.
EXT, DC \div 10	At least \pm 16 V, 32 V p-p. ^a
VAR HOLDOFF Control (NON STORE)	Increases Sweep holdoff time by at least a factor of 10. ^a See "VAR HOLDOFF Control" in Section 3, "Controls, Connectors, and Indicators" for effect in STORE Mode.
Acquisition Window Trigger Point	
Pretrigger	Seven-eighths of the waveform acquisition window is prior to the trigger. ^a
Posttrigger	One-eighth of the waveform acquisition window is prior to the trigger. ^a
Midtrigger	One-half of the waveform acquisition window is prior to the trigger. ^a

^aPerformance Requirement not checked in manual.

Table 1-2 (cont)

Characteristics	Performance Requirements	
HORIZONTAL DEFLECTION SYSTEM		
NON-STORE Sweep Rates Calibrated Range Sweep	0.5 s per division to 0.05 μ s per division in a 1-2-5 sequence of 22 steps. The X10 magnifier extends maximum sweep speed to 5 ns per division. The 4K COMPRESS multiplies the SEC/DIV by 4.	
STORE Mode Ranges	See Table 3-2 for Modes and Ranges and Default Acquisition Modes. ^a	
NON-STORE Accuracy +15°C to +35°C 0°C to +50°C	Unmagnified Within $\pm 2\%$ Within $\pm 3\%^a$	Magnified Within $\pm 3\%$ Within $\pm 4\%^a$
NON-STORE Sweep Linearity	$\pm 5\%$. Linearity measured over any two of the center eight divisions. Exclude the first 25 ns and anything past the 100th division of the X10 magnified sweeps.	
Digital Sample Rate 5 μ s per division (CHOP becomes ALT) 10 μ s per division 20 μ s per division to 5s per division (50% duty factor on each channel in CHOP) REPETITIVE STORE 0.05 μ s per division to 1 μ s per division 2 μ s per division	Single Trace 20 MHz ^a 10 MHz ^a 10 MHz ^a 20 MHz ^a 10 MHz ^a	CHOP/ALT 10 MHz ^a 5 MHz ^a 10 MHz ^a 20 MHz ^a 10 MHz ^a
External Clock		
Input Frequency	Up to 1 kHz.	
Digital Sample Rate	10 MHz. ^a	
Store Rate	One peak detected data pair for every second falling edge. ^a	
Duty Cycle	10% or greater (100 μ s minimum hold time). ^a	
Ext Clock Logic Thresholds	TTL Compatible. ^a	
Maximum Safe Input Voltage 	25 V (dc + peak ac) or 25 V p-p ac at 1 kHz or less. ^a	
Input Resistance	>20 k Ω . ^a	

^aPerformance Requirement not checked in manual.

Table 1-2 (cont)

Characteristics	Performance Requirements
STORE Mode Dynamic Range	10.24 divisions. ^a
STORE Mode Resolution Acquisition Record Length	4096 data points. ^a
Single Waveform Acquisition Display	1024 data points (100 data points per division across the graticule area). ^a
CHOP or ALT Acquisition Display	512 data points (50 data points per division across the graticule area). ^a
Horizontal POSITION Control Range (NON-STORE)	Start of the 10th division will position past the center vertical graticule line; 100th division in X10 magnified.
Horizontal Variable Sweep Control Range NON-STORE	Continuously variable between calibrated settings of the SEC/DIV control. Extends the Sweep speed by at least a factor of 2.5.
STORE	Has no affect on the STORE time base. Rotating the VAR SEC/DIV control out of the detent position horizontally compresses (4 X SEC/DIV) the 4 K display to be on screen (DISPLAY COMPRESS).
Displayed Trace Length NON-STORE	Greater than 10 divisions.
STORE	10.24 divisions. ^a

^aPerformance Requirement not checked in manual.

Table 1-2 (cont)

Characteristics	Performance Requirements
DIGITAL STORAGE DISPLAY	
Vertical Resolution	8 bits (1 part in 256). ^a
Position Registration NON-STORE to STORE	Within ± 0.5 division at graticule center at VOLTS/DIV switch settings from 2 mV per division to 5 V per division.
CONTINUE to SAVE	Within ± 0.5 division at VOLTS/DIV switch settings from 2 mV per division to 5 V per division.
Horizontal Resolution	10 bits (1 part in 1024). ^a Calibrated for 100 data points per division.
DIGITAL READOUT DISPLAY	
CURSORS Accuracy Voltage Difference	Within $\pm 3\%$ of the ΔV readout value.
Time Difference RECORD or ROLL/SCAN SAMPLE or AVERAGE PEAKDET or ACCPEAK	± 1 display interval. ^a ± 2 display intervals.
REPETITIVE SAMPLE or AVERAGE	$\pm (2 \text{ display intervals} + 0.5 \text{ ns})$.
ACCPEAK	$\pm (4 \text{ display intervals} + 0.5 \text{ ns})$. ^a A display interval is the time between two adjacent display points on a waveform.



^aPerformance Requirement not checked in manual.

Table 1-2 (cont)

Characteristics	Performance Requirements
X-Y OPERATION (X1 MAGNIFICATION ONLY)	
Deflection Factors	Same as vertical deflection system with the VOLTS/DIV Variable controls in the CAL detent positions.
NON-STORE Accuracy	Measured with a dc-coupled, five-division reference signal.
X-Axis	
+15°C to +35°C	Within ±3%.
0°C to +50°C	Within ±4%. ^a
Y-Axis	Same as vertical deflection system. ^a
NON-STORE Bandwidth (–3 dB)	Measured with a five-division reference signal.
X-Axis	Dc to at least 2.5 MHz.
Y-Axis	Same as vertical deflection system. ^a
NON-STORE Phase Difference Between X-Axis and Y-Axis Amplifiers	±3° from dc to 150 kHz. ^a Vertical Input Coupling set to dc.
STORE Accuracy	
Y-Axis and X-Axis	Same as digital storage vertical deflection system. ^a
Useful Storage Bandwidth	
RECORD and REPETITIVE Store Modes (Up to 60 MHz)	$\frac{5}{\text{SEC/DIV}}$ Hz. ^a
STORE Time Difference Between Y-Axis and X-Axis Signals	
RECORD, SCAN, and ROLL Modes	100 ns. X-Axis signal is sampled before the Y-Axis signal. ^a
REPETITIVE Store	$\frac{\text{SEC/DIV}}{100} \times 4$. ^a

^aPerformance Requirement not checked in manual.

Table 1-2 (cont)

Characteristics	Performance Requirements
PROBE ADJUST	
Output Voltage on PROBE ADJUST Jack	0.5 V \pm 5%.
Repetition Rate	1 kHz \pm 20%. ^a
Z-AXIS	
Sensitivity (NON STORE Only)	5 V causes noticeable modulation. Positive-going input decreases intensity. Useable frequency range is dc to 20 MHz.
Maximum Safe Input Voltage 	30 V (dc + peak ac) or 30 V p-p ac at 1 kHz or less. ^a
Input Resistance	>10 k Ω . ^a
POWER SUPPLY	
Line Voltage Range	90 Vac to 250 Vac. ^a
Line Frequency	48 Hz to 440 Hz. ^a
Maximum Power Consumption	85 watts (150 VA). ^a
Line Fuse	2 A, 250 V, slow blow. ^a
Primary Circuit Dielectric Requirement	Routine test to 1500 V rms, 60 Hz, for 10 seconds without breakdown. ^a
CRT DISPLAY	
Display Area	8 x 10 cm. ^a
Standard Phosphor	P31. ^a
Nominal Accelerating Voltage	14 kV. ^a
X-Y PLOTTER OUTPUT	
Maximum Safe Applied Voltage, Any Connector Pin 	25 V (dc + peak ac) or 25 V p-p ac at 1 kHz or less. ^a
X and Y Plotter Outputs	
Pen Lift/Down	Fused relay contacts, 100 mA maximum. ^a
Output Voltage Levels	500 mV per division, \pm 10%. Center screen is 0 V \pm 0.2 divisions.
Series Resistance	2 k Ω \pm 10%. ^a
4.2 V Output	4.2 V \pm 10% through 2 k Ω . ^a

^aPerformance Requirement not checked in manual.

Table 1-3
Environmental Characteristics

Characteristics	Performance Requirements
Environmental Requirements	Instrument meets the requirements of Tektronix Standard 062-2853-00, Class 5, except EMI. The instrument meets the following MIL-T-28800C requirements for Type III, Class 5 equipment, except where noted.
Temperature	
Operating	0°C to +50°C (+32°F to +122°F).
Nonoperating	–55°C to +75°C (–67°F to +167°F). Tested to MIL-T-28800C, para 4.5.5.1.3 and 4.5.5.1.4, except that in para 4.5.5.1.3 steps 4 and 5 are performed before step 2 (–55°C nonoperating test). Equipment shall remain off upon return to room ambient temperature during step 6. Excessive condensation shall be removed before operating during step 7.
Altitude	
Operating	To 4,500 meters (15,000 feet). Maximum operating temperature decreases 1°C per 1,000 feet above 5,000 feet.
Nonoperating	To 15,000 meters (50,000 feet).
Humidity	
Operating and Nonoperating	5 cycles (120 hours) referenced to MIL-T-28800C para 4.5.5.1.2.2 for Type III, Class 5 instruments. Operating and nonoperating at 95%, –5% to +0% relative humidity. Operating, +30°C to +50°C; nonoperating, +30°C to +60°C.
EMI (electromagnetic interference)	Meets radiated and conducted emission requirements per VDE 0871, Class B. To meet EMI regulations and specifications, use the specified shielded cable and metal connector housing with the housing grounded to the cable shield on the AUXILIARY CONNECTOR.
Vibration	
Operating	15 minutes along each of three major axes at a total displacement of 0.015 inch p-p (2.4 g at 55 Hz) with frequency varied from 10 Hz to 55 Hz to 10 Hz in one-minute sweeps. Hold for 10 minutes at 55 Hz in each of the three major axes. All major resonances must be above 55 Hz.
Shock	
Operating and Nonoperating	30 g, half-sine, 11 ms duration, three shocks per axis each direction, for a total of 18 shocks.

Table 1-4
Physical Characteristics

Characteristics	Description
Weight	See Figure 1-2 for dimensional drawing.
With Power Cord, Cover, Probes, and Pouch	9.4 kg (20.7 lb).
With Power Cord Only	8.2 kg (18 lb).
Domestic Shipping Weight	12.2 kg (26.9 lb).
Height	137 mm (5.4 in).
Width	
With Handle	362 mm (14.3 in).
Without Handle	327 mm (12.9 in).
Depth	
With Front Cover	445 mm (17.5 in).
Without Front Cover	435 mm (17.1 in).
With Handle Extended	510 mm (20.1 in).

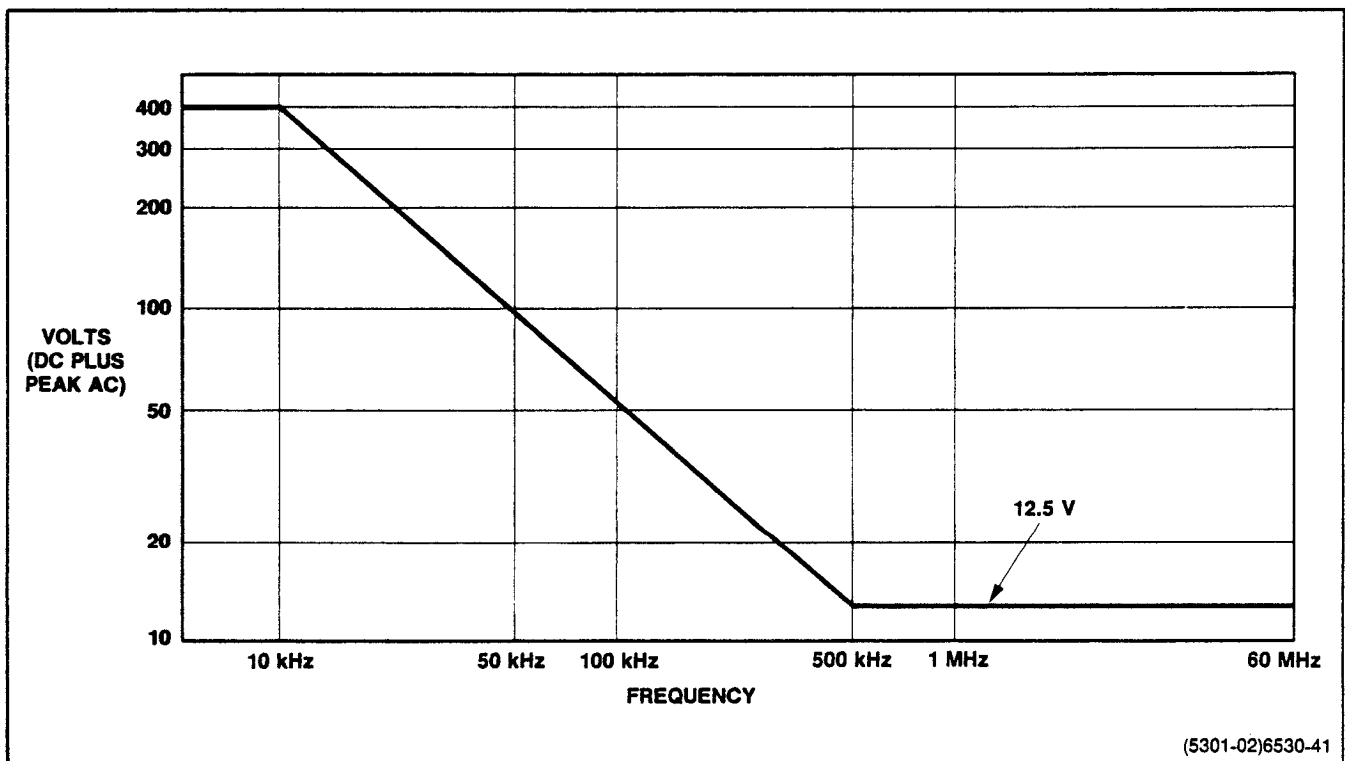
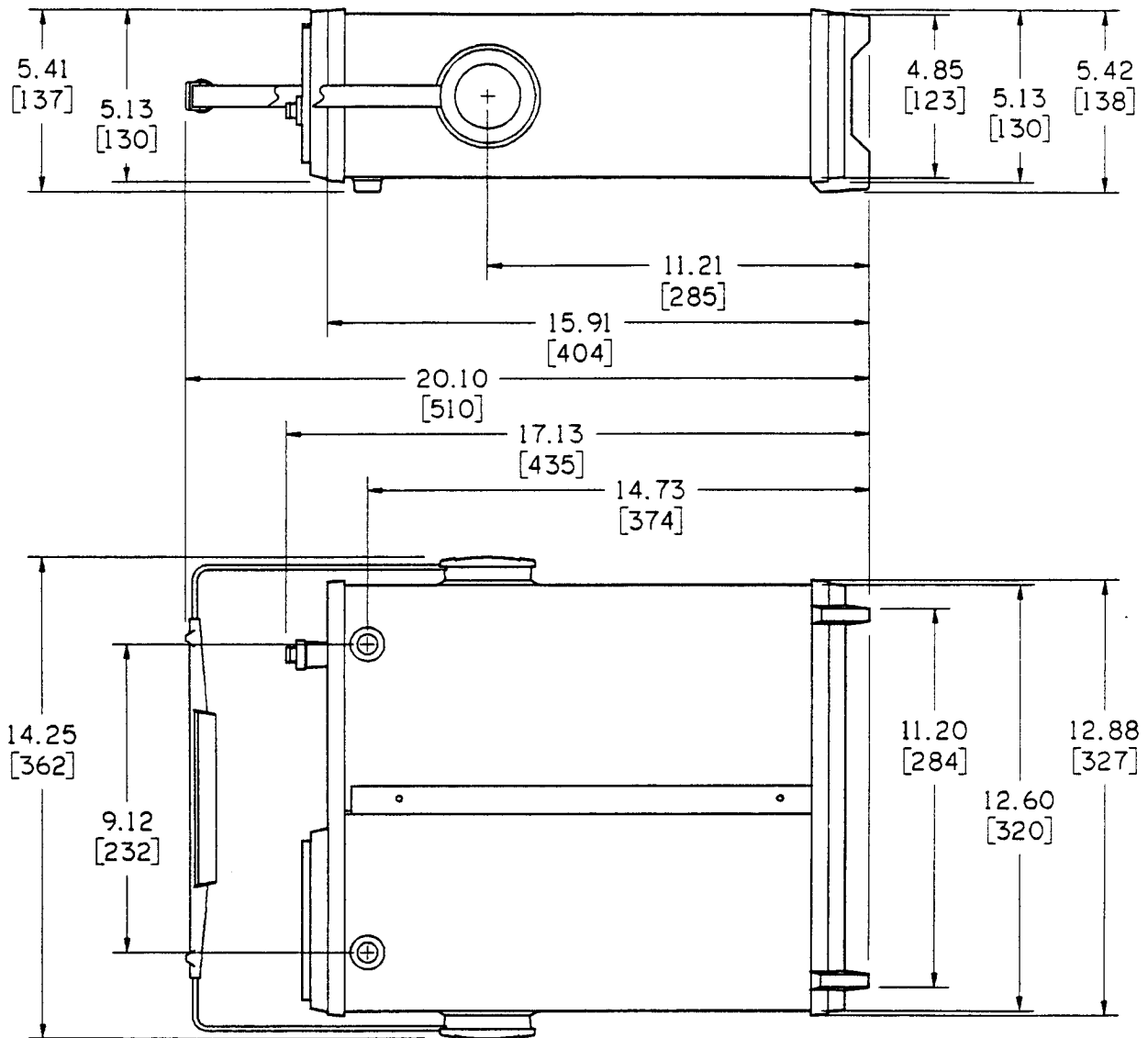

Figure 1-1. Maximum input voltage vs frequency derating curve for CH 1 OR X, CH 2 OR Y, and EXT INPUT connectors.



Dimensions are in inches [mm]

4735-40

Figure 1-2. Physical dimensions of the 2221 Oscilloscope.



PREPARATION FOR USE

SAFETY

This part of the manual tells how to prepare for and to proceed with the initial start-up of the instrument.

Refer to the Safety Summary at the front of this manual for power source, grounding, and other safety considerations pertaining to the use of the instrument. Before connecting the oscilloscope to a power source, read entirely both this section and the Safety Summary.

LINE VOLTAGE

This instrument is capable of continuous operation with input voltages that range from 90 V to 250 V with source voltage frequencies from 48 Hz to 440 Hz.

POWER CORD

A detachable three-wire power cord with a three-contact plug is provided with each instrument for connecting to both the power source and protective ground. The power cord may be secured to the rear panel by a cord-set-securing clamp (see Figure 2-1). The protective-ground contact in the plug connects (through the protective-ground conductor) to the accessible metal parts of the instrument. For electrical-shock protection, insert this plug only into a power-source outlet that has a properly grounded protective-ground contact.

Instruments are shipped with the power cord specified by the customer. Available power-cord information is given in Figure 2-2 and in "Options and Accessories" (Section 7). Contact your Tektronix representative or local Tektronix Field Office for additional power-cord information.

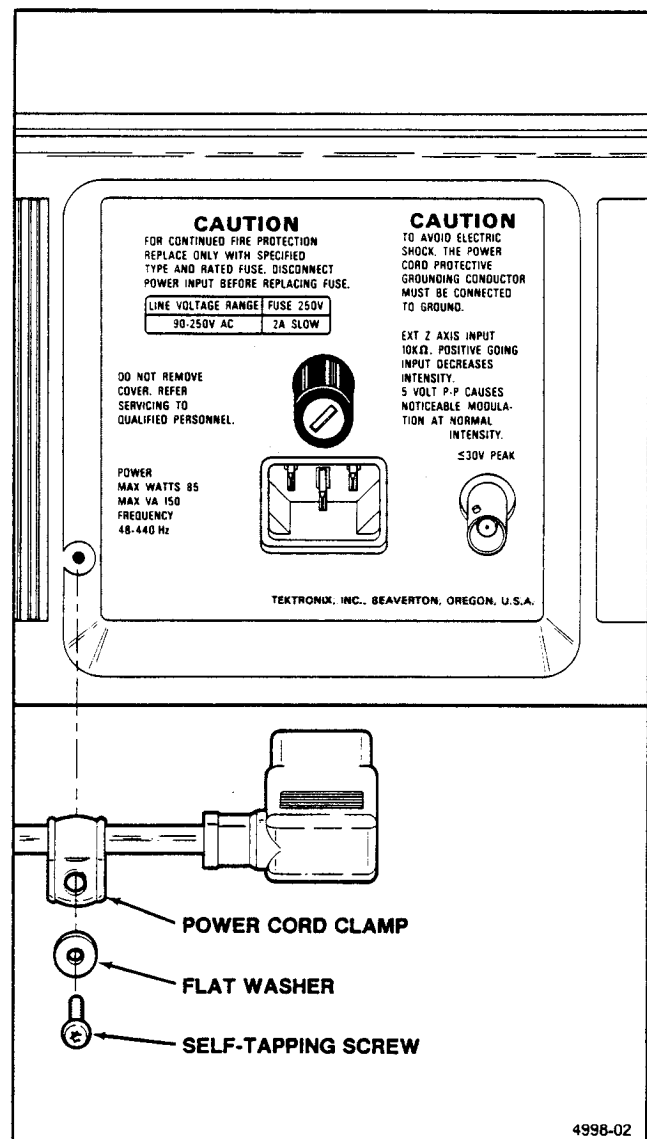

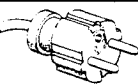

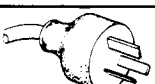

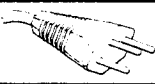

Figure 2-1. Securing the detachable power-cord to the instrument.

Preparation for Use—2221 Operators

Plug Configuration	Usage	Line Voltage	Reference Standards
	North American 120V/ 15A	120V	ANSI C73.11 NEMA 5-15-P IEC 83
	Universal Euro 240V/ 10-16A	240V	CEE (7).II,IV,VII IEC 83
	UK 240V/ 13A	240V	BS 1363 IEC 83
	Australian 240V/ 10A	240V	AS C112
	North American 240V/ 15A	240V	ANSI C73.20 NEMA 6-15-P IEC 83
	Switzerland 220V/ 6A	220V	SEV
Abbreviations: ANSI — American National Standards Institute AS — Standards Association of Australia BS — British Standards Institution CEE — International Commission on Rules for the Approval of Electrical Equipment IEC — International Electrotechnical Commission NEMA — National Electrical Manufacturer's Association SEV — Schweizerischer Elektrotechnischer Verein			

(2931-21)4204-53

Figure 2-2. Optional power-cord data.

LINE FUSE

The instrument fuse holder is located on the rear panel (see Figure 2-3) and contains the line-protection fuse. The following procedure may be used either to verify that the proper fuse is installed or to install a replacement fuse.

1. Unplug the power cord from the power-input source (if plugged in).
2. Press in the fuse-holder cap and release it with a slight counterclockwise rotation.
3. Pull the cap (with the attached fuse inside) out of the fuse holder.
4. Verify that the proper fuse is installed (see the rear-panel fuse nomenclature).

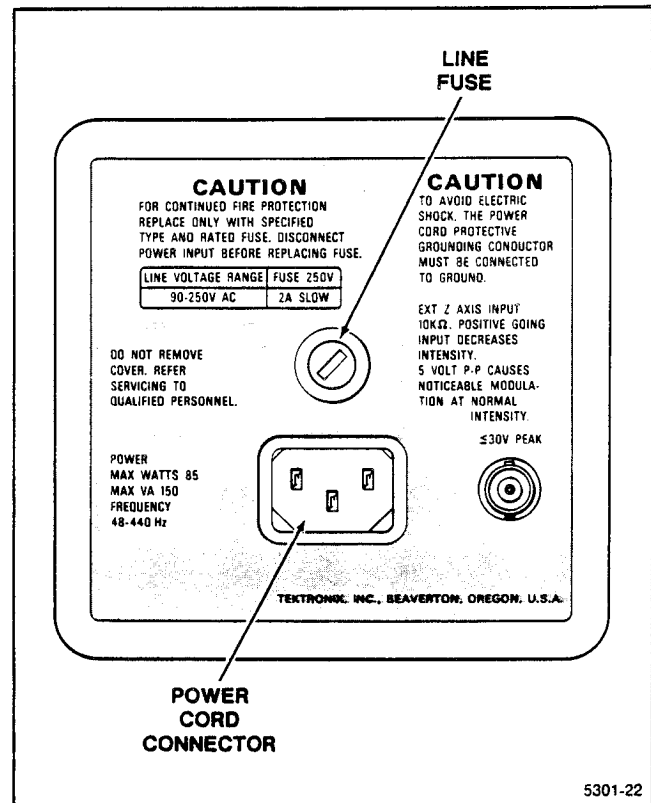

5301-22

Figure 2-3. Fuse holder and detachable power-cord connector.

5. Reinstall the proper fuse in the fuse cap and replace the cap and fuse in the fuse holder by pressing in and giving a slight clockwise rotation of the cap.

INSTRUMENT COOLING

To prevent instrument damage from overheated components, adequate internal airflow must be maintained at all times. Before turning on the power, first verify that both the fan-exhaust holes on the rear panel and the air-intake holes on the side panel are free from any obstructions to airflow. After turning on the instrument, verify that the fan is exhausting air.

START-UP

The instrument automatically performs power-up tests of the digital portion of the circuitry each time the instrument is turned on. The purpose of these tests is to provide

the user with the highest possible confidence level that the instrument is fully functional. If no faults are encountered during the power-up testing, the instrument will enter the normal operating mode. If the instrument fails one of the power-up tests, the instrument attempts to indicate the cause of the failure.

If a failure of any power-up test occurs, the instrument may still be usable for some applications, depending on the nature of the failure. If the instrument functions for your immediate measurement requirement, it may be used, but refer it to a qualified service technician for repair of the problem at the earliest opportunity. Consult your service department, your local Tektronix Service Center, or your nearest Tektronix representative if additional assistance is required.

REPACKAGING

If your instrument was shipped by commercial transportation, use the original packaging material. Unpack the instrument carefully from the shipping container and save the carton and packaging material for repackaging.

If the original packaging is unfit for use or is not available, repackage the instrument as follows:

1. Obtain a corrugated cardboard shipping carton having inside dimensions at least six inches greater than the instrument dimensions and having a carton test strength of at least 275 pounds.

2. If the instrument is being shipped to a Tektronix Service Center for repair or calibration, attach a tag to the instrument showing the following: owner of the instrument (with address), the name of a person at your firm who may be contacted if additional information is needed, complete instrument type and serial number, and a description of the service required.

3. Wrap the instrument with polyethylene sheeting or equivalent to protect the outside finish and prevent entry of packing materials into the instrument.

4. Cushion the instrument on all sides by tightly packing three inches of dunnage or urethane foam between the carton and the instrument.

5. Seal the carton with shipping tape or with an industrial stapler.

6. Mark the address of the Tektronix Service Center and your return address on the carton in one or more prominent locations.

CONTROLS, CONNECTORS, AND INDICATORS

The following descriptions are intended to familiarize the operator with the location and function of the instrument's controls, connectors, and indicators.

POWER AND DISPLAY

See Figure 3-1 for the location of items 1 through 9.

- ① **Internal Graticule**—Eliminates parallax viewing error between the trace and the graticule lines. Rise-time amplitude and measurement points are indicated at the left edge of the graticule.
- ② **POWER Switch**—Turns instrument power on or off. Press in for ON; press again for OFF.
- ③ **Power On Indicator**—Lights up while instrument is operating.
- ④ **FOCUS Control**—Adjusts for optimum display definition. Once set, proper focusing is maintained over a wide range of display intensity.
- ⑤ **PROBE ADJUST Connector**—Provides an approximately 0.5 V, negative-going, square-wave voltage (at approximately 1 kHz) for use in compensation voltage probes and checking the vertical deflection system. The PROBE ADJUST output is not intended as a reference in checking either the vertical or the horizontal accuracy of the instrument.
- ⑥ **BEAM FIND Switch**—Compresses the vertical and horizontal deflection to within the graticule area and intensifies the display to aid the user in locating traces that are overscanned or deflected outside of the crt viewing area.

- ⑦ **TRACE ROTATION Control**—Permits alignment of the trace with the horizontal graticule line. This control is a screwdriver adjustment that, once set, should require little attention during normal operation.

- ⑧ **INTENSITY Control**—Adjusts the brightness of all displayed NON-STORE waveforms.

- ⑨ **STORE/READOUT INTENSITY Control**—Adjusts the brightness of the STORE mode displayed waveforms and the readout intensity in both STORE and NON-STORE modes. The fully counterclockwise position of the control toggles the STORE/NON-STORE readout on and off.

VERTICAL

See Figure 3-2 for the location of items 10 through 17.

- ⑩ **VOLTS/DIV Switches**—Select the vertical channel deflection factors from 2 mV to 5 V per division in a 1-2-5 sequence. The VOLTS/DIV control settings for displayed waveforms containing cursor symbols are shown in the crt readout.

In STORE mode, SAVE waveforms and waveforms waiting to be updated between trigger events may be vertically expanded or compressed by up to a factor of 10 times (or as many VOLTS/DIV switch positions remaining—whichever is less) by switching the corresponding VOLTS/DIV control. (Waveforms acquired at 2 mV/div cannot be expanded and waveforms acquired at 5 V/div cannot be compressed.) The VOLTS/DIV readout reflects the vertical scale factor of the displayed waveform. If the VOLTS/DIV switch is switched beyond the available expansion or compression range, the readout is tilted to indicate that the VOLTS/DIV switch setting and the VOLTS/DIV readout no longer agree.

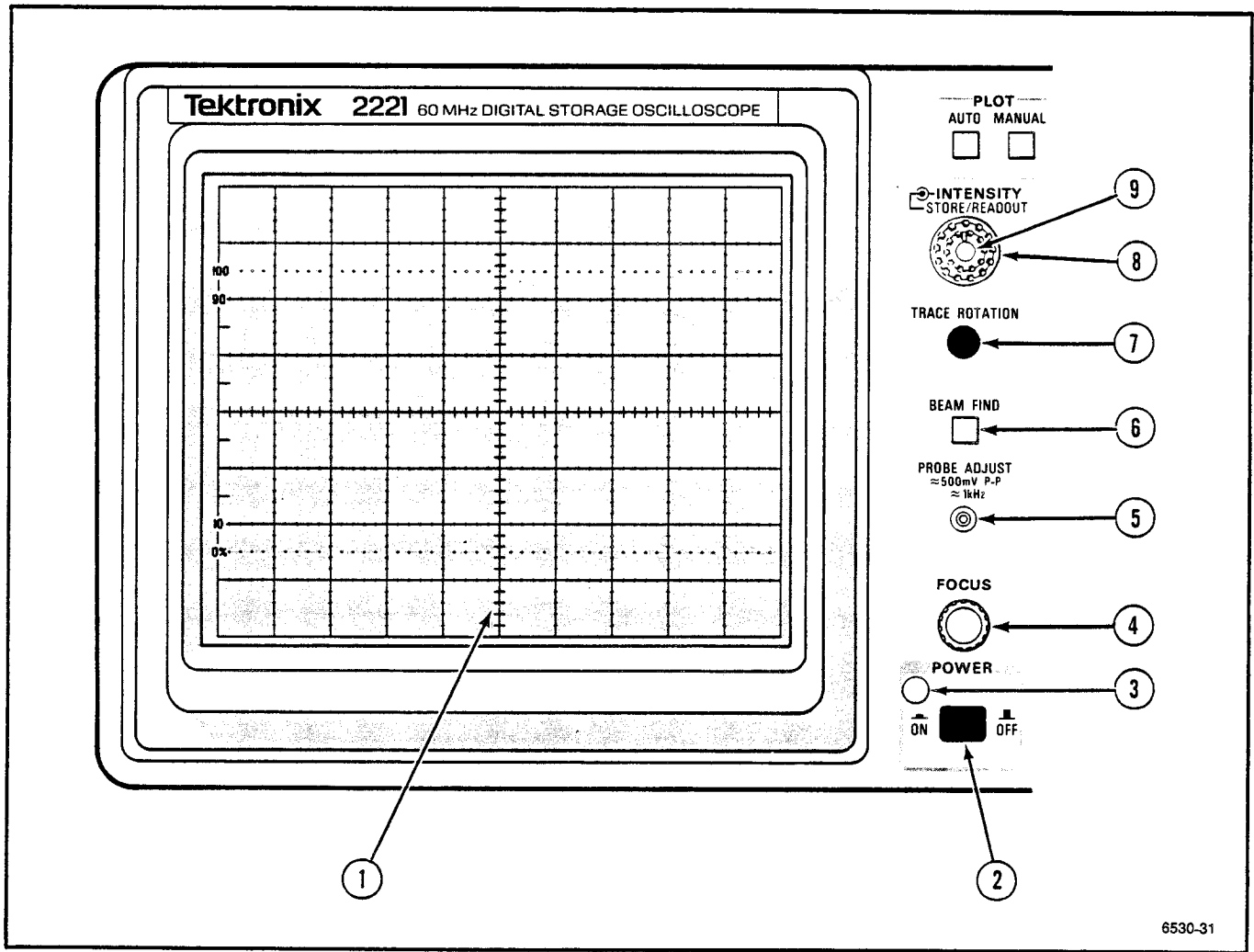
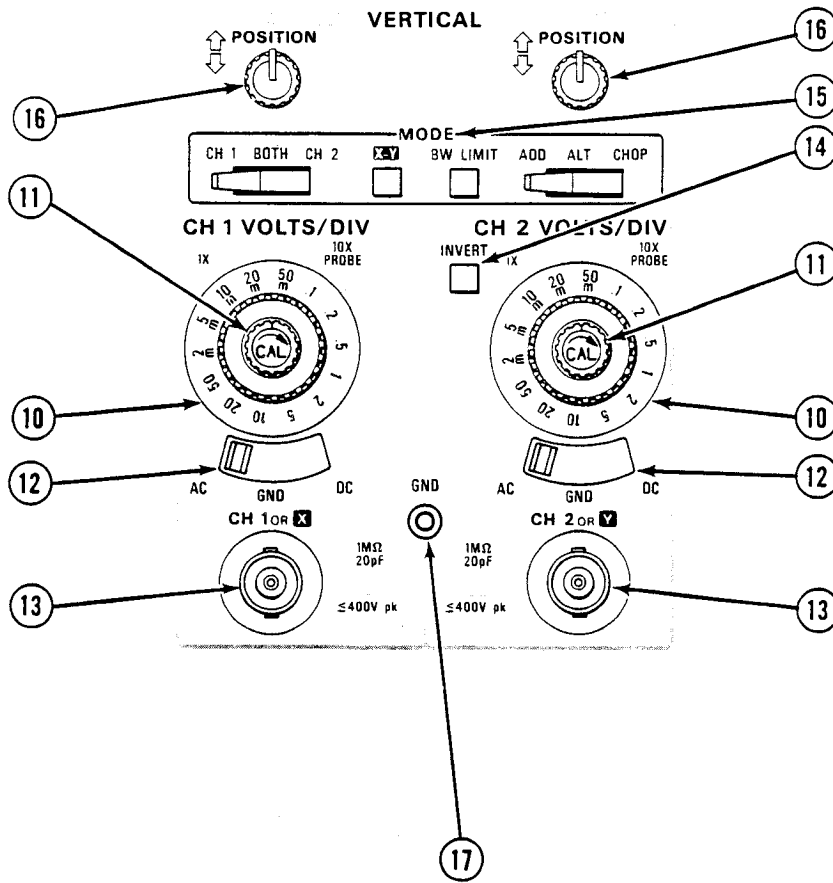

Figure 3-1. Power and display controls and power-on indicator.



6530-32

Figure 3-2. Vertical controls and connectors.

Controls, Connectors, and Indicators—2221 Operators

1X PROBE—Front-panel marking that indicates the deflection factor set by the VOLTS/DIV switch when a 1X probe or a coaxial cable is attached to the channel input connector.

10X PROBE—Front-panel marking that indicates the deflection factor set by the VOLTS/DIV switch when a properly coded 10X probe is attached to the channel input connector.

If properly coded probes (1X, 10X, or 100X; see Table 3-1) are connected to a channel input connector, the crt VOLTS/DIV readout will reflect the correct deflection factor of the display.

**Table 3-1
Probe Coding**

Probe	Coding Resistance
1X	Infinite
10X	11 kΩ ± 10%
100X	5.6 kΩ -10% to 6.2 kΩ +10%
IDENTIFY	0 Ω or none of the above

11 Variable VOLTS/DIV Controls—Provide continuously variable deflection factors between calibrated positions of the VOLTS/DIV controls. The VOLTS/DIV sensitivity may be reduced by up to at least 2.5 times at the fully counterclockwise rotation of the variable knob. A detent position at fully clockwise rotation indicates the calibrated VOLTS/DIV position of the variable knob. The uncalibrated condition is indicated by a greater-than symbol (>) in front of the affected VOLTS/DIV readout.

12 AC-GND-DC (Input Coupling) Switches—Select the method of coupling the input signal from the CH 1 and CH 2 vertical input connectors to the vertical amplifiers and the storage acquisition system.

AC—Capacitively couples the input signal to the vertical deflection and signal acquisition systems. The dc component of the input signal is blocked. The lower -3 dB bandpass is 10 Hz or less. Selection of AC input coupling is indicated in the readout by a tilde symbol (~) over the V on the associated channel's VOLTS/DIV readout.

GND—Grounds the input of the vertical deflection channel; provides a zero (ground) reference volt-

age display (does not ground the input signal). In STORE mode, the ground reference is acquired and displayed in the first sample location of the acquisition waveform display. When GND input coupling is selected, a ground symbol is displayed in the associated VOLTS/DIV readout.

DC—All frequency components of the input signal are coupled to the vertical deflection and signal acquisition systems. When DC input coupling is selected, no additional indicators are displayed with the associated VOLTS/DIV readout.

13 CH 1 OR X and CH 2 OR Y Input Connectors—Provide for application of signals to the inputs of the deflection systems and the storage acquisition system.

Coding-ring contacts on each of the input connectors are used to automatically switch the scale factor displayed by the crt readout when a properly coded probe is attached to the input connector. Displayed STORE mode waveforms are reformatted to maintain the correct deflection as indicated by the VOLTS/DIV readout on the affected channel(s). In X-Y mode, the signal connected to the CH 1 OR X input controls the horizontal deflection, and the signal connected to the CH 2 OR Y input controls the vertical deflection.

14 CH 2 INVERT Switch—Inverts the Channel 2 display and STORE mode Channel 2 acquisition signal when pressed in. An invert symbol (↓) is displayed with the CH 2 VOLTS/DIV readout when CH 2 is inverted. With CH 2 inverted, the oscilloscope may be operated as a differential amplifier when the BOTH-ADD VERTICAL MODE is selected.

15 VERTICAL MODE Switches—Select the mode of operation of the vertical channels. There are two three-position switches and one two-position switch that determine display and acquisition modes and one two-position push-button switch that controls the NON-STORE bandwidth.

CH 1—Selects only the Channel 1 input signal for acquisition or display.

BOTH—Selects a combination of Channel 1 and Channel 2 input signals for acquisition or display (CH 1-BOTH-CH 2 switch must be in the BOTH position for ADD, ALT, and CHOP operation).

CH 2—Selects only the Channel 2 input signal for acquisition or display.

ADD—Displays or acquires the sum of Channel 1 and Channel 2 input signals when BOTH is also selected. The difference of the Channel 1 and Channel 2 inputs signals is displayed and acquired when the Channel 2 signal is inverted.

ALT—Alternately displays the NON-STORE Channel 1 and Channel 2 input signals. The NON-STORE alternation occurs during retrace at the end of each sweep. ALT Vertical MODE is most useful for acquiring and viewing both channel input signals at sweep rates of 0.5 ms per division and faster. Channel 1 and Channel 2 STORE mode signals are acquired on alternate acquisition cycles at one-half the sampling rate of a single-channel acquisition.

CHOP—Switches the NON-STORE display between Channel 1 and Channel 2 vertical input signals during the sweep. The chopped switching rate for NON-STORE mode (CHOP frequency) is approximately 500 kHz. Chopped STORE mode signals are acquired on alternate time-base clock cycles with each channel being acquired at one-half the sampling rate of a single-channel acquisition. In STORE mode at sweep speeds of 5 μ s per division to 0.05 μ s per division, CHOP becomes ALT mode.

BW LIMIT Switch—In NON-STORE mode, limits the bandwidth of the vertical amplifier system and the Trigger system to approximately 10 MHz when pressed in. This reduces interference from unwanted high-frequency signals when viewing low-frequency signals. In STORE mode, pressing in the BW LIMIT switch reduces only the trigger system bandwidth. Press a second time to release the switch and regain full bandwidth.

X-Y Switch—Automatically selects the X-Y mode when pressed in. The CH 1 input signal provides horizontal deflection for X-Y displays, and the CH 2 input signal provides vertical deflection. The STORE mode X-Y sampling rate is controlled by the SEC/DIV switch. The X-Y waveform is normally acquired in SAMPLING mode and displayed with dots. In STORE mode at SEC/DIV switch settings of 5 s per division to 10 μ s per division, the CH 1 and CH 2 signals are acquired in a chopped manner with no more than 100 ns between corresponding sample points on opposite channels at the maximum sampling rate of 10 MHz per channel. The CH 1 signal is sampled before the CH 2 signal.

16 **Vertical POSITION Controls**—Control the vertical display position of the CH 1 and CH 2 signals.

In STORE mode, the controls determine the vertical position of displayed waveforms during acquisition and in SAVE mode. The STORE mode waveforms may also be vertically repositioned during the time between acquisitions. Any portions of a signal being acquired that are outside the dynamic range of the A/D converter are blanked when positioned on screen. The Vertical POSITION controls can also reposition a vertically expanded SAVE waveform so that portions of the waveform outside the graticule area can be observed.

In NON-STORE X-Y mode, the CH 2 POSITION control vertically positions the display, the horizontal POSITION control positions the display horizontally, and the CH 1 POSITION control is not active. In STORE mode, the CH 1 POSITION control is active, and both it and the Horizontal POSITION control affect the horizontal position of the displayed waveform.

17 **GND Connector**—Provides an auxiliary ground connection directly to the instrument chassis via a banana-tip jack.

HORIZONTAL

See Figure 3-3 for the location of items 18 through 22.

18 **SEC/DIV Switch**—Determines the SEC/DIV setting for the NON-STORE sweeps and the STORE mode time base for acquiring and displaying waveforms.

In NON-STORE, the SEC/DIV switch selects calibrated sweep rates from 0.5 s to 0.05 μ s per division in a 1-2-5 sequence of 22 steps.

In STORE mode, the SEC/DIV switch determines the acquisition and display modes, sets the sampling rate, and establishes the time scale factor of the displayed waveforms. The SEC/DIV parameters displayed on the crt readout are for the waveforms identified by CURSORS.

Table 3-2 lists the Storage, Acquisition and Display modes with respect to the SEC/DIV switch setting and the selected Trigger mode. The "Acquisition Mode" shown in bold face and listed first in Table

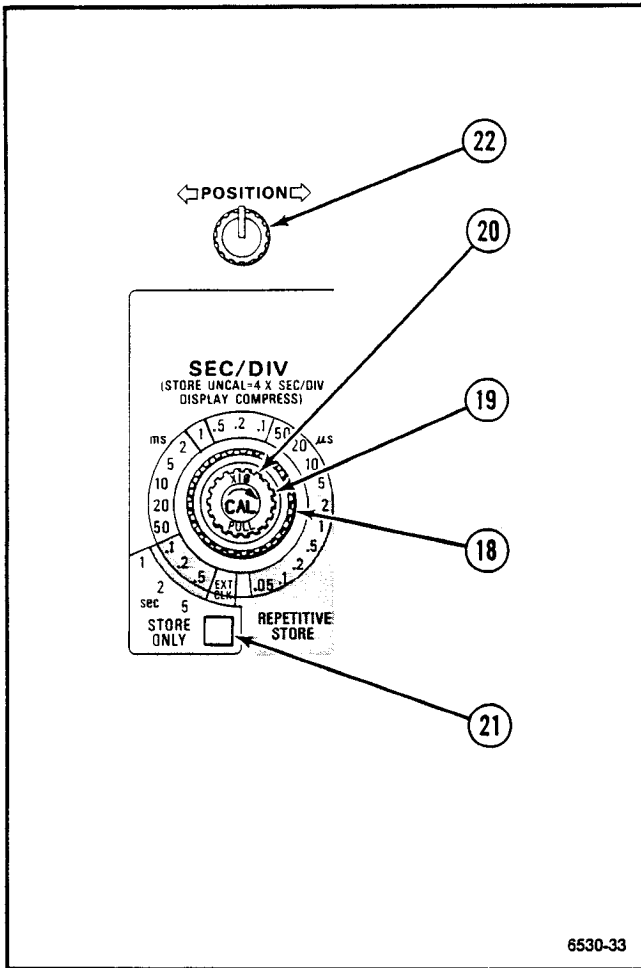

Figure 3-3. Horizontal controls.

3-2 for each "SEC/DIV Setting" is the default mode. The other Acquisition Modes listed for that setting may be selected using the ACQUISITION MODE button. Waveforms of SCAN and ROLL displays are updated one data point at a time. All data points of a RECORD display are updated at the same time (total record replacement).

Storage Modes

REPETITIVE (2 $\mu\text{s}/\text{div}$ to 0.05 $\mu\text{s}/\text{div}$) requires a repetitive trigger signal. Sampling of the input signal occurs at the maximum A/D conversion rate. If a control affecting an acquisition parameter or function is changed, the acquisition is reset, and the waveform being acquired is cleared on the next sample acquired. On each valid trigger, ten or more equally spaced samples are acquired and displayed on the waveform record, depending on

the SEC/DIV setting (see Table 3-3). The random time delay from the trigger to the following sample is measured and used to place the acquired waveform samples in the correct display memory location. Any display location is equally likely to be filled. Table 3-3 gives the statistically expected number of trigger events required to completely fill the display, assuming a uniform distribution of trigger events relative to the sample interval. The default Acquisition mode is Average.

FAST RECORD (5 $\mu\text{s}/\text{div}$ to 10 $\mu\text{s}/\text{div}$) updates a full record of the acquired waveform. The default Acquisition mode is Sample.

SLOW RECORD (20 $\mu\text{s}/\text{div}$ to 50 ms/div) updates a full record of the acquired waveform. The default Acquisition mode is Peak Detect.

SCAN (for NORM TRIGGER mode and 0.1 s/div to 5 s/div or EXT CLOCK) updates pretrigger data when a trigger is received. The waveform display then scans to the right from the trigger point to finish the post-trigger acquisition and then freezes. The default Acquisition mode is Peak Detect.

ROLL (for P-P AUTO TRIGGER mode and 0.1 s/div to 5 s/div or EXT CLOCK) continuously acquires and displays signals. Triggers are disabled except in SGL SWP. The waveform display scrolls from right to left across the crt with the latest samples appearing at the right edge of the crt. The default Acquisition mode is Peak Detect.

TRIGGERED ROLL (for SGL SWEEP TRIGGER mode and 0.1 s/div to 5 s/div)—In Triggered Roll, the display rolls from right to left until the trigger is received. Then, the display continues rolling until the posttrigger acquisition record is filled, and then the display freezes. The default Acquisition mode is Peak Detect.

Acquisition Modes

PEAK DETECT digitizes and stores, in acquisition memory as a data pair, the minimum and maximum levels of the input signal within the time represented by 1/50 of a division UN MAG (1/25 of a division in CHOP or ALT).

SAMPLE samples the signal at a rate that produces 100 samples per graticule division. In RECORD Sampling modes, the displayed sample points are displayed by vectors or dots.

Table 3-2
2221 Digital Storage Modes

SEC/DIV Setting	Trig Mode Selected	Storage Mode	Acquisition Mode	Display ^a
0.05 μ s/div to 2 μ s/div	All	REPETITIVE	AVERAGE ^b SAMPLE ACCPEAK	Dots
5 μ s/div to 10 μ s/div	All	FAST RECORD	SAMPLE ACCPEAK AVERAGE ^b	Vector/Dots
20 μ s/div to 50 ms/div	All	SLOW RECORD	PEAK DETECT ACCPEAK SAMPLE AVERAGE ^b	Vector/Dots
0.1 s/div to 5 s/div or EXT CLOCK to 1 kilosample/sec (cont)	NORM	SCAN	PEAK DETECT ACCPEAK SAMPLE AVERAGE ^b	Vector/Dots
	P-P AUTO or SGL SWP	ROLL	PEAK DETECT SAMPLE	Vector/Dots

^aIn X-Y mode, the Display mode is always Dots.

^bThe AVERAGE mode weight is 1/16.

AVERAGE Acquisition mode is used for multiple record averaging. A normalized algorithm continuously displays the signal at full amplitude during the averaging process. The averaging weight (the number of weighted waveform acquisitions included in each average display) is 1/16. The averaging process is reset by changing any control that causes an acquisition reset.

ACCPEAK Acquisition mode causes accumulation of peaks over multiple acquisitions. The largest maximum and smallest minimum samples are retained for each trigger-referenced acquisition record. For 20 μ s per division to 5 s per division, hardware peak detection is used, updating maximum and minimum samples within each time-base clock period. The ACCPEAK display is reset by changing any control that causes an acquisition reset. ACCPEAK mode is valid for triggered acquisitions only and is not operational in untriggered modes.

SEC/DIV switch (increases the slowest NON-STORE Sweep time per division to at least 2 s).

The Variable SEC/DIV control does not affect the STORE time base for acquiring signals. If rotated out of the CAL detent position, the Variable

Table 3-3
Repetitive Store Sampling Data Acquisition

SEC/DIV Switch Setting	Samples Per Acquisition	Expected Acquisitions Per Waveform ^a	
		One Channel	Two Channels
0.05 μ s	40	519	450
0.1 μ s	80	225	191
0.2 μ s	160	96	83
0.5 μ s	400	30	23
1 μ s	800	12	11
2 μ s	800	12	11

^aFor a 50% probability of fill.

19 **Variable SEC/DIV and DISPLAY COMPRESS Control**—Continuously varies the uncalibrated NON-STORE sweep time per division to at least 2.5 times the calibrated time per division set by the

SEC/DIV control has the effect of horizontally compressing (4 X SEC/DIV) the 4K display by a factor of four (DISPLAY COMPRESS). In PEAK DETECT acquisition mode, peaks are acquired but not displayed when DISPLAY COMPRESS is selected.

20 **X10 Magnifier Switch**—When the Variable SEC/DIV knob is pulled to the out position (X10 PULL), displays are magnified by ten times. In NON-STORE, magnification of the displays occurs around the center vertical graticule division. STORE mode displays are expanded when the Variable SEC/DIV knob is pulled to the out position (X10 PULL). The SEC/DIV scale factor readouts are adjusted to correspond to the correct SEC/DIV of the displayed waveform (either NON-STORE or STORE). STORE mode displays are expanded around the active CURSOR. The display window for STORE mode X10 expanded waveforms may be positioned using the CURSORS Control to view any one-window portion of the acquisition record.

21 **STORE ONLY Mode SEC/DIV Multiplier**—Functional in the STORE mode only at SEC/DIV switch settings of 0.1, 0.2, and 0.5 s per division. When pressed in, the Sweep time base of these three settings is increased by a factor of 10 to 1 s per division, 2 s per division, and 5 s per division. Releasing the button returns the STORE mode time base to X1. The normal X10 MAG feature is still functional on waveforms acquired at the slow STORE mode SEC/DIV settings.

22 **Horizontal POSITION Control**—Positions all the NON-STORE waveforms horizontally over a one-sweep-length range (either X1 or X10 Magnified). Using the Horizontal POSITION control, STORE mode waveforms may be positioned over a range of one display window. When a STORE mode acquisition display is longer than one screen, the CURSORS Position control is used to position the display window to any position of the acquisition record.

TRIGGER

See Figure 3-4 for the location of items 23 through 32.

NOTE

The trigger system controls affect the acquisition of the next waveform. They are inactive in SAVE STORE mode.

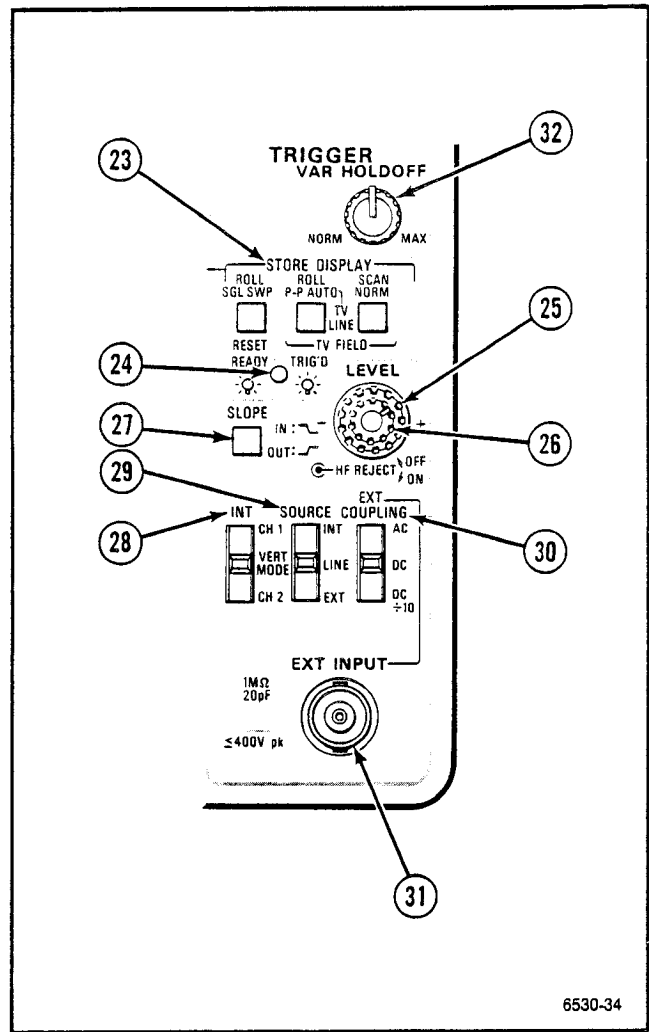

Figure 3-4. Trigger controls, connector, and indicator.

23 **Mode Switches**—Determine the NON-STORE Sweep triggering mode. STORE mode triggering operation depends on the position of the SEC/DIV switch and the trigger mode selected.

The trigger position is marked by a T on the acquired waveform. A symbol in the waveform display separates the new acquisition from the previous acquisition.

NORM—Permits triggering at all sweep rates (an autotrigger is not generated in the absence of an adequate trigger signal). NORM Trigger mode is especially useful for low-frequency and low-repetition-rate signals.

In STORE mode, the last acquired waveform is held on display between triggering events. The pretrigger portion of the acquisition memory is continually acquiring new pretrigger data until a trigger event occurs. How the waveform display is updated after the trigger occurs, depends on the SEC/DIV setting. SCAN mode is selected from 5 s per division to 0.1 s per division.

From 5 s per division to 0.1 s per division, the pretrigger portion of the displayed waveform is updated by the pretrigger data in the acquisition memory, then the posttrigger data points are placed in the display as they are acquired. For faster sweep speeds, the posttrigger data points are acquired in the acquisition memory prior to completely updating the waveform display, using the newly acquired data.

P-P AUTO-TV LINE—In the NON-STORE mode, triggering occurs on trigger signals having adequate amplitude and a repetition rate of about 20 Hz or faster. In the absence of a proper trigger signal, an autotrigger is generated, and the sweep free runs.

In STORE mode, for SEC/DIV settings of 5 s per division to 0.1 s per division, the P-P AUTO Trigger mode is disabled, ROLL mode is selected, and the acquisition is free running. At faster SEC/DIV settings, triggering occurs under the same conditions as NON-STORE mode P-P AUTO triggering, and acquisitions are auto triggered if proper triggering signal conditions are not met. The manner in which the display is filled and updated is the same as for NORM triggering.

When in ROLL mode, triggers are disabled and the signals are continuously acquired and displayed. The waveform display scrolls from right to left across the crt with the latest samples appearing at the right edge of the crt.

For either NON-STORE or STORE mode, the range of the TRIGGER LEVEL control is automatically restricted to the peak-to-peak limits of the trigger signal for ease in obtaining triggered displays and acquisitions. P-P AUTO is the usual Trigger Mode selection for obtaining stable displays of TV Line information.

TV FIELD—Permits stable triggering on a television field (vertical sync) signal when the P-P AUTO and the NORM Trigger buttons are pressed in together (see VAR HOLDOFF Control).

In the absence of an adequate trigger signal, the sweep (or acquisition) free-runs. The instrument otherwise behaves as in P-P AUTO.

SGL SWP—Arms the trigger circuit for a single sweep in NON-STORE or a single acquisition in STORE. Triggering requirements are the same as in NORM Trigger Mode. After the completion of a triggered NON-STORE sweep or STORE SGL SWP acquisition, pressing in the SGL SWP button rearms the trigger circuitry to accept the next triggering event or start the next storage acquisition.

In STORE mode, when the SGL SWP is armed, the acquisition cycle begins but the READY LED does not come on until the pretrigger portion of the acquisition memory is filled. At the time the READY LED comes on, the acquisition system is ready to accept a trigger. When a trigger event occurs, the posttrigger waveform data is stored to complete the single-sweep acquisition. After the acquisition completes, the READY LED goes out, and the Single Sweep can be rearmed.

The SEC/DIV switch setting and the STORE mode determine how the display is updated. For settings of 5 s per division to 0.1 s per division, a storage process known as Triggered Roll is used. The last acquired waveform is erased when SGL SWP is armed. In Triggered Roll the display rolls from right to left until the trigger is received. Then, the display continues rolling until the post-trigger acquisition record is filled, and then the display freezes.

For SEC/DIV settings of 50 ms to 5 μ s (RECORD store mode), the display is updated as a full record. The previously displayed waveform remains on the crt until the posttrigger portion of the acquisition memory is filled. The waveform display is then updated with the newly acquired data in its entirety. For SEC/DIV settings of 2 μ s to 0.05 μ s (REPETITIVE store mode), a partial record is acquired each time the SGL SWP button is RESET, overlaying the samples accumulated from past acquisitions.

- 24 **READY-TRIG'D Indicator**—A dual-function LED indicator. In P-P AUTO and NORM Trigger modes, the LED is turned on when triggering occurs. In SGL SWP Trigger mode, the LED turns on when the trigger circuit is armed, awaiting a triggering event, and turns off again after the single sweep (or acquisition) completes.

Controls, Connectors, and Indicators—2221 Operators

In STORE mode, pressing the SGL SWP button to arm the trigger circuitry does not immediately turn on the READY LED. The pretrigger portion of the acquisition memory starts filling after the SGL SWP button is pressed in, and the READY LED is turned on when the filling is completed. The storage acquisition system is then ready to accept a triggering event. After an acquisition is completed, the READY LED is turned off.

②5 **TRIGGER LEVEL Control**—Selects the amplitude point on the trigger signal that produces triggering. The trigger point for STORE mode is identified by a T on the acquired waveform.

②6 **HF REJECT**—Rejects (attenuates) the high-frequency components (above 40 kHz) of the trigger signal when the control is in the ON position.

②7 **TRIGGER SLOPE Switch**—Selects either the positive or negative slope of the trigger signal to start the NON-STORE Sweep or to reference the next STORE mode acquisition cycle.

②8 **INT Switch**—Determines the source of the internal trigger signal for the Trigger Generator circuits.

CH 1—Trigger signal is obtained from the CH 1 input.

VERT MODE—Trigger signals are automatically obtained alternately from the CH 1 and CH 2 input signals in ALT VERTICAL MODE. In the CHOP or ADD VERTICAL modes, the trigger signal source is the sum of the CH 1 and CH 2 input signals.

CH 2—Trigger signal is obtained from the CH 2 input. The CH 2 INVERT switch also inverts the polarity of the internal CH 2 trigger signal when the CH 2 display is inverted.

②9 **SOURCE Switch**—Determines if the source of the Trigger signal is internal, external, or from line.

INT—Routes the internal trigger signal selected by the INT switch to the Trigger circuit.

LINE—Routes a sample of the ac power line signal to the Trigger circuit.

EXT—Routes an external signal applied to the EXT INPUT connector to the Trigger circuit.

③0 **EXT COUPLING Switch**—Determines the method of coupling the external signal applied to the EXT INPUT connector to the input of the Trigger circuit.

AC—Input signal is capacitively coupled, and the dc component is blocked.

DC—All frequency components of the external signal are coupled to the Trigger circuit.

DC ÷ 10—Attenuates the external signal by a factor of ten before application to the Trigger circuit. As with DC COUPLING, all frequency components of the input signal are passed.

③1 **EXT INPUT Connector**—Provides for connection of external signals to the Trigger circuit.

③2 **VAR HOLDOFF Control**—Adjusts the NON-STORE Variable Holdoff time. NON-STORE Variable Holdoff starts at the end of the Sweep. STORE mode Holdoff starts at the end of the acquisition cycle and ends after the waveform data has been transferred from acquisition to display memory and the pre-trigger portion of the acquisition memory has been filled. After STORE mode Holdoff ends, the next acquisition can be triggered after the next (or current, if one is in progress) NON-STORE Variable Holdoff ends. STORE mode Holdoff may be many times the length of the Sweep time so that several NON-STORE Holdoffs may have occurred during STORE Holdoff time. *This ensures that STORE mode triggering is controllable by the VAR HOLD-OFF control and will be stable if the NON-STORE display is stable.*

STORAGE CONTROLS

See Figure 3-5 for the location of items 33 through 37.

③3 **STORE/NON-STORE Switch**—Selects either the NON-STORE or the STORE waveforms for display. The STORE acquisition system is turned off while NON-STORE is selected so that the last acquired STORE waveform remains in memory. Selects NON-STORE when out and STORE when pressed in.

③4 **ACQUISITION Controls**—Determine the method of acquiring and displaying the acquired STORE waveform.

SAVE/CONT Switch—Stops the current acquisition and display update in progress when pressed in. If the SEC/DIV switch setting is 0.1 s per division or slower, the SAVE state is entered immediately upon pressing the button. At SEC/DIV settings of 50 ms per division and faster, if an acquisition has been triggered, the acquisition is allowed to complete before the SAVE state is entered. Pressing the SAVE/CONT switch a second time restarts (continues) the acquisition process. The SAVE state is indicated by the word "SAVE" on the second line of readout in the upper right-hand portion of the crt.

The pretrigger portion of an untriggered acquisition stops filling in SAVE mode. Upon leaving SAVE, a new acquisition is started, and a trigger will not be accepted until the pretrigger portion again refills.

TRIG POS Switch—Positions the trigger point for acquisitions either near the end (pretrigger), the beginning (posttrigger), or the middle (midtrigger) of the waveform. A T is displayed on the waveform and bar graph to indicate the trigger point. Pressing the TRIG POS button causes a change in trigger position on the next acquisition. Successive presses of the TRIG POS button will cause the trigger position to rotate through three possible settings (posttrigger, midtrigger, and pretrigger). The change in trigger point will be seen on new acquisitions. The T on the bar graph will be moved (and tilted if the instrument is in SAVE) to indicate the trigger position for the next acquisition.

MODE Switch—Selects the acquisition modes for any appropriate sweep speed range (see Table 3-2). Pressing this button will cause the acquisition to reset. The new mode will apply to the new acquisition. If the MODE switch is pressed

while in SAVE, the readout will be updated to indicate the new acquisition mode, but the readout will be tilted to indicate that the presently acquired waveform and the readout do not match. The present acquisition mode is displayed in the crt readout at lower center.

VECTORS ON/OFF Control—Provides a choice of either dots or vector-connected points in the display of acquired waveforms for STORE mode SEC/DIV switch settings from 5 s per division to 5 μ s per division, except in X-Y mode. The change occurs on new acquisitions after the button is pushed.

35 CURSORS Controls—These controls apply to all displayed STORE mode waveforms. Delta Volts, Delta Time, and One Over Delta Time measurements of the STORE displays are made using the CURSORS controls. CURSORS controls are used to position the display window. See the "CRT READOUT" description for the cursor readout display.

SELECT WAVEFORM Control—Toggles between the reference waveform and the acquisition for the purpose of making cursor measurements. If there is no reference waveform, this button is inactive. Waveform selection is indicated on the second line of the crt readout by an underline that moves between A (acquisition) and SREF (reference) when the SELECT WAVEFORM button is pressed. When an acquisition control is changed, the cursors return to the acquisition waveform set. Cursors also move to the acquisition waveform set if the reference waveform set is turned off.

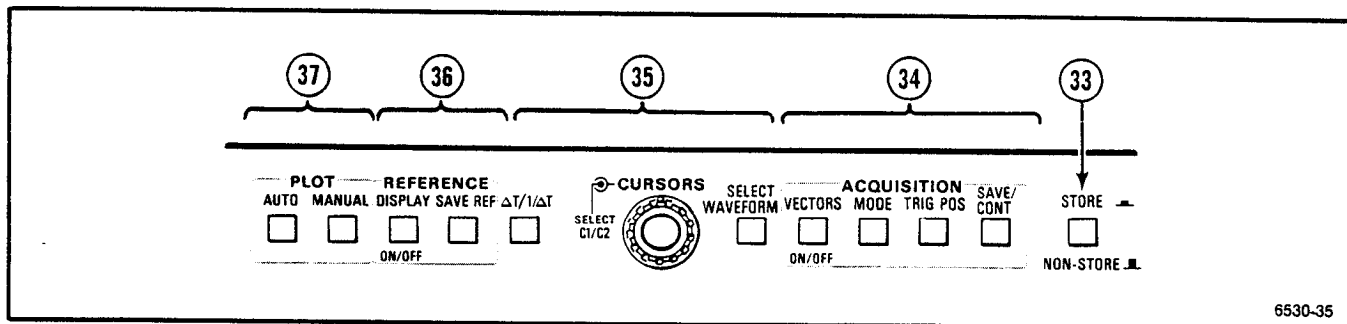

Figure 3-5. Storage controls.

CURSORS Position Control—Provides for horizontal positioning of the active cursor (or active cursors when there are two waveforms displayed in a display set). Cursor positioning continues to function during SAVE mode, and measurements can be made on any displayed waveform. Cursor positions are independently selectable between the Reference and Acquisition waveform sets. A 1K waveform window is always displayed around the active cursor.

Cursors are placed on all waveforms in a display set. A display set is one or both waveforms from the Acquisition (CH 1 and/or CH 2) or Reference (CH 1 and/or CH 2). The acquisition parameters of the waveform set in which the cursors are located are displayed in the crt readout. Cursors movable by the CURSORS Position control (active) are enclosed in a box.

A bar graph indicates the position of the display window within the acquisition record. The position of the display window is adjusted to provide a display of the active cursor position. If the active cursor is positioned to either edge of the display window, further positioning starts the waveform display scrolling in the opposite direction as the display-window position moves. Display-window positioning can be continued to the ends of the record, allowing observations and measurements to be made over the entire 4K acquisition record.

SELECT C1/C2 (cursor select) Switch—This switch selects the cursor(s) that can be positioned with the CURSORS position control. Cursors are activated alternately with each press of the C1/C2 button. Each selected cursor is enclosed in a box.

ΔT/1/ΔT Switch—Toggles between Delta Time and One Over Delta Time for display in the readout.

36 REFERENCE Controls—Control the saving and displaying of reference waveforms.

SAVE REF Control—When pressed while in STORE mode, causes the displayed acquisition waveform to be saved in the reference memory.

DISPLAY ON/OFF—Toggles the display of the reference waveform on and off.

37 PLOT Controls—Control waveform transmission over the X-Y PLOTTER output.

MANUAL—Pushing this button starts the plotting process any time the instrument is in STORE mode and is not presently plotting. Normally, only the displayed waveforms, trigger points, and readout are plotted (see "Plotting the Graticule" in Section 4).

If a plot is in progress, this button controls plot speed. Each push of MANUAL, while plotting, decrements the plot speed until the slowest speed is reached. The next button push causes the speed to increase to the highest speed. Ten speeds are available. At power-up, plot speed is set to the slowest speed.

AUTO—Toggles between AUTO and MANUAL PLOT modes. In AUTO PLOT a plot is started each time the number of acquisitions or pairs of acquisitions (ALT VERTICAL MODE) defined in Table 3-4 are acquired. Plots continue until the instrument is toggled back to MANUAL PLOT.

The first plot after AUTO PLOT is activated draws the graticule and waveform(s) (and readout if the readout is on). Upon entering AUTO PLOT mode:

1. A waveform(s) is acquired.
2. Plotting begins.

Table 3-4
Acquisitions Before a Plot

Acquisitions Required	Sweep Speed	Acquisition Mode
100	0.05 μs/div	REPETITIVE
50	0.1 μs	REPETITIVE
50	0.2 μs/div	REPETITIVE
30	0.5 μs/div	REPETITIVE
12	1 μs/div	REPETITIVE
12	2 μs/div	REPETITIVE
1	50 ms/div to 5 μs/div	RECORD
1	EXT CLK to 0.1 s/div	SCAN
—	No AUTO PLOT	ROLL

3. On the first plot, the graticule and waveform(s) are drawn first, then the readout.
4. The instrument then acquires another waveform(s) and plots only the newly acquired data (waveform).
5. Acquisitions and waveform plots continue as long as valid triggers are available.

REAR PANEL

See Figure 3-6 for the location of items 38 through 40.

- 38 **EXT Z-AXIS INPUT Connector**—Provides an input connector to allow external signals to be applied to the Z-Axis circuit to intensity modulate the NON-STORE waveform display. Applied signals do not affect the display waveshape. External signals with fast rise and fall times provide the best defined intensity modulation. Noticeable intensity modulation will be produced at normal viewing intensity levels by a 5 V p-p signal. The Z-Axis signals must be time related to the trigger signal to obtain a stable

intensity-modulation pattern on the displayed waveform.

- 39 **Fuse Holder**—Contains the ac-power-source fuse. See the rear panel nomenclature for fuse rating and line voltage range.
- 40 **Detachable Power Cord Receptacle**—Provides the connection point for the ac power source to the instrument.

SIDE PANEL

The standard side panel includes one AUXILIARY CONNECTOR. Refer to Figure 3-7 for the location of item 41.

NOTE

To meet EMI regulations and specifications, use the specified shielded cable and metal connector housing with the housing grounded to the cable shield for connections to the AUXILIARY CONNECTOR.

- 41 **AUXILIARY CONNECTOR**—Provides connections for an X-Y Plotter and an External Clock input. The connector is described in Table 3-5.

X-Y Plotter Connections—Provide connections for X-Axis output, Y-Axis output, and Pen Lift control to drive an external X-Y Plotter. All displayed waveforms are transmitted over the Plotter Interface. The settling time allowed for each movement is approximately proportional to the distance of the movement. Connections for

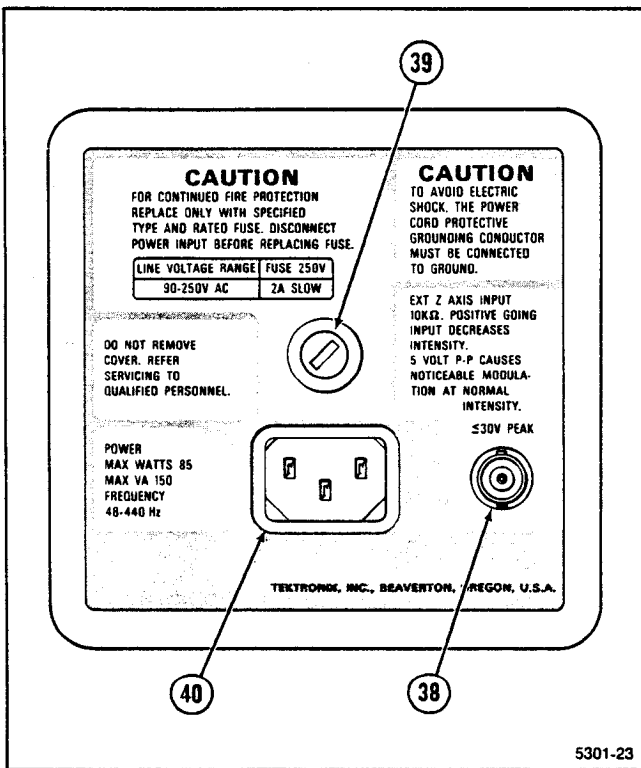

Figure 3-6. Rear Panel.

Table 3-5

Auxiliary Connector

Pin Number	Function
1	EXT CLK input
2	Pen Lift N.C.
3	X signal output
4	SHIELD GND
5	Y signal output
6	+4.2 V output
7	Pen Lift N.O.
8	Pen Lift RELAY COMM
9	SIG GND

Controls, Connectors, and Indicators—2221 Operators

Signal Ground and Shield Ground are also provided for grounding between the 2221 and the external X-Y Plotter. Waveforms and the Readout are plotted on the crt while a plot is in progress.

To be fully compatible, the X-Y Plotter used must have both pen-lift control and X and Y inputs with sensitivity control.

Signals available at the AUXILIARY connector allow the Pen Lift circuit to be wired for a plotter with either active HI or active LO drive requirements and several logic families. Examples for both an active HI and an active LO TTL drive are shown in Figure 3-8.

EXT CLK INPUT—Provides an input for EXT CLOCK signals to the storage acquisition circuit in conjunction with the EXT CLK position of the SEC/DIV switch. Samples are referenced by falling edges. Input is TTL compatible. Samples become visible by pairs, as SCAN or ROLL. Several clocks are required before the point associated with the first clock is visible.

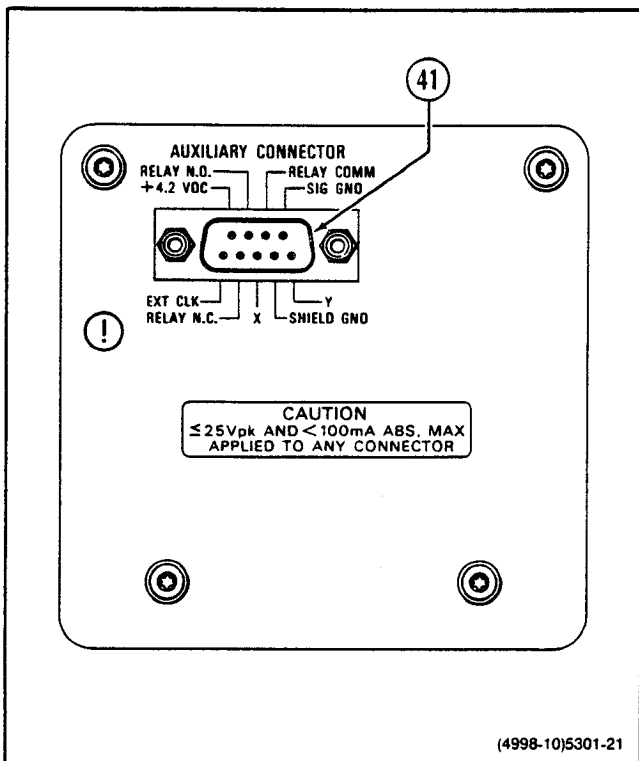

Figure 3-7. Left Side Panel.

CRT READOUT

The Readout System provides an alphanumeric display of information on the crt along with the waveform displays. The readout is displayed in three rows of characters. Two rows are within the top graticule division, and the other row is within the bottom graticule division. The locations and types of information displayed under normal operating modes are illustrated in Figure 3-9.

In NON-STORE mode, the current setting of the VOLTS/DIV and SEC/DIV switches are displayed. Greater-than symbols (>) are used to indicate uncalibrated VOLTS/DIV and SEC/DIV switch settings. A down-arrow symbol (\downarrow) is used in front of the CH 2 VOLTS/DIV readout to indicate CH 2 INVERT. The AC-GND-DC input coupling selection is indicated in the associated VOLTS/DIV readout with a tilde symbol (~) above the volts symbol for AC, a ground symbol (\perp) for GND, and no extra symbol for DC input coupling.

STORE Mode

In STORE mode, many of the crt readout displays are associated with the parameters of stored waveforms.

PARAMETER READOUT. Displays the VOLTS/DIV and SEC/DIV settings of the displayed waveforms on which the cursors are placed. The AC-GND-DC input coupling selection is indicated in the associated VOLTS/DIV readout with a tilde symbol (~) above the volts symbol for AC, a ground symbol (\perp) for GND, and no extra symbol for DC input coupling. If the VOLTS/DIV switch is switched beyond the available expansion or compression range, the readout is tilted, indicating that the VOLTS/DIV switch setting and the VOLTS/DIV readout no longer agree. In 4K COMPRESS, a c is displayed in front of the SEC/DIV readout.

CURSOR READOUT. Displays the voltage difference (either $\Delta V 1$ or $\Delta V 2$) and the time difference between cursors. Independent fields for CH 1 VOLTS/DIV, CH 2 VOLTS/DIV, and SEC/DIV are provided. When making ground-referenced voltage measurements (ground dot displayed and cursor on ground dot) the Δ symbol is replaced by a ground symbol (\perp).

A bar graph is used to indicate the position of the display window within the acquisition record.

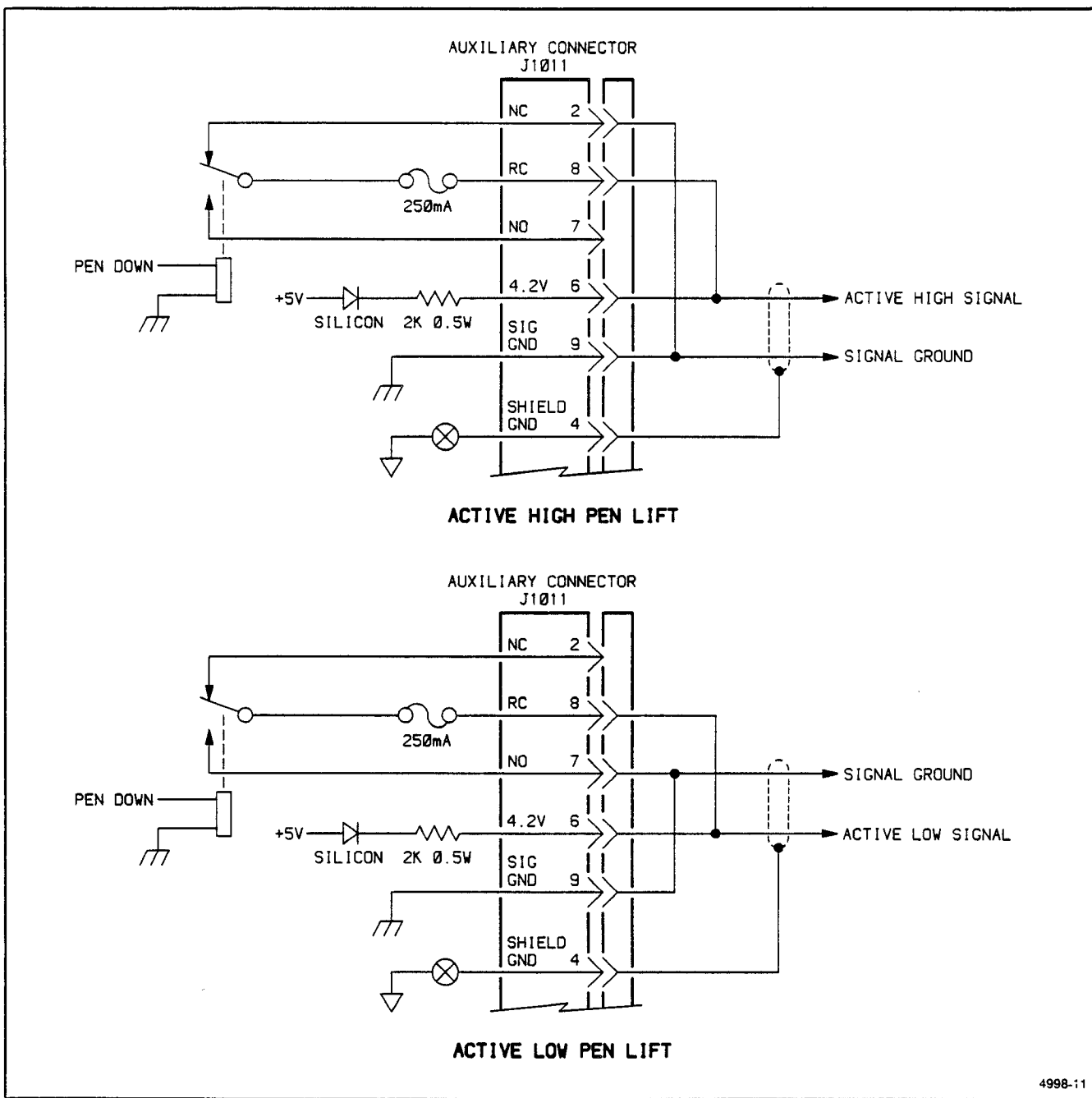

Figure 3-8. X-Y Plotter interfacing.

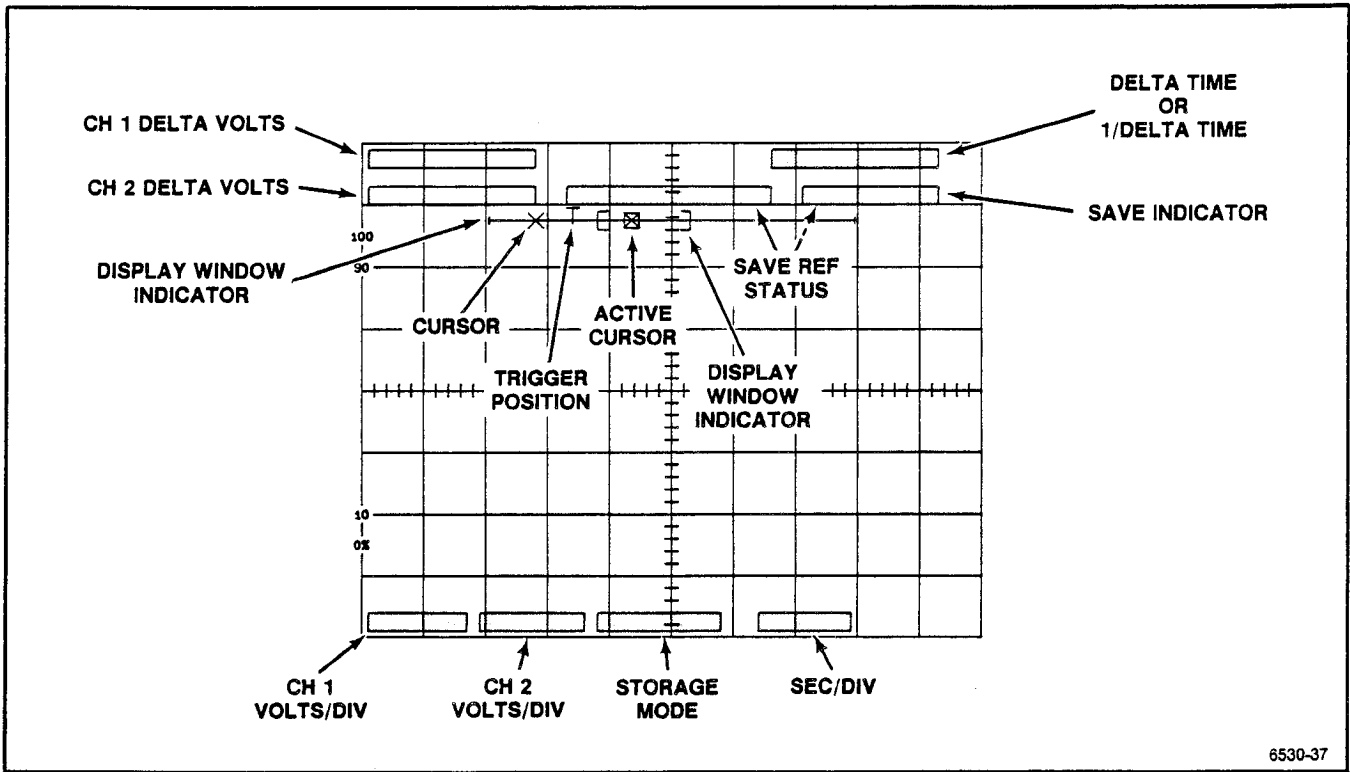

Figure 3-9. Crt readout display.

OPERATING CONSIDERATIONS

This section contains basic operating information and techniques that should be considered before attempting to make any measurements with the instrument.

GRATICULE

The graticule is internally marked on the faceplate of the crt to eliminate parallax-viewing errors and to enable measurements (see Figure 4-1). The graticule is marked with eight vertical and ten horizontal major divisions. In addition, each major division is divided into five subdivisions. The vertical deflection factors and horizontal timing are calibrated to the graticule so that accurate measurements can be made directly from the crt. Also, percentage marks for the measurement of rise and fall times are located on the left side of the graticule.

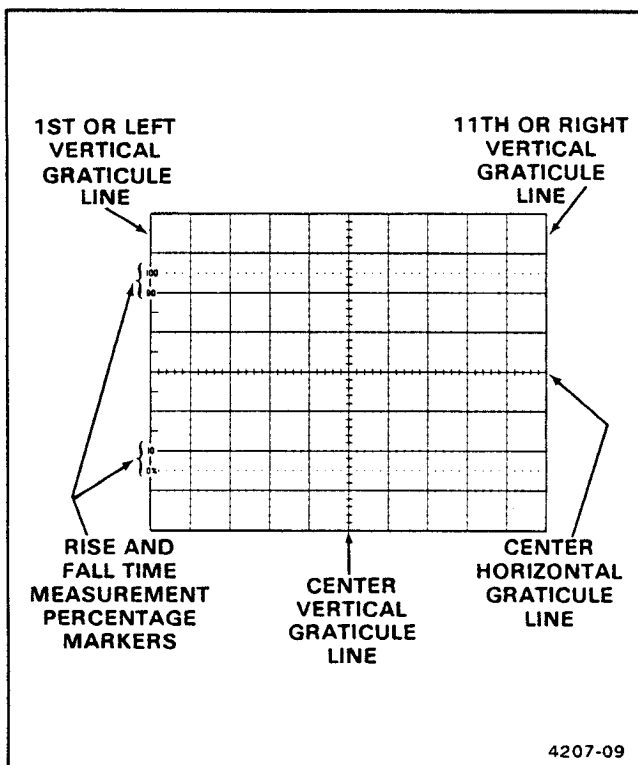

Figure 4-1. Graticule measurement markings.

GROUNDING

The most reliable signal measurements are made when the oscilloscope and the unit under test are connected by a common reference (ground lead) in addition to the signal lead or probe. The probe's ground lead provides the best grounding method for signal interconnection and ensures the maximum amount of signal-lead shielding in the probe cable. A separate ground lead can also be connected from the unit under test to the oscilloscope GND receptacle located on the front panel.

SIGNAL CONNECTIONS

Probes

Generally, the accessory probes supplied with the instrument provide the most convenient means of connecting a signal to the vertical inputs of the instrument. The probe and probe lead are shielded to prevent pickup of electromagnetic interference, and the 10X attenuation factor of the probe offers a high input impedance that minimizes signal loading in the circuitry under test.

Both the probe and the probe accessories should be handled carefully at all times to prevent damage to them. Avoid dropping the probe body. Striking a hard surface can cause damage to both the probe body and the probe tip. Exercise care to prevent the cable from being crushed or kinked. Do not place excessive strain on the cable by pulling.

The standard-accessory probe is a compensated 10X voltage divider. It is a resistive voltage divider for low frequencies and a capacitive voltage divider for high-frequency signal components. Inductance introduced by long signal or ground leads forms a series-resonant circuit. This circuit will affect system bandwidth and will ring if driven by a signal containing significant frequency components at or near the circuit's resonant frequency. Oscillations (ringing) can then appear on the oscilloscope waveform display and distort the true signal waveshape. Always keep both the ground lead and the probe signal-

Operating Considerations—2221 Operators

input connections as short as possible to maintain the best waveform fidelity.

Misadjustment of probe compensation is a common source of measurement error. Due to variations in oscilloscope input characteristics, probe compensation should be checked and adjusted, if necessary, whenever the probe is moved from one oscilloscope to another or between channels. See the probe compensation procedure in "Operator's Check and Adjustments" or consult the instructions supplied with the probe.

Coaxial Cables

Cables may also be used to connect signals to the vertical input connectors, but they may have considerable effect on the accuracy of a displayed waveform. To maintain the original frequency characteristics of an applied signal, only high-quality, low-loss coaxial cables should be used. Coaxial cables should be terminated at both ends in their characteristic impedance. If this is not possible, use suitable impedance-matching devices.

INPUT-COUPLING CAPACITOR PRECHARGING

When the Input Coupling switch is set to the GND position, the input signal is connected to ground through the input-coupling capacitor and a high resistance value. This series combination forms a precharging circuit that allows the input-coupling capacitor to charge to the average dc voltage level of the signal applied to the input connector. Thus, any large voltage transients that may accidentally be generated are not applied to the vertical amplifier input when the input coupling is switched from GND to AC. The precharging network also provides a measure of protection to the external circuitry by reducing the current level that is drawn from the external circuitry while the input-coupling capacitor is charging.

If AC input coupling is in use, the following procedure should be followed whenever the probe tip is connected to a signal source having a different dc level than that previously applied. This procedure becomes especially useful if the dc-level difference is more than ten times the VOLTS/DIV switch setting.

1. Set the AC-GND-DC (input coupling) switch to GND before connecting the probe tip to a signal source.

2. Touch the probe tip to the oscilloscope GND connector.

3. Wait several seconds for the input-coupling capacitor to discharge.

4. Connect the probe tip to the signal source.

5. Wait several seconds for the input-coupling capacitor to charge to the dc level of the signal source.

6. Set the AC-GND-DC switch to AC. A signal with a large dc component can now be vertically positioned within the graticule area, and the ac component of the signal can be measured in the normal manner.

PLOTTING THE GRATICULE

The graticule is not normally plotted in MANUAL PLOT, but it is plotted on the first acquisition after the AUTO PLOT mode is entered. Multiple AUTO plots may be avoided and the graticule still plotted in MANUAL in one of the following ways:

1. If the instrument is acquiring normally, put the instrument in AUTO PLOT. Wait for the plot to start. Exit AUTO PLOT before the plot finishes.

2. In cases where no acquisitions are being made (Save, no valid triggers, etc.), the information can be plotted by putting the instrument in AUTO PLOT and pushing the MANUAL PLOT button. The graticule and other information will be drawn as if it were the first plot of an Auto Plot cycle. Exit Auto Plot before making another acquisition unless Auto Plot mode is desired.

CANCELING A PLOT

Changing any of the following controls cancels plots in progress: VECTORS ON/OFF, ACQUISITION MODE, TRIG POSITION, STORE/NON-STORE, VERTICAL MODE (except BW LIMIT), SEC/DIV, VOLTS/DIV, CH 1 or CH 2 Coupling, Probe Code, CH 2 INVERT, or TRIGGER mode.

OPERATOR'S CHECKS AND ADJUSTMENTS

To verify the operation and basic accuracy of your instrument before making measurements, perform the following checks and adjustment procedures. If adjustments are required beyond the scope of these operator's checks and adjustments, refer the instrument to qualified service personnel.

Before proceeding with these instructions, refer to Section 2, "Preparation for Use," to prepare the instrument for the initial start-up before applying power. A complete instrument Performance Check can be found in Appendix A of this manual.

INITIAL SETUP

1. Verify that the POWER switch is OFF (switch is in the out position), then plug the power cord into the ac power outlet.

2. Press in the POWER switch (ON) and set the instrument controls to obtain a baseline trace:

Display

INTENSITY	Midrange
STORE/READOUT	Midrange (with
INTENSITY	READOUT toggled on)
FOCUS	Best defined display

Vertical (Both Channels)

VERTICAL MODE	CH 1
POSITION	Midrange
VOLTS/DIV	50 mV
AC-GND-DC	DC
Var Volts/Div	CAL (in detent)
BW LIMIT	Off (button out)
X-Y Display	Off (button out)

Horizontal

SEC/DIV	0.5 ms
Var Sec/Div	CAL (in detent)
POSITION	Midrange
X10 Mag	Off (Var Sec/Div knob in)

Trigger

VAR HOLDOFF	NORM (fully counterclockwise)
INT	VERT MODE
SOURCE	INT
Mode	P-P AUTO
LEVEL	For a stable display (with signal applied)
SLOPE	OUT: 
HF REJECT	OFF

Storage

STORE/NON-STORE	NON-STORE (button out)
-----------------	------------------------

3. Adjust the INTENSITY and FOCUS controls for the desired display brightness and best focused trace.

4. Adjust the Vertical and Horizontal POSITION controls to position the trace within the graticule area.

5. Allow the instrument to warm up for 20 minutes before commencing the adjustment procedures. Reduce the INTENSITY levels during the waiting time.

TRACE ROTATION ADJUSTMENT

NOTE

Normally, the trace will be parallel to the center horizontal graticule line, and TRACE ROTATION adjustment is not required.

Operator's Checks and Adjustments—2221 Operators

1. Preset the instrument controls and obtain a baseline trace as described in "Initial Setup."
2. Use the Channel 1 POSITION control to move the baseline trace to the center horizontal graticule line.
3. If the baseline trace is not parallel to the center horizontal graticule line, use a small-bladed screwdriver or alignment tool to adjust the TRACE ROTATION control to align the trace with the graticule line.

PROBE COMPENSATION

Misadjustment of probe compensation is a possible source of measurement error. The attenuator probes are equipped with a compensation adjustment. To ensure measurement accuracy, always check probe compensation before making measurements. Use the following steps to adjust the probe compensation:

1. Preset the instrument controls and obtain a baseline trace as described in "Initial Setup."
2. Connect the two 10X probes (supplied with the instrument) to the CH 1 OR X and CH 2 OR Y input connectors. Observe that the CH 1 VOLTS/DIV readout changes from 50 mV to 0.5 V when the 10X probe is attached to the CH 1 OR X input.

3. Remove the hook tip from the end of each probe.

NOTE

While the probe tip is in the PROBE ADJUST connector, use care not to break off the probe tip.

4. Insert the Channel 1 probe tip into the PROBE ADJUST connector.

5. Use the CH 1 POSITION control to vertically center the display. If necessary, adjust the TRIGGER LEVEL control to obtain a stable display on the \square (OUT) SLOPE.

6. Check the waveform display for overshoot and rounding (see Figure 5-1); if necessary, use a small-bladed screwdriver to adjust the probe compensation for a square front corner on the waveform.

7. Remove the Channel 1 probe tip from the PROBE ADJUST connector.

8. Insert the Channel 2 probe tip into the PROBE ADJUST connector.

9. Set the VERTICAL MODE to CH 2.

10. Use the CH 2 POSITION control to vertically center the display.

11. Check the waveform display for overshoot and rounding (see Figure 5-1); if necessary, use a small-bladed screwdriver to adjust the probe compensation for a square front corner on the waveform.

NOTE

Refer to the instruction manual supplied with the probe for more complete information on the probe and probe compensation.

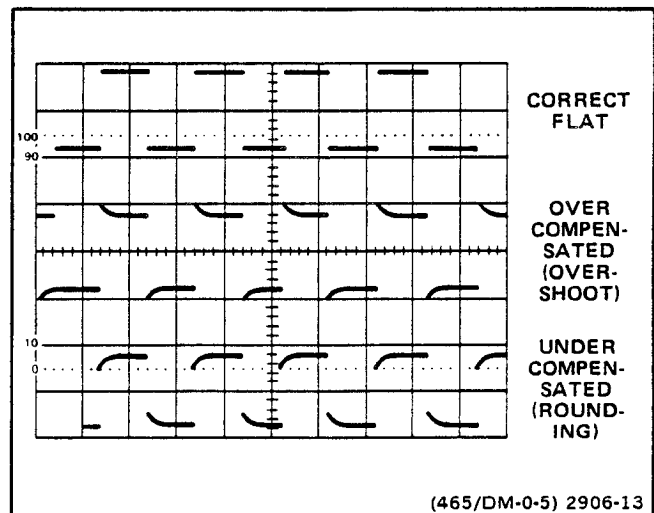

Figure 5-1. Probe compensation.

BASIC APPLICATIONS

INTRODUCTION

This section explains how to make basic measurements using the 2221 Oscilloscope. Many of these measurements can be obtained with either the nonstorage mode or one of the storage modes. After becoming familiar with the capabilities of the instrument, the operator can choose the best method for making a particular measurement. Read the "Operating Considerations" part of this manual for information on signal connections, grounding, and other general operating information.

When the procedures call for obtaining a baseline display, refer to Initial Setup in the "Operator's Checks and Adjustments" part of this manual. The control settings listed in the Initial Setup procedure are considered as the initial control setup. Alternate control settings are usually needed for making a specific measurement. The operator must determine the correct control settings for VOLTS/DIV, SEC/DIV, TRIGGER, and other controls to get a stable display. Only the readouts necessary for each specific example are shown in the associated illustrations.

OSCILLOSCOPE DISPLAYS

The most commonly used oscilloscope displays are described in the following procedures. Verify that the POWER switch is OFF (push button out), then plug the power cord into the ac-power-input source outlet.

NON STORE DISPLAYS

Use the following procedures to obtain the most commonly used conventional oscilloscope displays.

Normal Sweep Display

1. Preset the instrument controls and obtain a baseline display.
2. Using the supplied 10X probe or a properly terminated coaxial cable, apply a signal to the CH 1 OR X input connector. The signal source output impedance determines the termination required when using a coaxial cable to interconnect test equipment.

NOTE

Instrument warm-up time required to meet all specification accuracies is 20 minutes.

3. Advance the INTENSITY control until the display is visible. If the display is not visible with the INTENSITY control at midrange, press the BEAM FIND button and hold it in while adjusting the Channel 1 VOLTS/DIV switch to reduce the vertical display size. Center the compressed display using the Vertical and Horizontal POSITION controls. Release the BEAM FIND button.

4. Set the Channel 1 VOLTS/DIV switch and the Vertical and Horizontal POSITION controls to locate the display within the graticule area.

Basic Applications—2221 Operators

5. Adjust the TRIGGER LEVEL control for a stable, triggered display.

6. Set the SEC/DIV switch for the desired number of cycles of displayed signal. Then adjust the FOCUS control for the best-defined display.

Magnified Sweep Display

1. Preset the instrument controls and obtain a baseline display.

2. Adjust the Horizontal POSITION control to move the area to be magnified to within the center crt graticule division (0.5 division on each side of the center vertical graticule line). Change the SEC/DIV switch setting as required.

3. Pull out the SEC/DIV Variable knob and adjust the Horizontal POSITION control for precise positioning of the magnified display.

X-Y Display

1. Preset the instrument controls and obtain a baseline display.

2. Rotate the INTENSITY control fully counterclockwise and disconnect the CH 1 input signal.

3. Use two coaxial cables or probes of equal delay and apply the vertical signal (Y-axis) to the CH 2 OR Y input connector and the horizontal signal (X-axis) to the CH 1 OR X input connector.

4. Set the VERTICAL MODE switch to X-Y (button in).

5. Advance the INTENSITY control until the display is visible. If the display is not visible with the INTENSITY control at midrange, press and hold in the BEAM FIND button while adjusting the Channel 1 and Channel 2 VOLTS/DIV switches until the display is reduced in size, both vertically and horizontally. Center the compressed display with the POSITION controls (Channel 2 POSITION control for vertical movement; Horizontal POSITION control for horizontal movement). Release the BEAM FIND button. Adjust the FOCUS control for a well-defined display.

NOTE

The display obtained when sinusoidal signals are applied to the X- and Y-axis is called a Lissajous Figure. This display is commonly used to compare the frequency and phase relationship of the two input signals. The frequency relationship of the two input signals determines the pattern seen. The pattern will be stable only if a common divisor exists between the two frequencies.

6. Set the X-Y button to the out position and disconnect the input signals from the vertical input connectors.

Single Sweep Display

1. Preset the instrument controls and obtain a baseline display.

2. For random signals, set the TRIGGER LEVEL control to trigger the sweep on a signal that is approximately the same amplitude as the random signal.

3. Press in the SGL SWP RESET button for a moment. The next trigger pulse will initiate the sweep, and a single trace will be displayed. If no trigger signal is present, the READY indicator LED should illuminate to indicate that the SWEEP Generator circuit is set to initiate a sweep when a trigger signal is received.

4. When the single sweep has been triggered and the sweep is completed, the sweep logic circuitry is locked out. Another sweep cannot be generated until the SGL SWP RESET button is pressed in to set the Sweep Generator to the READY condition.

DIGITAL STORAGE DISPLAYS

The following procedures explain how to set up and use the digital storage capabilities of the instrument. The front-panel control selections set the conditions under which a waveform is acquired for display. Display amplitude is controlled by the VOLTS/DIV switches. The storage time base is controlled by the SEC/DIV switch, and the CURSORS controls. The SEC/DIV switch and the TRIGGER Mode switch will acquire and display waveforms using parameters of Table 3-2.

STORE Mode Display

1. Preset instrument controls and obtain a baseline trace.
2. Set the TRIG POS switch for the desired trigger position.
3. Set the STORE/NON-STORE switch to the STORE position (button in).
4. A STORE mode display may be expanded horizontally by the X10 Magnifier switch.

SAVE Mode Display

1. Acquire a waveform using the "STORE Mode Display" procedure.
2. Push the SAVE/CONT switch to the SAVE mode.

3. The SAVE mode display may be expanded or compressed vertically by a factor of 10 times (or by as many VOLTS/DIV switch positions remaining—whichever is less) by switching the corresponding VOLTS/DIV switch (a waveform acquired at 2 mV per division cannot be expanded, and a waveform acquired at 5 V per division cannot be compressed).

4. Saved waveforms may be repositioned using the POSITION controls even if they have been expanded or compressed.

SAVE REF Display

1. Acquire the waveform to be used as a reference using the previous "SAVE Mode Display" procedure.
2. Push the SAVE REF switch to copy the displayed waveform into SAVE REF memory.

3. Pull out the X10 MAG switch to horizontally expand the SAVE REF display by 10 times, if desired.

ACCPEAK or PEAKDET Displays

1. Preset the instrument controls and obtain a baseline display.

2. Set the STORE/NON-STORE switch to the STORE position (button in).

3. Adjust the TRIGGER LEVEL control to obtain a stable display of the waveform to be stored. This ensures that the trigger and the waveform to be stored are synchronized, especially on low-repetition-rate waveforms.

4. Set the trigger position to PRETRIGGER (7/8 of the waveform acquired before the trigger), POSTTRIGGER (7/8 of the waveform acquired after the trigger), or MID-TRIGGER (1/2 of the waveform acquired before or after the trigger).

5. Use the ACQUISITION MODE switch to select ACCPEAK or PEAKDET.

AVERAGE Mode Display

1. Preset the instrument controls and obtain a baseline display.

2. Set the STORE/NON-STORE switch to the STORE position (button in).

3. Adjust the TRIGGER LEVEL control to obtain a stable display of the waveform to be stored. This ensures that the trigger and the waveform to be stored are synchronized, especially on low-repetition-rate waveforms.

4. Set the trigger position to PRETRIGGER (7/8 of the waveform acquired before the trigger), POSTTRIGGER (7/8 of the waveform acquired after the trigger), or MID-TRIGGER (1/2 of the waveform acquired before or after the trigger).

5. Use the ACQUISITION MODE switch to select AVERAGE.

NOTE

The Weight acquisition to be averaged into the display is fixed at 1/16. A normalized algorithm is used to display the averaged signal. Averaging continues until a new mode is selected. Display of the average continues until a new mode is selected. Changing a front-panel control that affects the data being acquired restarts the averaging process; the algorithm displays the new average at full amplitude.

MAKING NONSTORAGE MEASUREMENTS

The following procedures will enable the operator to perform some basic measurements and familiarize the operator with the conventional oscilloscope capabilities of the 2221.

AC PEAK-TO-PEAK VOLTAGE

To make a peak-to-peak voltage measurement, use the following procedure:

NOTE

This procedure may also be used to make voltage measurements between any two points on the waveform.

1. Preset instrument controls and obtain a baseline trace.

2. Apply the ac signal to either vertical-channel input connector and set the VERTICAL MODE switches to display the channel used.

3. Set the appropriate VOLTS/DIV switch to display about five divisions of the waveform, ensuring that the VOLTS/DIV Variable control is in the CAL detent.

4. Adjust the TRIGGER LEVEL control to obtain a stable display.

5. Adjust the SEC/DIV switch to display several cycles of the waveform.

6. Vertically position the displayed waveform so that the negative peak of the waveform coincides with one of the horizontal graticule lines (see Figure 6-1, Point A).

7. Horizontally position the display so that one of the positive peaks coincides with the center vertical graticule line (see Figure 6-1, Point B).

8. Measure the vertical deflection from peak to peak (see Figure 6-1, Point A to Point B).

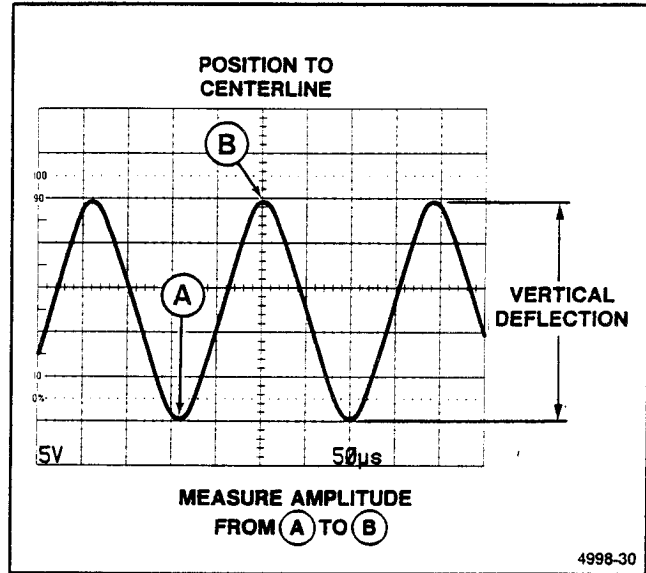

Figure 6-1. Peak-to-peak waveform voltage.

NOTE

A more accurate value can be obtained by measuring from the top of a peak to the top of a valley. This eliminates trace thickness from the measurement.

9. Calculate the peak-to-peak voltage, using the following formula:

$$\text{Volts (p-p)} = \text{Vertical Deflection (Divisions)} \times \text{VOLTS/DIV Switch Setting} \times \text{Probe Attenuation Factor}$$

EXAMPLE: The measured peak-to-peak vertical deflection is 5 divisions (see Figure 6-1) with a VOLTS/DIV switch setting of 0.5 V, using a 10X probe.

Substituting the given values:

$$\text{Volts (p-p)} = 5 \text{ div} \times 0.5 \text{ V/div} \times 10 = 25 \text{ V}$$

GROUND REFERENCED DC VOLTAGE

NOTE

Either channel input connector may be used for the signal input. Use the VERTICAL MODE switches to select the appropriate channel for display.

1. Apply the signal to be measured to the selected channel input and obtain a NON-STORE display.

2. Ensure that the VOLTS/DIV Variable control is in the calibrated detent and determine the polarity of the voltage to be measured as follows:

- a. Set the AC-GND-DC switch to GND and vertically position the baseline trace to the center horizontal graticule line.
- b. Set the AC-GND-DC switch to DC. If the waveform moves above the center line of the crt, the voltage is positive. If the waveform moves below the center line of the crt, the voltage is negative.

3. Set the AC-GND-DC switch to GND and position the baseline trace to a convenient reference line. For example, if the voltage to be measured is positive, position the baseline trace to the bottom graticule line. If a negative voltage is to be measured, position the baseline trace to the top graticule line.

4. Set the AC-GND-DC switch to DC. Measure the divisions of vertical deflection between the reference line and the desired point on the waveform (see Figure 6-2).

5. Calculate the voltage, using the following formula:

$$\text{Voltage} = \frac{\text{Vertical Distance (Divisions)}}{\text{Vertical Distance (Divisions)}} \times \begin{matrix} \text{Polarity} \\ (+ \text{ or } -) \end{matrix} \times \frac{\text{VOLTS/DIV}}{\text{Switch Setting}}$$

NOTE

The attenuation factor of the probe being used must be included if it is not a 10X scale-factor-switching probe.

EXAMPLE: The vertical distance measured is 4.6 divisions (see Figure 6-2). The waveform is above the refer-

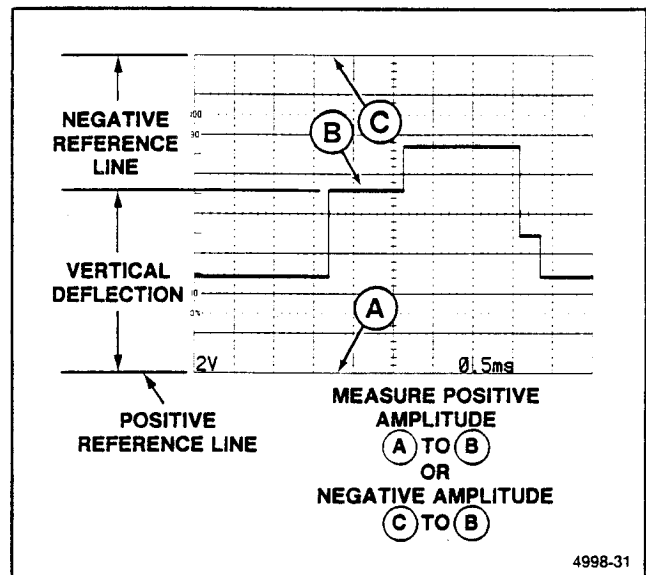

Figure 6-2. Ground referenced voltage measurement.

ence line, the VOLTS/DIV switch is set to 2 V, and a 10X scale-factor-switching probe is used.

Substituting the given values into the formula:

$$\text{Voltage} = 4.6 \text{ divisions} \times (+1) \times 2 \text{ V/div} = +9.2 \text{ V}$$

ALGEBRAIC ADDITION

With the VERTICAL MODE switches in the ADD position, the waveform displayed represents the algebraic sum of the signals applied to the Channel 1 and Channel 2 input connectors (CH 1 + CH 2). If the Channel 2 INVERT switch is pressed in, the resulting waveform is the difference of the signals applied to the Channel 1 and Channel 2 input connectors (CH 1 - CH 2). The total deflection factor in the ADD mode is equal to the deflection factor indicated by either VOLTS/DIV switch (when both VOLTS/DIV switches are set to the same deflection factor). A common use for the ADD mode is to provide a dc offset for a signal riding on top of a dc level.

The following general precautions should be observed when using the ADD mode:

- a. Do not exceed the input voltage rating of the oscilloscope.
- b. Do not apply signals that exceed the equivalent of about eight times the VOLTS/DIV switch set-

Basic Applications—2221 Operators

ting, since large voltages may distort the display. For example, with a VOLTS/DIV switch setting of 0.5 V, the voltage applied to that channel input should not exceed about 4 volts.

EXAMPLE: Using the graticule center line as 0 V, the Channel 1 signal is at a 3-division, positive dc level (see Figure 6-3A).

1. Multiply 3 divisions by the VOLTS/DIV switch setting to determine the dc-level value.
2. To the Channel 2 input connector, apply a negative dc level (or positive level, using the Channel 2 INVERT switch) whose value was determined in step 1 (see Figure 6-3B).
3. Select ADD and BOTH VERTICAL MODE to place the resultant display within the operating range of the Vertical POSITION controls (see Figure 6-3C).

COMMON-MODE REJECTION

The ADD mode can also be used to display signals that contain undesirable frequency components. The undesirable components can be eliminated through common-mode

rejection. The precautions given under the preceding "Algebraic Addition" procedure should be observed.

EXAMPLE: The signal applied to the Channel 1 input connector contains unwanted frequency components (see Figure 6-4A). To remove the undesired components, use the following procedure:

1. Preset instrument controls and obtain a baseline trace.
2. Apply the signal containing the unwanted components to the Channel 1 input.
3. Apply the unwanted signal to the Channel 2 input.
4. Select BOTH and ALT VERTICAL MODE and press in the Channel 2 INVERT button.
5. Adjust the Channel 2 VOLTS/DIV switch and Variable control so the Channel 2 display is approximately the same amplitude as the undesired portion of the Channel 1 display (see Figure 6-4A).
6. Select ADD VERTICAL MODE and slightly readjust the Channel 2 VOLTS/DIV Variable control for maximum cancellation of the undesired signal component (see Figure 6-4B).

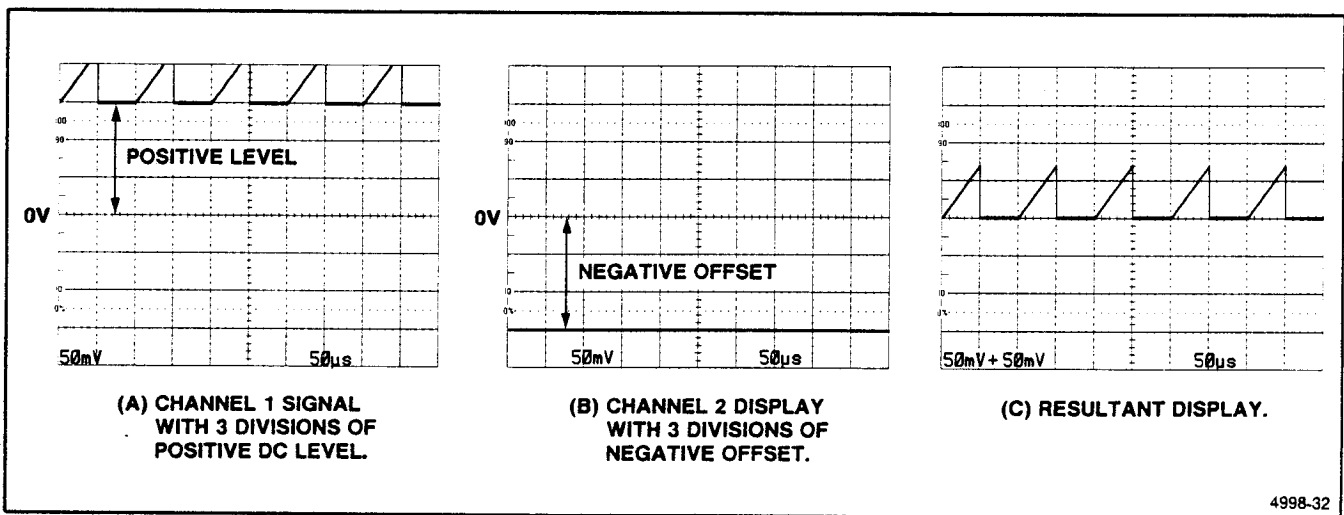

Figure 6-3. Algebraic addition.

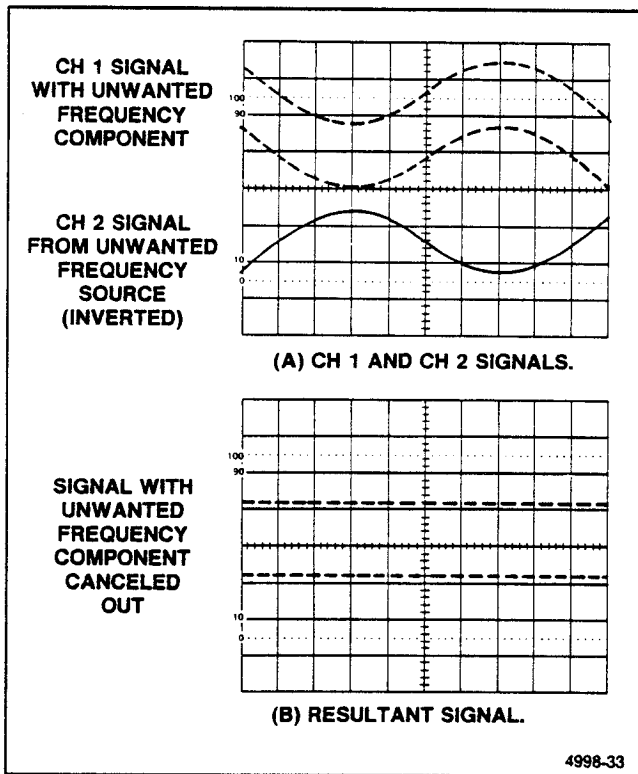

Figure 6-4. Common-mode rejection.

TIME DURATION

To measure time between two points on a waveform, use the following procedure:

1. Preset instrument controls and obtain a baseline trace.
2. Apply the signal to either vertical-channel input connector and set the VERTICAL MODE switches to display the channel used.
3. Adjust the TRIGGER LEVEL control to obtain a stable display.
4. Set the SEC/DIV control to display one complete period of the waveform. Ensure that the SEC/DIV Variable control is in the CAL detent.
5. Position the display to place the time-measurement points on the center horizontal graticule line (see Figure 6-5).

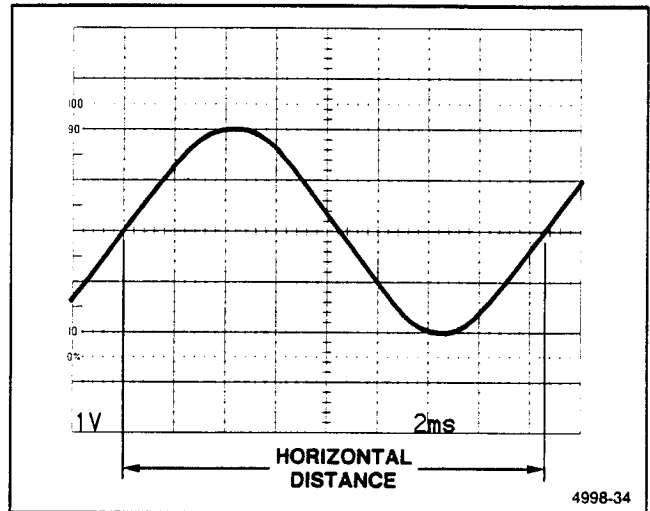

Figure 6-5. Time duration.

6. Measure the horizontal distance between the time-measurement points.
7. Calculate time duration, using the following formula:

$$\text{Time Duration} = \frac{\text{Horizontal Distance (Divisions)} \times \text{SEC/DIV Switch Setting}}{\text{Magnification Factor}}$$

EXAMPLE: The distance between the time-measurement points is 8.3 divisions (see Figure 6-5), and the SEC/DIV switch is set to 2 ms. The X10 Magnifier switch is pushed in (X1 magnification).

Substituting the given values:

$$\text{Time Duration} = 8.3 \text{ div} \times 2 \text{ ms/div} = 16.6 \text{ ms}$$

AMPLITUDE COMPARISON

In some applications it may be necessary to establish a set of deflection factors other than those indicated by the VOLTS/DIV switch settings. This is useful for comparing unknown signals to a reference signal of known amplitude. To accomplish this, a reference signal of known amplitude is first set to an exact number of vertical divisions by adjusting the VOLTS/DIV switch and Variable control. Unknown signals can then be quickly and accurately compared with the reference signal without disturbing the setting of the VOLTS/DIV Variable control. The procedure is as follows:

Basic Applications—2221 Operators

1. Preset instrument controls and obtain a baseline trace.
2. Apply the reference signal to either vertical channel input and set the VERTICAL MODE switch to display the channel used.
3. Set the amplitude of the reference signal to an exact number of vertical divisions by adjusting the VOLTS/DIV switch and VOLTS/DIV Variable control.
4. Establish a vertical conversion factor, using the following formula (reference signal amplitude must be known):

$$\text{Vertical Conversion Factor} = \frac{\text{Reference Signal Amplitude (Volts)}}{\text{Vertical Deflection (Divisions)} \times \text{VOLTS/DIV Switch Setting}}$$

5. Disconnect the reference signal and apply the unknown signal to be measured to the same channel input. Adjust the VOLTS/DIV switch to a setting that provides sufficient vertical deflection to make an accurate measurement. Do not readjust the VOLTS/DIV Variable control.

6. Establish an arbitrary deflection factor, using the following formula:

$$\text{Arbitrary Deflection Factor} = \text{Vertical Conversion Factor} \times \text{VOLTS/DIV Switch Setting}$$

7. Measure the vertical deflection of the unknown signal in divisions and calculate its amplitude using the following formula:

$$\text{Unknown Signal Amplitude} = \text{Arbitrary Deflection Factor} \times \text{Vertical Deflection (Divisions)}$$

EXAMPLE: The reference signal amplitude is 30 V, with a VOLTS/DIV switch setting of 5 V and the VOLTS/DIV Variable control adjusted to provide a vertical deflection of exactly 4 divisions.

Substituting these values in the Vertical Conversion Factor formula:

$$\text{Vertical Conversion Factor} = \frac{30 \text{ V}}{4 \text{ div} \times 5 \text{ V/div}} = 1.5$$

Continuing, for the unknown signal the VOLTS/DIV switch setting is 1, and the peak-to-peak amplitude spans five vertical divisions. The Arbitrary Deflection Factor is then determined by substituting values in the formula:

$$\text{Arbitrary Deflection Factor} = 1.5 \times 1 \text{ V/div} = 1.5 \text{ V/div}$$

The amplitude of the unknown signal can then be determined by substituting values in the unknown signal amplitude formula:

$$\text{Amplitude} = 1.5 \text{ V/div} \times 5 \text{ div} = 7.5$$

FREQUENCY

The frequency of a recurrent signal can be determined from its time-duration measurement as follows:

1. Measure the time duration of one waveform cycle using the preceding "Time Duration" measurement procedure.
2. Calculate the reciprocal of the time-duration value to determine the frequency of the waveform.

EXAMPLE: The signal in Figure 6-5 has a time duration of 16.6 ms.

Calculating the reciprocal of time duration:

$$\text{Frequency} = \frac{1}{\text{Time Duration}} = \frac{1}{16.6 \text{ ms}} = 60 \text{ Hz}$$

RISE TIME

Rise-time measurements use the same methods as time duration, except that the measurements are made between the 10% and 90% points on the leading edge of the waveform (see Figure 6-6). Fall time is measured between the 90% and 10% points on the trailing edge of the waveform.

1. Preset instrument controls and obtain a baseline trace.
2. Apply an exact 5-division signal to either vertical-channel input connector and set the VERTICAL MODE

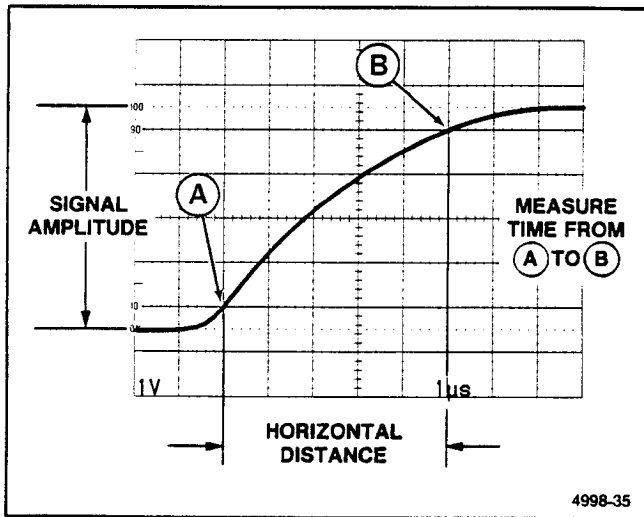

Figure 6-6. Rise time.

switches to display the channel used. Ensure that the VOLTS/DIV Variable control is in the CAL detent.

NOTE

For rise time greater than 0.2 μs, the VOLTS DIV Variable control may be used to obtain an exact 5-division display.

3. Set the TRIGGER SLOPE switch to OUT. Use a sweep-speed setting that displays several complete cycles or events (if possible).

4. Adjust the vertical positioning so that the zero reference of the waveform touches the 0% graticule line and the top of the waveform touches the 100% graticule line (see Figure 6-6).

5. Set the SEC/DIV switch for a single-waveform display, with the rise time spread horizontally as much as possible.

6. Horizontally position the display so the 10% point on the waveform intersects the second vertical graticule line (see Figure 6-6, Point A).

7. Measure the horizontal distance between the 10% and 90% points and calculate the time duration using the following formula:

$$\text{Rise Time} = \frac{\text{Horizontal Distance (Divisions)}}{\text{SEC/DIV Switch Setting Magnification Factor}} \times \text{SEC/DIV Switch Setting}$$

EXAMPLE: The horizontal distance between the 10% and 90% points is 5 divisions (see Figure 6-6), and the SEC/DIV switch is set to 1 μs. The X10 magnifier knob is pushed in (X1 magnification).

Substituting the given values in the formula:

$$\text{Rise Time} = \frac{5 \text{ div} \times 1 \mu\text{s/div}}{1} = 5 \mu\text{s}$$

TIME DIFFERENCE BETWEEN TWO TIME-RELATED PULSES

The calibrated sweep speed and dual-trace features of the instrument allow measurement of the time difference between two separate events. To measure time difference, use the following procedure:

1. Preset instrument controls and obtain a baseline trace.

2. Set the TRIGGER INT switch to CH 1.

3. Set both AC-GND-DC switches to the same position, depending on the type of input coupling desired.

4. Using either probes or cables with equal time delays, connect a known reference signal to the Channel 1 input and the comparison signal to the Channel 2 input.

5. Set both VOLTS/DIV switches for 4- or 5-division displays.

6. Select BOTH VERTICAL MODE; then select either ALT or CHOP, depending on the frequency of the input signals.

7. Adjust the TRIGGER LEVEL control for a stable display.

8. Set the SEC/DIV switch to a sweep speed which provides three or more divisions of horizontal separation between the reference points on the two displays. Center each of the displays vertically (see Figure 6-7).

9. Measure the horizontal difference between the two signal reference points and calculate the time difference using the following formula:

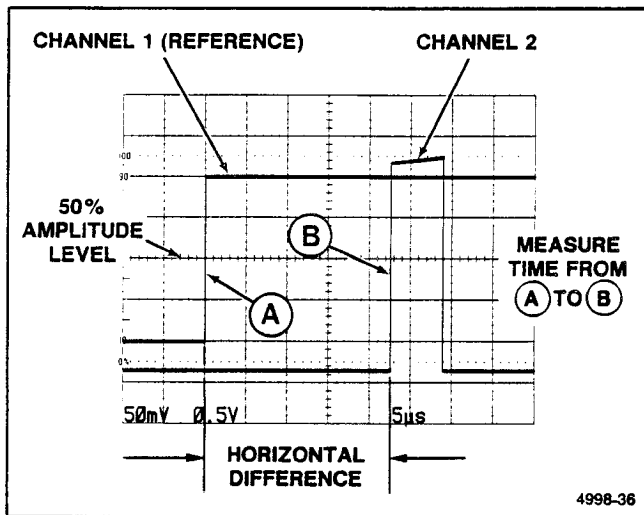

Figure 6-7. Time difference between two time-related pulses.

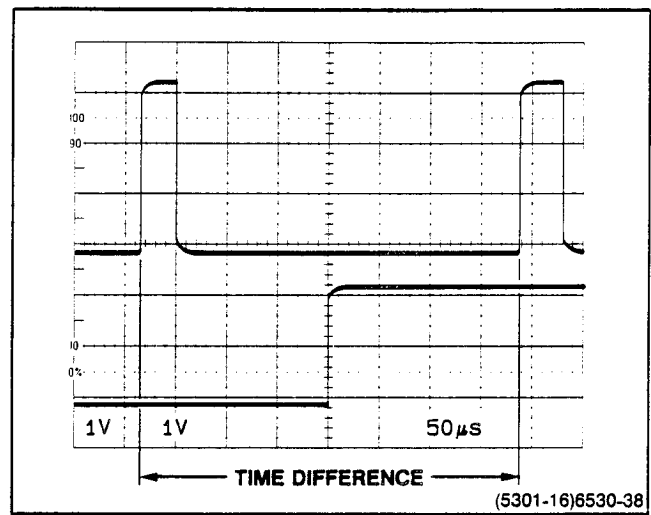

Figure 6-8. Time difference between repetitive pulses.

$$\text{Time Difference} = \frac{\text{SEC/DIV} \times \text{Horizontal Difference (Divisions)}}{\text{Switch Setting} \times \text{Magnification Factor}}$$

EXAMPLE: The SEC/DIV switch is set to 50 µs, the X10 magnifier knob is pulled out, and the horizontal difference between waveform measurement points is 4.5 divisions.

Substituting the given values in the formula:

$$\text{Time Difference} = \frac{50 \mu\text{s}/\text{div} \times 4.5/\text{div}}{10} = 22.5 \mu\text{s}$$

TIME DIFFERENCE BETWEEN REPETITIVE PULSES

1. Preset instrument controls and obtain a baseline trace.
2. Select a VOLTS/DIV switch setting that gives about 5 divisions of display amplitude.
3. Use the selected channel Vertical POSITION control to center the display.
4. Set the SEC/DIV switch to display the points of interest between which the measurement is to be made.
5. Read the time difference between pulses at the points of interest (see Figure 6-8).

PHASE DIFFERENCE

In a manner similar to "Time Difference," phase comparison between two signals of the same frequency can be made using the dual-trace feature of the instrument. This method of phase difference measurement can be used up to the frequency limit of the vertical system. To make a phase comparison, use the following procedure:

1. Preset instrument controls and obtain a baseline trace, then set the TRIGGER INT switch to CH 1.
2. Set both AC-GND-DC switches to the same position, depending on the type of input coupling desired.
3. Using either probes or coaxial cables with equal time delays, connect a known reference signal to the Channel 1 input and the unknown signal to the Channel 2 input.
4. Select BOTH VERTICAL MODE; then select either ALT or CHOP, depending on the frequency of the input signals. The reference signal should precede the comparison signal in time.
5. If the two signals are of opposite polarity, press in the Channel 2 INVERT button to invert the Channel 2 display.
6. Set both VOLTS/DIV switches and both Variable controls so the displays are equal in amplitude.

7. Adjust the TRIGGER LEVEL control for a stable display.

8. Set the SEC/DIV switch to a sweep speed which displays about one full cycle of the waveforms.

9. Position the displays and adjust the SEC/DIV Variable control so that one reference-signal cycle occupies exactly eight horizontal graticule divisions at the 50% rise-time points (see Figure 6-9). Each division of the graticule now represents 45° of the cycle ($360^\circ \div 8$ divisions), and the horizontal graticule calibration can be stated as 45° per division.

10. Measure the horizontal difference between corresponding points on the waveforms at a common horizontal graticule line (50% of rise time) and calculate the phase difference using the following formula:

$$\text{Phase Difference} = \frac{\text{Horizontal Difference (Divisions)}}{\text{Horizontal Graticule Calibration (deg/div)}}$$

EXAMPLE: The horizontal difference is 0.6 division with a graticule calibration of 45° per division as shown in Figure 6-9.

Substituting the given values into the phase difference formula:

$$\text{Phase Difference} = 0.6 \text{ div} \times 45^\circ/\text{div} = 27^\circ$$

More accurate phase measurements can be made by using the X10 Magnifier to increase the sweep speed without changing the SEC/DIV Variable control setting.

EXAMPLE: If the sweep speed were increased 10 times with the magnifier (X10 Magnifier out), the magnified horizontal graticule calibration would be 45°/division divided by 10 (or 4.5°/division). Figure 6-10 shows the same signals illustrated in Figure 6-9, but magnifying the displays results in a horizontal difference of 6 divisions between the two signals.

Substituting the given values in the phase difference formula:

$$\text{Phase Difference} = 6 \text{ div} \times 4.5^\circ/\text{div} = 27^\circ$$

TIME COMPARISON

In a similar manner to "Amplitude Comparison," repeated time comparisons between unknown signals and a reference signal (e.g., on assembly-line test) may be easily and accurately measured with the instrument. To accomplish this, a reference signal of known time duration is first set to an exact number of horizontal divisions by adjusting the SEC/DIV switch and the SEC/DIV Variable control. Unknown signals can then be compared with the reference signal without disturbing the setting of the SEC/DIV Variable control. The procedure is as follows:

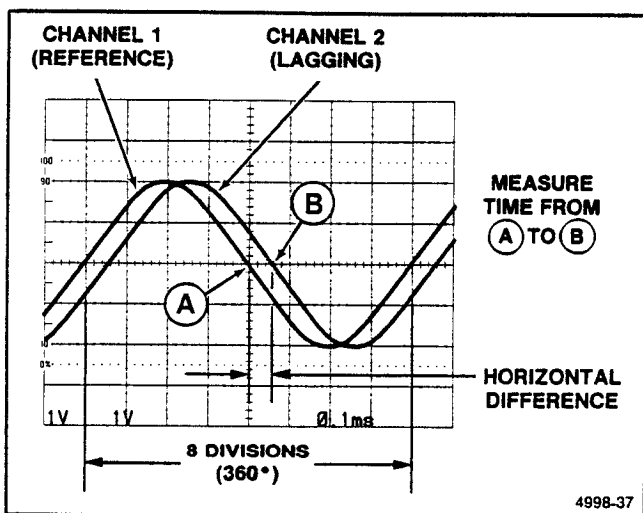

Figure 6-9. Phase difference.

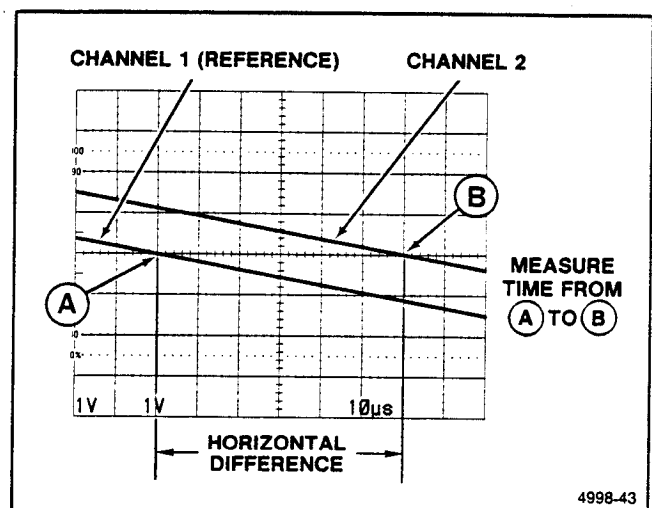

Figure 6-10. High-resolution phase difference.

Basic Applications—2221 Operators

1. Set the time duration of the reference signal to an exact number of horizontal divisions by adjusting the SEC/DIV switch and the SEC/DIV Variable control.

2. Establish a horizontal conversion factor, using the following formula (reference-signal time duration must be known):

$$\text{Horizontal Conversion Factor} = \frac{\text{Reference Signal Time Duration (Seconds)}}{\text{Horizontal Distance (Divisions)} \times \text{SEC/DIV Switch Setting}}$$

3. For the unknown signal, adjust the SEC/DIV switch to a setting that provides sufficient horizontal deflection to make an accurate measurement. Do not readjust the SEC/DIV Variable control.

4. Establish an arbitrary deflection factor, using the following formula:

$$\text{Arbitrary Deflection Factor} = \text{Horizontal Conversion Factor} \times \text{SEC/DIV Switch Setting}$$

5. Measure the horizontal distance of the unknown signal in divisions and calculate its time duration using the following formula:

$$\text{Time Duration} = \text{Arbitrary Deflection Factor} \times \text{Horizontal Distance (Divisions)}$$

EXAMPLE: The reference signal time duration is 2.19 ms, the SEC/DIV switch setting is 0.2 ms, and the SEC/DIV Variable control is adjusted to provide a horizontal distance of exactly 8 divisions.

Substituting the given values in the horizontal conversion factor formula:

$$\text{Horizontal Conversion Factor} = \frac{2.19 \text{ ms}}{8 \text{ div} \times 0.2 \text{ ms/div}} = 1.37$$

For the unknown signal the SEC/DIV switch setting is 50 μs , and one complete cycle spans seven horizontal divisions. The arbitrary deflection factor is then determined by substituting values in the formula:

$$\text{Arbitrary Deflection Factor} = 1.37 \times 50 \mu\text{s/div} = 68.5 \mu\text{s/div}$$

The time duration of the unknown signal can then be computed by substituting values in the formula:

$$\text{Time Duration} = 68.5 \mu\text{s/div} \times 7 \text{ div} = 480 \mu\text{s}$$

The frequency of the unknown signal is then calculated:

$$\text{Frequency} = \frac{1}{480 \mu\text{s}} = 2.083 \text{ kHz}$$

SLOPE

The slope of a particular portion of a waveform is the rate of change of voltage with respect to time. The following procedure is useful for making the measurements required to determine the slope of a portion of a waveform.

1. Preset instrument controls and obtain a baseline trace.

2. Set the VOLTS/DIV switch to obtain about 5 divisions of vertical amplitude.

3. Set the SEC/DIV switch to horizontally spread the portion of the waveform to be measured across the width of the graticule area (see Figure 6-11).

4. Read the voltage difference between the waveform points of interest.

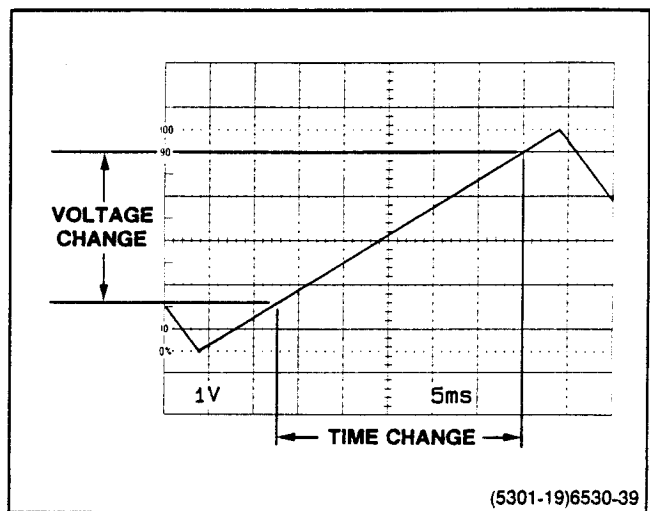

Figure 6-11. Slope.

5. Read the time difference between the two measurement points of interest.

6. Slope is determined by using the measured voltage and time to calculate the rate of change using the following formula:

$$\text{Slope (rate of change)} = \frac{\text{Change in voltage}}{\text{Change in time}}$$

As an example, in Figure 6-11, the voltage difference between the measurement points is 1.74 V, and the time difference is 5.42 ms.

Substituting these values into the formula:

$$\text{Slope} = \frac{1.74}{5.42 \text{ ms}} = 0.32 \text{ V/ms}$$

TV LINE SIGNAL

The following procedure is used to display a TV Line signal:

1. Preset instrument controls and select P-P AUTO/TV LINE TRIGGER Mode.
2. Apply the TV signal to either vertical-channel input connector and set the VERTICAL MODE switches to display the channel used.
3. Set the appropriate VOLTS/DIV switch to display 0.3 division or more of composite video signal.
4. Set the SEC/DIV switch to 10 μ s.
5. Set the TRIGGER SLOPE switch to either OUT (for positive-going TV signal sync pulses) or IN (for negative-going TV signal sync pulses).

NOTE

To examine a TV Line signal in more detail, use the X10 Magnifier.

TV FIELD SIGNAL

The television feature of the instrument can also be used to display TV Field signals.

1. Preset instrument controls and obtain a baseline trace.
2. Set the TRIGGER Mode switch to TV FIELD (P-P AUTO and NORM buttons both pushed in) and set the SEC/DIV switch to 2 ms.
3. To display a single field, connect the TV signal to either vertical-channel input connector and set the VERTICAL MODE switch to display the channel used.
4. Set the appropriate VOLTS/DIV switch to display 2.5 divisions or more of composite video signal.
5. Set the TRIGGER SLOPE switch to either OUT (for positive-going TV signal sync pulses) or IN (for negative-going TV signal sync pulses).
6. To change the field that is displayed, momentarily interrupt the trigger signal by setting the AC-GND-DC switch to GND and then back to AC until the desired field is displayed.

NOTE

To examine a TV Field signal in more detail, use the X10 Magnifier.

7. To display either Field 1 or Field 2 individually, connect the TV signal to both CH 1 and CH 2 input connectors and select BOTH and ALT VERTICAL MODE.
8. Set the SEC/DIV switch to a faster sweep speed (displays of less than one full field). This will synchronize the Channel 1 display to one field and the Channel 2 display to the other field.

MAKING DIGITAL STORAGE MEASUREMENTS

The following procedures will enable the operator to perform some basic measurements and familiarize the operator with digital storage measurement techniques.

AC PEAK-TO-PEAK VOLTAGE USING CURSORS

NOTE

Either channel input connector may be used for the signal input. Use the VERTICAL MODE switches to select the appropriate channel for display.

1. Preset instrument controls and obtain a baseline trace.
2. Set the STORE/NON-STORE switch to the STORE position (button in).
3. Select a VOLTS/DIV switch setting that gives the desired vertical deflection.
4. Set the SEC/DIV switch to display several cycles of the waveform.
5. Two cursors are displayed on the waveform to be measured. The boxed cursor is the active (selected) cursor.
6. Use the CURSORS control to move the active cursor to either peak of the waveform.
7. Push the SELECT C1/C2 button to select the other cursor, and use the CURSORS control to move the cursor to the opposite peak of the waveform (see Figure 6-12).

NOTE

After the waveform is acquired, the SAVE Storage mode may be selected. This mode holds the waveform frozen and reduces the amount of cursor jitter seen in the display. The SAVE display may be expanded horizontally and vertically for a more detailed examination of the waveform (see SAVE Mode Display).

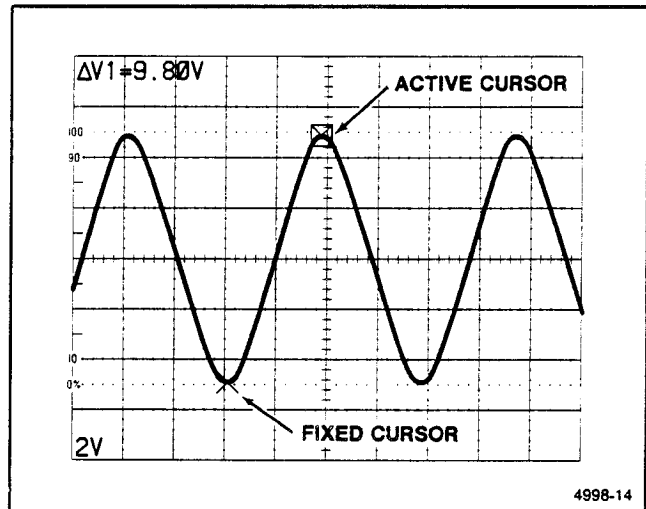

Figure 6-12. Ac peak-to-peak voltage, cursor method.

8. Read the peak-to-peak amplitude from the DELTA VOLTS readout. If the VOLTS/DIV Variable control is out of the calibrated detent, the DELTA VOLTS readout switches to RATIO.

GROUND REFERENCED DC VOLTAGE

NOTE

Either channel input connector may be used for the signal input. Use the VERTICAL MODE switches to select the appropriate channel for display.

1. Preset instrument controls and obtain a baseline trace.
2. Determine the polarity of the voltage to be measured as follows:
 - a. Set the AC-GND-DC switch to GND and vertically position the baseline trace to the center horizontal graticule line.

- b. Set the AC-GND-DC switch to DC.
- c. If the waveform moves above the center line of the crt, the voltage is positive. If the waveform moves below the center line of the crt, the voltage is negative.

3. Set the AC-GND-DC switch to GND and the STORE/NON-STORE switch to STORE mode (button in). If the channel signal is being used as the internal trigger source, ensure that the TRIGGER Mode switch is set to P-P AUTO.

4. Use the appropriate channel Vertical POSITION control to move the baseline trace to a convenient reference line. For example, if the voltage to be measured is positive, position the baseline trace to the bottom graticule line; if the voltage is negative, position the baseline trace to the top graticule line; and if the voltage is an alternating signal, position the baseline trace to the center graticule line.

NOTE

If the ground reference is set more than ±5 divisions from the center horizontal graticule line, the ground reference will not be stored. When using ADD VERTICAL MODE, both channel input coupling switches must be in GND to store a ground reference.

5. Set the selected channel AC-GND-DC switch to DC. An intensified ground reference dot is visible at the left edge (the first sample location of the waveform display) of the crt graticule.

NOTE

If the vertical position of the display is moved after the ground reference is stored, the displayed ground reference is no longer a valid reference. Also, the accuracy of the ground reference is affected by dc offsets due to thermal drift and balance (DC and INVERT) adjustments. Additionally, if the AC-GND-DC switch is set to AC, the location of the ground reference indicates the average value of the ac component of a waveform.

6. Use the CURSORS control to move the active cursor to the ground reference point.

7. Push the SELECT C1/C2 button to select the other cursor. The nonmoving cursor is now the 0-volt reference for making measurements on the waveform.

8. Use the CURSORS control to move the active cursor to the point of interest on the waveform (see Figure 6-13).

9. Read the dc voltage from the readout.

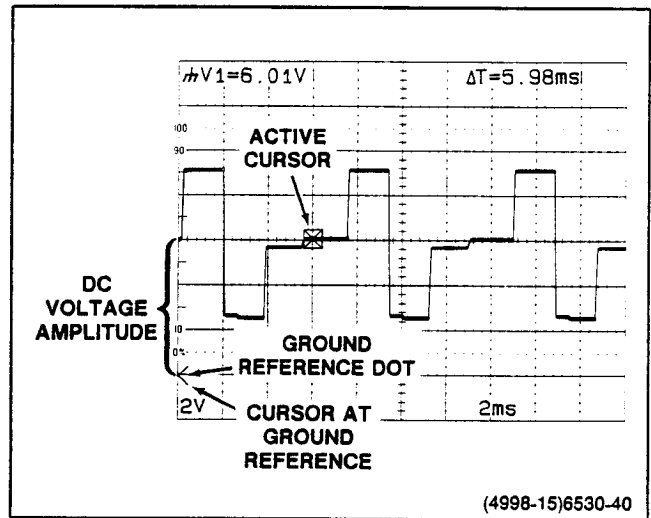

Figure 6-13. Ground referenced dc voltage, cursor method.

TIME DURATION

1. Preset instrument controls and obtain a baseline trace.

2. Set the STORE/NON-STORE switch to the STORE position (button in).

3. Select a VOLTS/DIV switch setting that gives the desired vertical deflection.

4. Set the SEC/DIV switch to display one complete period of the waveform to be measured (see Figure 6-14).

5. If necessary, use the $\Delta T/1/\Delta T$ button to set the time measurement mode to DELTA TIME (at power-up, the default is DELTA TIME).

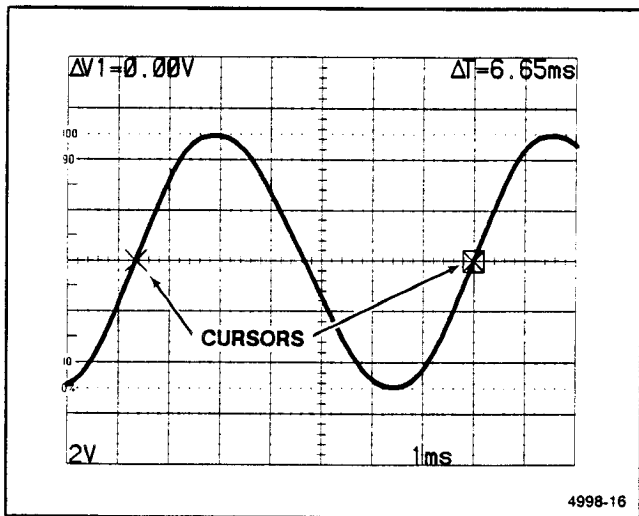

Figure 6-14. Time duration, cursor method.

6. Use the CURSORS control to move the active cursor to the start of the time to be measured.

7. Push the SELECT C1/C2 button to select the other cursor, and use the CURSORS control to move the cursor to the end of the time to be measured.

8. Read the time duration (between the cursors) from the crt readout.

FREQUENCY

1. Preset instrument controls and obtain a baseline trace.

2. Set the STORE/NON-STORE switch to the STORE position (button in).

3. Select a VOLTS/DIV switch setting that gives the desired vertical deflection.

4. Set the SEC/DIV switch to display one complete period of the waveform to be measured.

5. Use the $\Delta T/1/\Delta T$ button to set the time measurement mode to $1/\Delta T$ TIME.

6. Use the CURSORS control to move the active cursor to the start of the frequency to be measured.

7. Push the SELECT C1/C2 button to select the other cursor, and use the CURSORS control to move the cursor to the end of the frequency to be measured.

8. Read the frequency (between the cursors) from the crt readout.

RISE TIME

Rise-time measurements use the same methods as time duration, except that the measurements are made between the 10% and 90% points on the leading edge of the waveform. Fall time is measured between the 90% and 10% points on the waveform trailing edge.

1. Preset instrument controls and obtain a baseline trace.

2. Set the STORE/NON-STORE switch to the STORE position (button in).

3. Select the appropriate display window and Trigger SLOPE settings that will display the leading edge of the waveform at the start of the trace.

4. Set the SEC/DIV switch for a single-event display, with the rise time spread horizontally as much as possible within the viewing area. The waveform's maximum and minimum levels must still be visible (see Figure 6-15).

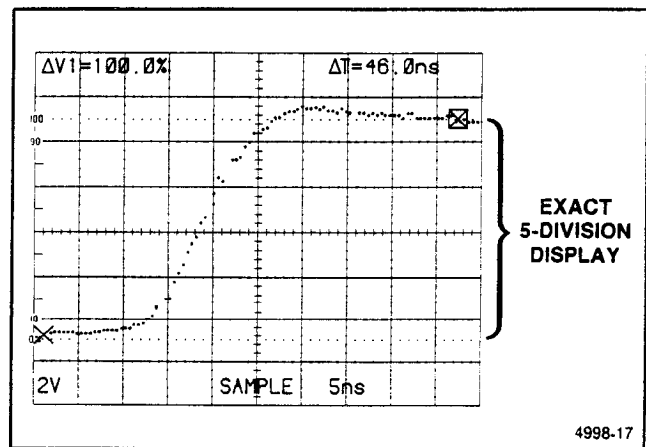

Figure 6-15. Rise-time setup, five-division display.

NOTE

Pulses with fast rise times have only a few sample points on the leading edge, and it may not be possible to place the cursor at exactly the 10%, 80%, 90%, or 100% points.

5. Use the CURSORS control to move the active cursor to the minimum level of the waveform.

6. Push the SELECT C1/C2 button to select the other cursor, and use the CURSORS control to move the active cursor to the maximum level of the waveform.

7. Set the VOLTS/DIV switch and the VOLTS/DIV Variable control (or signal amplitude) for a ΔV readout of 100%.

NOTE

The SAVE ACQUISITION mode button may be pressed in at this time to save the acquired waveform for as long as desired. Voltage and time measurements may be made on the SAVE waveform with less trigger jitter.

8. Use the CURSORS control to move the active cursor down the waveform's leading edge until the ΔV readout is 90%.

9. Push the SELECT C1/C2 button to select the other cursor, and use the CURSORS control to move the active cursor up the waveform's leading edge until the ΔV readout is 80% (see Figure 6-16).

10. Read the pulse rise time from the crt delta time readout.

WAVEFORM COMPARISON

Repeated comparisons of newly acquired signals with a reference signal for amplitude, timing, or pulse-shaped analysis may be easily and accurately made using the SAVE REF function of the instrument.

1. Preset instrument controls and obtain a baseline trace.

2. Set the STORE/NON-STORE switch to the STORE position (button in).

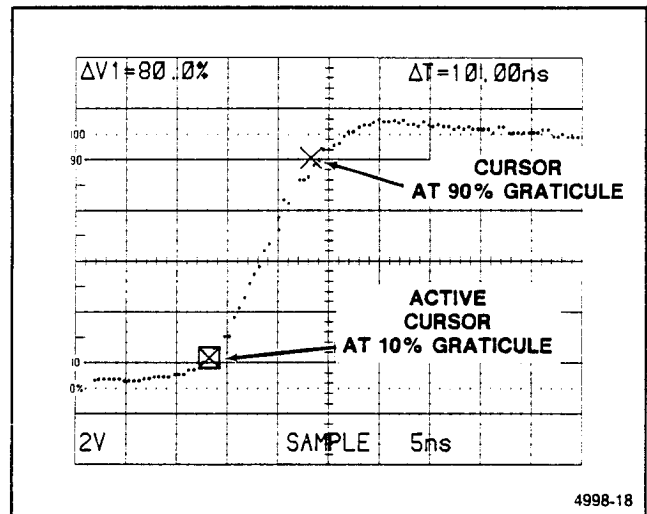

Figure 6-16. Rise time, cursor method.

3. Select a VOLTS/DIV switch setting that gives the desired vertical deflection.

4. Set the SEC/DIV switch to display the reference signal with the desired sweep rate.

5. Push the SAVE REF button.

6. Acquire the waveform that is to be compared with the reference waveform.

NOTE

A stored reference will remain displayed until the DISPLAY ON/OFF button is pushed. Switching the instrument to NON-STORE removes stored waveforms from the display, but the saved reference waveforms remain in the digital storage memory for use upon return to a storage mode. A new reference waveform is saved when the SAVE REF button is pushed.

7. Use the selected channel's Vertical POSITION control to overlay the newly acquired waveform on the reference waveform for making the comparison (see Figure 6-17). The vertical deflection and sweep rate remain calibrated to allow direct measurement from the graticule, or cursors may be used to determine voltage or time differences.

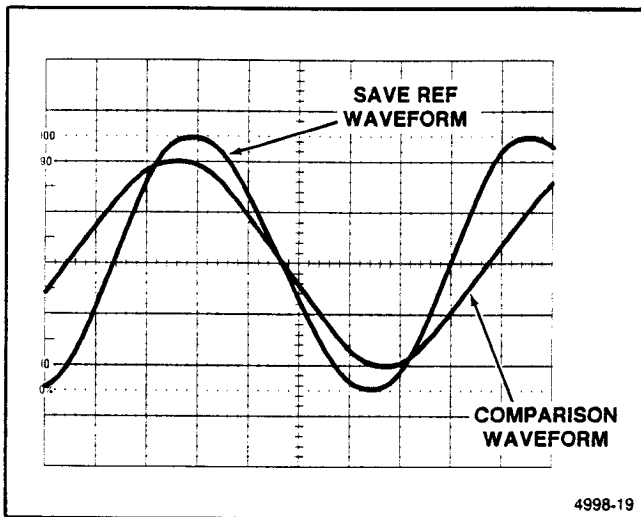

Figure 6-17. Waveform comparison.

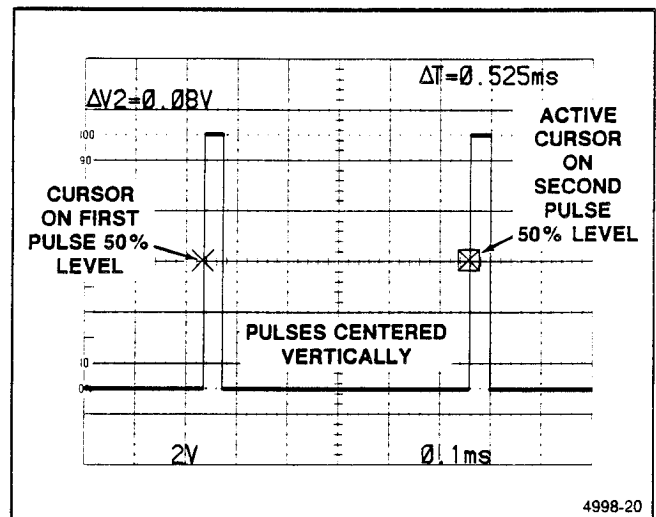

Figure 6-18. Time difference between repetitive pulses.

TIME DIFFERENCE BETWEEN REPETITIVE PULSES

1. Preset instrument controls and obtain a baseline trace.
2. Set the STORE/NON-STORE switch to the STORE position (button in).
3. Select a VOLTS/DIV switch setting that gives about five divisions of display amplitude.
4. Use the selected channel Vertical POSITION control to center the display.
5. Set the SEC/DIV switch to display the points of interest between which the measurement is to be made.
6. Push the SAVE/CONT button to activate SAVE mode to hold the acquired waveform and to provide a more stable display for measurement.
7. Use the CURSORS control to move the active cursor to the 50% level on the leading edge of the first pulse.
8. Push the SELECT C1/C2 button to select the other cursor and use the CURSORS control to move the active cursor to the 50% level on the leading edge of the second pulse (see Figure 6-18).

NOTE

Pulses with fast rise times have only a few sample points on the leading edge, and it may not be possible to place the cursor dot at exactly the 50% level.

9. Read the time difference between pulses from the crt readout.

TIME DIFFERENCE BETWEEN TWO TIME-RELATED PULSES

1. Set the VERTICAL MODE switches to BOTH and ALT.
2. Use probes or coaxial cables with equal time delay to apply the pulse signals to be measured to the input connectors; one to Channel 1 and the second to Channel 2.
3. Set the VOLTS/DIV switches to obtain about three divisions of display amplitude for each signal.
4. Set the STORE/NON-STORE switch to STORE (button in), set the TRIGGER Mode switch to NORM, set the SOURCE switch to INT, and set the INT switch to CH 1.
5. Adjust the TRIGGER LEVEL and SLOPE control for a continuous, triggered acquisition of the signals.

PHASE DIFFERENCE BETWEEN SINUSOIDAL SIGNALS

6. Set the SEC/DIV switch to obtain a display of the measurement points on the two pulses between which the measurement is to be made.

7. Set the trigger position as required to obtain the entire pulse display.

8. Press the SAVE/CONT switch to activate SAVE mode to save the waveform and to present a more stable display for measurement. Cursors will appear on both the Channel 1 and Channel 2 traces.

9. Use the CURSORS control to move the active cursor to the 50% point of the Channel 1 pulse leading edge.

NOTE

Pulses with a fast rise time have only a few sample points on the leading edge, and it may not be possible to place the dot at exactly the 50% level on the leading edge.

10. Push the SELECT C1/C2 button to select the other cursor, and use the CURSORS control to position the active cursor at the 50% level of leading edge of the Channel 2 pulse (see Figure 6-19).

11. Read the time difference between the pulses from the crt readout.

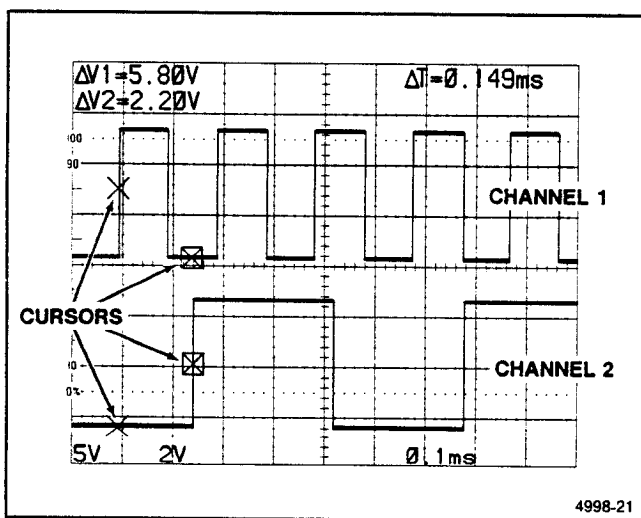

Figure 6-19. Time difference between two time-related pulses.

1. Preset instrument controls and obtain a baseline trace.

2. Using probes or coaxial cables with equal time delay, connect the reference signal to the CH 1 OR X input connector and the other (phase-shifted) signal to the CH 2 OR Y input connector.

3. Select a VERTICAL MODE of BOTH and ALT or CHOP, depending on the input signal frequencies.

4. Set the INT switch to the CH 1 position and adjust the TRIGGER LEVEL control and the TRIGGER SLOPE control for a stable, triggered display.

5. Use a SEC/DIV switch setting that displays about two cycles of each input signal.

6. Set the STORE/NON-STORE switch to the STORE position (button in).

7. Check that the TRIGGER LEVEL control is adjusted for a stable, triggered acquisition.

NOTE

Use the NORM Trigger Mode for low-repetition-rate signals (below approximately 20 Hz). This ensures that the storage window and trigger signal are synchronized when the trace is triggered.

8. Set both VOLTS/DIV switches and adjust the VOLTS/DIV Variable controls to obtain a 5-division vertical display of each input signal.

NOTE

Use the Vertical POSITION controls in conjunction with the VOLTS/DIV Variable controls to vertically center the 5-division display between the 0% and 100% dotted reference graticule lines.

9. Set the trigger position and TRIGGER SLOPE switch as necessary to place the measurement points within the graticule area (see Figure 6-20A).

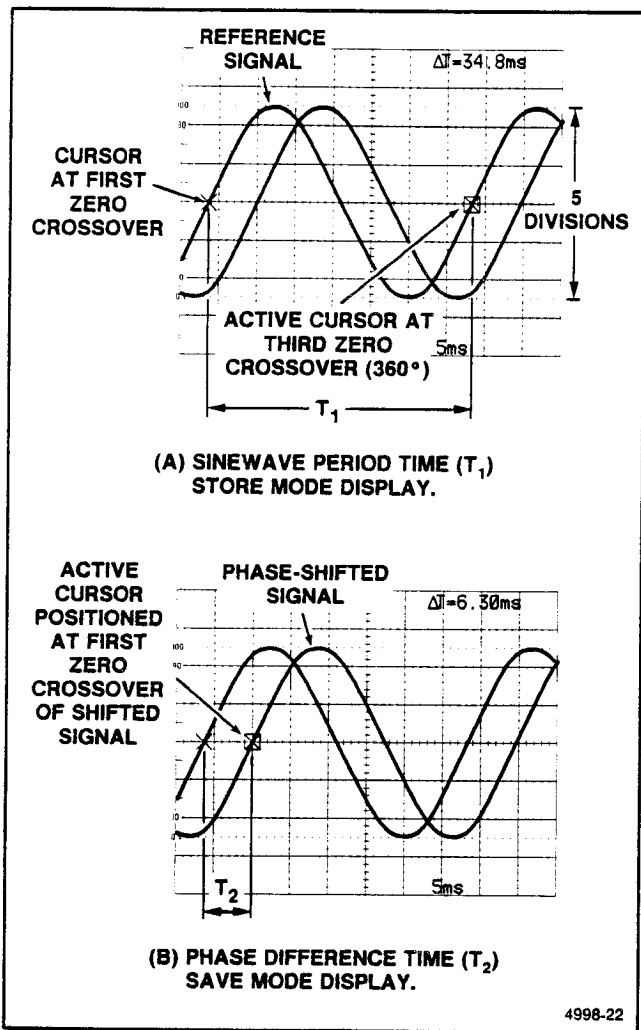

Figure 6-20. Phase difference between sinusoidal signals.

10. Push the SAVE/CONT switch to activate SAVE mode.

11. Use the CURSORS control to move the active cursor to the sine wave's first zero-crossover point (center horizontal graticule line).

12. Push the SELECT C1/C2 button to select the other cursor, and use the CURSORS control to position the active cursor to the sine wave's third zero-crossover point (360°).

13. Note the time of the sine-wave period (T_1) from the crt readout.

14. Use the CURSORS control to position the active cursor to the first zero-crossover point of the phase-shifted signal (see Figure 6-20B).

15. Note the phase-difference time (T_2) from the crt readout.

16. The amount of phase shift in degrees is calculated from the following formula:

$$\text{Phase shift (degrees)} = \frac{T_2}{T_1} \times 360^\circ$$

EXAMPLE: The period (T_1) of the reference signal shown in Figure 6-20 is 34.8 ms, and the phase-difference time (T_2) is 6.3 ms.

Substituting these values into the equation:

$$\text{Phase Shift (degrees)} = \frac{6.3 \times 10^{-3} \text{ s}}{34.8 \times 10^{-3} \text{ s}} \times 360^\circ = 65.17^\circ$$

SLOPE

The slope of a particular portion of a waveform is the rate of change of voltage with respect to time. The following procedure is useful for making the measurements required for determining the slope of a portion of a waveform.

1. Preset instrument controls and obtain a baseline trace.

2. Set the STORE/NON-STORE switch to the STORE position (button in).

3. Set the VOLTS/DIV switch to obtain about five divisions of vertical amplitude.

4. Set the SEC/DIV switch to horizontally spread the portion of the waveform to be measured across the width of the graticule area (see Figure 6-21).

Substituting these values into the formula:

$$\text{Slope} = \frac{1.74 \text{ V}}{5.42 \text{ s}} = 0.32 \text{ V/s}$$

LOW-LEVEL SIGNAL MEASUREMENTS

A displayed signal acquired in STORE mode at 5 mV per division may be vertically expanded up to ten times. Figure 6-22 is an illustration of a 4 mV peak-to-peak signal being displayed at 2 mV per division. The stair-step pattern is due to the small changes of signal applied to the digitizing circuitry when STORE mode is used to acquire the waveform. The numerous spikes in the waveform are due to the noise accompanying the signal.

The AVERAGE Processing mode may be used to reduce, or even eliminate, the noise displayed with the signal. Even though the signal-level changes applied to the digitizing circuitry are small, processing of the average waveform data results in a smooth display of the signal.

Figure 6-23 is an illustration of the same signal level as displayed in Figure 6-22, but the waveform was averaged before being displayed. Low-level signals can be acquired in the same manner as explained in previous acquisition procedures. External triggering may be helpful for producing a stable display if the amplitude of the signal being acquired is very low. All measurement procedures described in the preceding part of this manual are also valid for low-level signals.

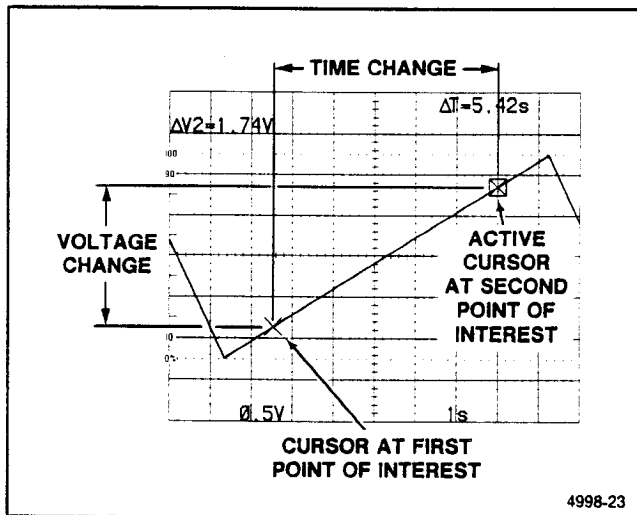

Figure 6-21. Slope using cursors.

5. Press the SAVE/CONT switch to activate SAVE mode to save the acquired waveform and to provide a more stable display for measurement.
6. Use the CURSORS control to move the active cursor to the first point of interest.
7. Push the SELECT C1/C2 button to select the other cursor, and use the CURSORS control to position the cursor to the second point of interest.
8. Read the voltage difference between cursors from the crt readout.
9. Read the time difference between the two measurement points from the crt readout.
10. Slope is determined by using the measured voltage and time to calculate the rate of change using the following formula:

$$\text{Slope (rate of change)} = \frac{\text{Change in voltage}}{\text{Change in time}}$$

As an example, in Figure 6-21, the voltage difference between the measurement points is 1.74 V, and the time difference is 5.42 s.

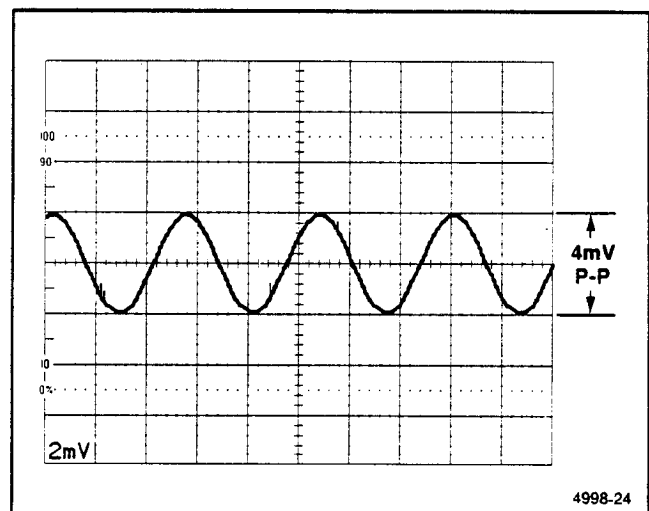

Figure 6-22. Low-level signal, STORE mode.

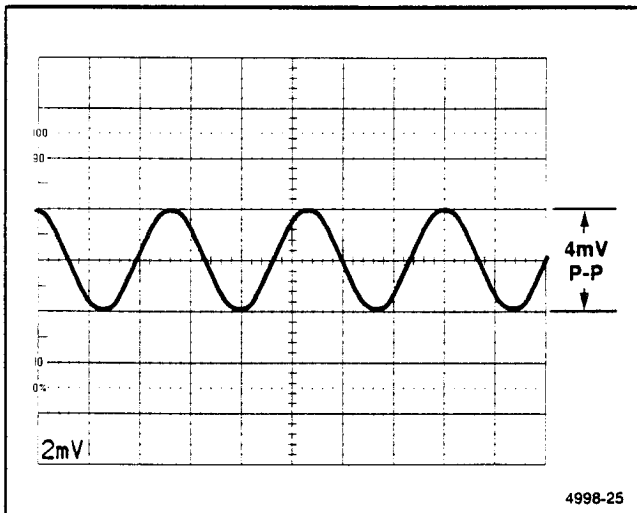

Figure 6-23. Low-level signal, AVERAGE mode.

OBSERVING AND REMOVING ALIASES IN STORE MODE

Aliasing

This discussion assumes the acquisition mode is set to SAMPLE. In digital sampling, the accuracy of the reproduced waveform, when displayed, increases with the number of samples obtained during one full cycle of the signal. That is, a more accurate reproduction of a signal is possible when more samples of the signal are obtained. The instrument displays 1000 samples across the full 10 horizontal divisions of the graticule when in the STORE mode. This means that a sine wave spread across the full screen is sampled 1000 times, but if the sine wave is only one graticule division in width, it will be sampled one-tenth as many times (100 samples). This number is still adequate for accurate reproduction of the stored waveform.

If the SEC/DIV switch is set so that the entire sine-wave period fills one-tenth of a graticule division, it is sampled only 10 times during its acquisition. This means that only ten samples of the waveform will be available to reproduce the waveform for display. In theory, if a sine wave is sampled at least two times during its period, it may be accurately reproduced. In practice, the sine wave can be reconstructed, using special filters, from slightly more than two samples.

At 5 μ s per division, the instrument's SAMPLE mode has a useful storage bandwidth of 2 MHz and a maximum sampling rate of 20 MHz. Consequently, a signal at the upper frequency limit is sampled a minimum of 10 times

during the complete sine-wave period (20 times for 2 periods), and the waveform will be accurately reproduced.

If the input frequency is increased beyond 8 MHz, the samples will soon become less than two times per period. This occurs at 10 MHz for a 20 MHz sample rate. Past this point, information sampled from two different sine-wave periods would be used to reconstruct the displayed waveform. Obviously, this waveform could not be a correct reproduction of the input signal. At certain input frequencies the data sampled would reproduce what appears to be a correct display, when in fact it was only related to the input signal by some multiple or part of a multiple of the input signal. This type of display is one type of "alias" (see Figure 6-24A).

The example given is for the maximum sampling rate of 20 MHz. However, the sampling rate is controlled by the SEC/DIV switch, and whenever it is set so that the input signal is sampled less than 10 times per period of the fastest frequency component, observable aliases occur.

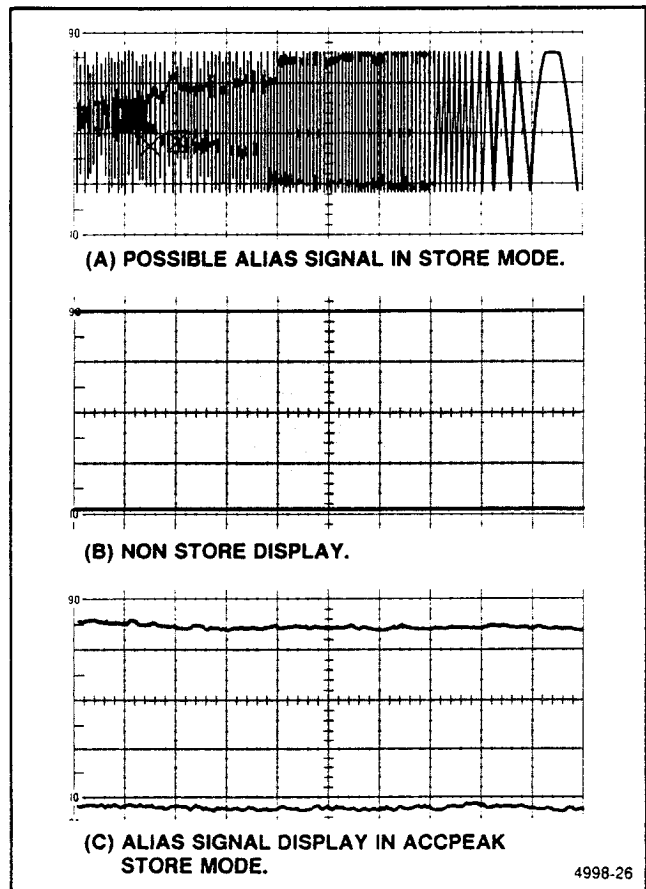

Figure 6-24. Anti-aliasing.

Anti-Aliasing

In the event that an alias is suspected, three things may be done to determine whether the display is of an alias. The first is to switch back to NON-STORE mode to determine if the input signal is higher in frequency than the apparent signal being displayed (see Figure 6-24B). Ensure that this display is being triggered as indicated by the TRIG'D LED being illuminated. The second is to use either the ACCPEAK or the PEAKDET storage modes (PEAKDET is the default mode for SEC/DIV settings from 5 s per division to 20 μ s per division), which hold the maximum and minimum points being acquired. PEAKDET storage mode holds the maximum and minimum points acquired in a single trigger cycle, and ACCPEAK accumulates the maximum and minimum points acquired over many trigger cycles. Since the maximum and minimum points of the alias waveform do not occur at exactly the same point in relation to the trigger each time, the display soon acquires maximum and minimum amplitude levels in every storage address and the top and bottom of the alias display become flat lines (see Figure 6-24C).

Third, if an alias is detected, the SEC/DIV switch may be set for a faster sweep rate so that the number of samples per cycle of the input signal is increased. However, at sweep speeds of 2 μ s per division and faster, the sampling rate is not increased; and if an alias signal is still present at 5 μ s per division, the frequency limit of the digital circuitry has been exceeded for nonrepetitive signals. When the SEC/DIV switch is set for sweep speeds faster than 5 μ s/div, Repetitive Store acquisition mode and AVERAGE are selected. On repetitive signals, the random phase between successive triggers and the time-base clock suppress aliased waveform displays as a result of the increased effective sample rate.

Glitch Catching

Pulses that are present for a very short time duration during the viewing of longer pulse duration signals, such as a logic pulse train, may not be visible at the sweep speed in use (see Figure 6-25A). In digital logic circuitry, a small switching transient (glitch) may cross the logic threshold level and cause an error. Setting up the instrument to trigger on the error event should position the storage window to acquire the pulse train that contains the glitch.

To catch a glitch, first set the trigger position to pre-trigger. This will acquire 7/8 of a waveform occurring before the trigger. Select ACCPEAK mode using the ACQUISITION MODE switch. This will acquire the waveform maximum and minimum points over a selected number of sweeps. The location of the glitch will be displayed in the accumulative envelope display (see Figure 6-25B).

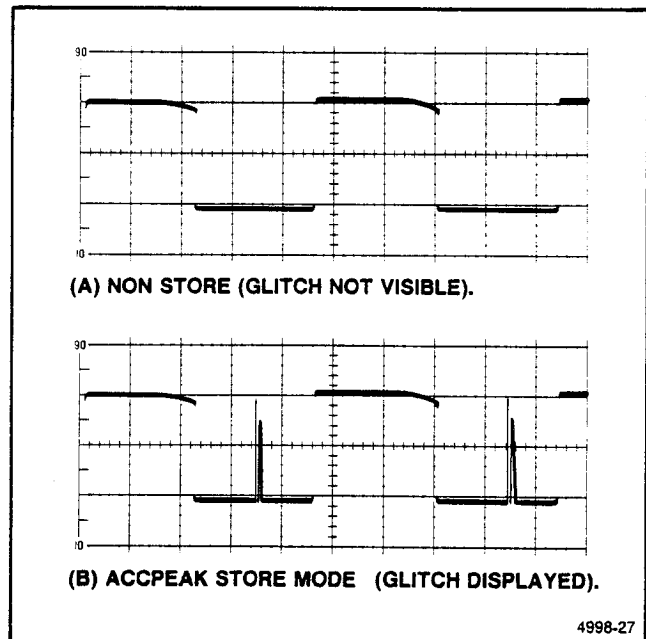

Figure 6-25. Glitch display, ACCPEAK Store mode.

Missing Pulse

ACCPEAK mode is useful for finding an intermittent pulse in a pulse train. The pulse may either be missing or present erratically. In either case, the change in amplitude levels is displayed as a completely filled in pulse (see Figure 6-26).

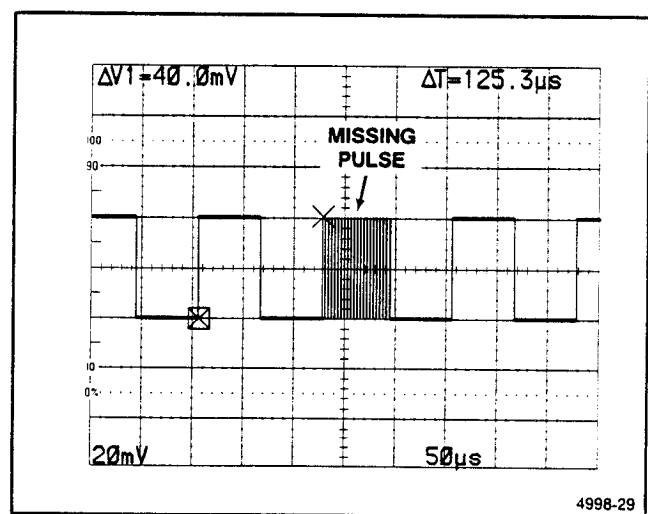

Figure 6-26. Missing pulse, ACCPEAK STORE mode.

Basic Applications—2221 Operators

1. Preset instrument controls and obtain a baseline trace.
2. Set the STORE/NON-STORE switch to the STORE position (button in).
3. Select the triggers, SEC/DIV setting, and storage window (pretrigger or posttrigger) to display the pulse train of interest.

4. Select ACCPEAK STORE mode using the ACQUISITION MODE switch.

If the waveform acquired is repetitive, each pulse in it will show only the pulse outline. A pulse missing or present part of the time will show a completely filled display at the pulse location. Pulse breakdown (erratic changes in amplitude or width) will also be displayed by this storage mode.

OPTIONS AND ACCESSORIES

INTRODUCTION

This section is divided into three subsections. The first contains a general description of available instrument options and the second is the operating instructions for the Option 10 and Option 12 Communications interfaces. The third subsection is the Command Lists, status-bytes and event codes, and waveform transmitting data common to both Communications Options. Also included in the first subsection is a complete list (with Tektronix part numbers) of standard accessories included with each instrument and a partial list of optional accessories. Additional information about instrument options, option availability, and other accessories can be obtained either by consulting the current Tektronix Product Catalog or by contacting your local Tektronix Field Office or representative.

GENERAL INFORMATION

STANDARD ACCESSORIES

The following standard accessories are provided with each instrument:

Qty	Description	Part Number
2	10X Probe packages	P6121
1	Power Cord	As Ordered
1	Operators Manual	070-6530-00
1	Users Reference Guide	070-6532-00
1	Front Panel Cover	200-2520-00
1	Accessory Pouch	016-0677-02
1	Fuse, 3AG, 2A, 250 V Slo-Blo	159-0023-00
1	DB-9 Female Connector and Connector Shell	131-3579-00
1	Loop Clamp	343-0003-00
1	Flat Washer	210-0803-00
1	Self-Tapping Screw	213-0882-00

OPTIONAL ACCESSORIES

The following optional accessories are recommended for use with the instrument.

Description	Part Number
Service Manual	070-6531-00
Probe Tips, IC grabber, (2 each for P612X probes)	013-0191-00
Rack Adapter	016-1003-00
Viewing Hood	016-0566-00
Carrying Strap	346-0199-00
Carrying Case	016-0792-01
C5C Option 04 Camera	
K117 Instrument Shuttle	
K212 Portable Instrument Cart	
1107 Dc Inverter	

INTERNATIONAL POWER CORD OPTIONS

Instruments are shipped with the detachable power-cord option ordered by the customer. Descriptive information about the international power-cord options is provided in Section 2, "Preparation for Use." The following list identifies the Tektronix option number for the available power cords.

Standard (or Option A0)	United States
Option A1	Universal Euro
Option A2	United Kingdom
Option A3	Australian
Option A4	North American
Option A5	Switzerland

OPTION 10

Option 10 provides a GPIB (General Purpose Interface Bus) communications interface and, with the 2230, additional memory. The interface implemented conforms to the specifications contained in *IEEE Standard Digital Interface for Programmable Instrumentation (ANSI/IEEE Std 488-1978)*. It also complies with a Tektronix Standard relating to GPIB Codes, Formats, Conventions and Features.

OPTION 12

Operating information for the Option 10 GPIB interface is given in the COMMUNICATION OPTION OPERATION subsection of this section.

Option 12 provides an RS-232-C serial communications interface and, with the 2230, additional memory. The interface implemented conforms to RS-232-C specifications. The option provides both DTE and DCE capability to aid in hooking up the various types of printers, plotters, personal computers, and modems that may be encountered. Operating information for the Option 12 RS-232-C interface is given in the COMMUNICATION OPTION OPERATION subsection of this section. Information regarding RS-232-C interconnection cables is given in Appendix B of this manual.

OPTION 33

Option 33, the Travel Line option, provides impact protection needed for rough industrial and service environments. When the instrument is ordered with Option 33, it comes equipped with the Accessory Pouch, the Front Panel cover, shock-absorbing rubber guards mounted on the front and rear of the cabinet, an easy-to-use power-cord wrap, and a carrying strap.

COMMUNICATIONS OPTION OPERATION

The communications options allow remote waveform acquisition and the transfer of waveform data both to and from the oscilloscope. Waveform data may also be directly output to compatible digital printers or plotters for producing hardcopies of the displayed signals.

Remote control and waveform transfer is accomplished by messages sent to the oscilloscope via one of the communication option interfaces. The Option 10 interface conforms to GPIB IEEE-488 bus standard and the Option 12 interface conforms to the standard for RS-232-C serial communication. Both options also conform to Tektronix standards on Codes, Formats, Conventions, and Features. In general, messages to the oscilloscope sent via the communication options have one of the following purposes:

1. Query the state of the oscilloscope.
2. Query the result of a measurement made.
3. Set or change the instrument's operating mode.
4. Request waveform data transfer.

ADVANCED FUNCTION MENU (for the 2230 only)

The following functions are available as part of the ADVANCED FUNCTIONS Menu on 2230 instruments containing either the GPIB or the RS-232-C option.

REFERENCE—Allows a non-volatile SAVE REF memory to be copied, deleted, or protected.

COPY—Selects and copies one non-volatile SAVE REF memory to another SAVE REF memory. Waveforms stored in the lettered extended memory locations (REFA through REFZ) must be moved to one of the numbered SAVE REF memory locations to be displayed. Waveform data to be retrieved from or written to an extended memory location must go through a numbered SAVE REF memory.

DELETE—Selects a non-volatile SAVE REF memory and erases the stored data if not locked.

PROTECT—Selects memory space to lock or unlock. Locked memory locations cannot be overwritten or deleted. Via the Communications interface, extended memory locations may be permanently protected to prevent them from being overwritten by the UNLOCK or DELETE menu functions.

COMM—Allows the selection of parameters for optional communications options, when they are present.

DATA—Selects the data-coding format (ASCII, HEX, or BINARY), source or destination target of the data (ACQ, REF1, REF2, REF3 or REF4), and channel selection (CH1 or CH2) for data transmissions.

STOP BITS—Selects the number of stop bits for RS-232-C data transmissions. (Stop bits are selected by interface command in the 2220 and 2221.) The usual choice for stop bits is 1, but some printers/plotters require two stop bits for some baud rates.

FLOW—Sets the data flow control over the interface ON and OFF. Binary waveform information cannot be sent with FLOW ON.

NON-VOLATILE EXTENDED MEMORY (for the 2230 only)

When either Communications option is installed in the 2230 DSO, extra battery-backed memory is also installed. Waveforms stored in the extra memory may be protected from overwriting or deleting (locked) using the Advanced Functions menu. Commands that are available via the communications interface can also lock that memory space. Memory spaces may be also made "permanent" via the Communications interface. Permanent waveforms cannot be overwritten, unlocked, or deleted by the operator with the Advanced Functions menu.

The extra memory provides 26 Kbytes of non-volatile waveform storage space. The memory is divided into 1 Kbyte locations labeled REFA through REFZ, but the number of actual waveforms that may be stored depends on the acquired waveform record length (1024 bytes or 4096 bytes) and acquisition mode (normal or average). Averaged waveforms require two bytes for each point so that an averaged 1 K waveform needs 2 Kbytes of non-volatile SAVE REF storage and an averaged 4 K waveform needs 8 Kbytes. Specifications for the non-volatile Extended Memory are given in Table 7-1.

OPTION 10 GPIB OPERATORS INFORMATION

The GPIB Communications Option complies with ANSI/IEEE Standard 488-1978. All other specifications for the instrument (including the performance conditions) are identical to those specified in "Specification" in Section 1 of this manual.

Standard Functions, Formats, and Features

The interface-function capabilities of a GPIB instrument, in terms of interface-function subsets, are identified in ANSI/IEEE Std 488-1978. The status of subsets applicable to this instrument with Option 10 are listed in Table 7-2.

The GPIB interface conforms to the Tektronix standard on Codes, Formats, Conventions, and Features of messages sent over the bus to communicate with other GPIB instruments. Specific format choices implemented in this instrument are listed in Table 7-3; specific features implemented are shown in Table 7-4.

**Table 7-1
Extended Memory Specification**

Characteristic	Performance Requirement
NON-VOLATILE EXTENDED MEMORY	
Available Waveform Memory	26 Kbytes.
Power Down	
Battery Voltage	Memory retained for battery voltages greater than 2.3 V.
Data Retention	Memory maintained greater than six months without instrument power.
Battery Life	Power down data-retention specification shall be maintained for three years without battery change with normal oscilloscope use.
Power Down Detection	
Threshold	Fail asserted for supply drop to less than 4.75 V. Reset held until supply is greater than 5.0 V.
Reset Delay	Power down interrupt to reset delay greater than or equal to 1 ms.

**Table 7-2
Function Subsets Implemented**

Function Subset	Capability	States Omitted	Other Requirements	Other Subsets Required
SH1 (Source Handshake)	Complete Capability	None	None	T6
AH1 (Acceptor Handshake)	Complete Capability	None	None	None
T6 (Talker)	Basic Talker, Serial Poll, Unaddress if MLA	None	Include [MLA (ACDS)]	SH1 and L3
L3 (Listener)	Basic Listener, Listen Only, Unaddress if MTA	None	Include [MTA (ACDS)]	AH1 and T6
SR1 (Service Request)	Complete Capability	None	None	T6
RL2 (Remote/Local)	No Local Lockout	LWLS and RWLS	None	L3
PP0 (Parallel Poll)	No Capability	All	None	None
DC1 (Device Clear)	Complete Capability (Selective Device Clear)	None	None	L3
DT0 (Device Trigger)	No Capability	All	None	None
C0 (Controller)	No Capability	All	None	None
E2 (Drivers)	Three-state			

Table 7-3
Specific Format Choices

Format Parameter	Choice Made
Format Characters	Not transmitted; ignored on reception.
Message Terminator	Either EOI or LF can be selected for message termination.
Measurement Terminator	Follows program message-unit syntax.
Link Data (Arguments)	Used in Listen and Talk.
Multiple Event Reporting	Not implemented to report all events on a single query. Multiple events may be reported by using multiple queries.
Instrument Identification Query	Descriptors added for all options.
Set Query	Extended by using other commands.
Device Trigger (DT)	Not implemented.
INIT Command	Causes the instrument to return to a default set up condition.
Time/Date Commands	Not implemented.
Stored Setting Commands	Not implemented.
Waveform Transmission	Implemented.
Return to Local (rtl)	Not implemented.
IEEE 728	Compliance not intended.

Option 10 GPIB Side Panel

The Option 10 instrument is supplied with the side panels shown in Figure 7-1. The Option 10 side panel includes one AUXILIARY connector, one GPIB (IEEE 488-1978) interface port, and one PARAMETERS switch. The Controls, Connectors, and Indicators part of this manual contains information on the use of the AUXILIARY Connector. Refer to Figure 7-1 for location of the Option 10 side-panel controls and connectors.

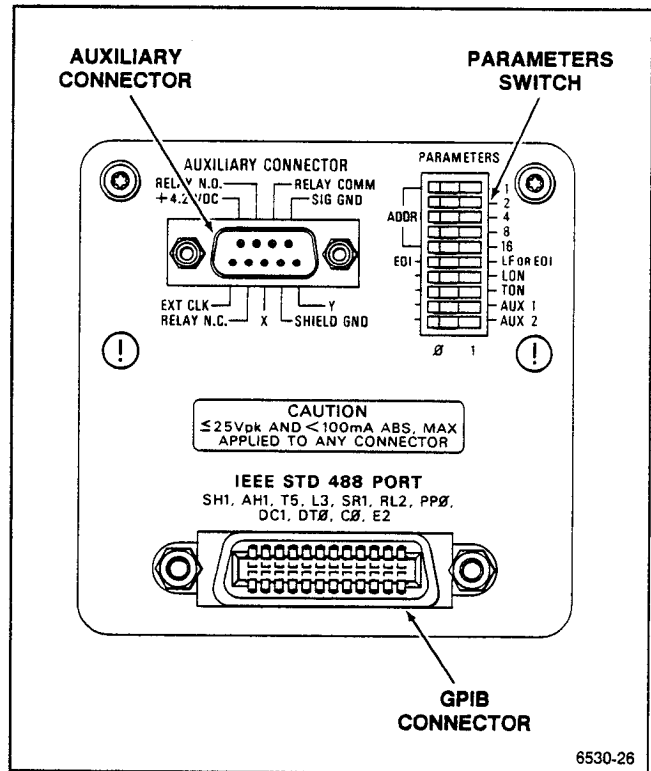

Figure 7-1. Option 10 side panel.

Table 7-4
Implementation of Specific Features

Feature	Choice Made	Comments
Secondary Addressing	Not implemented.	
Indicators	ADDR (addressed), SRQ (service request), and PLOT (acquisitions locked out) indicators are included.	
Parameter Selection	A ten-section switch sets the instrument's bus address, message terminator, listen-only or talk-only mode, and makes printer/plotter selections.	Switch settings are read only at power on.

Options and Accessories—2221 Operators

AUXILIARY Connector—Provides connections for an X-Y Plotter and an External Clock input (see Controls, Connectors, and Indicators).

GPIB Connector—Provides the ANSI/IEEE Std 488-1978 compatible electrical and mechanical connection to the GPIB. The connector is only on instruments with Option 10. The function of each pin of the connector is shown in Table 7-5.

GPIB PARAMETERS Switch—Allows the selection of setup options for the GPIB interface. The switch is read at power-up and when interface clear messages are received. Five sections of the switch select the GPIB address, one selects the terminator, two select talk/listen modes, and two are used for printer/plotter selection. The function of each switch section is shown in Table 7-6.

**Table 7-5
GPIB Connector**

Pin	Line Name	Description
1	DIO1	IEEE-488 Data I/O
2	DIO2	IEEE-488 Data I/O
3	DIO3	IEEE-488 Data I/O
4	DIO4	IEEE-488 Data I/O
5	EOI	IEEE-488 END or Identify
6	DAV	IEEE-488 Handshake
7	NRFD	IEEE-488 Handshake
8	NDAC	IEEE-488 Handshake
9	IFC	IEEE-488 Input
10	SRQ	IEEE-488 Output
11	ATN	IEEE-488 Input
12	SHIELD	System Ground (Chassis)
13	DIO5	IEEE-488 Data I/O
14	DIO6	IEEE-488 Data I/O
15	DIO7	IEEE-488 Data I/O
16	DIO8	IEEE-488 Data I/O
17	REN	IEEE-488 Input
18	GND	Digital Ground (DAV)
19	GND	Digital Ground (NRFD)
20	GND	Digital Ground (NDAC)
21	GND	Digital Ground (IFC)
22	GND	Digital Ground (SRQ)
23	GND	Digital Ground (ATN)
24	GND	Digital Ground (LOGIC)

**Table 7-6
GPIB PARAMETERS Switch**

Switch Section	Switch Position	Function
1	0	Address selection
	1	0 Binary weight = 1
2	0	Address selection
	1	0 Binary weight = 2
3	0	Address selection
	1	0 Binary weight = 4
4	0	Address selection
	1	0 Binary weight = 8
5	0	Address selection
	1	0 Binary weight = 16
6	0	Terminator selection
	1	EOI LF or EOI
7	0	No function
	1	LON (Listen only)
8	0	No function
	1	TON (Talk only)
9		Printer/plotter selection ^a
10		Printer/plotter selection ^a

^aSwitches 9 and 10 select printer/plotter devices at power-up. The devices may be changed after power-up using Option commands, or in the case of the 2230, the MENU controls. Two EPSON® formats are selectable. EPS7 uses seven print wires per head pass, and is usually slower. It is the chr\$(27) "L" mode. EPS8 uses eight print wires per head pass, and is usually the faster print-head speed. It is the chr\$(27) "Y" mode. In this mode, most Epson and Epson-compatible printers will not strike any print wire more often than every second pixel. EPS8 is selected when parity is disabled.

Printing/plotting devices are selected with the following switch positions:

Switch 9	Switch 10	Device Selected
0	0	HP-GL® plotter
1	0	Epson® EPS7 or EPS8
0	1	ThinkJet® printer
1	1	X-Y Plotter

HP-GL® and ThinkJet are trademarks of Hewlett-Packard Company. Epson is a trademark of Epson Corporation.

GPIB Parameter Selection

The correct selection of GPIB parameters (primary address, message terminator, and talk/listen mode) must be made before power on. That is when the GPIB PARAMETERS switch is read to determine what the address and other settings of the switch are. See Table 7-6 (shown previously) to determine the specific parameters switch settings.

PRIMARY ADDRESS—The selected GPIB address establishes the talk and listen address for the oscilloscope. It can be set to any value between 0 and 31, inclusive. Address 31 is "OFF LINE." With an address of 31, the instrument still presents an active load, but it neither responds to nor interferes with any bus traffic.

SECONDARY ADDRESS—Not implemented in the 2200 Family of digital storage oscilloscopes.

INPUT END-OF-MESSAGE TERMINATOR—The end-of-message terminator can be selected to be either the End-or-Identify (EOI) interface signal or the Line-Feed (LF) character.

When EOI (normal mode) is selected as the terminator, the instrument will:

- accept only EOI as the end-of-message terminator, and
- assert EOI concurrently with the last byte of a message.

When LF is selected as the terminator, the instrument will:

- accept either LF or EOI as the end-of-message terminator, and
- send Carriage Return (CR) followed by LF at the end of every message, with EOI asserted concurrently with the LF.

TALK/LISTEN MODE—Four talk/listen modes are selectable:

- **TALK ONLY** mode allows the instrument to send data over the GPIB.

- **LISTEN ONLY** mode permits the instrument to receive data over the GPIB.
- **TALK/LISTEN** mode (both TON and LON modes unselected) allows the instrument to both send and receive data over the GPIB.
- **OFF BUS** mode (both TON and LON modes selected) switches the instrument off the bus (same as setting address to 31).

To select a different Talk/Listen mode, see the GPIB PARAMETERS switch settings in Table 7-7. The new settings must be made before power on to be in effect.

Option 10 Interface Status Indicators

Three indicators appear in the CRT readout to indicate the status of the GPIB communication option. The indicators are labeled SRQ (service request pending), ADDR (addressed to talk), and PLOT (output data to the plotter) on the CRT bezel. The active indication is seen as an intensified line in the CRT display just below the associated label. Refer to Figure 7-2 for the location of the communications interface status indicators.

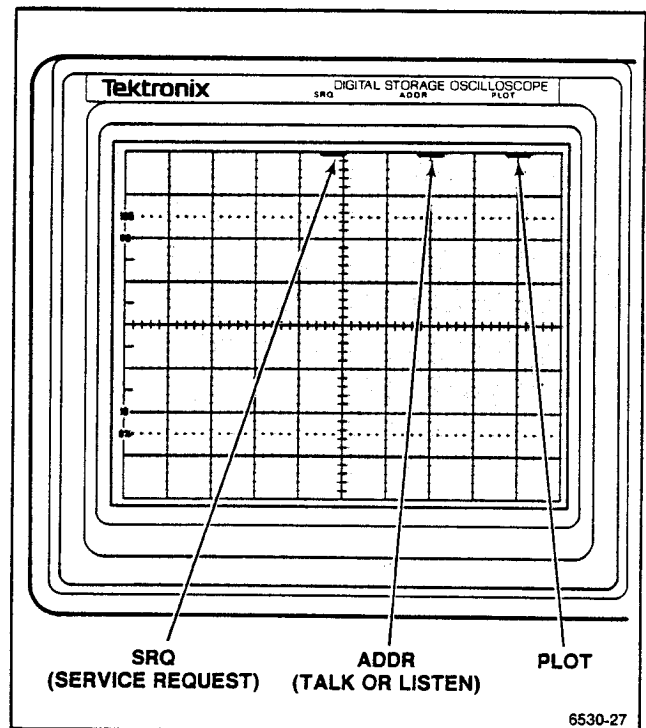

Figure 7-2. SRQ, ADDR, and PLOT indicators.

Options and Accessories—2221 Operators

SRQ Indicator—Indicates the communications option requires service by the controller. Service requests are cleared when the instrument has been polled for its status and no further warning or error conditions are pending. The communication option asserts a power-up service request (SRQ) when turned on. Other service requests are asserted as enabled by the RQS and OPC commands.

ADDR Indicator—Indicates the instrument is addressed to talk or listen.

PLOT Indicator—Indicates the communication option is currently sending waveform data over its interface and acquisitions are inhibited.

Instrument Response To Interface Messages

OPTION 10 GPIB. The following explain effects on the oscilloscope of standard interface messages received from a remote controller. Message abbreviations used are from ANSI/IEEE Std 488-1978.

LOCAL LOCKOUT (LLO)—Local Lockout is not supported by the instrument. In response to a LLO message via the GPIB interface, Option 10 generates an SRQ error.

REMOTE ENABLE (REN)—When Remote Enable is asserted and the instrument receives its listen address, the oscilloscope is placed in the Remote State (REMS). When in the Remote State, the oscilloscope's Addressed (ADDR) indicator is lit.

Unasserting REN causes a transition to LOCS; the instrument remains in LOCS as long as REN is false. The transition may occur after processing of a different message has begun. In this case, execution of the message being processed is not interrupted by the transition.

GO TO LOCAL (GTL)—Instruments that are already listen-addressed respond to GTL by assuming a local state. Remote-to-local transitions caused by GTL do not affect the execution of any message being processed when GTL was received.

MY LISTEN AND MY TALK ADDRESSES (MLA AND MTA)—The primary Talk/Listen address is established as previously explained in the GPIB Parameter Selection information.

UNLISTEN (UNL) AND UNTALK (UNT)—When the UNL message is received, the oscilloscope's listen function is placed in an idle (unaddressed) state. In the idle state, the instrument will not accept commands over the bus.

The talk function is placed in an idle state when the oscilloscope receives the UNT message. In this state, the instrument cannot transmit data via the interface bus.

INTERFACE CLEAR (IFC)—When IFC is asserted, both the Talk and Listen functions are placed in an idle state and the CRT ADDR indicator is turned off. This produces the same effect as receiving both the UNL and the UNT messages.

DEVICE CLEAR (DCL)—The DCL message reinitializes communication between the instrument and the controller. In response to DCL, the instrument clears any input and output messages as well as any unexecuted control settings. Also cleared are any errors and events waiting to be reported (except the power-on event). If the SRQ line is asserted for any reason (other than power-on), it becomes unasserted when the DCL message is received.

SELECTED DEVICE CLEAR (SDC)—This message performs the same function as DCL; however, only instruments that have been listen-addressed respond to SDC.

SERIAL POLL ENABLE AND DISABLE (SPE AND SPD)—The Serial Poll Enable (SPE) message causes the instrument to transmit its serial-poll status byte when it is talk-addressed. The Serial Poll Disable (SPD) message switches the instrument back to its normal operation.

Reset Under Communication Option Control

Some oscilloscope modes may be set to their default or power-on states by sending the INIt command via the communication option. The major settings that are affected by INIt are:

ACQUISITION REP:AVE
ACQUISITION HSREC:SAMPLE
ACQUISITION LSREC:PEAKDET
ACQUISITION SCAN:PEAKDET
ACQUISITION ROLL:PEAKDET
ACQUISITION SMOOTH:ON
ACQUISITION WEIGHT:4 (16 in the 2220 and 2221)
ACQUISITION NUMSWEEP:0
ACQUISITION VECTORS:ON
DATA ENCDG:BINARY
DATA SOURCE:ACQ
DATA TARGET:REF1 (REF4 in the 2220 and 2221)
PLOT GRAT:OFF
PLOT FORMAT:<power-on setting>
READOUT ON
Menu system reset.

Option 10 Status and Error Reporting

The status and error reporting system of Option 10 interrupts the GPIB bus controller by asserting an SRQ (service request). The service request indicates that an event has occurred that requires attention. When the controller polls the bus, the status-byte returned by the oscilloscope indicates the type of event that occurred. A further `EVEnt?` query will return an event code that gives more specific information about the cause of the service request. The SRQ status byte and the event code provide a limited amount of information about the specific cause of the service request. Command errors, execution errors, and internal errors assert an immediate SRQ (if RQS is on). To retrieve other system event and warning status bytes, OPC must also be ON, and the oscilloscope must be queried by the `STatus?` command. See Tables 7-34 and 7-35 at the back of this section for status and event codes.

GPIB Programming

Programming considerations are provided in this part to assist in developing your own unique programs for interfacing to the oscilloscope via the GPIB.

Before a program can be used for controlling the oscilloscope, the GPIB parameters (primary address, message terminator, and talk/listen mode) must be set. Procedures describing how these parameters are selected and set at the oscilloscope were given previously in this section of the manual.

Programs are usually composed of two main parts (or routines), which can be generally categorized as a command handler and a service-request handler.

COMMAND HANDLER—Basically, a command handler should establish communication between the controller and oscilloscope, send commands and queries to the oscilloscope, receive responses from the oscilloscope, and display responses as required. The following outline indicates the general sequence of functions that the command-handling routine should perform to accommodate communications between the controller and oscilloscope over the GPIB.

1. Initialize the controller.
2. Disable the service-request handler until the program is ready to handle them.
3. Get the GPIB address of the oscilloscope.

4. Enable the service-request handler.
5. Get the command to send to the oscilloscope.
6. Send the command to the oscilloscope.
7. Check for a response from the oscilloscope.
8. If there is a response, perform the desired function.
9. You are ready for a new command. Repeat the functions in statements 5 through 9 as many times as desired.

SERVICE-REQUEST HANDLER—Typical service-request handler routine contains the necessary instructions to permit proper processing of interrupts. For example, whenever power-on occurs, the oscilloscope asserts an SRQ interrupt. If a GPIB program is operating on the controller when a power-on SRQ is received, the program should be able to determine that the oscilloscope's power was interrupted at some time during program operation. This event could cause improper program execution, unless the program was written to adequately handle the possibility of a power-on SRQ occurring.

Other interrupts (or events) for which the oscilloscope asserts SRQ are identified in Table 7-14.

While some controllers have the capability of ignoring service requests, others require that all SRQs be managed. The programmer should understand the controller being used. If service requests are to be handled in the program, the interrupts must first be enabled.

A service-request handler routine can be developed to service interrupts when they occur during program operation. It basically should consist of an interrupt-enabling statement (`ON SRQ`) near the beginning of the program and a serial-poll subroutine somewhere in the program. The `ON SRQ` statement directs program control to the serial-poll subroutine whenever an SRQ interrupt occurs. For each interrupt received by the controller, the program should perform a serial-poll subroutine.

The following general steps are required to handle service requests from the oscilloscope:

Options and Accessories—2221 Operators

1. Perform a serial poll.
2. Send an EVENT? query to the oscilloscope requesting service.
3. If the EVENT? query response is not zero, then perform the response required to handle the event.
4. Return to the main program.

OPTION 12 RS-232-C OPERATORS INFORMATION

The RS-232-C Communications interface conforms to the Tektronix standard on Codes, Formats, Conventions, and Features for messages sent over to bus for communications to other RS-232-C devices. Specific formats implemented in the 2200 DSO family for the Option 12 Communications interface are listed in Table 7-7. Specific feature implementation is shown in Table 7-8.

Option 12 Side Panel

The side panel for Option 12 instruments (Figure 7-3) includes one AUXILIARY connector, one RS-232-C interface port (providing both DTE and DCE capability), and one PARAMETERS switch. The Controls, Connectors, and Indicators part of this manual contains information on the use of the AUXILIARY Connector. Refer to Figure 7-3 for location of the Option 12 side-panel controls and connectors.

AUXILIARY Connector—Provides connections for an X-Y Plotter and an External Clock input (see Controls, Connectors, and Indicators).

RS-232-C PARAMETER Switch—Allows the selection of setup options for the RS-232-C interface. The switches are read at power-up. Four sections of the switch select the baud rate, three select parity, one selects the terminator, and two are for printer/plotter selection. The function of each switch section is shown in Table 7-11.

NOTE

Do not hook up external devices to the DTE connector and the DCE connector at the same time.

Table 7-7
Specific Format Choices for Option 12

Format Parameter	Choice Made
Format Characters	Not transmitted; ignored on reception.
Message Terminator	Either CR or CR-LF may be selected as the message terminator.
Measurement Terminator	Follows program message-unit syntax.
Link Data (Arguments)	Used in sending and receiving messages.
Multiple Event	Not implemented to report multiple events on a single reporting query. Multiple events may be reported by multiple queries.
Instrument Identification Query	Descriptors added for all options.
Set Query	Extended by using other commands as queries.
Device Trigger (DT)	Not implemented.
INIT Command	Causes the instrument to return to a default initialization state.
Time/Date Commands	Not implemented.
Stored Setting Commands	Not implemented.
Waveform Transmission	Implemented. Waveforms may be encoded in ASCII, HEX, or BINARY. The oscilloscope powers on with the encoding set to BINARY.
Remote On/Off	REMOte must be set to ON to get the instrument to change a remote-controllable function. The instrument powers up with REMote OFF.
IEEE 728	Compliance not intended.

RS-232-C DTE Connector—Provides connection meeting the EIA RS-232-C standard for data terminal equipment (see Figure 7-3). Table 7-9 lists the function of each pin of the connector. This connector is provided only on Option 12 instruments.

Table 7-8
Implementation of Specific Features for Option 12

Feature	Choice Made	Comments
Secondary Addressing	Not implemented.	
Indicators		
ADDR (carrier detect)	Implemented.	ADDR indicator comes on when carrier is detected.
SRQ (service request)	Implemented.	SRQ indicator is on only when a status byte is sent.
PLOT	Implemented	PLOT indicator is on when acquisitions are locked out during a waveform plot.
Parameter Selection	Implemented	A ten-section switch sets the instruments's baud rate, data parity type, message terminator, and printer/plotter selections. Switch settings are read at power on only.

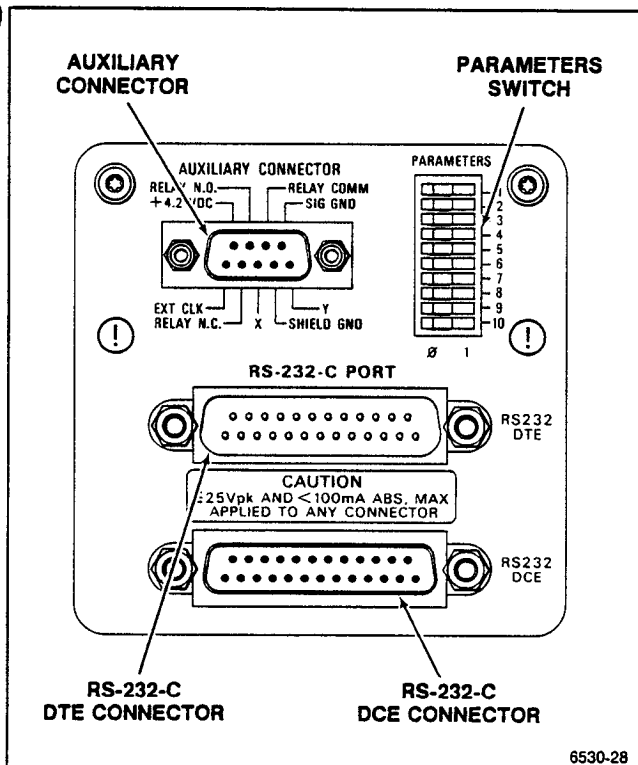

Figure 7-3. Option 12 side panel.

Table 7-9
RS-232-C DTE Connector

Pin	Signal Name		Function
	Internal	External	
1	CHAS GND	CHAS GND	Chassis ground
2 ^a	ITXD	TXD	Transmitted data
3 ^a	IRXD	RXD	Received data
4	IRTS	RTS	Request to send
5	ICTS	CTS	Clear to send
6	IDSR	DSR	Data set ready
7 ^a	SIG GND	SIG GND	Signal ground
8	IRLSD2	RLSD	Received line signal detect
20	IDTR	DTR	Data terminal ready

^aThese lines are all that are required for communication without hard control lines.

Options and Accessories—2221 Operators

NOTE

Do not hook up external devices to both the DTE connector and the DCE connector at the same time.

RS-232-C DCE Connector—Provides a connector that meets the EIA RS-232-2 standard for data communications equipment (see Figure 7-3). Table 7-10 lists the function of each pin of the connector. The connector is provided only on Option 12 instruments.

Option 12 Interface Status Indicators

The three indicator labels (SRQ, ADDR, and PLOT) above the CRT indicate the status of the Communications interface. Refer to Figure 7-2 (shown previously) for the location of the status indicators. Their operation is as follows:

The SRQ indicator is on only during the time an asynchronous status byte is being sent. A status byte or event code is not generated for power-on. Events must be queried to receive pending events codes. Status must also be queried to receive pending status bytes, except for command and execution error status which are returned immediately upon recognition of an

error. If OPC is also on, additional system events (i.e., warnings and operation complete) will also generate an asynchronous service request. All status bytes are prevented from reporting if RQS is off, but the SRQ indicator does not indicate that a status byte is pending. In this case, the event code must be queried (EVENt?) to find out if an event has happened.

The ADDR indicator is on when a carrier is detected. With no devices connected to either the DTE port or the DCE port, the ADDR indicator will be on. If an RS-232-C DCE device is connected to the DCE port, the carrier will also be on all the time. The indicator will be off if a DTE device is connected to the DTE port and no carrier is detected.

The PLOT indicator is on when the communication option is currently sending waveform data. Acquisitions are inhibited during this time.

RS-232-C Parameter Selection

Selection of RS-232-C parameters (baud rate, parity, and line terminator) must be made prior to power on using the RS-232-C PARAMETER switch and Table 7-11 through Table 7-13. Changes to the PARAMETER switch after power on will not be read until the next power on occurs. PARAMETERS switch settings and setups for some common printers and plotters are given in Appendix B. There are two other communications parameters that are set using commands via the interface itself. These are STOP bits and FLOW control. The most used setting for STOP is 1. The power-on default for FLOW is OFF.

Table 7-10
RS-232-C DCE Connector

Pin	Signal Name		Function
	Internal	External	
1	CHAS GND	CHAS GND	Chassis ground
2 ^a	IRXD	TXD	Transmitted data
3 ^a	ITXD	RXC	Received data
4	ICTS	RTS	Request to send
5	IRTS	CTS	Clear to send
6	IDTR	DSR	Data set ready
7 ^a	SIG GND	SIG GND	Signal ground
8	IRLSDC1	RLSD	Received line signal detect
20	IDSR	DTR	Data terminal ready

***These lines are all that are required for communication without hard control lines.**

Baud Rate. Baud rate switch settings determine the baud rate used by the instrument for both sending and receiving data. The available baud rates are listed in Table 7-12.

When OFF LINE (baud-rate switch settings 1111) is selected, the instrument still presents an active load to the other RS-232-C device, but it can't send or receive any interface traffic.

Use Table 7-11, Table 7-12, and the PARAMETERS switch to select the desired baud rate.

Parity. The selected parity setting determine the oscilloscope's response to received parity errors and the parity of data sent by the oscilloscope.

Table 7-11
RS-232-C PARAMETERS Switch

Switch Section	Switch Position	Function
1	--	Baud rate ^a
2	--	Baud rate ^a
3	--	Baud rate ^a
4	--	Baud rate ^a
5	0	Parity enable/disable
		Parity is not checked. The data word is 8 bits long.
5	1	Parity is checked according to the settings of switches 6 and 7. A parity error causes a status byte to be sent if RQS is on. The data word is 7 bits long with the 8th bit being the parity bit.
6		Parity select ^b
7		Parity select ^b
8	0	Line terminator selection
		Lines are terminated with carriage return (CR).
8	1	Lines are terminated with carriage return-line feed (CR-LF).
9		Printer/Plotter selection ^c
10		Printer/Plotter selection ^c

^aSee Table 7-12.

^bSee Table 7-13.

^cSwitches 9 and 10 select printer/plotter devices at power up. The devices may be changed after power-up using Option commands, or in the case of the 2230, the MENU controls. Two EPSON formats are selectable. EPS7 uses seven print wires per head pass, and is usually slower. It is the chr\$(27) "L" mode. EPS8 uses eight print wires per head pass, and is usually the faster print-head speed. It is the chr\$(27) "Y" mode. In this mode, most Epson and Epson-compatible printers will not strike any print wire more often than every second pixel. EPS8 is selected when parity is disabled. Printing/plotting devices are selected with the following switch positions:

Switch 9	Switch 10	Device Selected
0	0	HP-GL [®] plotter
1	0	Epson [®] (EPS7 or EPS8)
0	1	ThinkJet [®] printer
1	1	X-Y Plotter

HP-GL[®] and ThinkJet[®] are trademarks of Hewlett-Packard Company. Epson[®] is a trademark of Epson Corporation.

Table 7-12
Baud Rate

Switch Position	Baud Rate
4 3 2 1	
0 0 0 0	50
0 0 0 1	75
0 0 1 0	110
0 0 1 1	134.5
0 1 0 0	150
0 1 0 1	300
0 1 1 0	600
0 1 1 1	1200
1 0 0 0	1800
1 0 0 1	2000
1 0 1 0	2400
1 0 1 1	3600
1 1 0 0	4800
1 1 0 1	7200
1 1 1 0	9600
1 1 1 1	Off Line

Section 5 of the PARAMETERS switch determines whether or not received parity errors will cause an error report (see Table 7-11). With parity enabled, seven bits represent the characters being sent. The eighth bit is the parity bit, and is interpreted as selected by the settings of switches 6 and 7. These sections of the PARAMETERS switch determine the parity used when transmitting and receiving data over the RS-232-C interface. ODD, EVEN, MARK, or SPACE parity is selectable (see Table 7-13).

By setting both the transmitting and receiving devices to use parity, some degree of checking may be done on 7-bit data. Setting parity to "even" causes the transmitter to send a parity bit that makes the number of "mark" bits in the data (plus the parity bit) come out to an even number. Upon receiving the data, the receiving device adds up the "mark" bits in the data byte. If an error is detected, a system event status byte is sent. When the event code byte is interpreted, the controller may make a hardware change or alter its routine to handle the error.

"Odd" parity works in the same way, except that the number of "mark" bits is expected to be odd. Parity may also be set to "mark" or "space" where the parity bit is always set to a mark or a space respectively.

Table 7-13
Parity Selection^a

Switch Position	Parity Type	Comment
6 7		
0 0	ODD	The parity bit of each byte is set or cleared as needed to make the number of logical ones per word byte odd.
0 1	EVEN	The parity bit of each byte is set or cleared as needed to make the number of logical ones per word byte even.
1 0	MARK	The parity bit is always set to a logical one.
1 1	SPACE	The parity bit is always cleared to a logical zero.

^aCharacters are always accepted if possible. If parity is enabled and RQS is on, a status byte is sent if the received parity doesn't match the parity selected. Parity must be disabled (PARAMETERS switch position 5 set to 0 before power on) for binary data transfers.

Message Line Terminator. PARAMETERS switch section 8 selects the line terminator. The line terminator is either CR (carriage return), with switch section 8 open, or CR-LF (carriage return and line feed), with switch section 8 closed (see Table 7-11).

NOTE

Commands to the oscilloscope are interpreted and carried out as soon as they are recognized as such; the oscilloscope does not wait for a CR or CR-LF to end the command string. If a command needs to be correctly done before the next command is sent, the controller must wait for the correct return. If an error occurs (due to command syntax or incompatible instrument settings), the error status will be immediately reported. The controller can detect the error, query the event code, and take corrective action before going on with another command that may not be handled properly. This is especially true if the previous command puts the oscilloscope in a state that prevents it from responding. For this reason, the recommended practice is to send only one command in each message line to the oscilloscope.

When CR (normal mode) is selected as the terminator, the instrument will:

- Accept only CR as the line terminator.
- Send CR as the last byte of a message.

When CR-LF is selected as the terminator, the instrument will:

- Accept either CR-LF or LF only as the line terminator.
- Send CR-LF (carriage return followed by line feed) at the end of every message.

STOP Bits

Once communication is established between the controller and the oscilloscope, commands may be sent to the oscilloscope. When dealing with the transfer of data via the RS-232-C interface, the bits used to make up a character consist of a start bit, seven or eight data bits, and, finally, one or two stop bits. Start and stop bits separate the data bytes and are called framing pulses. The start bit is always set to a "mark," and the one or two stop bits are set to a "space." One stop bit is used in most applications. Two stop bits may be needed for some printers at some baud rates. The command STOP 1 or STOP 2 sets the number of stop bits in the character frame.

NOTE

For the 2220 and 2221 instruments, selection of the stop bits is not possible from the front-panel controls. When connecting to a printer or plotter with a choice of stop bits for different baud-rate settings, select a baud rate that requires only one stop bit.

The transition from one character's stop bit(s) to the next character's start bit is used to synchronize the receiver to the transmitter. This causes the coded data bits for each character to be read at the best time relative to the start of the character's start.

Errors that occur due to mismatched baud rates, data bits, or stop bits show up as "framing errors." The start-bit and stop-bit frame surrounding the character bits have the wrong timing relationship with respect to each other. Since they are not recognized properly, the data stream cannot be interpreted by the receiving device.

FLOW Control

When transmitting data using modems to interconnect two devices via the telephone lines, the normal handshaking lines are not used. The two devices can still communicate using a data-transmission technique called "flow control." Using this method, the data sent can be separated from non-data being received (such as noise). This is done by interpreting every correctly framed data pattern as a valid character and constantly checking for two specific characters that turn the transmission on and off.

These flow-control characters are called XON (transmission on) and XOFF (transmission off). The usual assignment for these is <control-Q> for XON and <control-S> for XOFF, though the specific characters chosen are a function of the communications program used. When communication over telephone lines, flow control greatly increases the chance that ASCII or HEX encoded data will be correctly transferred.

The FLOW ON command allows the oscilloscope some on/off control of the data transfer. At power-on, the default data encoding is BINARY. Flow control can not be used for the transmission of binary-encoded waveform data, so the power-on setting of FLOW is set to off. Before sending binary-encoded data, FLOW OFF must be sent if flow control was previously set ON. The Advanced Functions menu of the 2230 also has a menu choice for setting flow control.

Remote-Local Operating States

The following paragraphs describe the two operating states of the instrument: Local and Remote.

REMOTE OFF (LOCAL)—With REMOTE OFF, instrument settings are controlled manually by the operator using the front-panel controls. Option interface messages such as REMOTE ON, RQS ON, and OPC ON are received and executed. Queries about instrument's states or measurement results will be answered. Device-dependent commands that require an instrument operating mode change to be made cause an execution error, and a service request will be generated if RQS is on.

REMOTE ON (REMOTE)—In this state, the oscilloscope executes all commands sent to it. Remote-controllable front-panel indicators and CRT readouts are updated as commands are carried out. There is no local lockout (LLO). Changing any option-controllable front-panel setting locally overrides the remote settings. If a waveform

is being transmitted, the PLOT indicator will be lit, and new waveform data will not be acquired until the transmission is done.

Reset Under Communication Option Control

Certain default settings for acquisition and plot modes may be set up sending the INIt command. The INIt command does not invoke the power-up test. Upon completion of the INIt command, no status byte or event code is generated.

The default settings are as follows:

```
ACQUISITION REP:AVE
ACQUISITION HSREC:SAMPLE
ACQUISITION LSREC:PEAKDET
ACQUISITION SCAN:PEAKDET
ACQUISITION ROLL:PEAKDET
ACQUISITION SMOOTH:ON
ACQUISITION WEIGHT:4 (16 in the 2220 and 2221)
ACQUISITION NUMSWEEP:0
ACQUISITION VECTORS:ON
DATA ENCDG:BINARY
DATA SOURCE:ACQ
DATA TARGET:REF1 (REF4 in the 2220 and 2221)
PLOT GRAT:OFF
PLOT FORMAT:<power-on setting>
READOUT ON
Menu system reset.
```

RS-232-C PROGRAMMING

Things to consider when writing programs for your RS-232-C controller are given here to help you when you must develop your own interfacing software. Before a program can be used to control the oscilloscope, the RS-232-C communication parameters for baud rate, line terminator, and parity must be set. Settings for these parameters are selected and set using the RS-232-C PARAMETERS switch found on the side panel of the oscilloscope.

Controller programs are usually composed of two main parts or routines. The two parts are generally called the command handler and the service-request handler.

Options and Accessories—2221 Operators

COMMAND HANDLER—Basically, a command handler establishes communication between the controller and the oscilloscope, sends commands to the oscilloscope, receives responses from the oscilloscope, and displays the responses as required. The steps of the following procedure are the general functions that the command-handler software routine should be able to do for the most useful communications.

1. Initialize the controller in the communications mode.
2. Watch for a service request.
3. Check the event code (by sending an `EVEnt?` query) if a service request occurs.
4. Determine the action needed to be taken from the event code byte that is returned and take it.
5. Get a command to send to the oscilloscope.
6. Send a command to the oscilloscope.
7. Check for a response from the oscilloscope.
8. If the response is an error status, check the event code (Step 3) and take the appropriate action (Step 4).
9. Repeat Steps 5 through 8 as many times as needed.

SERVICE REQUEST HANDLER—The service-request handler routine should contain the necessary instructions to process the possible event codes generated by the 2200 Family DSO. The 2200 Family DSO requests service by sending asynchronous status bytes when certain errors occur (if `RQS` is `ON`). Other status bytes return as the

result of a `STatus?` query, or when `OPC` is on. The immediate mode service request may cause the controller to halt unless the controller's program is written to properly handle them. A user may also want the controller routine to be able to recognize and handle the other events requiring service. These events are identified in Tables 7-34 and 7-35 at the back of this section.

The following general steps are required to handle service requests from the oscilloscope.

1. Watch for an asynchronous service-request status byte. This is the same concept as checking for an `SRQ` with the GPIB controller program.

2. Send an `EVEnt?` query to obtain the event-code byte that describes in more depth what caused the service request.

3. If the response to the `EVEnt?` query is not zero, perform the action required to handle the event.

4. Return to the main program.

Option 12 Status and Error Reporting

The status and error reporting system used by the Communication Option sends status bytes that may be viewed as a service request when monitored by the appropriate controller software. As soon as a change of status or an error occurs, the 2200 Family instrument returns a service request status byte that indicates the type of event that occurred (if `RSQ` is on). The status byte returned and the event code returned as the reply to an `EVEnt?` query provide a limited amount of information about the specific cause of the service-request status-byte. Command errors, execution errors, and internal errors generate a service-request status byte immediately (if `RQS` is `ON`). To retrieve other system-event and warning status bytes, `OPC` must be `ON`, and the oscilloscope must be queried by the `STatus?` command. See Tables 7-34 and 7-35 at the back of this section for status-byte and event codes.

COMMUNICATION AND WAVEFORM TRANSFER

This subsection contains information common to both Option 10 and Option 12. The commands available, the command protocol, waveform transfer information, and the service request status bytes are included in this subsection.

READOUT/MESSAGE COMMAND CHARACTER SET

Character translations performed by the MESSage command and query, when sending data to or receiving data from the CRT readout, are indicated in Table 7-14. The standard ASCII character codes are given in Table 7-15.

NOTE

Values in Table 7-14 that have no CRT equivalent are translated into spaces when sent to the display.

MESSAGES AND COMMUNICATION PROTOCOL

The commands available to the user via either the Option 10 GPIB or the Option 12 RS-232-C communications option can set some of the instrument's digital storage operating modes, query the results of measurements made, or query the state of the oscilloscope. The commands are specified in mnemonics that are related to the functions implemented. For example, the command INit initializes instrument settings to states that would exist if the instrument's power was cycled. To further facilitate programming, command mnemonics are similar to front-panel control names.

NOTE

All measurement results returned by the options have the same accuracy as the main instrument.

Commands

Commands for this instrument, like those for other Tektronix instruments, follow the conventions established in a Tektronix Codes and Formats Standard. The command words were chosen to be as understandable as possible, while still allowing a user familiar with the commands to reduce the number of key strokes needed and still have the command unambiguous. Syntax is also standardized to make the commands easier to learn.

In the Command tables found at the end of this section, headers and arguments are listed in a combination of upper-case and lower-case characters. The instrument accepts abbreviated headers and arguments that contain at least the upper-case characters shown in the tables (whether sent in upper case or lower case). The lower-case characters may be added to the abbreviated (upper case) version, but they can only be those shown in lower case. For a query, the question mark must immediately follow the header. For example, any of the following formats are acceptable to the oscilloscope:

VMO? or vmo?
VMOd? or vmod?
VMODE? or vmode?

HEADERS—A command consists of at least a header. Each command has a unique header, which may be all that is needed to invoke a command; for example:

INit
OPC

ARGUMENTS—Some commands require the addition of arguments to their headers to describe exactly what is to be done. If there is more to the command than just the header (including the question mark if it is a query), then the header must be followed by at least one space.

In some cases, the argument is a single word; for example:

REFTo REF4
PLOt STArt

In other cases, the argument itself requires another argument. When a second argument, or "link argument," is required, a colon must separate the two arguments. Two examples of this are:

ACQuisition REPetitive:SAMple

and

WFMpre XINcr:1.0E-3

Table 7-14

Readout/MESage Command Character Set

BITS 84 83 82 81				0 0				0 1				1 0				1 1							
				0 0 0 0				0 0 1 1				0 1 0 1				1 0 0 1				1 1 0 1			
				CONTROL				SYMBOLS				UPPERCASE				LOWERCASE							
0	0	0	0	0	0	10	T	16	20	32	30	48	40	64	e	50	80	60	'	96	70	p	112
0	0	0	1	1	1	11		17	21	33	31	49	41	65	A	51	81	61	a	97	71	q	113
0	0	1	0	2	B _{WL}	2		12	18	22	34	32	50	42	B	66	52	82	62	98	72	r	114
0	0	1	1	3	⊠	3		13	19	23	35	33	51	43	C	67	53	83	63	99	73	s	115
0	1	0	0	4	Δ	4		14	20	24	36	34	52	44	D	68	54	84	64	100	74	t	116
0	1	0	1	5	—	5	μ	15	21	25	37	35	53	45	E	69	55	85	65	101	75	u	117
0	1	1	0	6	=	6	∇	16	22	26	38	36	54	46	F	70	56	86	66	102	76	v	118
0	1	1	1	7	∩	7	↓	17	23	27	39	37	55	47	G	71	57	87	67	103	77	w	119
1	0	0	0	8		8		18	24	28	40	38	56	48	H	72	58	88	68	104	78	x	120
1	0	0	1	9		9		19	25	29	41	39	57	49	I	73	59	89	69	105	79	y	121
1	0	1	0	A		10		1A	26	2A	42	3A	58	4A	J	74	5A	90	6A	106	7A	z	122
1	0	1	1	B		11		1B	27	2B	43	3B	59	4B	K	75	5B	91	6B	107	7B	{	123
1	1	0	0	C		12		1C	28	2C	44	3C	60	4C	L	76	5C	92	6C	108	7C	!	124
1	1	0	1	D		13		1D	29	2D	45	3D	61	4D	M	77	5D	93	6D	109	7D	}	125
1	1	1	0	E	Hz	14		1E	30	2E	46	3E	62	4E	N	78	5E	94	6E	110	7E	~	126
1	1	1	1	F	¼	15		1F	31	2F	47	3F	63	4F	O	79	5F	95	6F	111	7F		127

Table 7-15
ASCII Code Chart

BITS		CONTROL		NUMBERS SYMBOLS				UPPER CASE				LOWER CASE				
B7	B6 B5															
B4	B3 B2 B1															
0	0 0 0 0	NUL	DLE	SP	0	0	16	100	@	P	16	140	'	0	160	p
0	0 10	0	16	20	32	30	48	40	64	50	80	60	96	70	112	
1	1 1 1 1	SOH	DC1	!	1	1	17	101	A	Q	17	141	a	1	161	q
1	1 11	1	17	21	33	31	49	41	65	51	81	61	97	71	113	
2	2 1 1 0	STX	DC2	"	2	2	18	102	B	R	18	142	b	2	162	r
2	2 12	2	18	22	34	32	50	42	66	52	82	62	98	72	114	
3	3 1 1 1	ETX	DC3	#	3	3	19	103	C	S	19	143	c	3	163	s
3	3 13	3	19	23	35	33	51	43	67	53	83	63	99	73	115	
4	4 1 1 0	EOT	DC4	\$	4	4	20	104	D	T	20	144	d	4	164	t
4	4 14	4	20	24	36	34	52	44	68	54	84	64	100	74	116	
5	5 1 1 1	ENQ	NAK	%	5	5	21	105	E	U	21	145	e	5	165	u
5	5 15	5	21	25	37	35	53	45	69	55	85	65	101	75	117	
6	6 1 1 0	ACK	SYN	&	6	6	22	106	F	V	22	146	f	6	166	v
6	6 16	6	22	26	38	36	54	46	70	56	86	66	102	76	118	
7	7 1 1 1	BEL	ETB	'	7	7	23	107	G	W	23	147	g	7	167	w
7	7 17	7	23	27	39	37	55	47	71	57	87	67	103	77	119	
8	8 1 1 0	BS	CAN	(8	8	24	110	H	X	24	150	h	8	170	x
8	8 18	8	24	28	40	38	56	48	72	58	88	68	104	78	120	
9	9 1 1 1	HT	EM)	9	9	25	111	I	Y	25	151	i	9	171	y
9	9 19	9	25	29	41	39	57	49	73	59	89	69	105	79	121	
10	10 1 1 0	LF	SUB	*	10	10	26	112	J	Z	26	152	j	10	172	z
10	10 1A	10	26	2A	42	3A	58	4A	74	5A	90	6A	106	7A	122	
11	11 1 1 1	VT	ESC	+	11	11	27	113	K	[27	153	k	11	173	{
11	11 1B	11	27	2B	43	3B	59	4B	75	5B	91	6B	107	7B	123	
12	12 1 1 0	FF	FS	,	12	12	28	114	L	\	28	154	l	12	174	*
12	12 1C	12	28	2C	44	3C	60	4C	76	5C	92	6C	108	7C	124	
13	13 1 1 1	CR	GS	-	13	13	29	115	M]	29	155	m	13	175	}
13	13 1D	13	29	2D	45	3D	61	4D	77	5D	93	6D	109	7D	125	
14	14 1 1 0	SO	RS	.	14	14	30	116	N	^	30	156	n	14	176	~
14	14 1E	14	30	2E	46	3E	62	4E	78	5E	94	6E	110	7E	126	
15	15 1 1 1	SI	US	/	15	15	UNL	117	O	_	UNL	157	o	15	177	DEL (RUBOUT)
15	15 1F	15	31	2F	47	3F	63	4F	79	5F	95	6F	111	7F	127	

KEY

octal 25 PPU GPIB code
 NAK ASCII character
 hex 15 21 decimal

* | on some keyboards or systems

Options and Accessories—2221 Operators

Where a header has multiple arguments, the arguments (or argument pairs, if the argument has its own argument) must be separated by commas. Two examples of this syntax are:

DATa ENCDg:BINary,CHAnnel:CH2

and

VMODE? CH1,CH2,ADD

NOTE

With Option 12, multiple commands (especially queries) should not be used in a single programmed message line. Commands (and arguments to commands) are interpreted and acted on by the oscilloscope as soon as a separator is recognized; the oscilloscope does not wait for the message terminator (CR or CR-LF) to signal the end of the command line. If one of the commands in a command line requires a response for any reason (i.e., command error, illegal command, or unable to do the command), the oscilloscope's service-request status-byte response will be asynchronously sent. If the service request is not handled correctly, the controller may not be able to continue with its program.

COMMAND SEPARATOR—Multiple commands may be put into one command line by separating the individual commands with a semicolon; for example:

DATa ENCDg:BINary,CHAnnel:CH2;WFMpre XINcr:1.0E-3

Multiple commands in a message are not recommended with RS-232-C controller routines for Option 12. See the previous NOTE. However, the command separator is valid, and multiple commands on the same message line may be used. A waveform preamble is one example of using multiple commands in a single message. With Option 10, GPIB controller programs often use multiple commands in a single line.

GPIB MESSAGE TERMINATOR—As previously explained, GPIB messages may be terminated with either EOI or LF. Some controllers assert EOI concurrently with

the last data byte; others use only the LF character as a terminator. The GPIB interface can be set to accept either terminator. With EOI selected, the instrument interprets a data byte received with EOI asserted as the end of the input message; it also asserts EOI concurrently with the last byte of an output message. With the LF setting, the instrument interprets the LF character without EOI asserted (or any data byte received with EOI asserted) as the end of an input message; it transmits a Carriage Return character followed by Line Feed (LF with EOI asserted) to terminate messages.

RS-232-C MESSAGE TERMINATOR—RS-232-C messages from the oscilloscope may be terminated with either carriage return (CR) or the CR and line-feed (LF) characters. The RS-232-C Option can be set to send and receive either terminator as the last byte of a message. The instrument does not wait for the end-of-line terminator when it handles incoming messages. It recognizes a semicolon as the end of command terminator and immediately begins its response to the preceding command string. Because of the way the instrument handles commands, messages should be limited to one command per line. Incoming and outgoing messages are not stacked. If more than one command per line is sent, responses to the first commands in a line may be lost when the output buffer is reinitialized to output the response to the last command in a line. Even single command messages should not be terminated twice. The response to the command may be lost when the instrument sees the second terminator.

COMMAND FORMATTING—Commands sent to the oscilloscope must have the proper format (syntax) to be understood; however, this format is flexible in that many variations are acceptable. The following paragraphs describe this format and the acceptable variations.

The oscilloscope expects all commands to be encoded as either upper-case or lower-case ASCII characters. All data output is in upper case.

Spaces can be used as formatting characters to enhance the readability of command sequences. As a general rule, spaces can be placed either after commas and semicolons or after the space that follows a header.

NUMERIC ARGUMENTS—Table 7-16 shows the number formats for the <NR1>, <NR2>, and <NR3> arguments used in a command. Both signed and unsigned numbers are accepted, but unsigned numbers are taken as positive.

Table 7-16
Numeric Argument Format for Commands

Numeric Argument	Number Format	Examples
<NR1>	Integers	+1, 2, -1, -10
<NR2>	Explicit decimal point	-3.2, +5.1, 1.2
<NR3>	Floating point in scientific notation	+1.E-2, 1.0E+2, 1.E-2, 0.02E+3

WAVEFORM TRANSFERS

The instrument can transmit and receive waveforms. It can transfer these waveforms in binary, hexadecimal, or ASCII encoding. When sending waveforms to the instrument, the target must be one of the numbered reference memories (REF4 only for the 2220 and 2221). Waveforms transferred from the oscilloscope to the controller may be from either the current acquisition or one of the numbered reference memories (again REF4 for the 2220 and 2221). The data source (the memory location from which the waveform data comes) and the data target (the memory location where data sent to the oscilloscope ends up) are selected independently.

Waveform Preamble

The waveform preamble contains the attributes for the associated waveform data. These attributes include the number of points per waveform, scale factors, vertical offsets, horizontal increment, scaling units, and data encoding. The preamble information is sent as an ASCII-encoded string in all cases. The exact attributes sent depend on the waveform and the acquisition mode.

A typical response to the preamble query WFMpre? for a Y (time-implied) acquisition is:

```
WFM WFI:"ACQ, CH1,0.5V,DC,0.2mS,SAMPLE,
CRV# 1",NR.P:4096,PT.O:122,PT.F:Y,
XMU:0.0E0,XOF:0,XUN:S,XIN:2.0E-6,
YMU:20.0E-3,YOF:-20,YUN:V,ENC:HEX,BN.F:RP,
BYT:1,BIT:8,CRV:CHK;
```

A typical response to the preamble query for an X-Y acquisition is:

```
WFM WFI:"ACQ,XY,0.2V,DC,50.0mV,DC,
1.0μS, SAMPLE, CRV# 4",
NR.P:2048,PT.O:216,PT.F:XY,XMU:8.0E-3,
XOF:0,XUN:S,XIN:20.0E-9,YMU:2.0E-3,YOF:0,
YUN:V,ENC:BIN,BN.F:RP,BYT:1,BIT:8,CRV:CHK;
```

These replies are single line messages that end with the selected message terminator (CR or CR-LF). With the GPIB interface, EOI (end-or-identify) is also sent if that terminator mode is selected.

Transferring Waveforms

The oscilloscope can respond with the preamble only, the curve data only, or the preamble and curve data together. The queries to obtain these responses are, in order, WFMpre?, CURVe?, and WAVfrm?

For the combined response to WAVfrm?, the preamble is separated from the curve data by a semicolon (;).

The preamble information is always formatted as ASCII characters. Waveform (CURVE) data internal to the oscilloscope is stored as 8-bit, unsigned integers. Before that data is sent via the Communications option, it is changed into one of three formats: binary, hexadecimal, or ASCII. The resolution of the formatted data points may be either 8-bit or 16-bit. Waveform record length is 1024 data points for the shortest or 4096 data points for the longest. The number of bytes that are required to transfer data depends on several variables. See the NR.Pts description in the Waveform Preamble Fields command table for more information. The largest number of curve data bytes ever needed to send a waveform is 8192 bytes (for a 4K record that has two bytes per data point).

Binary Encoding

BINARY data is transferred as unsigned binary integers. Each data point in the record is either 8 bits or, when averaged, 16 bits. BINARY encoding format has the following waveform curve data form:

Options and Accessories—2221 Operators

CURVE <space> % <Binary Count MSB> <Binary Count LSB> <Binary Data> <Checksum> <Terminator>

Where:

CURVE	is a literal string indicating that curve data follows.
%	is used as a header character to show the start of a binary block.
<Binary Count MSB>	is the most-significant byte of the two-byte Binary Count. Binary Count is the length of the waveform, in bytes, plus the one-byte checksum.
<Binary Count LSB>	is the least-significant byte of the Binary Count.
<Binary Data>	is made up of 256, 512, 1024, 2048, or 4096 data points. Each data point is either a 1-byte (8 bits) or 2-byte (16 bits) representation of each digitized value.
<Checksum>	is the two's-complement of the modulo 256 sum of the preceding data bytes and the binary count. The Checksum is used by the controller program to verify that all data values have been received correctly.

Table 7-15 illustrates the data transferred for a 4096-point, 8-bit, binary-encoded waveform. The waveform data-point values vary with the signal amplitude.

Table 7-16 illustrates the data transferred for a 4096-point, 16-bit (averaged), binary-encoded waveform.

Hexadecimal Encoding

With HEXadecimal waveform data encoding, characters representing an 8-bit or 16-bit data point are sent in a fixed ASCII hexadecimal format. There are no delimiters (commas) between data points. Data format is very similar to BINary format, with the following exceptions:

Table 7-17
Typical 8-Bit Binary-Encoded Waveform Data

Byte	Contents	Decimal	GPB EOI (1 = Asserted)
1	C	67	0
2	U	85	0
3	R	82	0
4	V	86	0
5	E	69	0
6	<SP>	32	0
7	%	37	0
8	<Bin Count MSB>	16 ^a	0
9	<Bin Count USB>	01 ^a	0
10	1st Pt	d ₁	0
11	2nd Pt	d ₂	0
.	.	.	0
.	.	.	0
.	.	.	0
4105	4096th Pt	d ₄₀₉₆	0
4106	<Checksum>	chk	1 When TERM = EOI
4107 ^b	<CR>	13	0
4108 ^c	<LF>	10	1

^a(1001₁₆ or 4097₁₀)

^bAll RS-232-C or GPIB with TERM = LF/EOI.

^cRS-232-C with TERM = CR-LF.

1. The curve header is "CURVE #H" instead of "CURVE %".

2. Each data point is two ASCII hexadecimal characters for 8-bit transfers and four ASCII hexadecimal characters for 16-bit transfers.

3. The byte count is sent as four successive ASCII hexadecimal characters, but the value of the byte count is identical to a comparable BINary transfer.

4. The checksum is sent as two successive ASCII hexadecimal characters.

Table 7-18
Typical 16-Bit Binary-Encoded Waveform Data

Byte	Contents	Decimal	GPIO EOI (1 = Asserted)
1	C	67	0
2	U	85	0
3	R	82	0
4	V	86	0
5	E	69	0
6	<SP>	32	0
7	%	37	0
8	<Bin Count MSB>	32 ^a	0
9	<Bin Count LSB>	01 ^a	0
10	1st Pt MSB	d _{1H}	0
11	1st Pt LSB	d _{1L}	0
12	2nd Pt MSB	d _{2H}	0
13	2nd Pt LSB	d _{2L}	0
.	.	.	0
.	.	.	0
.	.	.	0
8200	4096th Pt MSB	d _{4096H}	0
8201	4096th Pt LSB	d _{4096L}	0
8202	<Checksum>	chk	1 When TERM = EOI
8203 ^b	<CR>	13	0
8204 ^c	<LF>	10	1

^a(2001₁₆ or 8193₁₀)

^bAll RS-232-C or GPIB with TERM = LF/EOI.

^cRS-232-C with TERM = CR-LF.

Tables 7-19 and 7-20 illustrate 8-bit and 16-bit HEXadecimal-encoded waveform-data transfers.

ASCII Encoding

With ASCII waveform data encoding, ASCII characters representing the binary value of each waveform data point are sent in variable length format, separated by commas. In ASCII format, the curve data transfer is represented as:

CURVE<space>data,data,data,.....,data<terminator>

Table 7-19
Typical 8-Bit Hexadecimal-Encoded Waveform Data

Byte	Contents	Decimal	GPIO EOI (1 = Asserted)
1	C	67	0
2	U	85	0
3	R	82	0
4	V	86	0
5	E	69	0
6	<SP>	32	0
7	#	35	0
8	H	72	0
9	<Bin Count MS 4 bits>	49	0
10	.	48	0
11	.	48	0
12	<Bin Count LS 4 bits>	49	0
13	1st Pt MS 4 bits	d _{1H}	0
14	1st Pt LS 4 bits	d _{1L}	0
15	2nd Pt MS 4 bits	d _{2H}	0
16	2nd Pt LS 4 bits	d _{2L}	0
.	.	.	0
.	.	.	0
.	.	.	0
203	4096th Pt MS 4 bits	d _{4096H}	0
204	4096th Pt LS 4 bits	d _{4096L}	0
205	<Checksum MS 4 bits>	chk _H	0
206	<Checksum LS 4 bits>	chk _L	1 When TERM = EOI
207 ^a	<CR>	13 (if term = LF/EOI)	0
208 ^b	<LF>	10 (if term = CR-LF)	1

^aAll RS-232-C or GPIB with TERM = LF/EOI.

^bRS-232-C with TERM = CR-LF.

Table 7-21 illustrates an 8-bit ASCII-encoded waveform transfer. Transmission length depends on specific waveform data values, record length, acquisition mode and smoothing, and whether the acquisition is one or two channels.

Table 7-20
Typical 16-Bit Hexadecimal-Encoded Waveform Data

Byte	Contents	Decimal	GPIB EOI (1 = Asserted)
1	C	67	0
2	U	85	0
3	R	82	0
4	V	86	0
5	E	69	0
6	<SP>	32	0
7	#	35	0
8	H	72	0
9	<Bin Count MS 4 bits>	50	0
10	.	48	0
11	.	48	0
12	<Bin Count LS 4 bits>	49	0
13	1st Pt MS 4 bits	d _{1H}	0
14	.	.	0
15	.	.	0
16	1st Pt LS 4 bits	d _{1L}	0
17	2nd Pt MS 4 bits	d _{2H}	0
18	.	.	0
19	.	.	0
20	2nd Pt LS 4 bits	d _{2L}	0
.	.	.	0
.	.	.	0
.	.	.	0
6393	4096th Pt MS 4 bits	d _{4096H}	0
6394	.	.	0
6395	.	.	0
6396	4096th Pt LS 4 bits	d _{4096L}	0
6397	<Checksum MS 4 bits>	chk _H	0
6398	<Checksum LS 4 bits>	chk _L	1 When TERM = EOI
6399 ^a	<CR>	13 (If term = LF/EOI)	0
6400 ^b	<LF>	10 (If term = LF/EOI)	1

^aAll RS-232-C or GPIB with TERM = LF/EOI.

^bRS-232-C with TERM = CR-LF.

Table 7-21
Typical ASCII-Encoded Waveform Data

Byte	Contents	Decimal	GPIB EOI (1 = Asserted)
1	C	67	0
2	U	85	0
3	R	82	0
4	V	86	0
5	E	69	0
6	<SP>	32	0
7	Pt ¹⁰⁰ ₁ ^a	d ¹⁰⁰ ₁	0
8	Pt ¹⁰ ₁ ^a	d ¹⁰ ₁	0
9	Pt ¹ ₁ ^a	d ¹ ₁	0
10	.	44 ^b	0
.	.	.	0
.	.	.	0
.	.	.	0
XXX	Pt ¹⁰⁰ ₄₀₉₆ ^a	d ¹⁰⁰ ₄₀₉₆	0
XXX	Pt ¹⁰ ₄₀₉₆	d ¹⁰ ₄₀₉₆	0
XXX	Pt ¹ ₄₀₉₆ ^a	d ¹ ₄₀₉₆	0
XXX ^c	<CR>	13	0
XXX ^d	<LF>	10	1

^aEach value sent may consist of from 1 to 3 characters. The notation Pt¹⁰⁰ means "the hundreds digit", and Pt¹⁰ means "the tens digit", which may or may not be sent, depending on the magnitude of the value.

^bThe decimal value 44 equates to the comma sent between each successive value.

^cAll RS-232-C or GPIB with TERM = LF/EOI.

^dRS-232-C with TERM = CR-LF.

COMMUNICATION COMMANDS

Tables 7-22 through 7-33 describe all commands available for the 2200 Family Digital Storage Oscilloscopes equipped with either Communications option. The Commands column lists the complete command with header and argument(s). Multiple link arguments are enclosed in angle brackets (<link1, link2, or link3>). Numeric value arguments are also enclosed in angle

brackets (<NR1>). Default arguments are enclosed in square brackets ([default]). Default arguments may be omitted from the command if that is the mode you want. The 2200 Family DSO for which the command is valid is identified immediately above the command. ALL indicates that the command is valid for all 2200 Family DSO instruments. Commands that are valid only for specific 2200 Family instruments are so indicated.

The capital letters shown are the fewest number of characters that identify the command as unique. They are also the letters returned by the oscilloscope with LONG OFF. Those letters shown in lower case are optional in the command. With LONG ON, all the letters of query return will be returned. All responses to queries are returned in upper case. The second column of the command tables gives a complete description of the command operation.

With GPIB, one or more arguments, separated by commas, may be given in a query to request only the information wanted rather than sending separate commands for each query. An example of this type of command is as shown:

CH1? VOLts,COUpling;

With RS-232-C, program your controller routines to send only one command at a time with single arguments of the form:

header argument:link argument;

This allows the controller to handle any asynchronous service request that may be generated by a command before attempting a second command.

Command Tables

Instrument commands are presented in tables divided into the following functional groups:

Table	Command Group
7-22	Vertical Commands
7-23	Horizontal Commands
7-24	Trigger Commands
7-25	Cursors Commands
7-26	Display Commands
7-27	Acquisition Commands
7-28	Save and Recall References Commands
7-29	Waveforms Commands
7-30	Waveform Preamble Fields
7-31	Miscellaneous Commands
7-32	Service Request Group Commands
7-33	RS-232-C Specific Commands

Table 7-22
Vertical Commands

Commands	Description
2221 and 2230 CH1?	Query only. Returns the present CH1 settings: CH1 VOL: <NR3>, COU: <AC, DC, or GND>. <NR3> is the VOLTS/DIV setting.
2221 and 2230 CH1? VOLts	Query only. Returns the CH1 VOLTS/DIV setting (including the probe attenuation factor). The value returned is a <NR3> number. For example, if the VOLTS/DIV setting is 50 mV, the value returned is CH1 VOL:5.0E-2. An execution warning is generated if the VOLTS/DIV CAL knob is not in the detent (calibrated) position.
2221 and 2230 CH1? COUpling	Query only. Returns the present CH1 input coupling: COU: <AC, GND, or DC>.
2221 and 2230 CH2? CH2? VOLts CH2? COUpling	Queries for CH2 the same as for CH1.
2221 and 2230 CH2? INVert	Query only. Returns CH2 INV: <ON or OFF>.
ALL VMODE?	Query only. Returns the vertical mode setting: VMO: <CH1, CH2, ADD, CHOp, ALT, or XY>.
2221 and 2230 PROBe? CH1 or CH2>	Query only. Returns the probe attenuation coding of the queried channel: CH<1 or 2> PROB: <NR1>. <NR1> may be 1000, 100, 10, 1, -1, or -2. The -1 value is for identify, and the -2 value is for unknown probe coding.

Table 7-23
Horizontal Commands

Commands	Description
2230 DELAy?	Returns the present horizontal delay settings as: DELA VAL:<NR3>,UNI:<S or DIV>.
2230 DELAy? VALue	Returns an <NR3> value that represents the present delay value in the units returned by the UNITS query as: DELA VAL:<NR3>.
2230 DELAy? UNITS	Returns a string of either S or DIV that corresponds to the DELAY? VALue units as: DELA UNI:<S or DIV>. The units are DIV when the SEC/DIV knob is set to EXT CLK.
ALL HORizontal?	Returns all present horizontal settings as appropriate for the type of instrument.
ALL HORizontal? ASEdiv	Returns an <NR3> value that represents the present A SEC/DIV setting in the form: HOR ASE:<NR3>. The value returned is zero when the SEC/DIV knob is set to EXT CLK.
2230 HORizontal? BSEdiv	Returns an <NR3> value that represents the present B SEC/DIV setting in the form: HOR BSE:<NR3>.
ALL HORizontal? EXTclk	Returns the state of the external clock as: HOR EXT:<ON or OFF>.
ALL HORizontal? HMAg	Returns the state of the X10 magnifier as: HOR HMA:<ON or OFF>.
2230 HORizontal? MODe	Returns the present horizontal mode setting as: HOR MOD:<ASW, AIN, or BSW>.

Table 7-24
Trigger Commands

Commands	Description
ALL ATRigger? [MODE]	Returns the present A trigger mode in the form: ATR MOD: <NOR, PPA, or SGL>;. PPA is returned for both Peak-to-Peak Auto and TV Field trigger modes. The reply is the same with or without the optional [MODE] argument.
ALL SGLswp ARM	Rearms a completed single sweep. An execution error is generated if the instrument is not in SGL SWP mode, and an execution warning is generated if the single sweep is already armed. With OPC ON, a service request status byte for operation complete is generated when the single sweep occurs.
ALL SGLswp?	Returns the state of the SGL SWP trigger mode as: SGL <ARM or DON>; when SGL SWP trigger mode is on. If SGL SWP trigger mode is not on, a reply of "SGL ;" is made, and an execution warning is generated.
ALL TRiggerd?	Returns the present state of the TRIG'D indicator as: TRI <ON or OFF>;.

Table 7-25
Cursor Commands

Commands	Description
2221 and 2230 CURSor CHANnel: <CH1-CH2>	Selects the named channel as the channel from which the cursor voltage difference is returned by the DELTAV? query. No warning is generated if the cursors are directed to an undisplayed channel.
2221 and 2230 CURSor POSition: <NR1>	Selects the horizontal data point position of the active cursor. If the acquisition is a 1-Kbyte record and the position requested is past 1023 data points, the value is limited to position 1023, and no warning is sent. If the acquisition is a 4-Kbyte record and the position requested is past 4095 data points, a command error service request is generated, and the command is ignored.
2221 and 2230 CURSor SElect: <CURS1-CURS2>	Selects the named cursor to be positioned by the CURS POS command.
2221 and 2230 CURSor TARget: ACQuisition	Attaches the displayed cursors to acquisition waveform.
2230 CURSor TARget: <REF1-REF3>	Attaches the displayed cursors to the named reference waveform. If the named reference is not displayed, the command is ignored. No warning is issued for directing the cursors to an undisplayed reference.
2221 and 2230 CURSor TARget: REF4	Attaches the displayed cursors to REF4. No warning is issued for directing the cursors to REF4 if it is not displayed, but an execution error service request is generated if REF4 is empty.
2221 and 2230 CURSor?	Returns all the present cursor argument states in the form: CURS SEL:CH1, TAR:ACQ,CHA:CH1,POS:1047;. Each of the CURSor arguments may be separately queried as in: CURSOR? TAR to obtain the present status of that argument only.
2221 and 2230 DELTAV?	Returns an <NR3> value that represents the present voltage difference between the selected TARget and CHANnel cursors and the measurement units as either V or PERcent. The form of the return is: DELTAV VAL:0.500E0,UNI:VOL;. PERcent is returned for the units when the VOLT/DIV variable knob is out of the CAL detent position.
2221 and 2230 DELTAV? VALue	Returns the cursor voltage difference only in the form: DELTAV VAL:<NR3>;. The return defaults to a displayed CHANnel even if directed elsewhere to an undisplayed CHANnel.
2221 and 2230 DELTAV? UNIts	Returns the voltage measurement units only in the form: DELTAV UNI:<V or PER>;. See the preceding DELTAV? query description.

Table 7-25 (cont)

Commands	Description
2221 and 2230 DELTAT?	Returns an <NR3> value that represents the present time difference between the two cursors with the measurement units in the form: DELTAT VAL:1.180E-3, UNI:SEC;. The measurement units are returned in DIVisions if the SEC/DIV setting is EXT CLK.
2221 and 2230 DELTAT? VALue	Returns the cursor time difference only in the form: DELTAT VAL:<NR3>; Time difference is returned even when the readout is in frequency units for 1/ Δt measurements.
2221 and 2230 DELTAT? UNIts	Returns the time measurement units only in the form: DELTAT UNI:<S or DIV>; See the preceding DELTAT? query description.

Table 7-26
Display Commands

Commands	Description
2221 and 2230 MESage <NR1>:"message"	<p>Writes the "message" text on the named row. Values of <NR1> row numbers are from 16 (the top row) to 1 (the bottom row). The normal readout displays are turned off by the MESage command. Changing a front-panel control that requires a readout overrides the "message" and returns the normal readout display. The MES 0 command turns off the message display and also turns the normal readout displays back on.</p> <p>The message must be enclosed in quote marks. The displayed message lines start at the left edge of the graticule area. If longer than about 40 characters, the message runs off the right edge of the CRT. If the message is too long, it is truncated and a service request is issued (if RQS is ON).</p> <p>Displaying many message lines can cause display flicker and may exceed the display memory area.</p>
ALL PLOt	<p>Starts a plot of the waveform (and graticule if PLOt GRAt is on) on the CRT of the oscilloscope.</p>
ALL PLOt ABOrt	<p>Stops a plot in progress and returns to the previous mode. PLOt ABOrt is the only command or query that the oscilloscope responds to during a plot.</p>
2221 and 2230 PLOt AUTo:<ON or OFF>	<p>Turns the AUTo plot mode ON or OFF. If AUTo is ON, each waveform is plotted after it is acquired. The graticule will be plotted once in AUTo, if GRAt is ON.</p>
ALL PLOt FORmat:<[XY], HPG1, EPS7, EPS8, or TJEt>	<p>Sets the output data format for the named plotter. If one of the named plotters is not selected, the data is plotted in the default XY format. HPG1 formats for HP-GP compatible plotters. EPS7 and EPS8 format for 7-bit (low-speed, double-density) and 8-bit (high-speed, double-density) EPSON® format printers respectively. TJEt formats for the Hewlett-Packard ThinkJet® printer.</p> <p>With Option 10, a GPIB controller may direct the plotting operation by addressing the plotter to listen and then addressing the oscilloscope to talk and giving the PLOt STArt command.</p>
ALL PLOt GRAt:<ON or OFF>	<p>Turns the plotted graticule either ON or OFF.</p>
ALL PLOt SPEed:<NR1>	<p>The <NR1> number must be an integer from 1 to 10 and changes the analog plotter pen speed. The units are roughly in divisions per second.</p>
ALL PLOt STArt	<p>Starts a plot using the parameters selected by PLOt FORmat, PLOt GRAt, and PLOt SPEed. While a plot is in progress, all commands and queries (except PLOt ABOrt) are ignored.</p>

Table 7-27
Acquisition Commands

Commands	Description
ALL ACQquisition CURRrent: <AVERage, [DEFault], PEAKdet, or SAMple>	Selects the named mode for the CURRrent acquisition type and SEC/DIV setting. If a mode argument is not specified, the command selects the default mode for the present acquisition type and SEC/DIV setting. A service request is generated if the mode asked for is not valid with the present acquisition type or SEC/DIV setting.
2221 and 2230 ACQquisition CURRrent: ACCpeak	Selects the ACCpeak mode for the current acquisition type and SEC/DIV setting.
2221 and 2230 ACQquisition HSRec: <ACCpeak or AVERage>	Selects the named mode for the SEC/DIV settings for 5 μ s/div and 10 μ s/div.
ALL ACQquisition HSRec: [SAMple]	Selects the SAMple mode for the acquisitions made at 5 μ s/div and 10 μ s/div. This is the default mode and will be selected if the mode argument is omitted.
2221 and 2230 ACQquisition LSRec: <ACCpeak or AVERage>	Selects the ACCpeak or AVERage mode for acquisitions made at 0.02 ms/div to 50 ms/div.
ALL ACQquisition LSRec: <[PEAKdet] or SAMple>	Selects the PEAKdet or SAMple mode for acquisitions made at 0.02 ms/div to 50 ms/div. PEAKdet will be selected if the argument to LSRec is omitted.
2221 and 2230 ACQquisition REPetitive: <ACCpeak or SAMple>	Selects the named mode for repetitive acquisitions at SEC/DIV settings from 0.05 μ s/div to 2 μ s/div.
ALL ACQquisition REPetitive: [AVERage]	Selects the AVERage mode for repetitive acquisitions for SEC/DIV settings from 0.05 μ s/div to 2 μ s/div. This is the default argument and will be selected if the mode argument is omitted.
ALL ACQquisition RESet	Command only. Sets sampling at all SEC/DIV settings to its default mode. Default modes are enclosed in brackets ([]) in the commands.
ALL ACQquisition ROLl: <[PEAKdet] or SAMple>	Selects the PEAKdet or SAMple mode for ROLl acquisitions from 0.1 sec/div to 5 sec/div. ROLl mode acquisitions are untriggered.
ALL ACQquisition SCAn: <[PEAKdet] or SAMple>	Selects the PEAKdet or SAMple mode for SCAn acquisitions.

Table 7-27 (cont)

Commands	Description
2221 and 2230 ACQquisition SCAN: <ACCpeak or AVErage>	Selects the ACCpeak or AVErage mode for SCAN acquisitions at 0.1 sec/div to 5 sec/div. The oscilloscope must in NORM or SGL SWP trigger mode to observe a change in the READOUT.
ALL ACQquisition SMOoth: <ON or OFF>	Applies smoothing to the acquired waveform data when ON.
2220 ACQquisition TRIGCount: <NR1>	Sets the number of data points acquired before the trigger point in the waveform record. The range of the <NR1> number is 16 to 2048 in post-trigger and 2048 to 4080 in pre- or mid-trigger. The resolution of the <NR1> value is 4.
2221 ACQquisition TRIGCount: <NR1>	Sets the number of data points acquired before the trigger point in the waveform record. The range of the <NR1> number is from 16 to 4080. The setting of the front-panel TRIG POS switch does not limit the range of the trigger point position within the waveform record. The resolution of the <NR1> value is 4.
2230 ACQquisition TRIGCount: <NR1>	Sets the number of data points acquired before the trigger point in the waveform record. The range of the <NR1> number depends on the record length and the selection of pre- or post-trigger. In pretrigger, the <NR1> range is 4 to 512 for 1 K records and 16 to 2048 for 4 K records. In post-trigger, the range is from 512 to 1020 for 1 K records and 2048 to 4080 for 4 K records. The resolution of <NR1> is ± 4 counts.
ALL ACQquisition VECTors: <ON or OFF>	Turns point-to-point display vectors ON or OFF.
ALL ACQquisition WEIght: <NR1>	Sets the number of acquisitions weighted into an AVEraged waveform record. The valid values for <NR1> are: 1, 2, 4, 8, 16, 32, 64, 128, and 256. A service request is generated and the command is ignored if the argument is not one of these numbers. If the argument for WEIght is omitted, <NR1> reverts to 4.
ALL ACQquisition?	Returns the settings of the acquisition modes in the following short form with LONG set to OFF. ACQ REP: AVE, HSR: SAM, LSR: PEA, SCA: PEA, ROL: PEA, SMO: ON, WEI: 4, SWP: 1037, NUM: 0, POI: 4096, TRIGM: POST, TRIGC: 2000, SAV: OFF, DIS: SCA, VEC: ON; Each of the acquisition command arguments (except RESet) may be queried separately to find out that argument's status.
ALL ACQquisition? DISPlay	Returns a string of either ROL or SCAN for the present state of the ROLL/SCAN button. The form of the return is: ACQ DIS: <ROL or SCA>;

Table 7-27 (cont)

Commands	Description
ACQquisition? POInts	Returns an <NR1> value that is the number of data points in the waveform record. The form of the return is: ACQ POI:<NR1>;
ALL ACQquisition? SAVE	Returns a string of either ON or OFF for the present state of the acquisition system (ON for SAVE and OFF for CONTINUE).
ALL ACQquisition? SWPcount	Returns an <NR1> value for the number of sweeps completed in an acquisition. The form of the return is: ACQ SWP:<NR1>;
ALL ACQquisition? TRIGMode	Returns a string of either PRE or POST for the present ACQquisition Trigger setting in the following form: ACQ TRIGM:<PRE or POST>;
ALL STORE?	Returns the present state of the STORE/NON-STORE button in the form: STOR <ON or OFF>;

Table 7-28
Save and Recall Reference Commands

Commands	Description
ALL REFFrom [ACQ]	Selects the acquisition as the source for the waveform data to be saved into one of the numbered reference memories by the SAVeref command. ACQ is the default argument (indicated by the square brackets, []) and need not be present in the command to select it as the data source. For the 2220 and 2221, ACQ is the only valid source.
2230 REFFrom REF<1-4>	Selects the named reference memory as the data source for the next SAVeref command. Acquisition (ACQ) waveforms must first be stored into one of the numbered references (REF1-REF4) before they may be saved into one of the lettered references (REFA-REFZ).

Table 7-28 (cont)

Commands	Description
2230 REFFrom REF<A-Z>	<p>Selects the named extended memory location (REFA-REFZ) as the source of waveform data for the next SAVeref command. The total extra memory is 26 Kbytes, and stored waveform records of 1 K to 8 K (averaged 4 K acquisitions) may be stored.</p> <p>The nonvolatile references of the 2230 may not be displayed, plotted, or transmitted directly; they must first be moved to one of the numbered references (REF1-REF4) using the REFFrom and SAVeref commands.</p>
2230 REFDisp REF<1-3>:ON, OFF or EMPTY>	<p>Turns the named 2230 reference display ON or OFF. EMPTY erases the named 2230 reference display and turns it off. Reference memory locations 1, 2 and 3 are 1024-point memories.</p>
ALL REFDisp REF4: <ON, OFF or EMPTY>	<p>REF4 is the only available reference memory for the 2220 and 2221 instruments. Reference memory 4 stores a 4 K (4096-point) reference waveform and occupies the REF1-REF3 memory locations in the 2230.</p>
2230 REFDisp REF<A-Z>:EMPTY	<p>The EMPTY command erases the named reference if it is not protected (see REFProt command). The lettered references may not be displayed directly; they must be moved to a numbered save reference memory (REF1-REF4).</p>
2230 REFProt REF<A-Z>:<LOCKed, PERM, or UNLOCKed>	<p>These commands control the write protection of the 2230 nonvolatile reference memories (REFA-REFZ). LOCKed and PERM disable further storage into the named reference or erasure of the waveform data. PERM protected waveform data cannot be overwritten using the front-panel controls. See REFStat queries to obtain write protection and bytes free status.</p>
2230 REFOFormat CHAnnel:<[CH1] or CH2>	<p>Selects which channel of the saved reference to REFOFormat. If there is no SAVE REF waveform for the named channel, a service request status byte is generated. If an XY waveform is selected for reformatting, either channel may be selected. CH1 is selected without the CH1 argument.</p>
2230 REFOFormat HMAg:ON	<p>Increases the horizontal gain of the REFOFormat TARget reference waveform set (affects vertical channels) by a factor of ten times.</p>
2230 REFOFormat HMAg:OFF	<p>Turns off the horizontal magnification of the REFOFormat TARget reference waveform set.</p>

Table 7-28 (cont)

Commands	Description
2230 REFOFormat VGAIN: <NR3>	Changes the vertical gain of the reference target and channel designated by REFOFormat TARget and REFOFormat CHAnnel. This command is not valid for XY waveforms. The maximum <NR3> value permitted is the equivalent of ± 3 detent positions of the VOLT/DIV switch (in a 1-2-5 sequence). An execution error status byte is generated either if the asked-for setting is out of the maximum change range or if it is not a 1-2-5 sequence setting.
2230 REFOFormat VPOsition: <NR2>	Adjusts the vertical position of the reformatting target waveform. The valid range of <NR2> is ± 10 divisions from the original position with a resolution of one displayed bit.
ALL REFDisp?	Returns the status of the REF1 reference memory location as ON, OFF, or EMPTY for the 2230; returns the status of REF4 for the 2220 and 2221.
2230 REFDisp? REF<1-3>	Returns the status of the named 2230 reference memory location as ON, OFF, or EMPTY.
ALL REFDisp? REF4	Returns the status of REF4 as ON, OFF, or EMPTY. For the 2210 and 2221 instruments, the default argument of REF4 is not needed.
ALL REFFrom?	Query returns the selected source of waveform data for the SAVeref command. The reply will be ACQ for the 2220 and 2221; for the 2230 it may be from ACQ or any REFErence from (REF1-REF4) and (REFA-REFZ).
2230 REFOFormat?	Returns the status of the REFOFormat command and query arguments. A sample return is: REFO TAR:REF4, CHA:CH2,VGA:0.5E+0, VPO: +3.96, HMA:OFF, BAS:0.2E+0,MOD:CH1; Each of the command arguments may be individually queried for their status with respect to the REFOFormat TARget and CHAnnel reference waveform.
2230 REFOFormat? BASegain	Returns the vertical gain setting at which the REFOFormat TARget waveform was acquired as an <NR3> number.
2230 REFOFormat? MODe	Returns the vertical mode in which the REFOFormat TARget waveform was acquired (CH1, CH2, ADD, CHOP, ALT, or XY).
2230 REFStat? FILI	Returns a thirty-number string that indicates the fill status of each of the reference memories from REF1 to REFZ. The numbers are 0 (empty), 1, 2, 4, or 8 and indicate the stored waveform record in Kbytes.

Table 7-28 (cont)

Commands	Description
2230 REFStat? FREe	Returns the number of free Kbytes in the nonvolatile reference memory as a <NR1> number from 0 to 26.
2230 REFStat? PROtect	Returns a thirty-character string that indicates the protected status of each of the reference memories from REF1 to REFZ. The characters returned are U, L, or P and correspond to unlocked, locked, or permanent protection status.
2230 SAVeref REF<1-3>	Command only. Saves the waveform selected by the REFFrom command into the named reference. REF1, REF2, and REF3 are 1 K (1024-point) memory locations. Any 1 K portion of 4 K waveform acquisition (from ACQ or REF4) may be saved as a 1 K reference in REF1-REF3; the 1 K portion stored into REF1-REF3 is determined by the position of the active cursor. The saved reference display is also turned on.
ALL SAVeref REF4	Command only. REF4 is a 4 K (4096-point) memory location. It is the only reference memory for the 2220 and 2221 instruments, and as such the REF4 argument may be omitted from the SAV command for those instruments.
2230 SAVeref REF<A-Z>	Command only. Saves the waveform selected by the REFFrom command into the named reference (REFA-REFZ). Reference waveforms stored as 4 K records cannot be moved as 1 K records into REF1-REF3; to be either displayed or transmitted 4 K records must be moved into REF4.
2230 SAVeref REF<1-3>	Command only. Saves the waveform selected by the REFFrom command into the named reference. REF1, REF2, and REF3 are 1 K (1024-point) memory locations. Any 1 K portion of 4 K waveform acquisition (from ACQ or REF4) may be saved as a 1 K reference in REF1-REF3; the 1 K portion stored into REF1-REF3 is determined by the position of the active cursor. The saved reference display is also turned on.
ALL SAVeref REF4	Command only. REF4 is a 4 K (4096-point) memory location. It is the only reference memory for the 2220 and 2221 instruments, and as such the REF4 argument may be omitted from the SAV command for those instruments.
2230 SAVeref REF<A-Z>	Command only. Saves the waveform selected by the REFFrom command into the named reference (REFA-REFZ). Reference waveforms stored as 4 K records cannot be moved as 1 K records into REF1-REF3; to be either displayed or transmitted 4 K records must be moved into REF4.

Table 7-29
Waveform Commands

Commands	Description
ALL CURVe	<p>Use as a command to send waveform data to the oscilloscope. The DATA TARGET command points to the reference memory where the data is sent. The DATA CHANNEL command points to the channel where the data is sent. (Only REF4 is available for the 2220 and 2221.) The DATA ENCDG command tells the oscilloscope the format of the data (HEX, BINARY, or ASCII).</p> <p>Use as a query to get waveform data from the oscilloscope. The DATA SOURCE and DATA CHANNEL commands select the source of the waveform data.</p> <p>The data sent or received is in the form:</p> <p>CURVE <data>; where the <data> is encoded for HEX, BINARY, or ASCII in the following form:</p> <p style="padding-left: 40px;">%<byte count> <binary data> <checksum> for BIN, #H<byte count> <hex data> <checksum> for HEX, or <ascii data> for ASCII encoding.</p> <p>With ASCII format, each data value is separated by a comma.</p>
ALL DATA CHANNEL: <[CH1] or CH2>	<p>Selects the channel of a waveform set from which CURVe?, WAVFrm?, or WFMpre? query will return data.</p> <p>If there is no waveform in the named channel, a service request is sent when the data is requested.</p> <p>At power-up, the selected channel is CH1. CH1 must be selected for an XY acquisition.</p>

Table 7-29 (cont)

Commands	Description
ALL DATa ENCDg: <ASCIi, [BINary], or HEX>	Sets the curve data encoding and decoding format. The power-on default is BINary. Data points are represented as unsigned integers in all formats.
2230 DATa SOURce: <REF1, REF2, or REF3>	Selects the named reference memory to provide the waveform data for a WAV?, WFM?, or CURV? query.
ALL DATa SOURce: <[ACQ] or REF4>	Selects either the present acquisition or the REF4 reference memory to provide the waveform data for a WAV?, WFM?, or CURV? query. The power-on default is ACQ, and it will be selected if the argument is omitted.
2230 DATa TARget: <REF1, REF2, or REF3>	Selects the named reference memory to receive data sent with a CURVe or WFMpre command. At power-on, REF1 is selected. There is no default selection.
ALL DATa TARget: REF4	Selects REF4 as the reference memory to receive data sent with a CURVe or WFMpre command. This is the only selection for the 2220 and 2221.
ALL DATa?	Returns the selection of data source, target, channel and encoding. The short form of the return is: DAT SOU:ACQ,TAR:REF1,CHA:CH1,ENC:BIN; Each DATa argument may be individually queried to obtain that selection only.
ALL WAVfrm?	Returns the waveform data from the oscilloscope. The return is the combined waveform preamble and waveform data. The waveform assigned by the DATa SOURce and DATa CHAnnel commands is sent in the encoding assigned by the DATa ENCDg command. The form of the return is: WFM <ascii preamble>;CURV <waveform data>;

NOTE

The information given in the Waveform Preamble Fields table is primarily to help identify the result of a WFMpre? query. As such, the arguments are not usually sent as individual commands, but are grouped together as a complete waveform preamble. If sent as a single command, an argument value is not accepted (except as noted for ENCdg) until the curve it is supposed to go with is transferred to the selected DATA TARget reference memory. If any size error in any of the waveform preamble numeric arguments is sent to the oscilloscope, it will be accepted. Then, when the curve data is sent the error will be rejected, and a waveform preamble error service request will be sent.

Table 7-30
Waveform Preamble Fields

Commands	Description
ALL WFMpre ENCdg: <ASCii, [BINary], or HEX>	Selects the waveform curve data encoding format for transferring data. WFEpre ENCdg and DATA ENCdg operate identically. Data points are represented as unsigned integers in any of the encoding formats.
ALL WFMpre?	Returns the waveform identification string as with the WFMpre? WFId query plus the value for all the waveform preamble arguments. The short form of the return is: WFM WFI:* <identification string>*, NR.P:2048, PT.O:256, PT.F:ENV, XMU:1.0E+3, XOF:0, XUN:S, XIN:10.0E-6, YMU:8.0E-3, YOF:0, YUN:V, ENC:ASC, BN.F:RP, BYT:1,BIT:8, CRV:CHK; Each of the arguments may be queried separately to find out its value.
ALL WFMpre? WFId	Returns an ASCII waveform identification string giving the key features of the waveform. The information returned is: acquisition source, channel, Volts/Div, input coupling, Sec/Div, acquisition mode, and the number of the curve being sent. In XY mode, the CH2 Volts/Div and input coupling are added. The waveform ID is ignored if received as a command. The form of the return is: WFM WFI:* ACQ, CH1, 0.2mV, DC, 0.5mS, AVERAGE, CRV# 3* ; or for XY: WFM WFI:* REF4, XY, 20mV, DC, 50mV, DC, 0.5mS, SAMPLE, CRV# 1* ; <p style="text-align: center;">NOTE</p> <p><i>The DATA CHannel must be CH1 to get the XY information. All vertical information is omitted for a 2220.</i></p>

Table 7-30 (cont)

Commands	Description																																																				
<p>ALL WFMpre NR.Pts:<NR1></p>	<p><NR1> is the number of points in the waveform. Each point can be a single Y value (with time implied), an X-Y pair, or a Max-Min pair. Although the record length is either 1024 data point or 4096 data points, the NR.Pts <NR1> value may be 256, 512, 1024, 2048, or 4096 points. The value depends on the number of channels, the acquisition mode, and whether smoothing is on or off. A table expressing the conditions and the record length to NR.Pts ratio value follows:</p> <table border="1" data-bbox="576 535 1487 1144"> <thead> <tr> <th>NR.Pts to Record Length Ratio</th> <th>Number of Channels</th> <th>Acquire Mode</th> <th>SMOOTH</th> </tr> </thead> <tbody> <tr><td>Rec/1</td><td>1</td><td>SAMple</td><td>NA</td></tr> <tr><td>Rec/1</td><td>1</td><td>AVErage</td><td>NA</td></tr> <tr><td>Rec/1</td><td>1</td><td>PEAKdet</td><td>ON</td></tr> <tr><td>Rec/1</td><td>1</td><td>ACCpeak</td><td>ON</td></tr> <tr><td>Rec/2</td><td>2</td><td>SAMple</td><td>NA</td></tr> <tr><td>Rec/2</td><td>2</td><td>AVErage</td><td>NA</td></tr> <tr><td>Rec/2</td><td>2</td><td>PEAKdet</td><td>ON</td></tr> <tr><td>Rec/2</td><td>2</td><td>ACCpeak</td><td>ON</td></tr> <tr><td>Rec/2</td><td>1</td><td>PEAKdet</td><td>OFF</td></tr> <tr><td>Rec/2</td><td>1</td><td>ACCpeak</td><td>OFF</td></tr> <tr><td>Rec/4</td><td>2</td><td>PEAKdet</td><td>OFF</td></tr> <tr><td>Rec/4</td><td>2</td><td>ACCpeak</td><td>OFF</td></tr> </tbody> </table> <p>For example, if the number of channels is two and the acquisition is peak detect with smoothing off, the number of points for a waveform in a 4 Kbyte record is 4096 divided by 4 (1024 points).</p>	NR.Pts to Record Length Ratio	Number of Channels	Acquire Mode	SMOOTH	Rec/1	1	SAMple	NA	Rec/1	1	AVErage	NA	Rec/1	1	PEAKdet	ON	Rec/1	1	ACCpeak	ON	Rec/2	2	SAMple	NA	Rec/2	2	AVErage	NA	Rec/2	2	PEAKdet	ON	Rec/2	2	ACCpeak	ON	Rec/2	1	PEAKdet	OFF	Rec/2	1	ACCpeak	OFF	Rec/4	2	PEAKdet	OFF	Rec/4	2	ACCpeak	OFF
NR.Pts to Record Length Ratio	Number of Channels	Acquire Mode	SMOOTH																																																		
Rec/1	1	SAMple	NA																																																		
Rec/1	1	AVErage	NA																																																		
Rec/1	1	PEAKdet	ON																																																		
Rec/1	1	ACCpeak	ON																																																		
Rec/2	2	SAMple	NA																																																		
Rec/2	2	AVErage	NA																																																		
Rec/2	2	PEAKdet	ON																																																		
Rec/2	2	ACCpeak	ON																																																		
Rec/2	1	PEAKdet	OFF																																																		
Rec/2	1	ACCpeak	OFF																																																		
Rec/4	2	PEAKdet	OFF																																																		
Rec/4	2	ACCpeak	OFF																																																		
<p>ALL WFMpre PT.Off:<NR1></p>	<p><NR1> is the trigger position relative to the first data point in the record. For a 1024 point record, <NR1> for PT.Off ranges from 4 to 1024 in increments of 4. The normal values for a 4096 point record range from 4 to 4096.</p> <p style="text-align: center;">NOTE</p> <p><i><NR1> will be a negative value if the trigger occurred before the first data point in the record window. Since any 1024 point window of a 4096 point record may be transferred, the legal values of <NR1> for PT.Off are -3096 to +4096. If the PT.Off value is unknown, -10000 in the <NR1> value returned.</i></p>																																																				

Table 7-30 (cont)

Commands	Description
ALL WFMpre PT.Fmt: <Y, XY, r ENV>	<p>Point format defines how to interpret the curve data points.</p> <p>Y format means that X-axis information is derived from the waveform preamble and not sent explicitly. The data values represent the vertical amplitude of the waveform at that data point position.</p> <p>XY format means that the data points are in X-Y pairs, with X first.</p> <p>ENV format means that the vertical data is sent in max-min pairs. The data is sent in the form:</p> <p style="text-align: center;">....,y1max,y1min,y2max,y2min,..</p> <p>ENV is valid for PEAKdet and ACCpeak acquisition modes with SMOoth OFF.</p>
ALL WFMpre XUNits: <S or CLKs>	<p>Gives the units value for the XINcr. If XUN is S the X-increment is in seconds; if in CLK, the X-increment is unknown. (CLK is returned when the SEC/DIV setting is EXT CLK.)</p>
ALL WFMpre XINcr: <NR3>	<p>The XINcr <NR3> value is the time between data points. If XINcr for a waveform being sent to the oscilloscope does not correspond to a legitimate SEC/DIV setting, the new curve data is not accepted, and a command argument error service request is sent (if RQS is ON). The queried XINcr value of <NR3> is set equal to 1 (0.1E+0) if it is unknown, as is the case for EXT CLK.</p>
ALL WFMpre YUNits: <V or DIVs>	<p>Indicates the units of YMUIt. When the CAL knob of the DATA CHANNEL is not in the detent position, the DIVs argument is returned. DIVs is always returned for the 2220 since the vertical scaling is unknown.</p>
ALL WFMpre YMUIt: <NR3>	<p>The YMUIt <NR3> value is the step size of the digitizer (volts between digitizer levels). If the YMUIt for a waveform being sent to the oscilloscope does not correspond to a legitimate VOLTS/DIV setting, the new curve data is not accepted, and waveform preamble error service request is sent (if RQS is ON). The queried YMUIt value of <NR3> is 40.0E-3 when the VOLTS/DIV CAL knob for the DATA SOURCE is not in the detent position.</p>
ALL WFMpre YOFF: <NR1>	<p>The YOFF <NR1> value is the Y coordinate of ground. If ground level is not known, the value of -10000 is returned.</p>
ALL WFMpre XMUIt	<p>XMUIt and XOFF are similar to YMUIt and WFMpre XOFF YOFF. They are added to the waveform preamble for XY waveforms. For all XY waveforms, the YUNits value is valid for both the X and the Y data points. The value of XUNits is referenced to the sampling rate.</p>

Table 7-30 (cont)

Commands	Description
ALL WFMpre BN.Fmt:RP	RP is the only argument valid argument. It means that the binary format is always right-justified and consists of positive binary integers (also known as unsigned binary integers).
ALL WFMpre BYT/nr:<NR1>	<p>The valid numbers for <NR1> are 1 and 2. Each data point value is represented by two bytes for for AVErage mode, only one byte in other modes. If two bytes are sent, the most significant byte is sent first.</p> <p>In HEX format, each data point is represented by tow ASCII encoded hex characters.</p>
ALL WFMpre BIT/nr:<NR1>	<p>The data points consists of either 8 or 16 bits.</p> <p style="text-align: center;">NOTE</p> <p><i>The least significant bits of a 16-bit waveform may or may not be valid, depending on the number of acquisitions averaged.</i></p>
ALL WFMpre CRVchk:CHKsm0	<p>The CHKsm0 argument indicates that the last byte of a binary curve is a checksum. The checksum byte is the two's complement of the modulo 265 sum of the binary count and curve data bytes. It does not include the word and symbol CURVE % that comes before the binary count.</p>

**Table 7-31
Miscellaneous Commands**

Commands	Description
ALL INIt	Command only. The INIt command causes the oscilloscope revert to the power-on default states for the acquisition modes. The 2230 menu system is also initialized.
ALL LONG <[ON] or OFF>	With LONG ON, replies to queries are reported with the full command words. With LONG OFF, replies use the short form of the command words. The short form characters are those that appear in capital letters in these command tables and are the minimum characters accepted as valid for commands. The power-on and default states of LONG are ON. The LONG? query returns its state, ON or OFF.
ALL ID?	Returns the oscilloscope identification string in the form: ID TEK/2230,V81.1,VERS:09; The instrument type and version numbers will be reported as appropriate for the instrument queried.
ALL HElP?	Returns a list of all the valid command headers available in the instrument queried. All the valid characters of the commands are returned; the short form of the commands (LONG OFF) are in capital letters.
ALL SEt?	Returns an ASCII string of headers and arguments reflecting the present states of the controls and modes that may be set via the communications interface. The query-only settings are not returned. The string returned by the SEt? query may be sent as a command message to the oscilloscope to recreate those settings. The state of the LONG command affects the length of the reply. NOTE <i>To comply to Codes and Formats, a header is not sent back with the settings string.</i>

Table 7-32
Service Request Group Commands

Commands	Description
ALL OPC <[ON] or OFF>	When ON, the oscilloscope sends a service request upon completion of certain system events (if RQS is also ON). Events that request service when completed with OPC ON include: Acquisition completed, and plot completed. When off, OPC (operation completed) events do not generate a service request. The power-on state of OPC is OFF.
ALL RQS <[ON] or OFF>	When ON, the oscilloscope sends a service request (SRQ) when it has an event to report. When OFF, event codes of different priority still accumulate and may be retrieved with an EEnt? query, but the reply to STATus? will be a 0. The power-on and default states of RQS are ON.
ALL EEnt?	Returns an <NR1> value that is the code number for oldest service-request event (if multiple events are pending). If no events are pending, <NR1> is 0. Multiple events of different priority are retrieved by sending EEnt? until 0 is returned. Querying the event clears the service request.

Table 7-33
RS-232-C Specific Commands

Commands	Description
ALL FLOW <[ON] or OFF>	<p>Enables (ON) or disables (OFF) DC1/DC3 flow control. FLOW ON is the default and power-on state. Binary data transfers cannot be made with FLOW ON. A FLOW? query returns the present state, ON or OFF.</p> <p>With FLOW ON, the <control-S>, <control-Q>, and <control-D> are recognized during data transfers. Their functions are as follows:</p> <p align="center"><control-S> Temporarily suspend output of characters.</p> <p align="center"><control-Q> Resume character output that has been temporarily suspended.</p> <p align="center"><control-D> Abort the command or query execution; erase both input and output buffers; reset the message processor.</p>
ALL REMote <[ON] or OFF>	<p>Enables (ON) or disables (OFF) setting of remote-controllable oscilloscope states. An execution error service request is sent if a control command is sent with REM OFF.</p> <p>REM? returns the present state, ON or OFF.</p>
ALL STOP <1 or 2>	<p>Sets the number of stop bits used in transferring character codes. The usual selection is 1 though some printers require two stop bits at certain baud rate settings. STOP is set to 1 at power on. When connecting to a printer or plotter, select a baud rate that uses only one stop bit.</p> <p>STOP? returns the present setting, 1 or 2.</p>
ALL STATus?	<p>Returns the current status of the instrument. If no service requests are pending, the status byte returned indicates No Status to Report. If RQS is off, an EVENT? query must be used to find out if an event occurred and, if so, which one. The EVENT? query produces more useful information about an event than the service request status byte.</p>

STATUS BYTES AND EVENT CODES

The various status events and errors that can occur are divided into several categories as defined in Table 7-34. Table 7-35 lists the event codes that are returned as the result of an `EVEnt?` query.

Option 10

If there is more than one event of different priority levels to be reported, the oscilloscope reasserts `SRQ` until it reports all events of different priority. It does not issue an `SRQ` for duplicate events pending or for more than one event of the same priority level. Each event is automatically cleared when its status byte is reported. The controller option can clear all events by repeatedly sending the `EVEnt?` query until a zero status byte is returned. The Device Clear (DCL) interface message may be used to clear all events, except the power-on event.

With `RQS` set `OFF`, all service requests (except the power-on `SRQ`) are prevented. With the service requests turned off, the `EVEnt?` query must be sent to the oscilloscope so that the controller can determine the oscilloscope and event status. The controller may address the oscilloscope and send the `STAtus?` or `EVEnt?` query at any time.

It is not necessary to wait for an `SRQ`. The instrument will return the status byte code for `STA?` status bytes pending and an event code for `EVE?` for events waiting to be reported (or a 0 for no events to report).

Option 12

If there is more than one event of different priority levels to be reported, the oscilloscope has a status byte and event code available for each one. It does not report duplicate events or more than one event of the same priority level. Each event is automatically cleared when its status byte or event code is reported. The Device Clear (DCL) interface message may be used to clear all events, except the power-on event. Querying `EVEnt?` until the return is `EVE 0` clears all pending status bytes and there is no power-on event.

With `RQS` set `OFF`, all service requests are prevented. With the service requests turned off, the `EVEnt?` query must be sent to the oscilloscope so that the controller can determine the oscilloscope and event status. The controller may send the `EVEnt?` query at any time, and the instrument will return the code for an event waiting to be reported (or a 0 for no events to report). The controller can clear all events by repeatedly sending the `EVEnt?` query until a zero status byte is returned.

Table 7-34
Status Event and Error Categories

Category	Status Byte	Description
Command Error	97 or 113	The instrument received a command that it cannot understand.
Execution Error	98 or 114	The instrument received a command that it cannot execute. This is caused by either out-of-range arguments or settings that conflict.
Internal Error	99 or 115	The instrument detected a hardware condition or a firmware problem that prevents operation.
System Events	65-67 and 81-83	Events common to instruments in a system (e.g., Power-on and User Request).
Execution Error Warning	101 or 117	The instrument received a command and is executing it, but a potential problem may exist. For example, the instrument is out of range, but is sending a reading anyway.
Internal Warning	102 or 118	The instrument detected a problem. It remains operational, but the problem should be corrected (e.g., out of calibration).
Device Status	0 or 16, 193-238, and 209-254	Device-dependent events.

Table 7-35
Event Codes

EVENT? Code	Instrument Status
000	No status to report
Command Errors	
101	Command header error.
102	Header delimiter error.
103	Command argument error.
104	Argument delimiter error.
105	Non-numeric argument, numeric expected.
105	Non-numeric argument, numeric expected.
106	Missing argument.
107	Invalid message-unit delimiter.
108	Checksum error.
109	Byte-count error.

Table 7-35 (cont)

EVENT? Code	Instrument Status
151	The argument is too large.
152	Illegal hex character.
153	Non-binary argument; binary or hex expected.
154	Invalid numeric input.
155	Unrecognized argument type.
Execution Errors	
201	Command cannot be executed when in LOCAL.
203	I/O buffers full, output dumped.
205	Argument out of range, command ignored.
206	Group execute trigger ignored.
251	Illegal command.
252	Integer overflow.
253	Input buffer overflow.
254	Invalid waveform preamble
255	Invalid instrument state.
256	GPIB (Option 10) command not allowed.
257	RS-232-C (Option 12) command not allowed.
258	Command not allowed on 2220 or 2221.
259	Command not allowed on 2230.
260	Cannot execute command with RQS OFF.
261	Reference memory busy with local (front-panel) command.
262	Reference memory non-existent or specified as different size than selected waveform.
263	Plot active; only PLOT ABORT allowed while plotting.
Internal Errors	
351	Firmware failure. Contact your nearest Tektronix Service Center for assistance.

Table 7-35 (cont)

EVENT? Code	Instrument Status
System Events	
401	Power on.
451	Parity error.
452	Framing error.
453	Carrier lost.
454	End of acquisition OPC.
455	End of plot OPC.
456	Diagnostics test complete OPC.
Execution Warnings	
551	Single sweep is already armed.
552	No ground-dot measurement available.
553	Invalid probe code or identify.
554	Query not valid for current instrument state.
555	Requested setting is out of detent (uncalibrated).
556	MESsage display buffer is full.
557	Waveform preamble is incorrect, has been corrected.
558	Waveform transfer ended abnormally.

2221 SPECIFIC COMMANDS

Commands specifically for the 2221 are given in short form as a quick users' reference in Table 7-36. The complete list of commands for the 2200 Family of DSOs is given in the preceding command tables, Table 7-22 through Table 7-33.

Table 7-36
2221 Commands, Short Form List

VERTICAL QUERIES	
CH1? CH1? VOL CH1? COU	Returns CH1 VOLTS/DIV and input coupling.
CH2? CH2? VOL CH2? COU CH2? INV	Returns CH2 VOLTS/DIV, input coupling, and CH2 INVERT state.
VMO?	Returns the vertical mode.
PROB? <CH1 or CH2>	Returns channel attenuation factors.
HORIZONTAL QUERIES	
HOR? HOR? ASE HOR? EXT HOR? HMA	Returns the A SEC/DIV and the states of external clock and X10 magnification.
TRIGGER COMMANDS AND QUERIES	
ATR? [MOD]	Returns A trigger mode.
SGL ARM	Returns warning if already armed. Returns error if not in single sweep.
SGL?	Returns state of single sweep.
TRI?	Returns state of the trigger indicator.
CURSOR COMMANDS AND QUERIES	
CURS CHA:<CH1 or CH2>	Selects cursor channel.
CURS POS:<NR1>	Positions selected cursor.
CURS SEL:<CURS1 or CURS2>	Selects cursor to position.
CURS TAR:<ACQ or REF4>	Selects waveform set to attach cursors.

Table 7-36 (cont)

CURSOR COMMANDS AND QUERIES (cont)	
CURS? DELTAV?	Returns the cursor channel, position, selected cursor, and cursor target. Voltage and units are returned from the selected cursor channel.
DELTAV? VAL	
DELTAV? UNI	
DELTAT?	Time and units are returned from the selected cursor target.
DELTAT? VAL	
DELTAT? UNI	
DISPLAY COMMANDS	
MES <NR1>:"message"	MES 0 restores the normal readout. Error warning is sent if the message overflows the buffer.
PLO ABO	Command only. This is the only command the instrument responds to with the plot running.
PLO AUT:<ON or OFF>	Plots each waveform as it is acquired. Plot abort turn AUT OFF.
PLO FOR:<[XY], HPG, EPS7, EPS8, or TJE>	Selects plot data format for the named printer/plotter.
PLO GRA:<ON or OFF>	Graticule is plotted only once for auto plots when on.
PLO SPE:<NR1>	About 1 to 10 divisions per second for <NR1>.
PLO STA	Command only. Starts the plot.
PLO?	Returns PLO status for GRA, FOR, SPE, and AUT.
ACQUISITION COMMANDS	
ACQ CURR:<ACC, AVE, [DEF], PEA, or SAM>	For current SEC/DIV setting.
ACQ HSR:<ACC, AVE, or SAM>	5 μ s/div and 10 μ s/div.
ACQ LSR:<ACC, AVE, [PEA], or SAM>	0.02 ms/div to 50 ms/div.
ACQ REP:<ACC, [AVE], or SAM>	0.05 μ s/div to 2 μ s/div.

Table 7-36 (cont)

ACQUISITION COMMANDS (cont)	
ACQ RES	Command only. Defaults are set for all SEC/DIV settings.
ACQ ROL: <[PEA] or SAM>	Untriggered from 0.1 s to 5 s/div.
ACQ SCA: <ACC, AVE, [PEA], or SAM>	Triggered from 0.1 s to 5 s/div.
ACQ SMO: <ON or OFF>	Turns Smoothing ON or OFF for applicable modes.
ACQ TRIGC: <NR1>	Position trigger point in the waveform for <NR1> from 16 to 4080.
ACQ VEC: <ON or OFF>	Turns data point vectors ON or OFF.
ACQ WEI: <NR1>	Power-on default is 16.
ACQ?	Add one of the preceding acquisition arguments for individual queries.
ACQ? DIS	Returns either ROL or SCA.
ACQ? POI	Returns number of data points.
ACQ? SAVE	Returns state of SAVE.
ACQ? SWP	Returns the number of sweeps that have occurred since the the present acquisition started.
ACQ? TRIGM	Returns POST or PRE trigger. Setting does not limit the position at which the trigger point may be placed in the waveform record.
STOR?	Returns the state of STORE mode, ON or OFF.
SAVE REFERENCE COMMANDS	
REFF[ACQ]	ACQ is the only valid source for reference data to be saved by the SAV REF4 command.
REFD REF4: <[ON], OFF, or EMPTY >	Turns REF4 ON or OFF or erases it.
REFD?	Returns the state of REF4.
REFF?	Returns source of reference waveform.
SAV REF4	Saves the acquisition waveform in REF4.

Table 7-36 (cont)

WAVEFORM COMMANDS	
CURV	Identifies the waveform data.
CURV?	Retrieves waveform data only.
DAT CHA: <[CH1] or CH2>	Selects waveform channel.
DAT ENC: <ASC, [BIN], or HEX>	Must be ASC or HEX for flow control.
DAT SOU: <[ACQ] or REF4>	Selects waveform source.
DAT TAR: REF4	Sets reference memory to receive waveform data from the controller.
DAT?	Returns the present selections for CHA, ENC, SOU, and TAR.
WAV?	Retrieves waveform and preamble.
WAVEFORM PREAMBLE FIELDS	
WFM?	Returns the waveform preamble.
WFM? WFI	Returns the waveform ID string only. The DATA CHANNEL must be CH1 to get the XY information.
WFM ENC: <ASC, [BIN], or HEX> WFM NR.Pt: <NR1> WFM PT.O: <NR1> WFM PT.F: <Y, XY, or ENV> WFM XUN: <S or CLK> WFM XIN: <NR3> WFM YUN: <V or DIV> WFM YMU: <NR3> WFM YOF: <NR1> WFM XMU WFM XOF WFM BN.F: RP WFM BYT: <NR1> WFM BIT: <NR1> WFM CRV: CHK	Same as DAT ENC.

Table 7-36 (cont)

SERVICE REQUEST GROUP COMMANDS	
OPC <[ON] or OFF>	Operation complete events issue a service request when OPC is ON.
RQS <[ON] or OFF>	All service request (except power-on for Option 10) are suppressed.
EVE?	Returns event code for service request occurrence.
MISCELLANEOUS COMMANDS	
INI	Sets up the power-on defaults.
LON <[ON] or OFF>	
ID?	Returns instrument type and firmware version.
HEL?	Returns a list of command headers.
SET?	To comply to Codes and Formats, a header is not sent back with the settings string.
RS-232-C SPECIFIC COMMANDS	
FLO <[ON] or OFF>	Used for ASC or HEX encoded waveform data.
REM <[ON] or OFF>	Must be ON to send instrument control commands.
STOP <1 or 2>	Use a printer baud rate that requires only 1 stop bit.
STA?	The EVE? query provides a more specific occurrence code.

APPENDIX A

PERFORMANCE CHECK PROCEDURE

INTRODUCTION

PURPOSE

The Performance Check Procedure is used to verify "Performance Requirements" listed in Table 1-2 and to determine the need for readjustment. The performance checks may also be used as an acceptance test or as a preliminary troubleshooting aid.

the minimum necessary to provide accurate results. Therefore, equipment used must meet or exceed the listed specifications. Detailed operating instructions for test equipment are not given in this procedure. If more operating information is required, refer to the appropriate test equipment instruction manual.

PERFORMANCE CHECK INTERVAL

To ensure instrument accuracy, check its performance after every 2000 hours of operation (or once each year if used infrequently). A more frequent interval may be necessary if the instrument is subjected to harsh environments or severe usage.

When equipment other than that recommended is used, control settings of the test setup may need to be changed. If the exact item of equipment given as an example in Table A-1 is not available, check the "Minimum Specification" column to determine if any other available test equipment can be used to perform the check.

STRUCTURE

This Performance Check Procedure is structured in subsections to permit checking individual sections of the instrument whenever a complete Performance Check is not required. At the beginning of each subsection there is an equipment-required list showing only the test equipment necessary for performing the steps in that subsection. In this list, the Item number that follows each piece of equipment corresponds to the Item number listed in Table A-1.

Also at the beginning of each subsection is a list of all the front-panel control settings required to prepare the instrument for performing Step 1 in that subsection. Each succeeding step within a particular subsection should then be performed, both in the sequence presented and in its entirety, to ensure that control-setting changes will be correct for the steps that follow.

LIMITS AND TOLERANCES

The tolerances given in this procedure are valid for an instrument that is operating in and has been previously calibrated in an ambient temperature between +20°C and +30°C. The instrument also must have had at least a 20-minute warm-up period. Refer to Table 1-2 for tolerances applicable to an instrument that is operating outside this temperature range. All tolerances specified are for the instrument only and do not include test-equipment error.

PREPARATION FOR CHECKS

It is not necessary to remove the instrument cover to complete any of the subsections in the Performance Check Procedure, since all checks are made using operator-accessible front- and rear-panel controls and connectors.

TEST EQUIPMENT REQUIRED

Table A-1 is a complete list of the test equipment required to accomplish the Performance Check Procedure. Test equipment specifications described in Table A-1 are

The most accurate display adjustments are made with a stable, well-focused, low-intensity display. Unless otherwise noted, adjust the INTENSITY, STORE/READOUT INTENSITY, FOCUS, and TRIGGER LEVEL controls as needed to view the display.

Table A-1
Test Equipment Required

Item and Description	Minimum Specification	Purpose	Example of Suitable Test Equipment
1. Calibration Generator	Standard-amplitude signal levels: 5 mV to 50 V. Accuracy: $\pm 0.3\%$. High-amplitude signal levels: 1 V to 60 V. Repetition rate: 1 kHz. Fast-rise signal level: 1 V. Repetition rate: 1 MHz. Rise time: 1 ns or less. Flatness: $\pm 2\%$.	Signal source for gain and transient response.	TEKTRONIX PG 506 Calibration Generator. ^a
2. Leveled Sine-Wave Generator	Frequency: 250 kHz to above 100 MHz. Output amplitude: variable from 10 mV to 5 V p-p. Output impedance: 50 Ω . Reference frequency: 50 kHz. Amplitude accuracy: constant within 3% of reference frequency as output frequency changes.	Vertical, horizontal, triggering, and Z-axis checks.	TEKTRONIX SG 503 Leveled Sine-Wave Generator. ^a
3. Time-Mark Generator	Marker outputs: 10 ns to 0.5 s. Marker accuracy: $\pm 0.1\%$. Trigger output: 1 ms to 0.1 μ s, time-coincident with markers.	Horizontal checks.	TEKTRONIX TG 501 Time-Mark Generator. ^a
4. Low-Frequency Generator	Range: 1 kHz to 500 kHz. Output amplitude: 300 mV. Output impedance: 600 Ω . Reference frequency: constant within 0.3 dB of reference frequency as output frequency changes.	Low-frequency trigger checks.	TEKTRONIX SG 502 Oscillator. ^a
5. Pulse Generator	Repetition rate: 1 kHz. Output amplitude: 5 V.	External clock and storage checks.	TEKTRONIX PG 501 Pulse Generator. ^a
6. Test Oscilloscope with 10X Probes	Bandwidth: dc to 100 MHz. Minimum deflection factor: 5 mV/div. Accuracy: $\pm 3\%$.	General troubleshooting, holdoff check.	TEKTRONIX 2235 Oscilloscope.
7. Digital Voltmeter (DMM)	Range: 0 to 140 V. Dc voltage accuracy: $\pm 0.15\%$. 4 1/2 digit display.	X-Y Plotter checks.	TEKTRONIX DM 501A Digital Multimeter. ^a
8. Coaxial Cable (2 required)	Impedance: 50 Ω . Length: 42 in. Connectors: BNC.	Signal interconnection.	Tektronix Part Number 012-0057-01.
9. Dual-Input Coupler	Connectors: BNC female-to-dual-BNC male.	Signal interconnection.	Tektronix Part Number 067-0525-01.
10. Coupler	Connectors: BNC female-to-BNC female.	Signal interconnection.	Tektronix Part Number 103-0028-00.
11. T-Connector	Connectors: BNC.	Signal interconnection.	Tektronix Part Number 103-0030-00.
12. Termination	Impedance: 50 Ω . Connectors: BNC.	Signal termination.	Tektronix Part Number 011-0049-01.

^aRequires a TM 500-Series Power Module.

Table A-1 (cont)

Item and Description	Minimum Specification	Purpose	Example of Suitable Test Equipment
13. Termination	Impedance: 600 Ω. Connectors: BNC.	Signal termination.	Tektronix Part Number 011-0092-00.
14. 10X Attenuator	Ratio: 10X. Impedance: 50 Ω. Connectors: BNC.	Vertical compensation and triggering checks.	Tektronix Part Number 011-0059-02.
15. Adapter	Connectors: BNC male-to-miniature-probe tip.	Signal interconnection.	Tektronix Part Number 013-0084-02.
16. Adapter	Connectors: BNC male-to-tip plug.	Signal interconnection.	Tektronix Part Number 175-1178-00.

INDEX TO PERFORMANCE CHECK STEPS

Page

Vertical

Page

- 1. Check Deflection Accuracy and Variable Range .. A-4
- 2. Check Store Deflection Accuracy A-5
- 3. Check Save Expansion and Compression..... A-5
- 4. Check Position Range A-5
- 5. Check Acquisition Position Registration A-6
- 6. Check Non Store Aberrations A-6
- 7. Check Store Aberrations A-7
- 8. Check Bandwidth..... A-7
- 9. Check Repetitive Store Mode A-7
- 10. Check Single Sweep Sample Acquisition A-8
- 11. Check Bandwidth Limit Operation A-8
- 12. Check Common-Mode Rejection Ratio..... A-8
- 13. Check Non Store and Store Channel Isolation A-9
- 14. Check Store Mode Cross Talk..... A-9
- 15. Check Store Pulse Width Amplitude..... A-10

Horizontal

- 1. Check Timing Accuracy and Linearity..... A-11
- 2. Check Store Differential and Cursor Time Difference Accuracy..... A-12

- 3. Check SEC/DIV Variable Range A-13
- 4. Check Position Range A-13
- 5. Check Store Expansion Range A-13
- 6. Check 4K to 1K Display Compress A-13
- 7. Check Non Store Sweep Length A-14
- 8. Check X Gain..... A-14
- 9. Check X Bandwidth A-14

Trigger

- 1. Check Internal Triggering A-15
- 2. Check HF Reject Triggering A-16
- 3. Check External Triggering A-16
- 4. Check External Trigger Ranges A-17
- 5. Check Single Sweep Operation A-17

External Z-Axis, Probe Adjust, External Clock and X-Y Plotter

- 1. Check External Z-Axis Operation A-18
- 2. Check Probe Adjust Operation A-18
- 3. Check External Clock A-19
- 4. Check X-Y Plotter A-19

VERTICAL

Equipment Required (see Table A-1):

Calibration Generator (Item 1)	Dual-Input Coupler (Item 9)
Leveled Sine-Wave Generator (Item 2)	50 Ω BNC Termination (Item 12)
50 Ω BNC Cable (Item 8)	10X Attenuator (Item 14)

INITIAL CONTROL SETTINGS

Vertical (Both Channels)

POSITION	Midrange
VERTICAL MODE	CH 1
X-Y	Off (button out)
BW LIMIT	On (button in)
VOLTS/DIV	2 mV
VOLTS/DIV Variable	CAL detent
INVERT	Off (button out)
AC-GND-DC	DC

Horizontal

POSITION	Midrange
SEC/DIV	20 μs
SEC/DIV Variable	CAL detent
X10 Magnifier	Off (knob in)

Trigger

VAR HOLDOFF	NORM
Mode	P-P AUTO
SLOPE	OUT
LEVEL	Midrange
HF REJECT	OFF
INT	VERT MODE
SOURCE	INT
EXT COUPLING	AC

Storage

STORE/NON-STORE	NON-STORE (button out)
SAVE/CONT	CONT
TRIG POS	POSTTRIGGER (power-up default)
DISPLAY ON/OFF	OFF (power-up default)
VECTORS ON/OFF	ON (power-up default)

PROCEDURE STEPS

1. Check Deflection Accuracy and Variable Range

a. Connect the standard-amplitude signal from the Calibration Generator via a 50 Ω cable to the CH 1 OR X input connector.

b. CHECK—Deflection accuracy is within the limits given in Table A-2 for each CH 1 VOLTS/DIV switch setting and corresponding standard-amplitude signal. When at the 20 mV VOLTS/DIV switch setting, rotate the CH 1 VOLTS/DIV Variable control fully counterclockwise and CHECK that the display decreases to 2 divisions or less. Then return the CH 1 VOLTS/DIV Variable control to the CAL detent and continue with the 50 mV check.

c. Move the cable from the CH 1 OR X input connector to the CH 2 OR Y input connector. Set the VERTICAL MODE switch to CH 2.

d. Repeat part b using the Channel 2 controls.

Table A-2
Deflection Accuracy Limits

VOLTS/DIV Switch Setting	Standard Amplitude Signal	Accuracy Limits (Divisions)
2 mV	10 mV	4.90 to 5.10
5 mV	20 mV	3.92 to 4.08
10 mV	50 mV	4.90 to 5.10
20 mV	0.1 V	4.90 to 5.10
50 mV	0.2 V	3.92 to 4.08
0.1 V	0.5 V	4.90 to 5.10
0.2 V	1 V	4.90 to 5.10
0.5 V	2 V	3.92 to 4.08
1 V	5 V	4.90 to 5.10
2 V	10 V	4.90 to 5.10
5 V	20 V	3.92 to 4.08

2. Check Store Deflection Accuracy

a. Set:

CH 2 VOLTS/DIV 2 mV
 STORE/NON-STORE STORE (button in)

b. Use the CURSORS control and SELECT C1/C2 switch to set one cursor at the bottom and the other cursor at the top of the square wave.

c. CHECK—Deflection accuracy is within the limits given in Table A-3 for each CH 2 VOLTS/DIV switch setting and corresponding standard-amplitude signal.

d. Move the cable from the CH 2 OR Y input connector to the CH 1 OR X input connector. Set the VERTICAL MODE switch to CH 1.

d. Repeat parts b and c using the Channel 1 controls.

c. Set the SAVE/CONT switch to SAVE.

d. Set the CH 1 VOLTS/DIV switch to 10 mV and reposition the display.

e. CHECK—The display is expanded to 5 divisions in amplitude.

f. Set:

CH 1 VOLTS/DIV 0.1 V
 SAVE/CONT CONT

g. Set the generator to produce a 5 division standard-amplitude signal.

h. Set the SAVE/CONT switch to SAVE.

i. Set the CH 1 VOLTS/DIV switch to 1 V.

j. CHECK—The display is compressed to 0.5 division in amplitude.

k. Move the cable from the CH 1 OR X input connector to the CH 2 OR Y input connector.

l. Set:

VERTICAL MODE CH 2
 SAVE/CONT CONT

m. Repeat parts a through j using the Channel 2 controls.

Table A-3
Storage Deflection Accuracy

VOLTS/ DIV Switch Setting	Standard Ampli- tude Signal	Divisions of Deflection	Voltage Readout Limits
2 mV	10 mV	4.90 to 5.10	9.80 to 10.20 mV
5 mV	20 mV	3.92 to 4.08	19.6 to 20.4 mV
10 mV	50 mV	4.90 to 5.10	49.0 to 51.0 mV
20 mV	0.1 V	4.90 to 5.10	98.0 to 102.0 mV
50 mV	0.2 V	3.92 to 4.08	198.0 to 204.0 mV
0.1 V	0.5 V	4.90 to 5.10	0.490 to 0.510 V
0.2 V	1 V	4.90 to 5.10	0.980 to 1.020 V
0.5 V	2 V	3.92 to 4.08	1.960 to 2.040 V
1 V	5 V	4.90 to 5.10	4.90 to 5.10 V
2 V	10 V	4.90 to 5.10	9.80 to 10.20 V
5 V	20 V	3.92 to 4.08	19.60 to 20.40 V

3. Check Save Expansion and Compression

a. Set the CH 1 VOLTS/DIV switch to 0.1 V.

b. Set the generator to produce a 0.5 division standard-amplitude signal.

4. Check Position Range

a. Set:

VOLTS/DIV (both) 50 mV
 AC-GND-DC (both) AC
 STORE/NON-STORE NON-STORE (button out)

b. Set the generator to produce a 0.5 V standard-amplitude signal.

c. Adjust the CH 2 VOLTS/DIV Variable control to produce a 4.4 division display. Set the CH 2 VOLTS/DIV switch to 10 mV.

Appendix A—2221 Operators

d. CHECK—The bottom and top of the trace may be positioned above and below the center horizontal graticule line by rotating the Channel 2 POSITION control fully clockwise and counterclockwise respectively.

e. Move the cable from the CH 2 OR Y input connector to the CH 1 OR X input connector. Set the VERTICAL MODE switch to CH 1.

f. Repeat parts c and d using the Channel 1 controls.

g. Disconnect the test equipment from the instrument.

5. Check Acquisition Position Registration

a. Set:

VOLTS/DIV (both)	10 mV
AC-GND-DC (both)	GND
SEC/DIV	10 μ s
SAVE/CONT	CONT

b. Position the trace exactly on the center horizontal graticule line using the Channel 1 POSITION control.

c. Set STORE/NON-STORE switch to STORE (button in).

d. CHECK—Trace remains within 0.5 division of the center graticule line.

e. Set:

VERTICAL MODE	CH 2
STORE/NON-STORE	NON-STORE

f. Repeat parts b through d for Channel 2 trace.

g. Position the trace 0.5 division below the top horizontal graticule line using the Channel 2 POSITION control.

h. Set SAVE/CONT switch to SAVE.

i. CHECK—Trace shift of 0.5 division or less.

j. Set SAVE/CONT switch to CONT.

k. Position the trace 0.5 division above the bottom horizontal graticule line using the Channel 2 POSITION control.

l. CHECK—Trace shift of 0.5 division or less.

m. Set the VERTICAL MODE switch to CH 1.

n. Repeat steps g through l for Channel 1 trace.

6. Check Non Store Aberrations

a. Set:

BW LIMIT	Off (button out)
VOLTS/DIV (both)	2 mV
AC-GND-DC (both)	DC
SEC/DIV	0.05 μ s
STORE/NON-STORE	NON-STORE (button out)

b. Connect the fast-rise, positive-going square-wave output via a 50 Ω cable, a 10X attenuator, and a 50 Ω termination to the CH 1 OR X input connector.

c. Set the generator to produce a 1 MHz, 5-division display.

d. CHECK—Display aberrations are within 4% (0.2 division or less) for the following VOLTS/DIV switch settings: 5 mV through 50 mV. Adjust the generator output and attach or remove the 10X attenuator as necessary to maintain a 5-division display at each VOLTS/DIV switch setting.

e. CHECK—Display aberrations are within 6% (0.25 division or less) for the following VOLTS/DIV switch settings: 0.1 V through 0.5 V. Adjust the generator output and attach or remove the 10X attenuator as necessary to maintain a 5-division display at each VOLTS/DIV switch setting.

f. Disconnect the cable from the CH 1 OR X input connector. Reconnect the 10X attenuator (if previously removed) and reduce the generator amplitude to minimum.

g. Connect the cable to the CH 2 OR Y input connector and set the VERTICAL MODE switch to CH 2.

- h. Set the generator to produce a 5-division display.
- i. Repeat parts d and e using the Channel 2 controls.

7. Check Store Aberrations

a. Reconnect the 10X attenuator and 50 Ω termination (if previously removed) and reduce the generator amplitude to minimum.

b. Set the CH 2 VOLTS/DIV switch to 2 mV.

c. Set the generator to produce a 5-division display.

d. Set:

STORE/NON-STORE	STORE (button in)
SAVE/CONT	CONT

e. Allow the acquisition cycle to complete and press the SAVE/CONT button to activate SAVE.

f. CHECK—Display aberrations are within 4% (0.2 division or less).

g. Repeat part f for each of the following VOLTS/DIV switch settings: 5 mV through 0.5 V. Adjust the generator output and attach or remove the 10X attenuator as necessary to maintain a 5-division display at each VOLTS/DIV switch setting.

h. Disconnect the cable from the CH 2 OR Y input connector. Reconnect the 10X attenuator (if previously removed) and reduce the generator amplitude to minimum.

i. Connect the cable to the CH 1 OR X input connector and set the VERTICAL MODE switch to CH 1.

j. Set the generator to produce a 5-division display.

k. Repeat parts e and f using the Channel 1 controls.

l. Disconnect the test equipment from the instrument.

8. Check Bandwidth

a. Set:

VERTICAL MODE	CH 2
VOLTS/DIV (both)	2 mV
SEC/DIV	0.2 ms
STORE/NON-STORE	NON-STORE (button out)

b. Connect the leveled sine-wave generator output via a 50 Ω cable and a 50 Ω termination to the CH 2 OR Y input connector.

c. Set the generator to produce a 50 kHz, 6-division display.

d. CHECK—Display amplitude is 4.2 divisions or greater as the generator output frequency is increased up to the value shown in Table A-4 for the corresponding VOLTS/DIV switch setting.

Table A-4

Settings for Bandwidth Checks

VOLTS/DIV Switch Setting	Generator Output Frequency
2 mV	50 MHz
5 mV to 5 V	60 MHz

e. Repeat parts c and d for all indicated CH 2 VOLTS/DIV switch settings, up to the output-voltage upper limit of the sine-wave generator being used.

f. Move the cable from the CH 2 OR Y input connector to the CH 1 OR X input connector. Set the VERTICAL MODE switch to CH 1.

g. Repeat parts c and d for all indicated CH 1 VOLTS/DIV switch settings, up to the output-voltage upper limit of the sine-wave generator being used.

9. Check Repetitive Store Mode

a. Set:

CH 1 VOLTS/DIV	10 mV
SEC/DIV	0.2 ms

Appendix A—2221 Operators

b. Set the generator to produce a 50 kHz, 6-division display.

c. Set:

SEC/DIV	0.05 μ s
X10 Magnifier	On (knob out)

d. Set the generator to produce a 60 MHz display.

e. Set:

STORE/NON-STORE	STORE (button in)
SAVE/CONT	CONT

NOTE

Allow the points to accumulate for a few seconds before saving the display.

f. CHECK—The 60 MHz display will accumulate and store.

g. Set the VERTICAL MODE switch to BOTH and ALT.

h. Repeat part f.

10. Check Single Sweep Sample Acquisition

a. Set:

VERTICAL MODE	CH 1
SEC/DIV	5 μ s
X10 Magnifier	Off (knob in)
TRIGGER Mode	NORM
INT	CH 1
SAVE/CONT	CONT

b. Set the generator to produce a 50 kHz, 6-division display.

c. Press in the TRIGGER Mode SGL SWP button.

d. Set the generator output to 2 MHz.

e. Press in the TRIGGER Mode SGL SWP button.

f. CHECK—The minimum peak-to-peak envelope amplitude is greater than 5.6 divisions.

11. Check Bandwidth Limit Operation

a. Set:

BW LIMIT	On (button in)
CH 1 VOLTS/DIV	10 mV
SEC/DIV	20 μ s
TRIGGER Mode	P-P AUTO
INT	VERT MODE
STORE/NON-STORE	NON-STORE (button out)

b. Set the generator to produce a 50 kHz, 6-division display.

c. Increase the generator output frequency until the display amplitude decreases to 4.2 divisions.

d. CHECK—Generator output frequency is between 8.5 and 11.5 MHz.

e. Disconnect the test equipment from the instrument.

12. Check Common-Mode Rejection Ratio

a. Set:

BW LIMIT	Off (button out)
CH 2 VOLTS/DIV	10 mV
INVERT	On (button in)

b. Connect the leveled sine-wave generator output via a 50 Ω cable, a 50 Ω termination, and a dual-input coupler to the CH 1 OR X and the CH 2 OR Y input connectors.

c. Set the generator to produce a 50 MHz, 6-division display.

d. Vertically center the display using the Channel 1 POSITION control. Then set the VERTICAL MODE switch to CH 2 and vertically center the display using the Channel 2 POSITION control.

e. Set the VERTICAL MODE switches to BOTH and ADD.

f. CHECK—Display amplitude is 0.6 division or less.

g. If the check in part f meets the requirement, skip to part p. If it does not, continue with part h.

- h. Set the VERTICAL MODE switch to CH 1.
- i. Set the generator to produce a 50 kHz, 6-division display.
- j. Set the VERTICAL MODE switch to BOTH.
- k. Adjust the CH 1 or CH 2 VOLTS/DIV Variable control for minimum display amplitude.
- l. Set the VERTICAL MODE switch to CH 1.
- m. Set the generator to produce a 50 MHz, 6-division display.
- n. Set the VERTICAL MODE switch to BOTH.
- o. CHECK—Display amplitude is 0.6 division or less.
- p. Disconnect the test equipment from the instrument.

13. Check Non Store and Store Channel Isolation

- a. Set:

VERTICAL MODE	CH 1
VOLTS/DIV (both)	0.1 V
VOLTS/DIV Variable (both)	CAL detent
INVERT	Off (button out)
Channel 1 AC-GND-DC	AC
Channel 2 AC-GND-DC	GND
SEC/DIV	0.1 μ s
- b. Connect the leveled sine-wave generator output via a 50 Ω cable and a 50 Ω termination to the CH 1 OR X input connector.
- c. Set the generator to produce a 50 MHz, 5-division display.
- d. Set the VERTICAL MODE switch to CH 2.
- e. CHECK—Display amplitude is 0.05 division or less.

- f. Move the cable from the CH 1 OR X input connector to the CH 2 OR Y input connector.

g. Set:

VERTICAL MODE	CH 1
Channel 1 AC-GND-DC	GND
Channel 2 AC-GND-DC	AC

- h. CHECK—Display amplitude is 0.05 division or less.

i. Set:

CH 2 VOLTS/DIV	50 mV
STORE/NON-STORE	STORE (button in)
SAVE/CONT	CONT

- j. CHECK—Display amplitude is 0.1 division or less.

- k. Move the cable from the CH 2 OR Y input connector to the CH 1 OR X input connector.

l. Set:

VERTICAL MODE	CH 1
CH 1 VOLTS/DIV	50 mV
CH 2 VOLTS/DIV	0.1 V
Channel 1 AC-GND-DC	GND
Channel 2 AC-GND-DC	AC

- m. CHECK—Display amplitude is 0.1 division or less.

- n. Disconnect the test equipment from the instrument.

14. Check Store Mode Cross Talk

- a. Set:

VERTICAL MODE	BOTH and CHOP
VOLTS/DIV (both)	0.1 V
SEC/DIV	10 μ s
- b. Connect the Pulse Generator pulse-period output via a 50 Ω cable and a 50 Ω termination to CH 1 OR X input connector.
- c. Set the generator to produce a 100 kHz, 5-division display.

Appendix A—2221 Operators

d. Use the Channel 1 POSITION control to center the display.

e. Set CH 1 VOLTS/DIV switch to 50 mV for a 10-division display.

f. CHECK—Display amplitude on Channel 2 is less than 1% (0.1 division).

g. Set the SEC/DIV switch to 10 ms.

h. CHECK—Display amplitude on Channel 2 is less than 1% (0.1 division).

i. Move the cable from the CH 1 OR X input connector to the CH 2 OR Y input connector.

j. Set:

CH 2 VOLTS/DIV	0.1 V
Channel 1 AC-GND-DC	GND
Channel 2 AC-GND-DC	AC

k. Use the Channel 2 POSITION control to center the display.

l. Set CH 2 VOLTS/DIV switch to 50 mV for a 10-division display.

m. Repeat parts f through h for Channel 1.

15. Check Store Pulse Width Amplitude

a. Set:

Channel 2 AC-GND-DC	DC
VERTICAL MODE	CH 2
SEC/DIV	1 ms
TRIGGER Mode	NORM
STORE/NON-STORE	NON-STORE (button out)

b. Set the generator to produce a 1 ms period, 100 ns pulse duration, 5-division display.

c. Set the STORE/NON-STORE switch to STORE (button in).

d. CHECK—The amplitude of the display is 2.5 divisions or greater.

e. Set the SEC/DIV switch to 0.1 sec.

f. CHECK—The amplitude of the display is 2.5 divisions or greater.

g. Set the TRIGGER Mode switch to P-P AUTO.

h. CHECK—The amplitude of the display is 2.5 divisions or greater and the sweep rolls from right to left.

i. Set:

VERTICAL MODE	BOTH and CHOP
SEC/DIV	1 ms
TRIGGER Mode	NORM
STORE/NON-STORE	NON-STORE (button out)

j. Set the generator to produce a 0.1 s period, 2 ms pulse duration, 5-division display.

k. Repeat parts c through h.

l. Set:

SEC/DIV	1 ms
TRIGGER Mode	NORM
STORE/NON-STORE	NON-STORE (button out)

m. Set the generator to produce a 1 ms period, 20 μ s pulse duration, 5-division display.

n. Repeat parts c and d.

o. Disconnect the test equipment from the instrument.

HORIZONTAL

Equipment Required (see Table A-1):

Calibration Generator (Item 1)	50 Ω BNC Cable (Item 8)
Leveled Sine-Wave Generator (Item 2)	50 Ω BNC Termination (Item 12)
Time-Mark Generator (Item 3)	

INITIAL CONTROL SETTINGS

Vertical

Channel 1 POSITION	Midrange
VERTICAL MODE	CH 1
X-Y	Off (button out)
BW LIMIT	Off (button out)
CH 1 VOLTS/DIV	0.5 V
CH 1 VOLTS/DIV Variable	CAL detent
Channel 1 AC-GND-DC	DC

Horizontal

POSITION	Midrange
SEC/DIV	0.05 μ s
SEC/DIV Variable	CAL detent
X10 Magnifier	Off (knob in)

Trigger

VAR HOLDOFF	NORM
Mode	P-P AUTO
SLOPE	OUT
LEVEL	Midrange
HF REJECT	OFF
INT	VERT MODE
SOURCE	INT
EXT COUPLING	DC \div 10

Storage

STORE/NON-STORE	NON-STORE (button out)
SAVE/CONT	CONT
TRIG POS	POSTTRIGGER (power-up default)
DISPLAY ON/OFF	OFF (power-up default)
VECTORS ON/OFF	ON (power-up default)

b. Select 50 ns time markers from the time-marker generator.

c. Use the Channel 1 POSITION control to center the display vertically. Adjust the TRIGGER LEVEL control for a stable, triggered display.

d. Use the Horizontal POSITION control to align the 2nd time marker with the 2nd vertical graticule line.

e. CHECK—Timing accuracy is within 2% (0.16 division at the 10th vertical graticule line) and linearity is within 5% (0.1 division over any two of the center eight divisions).

NOTE

For checking the timing accuracy of the SEC/DIV switch settings from 50 ms to 0.5 s, watch the time marker tips only at the 2nd and 10th vertical graticule lines while adjusting the Horizontal POSITION control.

f. Repeat parts c through e for the remaining SEC/DIV and time-mark generator setting combinations shown in Table A-5 under the "Normal (X1)" column.

g. Set:

SEC/DIV	0.05 μ s
X10 Magnifier	On (knob out)

h. Select 10 ns time markers from the time-mark generator.

i. Use the Horizontal POSITION control to align the 1st time marker that is 25 ns beyond the start of the sweep with the 2nd vertical graticule line.

PROCEDURE STEPS

1. Check Timing Accuracy and Linearity

a. Connect the time-mark generator output via a 50 Ω cable and a 50 Ω termination to the CH 1 OR X input connector.

Table A-5
Settings for Timing Accuracy Checks

SEC/DIV Switch Setting	Time-Mark Generator Setting	
	Normal (X1)	X10 Magnified
0.05 μ s	50 ns	10 ns
0.1 μ s	0.1 μ s	10 ns
0.2 μ s	0.2 μ s	20 ns
0.5 μ s	0.5 μ s	50 ns
1 μ s	1 μ s	0.1 μ s
2 μ s	2 μ s	0.2 μ s
5 μ s	5 μ s	0.5 μ s
10 μ s	10 μ s	1 μ s
20 μ s	20 μ s	2 μ s
50 μ s	50 μ s	5 μ s
0.1 ms	0.1 ms	10 μ s
0.2 ms	0.2 ms	20 μ s
0.5 ms	0.5 ms	50 μ s
1 ms	1 ms	0.1 ms
2 ms	2 ms	0.2 ms
5 ms	5 ms	0.5 ms
10 ms	10 ms	1 ms
20 ms	20 ms	2 ms
50 ms	50 ms	5 ms
0.1 s	0.1 s	10 ms
0.2 s	0.2 s	20 ms
0.5 s	0.5 s	50 ms

j. CHECK—Timing accuracy is within 3% (0.24 division at the 10th vertical graticule line), and linearity is within 5% (0.1 division over any 2 of the center 8 divisions). Exclude any portion of the sweep past the 100th magnified division.

k. Repeat parts i and j for the remaining SEC/DIV and time-mark generator setting combinations shown in Table A-5 under the "X10 Magnified" column.

2. Check Store Differential and Cursor Time Difference Accuracy

a. Set:

Channel 1 AC-GND-DC GND
 SEC/DIV 0.1 ms
 X10 Magnifier Off (knob in)
 STORE/NON-STORE STORE (button in)

b. Use the Channel 1 POSITION control to center the base line vertically and the Horizontal POSITION control to align the start of the trace with the 1st vertical graticule line.

c. Use the CURSORS control and SELECT C1/C2 switch to set one cursor exactly on the 2nd vertical graticule line and position the active cursor to the right using the CURSORS control until ΔT readout displays 0.800 ms.

d. CHECK—Graticule indication of cursor difference at the 10th vertical graticule line is within 0.16 division.

e. Set the Channel 1 AC-GND-DC switch to DC.

f. Select 1 ms time markers from the time-mark generator.

g. Align the 2nd time marker with the 2nd vertical graticule line using the Horizontal POSITION control.

h. Set the SAVE/CONT switch to SAVE for a stable display.

i. Use the CURSORS control and SELECT C1/C2 switch to set the first cursor on the trailing edge of the 2nd time marker.

j. Press in the C1/C2 button to activate the second cursor.

k. Set the second cursor on the trailing edge of the 10th time marker at the same voltage level as on the 2nd time marker.

l. CHECK—The ΔT readout is between 0.798 ms and 0.802 ms.

m. Set the SAVE/CONT switch to CONT.

n. Set the SEC/DIV switch to 0.5 μ s.

o. Select 0.5 μ s time markers from the time-mark generator.

p. Align the 2nd time marker with the 2nd vertical graticule line using the Horizontal POSITION control.

NOTE

Allow the points to accumulate for a few seconds before saving the display.

q. Repeat parts h through k.

NOTE

Pulses with fast rise and fall times have only a few sample points, and it may not be possible to place the cursors at exactly the same voltage levels.

r. CHECK—The ΔT readout is between 397.0 ns and 403.0 ns.

3. Check SEC/DIV Variable Range

a. Set:

SEC/DIV	0.2 ms
SEC/DIV Variable	Fully counterclockwise
X10 Magnifier	Off (knob in)

b. Select 0.5 ms time markers from the time-mark generator.

c. CHECK—Time markers are one division or less apart.

4. Check Position Range

a. Set:

SEC/DIV	10 μs
SEC/DIV Variable	CAL detent

b. Select 10 μs time markers from the time-mark generator.

c. CHECK—Start of the sweep can be positioned to the right of the center vertical graticule line by rotating the Horizontal POSITION control fully clockwise.

d. CHECK—The 11th time marker can be positioned to the left of the center vertical graticule line by rotating the Horizontal POSITION control fully counterclockwise.

e. Select 50 μs time markers from the time-mark generator.

f. Align the 3rd time marker with the center vertical graticule line using the Horizontal POSITION control.

g. Set the X10 Magnifier knob to On (knob out).

h. CHECK—Magnified time marker can be positioned to the left of the center vertical graticule line by rotating the Horizontal POSITION control fully counterclockwise.

i. CHECK—Start of the sweep can be positioned to the right of the center vertical graticule line by rotating the Horizontal POSITION control fully clockwise.

5. Check Store Expansion Range

a. Set:

SEC/DIV	0.1 μs
X10 Magnifier	Off (knob in)

b. Select 10 μs time markers from the time-mark generator.

c. Use the Horizontal POSITION control to align the start of the Sweep with the 1st vertical graticule line.

d. Set the STORE/NON-STORE switch to STORE (button in).

e. Set the X10 Magnifier knob to On (knob out).

f. CHECK—The time markers are one division apart.

6. Check 4K to 1K Display Compress

a. Set:

SEC/DIV	5 μs
X10 Magnifier	Off (knob in)
STORE/NON-STORE	STORE (button in)

b. Select 10 μs time markers from the time-mark generator and check that the time markers are two divisions apart.

Appendix A—2221 Operators

c. Rotate the SEC/DIV Variable control out of detent.

d. CHECK—For two time markers per division over the center eight divisions.

7. Check Non Store Sweep Length

a. Set:

SEC/DIV Variable	CAL detent
STORE/NON-STORE	NON-STORE (button out).

b. Use the Horizontal POSITION control to align the start of the Sweep with the 1st vertical graticule line.

c. CHECK—End of the sweep is to the right of the 11th vertical graticule line.

d. Disconnect the test equipment from the instrument.

8. Check X Gain

a. Set:

X-Y	On (button in)
CH 1 VOLTS/DIV	10 mV
Horizontal POSITION	Midrange

b. Connect the standard-amplitude signal from the Calibration Generator via a 50 Ω cable to the CH 1 OR X input connector.

c. Set the generator to produce a 50 mV signal.

d. Use the Channel 2 POSITION and Horizontal POSITION controls to center the display.

e. CHECK—Display is 4.85 to 5.15 horizontal divisions.

f. Disconnect the test equipment from the instrument.

9. Check X Bandwidth

a. Set the STORE/NON-STORE switch to NON-STORE (button out).

b. Connect the leveled sine-wave generator output via a 50 Ω cable and a 50 Ω termination to the CH 1 OR X input connector.

c. Set the generator to produce a 5-division horizontal display at an output frequency of 50 kHz.

d. Increase the generator output frequency to 2.5 MHz.

e. CHECK—Display is at least 3.5 horizontal divisions.

f. Disconnect the test equipment from the instrument.

TRIGGER

Equipment Required (see Table A-1):

Leveled Sine-Wave Generator (Item 2)	Dual-Input Coupler (Item 9)
Low Frequency Generator (Item 4)	50 Ω BNC Termination (Item 12)
50 Ω BNC Cable (Item 8)	600 Ω BNC Termination (Item 13)

INITIAL CONTROL SETTINGS

Vertical

POSITION (both)	Midrange
VERTICAL MODE	CH 1
X-Y	Off (button out)
BW LIMIT	Off (button out)
CH 1 VOLTS/DIV	5 mV
CH 2 VOLTS/DIV	50 mV
VOLTS/DIV Variable (both)	CAL detent
INVERT	Off (button out)
AC-GND-DC (both)	DC

Horizontal

POSITION	Midrange
SEC/DIV	0.2 μ s
SEC/DIV Variable	CAL detent
X10 Magnifier	Off (knob in)

Trigger

VAR HOLDOFF	NORM
Mode	P-P AUTO
SLOPE	OUT
LEVEL	Midrange
HF REJECT	OFF
INT	CH 1
SOURCE	INT
EXT COUPLING	DC

Storage

STORE/NON-STORE	NON-STORE (button out)
SAVE/CONT	CONT
TRIG POS	POSTTRIGGER (power-up default)
DISPLAY ON/OFF	OFF (power-up default)
VECTORS ON/OFF	ON (power-up default)

PROCEDURE STEPS

1. Check Internal Triggering

a. Connect the leveled sine-wave generator output via a 50 Ω cable and a 50 Ω termination to the CH 1 OR X input connector.

b. Set the generator to produce a 10 MHz, 3.5-division display.

c. Set the CH 1 VOLTS/DIV switch to 50 mV.

d. CHECK—Stable display can be obtained by adjusting the TRIGGER LEVEL control for each switch combination given in Table A-6.

Table A-6

Switch Combinations for Triggering Checks

TRIGGER Mode	TRIGGER SLOPE
NORM	OUT
NORM	IN
P-P AUTO	IN
P-P AUTO	OUT

e. Set

VERTICAL MODE	CH 2
INT	CH 2

f. Move the cable from the CH 1 OR X input connector to the CH 2 OR Y input connector.

Appendix A—2221 Operators

g. Repeat part d.

h. Set:

SEC/DIV	0.05 μ s
X10 Magnifier	On (knob out)

i. Set the generator to produce a 60 MHz, 1.0-division display.

j. Repeat part d.

k. Set:

VERTICAL MODE	CH 1
INT	CH 1

l. Move the cable from the CH 2 OR Y input connector to the CH 1 OR X input connector.

m. Repeat part d.

n. Disconnect the test equipment from the instrument.

2. Check HF Reject Triggering

a. Set:

VOLTS/DIV (both)	50 mV
SEC/DIV	5 μ s
X10 Magnifier	Off (knob in)
TRIGGER Mode	NORM
TRIGGER LEVEL	Midrange

b. Connect the low-frequency generator output via a 50 Ω cable and a 600 Ω termination to the CH 1 OR X input connector.

c. Set the low-frequency generator output to produce a 250 kHz, 1-division display.

d. Adjust the TRIGGER LEVEL control for a stable display.

e. Set HF REJECT switch to ON.

f. CHECK—Stable display cannot be obtained by adjusting the TRIGGER LEVEL control for each switch combination given in Table A-6.

g. Set:

VERTICAL MODE	CH 2
INT	CH 2

h. Move the cable from the CH 1 OR X input connector to the CH 2 OR Y input connector.

i. Repeat part f.

j. Disconnect the test equipment from the instrument.

3. Check External Triggering

a. Set:

VERTICAL MODE	CH 1
CH 1 VOLTS/DIV	5 mV
SEC/DIV	0.1 μ s
HF REJECT	OFF
INT	CH 1
SOURCE	EXT

b. Connect the leveled sine-wave generator output via a 50 Ω cable, a 50 Ω termination, and a dual-input coupler to both the CH 1 OR X and EXT INPUT connectors.

c. Set the leveled sine-wave generator output voltage to 40 mV and the frequency to 10 MHz.

d. CHECK—Stable display can be obtained by adjusting the TRIGGER LEVEL control for each switch combination given in Table A-6.

e. Set:

CH 1 VOLTS/DIV	50 mV
X10 Magnifier	On (knob out)

f. Set the generator output voltage to 120 mV and the frequency to 60 MHz.

g. Repeat part d.

4. Check External Trigger Ranges

a. Set:

CH 1 VOLTS/DIV	0.5 V
SEC/DIV	20 μ s
X10 Magnifier	Off (knob in)
TRIGGER SLOPE	OUT
TRIGGER Mode	NORM

b. Set the generator to produce a 50 kHz, 6.4-division display.

c. CHECK—Display is triggered along the entire positive slope of the waveform as the TRIGGER LEVEL control is rotated.

d. CHECK—Display is not triggered (no trace) at either extreme of rotation.

e. Set the TRIGGER SLOPE button to IN.

f. CHECK—Display is triggered along the entire negative slope of the waveform as the TRIGGER LEVEL control is rotated.

g. CHECK—Display is not triggered (no trace) at either extreme of rotation.

5. Check Single Sweep Operation

a. Adjust the TRIGGER LEVEL control to obtain a stable display.

b. Set:

Channel 1 AC-GND-DC	GND
SOURCE	INT

c. Press in the SGL SWP button. The READY LED should illuminate and remain on.

d. Set the Channel 1 AC-GND-DC switch to DC.

NOTE*The INTENSITY control may require adjustment to observe the single-sweep trace.*

e. CHECK—READY LED goes out and a single sweep occurs.

f. Press in the SGL SWP button several times.

g. CHECK—Single-sweep trace occurs, and the READY LED illuminates briefly every time the SGL SWP button is pressed in and released.

h. Disconnect the test equipment from the instrument.

EXTERNAL Z-AXIS, PROBE ADJUST, EXTERNAL CLOCK, AND X-Y PLOTTER

Equipment Required (see Table A-1):

Calibration Generator (Item 1)	BNC Female-to-BNC-Female Connector (Item 10)
Leveled Sine-Wave Generator (Item 2)	BNC T-Connector (Item 11)
Pulse Generator (Item 5)	50 Ω BNC Termination (Item 12)
Digital Voltmeter (Item 7)	BNC Male-to-Tip Plug (Item 16)
Two 50 Ω BNC Cables (Item 8)	10X Probe (provided with instrument)

INITIAL CONTROL SETTINGS

Vertical

Channel 1 POSITION	Midrange
VERTICAL MODE	CH 1
X-Y	Off (button out)
BW LIMIT	Off (button out)
CH 1 VOLTS/DIV	1 V
CH 1 VOLTS/DIV Variable	CAL detent
Channel 1 AC-GND-DC	DC

Horizontal

POSITION	Midrange
SEC/DIV	20 μ s
SEC/DIV Variable	CAL detent
X10 Magnifier	Off (knob in)

Trigger

VAR HOLDOFF	NORM
Mode	P-P AUTO
SLOPE	OUT
LEVEL	Midrange
HF REJECT	OFF
INT	VERT MODE
SOURCE	INT

Storage

STORE/NON-STORE	NON-STORE (button out)
SAVE/CONT	CONT
TRIG POS	POSTTRIGGER (power-up default)
DISPLAY ON/OFF	OFF (power-up default)
VECTORS ON/OFF	ON (power-up default)

PROCEDURE STEPS

1. Check External Z-Axis Operation

a. Connect the leveled sine-wave generator output via a 50 Ω cable and a T-connector to the CH 1 OR X input connector. Then connect a 50 Ω cable and a 50 Ω termination from the T-connector to the EXT Z-AXIS INPUT connector on the rear panel.

b. Set the generator to produce a 5 V, 50 kHz signal.

c. CHECK—For noticeable intensity modulation. The positive part of the sine wave should be of lower intensity than the negative part.

d. Disconnect the test equipment from the instrument.

2. Check Probe Adjust Operation

a. Set:

CH 1 VOLTS/DIV	10 mV
SEC/DIV	0.5 ms

b. Connect the 10X Probe to the CH 1 OR X input connector and insert the probe tip into the PROBE ADJUST jack on the instrument front panel. If necessary, adjust the probe compensation for a flat-topped square-wave display.

c. CHECK—Display amplitude is 4.75 to 5.25 divisions.

d. Disconnect the probe from the instrument.

3. Check External Clock

a. Set:

CH 1 VOLTS/DIV	1 V
X-Y	Off (button out)
SEC/DIV	1 ms

b. Connect the Pulse Generator output via a 50 Ω cable and a 50 Ω termination to CH 1 OR X input connector.

c. Set the generator to produce a 1 kHz, 5-division display.

d. Disconnect the cable from the CH 1 OR X input connector and connect it to the BNC male-to-tip plug via BNC female-to-BNC-female connector.

e. Insert the BNC male-to-tip-plug signal lead and ground lead into pin 1 and pin 9 respectively of the X-Y Plotter connector.

f. Set the SEC/DIV switch to 0.1 sec.

g. Connect the Calibration Generator high-amplitude output via a 50 Ω cable and a 50 Ω termination to CH 1 OR X input connector.

h. Set the generator to produce a 100 Hz, 5-division display.

i. Set:

SEC/DIV	EXT CLK
STORE/NON-STORE	STORE (button in)

j. CHECK—The 100 Hz signal is displayed on the screen and updated.

k. Set the SAVE/CONT switch to SAVE.

l. CHECK—The display is saved.

m. Disconnect the test equipment from the instrument.

4. Check X-Y Plotter

a. Set:

SEC/DIV	0.1 ms
SAVE/CONT	CONT

b. Connect the digital voltmeter low lead to either chassis ground or pin 9 (signal ground) of the X-Y Plotter connector. Connect the volts lead to pin 3 (X Output) of the X-Y Plotter connector.

c. Set the digital voltmeter to the 20 V scale.

d. Press the AUTO PLOT button to activate the X-Y Plotter.

NOTE

Voltage reading of the X Output will be negative left of the center vertical graticule line and positive to the right of it. Voltage reading of Y Output will be negative below the center horizontal graticule line and positive above it.

e. Record the voltage as the instrument plots the 1st and the 10th graticule line (as the intensity spot moves along the graticule line).

f. CHECK—The voltage difference between the 1st and 10th graticule line is between 4.5 V and 5.5 V.

g. Press the AUTO PLOT button again to turn off AUTO PLOT. Rotate the SEC/DIV switch to the next lower or higher sweep speed to abort the plot in process and reset the X-Y Plotter.

h. Move the volts lead of the voltmeter from pin 3 (X Output) to pin 5 (Y Output) of the X-Y Plotter connector.

i. Press the AUTO PLOT button.

j. Record the voltage as the instrument plots the top and the bottom graticule line (as the intensity spot moves along the graticule line).

k. CHECK—The voltage difference between the top and bottom graticule line is between 3.6 V and 4.4 V.

l. Repeat step g.

m. Disconnect the test equipment from the instrument.

This completes the Performance Check Procedure.

APPENDIX B

This appendix supplies some additional information about connecting and using the RS-232-C Communications Option. Printer/Plotter switch settings for some tested formats and plotter types are shown for both RS-232 and GPIB (Option 10). Some common questions and answers about the Communications Options are included. Most of questions are about Option 12.

RS-232-C DEVICE INTERCONNECTION

INTRODUCTION

This information will aid you in determining the cabling needed to hook your 2200 Family oscilloscope to other RS-232-C devices. The majority of interconnection situations that you may see are covered.

The RS-232-C standard defines the interconnection between two types of devices. They are Data Terminal Equipment (DTE) and Data Communications Equipment (DCE). A DTE device that conforms to the standard has a male RC-232-C connector. Examples are terminals, computers, and printers. Generally, the DTE device is the source of the data, but this is not always the case. A DCE device that conforms to the standard has a female RS-232-C connector. An example of a DCE device is a modem.

DETERMINING DEVICE TYPE

When interconnecting your 2200 Family oscilloscope to other RS-232-C devices you must determine the device type and the connector type. From that information, the interconnection cable you needed can be determined.

NOTE

You cannot reliably determine if a device is DTE or DCE by simply looking at the RS-232-C connector. You must verify the device type from the device's operators or service manuals.

1. To which "logical" type of device are you connecting?

From the equipment manual, find out if the device is DTE or DCE.

2. Which "physical" type of connector does the device have?

Male is standard for a DTE connector.

Female is standard for a DCE connector.

If you have a DTE device with a male connector or a DCE device with a female connector, you may use a standard RS-232-C "straight through" interconnection cable. If the connections are not standard, read the Interconnection Rules. Then read the Interconnection Cable-Type Identification information to find the interconnection cable type you will need for your application.

INTERCONNECTION RULES

There are several simple rules that satisfy most RS-232-C interconnections requirements.

1. A standard RS-232-C cable connects a DTE device to a DCE device. Both devices must adhere to the electrical and mechanical specifications of the RS-232-C standard. The standard cable has a female connector on one end and a male connector on the other end. The Transmit and Receive conductors are not interchanged. The standard RS-232-C cable is sometimes referred to as a "straight through" cable. In Table B-1, the Cable-Type Identification table, the straight-through cable is referred to as Type A.

2. A "Null Modem" cable or device may be used to interconnect two DTE or two DCE devices. Generally the cable is custom made with RS-232-C connectors that match the devices to be interconnected. A null modem cable permits two devices of the same type (DCE to DCE and DTE to DTE) to communicate as if they were connected DTE to DCE. The Transmit and Receive lines and the associated handshake line are swapped in the null modem to satisfy the requirements for data transfer between the two devices. See Figure B-1 for the "Null Modem" cable wiring schematic.

3. A "Gender Changer" has straight-through connections that may be used to convert a non-standard port connector (a DTE device with a female connector or a DCE device with a male connector) for connection with a standard RS-232-C cable. Gender changers come as male-to-male and female-to-female. The male-to-male changer is the most used.

The gender changer is connected between the non-conforming device and the appropriate end of a standard RS-232-C cable. Situations may occur when neither device has conforming connectors; in that case, use gender changers on both devices to permit interconnection with a standard RS-232-C cable (or use one of the specified cables from Table B-1).

4. If non-standard cabling or connectors are used, an interconnection terminal box may be needed to provide user-customized hookups.

The 2200 Family DSOs have both a DTE port and a DCE port to make it easy to connect to either a DTE or a DCE device using a standard RS-232-C cable. Both connectors conform to the electrical and mechanical specifications of the RS-232-C. Therefore, in most cases, you should not have to modify the 2200 Family DSO end of an interconnection cable to hook up other devices with the oscilloscope.

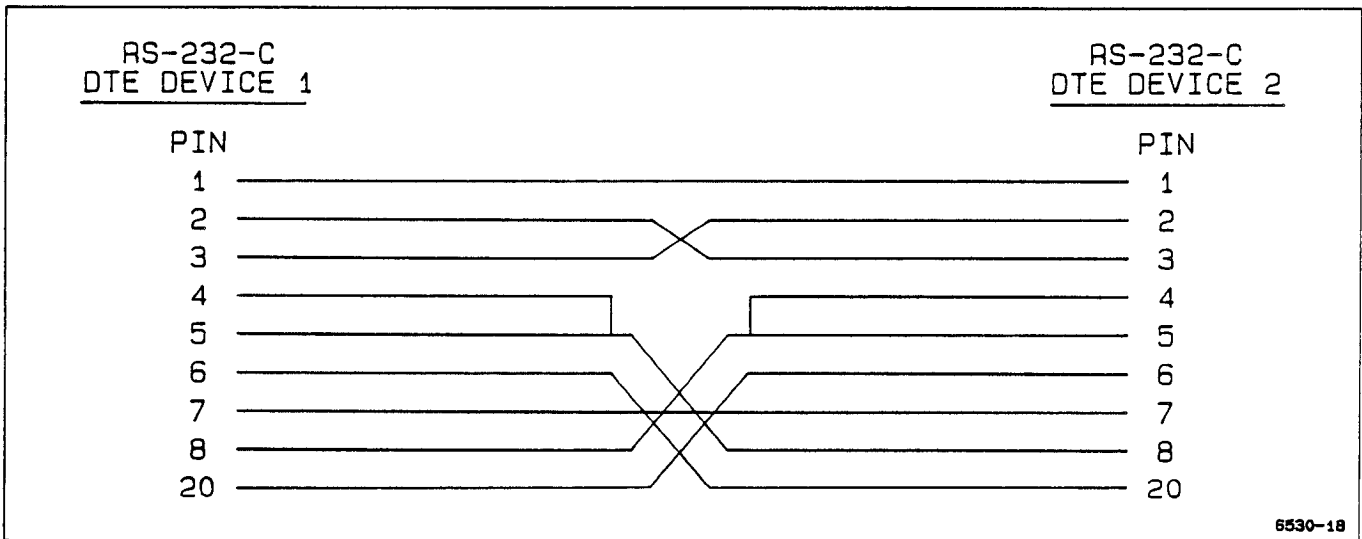

Figure B-1. Null Modem cable wiring.

INTERCONNECTION CABLE-TYPE IDENTIFICATION

The cable-type designations found in Table B-1 correspond to the interconnection illustrations following the table. The most-used interconnections seen with different RS-232-C printers are covered. In the table, the information in column 1 (Type of Interconnection) is interpreted as follows: DTE/male to DCE/female means a DTE type device with a male RS-232-C connector connected to a DCE type device that has a female RS-232-C connector (a standard RS-232-C male-to-female interconnection).

interconnections and the null modem (Type B) interconnections. Both the straight through and the null modem interconnections will also require gender changers when making male-to-male or female-to-female equipment hookups. In summary, the basic cable types are:

1. Standard or "straight through" cables with a male connector on one end and a female connector on the other.
2. Null modem cables that may be customized to make the necessary connector matings. These come as male-to-female, female-to-female, and male-to-male.
3. Gender changers are straight-through cables with either male connectors or female connectors on both ends.

RS-232-C INTERCONNECTION CABLE-TYPE ILLUSTRATIONS

The cable-wiring illustrations of B-2 through B-7 correspond to the Cable-Type designations of Table B-1. They are divided into the straight through (Type A)

**Table B-1
Cable-Type Identification**

Type of Interconnection	Cable-Type Designator	Application
Straight-Through Cables		
DTE/male to DCE/female	A	Use a straight through cable terminated on one end with a male connector and on the other end with a female connector. This is the "standard" cable connection in our discussion.
DTE/female to DCE/male		
DTE/female to DCE/female	A1	Use a male-to-male gender changer and a standard cable.
DTE/male to DCE/male	A2	Use a female-to-female gender changer and a standard cable.
Null-Modem Cables		
DTE/male to DTE/male	B	Use a null modem cable terminated with female connectors. This is the "standard null modem" in our discussion.
DCE/male to DCE/male		
DTE/female to DTE/male	B1	Use a standard null modem with a male-to-male gender changer or use a male-to-female null modem.
DCE/male to DCE/female		
DTE/female to DTE/female	B2	Use two male-to-male gender changers and a standard null modem cable or use a male-to-male null modem.
DCE/female to DCE/female		

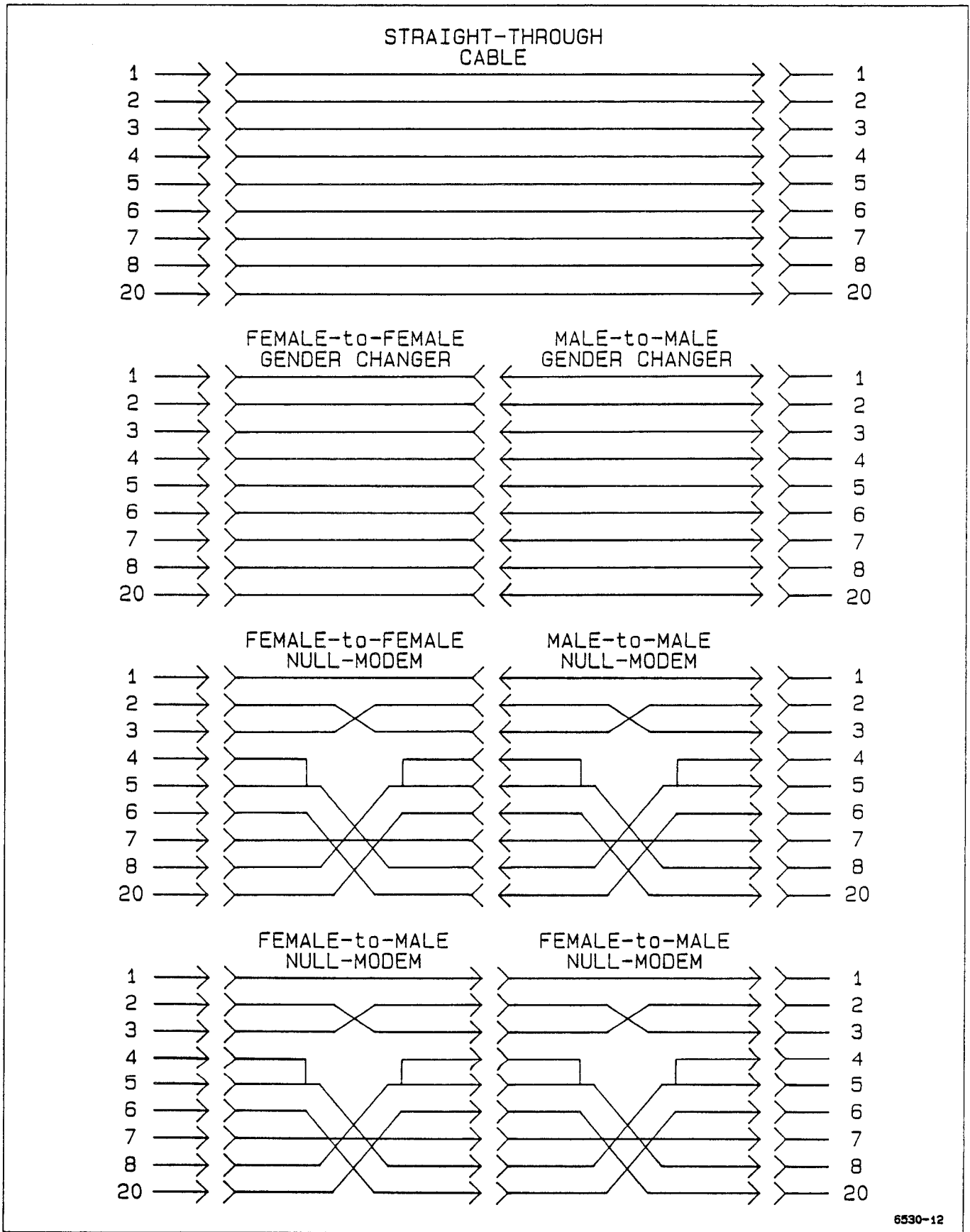

6530-12

Figure B-2. Type A Connections—DTE male to DCE female.

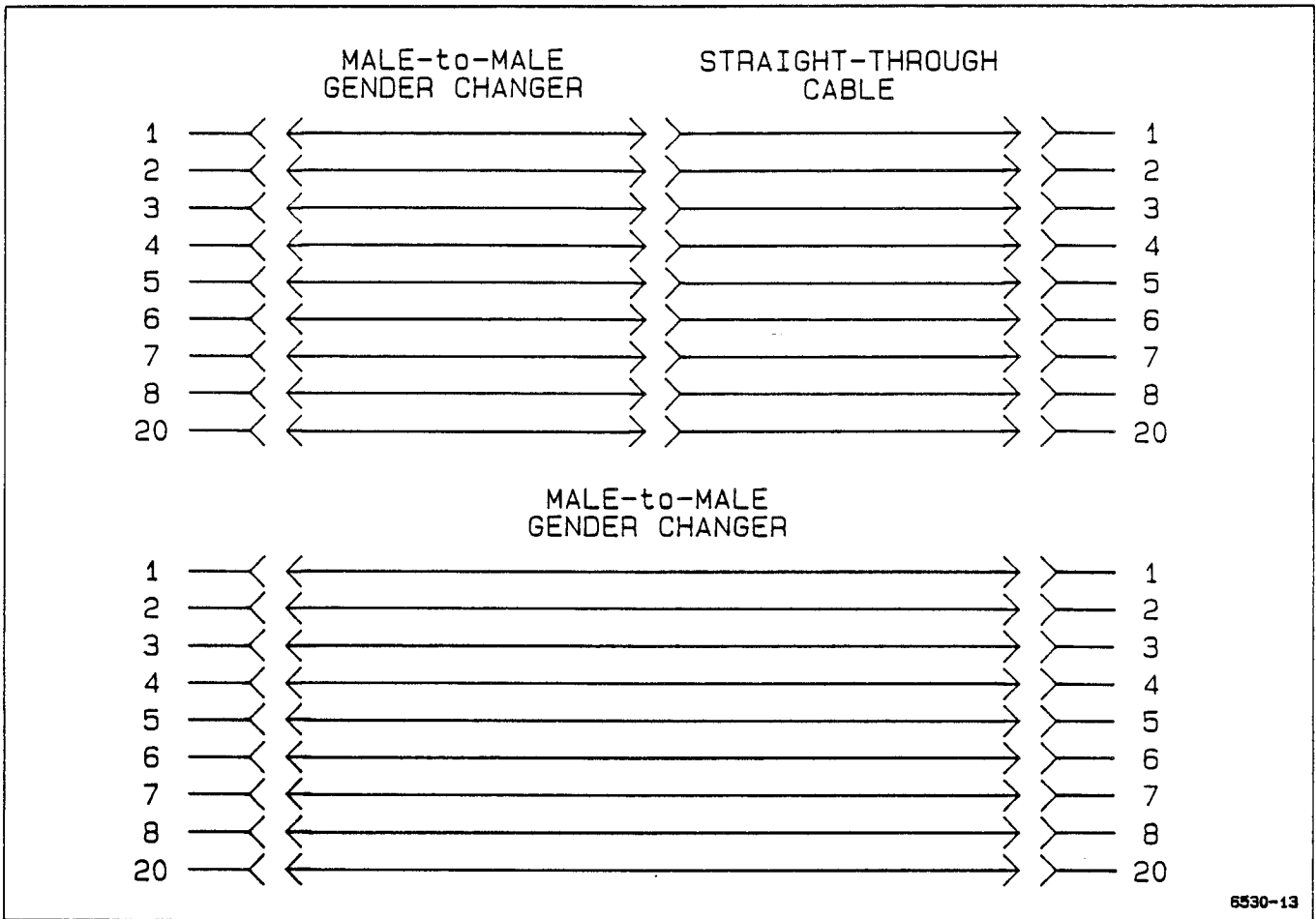

6530-13

Figure B-3. Type A1 Connections—DTE female to DCE female.

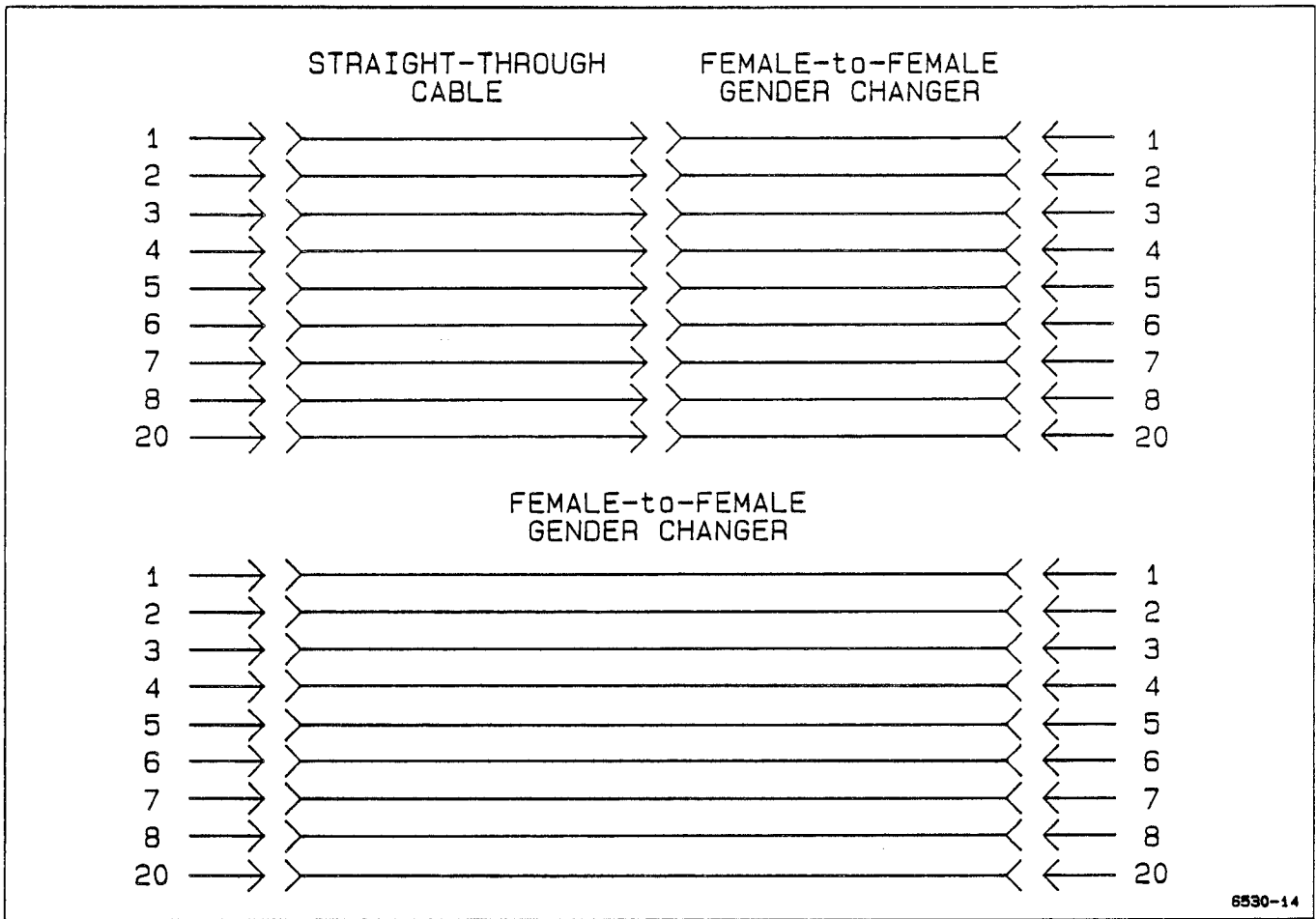

Figure B-4. Type A2 Connections—DTE male to DCE male.

INTERCONNECTION CABLE PART NUMBERS

Tektronix part numbers and stocks RS-232-C interconnection cables. Part numbers and a description are as follows:

RS-232 Interconnection cable, length 10 ft. 012-0911-00

RS-232 Null-Modem cable, length 16 ft. 012-0689-00

Type B connections require a "null-modem" cable to connect two devices of the same logical type together. Either two DTE devices or two DCE devices can be made to communicate by externally reversing the data and logic lines as shown in the figures. A gender change is needed for Type B and Type B2 connections. For Type B1 connections, a gender change is needed only to match up to the null-modem cable connectors. Gender changing can be done with the null-modem cable if it made with the correct gender connectors for the application.

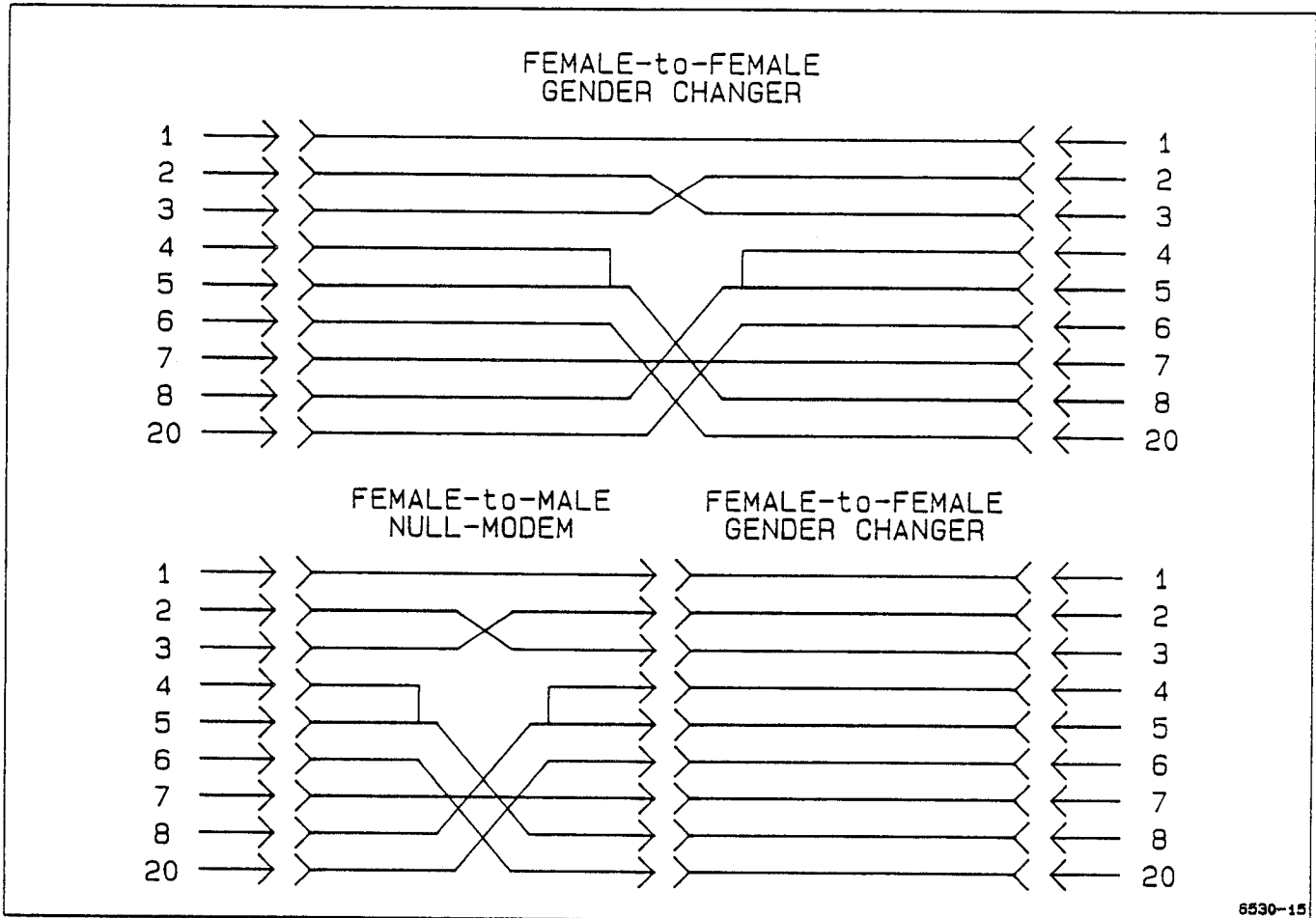
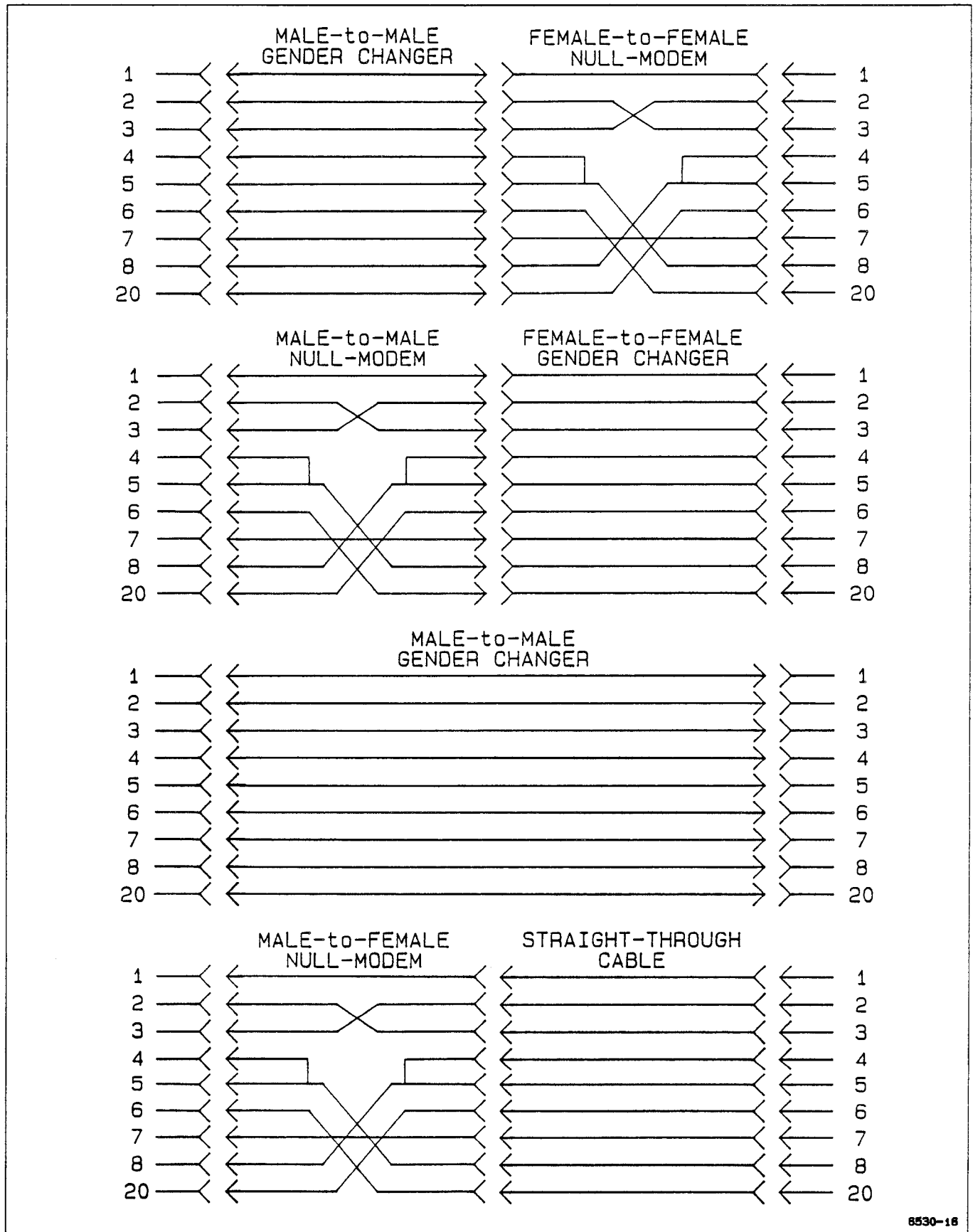
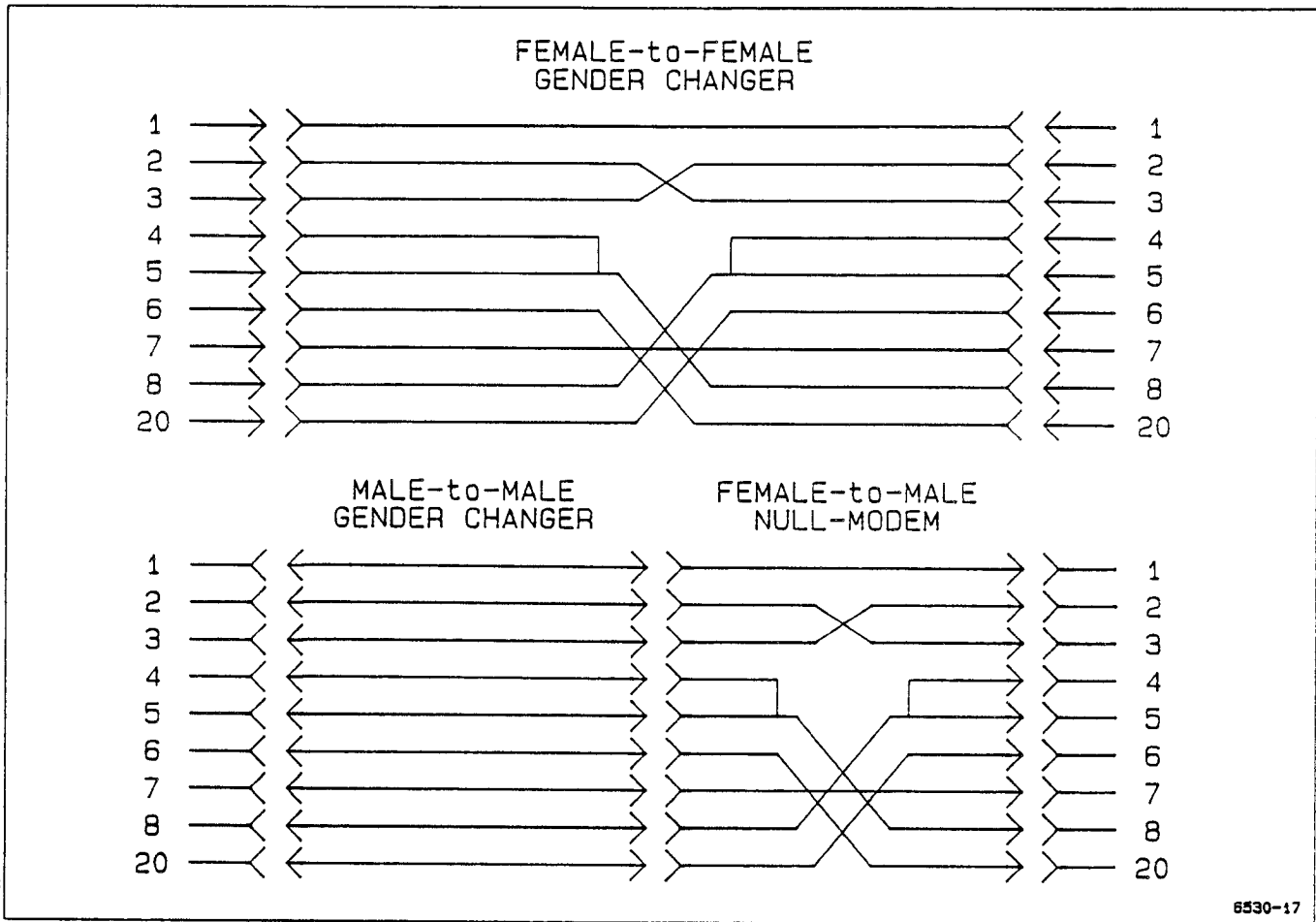

Figure B-5. Type B Connections—DTE male to DTE male and DCE male to DCE male.



8530-18

Figure B-6. Type B1 Connections—DTE female to DTE male and DCE female to DCE male.



6530-17

Figure B-7. Type B2 Connections—DTE female to DTE female and DCE female to DCE female.

PRINTER/PLOTTER OPERATION

PLOTTER TYPES

Both communication options allow waveform plotting through their communication port or through the X-Y plotter output. Four different digital plotter or printer formats are supported via the communications interface. They are: HP-GL[®], Epson[®] (both low-speed, double density, and high-speed, double density), ThinkJet[®], and the standard X-Y plotter.

Digital printer/plotter format can be selected two ways. The PARAMETERS switch settings (read at power on) for the compatible printer/plotter formats are illustrated in the following figures. The PARAMETERS switch supports direct oscilloscope to printer/plotter hookup. The PLOt FORmat commands (described in the Command Tables of

Section 7 in this manual) may be used to select the data format when a controller is used to control the communications.

NOTE

With Option 12, a controller and an RS-232 plotter can not be connected to the oscilloscope at the same time. An X-Y plotter may be connected to the X-Y plotter output and used in conjunction with a controller. With RS-232 plotters/printers, the RS-232-C controller may still be used to set up the formats, then disconnected to permit the printer to be connected to the oscilloscope. An alternative to disconnecting the controller is to use an interconnecting switching device to switch the oscilloscope between the controller and the printer/plotter. Plotting is then controlled using the front-panel PLOT switches or menus of the oscilloscope.

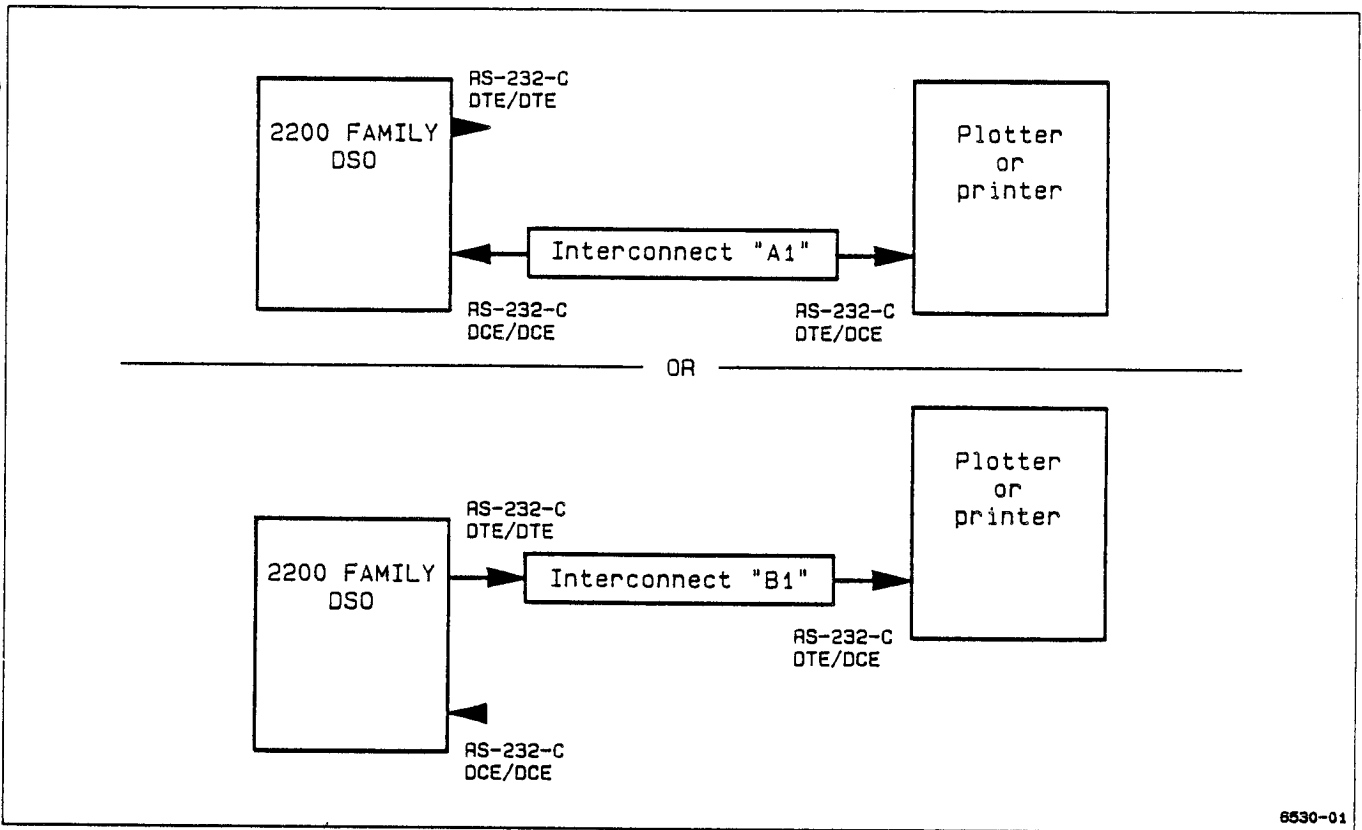

6530-01

Figure B-8. Option 12 RS-232-C Printer/Plotter interconnects.

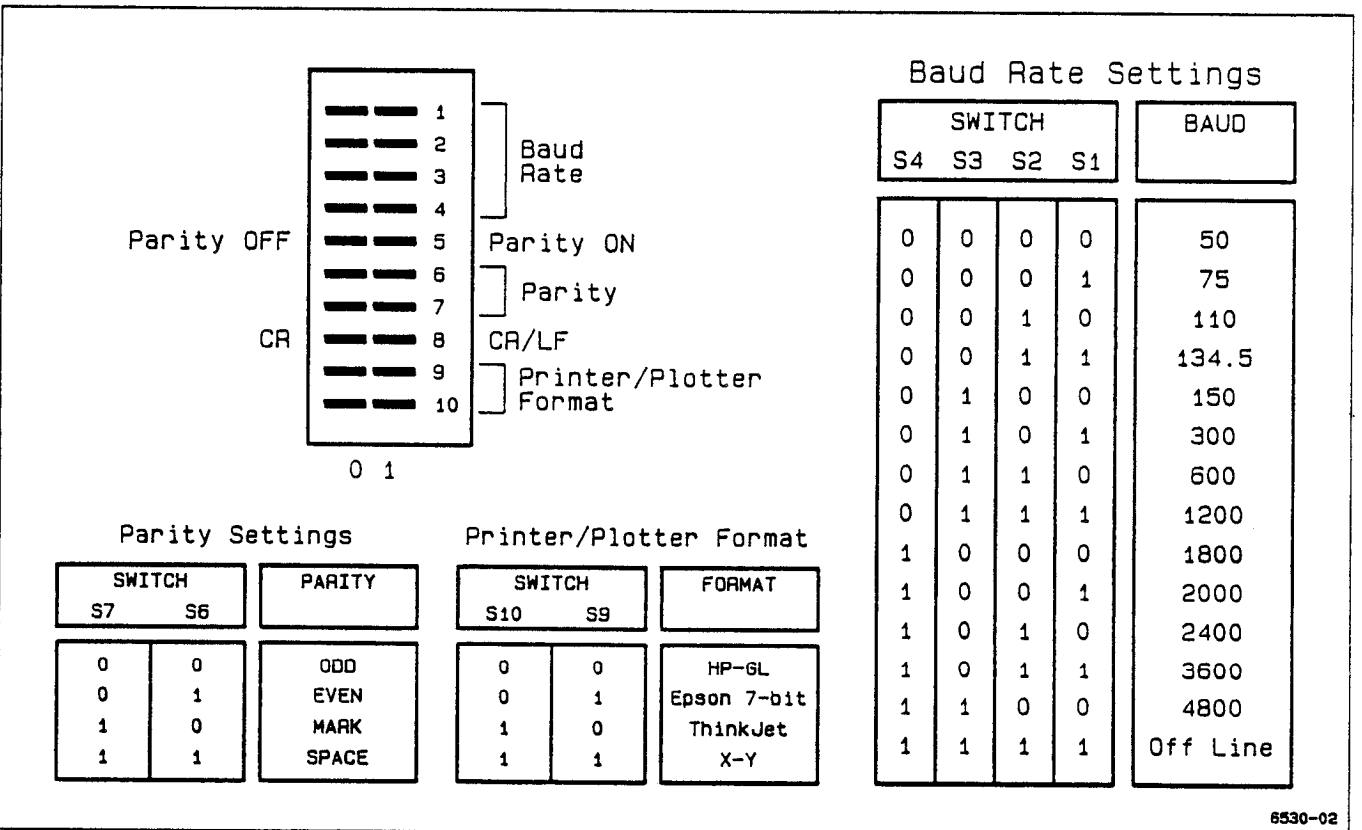

6530-02

Figure B-9. Option 12 RS-232-C communication parameters.

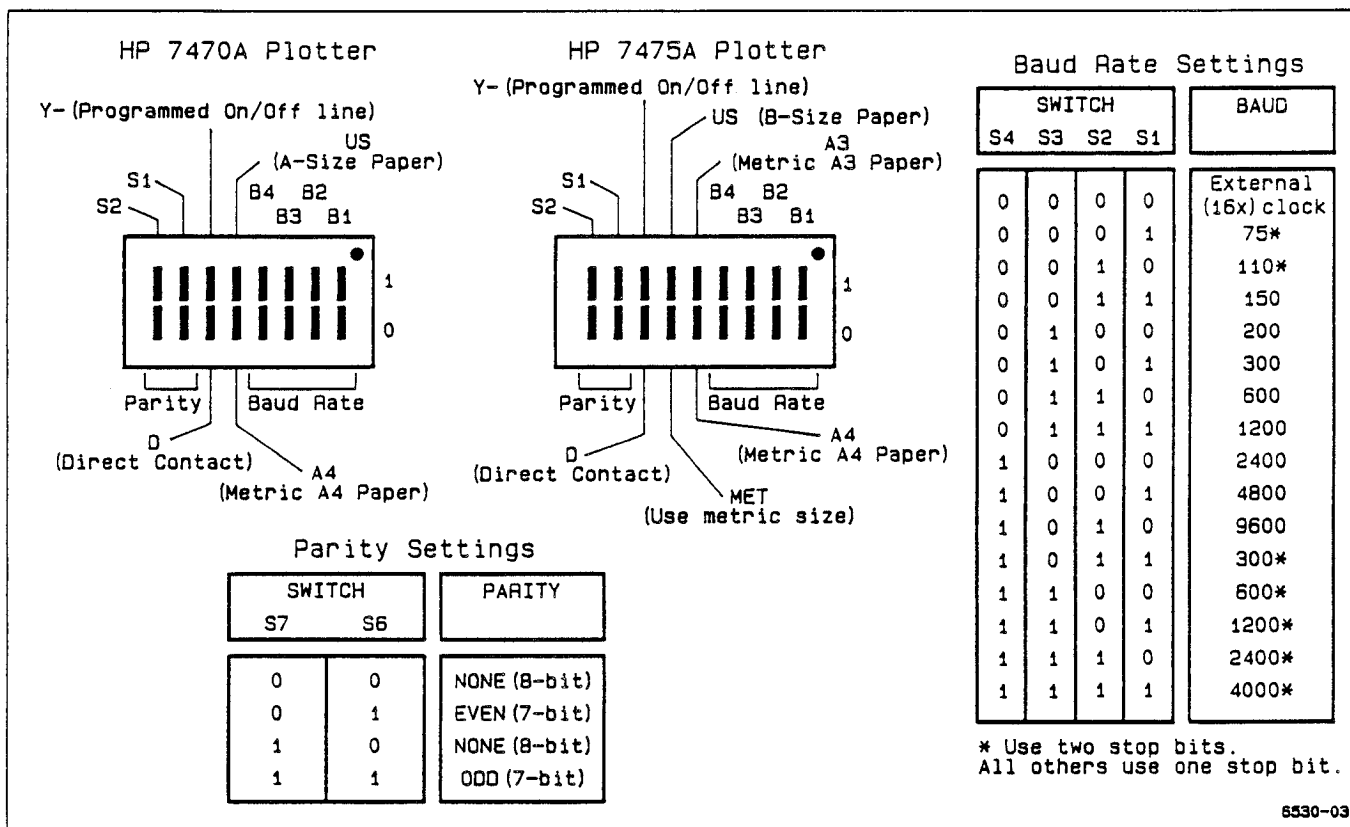

Figure B-10. HP 7470A and HP 7475A plotter RS-232-C switch settings.

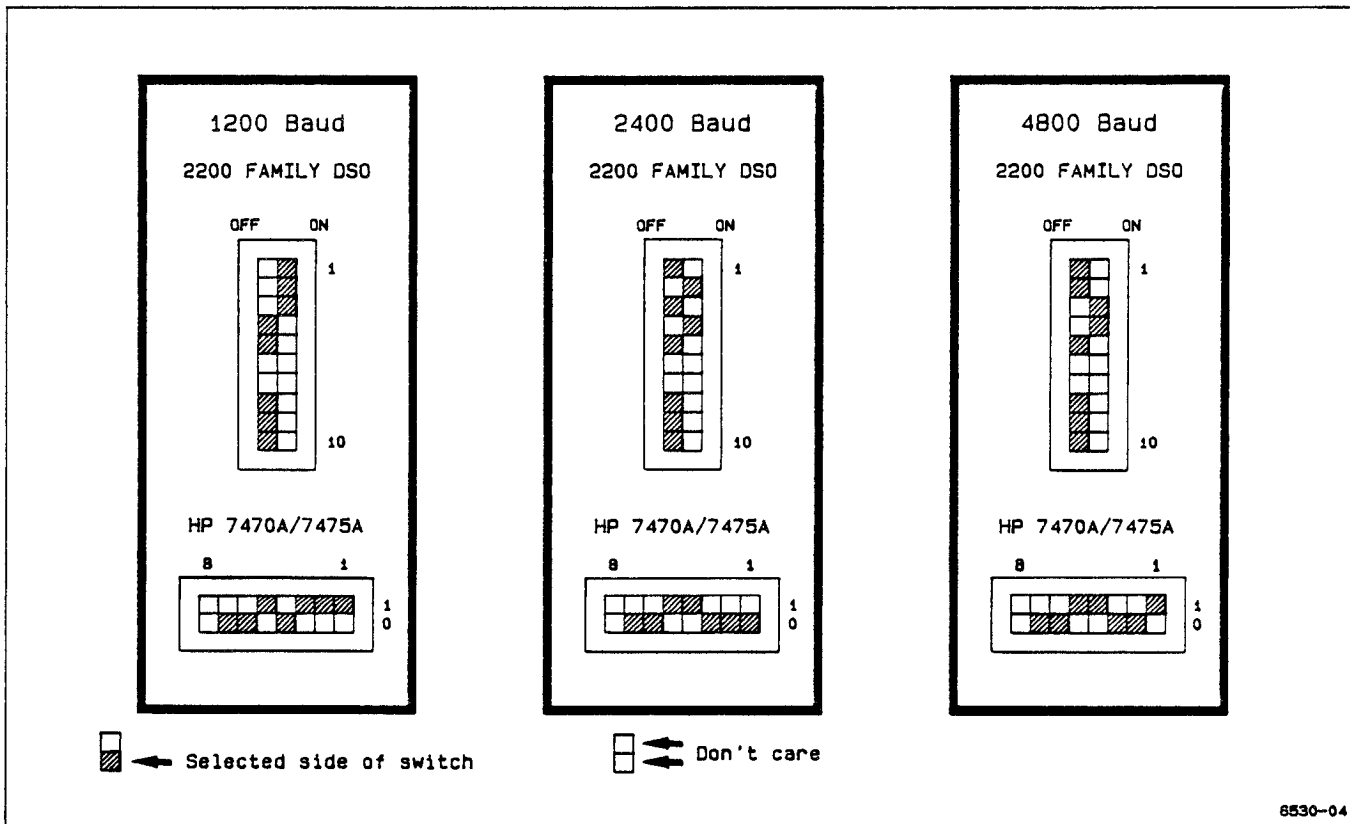
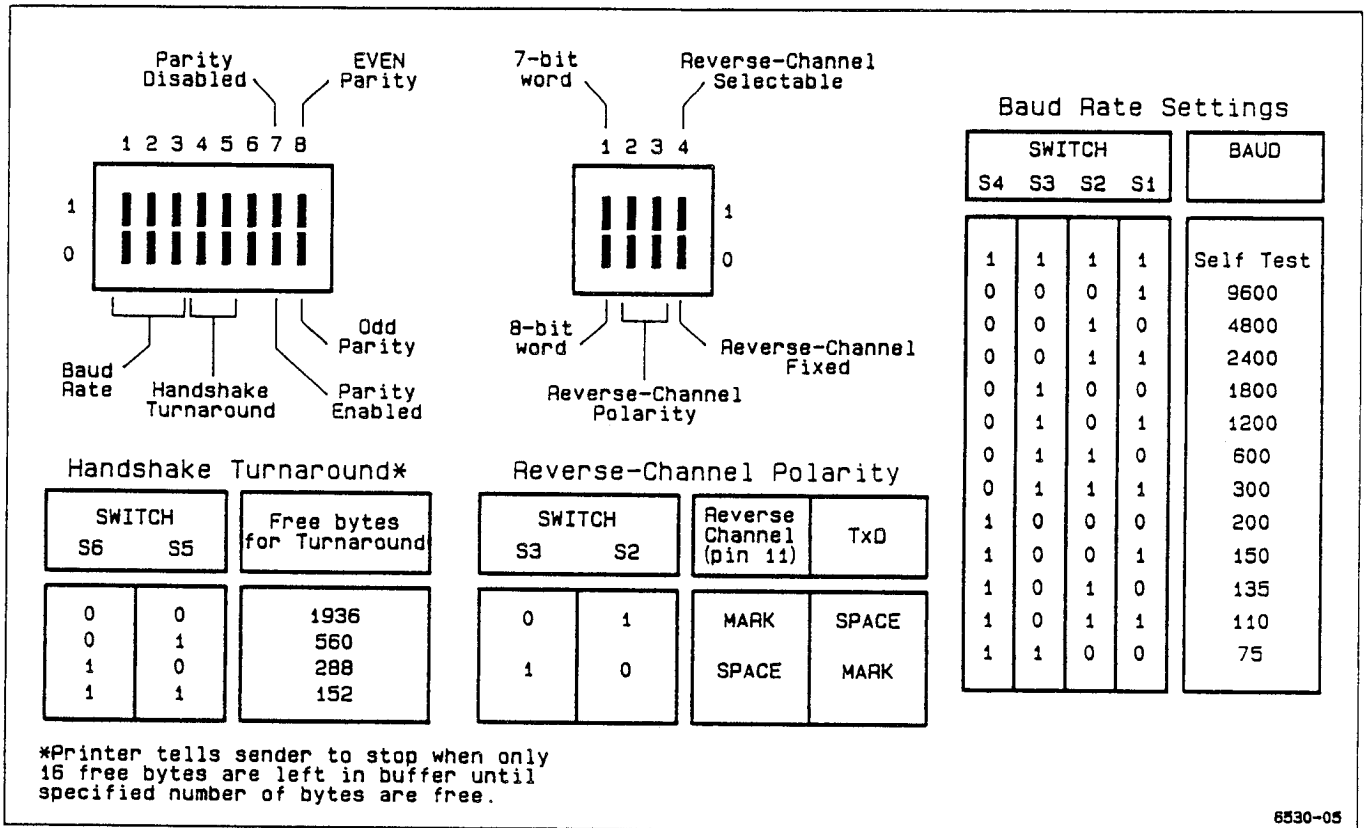
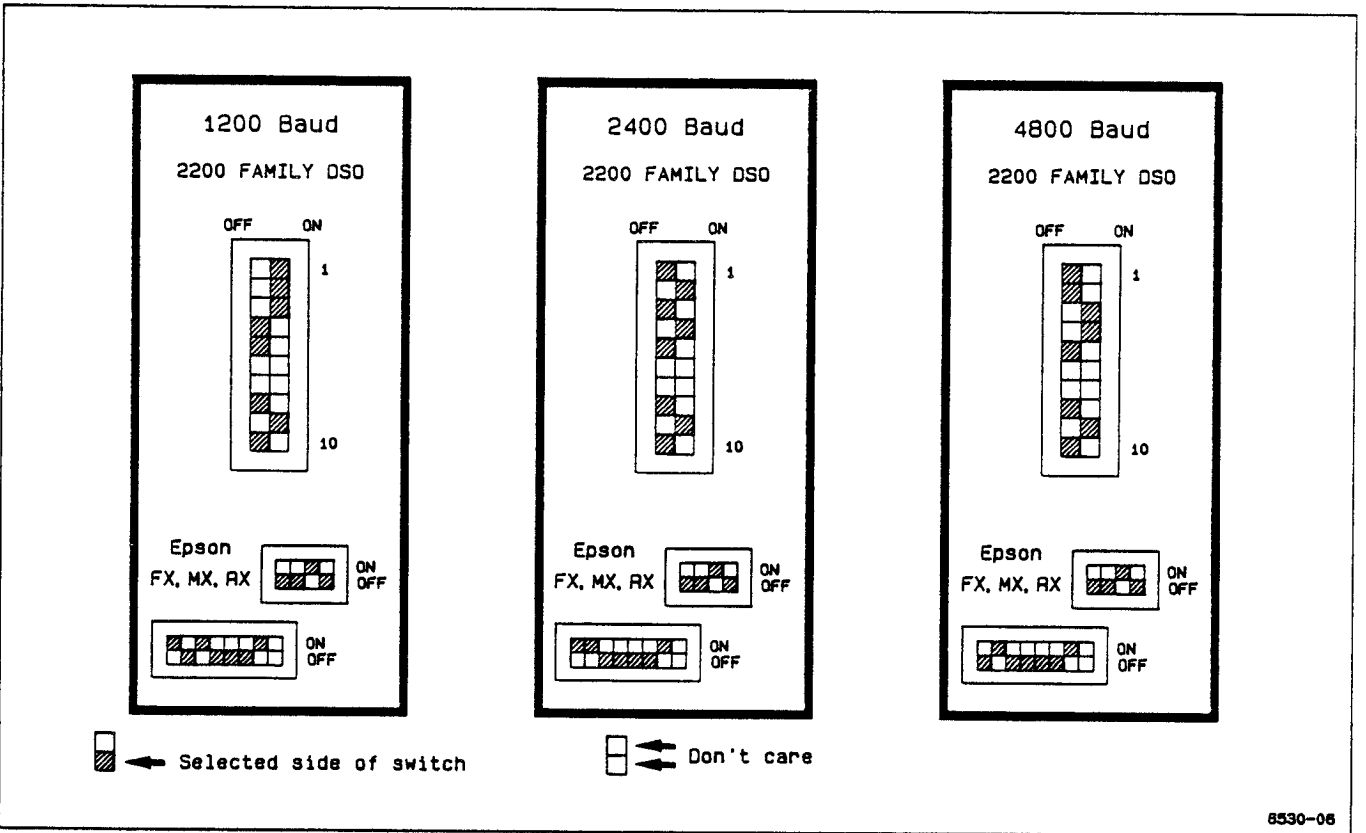

Figure B-11. Option 12 PARAMETERS switch settings for HP-GL compatible plotters.



8530-05

Figure B-12. Epson FX-Series printer RS-232-C switch settings.



8530-06

Figure B-13. Option 12 PARAMETERS switch settings for Epson printers.

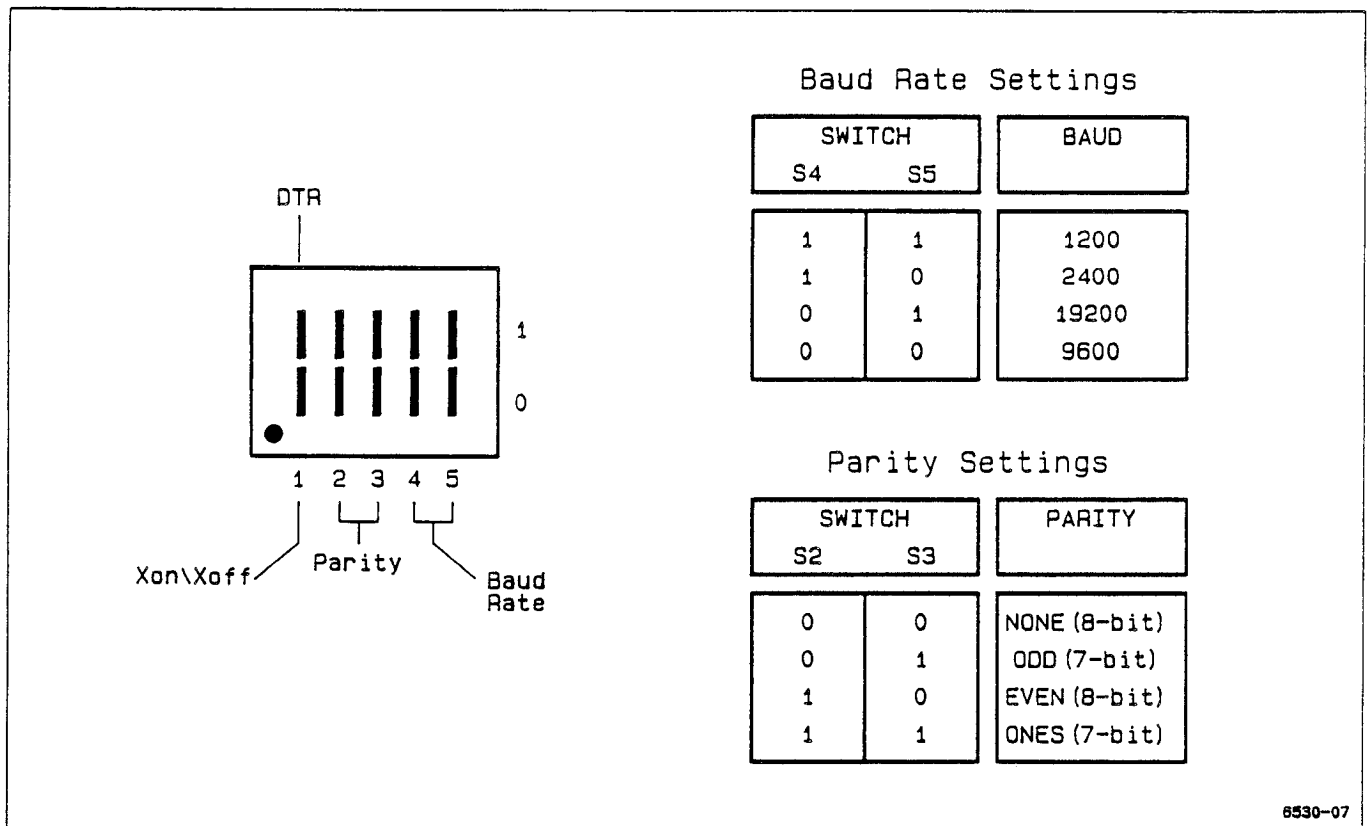

6530-07

Figure B-14. HP ThinkJet RS-232-C switch settings.

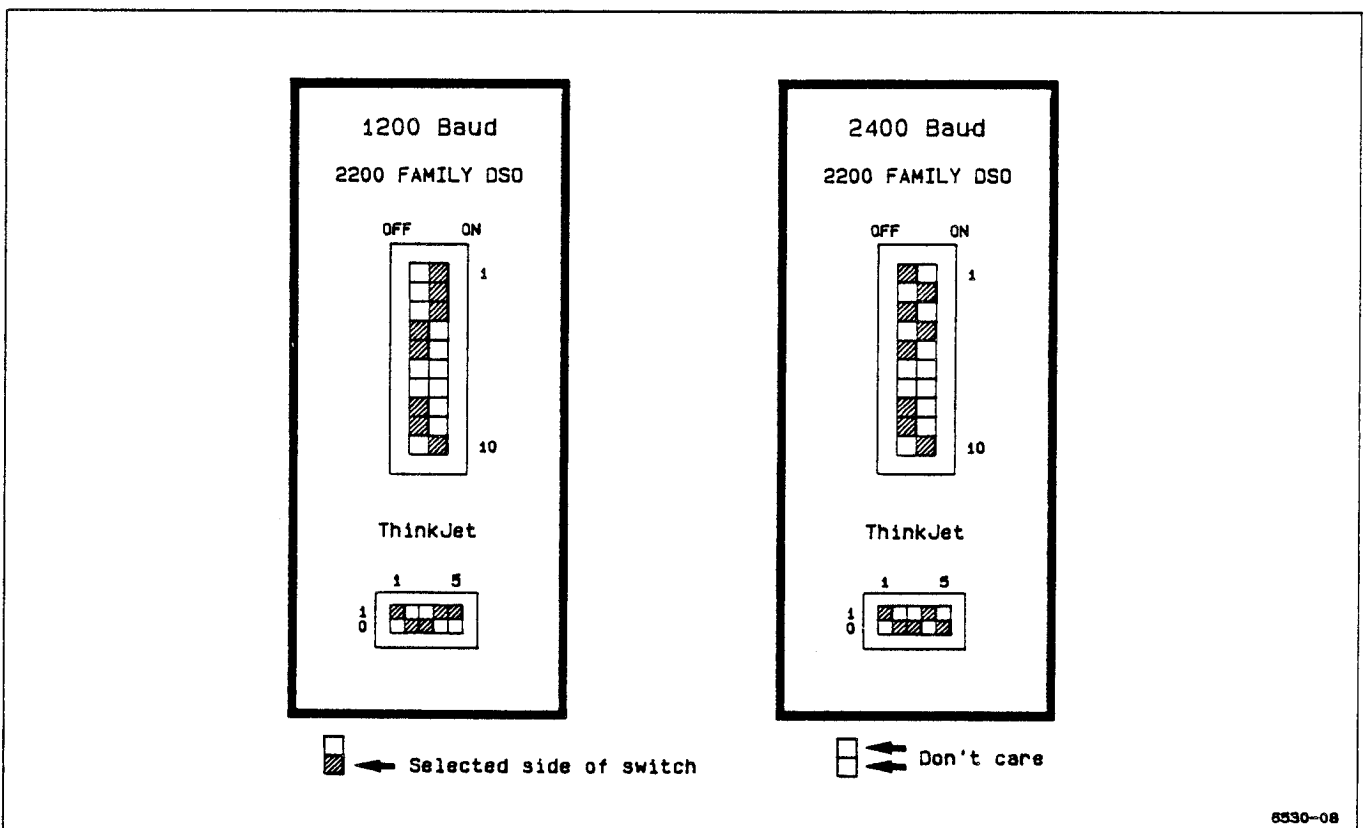

6530-08

Figure B-15. Option 12 PARAMETERS switch settings for HP ThinkJet printer.

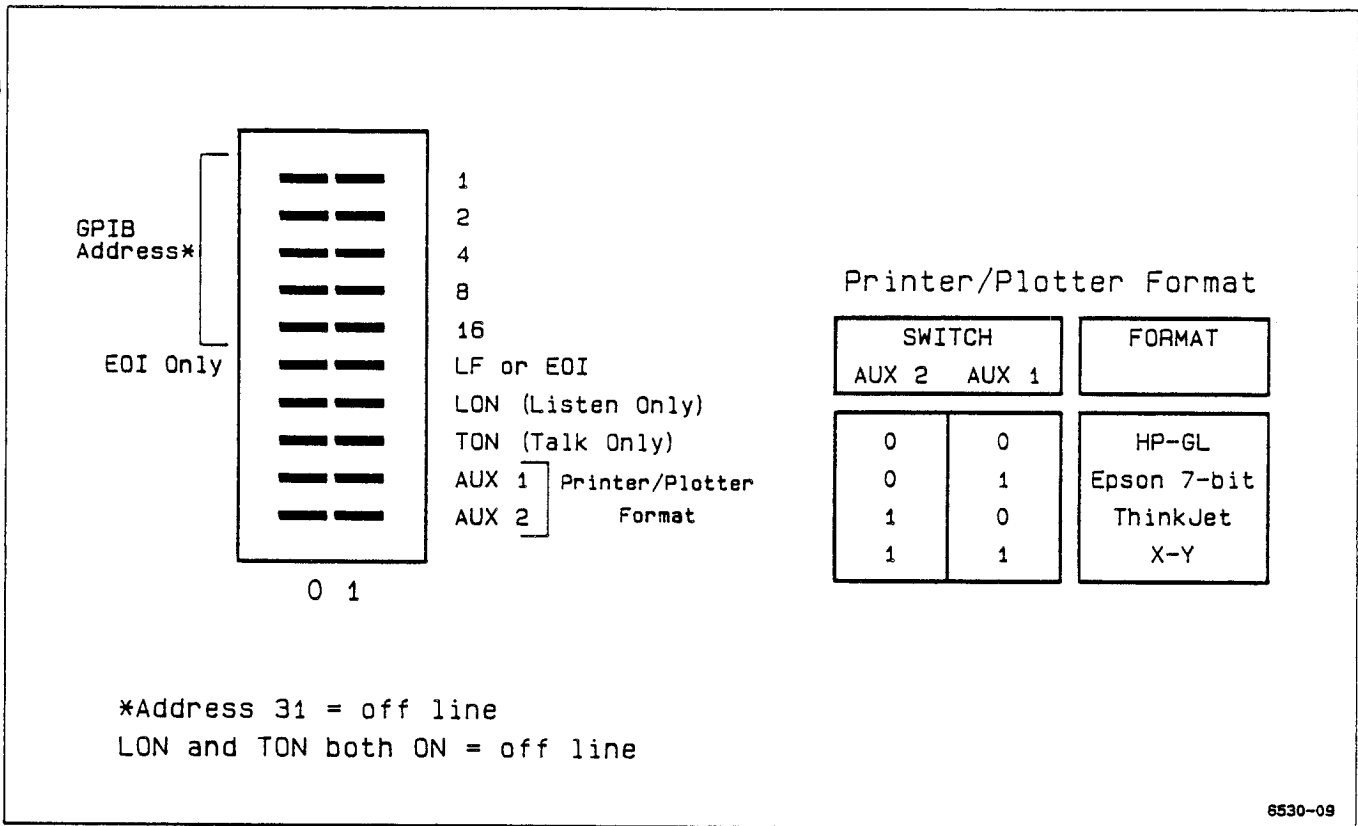

8530-09

Figure B-16. Option 10 GPIB Interface PARAMETERS switch.

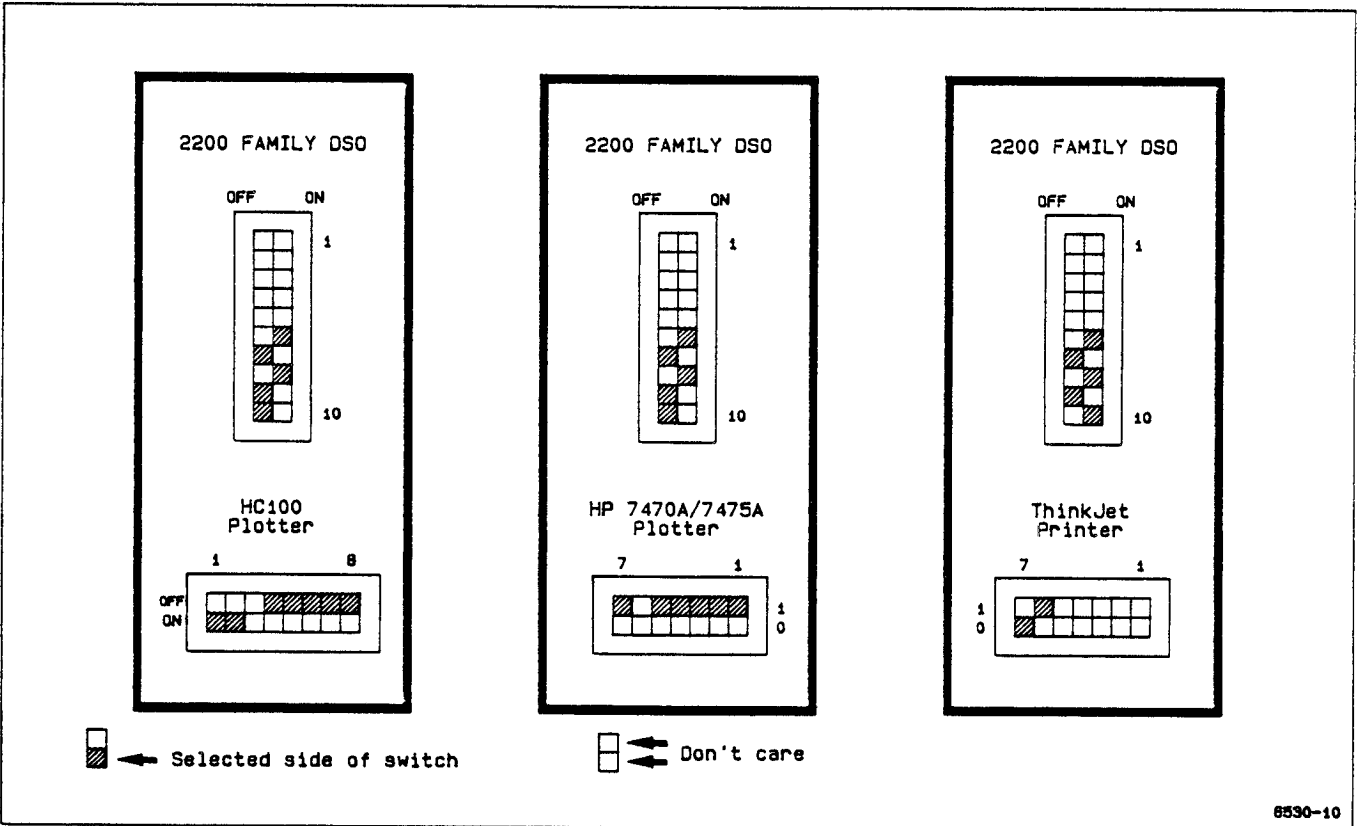

8530-10

Figure B-17. Option 10 PARAMETERS switch settings for compatible GPIB printers/plotters.

HP 7470A Plotter
To GPIB Interface

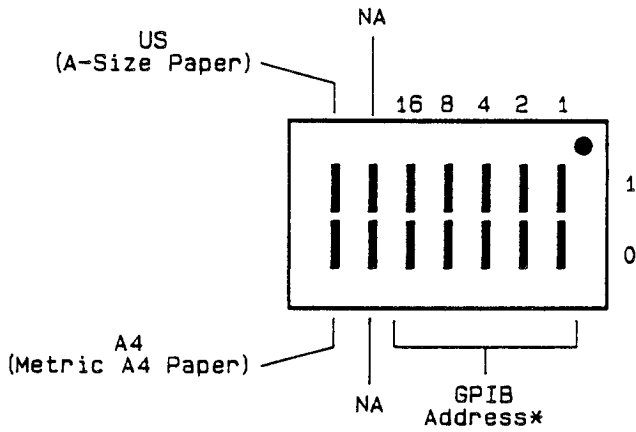

*Address 31 = Listen Always

HP ThinkJet Printer
To GPIB Interface

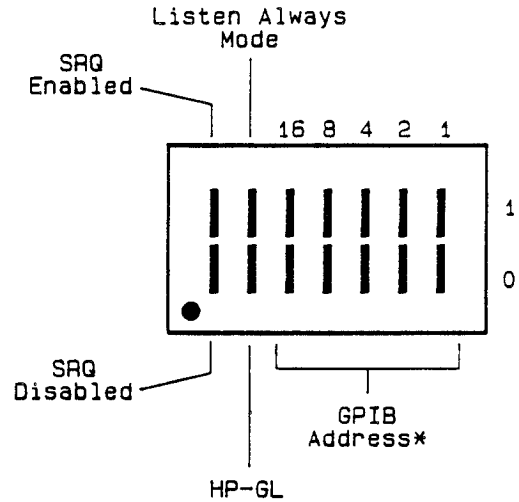

*Address 31 = Listen Always

HP 7475A Plotter
To GPIB Interface

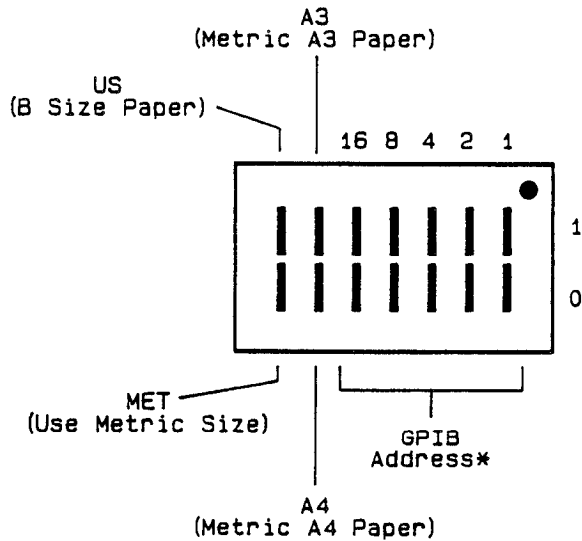

*Address 31 = Listen Always

Tektronix HC100 Color Plotter
To GPIB/Centronics Interface

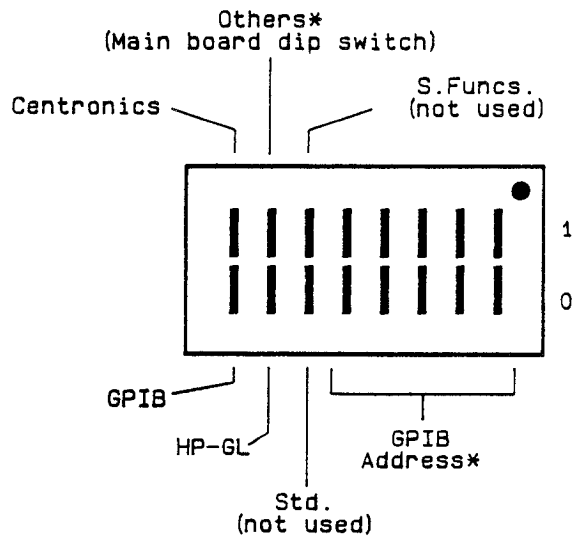

*When set to "Others", the modes defined by dip switches S4 and S5 on the Main board are active.

6590-11

Figure B-18. Switch settings for compatible GPIB plotters.

QUESTIONS AND ANSWERS

Here are answers to some typical questions that you may have about operation of the Communications Options.

Q: What is the data transfer rate?

A: For the Option 10 GPIB interface, the data transfer rate is approximately 1 Kbyte per second. This equates to one waveform per second for 1 K records or about four seconds for 4 K waveform records.

For the Option 12 RS-232-C interface, the data transfer rate depends on the format (ASCII, HEX, or BINARY) and the baud rate. Typical times for 1200, 2400, and 4800 baud are given in Table B-2.

Table B-2
RS-232-C Transfer Rates

Baud Rate	Record Size	Format	Transfer Time (Min:Sec)
1200	4K	ASCII	2:20
		HEX	1:10
		BINARY	0:36
	1K	ASCII	0:36
		HEX	0:20
		BINARY	0:10
2400	4K	ASCII	1:15
		HEX	0:40
		BINARY	0:20
	1K	ASCII	0:19
		HEX	0:10
		BINARY	0:05
4800	4K	ASCII	2:39
		HEX	1:16
		BINARY	0:45
	1K	ASCII	0:58
		HEX	0:29
		BINARY	0:13

Q: Why does the data transfer rate slow down at 4800 baud?

A: At that baud rate, the internal data buffer of the 2200 Family oscilloscope fills before the oscilloscope's processor is ready. That interrupts the processor from its other tasks, and it must stop to issue flow control commands to halt further data input while it gets ready to accept the data from the buffer. After it handles the buffer data, it must then start the data input again. All the interrupt handling slows down the transfer rate. At 2400 baud, the oscilloscope's processor is usually ready to handle the incoming data before the buffer fills, and it is not necessary to continually interrupt the data flow.

Q: The operators manual states that multiple commands may be sent in one message line, but sometimes errors are generated when I try this with Option 12. Why is that, and what can I do about it?

A: To answer the second question first, write RS-232-C controller programs to send only one command at a time.

For the first question of why multiple commands sometimes cause errors, the answer is that only one command at a time can be reliably handled by the processor. Commands (and arguments to commands) are interpreted and handled as they are recognized; the oscilloscope processor does not wait for the message terminator to end the message. If a service request is generated by one of the commands in a command string, a correcting action may have to be taken. If the service request is not handled properly, all following commands in a string may not be valid, and the controller program may not be able to continue.

Q: Sometimes when I send commands to change the operating state of the instrument, they are not accepted. What is the problem?

A: The REM ON command must be sent as the first command before attempting to change the operating state of the oscilloscope. The power-on state of REM is OFF.

Q: When I send waveforms to the oscilloscope at 2400 baud or more, I get bad transfers when I try to use binary-encoded curve data. What is the problem?

Appendix B—2221 Operators

- A:** Flow control must be used when sending waveform data to the oscilloscope at the higher baud rates. That is because the input data buffer is only 160 characters long and it fills up before the processor is ready to handle the input. Because of the nature of binary data, flow control can not be used to reliably send or receive binary-encoded curve data. Use either HEX or ASCII encoding instead. HEX-coded waveform data requires fewer characters to be transferred than ASCII-coded waveform data, and therefore is faster than ASCII format. Also, parity must be disabled with the PARAMETERS switch setting for binary data transfers. That setting has to be made before the instrument is turned on; at power-on is the only time the switch is read.
- Q:** What is the size of the oscilloscope's data output buffer?
- A:** The output buffer is about 1,000 characters.
- Q:** Why do I sometimes get bad curve data when I operate the DSO in the Repetitive Store Mode?
- A:** This problem is caused by not allowing enough sweeps to occur to fill the entire waveform record. Repetitive Store Mode (random equivalent-time sampling) depends on the probability of filling the waveform record in a specified number of sweeps. The more sweeps that are used to sample an input signal, the more probable it is that the waveform record will be filled when the waveform is asked to be transferred. If you receive bad curve data, you must allow more sweeps to occur before requesting the waveform from the oscilloscope.
- One way to do this is to set the number of sweeps (via either the oscilloscope's menu controls or a command message) to a value several times larger than the number of sweeps needed for a 50% probability of filling the record (see Controls, Connectors, and Indicators—Section 3 of the Operators manual). Also, you can set RQS and OPC on. Then, when the specified number of sweeps have been acquired, the oscilloscope will issue a single SRQ (service request). When the controller software determines that an the end-of-acquisition OPC state caused the service request, it can request the curve data.
- Q:** When operating in ALT or CHOP Vertical Mode, how do I designate from which channel of the acquisition or reference memory the waveform data is retrieved? How do I designate in which channel of a reference memory the waveform data is stored when sending waveforms to the oscilloscope?
- A:** The data channel for source and target for waveform transfers is designated using the REFERENCE WAVEFORM commands (see DATa CHAnnel). Either channel of the acquisition or Save Ref memory may be retrieved from the oscilloscope. Waveform data may be sent to either channel of a targetted Save Ref memory (see DATa TARget).
- Q:** What is the purpose of the external clock?
- A:** The external clock can be used to acquire signals that change too slowly for the normal calibrated SEC/DIV settings (for example, one sample every hour). Another use is to synchronize the 2230 so that samples are done on selected events.
- Q:** Can you re-arm Single Sweep via the communication option?
- A:** The Single Sweep function may be armed using the SGLswp ARM command. Single Sweep may also be queried to determine the state of the Single Sweep function (ARM or DONE).
- Q:** What is the maximum sensitivity in digital storage?
- A:** It is 2 mV/division, the same as in nonstore mode.
- Q:** Can I compress, expand, or reposition the stored waveforms?
- A:** The 2230 has commands for reformatting a target reference waveform; the 2220 and 2221 do not.
- Q:** What is the maximum expansion/compression factor for stored waveforms with the 2230?
- A:** Vertically, the reformat target waveforms may be expanded or compressed by a factor of ten from their acquired VOLTS/DIV setting. Horizontally, the X10 Magnification feature may be turned on for the reformat target waveforms.
- Q:** Can I return a reformatted waveform back to its original settings?
- A:** Yes. Query the BASegain to determine the acquired volts/div setting and set the VGAin to that setting. To return to the original vertical position, set VPOsition to 0; turn HMag off to regain the acquired sec/div setting.

Q: Can the baud rate, end-of-line terminator, or parity setups be changed from the RS-232-C controller?

A: No. Those communications parameters must be set up using the PARAMETERS switch on the oscilloscope's side panel before the oscilloscope is turned on.

Q: Can the GPIB address of the oscilloscope be changed from the bus or the front-panel?

A: The GPIB address and other communication parameters are settable only from the PARAMETERS switch on the oscilloscope's side panel, and the switch settings are read only at power on.

Q: Can a waveform preamble be sent to the instrument?

A: Yes, a waveform preamble can be sent to the oscilloscope. That preamble should correspond to the curve data that is sent to the target Save Ref memory.

Q: Can the waveform display be modified by changing the preamble fields?

A: Modifying the preamble information so that it does not correspond to the curve data invalidates the waveform, but it doesn't usually change the way it is displayed. If drastic changes are made to the preamble (such as data encoding or point format), the oscilloscope will probably reject the curve data as not matching the preamble.

Q: What type of averaging is used for the AVERAGE acquisition mode?

A: A normalized averaging algorithm is used.

$$A_s = A_{(s-1)} + (i_s - A_{(s-1)}) (\text{Weight})$$

Where:

A_s = the average after s number of sweeps,

$A_{(s-1)}$ = the average after (s-1) sweeps,

i_s = the sth input sample,

Weight = the selectable weighting factor from 1/1 though 1/256 in a power of 2 sequence.

Q: Can I get readout information over the communications interface?

A: CRT display information may be queried individually or obtained as part of the waveform preamble. The volts/div, sec/div, acquisition mode, trigger information, and cursor readouts are all available in the 2221 and 2230. Vertical information (except for Vertical Mode) and cursor readouts are not available with the 2220.

Q: What is the 26-K non-volatile memory supplied with the 2230 Communications option, and what are its waveform storage capabilities?

A: Memory space for 26, 1-K waveforms, or 6, 4-K waveforms, or any combination of waveform record totaling not more than 26 K bytes is provided by the added memory. The non-volatile memory is battery-backed for long-term waveform data storage.

Q: Can acquired waveforms be stored in the added memory using the 2230 front-panel controls?

A: Yes. Waveforms may be transferred into and out of the added memory using the Reference menu selections available in the Advanced Functions Menu. Waveforms must be transferred through one of the numbered Safe Ref memory locations (REF1—REF4).

Q: How are the waveforms stored in the added memory addressed via the 2230 communications option?

A: The added memory locations are designated REFA through REFZ. These memory locations are accessed through the REF1—REF4 memory locations for both reading and writing using the REFFrom and SAVeref commands; they cannot be directly accessed.

Q: What are the differences between Peak Detect (PEAK) and Accumulated Peak Detect (ACCPEAK) acquisition modes?

A: Peak Detect and Accumulated Peak Detect are both envelope acquisition modes. Peak Detect captures the latest maximum and minimum points during a single acquisition and discards them for the next acquisition. Accumulated Peak Detect holds those peak values until reset so that the changes over time are detectable. Accumulated Peak Detect is valid only for triggered acquisitions and is not allowed in untriggered modes. Peak Detect is valid for both triggered and untriggered modes, since no peak are held between acquisitions.

Appendix B—2221 Operators

- Q:** What is the default number of acquisitions in ACCPEAK mode?
- A:** The number of sweeps that may be accumulated can be set for a default of continuous (ACQ NUM:0) or any number between 1 through 2047. With each new acquisition, the most-positive and most-negative values are added to the existing display. When set to a specified number, the acquisition stops when the limit is reached, and the waveform is held displayed.
- Q:** What is the envelope sampling rate in Peak Detect and Accumulated Peak Detect?
- A:** 20 megasamples per second.
- Q:** Can the 2230 and 2221 cursor positions be addressed over the communications interface?
- A:** Yes. The cursors may be targeted to the acquisition or a Save Reference waveform and positioned within the waveform record. Their voltage difference and time difference may be queried to determine the readout values.
- Q:** Is delay time included in the 2230 waveform preamble?
- A:** No. The preamble does not indicate if the curve data was taken at an A or a B SEC/DIV setting, just what the SEC/DIV setting is for that curve data.
- Q:** Are the intensified zones seen in a 2230 BOTH Horizontal Mode acquisition stored in SAVE mode or in SAVE REF memory?
- A:** Yes, they are saved in both SAVE and in SAVE REF.
- Q:** What waveform data is sent by a 2230 if the waveform acquired in BOTH Horizontal Mode is requested?
- A:** The A Sweep waveform is sent.
- Q:** Can a waveform be sent to a controller from the front panel of the oscilloscope?
- A:** No, but the waveform may be sent to plotter or printer. With Option 10, the oscilloscope must be in Talk Only mode. With either option, the PARAMETERS switch must be set to output the correct format for the printer or plotter being used. See Section 7 of the Operators Manual and the Printer/Plotter Operation text in this Appendix for information.