

iHome.

User Manual

AUTOVAC Eclipse Series



Please read this user manual thoroughly before using this product

Contents

EN

Safety Instructions-----	1 - 2
Product Components-----	3 - 6
Product Assembly-----	7
Product Operation-----	8 -12
Product Maintenance-----	13 -16
Products Specs-----	17

Safety Instructions

Before using this product, please read the following safety instructions and follow all safety precautions.

Any operation inconsistent with this instruction manual may cause damage to this product.

Note:

- Only authorized technicians can disassemble this product. Users are not recommended to disassemble this product by themselves. Doing so will void warranty.
- Only use the included power adapter. Third part adapters may damage the iHome AUTOVAC Eclipse.
- Do not touch wires, sockets or power adapters when your hands are wet.
- Do not place this product near cigarette butts, lighters and other materials with smoldering fire
- Please clean Dustbin and brushes regularly.
- Do not place any object, pets or people on top of the iHome AUTOVAC Eclipse.
- This product is an indoor household product. Do not use outdoors.
- Do not use this product in wet environment (i.e, bathroom)
- Before using this product, please clear the floor of all objects other than furniture as some small objects may obstruct, get caught in, or damage the iHome AUTOVAC Eclipse.
- Please use and store iHome AUTOVAC Eclipse in room temperature environments only.

Safety Instructions

Warnings:

- Do not use products in environments with open flames or fragile objects.
- Do not allow human hair, clothes, fingers and other parts to approach the opening and operate parts of the product.
- Do not allow the iHome AUTOVAC Eclipse to pick up objects such as stones and waste paper that may clog product.
- Do not allow the iHome AUTOVAC Eclipse to pick up flammable substances such as oil, printer toner and photocopier toner.
- Do not allow the iHome AUTOVAC Eclipse to pick up any burning articles, such as cigarettes, matches, ashes and other articles that may cause fire.
- Do not place objects near the suction port. Do not use the product when the suction port is blocked. Clean up the garbage dust, wool, hair, etc to ensure smooth air circulation at the suction port.
- Use the power cord carefully to avoid damage. Do not use the power cord to drag or pull the product and the charging base. Do not use the power cord as a handle.

Product Components

Main body and Accessories

No.	Description	Quantity
1	iHome AUTOVAC Eclipse	1
2	Charging Base	1
3	Adapter	1
4	Dust Bin	1
5	Brush Maintenance Tool	1
6	Remote Control	1
7	Boundary Strip	1
8	User Manual	1
9	Water Tank (sold seperately in some models)	1
10	Mop Pads (sold seperately in some models)	2
11	HEPA Filter	1
12	Side Brushes	4

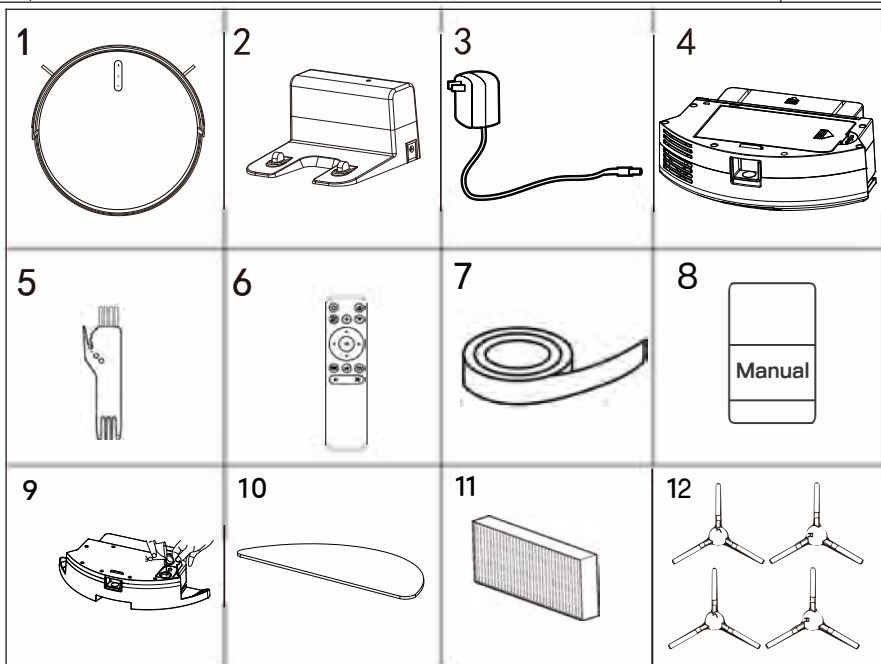

Product Components

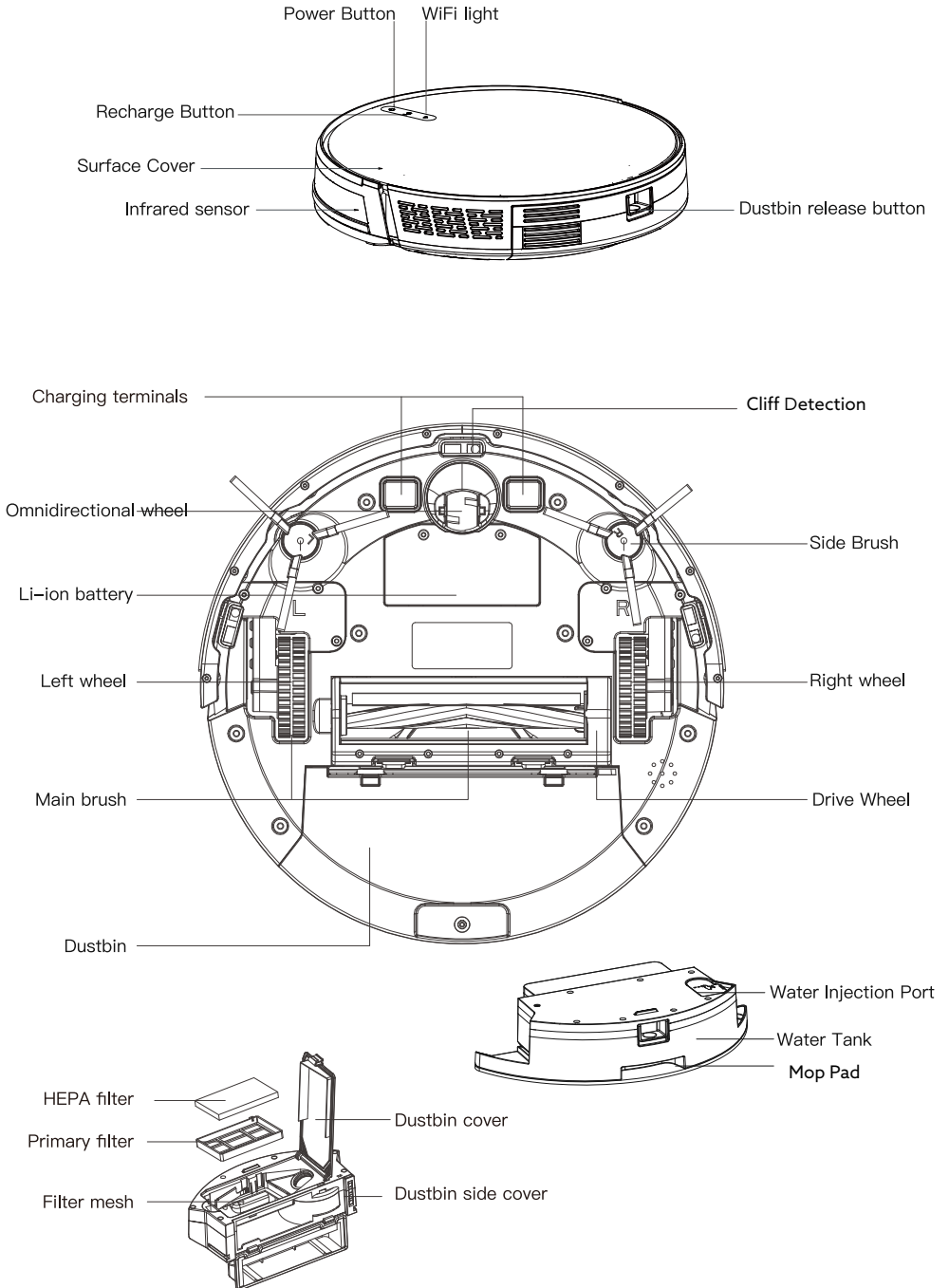

Product Components

Charging Base

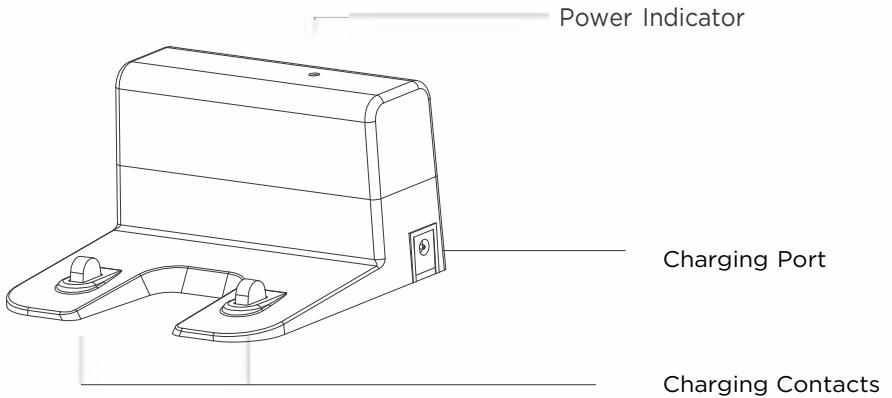



Main Body Buttons



1.  Power button

Hold  to power on/off
Press  to start/stop cleaning

2.  Recharge button

Hold  to enter network configuration mode (hold for 5 seconds)
Press  to return to charging base

Product Components

Remote Control

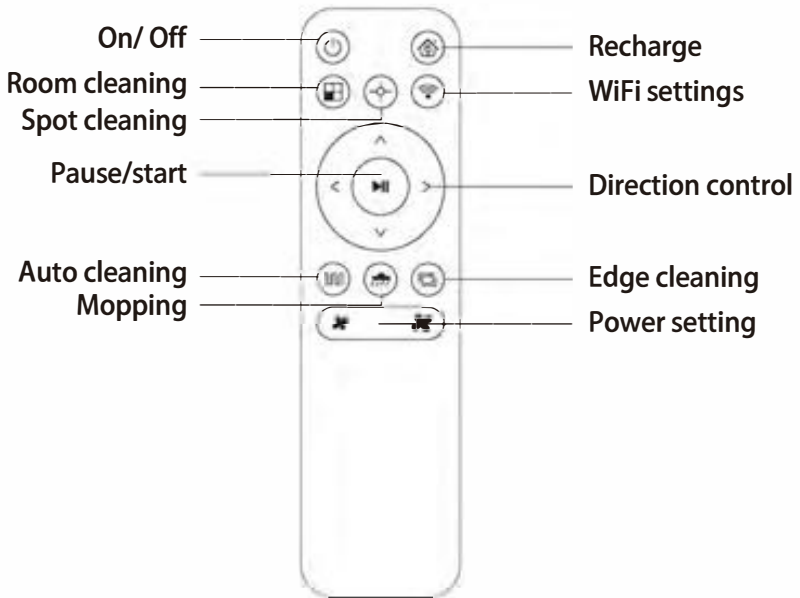

Boundary Strip

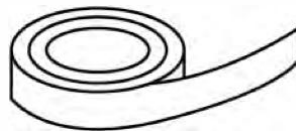

The iHome AUTOVAC Eclipse Series works with boundary strips

Easily cut the magnetic strip to fit doorways, around pet bowls, cords or anywhere you don't the vacuum going.

Simply place the strip on the floor wherever you do not want your iHome AUTOVAC Eclipse going.

Product Assembly

1. Remove the iHome AUTOVAC Eclipse from the packaging and place on the ground
2. Remove the Side Brushes (included in the packaging) and attach the Left and Right Side (1 Each) Brushes to the bottom of the iHome AUTOVAC Eclipse. There are 1 Left and 1 Right spare brushes included

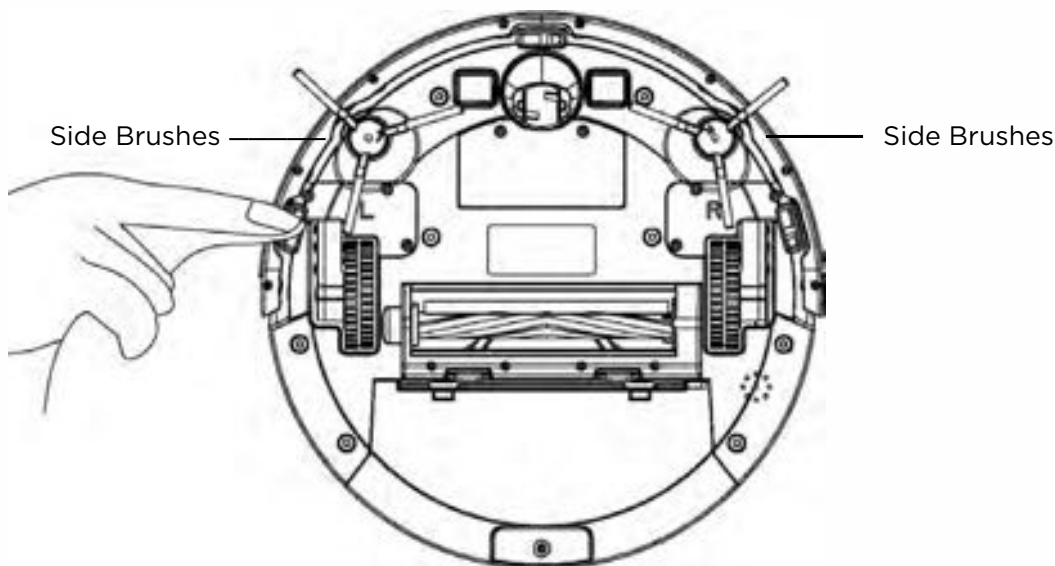

3. Flip the iHome AUTOVAC Eclipse back over and follow the following steps

Product Operation

Battery Charging

Place charging base against the wall and remove obstacles from within 2 feet of both sides and about 5 feet in front of the base, as shown in the right figure.

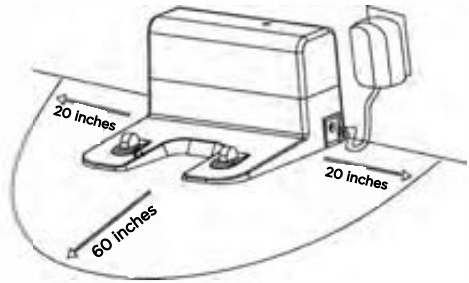

Battery Maintenance

a. Before first use, charge the iHome AUTOVAC Eclipse for 5 hours by turning on the unit and clicking the Home/Recharge button on the remote or iHome Clean APP in order for the unit to automatically return to the charging base. This will allow the iHome AUTOVAC Eclipse to learn where it's charging base is.

1. During Charging the Recharge/Home Button light is flashing
2. Charging is finished when the Recharge/Home Button light remains on steadily.

b. Charge the iHome AUTOVAC Eclipse as soon as possible when battery power is low.

c. The iHome AUTOVAC Eclipse will return to the charging base automatically when it finishes cleaning or battery power is low.

d. The charging base cannot be used in environments with strong reflection such as direct sunlight and nearby mirrors. If there is any object with strong reflection, please cover it 7cm from the bottom.

e. When charging, please make sure the iHome AUTOVAC Eclipse is not equipped with the water tank to ensure the safety of charging and prevent wet mop pads from damaging the floor.

Product Operation

App Use

Get the most out of your iHome AUTOVAC Eclipse Series robot by downloading the iHome Clean App. Download the App for Wi-Fi setup, Scheduled Cleanings, View Room Map, Switch Cleaning Modes and more!

Search “iHome Clean” in the Apple App Store or Google Play Store and download the app to your iPhone or Android.

Control iHome AUTOVAC Eclipse

- Start and Stop Cleaning from Anywhere
- Start and Stop POWERMOP from Anywhere
- Set your Cleaning Schedule
- Send your iHome AUTOVAC Eclipse back to the Charging Base
- Using HOMEMAP technology the Eclipse builds a virtual map of your floor plan within the app.
- Control the 3 suction modes with eco mode for energy saving and quiet cleaning, Normal mode for standard suction and cleaning and HYPERDRIVE for powerful suction for deep cleaning.
- View the iHome AUTOVAC's Remaining Battery
- Check the Cleaning Time (min), Cleaning Area (meters)
- Enable Single Room Cleaning
- Enable Edge Clean
- Enable Spot Clean
- Control your iHome AUTOVAC Manually

Settings

- Activating Alexa/Google Connectivity
- Modify your iHome AUTOVAC's personal name
- Update Firmware
- Cleaning Record
- Manage Shared Users

Account

- Help and Feedback
- Support
- Account Settings

Product Operation

APP instructions

1. Make sure your Mobile Phone is connected to Wi-Fi

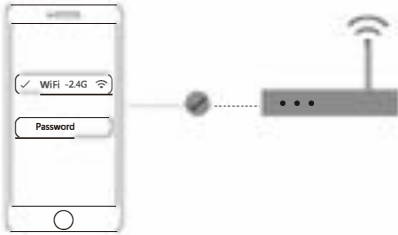

2. Scan the QR code below or search "iHome Clean" in APP store or Google Play to download the APP.



3. Open the app, select "add device" and select Eclipse Series.



4. Turn on the robot, press and hold the recharge/home button for 5 seconds until the Wi-Fi indicator flashes. Alternatively, you can press and hold the "Wi-Fi settings" button on the remote to enter network configuration mode.

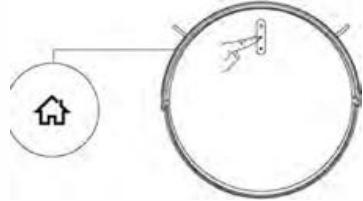

5. Select your home 2.4G Wi-Fi network and enter the password.

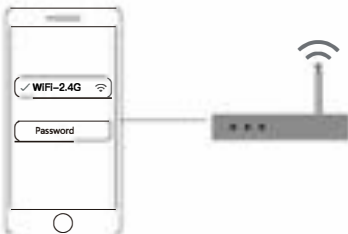

6. Go to Wi-Fi settings in your smartphone, select the Wi-Fi network "AUTOVAC Eclipse"

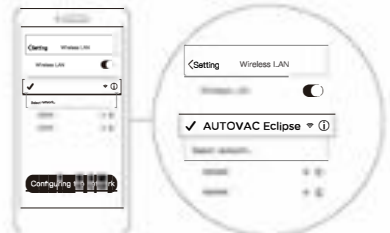

7. Reopen the APP after connected and waiting for network configuration.

Note:

In case of network failure, please confirm the following issues and retry:

- A. The Wi-Fi network is not 5G (The app supports only 2.4G network).
- B. The name and password of Wi-Fi do not contain any special characters.
- C. Make sure the robot is in close range to your router during pairing.
- D. Check to make sure your Wi-Fi network is not down
- E. Check your router to make sure it's operating normally.

Product Operation

How the iHome AUTOVAC Eclipse Series Works

* Before using this product, please clear the floor of all objects other than furniture as some small objects may obstruct, get caught in, or damage the iHome AUTOVAC Eclipse.

Cleaning

The iHome AUTOVAC Eclipse is designed to automatically and intelligently clean your home. Multiple sensors are used to avoid obstructions and cliffs. The AUTOVAC Eclipse will continue to clean until it has determined that the addressable floor area has been covered. A map of the AUTOVAC Eclipse path is available to view in the iHome Clean app after each cleaning. Once cleaning is finished or the battery is low, the iHome AUTOVAC Eclipse will automatically return to the charging base.

The iHome AUTOVAC Eclipse Series once charged, can be used to clean your home. Use the remote, or the iHome Clean APP to control your preferred cleaning method (Auto Clean, Spot Clean, Edge Clean, POWERMOP). Once you have chosen your preferred cleaning method, the iHome AUTOVAC Eclipse Series will start cleaning and will continue until it has covered the entire cleaning area, or until the battery is low and needs to be re-charged. Once cleaning is finished or the battery needs to be re-charged, the iHome AUTOVAC Eclipse Series will automatically return back to the charging base.

Cleaning Modes

Auto Clean - The iHome AUTOVAC Eclipse will automatically clean your floor until it has covered the entire surface. Once it has cleaned the entire surface it will automatically return back to the charging base

Edge Clean - The iHome AUTOVAC Eclipse will find the edges of your room and focus on cleaning those edges throughout its cleaning cycle

Spot Clean - The iHome AUTOVAC Eclipse will focus on a specific area you desire to have cleaned thoroughly. First, use the manual navigation control on the remote (or in the app) to guide the AUTOVAC Eclipse to the desired area. Then, choose Spot Clean mode.

Single Room Cleaning - The iHome AUTOVAC Eclipse will focus specifically on cleaning one room by avoiding any open door ways.

POWERMOP - Attach the water tank (some models sold separately) by removing the dustbin from the rear of the iHome AUTOVAC Eclipse. Choose POWERMOP in the iHome Clean APP or the included remote and the iHome AUTOVAC Eclipse will automatically mop the surface and return to the recharge base once complete.

Manual Control - Using the iHome Clean APP or the included remote, you can manually control where the vacuum goes by using this setting.

Product Operation

Water Tank Use

Note: Do not mop on carpet. We do not recommend using any cleaning solutions as it may clog the liquid outputs.

***Some Models Do Not include the Water Tank for POWERMOP mode.**

The POWERMOP is recommended for an extra layer of cleaning. It is recommended to only use the POWERMOP Water Tank after the iHome AUTOVAC Eclipse vacuums your floor.

1. Add water to the Water Tank via the fill port on the top of the tank
2. Install Mopping Pad on the bottom of the Water Tank
3. Remove the Dustbin from the rear of the iHome AUTOVAC Eclipse
4. Install the Water Tank into the rear of the iHome AUTOVAC Eclipse
5. Start Mopping by selecting POWERMOP on the iHome Clean APP or the Mopping button on the remote control.

After mopping please empty the water tank immediately and remove the Mopping Pad.

Mopping Pad can be machine washed and dried.

Add water

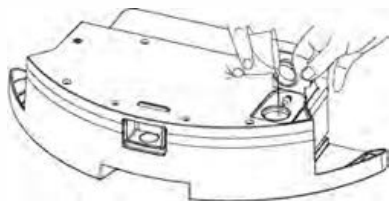

Install the Water Tank



Install Mopping Pad

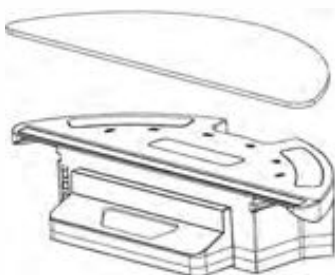

Start Mopping



Product Maintenance

Component maintenance / main brush and side brush

Remove and clean the main brush and side brushes regularly.

1. Press the main brush's release button and take the cover out.
2. Take the main brush out and clean the compartment and the main brush with the provided brush maintenance tool
3. Place the main brush and cover back into position and snap cover closed

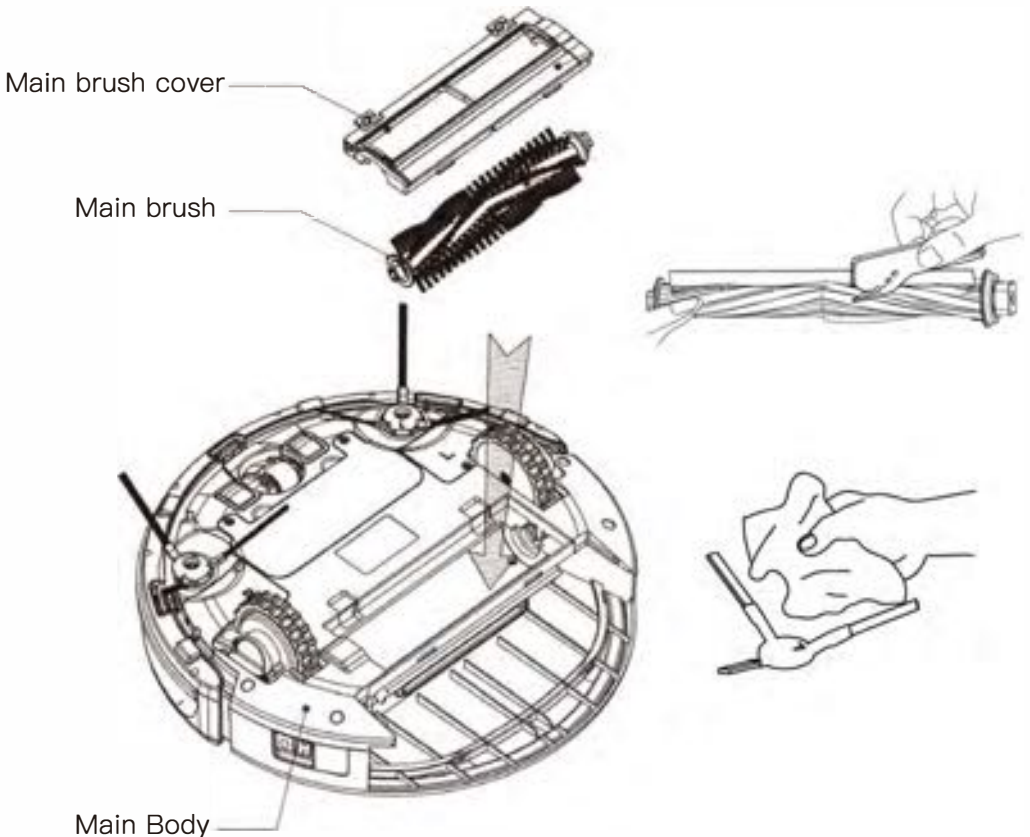

Product Maintenance

Component maintenance /Dustbin

1. Remove the dustbin from the robot by pressing the dustbin release button.



2. Open the dustbin side cover



3. Empty dust and debris

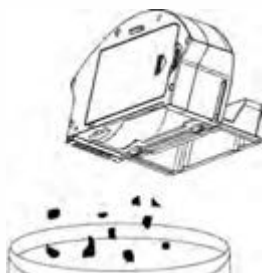

4. Open the filter cover

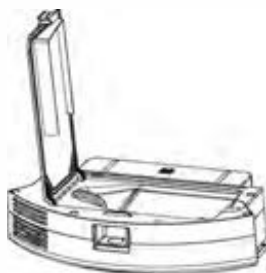

5. Take out the two filter screens: the HEPA filter and the primary filter. It is not recommended to wash the HEPA filter with water. Tap gently to remove dust.



6. Rinse the primary filter screen.



Product Maintenance

Clean dust bin with a dry cloth. Do not allow water to seep into the fan port when cleaning

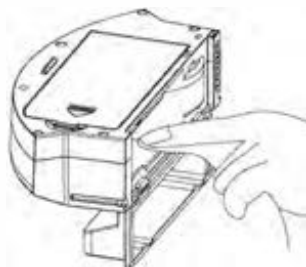

Note: It is recommended to wash the primary filter with water 15-30 days after it is used. The HEPA filter should be replaced every 3-6 months depending on use.

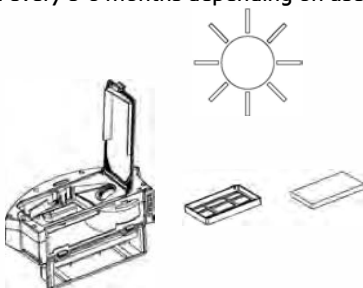

Replace the primary filter screen and the HEPA filter into the dustbin. Note. Please ensure both filters are dry before reinstalling. Do not expose the filters to direct sunlight

Warning:

DO NOT allow the water seep into the fan as it is inside the dustbin.

Product Maintenance

Component maintenance / charging pins

Note: The interior of the charging port, the sensor and the plate all contain sensitive electronic components, please use dry cloth when cleaning. Do not use wet cloths.

Charging Base

Clean the charging terminals and charging port regularly to prevent dust and dirt build up.

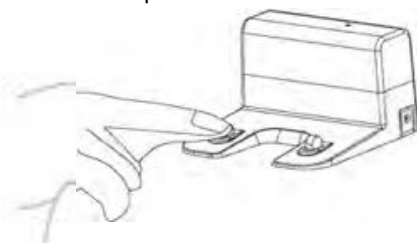

Free-fall sensors

Clean up the free-fall sensors in the bottom regularly.

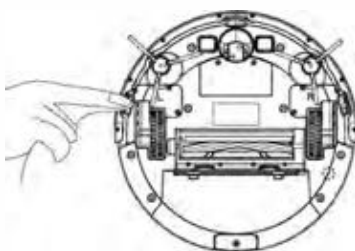

Product Specs

Classification	Item	Detail
Mechanical Specifications	Diameter	13 inches
	Height	3 inches
	Weight	6 lbs
Electrical Specifications	Power Rate	14.4V
Cleaning Specifications	Charging Type	Auto Charging/Manual Charging
	Cleaning Mode	Auto/single room/fixed point/edge/mop floor
	Charging Time	About 5 hours
	Cleaning Time	120 min (approx)
Robot Button Type		Touch

This manual applies to all Eclipse Series robots

FCC Warning

This device complies with Part 15 of the FCC Rules. Operation is subject to the following two conditions: (1) This device may not cause harmful interference, and (2) This device must accept any interference received, including interference that may cause undesired operation.

NOTE 1: This equipment has been tested and found to comply with the limits for a Class B digital device, pursuant to part 15 of the FCC Rules. These limits are designed to provide reasonable protection against harmful interference in a residential installation. This equipment generates, uses and can radiate radio frequency energy and, if not installed and used in accordance with the instructions, may cause harmful interference to radio communications. However, there is no guarantee that interference will not occur in a particular installation. If this equipment does cause harmful interference to radio or television reception, which can be determined by turning the equipment off and on, the user is encouraged to try to correct the interference by one or more of the following measures:

- Reorient or relocate the receiving antenna.
- Increase the separation between the equipment and receiver.
- Connect the equipment into an outlet on a circuit different from that to which the receiver is connected.
- Consult the dealer or an experienced radio/TV technician for help.

NOTE 2: Any changes or modifications to this unit not expressly approved by the party responsible for compliance could void the user's authority to operate the equipment.

This equipment complies with the FCC RF radiation exposure limits set forth for an uncontrolled environment. This equipment should be installed and operated with a minimum distance of 20cm between the radiator and any part of your body.

Sommaire

FR

Composition du produit -----	1-4
Fonctionnement du produit -----	5-7
Maintenance du produit-----	8-11
Spécifications -----	12

Composants du produit

Corps principal et accessoires

No.	La description	Quantité
1	iHome AUTOVAC Eclipse	1
2	Base de chargement	1
3	Adaptateur	1
4	Poubelle à poussière	1
5	Outil de maintenance	1
6	Bande de délimitation	1
7	de la télécommande	1
8	Manuel de l'Utilisateur	1
9	Réservoir d'eau (vendu séparément sur certains modèles)	1
10	Tampons de vadrouille (vendus séparément sur certains modèles)	2
11	Filtre HEPA	1
12	Brosses latérales	4

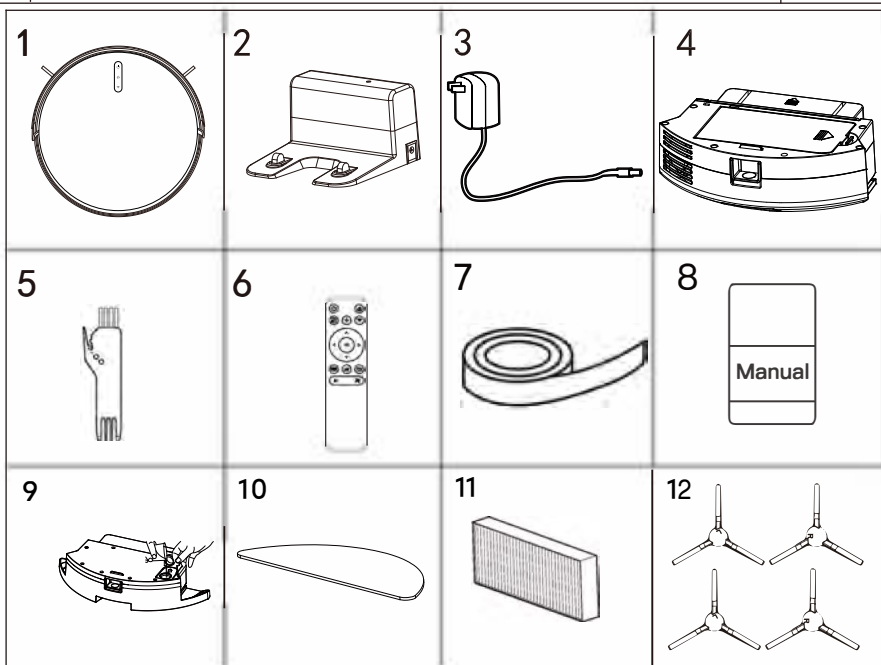

Composition du produit

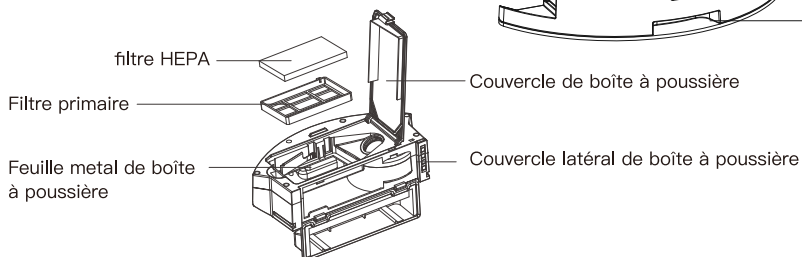
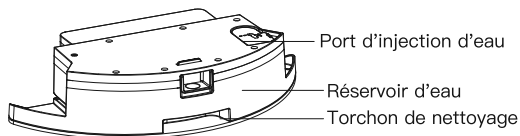
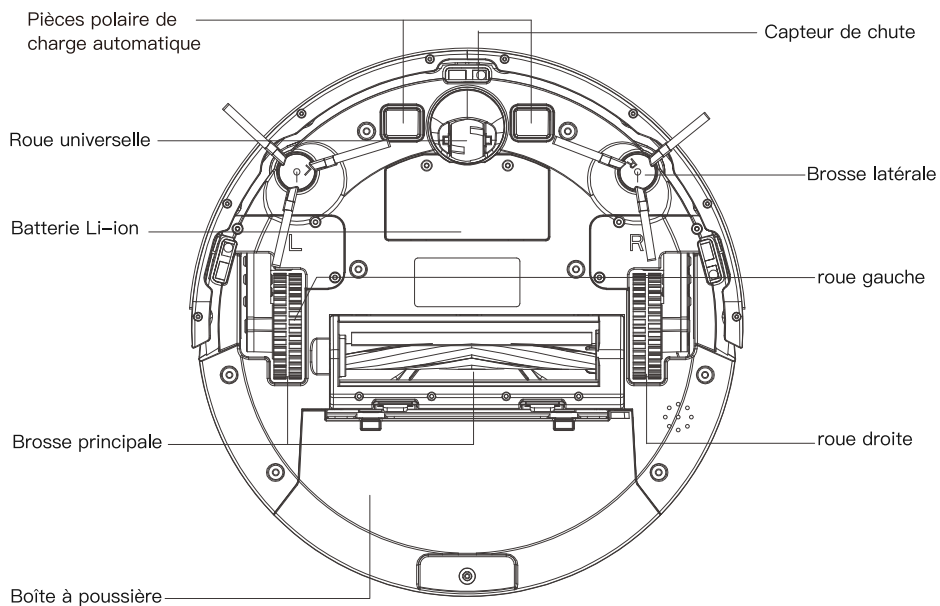
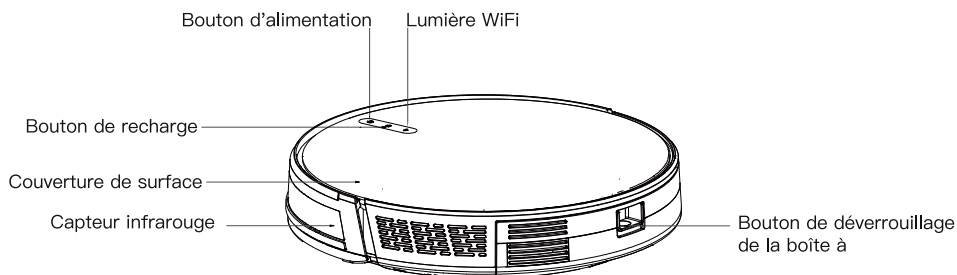

Composition du produit

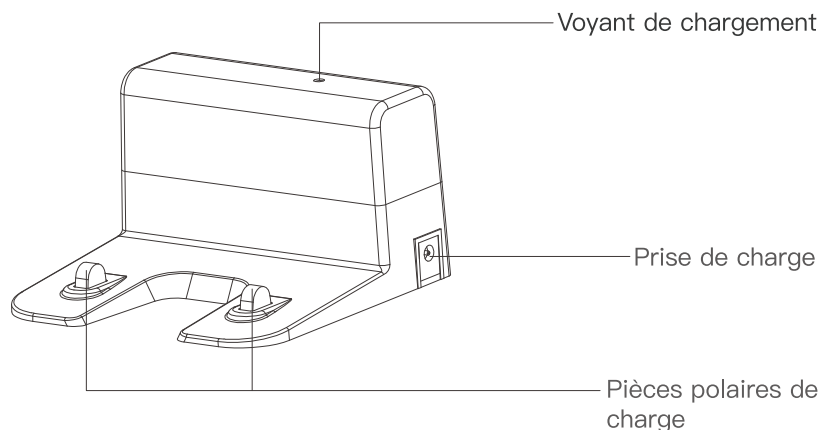

Station de charge





Principaux boutons



1. Bouton d'alimentation

- A. Appuyer longuement sur  : allumer / éteindre la machine
- B. Appuyer brièvement sur  : démarrer / arrêter le nettoyage

2. Bouton de recharge

- A. Appuyez longuement sur  : pour entrer en mode de configuration réseau (maintenez pendant 5 secondes)
- B. Appuyez brièvement sur  : retour à la charge

Composants du produit

Télécommande

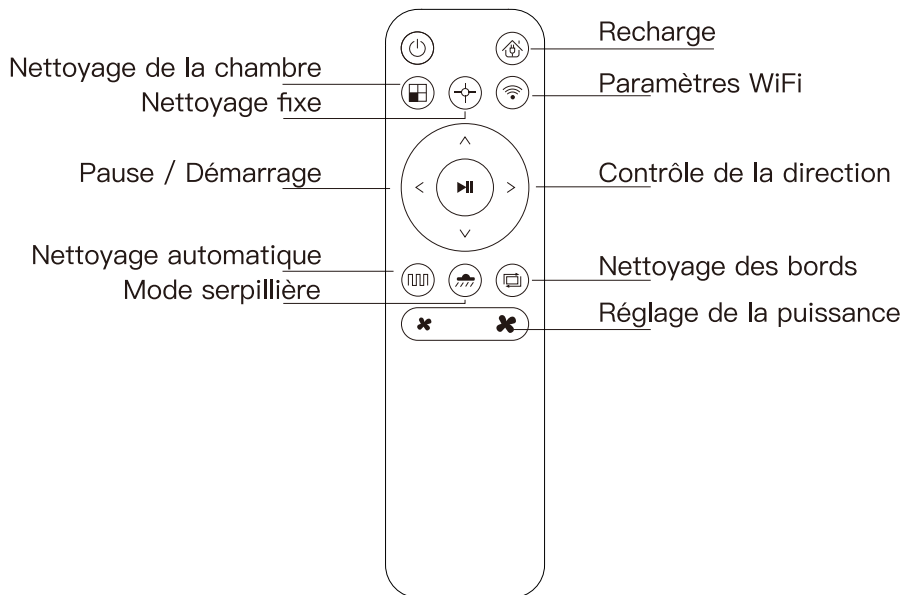

Mur bande magnétique

Le robot aspirateur fonctionne avec le mur bande magnétique. Coupez facilement la bande magnétique pour l'adapter aux portes, autour des bols d'animaux, des cordes ou partout où vous ne le souhaitez pas entrer.



Chargement de la batterie

1. Placez bien la station de charge
Placez la station de charge contre le mur et retirez les obstacles qui se trouve 0.5 mètre de côté et 1.5 mètres devant la station de charge, comme indiqué. Si la machine est

éteinte, veuillez allumer l'interrupteur d'alimentation latéral pour la recharger.

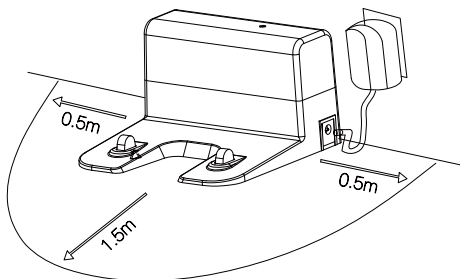

Méthodes efficaces pour prolonger la vie de la batterie :

a. Pour la première utilisation, veuillez charger la machine pendant 12 h.

b. Lorsque la batterie est faible, veuillez la charger dès que possible.

c. Lorsque le nettoyage est terminé ou que la batterie est trop faible, la machine cherchera automatiquement la station de charge pour charger.

d. Le socle de chargement ne peut pas être utilisé dans des environnements fortement réfléchissants tels que la lumière directe du soleil et s'il y a des miroirs à proximité. S'il y a un objet possédant une forte réflexion, couvrez-le à 7 cm du bas.

Fonctionnement du produit

Se connecter au client mobile

1. Téléphone portable connecté au WiFi.

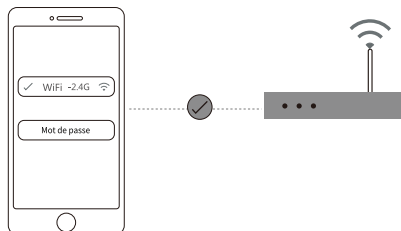

2. Téléchargez l'application en scannant le code QR ci-dessous ou en cherchant « iHome Clean » dans l'APP Store.



3. Activer l'application, ajouter le robot et sélectionner Eclipse Series
Note : Veuillez vous référer à la plaque signalétique de l'hôte pour le modèle spécifique.

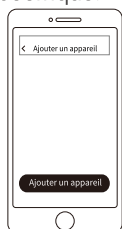

4. Allumez le robot, maintenez le bouton de recharge enfoncé pendant 5 secondes, puis passez au mode de configuration du réseau.

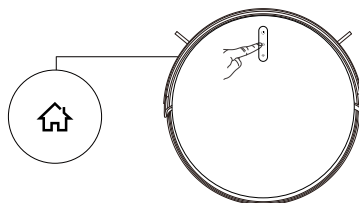

5. Sélectionnez le Wi-Fi à votre domicile et entrez le mot de passe en attendant la configuration du réseau.

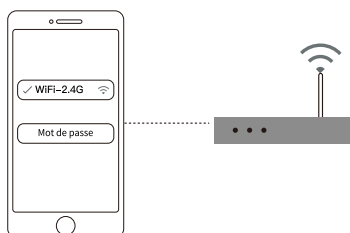

6. Allez sur la page Paramètres Wi-Fi de votre téléphone, sélectionnez le robot Wi-Fi « AUTOVAC Eclipse ».

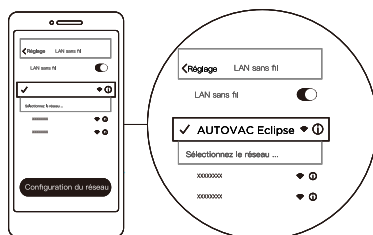

7. Rouvrez l'application une fois connecté et en attente de configuration du réseau.

Entrez la page de Configuration Wi-Fi dans votre téléphone, choisissez WiFi « AUTOVAC Eclipse ». Rouvrez APP après la connexion avec succès.

Remarque:

En cas de panne du réseau, veuillez confirmer les problèmes suivants et réessayer:

- A. Le réseau Wi-Fi n'est pas 5G (l'application prend en charge uniquement le réseau 2.4G).
- B. Le nom et le mot de passe du Wi-Fi ne contiennent aucun caractère spécial.
- C. Le robot est à proximité du routeur.
- D. Essayez d'éviter l'heure de pointe du réseau pour la première utilisation.

Fonctionnement du produit

Utilisation du réservoir d'eau

Après avoir nettoyé le sol, veuillez vider le réservoir d'eau à temps et retirer le torchon.

Note : Ne passez pas la serpillière sur le tapis pour éviter que le tapis ne soit mouillé.

Ajoutez de l'eau

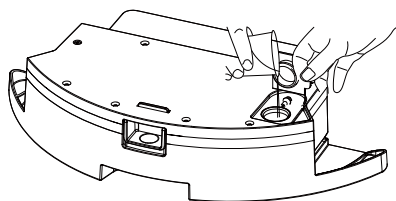

Installez le réservoir d'eau

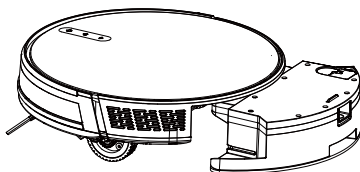

Installez le chiffon de nettoyage

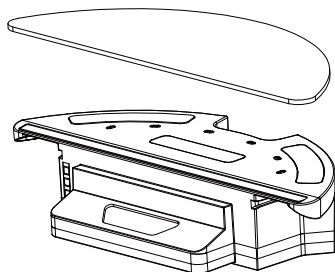

Commencez à nettoyer le sol

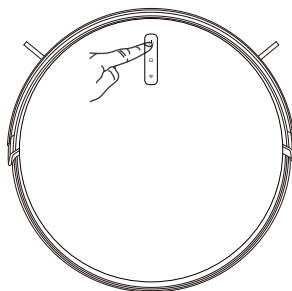

Maintenance du produit

Composant de la brosse à rouleau et assemblage de serpillière de lavage.
Suivez les étapes ci-dessous pour assembler l'appareil
(voir les figures ci-dessous)

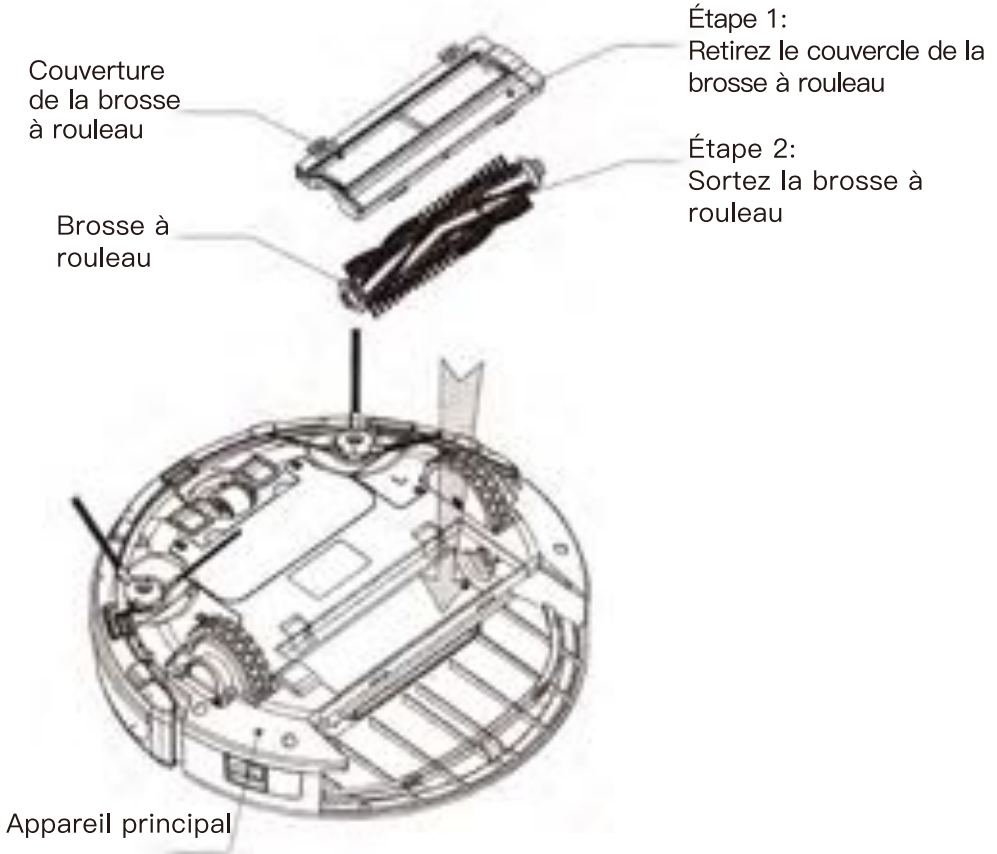

1. Outils utilitaire (inclus) pour nettoyer les cheveux emmêlés

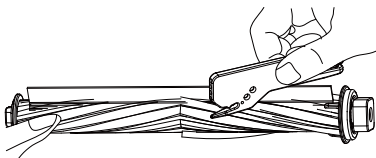

2. Nettoyage de la bosse latérale

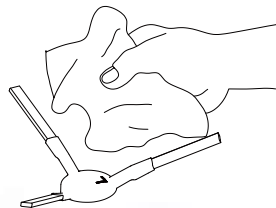

Maintenance du produit

Maintenance des composants / boîte à poussière

A. Retirez la boîte à poussière du robot en appuyant sur le bouton de dégageement de la boîte à poussière.

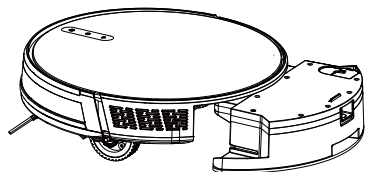

B. Ouvrez le capot latéral de la boîte à poussière et videz la poussière

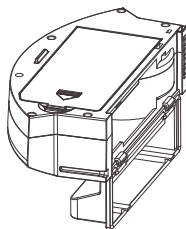

C. Déversement des déchets

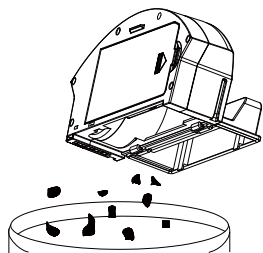

D. Ouvrez le couvercle de la boîte à poussière et retirez le filtre HEPA.

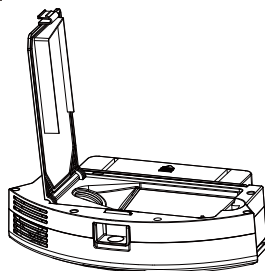

Attention:

NE PAS laisser l'eau s'infiltrer dans le ventilateur car elle se trouve dans la boîte à poussière.

E. Agitez le filtre HEPA et éliminez toute la poussière à l'aide de la brosse de nettoyage fournie.

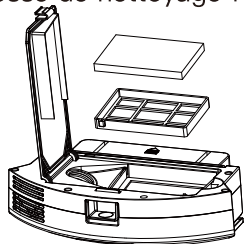

F. Rincer ou nettoyez le filtre primaire avec une brosse de nettoyage

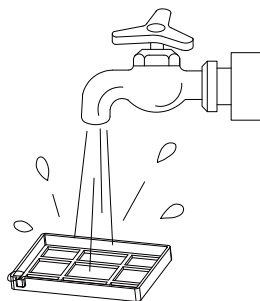

Attention:

A. NE PAS laver le filtre HEPA avec de l'eau.

B. Il est suggéré de remplacer le filtre HEPA tous les 3 mois.

Maintenance du produit

- G. Nettoyez la boîte à poussière avec une lavette. Ne laissez pas l'eau s'infiltrer dans le port du ventilateur lors du nettoyage.

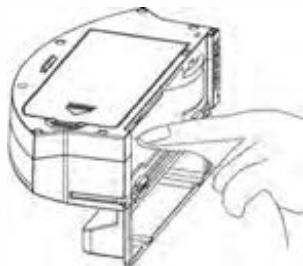

- H. Séchez la boîte à poussière et le filtre et laissez-le au sec pour assurer sa durée de vie.

Remarque: il est recommandé de laver le filtre primaire à l'eau 15 à 30 jours après son utilisation. La durée de vie maximale du filtre à haute efficacité est de 3 mois

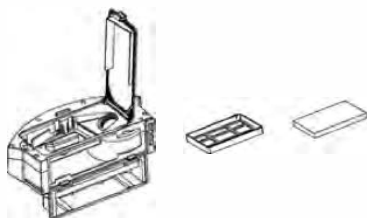

- I. Remplacez le filtre primaire et le filtre à haute efficacité dans la boîte à poussière.

Note:1.Avant d'installer le filtre, veuillez vous assurer que les deux filtres soient secs.

2.N'exposez pas le filtre à haute efficacité et le filtre primaire au soleil.

- J. Couvrez le couvercle de la boîte à poussière et installez-le sur le robot.

- ❶ Remarque: Ne laissez pas l'eau s'infiltrer dans le port du ventilateur lors du nettoyage.

Maintenance du produit

Maintenance des composants / brosse principale et brosse latérale

Entretien des composants / broches de chargement, capteur de vision vers le bas, roue motrice et roue universelle

Conseil important: l'intérieur de la pièce de charge, le capteur et le bord fermant contiennent tous des composants électroniques sensibles. Utilisez un torchon sec pour le nettoyage et n'utilisez pas de lavette humide pour éviter les dommages causés par l'arrivée d'eau.

Nettoyez régulièrement les pièces polaires de charge et la prise de charge.

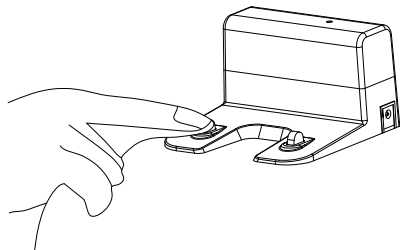

Nettoyez régulièrement les capteurs de chute.

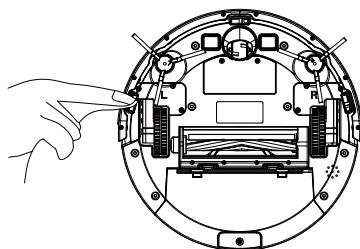

Spécifications

Classification	Sujet	Paramètre
Spécifications mécaniques	Diamètre	330 mm
	Hauteur	76 mm
	Poids net	2.7 kg
Spécifications électriques	Tension	14.4V
Spécifications de nettoyage	Type de charge	Chargement automatique/ chargement manuel
	Mode de nettoyage	Auto / chambre simple/ point fixe/bords/serpillière
	Temps de charge	Environ 5 heures
	Temps de nettoyage	120mins
Type de touches de l'appareil		Boutons tactiles

Ce manuel s'applique aux Eclipse Series.

ES

Componentes del producto	-----	1-4
Operaciones del producto	-----	5-7
Mantenimiento del producto	-----	8-11
Parámetro del producto	-----	12

Componentes del producto

Cuerpo principal y accesorios

No.	Descripción	Cantidad
1	iHome AUTOVAC Eclipse	1
2	Base de carga	1
3	Adaptador	1
4	Contenedor de polvo	1
5	Herramienta de mantenimiento de pincel	1
6	Control remoto	1
7	Franja de límite	1
8	Manual de usuario	1
9	Tanque de agua (se vende por separado en algunos modelos)	1
10	Mop Pads (se venden por separado en algunos modelos)	2
11	Filtro HEPA	1
12	Cepillos laterales	4

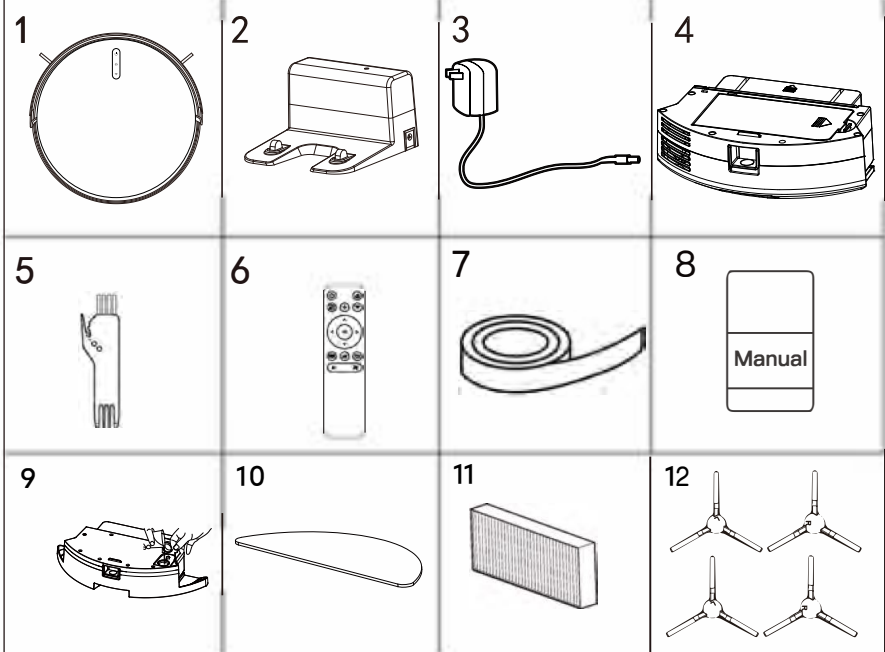

Componentes del producto

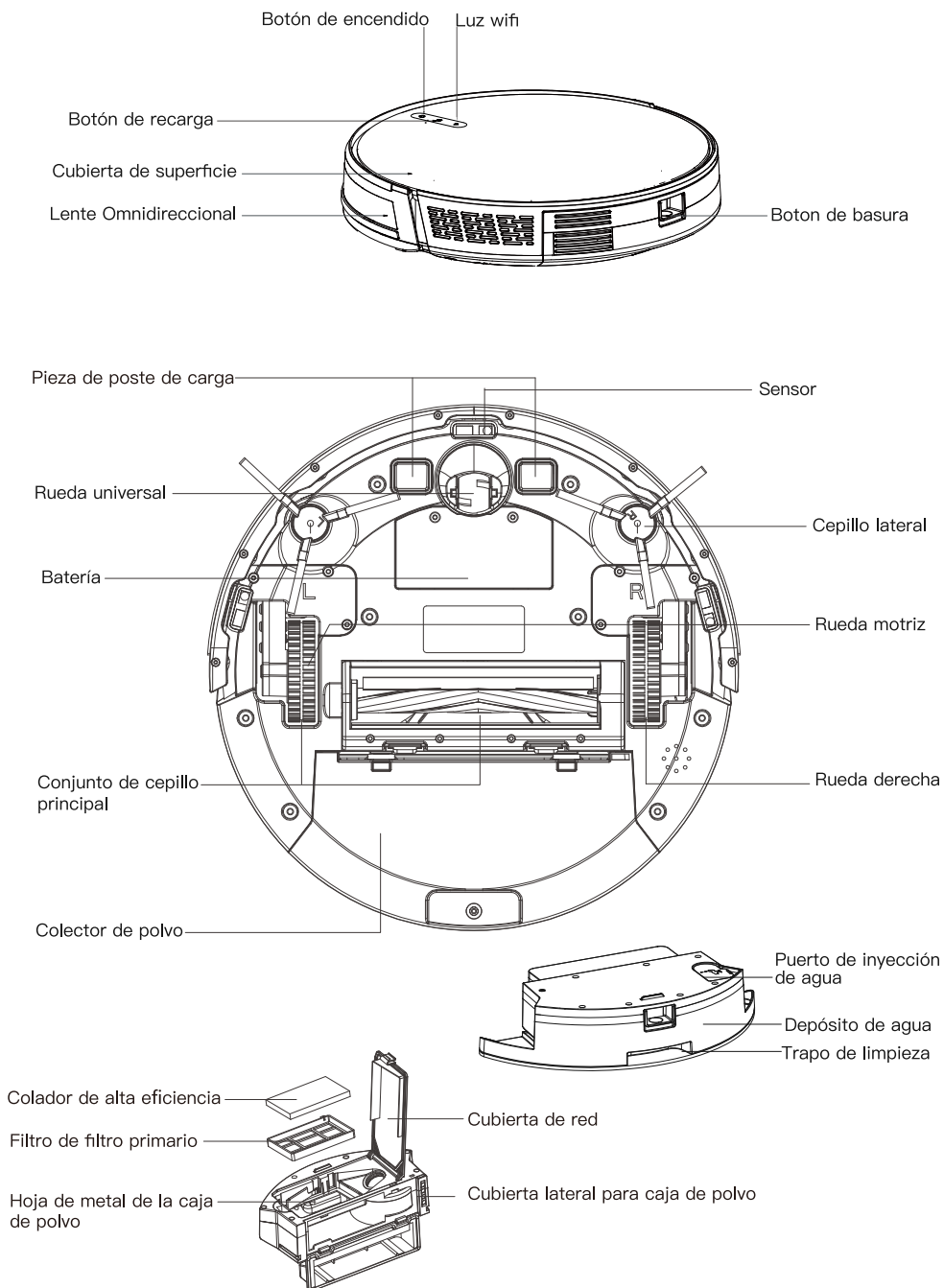

Componentes del producto

Base de carga

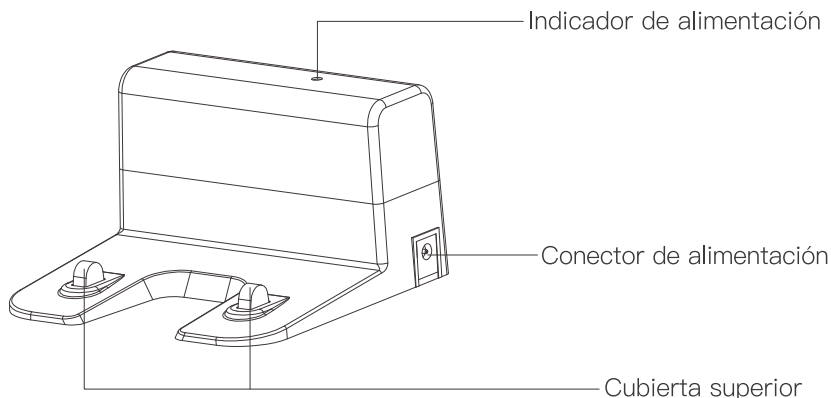

Botones De Cuerpo Principal



1.  botón de encendido

A. Mantenga presionado este botón para iniciar el robot y luego presione brevemente el botón para ingresar a la limpieza automática.

B. En el modo de espera, presione brevemente el botón para ingresar a la limpieza automática.

C. Presione brevemente el botón para detener su funcionamiento.

D. Mantenga pulsado el botón para apagar el robot.

E. Presione brevemente el botón para evitar que el robot regrese a su base de carga

2.  Botón de recarga

A. Presionando brevemente el botón puede hacer que el robot trabaje para devolver su base de carga para que se cargue.

B. En el estado de encendido, presione y mantenga presionado el botón de recarga durante 3 segundos, el indicador de WiFi parpadea e ingrese al modo de configuración de red.

Componentes del producto

Remoto

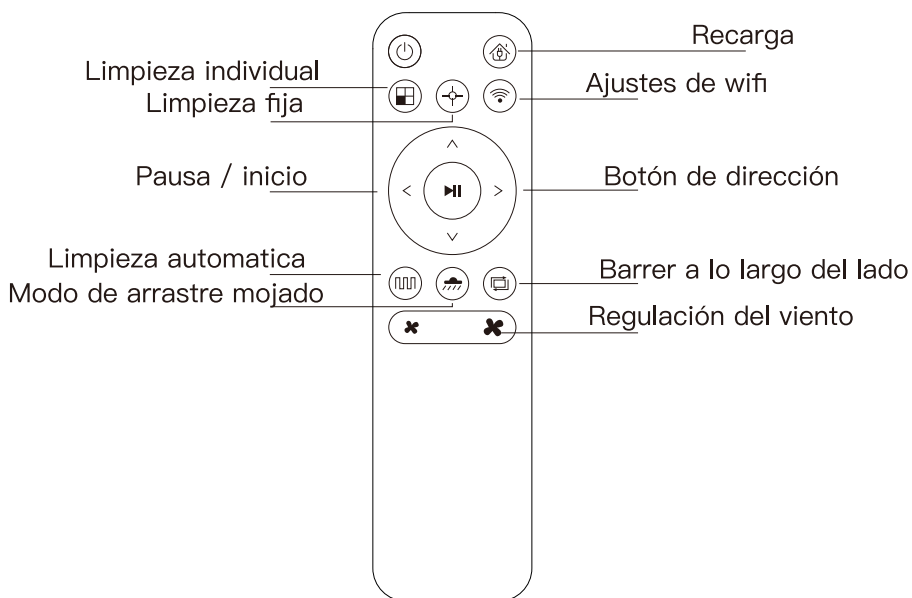

Cinta magnética

El robot aspirador funciona con cinta magnética. Corte la cinta magnética muy fácilmente para ajustarla a las aberturas de las puertas, comida para mascotas, cables o lugares a los que no desea que vaya.

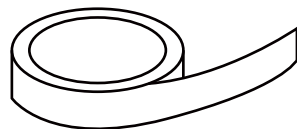

Carga de batería

1. Poner la base de carga contra la pared, y sacar los obstáculos que están en una zona rectangular de 1.5*1.0 metros cuadrados.

Como se muestra en la figura Si están en el estado de espera, por favor, encienda el interruptor lateral para cargarse.

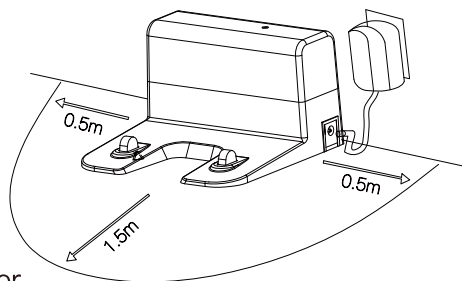

Maneras eficaces para prolongar la vida de batería:

- Asegúrese de que la primera carga se lleve a cabo durante 12 horas.
- Cuando esté insuficiente la electricidad, la cargue lo más rápido posible.
- Después de terminar la limpieza o cuando la electricidad esté insuficiente, la máquina busca automáticamente la base de carga para cargarse.
- El asiento de carga no se puede utilizar en entornos con fuertes reflejos, como la luz solar directa y los espejos cercanos. Si hay algún objeto con fuerte reflejo, cúbralo a 7 cm de la parte inferior.

Operaciones del producto

Conectarse al cliente móvil

1. Teléfono móvil conectado a wifi.

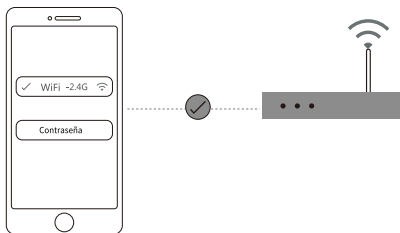

2. Descargue la aplicación mediante el código QR a continuación o buscando "iHomeClean" en la tienda de aplicaciones



3. Abra la aplicación, agregue el dispositivo, elija 830 o C500.
Nota: Refiera por favor a la placa de identificación de tierra del anfitrión para el modelo específico.



4. En el estado de encendido, presione y mantenga presionado el botón de recarga durante 5 segundos.

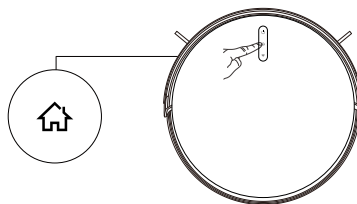

5. De acuerdo con los consejos de la página de la APLICACIÓN, seleccione WiFi e ingrese la contraseña en espera para con fi gurar la red.

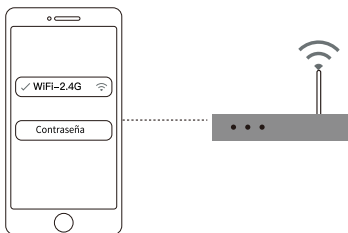

6. Conectar a Robot WiFi.

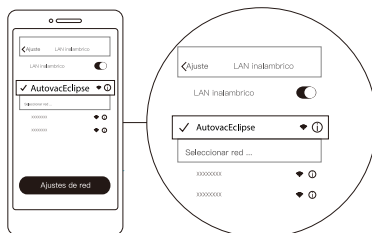

7. Vuelva a la APLICACIÓN esperando la red de con fi guración.

Ingrese la página de configuración de WiFi en su teléfono, elija WiFi "AutovacEclipse". Vuelva a abrir la aplicación después de conectar con éxito.

Operaciones del producto

Uso del tanque de agua

Después de limpiar el piso, vacíe el tanque de agua a tiempo y retire la almohadilla de limpieza.

Nota: No friegue la alfombra para evitar mojarla.

Agregue agua

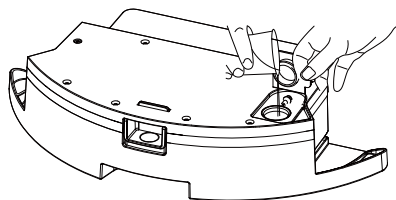

Instale el conjunto del tanque de agua

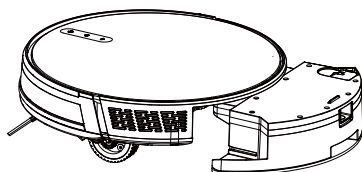

Instale la almohadilla de limpieza

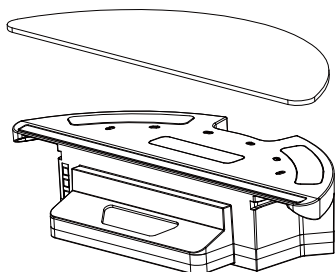

Comience a limpiar el piso

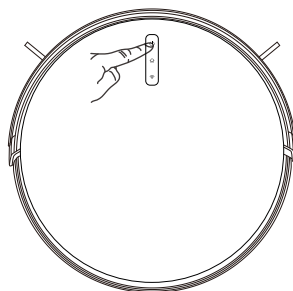

Mantenimiento del producto

Componente de Cepillo Cilíndrico y Montaje de Paño Trapeador Siga los siguientes pasos para el montaje (ver las siguientes figures)

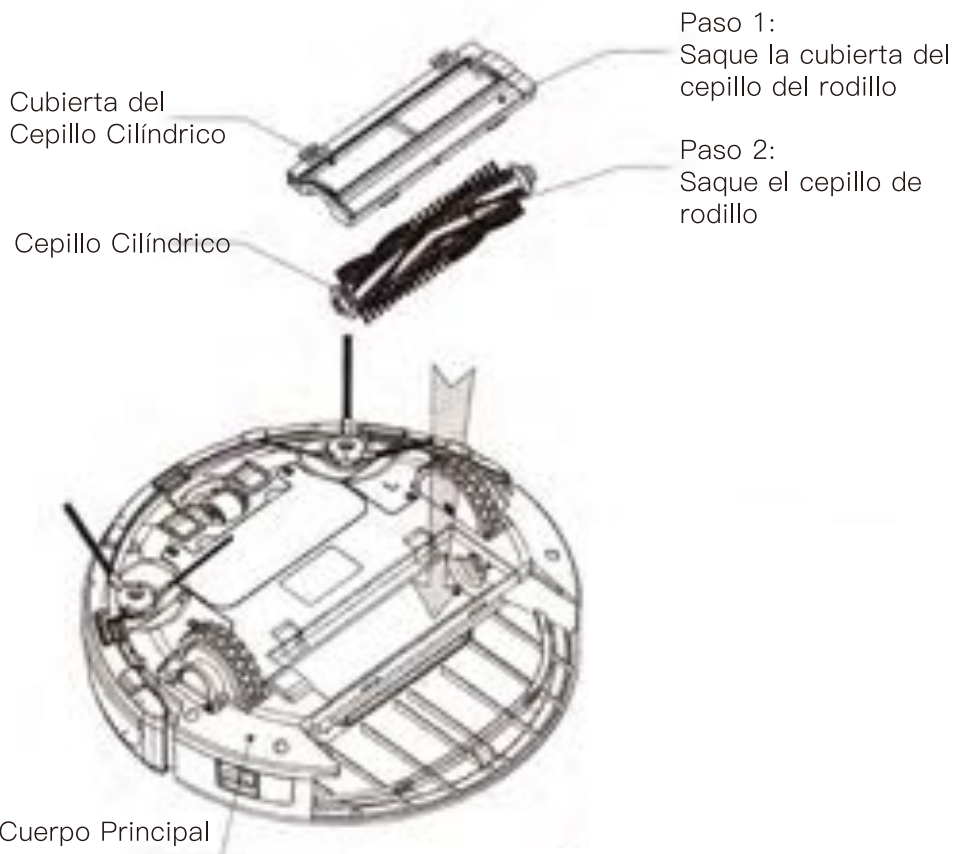

1. Herramienta de utilidades (incluida) para la limpieza del cabello enredado.



2. Cepillo lateral de limpieza

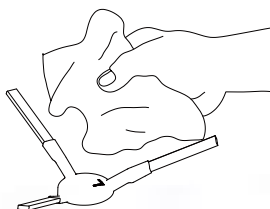

Mantenimiento del producto

Mantenimiento de componentes / caja de polvo

A. Presione el botón de la caja de polvo para sacar la caja de polvo

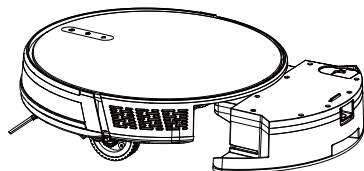

B. Abra la cubierta lateral de la caja de polvo

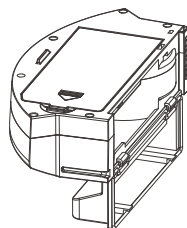

C. tirar basura

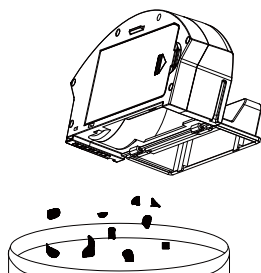

D. Abra la cubierta de red de alta eficiencia

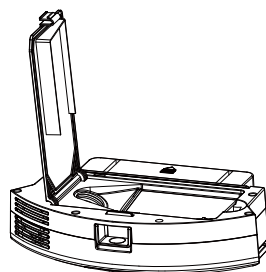

E. Saque las dos pantallas de filtro: la pantalla de alta eficiencia y la pantalla de eficiencia primaria. No se recomienda lavar la pantalla de alta eficiencia con agua. Golpee suavemente para eliminar el polvo.

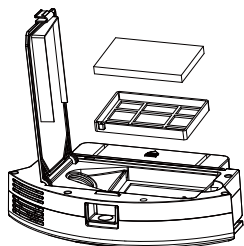

F. Enjuague la pantalla del filtro primario

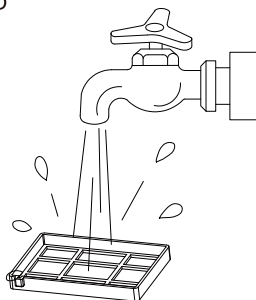

Mantenimiento del producto

- G. La caja de polvo se limpia con un paño. No permita que el agua se filtre por el orificio del ventilador al limpiar.

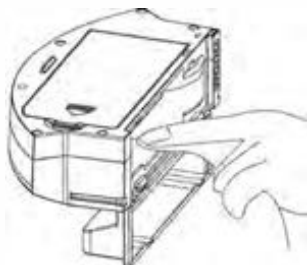

- H. Seque la caja de polvo y el conjunto del filtro, y manténgalo seco para garantizar su vida útil.

Nota: Se recomienda lavar el filtro primario con agua 15-30 días después de su uso. La vida útil máxima de la pantalla de filtro de alta eficiencia es de 3 meses.

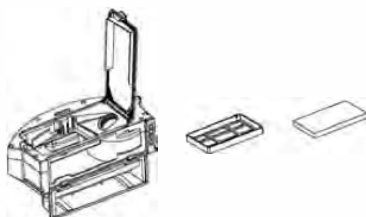

- I. Vuelva a colocar la pantalla del filtro primario y la pantalla del filtro de alta eficiencia en la caja de polvo;

Nota: 1. Antes de instalar la pantalla del filtro, asegúrese de que las dos pantallas del filtro estén en un estado seco.

2. No exponga el filtro de alta eficiencia y el filtro primario al sol.

- J. Cubra la cubierta de la caja de polvo e instale la caja de polvo en el Robot.

ⓘ Nota: No permita que el agua se filtre en el puerto del ventilador al limpiar.

Mantenimiento del producto

Componente de mantenimiento / cepillo principal y cepillo lateral

Pasadores del muelle de carga / mantenimiento de componentes, sensor de vista descendente, rueda motriz y rueda universal

Punta cálida: el interior de la pieza de polo de carga, el sensor y la placa de contacto contienen componentes electrónicos sensibles, utilice un paño seco para la limpieza y no utilice un paño húmedo para evitar daños causados por la entrada de agua.

Limpie los pines de la plataforma de carga.

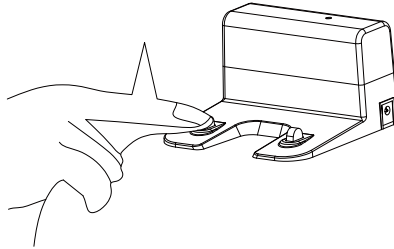

Limpie el sensor de vista descendente

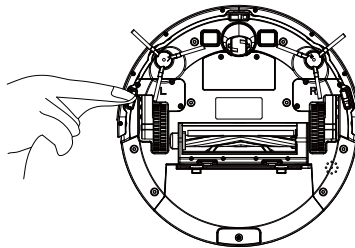

Parámetro del producto

calificaciones	ítems	párametro
de estructura	diámetro	330 mm
	altura	76 mm
	peso neto	2.7 kg
de electrón	voltaje	14.4V
especificaciones de limpieza	tipo de carga	carga manual/automática
	barrido de Modo	Auto/habitación individual/ punto fijo/borde/trapeador
	duración de carga	Alrededor de 5 horas
	duración de barrido	120mins
tipo de botones de la máquina central		botón táctil

Este manual de usuario aplica a serie de Eclipse Series.

Customer Service

Email: Support@silverpointtech.com
Phone: 877-370-4580



42 W. 39th Street, New York, NY, 10018