

15 48783

Radio - BUILD A SINEWAVE DESCRAMBLER

\$1.95 DEC. 86
IN CANADA \$2.50

Electronics

TECHNOLOGY - VIDEO - STEREO - COMPUTERS - SERVICE

BUILD THE R-E ROBOT

A
GERNSBACK
PUBLICATION

A personal robot you can customize

COMPUTERS IN ELECTRONICS

Computers on the workbench
Computer-aided electronic design

TOUCH-TONE CONTROL

DTMF encoding
and decoding
technique

BUILD A CLOSED-CAPTION DECODER

Get more from your TV

TV DESCRAMBLER

How to build a sinewave decoder

OSCILLATORS

TTL clocks

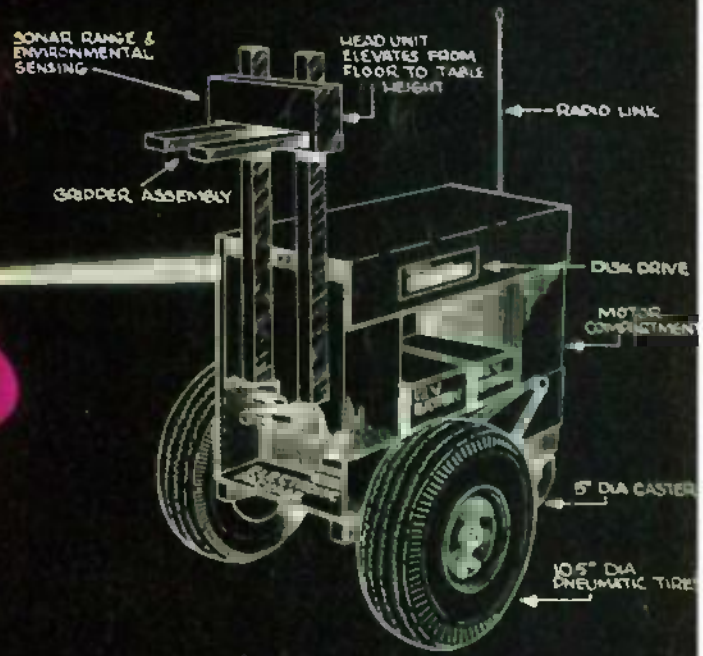

PLUS:

- ★ Ask R-E
- ★ Video News
- ★ Satellite TV
- ★ New Products
- ★ Robotics
- ★ **COMPUTERDIGEST**



New GPS Series: Tek sets the pace with SmartCursors™ and push-button ease.

Work faster, smarter, with two new general purpose scopes from Tektronix. The four-channel, 100 MHz 2246 and 2245 set the new, fast pace for measurements at the bench or in the field. They're easy to use and afford, by design.

On top: the 2246 with exclusive integrated push-button measurements. Measurements are accessed through easy, pop-up menus and implemented at the touch of a button. Measure peak volts, peak-to-peak, \pm peak, dc volts and gated volts with new hands-off convenience and on-screen readout of values.

SmartCursors™ track voltmeter measurements in the 2246 and visually indicate where ground and trigger levels are located. Or use cursors in the manual mode for immediate, effortless measurement of waveform parameters.

Both scopes build on performance you haven't seen at the bandwidth or prices. Lab grade features include sweep speeds to 2 ns/div. Vertical sensitivity of 2 mV/div at full bandwidth for low-level signal capture. Plus trigger

Features	2246	2245
Bandwidth	100 MHz	100 MHz
No. of Channels	4	4
Scale Factor Readout	Yes	Yes
SmartCursors™	Yes	No
Volts Cursors	Yes	No
Time Cursors	Yes	No
Voltmeter	Yes	No
Vertical Sensitivity	2 mV/div	2 mV/div
Max. Sweep Speed	2 ns/div	2 ns/div
Vert/Hor Accuracy	2%	2%
Trigger Modes	Auto Level, Auto, Norm., TV Field, TV Line, Single Sweep	
Trigger Level Readout	Yes	No
Weight	6.1 kg	6.1 kg
Warranty	3-year on parts and labor including CRT	
Price	\$2400	\$1875

sensitivity to 0.25 div at 50 MHz, to 0.5 div at 150 MHz.

Accuracy is excellent: 2% at vertical, 2% at horizontal. And four-channel capability includes two channels optimized for logic signals.

Best of all, high performance comes with unmatched convenience. You can see it and feel it — in the

responsive controls and simple front-panel design, in extensive on-screen scale factor readouts, and in simplified trigger operation that includes Tek's Auto Level mode for automatic triggering on any signal. Start to finish, the GPS Series saves steps and simplifies tasks.

Get out in front! Call toll-free today to order, to get more details or a videotape demonstration.

1-800-433-2323

In Oregon, call collect 1-627-9000



Featuring four channels, flexible triggering, extensive CRT readouts and push-button ease of use, the new Tek 2246 (left) and 2245 (above) bring high-quality, low-cost analysis to diverse applications in digital design, field service and manufacturing.

Tektronix
COMMITTED TO EXCELLENCE

DECEMBER '86

**Radio
Electronics.**

Electronics publishers since 1908

Vol. 57 No. 12

SPECIAL SECTION:	45 COMPUTERS ON THE WORKBENCH Learn how computers can be used as powerful oscilloscopes, and more. Robert Grossblatt	RADIO 84 ANTIQUE RADIOS Letters from our readers. Richard D. Fitch
	49 COMPUTER-AIDED ELECTRONICS DESIGN Computer-aided design software can end the drudgery of electronic-circuit design. And it's fun to use, too! Robert Grossblatt	
BUILD THIS	54 R-E ROBOT Introducing the R-E Robot, a powerful servant that you can customize for almost any application. Steven E. Sarns	EQUIPMENT REPORTS 24 Beckman Circuitmate LP25 Logic Probe 28 Beckman Circuitmate PR41 Logic Pulser
	61 CLOSED-CAPTION DECODER Part 2. This month we get to work and build the unit. J. Daniel Gifford	
	73 PC SERVICE Circuit boards for the closed-caption decoder and the sinewave descrambler.	
TECHNOLOGY	6 VIDEO NEWS Inside the fast-changing video scene. David Lachenbruch	DEPARTMENTS 112 Advertising and Sales Offices 112 Advertising Index 20 Ask R-E 113 Free Information Card 8 Letters 90 Market Center 38 New Products 4 What's News
	79 SATELLITE TV Breaking Videocypher. Bob Cooper, Jr.	
	81 ROBOTICS More on vision systems. Mark J. Robillard	
CIRCUITS AND COMPONENTS	57 TV DESCRAMBLING Part 6. Build a working sinewave descrambler. Rudolf Graf and William Sheets	Annual Index January Thru December 1986 Begins on page 75
	65 DTMF ENCODING AND DECODING New IC's make the power of DTMF signalling available to all. Dale Nassar	
	71 HOW TO DESIGN OSCILLATOR CIRCUITS Part 6. Building clock circuits using TTL IC's. Joseph J. Carr	
	86 DRAWING BOARD A remote-control system. Robert Grossblatt	
	88 SERVICE CLINIC Signal tracing. Jack Darr	
89 SERVICE QUESTIONS Solutions to servicing problems.	SEASON'S GREETINGS <i>The editors and staff of Radio-Electronics join in sending holiday greetings and our best wishes for a happy new year</i>	

RADIO-ELECTRONICS, (ISSN 0033-7862) November 1986. Published monthly by Gernsback Publications, Inc., 500-B B-County Boulevard, Farmingdale, NY 11735. Second-Class Postage paid at Farmingdale, NY and additional mailing offices. Second-Class mail registration No. 9242 authorized at Toronto, Canada. One-year subscription rate U.S.A. and possessions \$16.97. Canada \$22.97, all other countries \$25.97. Subscription orders payable in US funds only, international postal money order or check drawn on a U.S.A. bank. Single copies \$1.95. © 1986 by Gernsback Publications, Inc. All rights reserved. Printed in U.S.A.

POSTMASTER: Please send address changes to RADIO-ELECTRONICS, Subscription Dept., Box 55115, Boulder, CO 80321-5115. A stamped self-addressed envelope must accompany all submitted manuscripts and/or artwork or photographs if their return is desired should they be rejected. We disclaim any responsibility for the loss or damage of manuscripts and/or artwork or photographs while in our possession or otherwise.

DECEMBER 1986

COVER 1



This month we begin a continuing series detailing a versatile, powerful robot you can design and build yourself. The R-E Robot has several characteristics that set it apart from commercially available units or kits. For one, it can be customized to meet the demands of almost any user application. Further, it is backed by a powerful onboard computer that makes use of a custom robot control language. That language makes it possible to control the robot using simple commands. To help get the most out of the project, we have set up a special section of our computer bulletin-board (RE-BBS) for the rapid exchange of sources, applications, software, and updates among our readers, the author, and the editors. To learn more, turn to page 54.

NEXT MONTH

THE JANUARY ISSUE IS
ON SALE DECEMBER 2

BUILD THE R-E ROBOT

Part 2. A closer look at the Robotic Personal Computer.

HOW TO APPLY FOR A PATENT

Learn how to patent your next brainstorm.

BUILD A NINE-STATION INTERCOM

A sophisticated, versatile communications system for the home or office.

TV SIGNAL SCRAMBLING

Part 7 looks at descramblers for the gated-pulse and outband systems.

AUDIO UPDATE

Larry Klein joins our staff as Audio Editor with the first installment of his new column.

As a service to readers, RADIO-ELECTRONICS publishes available plans or information relating to newsworthy products, techniques and scientific and technological developments. Because of possible variances in the quality and condition of materials and workmanship used by readers, RADIO-ELECTRONICS disclaims any responsibility for the safe and proper functioning of reader-built projects based upon or from plans or information published in this magazine.

Since some of the equipment and circuitry described in RADIO-ELECTRONICS may relate to or be covered by U.S. patents, RADIO-ELECTRONICS disclaims any liability for the infringement of such patents by the making, using, or selling of any such equipment or circuitry, and suggests that anyone interested in such projects consult a patent attorney.

Radio-Electronics

Hugo Gernsback (1884-1967) founder
M. Harvey Gernsback,
editor-in-chief, emeritus

Larry Steckler, EHF, CET, editor-in-chief
and publisher

EDITORIAL DEPARTMENT

Art Kleiman, editorial director
Brian C. Fenton, managing editor
Carl Laron, WB2SLR, associate editor
Jeffrey K. Holtzman,
assistant technical editor
Robert A. Young, assistant editor
Julian S. Martin, editorial associate
Byron G. Weis, editorial associate
M. Harvey Gernsback,
contributing editor
Jack Darr, CET, service editor
Robert F. Scott,
semiconductor editor
Herb Friedman,
communications editor
Bob Cooper, Jr., satellite-TV editor
Robert Grossblatt, circuits editor
David Lachenbruch,
contributing editor
Richard D. Fitch,
contributing editor
Mark J. Robillard, robotics editor
Teri Scaduto Wilson, editorial assistant

PRODUCTION DEPARTMENT

Ruby M. Yee, production director
Robert A. W. Lowndes,
editorial production
Andre Duzant, technical illustrator
Karen Tucker, advertising production
Geoffrey S. Weil, production traffic

CIRCULATION DEPARTMENT

Jacqueline P. Cheeseboro,
circulation director
Wendy Alanko,
circulation analyst
Theresa Lombardo,
circulation assistant

Cover photo by Dan Muro

Typography by Mates Graphics

Radio-Electronics, Gernsback Publica-
tions, Inc., 500-B Bi-County Blvd.,
Farmingdale, NY 11735.
516-293-3000

Radio-Electronics is indexed in
Applied Science & Technology Index
and *Readers Guide to Periodical Litera-
ture*.

Microfilm & Microfiche editions are
available. Contact circulation depart-
ment for details.

Advertising Sales Offices listed
on page 112.



NEW! Lower Price Scanners

Communications Electronics,TM the world's largest distributor of radio scanners, introduces new lower prices to celebrate our 15th anniversary.

Regency[®] MX7000-GR

List price \$699.95/CE price \$469.95
10-Band, 20 Channel • No-crystal scanner
Frequency range: 26-550 MHz, continuous coverage and 800 MHz to 1.3 GHz, continuous coverage. The Regency MX7000 scanner lets you monitor Military, Space Satellites, Government, Railroad, Justice Department, State Department, Fish & Game, Immigration, Marine, Police and Fire Departments, Broadcast Studio Transmitter Links, Aeronautical AM band, Aero Navigation, Paramedics, Amateur Radio, plus thousands of other radio frequencies most scanners can't pick up. The Regency MX7000 is the perfect scanner to receive the exciting 1.2 GHz, amateur radio band.

Regency[®] Z60-GR

List price \$299.95/CE price \$179.95/SPECIAL
8-Band, 60 Channel • No-crystal scanner
Bands: 30-50, 88-108, 118-136, 144-174, 440-512 MHz. The Regency Z60 covers all the public service bands plus aircraft and FM music for a total of eight bands. The Z60 also features an alarm clock and priority control as well as AC/OC operation. Order today.

Regency[®] Z45-GR

List price \$259.95/CE price \$159.95/SPECIAL
7-Band, 45 Channel • No-crystal scanner
Bands: 30-50, 118-136, 144-174, 440-512 MHz. The Regency Z45 is very similar to the Z60 model listed above however it does not have the commercial FM broadcast band. The Z45, now at a special price from Communications Electronics.

Regency[®] RH250B-GR

List price \$859.00/CE price \$329.95/SPECIAL
10 Channel • 26 Watt Transceiver • Priority
The Regency RH250B is a ten-channel VHF land mobile transceiver designed to cover any frequency between 150 to 182 MHz. Since this radio is synthesized, no expensive crystals are needed to store up to ten frequencies without battery backup. All radios come with CTCSS tone and scanning capabilities. A monitor and night/day switch is also standard. This transceiver even has a priority function. The RH250 makes an ideal radio for any police or fire department volunteer because of its low cost and high performance. A 60 Watt VHF 150-182 MHz, version called the RH600B is available for \$454.95. A UHF 15 watt version of this radio called the RU150B is also available and covers 450-482 MHz, but the cost is \$449.95.

NEW! Bearcat[®] 50XL-GR

List price \$199.95/CE price \$114.95/SPECIAL
10-Band, 10 Channel • Handheld scanner
Bands: 29.7-54, 136-174, 406-512 MHz. The Uniden Bearcat 50XL is an economical, hand-held scanner with 10 channels covering ten frequency bands. It features a keyboard lock switch to prevent accidental entry and more. Also order part # BP50 which is a rechargeable battery pack for \$14.95, a plug-in wall charger, part # AD100 for \$14.95, a carrying case part # VC001 for \$14.95 and also order optional cigarette lighter cable part # PS001 for \$14.95.

NEW! Scanner Frequency Listings

The new Fox scanner frequency directories will help you find all the action your scanner can listen to. These new listings include Police, fire, ambulances & rescue squads, local government, private police agencies, hospitals, emergency medical channels, news media, forestry radio service, railroads, weather stations, radio common carriers, AT&T mobile telephone, utility companies, general mobile radio service, marine radio service, taxi cab companies, tow truck companies, trucking companies, business repeaters, business radio (simplex) federal government, funeral directors, veterinarians, buses, aircraft, space satellites, amateur radio, broadcasters and more. Fox frequency listings feature call letter cross reference as well as alphabetical listing by licensee name, police codes and signals. All Fox directories are \$14.95 each plus \$3.00 shipping. State of Alaska-RL019-1; State of Arizona-RL025-1; Baltimore, MD/Washington, DC-RL024-1; Buffalo, NY/Erie, PA-RL009-2; Chicago, IL-RL014-1; Cincinnati/Dayton, OH-RL006-2; Cleveland, OH-RL017-1; Columbus, OH-RL003-2; Dallas/Ft. Worth, TX-RL013-1; Denver/Colorado Springs, CO-RL027-1; Detroit, MI/Windsor, ON-RL008-3; Fort Wayne, IN/Lima, OH-RL001-1; Hawaii/Guam-RL015-1; Houston, TX-RL023-1; Indianapolis, IN-RL022-1; Kansas City, MO/KS-RL011-2; Long Island, NY-RL026-1; Los Angeles, CA-RL016-1; Louisville/Lexington, KY-RL007-1; Milwaukee, WI/Waukegan, IL-RL021-1; Minneapolis/St. Paul, MN-RL010-2; Nevada/E. Central CA-RL028-1; Oklahoma City/Lawton, OK-RL005-2; Orlando/Daytona Beach, FL-RL012-1; Pittsburgh, PA/Wheeling, WV-RL029-1; Rochester/Syracuse, NY-RL020-1; San Diego, CA-RL018-1; Tampa/SL Petersburg, FL-RL004-2; Toledo, OH-RL002-3. New editions are being added monthly. For an area not shown above call Fox at 800-543-7892, In Ohio call 800-621-2513.

NEW! Regency[®] HX1500-GR

List price \$369.95/CE price \$239.95
11-Band, 55 Channel • Handheld/Portable
Search • Lockout • Priority • Bank Select
Sidelit liquid crystal display • EAROM Memory
Direct Channel Access Feature • Scan delay
Bands: 29-54, 118-136, 144-174, 406-420, 440-512 MHz. The new handheld Regency HX1500 scanner is fully keyboard programmable for the ultimate in versatility. You can scan up to 55 channels at the same time including the AM aircraft band. The LCD display is even sidelit for night use. Includes belt clip, flexible antenna and earphone. Operates on 8 1.2 Volt rechargeable Ni-Cad batteries (not included). Be sure to order batteries and battery charger from accessory list in this ad.

Bearcat[®] 100XL-GR

List price \$349.95/CE price \$203.95/SPECIAL
9-Band, 16 Channel • Priority • Scan Delay
Search • Limit • Hold • Lockout • AC/DC
Frequency range: 30-50, 118-174, 406-512 MHz. The world's first no-crystal handheld scanner now has a LCD Channel display with backlight for low light use and aircraft band coverage at the same low price. Size is 1 3/4" x 7 1/2" x 2 1/2". The Bearcat 100XL has wide frequency coverage that includes all public service bands (Low, High, UHF and "T" bands), the AM aircraft band, the 2-meter and 70 cm, amateur bands, plus military and federal government frequencies. Wow...what a scanner! Included in our low CE price is a sturdy carrying case, earphone, battery charger/AC adapter, six AA Ni-Cad batteries and flexible antenna. Order your scanner now.

Bearcat[®] 210XW-GR

List price \$339.95/CE price \$209.95/SPECIAL
8-Band, 20 Channel • No-crystal scanner
Automatic Weather • Search/Scan • AC/DC
Frequency range: 30-50, 136-174, 406-512 MHz. The new Bearcat 210XW is an advanced third generation scanner with great performance at a low CE price.

NEW! Bearcat[®] 145XL-GR

List price \$179.95/CE price \$102.95/SPECIAL
10 Band, 16 channel • AC/DC • Instant Weather
Frequency range: 29-54, 136-174, 420-512 MHz. The Bearcat 145XL makes a great first scanner. Its low cost and high performance lets you hear all the action with the touch of a key. Order your scanner from CE today.

TEST ANY SCANNER

Test any scanner purchased from Communications Electronics[®] for 31 days before you decide to keep it. If for any reason you are not completely satisfied, return it in original condition with all parts in 31 days, for a prompt refund (less shipping/handling charges and rebate Credit).

NEW! Bearcat[®] 800XLT-GR

List price \$499.95/CE Price \$317.95
12-Band, 40 Channel • No-crystal scanner
Priority control • Search/Scan • AC/DC
Bands: 29-54, 118-174, 406-512, 806-912 MHz. The Uniden 800XLT receives 40 channels in two banks. Scans 16 channels per second. Size 9 1/4" x 4 1/4" x 1 1/2"

OTHER RADIOS AND ACCESSORIES

Panasonic RF-2800-GR Shortwave receiver \$179.95
RD95-GR Uniden Remote mount Radar Detector \$128.95
RD95-GR Uniden "Passport" size Radar Detector \$92.95
RD9-GR Uniden "Passport" size Radar Detector \$199.95
BC-WA-GR Bearcat Weather Alert[™] \$48.95
DX1000-GR Bearcat shortwave receiver SALE \$349.95
PC22-GR Uniden remote mount CB transceiver \$99.95
PC53-GR Uniden mobile mount CB transceiver \$59.95
R1060-GR Regency 10 channel scanner SALE \$92.95
MX3000-GR Regency 30 channel scanner \$229.95
XL156-GR Regency 10 channel scanner \$139.95
U102-GR Regency VHF 2 ch. 1 Watt transceiver \$124.95
P1405-GR Regency 5 amp regulated power supply \$69.95
P1412-GR Regency 12 amp reg. power supply \$184.95
MA256-GR Drop-in charger for HX1200 & HX1500 \$84.95
MA18-GR Wall charger for HX1500 scanner \$14.95
MA15-GR Carrying case for HX1500 scanner \$14.95
MA257-GR Cigarette lighter cord for HX1200/1500 \$19.95
MA917-GR Ni-Cad battery pack for HX1200 \$34.95
SMMX7000-GR Svc. man. for MX7000 & MX5000 \$19.95
SMMX3000-GR Service man. for Regency MX3000 \$18.95
B-4-GR 1.2 V AAA Ni-Cad batteries (set of four) \$9.95
B-8-GR 1.2 V AA Ni-Cad batteries (set of eight) \$17.95
FB-E-GR Frequency Directory for Eastern U.S.A. \$14.95
FB-W-GR Frequency Directory for Western U.S.A. \$14.95
ASD-GR Air Scan Directory \$14.95
SRF-GR Survival Radio Frequency Directory \$14.95
TSG-GR "Top Secret" Registry of U.S. Govt. Freq. \$14.95
TIC-GR Techniques for Intercepting Comms \$14.95
RRF-GR Railroad frequency directory \$14.95
CIE-GR Covert Intelligence, Elect. Eavesdropping \$14.95
A60-GR Magnet mount mobile scanner antenna \$35.95
A70-GR Base station scanner antenna \$35.95
USAM-GR Mag mount VHF/UHF ant. w/ 12' cable \$39.95
USAK-GR 3/4" hole mount VHF/UHF ant. w/ 17' cable \$35.95
USATLM-GR Trunk lip mount VHF/UHF antenna \$35.95
Add \$3.00 shipping for all accessories ordered at the same time.
Add \$12.00 shipping per scanner and \$3.00 per antenna.
Add \$7.00 shipping per scanner and \$3.00 per antenna.

BUY WITH CONFIDENCE

To get the fastest delivery from CE of any scanner, send or phone your order directly to Our Scanner Distribution Center.[™] Michigan residents please add 4% sales tax or supply your tax I.D. number. Written purchase orders are accepted from approved government agencies and most well rated firms at a 10% surcharge for net 10 billing. All sales are subject to availability, acceptance and verification. All sales on accessories are final. Prices, terms and specifications are subject to change without notice. All prices are in U.S. dollars. Out of stock items will be placed on backorder automatically unless CE is instructed differently. A \$5.00 additional handling fee will be charged for all orders with a merchandise total under \$50.00. Shipments are F.O.B. Ann Arbor, Michigan. No COD's. Most products that we sell have a manufacturer's warranty. Free copies of warranties on these products are available prior to purchase by writing to CE. Non-certified checks require bank clearance. Not responsible for typographical errors.

Mail orders to: Communications Electronics,[™] Box 1045, Ann Arbor, Michigan 48106 U.S.A. Add \$7.00 per scanner for R.P.S./U.P.S. ground shipping and handling in the continental U.S.A. For Canada, Puerto Rico, Hawaii, Alaska, or APO/FPO delivery, shipping charges are three times continental U.S. rates. If you have a Discover, Visa or MasterCard, you may call and place a credit card order. Order toll-free in the U.S. Dial 800-USA-SCAN. In Canada, order toll-free by calling 800-221-3475. WUI Telex anytime, dial 671-0155. If you are outside the U.S. or in Michigan dial 313-973-8888. Order today.

Scanner Distribution Center[™] and CE logo are trademarks of Communications Electronics Inc.

‡ Bearcat is a registered trademark of Uniden Corporation.
† Regency is a registered trademark of Regency Electronics Inc.

AD #070288-GR

Copyright © 1988 Communications Electronics Inc.

For credit card orders call
1-800-USA-SCAN

**COMMUNICATIONS
ELECTRONICS INC.**

Consumer Products Division
P.O. Box 1045 □ Ann Arbor, Michigan 48106-1045 U.S.A.
Call 800-USA-SCAN or outside U.S.A. 313-973-8888
CIRCLE 79 ON FREE INFORMATION CARD

Regency
RH250



Regency
MX7000



Regency
HX1500



WHAT'S NEWS

Closed-circuit "citizens band"

Subscribers to the CompuServe Information Service, based in Columbus, OH, have available a "closed-circuit" form of CB radio called the CB Simulator. Any of the 280,000 CompuServe subscribers can—by typing GO CB—switch to a CB menu that makes it possible to scan a complete listing of all persons speaking on all 36 channels of the band, and to join conversations on any of the bands. Private conversations may be held off-channel, as well.

The connect rate for the CB Simulator is \$6.00 per hour from 6 P.M. to 8 A.M. weekdays, and all day Saturdays, Sundays, and holidays. For weekday service between 8 A.M. and 6 P.M. the rate is \$12.50 per hour.

Numerous friendships have been made over the simulator, and at least two weddings have been reported.

Fast computer chips with "quasicrystals?"

Scientists from three departments of the University of Michigan, supported by a \$1.5-million grant from the National Science Foundation, are working to produce extremely fast computer chips and other advanced micro-electronic devices. They are working with a variety of metallic and semiconductor materials, sandwiched to form multilayered chips called superlattices.

In the past, researchers have depended on making semiconductor devices smaller and circuit leads shorter to make faster computers and other electronics devices. Already chips have been made that crowd more than a million electronics devices on a silicon chip less than a centimeter on a side.

Having reached the limit in reducing size, scientists are now

seeking new ways of speeding up computers and other electronics equipment. Under the new grant, U of M scientists will focus on building and testing the properties of superlattices made of synthetic "quasicrystals," new materials invented at the University. The atoms of faster quasicrystals have a predictable arrangement that falls between the repeating patterns of crystals and the total disarray of glasses.

The research will also examine properties of metallic superlattices, with potential applications in modern superconducting devices. Research will also involve building and testing heterostructures, materials similar to superlattices but with fewer layers, that can be manipulated to produce a variety of electrical and optical effects.

New transparent conductor uses organic materials

The first transparent polymeric conductor is under development by Honeywell. Made in a thin film, it is versatile enough to defrost a car window or control a building's temperature by reflecting heat and cold. It is made from the polymer polydiiodocarbazole (PDICZ) doped with bromine and formed into film from 1 to 30 microns thick.

By varying the thickness of the film and the level of doping, Honeywell has varied the conductivity from insulating levels to conductivity appropriate for such applications as defrosting car windows. Light transmission is from 60 to 90 per cent.

The new film can be made more readily and more easily than earlier inorganic types, and it can be made with greater surface areas and thicknesses. Therefore it is expected to be considerably lower in cost than present types.

New devices authenticate money transfer messages

Researchers at the National Bureau of Standards Institute for Computer Sciences and Technology have completed the first validation of a security device that will be used to authenticate messages used for the electronic transfer of funds.

This validation is part of a program to help protect the billions of dollars in Federal funds that are transferred electronically every year.

NBS developed the test methods to ensure that devices used to transfer funds electronically comply with federal standards for computer data authentication and with the American National Standard for Financial Institution Message Authentication. The validation system can be used to test equipment remotely through an electronic interconnection with NBS.

Further information can be obtained from Miles Smid, Institute for Computer Sciences and Technology, National Bureau of Standards, A216 Technology Bldg., Gaithersburg, MD 20899.

High-efficiency solar panels

Solar panels designed to operate four or five times more efficiently than the best photovoltaic cells currently available, and at only a fraction of the cost, are currently under development by Massachusetts inventor Alvin Marks, and by Westinghouse.

Lepcon, the preliminary design patented by Marks, consists of a glass panel covered by millions of aluminum or copper strips, each less than a micron wide. Energy in the sunlight striking the panel is transferred to the electrons in the metal strips, generating electricity. Lumeloid, also patented by Marks, uses a similar approach, but substitutes film-like sheets of plastic.

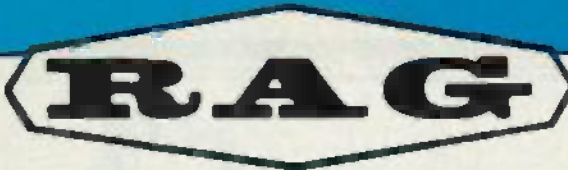

ELECTRONICS, INC.

New and Used Electronic Test Equipment
Sales • Service • Rental • Leasing

HAMEG Oscilloscopes with Component Tester 2-year warranty



HM 203-6 DC to 20MHz **\$489.00**

- Rectangular screen, internal graticule 8x10cm.
- Deflection: 5mV/cm to 20V/cm
- Timebase: 0.5µs/cm to 0.2s/cm X-Magnification x 10
- Component Tester
Test voltage: max. 8.5Vrms (open circuit)
Test current: max. 24mA rms (shorted)



HM 204-2 DC to 20MHz **\$629.00**

- Component Tester
- Deflection: 5mV/cm to 20V/cm Y-Magnification x 5
- Timebase: 0.1 µs/cm to 0.5s/cm X-Magnification x 10
- Sweep delay: 100 ns to 0.1 s.
- Calibrator: square-wave generator, ≈1 kHz/1MHz switchable, risetime < 5ns, for probe compensation, output voltages: 0.2V and 2V ± 1%.

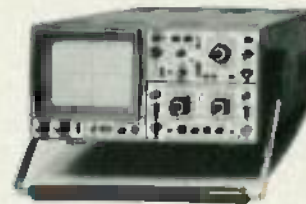

HM 605 DC to 60 MHz **\$899.00**

- Component Tester
- Deflection: 5mV/cm to 20V/cm Y-Magnification x 5
- Y-Output from Ch.I or Ch.II: ≈ 45 mV/cm into 50Ω.
- Timebase: 50ns/cm to 1 s/cm X-Magnification x 10
- Sweep delay: 100ns to 0.1s.



HM 205 **\$799.00**

Real-time - See 203-6 Specifications

Digital Storage

- Operating modes: Refresh and Single with Reset (incl. LED indication for Ready), Hold Ch.I, Hold Ch.II, 1024x8 bit for each chan. Sample rate: max. 100kHz. Resolution: vertical 28 pts/cm, horiz. 100 pts/cm.
- Option: interface for plotter.
- Component Tester

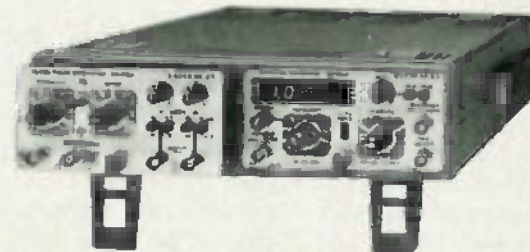

Modular System 8000



HM 208 **\$2,380.00**

HM 208-1 **\$2,860.00**
(with IEEE Interface)

Real-time - See 203-6 Specifications

Digital Storage

- Operating modes: XY, Roll, Refresh, Single (LED ind.), Hold Ch.I, Hold Ch.II, Plot I and Plot II with read-out check on screen, backing storage, Dot Joining button, 2 x 1024 x 8bit for each ch. Sample rate: max. 20MHz. Resolution: vert. 28 pts/cm, horiz. 200 or 100 pts/cm.
- Plotter output: vertical 0.1V/cm, horizontal 0.1V/cm. Output imped.: 100Ω each. Penlift: TTL/CMOS compat. Output speed rate: 5-10-20/10-20-40 s/cm.
- Option: Lithium battery for memory backup.

ATTACHES TO ALL HAMEG SCOPES ON THIS PAGE!

HM 8001	2 BAY Mainframe	\$228.00
HM 8002	4 BAY Mainframe	call 800N
HM 8011-2	Digital Multimeter 4½ digits	298.00
HM 8014	Milli Ohm Meter	298.00
HM 8021-2	Counter, 0.1Hz-1GHz	324.00
HM 8027	Distortion Meter	248.00
HM 8030-2	Function Gen. 0.1Hz-1MHz	288.00
HM 8032	Sine Wave Gen. 20Hz-20MHz	288.00
HM 8035	Pulse Generator, 2Hz-20MHz	455.00
HM 8037	Low Dist. Sine Gen. 5Hz-50kHz	248.00
HM 8040	Triple Power Supply	278.00
HM 8045	Oscilloscope Calibrator	378.00

CIRCLE 126 ON FREE INFORMATION CARD
CALL US TOLL FREE

1-800-732-3457
IN CALIFORNIA TOLL FREE
1-800-272-4225

- Master Charge
- VISA • COD
- Money Order
- Check



ADD FOR SHIPPING AND INSURANCE

\$0 to \$250.00	\$4.50
\$251.00 to \$500.00	\$6.50
\$501.00 to \$750.00	\$8.50
\$751.00 to \$1000.00	\$12.50
over \$1000.00	\$15.00/1000

Prices subject to change without notice.

RAG ELECTRONICS, INC. / 21418 Parthenia Street / Canoga Park, CA 91304 / 1-818-998-6500

VIDEO NEWS



DAVID LACHENBRUCH,
CONTRIBUTING EDITOR

• **Picture-in-Picture.** Digital circuitry is making possible a number of hot new features in VCR's, the most spectacular of which is *Picture-In-Picture*, or PIP. That feature heretofore has been found only in a few digital TV sets. Now PIP VCR's are being introduced one after the other—the first three by RCA, Hitachi, and Sears, with others to come later. All three of the first PIP VCR's are made by Hitachi. RCA's is the most sophisticated and contains nine dynamic RAM's with a total storage capacity of more than two megabits.

Using the hand-held remote-control unit, the user can superimpose a smaller picture in any corner of the main picture. The main picture may be the VCR tape playback, and the smaller picture can be from the VCR's TV tuner or from the video input terminal. The two pictures may be exchanged at will, and either one may be frozen, thanks to built-in field storage. The same field storage is used for fast motion without sound bars; there are unique special effects, such as "mosaic" and "posterization." The Hitachi and Sears recorders also have PIP but their special effects are limited. The RCA VCR uses two DRAM's for the PIP field memory, and six to enhance picture stability. The first PIP VCR's will sell for \$500 to \$700, depending on what other features are included.

• **Interactive VCR.** Worlds of Wonder, Inc., which brought us Teddy Ruxpin, the talking teddy bear, plans to introduce a unique computer attachment that will make any VCR interactive. Three years in development, it differs from programmable videodiscs in that the screen is never blanked during the interactive search. Special tapes for the system have four-way branching and give the effect of 20 tracks of information. There are four audio tracks, up to four branchable video tracks with motion, and up to 20 computer-generated tracks with limited motion. The entire attachment is scheduled to sell for less than \$250 in a year or so, or could be built into a digital TV or VCR for \$50 to \$100. The first program cassettes will be educational, and several producers—the first being Heron

Communications—are preparing programming. In addition, WOW is exploring the use of special cable-TV programming for the interactive machine. That is possible because the system is completely linear. The tape is never required to stop or reverse itself. The system can give quizzes with questions selected at random, keep score, provide music with a still picture, change pictures in response to the viewer's choice, react to user-manipulated arrows or cursors, and so forth.

• **The ultimate Beta.** The most elaborate, and probably the best, consumer VCR ever introduced is a new Beta model by Sony. The quality results from the fact that Sony didn't worry much about compatibility. It improved on Superbeta by shifting the carrier up to 1.2 MHz in the Beta I speed, as opposed to Superbeta's 800 kHz, thereby providing resolution of better than 300 lines. A switch preserves one-way compatibility—playback of standard Beta I tapes. The machine has features never seen before on a half-inch machine, such as flying erase heads, a frame counter, a character generator with eight-page memory, and a programmable assemble editing system to put together up to eight segments with accuracy within two frames. It even has an on-screen calendar for programming. Sony sees its principle use in editing onto VHS, Beta or 8mm VCR formats. It lists at \$1,700.

• **Zenith adds Bose sound.** Who says you need a ten-foot audio system to get good TV sound? Not Zenith or Bose. The two companies have united to produce a series of high-end 27-inch digital color sets with a folded waveguide woofer built into the back and occupying no space beyond the normal outside dimensions of the set. Two *twiddlers*—combination midband and tweeter speakers—are front-mounted below the TV screen. The sets have three amplifiers—a 25-watt to power the woofer and two 5-watt units for the twiddlers—and they have built-in World System Teletext reception. They'll sell for around \$1,400 for a table model, or \$1,700 for the best console.

R-E

What Pomona knows about banana plugs and adapters would fill a book.

For over 30 years the Pomona Electronics line of banana plugs, jacks and adapters has played a major role in our ability to stay on the leading edge of electronics test technology.

Every year we add new banana plug products to make your life as a professional design engineer a little easier. And the complete line is listed in our 1986 General Catalog.

In our new book you'll find over 400 models that utilize or adapt banana plugs in some useful fashion: plugs, jacks, binding posts, adapters, patch cords and cables, in standard or miniature sizes. You name it and you'll probably find exactly what you need in our new catalog.

Here's how to get your copy of our 1986 General Catalog: Just circle the reader service number below; call us at (714) 623-3463; write us at Pomona Electronics, a division of ITT Corporation, 1500 East Ninth Street, P.O. Box 2767, Pomona, California 91769.

Our products are available through your favorite electronics parts distributor.

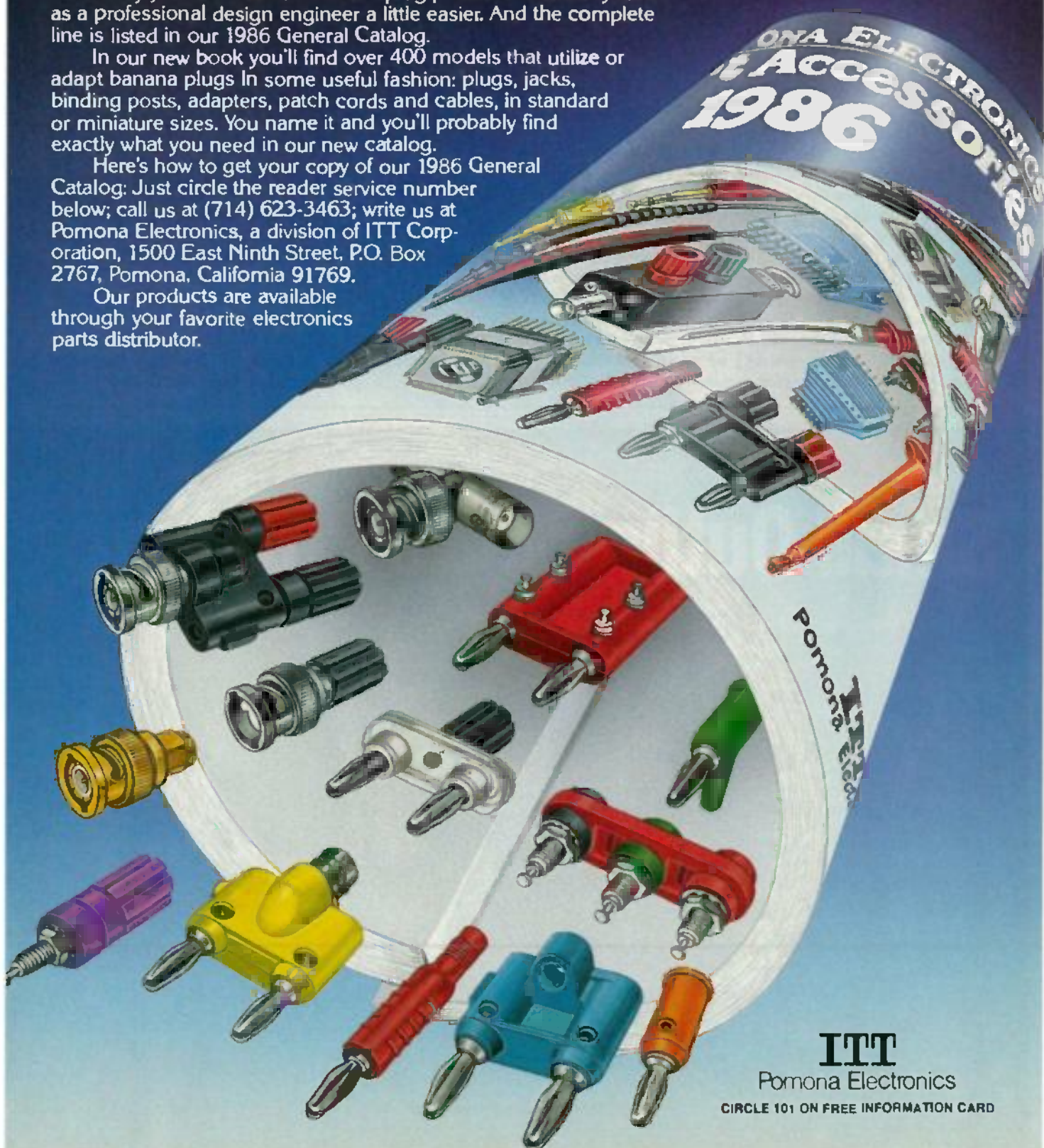

ITT
Pomona Electronics
CIRCLE 101 ON FREE INFORMATION CARD

LETTERS

OOOOPS!

A few errors crept into the the article "Build This Satellite-TV Descrambler" in the October 1986 issue of *Radio-Electronics*. In Fig. 2, the schematic diagram, pin 14 of IC's 2 and 3 should be tied to -5 volts, not +5 volts as shown. Resistor R29 should be tied to +5 volts. Transistor Q7 is misidentified: It should be a 2N3904. Finally, the positions of Q5 and Q6 have been reversed. The unit identified as Q5 should be Q6, a 2N3904 NPN transistor; the transistor identified as Q6 should be Q5, a 2N3906 PNP transistor.

In Fig. 3, the parts-placement diagram, two components are shown in the wrong location. Resistors R8 and R23 are shown vertically aligned; they should be mounted horizontally. Resistor R8 mounts between the top of what is shown as R8 and the top of what is shown as R23; resistor R23 mounts between the bottom of what is shown as R8 and the bottom of what is shown as R23.

Finally, a trace is missing from the PC pattern. It runs from the positive end of C5 to the center of Jack J2. Replace that trace with a jumper.—*Editor*.

NOV 1986
ISSN 0893-1122
\$2.75 per copy
\$11.95/yr



LETTERS

RADIO-ELECTRONICS
300-B BI-COUNTY BOULEVARD
FARMINGDALE, NY 11735

RADAR SPEED-GUN CALIBRATOR

In regard to Anthony Stevens' article, "Radar Speed-Gun Calibrator" (*Radio-Electronics*, August 1986), there seems to be a little information that he left out—and the reader should be aware of it.

On the first page of the article, he mentions that the Doppler shift is about 31 Hz per MPH of target velocity. That is correct, but he fails to point out that that amount of Doppler shift only applies to radar guns operating at the 10.525GHz frequency (X-band). He also does not inform the reader that the Gunn diode and microwave horn

Small Outlines. No Problem.

With A P Products™ brand SOIC Test Clips.

- Allows safe, convenient, fast and easy testing of normally hard-to-access Small Outline Integrated Circuits (SOICs).
- Eight sizes available for .30" and .15" package sizes.
- Helical compression springs and insulating contact combs ensure contact integrity during testing.
- Permits devices stacked as close as .025" end-to-end to be tested simultaneously.
- Standard .025" square contacts on .10" centers at the probe end of the clip easily accept test probes or single row female socket connectors.
- Steel hinge pin and acetal thermoplastic body provide long service life.
- Available with alloy 764 unplated and gold plated leads.

For immediate response contact a local authorized A P Products Prototype & Test Devices distributor. Or telephone 800-321-9668 or (216) 354-2101 in Ohio for further information.

We Solve Problems.

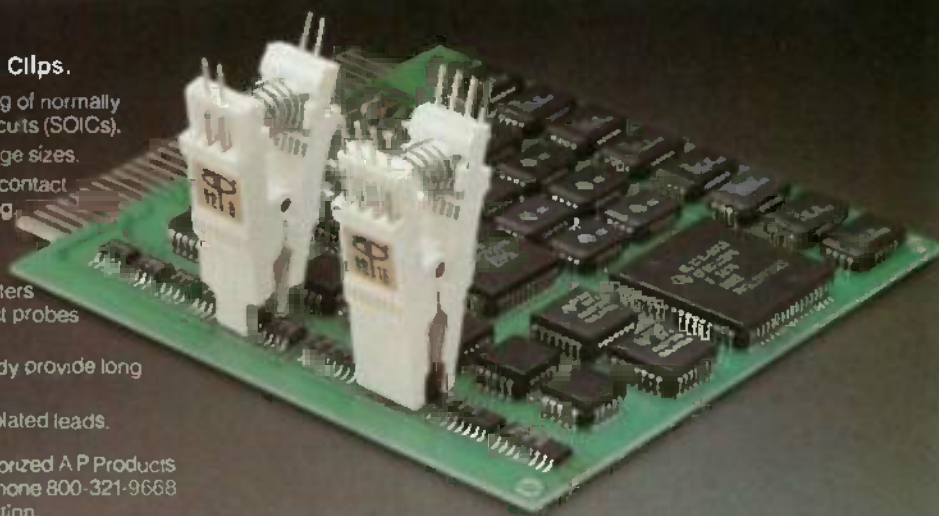

Associated Electronics/3M

A P Products Prototype & Test Devices
9325 Progress Parkway, P.O. Box 540
Mentor, Ohio 44060.

CIRCLE 76 ON FREE INFORMATION CARD

3M

SUPER VALUES from JOSEPH ELECTRONICS

Hitachi SCOPES

Full 3-year warranty

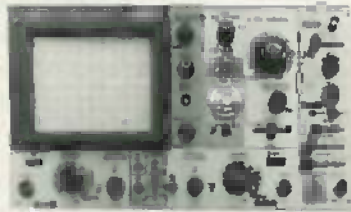

V1050F 100 MHz QUAD CHANNEL/8-TRACE DELAYED SWEEP SCOPE. The features you want and need • 500uV Sens. • 2% Accuracy • 6" CRT has internal graticule. 20KV acceleration. One-touch sync of TV-V, TV-H. Plus: autofocus, variable hold-off, trace rotation adjust; X-Y operation; 10X magnification. W/probes, dust cover.

Reg. \$1,595 **Sale Price \$1,198**

V650F 60 MHz TRIPLE-TRACE DELAYED SWEEP SCOPE. As above, except has 10KV acceleration, 1 MV sensitivity, 3% accuracy, triple trace. W/probes.

Reg. \$1,195 **Sale Price \$898**

CALL TOLL-FREE
1-800-323-5923
FREE SHIPPING to U.S.
Shippable Destinations

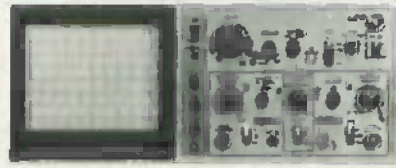

V422 40 MHz DUAL-CHANNEL SCOPE • Low profile portable • DC offset, 1 MV sensitivity, 3% accuracy, 6" CRT with internal graticule. Alternate magnification for simultaneous display of x1, x10 swept waveforms! Plus vertical mode triggering; auto-focus; TV sync separation circuit; built-in signal delay; X-Y Mode. Only 12 x 5 x 14 1/2" 14.3 lbs. W/probes.

Reg. \$925 **Sale Price \$678**

V222 20 MHz DUAL-CHANNEL SCOPE. Similar to above, except has 20 MHz bandwidth. W/probes.

Reg. \$715 **Sale Price \$538**

FLUKE DMM'S



MODEL 37-NEW 3 1/2 DIGIT BENCH DMM. 0.1% DC accuracy • Analog/Digital • Auto-ranging • Volt, Ohms, Amps. Diode Testing • 30kHz AC Bandwidth • Fused 10A Range • Storage compartment—2 year warranty.

Reg. \$229 **Sale \$198**



MODEL 8060A-4 1/2 DIGIT, TRUE RMS DMM
True RMS AC volt and amp measurement • 0.04% basic DC accuracy • Fast audible/visual continuity tests • Relative reference (offset) • Low-power ohms on all resistance ranges • Constant-current diode test mode • Resistance measurements to 300 MΩ • Frequency and dB measurements.

Reg. \$349 **Sale \$308**



MODEL 8050A-4 1/2 DIGIT, BENCH DMM
0.03% basic DC accuracy • True rms AC voltage and current measurement, AC to 50 KHz. • Conductance function checks high resistance to 100,000 MΩ • high power or low-power ohms • Five voltage ranges, 200 mV to 1000V • Extensive overload protection • Diode and dB measurement.

Reg. \$389 **Sale \$338**

HAND-HELD 3 1/2 DIGIT DMM'S



MODEL 73
Analog/digital display • Volts, ohms, 10A, mA, diode test • Autorange • 0.7% basic DC accuracy • 2000+ hour battery life • 3 year warranty

Reg. \$79 **Sale \$68**

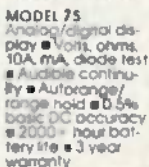

MODEL 75
Analog/digital display • Volts, ohms, 10A, mA, diode test • Audible continuity • Autorange/range hold • 0.5% basic DC accuracy • 2000+ hour battery life • 3 year warranty

Reg. \$99 **Sale \$88**

MODEL 77
Analog/digital display • Volts, ohms, 10A, mA, diode test • Audible continuity • "Touch Hold" Function • Autorange/range hold • 0.3% basic DC accuracy • 2000+ hour battery life • 3 year warranty • Multipurpose holster

Reg. \$139 **Sale \$118**

OK TEST INSTRUMENTS

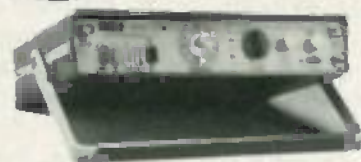

Model 203 2 MHz Function Generator
• 0.2 Hz to 2 MHz Function Generator
• Sine, Square, Triangle Waveforms
• External Sweep 1000:1 • TTL and 50 Ohm Outputs • Variable DC Offset
• Wt. 2.6 lbs. 10.2 x 6 x 2"

Reg. \$289 **Sale \$258**



Ultra-Portable Mini-Scope Model 1010
• 10 MHz Full-Featured Oscilloscope
• AC or Battery operated with internal battery charger • 10 mV Sensitivity, 21 Time Base Ranges • Internal or External Trigger • Bright, clear Blue/White CRT • Wt. 2 lb; 10.2 x 6 x 2"

Reg. \$385 **Sale \$338**



Model 515 600 MHz Frequency Counter
• 8 Digit 1/2" LED Display • Wide Frequency Range: 5 Hz to 600 MHz
• 10 mV RMS Sensitivity throughout range • 2 ppm Time Base Accuracy
• AC or DC Powered (AC Adaptor Included) • Wt. 1.8 lbs. 10.2 x 6 x 2"

Reg. \$340 **Sale \$308**

Model 512, 200 MHz Handheld Counter
Reg. \$145 **Sale \$128**

LIMITED TIME OFFER WHILE QUANTITIES LAST. PHONE TODAY TOLL-FREE!
1-800-323-5925 (In Illinois 1-312-297-4200)

VISA-MASTERCARD-DISCOVER
CARDS WELCOMED, OPEN ACCOUNT
ORDERS TO RATED COMPANIES.
ILLINOIS RESIDENTS ADD 7% TAX

**FREE 116 page Joseph Electronics
discount instrument catalog with
your order or on request!**

**Joseph
Electronics**
8830 N. Milwaukee Ave.,
Niles, IL 60648

in the parts list will only work in conjunction with the X-band radar units—that is, assuming that they are the same ones as shown on the lead page of the article. Also not mentioned is whether or not a K-band diode and horn is available.

While the K-band output is mentioned in passing on page 42, he does not elaborate on any of the details. The K-band output is derived from a different divider chain, because the Doppler shift on that band is different than it is

on the X-band for a target traveling at the same speed.

Although there are several K-band frequencies used, I used 24.5 GHz for my computation. That results in a Doppler shift of 73.1 Hz per MPH. That can be figured out by one of two methods. One is to multiply the ratio of 24.5 GHz to 10.525 GHz (2.328) by 31.4; the other is to use the formula for Doppler shift, DS:

$$DS \text{ (Hz/MPH)} = 89.49/\lambda$$

where λ is the wavelength in cen-

timeters, which equals 30/frequency in GHz.

Another item of note from the "Ask-RE" column in that same issue. A reader asked about an IC that would convert from a RGB signal to a composite signal. The author of the column did not know of a chip for generating the sync. Refer to the article on Cable-TV descrambling on page 53, and you will find an IC to do just that. There is an article in a back issue of *Ham Radio* that provides complete construction instructions. I'm not sure which issue it was, but I think it came out four or five years ago.

And finally (I know, I know; my high school English teacher said never to start a sentence with *and*), who is the new advertiser on page 14? (Mr. Sestero refers to the NutriWheat Diet Program.—*Editor*) I'm sure that I speak for many of your faithful readers when I say that we don't need that kind of advertising in an electronics magazine. It reminds me of reading through the old *Mechanix Illustrated* magazines of 20 years ago. Please, let's not repeat that.

ROBERT T. SESTERO
Baltimore, MD

We start sentences with "and" regularly—in spite of what our high school English teachers said. We also use prepositions to end sentences with. Times change.—Editor

INACCURACIES

I am writing to correct some of the many inaccuracies in the article, "The Early Days of Radio," by Martin Clifford, which appeared in the July issue. Hugo Gernsback must be turning in his grave! It is perhaps possible that some of them were due to editing, but I suspect that most came directly from the author, who hadn't done his homework. (By the way, the picture of an early radio station on the first page of the article is most interesting, and it would be pleasant to know something more about it. On the right side of the picture is a device that appears to be a microphone, either for a recording device or, perhaps, for radiotelephony. The instrument with a large dial at the center of the left side of the picture is also of interest.)

★ CABLE TV SPECIALS ★

CONVERTERS

JERROLD:	DRZ-3DIC105—66 Channel Wireless	\$199. ⁰⁰
	JRX-3 DIC—36 Channel Corded Remote.....	\$149. ⁰⁰
	JSX-3 DIC—36 Channel Set Top	\$129. ⁰⁰
	SB-3—'The Real Thing'	\$119. ⁰⁰
MAGNAVOX:	6400—60 Channel Wireless w/Parental Lockout for Jerrold systems.....	\$199. ⁰⁰
ZENITH:	Z-TAC Cable Add-On.....	\$225. ⁰⁰
VIEW STAR:	EVSC-2000—60 Channel Wireless— with Parental Lockout.....	\$ 99. ⁰⁰
	EVSC-2000A-B—Same as above with A-B Switch	\$109. ⁰⁰
	View Star 1000—60 Channel Wireless with Volume	\$119. ⁰⁰

MISCELLANEOUS

OAK:	N-12 Mini-Code	\$ 89. ⁰⁰
	N-12 Mini-Code Vari-Sync	\$109. ⁰⁰
	N-12 Mini-Code Vari-Sync Plus Auto On-Off ..	\$165. ⁰⁰
JERROLD:	400 & 450 Handheld Transmitters.....	\$ 29. ⁰⁰
HAMLIN:	MLD-1200	\$ 99. ⁰⁰
NEW ITEMS:	Standard Components—66 Channel Wireless— with Parental Lockout	\$ 99. ⁰⁰
	Scientific Atlanta	Call for Price
	Power Zapper Stun Gun, 48, 000V	\$ 59. ⁰⁰
	K-40 Radar Detector—Dash Model	\$199. ⁰⁰
	K-40 Radar Detector—Remote.....	\$229. ⁰⁰

ALL UNITS GUARANTEED. QUANTITY PRICES AVAILABLE.

UNITED ELECTRONIC SUPPLY

P.O. BOX 1206 • ELGIN, ILLINOIS 60121 • 312-697-0600

Regency "Scanner Answer" Giveaway



Here's your chance to win a complete monitoring package from Regency Electronics and Lunar Antennas. 18 scanners in all will be awarded, including a grand prize of the set-up you see above: the Regency HX1500 handheld, the Z60 base station scanner, the R806 mobile unit, and a Lunar GDX-4 Broadband monitoring/reference antenna.

55 Channels to go!

When you're on the go, and you need to stay tuned into the action, take along the Regency HX1500. It's got 55 channels, 4 independent scan banks, a top mounted auxiliary scan control, liquid crystal display, rugged die-cast aluminum chassis, covers ten public service bands including aircraft, and, it's keyboard programmable.

Compact Mobile

With today's smaller cars and limited installation space in mind, Regency has developed a new compact mobile scanner, the R806. It's the world's first microprocessor controlled crystal scanner. In addition, the R806 features 8 channels, programmable priority, dual scan speed, and bright LED channel indicators.

Base Station Plus!

Besides covering all the standard public service bands, the Regency Z60 scanner receives FM broadcast, aircraft transmissions, and has a built-in digital quartz clock with an alarm. Other Z60 features include 60

channels, keyboard programming, priority control, digital display and permanent memory.

Lunar Antenna

Also included in the grand prize is a broadband monitoring/reference antenna from Lunar Electronics. The GDX-4 covers 25 to 1300 MHz, and includes a 6 foot tower.

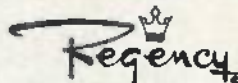

ELECTRONICS INC.
7707 Records Street
Indianapolis, IN 46226

Grand Prize (1 awarded)

- 1—Regency Z60 Base station scanner
- 1—Regency HX1500 Handheld scanner
- 1—Regency R806 Mobile scanner
- 1—Lunar GDX-4 Antenna

First Prize (5 awarded)

- 1—Regency Z60 Base station scanner
- 1—Regency R806 Mobile scanner

Second Prize (5 awarded)

- 1—Regency HX1500 scanner

Contest rules: Just answer the questions on the coupon, (all answers are in the ad copy) fill in your name and address and send the coupon to Regency Electronics, Inc., 7707 Records Street, Indianapolis, IN 46226. Winners will be selected from all correct entries. One entry per person. No purchase necessary. Void where prohibited by law. Contest ends June 30, 1987.

1. The Regency Z60 is
 - a digital alarm clock an FM radio
 - a scanner all of the above
2. The Regency R806 is the world's first _____ controlled crystal scanner.
3. The Regency HX1500 features
 - 55 channels Bank scanning
 - Liquid crystal display all of the above
4. The Lunar GDX-4 antenna covers _____ to _____ MHz.

Name: _____

Address: _____

City: _____ State: _____ Zipcode: _____

I currently own _____ scanners.

Brands owned: _____



Send in a photo (like this one of Mike Nikolich and his Regency monitoring station) and receive a free gift from Regency. Be sure to include your name, address and phone number.

CIRCLE 182 ON FREE INFORMATION CARD

DECEMBER 1986

11

Perhaps the most glaring errors appear in Fig. 1 and Fig. 2, which show schematics for crystal receivers that cannot work. (I think that those schematics were copied from other articles I have seen during the past few years; they were also written by someone who apparently did not understand electricity.) In both of those figures, the crystal and the headset are wired in series with the antenna and ground, and there is no direct-current return path. As a result, no

current could or would flow in the headphones, hence no reception. There should also be a bypass capacitor across the phones, but that is of no importance in a receiver that can't work.

Figure 3, while also flawed, does correspond to early practice. The problem with it is that the headset is connected to the "hot" end of the tuning coil, and capacitance from headset to ground would affect tuning. That wouldn't be of much importance in a receiver

with such poor selectivity, however. Fig. 4 is OK, but Fig. 5 has the same problem as Fig. 3; in addition, there should be a bypass capacitor between the potentiometer arm and the detector, but its omission was also typical of early receivers. Figs. 7 and 12 will work, although the use of a variable capacitor in series with the antenna will permit antenna circuit tuning and give much better selectivity.

A couple of other errors are less significant. The statement that "true solid-state receivers have been with us since 1918" would be more accurate if the date were 1906, when the Perikon detector was patented. The commercial use of crystal detectors in the following years was more limited by patent matters than by performance.

One more annoyingly incorrect statement is: "Early vacuum-tube rectifiers, such as the UX-201A and the UV-199 triodes, cost about \$15.00." That statement contains three errors. First of all, those tubes were triode amplifiers and detectors, not rectifiers. Second, those particular tubes were not particularly early. Third, they never cost \$15.00. The UV201, the predecessor to the UX201A, was announced in November, 1920, at a cost of \$6.50. It was considered an amplifier, with the corresponding detector being the UV200, at \$5.00. Although those were not the first tubes available to the public, they were the first sold by RCA, and correspond roughly to the beginning of broadcasting. The UV1999 is of interest as an early "dry battery tube;" it was announced in December, 1922, and it cost \$6.50. The UX201A was a relatively late tube, introduced at \$2.50 in August, 1925, to replace the UV201A, which had been introduced at the same time as the UV199, and at the same price. The UV201A and the UX201A, like the UV199, had thoriated tungsten filaments, which greatly reduced the required filament power.

There is really no excuse for such a poor article, because many excellent reference books are available these days. For early vacuum tubes, I would recommend *Saga of the Vacuum Tube*, by Gerald Tyne, and *70 Years of Radio Tubes and Valves*, by John Stokes.

Radio-Electronics REPRINT BOOKSTORE

- | | |
|--|--|
| <input type="checkbox"/> 150 TV Descrambler \$3.00 | <input type="checkbox"/> 113 Hands-On Electronics #3 \$4.50 |
| <input type="checkbox"/> 151 Build Your Own Robot \$12.00 | <input type="checkbox"/> 114 Hands-On Electronics #4 \$4.50 |
| <input type="checkbox"/> 152 8-Ball Satellite TV Antenna \$5.00 | <input type="checkbox"/> 115 Hands-On Electronics #5 \$4.50 |
| <input type="checkbox"/> 106 Radio-Electronics back issues (1986) ... \$3.00 | <input type="checkbox"/> 115A Hands-On Electronics #6 \$3.50 |
| Write in issues desired. | <input type="checkbox"/> 116A Hands-On Electronics (Jan-Feb '86) ... \$3.50 |
| <input type="checkbox"/> 105 Radio-Electronics back issues (1985) ... \$3.50 | <input type="checkbox"/> 116B Hands-On Electronics (Mar/Apr '86) ... \$3.50 |
| Write in issues desired. | <input type="checkbox"/> 116C Hands-On Electronics (May/June '86) ... \$3.50 |
| <input type="checkbox"/> 104 Radio-Electronics back issues (1984) ... \$4.50 | <input type="checkbox"/> 116D Hands-On Electronics (Jul/Aug '86) ... \$3.50 |
| (December 1984 issue is not available) | <input type="checkbox"/> 116E Hands-On Electronics (Sep/Oct '86) ... \$3.50 |
| Write in issues desired. | <input type="checkbox"/> 116K Hands-On Electronics (Nov '86) ... \$3.50 |
| <input type="checkbox"/> 103 Radio-Electronics back issues (1983) ... \$5.00 | <input type="checkbox"/> 116L Hands-On Electronics (Dec '86) ... \$3.50 |
| (Jan., Feb., May are not available) | <input type="checkbox"/> 153 Etch your own PC boards \$3.00 |
| Write in issues desired. | <input type="checkbox"/> 154 How to Repair VCR's \$3.50 |
| <input type="checkbox"/> 102 Radio-Electronics back issues (1982) ... \$5.50 | <input type="checkbox"/> 155 IBM Typewriter to Computer \$3.00 |
| (January 1982 is not available) | <input type="checkbox"/> 125 Radio-Electronics Annual 1985 \$3.50 |
| Write in issues desired. | <input type="checkbox"/> 126 Radio-Electronics Annual 1986 \$2.50 |
| <input type="checkbox"/> 101 Radio-Electronics back issues (1981) ... \$6.00 | <input type="checkbox"/> 156 How to Make PC Boards \$2.00 |
| (Jan., Feb., Mar., May, Jun., Oct., Dec. are not available) | <input type="checkbox"/> 157 All About Kits \$2.00 |
| Write in issues desired. | <input type="checkbox"/> 158 Electro Importing Co. Catalog (1918) ... \$5.95 |
| <input type="checkbox"/> SP4 Special Projects #4 (Summer 1982) ... \$5.50 | <input type="checkbox"/> 159 Low Frequency Receiving Techniques |
| <input type="checkbox"/> SP5 Special Projects #5 (Winter 1983) ... \$5.50 | Building and using VLF Antennas \$6.00 |
| <input type="checkbox"/> SP6 Special Projects #6 (Spring 1983) ... \$5.50 | <input type="checkbox"/> 160 New Ideas - 42 Circuits \$3.50 |
| <input type="checkbox"/> SP7 Special Projects #7 (Summer 1983) ... \$5.50 | <input type="checkbox"/> 161 Descrambling (Feb., 1984) \$2.00 |
| <input type="checkbox"/> SP8 Special Projects #8 (Fall 1983) \$5.50 | <input type="checkbox"/> 162 Build Your Own Satellite TV Receiver \$7.00 |
| <input type="checkbox"/> SP9 Special Projects #9 (Winter 1984) ... \$5.50 | <input type="checkbox"/> 163 Receiving Satellite TV \$7.00 |
| <input type="checkbox"/> SP10 Special Projects #10 (Spring 1984) ... \$5.50 | <input type="checkbox"/> 164 Modern Electrics (April, 1908) \$3.00 |
| <input type="checkbox"/> 111 Hands-On Electronics #1 \$4.50 | <input type="checkbox"/> 165 How to Repair CD Disc Players \$5.00 |
| <input type="checkbox"/> 112 Hands-On Electronics #2 \$4.50 | <input type="checkbox"/> 166 Collected Works of Mohammed Ulysses Fips |
| | (52 pages, April Fools Collection) ... \$10.00 |

To order any of the items indicated above, check off the ones you want. Complete the order form below, include your payment, check or money order (DO NOT SEND CASH), and mail to **Hands-on-Electronics**, Reprint Department, P.O. Box 4079, Farmingdale, NY 11735. Please allow 4-6 weeks for delivery.

If you need a copy of an article that is in an issue we indicate is unavailable you can order it directly from us. We charge 50¢ per page. Indicate the issue (month & year), pages and article desired. Include payment in full, plus shipping and handling charge. Make checks payable to Gernsback Publications, Inc.

ARTICLE	MONTH	YEAR
PAGES		
TOTAL PAGES	@ 50¢ each	TOTAL PRICE

MAIL TO: Radio-Electronics Reprint Bookstore, P.O. Box 4079, Farmingdale NY 11735 All payments must be in U.S. funds

SHIPPING CHARGES IN USA & CANADA			
\$0.01 to \$5.00	\$1.00	\$30.01 to 40.00	\$4.75
\$5.01 to \$10.00	\$1.75	\$40.01 to 50.00	\$5.75
\$10.01 to 20.00	\$2.75	\$50.01 and above	\$7.00
\$20.01 to 30.00	\$3.75		

OUTSIDE USA & CANADA
 Multiply Shipping by 2 for sea mail
 Multiply Shipping by 4 for air mail

Total price of merchandise \$ _____
 Sales Tax (New York State Residents only) \$ _____
 Shipping (See chart) \$ _____
 Name _____ Total Enclosed \$ _____
 Address _____
 City _____ State _____ Zip _____

RB126

PERFORMANCE

THAT IS OUT OF THIS WORLD...



\$389⁰⁰

**MODEL 2000 20MHz
DUAL TRACE**

\$549⁰⁰

**MODEL 3500 35MHz
DUAL TRACE DELAYED SWEEP**

...AT A DOWN TO EARTH PRICE

At last! Truly affordable test equipment with no compromise in design, and features you would expect to find only on oscilloscopes costing hundreds of dollars more! JDR Instruments presents two, new, high-performance models backed by a two year warranty and technical support which is only a phone call away. Perfect for the technician or advanced hobbyist, both models feature Dual Trace capability and a variety of operating and triggering modes, including CH-B Subtract and X-Y operation.

MODEL 2000 has a 20 MHz bandwidth and 20 calibrated sweeps ranging from .2s to .2 μ s. A convenient built-in component tester provides additional diagnostic power.

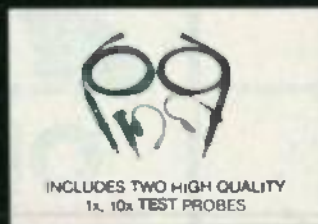

CIRCLE 59 ON FREE INFORMATION CARD

MODEL 3500 features a 35 MHz bandwidth and exceptional 1mV/DIV sensitivity. Delayed sweep and variable holdoff allow stable viewing of complex waveforms.

**ORDER TOLL FREE
800-538-5000
800-662-6279 (CA)**



JDR INSTRUMENTS

1224 South Bascom Avenue
San Jose, California 95128 (408) 995-5430

COPYRIGHT 1985 JDR INSTRUMENTS. EARTH PHOTO COURTESY OF NASA
THE JDR INSTRUMENTS LOGO IS A REGISTERED TRADEMARK OF JDR MICRODEVICES. JDR INSTRUMENTS IS A TRADEMARK OF JDR MICRODEVICES.

Both are available from Antique Electronic Supply, 688 W. First Street, Tempe, AZ 85281. A couple of other interesting histories are *The Development of Wireless to 1920*, Arno Press, New York, 1977, and *The Continuous Wave—Technology and American Radio, 1900–1932*, by Hugh Aikens, also available from Antique Electronics Supply. Anyone seriously interested in historical radio and wireless should join the Antique Wireless Association, Holcomb, New York. Dues are \$8.00 per year and include four issues of *The Old Timer's Bulletin*, which contains excellent articles of historical interest. In addition to many want ads. Membership applications should be sent to Bruce Roloson, Box 212, Penn Yan, New York 14527.

EDWARD PHILLIPS
San Gabriel, CA

The circuits shown in Figs. 1 and 2 are correct, and they can and do work. Apparently Mr. Phillips doesn't know the difference between a DC ground and an RF

ground. The circuit is grounded for RF, and current will flow in those circuits even if a capacitor is inserted in series with the antenna lead-in.

Hugo Gernsback need not turn in his grave, because those circuits, and others like them (surprise!) originally appeared in a book, *How to Read Circuit Diagrams*, published by Gernsback about 50 years ago.

It isn't necessary to put a bypass capacitor across the headphones. There is enough capacitance between the turns of the wire in the headphone to supply bypassing action for the carrier wave.

The headphones in Fig. 3 can be positioned before or after the crystal detector. The tuning is so extremely broad that the capacitance from headphones to ground is of little consequence.

I am well aware of the Perikon detector. However, it wasn't until about 1919 or 1920 that the iron pyrites crystal detector became a household item. As far as the price of tubes is concerned, one must

be aware that a new component is always at its highest price. As tube competition increased, and the supply of tubes went up, those early tubes dropped in price even lower than the figures Mr. Phillips stated.

I do not mind his comments on the article. What I do resent is the statement that Hugo Gernsback must be turning in his grave. That is arrogant and presumptuous, and implies that Mr. Phillips knew Gernsback. I doubt that he ever met the man. I used to have lunch with Hugo Gernsback from time to time, and was also a guest in his home. I was in France with him, and together we visited a noted technical publisher in Paris. I have no doubt that I was his friend; I have a photograph from him inscribed, "To my friend, Martin Clifford."

I was impressed with the books Mr. Phillips mentions in his letter. I would suggest that he take some time and read them.—Martin Clifford

continued on page 33

Send Purchase Order
Check, Money Order, or C.O.D.
or Call Toll Free
800-223-0826
In N.Y. State (212) 865-5580

JERROLD CORDLESS CABLE TV CONVERTERS

MODEL DRX3-105/400

- 60 channels
- Remote channel changing
- Remote ON/OFF switch
- Remote fine tuning

\$69⁹⁵

EXTRA HAND REMOTES
REM 400 - \$29⁹⁵



JERROLD CORDLESS
CABLE TV CONVERTER
Model STARCORD CS-V

\$129⁹⁵

- Volume control
- 68 channels
- Mute control
- Instant channel recall
- Automatic fine tuning



JERROLD CORDLESS
CABLE TV CONVERTER
Model DRZ/450

\$69⁹⁵

- 66 CHANNELS
- AUTOMATIC FINE TUNING
- A/B SWITCH OPTION



TEKNICA CORDLESS
CABLE TV CONVERTER
Model 6510

\$139⁹⁵

- VOLUME CONTROL
- 140 CHANNEL CAPABILITY



Universal MTS
Stereo TV Decoder
FRED

MODEL V-622

\$99.95

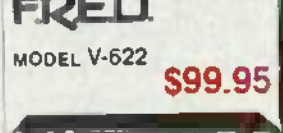

"THE RABBIT"
MODEL TR-7000 Video Multiplying System

\$54.95/12 up

\$9.95/6-11
\$9.95/1-5

IT'S LIKE HAVING A
VCR IN EVERY ROOM



■ MASTER CARD ■ VISA

OMNITRON

ELECTRONICS

770 Amsterdam Ave., New York, NY 10025

SHIPPING CHARGES

For Orders	Add
\$25-100	\$6.50
\$100-500	\$8.50
\$500-750	\$10.50
\$750 and up	\$20.00



Which Way To YOUR Future?

Are you at a crossroads in your career? Have you really thought about it? Are you *planning* for your future, or perhaps refusing to face the subject? Which way will you go — down the same old road? Or are you ready for something else?

In electronics you can't stand still. If you are not moving ahead, then you're falling behind. At the crossroads of your career, various choices are available — and, yes, *decisions* have to be made.

Which road will you take — one that doesn't go where you want to be, or one that leads to hard work *but also* to the better life? Ah, decisions, decisions!

Career decisions are so important that you need all the *input* you can get before locking-in on one of them. Grantham College of Engineering offers you *one* source of input which may help you in making that decision. It's our free catalog.

Ask for our free catalog and you may be surprised to learn how it is easily possible to earn a B.S. degree in electronics without attending traditional classes. Since you are already in electronics (you are, aren't you?), you can complete your B.S. degree work with Grantham while studying at home or at any convenient place.

But don't expect to earn that degree without hard work. Any degree that's worth your effort can't be had without giving effort to the task. And of course it is what you learn in the process, as much as the degree itself, that makes you stand out above the crowd — that places you in an enviable position, prestige-wise and financially.

Grantham College of Engineering
10570 Humbolt Street
Los Alamitos, California, 90720

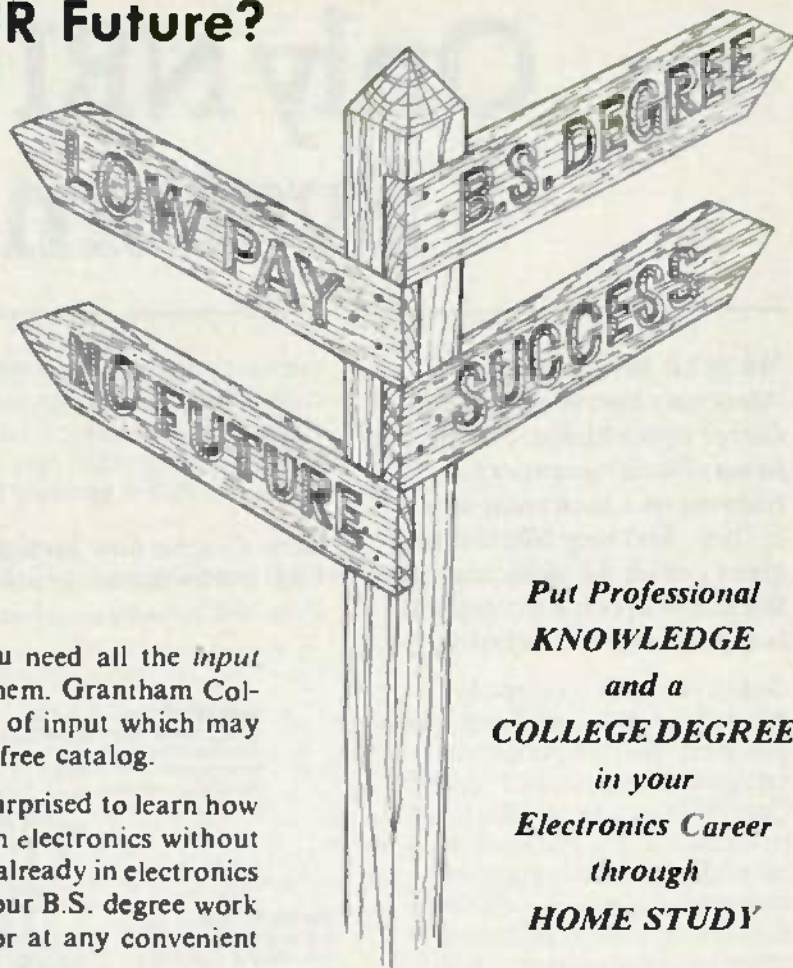

**Put Professional
KNOWLEDGE
and a
COLLEGE DEGREE
in your
Electronics Career
through
HOME STUDY**

Grantham offers this program, complete but without laboratory, to electronics technicians whose objectives are to upgrade their level of technical employment.

Recognition and Quality Assurance

Grantham College of Engineering is accredited by the Accrediting Commission of the National Home Study Council, as a degree-granting institution.

All lessons and other study materials, as well as communications between the college and students, are in the English language. However, we have students in many foreign countries; about 80% of our students live in the United States of America.

**This booklet
FREE!**

This free booklet explains the Grantham B.S. Degree Program, offered by independent study to those who work in electronics.

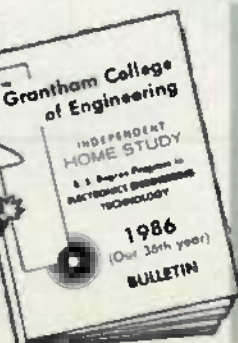

for
**FREE
Booklet
CLIP
COUPON**
and mail in
envelope or
paste on
postal
card.

Grantham College of Engineering R-12-86
10570 Humbolt Street, Los Alamitos, CA 90720

Please mail me your free catalog which explains your B.S. Degree independent-study program.

Name _____ Age _____

Address _____

City _____ State _____ Zip _____

DECEMBER 1986

Only NRI Gives You System for Total

You get it all . . . training for America's fastest growing career opportunity . . . training to service all computers . . . training on a total computer system. And only NRI training gives you all the skills and confidence to become a complete computer service technician.

Today, you can't successfully repair a computer with confidence unless you know that the peripheral equipment is operating properly. Only NRI can give you the well-rounded training you need because only NRI gives you a complete computer system . . . computer, monitor, disk drive, printer, software, even test instruments like a digital multimeter and logic probe. It all adds up to training that builds the knowledge, competence and ability you need to succeed as a computer service specialist.

Get inside the IBM PC compatible Sanyo

As an NRI student, you'll get total hands-on training as you actually build your own Sanyo 550 Series computer from the keyboard up. As you assemble it, you'll perform demonstrations and experiments that will give you a total mastery of computer operations and servicing techniques. You'll do programming in BASIC language—even run and interpret essential diagnostic software. You'll prepare interfaces for peripherals such as printers and joysticks. Using utility programs, you'll check

out the operation of the 8088 microprocessor. Step-by-step, NRI will guide you right into a high paying career in one of America's fastest growing fields.

New! Course now includes high performance printer
Only NRI includes an advanced

dot matrix printer as part of your hands-on training. Working with it, you'll get practical experience in adding peripherals, perform experiments bringing to life operating principles, and then go on to learn critical maintenance and servicing techniques, including changing the print head.

MONITOR High resolution monochrome monitor displays 80 crisp characters per line. Does equally well displaying high resolution graphics.

PRINTER Advanced dot matrix printer prints four sizes of italics and standard type at up to 120 cps bidirectionally in Near-Letter-Quality mode.

FLOPPY DISK AND PROGRAM Software includes MS-DOS 2.11 operating system, Sanyo BASIC, two word processing programs, a powerful spreadsheet program, and several useful NRI-written utility programs.

SANYO 550 SERIES COMPUTER has powerful 8088 CPU, runs many IBM PC programs, includes 256K RAM, double-sided double density disk drive, parallel printer port and detached intelligent keyboard.

MANUALS Documentation covers the Sanyo computer as well as the professional programs included.

A Total Computer Systems Training

Understanding you can get only through experience

You need no previous knowledge to succeed with NRI. You start with the basics, rapidly building on the fundamentals of electronics with bite-size lessons to master advanced concepts like digital

logic, microprocessors, and computer memories.

You'll reinforce this new understanding with hands-on practical demonstrations and experiments that give you real world experience. You'll use the exclusive NRI Discovery Lab to

see what makes transistors tick . . . build and test working electronic circuits that duplicate key computer circuitry . . . and construct digital logic circuits that demonstrate computer performance.

Do it at home in your spare time

NRI trains you in your own home at *your* convenience. You learn at your own pace, backed at all times by your own NRI instructor and the entire NRI staff of educators and engineers. They're always ready to answer questions, give you guidance, follow your progress, and help you over the rough spots to keep you moving toward your goal.

100 page free catalog tells more . . . send today

Send the postage-paid reply card today for NRI's 100 page catalog that gives all the facts about computer training plus career training in robotics, data communications, TV/audio/video servicing, and many other fields. You'll see how NRI can give you the skills and confidence you need for advancement, a new career—even a service business of your own in the existing world of electronics. If the card is missing, write to NRI at the address below.

DISCOVERY LAB Electronics comes to life on your NRI Discovery Lab*. You set up and modify prototype circuits, demonstrate action of components, gain valuable bench experience in construction, diagnosis, and repair of circuitry.

DIGITAL LOGIC PROBE Professional digital logic probe makes analyzing digital circuit operation a simple task.

LESSONS Bite-size lessons build knowledge and understanding step by step. Abundance of photos, illustrations and diagrams reinforce clear, easy-to-follow text.

DIGITAL MULTIMETER 3½ digit digital multimeter features liquid crystal display and four key functions. Your instructor talks you through its operation and professional use on Action Audio Cassette.

NRI SCHOOLS

McGraw-Hill Continuing Education Center
3939 Wisconsin Avenue
Washington, DC 20016

We'll give you tomorrow

DECEMBER 1986

Ask R-E

WRITE TO:

ASK R-E
Radio-Electronics
500-B Bi-County Blvd.
Farmingdale, NY 11735

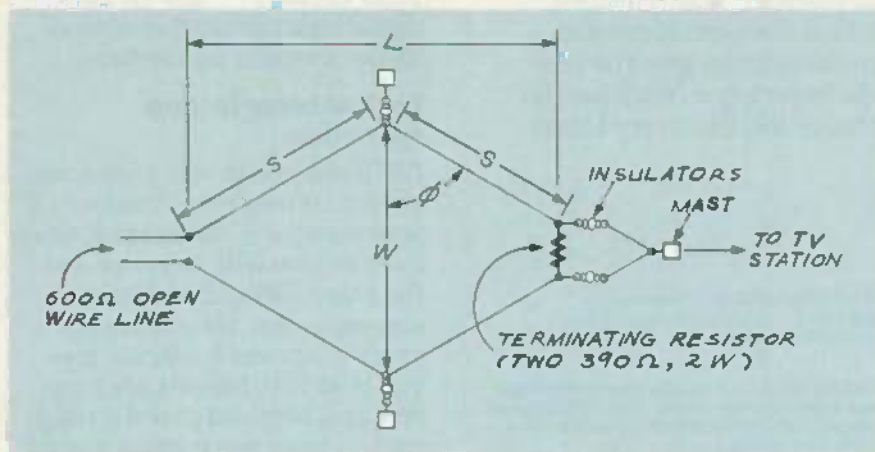

TABLE 1—RHOMBIC DIMENSIONS

	Wavelengths Per Leg	S	L	W	Gain dB	Beam Width	ϕ
VHF TV Channels 2-6	6	87'-0"	162'-0"	66'-0"	12	6°	68°
	4	58'-0"	104'-0"	54'-0"	10	8°	62°
	2	29'-0"	46'-0"	36'-0"	7	13°	52°
FM	3	30'-0"	55'-9"	22'-6"	12	6°	70°
VHF TV Channels 7-13	6	30'-9"	58'-0"	23'-2"	12	6°	68°
	4	20'-6"	36'-6"	19'-0"	10	8°	62°
	2	10'-3"	16'-6"	12'-8"	7	13°	52°
UHF TV Channels 14-47	6	9'-7"	17'-8"	7'-2"	12	6°	68°

TV-RHOMBIC ANTENNAS

Your response to the request for a balun for a TV rhombic left me puzzled. Whoever heard of a rhombic for TV frequencies? I thought that rhombics are used to obtain directivity at low frequencies when you have enough real estate to establish an "antenna farm." What are the dimensions for a TV rhombic? How does its performance compare with

that of a Yagi?—O. K. H., New Strawn, KS.

When the desired TV stations are 75 to 150 miles or so away and all in nearly the same direction, a good rhombic can provide high gain while offering broader frequency response and a constant impedance over a broader range than a Yagi. Specifically, a rhombic provides high gain over a 2:1 fre-

quency range; in other words, the design frequency $\pm 50\%$. Although any antenna for receiving distant stations should be as high as practical, a rhombic two or three wavelengths above ground may outperform a high-gain Yagi on a much higher tower.

Rhombic antennas were widely used in remote areas in the early days of television; they're still not uncommon in many rural areas today. A rhombic with six wavelengths in each leg can provide 12 dB of gain in the forward direction and it can be small enough to fit on many residential lots. Some high-band and UHF TV rhombics are small enough to be mounted on a rotator on a tower.

The diagram of a rhombic for TV frequencies is shown in Fig. 1. The dimensions of each leg for receiving signals at various frequencies are shown in Table 1. A rhombic's beam-width is usually much narrower than that of a Yagi with equal gain, so you must be extremely careful to orient the antenna carefully to within a degree or two. Beam-width decreases and tilt angle increases with the number of wavelengths in each leg. For maximum gain, orientation must be accurate within ± 3 , ± 4 , and ± 6.5 degrees for rhombics with six, four, and two wavelengths per leg, respectively.

The rhombic should be terminated by an 800-ohm non-inductive resistor. You can use two 390-ohm, 2-watt resistors in series.

DARKROOM TIMER

I need help in designing a darkroom timer for my enlarger. I'd like a countdown timer that can be set from 0 to 120 seconds in 0.1-

second increments. Time will be displayed on a 4-digit LED readout. A relay will energize the enlarger and turn it off at the end of the timer period. I've been thinking of a 10-digit keypad or three columns of individual switches for setting 0.1-, 1.0-, and 10-second increments.—G. K., Tampa, FL.

The design of a "dream" darkroom timer such as you describe is a project that would probably require much troubleshooting and several trips back to the drawing board before satisfactory performance is achieved. Unfortunately, we cannot undertake the R&D work needed to provide you with a foolproof design.

You can find some designs that do part of what you want in back issues of electronics and photography magazines. Consult the *Applied Science and Technology Index* and the *Readers Guide to Periodical Literature* in your local library. And try to get a copy of Intersil's *Timers, Counters, and Display Drivers Applications Handbook*. Write to Intersil at 10710 N. Tantau Ave., Cupertino, CA 95014. That 30-page booklet is chock full of circuits for programmable interval timers, stopwatches, counters, and digital displays and drivers. If it is not available, try for a copy of Intersil's *Hot Ideas in CMOS*. Chapter 6 of that work contains data sheets, application notes, and circuits covering the firm's line of counters, timers, and display drivers.

POWER DISTRIBUTION GRIDS

For a college research project, I'm doing a study on the losses in electrical power over long-distance power lines. I need maps showing the power distribution grids throughout the United States. Where can those maps be obtained?—D. D., Bloomington, IN.

Try the "Chief Transmissions Engineer" or the "Director of Power Distribution" of your local power company. If he can't help, contact your Congressman or Senator. The type of information you're looking for is probably available through a governmental agency such as the Department of Energy, the Energy Information Administration, or the Federal Energy Regulatory Commission.

Exclusive, triple patented dynamic cap and coil analyzing . . . guaranteed to pinpoint your problem every time or your money back



with the all new LC75 "Z METER 2"
Capacitor Inductor Analyzer
Patented \$995

The "Z METER" is the only LC tester that enables you to test all capacitors and coils dynamically — plus, it's now faster, more accurate, and checks Equivalent Series Resistance (ESR) plus small wire high resistance coils.

Eliminate expensive part substitution and time-consuming shotgunning with patented tests that give you results you can trust every time. Test capacitor value, leakage, dielectric absorption, and ESR dynamically; with up to 600 volts applied for guaranteed 100% reliable results — it's exclusive — it's triple patented.

Save time and money with the only 100% reliable, in- or out-of-circuit inductor tester available. Dynamically test inductors for value, shorts, and opens, automatically under "dynamic" circuit conditions.

Reduce costly parts inventory with patented tests you can trust. No more need to stock a large inventory of caps, coils, flybacks, and IHVTs. The "Z METER" eliminates time-consuming and expensive parts substituting with 100% reliable LC analyzing.

Turn chaos into cash by quickly locating transmission line distance to opens and shorts to within feet, in any transmission line.

Test troublesome SCRs & TRIACs easily and automatically without investing in an expensive second tester. The patented "Z METER 2" even tests SCRs, TRIACs, and High-Voltage Diodes dynamically with up to 600 volts applied by adding the new SCR250 SCR and TRIAC Test Accessory for only \$148 or FREE OF CHARGE on Kick Off promotion.

To try the world's only Dynamic LC Tester for yourself, CALL TODAY, WATS FREE, 1-800-843-3338, for a FREE 15 day Self Demo.



Call Today Wats Free 1-800-843-3338

SENCORE

3200 Sencore Drive
Sioux Falls, SD 57107
605-339-0100 In SD Only

*innovatively designed
with your time in mind.*

CIRCLE 196 ON FREE INFORMATION CARD

Super DiskTM Diskettes

Now...Diskettes you can swear by, not swear at.

Lucky for you, the diskette buyer, there are many diskette brands to choose from. Some brands are good, some not as good, and some you wouldn't think of trusting with even one byte of your valuable data. Sadly, some manufacturers have put their profit motive ahead of creating quality products. This has resulted in an abundance of low quality but rather expensive diskettes in the marketplace.

A NEW COMPANY WAS NEEDED AND STARTED

Fortunately, other people in the diskette industry recognized that making ultra-high quality diskettes required the best and newest manufacturing equipment as well as the best people to operate this equipment. Since most manufacturers seemed satisfied to give you only the everyday quality now available, an assemblage of quality conscious individuals decided to start a new company to give you a new and better diskette. They called this product the *Super Disk* diskette, and you're going to love them. Now you have a product you can swear by, not swear at.

HOW THEY MADE THE BEST DISKETTES EVEN BETTER

The management of *Super Disk* diskettes then hired all the top brains in the diskette industry to make the *Super Disk* product. Then these top bananas (sometimes called floppy freaks) created a new standard of diskette quality and reliability. To learn the "manufacturing secrets" of the top diskette makers, they've also hired the remaining "magnetic media moguls" from competitors around the world. Then all these world class, top-dollar engineers, physicists, research scientists and production experts (if they've missed you, send in your resume to *Super Disk*) were given one directive...to pool all their manufacturing know-how and create a new, better diskette.

HOW SUPER DISK DISKETTES ARE MANUFACTURED

The *Super Disk* crew then assembled the newest, totally quality monitored, automated production line in the industry. Since the manufacturing equipment at *Super Disk* is new, it's easy for *Super Disk* to consistently make better diskettes. You can always be assured of ultra-tight tolerances and superb dependability when you use *Super Disk* diskettes. If all this manufacturing mumbo-jumbo doesn't impress you, we're sure that at least one of these other benefits from using *Super Disk* diskettes will:

- 1. TOTAL SURFACE TESTING** - For maximum reliability, and to lessen the likelihood of disk errors, all diskettes must be totally surface tested. At *Super Disk*, each diskette is 100% surface tested. *Super Disk* is so picky in their testing, they even test the tracks that are in between the regular tracks.
- 2. COMPLETE LINE OF PRODUCTS** - For a diskette to be useful to you and your computer, it must be compatible physically. *Super Disk* has an entire line of 5 1/4-inch and 3 1/2-inch diskettes for your computer.
- 3. SPECIALLY LUBRICATED DISK** - *Super Disk* uses a special oxide lubricant which is added to the base media in the production of their diskettes. This gives you a better disk drive head to media contact and longer head and disk life.
- 4. HIGH TEMPERATURE/LOW MARRING JACKET** - A unique high temperature and low-marring vinyl jacket allows use of their product where other diskettes won't work. This special jacket is more rigid than other diskettes and helps eliminate dust on the jacket.
- 5. REINFORCED HUB RINGS** - Standard on all 48 TPI *Super Disk* mini-disks, to strengthen the center hub hole. This increases the life of the disk to save you money and increase overall diskette reliability.
- 6. DISK DURABILITY** - *Super Disk* diskettes will beat all industry standards for reliability since they will give you more than 75% of the original signal amplitude remaining even after an average (Weibull B-50) of 30 million passes. They are compatible with all industry specifications as established by ANSI, ECMA, ISO, IBM and JIS.
- 7. CUSTOMER ORIENTED PACKAGING** - All *Super Disk* diskettes are packaged 10 diskettes to a carton and 10 cartons to a case. The economy bulk pack is packaged 100 or 500 disks to a case without envelopes or labels.
- 8. LIFETIME WARRANTY** - If at all else fails, remember, all disks made by *Super Disk* Inc. have a lifetime warranty. If any *Super Disk* diskette fails to meet factory specifications, *Super Disk* Inc. will replace them under the terms of the *Super Disk* warranty.
- 9. SUPERB VALUE** - With *Super Disk's* automated production line, high-quality, error-free disks are yours without the high cost.

SAVE MONEY... QUANTITY DISCOUNTS AVAILABLE

Super Disk diskettes are packed 10 diskettes to a carton and 10 cartons to a case. To save you even more, we also offer *Super Disk* bulk product where 100 or 500 diskettes are packaged in the same box without envelopes or labels. Since we save packaging costs, these savings are passed on to you. For best value, you should order in increments of 100 diskettes. Quantity discounts are also available. Order 200 or more disks at the same time and deduct 1%; 300 or more 2%; 400 or more 3%; 500 or more 4%; 1,000 or more 5%; 2,000 or more 6%; 3,000 or more 7% and 5,000 or more disks earns you an 8% discount off our quantity 100 price. Super strong and tear resistant 5 1/4" diskette envelopes are available from us for only \$10.00 per pack of 100. Use order # CV-5 for a 100 pack of 5 1/4" diskette envelopes.

39¢ per disk Quantity One

Almost all diskettes are immediately available from *Super Disk*. With our efficient warehouse facilities, your order is normally shipped in less than a day.

SAVE ON SUPER DISK™ DISKETTES Product Description	Part #	Super Disk Price per disc (\$)
5 1/4" SSSD Soft Sector w/Hub Ring Retail 10 pack	6431-HR	0.64
5 1/4" Same as above, but bulk pack w/o envelope	6437-HR	0.39
5 1/4" SSDD Soft Sector w/Hub Ring Retail 10 pack	6461-HR	0.68
5 1/4" Same as above, but bulk pack w/o envelope	6487-HR	0.43
5 1/4" DSDD Soft Sector w/Hub Ring Retail 10 pack	6491-HR	0.74
5 1/4" Same as above, but bulk pack w/o envelope	6497-HR	0.49
5 1/4" DSQD Soft Sector (96 TPI) Retail 10 pack	6501-HR	1.09
5 1/4" Same as above, but bulk pack w/o envelope	6507-HR	0.79
5 1/4" DSHD for IBM PC/AT - bulk pack	6667-HR	1.49
3 1/2" SSHO (135 TPI) - Retail 10 pack	6311-HR	1.50
3 1/2" SSHO (135 TPI) - bulk pack	6317-HR	1.14
3 1/2" DSHD (135 TPI) - Retail 10 pack	6321-HR	1.68
3 1/2" DSHD (135 TPI) - bulk pack	6327-HR	1.49

SSSD = Single Sided Single Density; SSDD = Single Sided Double Density; DSDD = Double Sided Double Density; DSQD = Double Sided Quad Density; DSHD = Single Sided High Density; DSHD = Double Sided High Density.

BUY YOUR DISKETTES FROM CE WITH CONFIDENCE

To get the fastest delivery of your diskettes, phone your order directly to our order desk and charge it to your credit card. Written purchase orders are accepted from approved government agencies and most well rated firms at a 10% surcharge for net 10 billing. For maximum savings, your order should be prepaid. All sales are subject to availability, acceptance and verification. All sales are final. All prices are in U.S. dollars. Prices, terms and specifications are subject to change without notice. Out of stock items may be placed on backorder or substituted for equivalent product unless we are instructed differently. A \$5.00 additional handling fee will be charged for all orders with a merchandise total under \$50.00. All shipments are F.O.B. CE warehouse in Ann Arbor, Michigan. No COD's. Non-certified checks require bank clearance. Michigan residents add 4% sales tax or supply your tax ID number and reason for tax exemption.

For shipping charges add \$8.00 per 100 diskettes and/or any fraction of 100 5 1/4-inch or 3 1/2-inch diskettes for U.P.S./R.P.S. ground shipping and handling in the continental U.S. UPS 2nd day air rates are three times continental U.S. rates. For Canada, Puerto Rico, Hawaii, Alaska, or APO/FPO delivery, shipping is three times the continental U.S. rate.

Mail orders to: Communications Electronics Inc., Box 1045, Ann Arbor, Michigan 48106-1045 U.S.A. If you have a Discover, Visa or Master Card, you may call and place a credit card order. Order toll-free in the U.S. Dial 800-USA-DISK. In Canada, order toll-free by calling 800-CA1-DISK. If you are outside the U.S. or in Michigan dial 313-973-8888. Telex anytime 671-0155 (6710155 CE UW). Order today.

Copyright © 1986 Communications Electronics Inc.

Ad #100186-HR



Now  **39¢**
a disk

Order toll free 800-USA-DISK

CIRCLE 188 ON FREE INFORMATION CARD

WIND-GENERATED POWER FOR SALE

As an experimenter, I've long been interested in wind-generated electrical power. The idea of putting up a windmill and generating power for my own use and for selling to the power company is very attractive. However, the power company requires that I install a synchronous inverter between the wind generator and the power line. Can you supply the schematic of a synchronous inverter?—D. B., Astoria, OR.

A windmill generator produces direct current that must be inverted (converted) to alternating current before it can be used to power most household appliances, and certainly before it can be fed into the public-utility power lines. A synchronous inverter is a type of motor-generator set. The American National Standards Institute describes a synchronous inverter as "An inverter that combines both motor and generator action in one armature winding. It is excited by one magnetic field and changes direct-current power into alternating-current power."

Engineers from our tri-state regional power company and from an electric-power co-operative say that if you have enough power available to interest them—several hundred-thousand kilowatts—they would specify the inverter and you would have to have it built to their specifications.

PHILCO AM/FM SERVICE DATA

I need the schematic and service data for a Philco model N-1740-124 AM/FM radio that was manufactured around 1963. Can you help?—M. W., New Haven, CT.

The receiver that you are interested in is covered in Sams Photofact Set No. 794, Folder No. 8.

Other readers who need schematics and service data on many makes and models of consumer electronics products that were manufactured between 1946 and the present may find that information in a Sams Photofact folder. You can call Sams toll-free at 800-428-SAMS and ask for the name and address of the Photofact distributor in your area. You may also be able to obtain information on availability of the data you need. R-E

Analyze defective waveforms faster, more accurately, and more confidently — every time or your money back



with the SC61 Waveform Analyzer
Patented \$2,995

If you value your precious time, you will really want to check out what the exclusively patented SC61 Waveform Analyzer can do for you. 10 times faster, 10 times more accurate, with zero chance of error.

End frustrating fiddling with confusing controls. Exclusive ultra solid ECL balanced noise cancelling sync amplifiers, simplified controls, and bright blue dual trace CRT help you measure signals to 100 MHz easier than ever.

Accurately and confidently measure waveforms from a tiny 5 mV all the way to a whopping 3,000 V without hesitation with patented 3,000 VPP input protection — eliminates expensive "front end" repairs and costly equipment downtime.

Make only one circuit connection and push one button for each circuit parameter test: You can instantly read out DC volts, peak-to-peak volts and frequency 100% automatically with digital speed and accuracy. It's a real troubleshooting confidence builder.

Confidently analyze complex waveforms fast and easily. Exclusive Delta measurements let you intensify any waveform portion. Analyze glitches, interference signals, rise or fall times or voltage equivalents between levels; direct in frequency or microseconds.

Speed your digital logic circuit testing. Analyzing troublesome divide and multiply stages is quicker and error free — no time-consuming graticule counting or calculations. Simply connect one test lead to any test point, push a button, for test of your choice, for ERROR FREE results.

To see what the SC61 can do for your troubleshooting personal productivity and analyzing confidence, CALL TODAY, WATS FREE, 1-800-843-3338, for a FREE 15 day Self Demo.



Call Today Wats Free 1-800-843-3338

SENCORE

3200 Sencore Drive
Sioux Falls, SD 57107
605-339-0100 In SD Only

*innovatively designed
with your time in mind.*

CIRCLE 195 ON FREE INFORMATION CARD

EQUIPMENT REPORTS

Beckman Circuitmate LP25 Logic Probe

The easy way to
troubleshoot digital circuits

CIRCLE 9 ON FREE INFORMATION CARD



HOWEVER DIFFICULT IT IS TO DESIGN digital circuits, it's even more difficult to get them working properly. In a world where the delay of a few microseconds can mean the difference between a hit and a miss, pinpointing problems can be a problem in itself. There are lots of ways to debug circuits but all of them have one thing in common—you need tools to do the job.

If you can't afford an oscilloscope and a logic analyzer, all is not lost: You can still do a good amount of troubleshooting with a logic probe. Once upon a time, logic probes only indicated logic highs and lows, and they did that by using a resistor and an LED. Today's commercially available probes are a lot more sophisticated—and a lot more useful.

The *Circuitmate LP25* logic probe from Beckman Industrial (630 Puenta Street, Brea, CA 92621) is an inexpensive way to peek inside a digital circuit. It has every one of the features you'd like to see on a probe and, wonder of wonders, a reasonable price tag as well. At a suggested list of \$39.95, the LP25 will pay for itself the first time it saves you hours of debugging.

The LP25 is extremely easy to use and is compatible with any of the logic families you might be using. A small switch on the probe lets you select either a TTL or CMOS detection threshold, which is necessary because the industry standards for those two families are different. TTL specifications are less than 0.8 volt for a low and greater than 2.3 volts for a high. CMOS normally switches at about 50% of the supply rail but the industry standard is 70% of V_{CC} for a high and 30% of V_{CC} for a low. The TTL setting on the probe also is good for use with DTL, RTL, and HTL.

Card Size Digital Multimeter



TESTON'S CHECKMAN MINI

fits any shirt pocket. Carry it with you at all times to test and measure AC/DC volts, ohms, and even do diode checks. Self-contained in a vinyl case, with probes attached, this compact 3 1/2 digit multimeter folds to approx. 4.5"H x 3"W x 0.5"D and weighs only 3 oz. Always ready for action, the high quality CHECKMAN MINI offers built-in autoranging, easy-to-read 0.4" high LCD, continuity/diode testing, and low cost.

To order, for shipment within the USA, send check or money order for \$29.95 (CT residents add 7 1/2% sales tax) plus \$1.50 for handling and shipping or call TOLL FREE: 1-800/221-5749. FULL ONE YEAR WARRANTY.



SIBER HEGNER NORTH AMERICA INC.
5 Landmark Square, Stamford, CT 06901
Call TOLL FREE: 1-800/221-5749
In CT: 203/967-4441 Telex: 279653 SANDH UR

CIRCLE 192 ON FREE INFORMATION CARD

Electronics Paperback Books

EVERY BOOK IN THIS AD \$6 OR LESS!



- BP125—26 SIMPLE AMATEUR BAND ANTENNAS.....\$5.00.** All are inexpensive to build, yet perform well. Dipoles, beams, triangle and even a mini rhombic.
- BP126—20 PROGRAMS FOR THE ZX SPECTRUM & 16K ZX81.....\$5.75.** Programs to run. Programs to have fun with. Even programs that will help you learn to write programs.
- 160—COIL DESIGN & CONSTRUCTION MANUAL.....\$5.95.** How the hobbyist can build RF, IF, audio and power coils, chokes and transformers. Covers AM, FM and TV applications.
- 206—PRACTICAL STEREO & QUADROPHONY HANDBOOK.....\$3.00.** A reference book for all interested in stereo and multichannel sound reproduction.
- BP99—MINI-MATRIX BOARD PROJECTS.....\$5.00.** Here are 20 useful circuits that can be built on a mini-matrix board that is just 24 holes by ten copper-foil strips.
- BP157—HOW TO WRITE ZX SPECTRUM AND SPECTRUM+ GAMES PROGRAMS.....\$5.95.** A crystal-clear step-by-step guide to writing your own graphics games programs.
- BP117—PRACTICAL ELECTRONIC BUILDING BLOCKS—Book 1.....\$5.75.** Oscillators, Timers, Noise Generators, Rectifiers, Comparators, Triggers and more.
- 219—SOLID-STATE NOVELTY PROJECTS.....\$4.95.** Fun projects include the Optomin, a musical instrument that is played by reflecting a light beam with your hand, and many more.
- 222—SOLID STATE SHORT WAVE RECEIVERS FOR BEGINNERS.....\$5.00.** Modern solid-state circuits that will deliver a fairly high level of performance.
- BP126—BASIC & PASCAL IN PARALLEL.....\$4.95.** Takes these two programming languages and develops programs in both languages simultaneously.
- 224—50 CMOS IC PROJECTS.....\$5.25.** Includes sections on multivibrators, amplifiers and oscillators, trigger devices, and special devices.
- 225—A PRACTICAL INTRODUCTION TO DIGITAL IC'S.....\$4.95.** Mainly concerned with TTL devices. Includes several simple projects plus a logic circuit test set and a digital counter timer.
- 226—HOW TO BUILD ADVANCED SHORT WAVE RECEIVERS.....\$5.50.** Full practical construction details of a number of receivers are presented.
- 227—BEGINNERS GUIDE TO BUILDING ELECTRONIC PROJECTS.....\$5.00.** How to tackle the practical side of electronics so you can successfully build electronic projects.
- BP6—ENGINEERS AND MACHINISTS REFERENCE TABLES.....\$2.25.** Screw thread data, drill sizes, circle division, angles, tapers and more.
- 123—FIRST BOOK OF PRACTICAL ELECTRONIC PROJECTS.....\$3.75.** Projects include audio distortion meter, super FET receiver, guitar amplifier, metronome and more.
- BP24—52 PROJECTS USING IC 741.....\$5.25.** Lots of projects built around this one available IC.
- BP32—HOW TO BUILD YOUR OWN METAL & TREASURE LOCATORS.....\$5.00.** Electronic and practical details on the simple and inexpensive construction of hydrodyne metal locators.

- BP33—ELECTRONIC CALCULATOR USERS HANDBOOK.....\$5.75.** Invaluable book for all calculator owners. Tells how to get the most out of your calculator.
- BP36—50 CIRCUITS USING GERMANIUM, SILICON & ZENER DIODES.....\$5.00.** A collection of useful circuits you'll want in your library.
- BP37—50 PROJECTS USING RELAYS, SCR'S & TRIACS.....\$5.00.** Build priority indicators, light modulators, warning devices, light dimmers and more.
- BP39—50 FET TRANSISTOR PROJECTS.....\$5.50.** RF amplifiers, test equipment, tuners, receivers, tone controls, etc.
- BP42—SIMPLE LED CIRCUITS.....\$5.00.** A large selection of simple applications for this simple electronic component.
- BP127—HOW TO DESIGN ELECTRONIC PROJECTS.....\$5.75.** Helps the reader to put projects together from standard circuit blocks with a minimum of trial and error.
- BP122—AUDIO AMPLIFIER CONSTRUCTION.....\$5.75.** Construction details for preamps and power amplifiers up through a 100-watt DC-coupled FED amplifier.
- BP43—HOW TO MAKE WALKIE TALKIES.....\$5.00.** Equipment for low-power hand-held or portable operation.
- BP45—PROJECTS IN OPTOELECTRONICS.....\$5.00.** Includes infra-red detectors, transmitters, modulated light transmission and photographic applications.
- BP46—ELECTRONIC PROJECTS FOR BEGINNERS.....\$5.00.** A wide range of easily completed projects for the beginner. Includes some no-soldering projects.
- BP49—POPULAR ELECTRONIC PROJECTS.....\$5.50.** Radio, audio, household and test equipment projects are all included.
- BP51—ELECTRONIC MUSIC AND CREATIVE TAPE RECORDING.....\$5.50.** Shows how you can make electronic music at home with the simplest and most inexpensive equipment.
- BP56—ELECTRONIC SECURITY DEVICES.....\$5.00.** Includes both simple and more sophisticated burglar alarm circuits using light, infra-red, and ultrasonics.
- BP59—SECOND BOOK OF CMOS IC PROJECTS.....\$5.00.** More circuits showing CMOS applications. Most are of a fairly simple design.
- BP72—A MICROPROCESSOR PRIMER.....\$5.00.** We start by designing a small computer and show how we can overcome its shortcomings.
- BP78—PRACTICAL COMPUTER EXPERIMENTS.....\$5.00.** Construct typical computer circuits using discreet logic to form a basic understanding of how computers function.
- BP91—AN INTRODUCTION TO RADIO DXING.....\$5.00.** How you can tune in on those amateur and commercial broadcasts from around the world in the comfort of your home.
- BP94—ELECTRONIC PROJECTS FOR CARS AND BOATS.....\$5.00.** Fifteen simple projects that you can use with your car or boat. All are designed to operate from 12-volt DC supplies.



ELECTRONIC TECHNOLOGY TODAY INC.
P.O. Box 240, Massapequa Park, NY 11762-0240

Name _____
Address _____
City _____ State _____ Zip _____

SHIPPING CHARGES IN USA & CANADA

\$0.01 to \$5.00 \$1.00
\$5.01 to \$10.00 \$1.75
\$10.01 to 20.00 \$2.75
\$20.01 to 30.00 \$3.75
\$30.01 to 40.00 \$4.75
\$40.01 to 50.00 \$5.75
\$50.01 and above \$7.00

OUTSIDE USA & CANADA
Multiply Shipping by 2 for sea mail
Multiply Shipping by 4 for air mail

Number of books ordered

Total price of merchandise \$ _____
Sales Tax (New York State Residents only) \$ _____
Shipping (see chart) \$ _____

All payments must be in U.S. funds

Total Enclosed .. \$ _____

RE-1286

High and low logic levels are indicated with red and green LED's as well as high and low tones. Since the audio is generated by a small piezo element, the output level is rather low and you'll have to turn down your radio to hear it. The tones produced by the LP25 are about 2 kHz for a high and 1 kHz for a low. If you've never used a probe with an audio signal before, you'll wonder how you ever got along without one. It's really a tremendous convenience to be

able to test circuit points without having to look at the probe.

The LP25 can do more than show logic levels. If you're looking at clock pulses, the probe indicators will not only modulate, but they'll also give you some idea of the waveform. Different types of waveforms will produce both different LED combinations and sounds. The instruction sheet has a small chart to use in understanding what the probe is telling you.

The frequency range of the LP25

Beckman		LP25											
OVERALL PRICE													
EASE OF USE													
INSTRUCTION MANUAL													
PRICE/VALUE													
		1	2	3	4	5	6	7	8	9	10		
		Poor		Fair		Good		Excellent					

goes from DC to 25 MHz but its state indicators are responsive only up to 200 kHz. For any higher frequencies, circuit conditions are shown on the pulse catcher. A yellow LED near the back of the probe will flash whenever a logic transition occurs and the circuitry will see pulses as narrow as 30 nanoseconds. If you're looking at clock pulses faster than 200 kHz, the high and low LED's may or may not light, but the yellow LED will be flashing so rapidly it will appear to be on constantly.

Since the pulse-detector circuitry is triggered by both positive- and negative-going transitions, the LED will be flickering at twice the clock rate. Although Beckman lists 25 MHz as the upper limit of the probe, it didn't start to get flakey until the test frequency was past 40 MHz.

The pulse-detection circuitry in the probe can be made either to reset itself after each detection or to latch. That is done using the PULSE/MEMORY switch on the probe. In normal use, you would put the switch in the PULSE position. But if you're looking out for an occasional line glitch or pulse, flip the switch to MEMORY and go out for a pastrami sandwich. If the pulse shows up, the probe will detect it and latch the LED on.

There's no way that a logic probe, even one like the LP25, can substitute for a more powerful instrument such as a scope. If you want to do heavy-duty circuit debugging, a scope is the way to go; but for quick and dirty troubleshooting, you'll have to do a lot of looking before you find something as simple and useful as Beckman's LP25. It's powerful, well made, and won't put a big hole in your wallet. R-E

continued on page 28

Desoldering Tool

SALE

\$15⁹⁵ EA.

20 - 240 Volt, 150/60Hz. 25 - 30 Watt. Can be used for both soldering and desoldering. BM-483



Video Head VEH 0070

SALE

\$37⁹⁵ EA.

Panasonic type head used in 2-4 hour recorder system. T-682



Audiophile Headphone

with Volume Control and Walkman Style Adapter

SALE DM-398

\$24⁹⁵ EA.

CRT Brightner with Isolation Transformer

T-681 SALE

\$8²⁵ EA.



GE Voltage Suppressor

GESP-753 UL Listed

T-700 SALE

\$15⁹⁵ EA.



Telephone Amplifier

SALE BM-406

Easy Installation

\$10⁹⁵ EA.

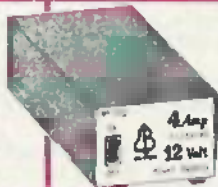

4 Amp Power Supply

SALE BM-231

\$18⁷⁵ EA.

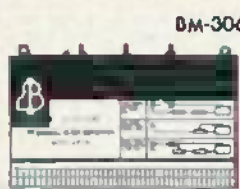

BM-306

46 Channel Block Converter

with Fine Tune Control

SALE

\$19⁹⁵ EA.

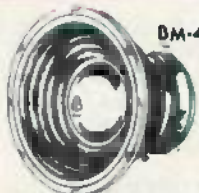

BM-474

10" Replacement Woofer

8 ohm 35/70 Watt

SALE

\$29⁹⁵ EA.



BM-317

SALE

\$39⁰⁰ EA.

200 Meg/Ohm Digital Multimeter

AC or DC, w/battery. Display boxed.

ESI

ORDER BY PHONE

800-645-4720

IN NYS CALL (718) 436-9700

Electronic Parts & Accessories

a unit of ALPHA-RENCO INC.

362D 14th Avenue, Brooklyn, NY 11218



call for our free CATALOG

HITACHI OSCILLOSCOPES

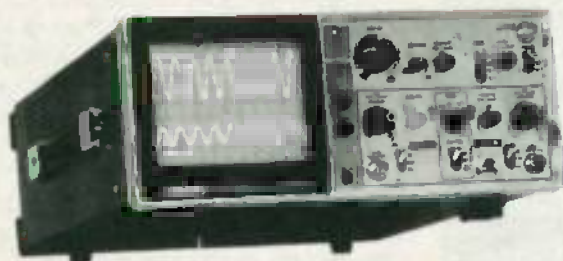

V-212

20 MHz Dual Channels

Convenient 0, 10, 90 and 100% amplitude markings, vertical mode triggering, 1mV/div. sensitivity & $\pm 3\%$ accuracy, TV sync separation circuit, X-Y mode, low drift.

\$429.



V222

20MHz Dual Channels

Same as above with DC offset to measure signals having DC components, CH1 output and DC offset voltage monitor outlet available for external counter or DVM*, alternate magnify function provides x1 and x10, sweep waveforms to be simultaneously displayed.

\$511.

*The purchase of a Model V222 oscilloscope entitles you to purchase a Revere Model RDMT10 3 1/2 digit, 10 amp. scale digital multi-meter for \$39.95! Regular price is \$49.95. Offer applies only to Hitachi Model V222.



The ALLEN INDUSTRIAL ELECTRONICS GROUP highly recommends these fine Industrial Quality

 Hitachi Oscilloscopes*

Richard S. Vialton MSEE
Sales Manager
ALLEN
INDUSTRIAL ELECTRONICS GROUP

 **HITACHI**
SAVE UP TO \$850.00!

V1100A

100MHz/Quad Channels, 8-trace, delayed sweep, CRT readout, digital measurement.

\$2260.

V1070A

100MHz/Quad Channels, 8-trace, delayed sweep, CRT readout.....

\$1610.

V1050F

100MHz/Quad Channels, 8-trace, delayed sweep.

\$1395.

V650F

60MHz/Triple Channels, delayed sweep.....

\$1057.

V-422

40MHz, Dual Channels.

\$785.

VC6041UG

40MHz, sampling, dual channels, 1mV dual trace, 6" CRT, 4k words per channel.

GPIB option. **\$5180.**

VC6041UX

40MHz, digital storage, 1mV dual trace, 6" CRT, 4k words per channel.

\$4380.

V509

50MHz, dual channels, mini portable, delayed sweep.

\$1199.

V134

10MHz, dual trace, bi-stable storage.....

\$1395.

V209

20MHz, dual channels, AC-DC, mini portable.....

\$815.



THE 928 PAGE
WM. B. ALLEN
ELECTRONICS CATALOG
A \$15.00 VALUE
FREE!
WITH ANY PURCHASE

WM. B. ALLEN SUPPLY COMPANY, INC.

ALLEN SQUARE

THE 300 BLOCK • NORTH RAMPART STREET

NEW ORLEANS • LOUISIANA 70112-3106

LOUISIANA TOLL FREE 800 462 9520 • NEW ORLEANS (504) 525 8222

CALL NATIONWIDE TOLL FREE

800 535 9593

24 HOURS A DAY!



CIRCLE 103 ON FREE INFORMATION CARD

DECEMBER 1986

Beckman Circuitmate PR41 Logic Pulser

A logic probe can't do it all
by itself!



CIRCLE 10 ON FREE INFORMATION CARD

A LOGIC PROBE LIKE THE THE LP25 IS A very useful stand-alone circuit-debugging tool, but its utility can really be increased by using a logic pulser, such as the *Circuitmate PR41* from Beckman Industrial Corporation (630 Puente Street, Brea, CA 92621). Both are perfect tools for people who don't want to spend a whole bunch of money on a set of basic instruments to help in designing and building digital electronic circuits. The *PR41* lists

for just \$44.95.

Logic pulsers are invaluable for forcing digital IC's to change state. You can do the same thing with a clip lead and a resistor; but the hallmark of digital circuitry is *controlled* changes and, as we all know, you can't be very precise if you're debugging stuff with nothing more than a hunk of wire. Logic pulsers do their thing accurately—and safely. That's important since a heavy-handed ap-

proach usually produces nothing more than smoke.

The *PR41* draws its power from the circuit under test. The coiled cord coming out of the back of the pulser ends in two clip-leads. All you have to do is to connect them to power and ground on your board, and the pulser is operational. Putting the unit to use involves nothing more than touching the tip to the input of the IC.

The circuitry in the pulser can operate at two different rates. Which one you choose will depend on what you're trying to do. The small slide switch allows you to select between pulse rates of 400 Hz and .5 Hz. The higher rate is useful if you want to clock part of your circuit and watch the results farther down the line. If you just want to force a logic transition, you're better off at the slow rate, since it will give you enough time to remove the tip from the IC before the second pulse is generated. You can see the number of pulses produced by watching the LED at the tip of the pulser.

COPPER ELECTRONICS

4200 PRODUCE ROAD - LOUISVILLE, KENTUCKY 40218

Call us FREE 1-800-626-6343

or write for FREE Flyer.



**Snake
Charmer**

WATTMETER

59.95

6 LOT

12 LOT

54.95

49.95

SPECIFICATIONS:

- Power Range: 20, 200, 2000 Watts
- VSWR: Voltage Standing Wave Reading
- Peak Reading During modulation
- Accuracy +/- 5 percent on dead carrier

We have a national factory warranty service on many brands, and we service All CB, Amateur, and Commercial Equipment.

THE LOWEST PRICES IN THE COUNTRY!

CIRCLE 125 ON FREE INFORMATION CARD

CONNECTION PROTECTION

SWITCHES & RELAYS
EDGE CONNECTORS
PLUGS & SOCKETS
POTENTIOMETERS
CONNECTING CABLES
TERMINAL STRIPS
GOLD PLATED CONNECTORS
BATTERY CONTACTS

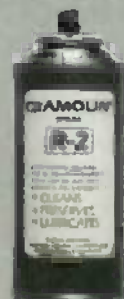

CRAMOLIN®

Even the finest equipment in the world cannot guarantee noise-free operation. One "dirty" connection anywhere in the electrical path can cause unwanted noise or signal loss.

"MORE THAN A CONTACT CLEANER"

CRAMOLIN® is a fast-acting, anti-oxidizing lubricant that cleans and preserves all metal surfaces, including gold.

When applied to metal contacts and connectors, **CRAMOLIN®** removes resistive oxides as it forms a protective molecular layer that adheres to the metal surfaces and maintains maximum electrical conductivity.

CRAMOLIN® . . . USED BY THOSE WHO DEMAND THE BEST

Boe & Howell	Hewlett Packard	McA/Bony	Metamichs
Capitol Records	John Fluke Mfg	Motorola	RCA
Dalby Laboratories	Mcintosh Labs	NASA	Switchcraft
			SINCE 1956

CAIG LABORATORIES INC.

1175-O Industrial Ave., (P.O. Box 1) - Escondido, CA 92025-0051 U.S.A. • (619) 743-7143

CIRCLE 180 ON FREE INFORMATION CARD

SHOCK ABSORBER.



RCA's Power Safe surge suppressors absorb voltage surges before your customers' electronics get damaged.

Now you can help your customers protect their expensive electronic equipment from sudden shock with two new surge suppressors from RCA.

The Power Safe (SK406) protects TVs, computers, microwaves and more by absorbing transient voltage surges resulting from nearby lightning strikes, load switching and other causes before the surge hits the equipment. Handsomely designed and easy to install, this handy six-outlet strip simply plugs into any grounded wall outlet.

The Power Safe Plus (SKF406) protects every way the Power Safe does, plus it filters out electronic noise interference. The suppressor's high-frequency bi-directional filter senses, absorbs, and dissipates noise interference before it can reach the equipment.

Together, they have the potential to become powerful profit builders for you.

To learn more about this shock-absorbing team, see your RCA Distributor. Or contact RCA Distributor and Special Products Division, Deptford, NJ 08096-2088.

RCA Distributor and
Special Products Division

CIRCLE 183 ON FREE INFORMATION CARD

The pulses being injected into the circuit have a risetime of 2 μ s, last 15 μ s, and then take about 30 μ s to decay. The PR41 has push-pull output circuitry so it can source or sink up to 100 mA, which is more than enough to drive any IC input—whether it's already being driven by an IC output, or even tied to one end of the supply rail through a resistor. And since the pulses are so short, the chances of doing any damage to the IC being pulsed are low.

Being able to trigger in-circuit logic transitions is a great aid in circuit debugging but, unless you're looking at unlocked inputs, it still doesn't give you a true picture of circuit operations. The people at Beckman understood that when they designed the PR41. The unit can put out pulses in sync with an external clock. There are three pins on the pulser - ground, clock in, and clock out. The pin labeled EXT SYNC is an input that accepts a clock signal and then forces the unit to output pulses at the clock-signal's rate. The clock

pulses are isolated and cleaned up by an internal Schmitt trigger and appear at the pin labeled sq.

There are two points to keep in mind if you want plan on using an external clock. If the clock you're feeding in has a frequency less than 400 Hz, the PR41 will put out pulses at the clock rate. If it sees a clock faster than 400 Hz, the output frequency isn't very easy to predict. The PR41 will lock to the input frequency and put out pulses at some indeterminate rate. The pulses will be synced to the incoming clock, but the maximum frequency will be 400 Hz. In other words, you'll be sure that every pulse the PR41 puts out coincides with an external clock pulse, but the output frequency won't be more than the pulser's maximum of 400 Hz.

The external clock input of the PR41 has an impedance of 1 megohm, so you can be confident that it will be invisible to just about any clock line you tap; there's very little chance of loading down your circuit. The pulser is extremely

Beckman		PR41												
OVERALL PRICE														
EASE OF USE														
INSTRUCTION MANUAL														
PRICE / VALUE														
		1	2	3	4	5	6	7	8	9	10			
		Poor		Fair		Good		Excellent						

easy to use and, since it's built around CMOS circuitry, it can operate over a wide range of supply voltages. Even CMOS, however, has outside limits and you should be careful to stay within them or you'll damage the probe. The clock pulses produced by the PR41 swing very close to the supply voltage so you should make sure the input you're testing can safely handle that voltage. If it can't, you'll have to use a resistive voltage divider or some other arrangement to cut the pulses down to a safe level. R-E

Experience the wonder... of fischertechnik® kits

Learn about:

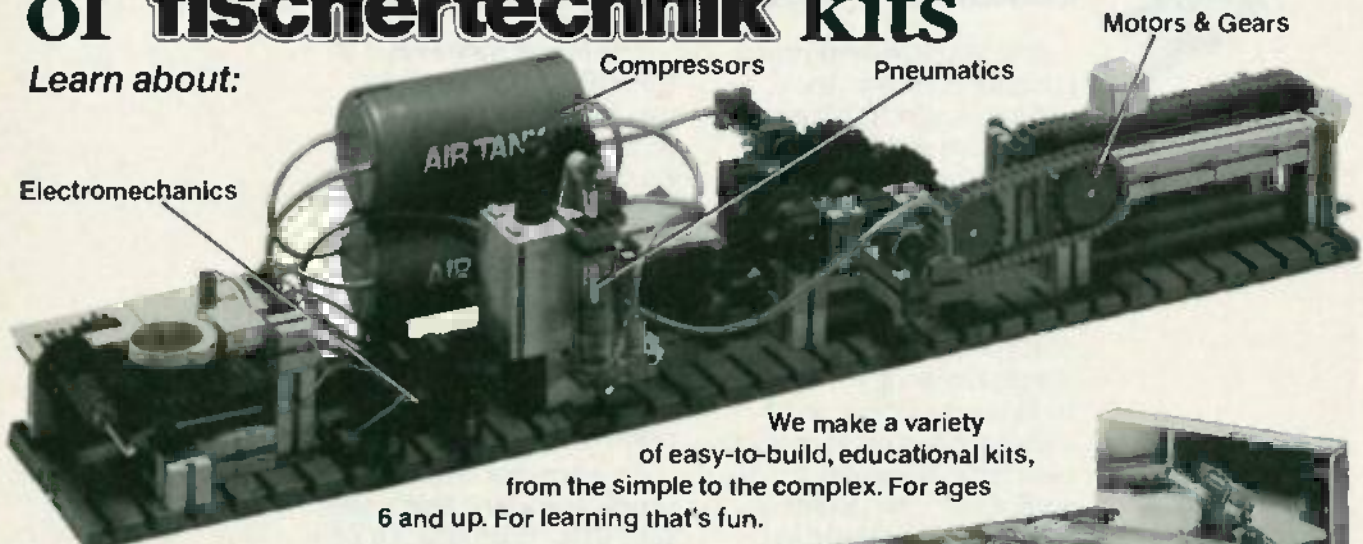

We make a variety of easy-to-build, educational kits, from the simple to the complex. For ages 6 and up. For learning that's fun.

Explore other fascinating concepts like Robotics, Hydraulics, Statics, and more!



Available at your Heath/Zenith Computers & Electronics Center. See your telephone white pages for the store nearest you. Or order from the Heathkit Catalog. To order by phone, call 1-800-253-0570.

fischertechnik®



ELENCO PRODUCTS AT DISCOUNT PRICES!

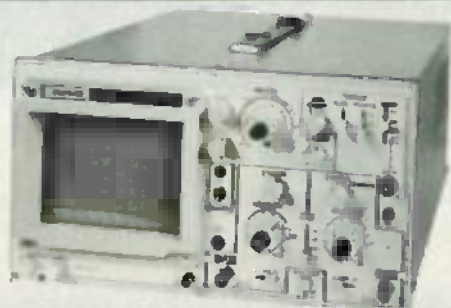

FREE
DIGITAL
METER
WITH
SCOPE
PURCHASE

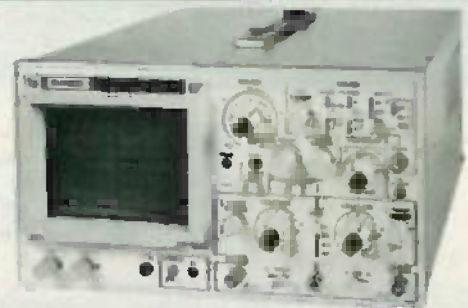

20 MHz DUAL TRACE OSCILLOSCOPE
\$369 MO-1251

35 MHz DUAL TRACE OSCILLOSCOPE
\$545 MO-1252

Top quality scopes at a very reasonable price. Contains all the desirable features. Elenco's 2 year guarantee assures you of continuous service. Two 1x, 10x probes, diagrams and manual included. Write for specifications.



MULTI METER with
CAPACITANCE and
transistor tester
\$65 Model
CM-1500
Reads Volts, Ohms,
Current, Capacitors
Transistors & Diodes



TRUE RMS 4 1/2
DIGIT MULTIMETER
\$135 Model
M-7000
.05% DC Accuracy
.1 % Resistance
with Freq. Counter
& Deluxe Case



AUTO RANGING
plus
MANUAL RANGING
3 1/2 DIGIT METER
28 FUNCTIONS
FULLY PROTECTED
M-1180 .7% ACY \$36.95
M-1182 .25% ACY \$39.95
M-1181 .1% ACY \$42.95



GF-8016 Function Generator
with Freq. Counter
\$219

- Sine, Square, Triangle,
- Pulse, Ramp, .2 to 2 MHz
- Frequency .1 thru 10 MHz

GF 8015 without Freq. Meter \$169

10 MHz OSCILLOSCOPE

\$190
S-3000



10 MHz DC or AC
Triggered Sweep
Calibrated Vert & Hor
Reads Volts & Freq

BREDBOARD

Shown
9434



9430 1,100 pins \$15
9434 2,170 pins \$25
9436 2,860 pins \$35

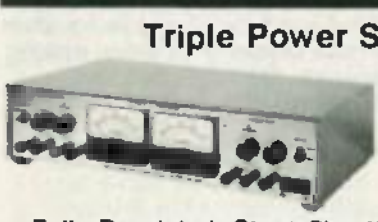

Triple Power Supply XP-660
\$149.50

0-20V @ 1A
0-20V @ 1A
5V @ 5A

Fully Regulated, Short Circuit Protected with 2
Limit Cont. 3 Separate Supplies.

50 MHz LOGIC PROBE

\$23



LP-700

20 nec with memory

LOGIC PULSER

\$25

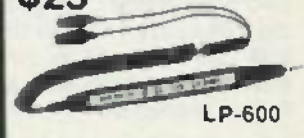

LP-600

2 us pulse @ 1A

3 Amp Power Supply XP-650

\$119.50



0-40V @ 1.5A
0-20V @ 3A

Fully regulated, short circuit protected current
limit control



DIGITAL LCR METER

Model LC-1800
Measures: Inductors
Capacitors, Resistors

\$148

Inductors .1µH to 200 H
Capacitor .1Pf to 200µf
Resistor .01Ω to 20M Ω
Ranges 6 Ind, 7 cap, 7 res

C&S SALES, 8744 W. North Ter. Niles, IL 60648
800-292-7711 (312) 459-9040

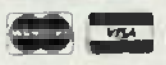

15 DAY MONEY
BACK GUARANTEE ASK FOR CATALOG

2 Year Limited Guarantee Add 5% for Postage (\$10 max.), IL Res., 7% Tax

CIRCLE 109 ON FREE INFORMATION CARD

DECEMBER 1986

KENWOOD

...pacesetter in Amateur radio

NEW

Hear it All!



R-5000

High performance receiver

THE high performance receiver is here from the leader in communications technology—the Kenwood R-5000. This all-band, all mode receiver has superior interference reduction circuits, and has been designed with the highest performance standards in mind. Listen to foreign music, news, and commentary. Tune in local police, fire, aircraft, weather, and other public service channels with the VC-20 VHF converter. All this excitement and more is yours with a Kenwood R-5000 receiver!

- Covers 100 kHz-30 MHz in 30 bands, with additional coverage from 108-174 MHz (with VC-20 converter installed).
- Superior dynamic range. Exclusive Kenwood DynaMix™ system ensures an honest 102 dB dynamic range. (14 MHz, 500 Hz bandwidth, 50 kHz spacing.)



- 100 memory channels. Store mode, frequency, antenna selection.
- Voice synthesizer option.
- Computer control option.
- Extremely stable, dual digital VFOs. Accurate to ± 10 ppm over a wide temperature range.
- Kenwood's superb interference reduction. Optional filters further enhance selectivity. Dual noise blankers built-in.
- Direct keyboard frequency entry.

- Versatile programmable scanning, with center-stop tuning.
- Choice of either high or low impedance antenna connections.
- Kenwood non-volatile operating system. Lithium battery backs up memories; all functions remain intact even after lithium cell expires.
- Power supply built-in. Optional DCK-2 allows DC operation.
- Selectable AGC, RF attenuator, record and headphone jacks, dual 24-hour clocks with timer, muting terminals, 120/220/240 VAC operation.

Optional Accessories:

- VC-20 VHF converter for 108-174 MHz operation
- YK-88A 1.6 kHz AM filter
- YK-88S 2.4 kHz SSB filter
- YK-88SN 1.8 kHz narrow SSB filter
- YK-88C 500 Hz CW filter
- YK-88CN 270 Hz narrow filter
- DCK-2 DC power cable
- HS-5, HS-6, HS-7 headphones
- MB-430 mobile bracket
- SP-430 external speaker
- VS-1 voice synthesizer
- IF-232C/IC-10 computer interface.

More information on the R-5000 and R-2000 is available from Authorized Kenwood Dealers.

R-2000

- 150 kHz-30 MHz in 30 bands
- All modes • Digital VFOs tune in 50 Hz, 500 Hz, or 5 kHz steps • 10 memory channels
 - Programmable scanning • Dual 24-hour digital clocks, with timer • 3 built-in IF filters (CW filter optional)
 - All mode squelch, noise blanker, RF attenuator, AGC switch, S meter • 100/120/220/240 VAC operation • Record, phone jacks
 - Muting terminals • VC-10 optional VHF converter (108-174 MHz)



KENWOOD

TRIO-KENWOOD COMMUNICATIONS
1111 West Walnut Street
Compton, California 90220

Specifications and Prices are subject to change without notice or obligation.

CIRCLE 102 ON FREE INFORMATION CARD



To 27 million Americans, this scene is a fairy tale.

Simply because they can't read.

Functional illiteracy is a problem that now affects 1 out of 5 American adults.

You can change that by making a tax-deductible contribution to the Coalition for Literacy. Call us toll-free at 1-800-228-8813 and bill it directly to your credit card.

Volunteer Against Illiteracy.
The only degree you need is a degree of caring.

Ad Council Coalition for Literacy

LETTERS

continued from page 14

BUILDING CRYSTAL SETS

I enjoyed Martin Clifford's article, "The Early Days of Radio," in the July 1986 *Radio-Electronics*. I have been building crystal sets as far back as I can remember. I would like to bring up a few things you missed, and make a suggestion or two.

First, as I remember, and according to the tradition that my father handed down to me, you could almost always get a better signal with a galena crystal and a cat's whisker than with a germanium diode (1N34). Also, the galena crystal and cat's whisker were never handled. Any film or oil from your skin would impede operation.

Second, all of the between-components wiring was done with "litz" wire, which you never touched the pure copper ends of. I doubt that many experimenters knew about the skin effect, but litz wire was part of the tradition.

Third, you needed 2000-ohm headphones. I have gotten results with lower-impedance headphones, but high-impedance headphones are a necessity for any degree of performance.

Fourth, you cannot overstress the importance of a good earth ground. The old cold-water pipe trick may suffice, but an eight-foot copper rod with a litz wire is really superior.

Then there are the little things. The wooden base, ideally, is made out of well-dried hardwood that is coated with several layers of varnish. The coil(s) are wound out of a medium-gauge pure copper wire with varnish insulation. Personally, I'm fond of oatmeal boxes as coil forms.

One thing that you made no mention of is the World War I crystal set. The heart of it was supposedly a razor blade and a piece of pencil lead. I have tried to duplicate that design with no luck but people tell me that it can be done. Perhaps you could offer some insight into that piece of lore.

Thanks again for the article.

MATTHEW KLEINMANN
 Binghamton, NY

R-E

Capacitance, logic and more. For less.

Now, a fully-loaded DMM combines a capacitance meter, logic probe, and an hFE meter, all for the price of a DMM.

TTL Logic Probe: 20 MHz
 Hi/lo/off indications
 Detects 25nS pulse width
 Capacitance: 5 ranges (2nF to 20μF)
 hFE (NPN or PNP): 1 range (1000)
 DMM: DCV-5 ranges (.2V to 1kV)
 ACV-5 ranges (.2V to 750V)
 DCA-4 ranges (200μA to 10A)
 ACA-3 ranges (20mA to 10A)
 Ohms-7 ranges (200 Ohms to 2000 Megohms)
 Continuity beeper
 Diode check
 Built-in bail
 Anti-skid pads

See one now at your local Beckman Industrial distributor.

DM25L... \$89⁹⁵*



* Suggested list price (U.S.) with battery, test leads and manual.

Beckman Industrial™

Beckman Industrial Corporation
 A Subsidiary of Emerson Electric Company
 630 Puente Street, Brea, CA 92621
 (714) 671-4800

© Copyright 1985 Beckman Industrial Corporation

CIRCLE 98 ON FREE INFORMATION CARD

DECEMBER 1986

33

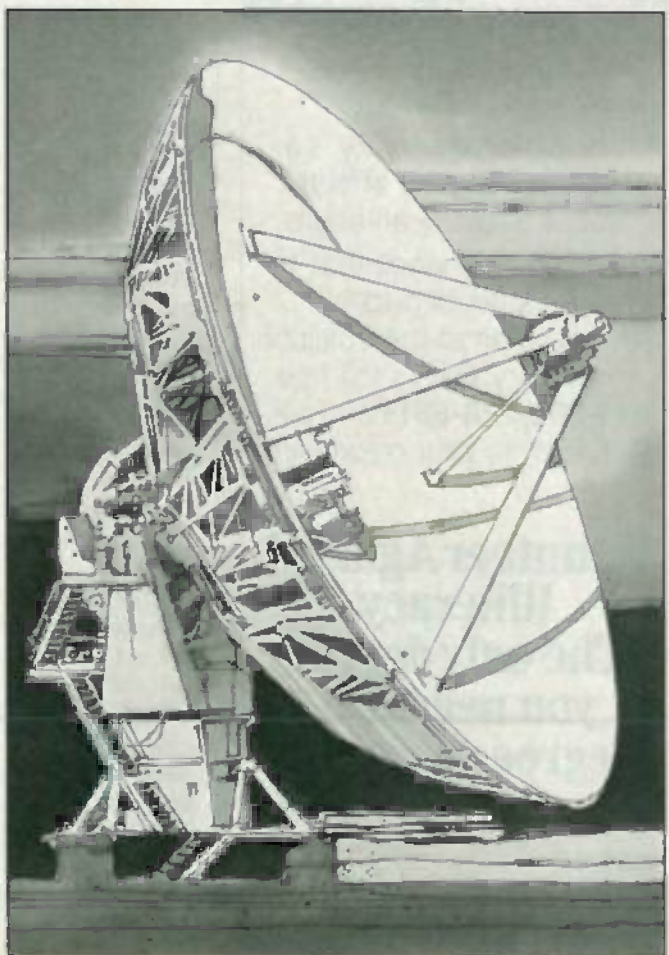
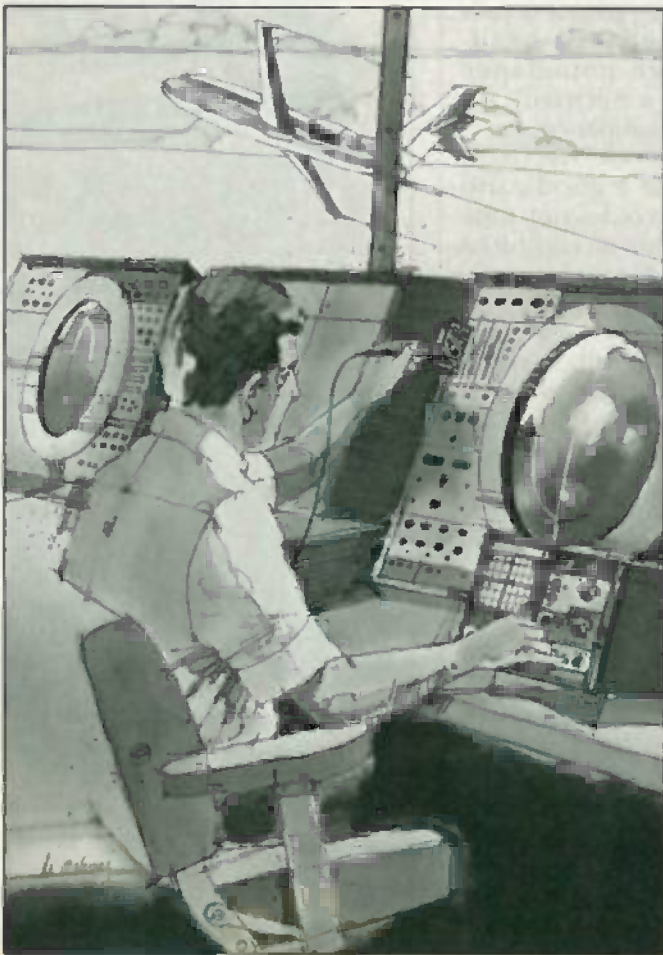
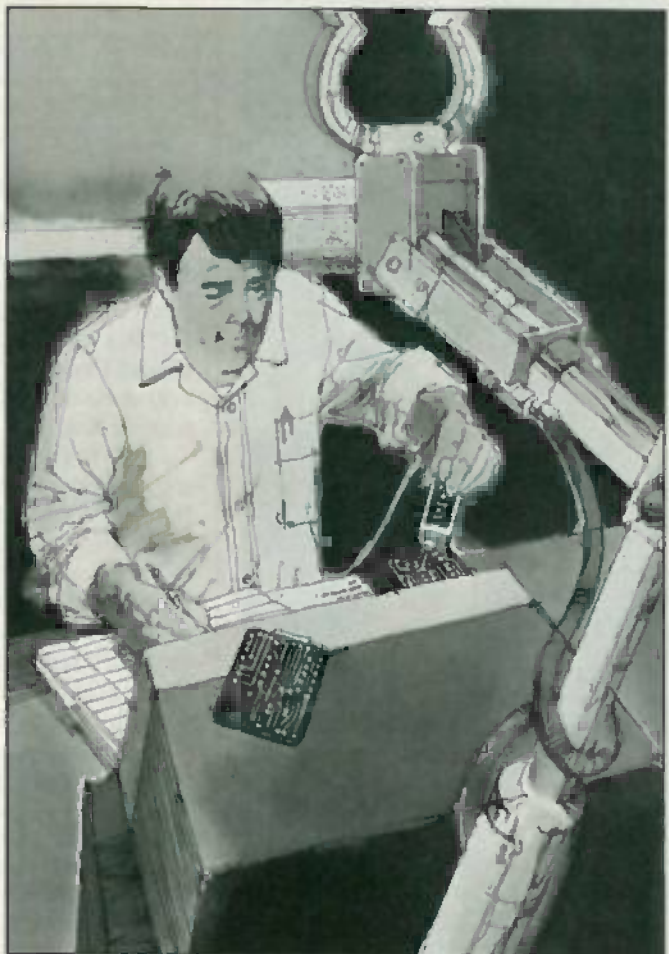

CIE MAKES THE WORLD OF ELECTRONICS YOURS.

Today's world is the world of electronics. To be part of it, you need the right kind of training, the kind you get from Cleveland Institute of Electronics, the kind that can take you to a fast growing career in business, aerospace, medicine, science, government, communications, and more.

Specialized training.

You learn best from a specialist, and that's CIE. We're the leader in teaching electronics through independent study. We teach only electronics and we've been doing it for over 50 years. You can put that experience to work for you just like more than 25,000 CIE students are currently doing all around the world.

Practical training.

You learn best with practical training, so CIE's Auto-Programmed® lessons are designed to take you step-by-step, principle-by-principle. You also get valuable hands-on experience at every stage with sophisticated electronics tools CIE-designed for teaching. Our 4K RAM Microprocessor Training Laboratory, for example, trains you to work with a broad range of computers in a way that working with a single, stock computer simply can't.

Personalized training.

You learn best with flexible training, so we let you choose from a broad range of courses. You start

with what you know, a little or a lot, and you go wherever you want, as far as you want. With CIE, you can even earn your Associate in Applied Science Degree in Electronics Engineering Technology. Of course, you set your own pace, and, if you ever have questions or problems, our instructors are only a toll-free phone call away.

The first step is yours.

To find out more, mail in the coupon below. Or, if you prefer, call toll-free 1-800-321-2155 (in Ohio, 1-800-523-9109). We'll send a copy of CIE's school catalog and a complete package of enrollment information. For your convenience, we'll try to have a representative contact you to answer your questions.

CIE Cleveland Institute of Electronics 1776 East 17th St., Cleveland, Ohio 44114

YES! I want to get started. Send me my CIE school catalog including details about the Associate Degree Program. I am most interested in:

- | | |
|--|---|
| <input type="checkbox"/> computer repair | <input type="checkbox"/> television/high fidelity service |
| <input type="checkbox"/> telecommunications | <input type="checkbox"/> medical electronics |
| <input type="checkbox"/> robotics/automation | <input type="checkbox"/> broadcast engineering |
| <input type="checkbox"/> other _____ | |

Print Name _____

Address _____ Apt. _____

City _____ State _____ Zip _____

Age _____ Area Code/Phone No. _____

Check box for G.I. Bulletin on Educational Benefits

- Veteran Active Duty

MAIL TODAY!

OR CALL TOLL FREE
1-800-321-2155
(In Ohio, 1-800-523-9109)

RE-50

DECEMBER 1986

37

NEW PRODUCTS

DMM, the model 4800, measures DC/AC voltage, DC/AC current, resistance, frequency (Channel A, 10 Hz to 100 kHz; Channel B, 10 Hz to 1000 kHz), period, dBm, diode test, continuity test and temperature (with K-type thermocouple). Also included are comparator, data hold, peak hold, relative, and auto-ranging.

The large 5-digit LCD display indicates pushbutton-selected functions and low line voltage or overrange conditions. Both manual and auto ranging are provided. A relative measurement mode is available, which stores the applied input as a zero-reference point from which subsequent measurements will be displayed as deviations.

The comparative measurement mode permits input of high or low values as percentages, and a beeper sounds (and "GO" appears on the LCD) if the value being measured falls within the set limits. "Hi" or "Lo" will be displayed if the value is beyond the set limits. A



CIRCLE 18 ON FREE INFORMATION CARD

relay contact is provided for the external comparator output. A "key lock" function prevents all switches except power-off from being actuated.

Accessories include: power cable, spare fuses, signal cable, alligator test leads, and comprehensive instruction manual. Optional accessories include various K-type thermocouples, bench "hold" probe, and 10-amp measurement probe.

The model 4800 is priced at \$600.00.—Triplet Corporation, One Triplet Drive, Bluffton, OH 45817.

SERVICE MONITOR, the model COM-3, is designed to analyze and test transceivers in the 100-kHz to 1000-MHz range, in 1-kHz steps. It features a programmable microprocessor memory that



CIRCLE 19 ON FREE INFORMATION CARD stores and recalls on command up to 10 commonly used test setups.

An easy-to use keyboard offers programmable offset keys that simplify frequency entry for duplex or repeater radios, and incremental-step keys facilitate the testing of a receiver throughout its frequency range.

The model COM-3 is portable and has a built-in, rechargeable battery pack that makes it ideal for off-site testing; the COM-3 weighs less than 10 lbs. For additional portability, a durable Cordura travel case with zippered pockets and shoulder strap is available.

The model COM-3 is priced at \$1995.00.—Ramsey Electronics Inc., 2575 Baird Road, Penfield, NY 14526.

IN-CIRCUIT IC TESTER, the *Chip Checker* model TTL-1 is a full-mode in-circuit IC tester with the capability of detecting and displaying IC errors during actual operating conditions; it can do so automatically.

It is designed to test most 14, 16, 18, and 20-pin TTL IC's, including low-power Schottky TTL. That includes logic gates, flip-flops, buffers, and interface elements. Newer and older logic families may also be tested.

Two front-panel-mounted switches are available for selecting the V_{CC} and GND pins on the IC under test. Lighted LED's indicate errors or differences between the IC under test and a reference IC:

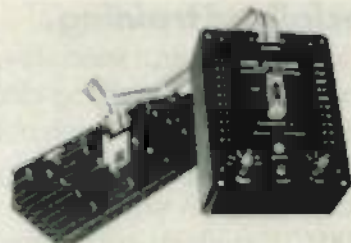

CIRCLE 20 ON FREE INFORMATION CARD

The model TTL-1 can be used to troubleshoot suspect IC's on a PC board, because the IC's do not have to be removed from the board to be tested. Good IC's can be verified without soldering or causing board damage. The TTL-1 In-Circuit IC tester can be adapted for low-volume incoming inspection and screening of IC's, and it can also be used as an in-circuit logic monitor.

The model TTL-1 is priced at \$299.95.—Microcraft Corporation, P. O. Box 513, Thiensville, WI 53092.

MARINE PACK is a submersible housing designed for use with a Sony *Handycam* 8 mm camcorder

World Series of Savings

INSTANT REBATES ON B&K-PRECISION SCOPES

Limited time offer—expires November 30, 1986

Call
1-800-654-7256

100 INSTANT REBATE

B&K PRECISION 100 MHz, Quad Input Oscilloscope

Model
590A

- 1 mV/div sensitivity — Full Bandwidth
- 2% Vertical and Horizontal Sweep Accuracy
- Dual Independent Time Base
- Calibrated Delayed Sweep
- 20 kV Accelerating Voltage
- V Mode — Displays Four Signals Unrelated in Frequency
- And Much More!!!

\$1886 Price less
\$100.00 Rebate

\$1786
FINAL PRICE

\$90 INSTANT REBATE

B&K PRECISION Digital Storage/Analog Oscilloscope

Model
2520

- 20 MHz Real Time Bandwidth 20 MHz Storage Bandwidth
- 2 Megabyte/Second Sampling Rate
- 1 K Memory Per Channel
- Equivalent Time Sampling
- Pre-Trigger Capture
- And Much More!!!

\$1895 Price less
\$90.00 Rebate

\$1805
FINAL PRICE

80 INSTANT REBATE

B&K PRECISION 80 MHz, Quad Input Oscilloscope

Model
570A

- 1 mV/div sensitivity — Full Bandwidth
- 2% Vertical and Horizontal Sweep Accuracy
- Dual Time Base/Calibrated Delayed Sweep
- 12 kV Accelerating Voltage
- V Mode — Displays Four Signals Unrelated in Frequency
- And Much More!!!

\$1464 Price less
\$80.00 Rebate

\$1384
FINAL PRICE

\$60 INSTANT REBATE

B&K PRECISION 60 MHz, Triple Input Oscilloscope

Model
1564

- 1 mV/div sensitivity
- ±3% Vertical and Horizontal Sweep Accuracy
- Dual Time Base/Calibrated Delayed Sweep
- 12 kV Accelerating Voltage
- V Mode — Displays Three Signals Unrelated in Frequency
- And Much More!!!

\$1267 Price less
\$60.00 Rebate

\$1207
FINAL PRICE

40 INSTANT REBATE

B&K PRECISION 40 MHz, Dual Input Oscilloscope

Model
541

- 1 mV/div sensitivity
- 3% Vertical and Horizontal Sweep Accuracy
- Single Time Base
- 20 Calibrated Sweeps
- 6 kV Accelerating Voltage
- V Mode — Displays Two Signals Unrelated in Frequency
- And Much More!!!

\$847 Price less
\$40.00 Rebate

\$807
FINAL PRICE

\$20 INSTANT REBATE

B&K PRECISION 25 MHz, Dual Input Oscilloscope

Model
1524

- 1 mV/div sensitivity
- 3% Vertical and Horizontal Sweep Accuracy
- Single Time Base
- 20 Calibrated Sweeps
- 8 kV Accelerating Voltage
- V Mode — Displays Two Signals Unrelated in Frequency
- And Much More!!!

\$767 Price less
\$20.00 Rebate

\$747
FINAL PRICE

B&K-Precision is offering these instant factory rebates on selected B&K-Precision Oscilloscopes to you through Participating Distributors.

HERE'S HOW IT WORKS!!!

Call 1-800-654-7256 for the name of your Participating B&K-PRECISION Distributor

Select the B&K-PRECISION Oscilloscope that meets your needs from the Participating Distributor's stock.

The Participating Distributor will deduct the "INSTANT REBATE" for that model directly from the invoice price. You save instantly!

PLEASE NOTE: This offer is available *only* at Participating B&K-PRECISION Distributors. Only B&K-PRECISION Models 2520, 1590A, 1570A, 1564, 1541 and 1524 are eligible for INSTANT REBATES. Sorry, no substitutions are allowed. INSTANT REBATES apply to purchases from October 1, 1986 through November 30, 1986 only.

B&K PRECISION DYNASCAN CORPORATION

6460 West Cortland Street • Chicago, Illinois 60635 • 312/889-9087

International Sales: 6460 W. Cortland St., Chicago, Illinois 60635

Canadian Sales: Atlas Electronics, Ontario

South and Central American Sales: Empire Exporters, Plainville, NY 11803

CIRCLE 77 ON FREE INFORMATION CARD

SEND FOR THIS
FREE CATALOG NOW



SAVE MONEY
HIGH QUALITY
FAST DELIVERY

We are utilizing the latest
equipment and technology to
maintain our quality at
reasonable prices.

JAN
CRYSTALS
Since 1958

- General Communication
- Industry
- Marine VHF
- Scanners
- Amateur Bands
- CB Standard
- CB Special
- Microprocessor

Call or Write
JAN CRYSTALS
P.O. Box 06017
Fort Myers
FL 33906-6017
(813) 936-2397

CIRCLE 104 ON FREE INFORMATION CARD

Learn micro-processing with the new MICRO-PROFESSOR 1P



Students, engineers or technicians—
upgrade your micro-processing skills
with the new Micro-Professor 1P.

The MPF-1P features:

- extensive software support
- more built-in memory
- improved keyboard
- larger display

Three tutorial guides help cover all
capabilities. The ideal training tool!
MPF-1P will deliver you into the growing
world of micro-processing. Invest now!

Plus—FREE GIFT Only \$199.95

Check this box for FREE
Z-80 Microprocessor
Programming and
Interfacing textbook when
you order, within 7 days.
\$16.95 value. (Include
\$7.50 postage &
handling!)

ETRONIX

Dept. RE 1286
5326 9th Ave. N.E.
Seattle, WA 98105-3617

For immediate action call TOLL FREE:

1-800-426-1044

Full money back guarantee.



CIRCLE 111 ON FREE INFORMATION CARD

inside it. The *Marine Pack* can be submerged to a depth of almost 140 feet. Made of plastic and glass, it is sealed with special buckles and a rubber ring clamp system. *Handycam* camcorder functions that can be controlled from outside the housing.

The *Marine Pack* features a piezoelectric underwater microphone for audio pickup, and a wide conversion lens. The unit weighs about 8 pounds, including ballast weight, and measures 11.80



CIRCLE 21 ON FREE INFORMATION CARD

× 10.25 × 10.45 inches.

The *Marine Pack* is priced at \$995.95; with video light, \$1400.95. (The *Handycam* camcorder is sold separately.)—Sony Corporation of America, Sony Drive, Park Ridge, NJ 07656.

CELLULAR ANTENNA, the model *CMR750*, is designed to be mounted on a window *inside* a vehicle; no outside radial is needed. The design enables the antenna to operate with minimum signal loss or pattern distortion.



CIRCLE 22 ON FREE INFORMATION CARD

Installing the cellular antenna inside the vehicle lowers the possibility of theft and vandalism, and the antenna is protected from damage resulting from automatic car washes and harsh weather conditions. Although the model *CMR750* is factory pretuned for the U. S. cellular band, a trimmer is provided for further adjustment. It comes complete with 12' of RG58XM/U low-loss cable and all connectors.

The model *CMR750* is priced at \$72.95.—Alliance Research Corporation, 20120 Plummer Street, P. O. Box 4029, Chatsworth, CA 91313.

DMM, the model *DM-1000*, has 3½ digits and a rotary switch. Designed for the professional engineer and technician, as well as for hobbyists and students, its features include: pocket-size, overload protection, 10A DC current readings, 0.5" LCD, and 200-hour battery life. The model *DM-1000* incorporates 6 functions in 17 ranges, including DCV, ACV, DCA, OHM, diode test, and battery test.

Ranges include 200 mV, 2/20/200/1000 volts DC; 200/750 volts AC; 200 μA, 200mA, 10A DC;



CIRCLE 23 ON FREE INFORMATION CARD

200/2K/200K/2M ohms; diode test (0-2K ohms); battery test: 2 volts DC.

The model *DM-1000* is priced at \$39.95.—A. W. Sperry Instruments, 245 Marcus Boulevard, Hauppauge, NY 11788.

R-E Engineering Admart

Rates: Ads are 2 1/4" x 2 1/4". One insertion \$825. Six insertions \$800 each. Twelve insertions \$775 each. Closing date same as regular rate card. Send order with remittance to Engineering Admart, Radio Electronics Magazine, 500-B Bi-County Blvd., Farmingdale, NY 11735. Direct telephone inquiries to Arline Fishman, area code-516-293-3000. Only 100% Engineering ads are accepted for this Admart.

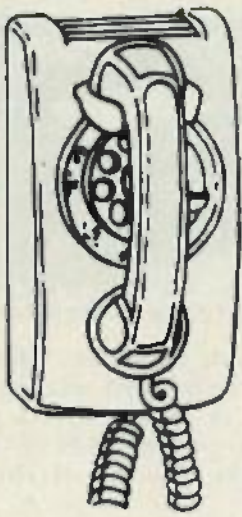

CALL NOW AND RESERVE YOUR SPACE

- 6 x rate \$800.00 per each insertion.
- Reaches 239,312 readers.
- Fast reader service cycle.
- Short lead time for the placement of ads.

Call 516-293-3000 to reserve space. Ask for Arline Fishman. Limited number of pages available. Mail materials to: Engineering Admart, RADIO-ELECTRONICS, 500-B Bi-County Blvd., Farmingdale, NY 11735.

IBM-PC Schematic Design

A professional package enabling you to design, edit, print & plot electronic schematics. Supports "A" through "E" size sheets, over 2000 Unique Library Parts, Part Rotation, Unlimited Hierarchy, Grids, Auto Panning, 5 Zoom Levels, Rubberbanding, Powerful Macros, Hi-Res Color & Monochrome Graphics, Much More! \$495 Includes Everything.

Call or Write for Free Demo Disk.

OrCAD Systems Corporation
1049 S.W. Baseline St. Suite 500
Hillsboro, OR 97123
(503) 640-5007

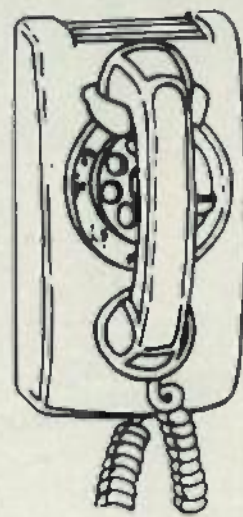

CALL NOW AND RESERVE YOUR SPACE

- 6 x rate \$800.00 per each insertion.
- Reaches 239,312 readers.
- Fast reader service cycle.
- Short lead time for the placement of ads.

Call 516-293-3000 to reserve space. Ask for Arline Fishman. Limited number of pages available. Mail materials to: Engineering Admart, RADIO-ELECTRONICS, 500-B Bi-County Blvd., Farmingdale, NY 11735.

LINEAR IC EQUIVALENTS & PIN CONNECTIONS

Linear IC
Equivalents
and Pin
Connections



BP141—Shows equivalents & pin connections of a popular user-oriented selection of European, American and Japanese linear IC's 320 pages, 8 x 10 inches. \$12.50 Plus \$2.75 shipping. ELECTRONIC TECHNOLOGY TODAY INC., PO Box 240, Massapequa Park, New York 11762-0240.

THYRISTOR TESTER, the model 20, is an easy-to-use instrument capable of measuring the basic DC parameters of thyristors and diodes. Important triggering characteristics are obtained without guesswork, confusion, or compromise. Forward and reverse blocking voltage measurements are safely made with the peak maximum current limited to the programmed condition. Two-terminal devices, such as rectifiers and diodes, may be tested as well.

The model 20 can be connected to a variety of devices—other test equipment, handlers, printers, or

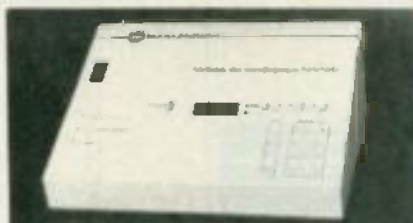

CIRCLE 24 ON FREE INFORMATION CARD

computer systems—through its IEEE-488 interface. The interface is activated easily by pressing the appropriate front-panel buttons. Bus commands emulate the front-panel controls and have similar mnemonics. The tester is a stand-alone unit; neither external power

supply nor curve tracer is needed.

The model 20 Thyristor Tester is priced at \$1995.00.—Markenrich, 14946-A Shoemaker Avenue, Santa Fe Springs, CA 90670.

VACATION/HOME SENTRY, the model GD 1702 is a device that monitors internal house conditions and relays that information over the telephone.

The easy-to-assemble unit automatically detects low temperatures, and can also be used to detect water, and other problems through the addition of various sensors. If any of the sensors de-

HAMEG Instruments

high quality at low cost

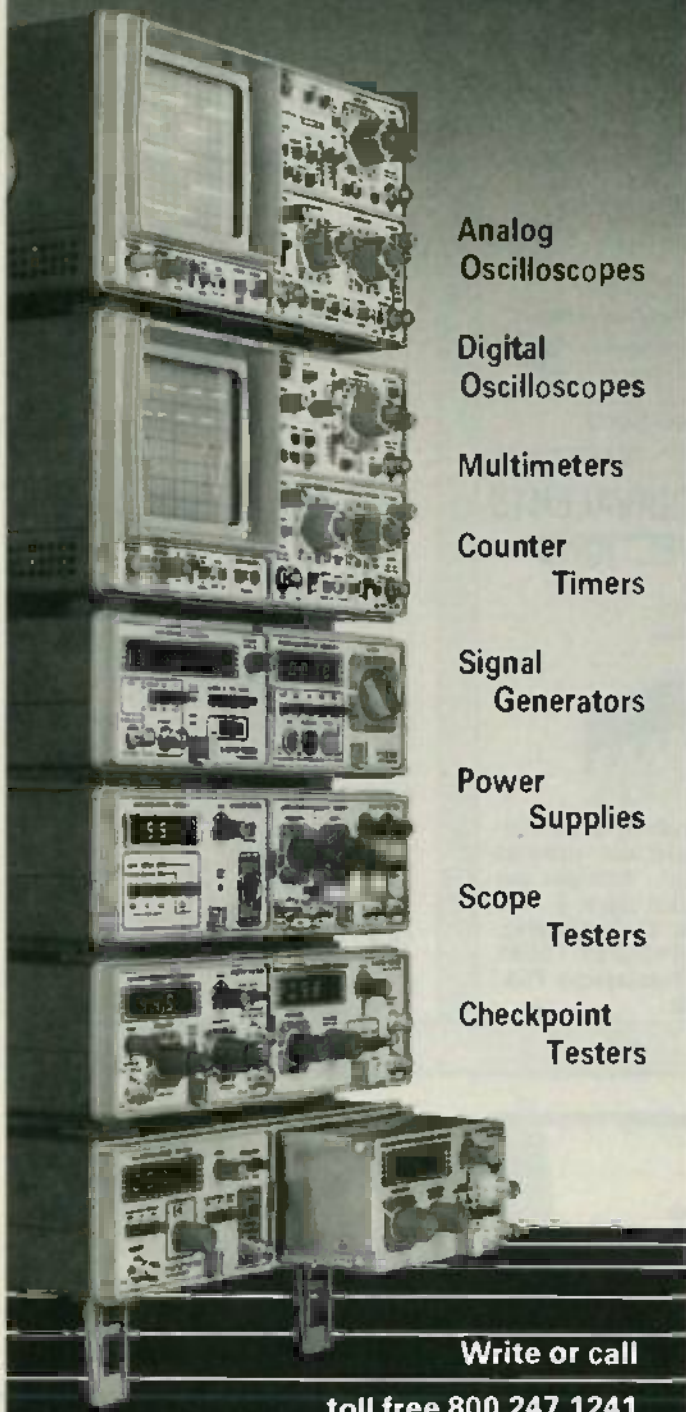

Analog
Oscilloscopes

Digital
Oscilloscopes

Multimeters

Counter
Timers

Signal
Generators

Power
Supplies

Scope
Testers

Checkpoint
Testers

Write or call
toll free 800.247.1241

HAMEG, INC.

88-90 Harbor Road · Port Washington N.Y. 11050
Phone (516) 883.3837 · TWX (510) 223.0889

A defense against cancer can be cooked up in your kitchen.

There is evidence that diet and cancer are related. Follow these modifications in your daily diet to reduce chances of getting cancer:

1. Eat more high fiber foods such as fruits and vegetables and whole grain cereals.
2. Include dark green and deep yellow fruits and vegetables rich in vitamins A and C.
3. Include cabbage, broccoli, Brussels sprouts, kale, cauliflower and cauliflower.
4. Be moderate in consumption of salt-cured, smoked, and name-cured foods.
5. Cut down on total fat intake from animal sources and fats and oils.
6. Avoid obesity.
7. Be moderate in consumption of alcoholic beverages.

HEALTH FACTS SHEET #100
AMERICAN CANCER SOCIETY

detect an abnormal condition, that fact is relayed to the homeowner via a beeping signal when he calls in.

The model GD-1702 easily plugs into a phone line, and operates on



CIRCLE 25 ON FREE INFORMATION CARD

two 9-volt batteries, which are tapped only when relaying information in response to a phone call. It is priced at \$29.95.—Heath Company, Benton Harbor, MI 49022.

DIP IC DISPENSERS, the MDD series, are designed for MOS and CMOS as well as standard devices. The dispensers offer flexibility and convenience. Each channel easily accepts any standard IC shipping tube, and can accommodate any

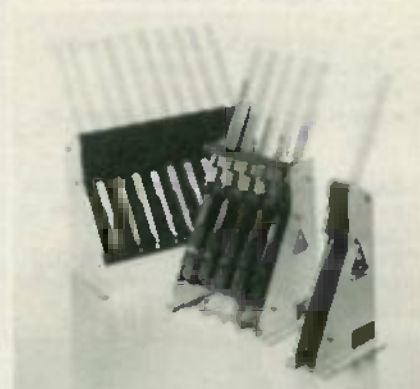

CIRCLE 26 ON FREE INFORMATION CARD

standard IC with 2 to 24 pins on 0.300, 0.400, or 0.600 centers. Adjustable guides position each IC individually for easy extraction, and simple gravity feed assures reliable deposit of each IC into extraction position after the previous IC is removed.

The MDD design ensures effective static dissipation (a grounding lug is included) as well as reliable performance. One-, five-, and ten-channel versions are available.

Dispensers are priced at \$22.88 (1); \$87.37 (5); and \$168.95 (10).—Davle Tech Inc., 2-05 Banta Place, Fair Lawn, NJ 07410. R-E



One tree can make
3,000,000 matches.



One match can burn
3,000,000 trees.



A Public Service of The Ad Council
© The Advertising Council

Radio-Electronics mini-ADS



AN INTRODUCTION TO BASIC PROGRAMMING TECHNIQUES. This book is based on the author's own experience in learning BASIC and also in helping others, mostly beginners to programming, to understand the language. Included is a program library of programs that the author has actually written and run. Order your copy today. Send \$5.00 plus \$2.65 for shipping in the U.S. to Electronic Technology Today Inc., P.O. Box 240, Massapequa Park, NY 11762-0240.

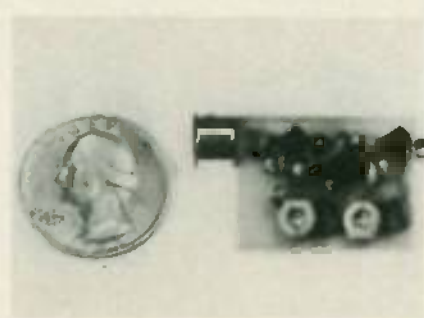

SIMPLY SNAP THE WAT-50 MINIATURE FM TRANSMITTER on top of a 9v battery and hear every sound in an entire house up to 1 mile away! Adjustable from 70-130 MHz. Use with any FM radio. Complete kit \$29.95 + \$1.50 S+H. Free shipping on 2 or more! COD add \$4. Call or send VISA, MC, MO. DECO INDUSTRIES, Box 607, Bedford Hills, NY 10507. (914) 232-3878.

CIRCLE 127 ON FREE INFORMATION CARD



FREE TOOL AND INSTRUMENT CATALOG packed with over 5,000 quality products for testing, repairing and assembling electronic equipment. A full selection of test instruments plus precision hand tools, tool cases, soldering equipment and much more. Products are shown in full color with detailed descriptions, pricing and a 100% satisfaction guarantee. **CONTACT EAST, PO Box 786, No. Andover, MA 01845.** Call (800)-225-5370 or in MA (617)-682-2000

CIRCLE 55 ON FREE INFORMATION CARD



DESCRAMBLE THE NEW VIDEO TAPE COPY PROTECTION SCHEME. When you rent or buy a recent movie release, stop the vertical jumping and jittering in your TV picture with the **LINE ZAPPER**. This project detects and removes selected lines of video that have been modified and often interfere with normal television operation. Get your kit today only \$49.95 plus \$2.00 for shipping and handling. **ELEPHANT ELECTRONICS, Box 41865-L, Phoenix, AZ 85080.** (602) 581-1973. MasterCard and Visa accepted.

CIRCLE 120 ON FREE INFORMATION CARD



SAFE-LEGAL-EFFECTIVE STUN GUN VIPER II. Instantly immobilizes an attacker up to 15 minutes. Penetrates through leather and thick clothing. Discharges 50,000v from a single 9v NiCad battery. Used by police around the country. 1 Year Guarantee. 1 Viper II \$39.95. With NiCad battery and charger \$49.95. Free belt clip with every VIPER II. Catalog Free. **United Imports & Mfg., 6846 Pacific St. RE1, Omaha, NE 68106.** (402) 554-0383. TLX: 5106016153. MC, VISA, C.O.D.

CIRCLE 199 ON FREE INFORMATION CARD



NEW JERROLD CS 68 CHANNEL CABLE TV CONVERTER with volume control & descrambler loop (Port). Programmable clock turns TV on/off & changes channel. Audio mute kills commercials. Programmable channel scan. Instant channel recall. Automatic fine tuning with manual override. Video & audio outputs. Friendly to all descramblers. Specify output. 1 year warranty. \$139. \$118 ea./case lot of 10. Free delivery. Dealers wanted. 514-739-9328. **CROSLEY ELECTRONICS, Box 840, Champlain, N.Y. 12919.**

CIRCLE 191 ON FREE INFORMATION CARD



60 dB SIGNAL ELIMINATOR—for removal of undesirable TV/FM/VHF signals. Can be tuned precisely to ANY signal within these ranges: *Model 26 - Ch's. 2-6 plus FM (54.108 Mhz) *Model 1422 - Ch's. 14(A) - 22(1) (120-174Mhz) *Model 713 - Ch's. 7-13 (174-216 Mhz) Highly selective notch/adjustable strength. Singles \$30. Quantity discounts to 60%. **STAR CIRCUITS - P.O. Box 8332 - Pembroke Pines, FL 33084**

CIRCLE 94 ON FREE INFORMATION CARD



MICROWAVE ANTENNAS \$69.95. Now including shipping and Lifetime warranty We Repair all types of Downconverters. Cable Converters and equipment available! Jerrold 400 wireless Converter \$72.95 plus shipping. Coax cable, T.V. parts, accessories, connectors, T.V. amplifiers. Write for free catalog or call for prices. **BLUE STAR IND., Dept. 105-RE12-86, 4712 Ave. N, Brooklyn, N.Y. 11234** (718) 338-8318 Ext. 105.

CIRCLE 85 ON FREE INFORMATION CARD



ZENITH SSAVI, SALE \$169. UHF gated pulse \$199. Original-reconditioned equipment for UHF channels 27,48,51, etc. Quantity discounts. Satellite Systems; surplus N-12, SB-3, Hamlin 1200. Converters, amplifiers, accessories. Catalog containing coupon \$1. SSAVI modification/troubleshooting handbook \$6.50 ppd. **AIS SATELLITE, INC., P.O. Box 1226-RE, Dublin, PA 18917.** (215) 249-9411.

CIRCLE 81 ON FREE INFORMATION CARD

Radio-Electronics mini-ADS



A CAREER START FOR THE 21ST CENTURY. Since 1905, National Technical Schools has helped people build successful careers. Enter the 21st Century through home study courses in Robotics, Computer Technology and Servicing, Microprocessors, Video Technology, Basic Electronics, Transportation Technology, Climate Control Technology or TV and Radio Servicing. For a **FREE** catalog, call 1-800-B-BETTER. Or write **NTS/INDEPENDENT TRAINING GROUP**, 456 West M. L. King Jr. Blvd. L.A., CA 90037.

CIRCLE 181 ON FREE INFORMATION CARD



THE MODEL WTT-20 IS ONLY THE SIZE OF A DIME, yet transmits both sides of a telephone conversation to any FM radio with crystal clarity. Telephone line powered - never needs a battery! Up to 1/4 mile range. Adjustable from 70-130 MHz. Complete kit \$29.95 + \$1.50 S+H. Free Shipping on 2 or more! COO add \$4. Call or send VISA, MC, MO. **DECO INDUSTRIES**, Box 607, Bedford Hills, NY 10507. (914) 241-2827.

CIRCLE 127 ON FREE INFORMATION CARD



"SODDER" WITH THE NEW BUTANE POWERED PORTASOL. No matter how you spell it Portasol is the handiest soldering iron around. Seven inches long. Variable power: 10 to 60 watts. 60 minutes use per refill. Only \$29.95 + 2.00 P&H. Replacement tips: 1.2, 2.4 (standard), 3.2, 4.8mm, 7.50 + .50. Butane: 3.50 + .50. VA add 4% tax. Quantity discounts/dealers invited. Visa/MC orders: (703) 323-8000. Mail Ck/Money-order to: **PORTASOL**, 4358 Harvester Farm Lane, Fairfax, VA 22032.

CIRCLE 190 ON FREE INFORMATION CARD

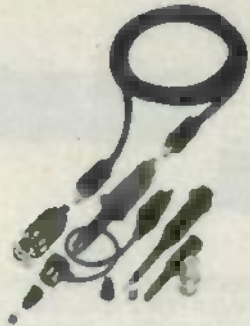

MODULAR PROBE FITS ALL SCOPES

- Save up to fifty percent
- Instant repair - no soldering
- Satisfaction guaranteed
- 250 MHz 10X Attenuation
- Model M12X10 ... \$62 with readout ... \$68

Free accessories catalog. For immediate service call: 800-368-5719 outside Calif. 800-643-8382 in Calif. **TEST PROBES, INC.**, P.O. Box 2113, La Jolla, California 92038.

CIRCLE 123 ON FREE INFORMATION CARD

CALL NOW AND RESERVE YOUR SPACE

- 6 x rate \$745.00 per each insertion.
- Reaches 239,312 readers.
- Fast reader service cycle.
- Short lead time for the placement of ads.
- We typeset and layout the ad at no additional charge.

Call 516-293-3000 to reserve space. Ask for Arline Fishman. Limited number of pages available. Mail materials to: mini-ADS, RADIO-ELECTRONICS, 500-B Bi-County Blvd., Farmingdale, NY 11735.

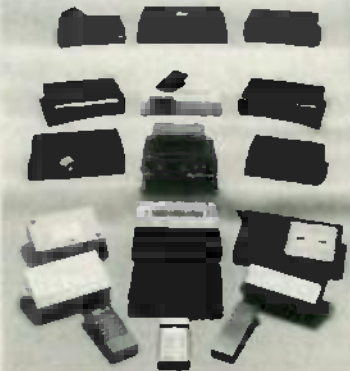

CABLE TV CONVERTERS AND DE-SCRAMBLERS. Large selection of top quality merchandise. Low prices. Quantity discounts. We ship COD. Most orders are shipped within 24 hrs. Send \$2.00 for catalog. **CABLETRONICS UNLIMITED**, P.O. Box 266 Dept. R, S. Weymouth, MA 02190 (617) 843-5191

CIRCLE 186 ON FREE INFORMATION CARD



KEY TO THE FUTURE MICROLAB I by MASTERTECH. A Digital Electronics Course (with working laboratory). Forty lab experiments, comprehensive instructional manual, includes layout techniques, digital logic circuits, flip flops, counters, shift registers, data handling logic—Appendix includes, logic IC's, manufacturers specification sheets. Completely assembled, no other equipment or parts necessary. Price \$249.00—\$15.00 shipping/handling. **MASTERTECH LABORATORIES INC.**, 302 Royal Trust Building, 612 View Street, Victoria, British Columbia, Canada, V8W 1J5, Telephone No. (604) 388-6631

CIRCLE 200 ON FREE INFORMATION CARD



TV STEREO ADAPTER KIT—For the price of a pre-recorded video tape, you and your family can enjoy dynamic stereo sound. Easily connects between your TV/VCR and your stereo system. Also contains a quality Stereo Simulator for non-stereo programming. Available in kit form \$47.95 or assembled \$67.95. **DEL-PHONE INDUSTRIES INC.** Box 150, Elmont NY 11003, NY Residence add Sales Tax. (718) 468-7367.

CIRCLE 56 ON FREE INFORMATION CARD

103 PROJECTS FOR ELECTRONICS EXPERIMENTERS



103 PROJECTS FOR ELECTRONICS EXPERIMENTERS. Soft cover; 308 pages of practical, proven plans for the electronics hobbyist...circuits, converters, amplifiers, synthesizers, optoelectronics, power supplies and more. Written and designed by Forrest M. Mims, III. 12491 \$11.50 plus \$2.65 postage in USA. **ELECTRONIC TECHNOLOGY TODAY INC.**, PO Box 240, Massapequa Park, NY 11762-0240.

Computers on the WORKBENCH

The personal computer does some surprising things in the electronics lab these days. Find out what and how right here.

ROBERT GROSSBLATT, CIRCUITS EDITOR

THERE ARE AS MANY APPROACHES TO ELECTRONIC DESIGN AS there are designers. Each one has his own way of going from initial idea to final circuit. Of course, it takes a combination of both experience and creativity to produce working circuitry. But no matter how you arrive at a design, success often depends on the tools you use. Scopes, multimeters, function generators, capacitance meters—all those (and many more) are invaluable when you're working on a circuit. The problem is that the more tools you have, the less space you have on your workbench.

One solution to the space problem is to use a multi-purpose test instrument. If you browse through the ads, you'll find that many different test-instrument combinations are available. For example, many DMM's now come with built-in frequency counters; and they can measure capacitance and

transistor gain, too. Some top-of-the-line scopes even have built-in multimeters. Now the trend to combine various pieces of equipment has been carried over to personal computers as well. More and more companies are producing hardware add-ons for computers so they can be used as bench instruments.

Before we talk about what sort of computer-based instruments are available, it's important to understand what advantages there are to using them. As a general rule, computer add-ons are much more expensive than traditional stand-alone instruments—but they have features that may simply be unavailable on traditional instruments.

For starters, since a computer is (or becomes) an integral part of the instrument, you get data storage and programmability for nothing. This means that the instrument can run



in an unattended mode, take periodic readings, and store them on a disk. You can find that feature on top-of-the-line stand-alone instruments, but you'll pay a top-of-the-line price for them as well.

There's another bonus to using a personal computer as the brains of a test instrument: flexibility. Everyone who has ever used a traditional test instrument has had the experience of not being able to perform some essential test. The desired test could be anything from measuring capacitance on a multimeter to doing distortion analysis with a VU meter. Upgrading a standard instrument, if possible at all, is a hardware hassle; but with a computer-based instrument it may be just a matter of upgrading the software.

Another point is accuracy. As with standard instruments, you can get computer-based instruments with as much accuracy as you want. The number of significant figures is a function of the add-on hardware, not the computer. In fact, the front end of a stand-alone instrument may be very similar to that of a computer-based instrument. The differences between the two come further downstream: LCD display circuits vs. bus-interface circuitry.

There's one BIG problem with computer-based instruments: Not all instruments work on all computers. Designing a computer peripheral is an expensive, time-consuming business. When you open the box and plug it into your computer, you're using a product that represents many man-hours of labor. As a result, the more sophisticated the instrument, the more computer-specific it's going to be.

The instruments we'll talk about here are no exception. If you are interested in a particular instrument, but own a non-supported computer, check with either the manufacturer, a local user's group, or both, for information on a device that is compatible with your hardware. Don't run out and spend your money on anything until you're certain that it will work on your machine.

The IBM DMM?

A multimeter is probably the most basic instrument that you can have on a bench. No matter what you're working on, the chances are that you'll use your multimeter often. The Virtual Instrument Corporation (73 Redding Road, Georgetown, CT 06829) has introduced a computer-based instrument for the IBM that not only works as a multimeter, but gives you a full-featured function generator and universal counter/timer as well. Its specs are shown in Table 1.

As with any other computer instrument, the Virtual Cat is a two-part system. The hardware, shown surrounding the IBM PC in Fig. 1, takes the input signal, processes it, and converts it into data that can be passed to the second half of the system—the software controlling the

TABLE 1—VIRTUAL CAT SPECIFICATIONS

4½-digit autoranging multimeter	
Volts (AC & DC)	200 mV to 200 V in 4 ranges
Amps (AC & DC)	2 mA to 2 A in 4 ranges
Resistance	200 ohms to 20 Megohms in 6 ranges
Decibels	-30 to +48 dB
Accuracy	±0.05%
Isolation	600 V to ground
Counter, timer, frequency meter	
Frequency	10 Hz to 100 MHz
Inputs: Channel A	10 Hz to 100 MHz
Channel B	10 Hz to 10 MHz
Period	0.5 μs to 10 s
Time interval	250 ns to 10 s
Maximum count	100 MHz
Resolution	100 ns
Function generator	
Waveforms	Sine, square, triangle
Frequency range	0.01 Hz to 10 MHz
Resolution	±10%
Accuracy	±4%
Amplitude	0.5 to 20 V
Sweep range	0.1 to 1000 sweeps/sec
Price	
Basic unit	\$1995



FIG. 1—THE VIRTUAL CAT puts a rack of test instruments inside an IBM PC.



FIG. 2—SCREEN DISPLAY of the Virtual CAT: the hardware/software combination provides a function generator, a universal counter, and a digital multimeter.

computer. The hardware for the Virtual Cat consists of a card for the IBM and a box that's used to connect the probes. Since the unit plugs into an expansion slot, it gets its power from the computer. That reduces on-board parts, and results in production savings.

The noise circulating in a personal computer can be a problem for many boards, and it can be a major problem for the Virtual Cat. The reason is that there

are several high-gain amplifiers on the board that are perfectly capable of amplifying noise as well as legitimate signal. The problem is solved, or at least considerably reduced, by housing the card in a metal shield. As you can see from the details in Table 1, the system's specifications are as good as the better stand-alone units.

As shown in Fig. 2, the software puts a sexy display up on the graphics screen that resembles a rack-mounted three-instrument set. That's a clever way to display the data, because it cuts the learning curve way down. Either a mouse or the keyboard can be used to move the cursor to any of the switches and change the settings. Doing so seems a bit strange at first, but after a while it becomes second nature.

You can use the Virtual Cat as a standard-instrument set, but the real strength of the product is its ability to be programmed. It's possible to write BASIC programs that control the operation of any of the three modules in the instrument. A simple program will cause the Virtual Cat to take measurements and record the information on a disk. Not only that, but the files can be loaded into a spreadsheet or database manager for later analysis. Each of the individual measurements will be time- and date-stamped, so you can get an annotated listing of circuit behavior.

If you plan on using the programmable feature of the Virtual Cat, there is a high-level language package available that gives you much more control over the instrument than you have from BASIC. For most applications, however, the

BASIC package will probably be more than adequate. You can load and save instrument setups, and program it to work in an unattended mode. Virtual Instruments plans to add more instruments to the basic package; by the time you read this there should be a digital scope, an IEEE-488 interface module, and a relay switch.

Computer scope

If you're in the market for a scope and you own a computer, you should seriously consider a computer scope. They're more expensive than stand-alone units, but they give you lots of goodies for the money. RC Electronics (5386-D Hollister Ave., Santa Barbara, CA 93111) makes various devices that work in Apples and IBM's, and Heathkit (Benton Harbor, MI 49022) makes two different models for the IBM. All units from both companies are hardware/software combinations that use the graphics capability of the computer to display a scope screen on the monitor.

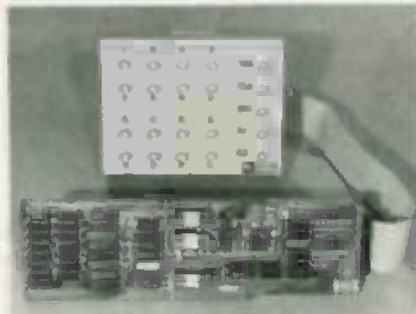

FIG. 3—RC'S IBM COMPUTERSCOPE provides 16 input channels; all interface circuitry fits on a standard IBM expansion card.

The hardware component of the RC Computerscope is a plug-in card and a front panel. The Apple scope is a two-board set, but, as shown in Fig. 3, there is enough room on the larger IBM board to mount everything on a single card. The spec sheets reveal that there is a considerable difference in performance between the two versions of the scope. The IBM scope is much more powerful, has a larger bandwidth, more input channels, and so on. The Apple scope comes in two versions; the difference between them is in the A/D converter used. The APL-D2 uses an 8-bit tracking A/D converter with a worst-case conversion time that provides a bandwidth of 100 kHz. In practice, bandwidth depends on the shape and amplitude of the signal. Some signals will cause the APL-D2 to fall apart at frequencies less than 100 kHz, but others will be measurable up to 1 MHz.

The APL-HR14 is based on a 14-bit A/D converter designed as a combination of tracking and flash converters to provide it with 14-bit accuracy up to a worst-case frequency of 500 kHz. As with the APL-D2, the upper frequency limit depends on the characteristics of the signal being measured.

TABLE 2—RC COMPUTER SCOPE SPECIFICATIONS

Parameter	APL-D2	APLHR-14	IBM	Units
Number of channels	2	4	16	
Vertical sensitivity	0.3-9	1-10	0.200-10	volts
Vertical accuracy	1	0.1	0.1	%
Vertical impedance	44	1000	20	k ohm
Frequency response	100	50	250	kHz
Maximum vertical input	±9	±9	±10	volts
Timebase	3.3 x 10 ⁻⁹	2 x 10 ⁻⁹	1.0 x 10 ⁻¹⁰	sec/
	3.5	-1	-99	datapoint
Sampling rate	3.5	0.5	1	MHz
Accuracy	0.1	0.1	0.1	%
Price	\$985	\$1195	\$2495	

TABLE 3—HEATH SCOPE SPECIFICATIONS

Number of channels	2	
Vertical sensitivity	5 mV to 5 V/div	
Vertical accuracy	5%	
Vertical impedance	1 megohm	
Frequency response	DC to 50 MHz	
Maximum vertical input	125 V	
Time base	500 μs to 20 s/div	
Sampling rate	100 kHz	
Accuracy	5%	
Price		
SD-4802	Kit \$399.95	Assembled \$575
SD-4850	\$499.95	\$750

TABLE 4—SYSTEM ONE SPECIFICATION

Frequency Generator	
Frequency range	10 Hz to 204.775 kHz
Resolution	0.005%
Maximum output	30 dBm (600 ohms)
Accuracy	0.1 dB at 1 kHz
Flatness	0.05 dB (20 Hz to 20 kHz)
Maximum distortion	0.01%
Analyzer Module	
Input range	0 to 140 V rms
Accuracy	0.1 dB at 1 kHz
Resolution	0.1%
Flatness	0.05 dB (20 Hz to 20 kHz)
Noise	-114 dBu
Distortion Module	
Frequency Range	10 Hz to 100+ kHz
THD Range	0 to 100%
Minimum Input	10 mV
Accuracy	0.5 dB
Resolution	0.1%
Price	
Basic unit, single channel, 3 modules	\$5475

The IS-16 and IS-16AT are RC's IBM scopes. The former is made to work in the XT and the latter is designed for the AT. Both are built around high-speed 12-bit converters with 1-MHz sampling rates. The Nyquist criterion indicates that you need a sampling rate that is at least twice the frequency of the measured signal in order to obtain meaningful results. RC claims only 250 kHz as the bandwidth. In practice the limit will vary for the same reason that it does with the Apple versions. Specifications for all versions are shown in Table 2.

All versions of the RC scopes offer digital storage, programmability, and a minimum of two-channel, triggered operation. The APL-HR14 has an optional four-channel upgrade, and the IBM versions can handle as many as sixteen channels. All scope controls are set by command keys on the keyboard, and switching from one mode to another is very simple.

The resolution of the displayed signals depends on the computer. The IBM screen presents a much better image than the Apple screen, but any part of the signal

can be examined in greater detail by expanding the scale. Sample screen and printer output is shown in Fig. 4.

Since the RC units are storage scopes, you can save their signals on disk, and load them for analysis at your leisure. Once you use a storage scope it's really hard to go back to a non-storage type.

You just know that computer instrumentation is where things are going if Heath is getting into it. They have two scopes, both of which are available either in kit or assembled form. Both scopes convert an IBM-PC compatible computer to a 50-MHz storage oscilloscope; one, the 4850, will also talk to an older stand-alone scope and convert it for use as the display of a 50-MHz storage scope. Consequently, the 4850 (shown as this story's lead photo) has a slew of front-panel controls that determine how it works when you use it as a smart front end for a regular scope.



FIG. 4—THE IBM VERSION of RC's Computer Scope provides both screen and hard-copy output.

The 4850, and its less expensive counterpart, the 4802, are stand-alone boxes that output serial data to your computer on a standard RS-232 line. The specs for both units are shown in Table 3. The serial interface lets you forget about computer-generated noise, but it also puts an extra box on your workbench. The Heath scopes put their display on a standard IBM CGA (Color Graphics Adapter) card and are dual-trace triggered oscilloscopes. The current settings, as well as the keyboard command options, are always displayed on the screen, so it doesn't take long to get comfortable with changing parameters and operating the instrument.

Waveforms can be frozen, stored on disk, and then recalled for examination later. One nice feature of the Heath scopes is that you can display two stored waveforms on the screen and simultaneously view a live dual-trace representation of the input signal. Since the stored waveforms are shown using the currently-set time-base and vertical-sensitivity settings, a real comparison can be made with the live traces. You can use any print utilities, including the PrtSc (Print Screen) key, to get a hardcopy image of the displayed waveforms.

The scope's operating software is writ-

ten in BASIC, and a compiled version of the program is what actually drives the system. The disk also contains the uncompiled version of the program, so that if you're into programming, you can customize the operation of the scope to fit any application you have in mind. And since the scopes deliver data via the RS-232 port, you can talk to the instrument via modem and do remote signal measurements. Heath supplies the necessary software on the disk that comes with the scope.

Stand-alone storage scopes are coming down in price, but even the most expensive ones don't have all the features you get on a computer-based scope. Both Heath instruments are reasonably priced when you add up all the goodies you get.

Computerized audio testing

Computer-based test instruments aren't limited to standard bench meters. Several companies make high-quality products designed for special markets. Audio Precision (P. O. Box 2209, Beaverton, OR 97075) is a small company that produces a set of instruments specifically designed for audio analysis. Their IBM system consists of a short-slot plug-in board as well as a set of external rack-mount boxes. The measuring hardware is external because of noise in the IBM. A DB-25 on the rear of the plug-in card allows the internal and external hardware to communicate. Specifications are shown in Table 4.

Although Audio Precision uses a DB-25 connector, communications between the two parts of the hardware are not done serially. As we mentioned earlier, when doing A/D conversion, the sampling rate must be at least twice the frequency of the signal being measured, depending on the accuracy you want. The lower limit is twice the measured frequency, but the upper limit is set by the designer, circuit costs, etc.

Audio Precision's *System One* was designed with no compromises in mind, and its performance specs are as good as, if not better than, many stand-alone instruments. The sampling rate is so high that it would require a rate of about 40 kilobaud on a standard RS-232 channel. As a result, the system uses a parallel interface. The rack (i. e., the external hardware) contains the notch and bandpass filters used for various kinds of analysis, as well as the generators for producing various test tones.

The *System One* is a computer-based instrument, so the rack and the device under test are controlled via software. To take a simple example: If after connecting the hardware you want to test to the rack, the rest of the test procedure is done from the computer's keyboard. Software is loaded and the instrument panel is selected from a menu that appears at the bottom of the screen. The output of the

frequency generator can be set on the left, and the measured data will be shown in the center. The present analyzer settings are also displayed in the center panel. You can change frequency, phase, bandwidth, and so on with a few keystrokes, and immediately see the results of those changes on the computer's screen.

The real advantage of the *System One* is the fact that it's being run on a computer. Not only can any of the test results be graphed, but the software lets you define the coordinates, scaling, signal source, and other parameters. And, like the computer-based scopes, test results and setups can be saved in disk files.

System One also allows unattended testing. In addition, a text editor can be called from the menu to let you write test procedures in an English-like language. Once you're familiar with the syntax, you can link several tests together and have them run sequentially at specified times. Procedures can have conditional statements in them, so you can run unattended tests with as much nested conditional branching as you need. You can also specify limits in any test or procedure. And since a procedure can call in as many previously-saved test and limit files as you want, the *System One* is flexible enough to do even the most complicated sort of audio testing automatically.

The basic Audio Precision hardware does a wide range of audio testing, but its utility can be increased with optional extras. The extra hardware allows you to measure several kinds of IM distortion and wow and flutter; the addition of a switcher will let several devices be connected to the system at the same time.

Sceptre III

Even major semiconductor manufacturers are recognizing the power available on today's personal computers. Gould-AMI (3800 Homestead Road, Santa Clara, CA 95051) has a system available for the IBM that aids the design of gate arrays and other IC's. The *Sceptre III* is a graphics-oriented package that allows OEM's to design and debug gate arrays. When the design is complete, you send the disk to AMI where its data is used to build an actual IC.

Conclusions

The computer-based instruments we've discussed are only the tip of the iceberg. There are many others, and more are showing up every day. In general, they're more expensive than their stand-alone counterparts, but you get much for your money. And as for IC-design software, it's interesting to note that several semiconductor companies have software packages that run on VAX workstations. But few have awakened to the incredible power waiting inside the very same box used for blasting aliens with a joystick. R-E

Computer-AIDED ELECTRONICS Design

High-powered design tools now run on personal computers; those tools eliminate much of the drudge work of design, increase productivity, and are fun to use!

ROBERT GROSSBLATT, CIRCUITS EDITOR

WHEN PERSONAL COMPUTERS STARTED TO SHOW UP IN THE late 1970's, the two most important qualifications for buying one were a healthy amount of both cash and curiosity. Even a basic machine cost a great deal of money, and there wasn't much software available. As a matter of fact, you could do little more than enter simple programs via front-panel switches, and read data on front-panel LED's. Not the most exciting way to spend a rainy evening.

Fortunately, the capability of the personal computer has increased dramatically in the ten or so years since it first appeared. As things stand now, the gap between the mainframe and the PC is narrowing rapidly. New silicon superstars such as the 68020 and the 80386 can address gigabytes of memory, run as fast as 25 Mhz, and do real multi-tasking. What that means is that, within a few years, about the only thing you'll need a mainframe for is operating NORAD—and who wants to do that in the living room?

As PC hardware gets more and more sophisticated, so does the software that runs on it. For example, the primitive graphics programs of a few years back have matured into sophisticated CAD packages with features specifically designed for particular applications—architecture, mechanical engineering, and, of course, electronics.

The number-crunching power of the typical PC has been used to eliminate the brain damage and tedium usually associated with a whole range of design activities. And nowhere is that more evident than in electronics design. As things stand now, a modest investment in software will not only save you countless hours of bench-time and breadboarding, but will also allow you to do waveform analysis and troubleshooting without ever touching a component!

There are many types of computers and many types of software; but there are also, unfortunately, no standards. A disk containing software for one computer is unusable on



TABLE 1—PROGRAMS AND PRICES

	Apple II	Macintosh	IBM-PC	HP-150
Microcap	\$475	—	\$475	\$475
Microcap II	—	\$895	\$895	\$895
Micrologic	\$450	—	\$450	\$450
DADiSP (1)	—	—	\$795	—
Modeler	—	(2)	—	—

Notes: 1. DADiSP is available for a number of computers. Contact the manufacturer for details.
2. Contact the manufacturer for current licensing information.

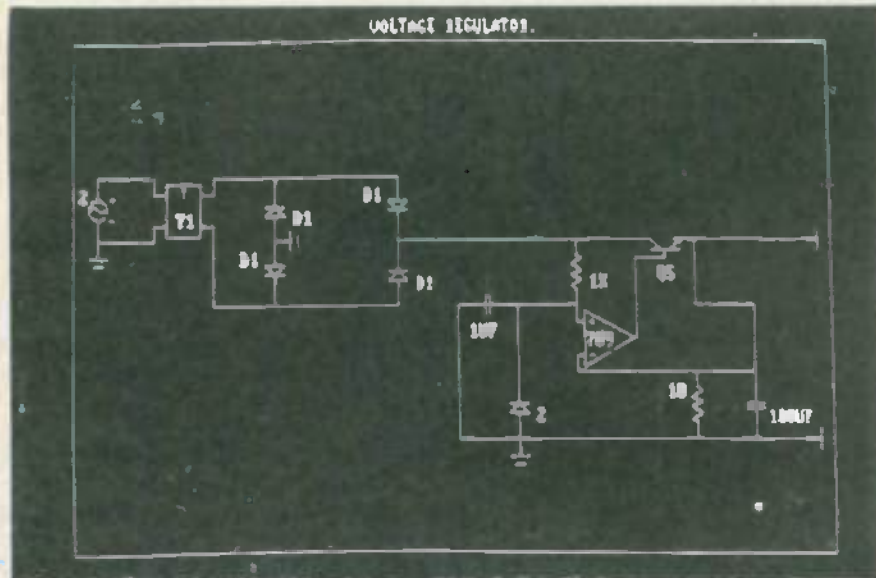

FIG. 1—THIS VOLTAGE REGULATOR was drawn by Microcap; the numbered nodes represent points where signal analysis can be done.

another. Some of the software we'll be describing is available for several different machines, but much of it runs on one and only one computer. Table 1 shows which of the programs that we'll discuss are presently available for which computers, but check with the manufacturers—new versions of hardware and software are announced from time to time.

1986-style design

In the past, the first thing you might do when you had an idea for a new circuit was to sit down with paper and pencil and start drawing circuits. Now you can use a computer for brainstorming; doing so gives you several advantages. For example, many general-purpose graphics programs will let you draw pictures on the screen, save them to disk, edit them, and print them. However, a few programs take things a step farther. Micrologic and Microcap from Spectrum Software (1021 S. Wolfe Road, Department F, Sunnyvale, CA 94087) work together to allow you to draw a circuit on the screen and then analyze it by looking at the waveform generated at any node in the circuit.

Although the look and the program flow of both Microcap and Micrologic are similar, Microcap deals with analog circuits, and Micrologic deals with digital

circuits. If you're familiar with one program, you'll have no trouble using the other.

Software simulation of a circuit is an easy way to check a design without risking turning silicon into scrap. And, given the complexity of those programs, the learning curve is surprisingly short. Circuit data can be entered graphically or by generating a netlist that describes the components and how they're connected.

A separate part of the program lets you define the characteristics of each of the components you'll be using. Doing so allows you to specify things like transistor gain, op-amp slew rate, logic-element truth tables, and so on. Then, after you've defined the operating characteristics of your components, you can lay out the circuit using the graphics editor. The last step is to analyze the circuit.

Example output

Figure 1 is a voltage regulator that was drawn with Microcap. The symbols used in that drawing come from a standard library that is supplied with the program.

Adding components to the drawing is a simple matter of moving the cursor to the desired position and then telling the program that you want to add a part. You'll be asked for the type of part, its orientation,

and other parameters. As soon as the software knows exactly what you want, it will draw the component on the screen.

If you're going to use a sub-section of a circuit more than once, you can save a great deal of time by building a circuit macro, analogous to a spreadsheet macro. The resistor network shown in Fig. 2, for example, could be converted to a macro and used in other drawings simply by loading it from disk.

Because a macro is a shorthand way of including a pre-drawn circuit in a new design, an additional step must be followed when the macro is defined. After the macro is complete, you must label the points in it that will connect to the circuit using it. (It's much easier to do than to describe.) In Fig. 2, we labeled four points (A, B, C, and D) and saved the drawing to disk. Then we could add it to another drawing just as we would add any component.

To insert a macro, move the cursor to the point in the circuit where you want the macro to appear, and then use the same keystrokes as in adding any other component. The result can be inserted as many times as you want. Macros not only simplify circuit creation, but they also make it easier to understand the drawing.

Figure 3 shows the drawing of a simple RLC circuit that is driven by a pulsed voltage source. By doing a transient analysis on the circuit, Microcap processes the drawing and comes up with a netlist similar to the one shown in Table 2. Microcap shows you the parameters used for the analysis and lets you change them, if desired. Then Microcap does the circuit

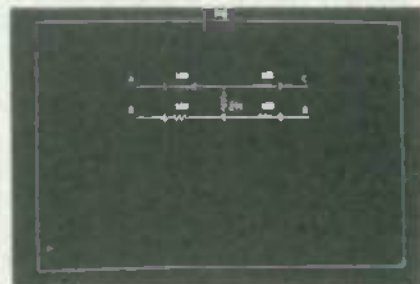

FIG. 2—THIS RESISTOR NETWORK is a "macro" circuit that can be inserted into another circuit as if it were a single component.

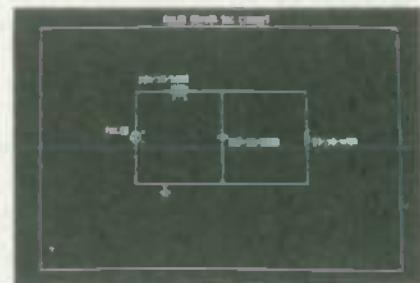

FIG. 3—THIS SIMPLE RLC NETWORK is driven by a pulsed voltage source; the pulse parameters can be defined independently.

TABLE 2—RLC NET LIST

No.	Type	A	B	C	D	Parameter
4	V(T)		0		1	Pulse
7	Inductor		1		2	1 μ H
10	Capacitor		2		0	0.001 μ F
17	Resistor		2		0	50 ohms

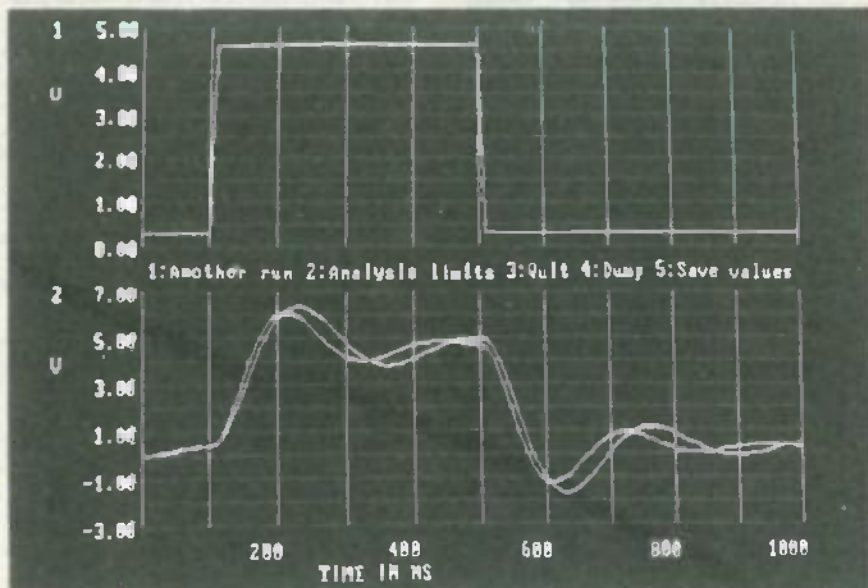

FIG. 4—THE UPPER WAVEFORM shows the output of the pulse source in Fig. 3; the lower waveform shows the waveform at the right edge of the coil (node 2).

math and graphically presents you with the results, as shown in Fig. 4. The top curve is the voltage waveform at node 1 (the output of the squarewave generator), and the bottom curve is the waveform generated at node 2.

In addition to transient analysis, Microcap can also do AC, DC, and Fourier analysis. Micrologic can do similar things with digital circuitry. Without going into detail, both the schematic (Fig. 5-a) and the timing diagrams (Fig. 5-b) are typical of what Micrologic can do for you.

Circuit-design spreadsheet

The real usefulness of Microcap and Micrologic is their ability to analyze the drawings they produce. There are more powerful graphics-only programs, but, as far as electronics is concerned, being able to simulate real-world circuit operation is much more important than generating pretty artwork.

Spreadsheets let you manipulate financial data and play "what if" games. Micrologic and Microcap let you examine the operation of a circuit without ever

touching a single piece of silicon. However, it takes much time and many keystrokes to analyze a circuit, change a few things, and then analyze it again. More than that, there's just no way to do a side-by-side comparison of several versions of a circuit. However, within the past year or so, software has become available that gives you the flexibility of a spreadsheet for doing that type of circuit analysis.

For example, DADiSP (Data Acquisition and Digital Signal Processing) is a piece of software from DSP Systems (1 Kendall Square, Cambridge, MA 02139) that gives circuit designers the same power that Lotus 123 gives to accountants. It's a scientifically oriented spreadsheet whose cells display graphs rather than numbers. DADiSP has more than 150 different scientific functions built in, so entering the formula for a particular waveform is relatively painless.

Let's suppose that you've designed a circuit and have collected data by operating the circuit with a range of different input signals, time constants, and so on. Once you've entered your data in a file, it can be loaded into one of the spreadsheet cells and the program will display the data in graphic form. See Fig. 6. DADiSP will let you perform a number of different analyses, as well as manipulate any of the graphs displayed on the worksheet. Available functions range from simple signal arithmetic to complex calculations that use trig and calculus.

One strength of the program is its ability to refer to one window as a variable. For example, as shown in Fig. 7, you can see the result of a point-by-point multiplication of two signals (which are displayed in windows 1 and 2) by moving the cursor to a third window and entering the formula $W2 \cdot W1$. Then you can integrate the output of the third window, and display it in a fourth. That sort of analysis and

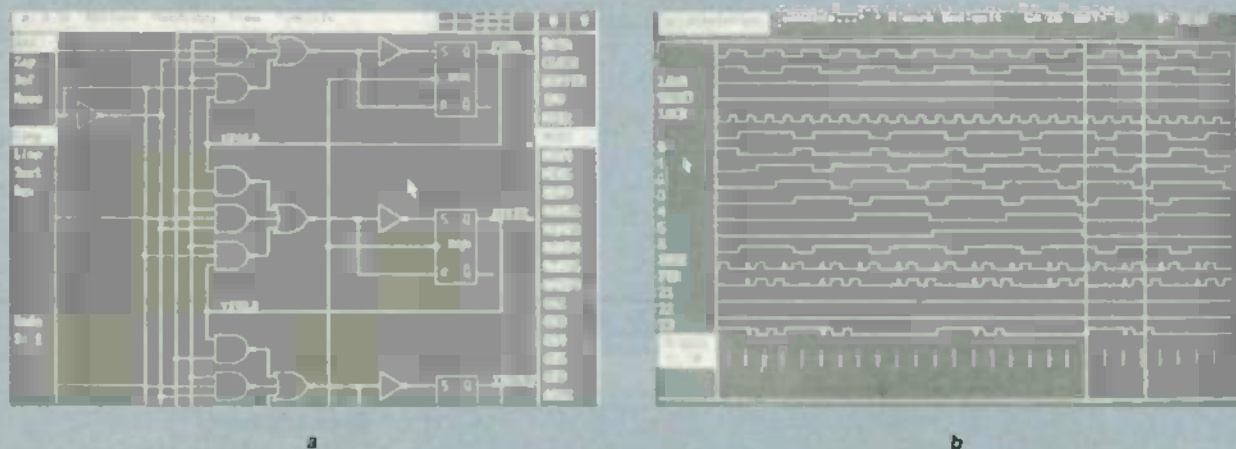

FIG. 5—MICROLOGIC, the sister program of Microcap, can also do digital circuit analysis.

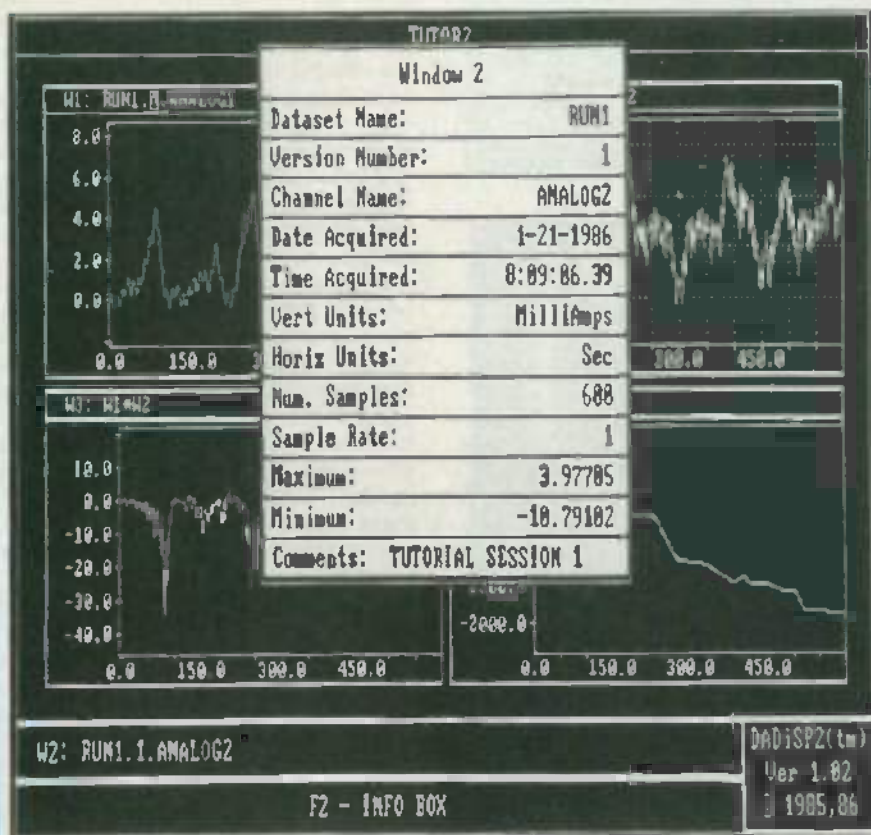

FIG. 6—A SPREADSHEET FOR ELECTRONICS DESIGNERS. DADiSP converts a circuit's operating parameters into graphic form and displays it in one of 64 cells. The software allows you to perform a wide variety of analyses and to manipulate the graph displayed in any of the cells. Mathematical operations ranging from simple arithmetic to complex calculations can be performed on the data.

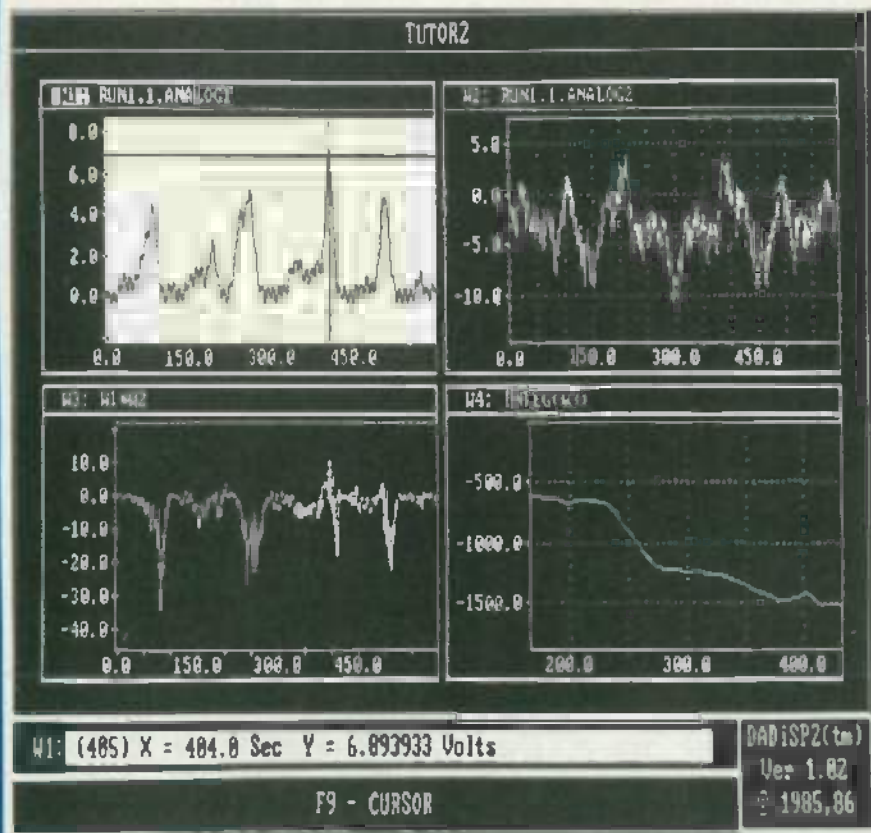

FIG. 7—THE DADiSP SPREADSHEET lets you relate cells and derive results by combining those cells in various ways. Windows 1 and 2 show two independent signals; and Window 3 shows their product; and Window 4 shows the integration of Window 3.

editing can be done with any of the program's built-in functions and arguments.

DADiSP is a 64-cell spreadsheet; the graphs contained in each cell can be interrelated. That means that changing the data in one cell will change the data in any related cells. Playing "what if" using those capabilities can enable you to fine-tune a complex analog circuit without physically changing a single component in the actual circuit.

One of the program's neatest features is its ability to graph the measured points and then interpolate the plot. DADiSP lets you look solely at a plot of your data, or at a curve that represents the best fit. After the program fits a curve to your data, you can activate a cursor that moves along the curve and shows you the interpolated coordinates. For example, if you've plotted voltage versus time, DADiSP will give you interpolated values of voltage as you sweep the cursor across the time scale.

That type of interpolation can be a real time-saver when you do some kinds of analog circuit design. Imagine, for example, designing an oscillator or a filter circuit and calculating the values for the RC components. Doing the math isn't difficult, but attaining a specific frequency using standard-value parts can be exasperating. A good deal of that type of brain damage can be eliminated with DADiSP by plotting a graph of the circuit's time-constant formula and then running the cursor along the result. As you move the cursor, the relevant RC values will show up at the bottom of the screen.

Other useful features include the ability to expand and compress the displays and automatically take care of scaling. Those features are important when you want to examine just a small part of a curve or look at an expanded time scale.

DADiSP isn't for everyone. It's an expensive piece of software, and it's only useful for some kinds of design and some kinds of designers. If you decide on component values by plugging things in and crossing your fingers, you won't get much use from the program. But for designers who do a lot of calculating and reading before ordering parts, DADiSP can be tremendously helpful.

DADiSP is like any other sophisticated analytical tool: the more it's used, the more useful it becomes. If your circuit designs are heavily math intensive, the software may be well worth the investment in time and money you'll have to make. The program goes a long way toward helping you visualize the effects of varying circuit parameters and making sense out of real-world data.

Bose's Modeler

The number-crunching and graphics capabilities of computers are slowly being put to use to solve problems in just about every area of electronic design. Paper-

work and guesswork are being replaced by software and keystrokes. One field that is just starting to benefit from the use of the computer is acoustic design. Setting up a successful sound system in a large room has traditionally been the result of a combination of physical measurements, past experience, speaker dynamics, and a great deal of personal bias.

Before any attempt can be made to decide on the installation for a particular room, an enormous amount of data must be collected. Room dimensions and construction details, architectural features, reflectivity, and speaker characteristics are only a few of the specifications that must be known before design work can begin. Even then the math is time-consuming and must be re-done if any of the data changes.

The Bose Corporation has recently introduced acoustic design software called Modeler that simplifies data entry and uses extensive graphics to display an acoustic model of the room. The designer

uses the program's graphics front end to create a set of planes that define the room, and then he specifies the physical material of each of the planes.

Next the computer builds a three-dimensional model of the room, taking account of the degree of sound absorbency and reflectivity of all surfaces. The model is displayed on-screen; it can be rotated around any of the three axes and redrawn to show the view from any angle. Figure 8-a shows a three-dimensional view of a room. You can see how the model was defined by building a series of planes. The location of any point in the room can be found because the plane dimensions and elevations were entered into the program while the room was being drawn on the screen.

The locations of the speaker clusters are entered by putting the cursor at the desired point and indicating which way they point. Since we're dealing with a three-dimensional model, the speaker direction is specified by entering three fig-

ures to represent pitch, roll, and yaw. See Fig. 8-b. The speaker's characteristics are contained in data files, so all that the designer must do is to tell the program what kind of speakers will be used.

After the speaker data has been entered, the computer has everything it needs to calculate and display any of the standard acoustic parameters at any point in the room. Those parameters include both direct and reflected components, time delay, relative loudness, and so on. If a change is made in any of the architectural features or speaker characteristics, the program will recalculate the parameters as necessary.

Being able to spot-check the acoustic parameters at any point in a room is nice, but the sexiest feature of the Bose software is its ability to draw an acoustic map of the room. It does that by calculating the sound-pressure level at every point in the room; it then displays the results using varying shades of gray to represent different acoustic levels.

The resulting gray-scale map gives the designer a graphic representation of the sound level anywhere in the room. That lets him spot areas that need reinforcement or muting, all without installing any hardware.

Modeler provides the acoustic designer with a diagnostic tool that is as powerful in its field as are the other software packages we discussed earlier in theirs. In this case the computer has given the designer capabilities that were unheard of as few as five years ago. The result is greater accuracy, lower design cost, and increased productivity.

Conclusions

The growth of sophisticated hardware and software for the personal computer has been unbelievably rapid since the days of the Altair and the Imsai (the mid-1970's). It's a bit of a mind-bender to realize that some of the things routinely done on personal computers today weren't possible even on mainframes ten years ago.

And there's no end in sight. Even those of us that only like to fool around on the weekend can use computerized tools on a PC to reduce the donkey work of electronics design.

The software we've discussed here is only the tip of the iceberg. Many more products are available and just about every area of electronics, from designing IC's to laying out printed-circuit boards, has benefited from the popularity of the personal computer. If you find yourself spending a great deal of time at the workbench, there's a good chance that your work can be made much easier by using a computer. And you don't need a mainframe to enjoy the benefits that sophisticated design circuitry can produce. Besides, you can't play Pacman on a mainframe. R-E

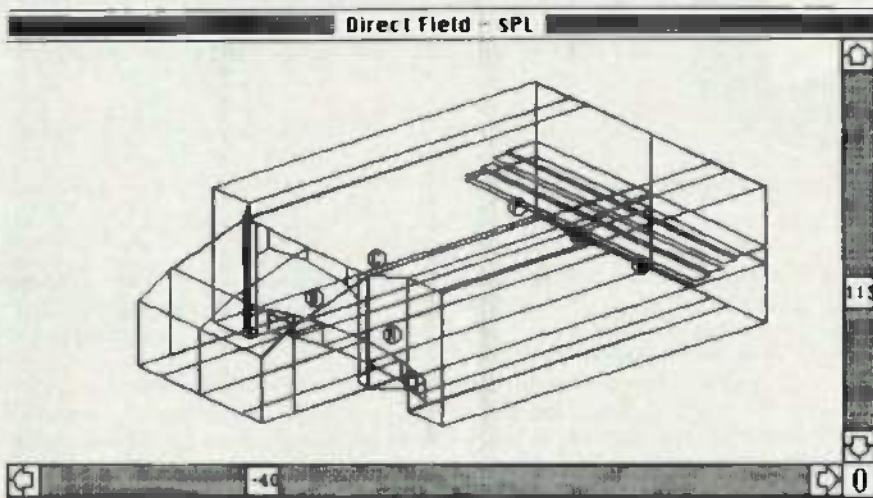

-GREELEY 6.5

Aiming Data							
Date: 9/1/86	Roll 0°		Pitch 0°		Yaw 0°		
SerialNo: 0	Roll		Pitch		Yaw		
Dimensions: Feet	Roll		Pitch		Yaw		
Speaker	Cluster	Height	Roll°	Pitch°	Yaw°	Power(W)	Time(ms)
BOSE S1802 1 kHz	A	8.0	0.0	22.0	0.0	0.0	0
BOSE S1802 1 kHz	B	8.0	0.0	22.0	0.0	0.0	0
BOSE B02 1 kHz	C	16.0	0.0	28.0	0.0	400.0	0
BOSE 102 -- 1 kHz	D	9.0	0.0	50.0	0.0	25.0	87
BOSE 102 -- 1 kHz	E	9.0	0.0	50.0	0.0	25.0	87
BOSE 102 -- 1 kHz	F	9.0	0.0	50.0	0.0	25.0	87

FIG. 8—BOSE'S MODELER lets you do acoustic design on the screen of your computer. The three-dimensional model of a room shown in a is defined by building a series of planes. As shown in b, speaker direction is defined by pitch, roll, and yaw parameters.

BUILD THIS



R-E ROBOT

You needn't be satisfied with a robot that looks and acts like all the rest. You can customize our robot to your heart's content—and share your designs with other readers!

STEVEN E. SARNS

THE BIG ONE FINALLY CAME THIS author's way: a job providing both financial reward and a fascinating challenge for his company, Vesta Technology. The project: To design a robot, including a control computer, an arm, and additional subsystems for motion control, navigation, and operator input/output. While designing the robot, we discovered much about the personal robot industry. For one, it appears to be dominated by expensive robots with limited capabilities. We felt that a new approach could make a home robot more affordable and more exciting.

Designing a robot requires expertise in a number of areas, including mechanics, electronics, and computer hardware and software. In order to augment Vesta's limited abilities in the field of mechanical engineering, we enlisted Stock Drive Products to aid our development effort. That company is the major supplier of mechanical components to the industrial robotics market. See the Sources box for their address.

The cost of a robot

Stop for a moment and consider why personal robots are so expensive. One rea-

son is that a considerable markup takes place at each point in the distribution chain. A manufacturer's purchasing department must have a secure supply of parts, so it may be willing to pay higher prices to attain that security. The hobbyist, however, has the advantage of being able to buy from less-expensive sources of parts. He can, for example, take advantage of surplus outlets, thereby eliminating middlemen; the result is a substantial savings over manufacturers' prices.

As for the controller, we designed a complete low-cost single-board computer that is highly compatible with the IBM-PC. Our approach emphasizes the use of flexible electronics that allow you to customize your robot with available mechanical parts.

By providing the electronic-control system and minimizing mechanical costs, we believe that building a personal robot can be both entertaining and affordable. In the upcoming series of articles, we will show you how you can adapt our designs to your problems.

The main components of our system are the single-board development system, a control/sensing board, and control software. Because the electronics systems are efficient and adaptable, you are free to interface them with whatever mechanical system meets your needs. The systems

software that we have developed (and are still developing) is quite sophisticated, but the applications programming is left to you.

The bottom line is that we are not offering a kit for the type of ready-to-assemble robot that so many other companies offer; rather, we are suggesting that you can build the robot that you really want or need by integrating our control system with your mechanical design.

Overview

As we discuss the specifications of the R-E Robot, keep in mind that you can build your robot with other components, and in other configurations.

Our robot is powered by two 12-volt lead-acid batteries; it has a top speed of five miles per hour. Although we used utility batteries, we could have used auto or motorcycle batteries. Circuitry that indicates when power is low is included on-board, as is a 117-volt AC battery charger.

The robot's drive system consists of two independent 10.5-inch pneumatic tires that are connected to two toothed belt drives and to two 1/2-horsepower DC torque motors. A caster mounted at the rear provides lateral stability and ease of movement.

The robot is equipped with sensors for measuring temperature, light, and sound.

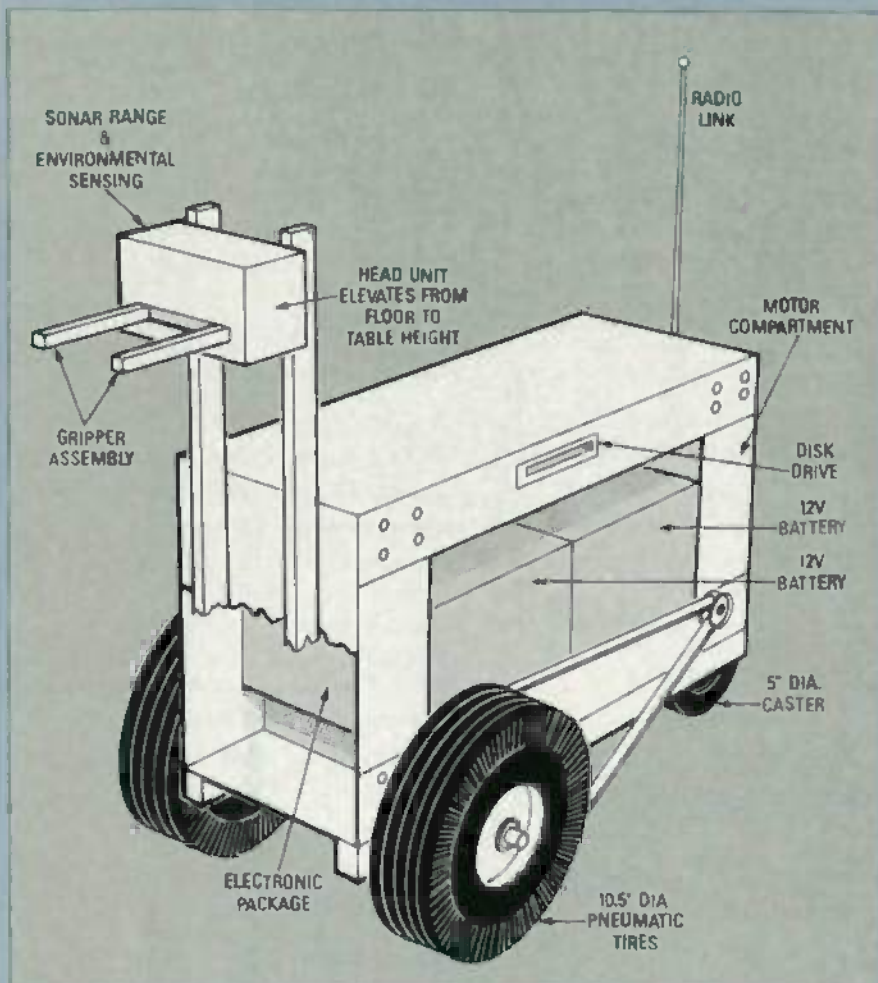

FIG. 1—R-E'S PERSONAL ROBOT has a unique mechanical configuration. This artist's conception shows the overall structure of our prototype. The robot can be modified to suit just about any application.

Microswitch collision detectors and sonar ranging, usable at distances as great as 20 feet, are also provided.

The robot lacks a traditional robot arm. Instead, it features a powerful gripper that rides a vertical track at the front of the unit. The arm, as shown in Fig. 1, somewhat resembles an industrial forklift. While some flexibility is sacrificed using that approach, some important advantages are gained. For one thing, the mechanical design is greatly simplified. That means that greater lifting capacity could be provided without greatly increasing cost. The gripper is capable of vertical travel from floor level to about table height.

In addition, the robot has options for an RF link, a speech synthesizer, and even a speech-recognition system.

The RPC

The hardware that makes it all possible is the RPC (Robotic Personal Computer). The heart of the RPC is a highly integrated Intel 80188 microprocessor; it signifi-

cantly reduces costs by including—in the IC package—many support devices that are external to the 8088 (used in a true-blue IBM-PC). The entire computer occupies a PC board that is less than eight inches on a side.

The interface between the RPC and the I/O unit is an adaptation of the IBM-PC bus. Signals from that bus are available at a 60-conductor IDC connector. That bus allows prototype circuits to be built without using special prototype cards.

Control boards

The RPC controls three custom boards. Board 1, shown in Fig. 2, contains most of the basic control circuits; with it and the RPC, the robot is capable of unsupervised operation. Board 1 controls the two torque (drive) motors. Each PWM (Pulse-Width Modulation) drive-motor controller can deliver as much as 500 watts per wheel. A feedback encoder allows the RPC to keep track of speed and position. Torque load is also monitored.

Other Board-1 functions include grip-

per-motor control, and control of the sonar ranging system. Based on the Texas Instruments and Polaroid sonar systems, the ranging system can be used for collision avoidance, navigation, and security. Board 1 also contains several miscellaneous systems, including the battery charger, the DC-DC converter, and a beeper alarm. The environmental sensing systems (temperature, light, and sound detectors) are also on Board 1. Last, the collision detector outputs are processed on that board.

The robot differs from many projects presented in *Radio-Electronics* in that it is an evolving project. Many of its circuits are still in the design or testing phase. As a result, some of the final details may differ from those presented here. The other two control boards fall into the still-being-designed category. As of now, Board 2 will contain the speech synthesis and recognition hardware, and that Board 3 will house the RF data link.

Software

Complementing the hardware is a flexible programming environment that allows the programmer to choose his favorite and most productive language. The RPC may be programmed in two different ways.

One approach involves use of either of the onboard languages: BASIC and FORTH. Each language is a combination operating system, development system, and high-level language. Each includes debugging support, inherent ROMability, and access to mass storage, and each supports interrupt programming, integrated procedures, and multitasking. An onboard EPROM programmer allows software to be written, tested, and burned into EPROM for dedicated use.

The other approach makes use of the RPC's IBM-PC compatibility. The RPC boots most operating systems designed for the PC, thereby allowing the programmer to choose his favorite language. Assembler, Fortran, Pascal, C, BASIC, Compiled BASIC, and many others are all available. Programs in those languages can also be burned into ROM, if the compiler used generates ROMable code. Program code can also remain stored in battery backed-up static RAM for power-on execution. In addition, programs and data can also be stored on floppy disks. The RPC can accommodate any mixture of as many as four 3.5- and 5.25-inch floppy-disk drives.

RCL

Although the robot's software is not yet as extensive as we would like, modules have been written to test each of the robot's capabilities. The next step is an extremely sophisticated Robotic Control

SOURCES

Can you imagine what a robot we could build with a staff of 250,000 (the entire readership of *Radio-Electronics*)? One key to the success of the R-E Robot is the collective development capability of that readership. In an effort to encourage the exchange of programs, sources of parts, hardware enhancements, and any other items of general interest, *Radio-Electronics*, Stock Drive Products, and Vesta Technology are each offering special support.

Radio-Electronics will open a special section of its new remote bulletin board system (RE-BBS) to builders of the R-E robot. You can reach the bulletin board by calling 516-293-2283.

Stock Drive Products (55 S. Denton Ave., New Hyde Park, NY 11040 516-328-0200) has agreed to supply a kit of parts for the drive sub-system, including two 10-inch pulleys and two 2-inch pulleys. Part number 2Z6-RL11882 is available for \$32.00.

To simplify the mechanical aspects of building a robot, Vesta will sell, for a limited time, an aluminum chassis (resembling the one in Fig. 1) at cost, approximately \$45. The fully-populated RPC will be available for \$294, including 16K of RAM and the FORTH operating system. The Board-1 PC board is available as a bare board for \$41, or fully assembled for \$289. All source code for testing the robot and implementing RCL is available on a 5.25-inch disk for \$2.00. All Vesta products are covered by a 15-day return policy. MasterCard or Visa accepted; no purchase orders or terms available. Please add \$8.00 for shipping and handling for the computer board. Vesta Technology, Inc., 7100 W. 44th Avenue, Suite 101, Wheatridge, CO 80033. 303-422-8088.

Additional sources for various parts and sub-systems will be listed in future installments of this article. **R-E**

Language (RCL). The inclusion of RCL on-board is possible only because of the power of the RPC.

The onboard RCL puts our robot a step ahead of almost all other home robots. Most robots are controlled with obscure software commands. A typical motion function could be programmed as follows:

```
OUT (1,1):REM Turn on drive motors
DELAY 1000:REM For one second
OUT (1,0):REM Then turn off motors
```

RCL allows the operator to program the same function as:

```
10 FEET FORWARD
```

Choosing a language in which to implement RCL was not an easy task. Because RCL was to be interpreted, we had to implement it in a language that executes quickly. To ease development and to allow people to customize RCL for their own purposes, it had to be written in a high-level language. We also wanted to minimize the cost of the hardware required for developing the RCL interpreter.

TABLE 1—
SPECIFICATIONS COMPARISON

	RB-5X Robot	HERO 2000	R-E Robot
Dimensions	13" diameter x 23" high	16.5" wide x 22.5" long x 32.4" high	19" long x 18" wide x 20" high
Weight	24 pounds with arm	78 pounds with arm	55 pounds with arm
Speed	.23 mph	1 mph	5 mph
Arm	4 axes and gripper 12 oz payload 1"/second	4 axes and gripper 16 oz payload 6"/second tactile feedback	1 axis and gripper 10 pound payload 8"/second
Language	Tiny BASIC	Interpreted BASIC with specialized robotic commands	Multitasking FORTH with user alterable Robot Control Language (RCL) overlay
Subsystems	Two RS-232 ports 8 I/O lines Sonar system 8 perimeter bumper panels Speech synthesis	Two RS-232 ports Cassette I/O Sonar system Environmental sensing Speech synthesis Motor speed control Real-time clock Keyboard LCD	Two RS-232 ports Disk drives (4) Sonar system Environmental sensing Speech synthesis Motor speed control Real-time clock Collection sensor
Sleep Mode	No	Up to 6 days	Months
Battery	6 VDC 90 WH Sealed	12 VDC 288 WH Sealed	2 x 12 VDC 480 WH
Operator Interface	Terminal	Teach pendant Keyboard with special function keys and keypad LCD on robot	Terminal Direct or remote connection
Remote Control	None	RF link, 100' range built in to teach pendant	RF link attaches to user supplied RF transceivers
Microprocessor	8073, 4MHz	8088, 5MHz	80188, 8MHz
Mass Storage	2K ROM	Cassette tape, disk optional in future	Disk, optional
Memory	8K/16K RAM 2K ROM	24K/576K RAM 64K ROM	16K/768K 48K ROM
Bus	None	Proprietary 12 slot back plane, based on S-100	Modified IBM "PC" bus using flex cable and simple "ROBUS" expansion bus
Wheels	2" casters 4" solid wheels	3" casters 6" solid wheels	5" casters 10.5" pneumatic tires.
Cost (Basic unit)	\$2,500 assembled	\$2,500 kit	\$850 components

After considering BASIC, C, FORTH, and Pascal, we decided that FORTH met our requirements best. It runs much faster than interpreted BASIC, but it allows interactive program development, testing, and debugging. In addition, that language promotes the writing of modular, struc-

tured programs (as do Pascal and C), but it does not require a disk-based development system.

Another benefit is that FORTH is extensible, which means that the code we write becomes a part of FORTH. Because most

continued on page 94

TV SIGNAL DESCRAMBLING



This month we put our theories to work and build a functional descrambler.

WILLIAM SHEETS and RUDOLF F. GRAF

Part 6 DURING THE PAST FEW months we've been looking at some of the principles behind television-signal encoding and decoding. Now it's time to put some of what we've learned to work. Beginning this month, we will look at three practical descrambler circuits that will decode sine-wave-, gated-sync-pulse-, and outband-sync-encoded signals. Complete schematics, parts lists, and PC patterns will be provided; in addition, a kit of parts will be available.

But before we begin, take heed of this warning:

The decoding circuits that will be presented are for educational or experimental purposes only. It may be illegal to use the circuits to decode encrypted signals before obtaining prior permission from the programming supplier. It is up to the user to determine the conditions for legal use of these circuits and to obtain any permission required.

Sinewave scrambling

As discussed in the June 1986 issue of *Radio-Electronics*, in sinewave scrambling a 15.75-kHz sinewave is added to the video signal. If the sinewave is synchronized to the video signal, the sinewave's negative peaks occur during the video sync's positive peaks. The result is that the peak level of the sync is suppressed below that of the video. See Fig.

1. That suppression confuses the sync separator circuit in a television receiver and stops it from functioning properly. The picture that results is unwatchable: There is a dark vertical band and the video is color-distorted.

The audio may or may not be scrambled. Actually, it's not really scrambled; instead, it's stripped away from the main audio channel and placed on a hidden subcarrier. In sinewave scrambling, that subcarrier usually is located at 62.5 kHz.

Sinewave descrambling

Unscrambling a sinewave-encoded signal is relatively simple. It involves mixing the scrambled signal with a sinewave of

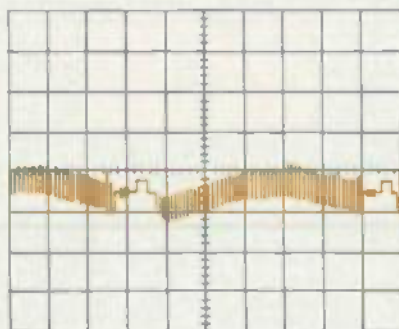
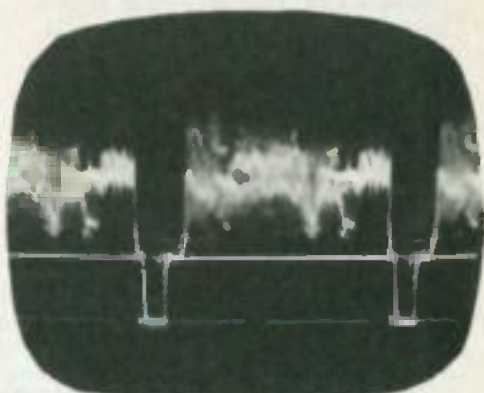

FIG. 1—A SINEWAVE-ENCODED VIDEO SIGNAL. The peak sync is suppressed below the level of the video, confusing the TV set's sync-separator circuitry.



the same amplitude and frequency as the scrambling sinewave, but shifted 180 degrees. The result is that the scrambling sinewave is canceled, leaving a standard video signal. A block diagram of an appropriate descrambler is shown in Fig. 2.

Leaving theory behind, let's look at a practical sinewave descrambler circuit. The bulk of the circuit is shown in Fig. 3. The input and output circuitry is shown in Fig. 4; that circuitry is mounted within a shielded "interface" box. We'll speak more about the box and why it is used when we look at how to install and align the decoder.

The first thing a sinewave descrambler must do is to extract the 15.75 kHz sinewave from the incoming signal. That can be done by filtering it directly from the video envelope after detection.

An IF and video-detector system is formed by Q1, IC1, and their associated circuitry. The output of the TV set's tuner is picked off and fed to that stage via the input/output circuitry. Resistor R1 is used to set the gain of the IF stage while C1 is a DC-blocking capacitor. Resistor R1 should be set so that the input to Q1 is on the order of 1 millivolt. That signal level is provided by most cable systems, but with the value shown for R1, the circuit can accommodate signal levels from 300 μ V to 5 mV.

Transistor Q1 is configured as a single-tuned bandpass amplifier with a gain of

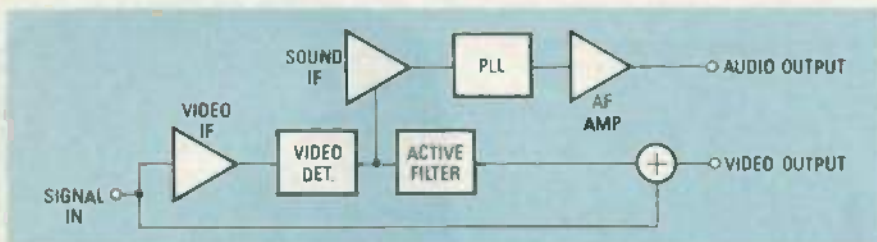

FIG. 2—THE STEPS REQUIRED TO DESCRAMBLE a sinewave-encoded signal are shown here. For more on the theory of sinewave scrambling and descrambling, see the June and August 1986 issues of Radio-Electronics.

about 15–20 dB. It is biased so that the collector current is about 3 mA. A band-pass network and matching transformer is formed by the circuit of L1, C3, and C4. The output of that circuit, at the junction of C3 and C4, is fed to pin 7 of IC1, the video detector. That IC is tuned by the L2-C6 circuit to accept either a Channel 3 or a Channel 4 input.

A 200-mV composite-video signal ap-

pears at the output of IC1, pin 4, and is fed to a narrowband active filter formed by IC2-a, R9, R10, C8, and C9. That filter extracts the 15.75-kHz decoding sinewave. The sinewave appears at the output of IC2-a, pin 1. That sinewave is shifted 180° by a sinewave-phasing network connected to the non-inverting input, pin 3, of IC2-a. That network consists of R12, R13, and C10. The passband of the filter

can be adjusted using R10. However, altering the setting of R10 will not alter the bandwidth of the filter, as that potentiometer also adjusts the Q of the filter. The nominal gain of the active filter is 20 dB. That gain can be altered by adjusting R14.

The output of the filter is coupled via C12 to a bias network consisting of R15 and R16. That network is used to set the DC level on D1, an MPN3404 PIN diode located within the interface box; see Fig. 4. That diode acts as a voltage-variable resistor. A positive-going voltage will cause the impedance of the diode to decrease; a negative-going voltage will cause the impedance of the diode to increase. An isolation network made up of L3 and R17 keeps the input RF isolated from the output sinewave. Capacitors C15 and C14 pass the RF signal but block the output sinewave. Therefore, to the RF input, D1 appears to be effectively across the Input (from tuner) and output (to TV

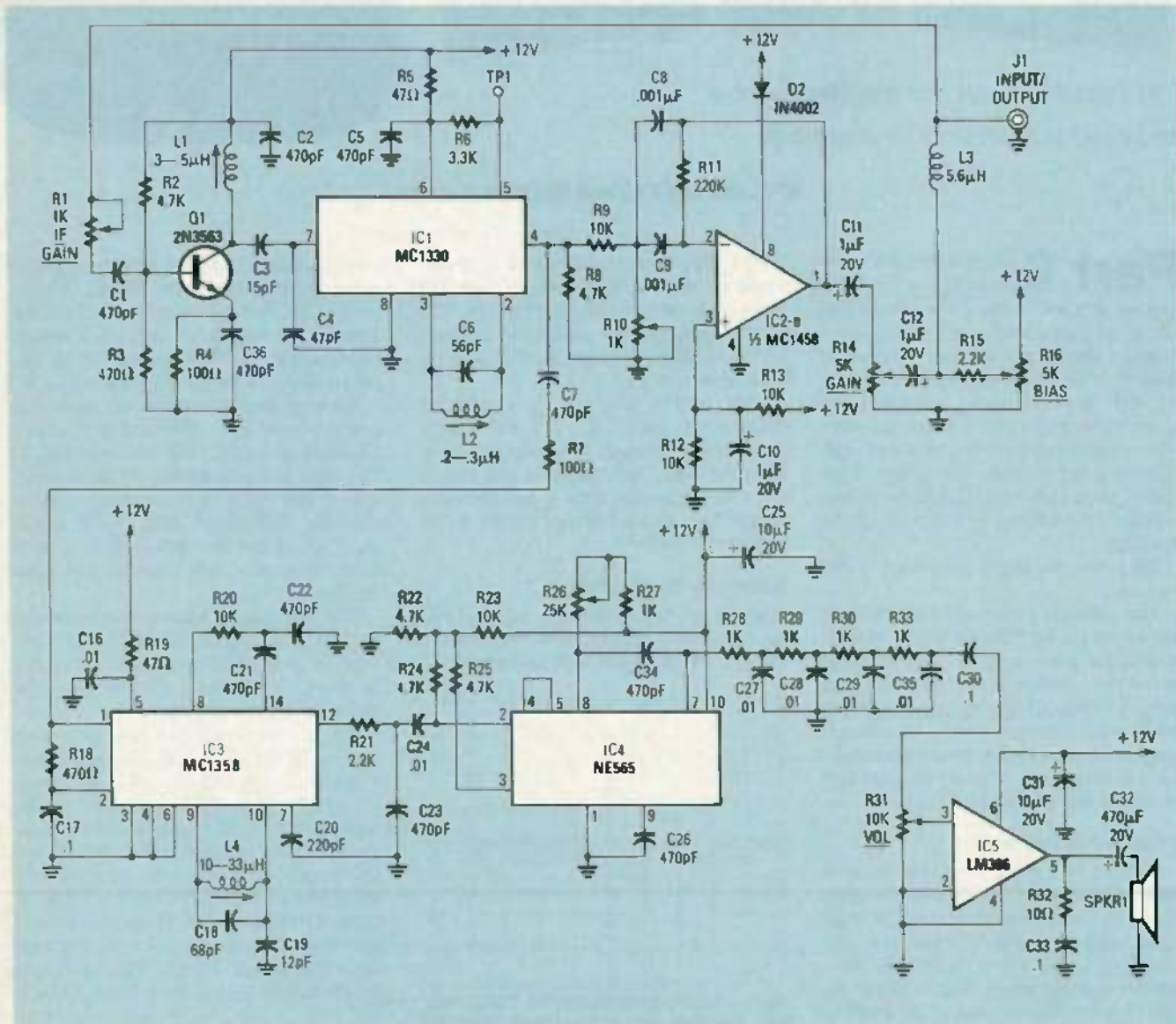

FIG. 3—A COMPLETE SINEWAVE DESCRAMBLER. Easy to build, and relatively easy to align, this circuit completely removes the 15.75-kHz scrambling sinewave.

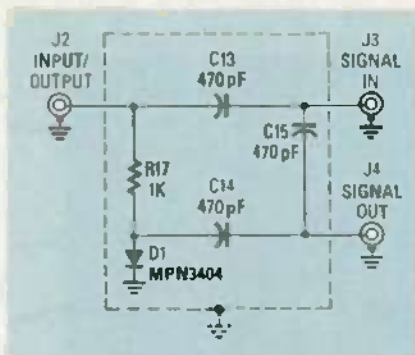

FIG. 4—THE INPUT/OUTPUT CIRCUITRY IS MOUNTED IN A SEPARATE, SHIELDED ENCLOSURE. THAT ALLOWS FOR GREATER FLEXIBILITY IN INSTALLING THE CIRCUIT IN A TV-SET.

network located between pins 9 and 10. The inductor, L2, should be tuned for maximum signal at pin 12. While 62.5 kHz is the most common audio subcarrier frequency, with the values shown virtually all other possible subcarrier frequencies can be tuned by adjusting L2.

The pin-12 output is filtered to extract the audio subcarrier and that signal is fed to the input (pin 2) of IC4, an NE565 PLL. The VCO control voltage appears at pin 7. Assuming that the PLL is in a locked condition, that voltage will correspond to the program audio. For more detailed information on PLL operation, see Part 4 of this series in the September 1986 issue of *Radio-Electronics*.

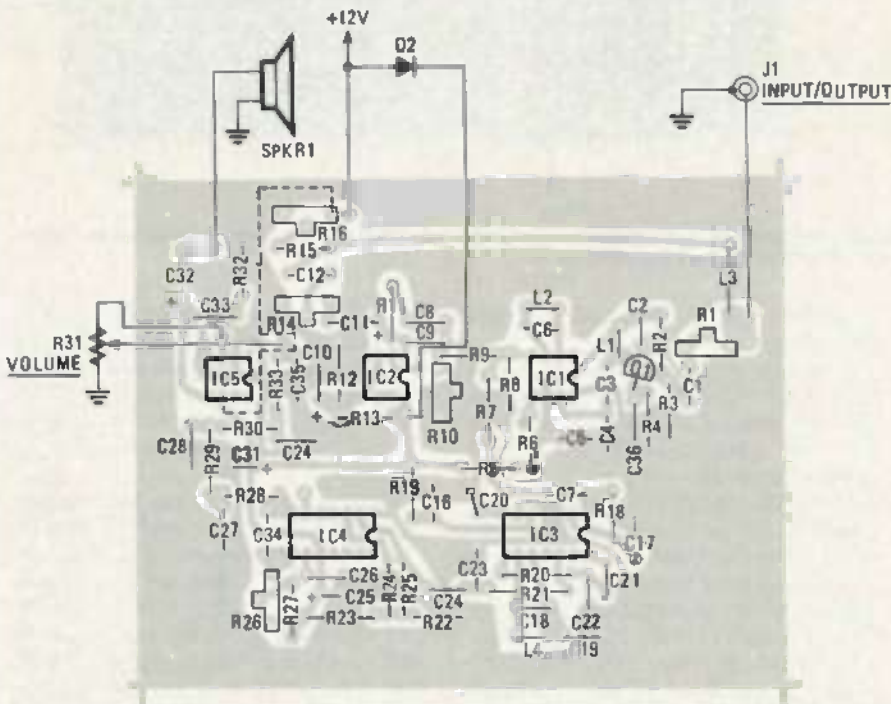

FIG. 5—USE THIS PARTS-PLACEMENT DIAGRAM WHEN BUILDING THE DESCRAMBLER. THE BOARD MAY BE ETCHED USING THE PATTERN FOUND IN PC SERVICE OR ORDERED FROM THE SUPPLIER LISTED IN THE PARTS LIST.

IF) terminals and acting as a lossy shunt. By biasing the diode correctly, the descrambling sinewave can be mixed with the scrambled video, cancelling the scrambling sinewave. The result is a descrambled video signal that is fed back to the TV IF stage via capacitor C14.

Descrambling audio

In sinewave scrambling, the programmer also has the option of encrypting the audio. For systems where the audio is scrambled, IC3, IC4, IC5, and their associated circuitry are used to recover the audio. If it is not needed, that part of the circuit may be omitted.

Part of the video signal at the output of IC1 is picked off and fed to IC3, an MC1358 TV-sound IF amplifier via a high-pass filter made up of C7, R7, and R18. That versatile IC provides 4.5-MHz detection, amplification, and limiting. The detector stage is tuned by the LC

The pin-7 signal is then filtered and coupled to an audio amplifier built around IC5. The output of the amplifier is fed to an external 8-ohm speaker. Volume is controlled via R31. A stabilizing network for the LM386, consisting of R32 and C33, is included to prevent the possibility of undesired high-frequency oscillation.

Building a descrambler

Most of the circuitry is mounted on a single PC board. The foil pattern for that board is found in PC Service. The parts-placement diagram is shown in Fig. 5 and a photograph is shown in Fig. 6.

Other than R31, the volume control, the only components not located on the board are those that make up the interface circuit of Fig. 4. Those parts should be mounted in a small shielded (metal) box. The circuit is simple and its placement within the box is not critical. Strictly speaking, the interface circuitry could have been located

PARTS LIST

All resistors 1/4 watt, 10% unless noted
R1, R10—1000 ohms, trimmer potentiometer

R2, R8, R22, R24, R25—4700 ohms
R3, R18—470 ohms
R4, R7—100 ohms
R5, R19, R33—47 ohms
R6—3300 ohms
R9, R12, R13, R20, R23—10,000 ohms
R11—220,000 ohms
R14, R16—5000 ohms, trimmer potentiometer

R15, R21—2200 ohms
R17, R27, R28, R29, R30—1000 ohms
R26—25,000 ohms, trimmer potentiometer

R31—10,000 ohms, potentiometer, audio taper
R32—10 ohms
R33—1,000 ohms

Capacitors
C1, C2, C5, C7, C13-C15, C21-C23, C26, C36—470 pF, ceramic disc
C3—15 pF, NPO or silver mica
C4—47 pF, NPO or silver mica
C6—56 pF, NPO or silver mica
C8, C9—0.001 μ F, Mylar
C10-C12—1 μ F, 20 volts, electrolytic
C16, C24, C27-C29, C35—0.01 μ F, ceramic disc

C17, C30, C33—0.1 μ F, Mylar
C18—68 pF, NPO or silver mica
C19—12 pF, NPO or silver mica
C20—220 pF, NPO or silver mica
C25, C31—10 μ F, 20 volts, electrolytic
C32—470 μ F, 20 volts, electrolytic
C34—470 pF, NPO or silver mica

Semiconductors
IC1—MC1330 video detector
IC2—LM1458 dual op-amp
IC3—MC1358 TV sound IF amplifier
IC4—NE565 PLL
IC5—LM386 audio amplifier
Q1—2N3563 NPN transistor
D1—MPN3404 PIN diode
D2—1N4002 rectifier diode

Other components
L1—0.3–0.5 μ H, see text
L2—0.2–0.3 μ H, see text
L3—5.6 μ H choke
L4—10–33 μ H (North Country Radio LX10-33 or equivalent), see text

J1-J3—phono jacks
SPKR1—8-ohm speaker
Miscellaneous: PC board, metal box for interface circuit, cabinet (optional), wire, solder, shielded cable, etc.

The following are available from North Country Radio, P.O. Box 53, Wykagyl Station, New Rochelle, NY 10804: Complete sinewave decoder kit, including PC board (metal box for interface circuit not included), item SW-1, \$52.95 plus \$2.50 shipping and handling; Pulse decoder kit, including PC board, item PD-1, \$49.95 plus \$2.50 shipping and handling; Outband decoder kit, including PC board, item OB-1, \$34.95 plus \$2.50 shipping and handling. All three kits may be purchased for \$129.95 plus \$3.50 shipping and handling. The LX10-33 coil (L4 of the sinewave descrambler) is available for \$4.00. NY state residents please include sales tax.

on the main board; but separating it from the main board allows for much more flexibility.

With our scheme, you can mount the interface box within the TV cabinet, physically close to the tuner and IF sections, but leave the remainder of the circuit outside for easier adjustments. Input and output signals are routed between the box and the board using shielded cables. With other schemes, either the whole circuit is mounted within the TV cabinet, making access difficult, or long signal runs are required, inevitably causing signal degradation.

Coils L1 and L2 are hand-wound. Coil L1 consists of 10 turns of number 22 enameled wire wound on an 8-32 screw. Coil L2 consists of 6 to 7 turns of number 22 enameled wire wound on an 8-32 screw. Once those coils are wound, remove the screws and replace them with ferrite slugs. You can salvage those slugs from an old TV set (from a coil in the IF circuit) or the front end of an old FM radio. Coil L4 is a custom part. It is designated as LX10-33 and is available only from the source given in the Parts List.

Aligning the circuit

It may be illegal to use or even align the circuit with the signal from an over-the-air or cable pay-TV programmer without obtaining prior permission. Do not use the circuit in that manner without first obtaining such permission.

In the meantime, it is possible to align the circuit "off-the-air." Doing that can give you greater insight into the way that signal descrambling works. Let's see what equipment is needed to perform such off-the-air alignment before looking at the procedure itself.

The circuit should be powered using a well-regulated, filtered +12-volt DC supply. Any excess ripple can interfere with circuit operation to the point where alignment is not possible.

You will also need an oscilloscope. It should have a bandwidth of at least 5 MHz and preferably 15 MHz, and a sensitivity of at least 100-mV/div. The scope should be equipped with a low-capacitance (less than 10 pF) probe.

You will need some way to simulate the 15.75-kHz scrambling sinewave. That can be done using an AF generator. Your VCR will suffice as a source of normal (descrambled) video. If one is available, a signal generator capable of outputting frequencies to about 70 MHz would be helpful, but it is not absolutely required and you can get away without one.

Connect J1 to J2 using a short length of shielded cable. Then connect power and apply a video signal to the signal-input jack (J3). Nothing should run hot. If it does, measure the resistance between the power supply and ground rails. If it is less than 100 ohms, you likely have a short

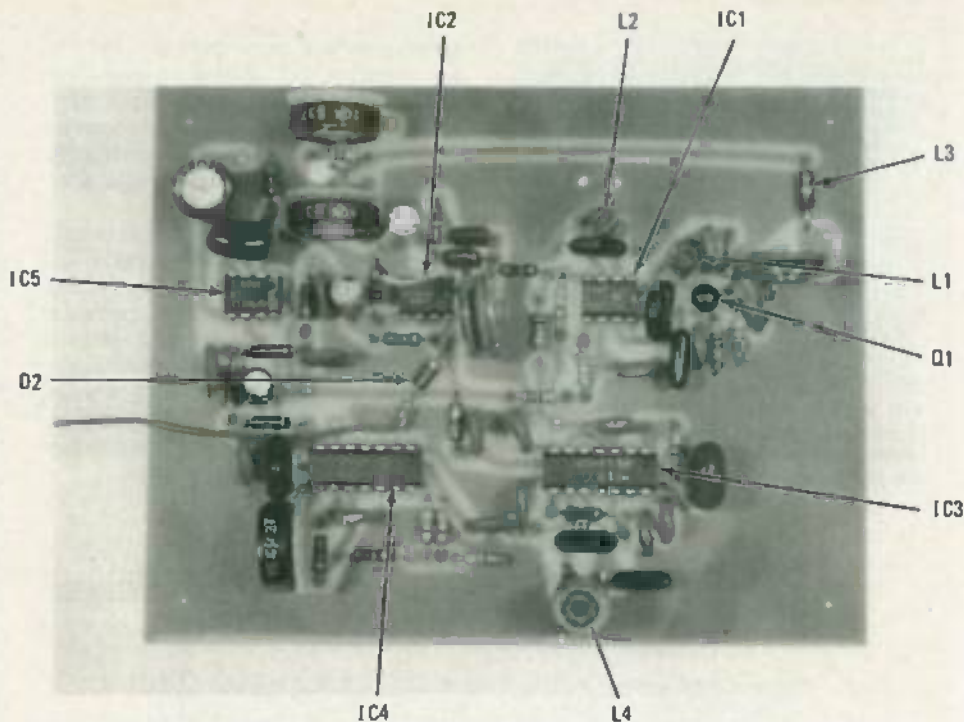

FIG. 6—THE COMPLETED SINEWAVE OESCRAMBLER BOARD contains everything except the volume control and the circuitry shown in Fig. 4.

somewhere. Correct any problems before proceeding.

Next, connect the oscilloscope probe to pin 4 of IC1. Adjust the settings of L1 and L2 for a maximum video signal display on the scope. Then adjust R1 for a video signal of about 250-mV p-p.

Move the scope probe to pin 12 of IC3. Adjust L4 for maximum audio signal as displayed on the scope.

Disconnect the video source. Set the signal generator to output either a 61.25-MHz (Channel 3) or 67.25-MHz (Channel 4) signal. Modulate that signal (30% modulation) with a 15.75-kHz, 1 millivolt p-p signal from the AF generator, and apply it to J3. Connect the scope probe to pin 1 of IC2-a and adjust R10 for maximum sinewave display.

If you do not have a signal generator, place a 1-megohm resistor in series with the AF generator and set the generator to output a 15.75-kHz, 1-volt p-p sinewave. Inject the signal at the junction of R9 and R10. Connect the oscilloscope probe to pin 1 of IC2-a and peak R10 for a maximum display.

Remove the sinewave signal. Replace the series 1-megohm resistor with a 0.01 μ F capacitor and couple the signal generator's output to the junction of C24 and R24. Set the generator's output to a 61.5-kHz, 300-mV p-p signal. Connect the scope to pin 7 of IC4. Adjust R27 so that phase lock occurs. You'll know that you have phase lock when you obtain a rock-steady DC display on the scope. Once you have phase lock, try varying the output frequency of the AF generator. The voltage at pin 7 should track those changes over a range of a few kHz.

That completes the essential checkout procedures. If you have a signal generator, there is one final test you can perform. Once again, modulate a 61.25- or 67.25-MHz signal with a 15.75-kHz sinewave from an AF generator. Apply the resulting signal to J3.

Connect a TV receiver to J4, the signal output jack. Normally, applying just the video carrier to the set will cause a uniform white raster. However, the sinewave should cause a rippling effect. If the circuit is working properly, you should be able to eliminate that ripple by adjusting R16, R10, and R14. If you can, it proves that the circuitry is capable of suppressing the scrambling sinewave.

That completes alignment. If you obtain permission to use the circuit with an over-the-air or cable signal, you will likely need to tweak up performance when the circuit is installed. However, those adjustments should be minor.

Installing the circuit is relatively simple. However working inside a TV can be very dangerous unless you are sure what you are doing. We urge you to be cautious. Basically, the sinewave decoder interface box is installed between the TV's tuner and its IF section. Coaxial cable should be used, and you should provide a bypass switch to take the decoder out of the circuit. You may prefer to use a separate tuner as decoder's front end. Then the only connection required is to the TV's IF. Either way will work, but using a separate tuner may be more desirable.

Next time, we will look at gated-sync and outband-sync descrambling circuits that you can build yourself and experiment with.

R-E

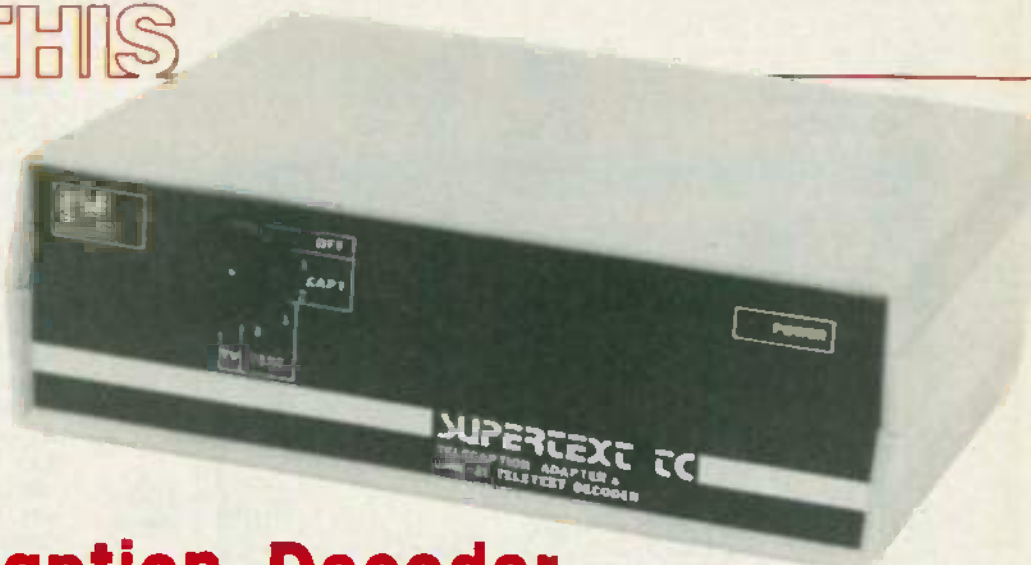

Closed-Caption Decoder

J. DANIEL GIFFORD

Last month we looked at the theory and the circuitry behind the closed-caption decoder. Now let's build one.

Part 2 WHEN WE FINISHED UP last time, we discussed the basics of how closed captioning works, and we presented the complete schematic diagrams of our closed-caption decoder. Now you can warm up your soldering iron—we're ready to build the circuit.

Construction

Building the decoder is fairly easy because it has only a single IC, and because all components, except the switches and power jack J1, mount on the PC board.

The NCI telecaption module, the heart of the decoder, mounts in the bottom of the case, and the PC board mounts in the top. The close quarters in the case require that all components on the PC board be low-profile types with heights less than one inch. The only problem component is the 7805 regulator, which requires a relatively large heatsink. We solved the problem by installing a vertical-mount heatsink horizontally.

To begin construction, first inspect the PC board (whether you make your own or buy the kit) for plugged holes and broken or shorted traces. Fix any and all faults before proceeding.

Following the component-placement diagram in Fig. 7, install the three jumpers using 22-gauge bus wire. Keep the jumpers tight and flat against the surface of the board to prevent shorts. Next, insert 26 PC pins into the holes in the board where wires will connect: 15 along the right edge of the board (where the NCI module will connect), two for J1, two for S2, and seven for S1. Turn the board over

carefully and rest it on the pins while you solder them in place.

Next install the 59 fixed-value resistors. The holes for all the resistors are spaced so that the leads of each resistor can be bent right at the body. To ease troubleshooting, mount the resistors so that the color codes point the same way.

Install the capacitors, taking care to orient the polarized electrolytic and tantalum types correctly. Keep all the capacitors as close to the board as possible, bending their leads if necessary to match the hole spacing.

Install the diodes next, taking care both to orient them correctly and not to mistake the different types. In particular, be certain that the 6.2-volt Zener is inserted in the D3 position, and that the 8.2-volt Zener goes in the D11 spot. Use care in bending the leads of the diodes, particularly the glass types.

Now install the transistors. To avoid mixing up the two types, first insert and solder the five PNP devices (Q3, Q5, Q10, Q13, and Q14). Then insert the nine NPN transistors in the remaining positions, and solder them in place. Keep the transistors close to the board—their cases should be no more than 1/4 inch from its surface.

Press the four RCA jacks (J2, J4, J5, and J6) into the board and bend their tabs over to hold them in place. Check that they are all firmly and squarely seated, then solder them in place, using a fair amount of solder to obtain firm joints.

Insert the two trimmer resistors, R50 and R55, into the board and solder them in place. Be certain that they are well

mounted, so that repeated adjustments will not work them loose.

Press the RF modulator into the board and twist its lugs to hold it in place. Solder the lugs to the foil, using plenty of solder to make a secure joint. Not only do the lugs hold the relatively heavy modulator in place, but they are used as jumpers to extend the ground plane to two points near the center of the board. Poor mounting will cause problems. Insert the modulator's four leads into their holes, noting that they angle back from the edge of the board slightly. Pull the leads tight, then solder them.

Now install the 7805 regulator and its heatsink. The heatsink supplied with the kit has two pins extending from one end to facilitate vertical mounting. Since the heatsink will be mounted horizontally, remove the pins with a pair of pliers.

Insert the 7805 regulator into the board with its metal tab toward C1, and then bend it so that the hole in its tab lines up with the hole in the board. DO NOT solder its leads yet.

Pass the heatsink's mounting screw through the PC board and through several metal washers to hold the regulator slightly above the board. Apply a layer of heatsink compound to the back of the 7805 and attach the heatsink, tightening the screw firmly. Solder the regulator's leads now.

The last step in building the PC board is to mount power-on indicator LED2. It must extend from the edge of the PC board to meet its mounting hole in the front panel. The easiest way to determine its mounting position is to temporarily fit the

help the decoder to remain trouble-free in changing humidity conditions.

Interconnections

The connectors that couple our board to the NCI module are an unusual type with 0.1" spacing between adjacent pins. They are insulation-displacement types, so you need only press a strand of ribbon cable into each contact. We use three connectors of different sizes: four-, five-, and six-contact points. Each interconnecting cable has a connector only at the end that attaches to the NCI module; the other end is soldered to the PC board.

Cut three pieces of ribbon cable about six or seven inches long, one each with four, five, and six conductors, and separate the conductors about one inch at each end. Insert the unstripped wires into the "bays" of the appropriate connector and, holding them in place, pull the cable down across the terminals, but don't apply too much pressure. With the cable seated, use a small flat-blade screwdriver to push each wire into the notch of its terminal.

Strip about 1/4-inch of insulation from the other end of each conductor of all three ribbon cables. Twist the strands together, and then solder the wires to the PC-board pins. Make sure that you solder those wires so that the connectors at the other end will be able to fit in the NCI module. Figure 8 shows how they should seat. The six-conductor cable should be split for an inch or so at the PC end between its second and third conductors in order to clear C15. Or you could push C15 so that it lies flat on the board. Don't break its ceramic coating or short any of the other connecting pins. After all of the wires are soldered in place, inspect your work and correct any errors.

Attach J1 and S2 to the rear panel, and insert the panel into the top half of the case. Install the PC board and secure it with four self-tapping screws. Make sure that the jacks line up with the holes in the panel.

Connect wires between J1's pins and the appropriate pins on the PC board. Then connect S2 to the channel-select pins, using segments of ribbon cable or other 20- to 24-gauge hookup wire. Keep the wires short and neat, but leave a small amount of slack to allow removal of the board or the panel.

Remove the anti-rotation lug from rotary switch S2 and mount the switch to the front panel, tightening its nut finger-tight. Fit the knob to the shaft and adjust the switch's position so that the knob's indicator lines up with the panel markings. Carefully remove the knob and tighten the nut. Then re-install the knob and make sure that the indicator still lines up.

Use bus wire to connect the five common terminals of S1-a together. Clip the terminals off just above the wire, and re-

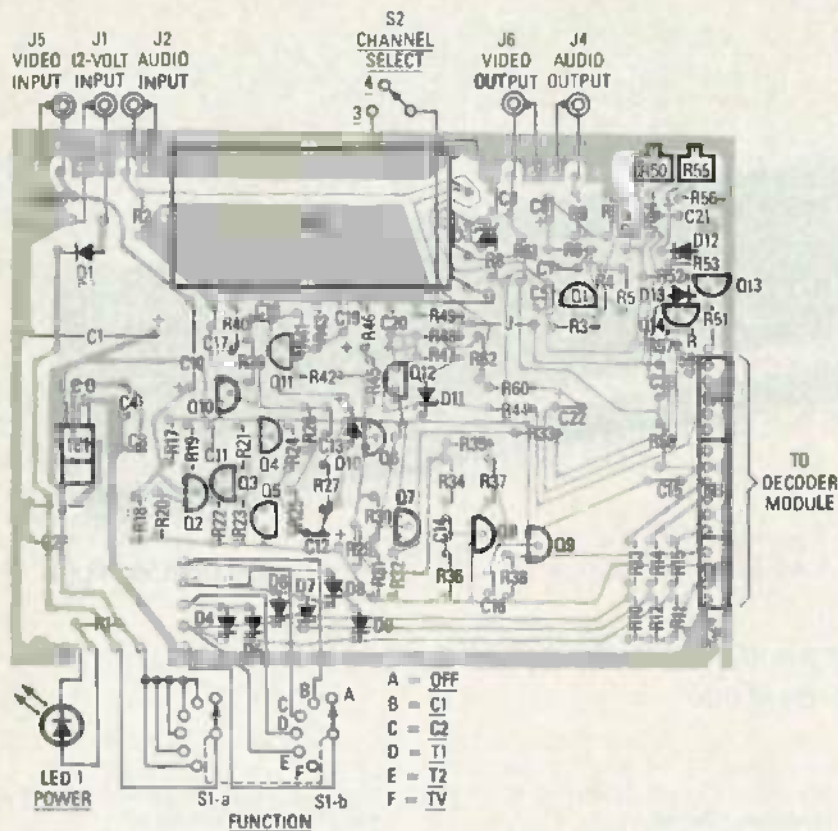

FIG. 7—MOST COMPONENTS EXCEPT THE SWITCHES AND J1 mount on the PC board. Use PC-board pins to connect the off-board components.

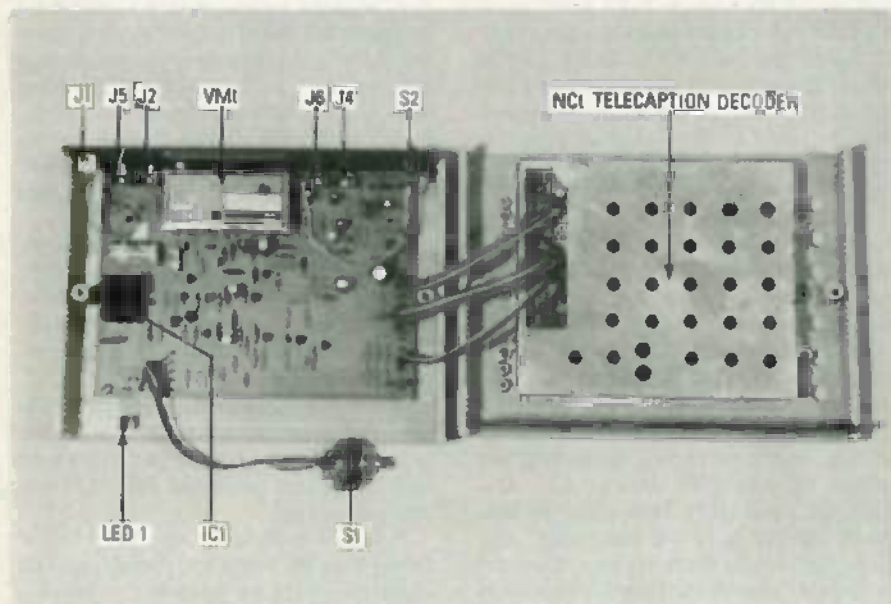

FIG. 8—THE PC BOARD MOUNTS IN THE BOTTOM of the case and the NCI decoder module mounts in the top. Make sure that the three jumper cables connecting the PC board and the module are oriented correctly.

PC-board and the front panel into the case. After the LED's leads are bent to fit, remove the board and solder the LED in place. Note that the lead next to the flat edge of the LED's case goes to the hole nearest the corner.

After all components have been mounted, inspect your work for incomplete joints and solder bridges, and correct any problems. Clean flux from the bottom of the board, and then spray it with an acrylic dielectric spray. Doing so will

PARTS LIST

All resistors are 1/2-watt, 5% unless otherwise noted.

R1, R22, R23, R52, R53, R56, R60—1000 ohms

R2—15,000 ohms

R3—270,000 ohms

R4—100,000 ohms

R5—22,000 ohms

R6—390 ohms

R7, R40—4700 ohms

R8, R58—180 ohms

R9, R20, R21—560 ohms

R10—R12, R17, R28—47,000 ohms

R13—R15, R34—470 ohms

R16, R61—75 ohms

R18—18,000 ohms

R19, R24—680 ohms

R25, R47, R48, R57—220 ohms

R26—180,000 ohms

R27—68,000 ohms

R29, R32, R38—2200 ohms

R30—1500 ohms

R31, R37, R44—3300 ohms

R33, R43, R49—330 ohms

R35—2700 ohms

R36—3900 ohms

R39, R59—10,000 ohms

R41, R45—12,000 ohms

R42—1800 ohms

R46, R54, R62—6800 ohms

R50, R55—1000 ohms, PC-mount, trimmer potentiometer

R5t—100 ohms

Capacitors

C1—1000 μ F, 16 volts, electrolytic

C2, C4, C6, C15, C24—0.1 μ F, ceramic disk

C3—1 μ F, 35 volts, tantalum

C5, C13—1 μ F, 16 volts, electrolytic

C7, C8, C19—10 μ F, 16 volts, electrolytic

C9, C21—22 μ F, 16 volts, electrolytic

C10—47 μ F, 16 volts, electrolytic

C11—39 pF, ceramic disk

C12—2.2 μ F, 16 volts, electrolytic

C14—150 pF, ceramic disk

C16—100 pF, ceramic disk

C17—0.001 μ F, ceramic disk

C18—220 pF, ceramic disk

C20, C22—100 μ F, 16 volts, electrolytic

C23—470 μ F, 16 volts, electrolytic

Semiconductors

IC1—LM7805T, 5-volt regulator

D1—1N4001, rectifier

D2—not used

D3—1N4735 6.2-volt, 1-watt Zener diode

D4—10, D12, D13—1N914 switching diode

D11—1N4738 8.2-volt, 1-watt Zener diode

LED1—standard red

Q1, Q2, Q4, Q6—Q9, Q11, Q12—2N2222A

NPN

Q3, Q5, Q10, Q13, Q14—2N3906 PNP

Other components

J1—1/2-inch miniature phone jack

J2—J6—RCA phono jack

S1—2P6T miniature rotary switch

S2—SPST miniature slide switch

Miscellaneous: Astec UM1285-8 video modulator, NCI Telecaption Decoder Module, PC board, 12-volt 500-ma wall-mount transformer, case, panels, wire, solder, etc.

Note: A kit (no. K-6314) including PC board, case, and all parts except RF modulator and power transformer is available for \$139 plus \$7.55 shipping and handling from Dick Smith Electronics, Inc., P. O. Box 8021, Redwood City, CA 94063. The modulator (no. K-6040) is available for \$9.95 and the power transformer (no. M-9526) is available for \$6.95. Allow shipping of \$1.50 plus 5% of order. California residents must add 6.5% sales tax. Orders outside the U. S. must include U. S. funds and add 20% of total for shipping.

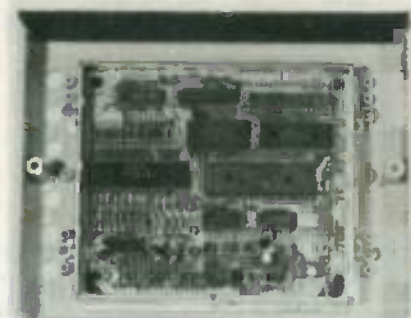

FIG. 9—THE NCI MODULE, shown here with its cover removed, mounts to the bottom of the case.

rear panel. The module must be all the way back to provide room for the rotary switch in front. Secure the module in place using self-tapping screws and washers. Do not connect the module to the PC board yet.

Testing and adjustment

Turn the rotary switch to OFF and plug the wall transformer's output plug into the power jack. Then plug the transformer into an AC socket and turn S1 to c1. LED1 should light up. Turn the knob through the other positions; the LED should remain lit.

Measure the voltage at the positive lead of C1. It should be no less than 12.5 and preferably no more than 16 volts. (That voltage will drop when the heavy load of the module is added.) Measure the 5-volt supply at either the +5 volt pin of S1-b or at module connector pin 5C4. It should be within 0.25 volt of 5 volts. Finally, measure the voltage at the cathode of D3; it should be between 5.8 and 6.2 volts. If all voltages are correct, turn the decoder off and attach the connectors to the NCI module. Turn the power back on.

move the OFF terminal completely. The terminals must be removed in order for the switch to clear the edge of the PC board. To prevent possible wiring errors, remove the two terminals corresponding to the OFF and the TV positions of S1-b.

Solder a six- to seven-inch length of seven-conductor ribbon cable to the pins near the front of the PC board. Connect the other end to the appropriate points of S1. Insert the front panel into the top of the case.

Drill a row of 3/8-inch cooling holes along the bottom of the left half of the case. Those holes will let air get in to cool the heatsink; waste heat will pass by convection through the gaps around the rear-panel jacks.

Next mount the NCI module in the bottom half of the case. The module has four mounting lugs designed for attachment to a flat surface. To mount the module to the standoffs in the bottom of the case, bend the lugs so that they extend straight out from the module's shielding can; then make an additional horizontal bend about

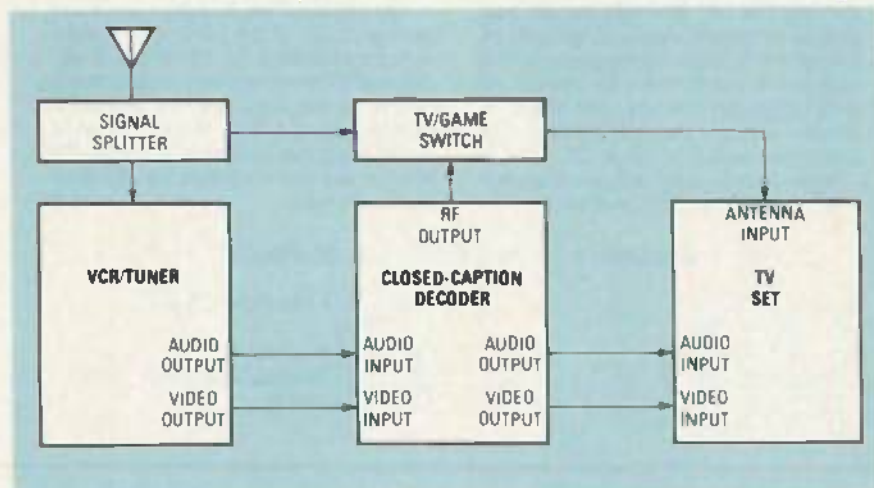

FIG. 10—SYSTEM WIRING DIAGRAM shows how the decoder should be connected to your video system. The signal splitter and TV/GAME switch are optional.

1/4 inch from the first bend. Press the module into place with the connectors on the opposite side of the cooling holes, and with the rear edge against the slot for the

Again measure the voltage at the positive end of capacitor C1. Ideally, it should be between 12 and 12.5 volts, but it may vary, depending on the wall trans-

ELECTRONIC FUNCTION SELECTOR

As promised last month, we'll describe an all-electronic function-selector circuit that can be used to replace the rotary function selector, S1. The circuit is shown in Fig. 1.

clock input; that pulse advances the counter by one. The 0 output goes low and the 1 output (pin 1) goes high, so the C2 LED lights up, and caption channel C2 is selected. Successive presses of S1 cycle

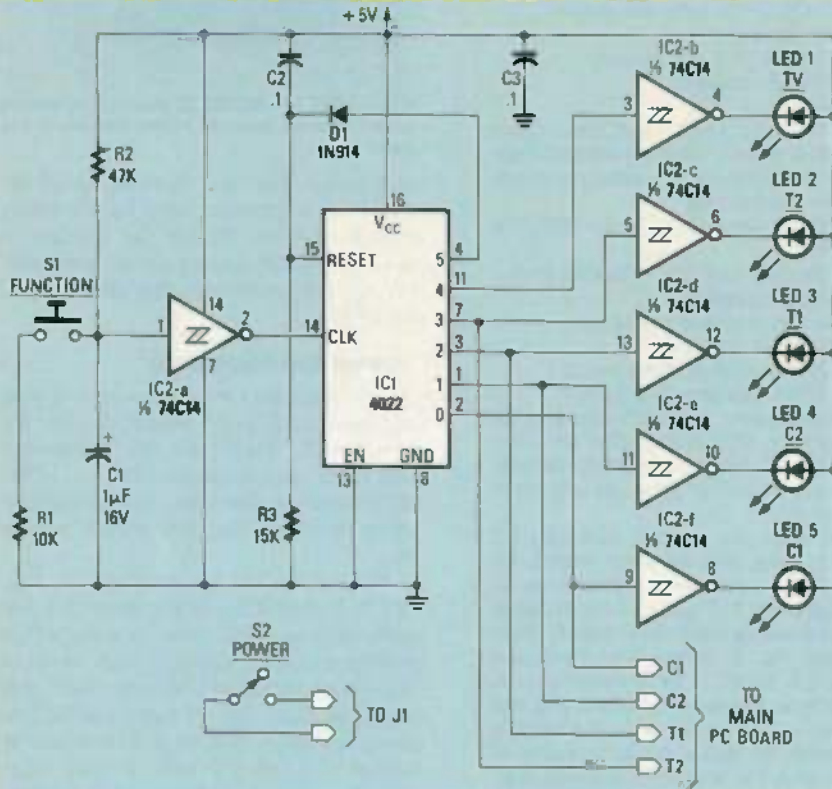

The heart of the circuit is a 4022 8-stage ring counter. In a ring counter, one and only one output is high at any time. Each output of the 4022 drives an LED via an inverter. The first four outputs are also connected to the corresponding inputs on the main PC board. When power is first applied, C2 and R3 reset the counter, so the 0 output (pin 2) is high. Therefore, the decoder comes up tuned to the most popular closed-caption channel, C1.

When S1 is pressed, a pulse is applied (via Schmitt trigger IC2-a) to the counter's

the 4022 through each of its states; a fifth press returns the decoder to the C1 mode, because the output 5 (pin 4) is coupled to the RESET input via diode D1.

You can build this circuit on a piece of perfboard and attach it to the front panel with spacers and screws. Note that a separate SPST switch will then be required to switch the decoder's power on and off; in addition, power-on indicator LED1 (on the main board) can be omitted, since one of the function LEDs will light up whenever the power is on. **R-E**

PARTS LIST— ELECTRONIC FUNCTION SELECTOR

R1—10,000 ohms
R2—47,000 ohms
R3—15,000 ohms
C1—1 µF, 16 volts
C2, C3—0.1 µF
IC1—4022 ring counter

IC2—74C14 hex Schmitt trigger
D1—1N914
LED1—LED5—Standard
S1—SPST normally open pushbutton
S2—SPST toggle

former used. To accommodate transformers with various output voltages, it may be necessary to alter the values of several resistors. We'll discuss those modifications in a moment.

Before closing up the case, temporarily connect the decoder to your video system

as shown in Fig. 9. Note that a video switch is shown in that figure; it can be used to bypass the decoder when caption decoding is not needed. If captions will be desired most or all of the time, the switch, and the signal splitter, can be omitted and the decoder's TV mode can be used to

bypass decoding, if necessary.

Select a strong station on the VCR or tuner, set your TV and S2 on the decoder to Channel 3 or 4. Now turn everything on. Place S1 in the TV position.

If the picture and sound on the TV are good, then no adjustments to the modulator are necessary. But if either picture or sound is faulty, use a 1/8-inch flat screwdriver to adjust the modulator's tuning coil (the one nearest the input leads) until the picture is good. Then adjust the other coil until the sound is clearest. You may have to adjust both coils several times to optimize both audio and video.

Set trimmer resistors R50 and R55 to the center of their travels, set S1 to C1, and tune in a captioned program. During the day, the best place to find one is on a PBS station. At night, try either a PBS or an ABC station. On satellite, tune in any of the ABC or PBS feed transponders.

If the captions appear with a dark background and bright, legible characters, no adjustments are necessary. But, if the boxes are too light, if the captions distort the picture, or if dark streaks appear in light scenes, adjust the BLACKNESS control (R50) until the boxes are as dark as they will get without streaks or distortion. If the characters are either too dim or smeared, adjust the CHARACTER control (R55) until they are clearly visible, but not smeared.

If proper adjustment cannot be obtained in the middle 1/3 of the trimmer's travel (or cannot be obtained at all), the problem is most likely the 12-volt supply. To compensate, one or two of the resistors in the blanking and Y level bias circuits will have to be changed. The resistors should be changed only if it is difficult to get clear captions and background.

If the background will not adjust properly, clip R47 from the board, leaving the lead stubs in place. Connect a 1K trimmer resistor to the stubs and, with the background trimmer set to the center of its travel, adjust the new resistor to obtain a dark background without streaks or distortion. Turn the decoder off, measure the value of the pot, and replace it with the closest standard resistor. If you're careful, you can solder the new resistor to the leads of the old one without having to remove the board from the case.

If it is the characters that will not adjust properly, perform the same procedure, but substitute a 2K trimmer resistor for R56.

After everything is working correctly, disconnect the decoder, assemble the case, and reconnect it to your video system. Now you're ready to enjoy the new world of closed-caption programming.

To conclude, it's our sincere hope that all of the hearing-impaired persons who are aided by this project enjoy using it as much as the author enjoyed designing and developing it and we enjoyed publishing it. It was truly our pleasure. **R-E**



DTMF Encoding and Decoding

Thanks to new low-cost DTMF encoders and decoders, the world of DTMF signalling now is available for use in your next project.

DALE NASSAR

DTMF (DUAL-TONE MULTI-FREQUENCY) signalling was developed about two decades ago by Bell Labs as a faster (by a factor of about 10), more versatile, and more reliable telephone-dialing scheme than the old pulse or rotary-dialing technique. The DTMF method is often referred to as tone dialing or *Touch-Tone* (note that *Touch-Tone* is a trademark of AT&T) and is used with push-button telephones and other equipment.

A standard DTMF signal consists of a pair of audio tones chosen from a group of eight standard frequencies. Those frequencies are divided into two groups: a low-tone group of four frequencies and a high-tone group of four frequencies. A valid DTMF signal consists of the algebraic sum of one tone from the low group and one tone from the high group. There are therefore 16 (4 low \times 4 high)

possible DTMF signals that can be encoded with the eight frequencies. The four standard low frequencies are 697, 770, 852, and 941 Hz, and are referred to as row frequencies R1, R2, R3, and R4, respectively. The four standard high frequencies are 1209, 1336, 1477, and 1633 Hz, and are referred to as column frequencies C1, C2, C3, and C4, respectively. Any combination of DTMF tone can be generated using a 4 \times 4 keypad switch matrix as shown in Fig. 1. The DTMF frequencies and the keypad layout of Fig. 1 are international standards. The frequencies produced by DTMF generators are allowed a $\pm 1.5\%$ deviation from the listed standards. Note that all of those tones are well within the telephone system's voice band.

The choice of the standard DTMF frequencies was by no means an arbitrary

one. The designers of the DTMF system used a great deal of care in selecting the particular frequencies. Other tones that may appear on the telephone line such as dial tones and power-line noise must not fall in the DTMF frequency band. Further, the standard frequencies must have no harmonic interaction, thus the highest standard frequency (1633 Hz) is lower than the third harmonic of the lowest standard frequency (697 Hz).

Conventional telephones that use DTMF signalling are usually equipped with a standard 3 \times 4 keypad matrix for representing the digits 0-9, and two spare symbols, * (star or asterisk), and # (pound or octothorpe), which can be used for various purposes. That 3 \times 4 matrix represents all four row frequencies (R1-R4), and the three lowest column frequencies (C1-C3). Some special-purpose

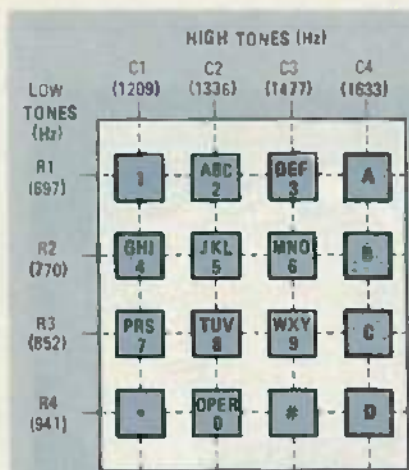

FIG. 1—STANDARD DTMF KEYPAD layout. The DTMF row and column frequencies are as shown.

telephones use the fourth column (C4) to represent four additional symbols (shown as A, B, C, and D in Fig. 1) in order to encode all of the sixteen possible DTMF signals.

If you have a tone-dial phone you can listen to a DTMF signal by simply picking up the telephone handset and pressing one of the buttons. For example, pressing the 8 key generates a 852-Hz tone (R3) and a 1336-Hz tone (C2) simultaneously. Those signals are processed and decoded by a DTMF receiver at the telephone company's central office.

The central office contains the switching equipment that provides local-exchange telephone service for a given geographical area. That area is designated by the first three digits of the telephone number. After the connection is established between the called and the calling parties, the DTMF receiver (at the central office) is no longer active and the connected parties are free to use the keypad-generated signals for station-to-station (end-to-end) signalling.

Until very recently, the DTMF encoders used by the telephone companies exclusively used large and bulky transistorized LC-tuned oscillator circuits to generate the tones. Many such LC circuits are still in use. Such rugged circuits were used by the telephone company because they were extremely dependable. They were designed to withstand the worst of operating conditions. For the hobbyist, limited parts availability makes building that type of circuit almost impractical. Fortunately it is also unnecessary, as DTMF generators are available in IC form.

Further, until just a few years ago the experimenter had to settle for a not-so-reliable IC decoding (receiving) system. The decoding circuitry had to be built up using a number of simple IC's. For instance, a separate 567 phase-locked-loop tone-detector IC was required for each

frequency used, for a total of eight. Additionally, each tone detector had to be tuned by critical external timing components. Because each DTMF signal received activated two detector outputs (one for each frequency received), a logic circuit had to be added to convert those outputs into a usable format. The net result was a complex circuit that was time-consuming to build and difficult to align. Also, performance was often unsatisfactory. True, performance could be improved with the addition of pre-filtering at the inputs of each tone detector. But the active-filter circuitry required for that

made an already complex circuit even more so.

Fortunately, those days are gone forever. With the new DTMF IC's available today, a complete and extremely reliable DTMF-encoding and -decoding system can be breadboarded in less than 10 minutes. Also, the built-in features of those decoding IC's usually include pre-filtering, complex processing, signal validation, etc., making possible a high degree of efficiency and reliability. In addition, no external tuning components are required, keeping the parts count minimal. DTMF IC's are manufactured by Nation-

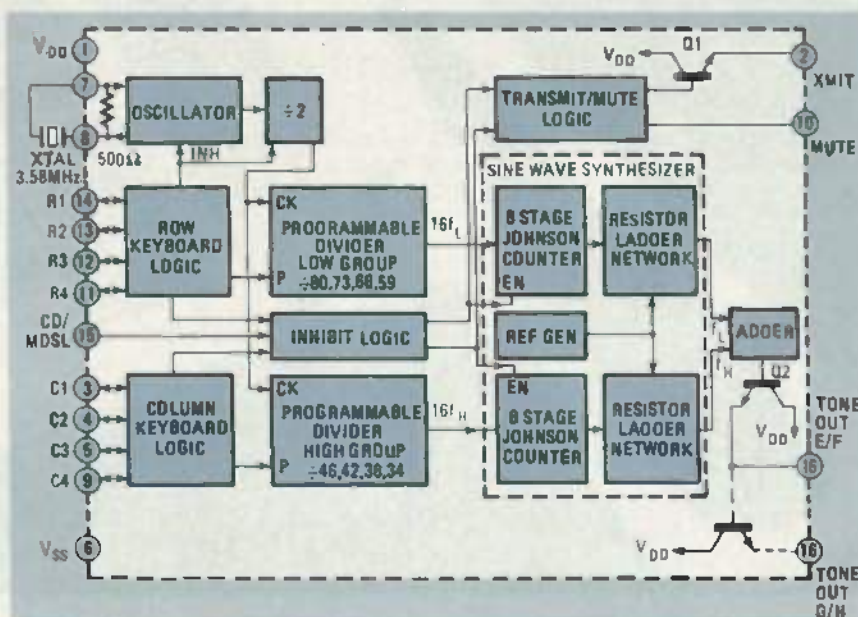

FIG. 2—INSIDE A DTMF ENCODER. The S2559E DTMF generator IC is shown here in block-diagram form.

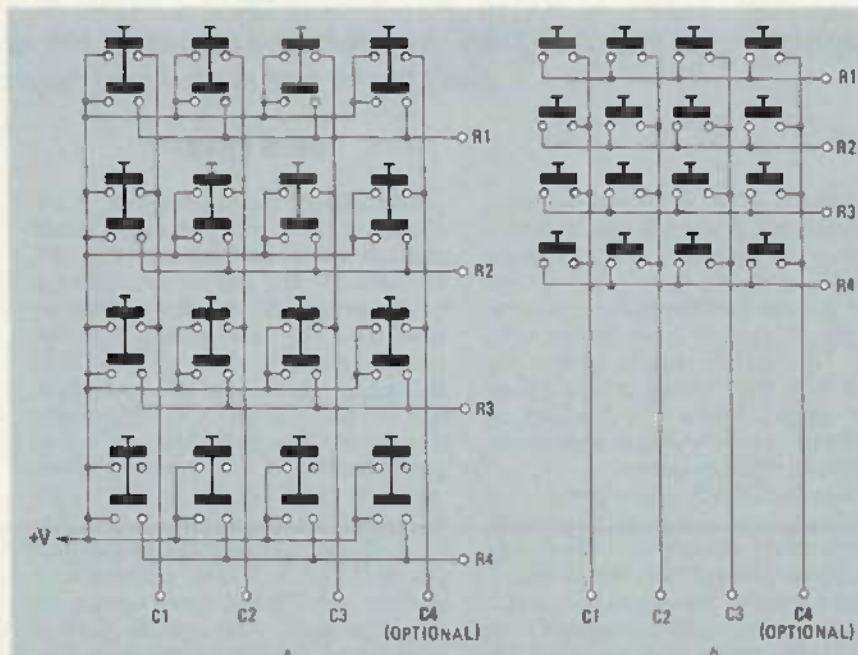

FIG. 3—TWO TYPES OF KEYPADS can be used with DTMF encoders. The one shown in a is a standard telephone tone-dialing keypad and uses DPST switches. The one shown in b is a calculator-type keypad and uses simple SPST switches, but it can not be used with all encoder IC's.

al. Silicon Systems. Mostek. Motorola. AMI. and Teltone.

Although the DTMF system was originally designed for telephone dialing, it is extremely useful as the basis for remote-control systems. In this article we'll describe some of the DTMF-encoding and -decoding IC's that are commercially available, and how they can be used in remote-control applications. After reading this article, you should have no trouble choosing and successfully using the DTMF IC's that best fit your needs.

DTMF encoding

The heart of a DTMF encoder is a a DTMF tone-generator IC. Those IC's are extremely easy to use and are very low in cost. Some DTMF tone generators are available for less than \$2.00 in single quantities! They generate the desired DTMF signals by dividing a crystal-generated reference frequency. The oscillator is on-board the IC; the crystal is simply connected across two terminals of the IC. The most-common crystal frequency is 3.579545 MHz; that's the TV color-burst frequency, so those crystals are readily available and low in cost. However, as we will see shortly, other frequency references may be used for special purposes.

A block diagram of a typical tone-encoder IC is shown in Fig. 2. The IC illustrated there is a Gould AM1 (3800 Homestead Rd., Santa Clara, CA 95051) S2559E. The desired DTMF signals are activated by a twelve-key (3 x 4) or sixteen-key (4 x 4) matrix keypad that is connected directly to the row- and column-input pins of the tone-generator IC. Two major types of keypads are used: One is the standard telephone pushbutton keypad. They are used with IC's that generate tones whenever the corresponding row and column pins are pulled high. As shown in Fig. 3-a, that keypad consists of a series of DPST momentary switches with a common line that simultaneously pulls the corresponding row and column outputs high when pressed. Note that some encoders are active low. For those, the keypad common line is connected to ground. Then, the appropriate row and common outputs are grounded when a key is pressed. The other, and simpler, keypad arrangement is shown in Fig. 3-b. Referred to as a calculator-type or X-Y keypad, it consists of SPST momentary switches and can be built easily. However, it can only be used with tone generators that use calculator-type scanning circuitry to detect switch closures. The S2559E contains such circuitry. Generally, the data sheet of a particular tone encoder will specify the type of keypad required.

A simple DTMF encoder is shown in Fig. 4. It mainly consists of a 16-key SPST keypad like the one shown in Fig. 3-b, and the S2559E tone-encoder IC. Power can be supplied by a small power

Pin	Function
SIGNAL IN	DTMF input. Internally biased so that the input signal may be AC coupled. SIGNAL IN also permits DC coupling as long as the input voltage does not exceed the positive supply.
12T ₀	DTMF-signal detection control. When 12T ₀ is at logic 1, the M-957 detects the 12 most commonly used DTMF signals (1 through #). When 12T ₀ is at logic 0, the M-957 detects all 16 DTMF signals (1 through 0).
A, B	Binary DTMF signal-sensitivity control inputs. A and B select the sensitivity of the SIGNAL IN input to a maximum of -31 dBm.
D ₀ , D ₂ , D ₁ , D ₀	Data outputs. When enabled by the OE input, the data outputs provide the code corresponding to the detected digit in the format programmed by the HEX pin. The data outputs become valid after a tone pair has been detected and are cleared when a valid pause is timed.
OE	Output enable. When OE is at logic 1, the data outputs are in the CMOS push-pull state and represent the contents of the output register. When OE is driven to logic 0, the data outputs are forced to the high-impedance or "third" state.
HEX	Binary output format control. When HEX is at logic 1, the output of the M-957 is full 4-bit binary. When HEX is at logic 0, the output is binary-coded 2-of-8.
STROBE	Valid data indication. STROBE goes to logic 1 after a valid tone pair is sensed and decoded at the data outputs. STROBE remains at logic 1 until a valid pause occurs or the CLEAR input is driven to logic 1, whichever is earlier.
CLEAR	STROBE control. Driving CLEAR to logic 1 forces the STROBE output to logic 0. When CLEAR is at logic 0, STROBE is forced to logic 0 only when a valid pause is detected. Tie to VNA or VND when not used.
BD	Early signal presence output. BD indicates that a possible signal has been detected and is being validated.
XIN, XOUT	Crystal connections. When an auxiliary clock is used, XIN should be tied to logic 1.
OSC/CLK	Time base control. When osc/CLK is at logic 1, the output of the M-957's internal oscillator is selected as the time base. When osc/CLK is at logic 0 and XIN is at logic 1, the AUXCLK input is selected as the time base.
AUXCLK	Auxiliary clock input. When osc/CLK is at logic 0 and XIN is at logic 1, the AUXCLK input is selected as the M-957's time base. The auxiliary input must be 3.58 MHz divided by 8 for the M-957 to operate to specifications. If unused, AUXCLK should be left open.
VNA, VND	Negative analog and digital power supply connections. Separated on the chip for greater system flexibility, VNA and VND should be at equal potentials.
VP	Positive power supply connection.

supply or by a conventional 9-volt battery. Because the S2559E is a CMOS device, power consumption is low. Typically, the circuit shown will draw 5 mA during encoding and 7 μ A when idle. Since the device is CMOS, be sure to observe all of the standard precautions when handling the IC.

Encoder output

The output of the encoder consists of two of the eight DTMF frequencies. Figure 5 shows an oscilloscope display of the row-3 signal (852 Hz) and Fig. 6 shows the column-2 signal (1336 Hz). The DTMF output is produced by adding the two signals together. The resulting signal,

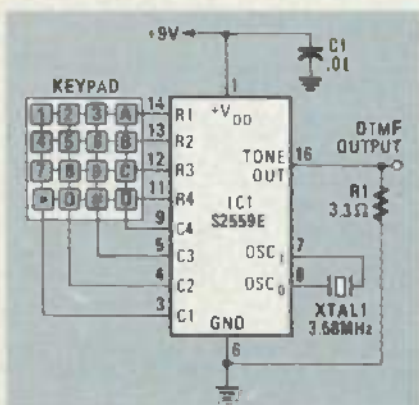

FIG. 4—A COMPLETE DTMF ENCODER requires just a keypad, an encoder IC, a crystal, and two additional components.

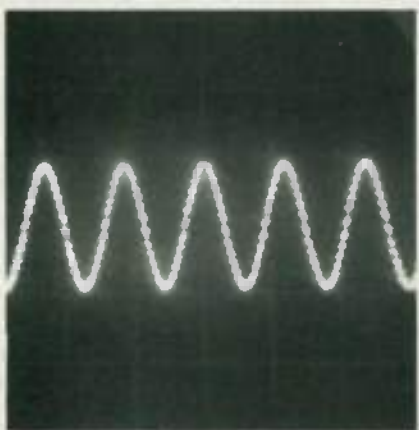

FIG. 5—A ROW 3, 852 Hz, DTMF signal.

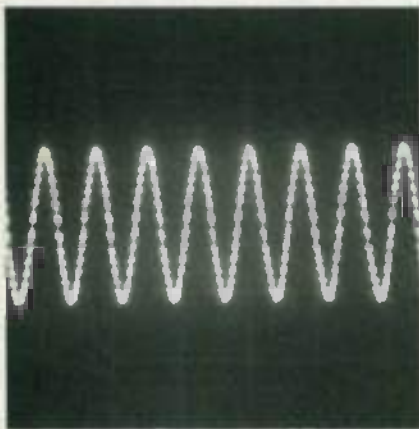

FIG. 6—A COLUMN 2, 1336 Hz DTMF signal.

which would be generated by pressing the "8" key, is shown in Fig. 7. Note that the output of the S2559E is not a pure sine wave. Instead the output is a digitally synthesized approximation, as shown in Fig. 8.

The S2559E also is capable of generating single-frequency tones. To place the IC in the single-frequency mode, pin 15, the mode-select pin (MDst.), is either tied high or left floating; for DTMF operation, that pin is grounded. Once in the single-frequency mode, a single frequency is output by pressing two keys in the appropriate row or column. For instance, simul-

taneously pressing the 4 and 5 keys (in row 2) will result in a 770-Hz output. The single-frequency mode is used primarily for testing.

The S2559E, as well as most other encoder IC's, have mute and transmit pins (MUTE and XMTR). In the S2559E, when no keys are pressed, the MUTE pin is low and the XMTR output is enabled and can

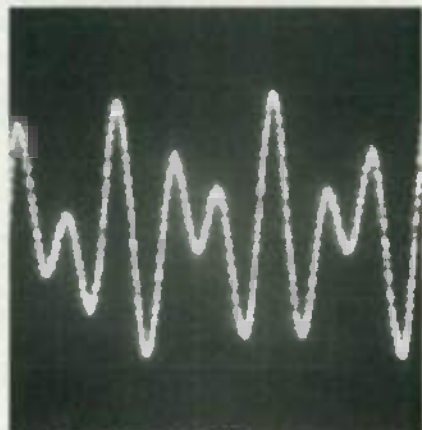

FIG. 7—WHEN THE DIGIT 8 is pressed on the keypad, the encoder generates the signal shown here. It consists of the sum of the row 3 (Fig. 5) and the column-2 (Fig. 6) signals.

source current to an external load. When a key is pressed, the XMTR output goes into a high-impedance state and the MUTE output goes high. Those pins are used in telephone applications. For instance, the MUTE pin is used to mute the telephone receiver during dialing so that the user does not hear the DTMF signals at full volume. The enterprising experimenter will doubtless find many other uses for those handy outputs.

To make the output of the encoder circuit audible, a speaker or some other transducer must be driven by the output signal. The S2559E output must be buffered to drive an 8-ohm speaker, but other high-impedance speakers can be driven by the IC directly. For example, the author has driven the earpiece from an old telephone headset by adding a 330-ohm resistor in series with the earpiece to prevent loading the encoder's output as well as to increase battery life.

We've been discussing the S2559E thus far, but there are three other members of that IC family. They are the S2559F, G, and H. Those four devices have replaced the earlier A, B, C, and D versions and feature extended operating voltage (2.5 to

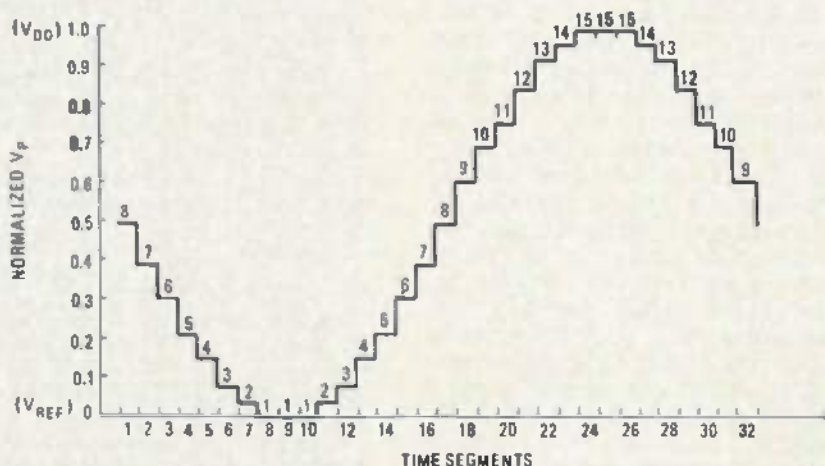

FIG. 8—THE OUTPUT OF THE S2559E is not a pure sine wave. Instead it is a digitally synthesized waveform. The staircase-shape of such a waveform is shown here.

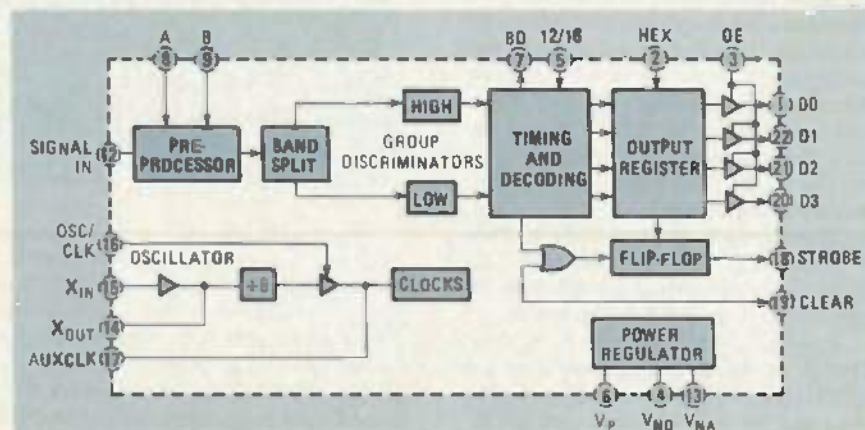

FIG. 9—INSIDE A DTMF DECODER. The M-957 DTMF decoder IC is shown here in block-diagram form.

TABLE 2—DTMF TO BINARY DECODING

Signal	Low-Frequency Component (Hz)	High-Frequency Component (Hz)	Hex Output Format	2-Of-8 Output Format
			3210	3210
1	697	1209	0001	0000
2	697	1336	0010	0001
3	697	1477	0011	0010
4	770	1209	0100	0100
5	770	1336	0101	0101
6	770	1477	0110	0110
7	852	1209	0111	1000
8	852	1336	1000	1001
9	852	1477	1001	1010
0	941	1336	1010	1101
.	941	1209	1011	1100
#	941	1477	1100	1110
A	697	1633	1101	0011
B	770	1633	1110	0111
C	852	1633	1111	1011
D	941	1633	0000	1111

Note: The M-957 detects signals A through D only when the 1276 input is at logic 0.

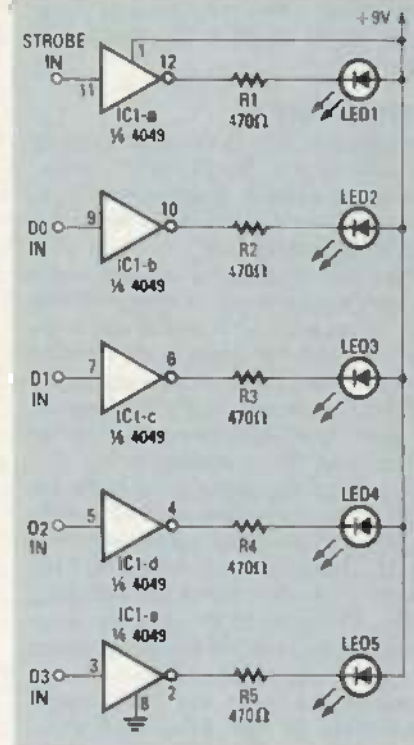

FIG. 11—USE THIS LED MONITOR CIRCUIT to verify that the encoder and decoder are operating correctly.

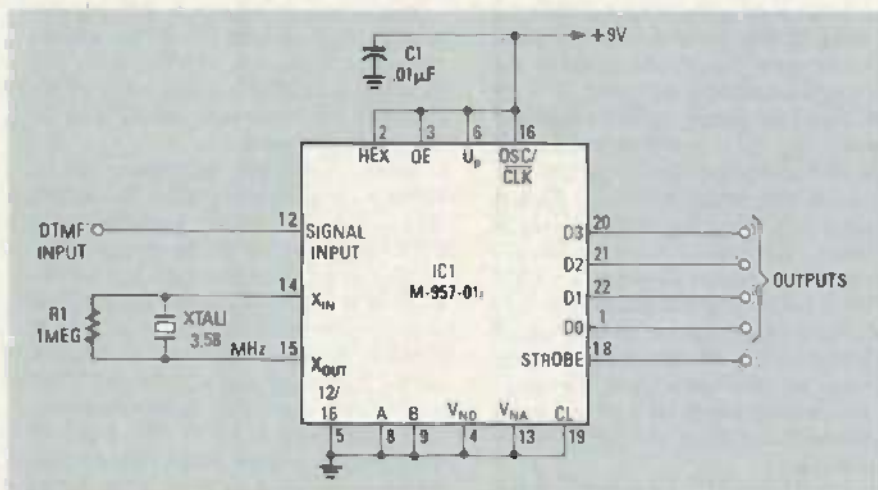

FIG. 10—USING THE M-957, building a DTMF decoder requires just the IC, a crystal, and a capacitor.

10 volts), improved tone fidelity, and an on-chip oscillator bias-resistor. In the S2995F, the most function of pin 15 is replaced by a chip disable (CD) function that is active high. When that pin is tied high, the row and column inputs are placed in a high-impedance state, the tone output is tied to ground, the oscillator is inhibited, the MUTE pin is tied high, and the XMIT pin is enabled. Essentially, the effect is that the IC is electronically disconnected from the keypad. That allows one keypad to be shared by several different devices.

The S2559G and H are identical to the S2559E and F, respectively, except that the output transistor has been replaced by a Darlington pair. In some applications that eliminates the need for an external transistor amplifier stage in the telephone circuit.

DTMF decoding

DTMF decoding is considerably more complex than DTMF encoding. The most involved function of the detector is to determine whether a received signal within the DTMF frequency band (697–1633 Hz) is a true DTMF signal or merely noise or speech. The detector must also be capable of detecting a DTMF signal that is combined with such noise. The DTMF detector should recognize any valid DTMF signal that is within $\pm 2\%$ of the standard value. The detector's job is made somewhat easier by the fact that a DTMF signal must have a minimum duration of 40 ms, and that each DTMF signal must be separated from others by at least 35 ms.

Somewhat surprisingly, most of the circuitry required to decode DTMF signals is now available in IC form. Therefore, despite its greater complexity, an entire 16-digit de-

coder can be built as easily and as simply as a 16-digit encoder.

DTMF decoders are often referred to by manufacturers as DTMF receivers. Those devices have only recently become commonly available at affordable prices. Some can be purchased for under \$15.00 in single-unit quantities. Just a few years ago, when the first IC encoders became available, those devices cost about \$100, and required external filters. The IC's on the market today are extremely sophisticated signal-processing devices with switched-capacitor filtering that use digital frequency-detection techniques. They can reliably detect DTMF signals with no need for pre-filtering.

The decoder that we'll use in our circuit is the M-957 from Teltone (P.O. Box 657, 10801-120th Ave. N.E., Kirkland, WA 98033). That CMOS device can be powered by a DC power supply or batteries. There are two versions of the M-957: the M-957-01, which can accept voltages of 5 to 12, and the M-957-02, which is designed for 5-volt operation only.

A block diagram of the M-957 is shown in Fig. 9. The function of each pin is outlined in Table 1. The pre-processing stages of the M-957 filter out noise and split the received DTMF signal into its high and low-frequency-group components, and limit each component to provide automatic gain control. The individual tones are then detected. The decoded output of the M-957-01 is a 4-bit binary code appearing at the D0–D3 output. The output code format can be selected via pin 2, HEX. When that pin is

high (logic 1), the output format is 4-bit hexadecimal; when the pin is low (logic 0), the output format is binary-coded 2-of-8.

Putting it together

It takes very little in the way of external circuitry to put the M-957 to work. Adding just a single capacitor and a crystal as shown in Fig. 10 yields a functional DTMF receiver/decoder.

Now that we have an encoder and a decoder, the next step is to verify that both work as intended. The easiest way to do that is to wire the output of the encoder (Fig. 4) to the input of the decoder. If you are using separate sources (batteries or DC power supplies) to power the circuits, be sure to tie their grounds together.

To monitor the output states of the encoder during testing you can build a simple monitor circuit like the one shown in Fig. 11. That circuit uses $\frac{1}{2}$ of a 4049 hex inverter as a buffer to drive five indicating LED's. Those five LED's show the states of the four data outputs as well as state of the STROBE output. Table 2 shows the correspondence between the DTMF signal received and the state of the data outputs. The strobe output should be high, as indicated by a lighted LED, any time that a valid DTMF signal is received and decoded by the circuit.

Once you are sure that the decoder is operational it is time to think about adding to its usefulness and versatility. For one thing, the outputs could be further decoded to provide a 1-of-16 output. A circuit for doing that is shown in Fig. 12.

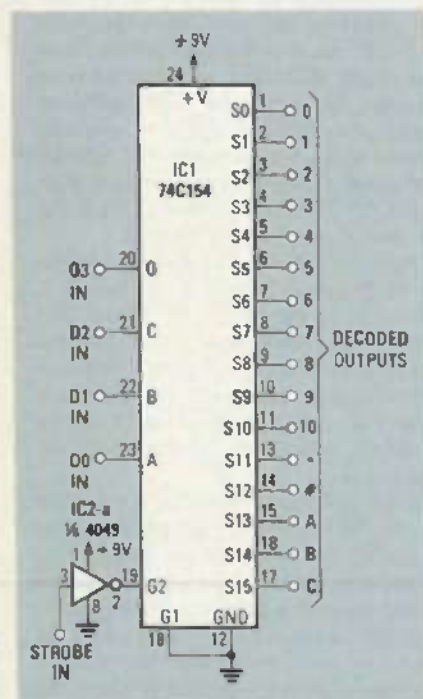

FIG. 12—THE FOUR-BIT OUTPUT of the M-957 is decoded using this circuit. With it, each DTMF code can be used to address one of the 16 outputs.

ORDERING INFORMATION

The following is available from High Technology Semiconductors, 2512 Chambers Road, Suite 204, Tustin, CA 92680, (714) 259-7733: Telone M-957-N, \$11.35; Stantel STC-5089-N (which is pin-for-pin compatible with the AMI S2559E), \$2.10; 3.58-MHz crystal, \$1.25. Also available is a kit of parts, TRK-957-N, which consists of the M-957, STC-5089, 3.58-MHz crystal, a 22-pin DIP socket, and a 1-megohm resistor for \$14.95. Please add \$2.30 shipping to all orders. MasterCard, Visa, and COD orders accepted.

Built around a 74C154 4-to-16 decoder/multiplexer, it provides 16 separate output lines. Each of the 16 DTMF signals will enable only one of the circuit's normally high outputs. For instance, if a DTMF 9 is received, only the 9 output, pin 10 of IC1, will go low. That output will remain low as long as a valid DTMF 9 is being received by the circuit.

Another useful enhancement would be to add some type of latched output. That means that once the appropriate DTMF signal is received, the output would remain either high or low until the next time the same DTMF signal is received. Such operation approximates the on/off action of a toggle or pushbutton switch.

A circuit for adding latched outputs is shown in Fig. 13. It is built around half of a 74C73 dual flip-flop that is configured to act as an edge-triggered binary divider (divide-by-2). When the circuit is used as shown, no external debounce circuitry is required. The input is shown as a DTMF D, but it could be any of the DTMF signals. Two complementary latched outputs are available. Use whichever output is appropriate for your application. Tie all of the IC's unused inputs (IC1-b) to ground to prevent oscillation and unnecessary current drain.

Switch S1 is used to clear both outputs to zero. That switch is not needed for all applications and can be eliminated if desired. Conversely, the circuit can be set up

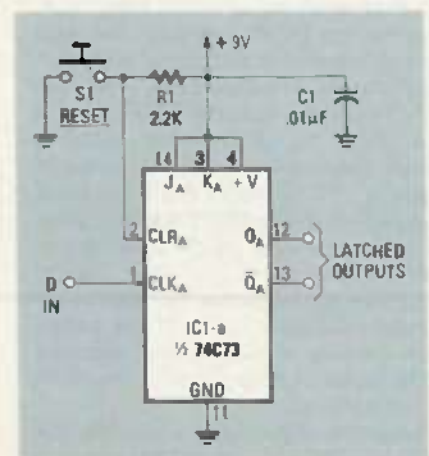

FIG. 13—LATCHED OUTPUTS can be provided using this circuit.

for remote reset. That is done by eliminating the switch and the 2.2K resistor (R1) and tying one of the momentary outputs of the 74C154 to the CLR_A pin of the 74C73. For example, if pin 17 of the 74C154 is connected to pin 2 of the 74C73, the latch will be reset anytime a DTMF C is received. If no reset function is desired, the CLR pin must be tied high.

Up to sixteen devices may be independently controlled by the outputs of the circuit in Fig. 12. If the controlled device is digital and if it is voltage-compatible with the decoder output, direct connection to that device is possible. If heavy driving currents are required, that current can be supplied by transistor switches located at the decoder outputs. If the voltages are not directly compatible, matching can be done using optocouplers or power-driver IC's. Also solid-state relays may be used to interface the digital signals with high-voltage, high-current loads, such as 117-volt AC household appliances, or even industrial devices with larger power requirements.

Going farther

If a wireless data link is desired, any simple, single-channel radio or infrared communications link may be used. For example, a toy walkie-talkie set or a low-cost FM wireless-microphone/FM radio system may be used.

Many DTMF tone generators can be driven by logic-level signals. That allows direct control of DTMF signaling by a microprocessor or ROM circuit. The S2559E requires active high logic-levels at all of its row and column inputs. That means that an 8-bit signal or some type of external driving circuitry is required for digital control of the IC. Other DTMF devices are better suited to digital control. One such device is AMI's S2579 DTMF tone generator with binary input. That device is designed so that a 4-bit digital signal can be used to encode all 16 DTMF signals.

The DTMF IC's will function with crystal frequencies other than those specified for DTMF operation. However, the frequencies that will be generated or decoded will differ from the standard DTMF ones. If a higher crystal frequency is used, all tones will be correspondingly higher in frequency; if a lower crystal frequency is used, all tones will be lower in frequency. That effect can be useful for applications such as when a private communications code is desired.

In this article we've presented some of the basics of DTMF communications. We've also presented some possible applications of that technology. For the enterprising experimenter there are countless more. Now that the cost of the required encoding and decoding IC's is so low, the only limit to their use is your own imagination.

R-E

How to

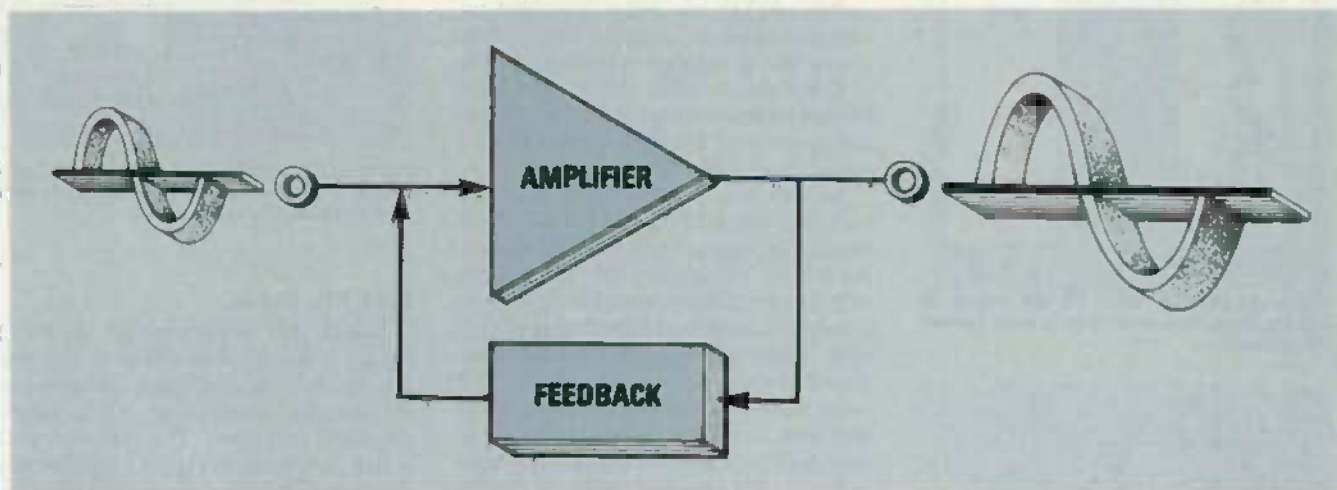

Design OSCILLATOR Circuits

Digital clock circuits using TTL IC's.

Part 6 THIS TIME WE'LL DISCUSS digital clocks. We don't mean time-of-day clocks, but circuits that create pulse trains for synchronizing digital circuits. Digital clocks usually produce either a squarewave or a trapezoidal wave. In this article we'll discuss digital-clock circuits based on TTL IC's.

TTL basics

The TTL logic family was probably the first really successful family of integrated digital devices. Previous families (e.g., RTL and DTL) never really attained the widespread popularity enjoyed by TTL devices. One reason for TTL's popularity is that it uses standard input and output circuits, and standard logic levels.

A digital circuit is binary in nature; that is, it permits only two possible states. Those states, 1 and 0, can be represented by the digits of the binary (base 2) number system. Those two states are often called high and low (respectively).

Figure 1 shows the standard logic levels for TTL devices. The high condition is attained when the input or output voltage is greater than +2.4, but less than +5. The low condition is represented by any voltage between 0.0 and 0.8. Voltages above +5 (the groan zone) and below ground (the zap zone) must be avoided. In addition, an inappropriately connected

capacitor or inductor can also feed too much (or incorrectly polarized) voltage to TTL devices.

The members of any logic family work together because inputs and outputs can be interconnected with only a conductor—no impedance-matching or other devices are necessary. Figure 2-a shows a standard TTL output, and Fig. 2-b shows a standard TTL input. The TTL input acts

as a 1.6-mA current source, and the TTL output acts as a 16-mA current sink.

To interface TTL devices, all we must do is make sure that current-drive requirements are met. Those requirements are simple to calculate because of standardization. A single 1.6-mA input is said to have a "fan-in" of 1. A single 16-mA output has a fan-out of 10. In other words, a standard TTL output can drive 10 standard (fan-in-of-1) devices.

There are several sub-families of TTL devices. For example, low-power TTL devices are signified by an "L" in the part number (e.g., 74L00). L-type devices have lower drive capacity than regular TTL. There is also high-speed TTL, which contains an "H" in the part number (e.g., 74H00). There is also low-power Schottky. That is probably the most commonly used type of TTL IC; it contains "LS" in the part number (e.g., 74LS00).

The LS type of TTL device has Schottky diodes at its inputs; those diodes are somewhat sensitive to static electricity. Therefore, it is recommended that you handle LS-series TTL devices almost as gingerly as you would handle CMOS devices. The various sub-families have differing drive capacities; consult a data book for details.

Using TTL

Figure 3 shows a circuit that converts

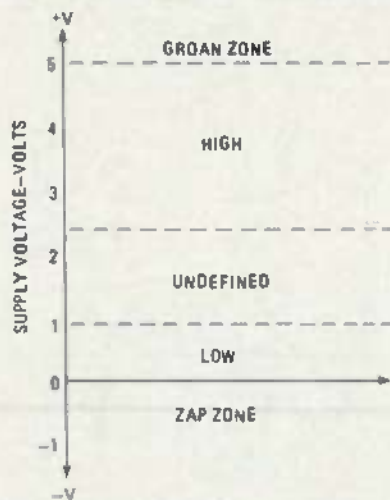

FIG. 1—VOLTAGE LEVELS OF A TTL IC determine logic state. Any voltage below 0.8 is a logical low; any voltage above 2.4 is a logical high. Signals in the groan and zap zones may destroy a TTL device.

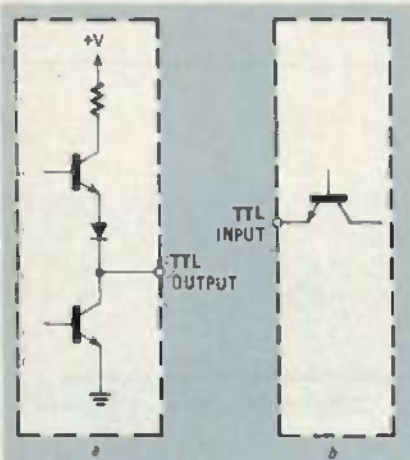

FIG. 2—STANDARD INPUT (a) and output (b) circuits make it easy to interconnect various TTL devices.

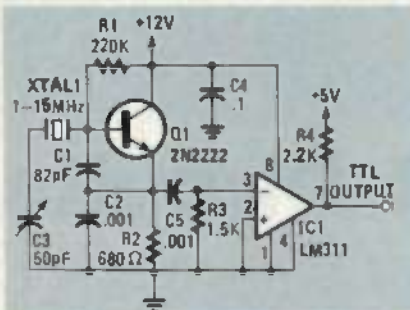

FIG. 3—A TRANSISTOR OSCILLATOR may be made TTL-compatible by following the output with a comparator.

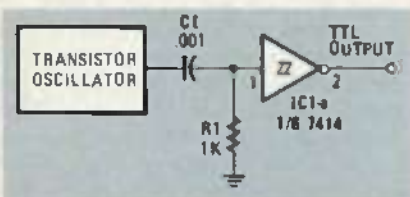

FIG. 4—A SCHMITT TRIGGER may also be used to make a transistor oscillator TTL-compatible.

the output of a transistor-based Colpitts oscillator circuit to TTL levels. As we saw in Part 5, which appeared in the November issue, the feedback level in a Colpitts oscillator is set by the capacitive voltage divider composed of C1 and C2. The oscillator's frequency is set by XTAL1, a piezoelectric crystal. Variable capacitor C3 allows fine control of frequency.

The output stage is an LM311 comparator. A comparator is basically a differential amplifier with too much gain. In any differential amplifier, the output voltage is a function of the difference between the two input voltages. When the input voltages are equal, the difference is zero, so the output voltage will be zero. But when those voltages differ by even a few millivolts, the output voltage will be non-zero. The gain of a typical comparator is 10,000 to 100,000, so the output will saturate

rate any time that the differential input voltage is non-zero.

In Fig. 3, the non-inverting input is grounded, so it sees a zero potential. Hence, whenever the signal applied to the inverting input (pin 3) exceeds zero volts, the output will go low.

The LM311 has what is called an "open-collector" output stage. That means that it requires a pull-up resistor (R4) in order to supply current. The 2.2K resistor shown can supply only about two mA of current at five volts, so the LM311's output is not truly TTL-compatible.

Another way to accomplish the same trick is to use a TTL IC called a Schmitt trigger. The operation of the Schmitt trigger follows this simple rule: The output will snap high when a positive-going input signal crosses a certain threshold (1.7 volts), and it will snap low when the input signal crosses a lower threshold (0.9 volts) in a negative-going direction. If the transistor oscillator shown in Fig. 3 is used to drive a Schmitt trigger, as shown in Fig. 4, the sinewave output of the oscillator will produce a train of square-waves at the output of the Schmitt trigger.

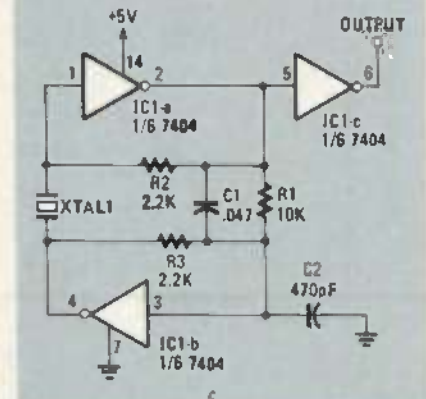
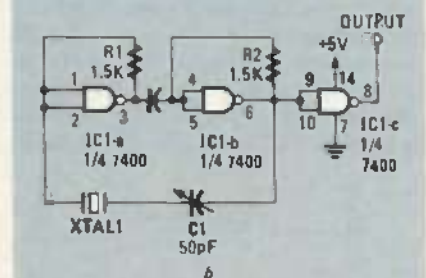
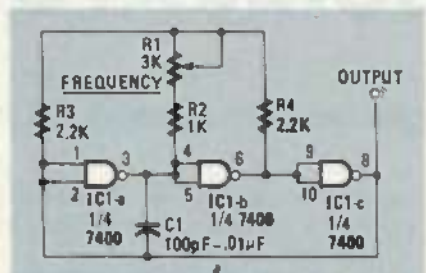

FIG. 5—AN RC OSCILLATOR (a) can be built with three gates and several discrete components. For better stability and accuracy a crystal oscillator may be used. Two popular configurations are shown in (b) and (c).

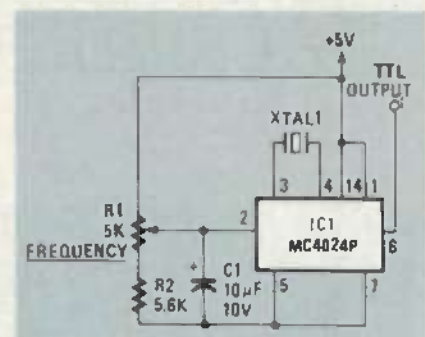

FIG. 6—A TTL-COMPATIBLE VCO requires just a crystal and a few discrete components to be a very stable oscillator.

Pure TTL clocks

Several TTL oscillators are shown in Figure 5. The circuits shown in Fig. 5-a and Fig. 5-b use NAND gates configured as inverters; the circuit in Fig. 5-c uses three standard inverters. The frequency at which the circuit in Fig. 5-a oscillates is determined by capacitor C1 and resistors R1 and R2. Potentiometer R1 allows you to vary the operating frequency over a small range. If only a single fixed frequency is needed for your application, replace R1 and R2 with a single fixed resistor.

One disadvantage of any RC oscillator is that its operating frequency is neither stable nor accurate. The effects of both problems can be reduced by using a piezoelectric crystal, as in Fig. 5-b and Fig. 5-c. Two of the NAND gates are used for the oscillator (IC1-a and IC1-b); the third functions as a buffer stage. Operating frequency is set by crystal XTAL1, and may be varied with capacitor C1.

The circuit shown in Fig. 5-c is similar to the one shown in Fig. 5-b, and is based on TTL inverters. Again, one stage (IC1-c) is used as an output buffer, and the oscillating stages are self-biased.

Special TTL oscillators

There are several all-in-one TTL oscillators on the market; Fig. 6 shows the diagram of a circuit based on the MC4024P dual voltage-controlled oscillator. Only one oscillator is used in that circuit. By the way, don't confuse the MC4024P with the 4000-series CMOS device called the 4024.

The center frequency of oscillation can be controlled in two ways: with a capacitor or with a crystal. For non-critical applications, a capacitor is used; it will have a value of approximately $300/f$ (Hz) picofarads. Potentiometer R1 gives you some control over the circuit's frequency.

TTL clocks are easy to build and to operate, especially in applications where a great deal of frequency stability is unnecessary. In the next and final installment of this series we will examine clock circuits made from CMOS IC's. R-E

PC SERVICE

One of the most difficult tasks in building any construction project featured in **Radio-Electronics** is making the PC board using just the foil pattern provided with the article. Well, we're doing something about it.

We've moved all the foil patterns to this new section where they're printed by themselves, full sized, with nothing on the back side of the page. What that means for you is that the printed page can be used directly to produce PC boards!

Note: The patterns provided can be used directly only for *direct positive photoresist methods*.

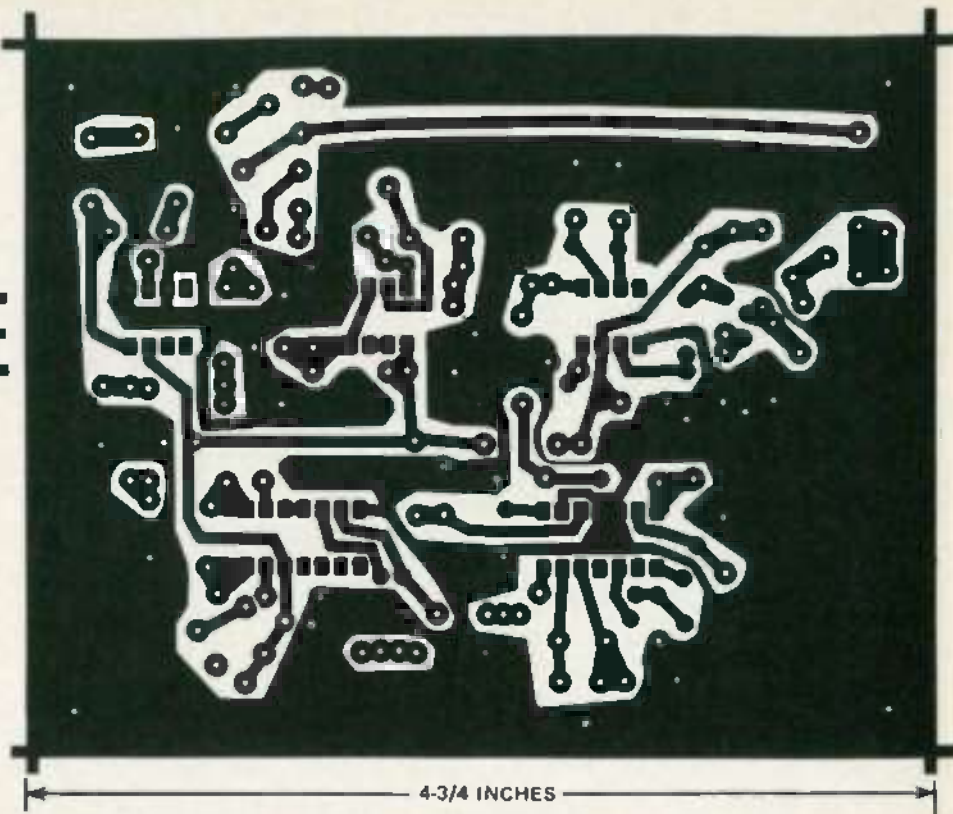

BUILD THE SINEWAVE DESCRAMBLER using this PC pattern.

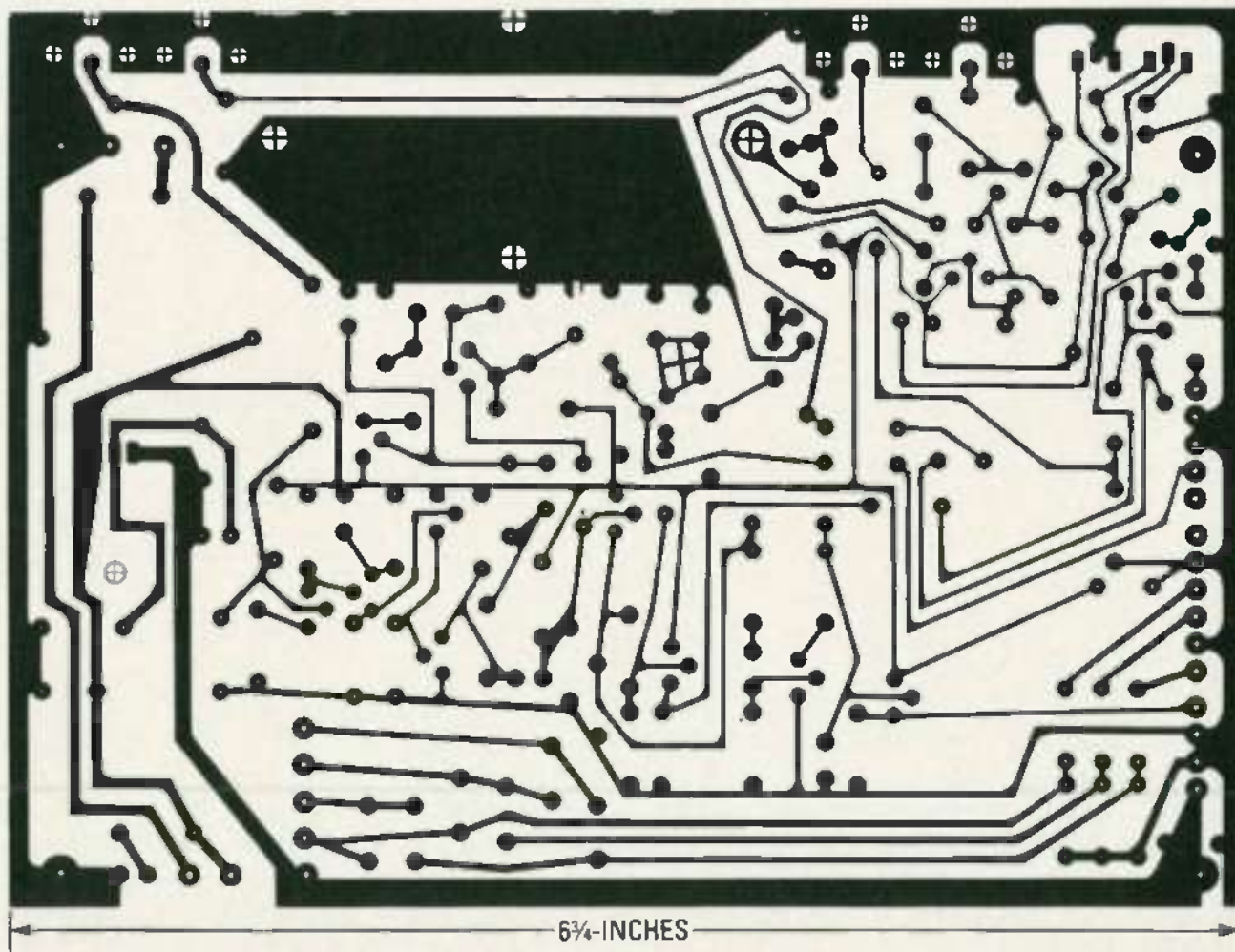

THE CLOSED CAPTION DECODER'S PC board is shown here.

COMPUTER DIGEST

VOL. 3 NO. 12 DEC. 1986

A NEW KIND OF MAGAZINE FOR ELECTRONICS PROFESSIONALS

ALL ABOUT INTERFACING

Everything You Need To
Know In the First Of A
Two-Part Article

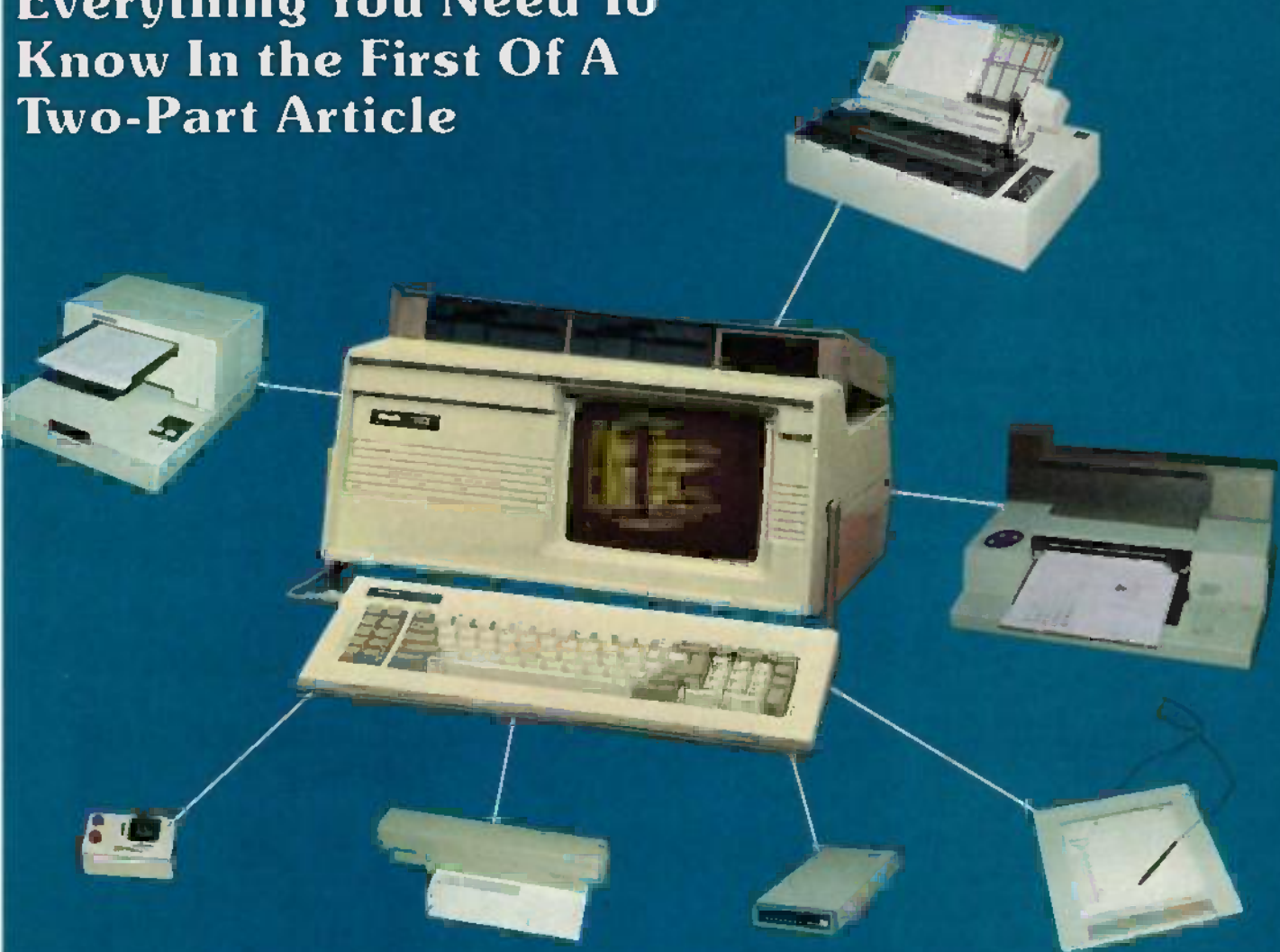

V-20 VS 8088

A New Battle Is Shaping Up

GERNSBACK
PUBLICATION

CONTENTS

Vol. 3 No. 12

December 1986

6 V-20 vs 8088

There's a new battle shaping up on the computer horizon. And when something new happens, we want to make sure you know about it. **Marc Stern**

9 All About Interfacing

This article has been a long time in coming. No matter what you want to connect to your computer, or what you want to connect your computer to, here, in the first of a 2-part article is all you need to know. **Jeff Holtzman**

3 Editorial

4 Letters

4 Computer Products

5 Software Review



See Page 6

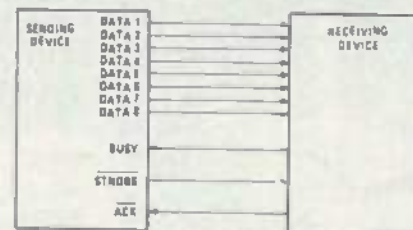

See Page 9

ON THE COVER

If you're going to be doing ANY interfacing, you'd better start by reading the story beginning on Page 9 of this issue. Admittedly, it's a bit more involved than laying out photos and drawing the connecting lines! Most of the photos of assorted equipment around our office, were taken by Herb Friedman.

COMING NEXT MONTH

Naturally, we try to pack all the information that we can into each issue. But in the January, 1987 Issue, we've really outdone ourselves. You won't want to miss the conclusion of our two-part article on interfacing, and we've got an important how-to on TVRO antenna pointing. We're finishing up with a fine piece on a five-volt RS-232. Don't miss it.



EDITORIAL

Let's standardize the "standards."

■Henry Ford has to be the father of mass production, and he built this scheme on totally-interchangeable parts. The carburetor of one car could easily be switched with the carburetor of another car. And the need for standards extends well-into electronics. Every young electronics devotee knows the standard for the resistor color code. You can see them counting on their fingers, as they recite, "Bad boys..."

But something began to go awry when it came to standardizing capacitor color codes. There were decimals to be considered, and multipliers, and the result was utter confusion.

Today, in the computer field, we have the so-called "RS-232" standard. But the manufacturers do not cleave to the standard, using their own variations for their own convenience. The result is a non-standard standard, and when you say "We're using RS-232," you find people asking just *which* "RS-232?"

It goes even beyond that. We have assorted operating systems, beginning with MS-DOS and CP/M and a host of other proprietary systems produced by various manufacturers; that prevent a software package that works on one, from working with another. The standard that seems to be emerging, is the IBM system, for almost every software manufacturer talks about "IBM compatibility."

Even the simple blank disk cries for standardization. You now have a choice of "hard sectored disks," or "soft sectored disks."

Wouldn't it be nice to be able to buy a computer without having to trace down the standards to make sure that they were indeed standard? Or that your projected computer purchase would operate *all* the disks you now have? Sure it would.

Now I'm shopping for a videocassette recorder. Top loading? Front loading? VHS? Beta? Programmable? Fast scan?

Decisions! All day long, decisions!

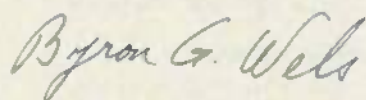

Byron G. Wels
Editor

COMPUTER DIGEST

M. Harvey Gernsback,
editor-in-chief, emeritus

Larry Steckler,
EHF, CET: publisher & editor in chief

Art Kleiman,
editorial director
Byron G. Wels,
editor

Brian C. Fenton,
managing editor

Carl Laron,
associate editor

Robert A. Young,
assistant editor

Jeff Holtzman
technical editor

Teri Scaduto Wilson
editorial assistant

Ruby M. Yee,
production director

Karen Tucker,
production advertising

Robert A. W. Lowndes,
production associate

Geoffrey S. Weil,
production assistant

Andre Duzant,
technical illustrator

Jacqueline P. Cheeseboro
circulation director

Arline R. Fishman,
advertising director

Computer Digest
Gernsback Publications, Inc.

Executive offices
500-B Bi-County Blvd.,
Farmingdale, NY 11735
516-293-3000

President: Larry Steckler
Vice President: Cathy Steckler

ADVERTISING SALES 516-293-3000

Larry Steckler
Publisher

NATIONAL SALES

Joe Shere
1507 Bonnie Doone Terrace
Corona Del Mar, CA 92625
714-760-8967

Computer Digest is published monthly as an insert in Radio-Electronics magazine by Gernsback Publications, Inc., 500-B Bi-County Blvd., Farmingdale, N.Y. 11735. Second-Class Postage Paid at New York, N.Y. and additional mailing offices. Copyright © 1986 Gernsback Publications, Inc. All rights reserved. Printed in U.S.A.

A stamped self-addressed envelope must accompany all submitted manuscripts and/or artwork or photographs if their return is desired should they be rejected. We disclaim any responsibility for the loss or damage of manuscripts and/or artwork or photographs while in our possession or otherwise.

LETTERS

Too Long

I submitted an article to your magazine, and got paid for it. Thank you. That was several months ago, and it still hasn't appeared in print. What's the delay?—S.T., Orlando, FL.

Have a heart! First of all, things just take time. For example, this column will actually appear in the December Issue, but as I write these words, it's really August. The 17th, to be exact. And yes, if you look it up on a calendar, it's a Sunday. And right now, the magazine is all set through February. So maybe the next time we need a three-pager, and yours fits, you might get lucky.

Warranty

I'm confused about my computer warranty. It runs for a full year, unless I open the case! Now

(a) how can I add a board or do some construction if I don't open the case, and (b) how are they going to know whether or not I did?—J.T., Fresno, CA.

You pays yer money and takes yer chance. Open it up, and you automatically void the warranty. And yes, they will know, for the manufacturers usually put a dab of paint on a cover-mounting screw, or paste on a small paper patch. Break the paint or paper and you kiss your warranty goodbye. We usually suggest waiting until the warranty expires before experimenting.

Budding Editor?

I'm fascinated with the publishing business and would (I think) like to get into it when I get older. What would you recommend?—A. L., Memphis, TN.

It's been extremely kind to me, and I'd suggest you start preparing the publishing business as well as yourself, by submitting articles on a freelance basis. This will help you learn to write, and will start getting your name around.

Expensive?

I've been pricing furniture (desks/tables) for my computer equipment. Now why is that stuff so expensive?—S.K., Reno, NV.

It doesn't have to be. Your local lumber yard can sell you a sheet of 4 x 8 plywood, finished one side and 3/4-inch thick at a very low price. For another couple of bucks they'll cut 30-inches off one end and run another cut 30-inches down the length of the remainder. That will give you two handsome table tops, ready-to-finish and enough wood to make legs with!

COMPUTER PRODUCTS

For more details use the free information card inside the back cover

VOICE-RECOGNITION SYSTEM, the *Voice Master*, is a half-card expansion board with resident program that recognizes hundreds of words. It is designed for the IBM-PC, XT, AT and compatible



CIRCLE 27 ON FREE INFORMATION CARD

personal computers. Versions are currently available for Commodore, Apple II series, and Atari 8-bit microcomputers.

The *Voice Master* has a suggested retail price of \$129.95, which includes half-card circuit board, microphone headset, and

resident system software.—**Covox, Inc.**, 675-D Conger St., Eugene, OR 97402.

SYNCHRONOUS MODEM

The model 91 is designed to function point-to-point or in a multi-poled network. Multi-dropped operation is achieved by using a daisy-chained approach to system wiring, in which each model 91 regenerates each signal before passing it on in the link. That process of incorporating signal repeaters results in extremely-high data reliability, especially at long distances. At 19,200 baud, the model 91 will support link distances of one mile.

The opto-isolation feature assures that devices connected to the model 91 are electrically isolated from each other, thereby eliminating problems associated with potential differences between grounds.

The model 91 provides full duplex synchronous serial data communica-

tion from 150 to 19,200 baud using frequency modulation. Transmission of a self-clocking FM signal on a balanced

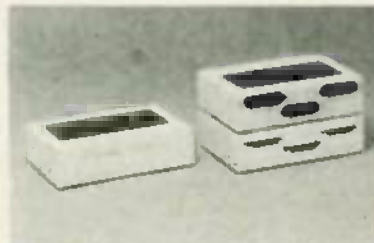

CIRCLE 28 ON FREE INFORMATION CARD

opto-isolated current-loop allows transfer of clocking information as well as data. The model 91 can also be linked to establish a full-duplex bus network between host and a number of remote terminals. It is priced at \$250.00.—**Telebyte Technology, Inc.**, 270 Pulaski Road, Greenlawn, NY 11740.

SOFTWARE REVIEW

That's right! A print shop in your computer.

■ Judging by its use, The Print Shop is probably the best-selling program. The program is used by schools, supermarkets, shops, even used-car dealers (and you know they're fussy about advertising).

For all its popularity, The Print Shop isn't a word processor, a spread sheet, time-manager or CAD/CAM. It's a signmaker. Using pin-feed paper it makes 8½ × 11 inch signs, greeting cards from folded 8-1/2 × 11 inch paper, letterheads, and banners; which can be used as advertising flyers, bookplates, report covers, award certificates, even abstract printed designs.

The program has an assortment of type styles in three formats (solid, outline and three-dimensional), borders, graphic characters and symbols, even abstract patterns. Each type style is its own size, each can be stretched to a proportional GIANT size. (The Commodore version has eight upper case fonts, nine border styles, and 60 graphics. The IBM version has twelve type styles in upper and lower case, sixteen borders, and 119 graphics.)

The user can integrate any type style with any border and any graphic, or any print function can be left out so the paper can be run through for a second or third printing, or run through to add conventional text from a word processor. When set to print greeting cards, all type, graphics and borders are reduced to the appropriate size and the printing is automatically rotated 180° so that everything comes out right side up when the paper is folded into a card.

Because the program was intended for children (if adults ever give them a chance to use it), it is menu-driven by cursor movement: the user steps the cursor to the desired mode and then hits RETURN. Each menu, except for graphics selection, shows the available and selected border and type styles. (The IBM version also shows the available and selected graphics.)

Special screens let the user select a small, medium or large graphic, built-in or custom graphic layouts, and line and page type-setting. The screen shows the possible graphic locations depending on the user's size selection (the graphics cannot overlap), and the allowable characters per line for each type and size type. If you select GIANT size and the characters won't fit the available space the screen shows what will fit, along with left, center or right positioning normal, reverse or 3-D type on a per line basis, and automatic top-to-bottom centering, if desired.

The program is goof-proof, and you can step back through each function one at a time and change only



what you want to change without losing all your work. For example, if after completing a sign you decide to change the border, say from stars to hearts, you step back through the composing, type selection, and graphics until you come to the border menu. You then change the border and step forward through graphics and type without affecting anything other than the border selection. You can even step back and change the position of a single line of type, or its outline, or even erase a line or characters (there is a built-in editor). What you can't do is mix type styles or graphics. The only variation on this rule is the IBM version, which permits the type to be upper or lower case on a per-line basis; that is, the line must be all upper case or all lower case.

The Print Shop has a graphics editor that lets you create your own graphics. In the Commodore version, the user-generated graphics can be saved to disk, but that's all that can be saved. In the IBM version the graphics and any sign, card, stationary or banner design can be saved to disk.

Each version supports a selection of printers, which is listed on the back of the box. If your printer isn't listed assume the program will not work.

The Print Shop is supplied on disk and requires at least one disk drive. It comes with a supply of heavyweight pinfeed paper and greeting card envelopes. Additional multi-color supplies and disk volumes of additional graphics characters are available. The Print Shop is heavily discounted: It sells for \$19.95 to \$59.95 depending on the version and the dealer.—Broderbund Software, 17 Paul Drive, San Rafael, CA, 94903-2101. ◀▶

V-20 vs 8088

Is there a direction change in the offing?

MARC STERN

■The way to stay afloat in the microcomputer world is IBM emulation, as it is accepted by big business, professionals, and home users.

Many manufacturers, having first tried to go their own ways found that crowds weren't flocking to their doors for solutions. The crowds were still heading toward IBM. Those firms that were able to switch have survived, while those that haven't are no longer active in the microcomputer market.

The ultimate in emulation would be a microprocessor that not only emulates, but surpasses that used in the IBM Personal Computer series.

Such a microprocessor is the Nippon Electric Co.'s (NEC) V20/V30 series. It not only emulates the 40 pin Intel 8086/8088 series, used in the IBM PC and close compatibles, but it betters that series by using less power (300 mW versus 1.7 W) and operates about 20 percent faster than the IBM version.

The only way you can differentiate between the two, is the NEC stamp on the microprocessor chip, and the "V" designation.

The V20/V30 series has an added mode, 8080 emulation. This gives CP/M users an out because CP/M was written to work in a Z80/8080 environment. With an emulator the V-20 will function effectively as an 8080. So those CP/M programs which may have been threatened with obsolescence by the 8086/8088 series and PC/MS-DOS will gain a new life and users will be able to retain their investment in software.

A closer look

The V20 and V30 are equivalent to the 8088 and 8086, respectively. Like the 8088, the V20 is an 8/16 microprocessor. It has an 8-bit data bus, but a 16-bit internal architecture. The marketing departments of various microcomputer manufacturers like to call this type of microprocessor a 16-bit device, but, it really isn't.

The true 16-bit device is the 8086. It has a 16-bit architecture, and also a 16-bit data bus. It is faster than the 8088 in realtime number crunching. The V30 is the

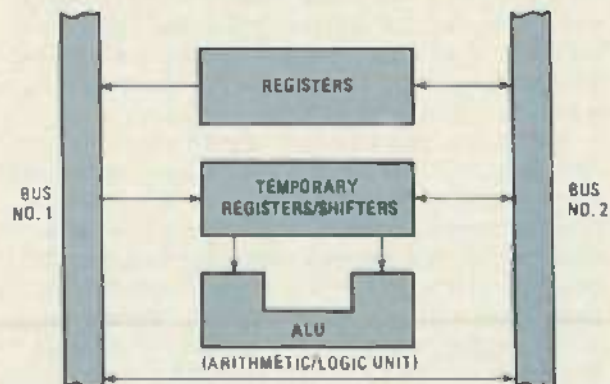

Fig. 1: A DUAL INTERNAL BUS helps increase the performance level of the V20/V30 series. The 8086/8088 family has a single internal bus and must suspend information processing as it moves source and destination data back and forth. The V20/V30 can move this data simultaneously.

functional equivalent to this device.

Both microprocessors are available in 5 and 8 MHz versions and they are CMOS devices. While both microprocessor series are functionally equivalent, the V20/V30 series uses 600 percent less power to handle the same jobs. For a system that is struggling at the razor edge of its power supply the lower demands of the NEC device can make a difference.

Not only are the V20/V30 chips power misers in their active mode, they offer a standby mode where their power consumption drops from 300 mW to 30 mW which means these devices can be used in standard desktop machines, and they can be used in briefcase or lap-top microcomputers.

The advantages seem to be with the V20/V30, because the V20/V30 series is much newer than the 8086/8088 family. Because it was designed recently, NEC has taken advantage of Very Large-Scale Integration and gate array technology, as well as advances in CMOS technology to produce this capable chip. The 8086/8088 series was designed in the mid-1970s and its age is beginning to show.

Another result of the age difference is the V20/V30's dual internal bus (See Fig. 1), which compares with the single internal bus of the 8086/8088 family. This can effectively increase the speed specifications of the V20/V30 because destination and source data can move along the data bus at the same time in two directions.

Data are taken into the registers in preparation for processing and the data are sent to the temporary storage registers and shifters. At this point, the data goes to the arithmetic-logic unit (ALU) for processing and then to either bus, depending on whether the information is source or destination. Data can pass from the registers back to the second bus.

Moving in parallel, the microprocessor is freed of wait states generated by having to free alternate cycles on the data bus for 16-bit source data and then destination data. Picture a single freeway lane trying to accommodate traffic in both directions during rush hour. This applies to the execution time of the 80886/8088 family. (We're talking about a difference of microseconds and the user won't notice the difference in speedup unless the application crunches a lot of numbers and must constantly fetch and latch the numeric data.)

Another change in the architecture of the V20/V30 is the substitution of hardware address calculations for the software (microcode) and hardware address calculation of the 8086/8088 series. The V20/V30 series includes a hardware section which performs address calculations from 2.6 to 6 times faster than the 8086/8088. Where it takes the 8086/8088 from five to 12 clock cycles to perform address calculations, the V20/V30 performs them in two. Address calculation, then, is also transparent to applications, which means that a developer only has to be concerned with a standard set of addresses for a particular device, rather than having to worry about both hardware and software addressing.

Another performance enhancement that is unique to

the V20/V30 is its prefetch pointer. (See Fig. 2)

Working with the instruction pointer, the prefetch pointer speeds things by moving to the next instruction and points to it as the microprocessor works through a program. A movable pointer, the prefetch jumps to the next instruction no matter how far it is from the instruction pointer. This enhances performance because the next instruction is always available for the micro.

The V20/V30 begins with performance advantages that the 8086/8088 series doesn't have. These advantages wouldn't make much difference if the V20/V30 wasn't compatible with the 8086/8088 family, which it is.

When it was developed, this series was modeled on and implemented the instruction set of the 80186/80188, a more powerful and later version of the 8086/8088 family. The differences were in the level of integration of such functions as the timer and interrupt controller, which are on-chip functions on the 80186/80188 series. The instruction set is enhanced with new instructions which add power and flexibility, but without sacrificing compatibility. There's no loss of compatibility as the complete instruction set of the 8086/8088 series is supported, as well as the additional code.

Speed improvement

While the specifications indicate a potential speed increase, it doesn't work out that way in practice. The V20/V30 series gives a user about a 20 percent increase in performance. Independent testing has confirmed this. The increase in speed is noticeable in processor-intensive applications where the microprocessor must constantly issue fetch commands for new instructions. The same testing has confirmed that input-output intensive applications, such as word-processing or telecommunications won't benefit that much from the new microprocessor because the system is constantly waiting for keyboard or communications port input.

You might be wondering why the speed differential exists. The microprocessor is busy doing other things—adding, subtracting, looping—while it is handling specific data addressing and calculation. Because it is, its resources are being spread through the system and they can't all be brought to bear for the ultimate speed increase.

Clock speed also seems to enter the picture. Running

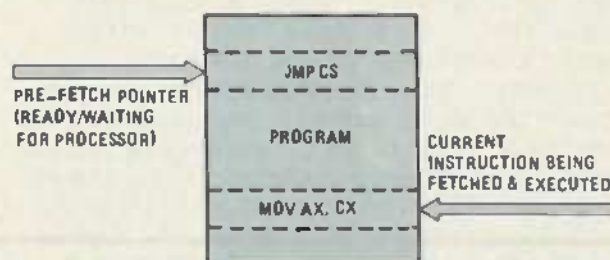
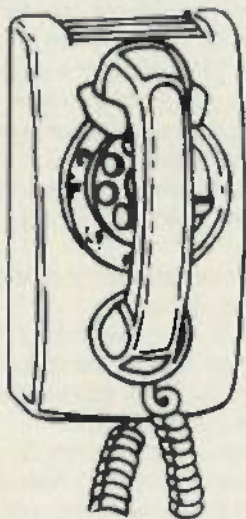

FIG. 2: THE PREFETCH POINTER speeds up processing in the V20/V30 series by moving directly to the next instruction to be executed by the microprocessor. This speeds things up because the micro always has the next instruction ready for its instruction pointer, which doesn't have to move around as much.

R-E Computer Admart

Rates: Ads are 2 1/4" x 2 1/4". One insertion \$825. Six insertions \$800 each. Twelve insertions \$775. each Closing date same as regular rate card. Send order with remittance to Computer Admart, Radio Electronics Magazine, 500-B Bi-County Blvd., Farmingdale, NY 11735. Direct telephone inquiries to Arline Fishman, area code-516-293-3000. Only 100% Computer ads are accepted for this Admart.



CALL NOW AND RESERVE YOUR SPACE

- 6 x rate \$800.00 per each insertion.
- Reaches 239,312 readers.
- Fast reader service cycle.
- Short lead time for the placement of ads.

Call 516-293-3000 to reserve space. Ask for Arline Fishman. Limited number of pages available. Mail materials to: Computer Admart, RADIO-ELECTRONICS, 500-B Bi-County Blvd., Farmingdale, NY 11735.

ICs PROMPT DELIVERY!!!

640 Kbytes VOLTAGE BOARD KITs - Zenith 200, IBM PC AT, Compaq Portable & Plus/1,ip Vectra

DYNAMIC RAM		
1Mbit	1000Kx1 100 ns	\$40.00
4464	64Kx4 150 ns	4.20
41256	256Kx1 100 ns	4.85
41256	256Kx1 120 ns	3.40
41256	256Kx1 150 ns	2.75
41128	128Kx1 180 ns	4.99
4164	64Kx1 150 ns	1.35
EPROM		
27512	64Kx8 250 ns	\$22.00
27C256	32Kx8 250 ns	6.50
27256	32Kx8 250 ns	5.25
27128	16Kx8 250 ns	3.95
27C64	8Kx8 200 ns	4.75
2764	8Kx8 250 ns	3.95
STATIC RAM		
43256L-12	32Kx8 120 ns	\$27.00
6264Lp-15	8Kx8 150 ns	3.10

OPEN 6 DAYS 7 AM-9 PM SUN 10 AM-5 PM VIA, FED-EX OR SAT
 SHIPMENTS: SHIPMENT ORIGINALLY TO U.S. EXPRESS MAIL
 SAT DELIVERY \$14.0000 (in-land) \$18.0000 (out-land)
 RECEIVED BY: 24,000 E. Plaines Ave., (918) 267-4961
 BEGGS, OK 74421
 *Prices will vary without notice on subject to change. Shipping & insurance cost extra. Payment by check or money order. Cash advance by VISA or MasterCard only. No cash advance.

CIRCLE 61 ON FREE INFORMATION CARD

GETTING THE MOST FROM YOUR PRINTER

Getting The Most From Your Printer



BP181—It is probable that 80% of dot-matrix printer users only ever use 20% of the features offered by their printers. This book will help you unlock the special features and capabilities that you probably don't even know exist. To order your copy send \$6.95 plus \$1.50 for shipping in the U.S. to Electronic Technology Today Inc., P.O. Box 240, Massapequa Park, NY 11762-0240.

COMPUTER MUSIC PROJECTS

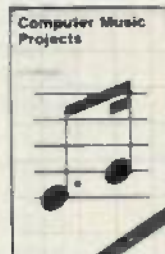

BP173—Computer Music Projects shows how to use your home computer to produce electronic music. Many circuits. Mostly jargon free. Send \$6.95 plus \$1.75 shipping to ELECTRONIC TECHNOLOGY TODAY INC., PO Box 240, Massapequa Park, New York 11762-0240.

A Z-80 WORKSHOP MANUAL

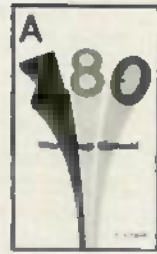

BP112—Starting with a review of computer principles, this book describes typical machine-code instructions followed by a detailed description of the Z-80 instruction set. Assembly language programming is also discussed with examples. Z-80 hex machine-code and assembler instructions are given in tabular form, along with in-out connections for the Z-80 and its associated devices...Order your copy from Electronic Technology Today Inc., PO Box 240, Massapequa Park, NY 11762. Price is \$6.95 plus \$1.00 for shipping.

a standard IBM Personal Computer or close compatible at its standard 4.7 MHz imposes timing and performance constraints on its 8088 processor. Reports circulated in the IBM user community for years of hyper-speed functionality brought about simply by changing the clock chip from 4.7 MHz to 8 MHz, at which the 8088 is easily capable of operating.

Although the V20 is a capable performer, when you run standard IBM applications or languages that are meant to operate at 4.7 MHz, you're imposing the same fetters on microprocessor performance that you have on the IBM's 8088 and performance of the system will be degraded, even though you are using the V20/V30. The 20 percent speed increase seems reasonable in light of this input.

Some users have complained about the speed shortfall and have questioned the capability of the V20/V30. But, those users have come to expect too much. It's one of the oldest marketing plays in the

microcomputer world, the specifications game, where the specifications are fantastic, but the performance doesn't match.

The solution, if you're considering the V20/V30, is knowledge. If you realize that the speeds won't be superfast, but will be modestly improved, then you'll get what you expect from the \$25 to \$30 V20/V30 chip.

Even a 20 percent performance increase is welcomed in some applications.

Finally, temperature and power usage are also important considerations and this is an area where the V20/V30 shines. It generates a lot less heat and uses manifestly less power than the 8088 and because it does it proves a blessing for a system overtaxed by the number of add-in cards and devices that may be on the motherboard because there's less heat and power consumption for the system box to contend with. ◀▶

ALL ABOUT INTERFACING PART I

All you need to know about microcomputer interfacing

Jeff Holtzman

Connecting peripheral devices such as printers, modems, and plotters to personal computers can be confusing. Many books dealing with the subject concentrate on connecting specific computers to specific peripherals.

We cannot guarantee that by absorbing the information presented here you will be able to connect any computer to any peripheral device. Designers and manufacturers in the microcomputer world do their best to avoid any efforts at following standards.

What you will learn are the basic principles of both parallel and series interfaces, with hints on how to get two pieces of equipment talking to each other. As Count Basie used to say, let's try it "just one more once."

Serial versus parallel

Most microcomputers move data to and from peripheral devices in eight-bit bytes. There are two methods of moving a byte from one location to another. We can send all eight bits at once, or we can send one bit at a time. The one-bit-at-a-time approach is called serial data transmission, and the all-at-once approach is called parallel data transmission. Neither is better; each has advantages and disadvantages that must be weighed for each application.

If we send one bit at a time, we can get by with as few as two lines (signal and ground) if we only need one-way communication, or three lines, if we need communications to and from a peripheral device. We'll talk about that later. But now, consider that for parallel transmission, we're going to need eight separate signal lines, plus a ground, and another one or two for synchronizing things so data won't be lost.

One advantage of parallel transmission is, since all bits are sent at once, transmission may occur at a higher speed than serial transmission. Also, the parallel circuitry is simpler and less expensive than serial circuitry. But the connecting cables are more expensive than serial cables, and there is less standardization of parallel connectors than serial connectors.

In another example, disk drives have (special) parallel interfaces that let them to take advantage of the speed advantage of the parallel approach. Some laboratory equipment and some low cost personal computers communicate with disk drives over (special) serial interfaces, but that is the exception.

Plotters and graphics printers usually operate with

parallel interfaces. The time to send—serially—the large amounts of data they require would be excessive.

Parallel transmission

The minimum parallel interface consists of ten signal lines and a ground. Frequently each active (non-ground) line of a parallel interface is twisted together with—or run close by—a ground line. That provides immunity to electrical interference, and is one reason parallel cables often have so many leads.

Of the active lines, eight are for data, one is a STROBE line, which indicates to the receiving device that it should take the data present on the data lines, one is a busy signal, which goes high to indicate that the receiving device is busy, and not to transmit any more data until it goes low, and the final signal is called $\overline{\text{ACK}}$, which is (usually) a short, negative-going pulse from the receiving device that indicates the data has been accepted properly. A simple parallel interface might be wired as shown in Fig. 1. Note that the twisted-pair grounds are not shown. Note also that the Busy and $\overline{\text{ACK}}$ lines come from the peripheral device, and that the STROBE line goes to it.

The normal sequence for sending a byte of data over such an interface is as follows. Refer to the timing diagram in Fig. 2. The character in that figure is the letter "U," which has an ASCII value of 55.

The computer monitors the busy line, waiting for the peripheral device to OK sending data. After the busy line goes low, the computer places its data on the eight data lines and pulses the STROBE line. That informs the peripheral device to grab the data. After it has taken the data, it pulses the $\overline{\text{ACK}}$ line, and turns the busy

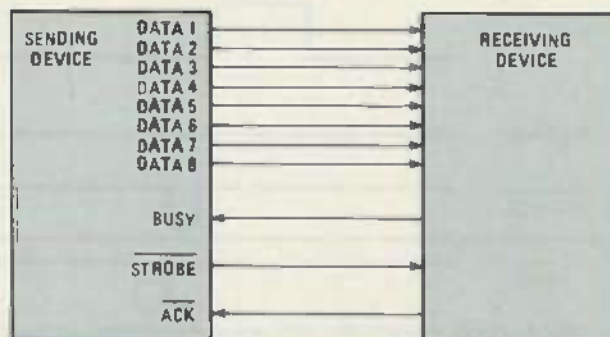

FIG. 1—EACH ACTIVE SIGNAL may have a ground, implemented as a twisted pair, as a shield, or as a nearby wire in a multi-conductor ribbon cable.

line on, if necessary, while processing that byte of data. When it finishes doing that, the busy line goes low, and the process may be repeated. If you are interested in how fast a parallel device can accept data, try connecting an oscilloscope to the STROBE line of your computer.

The highest bit, bit 8, is low. ASCII encoded data requires seven bits, so the eighth bit may be ignored or used for other purposes. Some word processing programs use the eighth bit to mark end of words, and in data communications, the eighth bit is often used to indicate the parity of a character.

Parity indicates how many of the lower seven bits of a character are "on" (high). Our "U" has four "on" bits, and four is an even number. If our transmitting device were set up for even parity, bit eight of the "U" would be low, since the character already has four bits. If our transmitter were set up for odd parity, bit eight of the "U" would be high, in order to make a total of 5 "on" bits. A transmitted "V" (ASCII 56, decimal 96) would cause the opposite parity values.

Parity is used for error checking. When a device using parity checking receives a character with incorrect parity, it signals the driving software that an error has

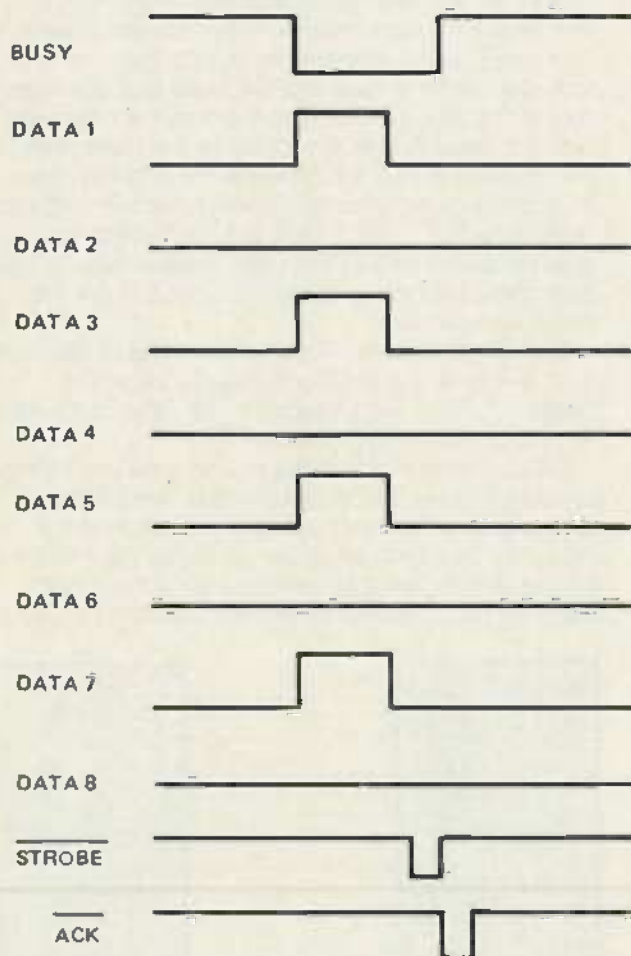

FIG. 2—DATA TRANSMISSION in a parallel interface begins with the busy line going low. Data bits may be sent, followed by a STROBE signal. Receipt of the character is acknowledged by sending the ACK line low. The character "U" is shown here.

occurred, which might then cause a request for the data to be re-transmitted. The most common circuitry allows parity to be set for odd, even, mark, space, or no parity. We have discussed the first two; mark and space simply force bit 8 high or low, respectively; and no parity simply ignores bit 8. Unless you have a specific reason not to do so, choose the latter when setting up your equipment. Otherwise only seven bits of each byte will carry useful data.

The transmission process outlined could be applied to any parallel interface: one linking a computer and a printer, a computer and a laboratory instrument, a computer and another computer, etc. However, a typical parallel printer interface will have a number of additional signal lines, as shown in Fig. 3.

The PAPER END signal indicates when the printer is out of paper. The SELECT line is generally high when the printer is "on-line"—that is, ready to receive data, and low when the ON-LINE switch has been pressed by the operator. The PRIME signal is a reset line that will force the printer into some well-defined (by each particular printer manufacturer!) state. Finally, the FAULT line goes high when the printer is off-line, when it is out of paper or ribbon, or if some sort of transmission error has occurred.

It is important to understand that not every printer will have all of those signals, and some printers may have additional signals (such as a low-current +5-volt source for powering peripheral devices such as a serial to parallel interface). It is also important to understand that little—if any—microcomputer software makes much use of any of the warning signals shown in Fig. 3. Usually, a printer suffering from a paper-out condition will cause the computer to lock up because the printer sends both the Busy and Paper End signals low, but software usually pays attention only to the Busy line. So your word-processing program might know that the printer is "busy" but not the reason for it.

A serial interface transmits bits of data one after the other. But not at random. When data is transmitted over a line conforming to the RS-232 standard, there are no timing restrictions on when individual bytes of data may be sent. However, each bit of a particular byte must be transmitted with strict attention to timing. Baud Rate refers to the speed at which transmission occurs, but not in a glib way.

Baud rate

First, let's define Baud Rate as the number of bits that may be transmitted per second. A Baud Rate of 300 means that 300 bits may be transmitted per second. That doesn't mean that 300 bits will necessarily be transmitted every second, though that's possible.

The term baud rate refers to the spacing between each bit of a single character, not the speed at which complete characters are transmitted. The way to find the time between each bit is take the inverse of the Baud Rate:

$$TC \text{ (sec)} = 1 / \text{Baud Rate}$$

To find the time it takes to transmit a complete character, multiply TC by the number of bits per character.

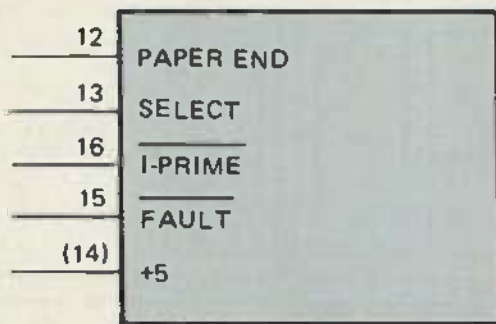

FIG. 3—ADDITIONAL SIGNALS in a parallel interface. These signals are frequently unused by software.

In a 300 baud system, the amount of time from the start of one bit to the start of the next is $1/300$, or 3.33 msec. To determine the amount of time a character takes, multiply the number of bits per character by 3.33. How many bits does a character have? In the microcomputer world of the 1980s, the correct answer is usually eight. There are exceptions.

An 8-bit character is going to be 10 or 11 bits long! Every character has a start bit, and one or more stop bits. Most equipment operates with one stop bit; older equipment used two stop bits to give slow machines a little bit (no pun intended) of "recovery" time.

Transmission of a character begins with a start bit. The data bits follow (usually eight, but not always), and then one or two stop bits. Figure 4 shows the transmission of the "U" character with 1 start bit, 1 stop bit and 8 data bits. Note the time "t" between each bit; that is the value $1/\text{Baud rate}$.

If our 8-bit character has one start and one stop bit, that is a total of 10 bits. So the time to transmit one character at 300 baud is $10 \times 3.33 = 33.3$ msec.

How many characters can be transmitted in one second, if it takes 33.3 msec to transmit one character? Using a little algebra, we see that

$$\frac{1\text{char}}{0.0333\text{sec}} = X\text{chars} \quad 1.0\text{sec}$$

So $X = 1 \times 1/0.0333 = 30$ chars/sec. We could have arrived at the same answer without the algebra—but doing it the hard way taught us something. Divide the baud rate by the number of bits per character. In our case, and in most you're likely to encounter, just divide

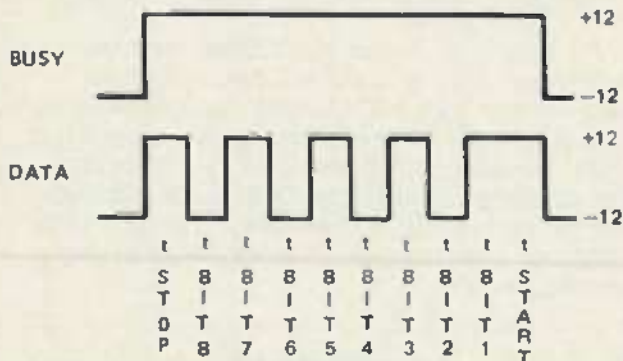

FIG. 4—SERIAL TRANSMISSION of data also begins with the busy line going low. A "U" is being transmitted here. Note the time "t" between each bit.

the baud rate by ten.

$$300 / 10 = 30 \text{ chars/sec.}$$

What is the character/second rate of a 110-baud transmission?

If you came up with 11, you jumped the gun. You can't really answer the question without knowing the number of bits per character. We picked 110 baud because the old Teletype machines used that as their baud rate. And they used two stop bits—so the TTY has 11 bits/char, and $110/11 = 10$ chars/sec.

Here's another trick question: If characters are coming over a transmission line at 300 baud, does that mean that 30 characters come through every second? It doesn't, and that brings us to our next topic.

Transmission rate

Transmission rate may be defined as the number of characters flowing over a communications line per unit of time. The most important thing to realize is that there is no relationship between baud rate and transmission rate! You might have one computer dumping data at 300 Baud and another at 9600 Baud, and the latter might have a lower transmission rate than the former. How could that happen?

The 300 baud machine might be dumping 30 characters every second, the 9600 baud machine might only send a character once every 30 minutes. Remember a transmission rate of 300 Baud guarantees only that there will be a delay of 3.33 msec between each bit of a character.

That example illustrates the point. Higher baud rates aren't necessarily better. You could attach circuitry (such as a "printer buffer") to a 110-baud Teletype machine that would enable your computer to dump characters at 9600 baud. The TTY will be unable to print at the rate of 960 characters/second, so as soon as the buffer memory inside your interface filled up, your effective transmission rate would fall from the baud rate to near the actual printing speed of the TTY.

Adding a high-speed interface to a slow piece of equipment may still be an advantage. If the buffer memory could hold a fairly large number of characters, your computer might dump an entire document at high speed and go on to do something else while the buffer outputs data at a rate the printer can handle.

If you attach a buffer memory to your printer (or MODEM, for that matter), make sure you get a buffer with enough memory to make it cost effective. If you mostly print double-spaced documents under about 25 pages, a 64K buffer should suffice. But with documents much longer than that, or with graphics dumps, you'll run up against the same problem. Once the buffer's memory is filled, transmission rate will

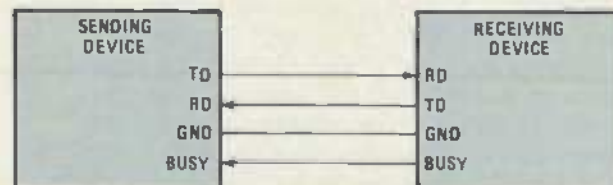

FIG. 5—RS-232 INTERFACES are commonly wired with only the signals shown here.

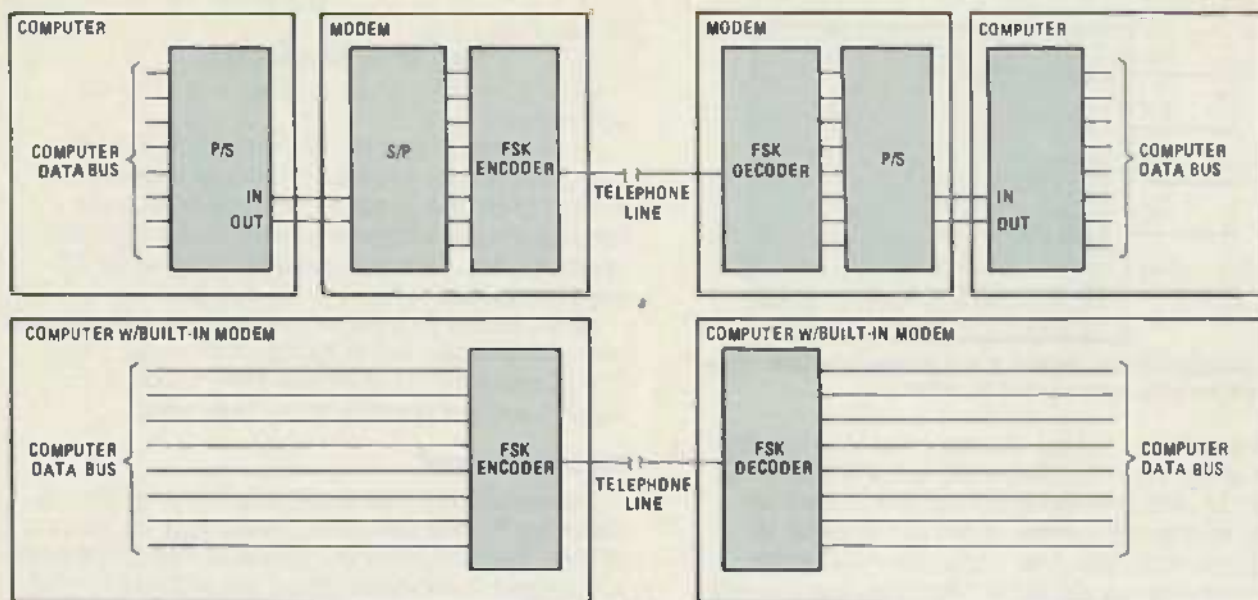

FIG. 6—TWO COMPUTERS connected via external MODEM's over the telephone lines are shown at a, and at b the computers are linked by internal MODEMS.

decrease drastically.

A practical RS-232 interface would appear as in Fig. 5. There are two data lines, a ground, and, like the parallel interface shown in Fig. 1, a busy line. There is no strobe line, as the start bit informs the receiving device that more is on the way. Neither is there an ACK. The busy line may perform the same function as in a parallel interface, as shown in Fig. 4, but there are other ways of indicating a busy condition.

Controlling transmission rate

Often we are unable to allow a computer to spew forth data at a transmission rate equal (or close to) the maximum value allowed by the baud rate—30 chars/sec, in the 300-baud system discussed here. The hardware on the receiving end must have a way of telling the transmitter "Hey—wait! I can't accept any more data right now."

There are two ways of doing that: With hardware and with software. With software we require two communication lines: One allowing data to flow from the transmitter to the receiver, and another allowing data to flow from the receiver to the transmitter.

What happens is that the transmitter sends data as fast as it can, while monitoring the line from the receiver for a special "wait" character that tells the transmitter not to send any more data. After receiving the "wait" character, the transmitter stops until it receives a "continue" character from the receiver. There are several such "protocols" in common use; you may have heard of ETX/ACK or X-OFF/X-ON. The first member of each pair simply represents the "wait" character, and the other, the "continue" character.

With hardware, a busy condition can be shown simply by the polarity of a signal line (high or low); the opposite polarity represents the "continue" condition. For example, low represents "Busy," high represents "continue."

Note that neither the hardware nor the software method is better than the other; each was developed to solve different problems. The software protocols for use with MODEMS and remotely operated printers where single-line communication links are a part of the system. A seismographic sensing unit might be located in a remote location, would be linked to a printer in a geological survey office by MODEM. A signal in addition to the transmit data and receive data lines that would distinguish between "wait" and "continue" conditions is hard to implement. Modem printers let you choose between software and hardware solutions, or both.

Historically, MODEMS were serial-in serial-out devices, as shown in Fig. 6a. There we see two computers connected through MODEMS via telephone lines. Each computer has a device labeled "P/S Converter," and each MODEM has a device labeled "S/P Converter." That is the same device, and is called a UART (Universal Asynchronous Receiver Transmitter). Another device inside the MODEM (called an FSK, for Frequency Shift Keying encoder) converts the parallel binary data into audio tones that can be transmitted over telephone lines.

It is becoming common for MODEMS to be built right in the computer; some MODEMS are built on plug-in cards. Such MODEMS give cost advantages, as shown in Fig. 6b: external packaging can be eliminated, as can the power supply, two UARTs, and associated circuitry. But a stand-alone MODEM can be used with any computer, printer or other device with appropriate interfaces, whereas plug-in cards are limited to one specific machine.

To be continued
in next month's issue

ANNUAL INDEX

Radio-Electronics Volume 57

and

COMPUTER DIGEST Volume 3

Abbreviations: (AR)Antique Radio; (ARE) Ask Radio-Electronics; (C)Construction; (CD)ComputerDigest; (COMC)Communications Corner; (COMPC)Computer Corner; (D)Department; (DB)Drawing Board; (DN)Designers Notebook; (E)Editorial; (ER)Equipment Report; (LTR)Letter; (NI)New Ideas; (R)Robotics; (SC)Service Clinic; (SQ)Service Questions; (SDSS)State Of Solid State; (STV)Satellite TV

A

Admiral (SQ)	Jan 109
Aircraft Radio on the FM Band (ARE)	Jul 8
Alarm	
Burglar, Phony (C)(Ringenberger)	Sep 44
Flood (NI)(Cook)	Apr 100
Temperature, IC (SOSS)	Apr 106
All About	
Frequency Counters (Martin)	Apr 69, May 71
Gravitational Waves? (Hodowanec)	Apr 53
Transistor Switches (Cable)	Feb 83
Amateur Packet Switching (COMMC)	Jul 89
Amplifier (see listing under STEREO; also see RADIO)	
Analog Delay Lines (Marston)	Oct 67
Antenna (see listing under RADIO)	
Antique Radios (DX)(Fitch)	Jan 97, Feb 108, Mar 86, Apr 92, May 85, Jun 80, Jul 86, Aug 76, Sep 88, Oct 94, Nov 76, Dec 84
Automatic Tuners	Jun 80
Back to the Present	Apr 92
Battery-Powered	Jan 97
Cabinets	Oct 82
Contributions by Hams and SWL's	May 85
Early Radio History	Feb 108, Mar 86
Letters From our Readers	Dec 84
Restoring AC-DC Radios	Nov 76
Speakers and Headphones	Sep 88
Test Equipment	Aug 77
Trimming AM Auto Radio	Sep 12
Tuning "Eyes" and AVC	Jul 86
Ask R-E (D)	Jan 22, Feb 12, Mar 8, Apr 6, May 8, Jun 6, Jul 8, Aug 8, Sep 12, Oct 14, Nov 23, Dec 20
Aircraft Radio on the FM Band	Jul 8
Audio Distortion Meter	Jul 10
Balun for TV Rhombic	Aug 8, Oct 16
Battery, Dual Auto	Nov 24
Building a Joystick	Feb 12
Composite Video from RGB Input	Aug 8
Electric Locks	Mar 10
Fluorescent Lights	Sep 12
FM Notch Filter	Apr 14
Frequency and Period	Feb 12
Magnetic Phone Preamp	Mar 8
Measuring Speaker Impedance	Apr 6
Needs Tuning Capacitor	Apr 12
PC Board Ground Plane	Apr 6
Parts For Crystal Radio	Apr 12
Pest Repeller Questions	May 6
Power Line Interference	Jul 8
R-J Speaker Enclosure	Mar 8
Reporting Shortwave Reception	Jan 26
Resistor Decade Box	Jan 22
Simple	
Power Supply	May 9, LTR Sep 22
RF Field Meter	Apr 14
Stroboscope	Aug 8
Speakerphone Information	Apr 6
Time Delay, Electronic	Oct 16
True North, Where Is?	Oct 14
Wiring Extension Speakers	Jan 26
World Time Conversion	Jun 8
Zener Diodes, Sorting	Nov 23
Zero Crossing	Jun 6
Audio (see STEREO)	
Audio Oscillator, An (DN)	Aug 83
Automatic Tuners (AR)	Jun 80
Automotive	
Battery, Dual (ARE)	Nov 24
Simple Circuit Foils Car Thieves (NI)(Goers)	May 32

B

B&K	
IC Tester, TTL (ER)	Aug 22
B + Too Low (SQ)	Feb 111
Back to the Present (AR)	Apr 92
Balun for TV Rhombic (ARE)	Aug 8, Oct 16
Bank-Switching (DB)	Aug 73
Battery	
Charger, Universal (C)(Wright)	Jul 67
Powered Antique Radios (AR)	Jan 97
Beats (see UNIDEN)	
Beckman	
Logic Probe, Circumate LP25 (ER)	Dec 24
Logic Pulser, Circumate PRM1 (ER)	Dec 28
Bandit	
BBT (SQ)	Aug 76
Black Box Descrambling (STV)	Jun 75
transform to Breadboard, from (Sweeney)	Sep 61
Breaker, Tripping (SQ)	Aug 76
Buyer's Guide to Personal Robots (SPECSECT)(Robillard)	Mar 41
C, Ku, and DBS (STV)	Jan 92
C-Band DBS? (STV)	Feb 103
Cable Tester (see listing under TEST EQUIPMENT)	
Cameras (see listing under VIDEO)	
Can't Tune The Lower Channels (SQ)	Oct 85
Capacitance Tester (see listing under TEST EQUIPMENT)	
Capri	
Scanner (SQ)	Sep 79
Car (see AUTOMOTIVE)	
CD Players (see listing under STEREO)	
Charger, Universal Battery (C)(Wright)	Jul 67
Chop-Amps (SOSS)	Aug 79
Click and Pop Filter (see listing under STEREO)	
Closed Captioning (COMMC)	Oct 92
Decoder (C)(Gifford)	Nov 41, Dec 61
CMOS Switching Circuit, A Simple (DN)	Jan 108
Color Coil Replacement (SC)	Sep 79
Communications (see RADIO)	
Communications Corner (see listing under RADIO)	
Compact Disc Players (see listing under STEREO)	
Composite Video from RGB Input (ARE)	Aug 8
Computer	
Aided Electronics Design (Grossblatt)	Dec 49
Memory	
Expansion (DB)	Apr 102
Management (DB)	Jul 84
On The Workbench (Grossblatt)	Dec 45
Printer, 150, Diotech (ER)	Oct 32
Software	
Doesn't Smoke (DB)	Jan 102
Program Connections and Lab Set-up (DB)	Sep 92
Construction	
Amplifier, Walkman	Mar 59
Battery Charger, Universal (Wright)	Jul 67
Burglar Alarm, Phony (Ringenberger)	Sep 44
Capacitance Leakage Tester (McClellan)	May 51, LTR Sep 22
Click and Pop Filter for your Stereo (Gorin)	May 46, Jun 55
Continuity Tester, Latching (Knight)	Nov 49
Crystal Radio, Old Time (O'Brien)	Oct 54
EPROM Programmer (Sawku)	Oct 61, Nov 55

C

Home Security System (LaMartina)	Jan 49
Humidity Monitor (Worley)	Feb 61
Joystick (ARE)	Feb 12
Laser, Helium-Neon (Grossblatt and Iannini)	Jun 42
Music Synthesizer, Mini	Feb 75
\$99 Satellite-TV Receiver (Maddox)	Jan 45
1.2-GHz Frequency Counter (Huff)	Jul 47
Power Supply, Versatile Bench Top (Swain and Ubiandi)	Jun 51
Radar Speed-Gun Controller (Slavens)	Aug 39, LTR Sep 14
Remote Controlled Power Switch (Cooper)	Aug 43
Robot	
R-E (Sarna)	Dec 54
Your Own (Robillard)	Mar 47
Satellite TV Descrambler (Terio and Perodi)	Oct 50
Stereo	
High Power FET Amplifier (Simpson and Clarke)	Jun 53, Jul 56, Aug 67, LTR Nov 10
TV Decoder (Sokolowski)	Mar 51, LTR Jul 20
Stun Gun (Grossblatt and Iannini)	Sep 41, LTR Nov 10
Telephone Line Tester (Friedman)	Apr 50, LTR Jun 10
Teletext Decoder (Gifford)	Apr 45, May 67, LTR Jun 12
Two Nifty Projects (Ook)(Fiction)	Apr 80
Video	
Camera Link, Wireless (Sheets & Graf)	Feb 51, LTR Mar 14
Trier (Flack)	Jan 57, Mar 62
Walkman Amplifier	Mar 59
Continuity Tester (see listing under TEST EQUIPMENT)	
Contributions by Hams and SWL's (AR)	May 85
Cross-Country Networking (COMC)	Mar 92
Crystal	
Radio, Old Time (C)(O'Brien)	Oct 84
Timebase, An Inexpensive (NI)(Rohrer)	Feb 46
Curing Electromagnetic Interference (Violante)	Jan 53, Feb 71, Apr 66
Customer Psychology (SQ)	Sep 78

D

DC	
On CRT Heater (SQ)	Jul 83
To Microwave (SPECSECT)(Bernard)	Sep 45
Dead-Set Servicing (SC)	Jul 82
Decade of Change, A: The Microprocessor (Grossblatt)	Apr 61
Decoder	
Closed Caption (C)(Gifford)	Nov 41, Dec 61
DTFM Encoding and (Nassar)	Dec 65
Teletext (C)(Gifford)	Apr 45, May 67, LTR Jun 12
Delay Lines, Analog (Marston)	Oct 67
Descrambling	
Black Box (STV)	Jun 75
Satellite TV (C)(Terio and Perodi)	Oct 50
TV Signal (Sheets and Graf)	Jun 47, Jul 44, Aug 51, Sep 64, Nov 46, Dec 57
Design Oscillator Circuits (Carr)	Oct 72, Nov 83, Dec 71
Designer's Notebook (D) (Grossblatt)	Jan 108, Mar 80, Apr 98, May 88, Jun 71, Aug 83, Aug 83
Audio Oscillator, An	Aug 83
More Single-Gate Designs	Mar 80
Precision Rectifiers	Jun 71
Schmitt Triggers	May 88
Simple CMOS Switching Circuit, A	Jan 106
Voltage Doublers	Apr 98
Designing With Digital IC's	
One Shots and Clocks (Carr)	Jan 71
Diotech	
Printer, Portable, 150 (ER)	Oct 31

Digital IC's, Designing With One Shots and Clocks (Carr) Jan 71
 Diodes, Zener, Sorting (ARE) Nov 23
 Diversity Reception, The Return of (COMC) Feb 96
 Drawing Board (DX) Grossblatt Jan 102, Feb 112, Mar 86, Apr 102, Jul 84, Aug 73, Sep 92, Dec 86, Aug 73
 Bank Switching Memory Expansion Apr 102
 Management, More On Jul 84
 Program Corrections and Lab Setup Sep 92
 Remote Control System Dec 86
 Software Doesn't Smoke! Z80 Demo Program Jan 102
 Feb 112, Mar 88
 DTFM Encoding and Decoding (Nassar) Dec 85
 Dual-Condition Sensing (SOSS) Oct 89
 OVM (see MULTIMETER listing under TEST EQUIPMENT)

E

Early Days of Radio, The (Clifford) Jul 80, Nov 60
 Radio History (AR) Feb 106, Mar 86
 Editorial (D) Feb 4, Mar 4, Jul 12, Oct 4, Feb 4
 Radio-Electronics is on the move! (Fonton) Feb 4
 Scrambling: Another View (Giner) Jul 12
 Who is the "Robotics Revolution"? (Fonton) Mar 4
 Electric Locks (ARE) Mar 10
 Electromagnetic Interference, Curing (Violetta) Jan 53, Feb 71, Apr 66
 EPROM Programmer (CNSawlow) Oct 61, Nov 55
 Equipment Reports (D) Jan 32, Feb 28, Mar 22, Apr 26, May 22, Jun 20, Jul 22, Aug 22, Sep 22, Oct 27, Nov 26, Dec 24, Jun 24, May 22
 Antenna, VHF, JV-2X, Mirage-KLM Cable Tester, 6500, Triplett Compact Disc Cleaner, Phot-On-Off, Melville Technologies (Fiction) Apr 34, LTR Oct 22
 Frequency Counter, WD-757, VIZ Function Generator, 205, OK Industries IC Tester, TTL, B&K Logic Analyzer, 16-Channel, 318, Tektronix Probe, Circumate LP25, Beckman Pulser, Circumate PR41, Beckman Multimeter DMV, 3430, Soai OVM-636, Scope Printer, Portable, 150, Diconix Prototyping Kit, Surface Mount, Vector Remote Control, Programmable, Control Center, G-E Scanner Receiver 800XLT, Under-Bearcat MX-7000, Regency May 26, LTR Sep 14
 Stereo Synthesizer, Teledapter TE-600 Rhoades Telephone Tester, Radio Shack Television, Projection Kit, GR-4500, Heathkit Tracker, 2000, Huntron VCR Distribution System, Rabbit Systems Video Board, Chaufer, STB Systems Wireless Speaker System, WTS-1, Nady

F

4007, Versatile, the (Marston) Sep 83
 FET, High Power Stereo Amp (C/Simpson and Clarke) Jun 83, Jul 56, Aug 57, LTR Nov 10
 Fiber Optic Communications (COMC) May 90
 Flasher, Sequential (NI) Dec 32
 Fleethood (SQ) Aug 78
 Flood Alarm (NI)(Cook) Apr 100
 Fluorescent Lights (ARE) Sep 12
 Flyback Hot (SQ) Aug 78
 Shorted (SQ) Jul 83
 FM (see listing under RADIO)
 Foreign Radio (SQ) Sep 79
 French Connection (SQ) Jul 83
 Frequency and Period (ARE) Feb 12
 Frequency Counter (see listing under TEST EQUIPMENT)
 Function Generator (see listing under TEST EQUIPMENT)

G

General Electric M-722 (SQ) Aug 78
 Remote Control, Programmable, Control Central (ER) Mar 22
 Gravitational Waves? (Hodowanoc) Apr 53, LTR Aug 12

H

HBO, The Raid On (Sheets and Graf) Oct 47
 Hearing with Electronics (Fish) Apr 78
 Heat Proofing Your Projects (Davis) Jan 83
 Heath New Hero (R) May 83
 Television, Projection Kit, GR-2400 (ER) Oct 27
 Helium-Neon Laser (C)(Grossblatt and Iannini) Jun 42

Hi-Fi (see STEREO)
 High Fidelity (see STEREO)
 High Power FET Stereo Amp (C/Simpson and Clarke) Jun 83, Jul 56, Aug 57, LTR Nov 10
 Home Security System, Build This (C)(LaMarina) Jan 49
 Hot Resistors and Shorted Capacitors (SC) Apr 68
 How To Design Oscillator Circuits (Carr) Jul 65, Aug 54, Sep 58, Oct 72, Nov 63, Dec 71
 Make Kirlian Photographs (Iovine) May 43, LTR Sep 14, LTR Oct 22
 Horizontal Swoop, No (SQ) Sep 79
 Humidity Monitor (C)(Worley) Feb 61
 Huntron Tracker 2000 (ER) Apr 26

I

IC Everywhere, I See (SC) Feb 110
 Making Measurements with (Thietley) May 63
 Packaging, A Revolution in (Byers) May 59, LTR Oct 25
 Temperature Sensors and More (SOSS) Jan 99
 Tester (see listing under TEST EQUIPMENT)
 Inexpensive Robotics Arms (R) Jul 80
 Inside the Telephone (Graf and Graf) Oct 56, Nov 51
 Interference, Curing Electromagnetic (LaViolette) Jan 53, Feb 71
 It's Kate—Bar the Door! (STV) Mar 81

J

Joystick, Building a (ARE) Feb 12

K

Kirlian Photographs, How to Make (Iovine) May 43, LTR Sep 22, LTR Oct 22

L

Lasers (SPECSECT) Jun 39
 Helium-Neon (C)(Grossblatt and Iannini) Jun 42
 Looking at (Bernard) Jan 39, LTR Oct 22
 Letters (D) Jan 12, Feb 15, Mar 14, Apr 22, May 12, Jun 10, Jul 14, Aug 12, Sep 14, Oct 22, Nov 10, Dec 8
 Locks, Electric (ARE) Mar 10
 Logic Analyzer (see listing under TEST EQUIPMENT)
 Logic Probe (see listing under TEST EQUIPMENT)
 Logic Pulser (see listing under TEST EQUIPMENT)
 Looking at Lasers (Bernard) Jun 39, LTR Oct 22
 Low Voltage (SQ) Sep 79

M

Magnavox E34018 (SQ) Oct 85
 Magnetic Phono Preamp (ARE) Mar 8
 Measurements with IC's, Making (Thietley) May 63
 Measuring Speaker Impedance (ARE) Apr 6
 Medical Electronics Healing with Electronics (Fish) Apr 78
 Melville Technologies Compact Disc Cleaner, Phot-On-Off (ER) (Fiction) Apr 34, LTR Oct 23
 Memory (see listing under COMPUTER)
 Microprocessor, The, A Decade of Change A (Grossblatt) Apr 61
 Microwave (see listing under TEST EQUIPMENT)
 Mini Music Synthesizer (C) Feb 78
 Mirage-KLM Antenna, VHF, JV-2X (ER) Jun 24
 Macrovergence (SQ) Sep 79
 Morse Electrophonic 7800 (SQ) Jul 83
 Multimeter (see listing under TEST EQUIPMENT)
 Music Synthesizer, Mini (C) Feb 75
 Mystery Computer Revealed (R) Apr 81

N

Needs Tuning Capacitor (ARE) Apr 12
 New Ideas (D) Feb 46, Mar 32, Apr 100, May 32, Jun 32, Aug 29, Nov 38, Dec 32
 Cable Tester, Simple (Dorling) Aug 29
 Crystal Timebase, An Inexpensive (Rohrer) Feb 46
 Flood Alarm, Easy to Build (Cook) Apr 100
 Robot Eyes (Ellis) Mar 32
 Light Seeking (Tavros) Nov 38
 Sequential Flasher Dec 32
 Simple Circuit Fails Car Thieves (Goorts) May 32
 Telephone Answering System (Ybuktursur) Jun 32

Products (D) Jan 111, Feb 24, Mar 30, Apr 40, May 38, Jun 28, Jul 30, Aug 30, Sep 34, Oct 42, Nov 31, Dec 38
 World of Communications (SPECSECT)(Kobbi) Sep 49
 Nady Systems Wireless Speaker System (ER) Aug 27
 Nifty Projects, Two (C)(O'Neil)(Fiction) Apr 60

O

OK Industries Function Generator, 205 (ER) Jul 26
 1-GHz Frequency Counter (C)(Muffl) Jul 47
 Op Amps, New (SOSS) May 88
 Oscillation (SQ) Jul 83
 Oscillator Circuits, How to Design (Carr) Jul 65, Aug 54, Sep 58, Oct 72, Nov 63, Dec 71, Mar 94
 Overload Protection (SOSS)

P

P-C Board Ground Plane (ARE) Apr 8
 Paris for Crystal Radio (ARE) Apr 12
 Pest Repeller Questions (ARE) May 8
 Pet Robot (R) Jun 74
 Photo (see listing under STEREO)
 Phony Burglar Alarm (C)(Ringenberger) Sep 44
 Photographs, How to Make Kirlian (Iovine) May 43, LTR Sep 22, LTR Oct 22
 Pocket Television Receivers (Bleichman) Jul 39, Aug 47
 Position Sensing (R) Sep 74
 Power Line TV Interference (ARE) Jul 8
 Supply (also see TEST EQUIPMENT) Supply, Simple (ARE) May 9
 Switch, Remote-Controlled (C)(Cooper) Aug 43
 Printed Circuit (see P-C)
 Printer (see listing under COMPUTER)
 Private Amateur Communications (COMC) Nov 80
 Programmer, EPROM (C)(Sawlow) Oct 61, Nov 55
 Programs (see listing under COMPUTERS)
 Projection Television (see listing under TELEVISION)
 Prototyping Kit, Surface Mount, SMT, Vector (ER) Sep 32

R

Rabbit Systems VCR Signal Distribution System (ER) Nov 26
 Radar Signal Detector (Hodowanoc) Jul 52
 Speed-Gun Controller (C)(Stevens) Aug 38, LTR Sep 14
 Radio (also see ANTIQUE RADIO)
 Aircraft Radio on the FM Band (ARE) Jul 10
 Antenna, VHF, JV-2X, Mirage-KLM (ER) May 24
 Communications (SPECSECT) Sep 45
 From DC to Microwave (Bernard) Sep 45
 Now World Of (Kobbi) Sep 49
 Communications Corner (DX)(Friedman) Feb 96, Mar 92, Apr 105, May 90, Jul 69, Aug 81, Aug 84, Oct 92, Nov 80, Jul 89, Apr 105, Oct 92, Sep 84, Mar 92, Feb 96, May 90, Nov 80, Aug 81, Oct 84
 Early Days Of, The (Clifford) Jul 61, Nov 60
 History (ARE) Feb 106, Mar 86
 FM Notch Filter (ARE) Apr 14
 Reporting Shortwave Reception (ARE) Jan 28
 Scanner Booster (SQ) Sep 79
 Receiver 800XLT, Under-Bearcat (ER) Mar 26
 MX-7000, Regency (ER) May 26, LTR Sep 14
 Telephone Tester (ER) Jul 23
 Trimming All Auto (ARE) Sep 12
 Radio-Electronics is on the Move (E)(Fonton) Feb 4
 Raid On HBO, The (Sheets and Graf) Oct 47
 RCA CTC-71 (SQ) Sep 78
 CTC-76 (SQ) Mar 85
 CTC-107 (SQ) Jul 83
 Reader Input (SQ) Oct 85
 Rectifiers, Precision (DN) Jun 71
 Red Hot Damper Tube (SQ) Jan 109
 Regency Scanner Receiver MX-7000 (ER) May 26, LTR Sep 14
 Remote Control Power Switch (C)(Cooper) Aug 43
 Programmable, Control Central, G-E (ER) Mar 22
 Repairing (see SERVICING)
 Replacing Transistors (SC) Aug 75
 Reporting Shortwave Reception (ARE) Jan 26

Resistor
Burnt, Simple Cure for (SQ) Mar 85
Decade Box (see listing under TEST EQUIPMENT)

Revolution in IC Packaging, A (Byers) May 59, LTR Oct 24

Rhoades
Stereo Synthesizer, TE-600 Teledapter (ER) Feb 40

Robot (see ROBOTICS)

Robotics (D)(Robillard)
Jan 84, Feb 94, Apr 81
May 83, Jun 74, Jul 80,
Aug 71, Sep 74, Oct 82,
Nov 74, Dec 81

Brains
Health's New Hero Feb 84
Inexpensive Arms May 83
More On Vision Systems Jul 50
Mystery Computer Revealed Dec 81
Personal (Robillard) Apr 81
Your Own, Build (Robillard) Jun 74
Revolution, Where Is (E)(Fenton) Sep 74
Robot Oct 82
Eyes (N)(Ellis) Nov 74
Light Seeking (N)(Tavara) Mar 41
Personal, Buyer's Guide To (Robillard) Jun 74
Pet (R) Dec 84
R-E (C)(Sams) Mar 47
Your Own, Build (Robillard) Oct 82

Roovers Revisited (R) Oct 82

S

Sanyo
91CS3 (SQ) Sep 79

Satellite TV (D)(Cooper)
Jan 82, Feb 103, Mar 81,
Apr 82, May 80, Jun 75,
Jul 78, Aug 69, Sep 72,
Oct 86, Nov 70, Dec 79

Black-Box Descrambling
Breaking VideoCypher Budget DBS System C, Ku, and DBS C-Band DBS? It's Kale—Bar the Door Kale Test, The Ku Change, the Microwave Test Equipment Scrambling And TVRO Systems Update Woes Jul 78

Black Box Descrambling (STV)
Breaking VideoCypher (STV) Budget DBS System (STV) C, Ku, and DBS (STV) C-Band DBS? Descrambler (C)(Terio and Perodi) It's Kale—Bar the Door (STV) Kale Test, the (STV) Ku Change, the (STV) Microwave Test Equipment (STV) Raid on HBO, The (Sheets and Graf) Receiver, Build This \$99 (C)(Maddox) Scrambling And TVRO Systems (STV) Another View (E) Update (STV) Woes (STV) Jul 78

Scanner (see listing under RADIO)

Schmitt Triggers (DN) May 88

Scope (also see listing under TEST EQUIPMENT)
Multimeter, DVM-630(ER) Jan 36

Scrambling
Another View (E) Jul 12
Update (STV) May 80
Woes (STV) Jul 78

Screwdriver Serviceman (SQ) Oct 83

Seam
564-4173 Jan 109
564-417700400 (SQ) Mar 85

Security System, Build This Home (C)(LaMartina) Jan 49

Sensors, IC Temperature and more (SOSS) Jan 99

Service Clinic (D)(Darr)
Jan 106, Feb 110, Mar 84,
Apr 88, Jul 82, Aug 76,
Sep 78, Oct 85, Dec 88

Customer Psychology
Dead-Set Servicing Jul 82
Hot Resistors and Shorted Capacitors Apr 88
I See IC's Everywhere Feb 110
Repairing Old TVs Jan 108
Replacing Transistors Aug 75
Screwdriver Serviceman: Oct 85
Signal Tracing Dec 88
Voltage Regulators Mar 84

Service Questions (D)(Darr) Jan 109, Feb 111, Mar 85,
Apr 90, Jul 83, Aug 76,
Sep 78, Oct 85, Dec 89

Servicing
B.I.G. Turntables (L) Apr 90
Compact Disc Players (Lenk) Jan 87, Feb 79, Mar 73
Repairing Old TVs (SC) Jan 108
Troubleshooting the Tough Ones (Salerno) Mar 76

Shrunken Video (SQ) Jan 109

Simple
Circuit Foils Car Thieves (Goers) May 32
Power Supply (ARE) May 9, LTR Sep 22
RF Field Monitor (ARE) Apr 14

Single
Chip Sync/Sweep Circuit (SOSS) Jun 72
Gate Designs, More (DN) Mar 90

Slow Guns (SQ) Aug 76

Soar
Digital Multimeter, 3430 (ER) Sep 24

Software (see listing under COMPUTER)

Sony
KX-2501 (SQ) Apr 90
Misconvergence (SQ) Sep 79
Static Convergence (SQ) Apr 90
Walkman Amplifier (C) Mar 59

Speaker (see listing under STEREO)

Speakerphone (see TELEPHONE)

Spikes and Cures (COMMIC) Aug 81

State of Solid State (D)(Scott) Jan 99, Mar 94, Apr 106,
May 89, Jun 72, Aug 78,
Oct 89

Chop-Amps
Dual-Condition Sensing Aug 79
IC Temperature Sensors and More Oct 89
New Op Amps Jan 99
Overvoltage Protection May 88
Single-Chip Sync-Sweep Circuit Jun 84
Temperature Alarm IC Apr 106

STB Systems
Video Board, Chaufer (ER) Jan 22

Stereo
Amplifier
High Power FET (C)(Simpson and Clarke) Jun 83, Jul 86, Aug 57,
LTR Nov 10
Walkman (C) Mar 59
Audio Distortion Filter (ARE) Jul 10
Click and Pop Filter for your (CHGorn) May 46, Jun 55
Compact Disc
Cleaner, Phot-On-Off, Melville Technologies (ER) Apr 34, LTR Oct 24
Repairing Players (Lenk) Jan 87, Feb 79, Mar 73
Bit-By-Bit (Bernard) Aug 83
Distortion Filter, Audio (ARE) Jul 10
Phono Preamp, Magnetic (ARE) Mar 8

Speaker
Enclosure, R-J (ARE) Mar 8
Headphones, and (AR) Sep 88
Measuring Impedance (ARE) Apr 6
System, Wireless, WTS-1, Nady (ER) Aug 27
Wiring Extension (ARE) Jan 26
Stroboscope, Simple (ARE) Aug 8
Synthesizer, Teledapter TE-800 Rhoades (ER) Feb 40
TV Decoder (C)(Sokolowski) Mar 51

Stroboscope (see listing under STEREO)

Stun Gun, Build This (C)(Grossblat and Lennin) Sep 41, LTR Nov 10

Surface Mount Technology, Prototyping Kit Vector (ER) Sep 32

Switches, Transistor, All About (Cebik) Feb 83

Switching, Bank (DB) Aug 73

Sylvania
GC4152W (SQ) Aug 76

Synthesizer (see MUSIC, also see STEREO, also see TELEVISION)

T

Tactile Sensing (R) Aug 71

Teknisk
3248 (SQ) Feb 111

Tektrons
Logic Analyzer, 16-Channel, 318 (ER) Feb 28

Telephone
Answering System (F)(Yoursurs) Jun 32
Inside the (Graf and Graf) Oct 58, Nov 81
Line Tester (C)(Friedman) Apr 50, LTR Jun 10
Speakerphone Information (ARE) Apr 8
Tester (ER) Jul 23

Teletex (see listing under VIDEO)

Television (see listing under VIDEO, also see SATELLITE TV)

Temperature
Alarm IC (SOSS) Apr 106
Sensors and more, IC (SOSS) Jan 99

Test Equipment
Antique (AR) Aug 77
Cable Tester
Simple (N)(Doering) Aug 29
8500, Triplet (ER) May 22
Capacitance Leakage Tester (C)(McChellan) May 51, LTR Sep 22
Continuity Tester, Latching (C)(Knight) Nov 49
Frequency Counter
All About (Martin) Apr 89, May 71
1.2-GHz (C)(Huff) Jul 47
WD-757, VIZ (ER) Jun 20

Function Generator
205, OK Machine (ER) Jul 26
IC Tester, TTL, B&K (ER) Aug 22

Logic
Analyzer, 16-Channel, 318, Tektronix (ER) Feb 28
Probe, Circuits LP25, Beckman (ER) Dec 24
Pulse, Circuits PR41, Beckman (ER) Dec 28
Microwave (STV) Sep 72

Multimeter
Digital, 3430, Soar (ER) Sep 24
DVM-630, Scope (ER) Jan 36
Power Supply, Variable Bench Top (C) (Swain and Ubaud) Jun 81
Resistor Decade Box (ARE) Jan 22
Scope For TV, What Kind (SQ) Apr 90

Telephone
Line Tester (C)(Friedman) Apr 50, LTR Jun 10
Tester (ER) Jul 23
Tracker, 2000, Huntron (ER) Apr 26
Time Delay, Electronic (AR) Oct 18
Titrer, Video (C)(Fleck) Jan 87, Mar 82

Tohiba
C998 (SQ) Oct 85
Tractor-Radio Problems (SQ) Aug 76
Transistor Switches, All About (Cebik) Feb 83

Triplet
Cable Tester, 6500 (ER) May 22

Troubleshooting (see SERVICING)

True North, Where Is? (ARE) Oct 14

Tuning 'Eyes' and AVC (AR) Jul 86

TV (see TELEVISION listing under VIDEO, also see SATELLITE TV)

Two Nifty Projects (C)(Oddy)(Fiction) Apr 50

U

Under-Bearcat
Scanner Receiver, 800XL (ER) Mar 28
Universal Battery Charger (C)(Wright) Jul 87

V

VCR (see listing under VIDEO)

Vector
Prototyping Kit, SMT (ER) Sep 32
Vertical Bar In Picture (SQ) Jan 109

Versatile
Bench Top Power Supply (C)(Swain and Ubaud) Jun 51
4007, The (Marston) Sep 83

Vertical Deflection, No (SQ) Aug 76

Video (also see SATELLITE TV)
Camera Link, Wireless (C)(Sheets & Graf) Feb 81, LTR Mar 14
Board, Chaufer, STB Systems(ER) Jan 22
News(D)(Lichenbruch) Jan 6, Mar 12, Apr 16,
May 10, Jun 4, Jul 8,
Aug 6, Sep 8, Oct 12,
Nov 6, Dec 8

Remote Control, Programmable, Control Center, G-E (ER) Mar 22

Teletex
Decoder (C)(Gifford) Apr 49, May 67, LTR Jun 12

Television
Bakur for Rhombic (ARE) Aug 8, Oct 16
Descrambling Signals (Sheets and Graf) Jun 47, Jul 44, Aug 51,
Sep 54, Nov 44, Dec 57
Pocket Receivers (Blechman) Jul 39, Aug 47
Power Line Interference (ARE) Jul 8
Projection Kit, GR-4500, Heathkit (ER) Oct 27
Repairing Old (SQ) Jan 108

Stereo
Decoder (C)(Sokolowski) Mar 81, LTR Jul 20
Synthesizer, Teledapter TE-800, Rhoades (ER) Feb 40
Sync-Sweep Circuit, Single Chip (SOSS) Jun 72
Titrer (C)(Fleck) Jan 87, Mar 82
TV (see TELEVISION under VIDEO)

VCR
Distribution System, Rabbit Systems (ER) Nov 26
Repairing (SQ) Aug 76

Voice Recognition, Robots and (R) Jan 84

Voltage
Comparators, Working with (Marston) Jun 58
Doublers (DN) Apr 98
Problems (SQ) Jul 83
Regulators (SQ) Mar 84

W

Walkman Amplifier (C) Mar 59

What Kind of Scope for TV? (SQ) Feb 111

What's News(D)
Jan 4, Feb 8, Mar 8,
Apr 4, May 4, Jun 4,
Jul 4, Aug 4, Sep 4,
Oct 8, Nov 4, Dec 4

Wireless Video Camera Link (Sheets & Graf) Feb 81, LTR Mar 14

Working with Voltage Comparators (Marston) Jun 58

World Time Conversion (ARE) Jun 8

Y

Yoke, What's (SQ) Mar 85

Z

Z80 Demo Program (DB) Feb 112

Zener Diodes, Sorting (ARE) Nov 23

Zenith
20Y1C50 (SQ) Sep 79
250C58 (SQ) Jan 109

Zero Crossing (ARE) Jun 8

COMPUTER DIGEST Volume 3

January 1986 — December 1986

Abbreviations: (C)Construction; (D)Department; (E) Editorial; (L)Letter; (ER)Equipment Review; (SR)Software Review

A				S	
All About Interfacing (Holtzman) Printers (Friedman)	Dec 9 Mar 8	Graphics Bioteedback Monitor Program (Peterson) Grates-32 (C)(Dahlby)	Oct 6 Feb 9, Mar 13, Apr 12	Schmitt Trigger Design (O'Connor)	Nov 8
B		H		Single Transistor Switching Circuit Design (Holtzman)	Aug 15
Best Friend...\$84.95 (SR)	Apr 5	Hard Disk Drives (Stern)	Jan 5	So You're Going to Buy a Monitor (Friedman)	Feb 4
General-Purpose Interface (Stern)	Jun 12	How to Back Up a Protected Disk	Oct 5	Software Program	
C		I		Computerized Power Supply Component Selection (Cunkelmann)	May 15
CB Scanner, Computer (C)(Maloney)	Sep 7	If I Give a Man a Fish... (E)	Jun 3	555 Design (Holtzman)	Jan 8
Changing Face of Computing (E)	Oct 3	Interface Bus, General Purpose (Stern)	Jun 12	Graphic Bioteedback Monitor (Peterson)	Oct 6
C'mon, You Guys! (E)	Jul 3	Interfacing, All About (Holtzman)	Dec 9	Single Transistor Switching Circuit Design (Holtzman)	Aug 15
Computer		L		TVRO Antenna Pointer (Smith)	Oct 10
Aided Design of Loudspeaker Enclosure (Raleigh & Raleigh)	Jan 10, Feb 7	LAN — Local Area Networking (Stone)	Jun 6	Review	Jan 4, Mar 7, Apr 5, May 5, Jun 5, Sep 6, Nov 5, Dec 5
Care (Friedman)	Apr 6	Letters (D)	Jan 3, Feb 3, Mar 4, Apr 4, May 4, Jun 4, Jul 4, Aug 4, Sep 4, Oct 4, Nov 4, Dec 4	Best Friend...\$84.95	Apr 5
CB Scanner (C)(Maloney)	Sep 7	Local Area Networking — LAN (Stone)	Jun 6	Crosstalk Is There a Universal Software?	Jun 8
Power Supply Component Selection (Cunkelmann)	May 15	Loudspeaker Enclosures, Computer-Aided Design Raleigh & Raleigh	Jan 10, Feb 7	How to Back Up a Protected Disk	Oct 5
Products (D)	Jan 3, Feb 3, Mar 4, Apr 4, May 4, Jun 4, Jul 4, Aug 4, Sep 5, Oct 4, Nov 4, Dec 4	M		Little Black Book	Mar 7
Construction		Media Master Plus (SR)	Nov 5	Media Master Plus	Nov 5
Computer CB Scanner (Maloney)	Sep 7	Mini-Jini (SR)	Oct 6	Mini-Jini	Sep 6
Grates-32 (Dahlby)	Feb 9, Mar 13, Apr 12	Modems		pls Write	Jul 5
Modem, No Frills (Kreuter)	Nov 9	More On (Friedman)	Jul 7	Teletach	Aug 18
Remote Power Controller for your Commodore-64 (Sowden)	May 11	No Frills (C)(Kreuter)	Nov 9	Typewrite — \$49.00	Jan 4
Crosstalk, Is There a Universal Software? (SR)	Jun 5	Monitor, So You're Going to Buy a (Friedman)	Feb 4	Word Finder — An Electronic Thesaurus	May 5
D		O		Soup Up Your PC (Byers)	Sep 11
Disc Drives		Okidata Upgrade (Kanter)	Oct 12	Speech Synthesizer (Jimenez & Valle)	Aug 10
Hard (Stern)	Jan 5	Optical Disks (Stern)	Sep 15	Synthesizer Speech (Jimenez & Valle)	Aug 10
Optical (Stern)	Sep 18	P		Systems (E)	Nov 3
E		Q		T	
Editorial (D)(Wels)	Mar 3, Apr 3, May 3, Jun 3, Jul 3, Aug 3, Sep 3, Oct 3, Nov 3, Dec 3	Packet Radio (Stern)	Apr 10	Tape Backup (Stern)	Nov 6
Changing Face of Computing	Oct 3	pls Write (SR)	Jul 5	Teletach (SR)	Aug 14
C'mon, You Guys!	Jul 3	Printers		Told Ya So! (E)(Wels)	Sep 3
If I Give a Man a Fish...	Jun 3	All About (Friedman)	Mar 8	Touchscreen Technology (Stern)	Jul 15
RM5241	Aug 3	Okidata Upgrade (Kantor)	Oct 12	TVRO Antenna Pointer Program (Smith)	Oct 10
Systems	Nov 3	Retrofitting (Friedman)	Aug 6	Typewrite — \$49.50 (SR)	Jan 8
Told ya so!	Sep 3	Program (see SOFTWARE)		U	
Who Are You Fooling?	May 3	Protocol Converter (Hu)	Jul 11	Universal Software?, Is There (SR)	Jun 5
Wonderful Ideas #1275	Apr 3	R		Using a TI-89 Keyboard on a Sinclair ZX-81 (Grossblatt)	May 7
You've Got To Sacrifice	Mar 3	Remote Power Controller for your Commodore-64 (C)(Sowden)	May 11	V	
F		Retrofitting Printers (Friedman)	Aug 6	V-20 vs 8088 (Stern)	Dec 6
555 Design Program (Holtzman)	Jan 8	S		W	
Frequency Counter for your C-64 (Neal)	Mar 12	T		When Lightning Strikes... (Friedman)	Jun 10
G		U		Who are you Fooling (E)	May 3
GPIB, General-Purpose Interface Bus (Stern)	Jun 12	V		Wonderful Ideas #1275 (E)	Apr 3
		W		Word Finder — An Electronic Thesaurus (SR)	May 5
		X		Y	
		Y		You've Got To Sacrifice (E)	Mar 3

SATELLITE TV



BOB COOPER, JR.,
SATELLITE-TV EDITOR

Hacking Videocipher

PARDON ME IF I'M REPEATING OLD news, but most of the major satellite signals are being broadcast in scrambled form. That scrambling has caused significant problems in the TVRO industry. For example, sales are off by more than half, and everyone from OEM to dealer is hurting. Some people are hurting badly enough that they are attempting to do something about scrambling—they're trying to beat it.

Black-box solutions abound already, and there is an active underground (and middleground) in which descrambling devices and information are being distributed. However, until quite recently, most claims about successful descrambling were fanciful flights of creative copywriting. But no more.

Oak and M/A-Com

Two unrelated scrambling systems are being used in the U.S. and Canada this year. One is the product of Oak Industries; they call their system the ORION (Oak Restricted Information and Operation Network). Two versions of their decoders are available; one is for cable-systems operators and one is for the home market. The home-style decoder for that system is called the ORION P; the P stands for Personal.

In the U.S., we have the M/A-Com Videocipher system, which has been widely adopted by cable programmers such as HBO, CNN, and more than a dozen others. (Even The Disney Channel is scrambling now.) There are also two versions of Videocipher; the VC-2, which is for the cable people, and the VC-2000, which is for home use.

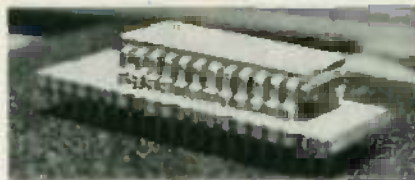

FIG. 1

Descrambling both Oak's and M/A-Com's video signals was child's play. In fact, at least one home-style receiver manufactured by Arunta Engineering (3111 E. Thomas Rd., Phoenix, AZ 85016) decodes that type of video straight out of the box. It may be coincidental, but Arunta's receiver was designed and marketed before Videocipher took off. But the fact is that it does produce perfect pictures from both types of signals.

The audio has been a greater

challenge. The first breakthrough comes from the Canadian firm Westar Technologies (2 Bloor Street West, Suite 100, Toronto, Ontario, Canada M4W 3E2). Westar has introduced an IC, shown in Fig. 1, that contains complete descrambling circuitry for the Oak system—both video and audio—on a 40-pin carrier.

In mid August that IC costs about \$250, and the ORION P decoders are selling for approximately the same price. So, for \$500 or so, you can have access to everything scrambled by the Oak system.

Needless to say, there are several legal problems here, because neither U.S. nor Canadian authorities condone descrambling signals that are intended only for authorized use.

The next breakthrough is imminent, if it has not been attained by the time this column reaches print. It involves the Videocipher system, which until now has been invincible to hacking attempts.

The Oak system converts audio to digital form and then hides it in the video signal. The M/A-Com system uses a similar technology, but it also encrypts the audio according to a Governmental security standard called DES (Digital Encryption Standard). To recover the Videocipher audio, one must first extract the digital data and then decrypt it according to a key.

The M/A-Com system might have been invincible were it not for design "features" of the Videocipher system. What really compromises the system is that a master decoding key is transmitted along with the encoded audio.

Interested In TVRO?

For nearly two years Bob Cooper has provided a no-charge kit of printed materials that describes the challenges of and opportunities in selling TVRO systems today. With the present intense interest in scrambling systems, Coop's CSD has made available a new no-charge service.

The SCRAMBLE FAX hotline is a 24-hour-per-day telephone service that provides accurate, detailed, and hard-to-find facts concerning the changeover to scrambling in the satellite communications industry. Information describing satellite receivers tested for scrambling compatibility, sources for authorized descramblers, wholesale rates of scrambling equipment and services—all are provided on the SCRAMBLE FAX hotline. There is no charge for that service, other than your long-distance telephone expenses. Simply dial (305) 771-0575 for a concise and timely three-minute capsule report that covers the latest in scrambling news.

Therefore the key to unlock scrambling the system is actually there in the data stream. The key itself is also encrypted, but it is nonetheless present.

Finding a way to decode that key is a considerable challenge, and it has attracted some of the most talented engineers, software hackers, and cryptanalysts in the world. Like Mount Everest, it is there; and, for the same reason that some climb the mountain, others are slowly revealing the se-

crets of *Videocipher*. There has been significant progress to date; much more will have been accomplished by the time you read this report.

For example, it was determined at an early stage that integrated circuit U7 in the *Videocipher* unit holds some of the decrypting keys. Getting inside that IC to recover the data hidden there was a trick, since removing it from the circuit killed it. To get inside, researchers used a microscopic drill

to enter the IC and reach a special location where the silicon chip is bonded to the carrier. A small drop of mercury was then placed in the microscopic hole to allow an electrical connection to that point. Signals within the IC could then be analyzed. All of that was accomplished while the chip was fired up and operating! Needless to say, several of the IC's were destroyed during that process.

Data was extracted and delivered to software analysts who were assigned the task of descrambling the programming secrets. Once the program is deciphered, the next trick is to write a new program that gets around M/A-Com's program.

The upshot of this is that we expect to see *Videocipher* clones soon. And since the hackers also expect that some of their clones will ultimately end up at M/A-Com, a clever "auto-cloning" technique is being studied; it will allow the clone IC's to "refresh" their decoding keys by continually analyzing the data stream fed via satellite that we now know is present.

Legalities

It is not illegal to take *Videocipher* apart to learn how it works. However, distributing hardware that does so, or even information describing how to do so may be illegal.

Many of those working on cracking *Videocipher* have no commercial interest in selling or in profiting in any way from cracking *Videocipher*; when the task is accomplished they will simply back out and leave any possible commercial exploitation and distribution to others. Rest assured that such exploitation will take place.

Needless to say, the people at Oak and M/A-Com are unhappy about any unauthorized descrambling. So lawsuits are probable. Even those who provide detailed decoder/hacking information in print run the risk of being sued. As in many other facets of American life, the lawyers will make lots of bucks while the public struggles to understand the how's and why's of what is happening, and tries to figure out how to react to the underground distribution of information and hardware.

R-E

SCRAMBLE-FAX SCRAMBLE-FAX

from Bob Cooper

IF satellite scrambling is important to you, here is a single source of timely, confidential information of great value; **SCRAMBLE-FAX**. Bob Cooper is routinely gathering all of the important scrambling information (who, what, when, where and how) and compiling it in printed form in an important newsletter called **SCRAMBLE-FAX** *tm*. Sources for pirate decoders, reports on attempts to 'beat the system', full lists of who is scrambling, how and when. Each issue of **SCRAMBLE-FAX** is timely and new; but, each issue is a detailed encyclopedia of scrambling information and totally complete.

REPORTS on M/A-Com efforts to shut down pirate units, exporting of bootleg descramblers outside of the USA, complete listings of all (37+) channels now scrambling and those planning to scramble. The activities of DESug, the DES Users Group, and their progress on 'breaking' the *Videocipher* 'code', modifying receivers to accept *Videocipher* and much-much more.



WESTAR Communications/Westcom, the Toronto area alleged manufacturer of 'pirate decoders' for HBO/Showtime and other *Videocipher* type scrambled services reportedly has been sold to a new group of investors all Canadian. The firm has been offering their pirate-type decoder unit for \$500 (US) for several weeks claiming it decodes all *Videocipher* scrambled video plus audio signals. Attempts to locate the firm other than through their 800 telephone number (1-800/265-5675) typically meet with failure and the firm is quick to explain that it would be inappropriate for them to identify their actual street address location (**SCRAMBLE-FAX** suggests you try 504 Ingersoll Shore, Oakville, Ontario, and 416/842-2877 or their non-800 telco).

EACH issue of **SCRAMBLE-FAX** is sent to you via AIR-mail the very day your order is entered. Simply call 305/771-0505 to order your copy (have VISA or Mastercharge card handy) or write for your copy enclosing payment for \$10 (US funds) to the address shown below. **PLUS** — each issue is 'supported' by a **SCRAMBLE-FAX 'Hotline'** telephone updating service.

DIAL 305/771-0575 anytime for a complete update on the status of scrambling. 'Hotline' recorded reports are provided by Bob Cooper as an 'instant update' to **SCRAMBLE-FAX** and carry fast-breaking news items of interest to the scrambling scene. But have your notebook and pen handy; each 'Hotline' report contains many telephone numbers and addresses you will want to retain!

SCRAMBLE-FAX by Bob Cooper

305/771-0505 or for free 'Hotline' service, 305/771-0575. To order by mail, send check/money order or enclose VISA/Mastercharge number and expiration date: CSD Magazine, P.O. Box 100858, Ft. Lauderdale, FL 33310

ROBOTICS



MARK J. ROBILLARD,
ROBOTICS EDITOR

Experimental robot vision

LAST TIME WE PRESENTED THE CONSTRUCTION details of a simple photocell-based vision sensor. To conclude the presentation, this time we'll show you how to connect it to a microcomputer, and then we'll discuss a few software algorithms that demonstrate how to use it.

The sensor consists of nine photocells. For a computer to be able to read the analog resistance of each photocell, that resistance must be converted into the digital language the computer understands. So we must use an ADC (Analog-to-Digital Converter). When a photocell is connected between the positive supply voltage and a resistor that is grounded

on the opposite end, the pair acts as a variable voltage divider. The divider is variable because the resistance of the photocell changes depending on the amount of light that reaches its active surface. When you connect the output of the divider circuit to the input of an ADC, a digital representation of the voltage dropped by the photocell may be read.

It would be inconvenient and expensive to connect a single ADC to each of the nine sensors in our vision unit. Fortunately, however, National Semiconductor has an IC (the ADC0816) that includes not only an ADC, but also a 16-channel analog multiplexer that allows us to monitor all nine photocells (and

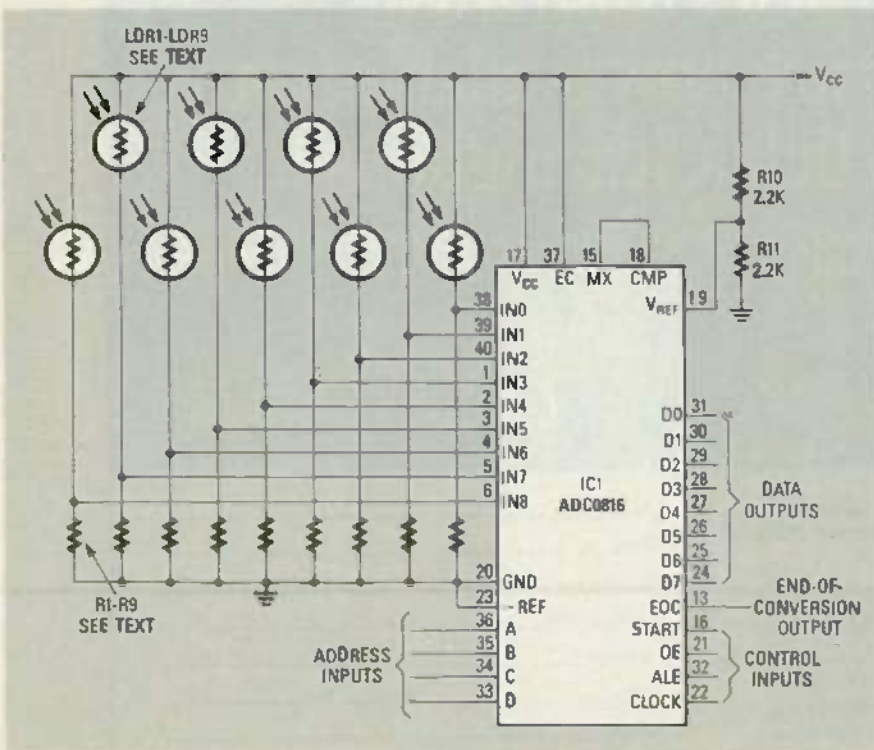

FIG. 1

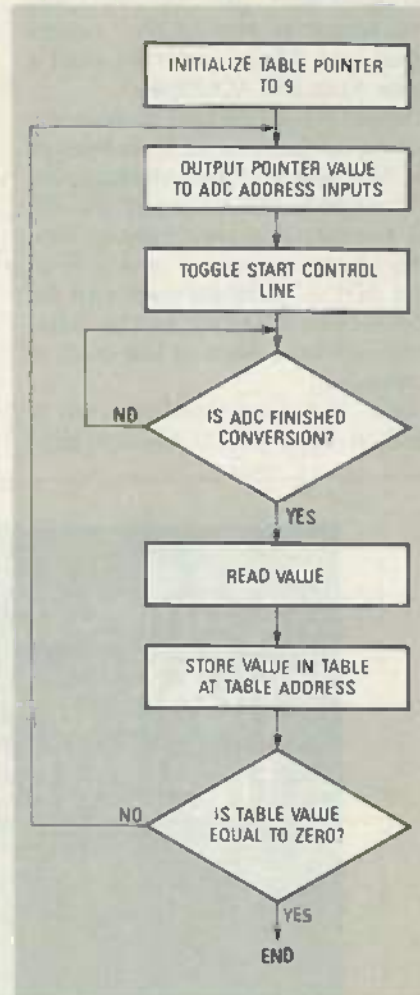

FIG. 2

seven other analog inputs, if desired) without multiplying costs nine times.

Figure 1 shows the circuit details of the sensor interface. In addition to the sixteen analog inputs, the ADC0816 has four address inputs that allow you to select which of the sixteen inputs you want to read. Further, the circuit has several control lines that are used to select various operations. We'll

discuss each of the control lines below.

If your computer has a built-in eight-bit parallel interface, you can probably use the circuit directly as shown. Otherwise, you'll have to add some external circuitry. One way of connecting the ADC0816 to an 8-bit computer system is as follows.

The computer's data bus (or eight-bit I/O bus) is connected directly to the IC's 3-state data outputs (pins 24-31). You could AND the computer's READ signal with a decoded port address and apply that signal to the OUTPUT ENABLE input (pin 21) in order to read a value from the ADC0816.

Selecting a channel is done by setting up the four address lines of the ADC0816 and then strobing the address into the ALE input (pin 32) via another decoded output AND-ed with the computer's WRITE line. The ADC's address lines can be connected directly to the low-order address lines of the control computer.

Last, the START input (pin 16) is used to start the conversion pro-

AN ENDING, A BEGINNING

This marks the 19th and final installment of Mr. Robillard's Robotics column. We'll miss Mark (who will contribute an occasional feature article), but we're happy to announce a new series of articles that includes complete details for building, operating, and experimenting with a personal robot. The new series begins in this issue and will continue for many months, as we continue keeping you up to date on the latest developments in the fascinating field of personal robotics. R-E

cess. You could drive that input with another decoded output port AND-ed with the computer's WRITE line.

Because the ADC works much slower than your computer, you cannot simply select a channel, send a "start" command, and then read the data. The ADC must sample the input and then convert it to digital form. The ADC0816 can take as long as 116 μ s to complete the conversion. To alert the computer when the conversion is done, the IC has a special END-OF-CONVERSION output (pin 13) that goes

high when a digital representation of the analog input may be read. You can monitor pin 13 by AND-ing a decoded I/O port address with your computer's READ line. Alternatively, you may want to connect pin 13 to an interrupt input; doing so would allow your computer to do other things while the ADC is working.

Figure 2 outlines the basic algorithm for scanning the nine-element sensor. First we select analog channel one. Then the START signal is activated. Then the computer goes into a loop and monitors the END-OF-CONVERSION output. When that signal goes high, the output buffer is read, and its value is stored in a nine-byte table for analysis later. The program loops to select the next channel (i.e., the next sensor element) and executes the same sequence of operations. When all sensors have been read, the algorithm is finished.

After reading in the data, it must be analyzed. It would simplify analysis if each sensor returned a value of 1 for light areas and a value of 0 for dark areas. Then the table

Copies of articles from this publication are now available from the UMI Article Clearinghouse.

For more information about the Clearinghouse, please fill out and mail back the coupon below.

UMI Article Clearinghouse

Yes! I would like to know more about UMI Article Clearinghouse. I am interested in electronic ordering through the following system(s):

- DIALOG/Dialorder ITT Dialcom
 OnTyme OCLC ILL Subsystem
 Other (please specify) _____
 I am interested in sending my order by mail.
 Please send me your current catalog and user instructions for the system(s) I checked above.

Name _____
Title _____
Institution/Company _____
Department _____
Address _____
City _____ State _____ Zip _____
Phone (_____) _____

Mail to: University Microfilms International
300 North Zeeb Road, Box 91 Ann Arbor, MI 48106

of bytes could be compared with a set of previously-stored templates. The program would interpret the object as being the one with the closest match.

However, things don't work quite so simply in the real world. In fact, the circuit shown here is so sensitive that, instead of getting two distinct values that represent light and dark, you'll be getting readings with 256 distinct values. Areas of your target that appear to be the same will actually register tremendous differences.

In order to eliminate most of that "clutter," an auto-sensitization adjustment must be made. What we must do is to trick the circuit into being less sensitive. One way of doing so is with a threshold adjustment. Looking back at the circuit in Fig. 1, notice the resistive voltage divider connected to pin 19 (V_{REF}) of the ADC. All converted values are compared to the value at that pin. By varying the reference, you can adjust the sensitivity of the circuit.

You could use a DAC (Digital-to-Analog Converter) to perform the auto-focus. Connect the digital inputs of the DAC to a separate output port, and the analog output of the DAC to the reference input of the ADC. Then, by placing a black and white cross (or some other shape) under the sensor, have the computer read the ADC. If the sensors under the black areas don't read similarly, have the computer change the reference voltage via the DAC converter. Adjust the reference until the output reads the way you want it to.

Also, you could calibrate the sensor manually using a potentiometer and some sort of program that outputs the values to the screen. The value of the automatic circuit, though, is that the computer can calibrate itself at any time.

I have found the sensor to be great at picking out brightly colored symbols on a dark block. In addition, the sensor reads well at a distance of one inch above the target object. As discussed last time, use a flash from an old camera to illuminate the area evenly. And be sure that the duration of the flash is at least 200 μ s to compensate for the conversion time. R-E

© The Advertising Council, 1985

"YOU'D DIE IF YOU HAD OUR JOB."

YOU COULD LEARN A LOT FROM A DUMMY. BUCKLE YOUR SAFETY BELT.

A Public Service Message

SUPER LONG PLAY TAPE RECORDERS

10 Hour Model — \$95.00*
14 Hour Model — \$159.00*

Modified Panasonic S-Line, high quality, AC-DC Recorders provide 5 or 7 continuous hours of quality recording & playback on each side of cassette for a total of 10 or 14 hours depending on model. Built-in features include • Voice level control. • Digital counter, etc. TOK DC 180 Cassette Furnished.

PHONE RECORDING ADAPTER

Records calls automatically. All Solid state connects to your telephone jack and tape recorder. Starts recording when phone is lifted. Stops when you hang up. **\$24.50*** FCC APPROVED

OK VOICE ACTIVATED CONTROL

Solid state. Self contained. Adjustable sensitivity. Voices or other sounds automatically activate and control recorder. Uses either remote or remote mike. **\$24.95***

*Add for ship & hdg. Phone Adapter & Vox \$1.50 ea. Recorders \$4.00 ea. Cal. Res. add tax. Mail order, VISA, M.C., COD's OK. Money Back Guarantee. Free data avail. Dealer inquiries invited. Free data.

AMC SALES, Dept. A, 9335 Lubec St., Box 928, Downey, CA (213) 902-1191

CIRCLE 108 ON FREE INFORMATION CARD

You can help us raise the colorectal cancer cure rate.

When detected early, the cure rate for colorectal cancer is very high. That's why we urge regular checkups for men and women 50 and over.

Warning signs are a change in bowel habits, blood in the stool.

Your doctor can perform the digital and procto exams, and you take care of the stool blood test at home.

Checkup Guidelines for men and women over 50 without symptoms:

- digital exam annually
- stool blood test annually
- procto exams every 3 to 4 years after 2 negative tests 1 year apart

No one faces cancer alone.

AMERICAN CANCER SOCIETY

HOME SECURITY SYSTEMS

Deluxe Wireless For Home, Apartment, Offices, Mobile Homes

FEATURES

- Main Module/Receiver is capable of telling what kind of alarm is triggered: intrusion, fire, maintenance, medical emergency, etc., and where the alarm is originated — 5 zones designated by the user.
 - This system can only be activated or deactivated by entering a 3 to 10 digit Secret Code selected by the user.
 - In case of emergency, the built-in siren speaker and the Remote Horn can be triggered instantly by pressing the "EMERGENCY" key.
 - Adjustable Exit Delay time allows the user to leave his/her home before the system is activated.
 - Adjustable Entry Delay time with flashing "BIST/OLY" LED to remind the user to deactivate the system when he/she enters the protected premise.
 - Built-in Window Reminder LED reminds the user if any or all windows are left open.
 - Once triggered, the system will emit an ear-piercing sound for five minutes before it resets itself to continue providing protection.
 - 5 sets of Wireless Magnetic Sensors/Transmitters are included to detect any door or window opening.
 - When the battery in the Main Module is low, the "BATTERY LOW" indicating light will light up to remind the user of low battery condition.
 - The Main Module is DC powered with AC adaptor provided and backed up by six 1 1/2 Volt Size "AA" cells.
 - The Magnetic Sensor/Transmitter is powered by a 9 Volt battery.
 - System is expandable with the following options:
 - Remote Wireless Siren Speaker to be turned on or off remotely by the Main Module.
 - Wireless Panic Switch capable of activating the alarm instantly at the push of a button.
 - Wireless Remote Turn-off allows the user to turn off the system from outside of the protected premise.
- Additional Magnetic Sensor/Transmitters



\$149.95
Plus \$6.00 shipping and handling

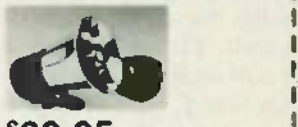

\$39.95
Plus \$3.00 shipping and handling

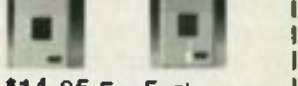

\$14.95 For Each
Plus \$2.00 shipping and handling

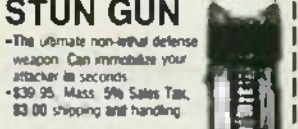

STUN GUN

-The ultimate non-lethal defense weapon. Can immobilize your attacker in seconds.

-\$39.95. Mass. 5% Sales Tax. \$3.00 shipping and handling.

1-800-522-2636 For Orders Only
617-843-1900 For Information

Cameo Enterprises, Inc.
P.O. Box 63, Accord, MA 02018

CIRCLE 89 ON FREE INFORMATION CARD

DECEMBER 1986

ANTIQUE RADIOS

Reader letters, filament checker

DURING THE PAST TWO YEARS I HAVE made many references to reader correspondence. It is gratifying to know that so many are interested in the history of radio, which is probably the most important scientific discovery of all time. At least it's the most fascinating, especially to readers of this column.

Writing this column has taught me a lot. Much of my knowledge comes out of the research I must do to get the column out, but more comes from information contained in readers' letters. I have heard from some very knowledgeable readers who have firsthand information on radio history. In fact, many have personal recollections of the developing days of radio. First broadcasts, homemade equipment, and early receivers are still fresh in the minds of many readers of this column.

While many letters share information, many others contain questions. Many of the latter cause me to do considerable research. Often readers ask about sets of which only a few were manufactured, and which have long been forgotten. Sometimes it's hard to believe that a reader actually has one. Of course, I'd like to show photos of all those forgotten radios, but there simply isn't room to do so.

Letters

Now let's get to the letters. Maybe we can all learn something from the problems experienced by these readers. Or perhaps readers can help each other.

Daniel Nevels (11836 Alamo, Baton Rouge, LA 70818) needs the glass dial cover for a Zenith Model

6S556 radio. Dan mentioned that he could get the set repaired for \$300.00, and that it is similar to the Zenith pictured in the June 1985 column. Dan, if you're referring to the Zenith console with the veneer problem, that's not the only thing wrong with it. There is also the matter of a burnt-out power transformer. You can have the whole thing for \$300.00. Actually, if you didn't live so far from me, you could get the whole set for \$30.00. If anyone in Dan's area can help, drop him a line.

Many antique-radio restorers find their sets complete except for one small but hard-to-locate part. Usually it's an accessory like an escutcheon, a knob, a cabinet, or a piece of curved glass. Often, if you have patience, you can fabricate a missing part from commonly available materials. For example, you can turn (or carve) a piece of dowel rod to simulate a knob. Other materials that come in handy include veneer, masonite, and stiff, clear plastic such as toys are packaged in. The plastic can be used to replace missing glass. Sometimes it's even worthwhile to buy an item just for the packaging.

Cliff Priddle, (P. O. Box 725, North Bend, OR 97459) is interested in crystal sets. He would like to obtain old parts. Cliff, my old tube sets keep me so busy I haven't had time to get into crystal sets. However, one company advises me that they can supply crystal-radio parts and information. Send an SASE to MIDCO (P.O. Box 2288, Hollywood, FL 33022). (Also check the Classified Advertisements in the back of the magazine.—Editor)



RICHARD D. FITCH,
CONTRIBUTING EDITOR

Here's an interesting letter for antique collectors who haven't located a suitable set yet, or for those who would like to add to their collection. Victor Jackman (230 April Court, North Huntingdon, PA 15642) has a fine collectable to sell. It was made by International Radio Inc., of Ann Arbor, MI and has serial No. 2914. I have some information on International Radio, but their sets are listed by model number. If anyone wants more information about this collectable, drop Vic a line.

Another interesting collectable is an Ultradyne Model L-2. It's a TRF with tubes, circuit, and cabinet. For more info contact Herb Henry (331 Elliot Road, Ft. Walton Beach, FL 32542.)

I have searched my files but am unable to help Eugene K. Warner (522 Weiman Street, Ridgecrest, CA 93555.) He has a small radio with no tubes. Also, no tube diagram or manufacturer's name or model number. It appears to use both a line-cord resistor and a ballast tube. The only clues are on the dial, which contains the image of a four-engine prop transport airplane and the name Clipper. The radio may be from the thirties.

I wish I could share the set of color photos sent in by Aille C. Lingo of Pierks, Arkansas. They show a classic southwestern tester and some equally classic radios.

While discussing photos, I have to mention the photo of a World War I military receiver sent in by Charles W. Dold of New Smyrna Beach, FL. Mr. Dold responded to my promise to discuss WW I equipment in a future issue. However, my visits to military mu-

BUILD YOUR OWN ANTIQUE-RADIO TUBE-FILAMENT CHECKER

This month, I am going to show you how to build a simple but useful piece of test equipment. That is a tube-filament tester. I've always found such a device very valuable in troubleshooting old radios.

While the much-altered filament tester shown in Fig. 1 is about 40 years old, I didn't invent it. Commercial versions were available for years before I built mine. Besides testing tube filaments you can also use it to test light bulbs, home and auto fuses, etc.

Even if you already own an emission-type tube tester, there is an advantage to having a simple filament checker: it's



FIG. 1

much easier to use because you don't have to set nine switches, three dials, and several pushbuttons, not to mention tube warm-up time. Besides, many late-model tube testers don't have sockets for the antique tubes we are interested in.

As shown in Fig. 2, the filament checker has sockets that are pre-wired to accept the most popular types of tubes, and a pair of test leads that allow you to check any tube with non-standard filament connections or a non-standard base. The box has special clamps to hold that type of tube in place while you connect the test leads.

The circuit works like this. The battery, lamp and the tube under test are all connected in series through the on/off switch. When you close the switch, the lamp will light if the filament is good. Otherwise it's bad.

The box shown in the photo measures 9" x 12" x 4". The two plastic boxes affixed to the sides of the checker can serve as "in" and "out" boxes when you're testing a batch of tubes. Place tested-good tubes in the out box, and simply discard any bad tubes.

You can use any low-voltage low-current lightbulb for LMP1, such as a number 48 or 49, or even a number 14, which is rated at 2.47 volts at 300 mA. The toggle switch isn't really necessary. I just like to have a switch on all electrical equipment to make sure that it is off when I'm not using it.

R-E

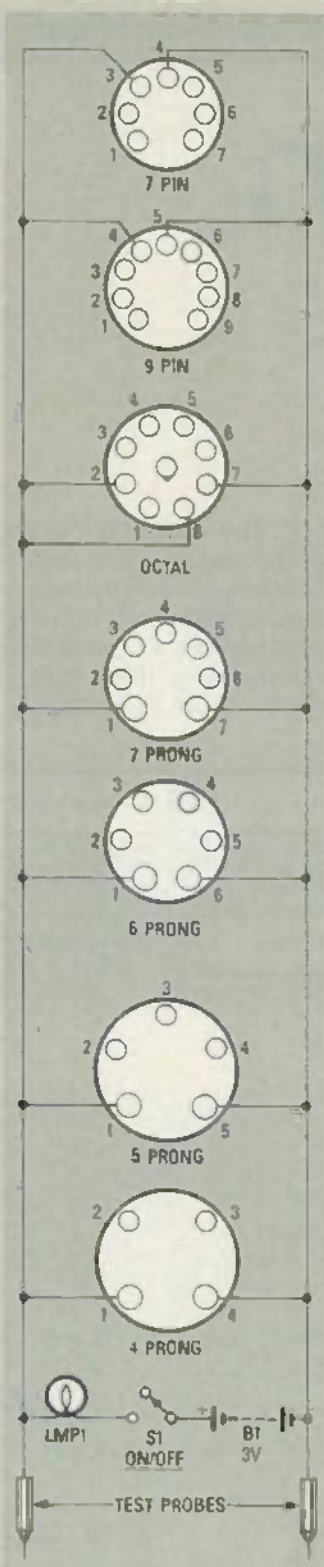

FIG. 2

seums failed to give me enough material for a complete column. But if I can obtain enough information, I will include it in a column.

Have and needs

A. B. Nacy (1421 Retallack Street, Regina, Canada S4T 2J3) has an an-

tique Arvin for sale. James Lindsay (85 Circuit Avenue, Weymouth, MA 02188) needs a complete speaker for a RCA Victor Model 87 T. And David Fentem (704 Emerald Forrest Circle, Lawrence, GA 30245) needs all major parts for an old Silvertone console.

R-E

Our guaranteed savings plan.



Fluke 70 Series Analog/Digital multi-meters are like money in the bank. Buy one, and you're guaranteed to save both time and money.

Money, because you get longer battery life and longer warranty coverage — 3 years vs. 1 year or less on others.

And time, because 70 Series meters are easier to operate and have more automatic measurement features.

So before buying any meter, look beyond the sticker price. And take a closer look at the new low-priced \$79 Fluke 73, the \$99 Fluke 75, and the deluxe \$139 Fluke 77. In the long run, they'll cost less, and give higher performance, too.

And that, you can bank on.

For a free brochure, and your nearest distributor, call toll-free 1-800-227-3800, ext. 229.

FROM THE WORLD LEADER
IN DIGITAL MULTIMETERS.

FLUKE

© 1985 Fluke
CIRCLE 121 ON FREE INFORMATION CARD

DECEMBER 1986

85

DRAWING BOARD

A remote-control system

IF YOU'RE A REGULAR READER OF THIS column, there's one thing you should realize by now—I'm a firm believer in a systematic approach to design. A sure road to brain damage is trying to design something without analyzing the prob-

lem first. The subject we're going to start discussing this month—remote control—is one that requires a systematic approach. There's just no way of doing a successful design without planning the whole system out on paper beforehand.



ROBERT GROSSBLATT,
CIRCUITS EDITOR

A remote-control system is more complex than many of the other circuits we've looked at in this column. The degree of complexity is, of course, directly related to how much you want the circuit to do for you. But even if you only want your remote controller to switch your TV on and off from your armchair, the first step is to list the overall specifications of your control system. Our system's specifications are as follows:

1. The transmitter will be battery powered.
2. The transmission medium will be infrared light.
3. The circuit will be able to control at least 10 devices.
4. Standard parts will be used wherever possible.
5. The receiver will be as noise-immune as possible.

If you think about those specifications for a moment, you'll see that the remote-control system is really a combination of two different circuits, each of which has several subsections. The two main sections are the transmitter, shown in Fig. 1-a, and the receiver, shown in Fig. 1-b. Each of the main sections is a complete circuit in itself, and each must be designed separately before the whole thing can be assembled. But before we can even start thinking about putting the electronics together, we must get an overview of the system's operation.

Keyboard and encoder circuits are nothing new. We've designed them several times in past columns. Basically, we're looking for something that will translate a key-press into a unique binary code and place that code on a data bus.

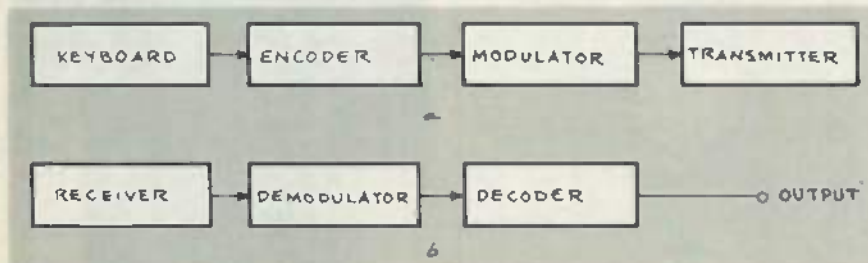

FIG. 1

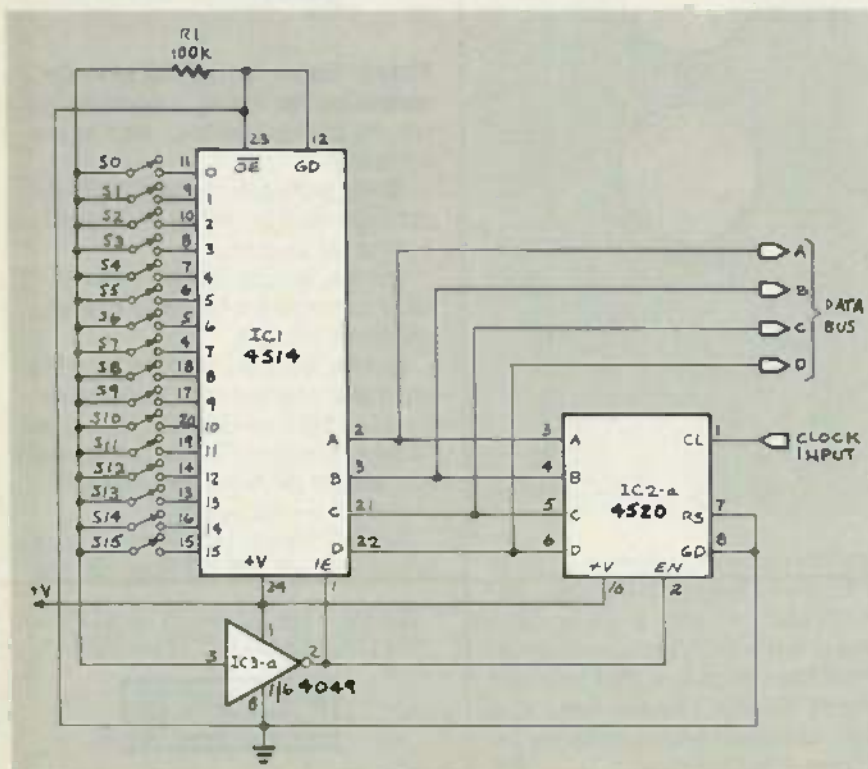

FIG. 2

After the code has been generated, we must modulate it before we send it on to the transmitter. The modulator (and the corresponding demodulator in the receiver) are both new circuits in this column.

The modulator must take the data from the keyboard and convert it to whatever is needed by our transmission circuitry. There are many schemes for accomplishing that. For example, the data can be encoded as FSK (Frequency-Shift Keying), AM (Amplitude Modulation), or DTMF (Dual Tone Multi-Frequency). We all know the latter from its use in Touch-Tone dialing.

After the data has been converted by the modulator, it is passed on to the transmitter. For a transmission medium we could use anything from a pair of twisted wires to ultrasonic sound, but we'll use infrared light. When we begin that part of the design, you'll see that it's very easy to change from one transmission medium to another. I'm using infrared because ultrasonic waves make my teeth hurt.

At the receiving end, the signal is detected, conditioned, and then passed on to the demodulator where it is converted back to its original binary form. Then the decoder turns on the selected output.

Now that we have an overall idea of how the circuit works, let's get started by looking at the transmitter's keyboard encoder.

From keypress to code

Figure 2 shows the schematic of the keyboard encoder we'll use for our remote-control system. The 4514 is a 4- to 16-line decoder with normally low outputs. When a 4-bit binary word is presented at its A-D inputs, the corresponding decoded 0-15 output goes high. Pin 1 is an active-high input enable (\overline{IE}), and pin 23 is an active-low output enable (\overline{OE}) control. In normal operation, pin 1 must be high and pin 23 must be low. The 4520 is a dual synchronous 4-bit binary counter. We've used it so often that you should be able to recite its pinout in your sleep.

The operation of the keyboard circuit is straightforward. One of

the 4520's counters is fed with a clock that causes the counter to cycle through its full 4-bit count (0 to 15) repetitively. The binary inputs of the 4514 are tied to the 4520's outputs, thereby causing its 16 outputs to go high one at a time in turn. Because \overline{OE} (pin 23) is tied to ground, the 4514's outputs are always enabled. The INPUT ENABLE (pin 1), however, is connected to the common terminal of switches S1-S16 through an inverter. As long as no key is pressed, resistor R1 holds that point low, so the output of the inverter is high, so the 4514 continues to cycle through its various states.

When a key is pressed, however, the outputs continue to cycle until the output corresponding to that key goes high. When that happens, the inverter's input goes high, so its output goes low. That disables the 4514 and the 4520. Therefore, the binary output of the 4520 is frozen on the data bus.

There is one special feature of the circuit that's not immediately apparent. You'll notice that nothing is done to debounce the switches. If you trace through the operation of the circuit carefully, you'll see that it's not necessary—the circuit is inherently bounce-free. If we happen to produce a bounce when the switch is closed, all that happens is that the inputs stay enabled and the 4514 continues to cycle through another full count. But by using the output of the inverter to strobe data into the following stage (which is what we'll do next time), we can ignore the additional pulses.

To see how the circuit works, breadboard it and feed it a clock of some sort—a 555 circuit will do just fine for test purposes. If you slow the clock down to a few Hertz, you'll be able to watch the circuit operate. Slowing the clock and watching the outputs will do more to help you understand how the circuit works than ten pages of written explanations.

The next thing we must do is take the 4-bit binary code from the keyboard and encode it for transmission. But that is a subject for next time. In case you're interested we'll be using the S2579 DTMF Generator from American Microsystems Inc. R-E

OVER 2,000 TUBE TYPES IN-STOCK

78% - 90% off list

Plus thousands of
electronic parts
including

- VCR/Cable Accessories
- Telephone Accessories
- Audio Accessories
- Computer Accessories
- Capacitors, Resistors, Diodes, etc.
- Speakers
- Many other Items

Send for FREE
Catalog

Steven



MAIL ORDER ELECTRONICS CORP.
P.O. Box 698 Melville, New York 11747
(516) 752-0060

CIRCLE 185 ON FREE INFORMATION CARD

Be an FCC LICENSED ELECTRONIC TECHNICIAN!

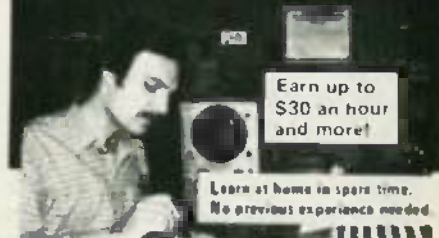

No costly school. No commuting to class. The Original Home-Study course prepares you for the "FCC Commercial Radiotelephone License". This valuable license is your "ticket" to thousands of exciting jobs in Communications, Radio-TV, Microwave, Computers, Radar, Avionics and more! You don't need a college degree to qualify, but you do need an FCC License. **No Need to Quit Your Job or Go To School** This proven course is easy, fast and low cost! **GUARANTEED PASS** - You get your FCC License or money refunded. **Send for FREE facts now. MAIL COUPON TODAY!**

COMMAND PRODUCTIONS

FCC LICENSE TRAINING, Dept. 90
P.O. Box 2223, San Francisco, CA 94126

Please rush FREE details immediately!

NAME _____
ADDRESS _____
CITY _____ STATE _____ ZIP _____

DECEMBER 1986

87

SERVICE CLINIC

Oughta be ain't is!

THE FIRST THING TO DO WITH any set that looks totally dead is to start measuring DC voltages. When you find one that looks incorrect, try to find a logical reason for it: look at nearby components that may be bad (open or shorted) and at other sections of the circuit that could affect the one with problems.

An incorrect or missing DC voltage is often the best clue we have to a bad stage. Always check DC signals first: No volts, no work! However, you can't use DC levels as your only source of troubleshooting information; some parts can stop an audio or video signal cold without having much effect on the DC voltages. If you find no odd-looking DC levels, you'll have to try another technique—signal tracing, for example.

If you've got decent service literature, most likely it has scope photos illustrating the shape and amplitude of signals at various points in the circuit. Try feeding a test signal (that approximates what you see in the literature) into the input of the circuit, and see if the output looks anything at all like what it should.

For example, take a look at the horizontal output stage in Fig. 1. You might try feeding a 10-volt p-p sinewave into D1. Then look at the collector of Q1. If you don't see something that resembles the 170-volt p-p signal shown in the schematic, Q1 may be bad. On the other hand, if the test signal gets through, that part of the circuit probably works correctly, so you can go on and test other stages.

By following that process in a

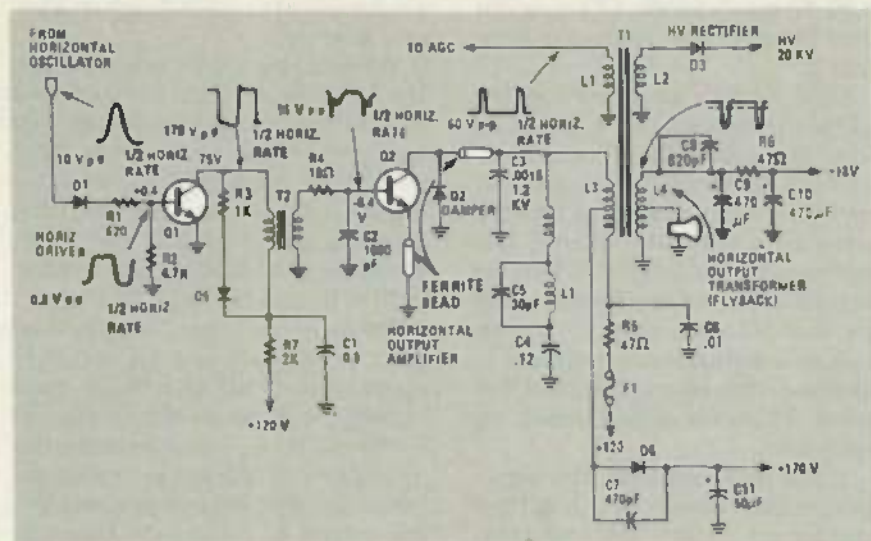

FIG. 1

logical manner, you'll eliminate possible sources of trouble one by one and eventually arrive at the real source of trouble.

Of course there are special things to look out for: coupling capacitors, for example. If one develops an open, it can stop the signal dead in its tracks, but the DC voltages will often be affected little, if at all. And that's when we've got to resort to signal tracing.

Always be careful with little things like coupling capacitors that look good. Don't assume that those capacitors never go bad. I used to have a bad habit of doing just that. That is, until the day I found one that had developed an open!

So never get into the bad habit of assuming any part is good without thoroughly checking it; always test everything. I used to make assumptions until one day I had a lot of trouble figuring out what was

wrong with several different sets. So always keep that most valuable asset of a service technician: the completely open mind! In other words, suspect everything in a circuit until you find out who the real culprit is! And don't be too sure then!

Here's an example of how making assumptions can lead you astray. I had a set that was completely dead: no video, no audio, not even any noise. There was one big solder joint on a terminal right in the middle of the chassis. It had a large blob of solder on it, and it looked like a perfectly good joint. I thrashed around in that circuit until I finally got a hold of myself, started signal-tracing, and, behold, the signal came right up to that "perfect" solder joint where it stopped!

I melted the joint, and the moment my iron touched it, it went up in a little puff of smoke! It wasn't solder at all, but a big blob



JACK DARR,
SERVICE EDITOR

of what is called "liquid solder." Obviously there wasn't much continuity in that joint. Hardened acetate cement doesn't conduct electricity very well. So I soldered that joint in the usual way, and the set began working right away.

The moral is that, if you never take anything for granted, you'll have fewer servicing headaches. Never assume that a solder joint is good. Check the dad-burned thing with an ohmmeter just to make sure. You'll find many pitfalls of that sort; don't let 'em throw you. When tracing a signal that suddenly stops, check everything in the immediate vicinity and you'll often find something that will surprise you.

Shop bookkeeping

One thing we seldom talk about is how to keep track of the amount of work that has been done for each customer, and which parts went into his set. One way to keep track of things is by keeping the parts we've pulled out for replacement in a separate pile for each customer. That way, when the job is over, we can just go through the pile and charge the customer accordingly. That makes bookkeeping (one of our favorite tasks!) much easier. And if you're your own bookkeeper, as most of us are, it's well worth spending a little time getting and staying organized; you could lose a lot of money if you're not careful.

Another thing that can help, when making out the bill, is to write down each part you installed, and its function (for example, 0.01 μ F, "2nd IF screen-bypass capacitor"). Keep a copy of the bill, and the next time the customer comes in, you'll quickly be able to see what you've already done to that set. And you'll want to know the date of installation for parts that are covered by warranty—yours or the manufacturer's.

And be sure to write clearly! If you can't read your own writing, get someone else to do it for you! That way, if you get a callback on a job, you'll have some idea of where to begin troubleshooting. If you can pull the original bill, you'll be able to tell just which parts you installed, and, more importantly, which you didn't.

That's about all for now. I got a card from an old friend, Bill Eslick, 2607 E. 12th Street, Wichita, KS 67214. He wants to buy old issues of *Radio-Electronics*, *Radio-Craft*, etc. Drop Bill a line if you have any back issues for sale. R-E

SERVICE QUESTIONS

BLOOMIN' PROBLEMS

I've got a problem in my own set! It's blooming with visible retrace lines, and the contrast control won't darken the screen. The brightness increases until the HV shuts off. I've checked all voltages, and they seem normal. The PC board is so delicate that I don't want to do a lot of desoldering without a good idea of where to begin. I hope you can help.—R. D. W., Bergen, NJ.

So do!! I think you'll find a leaky transistor somewhere. Check all DC voltages carefully and see if one is a good bit off. If so, that will change the bias on the CRT, and make it draw more current until the set shuts off. Start by measuring the CRT grid and cathode voltages very carefully, and then trace the circuit back until you come to the stage that controls it. There you will find the the trouble.

RED-HOT 6KD6 TUBE

I've got a Philco CT7340AWA. It uses a 6KD6 horizontal output tube. The problem is that the 6KD6 plate gets red hot and there is no HV. The sound also gets distorted. Any ideas?—M. R., Flushing, NY.

Several, and all boil down to one thing; you have lost the grid drive on the 6KD6 tube. That drive normally generates a high negative voltage to bias the tube. If you lose grid drive, the tube will draw a very high current, perhaps as much as 400–500 mA. That's normal. The fact that the tube will take that much current shows that it is still good, but don't allow high current to flow through the tube for too long, or it might be damaged.

Normal bias on the 6KD6 should be at least -60 volts. Check your schematic for the exact value, because sometimes it's even more. You may also want to check the horizontal oscillator. R-E

ATTENTION! ELECTRONICS TECHNICIANS



EARN YOUR
**B.S.E.E.
DEGREE**

THROUGH HOME STUDY

Our New and Highly Effective Advanced-Placement Program for experienced Electronic Technicians grants credit for previous Schooling and Professional Experience, and can greatly reduce the time required to complete Program and reach graduation. No residence schooling required for qualified Electronic Technicians. Through this Special Program you can pull all of the loose ends of your electronics background together and earn your B.S.E.E. Degree. Upgrade your status and pay to the Engineering Level. Advance Rapidly! Many finish in 12 months or less. Students and graduates in all 50 States and throughout the World. Established Over 40 Years! Write for free Descriptive Literature.

COOK'S INSTITUTE
OF ELECTRONICS ENGINEERING

347 RAYMOND ROAD
P.O. BOX 20345
JACKSON, MISSISSIPPI 39209

CIRCLE 184 ON FREE INFORMATION CARD

SEE YOUR DEALER TODAY

FROM

'Firestik'
ANTENNAS
ACCESSORIES

HERE'S A TIP
THAT'S PERFECT!

AM/FM AUTO RADIO
AND CB

'Firestik' II

GOLDEN SERIES

BARE-HANDS TUNABLE
"NO TOOLS NEEDED"
HIGH PERFORMANCE ANTENNAS

ALSO ANTENNAS FOR
CORDLESS TELEPHONES
MONITOR SCANNERS

Dealer & Distributor Inquiries Invited
SEND FOR FREE CATALOG

Firestik Antenna Company
2614 East Adams Phoenix, AZ 85034

Name _____
Street _____
City _____
State _____ Zip _____
Serving the CB and
Communications Market Since 1962

5-YEAR REPLACEMENT WARRANTY

CIRCLE 100 ON FREE INFORMATION CARD

MARKET CENTER

FOR SALE

TUBES new, unused. Send self-addressed, stamped envelope for list. **FALA ELECTRONICS**, Box 1376-2, Milwaukee, WI 53201.



A SINGER'S DREAM!

REMOVES VOCALS FROM RECORDS!
Now you can sing with the world's best bands! The Thompson Vocal Eliminator can remove most or virtually all of a lead vocal from a standard stereo record and leave the background!

Write or call for a free brochure and demo record.
LT Sound, Dept. R-1, P.O. Box 338,
Stone Mountain, GA 30086 (404) 493-1258

WHOLESALE car-radio computer telephone audio video accessories antenna catalog (718) 897-0509 **D&WR**, 68-12 110th St., Flushing, NY 11375.

WORLDS best channel 3 notch filter, \$19.95. (Dealer inquiries invited). **CROSLEY (A)**, Box 840, Champlain, NY 12919.

SPECTACULAR strobe light chasers, stroboscopic devices, Helium-Neon Laser components, scientific items, more! Free catalog. **ALLEGRO ELECTRONIC SYSTEMS**, #3R Mine Mountain, Cornwall Bridge, CT 06754.

ELECTRONICS, \$1.50 brings flyer, grab bag. **LYNN JOHNSON**, 2221 The Alameda #176, Santa Clara, CA 95050.

CABLE-TV converters and equipment. Plans and parts. Build or buy. Free information. **C&D ELECTRONICS**, PO Box 1402, Dept. RE, Hope, AR 71801.

HIGH gain descramblers, CRT automatic dimmer, SCR Tester, plus other unusual electronic devices. Send \$3.00 for info. **RB ELECTRONICS ENGINEERING**, PO Box 643, Kalamazoo, MI 49005.

CLONE kits, modems, hard drive kits, disk drives, diskettes and printers, memory, and IC's. Distributor pricing to end users and dealers. For catalog call 1-800-833-2600. In Ohio call (513) 531-8866. Free shipping.

CATALOG: cable converters, and descramblers, N12 mini-code \$98.00, SB3 \$99.00. Special: Combination Jerrold 400 and SB3 \$165. Pulse descrambler kit (assembles in half hour) \$79.00, built \$120.00. Satellite descrambler kit (assembles in one hour) \$120.00, built \$190.00. Send \$1.00. **MJ INDUSTRY**, Box 531, Bronx, NY 10461.

FIBER optics experimenter's kit: transmitter, receiver, 3m. lightguide cable, data sheets, application notes. Send \$12.00. **MASE**, R.D. #1 Box 1033, Onwagsburg, PA 17961.

MICROCONTROLLER tell me your application and I'll supply proper input/output electronics. Call or write for details. **WERNER SPECIALTY ELECTRONICS**, 4388 Crystal Peak Dr., Las Vegas, NV 89115 (702) 644-5938.

Z8 based control and acquisition systems. From \$299. **H.H.S. MICROCONTROLLERS**, 5876 Old State, Edinboro, PA 16412. (814) 734-4338.

USED technical books: Electronics, physics, mechanics, mathematics, \$3.37 stamp: **SOFTWAWE**, 1515 Sashabaw, Orionville, MI 48462.

AUTOMATIC headlamp dimmer for car, truck etc. \$10.00 for parts list, schematic, full instructions. Add \$3.00 for photos of completed unit and PCB with parts mounted. Under \$25 to build. **FRANGLO**, 8197 Lasombra Way, Sacramento, CA 95823.

RESTRICTED technical information: Electronic surveillance, schematics, locksmithing, covert sciences, hacking, etc. **Huge selection. Free brochure. MENTOR-Z**, 135-53 No. Blvd., Flushing, NY 11354.

WARNING (cable equip. buyers): Let the Dak's rot! Don't buy used equipment when you can buy new for less. N-1200 \$75.00, vari sync add \$10.00, 10-\$58.00, case of 20 \$48.00 channel 2 or 3. SB-3000 with auto switch \$75.00, 10 or more \$65.00, case of 20 \$55.00. Vari sync plane and parts list \$10.00. Remotes, converters, video accessories. 90 day guarantee. Free catalog. Call or write today. **MC, Visa, C.O.D.** (402) 331-4957. **M. D. ELECTRONICS**, 5076 So. 108th #115, Omaha, NE 68137.

CABLE television converter, descrambler, and microwave television antenna equipment accessories video catalog. Free. **CABLE DISTRIBUTORS UNLIMITED**, 116 Main Road, Washington, AR 71862.

ELECTRONIC projects, components, PCB supplies, test instruments. Oscilloscopes \$219.00, multimeters \$7.95, power supplies \$69.95. Resistors 1 cent, 2 year guarantee. Call or send SASE for free catalog. **T.O.R.C.C.C.**, 1131 Tower, Schaumburg, IL 60195 (312) 490-1374.

Quality Microwave TV Antennas

Multi-Channel 1.9 to 2.7 GHz
40dB Gain True Parabolic 20 inch Dish
Complete System \$99.95 (plus shipping)
Dealerships, Qty Pricing, Replacement Parts

Philips-Tech Electronics
P.O. Box 8533 • Scottsdale, AZ 85252
(602) 947-7700 (\$3.00 Credit All phone orders)
MasterCard • Visa • EDDs

LIFETIME WARRANTY

TELEPHONE extension in your car. Morse Code for the uninitiated. TV descramblers. Legal police radar blocker. Detective electronics. Home video production equipment. 50 page catalog \$3.00. **DBE, POB G, Waikiki, HI 96815.**

CB Tune-up manual Volume II. Specific adjustments, modifications for peaking all popular CB's. Covers over 1300 radios. \$19.95. Visa, MasterCard to: **THOMAS PUBLISHING**, 127-R Westwood, Pars, IL 61944.

CABLE-TV converters and descramblers. Low prices, quality merchandise, we ship C.O.D. Send \$2.00 for catalog. **CABLETRONICS UNLIMITED**, PO Box 266, South Weymouth, MA 02190. (617) 843-5195.

SELL blank video cassettes. Super High Grade Olympia VHS T-120. Fully guaranteed. Only \$3.49 your cost. Add \$5.00 shipping and handling for any quantity. **STRANDBERG**, 1001 S. Elm Street, Greensboro, NC 27406. Telephone (919) 274-3775. Check, M.O., VISA or MasterCard account number & expiration date.

BIG PROFITS

ELECTRONIC ASSEMBLY BUSINESS

Start home, spare time, investment knowledge or experience unnecessary. **BIG DEMAND** assembling electronic devices. Sales handled by professionals. Unusual business opportunity.

FREE Complete illustrated literature
BARTA, R.E.O. Box 248
Walnut Creek, Calif 94597

LOTTO Buster. Analyzes all 6 digit lotto games. \$22.50. IBM and compatibles **LOTTO BUSTER**, 912 North Hampton, Bay City, MI 48708.

Is it true...leaps for \$44 through the government? Call for facts! 1-312-742-1142, ext. 4673.

LINEAR parts, tubes, transistors—MRF454 \$16.00, MRF455 \$12.00, MRF477 \$11.00, MRF492 \$18.00. Catalog. **RFPC**, Box 700, San Marcos, CA 92069 (619) 744-0728.

TV tunable notch filters, free brochure. **D.K. VIDEO**, Box 6944, Margate, FL 33063. (305) 752-9202.

TEST equipment, reconditioned. For sale, \$1.25 for catalog. **WALTER'S**, 2697 Nickel, San Pablo, CA 94806 (415) 724-0587.

LASERS, components and accessories. Free catalog. **M.J. NEAL COMPANY**, 6672 Mallard Ct., Orient, OH 43146.

FREE AC adapter (limited offer) with Assortment #103—Toko coils 144LY-120K, 520HN-3000023, BKAN-K5552AXX(2); PCB transistors 2N3904(2), BFQ85 (Sub); IC's 7812, 74123, MC1330A1P; Diodes 1N914, 1N5231B. Only \$25.00. Coils (only) \$8.00/set. Free Shipping. MC/Visa/COD. Toll free 1-800-821-5226 Ext. 426 (orders). **JIM RHODES, INC.**, 1025 Ransome Lane, Kingsport, TN 37660.

TUBES, name brands, new, 80% off list. **KIRBY**, 298 West Carmel Drive, Carmel, IN 46032.

INDIVIDUAL Photofac folders #1 to #1400. \$3.00 postpaid. **LOEB**, 414 Chestnut Lane, East Meadow, NY 11554.

WHOLESALE catalog of unusual money making electronic items. Dealers wanted. Rush \$1. **CROSLEY (A)**, Box 840, Champlain, NY 12919.

CB MODIFICATIONS

Increase channels, range, privacy! We specialize in frequency expanders, speech processors, FM converters, PLL & slider tricks, how-to books, plans, kits. Expert mail-in repairs & conversions. 16-page catalog \$2. Our 11th year!

CBC INTERNATIONAL, P.O. BOX 31500RE
PHOENIX, AZ 85046

POWER supplies, powered/unpowered breadboards digital trainers. Kit or assembled. Lowest prices. High quality. Free catalog **TERA ELECTRONICS**, Box 2482-RD, Evergreen, CO 80439 (303) 674-6844.

SCIENTIFIC Atlanta non-addressable converters 8500 series (original units), remote control...\$250.00-\$275.00. Tacom and Zenith descramblers available, guaranteed. **N.A.S.**, (213) 631-3552.

CB'ERS Monitor your CB's modulation through headphones. "Audio Tracker"...\$19.95, details \$1.00. **LEK-TRONIX**, Box 5261, Long Beach, CA 90805. (213) 631-3552.

TUBES: "oldest," "latest." Parts, components, schematics. SASE for list. **STEINMETZ**, 7519 Maplewood Ave., R.E., Hammond, IN 46324.

TI-PIA software/hardware bargains. Hard-to-find items. Huge selection. Fast service. Free catalog. **DYNA**, Box 690, Hicksville, NY 11801.

VIDEO scrambling techniques. The original "secret manual" covers sinewave, gated pulse, and SSAVI systems. 56 pages of solid, useful, legible information. Only \$14.95. **ELEPHANT ELECTRONICS, INC.**, Box 41865-J, Phoenix, AZ 85080. (602) 581-1973.

WIREWRAPE labels. Identify IC's, pins. Easier, errorless wrapping. All DIPs 8-40 pins. Inexpensive. 363 labels \$6.00. **PAUL'S LABELS**, 7320 Embassy, Miramar, FL 33023.

BUY BONDS



SCIENTIFIC ATLANTA UNITS

LOWEST PRICES ANYWHERE!



CABLE-TV

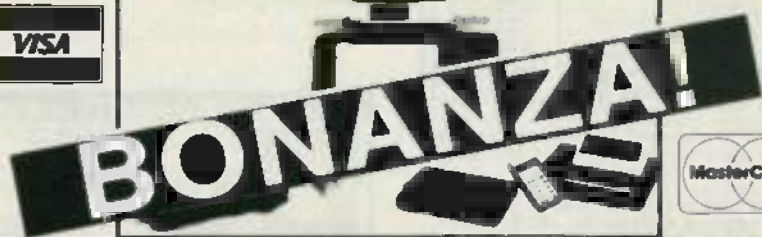

**WE'LL MATCH OR BEAT ANYONE'S
ADVERTISED RETAIL OR WHOLESALE PRICES!**

ITEM	SINGLE UNIT PRICE	DEALER 10-UNIT PRICE
RCA 36 CHANNEL CONVERTER (CH. 3 OUTPUT ONLY)	29.95	18.00 ea.
PIONEER WIRELESS CONVERTER (OUR BEST BUY)	88.95	72.00 ea.
LCC-58 WIRELESS CONVERTER	92.95	76.00 ea.
JERROLD 450 WIRELESS CONVERTER (CH. 3 OUTPUT ONLY)	105.95	90.00 ea.
SB ADD-ON UNIT	109.95	58.00 ea.
BRAND NEW — UNIT FOR SCIENTIFIC ATLANTA	<i>Call for specifics</i>	
MINICODE (N-12)	109.95	58.00 ea.
MINICODE (N-12) VARISYNC	119.95	62.00 ea.
MINICODE VARISYNC W/AUTO ON-OFF	179.95	115.00 ea.
M-35 B (CH. 3 OUTPUT ONLY)	139.95	70.00 ea.
M-35 B W/AUTO ON-OFF (CALL FOR AVAILABILITY)	199.95	125.00 ea.
MLD-1200-3 (CALL IF CH. 2 OUTPUT)	109.95	58.00 ea.
INTERFERENCE FILTERS — CH. 3	24.95	14.00 ea.
JERROLD 400 OR 450 REMOTE CONTROLLER	29.95	18.00 ea.
ZENITH SSAVI CABLE READY (DEALER PRICE BASED ON 5 UNITS)	225.00	185.00 ea.
SPECIFY CHANNEL 2 or 3 OUTPUT	Other products available — Please Call	

Quantity	Item	Output Channel	Price Each	TOTAL PRICE

California Penal Code #593-D forbids us from shipping any cable descrambling unit to anyone residing in the state of California. Prices subject to change without notice.

SUBTOTAL	
Shipping Add	\$3.00 per unit
COD & Credit Cards — Add 5%	
TOTAL	

PLEASE PRINT

Name _____
 Address _____ City _____
 State _____ Zip _____ Phone Number (_____) _____
 Cashier's Check Money Order COD Visa Mastercard
 Acct # _____ Exp. Date _____
 Signature _____

FOR OUR RECORDS

DECLARATION OF AUTHORIZED USE — I, the undersigned, do hereby declare under penalty of perjury that all products purchased, now and in the future, will only be used on cable TV systems with proper authorization from local officials or cable company officials in accordance with all applicable federal and state laws.

Dated _____ Signed _____

Pacific Cable Company, Inc.

7325 1/2 RESEDA BLVD., DEPT. R-12 • RESEDA, CA 91335
 (818) 716-5914 • No Collect Calls • (818) 716-5140

IMPORTANT: WHEN CALLING FOR INFORMATION
 Please have the make and model # of the equipment used in your area. Thank You

THE BEST PLACE TO BUY, SELL or TRADE NEW and USED EQUIPMENT
NUTS & VOLTS MAGAZINE
 BOX 1111E • PLACENTIA, CA 92670
 (714) 637-7731
 Join Thousands of Readers Nationwide Every Month
ONE YEAR U.S. SUBSCRIPTIONS
 \$10.00 - 3rd Class • \$15.00 - 1st Class
 \$35.00 - Lifetime - 3rd Class

NUTS & VOLTS
 NEW GEAR
 COMPLETE SOFTWARE
 SCHEMATIC & OPTICS
 TEST EQUIPMENT
 REPAIRMAN'S
 SUPPLIES
 AUDIO VISUAL
 NEW PRODUCTS
 COMPONENTS & KITS
 ANTENNA BLKCT.
 PUBLICATIONS
 PLANS • SERVICES

BUGGED? Wiretapped? Find out fast. Countermeasures equipment catalog \$1.00. **CAPRI ELECTRONICS**, Route 1R, Canon, GA 30520.

SSWIN with thoroughbred/harness. Greyhound handicapping software... \$29.95, enhanced... \$49.95. Professional football handicapping system. \$39.95. For most computers. Free information. **SOFTWARE EXCHANGE**, Box 5382RE, W. Bloomfield, MI 48033. (800) 527-9467.

CABLE TV equipment. Scientific Atlanta, Zenith, Jerrold, Oak, send \$2.00 for catalog. **K.O. VIDEO**, P.O. Box 29538 Mpls., MN 55429.

TUBES! 59 cents. Year guarantee. Free catalog. Tube tester \$8.95. **CORNELL**, 4215 University, San Diego, CA 92105.

SATELLITE TV VIEWERS
 Get the most complete weekly listings
 Send \$1 for sample copy.

Satellite TV Week

P.O. Box 308E, Fortuna, California 95540
 800.358.9977 (U.S.) • 800.358.8767 (Callf.)
 707-783-9476 (all others)

BRAND new Oak descramblers. \$35.00 each; Vari-sync Oak \$45.00 each; SB-3 \$89.00; Tri-mode \$125.00; Bi-state \$125.00; call us, we ship UPS COD. **PONDEROSA COMPANY**, (303) 634-6666.

TV SCR Tester. Hand-held will also test triacs, diodes, transistors, ECG 89 HO transistors in operational mode. Defines AKG. Will save time. \$49.95. Send check or money order **BFE**, P.O. Box 3942, Albany, GA 31706-3942.

Multi-Channel Microwave T. Tubes, PFS
 1.9-2.7 GHz Parabolic Dish 40+ dB Gain
LIFETIME WARRANTY
 Complete System \$89.95 (Shipping Incl.)
 Dealer Rates, Replacement Components & Expert Repairs Available

K & S ELECTRONICS Call now for same
 P.O. Box 34522 day (shipping)
 PHOENIX, AZ 85067 (602) 230-0640

VISA/MC/COD \$2 credit on phone orders!

PRINTED-CIRCUIT BOARDS

PRINTED circuit boards and artwork. Design Cad/Cam plated through holes. Competitive pricing. Sm Artwork supported. **EXPRESS CIRCUITS**, 314 Cothren Street, P.O. Box 58, Wilkesboro, NC 28697. (919) 667-2100.

LOW quotes, high quality, quick service. Single, double sided, multilayered boards. Prototypes through production quantities. Design/layout capabilities. Board assembly/turnkey facilities. Call or write for quotes and info.—**T.O.R.C.C.C.**, 1131 Tower, Schaumburg, IL 60195. (312) 490-1374.

INVENTORS

INVENTORS! Can you patent and profit from your idea? Call **AMERICAN INVENTORS CORPORATION** for free information. Over a decade of service. 1 (800) 338-5656. In Massachusetts or Canada call (413) 568-3753.

BUSINESS OPPORTUNITIES

MECHANICALLY inclined individuals desiring ownership of small electronics manufacturing business—without investment. Write: **BUSINESSES**, 92-R, Brighton 11th, Brooklyn, NY 11235.

YOUR own radio station! AM, FM, TV, Cable. Licensed/unlicensed. **BROADCASTING**, Box 130-F12, Paradise, CA 95969.

\$10.00-\$360.00 weekly! Become circular mailer. No quotas. Sincerely interested, rush stamped envelope: **NATIONAL MAILING**, Box 19759-RA12, San Diego, CA 92119.

DEALERS wanted! DMM's, solderless breadboards, soldering tools, individuals welcome. **CENTURY INTERNATIONAL COMPANY**, Box 29762, Dallas, TX 75229.

EDUCATION & INSTRUCTION

COMPUTER repair career training in 5 months by accredited Florida electronics school. Lifetime placement. Financial assistance if qualified. Call **SYSTEMS TECHNOLOGY INSTITUTE**. (305) 331-2840.

LEARN to be a television studio technician! After only 14 months earn your degree and a great career in video. Financial aid and national placement assistance. Dallas (214) 263-2613 or Long Beach (213) 595-1660. **VIDEO TECHNICAL INSTITUTE**.

FCC commercial general radiotelephone license correspondence course. 60 individual lessons for \$89.50. Payment plan. Results guaranteed! Details free. **AMERICAN TECHNICAL INSTITUTE**, Box 201, Cedar Mountain, NC 28718.

MASTERCARD AND **VISA** are now accepted for payment of your advertising. Simply complete the form on the first page of the Market Center and we will bill.

ALL SALES SUBJECT TO THE TERMS OF OUR 90 DAY LIMITED WARRANTY. FREE COPY UPON REQUEST.

THE NEW 65/9028 VT ANSI VIDEO TERMINAL BOARD!

* FROM LINGER ENTERPRISES *

A second generation, low cost, high performance, mini sized, single board for making your own RS232 Video Terminal. Use as a computer console or with a MODEM for hook up to any of the telephone-line computer services.

FEATURES:

- Uses the new SMC 9028 Video Controller Chip coupled with a 6502A CPU.
- RS-232 at 16 Baud Rates from 50 to 19,200
- On board printer port!
- 24 X 80 format (50/60 Hz).
- For 15,750 Hz (Horiz.) monitors.
- 3 Terminal Modes: M-19, ADM3A, and ANSI X 3.64-1979
- Wide and thin-line graphics.
- White characters on black background or reversed.
- Character Attributes: De-Inten, Inverse or Underline.
- Low Power: 5VDC @ .7A. ± 12VDC @ 20MA.
- Mini size: 6.5 X 5 inches.
- Composite or split video.
- 5 X 8 Dot Matrix characters (U/L case).
- Answer back capability.
- Battery backed up status memory.
- For ASCII parallel keyboard.

MICRO SIZE!

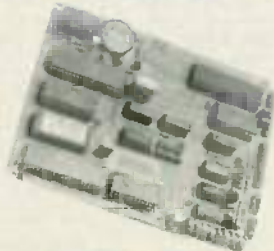

\$99.95
(Full Kit)

SOURCE DISKETTE:
PC/XT FORMAT
5 1/4 IN. \$15

ADD \$40 FOR A&T

Digital Research Computers

(OF TEXAS)

P.O. BOX 381450 • DUNCANVILLE TX 75138 • (214) 225-2309

Call or write for a free catalog on Z-80 or 6809 Single Board Computers, SS-50 Boards, and other S-100 products.

TERMS: Add \$3.00 postage. We pay balance. Orders under \$15 add 75¢ handling. No C.O.D. We accept Visa and MasterCard. Texas Res. add 5-10% Tax. Foreign orders (except Canada) add 20% P & H. Orders over \$50 add 85¢ for insurance.

HIGH VOLTAGE TRIPLERS/MULTIPLIERS

REPLACEMENT FOR

ECG®/GE®/SK®

500A/ GE527 & SK3304	8.75	6.95
523/ GE528 & SK3306	8.85	7.20
526A/ SK3306	8.85	7.20
528/ SK3906	10.70	8.70
529/ GE529 & SK3307	9.99 5 MIN.	7.95 100 MIN.

OUTPUT TRANSISTORS

165/ SK3145 & GE3B	2.25	1.95	1.75
238/ GE37 & SK3710	2.25	1.95	1.75
283/ SK3457	2.75	2.35	1.80
2SD1341P	2.25	1.95	1.75
2SC1172B	2.25 5 MIN.	1.95 50 MIN.	1.55 100 MIN.

AUDIO POWER

	10 min	50 min	100 min		10 min	50 min	100 min		10 min	50 min	100 min
TYPE				TYPE				TYPE			
192/SK3893	30.25	21		196/SK3054	48.44	39		291/SK3440	49.44	39	
188/SK3274	30.25	21		197/SK3083	59.54	49		292/SK3441	49.44	39	

RECTIFIER DIODES

125	1000V/2.5A	7¢	500	1000
156	1000V/5A	18¢	16¢	13¢
506	DAMPER/MI-VOLT—FAST RECOVERY	29¢	24¢	19¢

\$\$\$ ADDITIONAL SAVINGS \$\$\$

TYPE	10 min	50 min	100 min	TYPE	10 min	50 min	100 min
102A	.39	.32	.29	171	.49	.44	.38
125A	.18	.16	.14	184	.38	.33	.28
125AP	.15	.11	.09	185	.38	.33	.28
128	.38	.35	.29	198	.60	.54	.49
129	.38	.35	.29	199	.18	.15	.12
130	.59	.55	.49	234	.19	.16	.13
159	.16	.13	.11	373	.44	.42	.39
162	2.25	1.95	1.49	712	.75	.69	.60
163A	2.35	1.99	1.55				

FOR A COMPLETE LIST CALL OR WRITE—C.O.D. Orders Welcome (Min. Order \$25)

DIGITRON ELECTRONICS

110 HILLSIDE AVENUE, SPRINGFIELD, NEW JERSEY 07081
 Toll Free 1-800-526-4928 In NJ 201-378-9016 Telex 138441

PRICES SUBJECT TO CHANGE WITHOUT NOTICE. OFFER GOOD WHILE SUPPLY LASTS. ECG is a Trade Mark of Philips ECG. Digitron is not associated with Philips ECG.

CIRCLE 57 ON FREE INFORMATION CARD

WANTED

INVENTORS! AIM wants—ideas, inventions, new products, improvements on existing products. We present ideas to manufacturers. Confidentiality guaranteed. Call toll free 1 (800) 225-5800 for information kit.

INVENTIONS, ideas, new products wanted! Industry presentation/national exposition. Call free 1 (800) 528-6050. Canada, 1 (800) 528-6060. X831.

DO IT YOURSELF TV REPAIR

NEW...repair any TV...easy. Retired serviceman reveals secrets. Write, **RESEARCH**, Rt.3, Box 601BR, Colville, WA 99114.



WRITE FOR McGEE'S

SPEAKER & ELECTRONICS CATALOG

1001 BARGAINS IN SPEAKERS

toll free 1-800-346-2433 for ordering only.

4901 MCGEE STREET KANSAS CITY, MO 64108

CABLE-TV DESCRAMBLERS

ALL brands available. "We won't be undersold." Dealer inquiries welcome. We ship C.O.D.'s. For catalog send \$3.00 to **CONSUMER VIDEO CORP.**, P.O. Box 913, Clifton Park, NY 12065. (518) 783-5636 M-F 9AM-5PM E.S.T.

EPROM PROGRAMMING

HOBBYISTS; Pretested EPROMS sold with your programming installed. Program listing provided. Fast service. Write or call: **ROMULUS MICRO-CONTROL**, Box 8669, Rockville, MD 20856. (301) 540-8863.

SPEAKER REPAIR

SPEAKER reconfig—radio, hi-fi, musical instrument. All work guaranteed. SSI, 725 Archer Ave., Ft. Wayne, IN 46808. (219) 42-MUSIC.

LASERS

HE-NE complete \$129.95, modulated systems available **LES ELECTRONICS**, PO Box 800276, Dallas, TX 75380.

SATELLITE TV

CABLE TV secrets—the outlaw publication the cable companies tried to ban. HBO, Movie Channel, Showtime, descramblers, converters, etc. Suppliers list included \$8.95. **CABLE FACTS**, Box 711-R, Pataskala, OH 43062.

CABLE TV Source Book—a complete listing of suppliers for hard-to-find converters, descramblers, technical information, schematics and much more. Full refund if not satisfied. Send \$4.95 to **CABLE**, Box 12505-R, Columbus, OH 43212.

PATENTED optical process satellite sound system. For information send \$3.00 to: **BEDINI ELECTRONICS**, PO Box 769, San Fernando, CA 91341.

SATELLITE systems \$349.00, catalog \$2.00. Also: KU band, exports. **STARLINK, INC.**, 2603-16R Arto, Huntsville, AL 35805.

BUILD your own satellite system and save! Instructions, schematics, partial Catalog \$1.00 (refundable); **XANDI**, Box 25647, Dept. 21H, Tempe, AZ 85262.

TUNE subcarriers on FM receiver. Including multiplex stereo. Plans \$8.65, components \$14.60, board \$9.50. I.F. **IN-NOVATIVE**, Box 745, Madras, OR 97741.

59 degree brand name LNA's! LNB's! Ku-Band LNB's! Discount pricing! Send stamped envelope: **LNA**, 201 E. Southern, Suite 100H, Tempe, AZ 85282.

QUALITY products—low prices—no gimmicks—send for free brochure and 800 number to S.S.E., POB 3833, Ocala, FL 32678.

OAK Orion "turn-on" modifications: "Chip-Kit" or "remote keypad" details \$1.00. **NAS-SAT**, Box 5261, Long Beach, CA 90805. (213) 631-3552.

Pay TV and Satellite Descrambling All New 6th Edition!

Now 100 pages of working schematics and theory for all major cable and satellite systems, including Orion, Video Cypher, Fantasy and Extasy. New sections on how illegal descramblers are detected. Scientific Atlanta, Tri-Mode, Pilotless, Pico, Star-Lok IV and B-Mac bypasses. Latest info on Orion pirate chips and the breaking of Video Cypher. The most complete source of descrambling info available \$14.95. MDS handbook \$10.. Satellite systems under \$600.00, \$11.95. New winter product catalog \$2.00.

Shojiki Electronics Corp. 1327R
Niagara St., Niagara Falls, NY
14303. COD's 716-284-2163

ATTENTION satellite dealers. See everything with your video cypher 2000E demonstrator on all the transponders (secret modification voids manufacturers warranty). Send \$24.00 for VC kit. Send \$10.00 for full set of schematics of the Ma/com model 2000E receiver. **TV SHOP**, 127 E. Mission, Fallbrook, CA 92028. (619) 723-1302.

DESCRAMBLER unscramble videocipher II satellite TV signals with Decipher-Two (video only). Simple low cost circuit using only three timer IC's. P.C. board, instructions \$35.00. **P.P. VALLEY MICRO-WAVE ELECTRONICS**, Bear River, Nova Scotia, Canada BOS-1B0. (902) 467-3577.



Quality Microwave TV Antennas

Multi-Channel 1 B to 2.7 GHz
40 dB Gain True Parabolic 20 inch Dish
U.L. Listed Power Tuner
Comp System \$89.95 (Shipp net incl.)
DREAM CHASER SYSTEMS

P.O. Box 8014 • Blaine, WA, 98230
604-590-3367 (3 credit-phone orders)
MasterCard Visa COD's Qty. Pricing

LIFETIME
WARRANTIES

PLANS AND KITS

CATALOG: Hobby/Broadcasting/1750 meters/Ham/CB: transmitters, amplifiers, antennas, scramblers, bugging devices, more! **PANAXIS**, Box 130-F12, Paradise, CA 95969.

CRYSTAL radio sets, plans, parts, kits, catalog \$1.00. **MIDCO**, 660 North Dixie Highway, Hollywood, FL 33020.

BUILD this five digit panel meter and square wave generator including an ohms, capacitance and frequency meter. Detailed instructions \$2.50. **BAGNALL ELECTRONICS**, 179 May, Fairfield, CT 06430.

CABLE TV converters: Jerrold Products include "New Jerrold Tri-Mode," SB-3, Hamlin, Oak VN-12, M-35-B, Zenith, Magnavox, Scientific Atlanta, and more. (Quantity discounts) 60 day warranty. Service converters sold here. For fast service C.O.D. orders accepted. Send SASE (60 cents postage) or call for info (312) 637-4408. **Midwest Electronics, Inc.**, **HIGGINS ELECTRONICS**, 5143-R W. Diversey, Chicago, IL 60639. MC/Visa orders accepted. No Illinois orders accepted.

JERROLD gated pulse theory. Twelve information packed pages covering DI & DIC converter operation. Includes introduction to trimode system. \$6.95 plus \$1.50 postage and handling. **ELEPHANT ELECTRONICS, INC.**, Box 41865-J, Phoenix, AZ 85080. (602) 581-1973.

TELEPHONE bug, FM room bug schematics with detailed construction procedures using Radio Shack's numbered parts. Both \$6.00. Receiver available. **SHEFFIELD ELECTRONICS**, 7223 Stony Island, Chicago, IL 60649.

STRANGE stuff. Plans, kits, new items. Build satellite dish \$69.00. Descramblers, bugs, adult toys. Informational photo package \$3.00 refundable. **DIRIJO CORPORATION**, Box 212, Lowell, NC 28098.

DESCRAMBLE the latest video cassette copy protection scheme. Our simple Line Zapper circuit takes the jitter out of your picture. Complete plans and theory only \$9.95 plus \$1.50 postage and handling. **ELEPHANT ELECTRONICS, INC.**, Box 41865-J, Phoenix, AZ 85080. (602) 581-1973.

Hi-Fi speaker systems, kits and speaker components from the world's finest manufacturers. For beginners and audiophiles. Free literature. **A&S SPEAKERS**, Box 7462R, Denver, CO 80207. (303) 399-8609.

VOICE disguisers! Telephone bugs! FM bugs! Other kits! Catalog \$1.00 (Refundable): **XANDI**, Box 25647, Dept. 60F, Tempe, AZ 85282.

EXPERIMENT with fiber optics! Send your voice over a beam of light via an optical fiber. Complete kit (\$39.95) includes microphone, speaker, fiber, PCB's and all parts. Easily assembled. Complete plans package only \$5.95. Send to: **FIBER SCIENCES**, Box 5355, Chatsworth, CA 91313-5355. CA residents add 6.5%.

ROBOTICS catalog for hobbyists. 20% off sale \$2.00 (refundable). **ALPHA ROBOTICS INC.**, Box 21091, St. Paul, MN 55121.

SURROUND sound decoder plans. Extracts hidden surround sound track from any stereo audio-visual source. Effects produced create remarkable spaciousness like being in a theater. SSD features a built-in amplifier, volume and tone controls and line level out. Easy to build. For complete plans send \$8.95 to **SYNECTICS**, 524 San Anselmo Avenue, Suite 201, San Anselmo, CA 94960.

JERROLD tri mode add-on circuit. Complete kit includes PC board, parts, schematic and instructions for interface in SB or DIC type units \$15.00. **ARUS ELECTRONICS**, PO Box 662, Chappaqua, NY 10514.

BODMING bass! Incredible hi-fi! Build your own graphic equalizer. Studio quality! Plans \$5.00. **BRUCE EDWARDS**, 10326 Lawson Rd., Jacksonville, FL 32216.

BRAIN waves control robot inexpensively with computer. System plans \$19.95. **ROSE**, 990 Seacoast I.B., CA 92032.

DESIGN your own custom circuits on your Commodore *Vis. Just enter specifications and the computer does the rest. Send for free information. **WEASELGRAPHICS PROGRAM**, Dept. RE11, 606 Thomasville, Pochahontas, AR 72455.

KITS! Stereo scratch filter, frequency counter, radar detector and more. Semi-assembled and tested. Write for free literature. **SERENA INDUSTRIES**, 1180-A Aster Ave., Sunnyvale, CA 94086.

ZENITH cable anti-flash kits. Dealers only. 100% guaranteed. Works where others fail. **UES**, Box 1206 Elgin, IL 60121. (312) 697-0600.

PROGRAMMABLE chase light circuit. Useful as auto brake light system P.C.B., plans \$6.50 PPD. **J.G.M. LABS**, PO Box 62, Eola, IL 60519.

FREE microprocessing, memory chips, etc. Free electronics magazine subscriptions, free education in computers. For information write **MICROSAT CORPORATION**, 2401 N.E. Cornell Bldg., 133 Hill-sboro, OR 97124.

DESCRAMBLING, new secret manual. Build your own descramblers for cable and subscription TV. Instructions, schematics for SSAVI, gated sync, sine wave \$8.95. Satellite descrambling manual. Thorough explanation of digital audio encoding. \$10.95. (HBO, Cinemax, Showtime, etc.) For immediate delivery add \$1.00. **CABLETRONICS**, Box 30502R, Bethesda, MD 20814.

COMPUTER plans/kits 6802 micro kit \$35.00, Z80 micro \$40.00, EPROM programmer \$30.00, plans \$5.00. Build it yourself and save! **MICRO MOD**, 1419W. Colt. Chandler, AZ 85224.

SURVEILLANCE transmitters. Dozen proven schematics, parts lists \$10.00. **SEAL**, PO Box 15253, Plantation, FL 33318.

AMAZING DEVICES

- PHASORS**
- PLANS—All Parts Available in Stock
 - LC5 BURNING CUTTING CO2 LASER ... \$20.00
 - RUB3 RUBY LASER RAY PISTOL ... 20.00
 - BTC5 1.5 MILLION VOLT TESLA COIL ... 15.00
 - PTG1 PLASMA TORNADO GENERATOR ... 10.00
 - GRA1—GRAVITY GENERATOR ... 10.00
 - MAGNETIC CANNON PROJECTOR ... 10.00

- LASERS**
- KITS—Includes Plans and Parts**
- LHC2K SIMULATED RED/GRN/YEL LIGHT LASER ... 34.50
 - BTC3K 250,000 VOLT TESLA COIL ... 159.50
 - 10G1K ION RAY GUN ... 109.50
 - PSP3K PHASOR SHOCK WAVE PISTOL ... 49.50
 - STG1K—STUN/PARALYZING GUN ... 39.50
 - INF1K INFINITY TRANSMITTER ... 134.50
 - MFT1K 2-3 MILE RANGE FM VOICE XMTR PC BOARD ... 49.50

- SECURITY**
- ASSEMBLED AND TESTED PRODUCTS**
- LGU30 RED 1MW PORTABLE HENE LASER ... 349.50
 - TCL30 SOLID STATE TESLA COIL 35KV ... 84.50
 - IPG50 POCKET PAIN FIELD GENERATOR ... 64.50
 - BLS10 BLASTER DEFENSE WEAPON ... 89.50
 - ITM10—100KV SHOCK AND STUN GUN ... 99.50
 - PPF10 PHASOR PAIN FIELD PORTABLE ... 249.50
 - SNP20 SECURITY PHONE LISTENER ... 99.50
- CATALOG CONTAINING DESCRIPTIONS OF ABOVE PLUS HUNDREDS MORE AVAILABLE FOR \$1.00 OR INCLUDED FREE WITH ALL ABOVE ORDERS
- PLEASE INCLUDE \$3.00 PH ON ALL KITS AND PRODUCTS. PLANS ARE POSTAGE PAID. SEND CHECK. MD. VISA. MC TO

INFORMATION UNLIMITED
P.O. BOX 716, DEPT. N1 AMHERST, NH 03031

THIS I.B.M.® PC. CLONE IS FOR HARDWARE HACKERS ONLY

- 640 BY 420 LCD MONITOR
 - SOCKETS FOR 640K RAM
 - COLOR GRAPHICS CARD
 - 63 KEY KEYBOARD
 - HAYES MODEM SOFTWARE
 - DESK TOP SOFTWARE
 - 12VDC/115VAC OPERATION
 - FLOPPY DISK CONTROLLER
 - SCHEMATICS
 - TECH. MANUAL
 - CASE NOT AVAILABLE
- only 99⁰⁰
- MADE FOR THE ZENITH® ZX171⁰ PORTABLE PC CALL FOR DETAILS

SMART STEPPER SYSTEM

- 8085 CPU BOARD
 - RS232 INTERFACE
 - 50-192K BAUD
 - 36 INSTRUCTIONS IN ROM
 - 2 STEPPER MOTORS
 - 1.8 DEG • 9 OZIN
 - DRIVER BOARD
 - JOYSTICK CONTROL
 - SOLINOID DRIVER
 - POWER SUPPLY
 - TRANSFORMER REQUIRED
 - 74 PAGE MANUAL
 - SCHEMATICS
- only 99⁰⁰
- USE IT FOR A PLOTTER OR ROBOT

APPLE SERIAL CARD

- HARDWARE HANDSHAKING WORKS WITH MODEMS FULL APPLE FIRMWARE PROTOCOLS ARE SUPPORTED ON CARD NO HARDWARE DEPENDENT CODE IS NEEDED JUST PLUG AND GO
- only 29⁰⁰

Advanced Logic Systems
"DISPATCHER" BRAND

CA ADD & 5% TAX PREPAID OR C.O.D. ONLY. OFFER GOOD WHILE SUPPLIES LAST. 15 DAY TRIAL PERIOD ON MOST ITEMS. PRICES SUBJECT TO CHANGE. SUBJECT TO OUR 15 DAY SALES AGREEMENT CALL FOR A COPY

SILICON VALLEY SURPLUS 4401 DAK PORT OAKLAND CA 94601 AT HIGH & B80
415-261-4506
10AM-6PM CLOSED SUN & MON

CIRCLE 187 ON FREE INFORMATION CARD

R-E ROBOT

continued from page 56

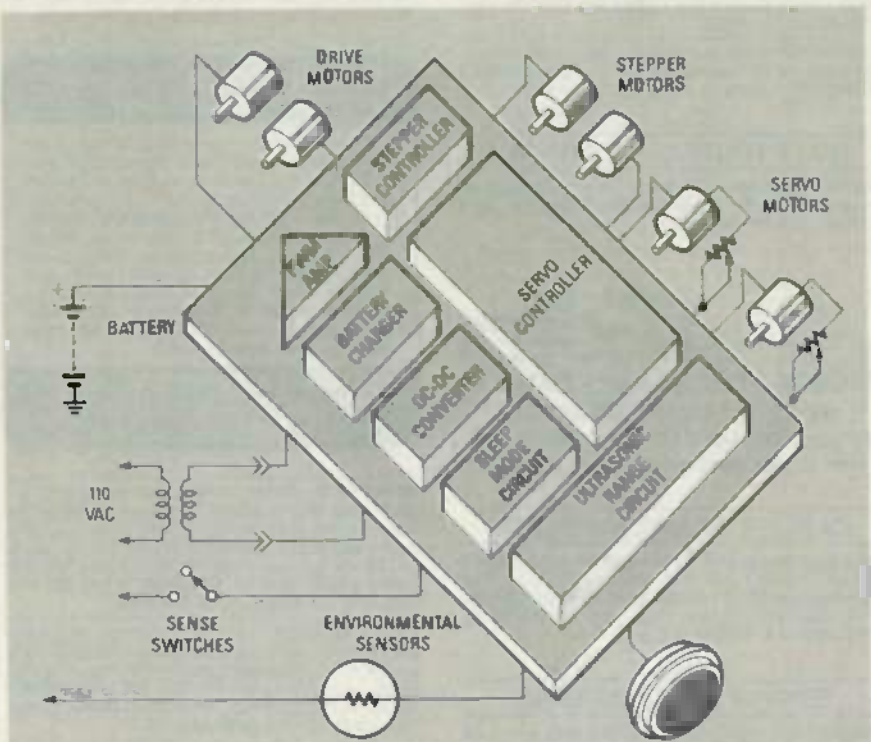

FIG. 2—MOST OF THE BASIC CONTROL CIRCUITS are located on a single custom board, designated Board 1. That board is shown here in block-diagram form.

of FORTH is written in FORTH, the internal routines are available to the programmer, and we can use parts of the FORTH interpreter in the RCL interpreter. The end result is an interactive RCL that can be modified by the user, and that can be used without a disk drive. We will be looking at RCL in depth in a future installment.

Operator interface

Most applications of robots are limited not by the ability of the hardware to perform a given task, but by the amount of time it takes to "teach" the robot. RCL significantly improves programming productivity.

Several methods of operator interface were considered. One was the "teach pendant" approach wherein motion sequences are learned and stored for recall and execution at a later time. However, after both utility and expense were considered, all other methods of interface were abandoned in favor of using a serial terminal. The reason is that almost everyone who considers building a robot has a terminal or a personal computer that can emulate a terminal. And if a more sophisticated method of control is desired, the required modifications are easy to perform. However, modifications of that sort are left to the ingenuity of the reader.

It is important to be able to operate the robot from a remote location. What we

need is a way to transport our commands from the control terminal to the robot. That is done using an RF link. The link interfaces to the terminal via the termi-

nal's serial port.

Table 1 shows how our robot stacks up against several of the leaders in the personal-robot market: the RB-SX from RB Robots (14618 W. Sixth St., Golden, CO 80401) and the Heath (Benton Harbor, MI 49022) HERO 2000. When you compare the capabilities of those robots to ours, we think you'll find that our inexpensive, build-it-yourself robot more than holds its own against the competition.

That concludes our overview of the R-E robot. In the coming months we will analyze each of the robot's subsystems in detail and show you how you can adapt our design to your applications.

As part of the design process, a special section of RE-BBS, Radio-Electronics' new computer bulletin-board service, will be dedicated for use by robot builders. We invite readers who devise interesting applications, programs, and experiments, or who discover sources of parts, or who have questions, answers, or any other information of general interest to share it on the bulletin board. In addition, the author and the editors will be posting circuit modifications, design updates, and supplier information there for your convenience. By sharing information in that way, we hope to develop the kind of personal robot that has long been promised but never produced.

R-E

Radio Shack Parts Place™

HOBBYIST'S HOLIDAY! OVER 1000 PARTS IN STOCK!

Sound-Generator IC



995 3 Independent Analog Outputs

Adds Sound Effects to Your Computer

This chip is a great way to "dress-up" your programs! Only your imagination will limit the type of sound effects and music you can produce! The three analog audio outputs are independently programmable. Two general-purpose 8-bit I/O ports and single 5 VDC supply operation make it easy to interface with most microprocessors. 40-pin DIP. With interfacing and programming data. #276-1787

#276-1787 9.95

Touch-Tone Decoder IC



DTMF Receiver In A Single IC **1295**

For Many Remote Control Applications

High performance, easy to use! Features single analog input and 8 built-in switched-capacitor filters. Selectable hexadecimal or binary coded 2 of 8 output. Clocked by low-cost 3.58 MHz crystal (see below). 18-pin, 5 VDC, single supply. With detailed data and circuitry examples. #276-1303 3.58-MHz Crystal. #272-1310

..... 1.69

Voice Synthesizer Team

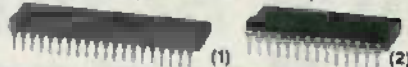

Adds Voice Function to Your Computer

(1) Text-to-Speech IC. Translates ASCII data to direct Synthesizer. #276-1786 16.95
(2) Speech Synthesizer. MOS/LSI. Easy interfacing with most computers. #276-1784 12.95

8-Bit A/D Converter IC

Complete Data Acquisition System in One IC



High-speed data transfer with minimum support components. Features single 5 VDC supply operation, internal system clock, single analog input and an on-chip sample-and-hold circuit. 8-pin DIP with data. #276-1796

..... 6.95

DC Fan and Trans

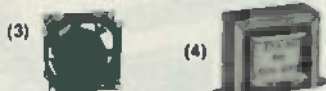

(3) 3" Brushless DC Fan. Low-noise. No hum or AC field problems. #273-243 14.95
(4) UL-Recognized Heavy-Duty Transformers.

Volts	Amps	Cat. No.	Each
12.6 CT	3.0	273-1511	6.99
25.2 CT	2.0	273-1512	7.49
18.0 CT	2.0	273-1515	6.99

IC Chime, Siren and Buzzer



For Alarms, Alarms, Timers and Fun!
(5) Electronic Chime. Delivers 80 dB "ding-dong" at 12 VDC. #273-071 6.95
(6) Tri-Sound Siren. 3 distinctive sounds. Delivers 80 dB at 3 VDC. #273-072 5.95
(7) Two-Tone Piezo Buzzer. 100 dB minimum. 8 to 16 VDC. #273-070 6.95

LEDs Light Up the Season!



(8) Super-Bright Red LED. #276-066 99c
(9) Blinking Red LED. #276-036 1.19
(10) Blinking Green LED. #276-030 1.19
(11) Flashing Lamps. Yellow, red, green. Ideal for model trains. #272-1097 Pkg. of 3/99c
(12) Xenon Strobe Tube. #272-1145 2.99

"Pro-Look" Finishing Touches



(13) (14) 1 1/16" Dia. Knobs For 1/8" shafts. #274-432 Pkg. of 2/1.49
1" Dia. Knobs. #274-433 Pkg. of 2/99c
(15) Our Finest Two-Tone Enclosures. Small. 1 1/16" x 8 1/16" x 6 1/16". #270-272 5.99
Large. 3 1/16" x 8 1/16" x 6 1/16". #270-274 7.99

Mini Relays and Switches

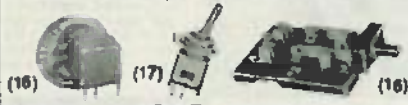

(16) Micro-Mini SPDT. Rated 1 amp at 125 VAC. 5 VDC, 90 mA, 550-ohm coil. #275-240 1.69
With 12 VDC Coil. #275-241 1.69
(17) Submini SPST PC-Mount Toggle. Rated 0.3 amp at 125 VAC. #275-645 1.59
(18) DPDT Knife Switch. Rated 0.5 amp at 250 VAC. #275-1537 99c

Insulated-Clip Jumpers

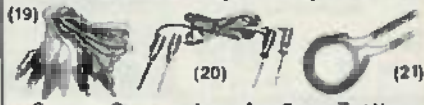

Secure Connections for Easy Testing
(19) Set of 10 Test Cables. 14" long. #278-001 3.49
(20) 20" Mini-Clip Leads. #278-016 Pair/2.99
(21) 6-ft. Coiled Leads. Probes at one end, banana Plugs at other. #278-750 Pair/3.89

10-Piece Electronic Tool Kit

1495

Complete Home/Shop Set-Up



Includes 30-watt UL listed soldering iron and stand, solder, solder aid, needle-nose pliers, diagonal cutter, three screwdrivers and heat sink. #64-2801

Solderless Breadboard



1995

Big 2 1/4" x 6 1/2" size, mounted on a 7 x 8" "stay-pull" steel base with rubber feet. Provides a total of 840 plug-in tie points. Includes three binding posts for external connections. #276-169

Scientific Calculator



Never Needs Batteries!

2995

EC-4018. Solar-powered. Folding-style. Extra-large keys and LCD display. 16 useful functions. 10-digit mantissa, 2-digit exponent. #65-982

Solar Energy Project Set



Perfect for Science Projects

995

Discover the future promise of solar technology today! Comes complete with solar cell prewired to a DC motor, color wheels, propeller and booklet with interesting projects. #277-1201

Handy Folding Multimeter

Ideal for Home/Auto/Shop

SALE!
27% OFF

Reg. 29.95
21⁸⁸



You get durability and famous Micronta® quality and save \$8.07. Features 25 switch-selected ranges. Meter movement is shunted when closed. Fuse and surge absorber protected. Four detented hinge positions for easy-view positioning. Measures AC/DC voltage, DC current and resistance. 7 1/4" x 4 1/16" x 1 1/4" when open. With probes, manual. Batteries extra. #22-211

Over 1000 items in stock: Binding posts, Books, Breadboards, Buzzers, Capacitors, Chokes, Clips, Connectors, Fuses, Hardware, ICs, Jacks, Knobs, Lamps, Multimeters, PC Boards, Plugs, Rectifiers, Relays, Resistors, Switches, Tools, Transformers, Transistors, Wire, Zeners and more!

Radio Shack®
A DIVISION OF TANDY CORPORATION

Prices apply at participating Radio Shack stores and dealers.

CHECK US OUT!

Dick Smith Electronics for Service, Value & Innovation!



Featured
in this
issue!

Open up the world of Closed Captions!

Many TV programs carry specially encoded signals to provide captions that allow hearing-impaired people to follow dialogue & narration! Educators find captions improve reading skills!

The DSE SuperText IC is a low-cost alternative to the more expensive NCI Telecaption II. Using the same decoding technology (under license from NCI), the SuperText IC offers super performance (displaying crisp white text in a black background) and easy operation. Cost & complexity are minimized by eliminating the tuner & remote control features of the expensive NCI version. The SuperText IC connects to the audio/video outputs of newer model TVs or VCRs or component TV tuners (an RF modulator for direct antenna connection is optional) to provide two separate captioning channels as well as two full-screen text services. (A fifth "channel" bypasses all captions & text to display the regular TV image without disconnecting the decoder.) All channels & power are controlled by a single front-panel knob. The text channels include program listings of upcoming captioned broadcasts.



SUPERTEXT IC TELECAPTION ADAPTER & LINE-21 TELETEXT DECODER

Col K-6344

\$139

This kit is fairly simple and easy to build. All components except the decoder module & front panel switch mount on a single PCB. Any hobbyist with basic bench tools, a multimeter, and good soldering technique can build the adapter. Once it is built and a few basic tests are made, the adapter can be hooked up. The remaining adjustments (for caption display contrast) can be made with the case assembled. No special tools are required. The kit comes with a handsome camel brown case, punched & screened front and rear panels, all parts, instructions - even solder! Includes "Sorry, Dick" repair coupon. If your kit fails to operate when assembled, return it with coupon & fixed service fee, and we'll get it up & running!

Features

- Direct audio & video inputs & outputs
- Single off-function control
- Contrast adjustment
- Compact size
- No dangerous internal voltages
- Easy assembly & set-up
- Full closed-circuit & text service operation

Options

- Power Supply Col M-9526 \$4.95
- RF Modulator Col K-6040 \$9.95



Get the latest scores, weather, & stock prices at the touch of a button! This easy-to-build kit features pre-adjusted, pre-assembled decoder module & 21 button wired remote. You get TV, Teletext, TV/Teletext, & refresh modes - all without user fees!

Featured in April & May
Radio-Electronics

**TELETEXT
Decoder Kit** **\$199**
Col K-4315

**Teletext Intra-Red
Remote Control** **\$34.95**
Upgrade to wireless remote Col K-3428



PLAYMASTER
200W Mosfet Stereo Amp Kit
GREAT VALUE! **\$299**
Col K-3816

Get the Audio Quality You Deserve!

Feature for feature, dollar for dollar, this kit outperforms the big name competitor! Electronic input circuitry handles moving magnet, moving coil, CD, hi-fi, NCR, cassette, tuner, & more. Soft touch controls, de-tump, toroidal transformers and much more! Step-by-step instructions make it easy to build (but it's after examination, you decide if it's beyond your abilities. Just return the kit in-lieu for a full refund.

- 100W RMS/channel into 8 ohms • Muft. -100dB below full output • Freq. response 6Hz-20KHz (-3dB) 20Hz - 65KHz (-1dB) • Unconditional stability into any load • Distortion | 0.01% (typ) 0.003% 20Hz-20KHz • Sensitivity: MM 2mV (80dB S/N) MC 200uV (75dB) Line 300mV (90dB) CD 2V (94dB)



Only at
DSE!

Featured
in October
Radio-Electronics

Return with us now to those thrilling days of yesteryear

DSE has an exclusive selection of genuine antique radio kits for builders & collectors. Assembled by David Whitby, Australia's leading vintage radio enthusiast, the kits feature authentic antique components and original circuitry. Tuning coils are hand-wound & the attention to detail impressive. Due to the restricted supply genuine components, production of kits is limited, so don't delay - order now!

- Underline 1 tube Col E-9001 \$99
- Spentwood coil varnished tuning
- Reinartz AB-Sound Col E-9000 \$99
- 4 coils from 500 kHz to 18 MHz
- Vacometer Super Crystal Col E-9002 \$79

Enjoy your Home Electronics in Total Comfort

Build this matchbox-sized IR transmitter and its matching receiver (capable of switching a 10 amp load) and you can control lights & appliances (even some heaters & air conditioners) at distances up to 40'. Line-of-sight is required, and electrical noise, strong light or RF signals may affect the sensitive high gain front-end of the receiver, but even under adverse conditions, the system will operate in an average size room.

- Receiver: Kit Col K-3428 \$32.00
- Transmitter: Kit Col K-3429 \$7.95



**Receiver
WITH CASE**
Includes screened front & rear panels, all parts & hardware & instructions

**Transmitter
WITH CASE**
Includes all parts & instructions

CIRCLE 95 ON FREE INFORMATION CARD

DSE's RDF rates outstanding technical reviews!

"After spending considerable time playing with the RDF, I have a lot of confidence in it. . . . If you are considering an FM DFing application, the Dick Smith RDF is certainly worth looking at. When you consider that similar commercial items may cost as much as \$500-\$800, it seems to be a good value at \$100."

Bruce Whitman WABVC, QST Aug 88

- 12V Operation
- 50-500 MHz range
- Internal alignment reference
- 170° calibration
- Stable digital circuitry
- Adjustable internal monitor speaker
- Self-aligning commutating filter



**Radio
Direction
Finder Kit** **\$99**
Col K-6345

See 73 for Radio Amateurs, July

2 Meter Operation?

Use four whip antennas (D-4205, \$15.50 each).

RDF at a Base Station?

Use 12V @ 1.2A power supply (M-95, \$13.95 each)

R-E Reader's Special

PC/XT compatible
10-key Keyboard

read keyboard (equivalent to Kaypro's) with separate cursor & numeric keys and LED indicators. Typewriter-style is easy to learn. It's ready to go - complete with schematic & instructions. One color. 20 1/2" x 8 1/2" W x 1 1/2" H.

NOT SURPLUS - It's FCC APPROVED but was so limited, so hurry! Offer valid from Dec 20 through December 31, 1986.

SAVE 40%
was \$99.95
\$59
Cat X-1124



Look at the savings this system offers!

XT Motherboard	X-1001	\$129.00
BIOS for Motherboard	X-1000	29.95
64K RAM	X-1187	14.95
Monochrome Graphics	X-1012	89.95
Floppy Disk Controller	X-1009	34.95
130W Power Supply	X-1110	69.95
IBM-style case	X-1120	39.95
1/2 Height Disk Drive	X-7506	99.95
Monochrome Monitor	X-1132	99.95
84-key Keyboard	X-1122	59.95

Individual Components Total: \$668.95

More IBM-compatible options:

● 512K RAM Card	X-1014	\$37.95
● Winchester Hard Disk Controller Card	X-1016	\$174.95

ONLY \$599



IBM PC/XT® Kit
Computer Compatible

130 Watt Switching Regulated POWER SUPPLY
IBM COMPATIBLE
was \$89 now \$69.95
Cat X-1110

Keyboard
key \$79.95
X-1122 \$59.95

compatible Case
was \$49.95 Cat X-1120 \$39.95

Check out our new low prices on computer gear!

Effective September 20, 1986

Description	Cat. No.	Was
● XT compatible Motherboard	X-1001	\$149 \$129
● Non-intruding BIOS	X-1000	\$39.95 \$29.95
● Multi-function Card Serial & parallel interfaces, clock/calendar	X-1005	\$119.95 \$89.95
● Color Graphics Adapter Card	X-1007	\$189.95 \$69.95
● Multi I/O Card Serial, parallel, clock, game, disk drive	X-1016	\$129.95 \$89.95
● Floppy Disk Controller	X-1009	\$44.95 \$34.95

COMPTERFACTS™

from SAMS™ Publishing

Easy to use, informative technical data at your fingertips. Each edition includes specific service information on that particular system as well as overall troubleshooting hints.

- Preliminary service checks
- Schematics
- Step-by-step troubleshooting guides
- Complete component parts lists
- Reference photos for quick component location
- Logic chart w. logic probe readings
- Much more!

Apple II/II Plus	Cat B-7518	\$16.95
Apple III	Cat B-7516	19.95
Apple IIc	Cat B-7517	39.95
IBM PC/XT	Cat B-8601	39.95
IBM PC 5150	Cat B-8602	39.95

NEW! Get Better GRAPHICS for your PC Compatible

This versatile card slots into an expansion slot to provide high quality text and full spectrum color graphics for IBM PC, PC/XT, PC/AT, and compatibles. You can switch between monochrome & enhanced color displays without removing the PC's cover. Look at these superb features: 256K video RAM ● Light pen interface ● RAM loadable character generator ● Full 16 color support for 640 x 350 graphics.

Enhanced Graphics \$259.95
Adaptor Card Cat X-1008

12" Monitor
Monochrome
● Apple compatible Cat X-1130
● IBM compatible Cat X-1132

ystick
Apple compatible \$19.95
Cat X-1135

ower Command
on/for Stand
... surge
... cable
... protection
... wh-
... button
... per-
... al control
\$39.95
Cat X-1128

witch Boxes
232 A/B X-3586 \$24.95
label A/B X-3585 \$29.95

OSCILLOSCOPES

5MHz Single-Trace Retrace blanking for clearer display. 10mV/division horizontal sensitivity. Internal or external sync. Usable response to 6.5 MHz. Solid state. \$169 Cat Q-1280
35 MHz Dual-Trace Fast sweep time & extra brightness for computer applications. delayed triggering sweep addressed at any point. \$529 Cat Q-1241
50 MHz Dual-Trace Similar to 35 model above but with greater bandwidth. 15V accelerating voltage, scale illumination & more. \$899 Cat Q-1243
15 MHz Dual-Trace Portable Rechargeable battery operation. 5.5" CRT. TV video sync lines. High-sensitivity X-Y mode, and more. \$499 Cat Q-1244

MULTIMETERS

3.5 DIGIT LCD: Super meter with 24 ranges for measuring volts, amps, impedance, current, capacitance, inductance, temperature, resistance. Volt mode test by continuity. Great value! \$99.95 Cat Q-1512
AUTO-RANGING LCD: 11 ranges, memory mode. 2 & digit display auto-range, low loss, 10 primary indicators, includes 100 loads, probes & clips. \$59.95 Cat Q-1515
MM/TRANS-CAP CHECKER: DCV 0.25-2.5, 10-50, 250, 1000, 10000; ACV 0.1-50, 250, 1000; RMS-AC 0.1-1000; 3.5mV, 25mA, 500mA, 10A AC; 0.01-99.99, 10 to 99.99; RES: 0.1, 10, 100, 1K, 10K, TRANS: 0.1-1000; 0.01-99.99; CAP: 0.001-99.99, 0.01-99.99. \$59.95 Cat Q-1140
RF & AF SIGNAL GENERATORS RF signal generator: 100kHz - 150MHz in 6 overlapping ranges. Cat Q-1312 \$99.95 AF signal generator: 20Hz - 200kHz. Cat Q-1310 EACH

ATTENTION BULK BUYERS!

Schools, Colleges, Manufacturers - Call 415-368-8844 for special quantity pricing!

DEALER INQUIRIES WELCOME!

99.95
K-6314

See Jan. 86 R-E

Get a Satellite Receiver
... fully to build with comprehensive instructions. Features: bandpass filter, greater selectivity & stability, 91 mod. ... included. Requires 18V AC power.

Australis 1

IC Protective Foam

This wonderful anti-static foam will protect those MOS chips! It comes in huge 12" x 12" sheets that can easily be cut into smaller sections for storing your IC's in parts drawers. Or use a whole sheet on your workbench to make chips more accessible. Excellent value!

\$6.95 16.50 10 & up
Cat H-5072

Rechargeable Solder Iron

This quality cordless tool has a built-in solder point lamp & protective cap. It recharges in 12-18 hours in its stand (AC adaptor included). It's a great Christmas gift!

ONLY \$21.95
Cat F-1700

NEW!

ONLY \$39.95
Cat T-4385



Get cordless convenience with forward & reverse removable handle (which also stores the 4 easy-to-change bits). Includes charger & mounting strap. Recharges in 12 hrs. 1/80 gear ratio, 150 max. s.p.m.

Rechargeable Screwdriver

NEWS FLASH!
The Dick Smith Funway Into Electronics books will now be available for sale right here in the U.S.A. by Howard Sams. Check your local electronics retailer for availability.

Visit our Retail Centers!

800-333-3333
415-368-8844

610000 CITY SAN JOSE HEAD OFFICE
1980 Stevens Canyon Blvd. #100, San Jose, CA 95128
1830 Woodward Blvd., #100, San Jose, CA 95128
200 Convention Way, #100, San Jose, CA 95128

NEW! See your computations on graphic display!

This fantastic new instrument has a 2 1/4" x 1 1/2" LCD panel which can display numerical equations & graphs at the touch of a key! Calculating time of many scientific & engineering functions is reduced by the fit 7000G's ability to show the characters of a wide range of mathematical functions. It can display the results of a single function, equation display changes in numerical values as fluctuations in the display show two or more equations simultaneously on a graph, or even several equations to formulate a combined graph. Overall (and local) minimum & maximum points, intersection and approach of different functions, and other features can be seen by a simple keyboard operation.

LCD resolution: 64 x 64 dots
3.3 x 6.6 x .03" ● 8.8 ounces

\$79.95
Cat Q-3055

CASIO fx 7000 G

DICK SMITH ELECTRONICS

EVERYTHING FOR THE ELECTRONICS ENTHUSIAST

Did you get your FREE CATALOG?
The new 1986/7 DICK SMITH ELECTRONICS catalog is 148 colorful pages packed with thousands of fantastic products, incredible values, and an exclusive 15 page data section. We ship our catalogs first class mail, so you'll get yours with no delay!

Send \$1 for postage & handling to: P.O. Box 1246, Redwood City, CA 94064

Name _____

Address _____

City _____ State _____ Zip _____

612E

Order Toll Free 1-800-332-5373
Call Monday - Friday 10a.m. - 6p.m. Pacific Time. In California call 415-368-1066

CIRCLE 95 ON FREE INFORMATION CARD

★ QUALITY PARTS ★ DISCOUNT PRICES ★ FAST SHIPPING!

SEND FOR FREE 1986 CATALOG... 48 PAGES!

ALL ELECTRONICS CORP.

SPECIAL PURCHASE

COMMODORE PRINTER/PLOTTER

Commodore Model # 1520
Four color X.Y. plotter. Standard VIC serial interface allows easy connection to Commodore 64 computers. Up to 80 characters per line (upper and lower case) in four sizes.

CAT # COM-1520 \$49.95 each
EXTRA pen sets \$1.50 per set.



2K 10 TURN
MULTI-TURN POT
SPECTROL
#MOD 534-7161
\$8.00 EACH

SOLID STATE BUZZER
Star # SSB-06L
6 vdc
TTL compatible
\$1.00 each
10 for \$10.00

EDGE CONNECTORS

ALL ARE 1.56" SPACING

- 22 EDGE CONNECTOR \$1.25 ea solder lug style 10 for \$11.00
- 22/44 EDGE CONNECTOR \$2.00 ea PC style 10 for \$18.00
- 22/44 EDGE CONNECTOR solder lug style \$3.50 each
- 36/96 EDGE CONNECTOR \$2.50 ea PC style
- 36/72 EDGE CONNECTOR PC style \$3.00 each
- 48/96 EDGE CONNECTOR PC style \$4.50 each

TRANSISTORS

- 2N706 4 for \$1.00
- 2N2222A 3 for \$1.00
- 2N2904 4 for \$1.00
- 2N2904 5 for \$1.00
- 2N2905 5 for \$1.00
- MJ2955 11.50
- MJ3055 11.00
- PMD 10K40 \$1.00
- TPP 121 75¢
- TPP 125 75¢

TRANSFORMERS

- 120 volt primaries
- 5.0 vdc @ 750 ma \$3.00
- 6.3 vdc @ 400 ma \$1.75
- 12 VCT @ 200 ma \$2.00
- 12 VCT @ 400 ma \$3.00
- 12 VCT @ 1 amp \$4.00
- 18 VCT @ 2 amp \$4.50
- 12 VCT @ 4 amp \$7.00
- 10 vdc @ 650 ma \$2.00
- 24 VCT @ 200 ma \$2.50
- 24 VCT @ 1 amp \$4.00
- 24 VCT @ 2 amp \$6.75
- 24 VCT @ 3 amp \$8.50
- 24 VCT @ 4 amp \$11.00

WALL TRANSFORMERS

- all plug directly into 120 vac outlet
- 4 VDC @ 70 ma \$2.00
- 6 VDC @ 500 ma \$3.50
- 8 VDC @ 750 ma \$4.50
- 9 VDC @ 500 ma \$5.00
- 12.6 VDC @ 285 ma \$3.00
- 18 VDC @ 180 ma \$3.50
- 24 VDC @ 285 ma \$3.00
- MULTI-VOLTAGE @ 500 ma 3.4V, 6.7V, 9 or 12 VDC \$7.50

MINI-BOX

Pomona #2104
Heavy-duty black phenolic project box with cover and screws 2 1/2" x 1 1/2" x 1 1/2"

FUSES

- 3AG (AGC) SIZE 1, 1 1/2, 2, 2 1/2, 3, 4, 5, 6 AMP
- 5 AMP SIZE 1, 2, 3, 4, 5 AMP
- 5 of any ONE amperage 75¢

SPECIALS

1 AMP 50 VOLT DIODES
INADU TAPE AND REEL
100 for \$4.50
1000 for \$30.00

SOLDER TAIL I.C. SOCKETS
28 Pin 10 for \$7.50
100 for \$72.00
1000 for \$200.00

SPECIAL PRICE TRANSISTOR
Plastic transistor
PN3569 TO 92 N.P.N.
100 for \$8.00
1000 for \$60.00
LARGE QUANTITIES AVAILABLE

48 KEY ASSEMBLY FOR COMPUTER OR HOBBYIST

NEW T.I. KEYBOARDS. Originally used on computers, these keyboards contain 48 S.P.S.T. mechanical switches. Terminates to 15 pin connector. Frame 4" x 9" \$3.80 each SPECIAL
CAT # KP-48 10 for \$30.00

TI SWITCHING POWER SUPPLY

Compact, well-regulated switching power supply designed to power Texas Instruments computer equipment.
INPUT 10-25 vdc @ 1 amp
OUTPUT 12 vdc @ 350 ma
5 vdc @ 1.2 amp
8 vdc @ 700 ma
SIZE 4 1/2" x 4 1/2" x 1 1/2" high
\$3.50 each

13.8 VDC REGULATED POWER SUPPLY

These are solid state, fully regulated 13.8 vdc power supplies. Both feature 100% solid state construction, fuse protection and L.E.D. power indicator. U.L. listed.
2 amp constant, 5 amp surge \$20.00 each
3 amp constant, 5 amp surge \$27.50 each

8 OHMS 15 WATTS

EXTRA SPECIAL VALUE
A.T.C. model 803015
8 OHMS 15 WATT
5.0 AMP 15.0 VOLT
7575648 15.0VOLT 4.0AMP
7575648 15.0VOLT 4.0AMP
7575648 15.0VOLT 4.0AMP
POWER RATING 15 WATTS
CIRCLE 107 ON FREE INFORMATION CARD

MICRO-CASSETTE MECHANISM

Micro-cassette tape transport for standard MC60 or MC45 micro-cassettes. 3 Vdc operation. Contains: drive motor, belt head, capstan, pinch wheel and other components. 3 1/2" X 2 1/4" X 5.5" CAT# MCMEC \$3.00 each 10 for \$27.50

COMPUTER GRADE CAPACITORS

- 2,000 mfd 200 Vdc 1 3/4" x 5" high \$2.00
- 6,400 mfd, 60 Vdc 1 3/8" x 3 3/4" high \$2.50
- 9,700 mfd 50 Vdc 1 3/8" x 4 1/2" high \$3.00
- 31,000 mfd, 18 Vdc 1 3/4" x 4" high \$2.50
- 50,000 mfd, 40 Vdc 3" x 5 3/4" high \$4.50
- 60,000 mfd, 40 Vdc 3" x 5" high \$3.50
- 66,000 mfd, 18 Vdc 3" x 3" high \$3.00
- 90,000 mfd, 30 Vdc 3" x 5 1/4" high \$3.50

50.00 SPECIALS

- 5,900 mfd, 30 Vdc 1 3/4" x 3 1/2" high \$1.00
- 8,900 mfd, 30 Vdc 1 3/8" x 2 1/4" high \$1.00
- 6,300 mfd, 50 Vdc 2" x 5 1/2" high \$1.00
- 18,000 mfd, 10 Vdc 1 3/8" x 2 3/4" high \$1.00
- 48,000 mfd, 10 Vdc 2 1/2" x 3 1/4" high \$1.00
- 100,000 mfd, 10 Vdc 2 1/2" x 6" high \$1.00
- 185,000 mfd, 4 Vdc 2 1/2" x 4 1/2" high \$1.00

RELAYS

10 AMP SOLID STATE
CONTROL 3-32 vdc
LOAD 140 vac 10 amp
SIZE: 2 1/4" x 4" x 9"

ULTRA-MINIATURE 5 VDC RELAY

Fujitsu # FB271HE0005M20
High sensitivity
COIL: 120 ohms
CONTACTS: 1 amp
Mounts on 14 pin DIP socket
\$1.25 each 10 for \$10.00

MINIATURE 6 VDC RELAY

Aromat #RSD 6V
Super Small S.P.D.T. relay
GOLD contact contacts failed
1 amp @ 30 vdc. Highly sensitive
TTL direct drive possible 120 ohm coil.
Operate from +3-6 vdc
COIL: 120 ohms \$1.50 each
10 for \$13.50

13 VDC RELAY

CONTACTS: S.P.N.C.
10 amp @ 120 vdc
Energy coil to open contact
COIL: 13 vdc 550 ohms
SPECIAL PRICE \$1.00 each

4PDT RELAY

14 pin KH style
3 amp contacts
USED but fully tested \$1.70 each
Specify coil voltage desired
Either 24 vdc or 120 vdc
LARGE QUANTITIES AVAILABLE
SOCKETS FOR 8H RELAY 75¢ each

RECHARGEABLE NI-CAD BATTERIES

- AAA SIZE 1.25V 500MAH \$1.85
- AA SIZE 1.25V 500MAH \$1.85
- AA high solder tab \$2.00
- C SIZE 1.2V 1200MAH \$3.50
- SUB-C SIZE solder tab \$3.50
- D SIZE 1.2V 1200MAH \$3.50

UNIVERSAL CHARGER

Will charge 4 AA, C, D or AAA ni-cads or one 9 volt ni-cad at one time
\$11.00 per charger

POLARITY SWITCH

CAT # POPS
Designed to control an external coaxial relay on a satellite TV system. IDEAL FOR THE EXPERIMENTER AS PARTS. Heavy chassis box containing a 5 Vdc relay, CA 358 op amp and other parts.
\$1.75 each
10 for \$16.00

PHOTO-FLASH CAPACITORS

- 170 ml 330v 75¢ ea.
- CAT# PPC-170
- 400 ml 330v
- CAT# PPC-400 1.00 ea.
- 800 ml 330v
- CAT# PPC-800 1.35 ea.

WALL TRANSFORMER

11.5 Vdc 1.95 Amp.
INPUT 120 Vac
SIZE 3 3/4" X 2 7/8" X 2 5/8"
CAT # DCTX-11818 \$6.50 each

3 1/2" SPEAKER

8 ohm impedance
Full range
Speaker or magnet
4 diagonal mounting centers.
\$2.50 each 10 for \$20.00

TELEPHONE COUPLING TRANSFORMER

Starco # TTC-P or Trax # TY-304 P
600 ohms Z
to 600 ohms C
P.C. board mount
3/4" x 5/8" x 3/4"
CAT # TCR \$1.21

SPRING LEVER TERMINALS

Two color terminals on a sturdy 2 1/2" x 3 1/2" bakelite plate.
Great for speakers or enclosures or power supplies.
75¢ EACH 10 for \$6.00

XENON FLASH TUBE

3/4" long X 1/8" dia. Flash tube designed for use in compact camera flash units ideal for experimenters.
CAT# FLT-7 2 for \$1.00

MINIATURE TOGGLE SWITCHES

- ALL ARE RATED 5 AMPS @ 125 VAC
- S.P.D.T. (on-on) PC style non-threaded bushing 75¢ each 10 for \$7.00
 - S.P.D.T. (on-on) Solder lug terminals \$1.00 each 10 for \$9.00 100 for \$80.00
 - S.P.D.T. (on-off-on) Solder lug terminals \$1.00 each 10 for \$9.00 100 for \$80.00
 - S.P.D.T. (on-off-on) PC style non-threaded bushing 75¢ each 10 for \$7.00
 - S.P.D.T. (on-on) PC lugs threaded bushing \$1.00 each 10 for \$9.00 100 for \$80.00
 - D.P.D.T. (on-on) Solder lug terminals \$2.00 each 10 for \$19.00 100 for \$180.00

STANDARD JUMBO DIFFUSED T-1 3/4

- RED 10 for \$1.50 100 for \$13.00
- GREEN 10 for \$2.00 100 for \$17.00
- YELLOW 10 for \$2.00 100 for \$17.00

D.P.S.T. LIGHTED ROCKER SWITCH

115 vdc lighted rocker snap mounts in 1/2" x 1 1/4" hole
Orange lens 16 amp contact
\$15.00

FLASHER LED

3 volt operation
red jumbo T 1 1/4 size \$1.00 each
NEW GREEN FLASHER CAT # LED-4G \$1.00

MINI-PUSH BUTTON

5 P.S.T. momentary normally open 1/4" bushing Red button
35¢ each 10 for \$3.00

BI-POLAR LED HOLDERS

Two piece holder for jumbo LED
10 for \$5¢ 100 for \$5.00

SNAP ACTION SWITCH

Cherry elect # E 21 N.O. or N.C. 0.1A contacts. Suitable for alarm and other low energy circuits.
1 1/2" lever
43¢ EACH 10 FOR \$4.30

CLEAR CLIPUTE LED HOLDER

Make LED a fancy indicator Clear
4 for \$1.00

220 Vac COOLING FAN

ROTRON # MK77A3
Muffin XL
220 Vac
4 1/8" square metal frame fan
CAT# CF-220 \$8.50 ea 10 for \$60.00 100 for \$500.00
QUANTITIES AVAILABLE

ALL ELECTRONICS CORP.
180 ANGELES, CA STORE
905 S. Vermont Ave
213 380 8000
VAN NUYS, CA STORE
6228 Sepulveda Blvd
818 997-1806

MAIL ORDERS TO:
P.O. BOX 20406
Los Angeles, CA 90006
TWX - 5101010163 ALL ELECTRONIC
EASVINK MBR - A288748

TOLL FREE ORDERS ONLY
1-800-828-5432
(ORDER ONLY)
(IN CALIFORNIA: 1-800-258-6566)
ALASKA, HAWAII, OR INFORMATION
(213) 380-8000 N.O.C.O.D.

QUANTITIES LIMITED
MINIMUM ORDER \$10.00
USA \$3.00 SHIPPING
FOREIGN ORDERS INCLUDING SUFFICIENT SHIPPING
CALIF RES. ADD 6 1/2%

MARK V ELECTRONICS INC.,
248 EAST MAIN STREET, SUITE 100,
ALHAMBRA, CA 91801.
TELEX 3716914 MARK 6

INFORMATION: 1-818-282-1196
MAIL ORDERS: P.O. BOX 6510
ALHAMBRA CA 91802.

1-800-423-3483
TOLL FREE FOR ORDERS MADE
BY MASTER OR VISA CARD
IN CAL.: 1-800-521-MARK

CALL OR WRITE FOR A FREE CATALOG — OVER 60 HOT & WELL-QUALIFIED ITEMS FOR YOUR SELECTION!

MULTIPURPOSE MELODY GENERATOR

SPECIFICATIONS:

Output Power: 500mw
Output Impedance: 4-8Ω
Power Supply: DC 1.5-5V 100mA
It can also be used as a doorbell, musical box and electronic alarm.



TA-50A CIC-481E

- Jingle Bell
- Silent night
- Rudolph, the red-nosed reindeer
- O come, All ye faithful

- Santa Claus is coming to town
- Joy to the world
- I wish you a merry X'mas
- Mark, the herald Angels sing

TA-50B CIC-482E

- London Bridge is falling Down
- Are you Sleeping
- Toy Symphony
- Wagonwheel

- Row your Boats
- Happy Birthday
- Home sweet home
- Melody on purple bamboo

CORDLESS SOLDERING IRON RECHARGEABLE

No. 620

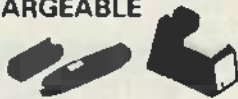

The most perfect handy, lightweight soldering iron for work shop, home, hobby & outdoor work. Includes US approval charger & cleaning sponge. With built in solder stand illumination.

Each set \$22.80

TALKING CLOCK



1. Turn on/off button for 10000 announcements of time
2. Read out twelve hours digital display for hour, minute, second (the complete AM & PM)
3. Display shows display modes of time, alarm time & date
4. Alarm on off switch with busy, no sound sleep alarm
5. Synthetic reminder voice alarm of thirty seconds after 4 minutes of 1-10 voice alarm
6. Volume tone level of voice output
7. Languages available English, Mandarin

PARROT 8801 \$17.75 NOT IN STOCK
MYNAR 8802 \$18.90

100W DYNAMIC CLASS "A" MAIN POWER AMPLIFIER

TA-1000A



NOW PAY LESS!

This powerful dynamic class "A" circuit makes this unit unique in its class. Crystal clear, 100W R.M.S. POWER output will satisfy the most picky Hi-Fi fans. This is a single channel amplifier. If you need a stereo effect you can buy two to make a total of 200W DYNAMIC POWER! Over 3000 KITS ARE SOLD IN THE STATE!

Kit \$45.50

Model No	Description	Kit/Assembled	Unit Price
TA-001	1W Mini Amplifier	Ki	\$3.80
TA-005	8W Mini Amplifier	Ki	\$4.92
TA-007	17W Stereo Power Booster	Ri	\$8.00
TA-008	AC/DC SHOULDER AMPLIFIER	Ass	\$48.00
TA-10	STEREO PRE-AMPLIFIER WITH MAGNETIC MIC AMP	Ki	\$6.00
TA-30 A, B	MULTIPURPOSE MELODY GENERATOR	Ri	\$10.78
TA-120	PURE CLASS "A" MAIN POWER AMPLIFIER	Ki	\$25.00
TA-207	20W AC/DC STEREO AMPLIFIER	Ass	\$60.00
TA-300	30W Music Purpose Single Channel Amp	Ki	\$11.07
TA-302	50W Stereo Power Booster	Ki	\$50.00
TA-222A	High Quality 30W+30W Stereo Amplifier	Ki	\$24.60
TA-222	60W IC Stereo Pre Amplifier & Power Amplifier	Ki	\$29.50
TA-400	400W TRANSISTORIZED MONO AMPLIFIER	Ri	\$17.84
TA-177	120W MOSFET POWER AMPLIFIER	Ki	\$55.00
TA-800	100W DC LOW TIM PRE-AMPLIFIER & POWER AMP	Ki	\$49.95
TA-802	160W PURE DC ST POWER AMP W/SPK. PROTECTOR	Ki	\$29.95
TA-820A	170W OCL DC PRE MAIN & STEREO AMPLIFIER	Ki	\$43.00
TA-1000A	100W DYNAMIC CLASS "A" MAIN POWER AMP (MONO)	Ki	\$45.50
TA-1300	200W NEW CLASS "A" DC STEREO PRE MAIN AMP	Ki	\$67.00
TA-2400A	ELECTRONIC ECHO AND REVERBERATION AMP	Ass	\$59.35
TA-2500	HIGH QUALITY MULTIPURPOSE PRE AMPLIFIER	Ass	\$62.00
TA-2200	DC FET STEREO CLASS "A" PRE AMPLIFIER	Ki	\$38.00
TA-2800	NF-CR BI-FET PRE AMP WITH 3WAY TONE CONTROL	Ki	\$36.80
TA-3000	STEREO SIMULATOR	Ass	\$30.00
SM-43	3 1/2 MULTIFUNCTIONAL LED D.P.M.	Ass	\$75.00
SM-48	4 1/2 MULTIFUNCTIONAL D.P.M.	Ass	\$75.00
SM-100	150MC UNIVERSAL DIGITAL FREQUENCY COUNTER	Ass	\$99.00
TY-43	3 1/2 DIGITAL PANEL METER	Ki	\$26.00

TERMS: Minimum order: \$10.00. Charge card order \$20.00. No C.O.D.! Check & Money order, phone order accept. CA. residents must include 6.5% sales tax. Prices are subject to change without notice. All merchandise subject to prior sale. Shipping & handling: Inside L.A. 5% of total order (Min. \$1.50). Outside L.A. 10% of total order (Min. \$2.50). Outside U.S.A. 20% of total order (Min. \$5.00). Shipped by UPS ground. HOURS: Mon-Fri 9:30 to 5:00, Sat 9:30 to 1:00 (PACIFIC TIME)
NATION-WIDE DISTRIBUTORS WANTED FOR OUR PRODUCTS, QUANTITY DISCOUNTS AVAILABLE!

60W VERSATILE STEREO POWER BOOSTER

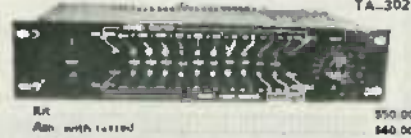

Kit \$50.00
Ass with tested \$40.00

80W + 80W DC LOW TIM PRE-MAIN AMPLIFIER

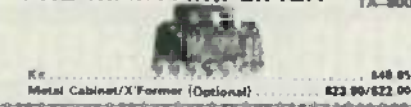

Kit \$48.95
Metal Cabinet/X-Former (Optional) \$23.90/\$22.00

150MC Universal Digital Frequency Counter SM-100



Frequency Range: 10Hz - 150MHz
Event Counter: 0 to 99999999 counts, 10 Digit
Input sensitivity: 10Hz range 10Hz - 10MHz 50mVrms, 100Hz range 10Hz - 150MHz 40mVrms
Response time: 0.2 second
Hold Function: Holds the last input signal
Power Supply: DC9V Battery or DC9V 750MA Adaptor
Dimension: 9 1/2" x 8 1/2" x 2 1/4"
Assembled with tested \$99.00

NF-CR BI-FET IC PRE-AMPLIFIER WITH 3 WAY TONE CONTROL



Kit \$36.80

STEREO SIMULATOR



TA-3000
KIT ONLY \$25.00
You can own a stereo TV from today! This simulator is a special design of using the most advanced monophonic L.S.L. It produced a superior analog stereo effect across the L.S.L. It is equal to one of LOW NOISE FET & TRANSISTOR. The simulator can even help you to promote your television from a normal one to a special one with a HI-FI STEREO function. Our simulator is also applicable to any other "mono source" in covering it to ANALOG STEREO. Undoubtedly, it is the most advanced equipment to every family while it should contribute to your listening pleasure.
Ass. with tested \$30.00

COLOR LIGHT CONTROLLER



Best for Party!
As a result of the advanced technology, this unit can control various colorful light bulbs, the visual effect of which is most suitable in glass bar party, disco, electronic game center and also in lightings for advertisement. Total output power is 3000W (1000W Ch) which means that it can control 30 pieces of 100W or 600 pieces of 50W color light which is enough for most usages.
Kit \$65.80
Ass with tested \$75.00

TA-2400A ELECTRONIC ECHO AND REVERBERATION AMPLIFIER

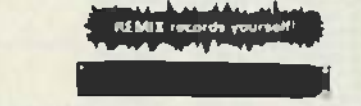

REMIK records yourself!
This unit combines the most advanced B.B.D. technique with high quality Japan made components. It has the following FEATURES:
It can generate various reflection and reverb effects. It has 3 special effect controls which include reverb control, delay control and depth control. Special effect can be made in your record tapes by using this model. All kinds of weird sound effect can be obtained by skillful use of the control. It has LED display to show reflection and reverbation.
Ass. with tested \$99.85

HIGH QUALITY MULTIPURPOSE PRE-AMPLIFIER

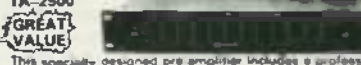

TA-2500
GREAT VALUE
This specially designed pre amplifier includes a professional GRAPHIC EQUALIZER TONE control system and has a gain of 212dB. Frequency response extends from 20Hz to 20KHz, so as to ensure best performance in whatever adverse condition. It can accept input from various magnetic cartridge record deck, CD player and tuner; its output can be connected to all kinds of power amplifier.
Assembled with tested \$82.00

120W MOSFET POWER AMPLIFIER



TA-477
This amplifier consists of three super low TIM differential stages, and Hitachi 2SJ4822K 124 match pair "MOSFET" as output components whose frequency response and transient response is superior to the other power transistor. Therefore this amplifier has high-fidelity and superior analytic power over the entire Audio Spectrum. It is suitable for reproducing classic and modern music. Heavy Duty Heat Sink with 20 radial fins is included!
Kit \$66.00
Metal Cabinet/X-Former (Optional) \$23.90/\$19.80

Model No	Description	Kit/Assembled	Unit Price
TR-355 A, B	3.5A REGULATED DC POWER SUPPLY	Ki	\$10.88
TR-503	0-50V 3A POWER SUPPLY WITH SHORT CIRCUIT BREAK & OVERLOAD PROTECTOR	Ki	\$12.30
TR-100	0-15V 7A REGULATED DC POWER SUPPLY	Ki	\$69.80
TY-1A M&A	BATTERY FLUORESCENT LIGHT	Ki	\$3.99
TY-7	ELECTRONIC TOUCH SWITCH	Ki	\$5.50
TY-11A	MULTIFUNCTIONAL CONTACT RELAY	Ki	\$3.99
TY-12A	DIGITAL CLOCK WITH TWO TIMER	Ki	\$13.88
TY-13	COLOR LED VU METER	Ki	\$17.50
TY-14	ELECTRONIC SHOCK	Ki	\$3.00
TY-18	HIGH PRECISION BOUND CONTROL SWITCH	Ki	\$7.68
TY-20	SUPER SENSITIVE AUDIO LEVEL INDICATOR	Ki	\$19.50
TY-73B	COLOR LIGHT CONTROLLER	Ki	\$65.00
TY-25	SPEAKER PROTECTOR	Ass	\$75.00
TY-26	FM WIRELESS MICROPHONE	Ri	\$7.68
TY-28	AC/DC QUARTZ DIGITAL CLOCK	Ki	\$18.92
TY-38	SOUND OR TOUCH CONTROL SWITCH	Ki	\$10.00
TY-41 M&H	INFRARED REMOTE CONTROL UNIT	Ki	\$25.00
TY-42	BARODOT LEVEL METER	Ki	\$21.00
TY-45	BARODOT AUDIO LEVEL DISPLAY	Ki	\$34.95
TY-47	SUPERIOR ELECTRONIC ROULETTE	Ki	\$18.92
YAMATO 4001	3 1/2 DIGITAL MULTIMETER	Ass	\$23.80
T2	LED THERMOMETER CLOCK VIEW & OUT DOOR SENSOR	Ass	\$20.00
T2	LED THERMOMETER CLOCK VIEW & C MEASURING	Ass	\$18.00
8504	TALKING CLOCK MYNAR (GOLDEN OR BLACK)	Ass	\$25.00
NO 620	CORDLESS SOLDERING IRON RECHARGEABLE	Ass	\$22.80

Ass=Assembled form, if a fully checked and tested
TERMS: Minimum order: \$10.00. Charge card order \$20.00. No C.O.D.! Check & Money order, phone order accept. CA. residents must include 6.5% sales tax. Prices are subject to change without notice. All merchandise subject to prior sale. Shipping & handling: Inside L.A. 5% of total order (Min. \$1.50). Outside L.A. 10% of total order (Min. \$2.50). Outside U.S.A. 20% of total order (Min. \$5.00). Shipped by UPS ground. HOURS: Mon-Fri 9:30 to 5:00, Sat 9:30 to 1:00 (PACIFIC TIME)
NATION-WIDE DISTRIBUTORS WANTED FOR OUR PRODUCTS, QUANTITY DISCOUNTS AVAILABLE!

CIRCLE 93 ON FREE INFORMATION CARD

DECEMBER 1986

20MB HARD DISK SYSTEM ONLY \$389.95!

STATIC RAMS			
2101	256x4	(450ns)	1.95
9101	256x4	(450ns)(CMOS)	3.95
2102L-4	1024x1	(450ns)(LP)	.99
2112	256x4	(450ns)	2.99
2114	1024x4	(450ns)	.99
2114L-4	1024x4	(450ns)(LP)	1.09
2114L-2	1024x4	(200ns)(LP)	1.49
2114L-15	1024x4	(150ns)(LP)	1.95
TMS4044-4	4096x1	(150ns)	1.95
TMM2018-150	2048x8	(150ns)	1.49
TMM2018-100	2048x8	(100ns)	1.99
HME118-4	2048x8	(200ns)(CMOS)	1.89
HME118-4	2048x8	(150ns)(CMOS)	1.95
HME118LP-4	2048x8	(200ns)(CMOS)(LP)	1.89
HME118LP-4	2048x8	(150ns)(CMOS)(LP)	2.05
HME118LP-2	2048x8	(120ns)(CMOS)(LP)	2.95
HME264P-15	8192x1	(150ns)(CMOS)	3.89
HME264LP-15	8192x1	(150ns)(CMOS)(LP)	3.95
HME264LP-12	8192x1	(120ns)(CMOS)(LP)	4.49

LP: Low power

DYNAMIC RAMS			
4116-250	16384x1	(250ns)	.49
4116-200	16384x1	(200ns)	.89
4118-150	16384x1	(150ns)	.99
4118-120	16384x1	(120ns)	1.49
MM6322	32768x1	(200ns)	0.95
4164-200	65536x1	(200ns)(Hsv)	1.19
4164-150	65536x1	(150ns)(Hsv)	1.29
4164-120	65536x1	(120ns)(Hsv)	1.95
MC66465	65536x1	(200ns)(Hsv)	1.95
TMS4164	65536x1	(150ns)(Hsv)	1.95
4164 REFRESH	65536x1	(150ns)(Hsv)(REFRESH)	2.95
TMS4416	16384x4	(150ns)(Hsv)	4.95
41128-150	131072x1	(150ns)(Hsv)	5.95
TMS4464-15	65536x4	(150ns)(Hsv)	6.95
4254-200	262144x1	(200ns)(Hsv)	3.89
4254-150	262144x1	(150ns)(Hsv)	2.95

Be Single 5 Volt Supply
Hsv: Refresh, Pin 1 refresh

★★★★ HIGH-TECH ★★★★★
NEC V20 UPD70108 \$11.95
 REPLACES 8088 TO SPEED UP IBM PC 10-40%
 • HIGH-SPEED ADDRESS CALCULATION IN HARDWARE
 • PIN COMPATIBLE WITH 8088
 • SUPERSET OF 8088 INSTRUCTION SET
 • LOW POWER CMOS
8MHZ V20 UPD70108-8 \$13.95
8MHZ V30 UPD70118-8 \$19.95
 ★★★★★ SPOTLIGHT ★★★★★

EPROMS			
2706	1024x8	(450ns)	4.95
2716	2048x8	(450ns)(SV)	3.49
2718	2048x8	(250ns)(SV)	3.95
TMS2732	4096x8	(450ns)(SV)	5.95
2732	4096x8	(450ns)(Hsv)	3.95
2732A	4096x8	(250ns)(SV)(21V PGM)	3.95
2732A-2	4096x8	(200ns)(SV)(21V PGM)	4.25
27C64	8192x8	(250ns)(SV)(CMOS)	5.95
2764	8192x8	(450ns)(SV)	3.49
2764-250	8192x8	(250ns)(SV)	3.95
2764-200	8192x8	(200ns)(SV)	4.25
MCM68766	8192x8	(350ns)(SV)(24 PIN)	12.95
27128	16384x8	(250ns)(Hsv)	4.25
27C256	32768x8	(250ns)(SV)(CMOS)	10.99
27256	32768x8	(250ns)(Hsv)	7.49

21V Single 5 Volt Supply
21V PGM: Program at 21 Volts

ORDER TOLL FREE 800-538-5000

SPECTRONICS CORPORATION EPROM ERASERS

Model	Terror	Capacity Chip	Intensity (uW/cm²)	Unit Price
PE-14	NO	8	8,000	\$82.00
PE-14T	YES	8	8,000	\$119.00
PE-24T	YES	12	9,800	\$175.00

8000	
8035	1.49
8039	1.95
8080	2.99
8085	2.49
8087.2	169.95
8087	129.00
8088	6.95
8088-2	9.95
8155	2.49
8156-2	3.95
8740	7.95
8751	14.95
80286	129.95
80287	199.95

6500 1.0 MHz	
6502	2.89
6502CMOS	12.95
6507	9.95
6508	4.95
6522	4.95
6526	26.95
6532	6.95
6545	8.95
6551	5.95
6561	13.95
6581	34.95

CRT CONTROLLERS	
6845	4.95
6846	8.95
6847	11.95
WD465055P	6.95
MC1372	2.95
8275	26.95
7230	19.95
CRT5027	12.95
CRT5037	9.95
TMS9918A	15.95

CRYSTALS	
32.768 KHz	.95
1.0 MHz	2.95
1.8432	2.95
2.0	1.85
2.097152	1.95
2.4576	1.95
3.2768	1.95
3.679545	1.95
4.0	4.95
4.032	1.95
5.0	1.95
5.0688	1.95
6.0	1.95
8.144	1.95
8.5536	1.95
10.0	1.95
10.718635	1.95
12.0	1.95
14.31418	1.95
15.0	1.95
16.0	1.95
17.430	1.95
18.0	1.95
18.432	1.95
19.95	2.00
22.1184	1.95
22.0	1.95
32.0	1.95

74LS00	
74LS00	.16
74LS01	.18
74LS02	.17
74LS03	.18
74LS04	.18
74LS05	.18
74LS08	.18
74LS09	.18
74LS10	.16
74LS11	.22
74LS12	.22
74LS13	.26
74LS14	.26
74LS15	.26
74LS20	.17
74LS21	.22
74LS22	.22
74LS27	.27
74LS28	.26
74LS30	.17
74LS32	.18
74LS33	.28
74LS37	.26
74LS38	.26
74LS42	.35
74LS47	.79
74LS48	.95
74LS51	.17
74LS53	.28
74LS74	.24
74LS75	.28
74LS76	.28
74LS83	.48
74LS85	.49
74LS86	.22
74LS90	.39
74LS92	.49
74LS93	.39
74LS95	.45
74LS107	.34
74LS109	.36
74LS112	.78
74LS112	.45
74LS123	.48
74LS124	2.75
74LS125	.39
74LS126	.39
74LS132	.39
74LS134	.39
74LS138	.39
74LS139	.39
74LS145	.99
74LS147	.99
74LS148	.99
74LS151	.39
74LS153	.38
74LS154	1.48
74LS155	.89
74LS156	.45
74LS157	.35
74LS158	.39
74LS180	.28
74LS161	.39
74LS162	.49
74LS163	.39
74LS184	.45

HIGH SPEED CMOS
 A new family of high speed CMOS logic featuring the speed of low power Schottky, (8ns typical gate propagation delay), combined with the advantages of CMOS: very low power consumption, superior noise immunity, and improved output drive.

74HC00
 74HC Operate at CMOS logic levels and are ideal for conv. all CMOS designs.

74HC00	.59	74HC148	1.19
74HC02	.89	74HC181	.89
74HC04	.59	74HC154	2.49
74HC08	.59	74HC187	.49
74HC10	.59	74HC188	.95
74HC14	.79	74HC153	1.18
74HC20	.59	74HC176	.99
74HC27	.59	74HC240	1.59
74HC30	.59	74HC244	1.89
74HC32	.69	74HC245	1.99
74HC51	.59	74HC257	1.89
74HC74	.78	74HC259	1.39
74HC95	1.35	74HC273	1.89
74HC96	.69	74HC299	4.99
74HC93	1.19	74HC368	.99
74HC107	.79	74HC373	2.29
74HC109	.79	74HC374	2.29
74HC112	.78	74HC389	1.39
74HC125	1.19	74HC393	1.39
74HC132	1.19	74HC4017	1.99
74HC133	.69	74HC4020	1.39
74HC138	.89	74HC4049	.99
74HC139	.99	74HC4050	.89

8200	
8203	24.95
8205	3.49
8212	1.29
8216	1.49
8224	2.25
8237	4.95
8237-5	5.49
8260	9.95
8251	1.89
8251A	1.89
8253	1.49
8253-5	1.89
8255	1.89
8259	1.95
8259-6	2.79
8272	4.95
8279	2.49
8279-5	2.95
8281	1.95
8284	2.95
8284	3.95
8284	4.95

2.0 MHz	
6502A	2.95
6520A	2.95
6822A	5.95
6532A	11.95
6945A	7.95
6551A	8.95

3.0 MHz	
6502B	6.95

8800 1.0 MHz	
6800	1.95
6802	4.95
6803	9.95
6809	9.95
6809E	8.95
6810	1.95
6820	2.95
6821	1.95
6840	6.95
6843	18.95
6844	12.95
6845	6.95
6847	11.95
6850	1.95
6883	22.95

DISK CONTROLLERS	
1771	4.95
1791	3.95
1793	9.95
1795	12.95
1797	12.95
1855	18.95
2793	19.95
2797	29.95
6843	18.95
8272	4.95
UPD7665	4.95
M88476	12.95
M8877	12.95
1691	6.95
2143	8.95

BIT RATE GENERATORS	
MC14411	9.95
BR1941	4.95
4202	9.95
CM80116	8.95
MMS5007	4.95

UARTS	
AY1-1013	3.95
AY1-1015	4.95
TR1602	3.95
2651	4.95
IM6402	6.95
IM6403	9.95
INS8250	6.95

CRYSTAL OSCILLATORS	
1.0MHz	5.95
1.8432	5.95
2.0	5.95
2.4576	8.95
2.8	4.95
4.0	4.95
5.0688	4.95
6.0	4.95
8.144	4.95
8.0	4.95
10.0	4.95
12.0	4.95
12.480	4.95
15.0	4.95
16.0	4.95
18.432	4.95
20.0	4.95
28.0	4.95

MISC.	
TMS99531	9.95
TMS99532	19.95
ULN2003	.79
3242	7.95
3341	4.95
MC3470	1.95
MC3480	8.95
MC3497	2.95
11C90	19.95
7613-001 LP	6.95
AYS-2376	11.95
AYS-3600 PRG	11.95

74HC00	
74HC00	.59
74HC02	.89
74HC04	.59
74HC08	.59
74HC10	.59
74HC14	.79
74HC20	.59
74HC27	.59
74HC30	.59
74HC32	.69
74HC51	.59
74HC74	.78
74HC95	1.35
74HC96	.69
74HC93	1.19
74HC107	.79
74HC109	.79
74HC112	.78
74HC125	1.19
74HC132	1.19
74HC133	.69
74HC138	.89
74HC139	.99
74HC192	3.95
74LS323	2.49
74LS384	1.95
74LS389	.29
74LS387	.38
74LS368	.39
74LS374	.78
74LS374	.78
74LS375	.95
74LS377	.79
74LS378	1.18
74LS390	1.19
74LS393	.79
74LS94	1.49
74LS624	1.95
74LS640	.99
74LS645	.99
74LS669	1.29
74LS670	.83
74LS682	3.20
74LS683	3.20
74LS684	3.20
74LS688	2.40
74LS783	32.95
81LS95	1.49
81LS96	1.49
81LS97	1.49
81LS98	1.49
74F08	.79
74F09	.89
74F10	.89
74F11	.89
74F12	.89
74F13	.89
74F14	.89
74F15	.89
74F16	.89
74F17	.89
74F18	.89

74HC00	
74HC00	.59
74HC02	.89
74HC04	.5

20MB HARD DISK SYSTEM ONLY \$389⁹⁵!

CMOS

4001	.18	14413	4.95
4011	.18	14433	14.95
4012	.28	4503	.48
4013	.35	4511	.85
4019	.28	4518	.78
4018	.28	4518	.85
4017	.48	4522	.78
4018	.85	4526	.78
4020	.58	4527	1.95
4021	.88	4528	.78
4024	.48	4528	2.95
4025	.28	4532	1.95
4027	.98	4538	.88
4026	.88	4541	1.28
4035	.88	4553	0.78
4040	.88	4555	.78
4041	.75	4702	12.95
4042	.88	74C00	.28
4043	.88	74C14	.88
4044	.88	74C74	.38
4045	1.88	74C63	1.88
4046	.88	74C85	1.48
4047	.88	74C95	.88
4048	.28	74C180	8.78
4050	.28	74C151	2.28
4051	.88	74C181	.95
4052	.88	74C183	.88
4053	.88	74C184	.88
4054	2.18	74C192	1.48
4060	.88	74C193	1.48
4066	.78	74C221	2.48
4069	.15	74C240	1.68
4078	.58	74C244	1.88
4077	.28	74C374	1.98
4081	.88	74C905	10.95
4085	.78	74C911	8.95
4086	.88	74C917	12.95
4093	.48	74C922	4.48
4094	2.48	74C923	4.95
14411	5.95	74C926	7.88
14412	8.98	80C97	.95

7400/9000

7400	.18	74147	2.48
7402	.18	74148	1.28
7404	.18	74150	1.35
7406	.28	74151	.88
7407	.28	74153	.88
7408	.24	74154	1.88
7410	.18	74155	.78
7411	.28	74157	.55
7414	.48	74158	1.88
7416	.25	74181	.88
7417	.25	74183	.88
7420	.18	74184	.88
7423	.28	74185	.88
7430	.15	74186	1.00
7432	.28	74175	.85
7438	.28	74177	.78
7442	.48	74178	1.15
7445	.88	74181	2.25
7447	.88	74182	.78
7470	.38	74184	2.88
7473	.38	74181	1.18
7474	.38	74192	.78
7475	.45	74194	.85
7478	.35	74196	.78
7483	.58	74197	.78
7488	.58	74199	1.35
7489	.58	74221	2.88
7489	2.18	74248	1.25
7490	.38	74247	1.25
7492	.60	74248	1.88
7493	.38	74249	1.95
7495	.58	74251	.75
7497	2.75	74265	1.35
74100	2.28	74273	1.95
74121	.28	74278	3.11
74123	.48	74367	.65
74125	.45	74368	.65
74141	.68	9348	3.95
74143	8.95	9802	1.58
74144	2.95	9837	2.95
74145	.80	98502	1.95

74500

74500	.28	745163	1.28
74502	.28	745168	3.95
74503	.28	745174	.78
74504	.28	745175	.78
74505	.28	745188	1.95
74506	.38	745189	1.95
74510	.28	745195	1.48
74518	.48	745196	2.48
74520	.28	745157	2.85
74532	.35	745226	3.98
74537	.88	745240	1.48
74538	.88	745241	1.48
74574	.48	745264	1.85
74586	.35	745267	.78
74588	.35	745253	.78
745112	.50	745268	.95
745124	2.75	745280	1.95
745138	.78	745287	1.68
745140	.88	745288	1.68
745181	.78	745293	2.88
745193	.78	745373	1.85
745187	.78	745374	1.85
745188	.88	745471	4.95
745181	1.28	745571	2.95

VOLTAGE REGULATORS

TO-220 CASE

7805T	.48	7905T	.88
7808T	.48	7908T	.88
7812T	.48	7912T	.88
7818T	.48	7918T	.88

TO-3 CASE

7805K	1.88	7905K	1.88
7812K	1.88	7912K	1.48

TO-93 CASE

78L05	.48	79L05	.88
78L12	.48	79L12	1.48

OTHER VOLTAGE REGS

LM323K	8V 34	TO-3	4.78
LM328K	4A 5A	TO-3	3.95
78H05K	8V 5A	TO-3	7.95
78H12K	12V 5A	TO-3	8.95
78P05K	8V 10A	TO-3	14.95

LINEAR

TL044	.98	LM733	.98
TL071	.88	LM741	.28
TL072	1.08	LM747	.88
TL081	1.98	LM748	.88
LM104	.88	MC1330	1.68
TL082	.98	MC1335	1.18
TL084	1.48	MC1372	6.98
LM101	.34	LM1414	1.88
LM309K	1.28	LM1458	.48
LM311	.88	LM1484	.48
LM311H	.88	LM1485	.48
LM317K	3.48	LM1498	.88
LM317T	4.88	LM1812	8.78
LM318	1.48	LM1849	1.95
LM319	1.28	ULN2003	.78
LM320	8.98	KR2208	3.95
LM322	1.95	KR2211	2.88
LM324	4.78	KR2240	1.98
LM324	.48	MP02907	1.98
LM331	3.95	LM2917	1.98
LM334	1.18	CA33046	.88
LM335	1.78	CA3081	.88
LM338	1.78	CA3082	.88
LM337K	3.95	CA3086	.88
LM338K	4.95	CA3089	1.98
LM339	.88	CA3130E	.88
LM340	8.98	CA3148	1.28
LM350T	4.88	CA3180	4.98
LF353	.88	MC3470	.95
LF356	.98	MC3480	.95
LF357	.98	MC3487	2.95
LM358	.88	LM3900	.48
LM380	.88	LM3909	.98
LM383	1.95	LM3911	2.28
LM386	.88	LM3914	2.28
LM393	.48	MC4044	3.48
LM394H	8.98	MC4044	3.98
TL494	4.28	RC4136	1.28
TL497	3.25	RC4558	.48
NE555	.28	LM13800	1.48
NE556	.48	78107	1.48
NE558	1.28	78110	1.98
NE564	1.98	78150	1.68
LM565	.88	78184	1.95
LM566	1.48	78188	1.28
LM567	.78	78189	1.78
NE570	2.95	75451	.38
NE590	2.88	75452	.38
NE592	.98	75483	.38
LM710	.75	75477	1.28
LM723	.48	75492	.78

DATA ACQ INTERFACE

ADC0800	15.55	8726	1.28
ADC0804	3.48	8728	1.28
ADC0809	4.48	8795	.88
ADC0814	14.95	8796	.88
ADC0817	9.95	8797	.88
ADC0831	8.95	8798	1.88
DAC0800	4.48	D88131	2.95
DAC0806	1.95	D88304	2.28
DAC0808	2.95	D88303	2.28
DAC1020	8.25	D88305	1.98
DAC1022	5.95	D88306	.98
MC1408LS	2.95	D88307	1.65

IC SOCKETS

8 PIN ST	1.99	100-
14 PIN ST	.11	.10
18 PIN ST	.12	.10
14 PIN ST	.15	1.3
20 PIN ST	.18	.15
22 PIN ST	.18	.12
24 PIN ST	.20	.15
28 PIN ST	.22	.18
40 PIN ST	.30	.22
84 PIN ST	1.95	1.48

ST-SOLDER TAIL

8 PIN WW	.88	.88
14 PIN WW	.88	.88
18 PIN WW	.88	.88
18 PIN WW	.98	.98
20 PIN WW	1.08	.88
22 PIN WW	1.28	1.28
24 PIN WW	1.48	1.35
28 PIN WW	1.88	1.48
40 PIN WW	1.95	1.80

WW-WIRE WRAP

18 PIN ZIF	4.95	CALL
24 PIN ZIF	5.95	CALL
28 PIN ZIF	6.95	CALL
40 PIN ZIF	9.95	CALL

ZIF-TEXTURE
IZI-INSERTION FORCE!

EDGE CARD CONNECTORS

100 PIN ST	5.100	.125	3.95
100 PIN WW	8.100	.125	4.95
52 PIN ST	IBM PC	100	1.95
50 PIN ST	APPLE	100	2.95
44 PIN ST	STD	154	1.95
44 PIN WW	STD	154	4.95

36 PIN CENTRONICS

IDCEN36	RIBBON CABLE	6.95
CEN36	SOLDER CUP	4.95
IDCEN36/F	RIBBON CABLE	7.95
CEN36PC	RT ANGLE PC MOUNT	4.95

INTERSIL

ICL7106	3.95
ICL7107	12.95
ICL7660	2.95
ICL8038	4.95
ICM7207A	5.95
ICM7208	15.95

DIP CONNECTORS

DESCRIPTION	ORDER BY	CONTACTS								
		8	14	16	18	20	24	28	40	
HIGH RELIABILITY TOOLED ST IC SOCKETS	AUGAT _{ST} ST	.62	.78	.88	1.08	1.28	1.38	1.48	2.48	
HIGH RELIABILITY TOOLED WW IC SOCKETS	AUGAT _{ST} WW	1.30	1.80	2.10	2.40	2.80	2.90	3.15	3.70	5.40
COMPONENT CARRIERS (DIP HEADERS)	ICC _{xx}	.88	.88	.88	.98	.98	.98	.98	1.08	1.48
RIBBON CABLE (DIP PLUGS) (DC)	IDP _{xx}98	.98	1.78	...	2.98

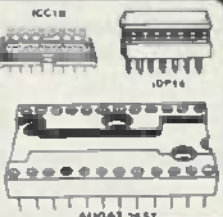

FOR ORDERING INSTRUCTIONS SEE D-SUBMINIATURE BELOW

D-SUBMINIATURE

DESCRIPTION	ORDER BY	CONTACTS						
		8	15	15	25	37	60	
SOLDER CUP	MALE	DB _{xx} P	.82	.90	1.26	1.28	1.80	3.48
	FEMALE	DB _{xx} S	.96	1.18	1.50	1.60	2.38	6.32
RIGHT ANGLE PC SOLDER	MALE	DB _{xx} PR	1.20	1.48	...	1.98	2.65	...
	FEMALE	DB _{xx} SR	1.28	1.88	...	2.00	2.78	...
WIRE WRAP	MALE	DB _{xx} PWW	1.68	2.68	...	3.88	5.40	...
	FEMALE	DB _{xx} PWW	2.78	4.27	...	5.84	8.96	...
ICC RIBBON CABLE	MALE	IDB _{xx} P	2.70	2.96	...	3.96	6.70	...
	FEMALE	IDB _{xx} S	2.92	3.20	...	4.33	8.78	...
HOODS	METAL	NH000 _{xx} R	1.28	1.28	1.30	1.30
	GREY	HO00 _{xx}	.68	.8688	.78	.98

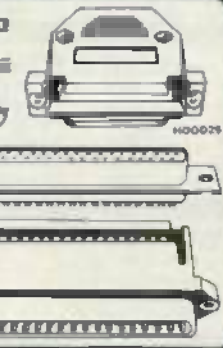

ORDERING INSTRUCTIONS: INSERT THE NUMBER OF CONTACTS IN THE POSITION MARKED "x" OF THE "ORDER BY" PART NUMBER LISTED
EXAMPLE: A 15 PIN RIGHT ANGLE MALE PC SOLDER WOULD BE DB15PR

MOUNTING HARDWARE \$1.00

IDC CONNECTORS

DESCRIPTION	ORDER BY	CONTACTS					
		10	20	26	34	40	60
SOLDER HEADER	IDH _{xx} S	.82	1.28	1.88	2.20	2.80	3.24
RIGHT ANGLE SOLDER HEADER	IDH _{xx} SR	.85	1.38	1.78	2.31	2.72	3.38
WW HEADER	IDH _{xx} W	1.88	2.88	3.84	4.80	5.28	16.63
RIGHT ANGLE WW HEADERS	IDH _{xx} WR	2.08	3.20	4.22	4.48	4.88	7.30
RIBBON HEADERS SOCKET	IDH _{xx} S	.78	.98	1.38	1.58	1.98	2.25
RIBBON HEADERS	IDH _{xx} R	...	5.50	6.20	7.00	7.50	8.80
RIBBON EDGE CARD	IDH _{xx}	1.78	2.25	2.80	2.78	3.80	3.98



FOR ORDERING INSTRUCTIONS SEE D-SUBMINIATURE ABOVE

HARD TO FIND "SNAPABLE" HEADERS

20MB HARD DISK SYSTEM ONLY \$389⁹⁵!

BARGAIN HUNTERS CORNER

ENHANCED GRAPHICS ADAPTOR

100% IBM COMPATIBLE - BASED ON EGA BIOS

- COMPATIBLE WITH IBM COLOR GRAPHICS ADAPTOR AND MONOCHROME ADAPTOR
- DISPLAYS 16 COLORS OUT OF 64 COLORS
- COMES WITH 256K VIDEO RAM
- DUAL SCANNING FREQUENCIES
- WORKS WITH STANDARD OR EGA TYPE RGB MONITORS
- LIGHT PEN INTERFACE

NOW ONLY \$259.95

EGA MONITOR

- FULL ONE YEAR WARRANTY
- EGA AND CGA COMPATIBLE
- SCANNING FREQUENCIES 18.75 KHz / 21 KHz
- 16" BLACK MAT MONITOR
- NON-GLARE SCREEN
- RESOLUTION 640 x 200 / 640 x 350
- .31mm DOT 2500 Hz
- 16 COLORS OUT OF 64
- TEXT SWITCH OPTION

\$499.95

SPECIALS END 12/31/86



PAGE WIRE WRAP WIRE PRECUT ASSORTMENT

IN ASSORTED COLORS \$27.50

1000m 5.5", 6.0", 6.5", 7.0"

2500m 2.5", 4.5", 5.0"

5000m 3.0", 3.5", 4.0"

SPOOLS

100 feet \$4.30

500 feet \$13.25

750 feet \$7.25

1000 feet \$21.95

Please specify color: Blue, Black, Yellow or Red

EMI FILTER

\$4.95

- MANUFACTURED BY COCOM
- LOW COST
- FITS LC.HP BELOW
- 6 AMP 120/240 VOLT



6 FOOT LINE CORDS

LC-2 2 CONDUCTOR .39

LC-3 3 CONDUCTOR .99

LC.HP 3 CONDUCTOR W STD FEMALE SOGRET 1.49

MUFFIN FANS

3.15" SQ ROTRON 14.95

3.63" SQ ETRI 14.95

3.15" SQ MASUSHITA 16.95

WIRE WRAP PROTOTYPE CARDS

FR-4 EPOXY GLASS LAMINATE

WITH GOLD-PLATED EDGE-CARD FINGERS

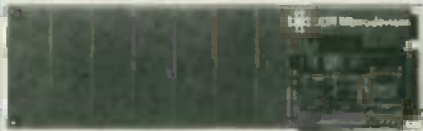

IBM PR2

IBM

BOTH CARDS HAVE SILK SCREENED LEGENDS AND INCLUDES MOUNTING BRACKET

IBM PR1

IBM PR2

WITH +5V AND GROUND PLANE \$27.95

AS ABOVE WITH DECODING LAYOUT \$29.95

S-100

P100-1

P100-2

P100-3

P100-4

BARE - NO FOIL PADS \$16.15

HORIZONTAL BUS \$21.80

VERTICAL BUS \$21.80

SINGLE FOIL PADS PER HOLE \$22.78

APPLE

P500-1

P500-3

P500-4

7060-45

BARE - NO FOIL PADS \$16.15

HORIZONTAL BUS \$22.75

SINGLE FOIL PADS PER HOLE \$21.80

FOR APPLE IIe AUX SLOT \$30.00

SOCKET-WRAP I.O.™

- SLIPS OVER WIRE WRAP PINS
- IDENTIFIES PIN NUMBERS ON WRAP SIDE OF BOARD
- CAN WRITE ON PLASTIC, SUCH AS IC'S

PINS	PART#	PCR. OF	PRICE
11	IDWRAP 08	10	1.95
14	IDWRAP 14	10	1.95
16	IDWRAP 16	10	1.95
18	IDWRAP 18	8	1.95
20	IDWRAP 20	8	1.95
22	IDWRAP 22	8	1.95
24	IDWRAP 24	5	1.95
28	IDWRAP 28	6	1.95
40	IDWRAP 40	5	1.95

PLEASE ORDER BY NUMBER OF PACKAGES (PKC OF)



FRAME STYLE TRANSFORMERS

12.6V AC CT 2 AMP 5.95

12.6V AC CT 4 AMP 7.95

12.4V AC CT 5 AMP 10.95

25.2V AC CT 2 AMP 7.95

25.2V AC CT 4 AMP 10.95

25.2V AC CT 5 AMP 13.95

25.2V AC CT 7.95

25.2V AC CT 10.95

25.2V AC CT 13.95

25.2V AC CT 16.95

25.2V AC CT 19.95

25.2V AC CT 22.95

25.2V AC CT 25.95

25.2V AC CT 28.95

25.2V AC CT 31.95

25.2V AC CT 34.95

25.2V AC CT 37.95

25.2V AC CT 40.95

25.2V AC CT 43.95

25.2V AC CT 46.95

25.2V AC CT 49.95

25.2V AC CT 52.95

25.2V AC CT 55.95

25.2V AC CT 58.95

25.2V AC CT 61.95

25.2V AC CT 64.95

25.2V AC CT 67.95

25.2V AC CT 70.95

25.2V AC CT 73.95

25.2V AC CT 76.95

25.2V AC CT 79.95

25.2V AC CT 82.95

25.2V AC CT 85.95

25.2V AC CT 88.95

25.2V AC CT 91.95

25.2V AC CT 94.95

25.2V AC CT 97.95

25.2V AC CT 100.95

25.2V AC CT 103.95

25.2V AC CT 106.95

25.2V AC CT 109.95

25.2V AC CT 112.95

25.2V AC CT 115.95

25.2V AC CT 118.95

25.2V AC CT 121.95

25.2V AC CT 124.95

25.2V AC CT 127.95

25.2V AC CT 130.95

25.2V AC CT 133.95

25.2V AC CT 136.95

25.2V AC CT 139.95

25.2V AC CT 142.95

25.2V AC CT 145.95

25.2V AC CT 148.95

25.2V AC CT 151.95

25.2V AC CT 154.95

25.2V AC CT 157.95

25.2V AC CT 160.95

25.2V AC CT 163.95

25.2V AC CT 166.95

25.2V AC CT 169.95

25.2V AC CT 172.95

25.2V AC CT 175.95

25.2V AC CT 178.95

25.2V AC CT 181.95

25.2V AC CT 184.95

25.2V AC CT 187.95

25.2V AC CT 190.95

25.2V AC CT 193.95

25.2V AC CT 196.95

25.2V AC CT 199.95

25.2V AC CT 202.95

25.2V AC CT 205.95

25.2V AC CT 208.95

25.2V AC CT 211.95

25.2V AC CT 214.95

25.2V AC CT 217.95

25.2V AC CT 220.95

25.2V AC CT 223.95

25.2V AC CT 226.95

25.2V AC CT 229.95

25.2V AC CT 232.95

25.2V AC CT 235.95

25.2V AC CT 238.95

25.2V AC CT 241.95

25.2V AC CT 244.95

25.2V AC CT 247.95

25.2V AC CT 250.95

25.2V AC CT 253.95

25.2V AC CT 256.95

25.2V AC CT 259.95

25.2V AC CT 262.95

25.2V AC CT 265.95

25.2V AC CT 268.95

25.2V AC CT 271.95

25.2V AC CT 274.95

25.2V AC CT 277.95

25.2V AC CT 280.95

25.2V AC CT 283.95

25.2V AC CT 286.95

25.2V AC CT 289.95

25.2V AC CT 292.95

25.2V AC CT 295.95

25.2V AC CT 298.95

25.2V AC CT 301.95

25.2V AC CT 304.95

25.2V AC CT 307.95

25.2V AC CT 310.95

25.2V AC CT 313.95

25.2V AC CT 316.95

25.2V AC CT 319.95

25.2V AC CT 322.95

25.2V AC CT 325.95

25.2V AC CT 328.95

25.2V AC CT 331.95

25.2V AC CT 334.95

25.2V AC CT 337.95

25.2V AC CT 340.95

25.2V AC CT 343.95

25.2V AC CT 346.95

25.2V AC CT 349.95

25.2V AC CT 352.95

25.2V AC CT 355.95

25.2V AC CT 358.95

25.2V AC CT 361.95

25.2V AC CT 364.95

25.2V AC CT 367.95

25.2V AC CT 370.95

25.2V AC CT 373.95

25.2V AC CT 376.95

25.2V AC CT 379.95

25.2V AC CT 382.95

25.2V AC CT 385.95

25.2V AC CT 388.95

25.2V AC CT 391.95

25.2V AC CT 394.95

25.2V AC CT 397.95

25.2V AC CT 400.95

25.2V AC CT 403.95

25.2V AC CT 406.95

25.2V AC CT 409.95

25.2V AC CT 412.95

25.2V AC CT 415.95

25.2V AC CT 418.95

25.2V AC CT 421.95

25.2V AC CT 424.95

25.2V AC CT 427.95

25.2V AC CT 430.95

25.2V AC CT 433.95

25.2V AC CT 436.95

25.2V AC CT 439.95

25.2V AC CT 442.95

25.2V AC CT 445.95

25.2V AC CT 448.95

25.2V AC CT 451.95

25.2V AC CT 454.95

25.2V AC CT 457.95

25.2V AC CT 460.95

25.2V AC CT 463.95

25.2V AC CT 466.95

25.2V AC CT 469.95

20MB HARD DISK SYSTEM ONLY \$389.95!

DISK DRIVES FOR APPLE COMPUTERS

AP-150
\$99.95



- 1/2 HT. DIRECT DRIVE
- 100% APPLE COMPATIBLE
- SIX MONTH WARRANTY

BAL-500
\$129.95



- TEAC MECHANISM DIRECT DRIVE
- 100% APPLE COMPATIBLE
- FULL ONE YEAR WARRANTY

AP-135
\$129.95



- FULL HT SHUGART MECHANISM
- DIRECT REPLACEMENT FOR APPLE DISK II
- SIX MONTH WARRANTY

DOUBLE SIDED!

MAC535
\$249.95



- 3.5" ADD ON DISK DRIVE
- 100% MACINTOSH COMPATIBLE
- DOUBLE SIDED 800K BYTE STORAGE
- HIGH RELIABILITY DRIVE HAS AUTO EJECT MECHANISM
- FULL ONE YEAR WARRANTY

AD-3C
\$139.95



- 100% APPLE IIc COMPATIBLE
- READY TO PLUG IN W/ SHIELDED CABLE & MOLDED 15 PIN CONNECTOR
- FAST RELIABLE SLIMLINE DIRECT DRIVE
- SIX MONTH WARRANTY

DISK DRIVE ACCESSORIES

FDD CONTROLLER CARD \$49.95
IIc ADAPTOR CABLE \$19.95
ADAPTS STANDARD APPLE DRIVES FOR USE WITH APPLE IIc

KB-1000 **\$79.95**

CASE WITH KEYBOARD FOR APPLE TYPE MOTHERBOARD

- USER DEFINED FUNCTION KEYS
- NUMERIC KEYPAD WITH CURSOR CONTROL
- CAPS LOCK
- AUTO-REPEAT



KEYBOARD-AP **\$49.95**

REPLACEMENT FOR APPLE II KEYBOARD

- CAPS LOCK KEY, AUTO-REPEAT
- ONE KEY ENTRY OF BASIC OR CP/M COMMANDS



EXTENDER CARDS

IBM-PC	\$45.00
IBM-AT	\$68.00
APPLE II	\$45.00
APPLE IIc	\$45.00
MULTIBUS	\$86.00

APPLE COMPATIBLE INTERFACE CARDS

EPROM PROGRAMMER \$59.95

MODEL RP525



- DUPLICATE OR BURN ANY STANDARD 27xx SERIES EPROM
- EASY TO USE MENU DRIVEN SOFTWARE IS INCLUDED
- MENU SELECTION FOR 2716, 2732, 2732A, 2764 AND 27128
- HIGH SPEED WRITE ALGORITHM
- LED INDICATORS FOR ACTIVITY
- NO EXTERNAL POWER SUPPLY NEEDED
- ONE YEAR WARRANTY

16K RAMCARD \$39.95



- FULL TWO YEAR WARRANTY
- EXPAND YOUR 48K APPLE TO 64K
- USE IN PLACE OF APPLE LANGUAGE CARD

BASE PC CARD W/ INSTRUCTIONS \$8.95

IC TEST CARD \$89.95



- QUICKLY TESTS MANY COMMON ICs
- DISPLAYS PASS OR FAIL
- ONE YEAR WARRANTY
- TESTS: 4000 SERIES CMOS, 74HC SERIES CMOS, 7400, 74LS, 74L, 74H & 765

300B MODEM \$49.95

FOR APPLE OR IBM

INCLUDES ASCI PRO-EZ SOFTWARE



- FCC APPROVED
- BELL SYSTEMS 103 COMPATIBLE
- INCLUDES AC ADAPTOR
- AUTO-DIAL
- DIRECT CONNECT

CABLE FOR APPLE IIc \$14.95

JOYSTICK CR-401 \$7.95

FOR ATARI 400, 800, 2600, VIC 20 '84 AND APPLE IIc

DISKFILE

HOLDS 70 5 1/4" DISKETTES

\$89.95



3.5" DISKFILE HOLDS 40 \$89.95

POWER STRIP \$12.95

UL APPROVED
15A CIRCUIT BREAKER



3-WAY SWITCH BOXES

- SERIAL OR PARALLEL
- CONNECTS 3 PRINTERS TO ONE COMPUTER OR VICE VERSA
- ALL LINES SWITCHES
- HIGH QUALITY ROTARY SWITCH MOUNTED ON PCB
- GOLD CONTACTS
- STURDY METAL ENCLOSURE



SWITCH-3P CENTRONICS PARALLEL \$89.95

SWITCH-3S RS232 SERIAL \$89.95

PRINTER BUFFERS

- FRIES COMPUTER FOR OTHER TASKS WHILE PRINTING LONG DOCUMENTS
- STAND-ALONE DESIGN, WORKS WITH ANY COMPUTER OR PRINTER
- ALL MODELS FEATURE PRINT PAUSE MEMORY CHECK, GRAPHICS CAPABILITY

SP120P PARALLEL \$139.95

- 84K UPGRADABLE TO 256K
- LED INDICATOR SHOWS VOLUME OF DATA IN BUFFER

SP120S RS232 SERIAL \$159.95

- 84K UPGRADABLE TO 256K
- 6 SELECTABLE BAUD RATES, FROM 600B-19,200B

SP110P PARALLEL \$249.95

- 84K UPGRADABLE TO 812K
- SPOOLS OUTPUT OF UP TO 3 COMPUTERS
- LED BARGRAPH DISPLAYS AMOUNT OF DATA IN BUFFER
- RESET FUNCTION CLEARS DATA IN BUFFER
- REPEAT FUNCTION CAN PRODUCE MULTIPLE COPIES OF A DOCUMENT



NASHUA DISKETTES DEALS

5 1/4" SOFT SECTOR
DS/DD WITH HUB RINGS

\$9.90 **69¢ ea** **59¢ ea**

BOX OF 10 BULK QTY 50 BULK QTY 250

NASHUA DISKETTES WERE JUDGED TO HAVE THE HIGHEST POLISH AND RECORDED AMPLITUDE OF ANY DISKETTES TESTED ACCORDING TO "COMPARING FLOPPY DISKS", BYTE 9 '84

DISKETTES

NASHUA 5 1/4"

N MD2D DS/DD SOFT	\$9.90
N MD2F DS/QUAD SOFT	\$34.95
N MD2H DS/HD FOR AT	\$49.95

NASHUA 8"

N FD1 SS/DD SOFT	\$27.95
N FD2D DS/DD SOFT	\$34.95

NASHUA 3.5"

N 3 5S5 3 1/2" SS/DD FOR MAC	\$32.95
------------------------------	---------

VERBATIM 5 1/4"

V MD1D SS/DD SOFT	\$23.95
V MD2D DS/DD SOFT	\$29.95
V MD110D SS/DD 10 SECTOR HARD	\$23.95

TEST EQUIPMENT FROM JDR INSTRUMENTS

DIGITAL MULTIMETER PEN DPM-1000

AUTO RANGING, POLARITY AND DECIMAL! **\$54.95**

- LARGE 3 1/2 DIGIT DISPLAY
- DATA HOLD SWITCH FREEZES READING
- FAST, AUDIBLE CONTINUITY TEST
- LOW BATTERY INDICATOR
- OVERLOAD PROTECTION



20MHZ DUAL TRACE OSCILLOSCOPE	MODEL 2000	\$389.00
35MHZ DUAL TRACE OSCILLOSCOPE	MODEL 3500	\$549.00

FOR MORE INFORMATION ON THE OSCILLOSCOPES, CALL US FOR FREE PRODUCT BRIEF.

BUILD STEVE GARCIA'S INTELLIGENT EPROM PROGRAMMER

AS SEEN IN BYTE, OCT. 88

- STAND-ALONE OR RS-232 SERIAL OPERATION
- MENU SELECTABLE EPROM TYPES—NO CONFIGURATION JUMPERS
- PROGRAMS ALL 5V 27XXX EPROMS FROM 2716 TO 27612
- READ, COPY OR VERIFY EPROM
- UPLOAD/DOWNLOAD INTEL HEX FILES
- PROGRAMMER DRIVER USER MODIFIABLE

ONLY \$199

KIT INCLUDES PCB AND ALL COMPONENTS EXCEPT CASE AND POWER SUPPLY

5 1/4" FLOPPY DISK DRIVES

TEAC FD-55B 1/2 HT DS/DD FOR IBM	\$109.95
TEAC FD-55F 1/2 HT DS/QUAD FOR IBM	\$124.95
TEAC FD-55GV 1/2 HT DS/HD FOR IBM AT	\$189.95
TANDON TM100-2 DS/DD FOR IBM	\$119.00
TANDON TM50-2 1/2 HT DS/DD FOR IBM	\$79.95
MPI-862 DS/DD FOR IBM	\$79.95
QUME QT-142 1/2 HT DS/DD FOR IBM	\$79.95

8" FLOPPY DISK DRIVES

FD 100-8 DS/DD (SA-801 EQUM)	\$118.00
FD 200-8 DS/DD (SA-801R EQUM)	\$159.00

DISK DRIVE ACCESSORIES

TEAC SPECIFICATION MANUAL	\$6.00
TEAC MAINTENANCE MANUAL	\$26.00
1/2 HT MOUNTING HARDWARE	\$2.95
MOUNTING RAILS FOR IBM AT	\$4.96
"Y" POWER CABLE FOR 5 1/4" FDDs	\$2.55
5 1/4" FDD POWER CONNECTORS	\$1.15



DISK DRIVE ENCLOSURES

CAB-APPLE APPLE TYPE CABINET W/ OUT POWER SUPPLY	\$24.95
CAB-1FNS FULL HT 5 1/4" BEIGE CABINET W/POWER SUPPLY	\$69.95
CAB-2SVS DUAL SLIMLINE 5 1/4" CABINET W/POWER SUPPLY	\$49.95
CAB-2SVB VERTICAL DUAL SLIMLINE 5 1/4" CABINET W/POWER SUPPLY	\$209.95
CAB-2FNB HORIZONTAL DUAL FULL HT 8" CABINET W/POWER SUPPLY	\$219.95

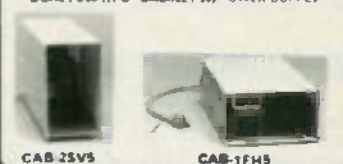

20 MEGA BYTE HARD DISK SYSTEM

ONLY \$389.95!

SEAGATE ST-225 20 MB HARD DISK SYSTEM

INCLUDES HARD DISK CONTROLLER, CABLES AND INSTRUCTIONS. ALL DRIVES ARE PRE-TESTED AND COME WITH A ONE YEAR WARRANTY.

\$389.95

XT COMPATIBLE MOTHERBOARD

\$129.95

- 4.77 MHz 8088 CPU, OPTIONAL 8087 CO. PROCESSOR
- 8 EXPANSION SLOTS
- 64K RAM INSTALLED, EXPANDABLE TO 640K ON BOARD MEMORY
- ALL IC'S SOCKETED, HIGHEST QUALITY PC BOARD
- ACCEPTS 2764 OR 27128 ROMS

PRO-BIOS \$19.95



IBM COMPATIBLE INTERFACE CARDS

ALL WITH A ONE YEAR WARRANTY

MULTI I/O FLOPPY CARD

\$89.95

PERFECT FOR THE 640K MOTHERBOARD



- 2 DRIVE FLOPPY DISK CONTROLLER
- 1 RS232 SERIAL PORT, OPTIONAL 2nd SERIAL PORT
- PARALLEL PRINTER PORT
- GAME PORT
- CLOCK / CALENDAR
- SOFTWARE CLOCK UTILITIES, RAMDISK, SPOOLER
- OPTIONAL SERIAL PORT \$15.95

MULTIFUNCTION CARD

\$84.95

ALL THE FEATURES OF AST'S 8 PACK PLUS AT HALF THE PRICE



- CLOCK/CALENDAR
- 0.256K RAM
- SERIAL PORT
- PARALLEL PORT
- GAME PORT
- SOFTWARE INCLUDED
- PRINTER CABLE \$9.95
- 512K RAM UPGRADE \$11.95

COLOR GRAPHICS ADAPTOR

\$69.95

FULLY COMPATIBLE WITH IBM COLOR CARD



- 4 VIDEO INTERFACES: RGB, COMPOSITE COLOR, HI RES, COMPOSITE MONOCHROME, CONNECTOR FOR RT. MODULATOR
- COLOR GRAPHICS MODE: 320 x 200
- MONO GRAPHICS MODE: 640 x 200
- LIGHT PEN INTERFACE

MONOCHROME GRAPHICS CARD

\$89.95

FULLY COMPATIBLE WITH IBM MONOCHROME ADAPTOR & HERCULES GRAPHICS



- LOTUS COMPATIBLE
- TEXT MODE: 80 x 25
- GRAPHICS MODE: 720 x 348
- PARALLEL PRINTER INTERFACE
- OPTIONAL SERIAL PORT \$15.95

MONOCHROME ADAPTOR

\$49.95

ANOTHER FANTASTIC VALUE FROM JDR

- IBM COMPATIBLE TTL OUTPUT
- 720 x 350 PIXEL DISPLAY
- PLEASE NOTE THIS CARD WILL NOT RUN LOTUS GRAPHICS AND DOES NOT INCLUDE A PARALLEL PORT

FLOPPY DISK DRIVE ADAPTOR

\$34.95



- INTERFACES UP TO 4 STANDARD FDDs TO IBM PC OR COMPATIBLES
- INCLUDES CABLE FOR TWO INTERNAL DRIVES
- STANDARD DB37 FOR EXTERNAL DRIVES
- RUNS QUAD DENSITY DRIVES WHEN USED WITH JFORMAT

1200 BAUD MODEMS

HAYES COMPATIBLE, AUTO-DIAL, AUTO-ANSWER, AUTO RE-DIAL ON BUSY, POWER-UP SELF TEST, FULL ONE YEAR WARRANTY

MODEL 1200B*

- INTERNAL DESIGN
- 10 INCH CARD
- SERIAL PORT INCLUDED

\$169.95

*FOR IBM, INCLUDES PC TALK III COMMUNICATIONS SOFTWARE

MODEL 1200H*

- INTERNAL DESIGN
- HALF LENGTH (5") CARD
- INCLUDES SPEAKER

\$149.95

SMARTTEAM

- EXTERNAL DESIGN
- WITH POWER SUPPLY
- LED STATUS INDICATORS

\$169.95

CRT MONITORS FOR ALL APPLICATIONS



LUXOR
HI-RES RGB MONITOR
MODEL 190-9529

- DIGITAL RGB IBM COMPATIBLE
- 14" SCREEN
- 16 TRUE COLORS
- 25 MHz BANDWIDTH
- RESOLUTION > 640 x 262
- 37mm DOT PITCH
- CABLE FOR IBM PC INCLUDED

\$299.95



SAKATA
COMPOSITE COLOR
MODEL SC-700

- TOP RATED FOR APPLE
- 12" COMPOSITE VIDEO
- RESOLUTION: 280H x 300V
- INTERNAL AUDIO AMP
- ONE YEAR WARRANTY

\$169.95



CENTER SYSTEMS
MONOCHROME
MODEL KLM-1211

- IBM COMPATIBLE TTL INPUT
- 12" NON GLARE SCREEN
- P33 GREEN PHOSPHORUS
- VERY HIGH RESOLUTION
- 25 MHz BANDWIDTH
- 1100 LINES (CENTER)

AMBER VERSION \$109.95

\$99.95

BUILD YOUR OWN 258K XT COMPATIBLE SYSTEM

- XT MOTHERBOARD \$129.95
- PRO-BIOS \$19.95
- 258K RAM \$28.55
- 130 WATT POWER SUPPLY \$89.95
- FLIP-TOP CASE \$39.95
- DKM-2000 KEYBOARD \$59.95
- 1/2 HEIGHT QUME DRIVE \$79.95
- FLOPPY DISK CONTROLLER \$34.95
- MONOCHROME ADAPTOR \$49.95
- MONOCHROME MONITOR \$99.95

TOTAL: \$811.10

MONITOR STAND

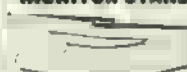

TILTS AND SWIVELS
ONLY \$12.95

IBM PRINTER CABLE



• DB25 TO CENTRONICS
• SHIELDED CABLE \$9.95

IBM STYLE COMPUTER CASE

AN ATTRACTIVE STEEL CASE WITH A HINGED LID FITS THE POPULAR PC/XT COMPATIBLE MOTHERBOARDS

- SWITCH CUT-OUT ON SIDE FOR PC/XT STYLE POWER SUPPLY
- CUT-OUT FOR 8 EXPANSION SLOTS
- ALL HARDWARE INCLUDED

\$39.95



IBM COMPATIBLE KEYBOARDS

DKM-2000 \$89.95

IBM-5151 \$79.95



- IBM STYLE KEYBOARD
- FULLY IBM COMPATIBLE
- LED STATUS INDICATORS FOR CAPS & NUMBER LOCK
- 83 KEY - SAME LAYOUT AS IBM PC/XT KEYBOARD



- REPLACEMENT FOR KEYTRONICS KB-5151™
- SEPARATE CURSOR & NUMERIC KEYPAD
- CAPS LOCK & NUMBER LOCK INDICATORS
- IMPROVED KEYBOARD LAYOUT

POWER SUPPLY



NOW ONLY \$69.95

- FOR IBM PC/XT COMPATIBLE
- 135 WATTS
- .5V @ 15A, +12V @ 4.2A
- 5V @ 5A, -12V @ 5A

150 WATT MODEL \$79.95

DISK DRIVES

TANDON TM50-2 \$79.95

- 1/2 HT DS/DD
- IBM COMPATIBLE
- EXTREMELY QUIET!

TEAC FD-55B	DS/DD	\$109.95
TEAC FD-55F	DS/QUAD	\$124.95
TEAC FD-55B	DS/DD	\$154.95
QUME QT-142	DS/DD	\$79.95
MOUNTING HARDWARE		\$2.95
AT/RAILS		\$4.95

JDR Microdevices

1224 S. Bascom Avenue, San Jose, CA 95128

Toll Free 800-538-5000 • (408) 995-5430 • FAX (408) 275-8415 • Telex 171-110

CIRCLE 179 ON FREE INFORMATION CARD

© COPYRIGHT 1986 JDR MICRODEVICES

7400

Part No.	1-9	10+	Part No.	1-9	10+
7400	29	19	7405	65	55
7402	29	19	7406	48	35
7404	35	25	7408	205	195
7405	38	29	7409	48	39
7406	39	29	7410	48	35
7407	39	29	7411	45	35
7408	35	25	7412	59	49
7410	35	25	7413	55	48
7411	38	29	7414	78	65
7412	45	35	7415	40	35
7413	48	35	7416	135	125
7420	35	25	7419	135	125
7430	35	25	7418	150	148
7432	39	29	7417	89	75
7438	39	29	7418	65	55
7442	85	45	7417	65	55
7445	79	69	7417	90	80
7446	89	79	7419	105	105
7447	99	79	7419	205	195
7448	705	195	7419	78	65
7472	78	65	7419	185	178
7473	45	35	7422	89	89
7474	45	35	7423	205	195
7475	49	39	7435	60	59
7476	45	35	7437	60	59

74LS

Part No.	1-9	10+	Part No.	1-9	10+
74LS00	29	19	74LS165	75	55
74LS02	29	19	74LS166	59	59
74LS04	35	25	74LS167	59	59
74LS05	35	25	74LS174	48	38
74LS06	109	99	74LS175	40	38
74LS07	109	99	74LS180	450	448
74LS08	29	19	74LS191	89	49
74LS10	29	19	74LS192	78	68
74LS14	48	38	74LS201	89	89
74LS17	38	28	74LS240	78	68
74LS20	29	19	74LS243	78	68
74LS22	38	28	74LS244	79	69
74LS24	48	38	74LS246	89	79
74LS27	38	28	74LS259	89	89
74LS29	38	28	74LS273	89	79
74LS30	29	19	74LS279	48	38
74LS32	38	28	74LS322	405	395
74LS34	48	38	74LS336	89	79
74LS37	38	28	74LS369	89	79
74LS41	38	28	74LS373	78	68
74LS42	48	38	74LS374	78	68
74LS43	48	38	74LS380	89	79
74LS45	48	38	74LS390	89	79
74LS47	48	38	74LS393	220	219
74LS49	48	38	74LS400	100	99
74LS50	48	38	74LS404	100	99
74LS51	48	38	74LS405	100	99
74LS52	48	38	74LS406	100	99
74LS53	48	38	74LS407	100	99
74LS54	48	38	74LS408	100	99
74LS55	48	38	74LS409	100	99
74LS56	48	38	74LS410	100	99
74LS57	48	38	74LS411	100	99
74LS58	48	38	74LS412	100	99
74LS59	48	38	74LS413	100	99
74LS60	48	38	74LS414	100	99
74LS61	48	38	74LS415	100	99
74LS62	48	38	74LS416	100	99
74LS63	48	38	74LS417	100	99
74LS64	48	38	74LS418	100	99
74LS65	48	38	74LS419	100	99
74LS66	48	38	74LS420	100	99
74LS67	48	38	74LS421	100	99
74LS68	48	38	74LS422	100	99
74LS69	48	38	74LS423	100	99
74LS70	48	38	74LS424	100	99
74LS71	48	38	74LS425	100	99
74LS72	48	38	74LS426	100	99
74LS73	48	38	74LS427	100	99
74LS74	48	38	74LS428	100	99
74LS75	48	38	74LS429	100	99
74LS76	48	38	74LS430	100	99
74LS77	48	38	74LS431	100	99
74LS78	48	38	74LS432	100	99
74LS79	48	38	74LS433	100	99
74LS80	48	38	74LS434	100	99
74LS81	48	38	74LS435	100	99
74LS82	48	38	74LS436	100	99
74LS83	48	38	74LS437	100	99
74LS84	48	38	74LS438	100	99
74LS85	48	38	74LS439	100	99
74LS86	48	38	74LS440	100	99
74LS87	48	38	74LS441	100	99
74LS88	48	38	74LS442	100	99
74LS89	48	38	74LS443	100	99
74LS90	48	38	74LS444	100	99
74LS91	48	38	74LS445	100	99
74LS92	48	38	74LS446	100	99
74LS93	48	38	74LS447	100	99
74LS94	48	38	74LS448	100	99
74LS95	48	38	74LS449	100	99
74LS96	48	38	74LS450	100	99
74LS97	48	38	74LS451	100	99
74LS98	48	38	74LS452	100	99
74LS99	48	38	74LS453	100	99
74LS100	48	38	74LS454	100	99

74S/PROMS*

Part No.	1-9	10+	Part No.	1-9	10+
74S04	25	15	74S188	150	140
74S06	25	15	74S196	240	230
74S10	29	19	74S200	140	130
74S32	35	25	74S244	140	130
74S74	45	35	74S293	79	69
74S85	179	169	74S297	140	130
74S95	48	38	74S301	140	130
74S124	295	285	74S373	140	130
74S174	79	69	74S374	140	130
74S178	79	69	74S472*	295	285

74ALS

Part No.	1-9	10+	Part No.	1-9	10+
74ALS00	35	25	74ALS138	89	79
74ALS02	35	25	74ALS174	89	79
74ALS04	39	29	74ALS240	140	130
74ALS06	39	29	74ALS243	140	130
74ALS10	39	29	74ALS244	140	130
74ALS12	39	29	74ALS245	140	130
74ALS30	39	29	74ALS373	140	130
74ALS32	39	29	74ALS374	140	130
74ALS74	40	30	74ALS573	140	130

74F

Part No.	1-9	10+	Part No.	1-9	10+
74F00	38	28	74F139	80	70
74F04	38	28	74F157	98	88
74F06	38	28	74F160	395	385
74F10	38	28	74F240	130	120
74F32	48	38	74F244	130	120
74F74	48	38	74F283	98	88
74F85	58	48	74F373	130	120
74F138	88	78	74F374	130	120

CD-CMOS

Part No.	1-9	10+	Part No.	1-9	10+
CD4001	19	10	CD4061	25	15
CD4011	19	10	CD4082	25	15
CD4013	19	10	CD4093	25	15
CD4018	25	15	CD4094	59	49
CD4020	25	15	CD40188	240	230
CD4024	48	38	CD4503	35	25
CD4027	38	28	CD4510	89	79
CD4030	38	28	CD4511	89	79
CD4040	38	28	CD4515	89	79
CD4049	38	28	CD4520	78	68
CD4050	38	28	CD4524	78	68
CD4061	38	28	CD4537	140	130
CD4062	38	28	CD45374	140	130
CD4063	38	28	CD4573	140	130
CD4069	38	28	CD4643	89	79
CD4070	38	28	CD4643	89	79
CD4071	38	28	CD4643	89	79
CD4072	38	28	CD4643	89	79
CD4073	38	28	CD4643	89	79
CD4074	38	28	CD4643	89	79
CD4075	38	28	CD4643	89	79
CD4076	38	28	CD4643	89	79
CD4077	38	28	CD4643	89	79
CD4078	38	28	CD4643	89	79
CD4079	38	28	CD4643	89	79
CD4080	38	28	CD4643	89	79
CD4081	38	28	CD4643	89	79
CD4082	38	28	CD4643	89	79
CD4083	38	28	CD4643	89	79
CD4084	38	28	CD4643	89	79
CD4085	38	28	CD4643	89	79
CD4086	38	28	CD4643	89	79
CD4087	38	28	CD4643	89	79
CD4088	38	28	CD4643	89	79
CD4089	38	28	CD4643	89	79
CD4090	38	28	CD4643	89	79
CD4091	38	28	CD4643	89	79
CD4092	38	28	CD4643	89	79
CD4093	38	28	CD4643	89	79
CD4094	38	28	CD4643	89	79
CD4095	38	28	CD4643	89	79
CD4096	38	28	CD4643	89	79
CD4097	38	28	CD4643	89	79
CD4098	38	28	CD4643	89	79
CD4099	38	28	CD4643	89	79
CD4100	38	28	CD4643	89	79
CD4101	38	28	CD4643	89	79
CD4102	38	28	CD4643	89	79
CD4103	38	28	CD4643	89	79
CD4104	38	28	CD4643	89	79
CD4105	38	28	CD4643	89	79
CD4106	38	28	CD4643	89	79
CD4107	38	28	CD4643	89	79
CD4108	38	28	CD4643	89	79
CD4109	38	28	CD4643	89	79
CD4110	38	28	CD4643	89	79
CD4111	38	28	CD4643	89	79
CD4112	38	28	CD4643	89	79
CD4113	38	28	CD4643	89	79
CD4114	38	28	CD4643	89	79
CD4115	38	28	CD4643	89	79
CD4116	38	28	CD4643	89	79
CD4117	38	28	CD4643	89	79
CD4118	38	28	CD4643	89	79
CD4119	38	28	CD4643	89	79
CD4120	38	28	CD4643	89	79
CD4121	38	28	CD4643	89	79
CD4122	38	28	CD4643	89	79
CD4123	38	28	CD4643	89	79
CD4124	38	28	CD4643	89	79
CD4125	38	28	CD4643	89	79
CD4126	38	28	CD4643	89	79
CD4127	38	28	CD4643	89	79
CD4128	38	28	CD4643	89	79
CD4129	38	28	CD4643	89	79
CD4130	38	28	CD4643	89	79
CD4131	38	28	CD4643	89	79
CD4132	38	28	CD4643	89	79
CD4133	38	28	CD4643	89	79
CD4134	38	28	CD4643	89	79
CD4135	38	28	CD4643	89	79
CD4136	38	28	CD4643	89	79
CD4137	38	28	CD4643	89	79
CD4138	38	28	CD4643	89	79
CD4139	38	28	CD4643	89	79
CD4140	38	28	CD4643	89	79

Worldwide • Since 1974

• QUALITY COMPONENTS • COMPETITIVE PRICING
• PROMPT DELIVERY

Mail Order Electronics • Worldwide
Jameco
ELECTRONICS

COMMODORE COMPATIBLE ACCESSORIES



Now Compatible With C-128!
RS232 Adapter for VIC-20, C-64 and C-128

The JE232CM allows connection of standard RS232C modems, etc. to your VIC-20, C-64 (including the 6545 portable), and C-128. A 4-pole port allows the insertion of the 4 control lines. Complete installation and operation instructions included.

Plugs into User Port - Provides Standard RS232C signal levels Uses 8 signals (Transmit, Receive, Clear to Send, Request to Send, Data Terminal Ready, Data Set Ready)

JE232CM.....\$39.95

Voice Synthesizer VIC-20 & C-64

Plug-In - Talking in Minutes!
JE520CM.....\$99.95

External Power Supply

CPS-10 (For C-64).....\$39.95

Parallel Printer Interface

2K Buffer, Expandable to 10K!
VW350 (For VIC-20, C-64 & C-128).....\$54.95

TRS-80™ COMPATIBLE ACCESSORIES

E-X-P-A-N-D TRS-80 MEMORY
All kits come complete with documentation

TRS-80 MODEL I, III

TRS-16K3 200ms (Model III).....\$5.95

TRS-16K4 250ms (Model I).....\$5.40

TRS-80 COLOR AND COLOR II

TRS-64K-2.....\$7.95

New models only

TRS-CoCo-Incl 2-50464's (41644's).....\$10.95

TRS-80 MODEL 4, 4P, AND 4D

TRS-64K-2.....\$7.95

Expands Model 4 from 16K-64K or Model 4P and 4D from 64K-128K

TRS-64K-2PAL.....\$14.95

Expands Model 4 from 64K to 128K

TRS-80 Model 100 • NEC • Olivetti

M1008K.....\$19.95 ea. or 3 for \$54.95

TRS-80 Model 100 8K Expansion

NEC8KR.....\$19.95 ea. or 3 for \$54.95

NEC Model PC-8201A 8K Extension

CM108K.....\$19.95 ea. or 3 for \$54.95

Olivetti Model M10 8K Expansion

TANDY 200

M200R.....\$59.95 ea. or 2 for \$109.95

Tandy Model 200 24K Expansion

UV-EPROM ERASER

Erases all EPROMs. Erases up to 8 chips within 21 minutes (1 chip in 18 minutes). Maintains constant exposure distance of 1". Special conductive foam liner eliminates static build-up. Built-in safety lock to prevent UV exposure. Compact, 9.00" x 3.70" x 2.00". Complete with holding tray for 8 chips.

DE-4 UV-EPROM Eraser.....\$69.95

UVS-11EL Replacement Bulb.....\$19.95

DATA BOOKS

30003 National Linear Data Book (82).....\$14.95

30009 Intertek Data Book (85).....\$ 9.95

30013 Zilog Data Book (85).....\$14.95

30032 National Linear Supplement (84).....\$ 6.95

210830 Intel Memory Handbook (89).....\$17.95

230843 Intel Microsystem Handbook, Set (89).....\$24.95

MUFFIN/Sprite-STYLE FANS

MUF60.....\$9.95

Form Inductive (4.88" sq, 60 cfm)

SUZ21.....\$8.95

EG&G Robotron (3.125" square, 70 cfm)

NEW PRODUCTS!



TTX 14" RGB Color Monitor
for IBM PC, XT and Compatible Computers

• Input Signal (Video) RGB TTL Level and Intensity Signal Sync; Separate TTL Level (positive or negative) • Scanning Freq. (Hor.) 14.5KHz to 17.5KHz • Video Bandwidth: 18MHz • Resolution: 640 x 200 • Connector: DB 9-pin (incl.) • Power Consumption: 70 Watts • Size: 14.8" H x 15.5" W x 13.6" D • Weight: 27 lbs. • TTX-1410 is compatible with the IBM ICB and the IBM EGA Cards (right)

TTX-1410.....\$299.95

DISK DRIVE SALE!

MP152S Double-sided 48TPI IBM PC/XT Compatible.....\$69.95

TM100-4 Double-sided 96TPI QUAD Drive.....\$59.95

ZUCKERBOARD



Expansion Memory Half-Card for IBM-PC, XT, Portable, Tandy 1200 and Compatible Computers

Expand your computer to its full capacity of 640K. It will accept either 64K memory chips (4164) or 256K memory chips (41256)

Expansion Memory Half Card with OK RAM.....\$59.95

RAM Disk and Printer Spooler Software.....\$39.95

ZUCKERBOARD

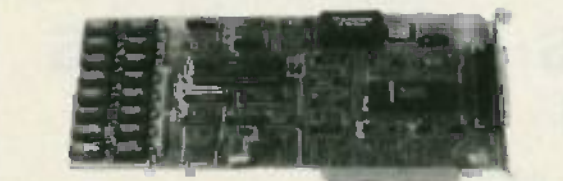

Multifunction Board with Clock Calendar for the Tandy 1000

The Zuckerboard Multifunction Board allows you to expand the memory on your Tandy 1000 to as much as 640K. The Multifunction Board comes complete with Disk Controller, RS232 port, a clock/calendar and RAM Disk Printer Spooler. The Zuckerboard Multifunction Board is made in the U.S.A. and comes with a standard 2-year warranty.

MTAN-256K Includes 256K RAM and Manual.....\$179.95

MTAN-512K Includes 512K RAM and Manual.....\$209.95

Expansion Memory Half-Card and Clock/Calendar for the Tandy 1000 - DMA Controller Chip on board!

TAN-EM256K Includes 256K RAM and Manual.....\$ 99.95

TAN-EM512K Includes 512K RAM and Manual.....\$129.95

Options for TAN-EM256K/512K

TAN-C Includes Plug-in Clock Option Chip (only).....\$39.95

TAN-D Includes RAM Disk Spooler Software (only).....\$39.95

3.5" Micro Floppy Disk Drive for Tandy 100 & 200, NEC8201A, IBM PC, XT, AT and Compatible Computers

Now your IBM PC or compatible can read and write the same disks as your portable!



Part No. Description Price

FD-103 Includes 3.5" Disk Drive, Cable, AC Adapter, Blank Diskette and Documentation.....\$179.95

Software for the FD-103 Disk Drive (Software needed for operation)

T31 Tandy 100 TSDOS Disk Operating System Software.....\$44.95

T32 Tandy 200 TSDOS Disk Operating System Software.....\$44.95

T3N NEC PC8201A Disk Operating System Software.....\$44.95

LAPDOS IBM PC, XT, AT and Compatible LAPDOS Disk Operating System Software.....\$74.95

IBM COMPATIBLE ACCESSORIES

83-KEY KEYBOARD



• Identical layout as original IBM PC keyboard - Highly desirable cable with palm rest - Complete with cable and data - JUST PLUG IN!

KB83.....SALE.....\$29.95

Build an IBM PC/XT™ Compatible!

IBM-64K(2) 64K RAM Chips (18).....\$ 19.90

KB-83 83-Key Keyboard.....\$ 29.95

IBM-FCC Floppy Controller Card.....\$ 39.95

IBM-Cass Cass.....\$ 39.95

IBM-MCC Monochrome Card.....\$ 69.95

IBM-PS Power Supply.....\$ 69.95

FD55B Disk Drive.....\$109.95

IBM-MON Monochrome Monitor.....\$ 99.95

IBM-MB Motherboard.....\$129.95

Regular List \$609.50

IBM™-Special (incl. 9 items above).....\$549.95

Additional Add-Ons Available!

IBM-KB 83-Key Keyboard.....\$ 69.95

IBM-ENH Enhanced Keyboard.....\$ 89.95

IBM-ICB Integrated Color Board.....\$ 99.95

IBM-EGA Enh. Graphics 256K RAM.....\$259.95

IBM-20MBK 20MB Hard Disk Drive.....\$449.95

IBM is a registered trademark of IBM Computers

NEW! Universal 64K/256K NEW! Printer Buffer



JOHNATHAN FREEMAN DESIGNS



The UBUFFER Universal Printer Buffer is a low speed data buffer that accepts data at a high rate, and then outputs your data to your printer. You have selectable computer link. The UBUFFER can be connected to practically any computer or printer. There are four possible combinations: 1) Serial to Serial, 2) Serial to Parallel, 3) Parallel to Parallel, 4) Parallel to Serial. Manual included. Size 9-1/2" L x 4-1/2" W x 1-1/2" H

UB64K.....\$199.95

UB256K.....\$239.95

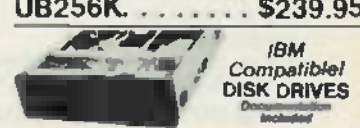

FD55B 5 1/4" 5 1/4" High.....\$109.95

JU-455 Panasonic 5 1/4" 5 1/4" High.....\$109.95

TM100-2 Tandon 5 1/4" 5 1/4" High.....\$119.95

JMR 5 1/4" DISK DRIVE ENCLOSURES

Complete with power supply switch, power cord, headholder and connectors.

DDE-1FH.....\$59.95

Houses 1 Full-Height 5 1/4" Floppy Drive

DDE-2HH.....\$69.95

Houses 2 Half-Height 5 1/4" Floppy Drives - Vertical

HDDE-1FH.....\$194.95

Houses 1 Hard Disk Drive

\$20 Minimum Order - U.S. Funds Only
Shipping: Add 5% plus \$1.50 Insurance

California Residents: Add 6%, 6 1/2% or 7% Sales Tax

Spec. Sheets - 50c each
Prices Subject to Change

Send stamped, self-addressed envelope to receive a Quarterly Sales Flyer - FREE!

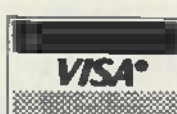

Send \$1.00 Postage for a FREE 1987 JAMECO CATALOG

©1986 Jameco Electronics

1355 SHOREWAY ROAD, BELMONT, CA 94002 • PHONE ORDERS WELCOME 415-592-8097 Telex: 176043

cable tv

DESCRAMBLER PARTS!

We stock the exact parts, PC board and AC adaptor for Radio Electronics February 1984 article on building your own Cable TV Descrambler.

#701 PARTS PACKAGE.....\$29.95

Includes all the original resistors, capacitors, diodes, transistors, integrated circuits, coils, IF transformers (toko BKAN-K5552AXX).

#702 PC BOARD.....\$12.95

Original etched & drilled silk-screened PC board used in the article.

#704 AC ADAPTOR.....\$12.95

Original (14 volts DC @ 285ma) ac adaptor used in the article.

S P E C I A L S

BOTH #701 & #702.....NOW \$39

ALL THREE #701, #702 & #704.....NOW \$49

Add \$2.50 shipping and handling — \$4.50 for Canadian orders
We also offer quantity Discounts on 5 or more units

FREE Reprint of Radio Electronics article (February 1984) on Building Your Own CABLE TV DESCRAMBLER with any purchase of above.

60-CHANNEL CABLE CONVERTER



WITH INFRARED REMOTE CONTROL

SC-60R CONVERTER.....\$69.95

Thousands of these converters sold nationally for \$119.95
We offer you this same type of converter for only \$69.95
All converters are NEW, with Full manufacturer's WARRANTY.

FEATURES:

- Full 60 Channel Capability
- Cordless Infrared remote control
- Ultra-Stable Synthesized tuning
- Microprocessor controlled PLL
- Works on all TV models, channel 3 output
- Standard/HRC Switch for compatibility with all Cable Systems
- Will work with all types of external descramblers

Add \$3.50 Shipping and Handling
\$4.50 on Canadian Orders

ORDER TOLL FREE

1-800-227-8529



inside MA 617-695-8699
VISA, MASTERCARD or C.O.D.



J & W ELECTRONICS, INC.

P.O. BOX 800R • MANSFIELD, MA 02048

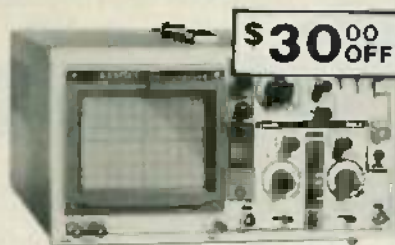

\$30.00 OFF

Save \$30 on the RAMSEY 20MHz Dual Trace Oscilloscope

Unsurpassed quality at an unbeatable price, the Ramsey oscilloscope compares to others costing hundreds more. Features include a component testing circuit for resistor, capacitor, digital circuit and diode testing • TV video sync filter • wide bandwidth & high sensitivity • internal graticule • front panel trace rotator • Z axis • high sensitivity x-y mode • regulated power supply • built-in calibrator • rock solid triggering

Was \$399.95 NOW ONLY **\$369.95** High quality hook on probes included

NEW 35 MHz DUAL TRACE OSCILLOSCOPE



A heavy duty and accurate scope for service as well as production use. Features include • wide frequency bandwidth • optimal sensitivity • extremely bright display • delayed triggering sweep • hold off • ALT trigger • single sweep • TV sync • 5X magnification • XY or XYZ operation • HF/LF noise reduction

3500 Dual Trace Oscilloscope **\$499.95** includes 2 high quality probes

ALL OSCILLOSCOPES INCLUDE 2 PROBES

NEW 15 MHz DUAL TRACE PORTABLE OSCILLOSCOPE



Ideal for field/bench applications, this scope can display up to 15 MHz signals. Internal battery pack allows up to 2 hours operation on a single charge. Features include • built-in battery charger • 5X horizontal magnification • high brightness CRT • front panel trace rotator • internal rechargeable battery pack

2500 Portable Oscilloscope **\$449.95** includes 2 high quality probes



NEW RAMSEY 1200 VOM MULTITESTER

Check transistors, diodes and LEDs with this professional quality meter. Other features include: decibel scale • 20K volt metering system • 3% mirrored scale • polarity switch • 20 measuring ranges • safety probes • high impact plastic case

\$24.95 test leads and battery included



NEW RAMSEY D-4100 COMPACT DIGITAL MULTITESTER

Compact sized reliability and accuracy. This LCD digital multimeter easily fits in your pocket, you can take it anywhere. It features full overload protection • 3% digit LCD readout • recessed input jacks • safety probes • diode check function • 2000 hours battery life

\$24.95 test leads and battery included

MINI KITS—EASY TO ASSEMBLE, FUN TO USE BEGINNERS & PROS WILL HAVE A GREAT TIME WITH THESE KITS

FM MINI MIKE



A super high performance FM wireless mike kit! Transmits a stable signal up to 300 yards with exceptional audio quality by means of its built in electrical mike. Kit includes case, mike, on-off switch, antenna, battery and super instructions. This is the finest unit available.

FM-3 Kit **\$14.95**
FM-3 Wired and Tested **19.95**

Color Organ

See music come alive! 3 different lights flicker with music. One light each for high, mid-range and lows. Each individually adjustable and drives up to 300 W. runs on 110VAC.

Complete kit, ML-1 **\$8.95**

Video Multimeter Kit

Converts any TV to video monitor. Super stable, luminous color CRT. Runs on 5-15V. accepts all video inputs. Best unit on the market! Complete kit, VL-1 **\$9.95**

Super Sleuth

A super sensitive amplifier which will pick up a pin drop at 15 feet! Great for monitoring baby's room or as general purpose amplifier. Full 2W rms output, runs on 6 to 15 volts, uses 8-45 ohm speaker. Complete kit, BN-9 **\$5.95**

Led Blinker Kit

A great attention getter which alternately flashes 2 jumbo LEDs. Use for name badges, buttons, warning panel lights, anything! Runs on 3 to 15 volts. Complete kit, BL-1 **\$2.95**

CPO-1

Runs on 3-12 Vdc. 1 watt out. 1 KHZ good for CPO. Alarm, Audio Oscillator. Complete kit **\$2.95**

FM Wireless Mike Kit



Transmits up to 300' to any FM broadcast radio, uses any type of mike. Runs on 3 to 9V. Type FM-2 has added sensitive mag preamp stage.

FM-1 Kit **\$3.95** FM-2 Kit **\$4.95**

Whisper Light Kit

An interesting kit, small mike picks up sounds and converts them to light. The louder the sound, the brighter the light. Includes mike, controls up to 300 W. runs on 110 VAC. Complete kit, WL-1 **\$6.95**

Tone Decoder

A complete tone decoder on a single PC board. Features 400-5000 Hz adjustable range via 20 turn pot, voltage regulation, 567 IC. Useful for touch-tone burst detection, FSK, etc. Can also be used as a stable tone encoder. Runs on 5 to 12 volts. Complete kit, TD-1 **\$6.95**

Universal Timer Kit

Provides the basic parts and PC board required to provide a source of precision timing and pulse generation. Uses 555 timer IC and includes a range of parts for most timing needs.

UT-5 Kit **\$6.95**

Mad Blaster Kit

Produces LOUD ear shattering and attention getting siren like sound. Can supply up to 15 watts of obnoxious audio. Runs on 6-15VDC.

MB-1 Kit **\$4.95**

Siren Kit

Produces upward and downward wail characteristic of a police siren. 5 W peak audio output runs on 3-15 volts, uses 3-45 ohm speaker. Complete kit, SM-3 **\$2.95**

96 Hr Time Base

Runs on 5-15 VDC. Low current (25mA), 1 min. accuracy. TB-1 Kit **\$6.95**

30 Watt 2 mtr PWR AMP

Simple Class C power amp features 8 times power gain, 1 W in for 8 out, 2 W in for 16 out, 4 W in for 30 out. Max output of 35 W incredible value, complete with all parts, less case and T-R relay.

PA-1, 30 W per amp kit **\$22.95**
PA-1, RF sensed T-R relay kit **6.95**

Power Supply Kit

Complete triple regulated power supply provides variable 6 to 18 volts at 200 ma and 8 at 1 Amp. Excellent load regulation, good filtering and small size. Less transformers, requires 8 3/4" x 1 1/2" and 24 VCT. Complete kit, PS-3LT **\$6.95**

CT-70 7 DIGIT 525 MHz COUNTER

Lab quality at a break through price. Features • 3 frequency ranges each with pre amp • dual selectable gate times • gate activity indicator • 50mV @ 150 MHz typical sensitivity • wide frequency range • 1 ppm accuracy

\$139.95 wired includes AC adapter
CT-70 kit **\$119.95**
BP-4 nicad pack **6.95**

CT-90 9 DIGIT 600 MHz COUNTER

The most versatile for less than \$300. Features 3 selectable gate times • 8 digits • gate indicator • display hold • 20mV @ 150 MHz typical sensitivity • 10 MHz timebase for WWW calibration • 1 ppm accuracy

\$169.95 wired includes AC adapter
CT-90 kit **\$149.95**
CR-1 0.1 PPM oven timebase **\$9.95**
BP-4 nicad pack **6.95**

CT-50 8 DIGIT 600 MHz COUNTER

\$189.95 wired
CT-50 kit **\$159.95**
RA-1 receiver adapter kit **14.95**

CT-125 9 DIGIT 1.2 GHz COUNTER

\$189.95 wired includes AC adapter
CT-125 kit **\$169.95**
BP-4 nicad pack **10.95**

OM-700 DIGITAL MULTIMETER

Professional quality at a hobbyist price. Features include 26 different ranges and 8 functions • 3 1/2 digit, 1 1/2 inch LED display • automatic decimal placement • automatic polarity

\$119.95 wired includes AC adapter
OM-700 kit **\$99.95**
MP-1 Probe set **4.95**

PR-2 COUNTER PREAMP

The PR-2 is ideal for measuring weak signals from 10 to 1,000 MHz • Bat 25 db gain • BNC connectors • Great for shifting RF • ideal receiver/TV preamp

\$49.95 wired includes AC adapter
PR-2 kit **\$39.95**

PS-2 AUDIO MULTIPLIER

The PS-2 is handy for high resolution audio resolution measurements. Multiplies up in 1/2 quantity • great for PL tone measurements • multiplies by 10 or 100 • 0.01 Hz resolution • built-in signal preamp/conditioner

\$69.95 wired
PS-2 kit **\$49.95**

PS-10B 1.5 GHz PRESCALER

Extends the range of your present counter to 1.5 GHz • 2 stage preamp • driven by 5000 ohm load • super sensitive (50 mV typical) • BNC connectors • 1 GHz in, 1 MHz out • drive any counter

\$89.95 wired includes AC adapter
PS-10B Prescaler **\$89.95**

ACCESSORIES FOR RAMSEY COUNTERS

- Telescopic whip antenna—BNC plug **\$ 8.95**
- High impedance probe, light loading **16.95**
- Low pass probe, audio use **16.95**
- Direct probe, general purpose use **13.95**
- Tilt ball, for CT-70, 90, 125 **3.95**

PHONE ORDERS CALL **716-586-3950**
TELEX 466735 RAMSEY CI

TERMS • satisfaction guaranteed • examine for 10 days, if not pleased, return in original form for refund • add 6% for shipping and insurance to a maximum of \$10.00 • overseas add 15% for surface mail • CDD add \$2.50 (CDD in USA only) • order under \$15.00 add \$1.50 • NY residents add 7% sales tax • 90 day Parts warranty on all kits • 1 year parts & labor warranty on all wired units

RAMSEY ELECTRONICS, INC.
2575 Baird Rd.
Penfield, N.Y. 14526

TENMA

© 1986, MCM Electronics

TENMA Combination Function Generator and Frequency Counter

- Six digit display • Output range: 2Hz-2MHz, seven ranges • Counter range: .1Hz-10MHz • 5-15V TTL and CMOS output
- Wave forms: sine, triangle, square, pulse, and ramp For detailed specifications call for a complete Tenma catalog

#72-380
\$21990
(ea.)

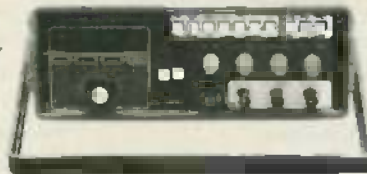

THE NAME YOU CAN TRUST IN ELECTRONIC TEST EQUIPMENT

TENMA Combination DMM/ Capacitance Meter

- Measures voltage, AC and DC current up to 10A
- Resistance up to 20Mohm
- Capacitance up to 20µF
- Built-in transistor tester
- Test leads and carrying case included • For detailed specifications call for a complete Tenma Catalog

#72-045
\$7495
(ea.)

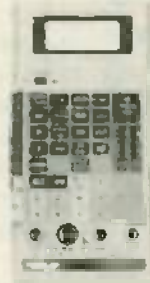

TENMA 120MHz Frequency Counter

- Eight digit LED display • Measurement range: .1Hz-120MHz • High input sensitivity of 20mV RMS For detailed specifications call for a complete Tenma catalog

#72-375
\$18995
(ea.)

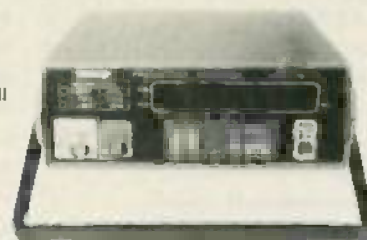

TENMA 30A Power Supply

- Output voltage, 1-15VDC • Lighted cross needle meter. Displays voltage, current and power simultaneously • Output current, 30A, 24A Continuous • Fan cooled

#72-035
\$22780
(ea.)

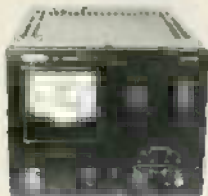

TENMA Digital LCR Meter

- Measures inductance, capacitance and resistance • L = 1µH-200H, C = .1pF-200µF, R = .01ohm-20Mohm
- Carrying case included. For detailed specifications call for a complete Tenma catalog.

#72-370
\$14995
(ea.)



TENMA Clamp-On/DMM

- Measures AC current via clamp • High quality built-in DMM measures DC volts, AC volts, resistance, AC current • Peak hold • Data hold • Audible continuity buzzer • Test leads and carrying case included. For detailed specifications call for a complete Tenma catalog.

#72-395
\$8490
(ea.)

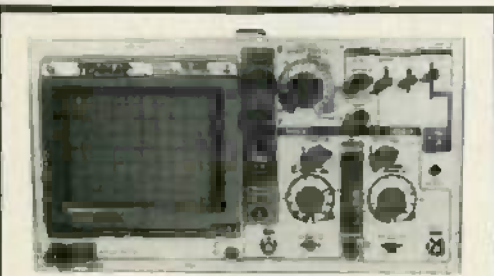

TENMA 20MHz Dual Trace Oscilloscope

- Two high quality 10:1 probes included. For detailed specifications call for a complete Tenma catalog

#72-320
\$38995 **SPECIAL!**
\$34995
(ea.)



TENMA 4 1/2" Digit Multimeter

- True RMS AC voltage and current functions • Built-in frequency counter, 20KHz and 200KHz range • Date hold feature • Measures AC and DC voltage/current, resistance and frequency • Carrying case included.

#72-430
\$15980
(ea.)



Be Sure To Call For Your FREE Catalog! Over 6,000 Items!

We also have ... a full line of test equipment, computer accessories, telephone accessories, speakers, television parts, flybacks, yokes, switches, fuses, lamps, capacitors, resistors, cartridges, styli, wire, CATV equipment, the largest selection of original Japanese semiconductors in the country and more.



Terms: •\$10 minimum order \$1.00 charge for orders under \$10
•\$20 minimum charge card order.
•Orders shipped UPS G.O.D.
•Most orders shipped within 24 hours
•Sales office open 8:30 am to 7:00 pm Saturdays 10:00 am to 3 pm EST
•For prepaid orders add \$2.75 for shipping and handling
•Should shipping and handling charges exceed \$2.75, the balance due will be sent C.O.D.



858 E. CONGRESS PARK DR. • CENTERVILLE, OH 45459
(513) 434-0031



MCM ELECTRONICS

A PREMIER Company

SOURCE NO. RE-27

CALL TOLL FREE 1-800-543-4330
In Ohio 1-800-762-4315 • In Alaska and Hawaii 1-800-858-1849

CIRCLE 87 ON FREE INFORMATION CARD

DECEMBER 1986

141

Saratoga Electronics

12380 SARATOGA-SUNNYVALE RD. SARATOGA, CA 95070



DYNAMIC RAMS

4164-150NS \$.99
41256-150NS 2.95

INTEGRATED CIRCUITS

65C02 \$8.95 MC10231P \$.39
ADC0816CCN 6.95 LF347 95
FO1797B-02 7.95 LM350K 2.00
WD2143M-02 4.95 MSM5832 1.95
PAL20L10NC 2.95

EPROMS

2716-450NS \$2.95
2732A-450NS 2.25
2764-450NS 3.00
2764-250NS 3.75
27256-300NS 6.75

DRIVES

Teac 55B \$ 85.00
Fujitsu M2551A 79.00
MIT 4853 Quad/QS 96 TP1 69.95
Seagate 20MB 1/2 Ht. 299.00
Quantum 40MB Full Ht. 795.00
Hard Disk Controller (Omif 5510) 109.00

PC/AT COMPATIBLE SYSTEM BOARD \$749.00

1 Megabyte Installed

PC/XT COMPATIBLE SYSTEM BOARD \$129.00

Turbo/640KB w/o Bios & Ram

PC/XT SYSTEM KIT \$795.00

Turbo/640KB

HARD DISK DRIVE \$895.00

PC AT Compatible
70MB—25msec Access

800/446-2949

TOLL FREE
800/621-0854 ext. 245

PRICES SUBJECT TO CHANGE
\$25 MIN. ORDER



CIRCLE 97 ON FREE INFORMATION CARD

ADVERTISING INDEX

RADIO-ELECTRONICS does not assume any responsibility for errors that may appear in the index below.

Free Information Number	Page		
—	"2001"	CV3	190
81	A.I.S. Satellite	43	126
108	AMC Sales	83	183
76	AP Products Brand of AMI	8	78
107	All Electronics	98	70
—	Amazing Devices	94	182
—	American Design Components	110	—
77	H&K Precision	39	97
98	Beckman Industrial	33	195,196
85	Blue Star Industries	43	192
109	C & S Sales	31	187
60	CIE	34	94
186	Cabletronics	44	185
180	Caig Laboratories	28	92
89	Cameo Enterprises	83	123
—	Command Productions	87	102
79,188	Communications Electronics	3,22	197
55	Contact East	43	199
184	Cook's Institute	89	103
—	Coop's Satellite Digest	80	—
125	Copper Electronics	28	—
191	Crosley	43	—
127	Deco Industries	43,44	—
56	Del. Phone Industries	44	—
95	Dick Smith Electronics	96,97	—
82	Digi-Key	105	—
—	Digital Research Computers	92	—
57	Digitron	92	—
194	ESI	26	—
—	Electronic Technology Today	43,44	—
120	Elephant Electronics	43	—
111	Etronix	40	—
100	Firestik II	89	—
—	Fischertechnik	30	—
121	Fluke Manufacturing	85	—
—	Fordham Radio	CV4	—
—	Grantham College of Engineering	15	—
62	Hameg	42	—
65	J & W	108	—
59	JDR Instruments	13	—
113,176	JDR Microdevices	100,101	—
177,178	JDR Microdevices	102,103	—
179	JDR Microdevices	104	—
114	Jameco	106,107	—
104	Jan Crystals	40	—
—	Joseph Electronics	9	—
87	MICM Electronics	111	—
93	Mark V. Electronics	99	—
200	MasterTech Laboratories	44	—
61	Microprocessors Unitd.	CD8	—
—	NRI	16	—
181	NTS	44	—
110	Omnitron	14	—
—	OrCad Systems	41	—
—	Pacific Cable	91	—
101	Pomona Electronics	7	—
—	Portasol	44	—
—	RAG Electronics	5	—
—	RCA D&SP	29	—
—	Radio Shack	95	—
—	Ramsey	109	—
—	Regency	11	—
—	RE Reprint Bookstore	12	—
—	Saratoga Electronics	112	—
—	Sencore	21,23	—
—	Siber Hiegner	24	—
—	Silicon Valley Surplus	94	—
—	Star Circuits	43	—
—	Steven Mail Order Electronics	87	—
—	Tektronix	CV2	—
—	Test Probes	44	—
—	Trio-Kenwood	32	—
—	United Electronic Supply	10	—
—	United Imports	43	—
—	Wm B Allen	27	—

Gernsback Publications, Inc.
500-B Bi-County Blvd.
Farmingdale, NY 11735
(516) 293-3000
President: Larry Steckler
Vice President: Cathy Steckler

For Advertising ONLY 516-293-3000

Larry Steckler
publisher
Arlene Fishman
advertising director
Shelli Weinman
advertising associate
Lisa Strassman
credit manager
Christina Estrada
advertising assistant

SALES OFFICES

EAST/SOUTHEAST

Stanley Levitan
Eastern Sales Manager
Radio-Electronics
259-23 57th Avenue
Little Neck, NY 11362
718-428-6037, 516-293-3000

MIDWEST/Texas/Arkansas/Okla.

Ralph Bergen
Midwest Sales Manager
Radio-Electronics
540 Frontage Road—Suite 339
Northfield, IL 60093
312-446-1444

PACIFIC COAST/ Mountain States

Marvin Green
Pacific Sales Manager
Radio-Electronics
15335 Morrison St.—Suite 227
Sherman Oaks, CA 91403
818-986-2001

2001 IS COMING IN MAY



An electronics revolution is in the making, but you don't have to wait until 2001 to find out how it will change your life in the 21st century. Radio-Electronics will forecast the coming changes and how they will affect you in the May 1987 issue!

Created by a special editorial task force—two years in preparation—this unique issue, 2001, takes you into the research laboratories of Westinghouse, Texas Instruments, Ford and Bell Labs where the future is being invented today!

You'll get an advance look at what's coming in artificial intelligence... new cars and highways (cleaner, quieter and more efficient)... futuristic energy sources like magneto-hydrodynamic and particle-beam generators... personal communications systems that will give you instant access to anyone anywhere... super computers and teaching breakthroughs that will multiply your capacity to learn!

Arthur Clarke introduces 2001. Isaac Asimov explores the marvels of robotics. But it is not science fiction. Rather it is

emerging technology with a solid foundation in current research and development.

And its impact will be enormous. It will change the way you work... the way you think... the way you live!

2001 is the kind of special publishing event that can only happen once in any magazine's lifetime and it will happen to Radio-Electronics in May, 1987.

With extra features and extra pages, 2001 will bear a premium cover cost, but you can reserve your copy now at less than the regular cover cost by mailing any one of the subscription orders in this issue.

2001 is coming in May. Make sure now that you don't miss it!

Radio-Electronics

BP Video Processor gives you precision picture control.



You'll get 5 units in one! The BP Video Processor functions as a **Stabilizer** to end video guard distortion... as an **Enhancer** to provide peak sharpness... as an **RF Converter** to feed signals from video cameras, computer or VCR in your TV... as a **Video Fader** for professional fade-in and fade-out effects... and as a **Dual Output Distribution Amplifier** to send TV signals to other sets.

\$79⁹⁵

Model V-1880

Preserve your memories on videotape



The video-cine converts your slides and home movies to VCR tape with any video camera. This easy to use model features precision optics and rear projection. Macro lens attachment available for cameras without close-up capability.

Model V-1701
\$34⁹⁵

Macro Lens Attachment
Model V-14 **\$14⁹⁵**

Increase the life of your VCR head and tape with BP VHS or Beta Tape Rewinders.



Don't risk worn-down heads and tape damage by rewinding on your VCR. BP Tape Rewinders feature counter, soft button action, controlled speed and automatic shutoff.

Model V-7779 **\$49⁹⁵**
VHS

Model V-7780 **\$49⁹⁵**
BETA

A small investment...buys

BIG VIDEO

PERFORMANCE!
Get the most out of your video and stereo equipment

Add Stereo to your Video



The mini speaker with maxi sound. 3" long throw woofer; 1" soft dome tweeter; 2" extended midrange speaker. Max power 50 watts.

\$29⁹⁵
per pair

Model HF-9

FM Antenna fine-tunes your fm/stereo reception.



You'll get clear, crisp, undistorted sound from this high quality, directional FM antenna. Mounts instantly indoors, comes complete with coaxial cable and transformer.

\$34⁹⁵

Model FM-9700

Get true-to-life color...and reduce noise...with Audio Video Color Processor.



This versatile color processor corrects off color tape, eliminates single color dominance and restores sharpness in detail. Plus, it stabilizes copy guarded tapes and filters audio noise.

\$149⁹⁵

Model V-1895

Send for FREE catalog of hundreds of items. Money orders, checks accepted. C.O.D.'s require 25% deposit.

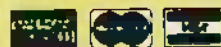

Fordham

260 Motor Parkway, Hauppauge, NY 11788

Toll Free
800-645-9518
In NY State 800-832-1448

Service & Shipping Charge Schedule
Continental U.S.A.

FOR ORDERS	ADD
\$25-\$100	\$4.50
\$101-\$250	\$8.00
\$251-\$500	\$8.00
\$501-750	\$10.50
\$751-1,000	\$12.50
\$1,001-1,500	\$16.50
\$1,501-2,000	\$20.00
\$2,001 and up	\$25.00