

# **DS-530 II/DS-575W II/DS-770 II User's Guide**



---

# Contents

<b>DS-530 II/DS-575W II/DS-770 II User's Guide</b> .....	<b>7</b>
<b>Scanner Basics</b> .....	<b>8</b>
Scanner Parts Locations .....	8
Scanner Parts.....	9
Scanner Buttons and Lights.....	12
User Replaceable Epson Scanner Parts .....	15
Changing the Power Off and Sleep Timer Settings .....	16
Using the Epson Smart Panel Mobile App.....	18
<b>Loading Originals</b> .....	<b>19</b>
Loading Originals in the Input Tray.....	19
Loading Multiple Sizes of Originals in the Input Tray .....	26
Original Document Specifications.....	29
Loading Plastic and Laminated Cards in the Input Tray .....	33
Plastic and Laminated Card Specifications .....	38
Loading Special Originals.....	38
Special Original Specifications .....	44
<b>Wi-Fi Networking</b> .....	<b>46</b>
Network Security Recommendations .....	46
Connecting to an Existing Wi-Fi Network .....	47
Manually Connecting to a Wi-Fi Network.....	48
Setting Up Wireless Scanning from a Smart Device Using Epson Smart Panel.....	48
Direct Wi-Fi Mode (AP Mode) Setup .....	50
Enabling a Direct Wi-Fi (AP Mode) Connection .....	51
Using WPS to Set Up a Direct Wi-Fi Connection .....	51
Wi-Fi Protected Setup (WPS).....	52
Using WPS to Connect to a Network .....	52
Using WPS PIN Mode to Connect to a Network .....	53
Setting Up Network Scanning .....	54
Determining the Scanner's IP Address .....	57
Disabling Wi-Fi Features .....	57

Restoring Default Network Settings.....	57
<b>Scanning .....</b>	<b>59</b>
Starting a Scan.....	59
Starting a Scan from a Scanner Button.....	59
Adding and Assigning Scan Jobs with Document Capture Pro - Windows .....	60
Assigning Start Button Settings or Scan Jobs - Mac .....	63
Starting a Scan Using the Epson Scan 2 Icon .....	64
Starting a Scan from a Scanning Program.....	66
Starting a Scan from a Smart Device.....	68
Scanning with Simple Scan in Document Capture Pro - Windows .....	68
Scanning with Job Scan in Document Capture Pro - Windows .....	70
Scanning with Document Capture - Mac .....	71
Scanning in Epson Scan 2 .....	75
Additional Scanning Settings - Main Settings Tab .....	79
Additional Scanning Settings - Advanced Settings Tab .....	80
Scanning Settings for Special Documents.....	81
Image Format Options .....	82
Scan Resolution Guidelines .....	83
Scanning Special Projects.....	84
Scanning Two Originals onto One Sheet (Stitching Images) - Windows .....	84
Scanning Multi-Page Originals as Separate Files - Windows .....	87
Saving Scanned Documents as a Searchable PDF Using Epson Scan 2 .....	89
Saving Scanned Documents as a Searchable PDF with Document Capture - Mac.....	91
Saving a Scan as an Office Format File - Windows .....	94
Saving a Scan as an Office Format File - Mac.....	96
Scanning to a SharePoint Server or Cloud Service - Windows.....	100
Scanning to a SharePoint Server or Cloud Service - Mac .....	102
<b>Using the Optional Flatbed Scanner Dock - Windows .....</b>	<b>104</b>
Flatbed Scanner Dock Parts .....	104
Scanning from the Flatbed Scanner Dock.....	105
Scanning from the Docked Flatbed Scanner .....	105
Scanning from the ADF with the Flatbed Scanner Dock Attached .....	107
Cleaning the Flatbed Scanner Dock.....	109

Transporting the Flatbed Scanner Dock.....	109
<b>Cleaning and Transporting Your Scanner.....</b>	<b>112</b>
Cleaning Your Scanner .....	112
Cleaning Inside Your Scanner.....	112
Resetting the Number of Scans After Cleaning .....	117
Replacing the Scanner Rollers.....	119
Resetting the Scanner Roller Counter .....	125
Transporting Your Scanner .....	126
<b>Solving Problems .....</b>	<b>130</b>
Scanner Light Status .....	130
Solving Scanning Problems .....	133
Scanner Does Not Turn On or Turns Off Unexpectedly.....	133
Scanner Button Does Not Work as Expected .....	134
Scanning Software Does Not Operate Correctly .....	134
Cannot Start Epson Scan 2 .....	135
Original Feeds Incorrectly in Scanner.....	136
Original Jams in Scanner.....	137
Paper Protection Does Not Work Correctly .....	139
Scanning is Slow .....	140
Solving Network Scanning Problems .....	140
Cannot Scan Over a Network .....	141
Scanner Cannot Connect to a Wireless Router .....	142
Solving Scanned Image Quality Problems .....	143
Back of Original Image Appears in Scanned Image .....	143
Scanned Characters are Blurry .....	143
Characters are not Recognized During Conversion to Editable Text (OCR) .....	144
Ripple Patterns Appear in an Image .....	145
Spots or Lines Appear in All Scanned Images.....	145
Scanned Image is Cropped .....	146
Resetting the Epson Scan 2 Settings .....	146
Solving Flatbed Scanner Dock Problems .....	147
Scanned Image Edges are Cropped .....	147
Line of Dots Appears in All Scanned Images.....	147

Back of Original Image Appears in Scanned Document .....	148
Uninstall Your Scanner Software.....	148
Uninstalling Scanner Software - Windows.....	148
Uninstalling Scanner Software - Mac.....	149
Where to Get Help (U.S. and Canada) .....	150
Where to Get Help (Latin America).....	151
<b>Technical Specifications .....</b>	<b>153</b>
Windows System Requirements .....	153
Mac System Requirements .....	153
General Specifications .....	154
Dimension Specifications .....	155
Electrical Specifications .....	156
Environmental Specifications .....	158
Flatbed Scanner Dock Specifications (DS-530 II/DS-770 II) .....	158
Network Interface Specifications (DS-575W II) .....	159
Safety and Approvals Specifications .....	160
<b>Notices .....</b>	<b>163</b>
Important Safety Instructions.....	163
Restrictions on Copying .....	165
Default Delay Times for Power Management for Epson Products.....	166
Binding Arbitration and Class Waiver .....	166
Trademarks .....	169
Copyright Notice.....	170
libTIFF Software Acknowledgment.....	171
A Note Concerning Responsible Use of Copyrighted Materials.....	171
Copyright Attribution .....	171

---

# DS-530 II/DS-575W II/DS-770 II User's Guide

Welcome to the DS-530 II/DS-575W II/DS-770 II *User's Guide*.

For a printable PDF copy of this guide, [click here](#).

**Note:** Availability of products in this guide varies by country.

---

## Scanner Basics

See these sections to learn about the basic features of your scanner.

[Scanner Parts Locations](#)

[User Replaceable Epson Scanner Parts](#)

[Changing the Power Off and Sleep Timer Settings](#)

[Using the Epson Smart Panel Mobile App](#)

## Scanner Parts Locations

See these sections to identify the parts on your scanner.

[Scanner Parts](#)

[Scanner Buttons and Lights](#)

**Parent topic:** [Scanner Basics](#)



## Scanner Parts

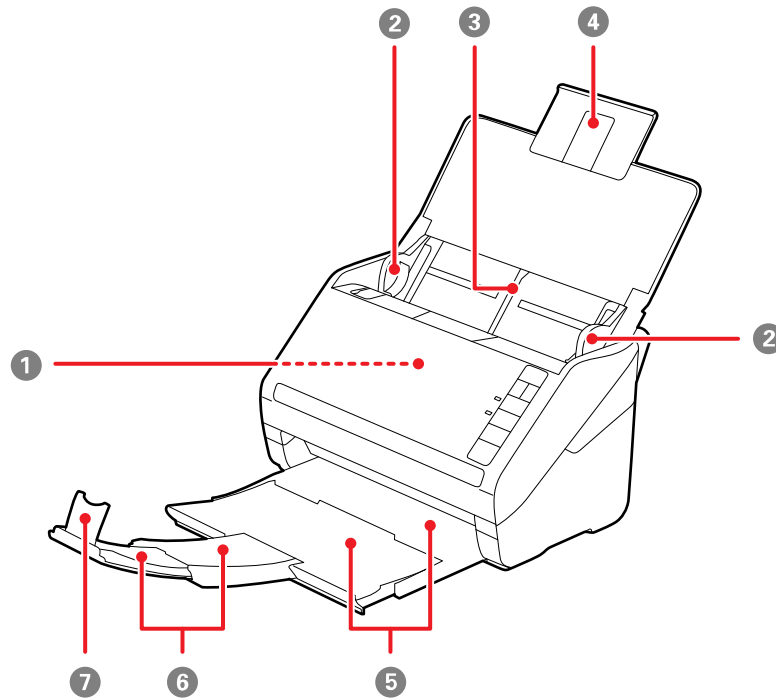

**Note:** The illustrations show the DS-575W II, but the parts are the same for the DS-530 II and DS-770 II.

- 1 ADF (Automatic Document Feeder)
- 2 Edge guides
- 3 Input tray
- 4 Input tray extension
- 5 Output tray
- 6 Output tray extensions

## 7 Stopper

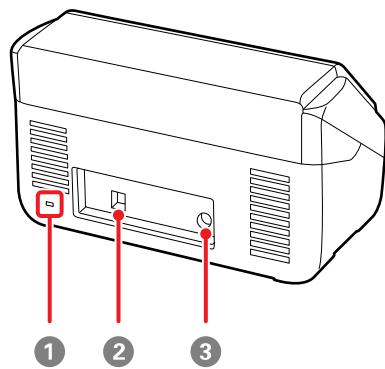

- 1 Kensington security slot
- 2 USB 3.0 port
- 3 Power inlet

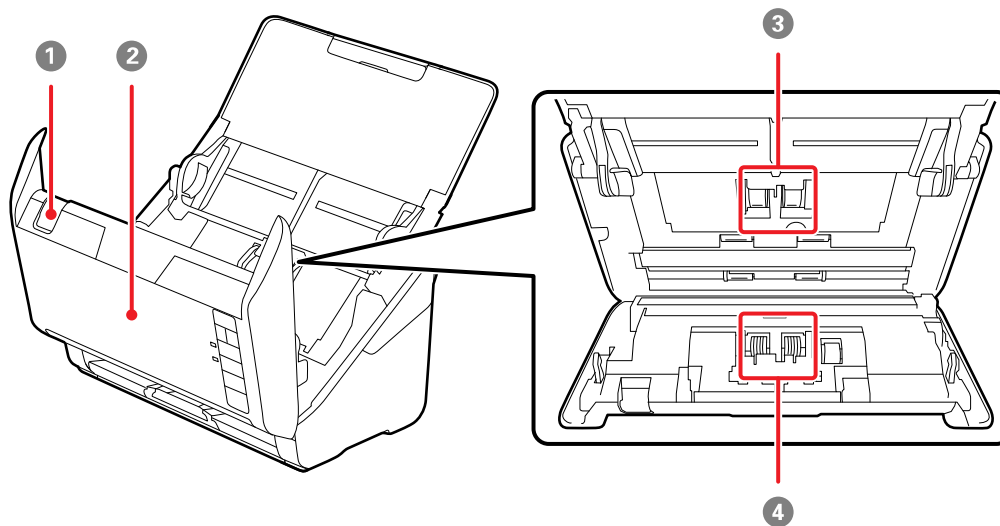

- 1 Cover open lever
- 2 Scanner cover
- 3 Pickup rollers
- 4 Separation rollers

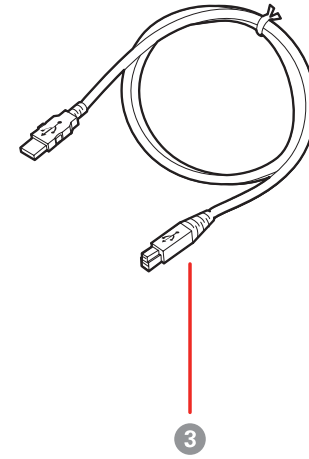
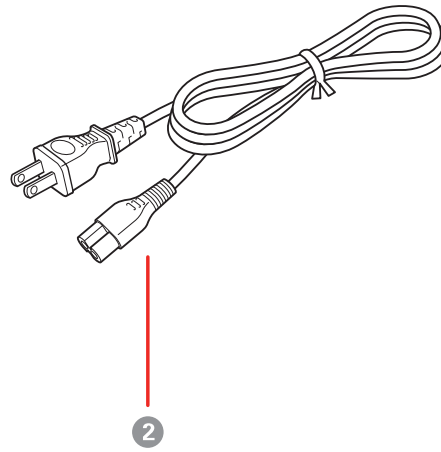
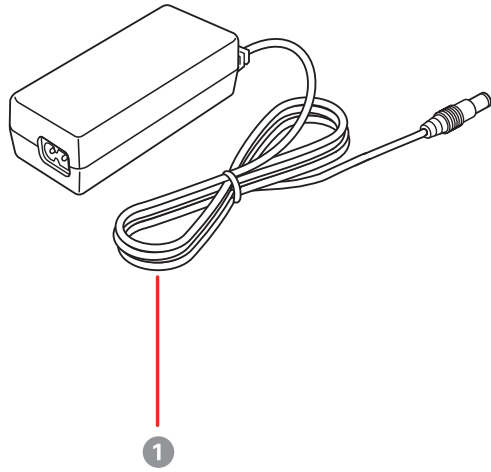

- 1 AC adapter
- 2 Power cord
- 3 USB 3.0 cable





**Parent topic:** [Scanner Parts Locations](#)

## Scanner Buttons and Lights

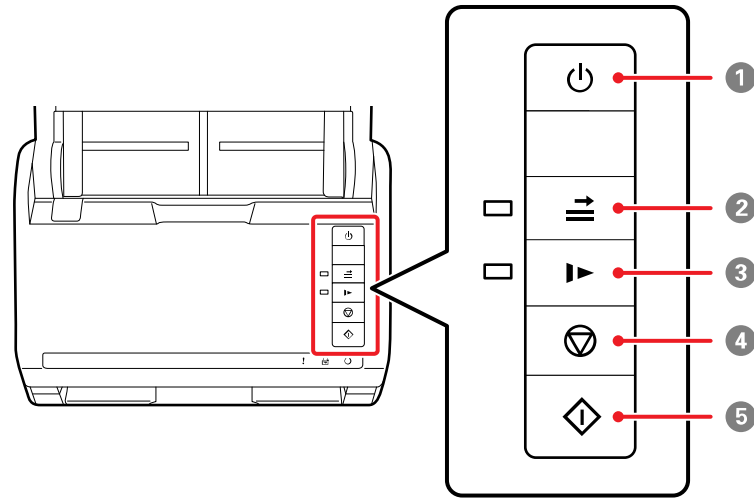
### Buttons







DS-530 II/DS-770 II

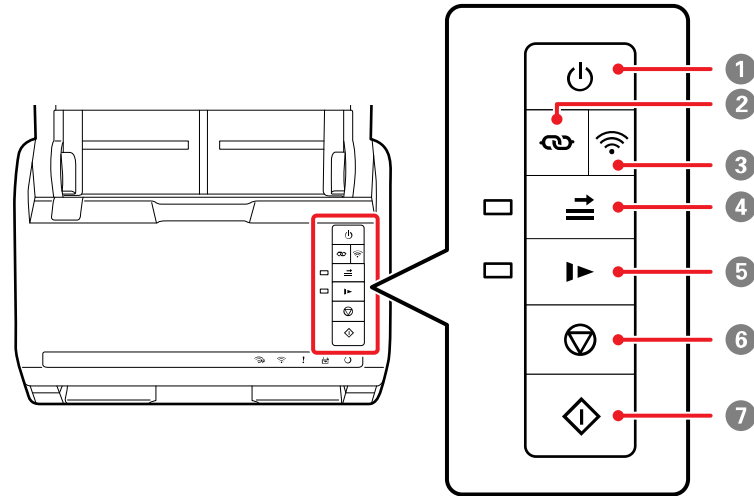

- 1  power button
- 2  double feed detection skip button
- 3  slow mode button
- 4  stop button
- 5  start button

## DS-575W II





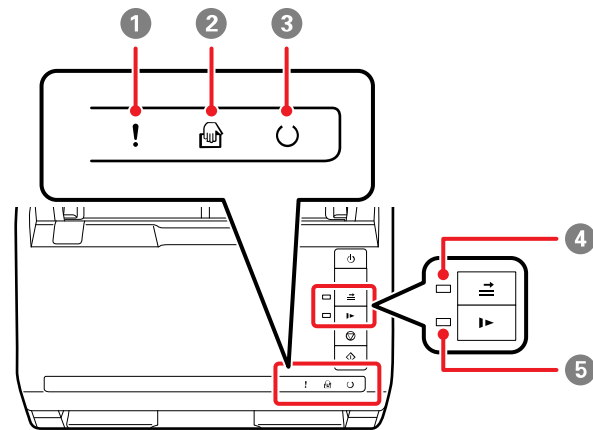

- 1  power button
- 2  Wi-Fi connect button
- 3  Wi-Fi button
- 4  double feed detection skip button
- 5  slow mode button
- 6  stop button
- 7  start button

## Lights







### DS-530 II/DS-770 II

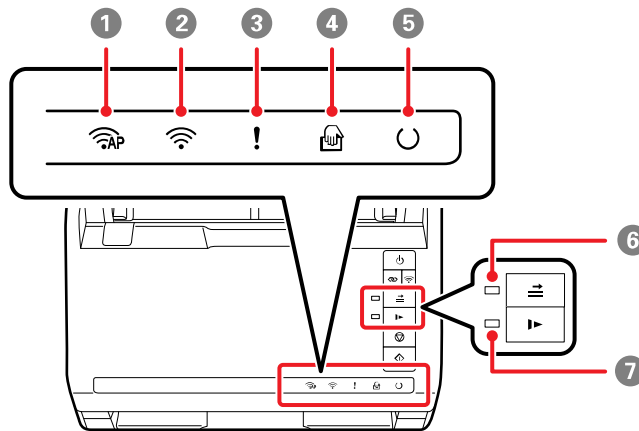

- 1 ! error light
- 2  automatic feeding mode light
- 3  ready light
- 4  double feed detection skip light
- 5  slow mode light

## DS-575W II



- 1  AP mode light
- 2  Wi-Fi light
- 3  ! error light
- 4  automatic feeding mode light
- 5  ready light
- 6  double feed detection skip light
- 7  slow mode light

Parent topic: [Scanner Parts Locations](#)

## User Replaceable Epson Scanner Parts

**U.S. and Canada:** You can purchase optional accessories and replacement parts at [epson.com](http://epson.com) (U.S. sales) or [epson.ca](http://epson.ca) (Canadian sales). You can also purchase accessories from an Epson authorized reseller. To find the nearest one, call 800-GO-EPSON (800-463-7766) in the U.S. or 800-807-7766 in Canada.

**Latin America:** You can purchase optional accessories and replacement parts from an Epson authorized reseller. To find the nearest reseller, go to [latin.epson.com](http://latin.epson.com). Or you can contact your nearest sales office as described in "Where to Get Help".

**Note:** Availability of accessories varies by country.

Part	Part number
Carrier sheet (5)	B12B819051
Roller assembly kit	B12B819671
Cleaning kit	B12B819291
Flatbed scanner dock (DS-530 II/DS-770-II only)	B12B819011
Epson Perfection V19 (for use with scanner dock)	B11B231201
Epson Perfection V39 (for use with scanner dock)	B11B232201

**Parent topic:** [Scanner Basics](#)

**Related references**



[Where to Get Help \(U.S. and Canada\)](#)

[Where to Get Help \(Latin America\)](#)

## Changing the Power Off and Sleep Timer Settings

You can use the Epson Scan 2 Utility to change the time period before the scanner enters sleep mode and turns off automatically.

**Note:** The Power Off and Sleep Timer settings may not be available when you connect to the scanner over a network (ES-500W II) (DS-575W II).

1. Do one of the following to access the Epson Scan 2 Utility:
  - **Windows 10:** Click  and select **EPSON > Epson Scan 2 Utility**.
  - **Windows 8.x:** Navigate to the **Apps** screen and select **Epson Scan 2 Utility**.
  - **Windows (other versions):** Click  or **Start**, and select **All Programs** or **Programs**. Select **EPSON > Epson Scan 2 > Epson Scan 2 Utility**.
  - **Mac:** Open the **Applications** folder, open the **Epson Software** folder, and select **Epson Scan 2 Utility**.



2. Click the **Power Save** tab.

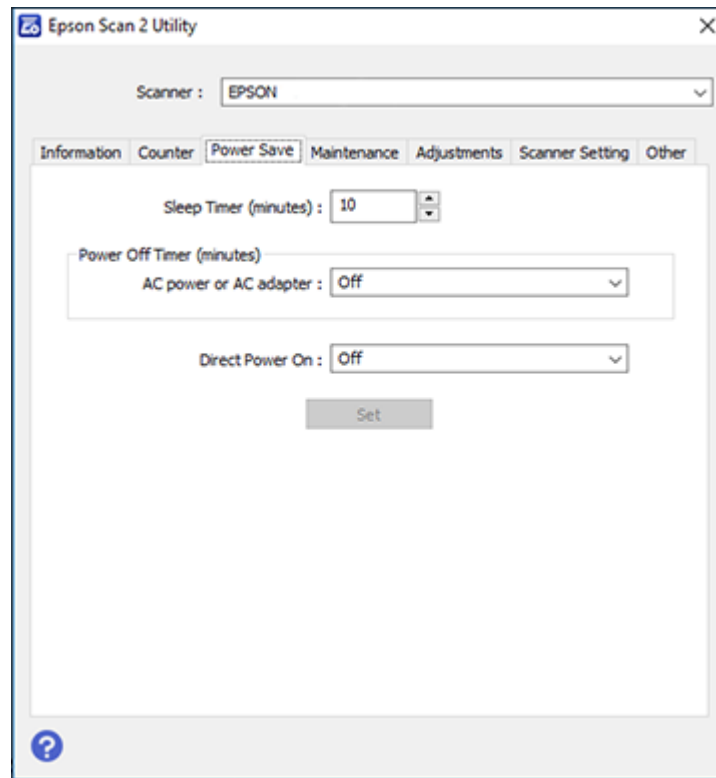

3. Select the length of time after which you want the scanner to go to sleep as the **Sleep Timer** setting.
4. Select the length of time after which you want the scanner to automatically turn off when not in use as the **Power Off Timer** setting.
5. Select the length of time after which you want the scanner to automatically turn off when not in use as the **AC power or AC adapter** setting. You can also turn off the timer.
6. Turn on the **Direct Power On** setting if you want the scanner to turn on when it is connected to the power source, without pressing the power button.
7. Click **Set** to save the settings.
8. Close the Epson Scan 2 Utility.

**Parent topic:** [Scanner Basics](#)

## Using the Epson Smart Panel Mobile App

Use this free Apple and Android app to scan with networked Epson products (DS-575W II).

1. Connect your product to your wireless network. See the link below.
2. Visit [epson.com/connect](http://epson.com/connect) (U.S), [epson.ca/connect](http://epson.ca/connect) (Canada), or [latin.epson.com/connect](http://latin.epson.com/connect) (Caribbean) to learn more about Epson Smart Panel and check the compatibility of your mobile device.
3. Download Epson Smart Panel from the Apple App Store or Google Play.
4. Connect your mobile device to the same wireless network as your product.
5. Open Epson Smart Panel and select your Epson product, if necessary.

Now you are ready to scan with your mobile device and your Epson product.

**Parent topic:** [Scanner Basics](#)

### **Related tasks**

[Setting Up Network Scanning](#)

---

# Loading Originals

Follow the instructions here to load your originals into the scanner.

**Note:** The illustrations show the DS-575W II, but the steps are the same for the DS-530 II and DS-770 II.

[Loading Originals in the Input Tray](#)

[Loading Plastic and Laminated Cards in the Input Tray](#)

[Loading Special Originals](#)

## Loading Originals in the Input Tray

You can load originals that meet the document specifications in the input tray.

**Caution:** Do not load photos, valuable original documents or artwork, directly into the input tray. This may wrinkle or damage the original. Load these originals using an optional carrier sheet.

**Note:** Photos scanned using a document scanner may not have the same color depth as the original. Use a flatbed photo scanner with the optional flatbed scanner dock (DS-530 II/DS-770 II) to achieve the best color reproduction of photos.

The steps below describe loading originals of the same size. To load originals of multiple sizes at once, see the link at the end of these steps.

1. Open the input tray and pull up its extension.

2. Pull out the output tray and its extension, and open the stopper.

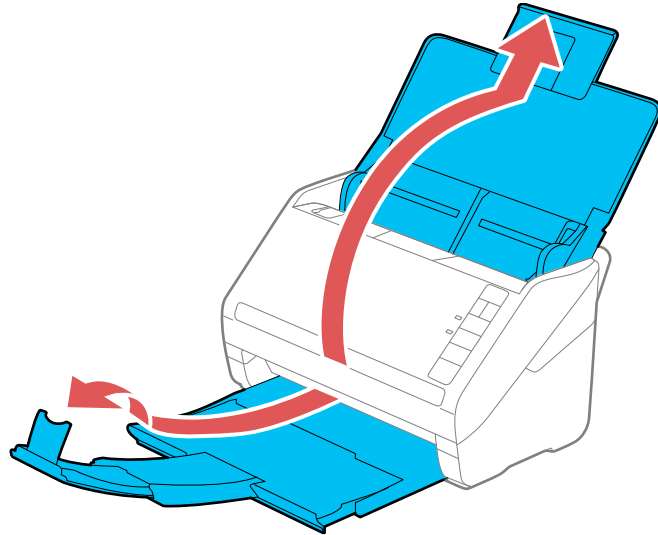

**Note:** If you are loading an original that is 15.5 inches (393.8 mm) or longer, do not pull out the input or output tray extensions and do not open the stopper.

3. Slide the input tray edge guides all the way out.

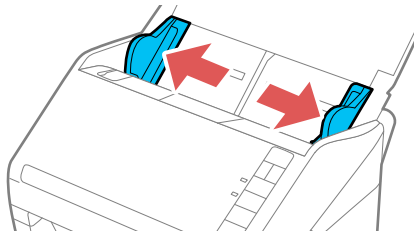

4. If you are loading a multi-page original, fan your stack of originals.

**Note:** If you are loading an original that is 15.5 inches (393.8 mm) or longer, load only one sheet at a time.

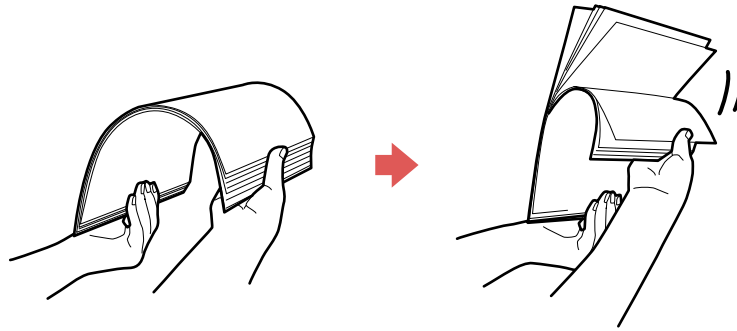

5. Stack the originals with the printed side facing down and slide the stack so the leading edge is at an angle as shown.

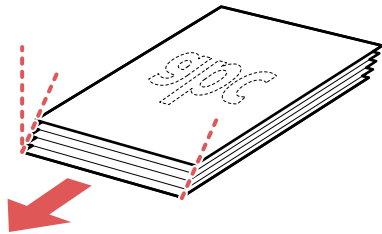

6. Load standard originals into the input tray printed side down and top edge first, and guide them in until they meet resistance.

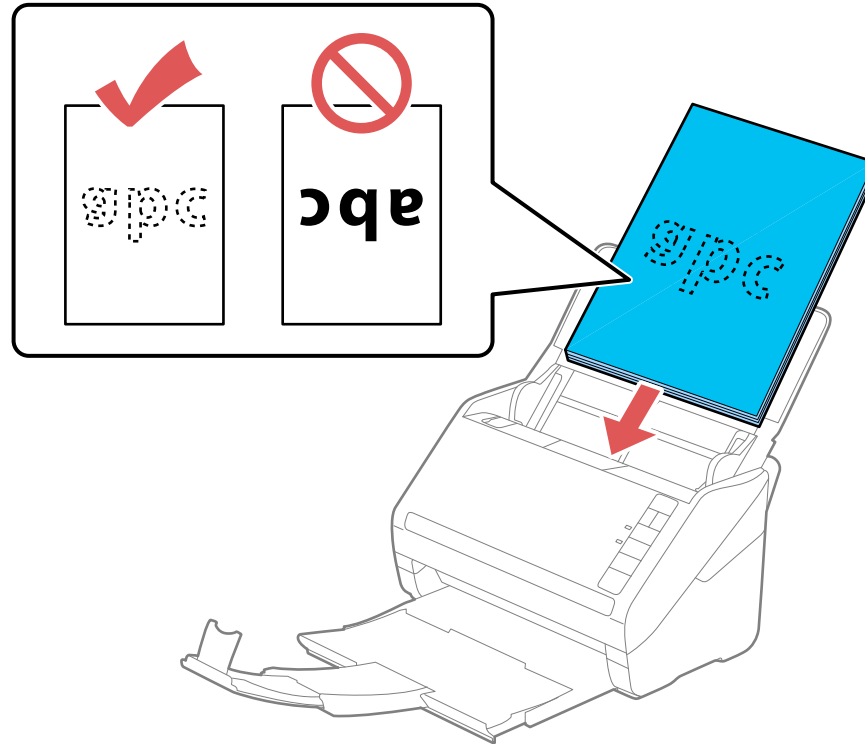

- If you are loading paper business cards, load up to 15 (DS-530 II/DS-575W II) or 30 (DS-770 II) cards printed side down and long edge first into the input tray horizontally, and slide them in until they meet resistance.

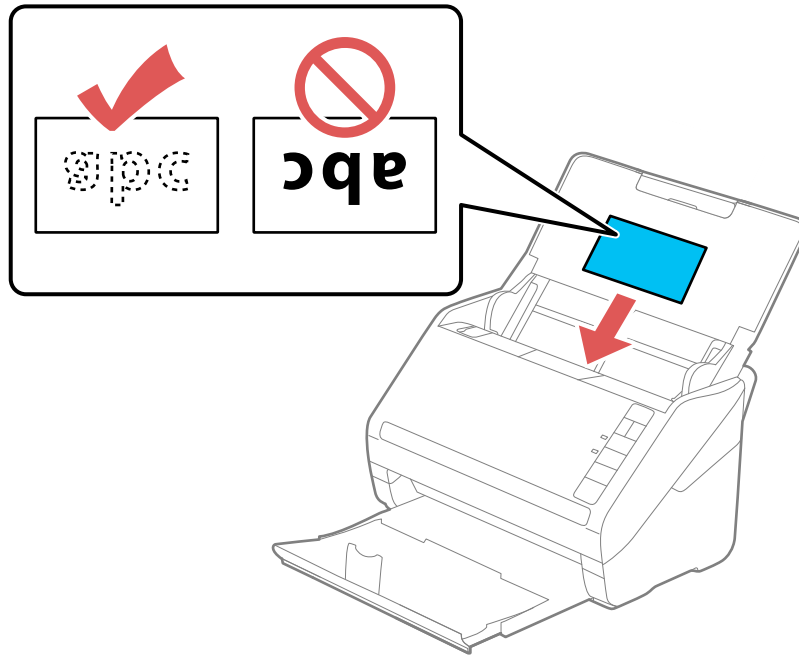

- If you are loading hole-punched originals, load them with the holes facing down or to the side as shown. The holes must be within 1.2 inches (30 mm) of the edge of the originals.

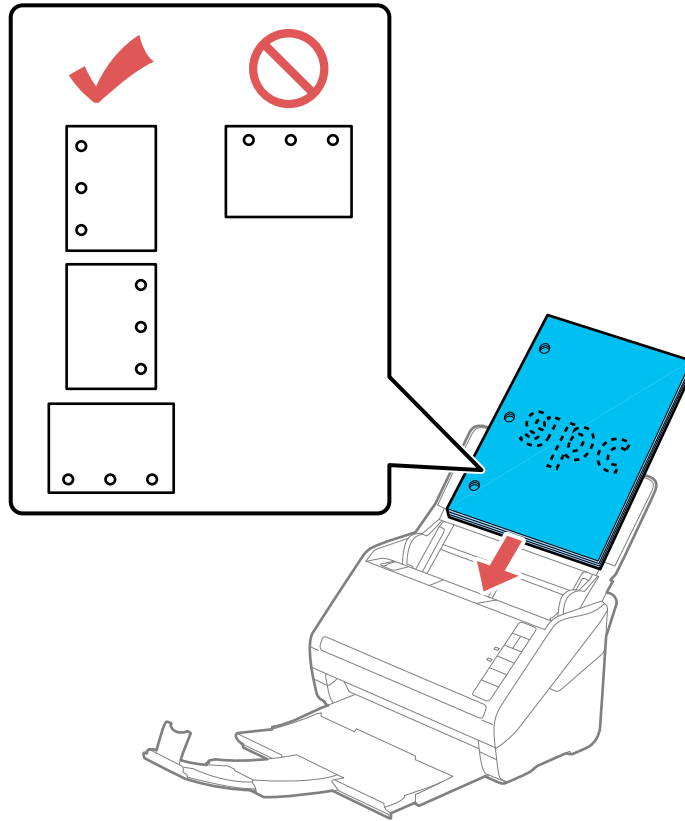

7. Slide the edge guides against the edges of the original.

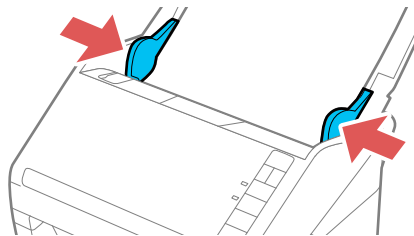



**Note:** If you are scanning originals that are 15.5 inches (393.8 mm) or longer, support the original as it enters into and ejects from the scanner as shown.

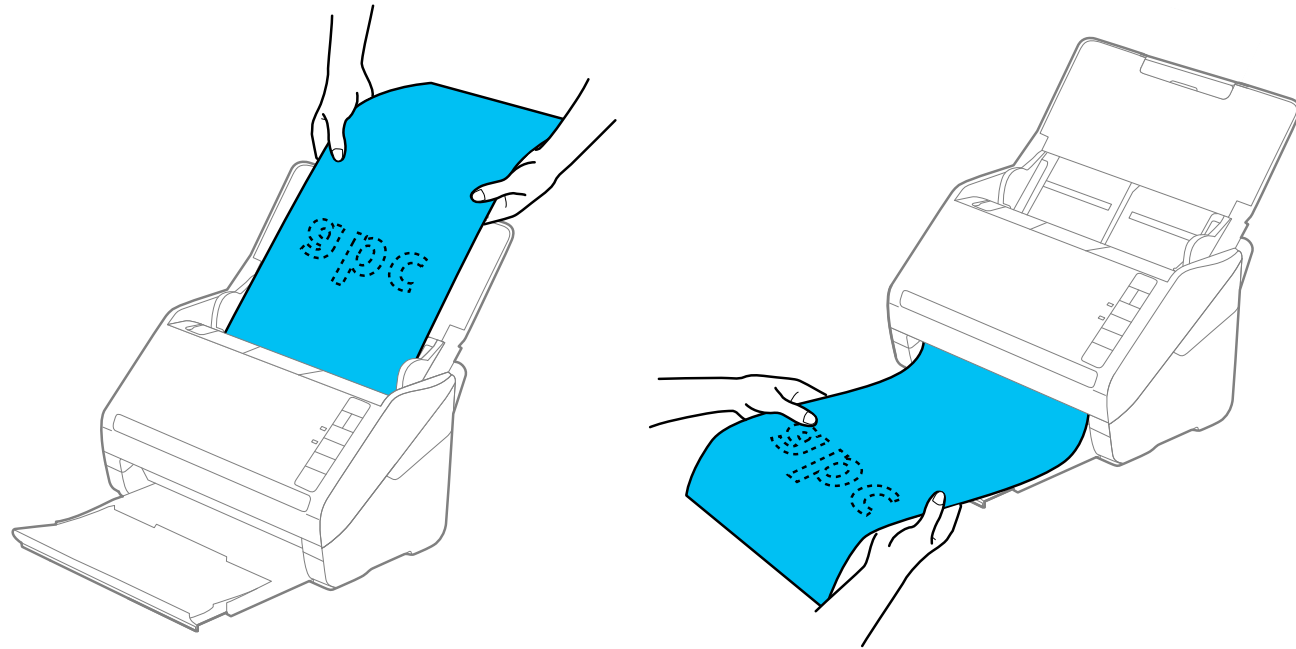

8. If necessary during scanning, adjust the position of the stopper on the output tray extension to fit the ejected originals.

**Note:** If thicker paper does not eject properly or falls from the output tray, push in the output tray and allow the originals to eject freely onto the surface below the scanner. If the scanned images are affected by the originals ejecting below the scanner, try placing the scanner on the edge of a table where the ejected originals can drop freely.

9. If scanning thin or wrinkled paper causes paper jams, press the  slow mode button once before scanning to slow down the feeding speed; press it again to return to normal speed.

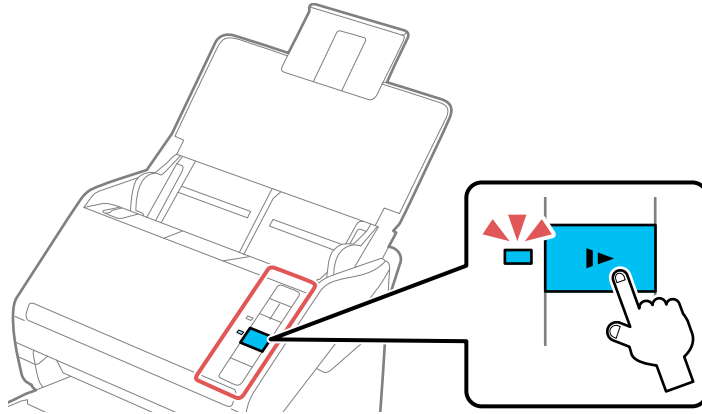

If a paper feed error is detected, the Paper Protection feature stops the scanning process automatically to reduce damage to the original. To change the Paper Protection detection level, open the Epson Scan 2 Utility, click on the **Scanner Setting** tab, and select the desired level from the Paper Protection drop-down list.

**Note:** The Paper Protection feature does not prevent all documents from being damaged. Paper feed errors may not be detected depending on the paper feeding conditions.

#### [Loading Multiple Sizes of Originals in the Input Tray](#)

[Original Document Specifications](#)

**Parent topic:** [Loading Originals](#)

#### **Related references**

[Original Document Specifications](#)

#### **Related topics**

[Scanning](#)

## **Loading Multiple Sizes of Originals in the Input Tray**

You can load originals of different sizes, paper types, and thicknesses at one time in the input tray. Just make sure they meet the original document specifications.

**Caution:** Do not load photos, or valuable original documents or artwork, directly into the input tray. This may wrinkle or damage the original. Load these originals using an optional carrier sheet.

**Note:** Photos scanned using a document scanner may not have the same color depth as the original. Use a flatbed photo scanner with the optional flatbed scanner dock (DS-530 II/DS-770 II) to achieve the best color reproduction of photos.

1. Open the input tray and pull up its extension.
2. Pull out the output tray and its extension, and open the stopper.

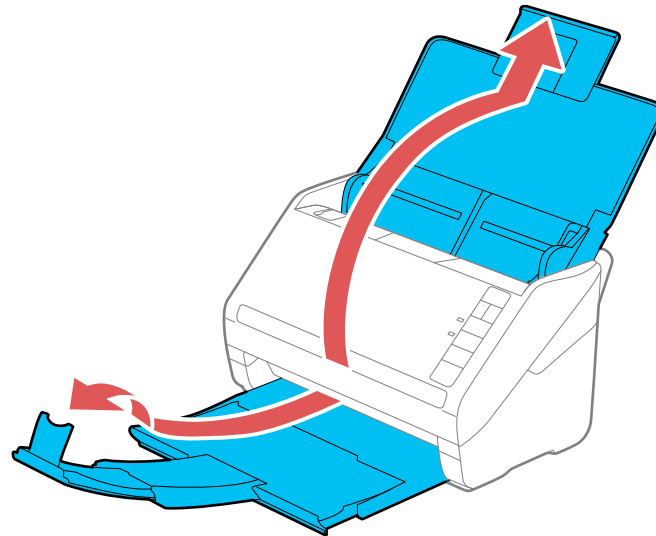

**Note:** If you are loading originals that are 15.5 inches (393.8 mm) or longer, do not pull out the input or output tray extensions and do not open the stopper.

3. Slide the input tray edge guides all the way out.

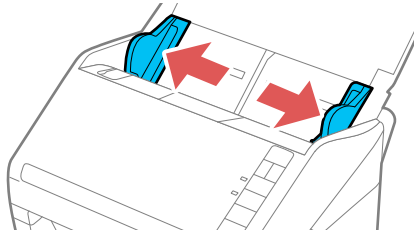

4. Load the originals in the input tray in descending order of paper size with the widest at the back and the narrowest at the front. Slide them in until they meet resistance. Make sure the printed sides are facedown and the top edges are slightly angled in the input tray.

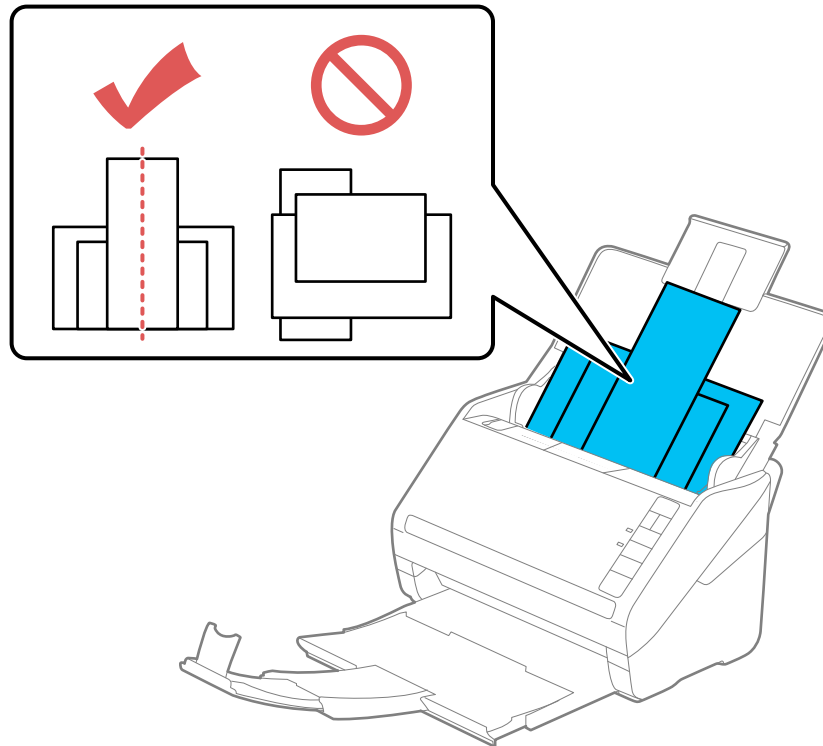

5. Slide the edge guides against the edges of the widest original.
6. If necessary during scanning, adjust the position of the stopper on the output tray extension to fit the ejected originals.

**Note:** If thicker paper does not eject properly or falls from the output tray, push in the output tray and allow the originals to eject freely onto the surface below the scanner. If the scanned images are affected by the originals ejecting below the scanner, try placing the scanner on the edge of a table where the ejected originals can drop freely.

If scanning thin or wrinkled paper causes paper jams, press the  slow mode button once before scanning to slow down the feeding speed; press it again to return to normal speed.

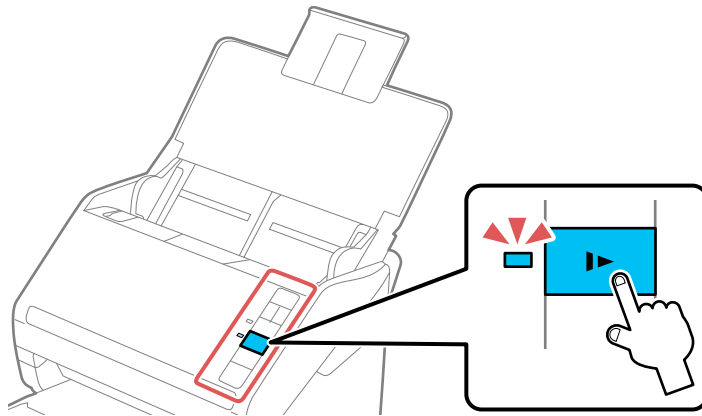

**Parent topic:** [Loading Originals in the Input Tray](#)

**Related topics**

[Scanning](#)

## Original Document Specifications

You can load original documents that meet these specifications in your scanner.

**DS-530 II/DS-575W II**

Paper type	Paper size	Paper weight	Loading capacity
Plain paper Fine paper Recycled paper	Letter (8.5 × 11 inches [216 × 279 mm])	7 to 110 lb (27 to 413 g/m <sup>2</sup> )	21 lb (80 g/m <sup>2</sup> ): 50 sheets
	Legal (8.5 × 14 inches [216 × 356 mm])		24 lb (90 g/m <sup>2</sup> ): 43 sheets
	A4 (8.3 × 11.7 inches [210 × 297 mm])		28 lb (104 g/m <sup>2</sup> ): 37 sheets
	A5 (5.8 × 8.2 inches [148 × 210 mm])		34 lb (127 g/m <sup>2</sup> ): 31 sheets
	A6 (4.1 × 5.8 inches [105 × 148 mm])		42 lb (157 g/m <sup>2</sup> ): 25 sheets
	B5 (7.2 × 10.1 inches [182 × 257 mm])		56 lb (209 g/m <sup>2</sup> ): 19 sheets
	B6 (5 × 7.2 inches [128 × 182 mm])		68 lb (256 g/m <sup>2</sup> ): 15 sheets
	A8 (2.1 × 2.9 inches [52 × 74 mm])	110 lb (413 g/m <sup>2</sup> ): 9 sheets	
	A8 (2.1 × 2.9 inches [52 × 74 mm])	34 to 110 lb (127 to 413 g/m <sup>2</sup> )	Loading capacity may vary depending on the paper type.
Paper business cards	Business cards	Up to 56 lb (210 g/m <sup>2</sup> )	15 cards loaded horizontally

**DS-770 II**

<b>Paper type</b>	<b>Paper size</b>	<b>Paper weight</b>	<b>Loading capacity</b>
Plain paper Fine paper Recycled paper	Letter (8.5 × 11 inches [216 × 279 mm])	7 to 110 lb (27 to 413 g/m <sup>2</sup> )	21 lb (80 g/m <sup>2</sup> ): 100 sheets
	A4 (8.3 × 11.7 inches [210 × 297 mm])		24 lb (90 g/m <sup>2</sup> ): 86 sheets
	A5 (5.8 × 8.2 inches [148 × 210 mm])		28 lb (104 g/m <sup>2</sup> ): 74 sheets
	A6 (4.1 × 5.8 inches [105 × 148 mm])		34 lb (127 g/m <sup>2</sup> ): 62 sheets
	B5 (7.2 × 10.1 inches [182 × 257 mm])		42 lb (157 g/m <sup>2</sup> ): 50 sheets
	B6 (5 × 7.2 inches [128 × 182 mm])		56 lb (209 g/m <sup>2</sup> ): 38 sheets
	A8 (2.1 × 2.9 inches [52 × 74 mm])		34 to 110 lb (127 to 413 g/m <sup>2</sup> )
		110 lb (413 g/m <sup>2</sup> ): 18 sheets	
			Loading capacity may vary depending on the paper type.

Paper type	Paper size	Paper weight	Loading capacity
Plain paper Fine paper Recycled paper	Legal (8.5 × 14 inches [216 × 356 mm])	7 to 110 lb (27 to 413 g/m <sup>2</sup> )	21 lb (80 g/m <sup>2</sup> ): 80 sheets 24 lb (90 g/m <sup>2</sup> ): 69 sheets 28 lb (104 g/m <sup>2</sup> ): 59 sheets 34 lb (127 g/m <sup>2</sup> ): 50 sheets 42 lb (157 g/m <sup>2</sup> ): 40 sheets 56 lb (209 g/m <sup>2</sup> ): 30 sheets 68 lb (256 g/m <sup>2</sup> ): 24 sheets 110 lb (413 g/m <sup>2</sup> ): 14 sheets
Paper business cards	Business cards	Up to 56 lb (210 g/m <sup>2</sup> )	30 cards loaded horizontally

**Note:** You can load originals of different sizes, paper types, and thicknesses up to this size: Letter (8.5 × 11 inches [216 × 279 mm]).

The following types of originals may not be successfully scanned or may require special attention:

- Originals with uneven surfaces, such as embossed documents or letterhead
- Originals with wrinkles or fold lines
- Perforated originals
- Originals with labels or stickers
- Carbonless paper
- Curled originals
- Coated paper

**Note:** Lightly wrinkled paper may scan better if you slow down the feeding speed during scanning or smooth out the wrinkles before loading. Use a carrier sheet to scan delicate originals or originals that are



easily wrinkled. To scan originals that are incorrectly detected as double feeds, press the  double feed detection skip button before scanning, or set the **Detect Double Feed** setting to **Off** on the Main Settings tab in the Epson Scan 2 window.

**Caution:** Do not load the following types of originals directly in the scanner, or they may be damaged or may damage the scanner:

- Photos
- Originals that are bound
- Passports
- Thermal paper
- Fabric or other non-paper originals
- Originals containing staples or paper clips
- Originals with wet ink or glue
- Ripped originals
- Heavily wrinkled or curled originals
- Originals with holes on the bottom of them
- Transparencies
- Originals with carbon paper backing
- Originals with sticky notes attached
- Glossy originals

**Note:** Photos scanned using a document scanner may not have the same color depth as the original. Use a flatbed photo scanner with the optional flatbed scanner dock (DS-530 II/DS-770 II) to achieve the best color reproduction of photos.

**Parent topic:** [Loading Originals in the Input Tray](#)

## Loading Plastic and Laminated Cards in the Input Tray

You can load plastic and laminated cards that meet the card specifications in the input tray.

1. Open the input tray, pull out the output tray, and open the stopper. Do not pull out the extensions.

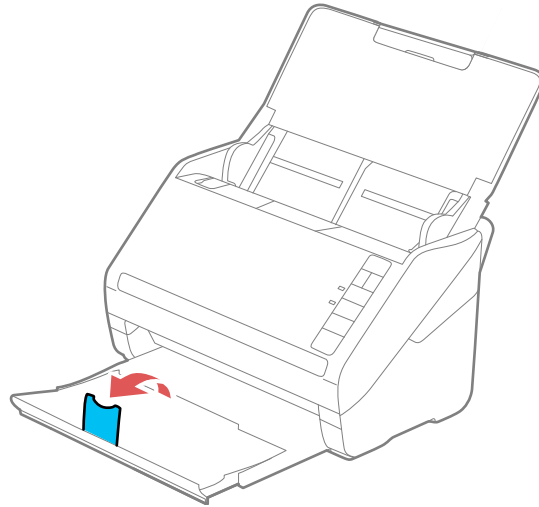

2. Slide the input tray edge guides all the way out.

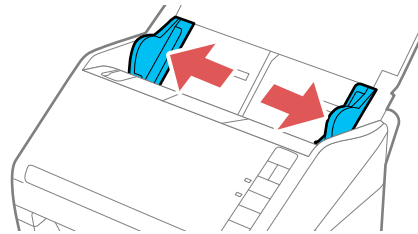

3. Load plastic or laminated cards printed side down and long edge first into the input tray horizontally, and slide them in until they meet resistance.

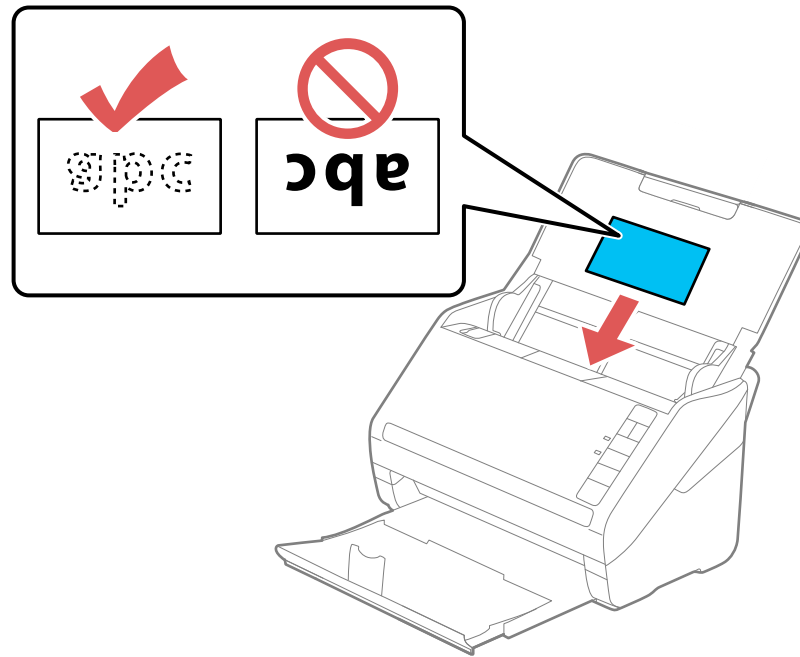

**Note:** Do not load plastic cards vertically.

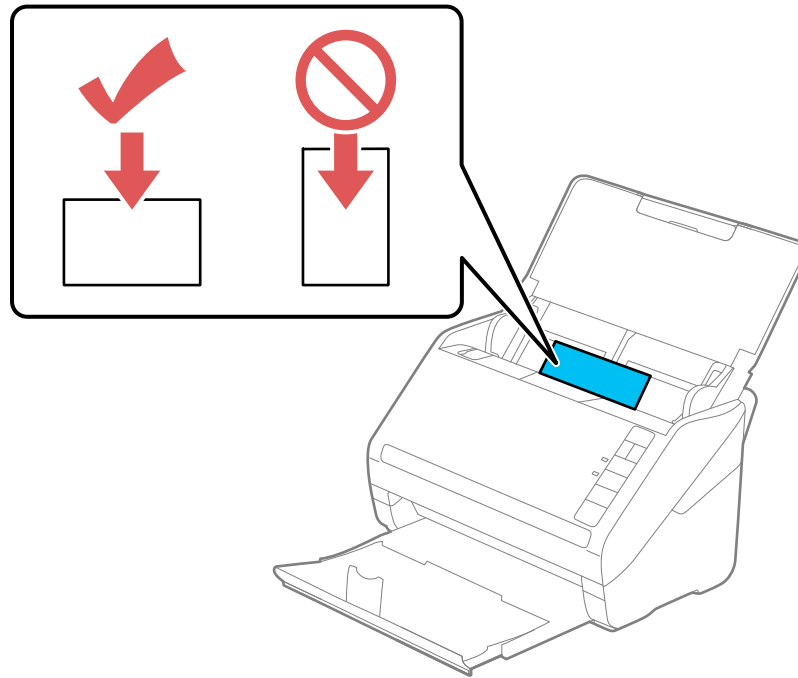

- Slide the edge guides against the edges of the card.

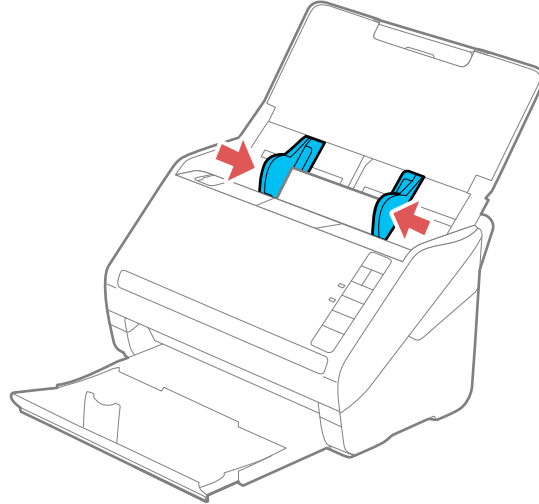

- Turn off the **Detect Double Feed** setting on the Main Settings tab in Epson Scan 2 when scanning the cards.

**Note:** If you do not disable the **Detect Double Feed** setting and a double feed error occurs, remove the plastic or laminated card from the input tray and reload it. Press the  double feed detection skip button to disable the Detect Double Feed feature and scan again.

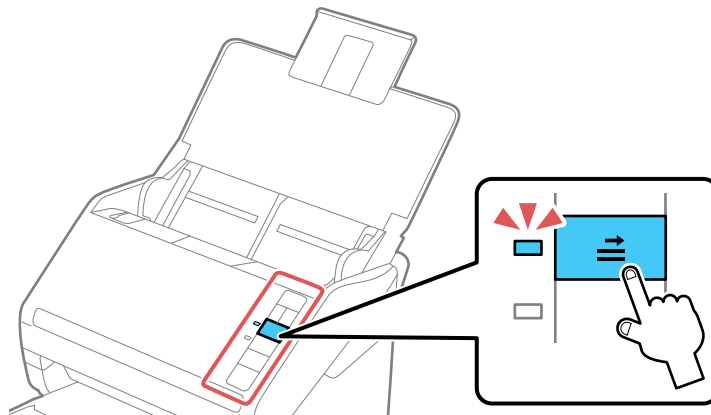

## Plastic and Laminated Card Specifications

**Parent topic:** [Loading Originals](#)

### Related references

[Plastic and Laminated Card Specifications](#)

### Related topics

[Scanning](#)

## Plastic and Laminated Card Specifications

You can load original plastic and laminated cards that meet these specifications in your scanner.

Paper type	Paper size	Paper thickness	Loading capacity
Plastic cards, embossed (ISO781A ID-1 compliant)	2.1 × 3.3 inches (54 × 85.6 mm)	0.05 inch (1.24 mm) maximum	1 card (horizontal)
Plastic cards, standard (ISO781A ID-1 compliant)		0.03 inch (0.76 mm) maximum	5 cards (horizontal)
Laminated cards	4.7 × 5.9 inches (120 × 150 mm) or smaller	0.03 inch (0.8 mm) maximum	1 card

**Note:** Plastic cards with glossy surfaces may not scan properly.

**Parent topic:** [Loading Plastic and Laminated Cards in the Input Tray](#)

## Loading Special Originals

You can load a photo or large, thick, or folded original in the input tray using one or more carrier sheets. You can also load envelopes. Make sure the originals meet the specifications for special originals before loading them.

1. Open the input tray and pull up its extension.

2. Pull out the output tray and its extension, and open the stopper.

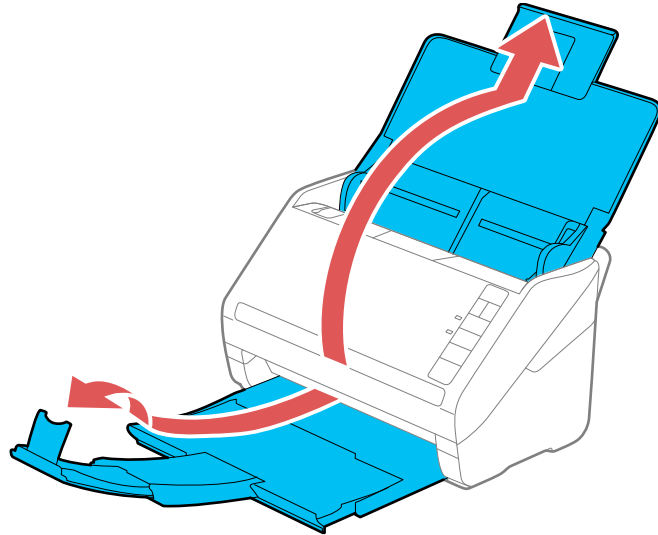

**Note:** If you are loading originals that are 15.5 inches (393.8 mm) or longer, do not pull out the input or output tray extensions and do not open the stopper.

3. Slide the input tray edge guides all the way out.

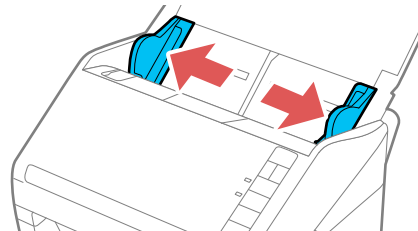

4. Load envelopes vertically in the input tray with the printable side down and the flap facing as shown. Slide in the envelopes until they meet resistance.

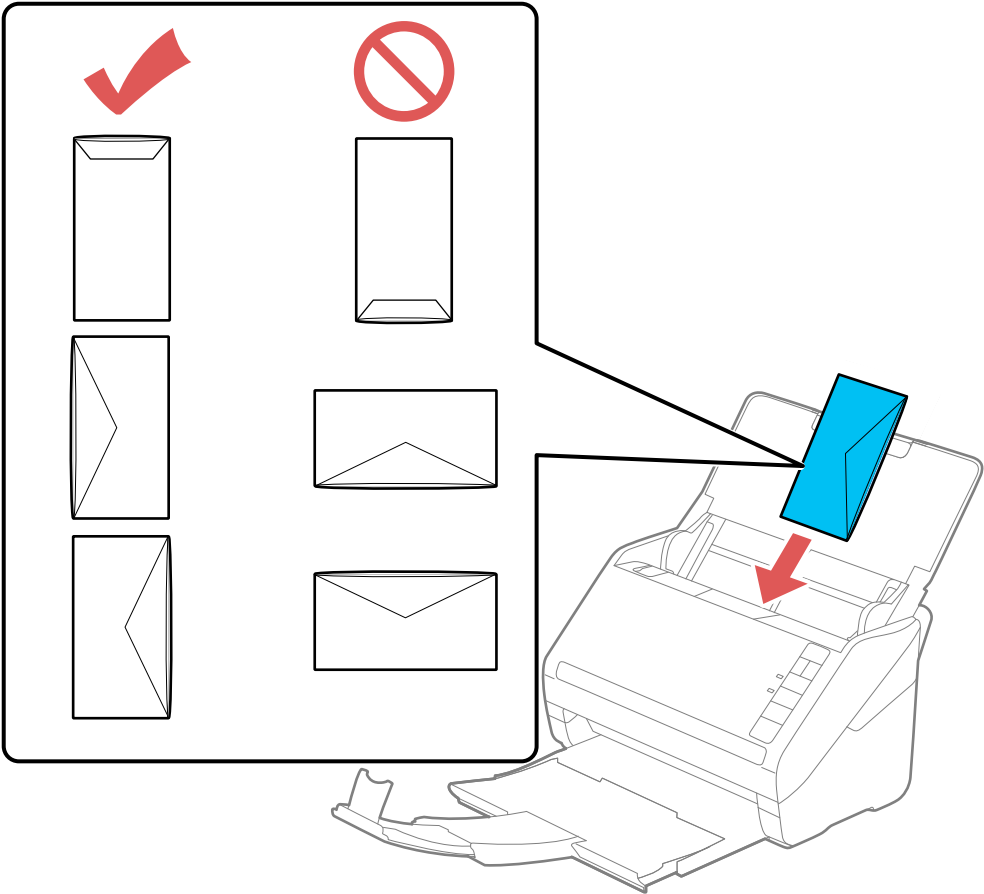



5. Do one of the following to load a photo, or folded or irregularly shaped originals:

- For a Letter- or A4-size or larger original, fold it as shown and place it in the center of an optional carrier sheet. Make sure the illustration on the front edge of the carrier sheet is facing up.

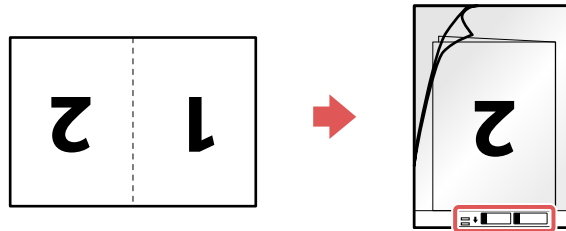

- For a photo or an irregularly shaped original, load it in the center of an optional carrier sheet with the printed side face down. Make sure the illustration on the front edge of the carrier sheet is facing up.

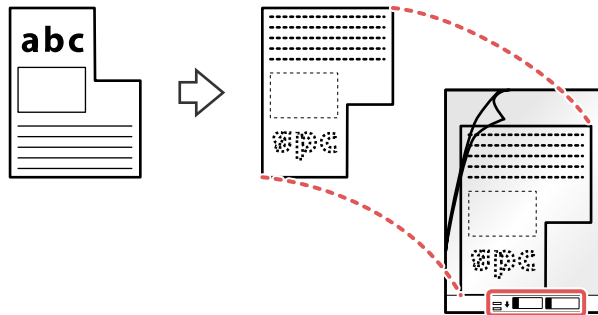

**Note:** Photos scanned using a document scanner may not have the same color depth as the original. Use a flatbed photo scanner with the optional flatbed scanner dock (DS-530 II/DS-770 II) to achieve the best color reproduction of photos.

6. Load the carrier sheet in the input tray as shown until it meets resistance.

**Folded original**

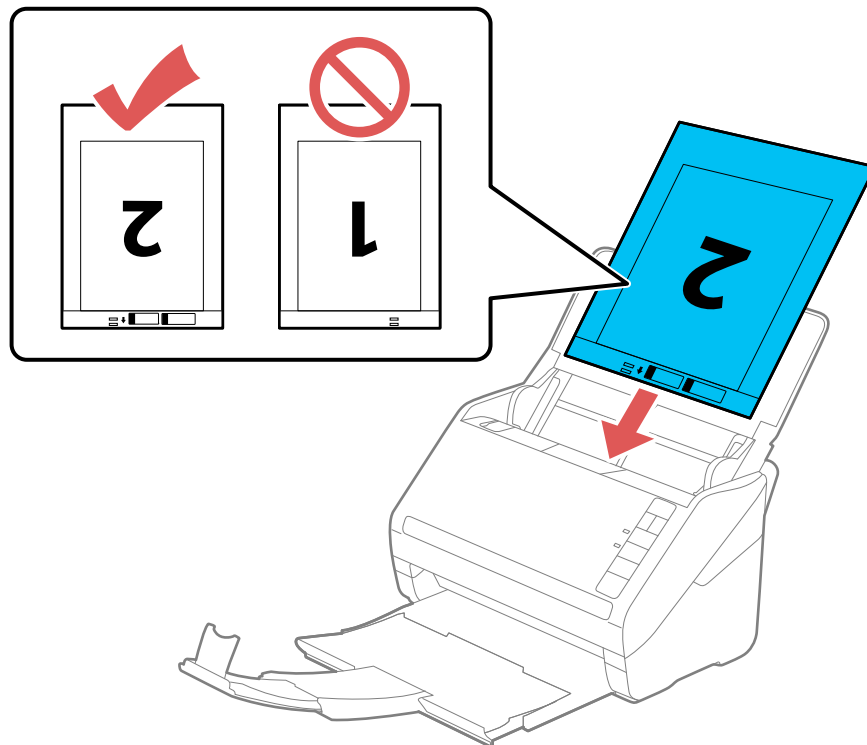

## Photo or irregularly shaped original

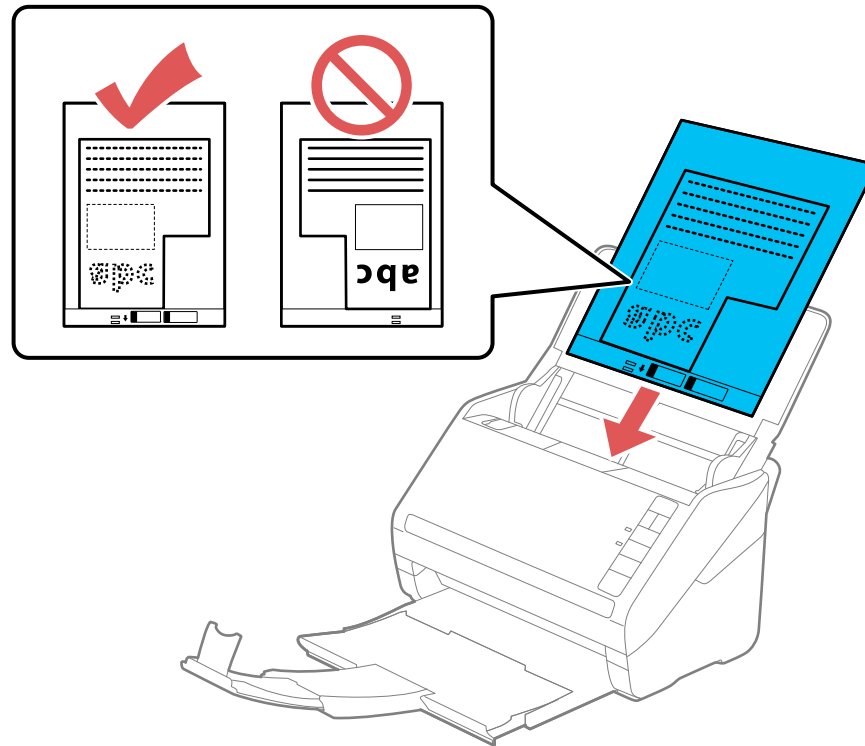

7. Slide the edge guides against the edges of the original or carrier sheet.

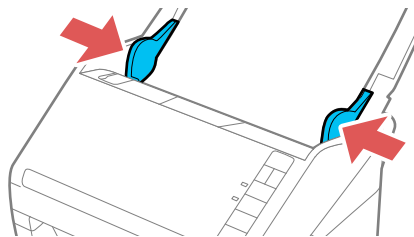

8. Turn off the **Detect Double Feed** setting on the Main Settings tab in Epson Scan 2 when scanning special originals.

9. If necessary during scanning, adjust the position of the stopper on the output tray extension to fit the ejected originals.

**Note:** If thicker paper does not eject properly or falls from the output tray, push in the output tray and allow the originals to eject freely onto the surface below the scanner. If the scanned images are affected by the originals ejecting below the scanner, try placing the scanner on the edge of a table where the ejected originals can drop freely.

[Special Original Specifications](#)

**Parent topic:** [Loading Originals](#)

**Related references**

[Special Original Specifications](#)

**Related topics**

[Scanning](#)

## Special Original Specifications

You can load photos, envelopes, or large, thick, or folded originals that meet these specifications in your scanner.

**Note:** Photos scanned using a document scanner may not have the same color depth as the original. Use a flatbed photo scanner with the optional flatbed scanner dock (DS-530 II/DS-770 II) to achieve the best color reproduction of photos.

Paper type	Paper size	Paper thickness	Loading capacity
Large originals (plain paper, fine paper, or recycled paper) (load only in a carrier sheet)	Up to this size: A3 (11.7 × 16.5 inches [297 × 420 mm])	0.012 inch (0.3 mm) maximum (excluding the thickness of the carrier sheet)	DS-530 II/DS-575W II: 5 carrier sheets DS-770 II: 10 carrier sheets
Photos (load only in a carrier sheet)	Up to this size: A4 (8.3 × 11.7 inches [210 × 297 mm])	0.012 inch (0.3 mm) maximum (excluding the thickness of the carrier sheet)	DS-530 II/DS-575W II: 5 carrier sheets DS-770 II: 10 carrier sheets

Paper type	Paper size	Paper thickness	Loading capacity
Envelopes	4.49 × 6.38 inches (114 × 162 mm) 4.33 × 8.66 inches (110 × 220 mm)	0.015 inch (0.38 mm) maximum	DS-530 II/DS-575W II: 5 envelopes DS-770 II: 10 envelopes
Irregularly shaped originals (load only in a carrier sheet)	Up to this size: A4 (8.3 × 11.7 inches [210 × 297 mm])	0.012 inch (0.3 mm) maximum (excluding the thickness of the carrier sheet)	DS-530 II/DS-575W II: 5 carrier sheets DS-770 II: 10 carrier sheets

**Note:** Originals that are wider than 8.5 inches (215.9 mm) need to be folded in half. The leading edge of originals approximately 11.7 inches (297 mm) long must be placed at the binding part of the carrier sheet. Otherwise, the length of the scanned image may be longer than intended as the scanner scans to the end of the carrier sheet when you select **Auto Detect** as the Document Size setting in the scanning software.

**Parent topic:** [Loading Special Originals](#)

---

# Wi-Fi Networking

See these sections to use your scanner over a Wi-Fi network (DS-575W II).

[Network Security Recommendations](#)

[Connecting to an Existing Wi-Fi Network](#)

[Setting Up Wireless Scanning from a Smart Device Using Epson Smart Panel](#)

[Direct Wi-Fi Mode \(AP Mode\) Setup](#)

[Wi-Fi Protected Setup \(WPS\)](#)

[Setting Up Network Scanning](#)

[Disabling Wi-Fi Features](#)

[Restoring Default Network Settings](#)

## Network Security Recommendations

To help deter unauthorized access to your product over a network, you should protect your network environment using appropriate security measures.

Security measures such as these can help deter threats such as loss of user data, use of telephone and fax lines, and other intrusions:

- **Enable security on your wireless LAN**

Enable the appropriate security on the wireless LAN you plan to use with your product. Network security such as a network password can deter interception of traffic over the wireless LAN. Your router may already have a default password enabled by your Internet service provider (ISP). See your ISP and router documentation for instructions on how to change the default password and better secure your network.

- **Connect your product only to a network protected by a firewall**

Connecting your product directly to the Internet may leave it vulnerable to security threats. Instead, connect it to a router or other network connection protected by a firewall. Your router may already have a firewall set up by your Internet service provider; check with your ISP for confirmation. For best results, set up and use a private IP address for your network connection.

- **Change the default administrator password on your product**

If your product has an option to set an administrator password, change the default administrator password to deter access by unauthorized users to personal data stored on your product, such as IDs, passwords, and contact lists.

**Parent topic:** [Wi-Fi Networking](#)

## Connecting to an Existing Wi-Fi Network

You can set up your scanner to communicate with your computer using a wireless router. The wireless router can be connected to your computer over a wireless or wired network.

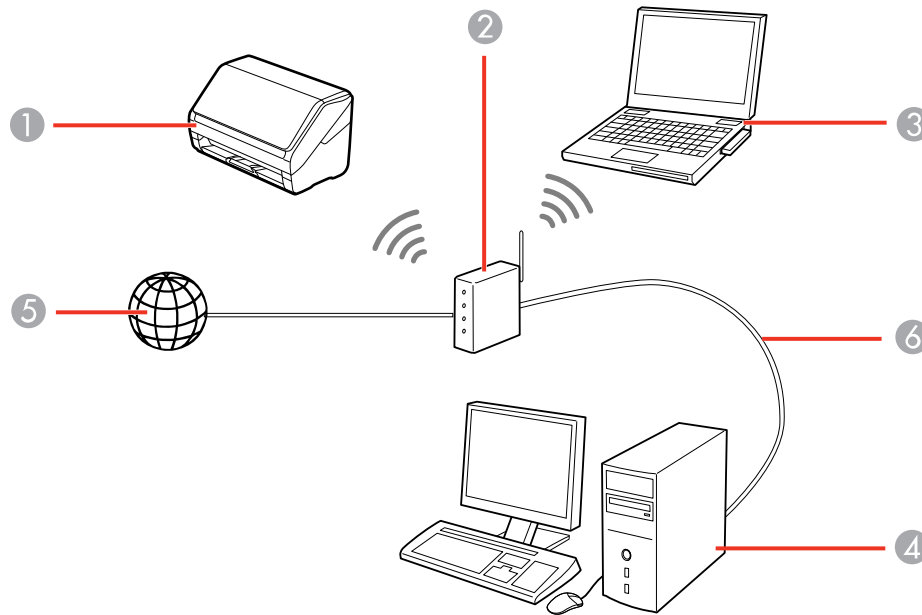

- 1 Epson scanner
- 2 Wireless router
- 3 Computer with a wireless interface
- 4 Computer
- 5 Internet
- 6 Ethernet cable (used only for wired connection to the wireless router)



[Manually Connecting to a Wi-Fi Network](#)

**Parent topic:** [Wi-Fi Networking](#)

## Manually Connecting to a Wi-Fi Network

You can manually connect the scanner to a Wi-Fi network by entering the network names (SSIDs) and passwords for your wireless network router and scanner. You must have a computer with a wireless adapter to set up the connection. Also make sure you have installed the scanner software as described on the scanner *Start Here* sheet.

**Note:** For best results, re-install your scanner software and follow the on-screen instructions to connect to a network.

1. Make a note of the SSID and password shown on the label on the back of the scanner.
2. Turn on the scanner.
3. Press the  Wi-Fi button on the scanner's control panel.
4. From your computer or device, open the list of wireless networks and select the SSID shown on the scanner label. Then select the connect option.
5. Enter the password shown on the scanner label.  
The  AP mode light comes on in blue, indicating an AP mode connection.
6. Connect your computer or device to the wireless network.  
Wait for the  Wi-Fi light on the scanner to stop flashing and stay on, indicating that the scanner is connected to the network.
7. Select the link below to set up network scanning. You must set up network scanning to connect your computer and wireless scanner.

**Parent topic:** [Connecting to an Existing Wi-Fi Network](#)

### Related tasks

[Setting Up Network Scanning](#)

## Setting Up Wireless Scanning from a Smart Device Using Epson Smart Panel

You can use the Epson Smart Panel app to connect your Epson product to a wireless network or connect your smart device directly to the product. Epson Smart Panel is available on iOS and Android devices.

Make sure you have the following:

- A Bluetooth-enabled device that is connected to a wireless network



- The Epson Smart Panel app installed on the device
- The wireless network name (SSID) and password

**Note:** Your device must be close enough to the product to create and maintain a Bluetooth connection.

1. Make sure the product is turned on and is ready to scan.

**Note:** You must perform initial setup before setting up wireless scanning.

2. Open the Epson Smart Panel app on your device.
3. Do one of the following:
  - If the app automatically recognizes the product, follow the on-screen instructions to set up the wireless connection.
  - If the app does not automatically recognize the product, select the **+** icon and continue with the next step.
4. On the next screen, select **Connect to a New Product**.
5. Select your product from the list.

**Note:** If your product is not listed, move closer to the product and try again. If the product is still not shown, connect your scanner to the wireless network again and then select **Connect to Existing Product** in the Epson Smart Panel app and follow the on-screen instructions. See the link below for wireless setup instructions.

6. Select **Next** to select the current wireless network.

**Note:** If you want to connect the product to a different wireless network, select **Change another Wi-Fi SSID**.

7. Enter the password for the wireless network and select **OK**.

The app starts configuring the product.

**Note:** Do not move the smart device away from the product during configuration. Wait for the completion message in the Epson Smart Panel app and do not cancel the configuration before it is completed.

Your product is now connected to a wireless network and set up for use with the Epson Smart Panel app.

**Parent topic:** [Wi-Fi Networking](#)

**Related tasks**

[Using the Epson Smart Panel Mobile App](#)

[Starting a Scan from a Smart Device](#)

## Direct Wi-Fi Mode (AP Mode) Setup

You can set up your scanner to communicate directly with your computer or another device without requiring a wireless router. If your product is not already connected to a wireless network, it enters access point mode and the scanner itself acts as the network access point for up to 4 devices.

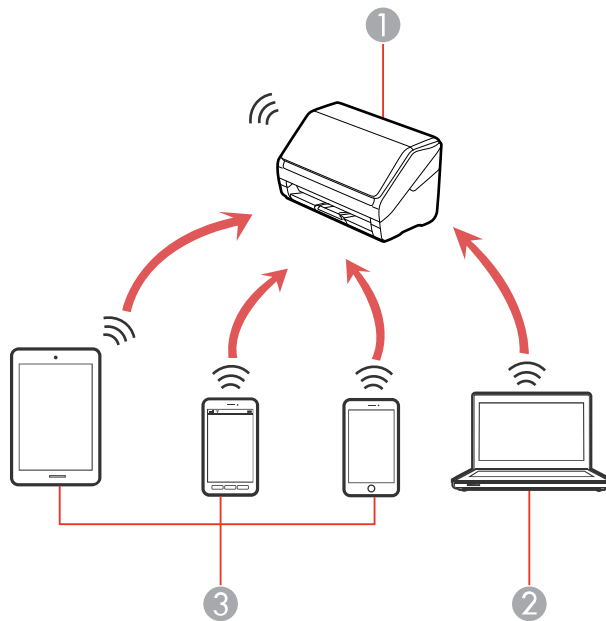

- 1 Epson scanner
- 2 Computer with a wireless interface
- 3 Other wireless devices

**Note:** Devices directly connected to the scanner cannot communicate with each other through the scanner.

[Enabling a Direct Wi-Fi \(AP Mode\) Connection](#)  
[Using WPS to Set Up a Direct Wi-Fi Connection](#)

**Parent topic:** [Wi-Fi Networking](#)

## Enabling a Direct Wi-Fi (AP Mode) Connection

You can enable a direct Wi-Fi connection to allow direct communication between your scanner and computer or other devices without a wireless router or access point.

**Note:** If you are connecting a wireless device to the scanner using a direct Wi-Fi (AP mode) connection, the scanner is connected to the same Wi-Fi network (SSID) as the wireless device. When you turn off the scanner, the wireless device is automatically connected to other Wi-Fi networks, so you must reconnect to the scanner in AP mode from the wireless device when you turn the scanner back on. To avoid reconnecting every time you turn the scanner off and back on, connect the scanner to an access point instead.

1. Make a note of the SSID and password shown on the label on the back of the scanner.
2. Open the scanner's input tray.
3. Press the  Wi-Fi button on the scanner's control panel.
4. From your computer or device, search for and select the SSID shown on the label on the back of the scanner.
5. Enter the password shown on the label on the back of the scanner.

The  AP mode light lights up in blue indicating an AP mode connection. If the connection is unsuccessful, make sure you entered the password correctly.



**Parent topic:** [Direct Wi-Fi Mode \(AP Mode\) Setup](#)

## Using WPS to Set Up a Direct Wi-Fi Connection

You can use Wi-Fi Protected Setup (WPS) to create a direct Wi-Fi connection to a WPS-enabled computer or device.

1. Press the **WPS** button on your computer or device, or enable the WPS feature.

The computer or device enters standby mode for WPS connection for 2 minutes.

2. Press and hold the  Wi-Fi connect button on the scanner for at least 3 seconds, then release it when the  Wi-Fi light flashes blue.

When the  Wi-Fi light on the scanner stays on, the connection is established.

**Parent topic:** [Direct Wi-Fi Mode \(AP Mode\) Setup](#)

## Wi-Fi Protected Setup (WPS)

If your network uses a WPS-enabled wireless router, you can quickly connect your scanner to the network using Wi-Fi Protected Setup (WPS).

**Note:** To check if your router is WPS-enabled, look for a button labeled **WPS** on your router. If there is no hardware button, there may be a WPS setting in the software for the device. Check your network product documentation for details.

[Using WPS to Connect to a Network](#)

[Using WPS PIN Mode to Connect to a Network](#)

**Parent topic:** [Wi-Fi Networking](#)

## Using WPS to Connect to a Network



If you have a WPS-enabled wireless router, you can use Wi-Fi Protected Setup (WPS) to connect your scanner to the network. Make sure you have installed your scanner software as described on your scanner *Start Here* sheet.

**Note:** For best results, re-install your scanner software and follow the on-screen instructions to connect to a network.



1. Open the scanner's input tray.
2. Enable WPS on your router by pressing and holding the **WPS** button on your wireless router until the security light flashes or by enabling the WPS setting in your router firmware.

The router enters WPS discovery mode for 2 minutes.

**Note:** If you cannot locate the WPS button, or there are no buttons on the router or access point, see the documentation provided with your router for details.

3. Press and hold the  Wi-Fi connect button on the scanner for at least 3 seconds, then release it when the  Wi-Fi light flashes blue.

**Note:** If you do not complete this step within 2 minutes, repeat steps 1 through 3.

The  Wi-Fi and  AP mode lights flash alternately while establishing the connection. When the  Wi-Fi light on the scanner stays on, the scanner is connected to the network.

**Note:** If the ! error light turns on, the connection failed. Press the  stop button to clear the error, restart the scanner and router, and repeat these steps.

4. Select the link below to set up network scanner. You must set up network scanning to connect your computer and wireless scanner.



**Parent topic:** [Wi-Fi Protected Setup \(WPS\)](#)

#### **Related tasks**

[Setting Up Network Scanning](#)

## **Using WPS PIN Mode to Connect to a Network**



If you have a WPS-enabled wireless router that supports PIN mode, you can use Wi-Fi Protected Setup (WPS) PIN mode to connect your scanner to the network.

1. Open the scanner's input tray.
2. Press and hold the  Wi-Fi button and the  Wi-Fi connect button on the scanner simultaneously for at least three seconds, then release them when the  Wi-Fi light flashes blue.

**Note:** The scanner enters discovery mode for 2 minutes.

3. Use your computer to enter the PIN code **01234565** into the WPS PIN number setting in the wireless router within 2 minutes.

**Note:** If you do not enter the code within 2 minutes, repeat steps 1 through 3.

The  Wi-Fi and  AP mode lights flash alternately while establishing the connection. When the  Wi-Fi light on the scanner stays on, the scanner is connected to the network.

**Note:** If the ! error light turns on, the connection failed. Press the  stop button to clear the error, restart the router, and repeat these steps.

4. Select the link below to set up network scanning. You must set up network scanning to connect your computer and wireless scanner.

**Parent topic:** [Wi-Fi Protected Setup \(WPS\)](#)

**Related tasks**



[Setting Up Network Scanning](#)

## Setting Up Network Scanning

You can set up network scanning to your scanner through a direct connection to your scanner.

First, manually configure your scanner to connect to your network. Then follow the instructions here to set up your computer for network scanning using the Epson Scan 2 Utility. Your scanner must be turned on and connected to the network.

**Note:** Make a note of the IP address or host name of the scanner so you can enter it in these steps.

1. Do one of the following to start the Epson Scan 2 Utility:
  - **Windows 10:** Click  > **EPSON** > **Epson Scan 2 Utility**.
  - **Windows 8.x:** Navigate to the **Apps** screen and select **Epson Scan 2 Utility**.
  - **Windows (other versions):** Click  or **Start** > **All Programs** or **Programs** > **EPSON** > **Epson Scan 2** > **Epson Scan 2 Utility**.
  - **Mac:** Open the **Applications** folder, click **Epson Software**, and click **Epson Scan 2 Utility**.
2. Select **Settings** from the Scanner drop-down list.

You see a screen like this:

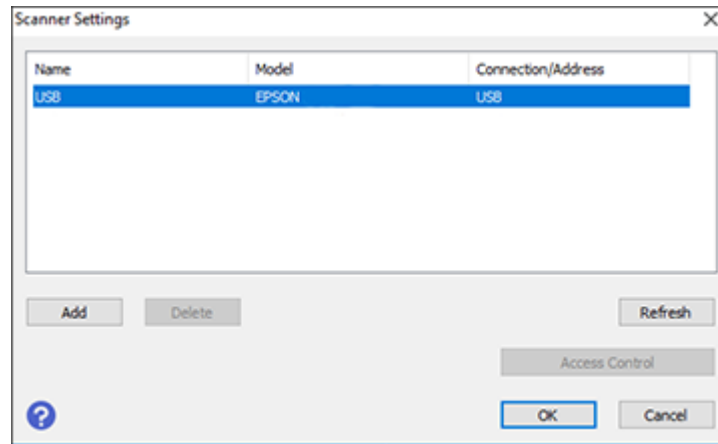

**Note:** If you see an **Enable Editing** button (Windows) or the lock icon (Mac), click it so that you can modify the scanner settings.

3. Select your scanner and click **Add**.

You see a screen like this:

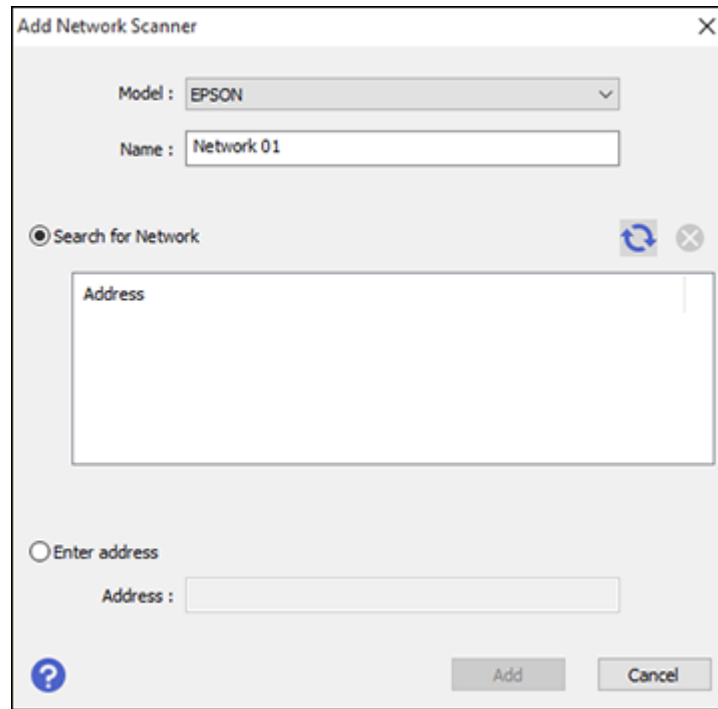

4. Do one of the following:
  - Under **Search for Network**, select the IP address of your Epson scanner and click **Add**.
  - Select the **Enter address** setting, type in the IP address or host name of your Epson scanner, and click **Add**.
5. Click **OK** to check the connection.  
You see a confirmation message.
6. Click **OK** to save your settings and close the Epson Scan 2 Utility.

[Determining the Scanner's IP Address](#)

**Parent topic:** [Wi-Fi Networking](#)



**Related tasks**

[Determining the Scanner's IP Address](#)



## Determining the Scanner's IP Address

If you have multiple scanners on your network, you need to know the IP address of the scanner when setting up network scanning.



1. Do one of the following to start EpsonNet Config:
  - **Windows 10:** Click  > **EpsonNet** > **EpsonNet Config**.
  - **Windows 8.x:** Navigate to the **Apps** screen and select **EpsonNet Config**.
  - **Windows (other versions):** Click  or **Start**, and select **All Programs** or **Programs**. Select **EpsonNet** > **EpsonNet Config** > **EpsonNet Config**.
  - **Mac:** Open the **Applications** folder and select **Epson Software** > **EpsonNet** > **EpsonNet Config** > **EpsonNet Config**.
2. Locate your scanner in the list and write down the IP address.

Parent topic: [Setting Up Network Scanning](#)

## Disabling Wi-Fi Features

You may need to disable your product's Wi-Fi features if you change your network connection type or need to solve a problem with your network connection.







**Note:** Before disabling Wi-Fi features, make a note of your product's SSID (network name) and password, and any network settings selected for Epson DocumentScan.

Press and hold the  Wi-Fi button on the scanner for at least three seconds to disable the Wi-Fi features. When the  Wi-Fi light and the  AP mode light turn off, Wi-Fi is disabled.

Parent topic: [Wi-Fi Networking](#)

## Restoring Default Network Settings

If you need to solve a problem with your network connection, you can restore all network settings to their defaults.

1. Turn off your scanner.
2. Press and hold the  Wi-Fi button and the  power button until the  Wi-Fi and  AP mode lights turn on. Then release the buttons.
3. Wait until the  Wi-Fi and  AP mode lights flash alternately and then turn off.

The default network settings are restored.

**Parent topic:** [Wi-Fi Networking](#)

---

# Scanning

You can scan your originals and save them as digital files.

**Note:** Your product may differ from the images in this guide, but the instructions are the same unless otherwise noted.

[Starting a Scan](#)

[Scanning with Simple Scan in Document Capture Pro - Windows](#)

[Scanning with Job Scan in Document Capture Pro - Windows](#)

[Scanning with Document Capture - Mac](#)

[Scanning in Epson Scan 2](#)

[Scan Resolution Guidelines](#)

[Scanning Special Projects](#)

## Starting a Scan

After placing your originals on your product for scanning, start scanning using one of these methods.

**Note:** You can also scan using Document Capture Pro (Windows) or Document Capture (Mac).

[Starting a Scan from a Scanner Button](#)

[Starting a Scan Using the Epson Scan 2 Icon](#)



[Starting a Scan from a Scanning Program](#)

[Starting a Scan from a Smart Device](#)

**Parent topic:** [Scanning](#)

## Starting a Scan from a Scanner Button

You can scan using the  start button on your scanner. This automatically starts Document Capture Pro (Windows) or Document Capture (Mac) and the scan job you have assigned to the button.

**Note:** Make sure Epson Scan 2 and either Document Capture Pro (Windows) or Document Capture (Mac) are installed on the computer connected to the scanner. Document Capture Pro (Windows) and Document Capture (Mac) do not support scanning from the  start button on your scanner over a wireless network (DS-575W II). Launch Epson Scan 2 before scanning from the  start button on your scanner.

1. Make sure the scanner is connected to your computer or network.
2. Load an original in your scanner.
3. Press the  start button.

The scanner starts the job that was assigned to the  start button in Document Capture Pro (Windows) or Document Capture (Mac).

**Note:** You can view or change the scan settings using Document Capture Pro (Windows) or Document Capture (Mac).

**Note:** If your scanner is connected to one computer via USB and another computer via wireless, pressing the  start button on the scanner will save the scanned images to the wirelessly connected computer (DS-575W II).

[Adding and Assigning Scan Jobs with Document Capture Pro - Windows](#)  
[Assigning Start Button Settings or Scan Jobs - Mac](#)

**Parent topic:** [Starting a Scan](#)



**Related topics**

[Loading Originals](#)

## **Adding and Assigning Scan Jobs with Document Capture Pro - Windows**

You can view, change, or add available default scan settings when you scan using the  start button on your product or the Job Scan option in Document Capture Pro. You do this by accessing the scan jobs in the Document Capture Pro program.

**Note:** The settings may vary, depending on the software version you are using. See the help information in Document Capture Pro for details.

1. Do one of the following to start Document Capture Pro:
  - **Windows 10:** Click  and select **Epson Software > Document Capture Pro**.
  - **Windows 8.x:** Navigate to the **Apps** screen and select **Document Capture Pro**.
  - **Windows (other versions):** Click  or **Start**, and select **All Programs** or **Programs**. Select **Epson Software > Document Capture Pro**.

You see the Document Capture Pro window.

2. Select the **Job Scan** tab.

You see a window like this:

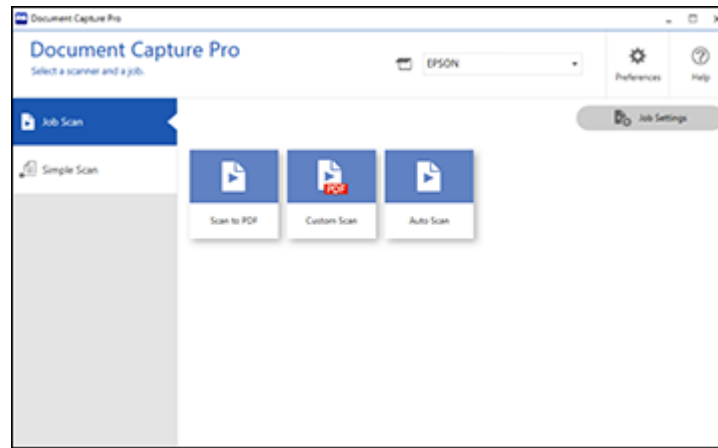

3. Click the **Job Settings** button.

You see a window like this:

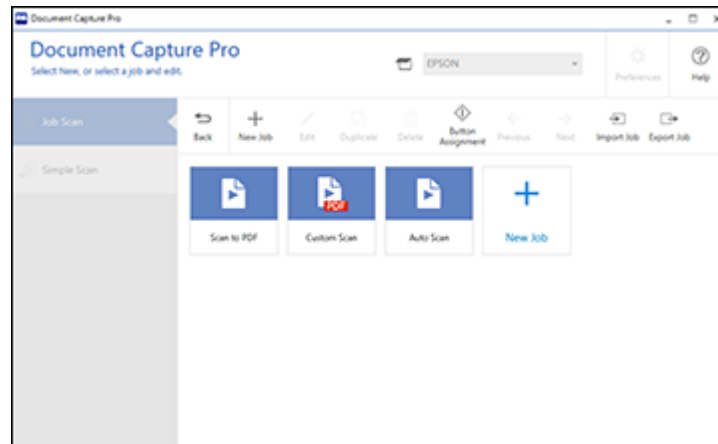

4. To add a scan job, click the **New Job** icon.

5. Enter a name for the new job, and select any settings as necessary from the following options:
  - **Scan:** select the size, color, or resolution
  - **Save:** select the file name, file type, or destination folder
  - **Index:** enable the index setting and choose output options for an index file
  - **Send:** select the destination for the scanned file, or choose to email or print the file
  - **Confirm/Test:** select the job button icon and color, choose display settings, and run a test scan if necessary
6. Click **Save** when you are finished.  
The new job appears in the Job Scan window.
7. To assign a scan job to the  start button on your product, click the **Button Assignment** icon.  
You see a screen like this:

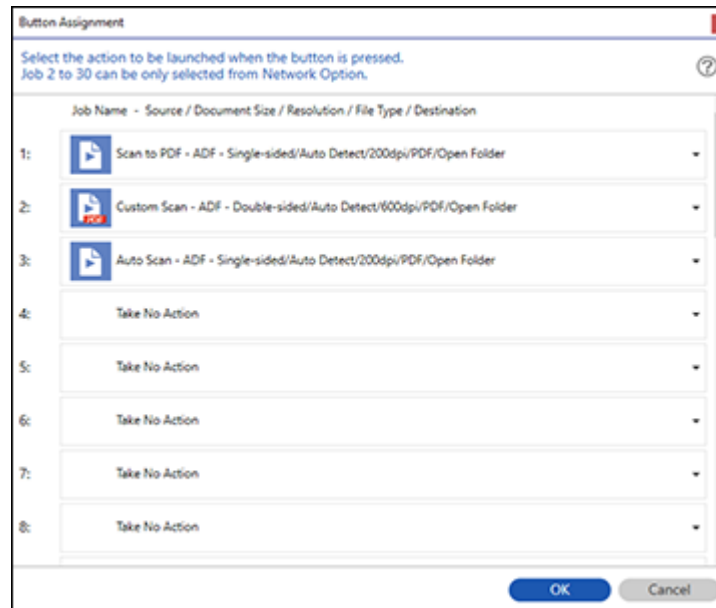

8. Select the job that you want to assign to the  start button using any of the pull-down menus.

**Note:** The number of pull-down menus available may vary, depending on your product and any connected options.



9. Click **OK**, then click **Back**.

You can now use the added scan jobs when you scan from the  start button on your product.

**Parent topic:** [Starting a Scan from a Scanner Button](#)

### Assigning Start Button Settings or Scan Jobs - Mac



You can view or change the default scan settings when you scan using the  start button on your scanner. You do this by accessing the scan jobs in the Document Capture program.

**Note:** Document Capture (Mac) does not support scanning from the  start button on your scanner over a wireless network (DS-575W II). Launch Epson Scan 2 before scanning from the  start button on your scanner.

1. Start Document Capture on a computer connected to the product.
2. Click the  Manage Job icon from the toolbar at the top of the window.  
You see a window showing the current scan job list.
3. If you want to add a scan job, click **Add** or the **+** icon, enter a name for the new job, select settings as necessary, and click **OK**.

You can now use the new scan job when you scan with Document Capture.

**Note:** See the Help information in Document Capture for details.

4. If you want to assign a scan job to the  start button, click the  icon at the bottom of the window and click **Event Settings**.

5. Select the job that you want to assign to the  start button.

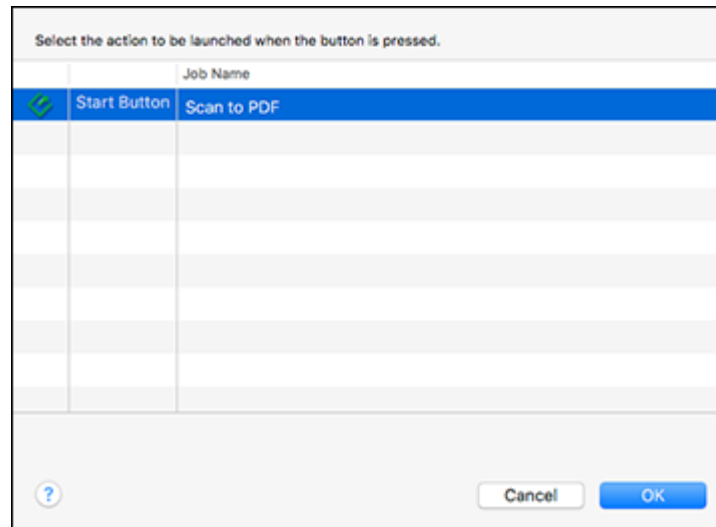



6. Click **OK**.

**Parent topic:** [Starting a Scan from a Scanner Button](#)

## Starting a Scan Using the Epson Scan 2 Icon

You can start the Epson Scan 2 program to select scan settings, scan, and save the scanned image to a file.

**Note:** If you are using your Epson product with the Windows 10 S operating system, you cannot use the software described in this section. You also cannot download and install any Epson product software from the Epson website for use with Windows 10 S; you must obtain software only from the Windows Store.

- **Windows 10:** Click  and select **EPSON > Epson Scan 2**.
- **Windows 8.x:** Navigate to the **Apps** screen and select **Epson Scan 2**.
- **Windows (other versions):** Click  or **Start**, and select **All Programs** or **Programs**. Select **EPSON > Epson Scan 2 > Epson Scan 2**.
- **Mac:** Open the **Applications** folder, open the **Epson Software** folder, and select **Epson Scan 2**.



You see an Epson Scan 2 window like this:

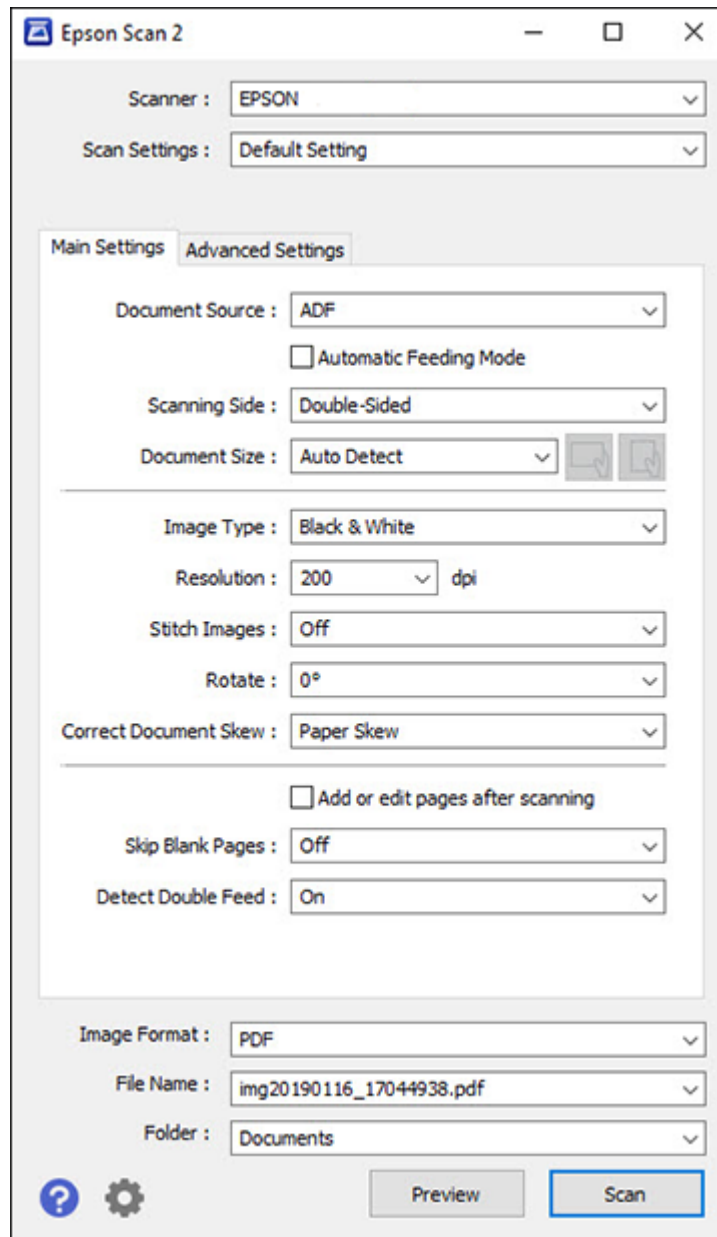

Parent topic: [Starting a Scan](#)

## Starting a Scan from a Scanning Program

You can start Epson Scan 2 from a TWAIN-compliant scanning program to select scan settings, scan, and open the scanned image in the program.

**Note:** If you are using your Epson product with the Windows 10 S operating system, you cannot use the software described in this section. You also cannot download and install any Epson product software from the Epson website for use with Windows 10 S; you must obtain software only from the Windows Store.

1. Open your scanning program and select its scanning option. (See your scanning program help for instructions.)
2. Select your product.

**Note:** In certain programs, you may need to select your product as the "source" first. If you see a **Select Source** option, choose it and select your product. With Windows, do not select a **WIA** option for your product; not all scan functions will be available.

You see an Epson Scan 2 window like this:

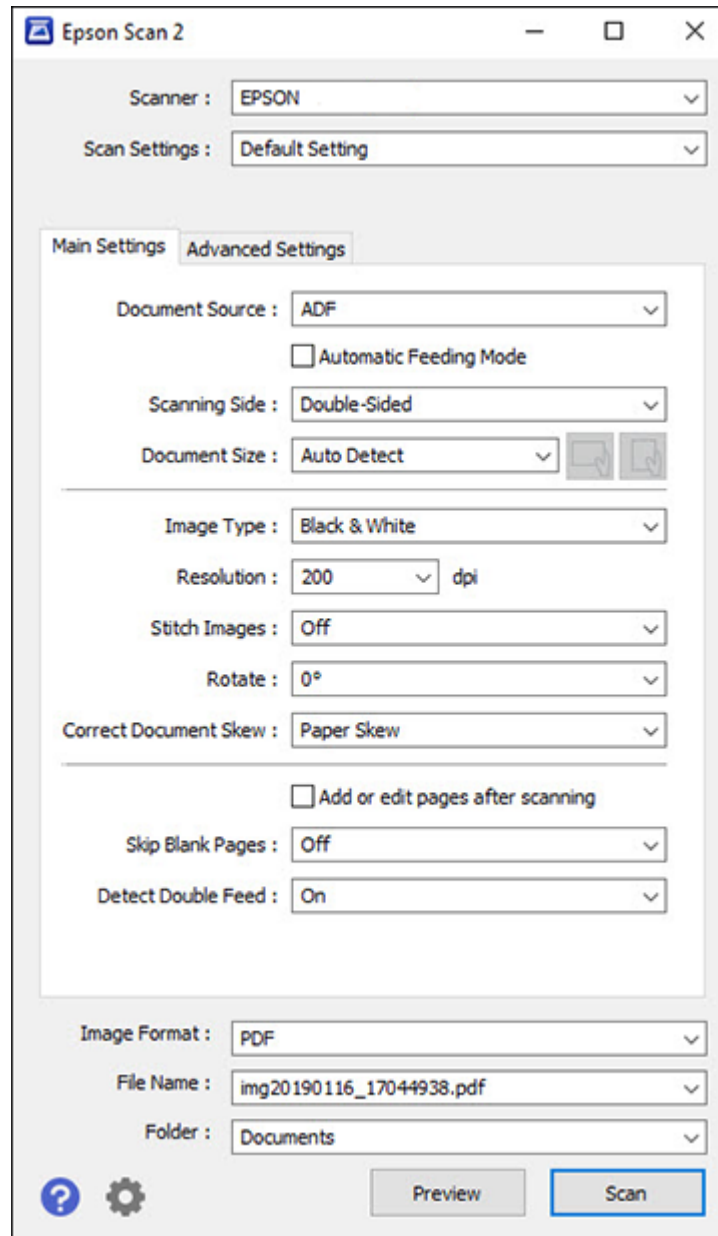

Parent topic: [Starting a Scan](#)

## Starting a Scan from a Smart Device

You can use the Epson Smart Panel app to scan from a network scanner to an iOS or Android device over a direct Wi-Fi connection (DS-575W II).

1. Download the Epson Smart Panel app from your device's app store or from Epson's website. See the link below.
2. Place your original on the product for scanning.
3. Open the Epson Smart Panel app and select a scan menu on the home screen.
4. Follow the on-screen instructions to scan and save your original.

Parent topic: [Starting a Scan](#)



### Related tasks

[Using the Epson Smart Panel Mobile App](#)

## Scanning with Simple Scan in Document Capture Pro - Windows

You can use the Simple Scan option in Document Capture Pro to quickly scan an original.

**Note:** Settings may vary depending on the software version you are using. Click the **Help** icon in Document Capture Pro at any time for more information.

1. Load your original in the product.
2. Do one of the following to start Document Capture Pro:
  - **Windows 10:** Click  and select **Epson Software > Document Capture Pro**.
  - **Windows 8.x:** Navigate to the **Apps** screen and select **Document Capture Pro**.
  - **Windows (other versions):** Click  or **Start**, and select **All Programs** or **Programs**. Select **Epson Software > Document Capture Pro**.

You see the Document Capture Pro window.

**Note:** You may need to select your scanner from the list, if necessary.

3. Select the **Simple Scan** tab.

You see a window like this:

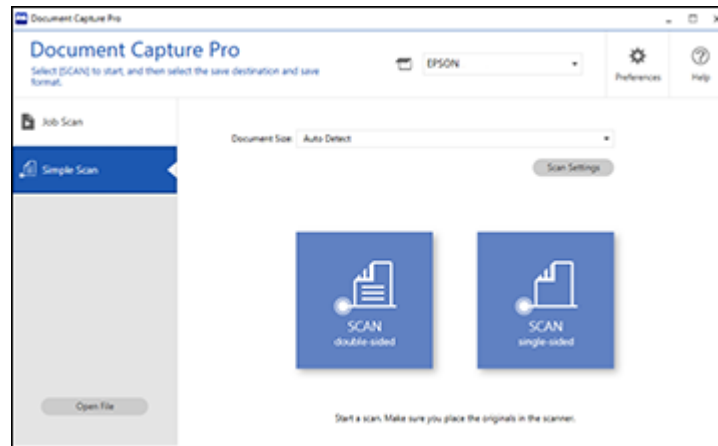

4. Select the size of your original from the **Document Size** menu.
5. If you want to change specific settings for the scan, click the **Scan Settings** button. Change any of the settings as necessary and click **OK**. For additional settings, click the **Detailed Settings** button on the Scan Settings screen.
6. Do one of the following:
  - To scan the front side of an original, select **SCAN single-sided**.
  - To scan both sides of an original, select **SCAN double-sided**.Your product scans the original and the image appears in the Edit Scanned Results window.
7. Review and edit the scanned image as necessary and click **Next** when you are finished.
8. Select a destination for the scanned image, change any settings as necessary, and click **Complete**.

**Note:** If you are sending the scanned image to a server or cloud destination, you need to enter your login information.

**Parent topic:** [Scanning](#)

**Related tasks**

[Scanning in Epson Scan 2](#)



## Related topics

[Loading Originals](#)

# Scanning with Job Scan in Document Capture Pro - Windows

You can create scan jobs in Document Capture Pro and use them to quickly scan originals and save them to various destinations.

**Note:** Settings may vary depending on the software version you are using. Click the **Help** icon in Document Capture Pro at any time for more information.

1. Load your original in the product.
2. Do one of the following to start Document Capture Pro:
  - **Windows 10:** Click  and select **Epson Software > Document Capture Pro**.
  - **Windows 8.x:** Navigate to the **Apps** screen and select **Document Capture Pro**.
  - **Windows (other versions):** Click  or **Start**, and select **All Programs** or **Programs**. Select **Epson Software > Document Capture Pro**.

You see the Document Capture Pro window.

**Note:** You may need to select your scanner from the list, if necessary.

3. Select the **Job Scan** tab.

You see a window like this:

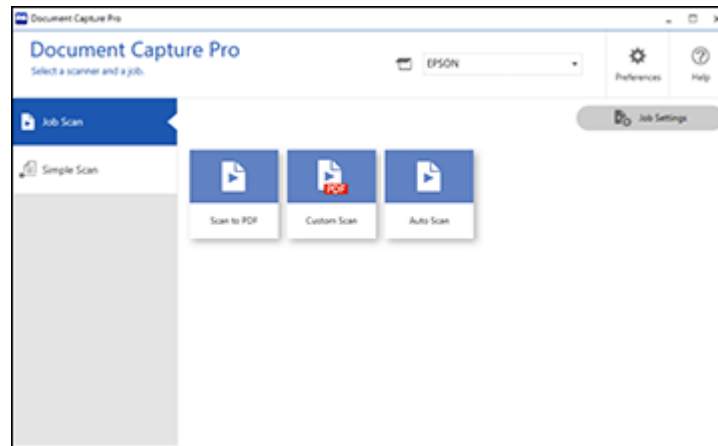

4. Select one of the scan jobs (or click **Job Settings** to create a new scan job).  
The product scans the loaded original and saves it according to the job settings.
5. Depending on the settings for the scan job you selected, you may be able to view and edit the pages before saving them. If so, click **Complete** when finished.  
The scanned image is saved according to the job settings.

**Parent topic:** [Scanning](#)

**Related tasks**

[Scanning in Epson Scan 2](#)

**Related topics**

[Loading Originals](#)

## Scanning with Document Capture - Mac

When you scan with Document Capture, the program automatically saves your scanned file on your computer in the folder you specify. You can select settings, preview, and change the scanned file settings as necessary.

**Note:** Settings may vary depending on the software version you are using. See the **Help** menu in Document Capture at any time for more information.

1. Load your original in the product.
2. Open the **Applications** folder, open the **Epson Software** folder, and select **Document Capture**.  
You see a window like this:

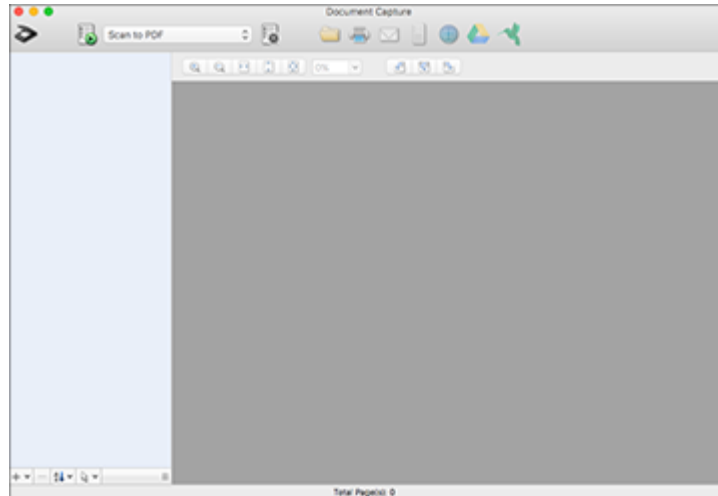



**Note:** You may need to select your scanner from the scanner list.

3. Click the  scan icon.

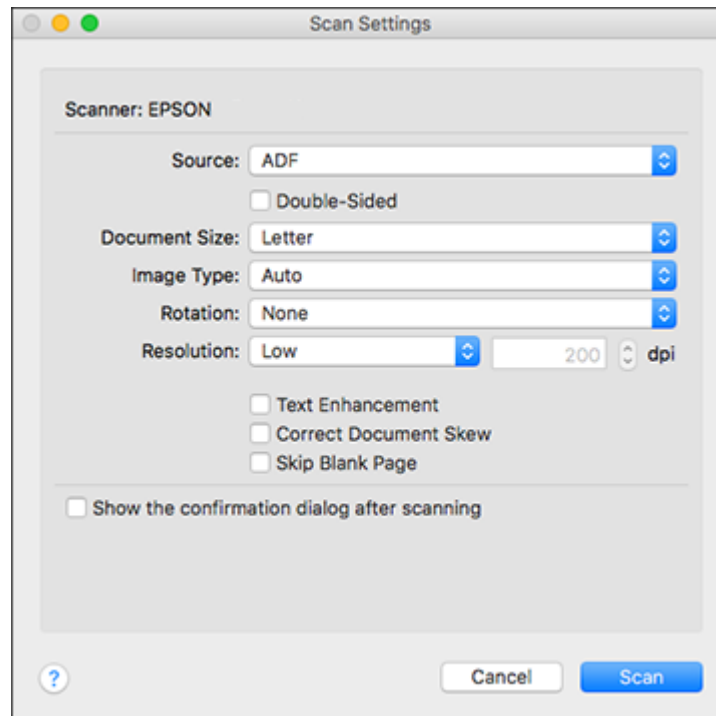

You see a window like this:



**Note:** If you want to use a scan job that you created instead, select it from the Job list in the Document Capture window, click the  Start Job button, and skip the rest of these steps.

4. Select any displayed scan settings you want to use.

**Note:** See the Help information in Document Capture for details.

5. If you want to select detailed scan settings, close the Scan Settings window, open the **Scan** menu at the top of the Mac desktop, and select **Displays the EPSON Scan Setup Screen**.
6. Click the  Scan icon and select any detailed scan settings you want to use from the Epson Scan 2 window.
7. Click **Scan**.

You see a preview of your scan in the Document Capture window.

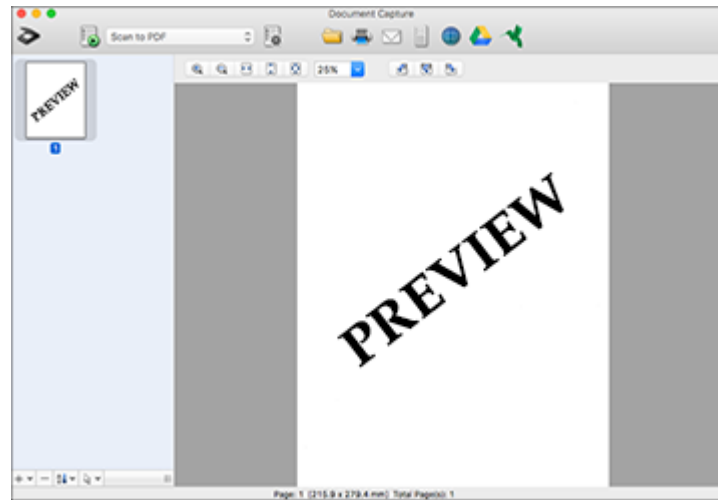

**Note:** You may have to close the Epson Scan 2 window to view your scan in the Document Capture window.

8. If you would like to scan additional originals and add them to the current captured images, click the + icon, select **Acquire from Scanner**, and repeat the previous steps.
9. Check the scanned images and edit them as necessary.
10. Click one of the destination icons to choose where to send your scanned files. (If you cannot see all of the icons below, click the arrow next to the icons.) Change any settings as necessary.



**Note:** If you are sending the scanned image to a server or cloud destination, you need to enter your login information.

11. Depending on the destination you chose, click **OK** or **Send** to complete the operation.

**Parent topic:** [Scanning](#)

**Related tasks**[Scanning in Epson Scan 2](#)**Related topics**[Loading Originals](#)

## Scanning in Epson Scan 2

Epson Scan 2 gives you access to basic and advanced scanning features. You can scan your document and save the scanned image in various file formats in your operating system's Documents or My Documents folder, or open it in your scanning program. You can preview the scanned image and select or change settings as necessary.

1. Load your original in the product.
2. Start Epson Scan 2.

You see this window:

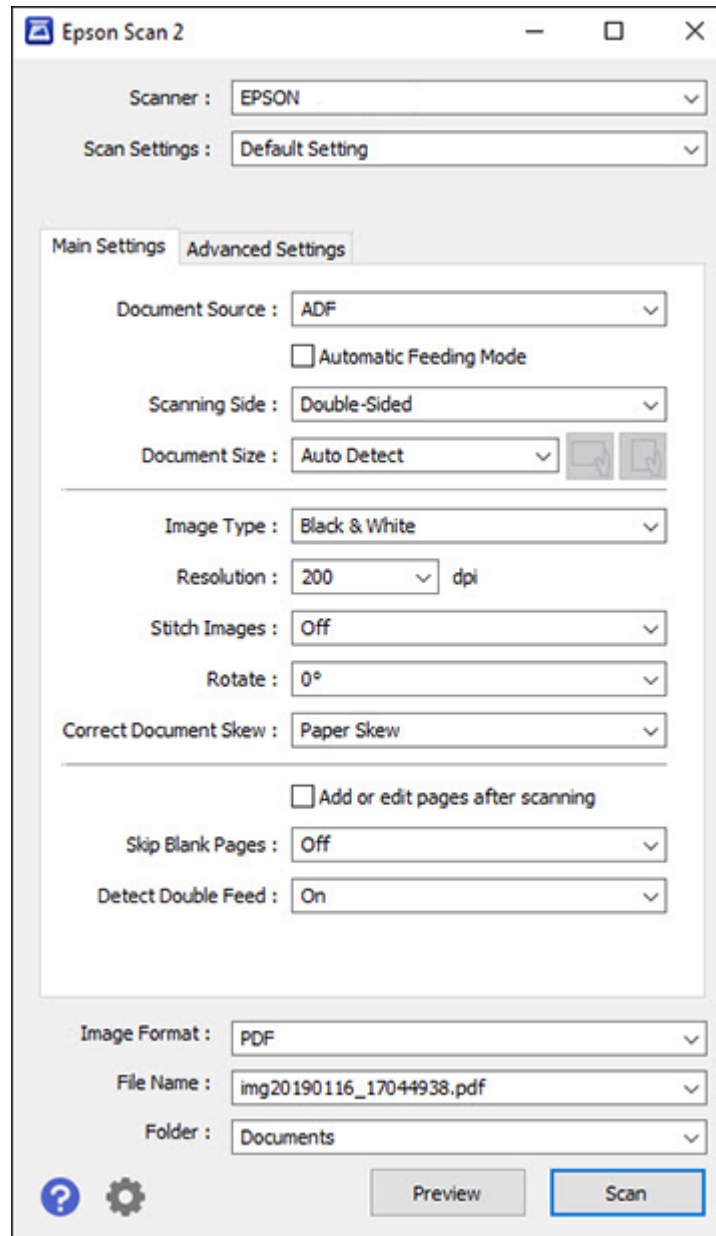

**Note:** The **Document Source** setting is automatically set to **ADF** for your product.

3. If you want to scan different size originals by loading them into the ADF one by one, check the **Automatic Feeding Mode** checkbox and click **Scan**. Scanning begins as soon as you load each original.
4. Select the **Scanning Side** setting that matches the sides of the original that you want to scan.
5. Select the **Document Size** setting that matches the size of your original, or select **Auto Detect** to have Epson Scan 2 automatically detect the size. You can select **Customize** to enter a custom size, if necessary.
6. Click on one of the orientation icons, if applicable.
7. Select your original image type and how you want it scanned as the **Image Type** setting, or select **Auto** to have Epson Scan 2 automatically detect the image type.
8. Select the **Resolution** setting you want to use for your scan.
9. Select any of the additional settings that you want to use on the **Main Settings** tab.
10. Click the **Advanced Settings** tab and select any settings that you want to use.
11. To see a preview of your scan with the settings you selected, click the **Preview** button.

Epson Scan 2 previews your original and displays the results in the Epson Scan 2 window.

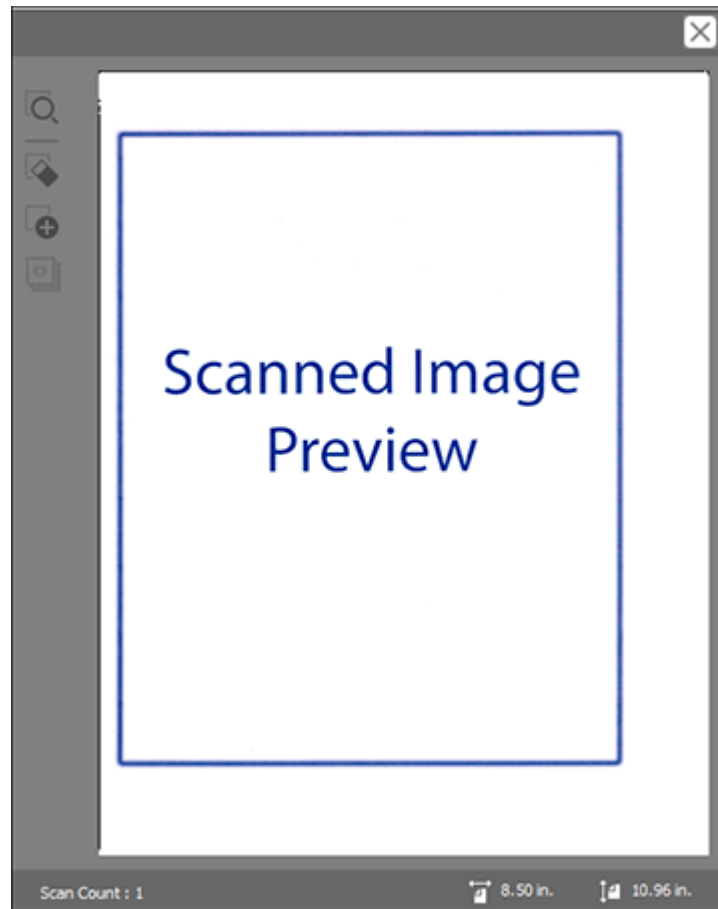

12. Reinsert your original into the ADF.
13. If scanning an original in a carrier sheet or other special original, see the link below for other setting requirements for special documents.
14. Select the format in which you want to save your scanned file as the **Image Format** setting. If necessary, select **Options** and select any desired format options.
15. Select **Settings** to modify the file name settings. Enter the file name for your scanned file in the **File Name** field.

16. Select the location in which you want to save your scanned file as the **Folder** setting. If necessary, select **Select** to choose an alternate folder or create a new folder.
17. Click **Scan**.  
The product scans your original and saves the scanned file in the location you specified.
18. If you selected the **Automatic Feeding Mode** setting, place your next original in the ADF for scanning. When you finish scanning originals, click **Finish**.

[Additional Scanning Settings - Main Settings Tab](#)

[Additional Scanning Settings - Advanced Settings Tab](#)

[Scanning Settings for Special Documents](#)

[Image Format Options](#)

**Parent topic:** [Scanning](#)

**Related topics**

[Loading Originals](#)

## Additional Scanning Settings - Main Settings Tab

You can select these additional scanning settings on the Epson Scan 2 Main Settings tab.

### Stitch Images

When scanning double-sided originals, lets you lay out images from both sides of the original onto one scanned page.

### Rotate

Rotates the original image clockwise to the desired angle before scanning it. Select **Auto** to allow your product to automatically rotate the image based on the orientation of the text (may take longer to scan).

### Correct Document Skew

Corrects skewed originals, image contents, or both.

### Add or edit pages after scanning

Lets you add, remove, or edit the pages in a scan, including rotating pages and changing the page order.

**Note:** To save multiple pages in a single file, you must select a file format that supports multiple pages such as **PDF** or **Multi-TIFF**. If you select another file format, each scanned image or page is saved as a separate file.

**Skip Blank Pages**

If the scanner detects marks from the other side of a blank page and adds the marks to the scanned image, adjust this setting to prevent this.

**Detect Double Feed**

Detects a double-feed paper error in the ADF. If you are scanning an original envelope or plastic card, select **Off**.

Parent topic: [Scanning in Epson Scan 2](#)

## Additional Scanning Settings - Advanced Settings Tab

You can select these additional scanning settings on the Epson Scan 2 Advanced Settings tab. Not all adjustment settings may be available, depending on other settings you have chosen.

**Unsharp Mask**

Makes the edges of certain image areas clearer. Turn off this option to leave softer edges.

**Descreening**

Removes the ripple pattern that might appear in subtly shaded image areas, such as skin tones. This option improves results when scanning magazines or newspapers. (The results of descreening do not appear in the preview image, only in your scanned image.)

**Remove Background**

Removes the background of the originals.

**Text Enhancement**

Sharpens the appearance of letters in text documents.

**Auto Area Segmentation**

Makes black and white images clearer and text recognition more accurate by separating the text from the graphics.

**Dropout**

The scan will not pick up the color you select. This setting is available only if you select **Grayscale** or **Black & White** as the Image Type setting.

**Color Enhance**

Enhances the shades of the color you select in the scanned image. This setting is available only if you select **Grayscale** or **Black & White** as the Image Type setting.

**Brightness**

Adjusts the overall lightness and darkness of the scanned image.

**Contrast**

Adjusts the difference between the light and dark areas of the overall scanned image.



**Gamma**

Adjusts the midtone density of the scanned image.

**Threshold**

Adjusts the level at which black areas in text and line art are delineated, improving text recognition in OCR (Optical Character Recognition) programs.

**Edge Fill**

Corrects shadowing around the edges of the image by filling the shadows with black or white.

**Remove Punch Holes**

Removes the shadows caused by holes on the edges of the original.

**Dual Image Output**

Scans the original image twice using different output settings (Windows only).

**Watermark**

Adds text to the background of the scanned image.

Parent topic: [Scanning in Epson Scan 2](#)

## Scanning Settings for Special Documents

You need to select specific options on the Main Settings tab in Epson Scan 2 when scanning special originals.

Type of original	Required settings
Envelope	Select <b>Off</b> as the <b>Detect Double Feed</b> setting.
Plastic cards	Select <b>Plastic Card (Landscape)</b> as the <b>Document Size</b> setting and <b>Off</b> as the <b>Detect Double Feed</b> setting.
Carrier sheet	If you select <b>Auto Detect</b> as the <b>Document Size</b> setting, paper skew is automatically corrected even if the <b>Correct Document Skew</b> setting is set to <b>Off</b> .  If you select a setting other than <b>Auto Detect</b> as the <b>Document Size</b> setting, you can only use <b>Contents Skew</b> as the <b>Correct Document Skew</b> setting. As paper skew is not applied in this case, only contents skew is corrected when you select the <b>Paper and Contents Skew</b> setting.
Large originals	If the <b>Document Size</b> list does not contain the document size you want to scan, select <b>Customize</b> to create a custom size.

Type of original	Required settings
Long paper	<p>If the <b>Document Size</b> list does not contain the document size you want to scan, select <b>Auto Detect (Long Paper)</b> or select <b>Customize</b> to create a custom document size.</p> <p>If you are scanning folded originals without the carrier sheet, select <b>Off</b> as the <b>Detect Double Feed</b> setting.</p>
Laminated cards	<p>To scan any transparent areas around the edges of the card, select <b>Settings</b> as the <b>Document Size</b> setting and either select the <b>Scan laminated card</b> checkbox or create a custom size.</p>

Parent topic: [Scanning in Epson Scan 2](#)

## Image Format Options

You can select different image formats and related options. For details on available options, click the ? icon on the Epson Scan 2 Image Format Options window. Not all image formats have options.

### **BITMAP (\*.bmp)**

A standard image file format for most Windows programs.

### **JPEG (\*.jpg)**

An image format that lets you highly compress image data. However, the higher the compression, the lower the image quality. (The TIFF format is recommended when you need to modify or retouch your scanned image.)

### **PNG (\*.png)**

An image format that does not lose quality during editing.

### **TIFF (\*.tif)**

A file format created for exchanging data between many programs, such as graphic and DTP software.

### **Multi-TIFF (\*.tif)**

A TIFF file format when multiple pages are saved to the same file, allowing you to edit the images using a compatible program.

### **PDF (\*.pdf)**

A document format that is readable by Windows and Mac systems using Adobe Reader, Acrobat, or other programs. You can save multi-page documents in one PDF file.

**Searchable PDF (\*.pdf)**

A document format that is readable by Windows and Mac systems using Adobe Reader, Acrobat, or other programs. You can save multi-page documents in one PDF file. Recognized text in the scanned document can be searched.

**Note:** If you do not see the Searchable PDF option, run the Epson Software Updater and install the EPSON Scan OCR Component/Pro.

**Parent topic:** [Scanning in Epson Scan 2](#)

## Scan Resolution Guidelines

The resolution setting in your scanning software, measured in dpi (dots per inch), controls the amount of detail captured in your scans. Increasing the resolution raises the amount of detail captured but comes with the following disadvantages:

- Larger file sizes
- It takes longer to scan your originals, send/receive your scans by email or fax, and to print your scans
- The image may become too large to fit on your display or print on paper
- The maximum length you can scan is reduced

If you plan to enlarge a scanned image so you can print it at a larger size, you may need to increase the resolution from the default resolution set by the software. Follow these guidelines to determine the resolution setting you need:

- You will scan the image at its original size but enlarge it later in an image-editing program.

Increase the resolution setting in your scanning software. Increase the resolution by the same amount you will increase the image size to retain a high image quality. For example, if the resolution is 300 dpi (dots per inch) and you will double the image size later, change the resolution setting to 600 dpi.

- You will scan the image at 100% or smaller size.

Select the resolution setting based on how you will use the scanned image:

- Email/view on a computer screen/post on the web: 96 to 200 dpi
  - Print/fax/convert to editable text (OCR)/create searchable PDF: 200 to 300 dpi
- You will scan a long original.

Scan paper up to 240 inches (6096 mm) in length with a maximum resolution of 300 dpi or less.

**Parent topic:** [Scanning](#)

## Scanning Special Projects

Your product's scanning software offers various options to help you quickly complete special scan projects.

[Scanning Two Originals onto One Sheet \(Stitching Images\) - Windows](#)

[Scanning Multi-Page Originals as Separate Files - Windows](#)

[Saving Scanned Documents as a Searchable PDF Using Epson Scan 2](#)

[Saving Scanned Documents as a Searchable PDF with Document Capture - Mac](#)

[Saving a Scan as an Office Format File - Windows](#)

[Saving a Scan as an Office Format File - Mac](#)

[Scanning to a SharePoint Server or Cloud Service - Windows](#)

[Scanning to a SharePoint Server or Cloud Service - Mac](#)

**Parent topic:** [Scanning](#)



### Scanning Two Originals onto One Sheet (Stitching Images) - Windows

You can scan both sides of a double-sided or folded original in Document Capture Pro and combine them into a single image with the Epson Scan 2 Stitch Images setting (not available for all products).

**Note:** Settings may vary depending on the software version you are using. Click the **Help** icon in Document Capture Pro at any time for more information.

1. Load your original in the product.

**Note:** If an optional carrier sheet is included with your product, use it when scanning a folded original or damage to the original may occur. Place the original into the carrier sheet with the folded edge against the right side of the carrier sheet. Make sure to insert the carrier sheet into your product with the white edge facing down.

2. Do one of the following to start Document Capture Pro:
  - **Windows 10:** Click  and select **Epson Software > Document Capture Pro**.
  - **Windows 8.x:** Navigate to the **Apps** screen and select **Document Capture Pro**.
  - **Windows (other versions):** Click  or **Start** and select **All Programs** or **Programs**. Select **Epson Software > Document Capture Pro**.
3. Select the **Simple Scan** tab.

You see a window like this:

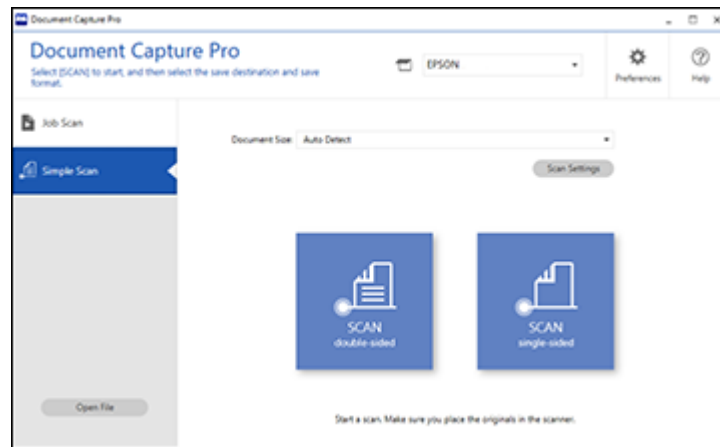

4. Click **Scan Settings > Detailed Settings**.

You see an Epson Scan 2 window like this:

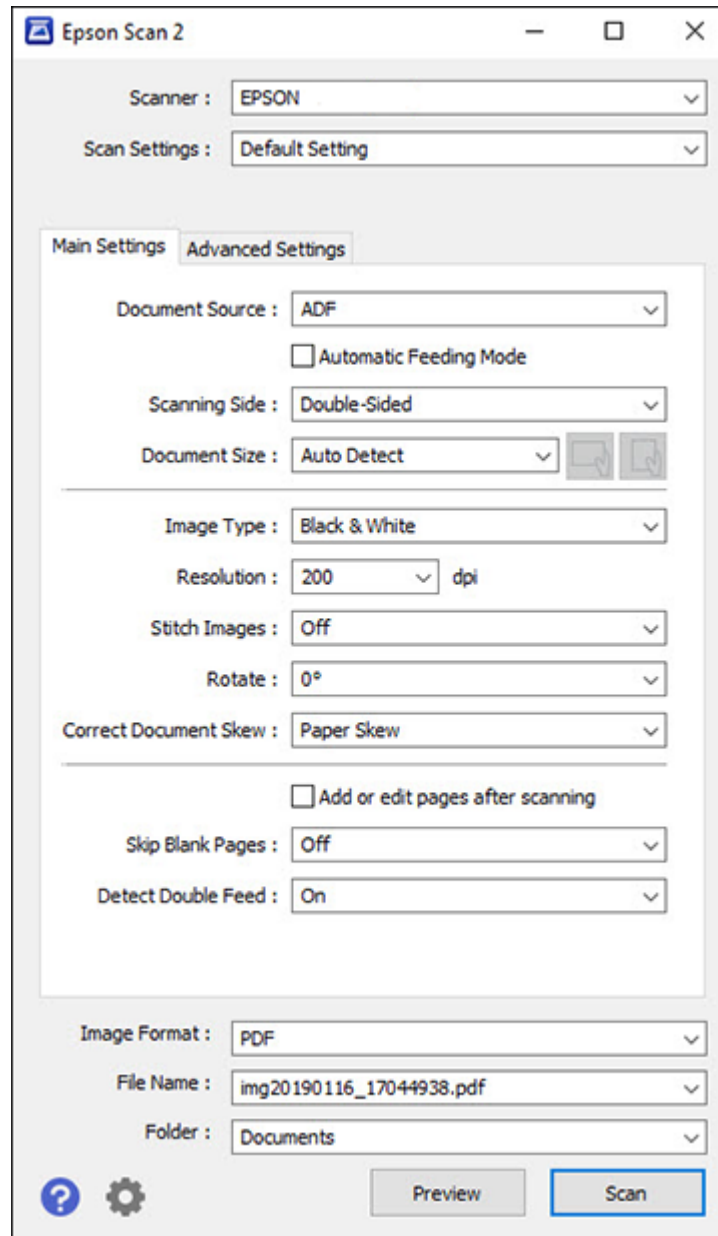

5. Select **Double-Sided** as the **Scanning Side** setting.
6. Select the original document size or **Auto Detect** as the **Document Size** setting.
7. Select one of the following as the **Stitch Images** setting:
  - **Top & Bottom**: Places the scanned images one above the other.
  - **Left & Right**: Places the scanned images side by side.
8. Select the **Advanced Settings** tab and verify that the **Edge Fill** setting is set to **None**.
9. Click **Save**.
10. Click **OK**.
11. Click **SCAN double-sided**.

Your product scans the original and the image appears in the Edit Scanned Results window.

**Note:** If the scanned images are not stitched together in the correct orientation, click **Scanning Side** on the Epson Scan 2 window, select **Settings**, set the Binding Edge to **Left** or **Top**, and rescan the document.

12. Review and edit the scanned pages as necessary and click **Next** when you are finished.
13. Select a destination and any settings as necessary and click **Complete**.

**Parent topic:** [Scanning Special Projects](#)

## Scanning Multi-Page Originals as Separate Files - Windows

You can use Document Capture Pro to scan multi-page originals as separate scanned files. You can indicate how the separate files are created by defining a maximum page count per file or by inserting blank pages, barcodes, or characters that can be detected by the software as separation markers.

**Note:** Settings may vary depending on the software version you are using. Click the **Help** icon in Document Capture Pro at any time for more information.

1. Load your multi-page original in the product.
2. Do one of the following to start Document Capture Pro:
  - **Windows 10:** Click  and select **Epson Software > Document Capture Pro**.
  - **Windows 8.x:** Navigate to the **Apps** screen and select **Document Capture Pro**.

- **Windows (other versions):** Click  or **Start**, and select **All Programs** or **Programs**. Select **Epson Software > Document Capture Pro**.

You see the Document Capture Pro window.

3. Select the **Job Scan** tab.

You see a window like this:

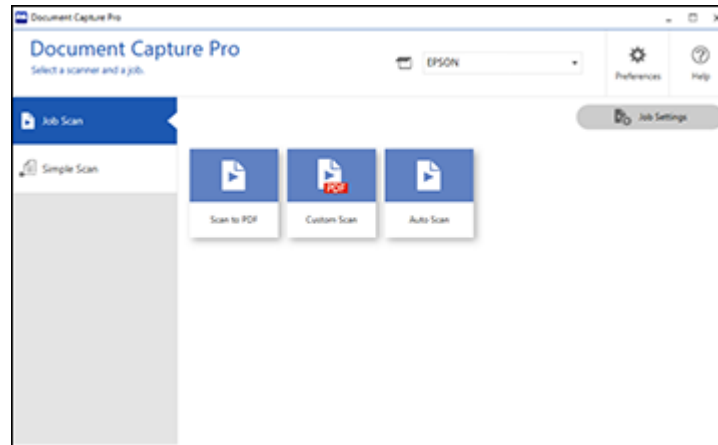

4. Click the **Job Settings** button.

You see a window like this:

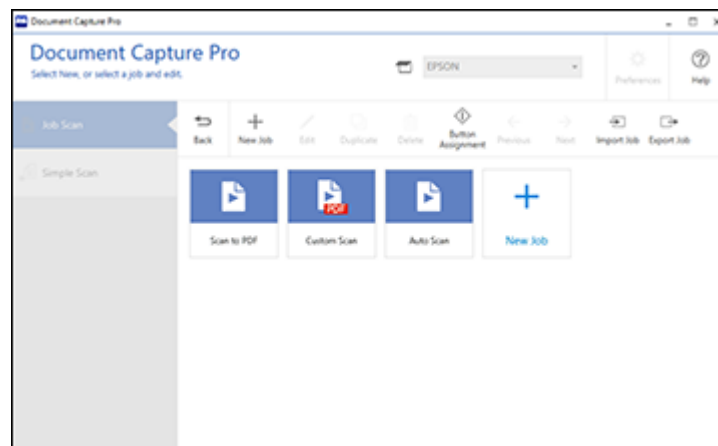



5. Select **New Job** and select the scan settings. Click **Next** when finished.  
You see a window like this:

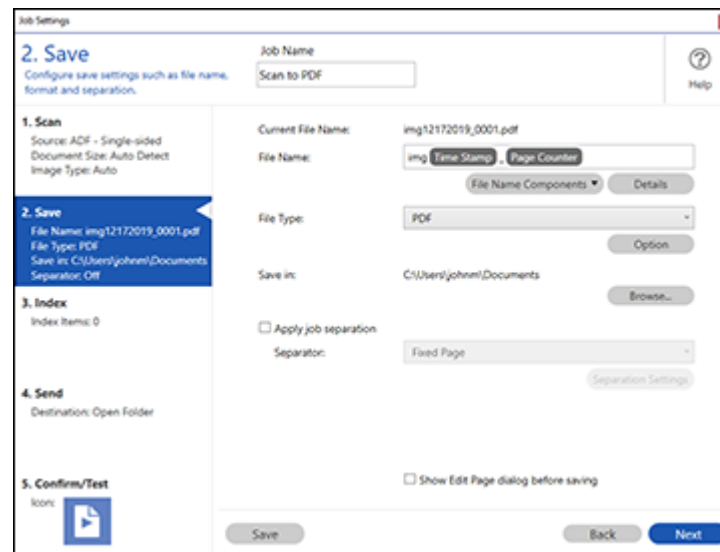

6. Select the **Apply job separation** checkbox.
7. Select the method you want to use to separate the originals as the **Separator** setting. Click **Separation Settings** to specify the settings for the selected option.
8. Finish creating the new scan job and click **Save**.
9. Click **Back** on the Job Settings screen.

Your originals are saved into separate files and folders as specified when the job is run.

**Parent topic:** [Scanning Special Projects](#)

## Saving Scanned Documents as a Searchable PDF Using Epson Scan 2

You can scan a document and save the text in a searchable PDF. In a searchable PDF, text is recognized using Optical Character Recognition (OCR) and then embedded in the scanned original.

**Note:** The required Epson Scan 2 OCR Component is installed automatically when you install your product software. If you install your scanner software programs individually, be sure to also install this component if you want to perform OCR.

1. Load your original in the product for scanning.
2. Start Epson Scan 2.
3. Select your scan settings.
4. Click **Preview** and adjust the area you want to scan, if necessary.
5. Reload the ejected original in the scanner.
6. Select **Searchable PDF** as the Image Format setting.
7. Select **Options** from the Image Format list.

You see this window:

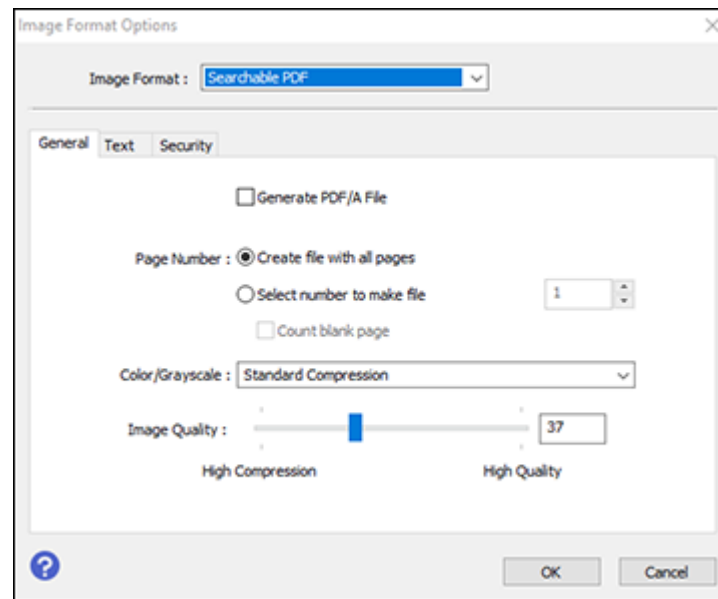

8. Select any of the options on the **General** tab.
9. Select the **Text** tab.
10. Make sure the language used in the document text is selected as the **Text Language** setting.
11. Select the **Security** tab if you want to add a password to the PDF or protect printing or editing properties.
12. Click **OK**.

13. Confirm the **File Name** setting and select a **Folder** setting for your document.
14. Click **Scan**.

The scanned image is saved as a searchable PDF.

**Parent topic:** [Scanning Special Projects](#)

**Related topics**

[Loading Originals](#)

## Saving Scanned Documents as a Searchable PDF with Document Capture - Mac

You can scan a document with Document Capture and save the text in a searchable PDF. In a searchable PDF, text is recognized using Optical Character Recognition (OCR) and then embedded in the scanned original.

**Note:** The settings may vary, depending on the software version you are using. See the Help information in Document Capture for details.

1. Load your original in the product for scanning.
2. Open the **Applications** folder, open the **Epson Software** folder, and select **Document Capture**.

You see a window like this:

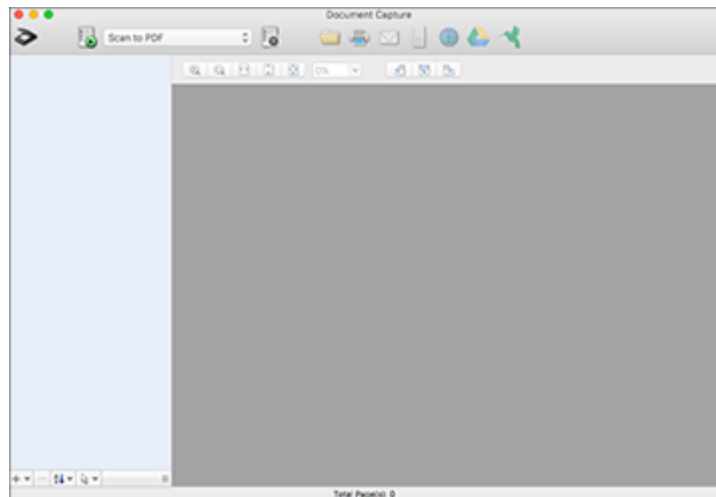

**Note:** You may need to select your scanner from the scanner list.

3. Click the  **Scan** icon.

You see a window like this:

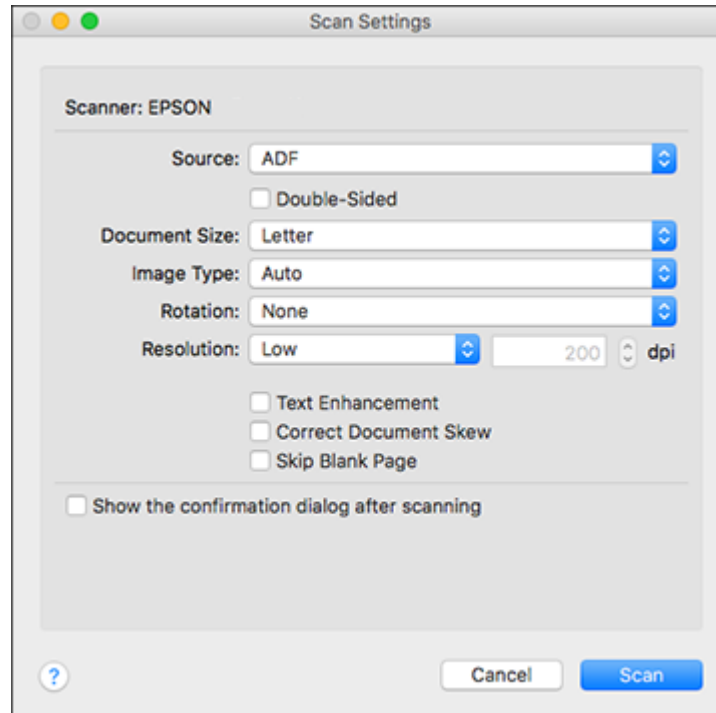

**Note:** If you want to use a scan job that you created instead, select it from the Job list in the Document Capture window, click the  Start Job button, and skip the rest of these steps.

4. Select any displayed scan settings you want to use.

**Note:** See the Help information in Document Capture for details.

5. If you want to select detailed scan settings, close the Scan Settings window, open the **Scan** menu at the top of the Mac desktop, and select **Displays the EPSON Scan Setup Screen**.

6. Click the  Scan icon and select any detailed scan settings you want to use from the Epson Scan 2 window.
7. Click **Scan**.

You see a preview of your scan in the Document Capture window.

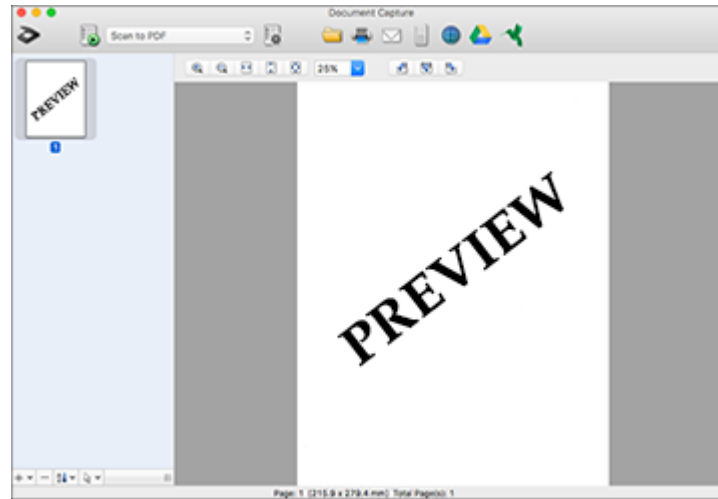

**Note:** You may have to close the Epson Scan 2 window to view your scan in the Document Capture window.

8. If you would like to scan additional originals and add them to the current captured images, click the + icon, select **Acquire from Scanner**, and repeat the previous steps.
9. Check the scanned images and edit them as necessary.
10. Open the **File** menu at the top of the Mac desktop and select **Save As**.
11. Select **PDF** as the **File Type** setting and click the **Options** button.
12. Select the **Create Searchable PDF** checkbox and click **OK**.

13. Click one of the Destination icons to choose where to send your scanned file. (If you cannot see all of the icons below, click the arrow next to the icons.)



14. Depending on the destination you chose, click **OK** or **Send** to complete the operation.

**Parent topic:** [Scanning Special Projects](#)



**Related topics**

[Loading Originals](#)

## Saving a Scan as an Office Format File - Windows

You can use Document Capture Pro to save your scans in one of the following Microsoft Office file formats: Microsoft Word (.docx), Microsoft Excel (.xlsx), or Microsoft PowerPoint (.pptx).

**Note:** The settings may vary, depending on the software version you are using. See the help information in Document Capture Pro for details.

1. Load your original in the product.
2. Do one of the following to start Document Capture Pro:
  - **Windows 10:** Click  and select **Epson Software > Document Capture Pro**.
  - **Windows 8.x:** Navigate to the **Apps** screen and select **Document Capture Pro**.
  - **Windows (other versions):** Click  or **Start**, and select **All Programs** or **Programs**. Select **Epson Software > Document Capture Pro**.
3. Select the **Simple Scan** tab.

You see a window like this:

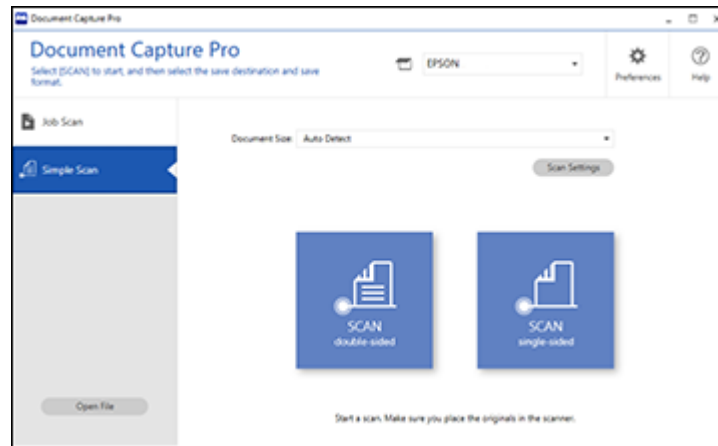

4. If you want to select specific scan settings for the scan, click the **Scan Settings** button, select any displayed settings you want to use, and click **OK**.

**Note:** See the help information in Document Capture Pro for details.

5. Do one of the following:
  - To scan the front side of an original, select **SCAN single sided**.
  - To scan both sides of an original, select **SCAN double sided**.

Your product starts scanning and you see the Edit Scanned Results window.

6. View and edit the scanned pages as necessary and click **Next** when you are finished.

**Note:** See the help information in Document Capture Pro for details.

7. Click one of the destination icons (except **Print**) to choose where to send your scanned files. You see the settings window.
8. Select the Office format file you want to use from the **File Type** drop-down list.

**Note:** The first time you select an Office format file you are prompted to download a plug-in update for Microsoft Office files. Select **Yes** to download and install the plug-in.

9. Click **Option** to display additional settings.
10. Select any additional settings as necessary and click **OK**.

**Note:** See the help information in Document Capture Pro for details.

11. Confirm your settings and click **Complete**.

Your originals are saved in the Office file format you selected.

**Parent topic:** [Scanning Special Projects](#)

**Related topics**

[Loading Originals](#)

## **Saving a Scan as an Office Format File - Mac**

You can use Document Capture (Mac) to save your scans in one of these Microsoft Office file formats: Microsoft Word (.docx) and Microsoft Excel (.xlsx).

**Note:** The settings may vary, depending on the software version you are using. See the Help information in Document Capture for details.

1. Load your original in the product for scanning.
2. Open the **Applications** folder, open the **Epson Software** folder, and select **Document Capture**.



You see a window like this:

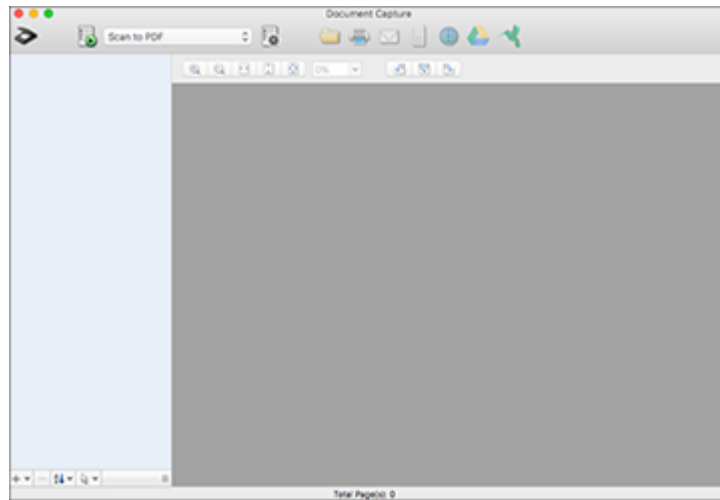

**Note:** You may need to select your scanner from the scanner list.

3. Click the  **Scan** icon.

You see a window like this:

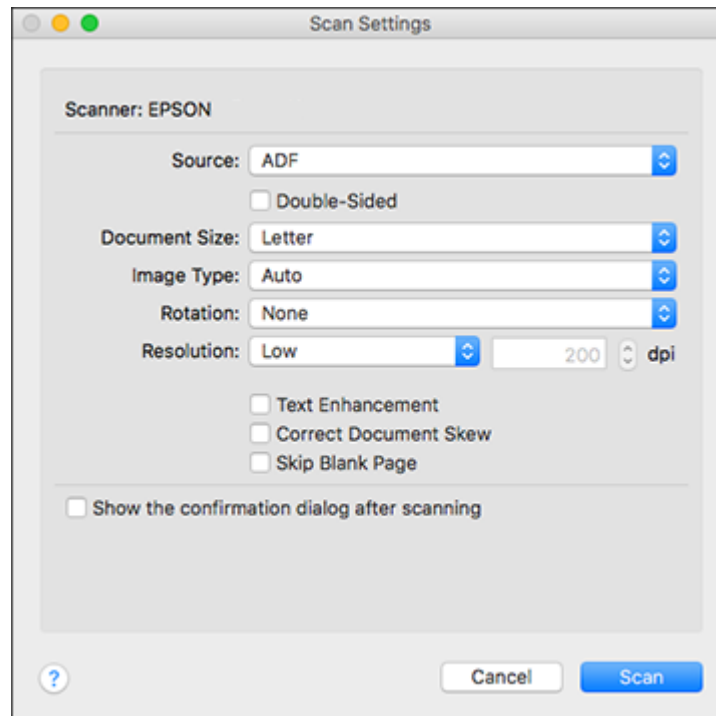

**Note:** If you want to use a scan job that you created instead, select it from the Job list in the Document Capture window, click the  Start Job button, and skip the rest of these steps.

4. Select any displayed scan settings you want to use.

**Note:** See the Help information in Document Capture for details.

5. If you want to select detailed scan settings, close the Scan Settings window, open the **Scan** menu at the top of the Mac desktop, and select **Displays the EPSON Scan Setup Screen**.
6. Click the  Scan icon and select any detailed scan settings you want to use from the Epson Scan 2 window.
7. Click **Scan**.

You see a preview of your scan in the Document Capture window.

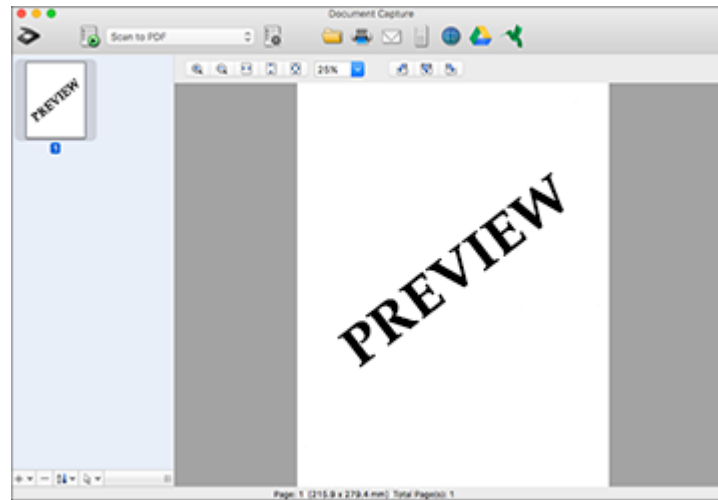

**Note:** You may have to close the Epson Scan 2 window to view your scan in the Document Capture window.

8. If you would like to scan additional originals and add them to the current captured images, click the + icon, select **Acquire from Scanner**, and repeat the previous steps.
9. Check the scanned images and edit them as necessary.
10. Open the **File** menu at the top of the Mac desktop and select **Save As**.
11. Select **DOCX** (Word) or **XLSX** (Excel) as the **File Type** setting.

**Note:** The first time you select an Office file type setting in Document Capture, you see a prompt to download a necessary plug-in for Microsoft Office files. Select **Yes** and follow the on-screen instructions to download and install the plug-in to continue.

12. Click the **Options** button, select any necessary Office file type options, and click **OK**.

13. Click one of the Destination icons to choose where to send your scanned file. (If you cannot see all of the icons below, click the arrow next to the icons.)



14. Depending on the destination you chose, click **OK** or **Send** to complete the operation.

**Parent topic:** [Scanning Special Projects](#)



**Related topics**

[Loading Originals](#)

## Scanning to a SharePoint Server or Cloud Service - Windows

You can use Document Capture Pro to upload scanned images to a SharePoint server or a cloud service.

**Note:** The settings may vary, depending on the software version you are using. See the help information in Document Capture Pro for details.

1. Load your original in the product.
2. Do one of the following to start Document Capture Pro:
  - **Windows 10:** Click  and select **Epson Software > Document Capture Pro**.
  - **Windows 8.x:** Navigate to the **Apps** screen and select **Document Capture Pro**.
  - **Windows (other versions):** Click  or **Start**, and select **All Programs** or **Programs**. Select **Epson Software > Document Capture Pro**.
3. Select the **Simple Scan** tab.

You see a window like this:

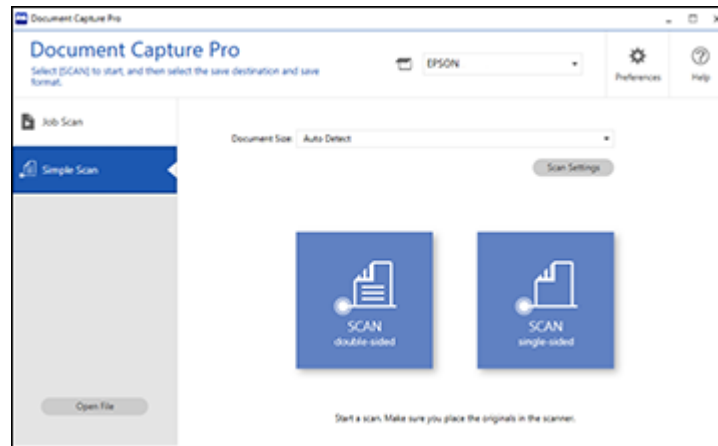

4. If you want to select specific scan settings for the scan, click the **Scan Settings** button, select any displayed settings you want to use, and click **OK**.

**Note:** See the help information in Document Capture Pro for details.

5. Do one of the following:
  - To scan the front side of an original, select **SCAN single sided**.
  - To scan both sides of an original, select **SCAN double sided**.

Your product starts scanning and you see the Edit Scanned Results window.

6. View and edit the scanned pages as necessary and click **Complete** when you are finished.

**Note:** See the help information in Document Capture Pro for details.

7. Click one of the cloud server or service destination icons. You see the settings window.
8. Enter any required information to set up the destination. You may need to log in to your cloud service to authenticate the connection and allow Document Capture Pro to access the cloud service.
9. Adjust any settings and click **Complete**.

**Note:** See the help information in Document Capture Pro for details.

Your originals are uploaded to the indicated server or cloud service.

**Parent topic:** [Scanning Special Projects](#)

**Related topics**

[Loading Originals](#)

## Scanning to a SharePoint Server or Cloud Service - Mac

You can use Document Capture to upload scanned images to a SharePoint server or a cloud service.

1. Open the **Applications** folder, open the **Epson Software** folder, and select **Document Capture**.

You see a window like this:

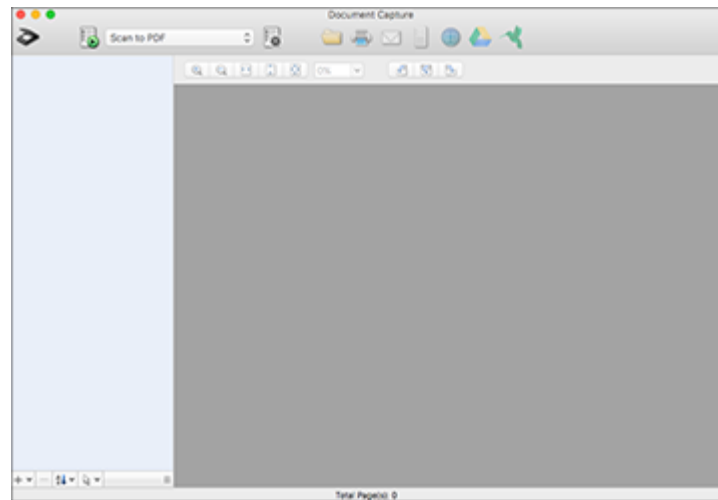

**Note:** You may need to select your scanner from the scanner list.

2. Click the  scan icon.
3. Select any displayed scan settings you want to use.

**Note:** See the Help information in Document Capture for details.

4. Click **Scan**.

You see a preview of your scan in the Document Capture window.

5. Click one of the cloud service Destination icons to choose where to save your scanned file. (If you cannot see all of the icons, the service software may not be installed, the service may not be available on your platform, or you need to click the arrow next to the icons.)

You see the Transfer Settings window.

6. Enter any required information to set up the destination. You may need to log in to your cloud service to authenticate the connection and allow Document Capture to access the cloud service. If you have previously created a saved setting for the destination, select it from the drop-down list.
7. Adjust any save settings, then click **OK** or **Send**, depending on the destination.

Your originals are scanned and uploaded to the indicated server or cloud service.

**Parent topic:** [Scanning Special Projects](#)

**Related topics**

[Loading Originals](#)

---

## Using the Optional Flatbed Scanner Dock - Windows

The optional flatbed scanner dock combines your document scanner with a flatbed scanner into a single unit (DS-530 II/DS-770 II). This allows you to scan thick or over-sized originals, such as cardboard and books, that won't fit into the document scanner's ADF.

You must purchase a flatbed scanner (Epson Perfection V19/V39) to use the optional flatbed scanner dock. To attach the flatbed scanner and dock to your document scanner, follow the installation instructions that came with your flatbed scanner dock.

See these sections to learn about the flatbed scanner dock option.

**Note:** Your product may differ from the images in this guide, but the instructions are the same unless otherwise noted.

[Flatbed Scanner Dock Parts](#)

[Scanning from the Flatbed Scanner Dock](#)

[Cleaning the Flatbed Scanner Dock](#)

[Transporting the Flatbed Scanner Dock](#)

### Flatbed Scanner Dock Parts

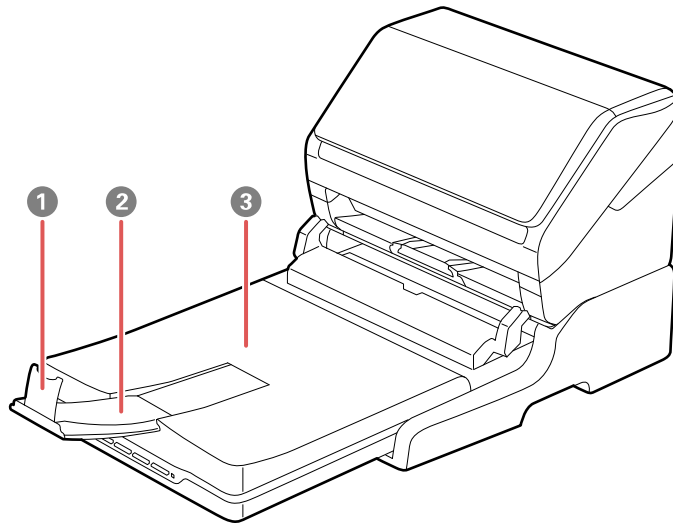



- 1 Stopper
- 2 Output tray extension
- 3 Scanner cover/output tray

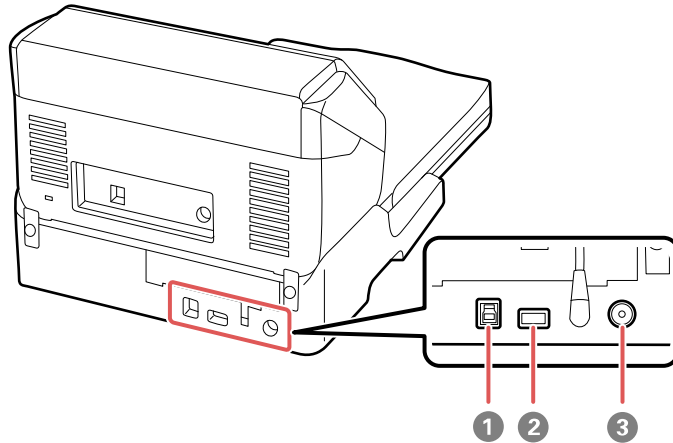

- 1 USB port 1 (for connecting flatbed dock to computer)
- 2 USB port 2 (for connecting flatbed dock to document scanner)
- 3 Power inlet

Parent topic: [Using the Optional Flatbed Scanner Dock - Windows](#)

## Scanning from the Flatbed Scanner Dock

See these sections to scan when using the optional flatbed scanner dock.

[Scanning from the Docked Flatbed Scanner](#)

[Scanning from the ADF with the Flatbed Scanner Dock Attached](#)

Parent topic: [Using the Optional Flatbed Scanner Dock - Windows](#)

## Scanning from the Docked Flatbed Scanner

You can place originals directly on the scanner glass of the flatbed scanner attached to the optional flatbed scanner dock.

**Caution:** Make sure the scanner is placed on a flat surface. Do not place heavy objects on the scanner glass and do not press on the glass with too much force, or it may damage the scanner. Do not leave photos on the scanner glass for an extended period, or they may stick to the glass.

1. Close the document scanner's output tray.
2. Open the flatbed scanner cover.
3. Place your original facedown on the scanner glass with the top edge facing as shown. Slide the original to the edges of the indicated corner.

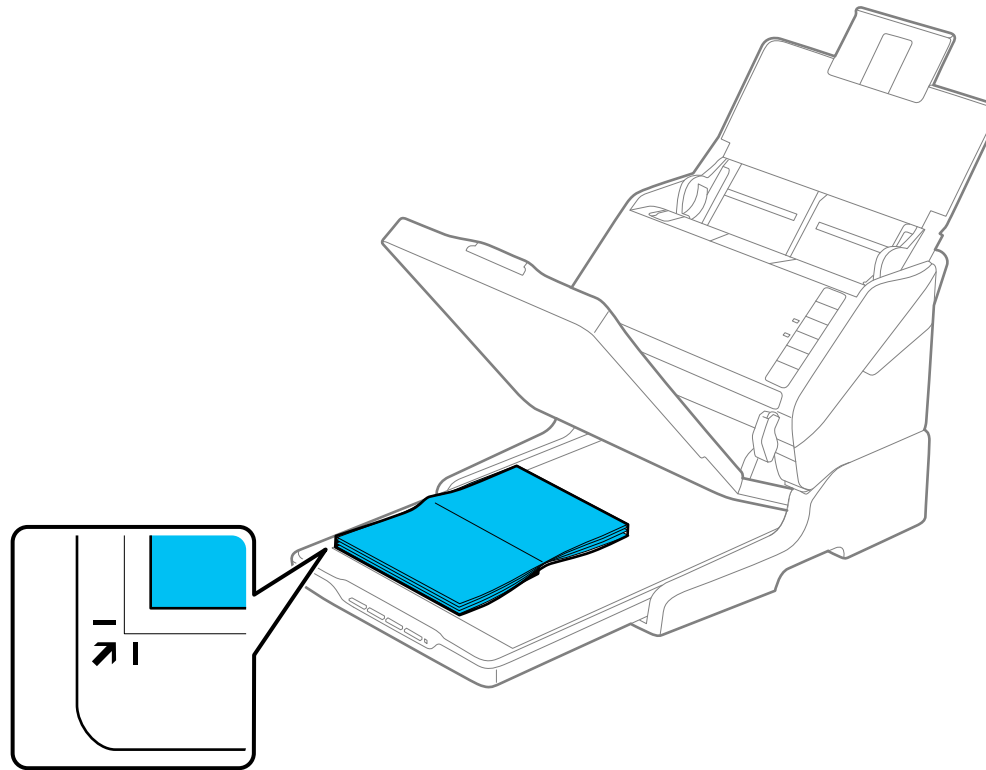

**Note:** Place your original 0.1 inch (2.5 mm) from the top and side edges of the scanner glass as shown in order to avoid cropping. If you are scanning multiple photos at once, place them at least 0.8 inch (20 mm) apart from each other.

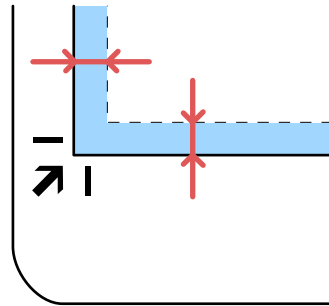

4. Close the flatbed scanner cover gently to keep your original in place. If you are scanning a book or other thick document, hold the scanner cover down as you scan.
5. Start Document Capture Pro (Windows), Document Capture (Mac), or Epson Scan 2.
6. Select **Scanner Glass** as the Document Source setting.
7. Select other scan settings as necessary.
8. Click **Scan**.

**Parent topic:** [Scanning from the Flatbed Scanner Dock](#)

#### **Related tasks**

[Scanning from the ADF with the Flatbed Scanner Dock Attached](#)

[Scanning in Epson Scan 2](#)

## **Scanning from the ADF with the Flatbed Scanner Dock Attached**

Depending on the length of your originals, you may need to adjust the position of the input tray, output tray, and stopper when scanning from the document scanner's ADF with the optional flatbed scanner dock attached.

For originals shorter than 8.2 inches (210 mm) long:

- Open the document scanner's input tray, pull out the output tray and output tray extension, and open the stopper.
- Extend the output tray a little longer than the length of the original and move the stopper forward or backward as necessary.

For originals between 8.2 inches (210 mm) and 11.7 inches (297 mm) long:

- Open and extend the document scanner's input tray, open the flatbed scanner's stopper, and slide the stopper forward or backward so that it is a little longer than the length of the original. (Do not open the output tray on the document scanner.)

For originals between 11.7 inches (297 mm) and 14 inches (356 mm) long:

- Open the document scanner's input tray, pull out and extend the scanner dock's output tray and output tray extension, and open the stopper. (Do not open the output tray on the document scanner.)
- Extend the output tray a little longer than the length of the original and move the stopper forward or backward as necessary.

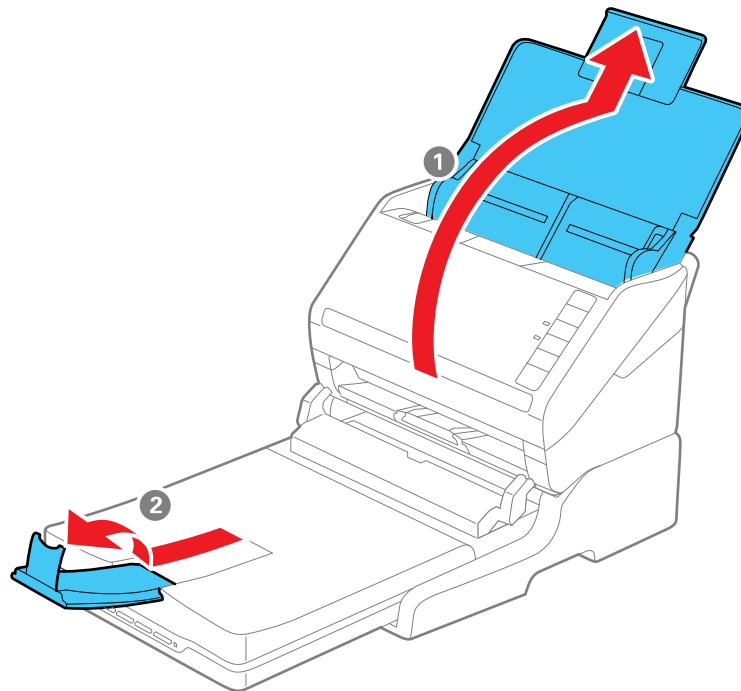

For originals that are 14 inches (356 mm) or longer:

- Open the document scanner's input tray.
- Leave the output tray closed, and close the flatbed and document scanner's stoppers.

**Parent topic:** [Scanning from the Flatbed Scanner Dock](#)

**Related tasks**

[Scanning from the Docked Flatbed Scanner](#)

[Scanning in Epson Scan 2](#)

## Cleaning the Flatbed Scanner Dock

To keep your product working at its best, you should clean it several times a year.

**Caution:** Do not use a hard brush, alcohol, or paint thinner to clean the product or you may damage it. Do not use oil or other lubricants inside the product or let water get inside it. Do not open the product case.

1. Turn off the document scanner using the ⏻ power button.

**Note:** There is no power button on the scanner dock.

2. Unplug the AC power cord and disconnect the USB cable that connects the flatbed scanner dock to the computer.
3. Clean the outer case with a cloth dampened with mild detergent and water.
4. If the scanner glass is dirty, clean it with a soft dry cloth. If the glass surface is stained with grease or some other hard-to-remove material, use a small amount of glass cleaner on a soft cloth to remove it. Wipe off all remaining liquid.

**Caution:** Do not spray glass cleaner directly on the scanner glass. Do not press the surface of the scanner glass with any force and be careful not to scratch or damage the scanner glass. A damaged glass surface can decrease the scan quality.

**Parent topic:** [Using the Optional Flatbed Scanner Dock - Windows](#)

## Transporting the Flatbed Scanner Dock

If you need to ship your product, transport it a long distance, or store it for an extended period, prepare it for transportation as described here.

**Note:** If you are transporting only the flatbed scanner dock (without the document scanner), follow the installation instructions that came with the flatbed scanner dock in reverse to remove the flatbed scanner and dock from the document scanner.

1. Turn off the document scanner using the ⏻ power button.

**Note:** There is no power button on the flatbed scanner.

2. Unplug the AC power cord and disconnect the USB cable that connects the flatbed scanner dock to the computer.

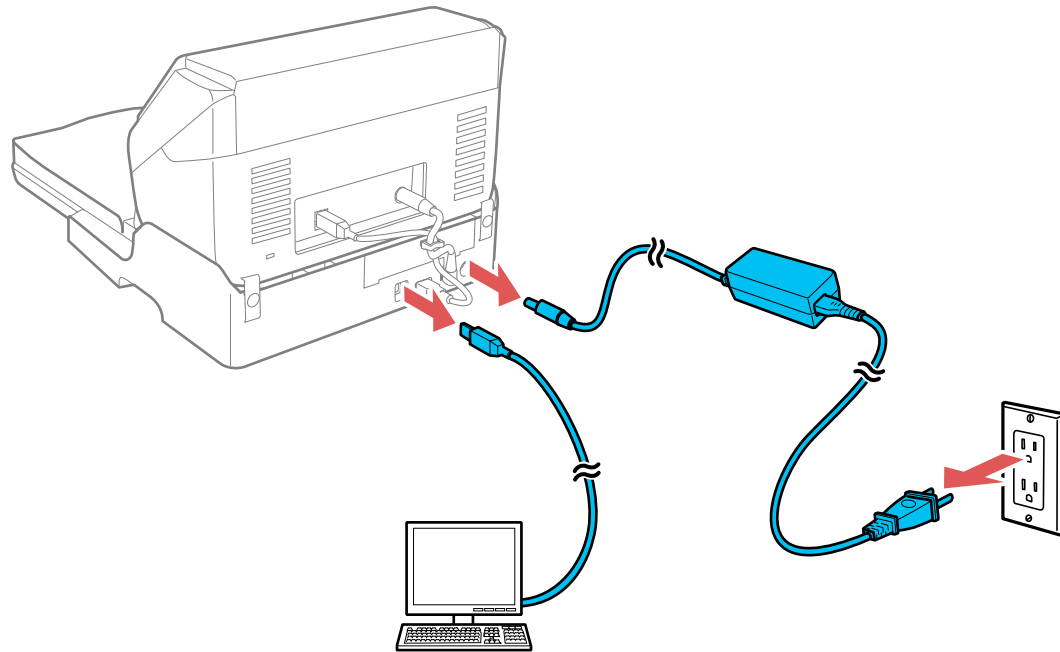

3. Lift the entire scanner unit as shown, making sure to keep it level during transport.

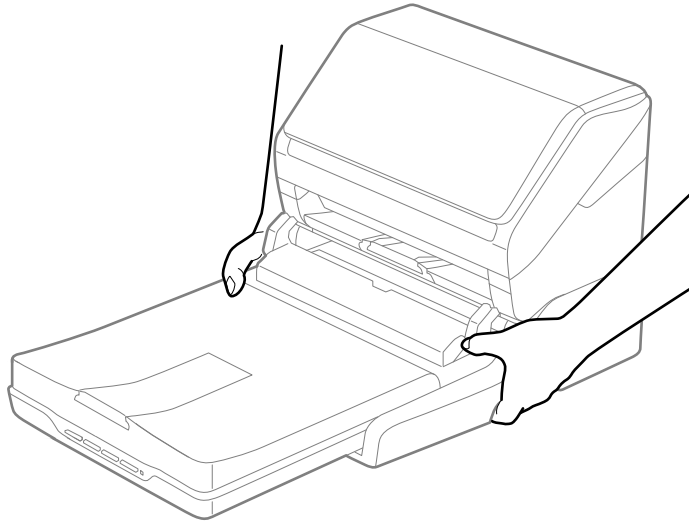

4. Place the scanner unit in its original packing materials if possible, or use equivalent materials with cushioning around the scanner.

**Caution:** Avoid turning the scanner upside down when transporting it or you may damage the scanner.

**Parent topic:** [Using the Optional Flatbed Scanner Dock - Windows](#)

---

# Cleaning and Transporting Your Scanner

See these sections if you need to clean or transport your scanner.

[Cleaning Your Scanner](#)

[Cleaning Inside Your Scanner](#)

[Replacing the Scanner Rollers](#)

[Transporting Your Scanner](#)

## Cleaning Your Scanner

To keep your product working at its best, you should clean it several times a year.

**Caution:** Do not use a hard brush, alcohol, or paint thinner to clean the product or you may damage it. Do not use oil or other lubricants inside the product or let water get inside it. Do not open the product's outer case.

1. Turn off the scanner and unplug the AC adapter.
2. Disconnect any connected cables.
3. Clean the outer case with a soft, dry cloth. Do not use liquid or chemical cleansers.

**Note:** If the outer case still requires additional cleaning, use a slightly damp cloth to wipe the outer case. Then wipe the case with a soft, dry cloth.

**Parent topic:** [Cleaning and Transporting Your Scanner](#)

## Cleaning Inside Your Scanner

Clean your scanner regularly to make sure that no dust builds up on the glass scanning surfaces. Dust can cause spots or lines in your scanned images. Clean the inside of the scanner every 5,000 scans. You can check the latest number of scans using the Epson Scan 2 Utility.

**Note:** The illustrations show the DS-575W II, but the instructions are the same for the DS-530 II and DS-770 II.

**Caution:** Do not use a hard brush, alcohol, or paint thinner to clean the product or you may damage it. Do not use oil or other lubricants inside the product or let water get inside it.



1. Turn off the scanner and unplug the AC adapter.
2. Disconnect any connected cables.
3. Pull down on the cover open lever and open the scanner cover.

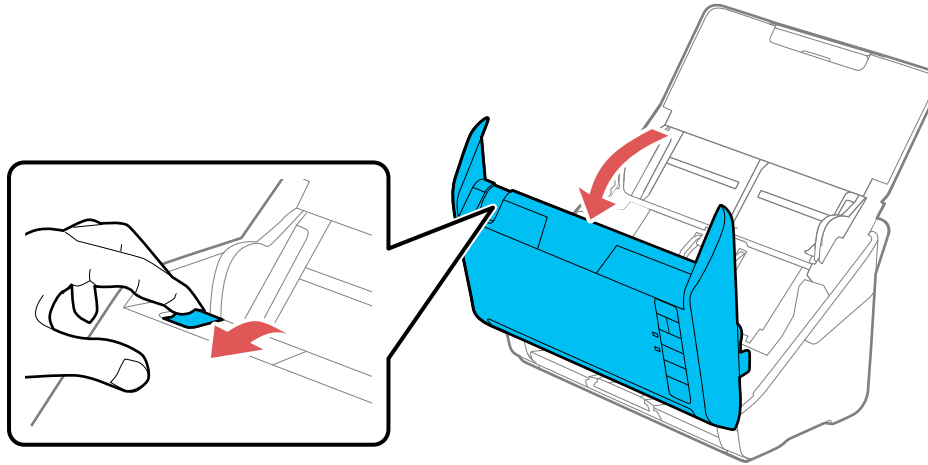

4. Use a genuine Epson cleaning kit or a soft, moist cloth to wipe off any dust or dirt on the glass scanning surfaces and the rollers inside the scanner cover. If the glass surface is stained with grease or some other hard-to-remove material, use a genuine Epson cleaning kit to remove stains.

Use a small amount of cleaner on the cleaning cloth to remove the stains. Wipe off all remaining liquid.

**Caution:** Do not spray glass cleaner directly on the scanning surfaces. Be careful not to place too much force on the glass.

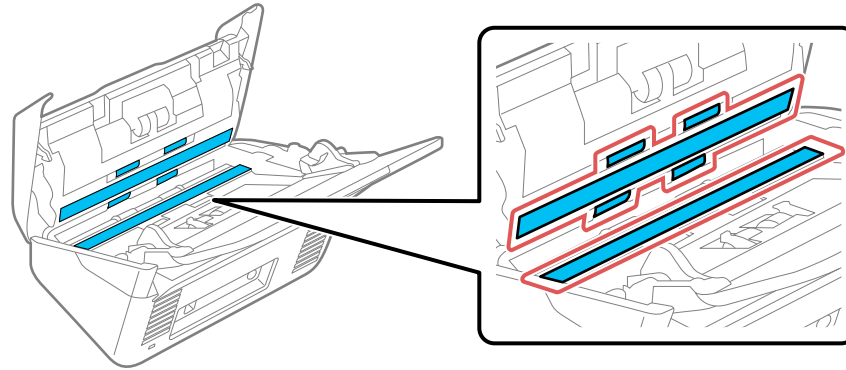

5. Use a cotton swab to wipe off any dust or dirt on the sensors.

**Caution:** Do not use liquid or glass cleaner on the cotton swab.

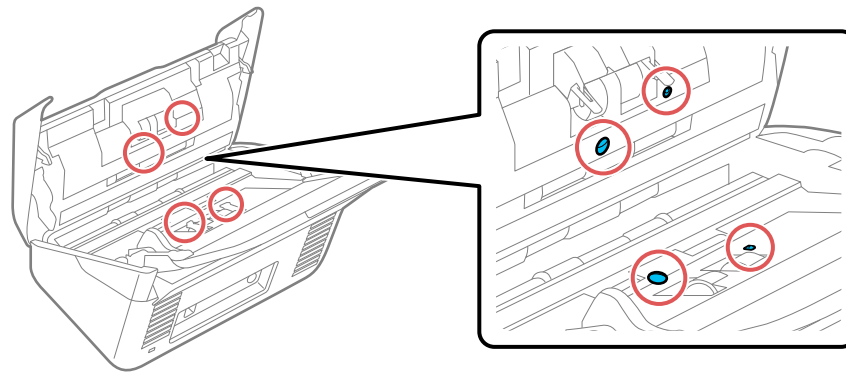

6. Wipe off any dust or dirt on the separation roller using a genuine Epson cleaning kit or a soft, moist cloth.

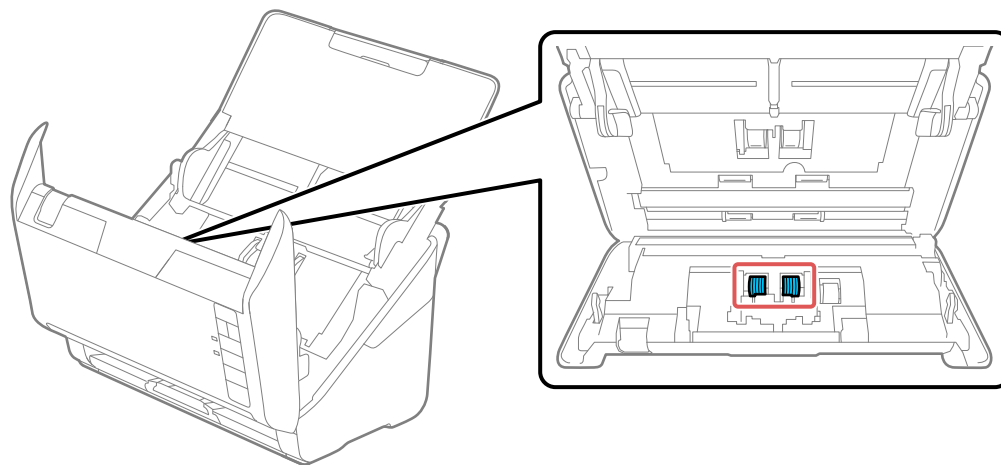

**Caution:** Use only a genuine Epson cleaning kit or soft, moist cloth to clean the roller; using a dry cloth may damage the surface of the roller.

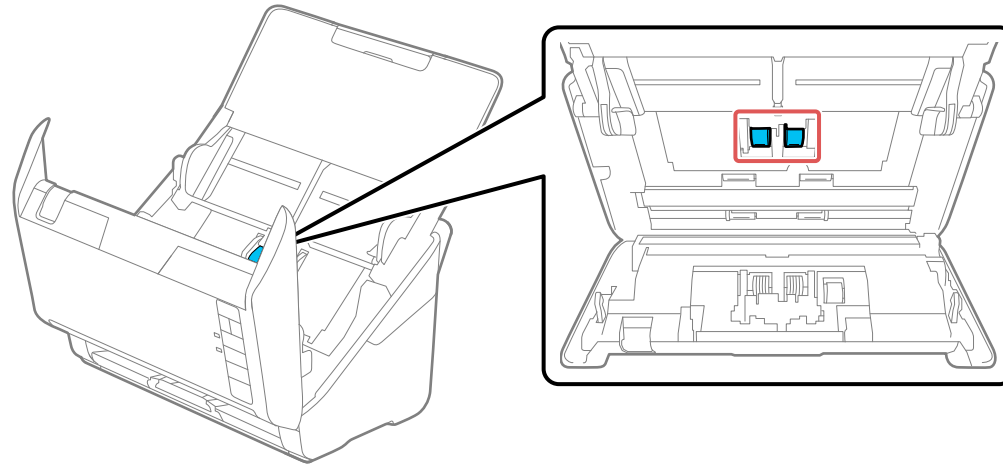

7. Wipe off any dust or dirt on the pickup roller using a genuine Epson cleaning kit or a soft, moist cloth.

**Caution:** Use only a genuine Epson cleaning kit or soft, moist cloth to clean the roller; using a dry cloth may damage the surface of the roller.



8. Plug in the AC adapter and press the  power button to turn on the scanner.
9. Hold down the  start button for at least two seconds while opening the scanner cover. The rollers on the bottom move momentarily, and then the scanner enters cleaning mode. Press the  start button several times to rotate the rollers shown here. Use a genuine Epson cleaning kit or a soft,

moist cloth to wipe off any dust or dirt on the rollers as they rotate. Repeat this step until the rollers are clean.

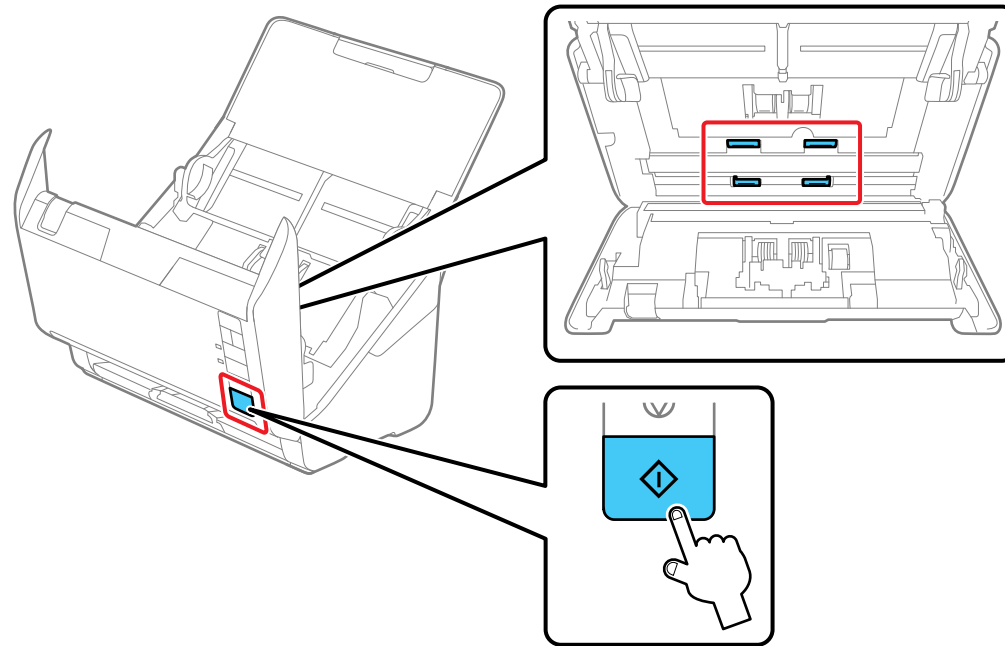

**Caution:** Be careful not to get your hands or hair caught in the mechanism when operating the roller.

10. Close the scanner cover.

[Resetting the Number of Scans After Cleaning](#)

**Parent topic:** [Cleaning and Transporting Your Scanner](#)

## Resetting the Number of Scans After Cleaning

Reset the number of scans using the Epson Scan2 Utility after regular cleaning.

1. Make sure the scanner is turned on and connected to your computer.
2. Do one of the following to open the Epson Scan 2 Utility:
  - **Windows 10:** Click  and select **EPSON > Epson Scan 2 Utility**.

- **Windows 8.x:** Navigate to the **Apps** screen and select **EPSON > Epson Scan 2 Utility**.
  - **Windows (other versions):** Click  or **Start > All Programs** or **Programs > EPSON > Epson Scan 2 > Epson Scan 2 Utility**.
  - **Mac:** Open the **Applications** folder, click **Epson Software**, and click **Epson Scan 2 Utility**.
3. Click the **Maintenance** tab.
- You see a screen like this:

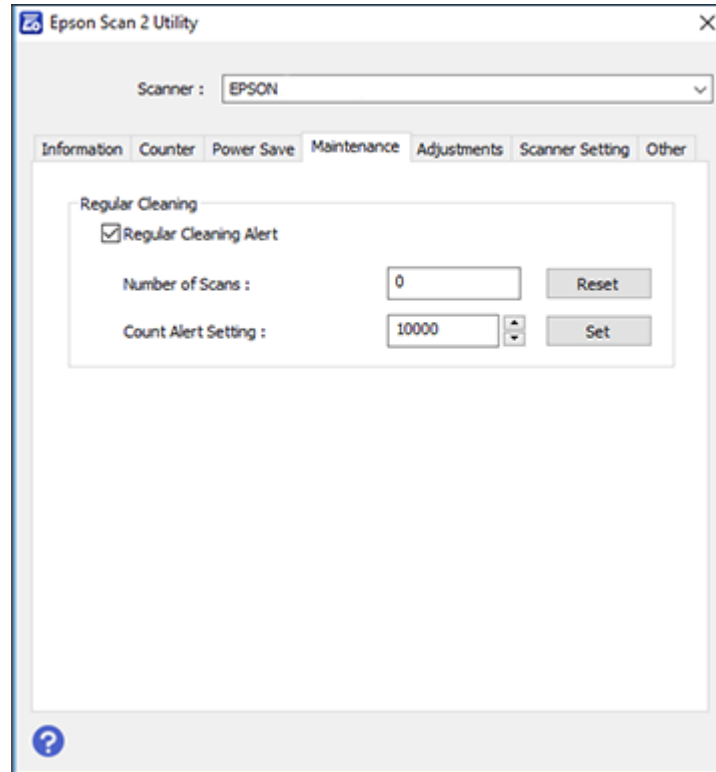

4. Select the **Regular Cleaning Alert** checkbox and click the **Reset** button.
5. Close the Epson Scan 2 Utility.

**Parent topic:** [Cleaning Inside Your Scanner](#)

## Replacing the Scanner Rollers

Replace the scanner rollers when the number of scans exceeds the life cycle of the rollers. Check the scanner roller counter to see when you need to replace the rollers.

**Note:** The illustrations show the DS-575W II, but the instructions are the same for the DS-530 II and DS-770 II.

**Note:** Frequent use of textured media may cause premature wear on the rollers. If frequent paper jams occur before the life cycle of the rollers is exceeded, try cleaning the rollers. In some cases, the rollers may need to be replaced before the number of scans exceeds the life cycle of the rollers.

1. Turn off the scanner.
2. Unplug the AC adapter.
3. Disconnect any connected cables.
4. Pull down on the cover open lever and open the scanner cover.

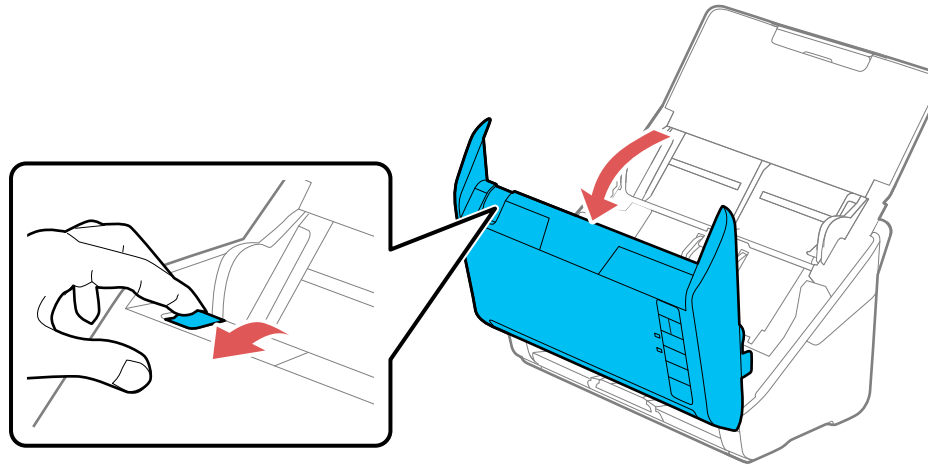

5. Press down on the pickup roller cover latch and pull up the cover to remove it.

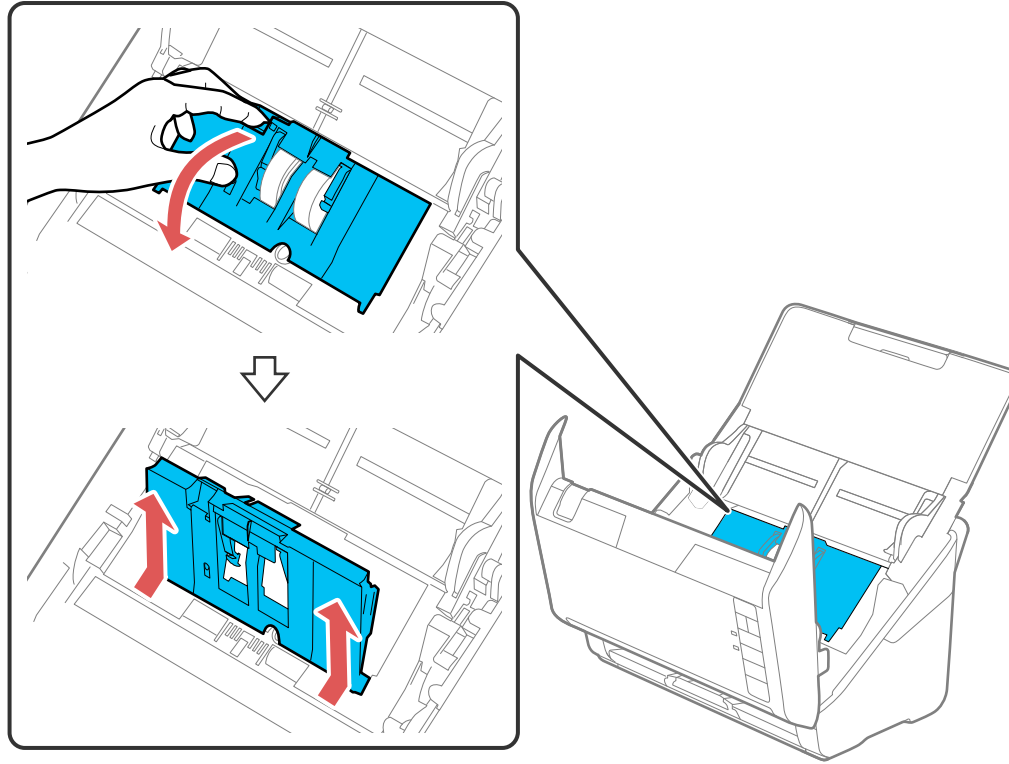



6. Pull down the tab on the pickup roller and slide the roller to the right to remove it.

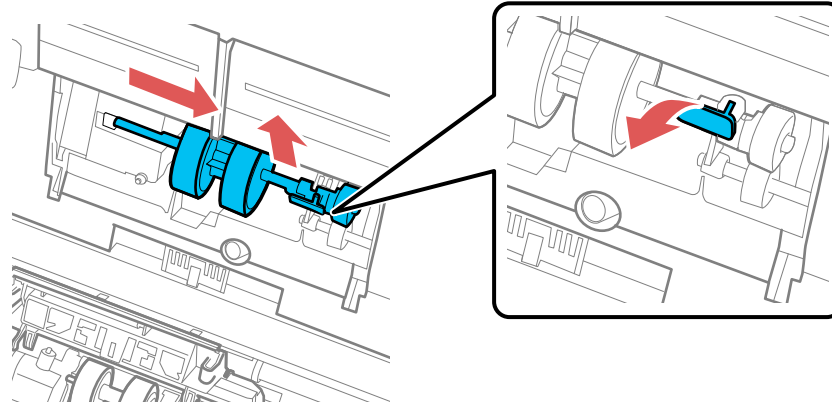

**Note:** Do not use force to pull out the pickup roller; doing so may damage the inside of the scanner.

7. To install the new pickup roller, align the notches on the roller unit and slide it to the left. Press up on the tab to secure the roller.

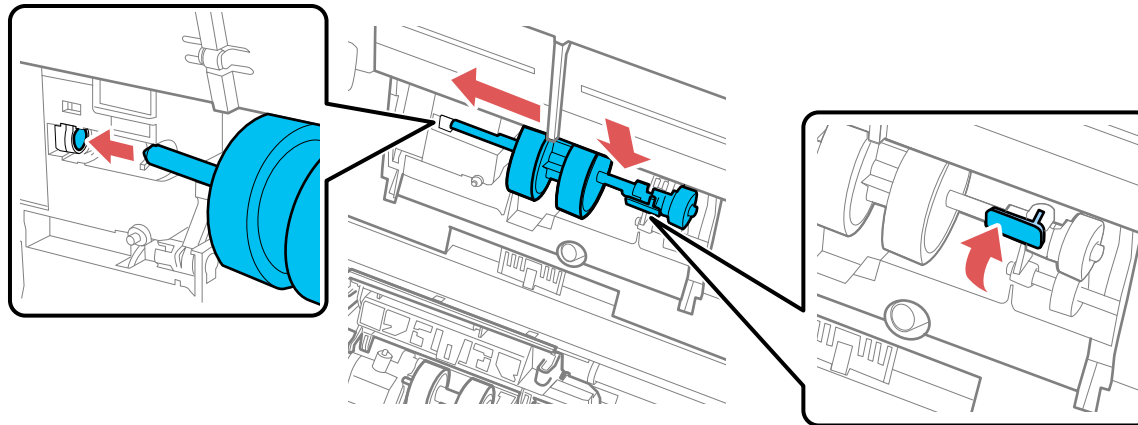

8. Align the bottom edge of the pickup roller cover into the notches as shown and press it down until it clicks into place.

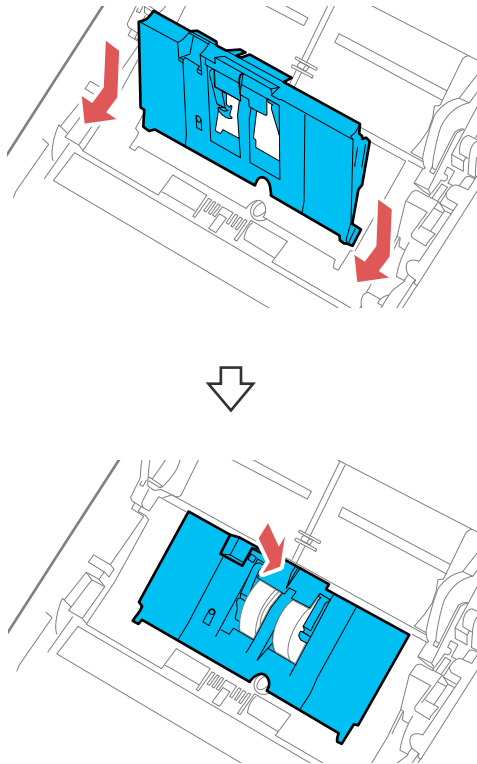

**Note:** If you are not able to close the cover, the pickup roller is not installed correctly. Remove the roller unit and reinstall it, then try to close the cover again.

9. Squeeze the tabs on the sides of the separation roller cover and open the cover.

**Caution:** Be careful not to apply too much force when opening the cover.

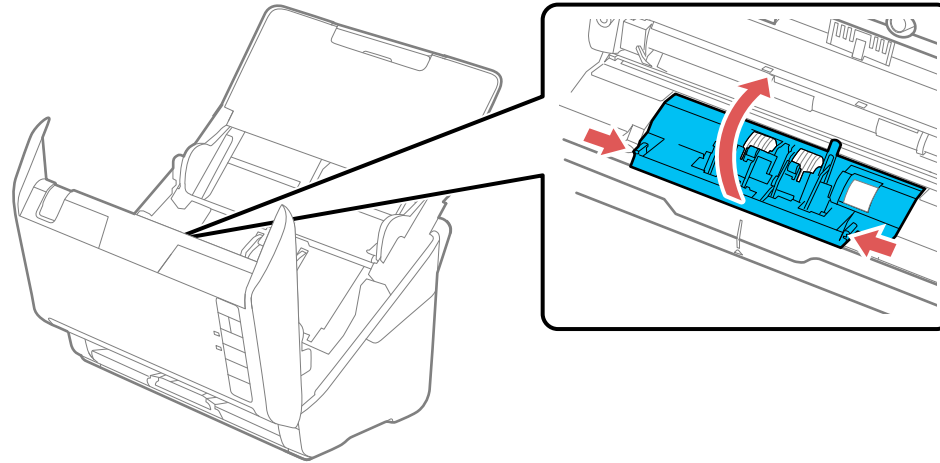

10. Slide the separation roller to the left and remove it.

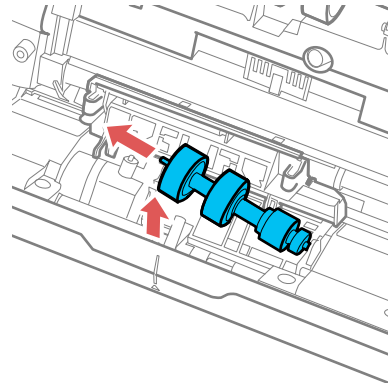

11. To install a new separation roller, insert the end of the roller into the hole on the right side and lower the other end of the roller into place.

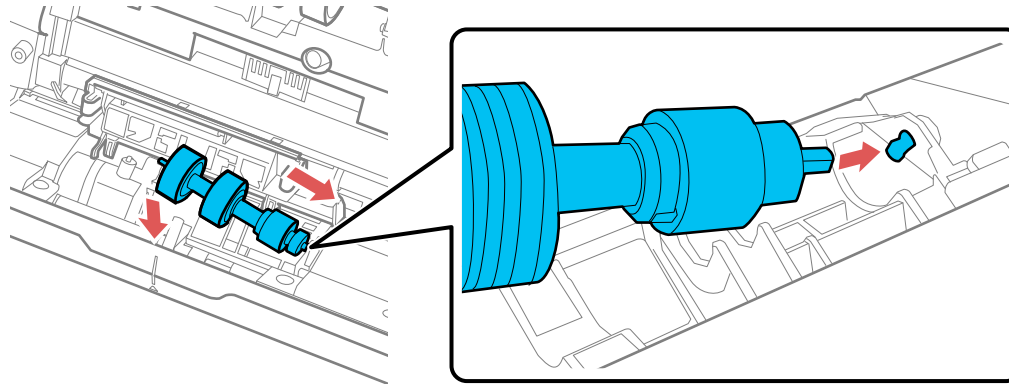

12. Close the separation roller cover until you hear it click into place.

**Note:** If you are not able to close the cover, the roller is not installed correctly. Remove the roller and reinstall it, then try to close the cover again.

13. Close the scanner cover.
14. Connect any disconnected cables.
15. Plug in the AC adapter and turn on the scanner.
16. Reset the roller counter.

**Note:** Make sure to dispose of the pickup roller and the separation roller following the rules and regulations of your local authority. Do not disassemble them.

[Resetting the Scanner Roller Counter](#)

**Parent topic:** [Cleaning and Transporting Your Scanner](#)

**Related references**



[User Replaceable Epson Scanner Parts](#)

**Related tasks**

[Resetting the Number of Scans After Cleaning](#)

## Resetting the Scanner Roller Counter

When you replace the scanner rollers, reset the scanner roller counter so you know when you may need to replace the rollers again.

1. Make sure the scanner is turned on and connected to your computer.
2. Do one of the following to open the Epson Scan 2 Utility:
  - **Windows 10:** Click  and select **EPSON > Epson Scan 2 Utility**.
  - **Windows 8.x:** Navigate to the **Apps** screen and select **EPSON > Epson Scan 2 Utility**.
  - **Windows (other versions):** Click  or **Start > All Programs** or **Programs > EPSON > Epson Scan 2 > Epson Scan 2 Utility**.
  - **Mac:** Open the **Applications** folder, click **Epson Software**, and click **Epson Scan 2 Utility**.
3. Click the **Counter** tab.

You see a screen like this:

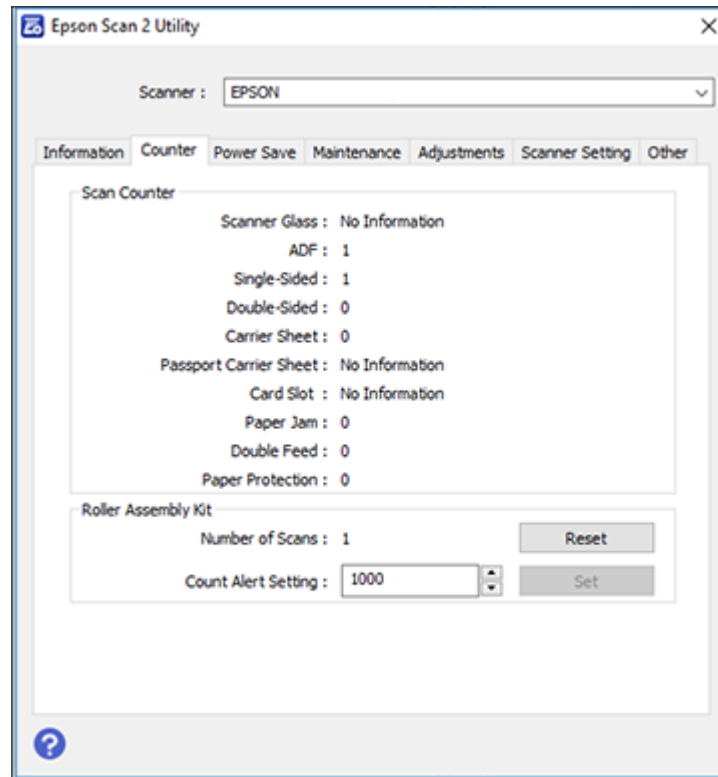

4. Click **Reset**.  
The Number of Scans field changes to 0 (zero).
5. Close the Epson Scan 2 Utility.

**Parent topic:** [Replacing the Scanner Rollers](#)

## Transporting Your Scanner

If you need to ship your product, transport it a long distance, or store it for an extended period, prepare it for transportation as described here.

**Note:** The illustrations show the DS-575W II, but the instructions are the same for the DS-530 II and DS-770 II.

1. Turn off the scanner and unplug the AC adapter.
2. Disconnect any connected cables.

3. Close the input tray and the output tray.

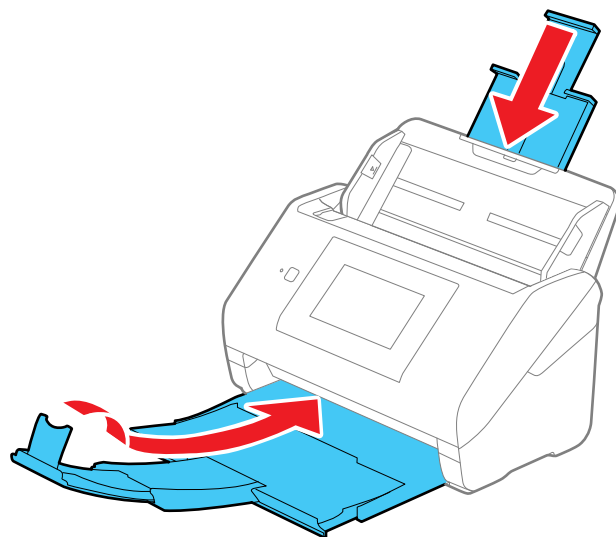
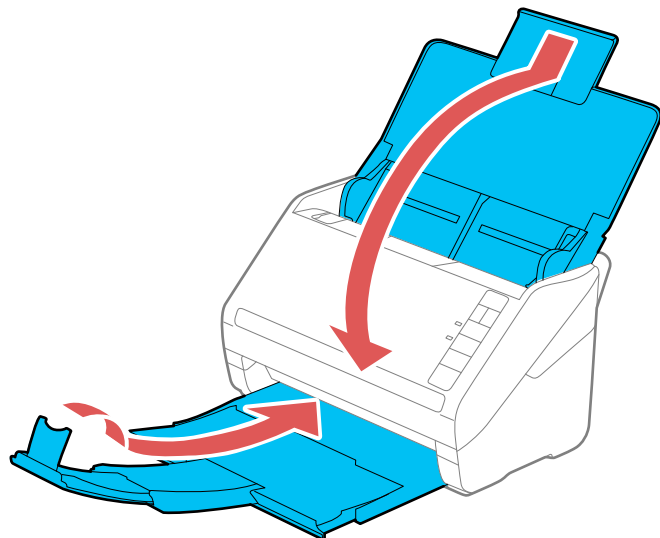

**Note:** Make sure the output tray is securely closed.



4. Place the scanner in its original packing materials, if possible, or use equivalent materials with cushioning around the product.

**Parent topic:** [Cleaning and Transporting Your Scanner](#)

---

# Solving Problems

Check these sections for solutions to problems you may have using your product.

**Note:** Your product may differ from the images in this guide, but the instructions are the same unless otherwise noted.

[Scanner Light Status](#)

[Solving Scanning Problems](#)

[Solving Network Scanning Problems](#)

[Solving Scanned Image Quality Problems](#)

[Resetting the Epson Scan 2 Settings](#)

[Solving Flatbed Scanner Dock Problems](#)

[Uninstall Your Scanner Software](#)

[Where to Get Help \(U.S. and Canada\)](#)

[Where to Get Help \(Latin America\)](#)

## Scanner Light Status

You can often diagnose problems with your scanner by checking its lights.

**DS-530 II/DS-770 II**

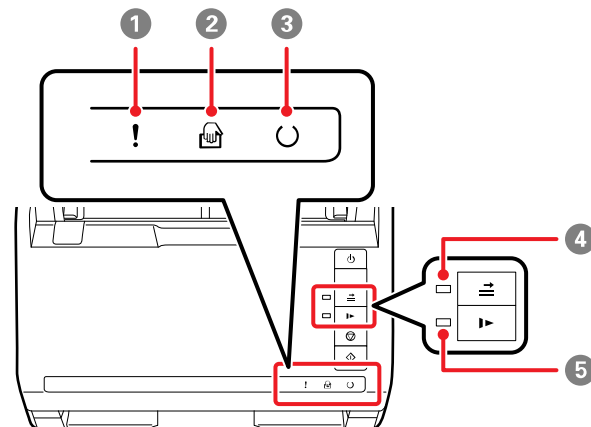





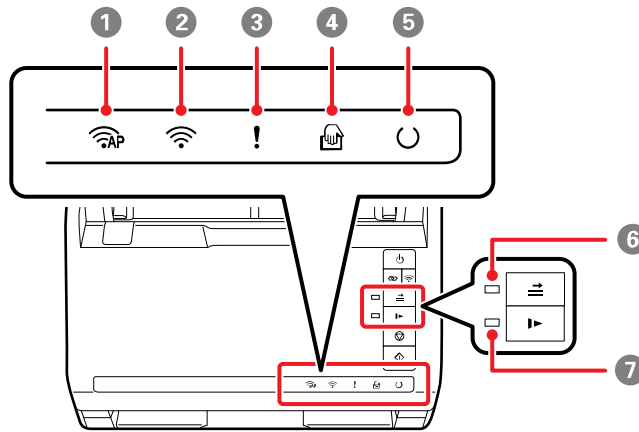





- 1 ! error light
- 2 📄 automatic feeding mode light
- 3 ○ ready light
- 4 ⇄ double feed detection skip light
- 5 ▶ slow mode light

**DS-575W II**



- 1 📶 AP mode light
- 2 📶 Wi-Fi light
- 3 ! error light
- 4 📄 automatic feeding mode light
- 5 ○ ready light
- 6 ⇄ double feed detection skip light
- 7 ▶ slow mode light

Light status	Condition/solution
The ! error light is flashing slowly	A paper jam or a double feed has occurred. Remove any paper loaded in the input tray. If the light continues to flash, a scanner error may have occurred. Turn the scanner off and then back on again. If the error continues, contact Epson for support.
The ! error light is on	The scanner cover is open. Make sure the scanner cover is closed and there is no jammed paper inside.
<p>The following lights are flashing quickly:</p> <ul style="list-style-type: none"> <li>• ! error</li> <li>• ◯ ready</li> <li>•  AP mode (DS-575W II)</li> <li>•  Wi-Fi (DS-575W II)</li> </ul>	<p>A fatal error has occurred. Try the following:</p> <ul style="list-style-type: none"> <li>• Check the scanner connection to your computer to make sure it is secure.</li> <li>• Turn the scanner off and then back on again. If the error continues, the scanner may be malfunctioning. Contact Epson for support.</li> </ul>
<p>The ◯ ready light is off and the following lights are on:</p> <ul style="list-style-type: none"> <li>• ! error</li> <li>•  automatic feeding mode</li> <li>•  double feed detection skip</li> <li>•  slow mode</li> <li>•  AP mode (DS-575W II)</li> <li>•  Wi-Fi (DS-575W II)</li> </ul>	The firmware update has failed and the scanner is in recovery mode. Try updating the firmware again.
The  Wi-Fi and ! error lights are flashing slowly (DS-575W II)	An access point settings error (security error) has occurred. Press the  stop button to clear the error, restart the devices you want to connect to the network, then reconnect to the network.
The  Wi-Fi light is flashing slowly and ! error light is on (DS-575W II)	
The  Wi-Fi (white) and ! error lights are flashing slowly (DS-575W II)	A network connection error has occurred (the date and time have not been set correctly). Reset the date and time in Web Config.

**Parent topic:** [Solving Problems](#)

**Related references**

[Original Jams in Scanner](#)

[Where to Get Help \(U.S. and Canada\)](#)

[Where to Get Help \(Latin America\)](#)

**Related topics**

[Loading Originals](#)

[Wi-Fi Networking](#)

[Scanning](#)

## Solving Scanning Problems

Check these solutions if you have problems scanning with your product.

[Scanner Does Not Turn On or Turns Off Unexpectedly](#)

[Scanner Button Does Not Work as Expected](#)

[Scanning Software Does Not Operate Correctly](#)

[Cannot Start Epson Scan 2](#)

[Original Feeds Incorrectly in Scanner](#)

[Original Jams in Scanner](#)

[Paper Protection Does Not Work Correctly](#)

[Scanning is Slow](#)

**Parent topic:** [Solving Problems](#)

## Scanner Does Not Turn On or Turns Off Unexpectedly

If the scanner does not turn on or if it turns off unexpectedly, try these solutions:

- Make sure the AC adapter is securely connected to the scanner and to a working electrical outlet.
- If the scanner turns off unexpectedly, you may need to adjust the **AC power or AC adapter** setting in the Epson Scan 2 Utility.

**Parent topic:** [Solving Scanning Problems](#)

**Related tasks**

[Changing the Power Off and Sleep Timer Settings](#)

## Scanner Button Does Not Work as Expected

If the scanner button does not start the correct program or perform the correct action, try these solutions:

- Document Capture Pro (Windows) and Document Capture (Mac) do not support using the  start button to scan over a wireless connection (DS-575W II). Connect the scanner using a USB cable or launch Epson Scan 2 before scanning from the button on your scanner.
- Check that the correct scanner is selected using the Epson Scan 2 Utility.
- In Windows, be sure that the scanner is listed under **Imaging Devices** in the Device Manager.
- Make sure Document Capture Pro is installed correctly. If necessary, uninstall and reinstall it.
- Make sure you have assigned the correct job to the scanner button and change it, if necessary.
- Check the status of the lights and make sure the scanner is ready to scan.
- When using a wireless connection, start Epson Scan 2 on your computer before scanning from the product (DS-575W II).
- Make sure Epson Scan 2 and other applications are installed correctly. If necessary, uninstall and reinstall it.

**Parent topic:** [Solving Scanning Problems](#)

### Related tasks

[Adding and Assigning Scan Jobs with Document Capture Pro - Windows](#)

[Assigning Start Button Settings or Scan Jobs - Mac](#)

## Scanning Software Does Not Operate Correctly

If your scanning software does not operate correctly, try these solutions:

- Make sure your computer has adequate memory and meets the system requirements for your operating system.
- Make sure your computer is not running in a power-saving mode, such as sleep or standby. If so, wake your system and restart your scanning software.
- Make sure the scanner is turned on.
- Make sure the connection between the scanner and your computer is secure.
- If you upgraded your operating system but did not reinstall your scanning software, try reinstalling it.
- In Windows, be sure that the scanner is listed under **Imaging Devices** in the Device Manager.
- Check that the correct scanner is selected using the Epson Scan 2 Utility.

- Check that the correct setting is assigned to the scanner button in Document Capture Pro (Windows) or Document Capture (Mac).
- Make sure the scanning software is installed.
- Use the USB cable that came with the scanner.
- Connect the scanner directly to the computer. The scanner may not work properly when connected through a USB hub.
- If you are using a TWAIN-compliant program, make sure that the correct product is selected as the **Scanner** or **Source** setting.
- Check that the Wi-Fi connection is working correctly. Try turning the wireless router off and on (DS-575W II).
- If your scanner is connected to one computer via USB and another computer via wireless connection, and Epson Scan 2 is running on the wirelessly connected computer, pressing the  start button on the scanner will save the scanned images to the wirelessly connected computer (DS-575W II).

**Parent topic:** [Solving Scanning Problems](#)

**Related concepts**

[Uninstall Your Scanner Software](#)

**Related references**

[Windows System Requirements](#)

[Mac System Requirements](#)

## Cannot Start Epson Scan 2

If you cannot start Epson Scan 2, try these solutions:

- Make sure your scanner appears in the Epson Scan 2 Utility.
- Make sure your scanner is turned on and any interface cables are securely connected at both ends.
- Make sure your computer is not running in a power-saving mode, such as sleep or standby. If so, wake your system and restart Epson Scan 2.
- Connect the scanner directly to the computer. The scanner may not work properly when connected through a USB hub.
- If you connected the scanner using a USB cable, make sure it is connected directly to your computer or through only one USB hub.
- If you upgraded your operating system but did not reinstall Epson Scan 2, try reinstalling it.

- If you are using a TWAIN-compliant program, make sure that the correct product is selected as the **Scanner** or **Source** setting.
- Make sure the ready light stops flashing, indicating that the scanner is ready to scan.

**Parent topic:** [Solving Scanning Problems](#)

**Related concepts**

[Uninstall Your Scanner Software](#)

**Related references**

[Windows System Requirements](#)

[Mac System Requirements](#)

## Original Feeds Incorrectly in Scanner

If you have problems feeding originals in your scanner, try these solutions:

- If multiple pages feed at once, try the following:
  - Remove the originals, fan the edges to separate the sheets, if necessary, and reload them.
  - Load fewer originals at a time.
  - Load only originals that meet the specifications for your scanner.
  - Clean inside the scanner and replace the roller assembly kit, if necessary.
  - Check the pickup rollers and clean, if necessary.
  - Scan the originals one by one using the **Automatic Feeding Mode** setting in Epson Scan 2.
  - Press the  slow mode button to slow down the scanning speed.
  - Use **Automatic Feeding Mode** in Epson Scan 2 and scan originals one at a time.
  - Use the optional carrier sheet for thin, folded, or irregularly shaped originals.
- If you see a double feed error in the Epson Scan 2 window or the Document Capture Pro window, start Epson Scan 2, select the **Main Settings** tab, select the **Detect Double Feed** setting, and select **Off**.

**Note:** On a Mac, only Epson Scan 2 displays double feed errors. Document Capture for Mac does not include this setting.

**Parent topic:** [Solving Scanning Problems](#)

**Related tasks**

[Cleaning Inside Your Scanner](#)



## Related topics

[Loading Originals](#)

## Original Jams in Scanner

If an original has jammed inside the scanner, follow these steps:

**Note:** The illustrations show the DS-575W II, but the instructions are the same for the DS-530 II and DS-770 II.

1. Turn off your scanner.
2. Remove all originals from the input tray.
3. Pull down the cover open lever and open the scanner cover.

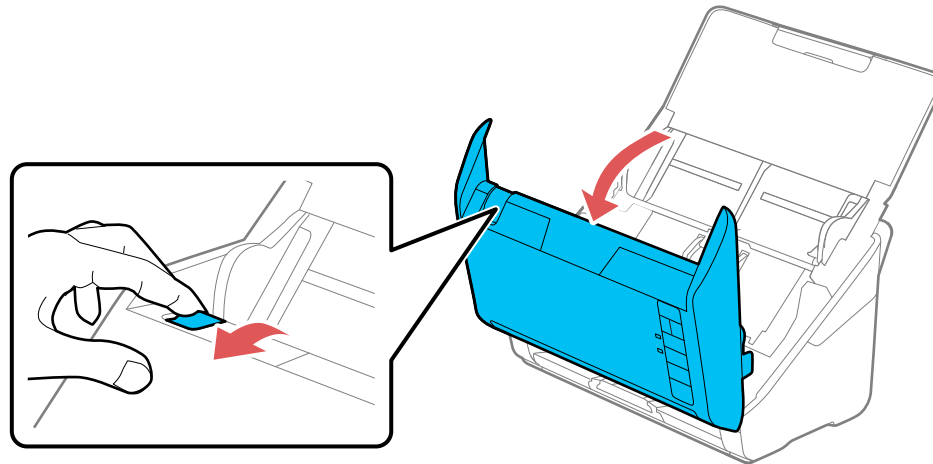

4. Gently pull out any jammed originals from inside the scanner.

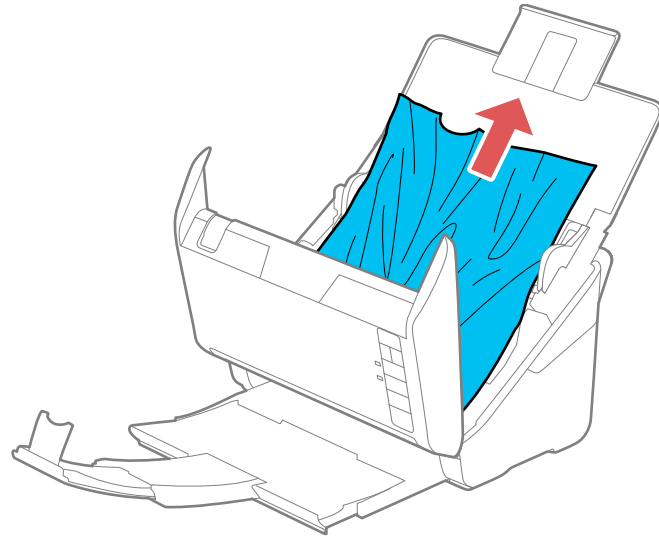

5. Gently pull out any jammed originals from the output tray.

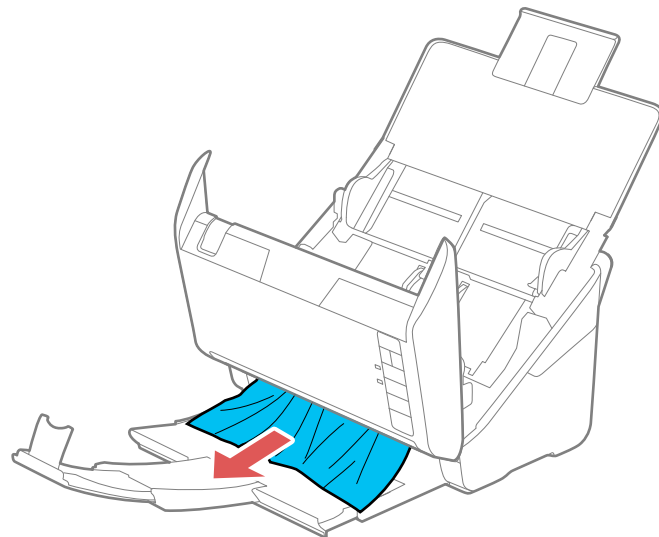

6. Close the scanner cover.
7. Carefully follow all loading instructions when you reload originals.

If originals jam in the scanner frequently, try the following:

- Press the **▶** slow mode button to slow down the scanning speed.
- Turn off the **Detect Double Feed** setting.
- Clean inside the scanner and clean the rollers.
- Close the output tray and let the originals fall freely onto the surface below the scanner.
- If the roller counter is nearing end of life, replace the roller assembly kit.

**Parent topic:** [Solving Scanning Problems](#)

#### **Related tasks**

[Cleaning Inside Your Scanner](#)

#### **Related topics**

[Loading Originals](#)

## **Paper Protection Does Not Work Correctly**

To reduce damage to the original, the Paper Protection feature stops immediately stops scanning if a paper feed error is detected. If the Paper Protection feature does not work correctly, try these solutions:

- If your scanned original is damaged, make sure that the Paper Protection feature is enabled. Increase the detection level, if necessary.
- If misdetection occurs frequently, lower the Paper Protection detection level in the Epson Scan 2 Utility (**On-Medium** is the default).
- Turn the Paper Protection feature off in the Epson Scan 2 Utility (**Scanner Setting > Paper Protection > Off**).

**Note:** Set the Paper Protection feature to **Off** when scanning plastic cards and thick originals.

- When scanning multiple originals, make sure that the leading edges of the documents are aligned. If the leading edges of the documents are not aligned, they may be mistakenly detected as a paper feed error even if they are scanned correctly.
- Make sure you align the edge guides with the original to avoid scanning at an angle.

**Parent topic:** [Solving Scanning Problems](#)

## Scanning is Slow

If scanning becomes slow, try these solutions:

- Scan your original at a lower resolution, if possible.
- Make sure your system meets the requirements for your operating system. If you are scanning a high-resolution image, you may need more than the minimum requirements. If necessary, increase your system's memory or reduce the resolution.
- Make sure you did not press the  slow mode button to slow down the scanning speed.
- The scanning speed may be reduced depending on the image adjustment features in Epson Scan 2.
- If scanning becomes slower after scanning continuously with the ADF for a long time, the scanner may have automatically slowed down to protect the scanner mechanism from overheating or becoming damaged. Let the scanner rest with the power on for 30 minutes, then try scanning again.
- Make sure slow mode is turned off.
- If you are running virus protection or other security software, exclude the TWAIN.log files from monitoring or set the TWAIN.log file as read only. See your virus protection or security software instructions for details. The TWAIN.log file is saved in C:\Users\\AppData\Local\Temp.

**Note:** You may need to unhide system folders to view files in that location.

- If you are scanning over a wireless network, factors such as interference, network traffic, or weak signal strength may affect your scanning speed (DS-575W II).
- Computers with USB 3.0 (SuperSpeed) or USB 2.0 (Hi-Speed) ports can scan faster than those with USB 1.1 ports. If you are using a USB 3.0 or 2.0 port with the scanner, make sure it meets the system requirements.

**Parent topic:** [Solving Scanning Problems](#)

### Related references

[Windows System Requirements](#)

[Mac System Requirements](#)

## Solving Network Scanning Problems

Check these solutions if you have problems scanning over a network (DS-575W II).



[Cannot Scan Over a Network](#)

[Scanner Cannot Connect to a Wireless Router](#)

**Parent topic:** [Solving Problems](#)

## Cannot Scan Over a Network

If you have problems scanning over a network, try these solutions:

- Move the scanner and computer or smart device closer to the access point.
- If you cannot scan from the  start button on the scanner, make sure you restarted your computer after installing the scanning software. Also start Epson Scan 2 before scanning with the  start button.
- Document Capture Pro (Windows) and Document Capture (Mac) do not support starting a scan from the scanner button over a wireless network. Launch Epson Scan 2 before scanning from the scanner button over a network.
- If you are scanning a large original at a high resolution, a network communication error may occur. Try scanning again at a lower resolution.
- If network communication was interrupted while starting Epson Scan 2, exit Epson Scan 2, wait a few seconds, and restart it. If Epson Scan 2 cannot restart, turn off your scanner, turn it back on, and try starting Epson Scan 2 again.
- Check the network connection setting in the Epson Scan 2 Utility.
- You may need to disable the firewall and any anti-virus software on your wireless router or access point.
- If you see the message "Network product is not available: currently being used by user", there may be a communication error between the scanner and computer. Restart the scanner.
- Epson Scan 2 does not support networks that use only IPv6. Use Epson Scan 2 on a network that supports IPv4.
- If the Firewall function is active, the scanner may not be discovered by the Epson Scan 2 Utility. Open the Epson Scan 2 Utility, enter the IP address for your scanner, and click **Add**.
- If the scanner and computer cannot communicate and are connected to the same network (subnet or VLAN), check if your router uses the privacy separator and disable it, if necessary. Follow the instructions in your router documentation to disable the privacy separator.

**Parent topic:** [Solving Network Scanning Problems](#)

### **Related topics**

[Wi-Fi Networking](#)

## Scanner Cannot Connect to a Wireless Router

If your scanner has trouble finding or connecting to a wireless router, try these solutions:

- If you are connecting the scanner via Wi-Fi Protected Setup (WPS), make sure you activate WPS on your scanner within 2 minutes of activating WPS discovery mode on the router by pressing the WPS button or enabling the WPS setting in your router firmware.
- Make sure to place your scanner within contact range of your router. Avoid placing your scanner near a microwave oven, 2.4 GHz cordless phone, or large metal object, such as a filing cabinet.

**Note:** If you are using a 5 GHz wireless router, set the router to operate in dual band (2.4 GHz and 5 GHz) mode. If your router uses a single network name (SSID) for both the 2.4 GHz and 5 GHz band, give each band its own network name (SSID) instead, such as Home Network 2.4 GHz and Home Network 5 GHz. See your router documentation or contact your internet service provider for instructions. Be sure to connect your scanner only to a 2.4 GHz network name (SSID).

- Verify that your router is operating correctly by connecting to it from your computer or another device.
- You may need to temporarily disable your firewall and any anti-virus software on your wireless router. Then try scanning again. You can also unblock your scanner driver or network address in your firewall or anti-virus software.
- Check to see if access restrictions, such as MAC address filtering, are set on the router. If access restrictions are set, add your scanner's MAC address to your router's address list. To obtain your scanner's MAC address, check the label on the back or bottom of your scanner. Then follow the instructions in your router documentation to add the address to the list.
- If your router does not broadcast its network name (SSID), follow the instructions that came with your scanner to enter your wireless network name manually.
- If your router has security enabled, determine the kind of security it is using and any required password or passphrase for connection. Then make sure to enter the exact WEP key or WPA passphrase correctly.
- Check if your computer is restricting the available wireless channels. If so, verify that your wireless access point is using one of the usable channels and change to a usable channel, if necessary.
- The scanner may not be able to communicate with a computer with both Ethernet and Wi-Fi adapters enabled. Disable all network interfaces except for the interface connected to the scanner.
- Enable the DHCP function on the access point or router.
- Check that the scanner's IP address is set correctly.

**Parent topic:** [Solving Network Scanning Problems](#)

## Related topics

[Wi-Fi Networking](#)

# Solving Scanned Image Quality Problems

Check these sections if a scanned image on your computer screen has a quality problem.

**Note:** For solutions when using Document Capture Pro (Windows) or Document Capture (Mac) software, see the Document Capture Pro (Windows) or Document Capture (Mac) help utility.

[Back of Original Image Appears in Scanned Image](#)

[Scanned Characters are Blurry](#)

[Characters are not Recognized During Conversion to Editable Text \(OCR\)](#)

[Ripple Patterns Appear in an Image](#)

[Spots or Lines Appear in All Scanned Images](#)

[Scanned Image is Cropped](#)

**Parent topic:** [Solving Problems](#)

## Back of Original Image Appears in Scanned Image

If an image from the back of a thin original appears in your scanned image, make sure you selected the correct Image Type setting for your original and select the **Text Enhancement** setting in Epson Scan 2. You can also select the **Remove Background** setting in Epson Scan 2.

**Note:** If you select **Color** as the Image Type setting, you can change the level from Standard to High to remove more of the background.

**Parent topic:** [Solving Scanned Image Quality Problems](#)

### Related references

[Image Format Options](#)

### Related tasks

[Scanning in Epson Scan 2](#)

## Scanned Characters are Blurry

If characters in your scanned images are blurry, try these solutions:

- Make sure you do not move the scanner or original while scanning.

- Operate the scanner on a flat, stable surface.
- Make sure the originals are ejecting properly.
- Adjust these Epson Scan 2 settings (if available) and try scanning again:
  - Select the **Text Enhancement** setting.
  - If the **Image Type** setting is **Black & White**, adjust the **Threshold** setting or change the **Edge Enhancement** and **Noise Reduction Level** settings.
  - Increase the **Resolution** setting.
  - Set the **Image Type** to **Grayscale**.
  - If you are scanning in JPEG format, change the compression level. Click **Options** in the Image Format menu and change the **Image Quality** setting.

**Parent topic:** [Solving Scanned Image Quality Problems](#)

#### **Related references**

[Image Format Options](#)

#### **Related tasks**

[Scanning in Epson Scan 2](#)

## **Characters are not Recognized During Conversion to Editable Text (OCR)**

If characters in your scanned images are not recognized during OCR conversion, try these solutions:

- Make sure your original is loaded straight on your product.
- Use an original with clear text.
- Adjust these Epson Scan 2 settings (if available) and try scanning again:
  - Select the correct **Image Type** setting.
  - Select or adjust the **Text Enhancement** setting.
  - If the **Image Type** is set to **Black & White**, adjust the **Threshold** setting.
  - Set the **Image Type** to **Grayscale**.
- Set the scanning resolution between 200 and 600 dpi.
- If the original document is in landscape mode, set the **Rotate** setting to **Auto** in Epson Scan 2.
- If you are using OCR software, check the manual for any additional adjustments.
- Scan thermal paper receipts as soon as possible. They may deteriorate due to age or friction.



- When saving to Microsoft Office or Searchable PDF files, check that the correct languages are selected. Check the language in each save setting window.
- Some font types may cause recognition errors. If the original font cannot be changed, you may need to manually edit the unrecognized text.

**Parent topic:** [Solving Scanned Image Quality Problems](#)

**Related references**

[Image Format Options](#)

**Related tasks**

[Scanning in Epson Scan 2](#)

## Ripple Patterns Appear in an Image

You may see a ripple pattern (called a moiré) in scanned images of printed documents. This is caused by interference from differing pitches in the scanner's screen and your original's halftone screen. To reduce this effect, adjust these Epson Scan 2 settings (if available) and try scanning again:

- Select the **Descreening** setting on the Advanced Settings tab.
- Select a lower **Resolution** setting.

**Parent topic:** [Solving Scanned Image Quality Problems](#)

**Related references**

[Image Format Options](#)

**Related tasks**

[Scanning in Epson Scan 2](#)

## Spots or Lines Appear in All Scanned Images

If spots or lines appear in all your scanned images, try the following solutions:

- Clean the rollers and glass scanning surfaces inside your scanner using a genuine Epson cleaning kit or a soft, moist cloth.
- Remove any dirt from your original.
- Enable the **Detect Glass Dirt** setting in the Epson Scan 2 Utility.

**Note:** If glass dirt detection does not work correctly, adjust the setting. If the glass dirt alert screen appears after cleaning the inside of the scanner, check the glass surface again (scratches on the glass may be detected as a glass dirt).

**Parent topic:** [Solving Scanned Image Quality Problems](#)

**Related tasks**

[Cleaning Inside Your Scanner](#)

## Scanned Image is Cropped

If the edges of a scanned image are cropped, try the following solutions:

- Select **Auto Detect** or **Auto Detect (Long Paper)** as the Document Size setting in Epson Scan 2, Document Capture Pro, or Document Capture.
- If the document size is not detected correctly using the **Auto Detect** setting, select the size of your original from the **Document Size** list.

**Note:** If the size you want to scan is not on the list, select **Customize** to create it manually (Windows only).

- In Epson Scan 2, select the **Main Settings** tab. Select **Document Size > Settings** and adjust the cropping area shown in the **Crop Margins for Size "Auto"** setting.
- In Epson Scan 2, select the **Advanced Settings** tab. Make sure the **Edge Fill** setting is set to **None**.

**Parent topic:** [Solving Scanned Image Quality Problems](#)

**Related tasks**

[Scanning in Epson Scan 2](#)



[Scanning with Simple Scan in Document Capture Pro - Windows](#)

[Scanning with Job Scan in Document Capture Pro - Windows](#)

[Scanning with Document Capture - Mac](#)

## Resetting the Epson Scan 2 Settings

If you continue to experience image quality problems after trying all possible solutions, you may need to reset the Epson Scan 2 settings using the Epson Scan 2 Utility.

1. Do one of the following to start the Epson Scan 2 Utility:
  - **Windows 10:** Click  > **EPSON > Epson Scan 2 Utility**.
  - **Windows 8.x:** Navigate to the **Apps** screen and select **Epson Scan 2 Utility**.
  - **Windows (other versions):** Click  or **Start**, and select **All Programs** or **Programs**. Select **EPSON > Epson Scan 2 > Epson Scan 2 Utility**.

- **Mac:** Open the **Applications** folder, open the **Epson Software** folder, and select **Epson Scan 2 Utility**.
2. Click the **Other** tab.
  3. Click **Reset** and confirm your choice.

**Note:** If resetting the Epson Scan 2 settings does not solve your problem, uninstall Epson Scan 2 and re-install it.

**Parent topic:** [Solving Problems](#)

## Solving Flatbed Scanner Dock Problems

Check these solutions if you have problems scanning with the optional flatbed scanner dock (DS-530 II/DS-770 II).

[Scanned Image Edges are Cropped](#)

[Line of Dots Appears in All Scanned Images](#)

[Back of Original Image Appears in Scanned Document](#)

**Parent topic:** [Solving Problems](#)

### Scanned Image Edges are Cropped

If the edges of a scanned image are cropped, make sure your original is placed correctly for scanning. If necessary, move your original away from the edges of the scanner glass slightly.

In the Epson Scan 2 settings, set the **Edge Fill** setting to **None**.

**Parent topic:** [Solving Flatbed Scanner Dock Problems](#)

### Line of Dots Appears in All Scanned Images

If a line of dots appears in all your scanned images, try these solutions:

- Clean the scanner glass with a soft, dry, lint-free cloth or use a small amount of glass cleaner on the cloth, if necessary. Paper towels are not recommended.

**Caution:** Do not spray glass cleaner directly on the scanner glass.

- Make sure any interface cables are securely connected at both ends.
- Remove any dust or dirt that may have adhered to your original.

- Do not press with too much force on the original or the document cover. Keep the document cover closed to prevent dirt or dust from getting inside.

**Parent topic:** [Solving Flatbed Scanner Dock Problems](#)

## Back of Original Image Appears in Scanned Document

If an image from the back of a thin original appears in your scanned image, try the following solutions:

- Place a piece of black paper on the back of the original and scan it again.
- Make sure you selected the correct Image Type setting for your original and select the **Text Enhancement** setting in Epson Scan 2. You can also select the **Remove Background** setting in Epson Scan 2.
- Adjust the **Brightness** setting in Epson Scan 2.

**Parent topic:** [Solving Flatbed Scanner Dock Problems](#)

### Related references

[Image Format Options](#)

### Related tasks

[Scanning in Epson Scan 2](#)

## Uninstall Your Scanner Software

If you have a problem that requires you to uninstall and re-install your software, follow the instructions for your operating system.

[Uninstalling Scanner Software - Windows](#)



[Uninstalling Scanner Software - Mac](#)

**Parent topic:** [Solving Problems](#)

## Uninstalling Scanner Software - Windows

You can uninstall and then re-install your scanner software to solve certain problems.

1. Exit all applications currently running on your computer.
2. Turn off the scanner.
3. Disconnect any interface cables.

4. Do the following to uninstall each of your scanning software programs and follow any on-screen instructions:
  - **Windows 10:** Click  and select  (Settings) > **Apps** > **Apps & features**. Select the scanner software program and click **Uninstall**.
  - **Windows 8.x:** Navigate to the **Apps** screen and select **Control Panel** > **Programs** > **Programs and Features**. Select the scanner software program and click **Uninstall/Change**.
  - **Windows 7:** Open the Windows **Control Panel** utility. Select **Programs and Features**. (In Classic view, select **Programs** and click **Uninstall a program**.) Select the scanner software program and click **Uninstall/Change**.
5. Restart your computer, then see the *Start Here* sheet to re-install your software.

**Note:** If you find that re-installing your scanner software does not solve a problem, contact Epson.

**Parent topic:** [Uninstall Your Scanner Software](#)

## Uninstalling Scanner Software - Mac

In most cases, you do not need to uninstall your scanner software before re-installing it. However, you can download the Uninstaller utility from the Epson support website to uninstall your scanner software as described here.

1. To download the Uninstaller utility, visit [epson.com/support](http://epson.com/support) (U.S.), [epson.ca/support](http://epson.ca/support) (Canada), or [latin.epson.com/support](http://latin.epson.com/support) (Caribbean) and select your product.
2. Follow the instructions on the screen to install the Uninstaller utility.
3. Quit all applications currently running on your Mac.
4. Double-click the **Uninstaller** icon.
5. In the Epson Uninstaller screen, select the checkbox for each software program you want to uninstall.
6. Click **Uninstall**.
7. Follow the on-screen instructions to uninstall the software.
8. To reinstall your scanner software, see the *Start Here* sheet for instructions.

**Note:** If you find that re-installing your scanner software does not solve a problem, contact Epson.

**Parent topic:** [Uninstall Your Scanner Software](#)

## Where to Get Help (U.S. and Canada)

If you need to contact Epson for technical support services, use the following support options.

### Internet Support

Visit Epson's support website at [epson.com/support](http://epson.com/support) (U.S.) or [epson.ca/support](http://epson.ca/support) (Canada) and select your product for solutions to common problems with your product. You can download utilities and documentation, get FAQs and troubleshooting advice, or e-mail Epson with your questions.

### Speak to a Support Representative

Before you call Epson for support, please have the following information ready:

- Product name
- Product serial number (located on a label on the product)
- Proof of purchase (such as a store receipt) and date of purchase
- Computer configuration
- Description of the problem

Then call:

- U.S.: (562) 276-4300, 6 AM to 8 PM, Pacific Time, Monday through Friday, and 7 AM to 4 PM, Pacific Time, Saturday
- Canada: (905) 709-3839, 6 AM to 8 PM, Pacific Time, Monday through Friday, and 7 AM to 4 PM, Pacific Time, Saturday

Days and hours of support are subject to change without notice. Toll or long distance charges may apply.

**Note:** For help using any other software on your system, see the documentation for that software for technical support.

### Purchase Supplies and Accessories

You can purchase genuine Epson accessories at [epson.com](http://epson.com) (U.S. sales) or [epson.ca](http://epson.ca) (Canadian sales). You can also purchase accessories from an Epson authorized reseller. To find the nearest one, call 800-GO-EPSON (800-463-7766) in the U.S. or 800-807-7766 in Canada.

**Parent topic:** [Solving Problems](#)

## Where to Get Help (Latin America)

If you need to contact Epson for technical support services, use the following support options.

### Internet Support

Visit Epson's support website at [latin.epson.com/support](http://latin.epson.com/support) and select your product for solutions to common problems. You can download utilities and documentation, get FAQs and troubleshooting advice, or e-mail Epson with your questions.

### Speak to a Support Representative

Before you call Epson for support, please have the following information ready:

- Product name
- Product serial number (located on a label on the product)
- Proof of purchase (such as a store receipt) and date of purchase
- Computer configuration
- Description of the problem

Then call:

Country	Telephone
Argentina	(54 11) 5167-0300 0800-288-37766
Bolivia*	800-100-116
Brazil	State capitals and metropolitan areas: 3004-6627 Other areas: 0800-377-6627 / 0800-EPSONBR
Chile	(56 2) 2484-3400
Colombia	Bogota: (57 1) 592-2200 Other cities: 018000-915235
Costa Rica	800-377-6627
Ecuador*	1-800-000-044
El Salvador*	800-6570
Guatemala*	1-800-835-0358

Country	Telephone
Mexico	Mexico City: (52 55) 1323-2052 Other cities: 01-800-087-1080
Nicaragua*	00-1-800-226-0368
Panama*	00-800-052-1376
Paraguay	009-800-521-0019
Peru	Lima: (51 1) 418-0210 Other cities: 0800-10-126
Uruguay	00040-5210067
Venezuela	(58 212) 240-1111

\* Contact your local phone company to call this toll-free number from a mobile phone.

If your country does not appear in the list, contact the sales office in the nearest country. Toll or long distance charges may apply.

**Note:** For help using any other software on your system, see the documentation for that software for technical support.

### **Purchase Supplies and Accessories**

You can purchase genuine Epson accessories from an Epson authorized reseller. To find the nearest reseller, visit [latin.epson.com](http://latin.epson.com) or call your nearest Epson sales office.

**Parent topic:** [Solving Problems](#)



---

# Technical Specifications

These sections list the technical specifications for your scanner.

**Note:** Epson offers a recycling program for end of life Epson products. Please go to [this site](#) (U.S) or [this site](#) (Canada) for information on how to return your Epson products for proper disposal.

[Windows System Requirements](#)

[Mac System Requirements](#)

[General Specifications](#)

[Dimension Specifications](#)

[Electrical Specifications](#)

[Environmental Specifications](#)

[Flatbed Scanner Dock Specifications \(DS-530 II/DS-770 II\)](#)

[Network Interface Specifications \(DS-575W II\)](#)

[Safety and Approvals Specifications](#)

## Windows System Requirements

To use your product and its software, your computer should use one of these Microsoft operating systems:

- Windows 10
- Windows 8.x
- Windows 7

**Note:** For the latest product software available for your operating system, visit the Epson support site at [epson.com/support](#) (U.S.), [epson.ca/support](#) (Canada), or [latin.epson.com/support](#) (Caribbean), select your product, and select **Downloads**.

**Parent topic:** [Technical Specifications](#)

## Mac System Requirements

To use your product and its software, your Mac should use one of these operating systems:

- macOS 11.x

- macOS 10.15.x
- macOS 10.14.x
- macOS 10.13.x
- macOS 10.12.x
- OS X 10.11.x
- OS X 10.10.x
- OS X 10.9.x
- OS X 10.8.x
- OS X 10.7.5

**Note:** The UNIX File System (UFS) for OS X and Fast User Switching on OS X is not supported.

For the latest product software available for your operating system, visit the Epson support site at [epson.com/support](http://epson.com/support) (U.S.), [epson.ca/support](http://epson.ca/support) (Canada), or [latin.epson.com/support](http://latin.epson.com/support) (Caribbean), select your product, and select **Downloads**.

**Parent topic:** [Technical Specifications](#)

## General Specifications

<b>Scanner type</b>	Sheet feed, one pass duplex, color
<b>Photoelectric device</b>	CIS
<b>Effective pixels</b>	5100 × 9300 pixels at 600 dpi 2550 × 64,500 pixels at 300 dpi
<b>Document size</b>	Maximum: 8.5 × 240 inches (215.9 × 6096 mm) Minimum: 2 × 2 inches (50.8 × 50.8 mm)
<b>Paper input</b>	Facedown loading
<b>Paper output</b>	Facedown ejection

<b>Paper capacity</b>	DS-530 II/DS-575W II: 50 sheets of paper at 21 lb (80 g/m <sup>2</sup> ) weight DS-770 II: 100 sheets of paper at 21 lb (80 g/m <sup>2</sup> ) weight
<b>Scanning resolution</b>	600 dpi (main scan) 600 dpi (sub scan)
<b>Output resolution</b>	50 to 1200 dpi in 1 dpi increments 53 inches (1346.0 mm) or less: up to 600 dpi 215 inches (5461.0 mm) or less: up to 300 dpi 240 inches (6096.0 mm) or less: up to 200 dpi
<b>Color Depth</b>	Color: 30 bits per pixel internal (10 bits per pixel per color) 24 bits per pixel external (8 bits per pixel per color) Grayscale: 10 bits per pixel internal 8 bits per pixel external Black-and-white: 10 bits per pixel internal 1 bit per pixel external
<b>Interface*</b>	SuperSpeed USB 3.0 (backward-compatible with USB 1.1) IEEE802.11b/g/n (DS-575W II)
<b>Light source</b>	RGB LED

\* You cannot use a USB and network connection at the same time (DS-575W II).

Parent topic: [Technical Specifications](#)

## Dimension Specifications

<b>Height</b>	6.9 inches (176 mm)
---------------	---------------------

<b>Width</b>	11.7 inches (296 mm)
<b>Depth</b>	6.7 inches (169 mm)
<b>Weight</b>	8.2 lb (3.7 kg)

**Note:** Dimensions do not include projecting parts.

**Parent topic:** [Technical Specifications](#)

## Electrical Specifications

### Scanner

**Note:** Check the label on the scanner and the AC adapter for voltage information. Power consumption varies depending on operating conditions or whether an option is installed.

<b>Rated DC input power supply voltage</b>	DC 24 V
<b>Rated DC input current</b>	1 A

## Power consumption

### DS-530 II/DS-770 II

Operating: 11 W (approximate) (DS-530 II)

12 W (approximate) (DS-770 II)

Ready mode: 5.4 W (approximate)

Sleep mode: 1.0 W (approximate)

Power off mode: 0.1 W (approximate)

### DS-575W II

USB Connection:

Operating: 11 W (approximate)

Ready mode: 5.4 W (approximate)

Sleep mode: 1.0 W (approximate)

Power off mode: 0.1 W (approximate)

Wi-Fi Connection:

Operating: 12 W (approximate)

Ready mode: 5.5 W (approximate)

Sleep mode: 1.3 W (approximate)

Power off mode: 0.1 W (approximate)

## AC Adapter

**AC adapter model** 100 to 240 V model: A461H

**Rated input current** 1 A

**Rated frequency range** 50 to 60 Hz

**Rated output power supply voltage** DC 24 V

**Rated output current** 1 A

Parent topic: [Technical Specifications](#)

## Environmental Specifications

<b>Temperature</b>	Operating: 41 to 95 °F (5 to 35 °C) Storage: –13 to 140 °F (–25 to 60 °C)
<b>Humidity</b> (non-condensing)	Operating: 15 to 80% RH Storage: 15 to 85% RH
<b>Operating conditions</b>	Ordinary office or home conditions

**Note:** Avoid operating the scanner in direct sunlight, near a strong light source, or in extremely dusty conditions.

**Parent topic:** [Technical Specifications](#)

## Flatbed Scanner Dock Specifications (DS-530 II/DS-770 II)

<b>Interface</b>	Hi-Speed USB
<b>Rated DC input power supply voltage</b>	DC 24 V
<b>Dimensions</b> (when assembled with a sheet feed scanner and a flatbed scanner)	Width: 11.8 inches (300 mm) Depth: 18.9 inches (481 mm) Height 9.6 inches (245 mm)
<b>Weight</b>	Approximately 2.4 lb (1.1 kg)
<b>Temperature</b>	Operating: 50 to 95 °F (10 to 35 °C) Storage: –4 to 140 °F (–20 to 60 °C)
<b>Humidity</b> (non-condensing)	Operating: 20 to 80% Storage: 20 to 85%

**Parent topic:** [Technical Specifications](#)

## Network Interface Specifications (DS-575W II)

### Wi-Fi

<b>Wireless LAN standard</b>	IEEE802.11 b/g/n
<b>Wireless security</b>	WPA2-PSK (AES); WPA2 compliant support for WPA/WPA2 Personal WPA2-Enterprise; WPA2 compliant with support for WPA/WPA2 Enterprise WEP (64/128 bit)
<b>Frequency range</b>	2.4 GHz
<b>Communication mode</b>	Infrastructure mode Ad hoc mode; not supported for IEEE802.11n AP mode; not supported for IEEE802.11b
<b>Radio frequency power transmitted</b>	Maximum 20 dBm (EIRP)

**Note:** AP mode and Wi-Fi connection can be used at the same time.

## Security Protocol

SSL/TLS	HTTPS (Server/Client) SMTPS (Client) STARTTLS Root certificate (Client) Root certificate updating (Client) CA-signed certificate (Server) CA certificate (Server) CSR generation (Server) Self-signed certificate (Server) EC key CSR/self-signed certificate generation (Server) Certificates/Secret key imports (Server)
Authentication for email sending	POP before SMTP, APOP, SMTP Authentication
MIB accessing Authentication/Encryption	SNMPv3

Parent topic: [Technical Specifications](#)

## Safety and Approvals Specifications

### Scanner

United States	EMC: FCC part 15 Subpart B class B
Canada	EMC: CAN ICES-3 (B)/NMB-3 (B)

### AC Adapter (A461H)

United States	Safety: UL60950-1 EMC: FCC part 15 Subpart B class B
Canada	Safety: CAN/CSA C22.2 No. 60950-1 EMC: CAN ICES-3 (B)/NMB-3 (B)



## **Optional Flatbed Scanner Dock (DS-530 II/DS-770 II)**

### **United States**

EMC: FCC part 15 Subpart B class B

### **Canada**

EMC: CAN/CSA-CEI/IEC CISPR 22 class B

This equipment contains the following wireless module: (DS-575W II)

- Manufacturer: FOXCONN ELECTRONICS INC.
- Type: J26H006

This product conforms to Part 15 of the FCC Rules and RSS-210 of the IC Rules. Epson cannot accept responsibility for any failure to satisfy the protection requirements resulting from a non-recommended modification of the product. Operation is subject to the following two conditions: (1) this device may not cause harmful interference, and (2) this device must accept any interference received, including interference that may cause undesired operation of the device.

To prevent radio interference to the licensed service, this device is intended to be operated indoors and away from windows to provide maximum shielding. Equipment (or its transmit antenna) that is installed outdoors is subject to licensing.

This equipment complies with FCC/IC radiation exposure limits set forth for an uncontrolled environment and meets the FCC radio frequency (RF) Exposure Guidelines in Supplement C to OET65 and RSS-102 of the IC radio frequency (RF) Exposure rules. This equipment should be installed and operated so that the radiator is kept at least 7.9 inches (20 cm) or more away from a person's body (excluding extremities: hands, wrists, feet and ankles).

### **Notice for Argentina**

 CNC ID: C-20841

### **Notice for Mexico**

Operation is subject to the following two conditions: (1) this device may not cause harmful interference, and (2) this device must accept any interference received, including interference that may cause undesired operation of the device.

Product model: J382E (DS-575W II)

Brand: EPSON

IFT Certification Number: RCPEPJ218-0025

**Notice for Paraguay**

Imported by:

Fastrax, S.A.

Av. Perú esq. Río de Janeiro, Barrio Las Mercedes, Asunción, Paraguay

Imported by:

Sol Control S.R.L.

Av. Gral. Bernardino Caballero 810 esq. Celsa Speratti, Asunción, Paraguay

**Notice for Peru**

Product Model: DS-575W II (J382E)

Brand: EPSON

This product uses the following WLAN module:

WLAN Module Model: J26H006

FCC ID: BKMFBJ26H006

Product Manufacturer: Seiko Epson Corporation

Address: 3-3-5 Owa Suwa-shi, Nagano-Ken 392-8502, Japan

**Parent topic:** [Technical Specifications](#)

---

## Notices

Check these sections for important notices about your scanner.

**Note:** Epson offers a recycling program for end of life Epson products. Please go to [this site](#) (U.S) or [this site](#) (Canada) for information on how to return your Epson products for proper disposal.

[Important Safety Instructions](#)

[Restrictions on Copying](#)

[Default Delay Times for Power Management for Epson Products](#)

[Binding Arbitration and Class Waiver](#)

[Trademarks](#)

[Copyright Notice](#)

## Important Safety Instructions

Follow these safety instructions when setting up and using the scanner:

- Read all these instructions, and follow all warnings and instructions marked on the scanner.
- Place the scanner close enough to the computer for the interface cable to reach it easily.
- Do not use with wet hands.
- When connecting this product to a computer or other device with a cable, ensure the correct orientation of the connectors. Each connector has only one correct orientation. Inserting a connector in the wrong orientation may damage both devices connected by the cable.
- Do not insert objects into any opening as they may touch dangerous voltage points or short out parts. Beware of electrical shock hazards.
- Place the product on a flat, stable surface that extends beyond the base of the product in all directions. If you place the product by the wall, leave at least 3.9 inches (10 cm) between the back of the product and the wall.
- After replacing consumable parts, dispose of them correctly following the rules of your local authority. Do not disassemble them.
- Do not place or store the scanner outdoors, in a car, near excessive dirt or dust, water, heat sources, or in locations subject to shocks, vibrations, condensation, high temperature or humidity, direct sunlight, strong light sources, or rapid changes in temperature or humidity.

- Never disassemble, modify, or attempt to repair the scanner or a scanner option by yourself except as specifically explained in this guide.

**Caution:** Radio waves from this product may adversely affect the operation of medical equipment, airplanes, or automatically controlled devices, such as pacemakers, automatic doors, or fire alarms. When using this product near such devices or inside a medical facility, follow the directions from authorized staff members at the facility, and follow all posted warnings and directions on the device to avoid causing an accident (DS-575W II).

### **AC Adapter**

- Do not place or store the AC adapter outdoors, in a car, near excessive dirt or dust, water, heat sources, or in locations subject to shocks, vibrations, condensation, high temperature or humidity, direct sunlight, strong light sources, or rapid changes in temperature or humidity.
- Place the scanner and the AC adapter near an electrical outlet where the adapter can be easily unplugged.
- The AC power cord should be placed to avoid abrasions, cuts, fraying, crimping, and kinking.
- Do not place objects on top of the AC power cord and do not allow the AC adapter or the power cord to be stepped on or run over. Be particularly careful to keep the AC power cord straight at the end and the point where it enters the AC adapter.
- Use only the AC adapter that comes with your scanner. Using any other adapter could cause fire, electrical shock, or injury.
- Use only the power cord that comes with your scanner. Use of another cord may cause fires or shock. Do not use the cord with any other equipment.
- The AC adapter is designed for use with the scanner with which it was included. Do not attempt to use it with other electronic devices unless specified.
- Use only the type of power source indicated on the AC adapter's label, and always supply power directly from a standard domestic electrical outlet with the AC adapter that meets the relevant local safety standards.
- Avoid using outlets on the same circuit as photocopiers or air control systems that regularly switch on and off.
- If you use an extension cord with the scanner, make sure the total ampere rating of the devices plugged into the extension cord does not exceed the cord's ampere rating. Also, make sure the total ampere rating of all devices plugged into the wall outlet does not exceed the wall outlet's ampere rating.

- Never disassemble, modify, or attempt to repair the AC adapter by yourself except as specifically explained in the scanner's guides.
- If damage occurs to the plug, replace the cord set or consult a qualified electrician. If there are fuses in the plug, make sure you replace them with fuses of the correct size and rating.
- Unplug the scanner and the AC adapter, and refer servicing to qualified service personnel under the following conditions: The AC adapter or plug is damaged; liquid has entered the scanner or the AC adapter; the scanner or the AC adapter has been dropped or the case has been damaged; the scanner or the AC adapter does not operate normally or exhibits a distinct change in performance. (Do not adjust controls that are not covered by the operating instructions.)
- Unplug the scanner and the AC adapter before cleaning. Clean with a damp cloth only. Do not use liquid or aerosol cleaners.
- If you are not going to use the scanner for a long period, be sure to unplug the AC adapter from the electrical outlet.

## **USB**

- Use only the USB cable supplied with your product. Using any other USB cable could cause fire, electrical shock, or injury.
- The USB cable is designed for use with the product with which it was included. Do not attempt to use it with other electrical devices unless specified.
- The USB cable should be placed to avoid abrasions, cuts, fraying, crimping, and kinking.
- Do not place objects on top of the USB cable and do not allow the cable to be stepped on or run over. Be particularly careful to keep the USB cable straight at the end.
- If you are not going to use the product for a long period, unplug the USB cable from the computer.
- Unplug the scanner and the USB cable, and refer servicing to qualified service personnel under the following conditions: Liquid has entered the scanner; the scanner has been dropped or the case has been damaged; the scanner does not operate normally or exhibits a distinct change in performance. (Do not adjust controls that are not covered by the operating instructions.)

**Parent topic:** [Notices](#)

## **Restrictions on Copying**

Observe the following restrictions to ensure responsible and legal use of your scanner.

Copying of the following items is prohibited by law:

- Bank bills, coins, government-issued marketable securities, government bond securities, and municipal securities

- Unused postage stamps, pre-stamped postcards, and other official postal items bearing valid postage
- Government-issued revenue stamps, and securities issued according to legal procedure

Exercise caution when copying the following items:

- Private marketable securities (stock certificates, negotiable notes, checks, etc.), monthly passes, concession tickets, etc.
- Passports, driver's licenses, warrants of fitness, road passes, food stamps, tickets, etc.

**Note:** Copying these items may also be prohibited by law.

#### **Restriction on disassembling and decompiling**

You may not disassemble, decompile, or otherwise attempt to derive the source code of any software included with this product.

**Parent topic:** [Notices](#)

## **Default Delay Times for Power Management for Epson Products**

This product will enter sleep mode after a period of nonuse. This is to ensure that the product meets Energy Star standards of energy efficiency. More energy savings can be achieved by setting the time to sleep to a shorter interval.

**Parent topic:** [Notices](#)

## **Binding Arbitration and Class Waiver**

### **1. DISPUTES, BINDING INDIVIDUAL ARBITRATION, AND WAIVER OF CLASS ACTIONS AND CLASS ARBITRATIONS**

**1.1 Disputes.** The terms of this Section 1 shall apply to all Disputes between you and Epson. The term "Dispute" is meant to have the broadest meaning permissible under law and includes any dispute, claim, controversy or action between you and Epson arising out of or relating to this Agreement, Epson branded products (hardware and including any related software), or other transaction involving you and Epson, whether in contract, warranty, misrepresentation, fraud, tort, intentional tort, statute, regulation, ordinance, or any other legal or equitable basis. "DISPUTE" DOES NOT INCLUDE IP CLAIMS, or more specifically, a claim or cause of action for (a) trademark infringement or dilution, (b) patent infringement, (c) copyright infringement or misuse, or (d) trade secret misappropriation (an "IP Claim"). You and Epson also agree, notwithstanding Section 1.6, that a court, not an arbitrator, may decide if a claim or cause of action is for an IP Claim.

**1.2 Binding Arbitration.** You and Epson agree that all Disputes shall be resolved by binding arbitration according to this Agreement. **ARBITRATION MEANS THAT YOU WAIVE YOUR RIGHT TO A JUDGE OR JURY IN A COURT PROCEEDING AND YOUR GROUNDS FOR APPEAL ARE LIMITED.**

Pursuant to this Agreement, binding arbitration shall be administered by JAMS, a nationally recognized arbitration authority, pursuant to its code of procedures then in effect for consumer related disputes, but excluding any rules that permit joinder or class actions in arbitration (for more detail on procedure, see Section 1.6 below). You and Epson understand and agree that (a) the Federal Arbitration Act (9 U.S.C. §1, et seq.) governs the interpretation and enforcement of this Section 1, (b) this Agreement memorializes a transaction in interstate commerce, and (c) this Section 1 shall survive termination of this Agreement.

**1.3 Pre-Arbitration Steps and Notice.** Before submitting a claim for arbitration, you and Epson agree to try, for sixty (60) days, to resolve any Dispute informally. If Epson and you do not reach an agreement to resolve the Dispute within the sixty (60) days, you or Epson may commence an arbitration. Notice to Epson must be addressed to: Epson America, Inc., ATTN: Legal Department, 3840 Kilroy Airport Way, Long Beach, CA 90806 (the "Epson Address"). The Dispute Notice to you will be sent to the most recent address Epson has in its records for you. For this reason, it is important to notify us if your address changes by emailing us at [EAILEgal@ea.epson.com](mailto:EAILEgal@ea.epson.com) or writing us at the Epson Address above. Notice of the Dispute shall include the sender's name, address and contact information, the facts giving rise to the Dispute, and the relief requested (the "Dispute Notice"). Following receipt of the Dispute Notice, Epson and you agree to act in good faith to resolve the Dispute before commencing arbitration.

**1.4 Small Claims Court.** Notwithstanding the foregoing, you may bring an individual action in the small claims court of your state or municipality if the action is within that court's jurisdiction and is pending only in that court.

**1.5 WAIVER OF CLASS ACTIONS AND CLASS ARBITRATIONS. YOU AND EPSON AGREE THAT EACH PARTY MAY BRING DISPUTES AGAINST THE OTHER PARTY ONLY IN AN INDIVIDUAL CAPACITY, AND NOT AS A PLAINTIFF OR CLASS MEMBER IN ANY CLASS OR REPRESENTATIVE PROCEEDING, INCLUDING WITHOUT LIMITATION FEDERAL OR STATE CLASS ACTIONS, OR CLASS ARBITRATIONS. CLASS ACTION LAWSUITS, CLASS-WIDE ARBITRATIONS, PRIVATE ATTORNEY-GENERAL ACTIONS, AND ANY OTHER PROCEEDING WHERE SOMEONE ACTS IN A REPRESENTATIVE CAPACITY ARE NOT ALLOWED. ACCORDINGLY, UNDER THE ARBITRATION PROCEDURES OUTLINED IN THIS SECTION, AN ARBITRATOR SHALL NOT COMBINE OR CONSOLIDATE MORE THAN ONE PARTY'S CLAIMS WITHOUT THE WRITTEN CONSENT OF ALL AFFECTED PARTIES TO AN ARBITRATION PROCEEDING.**

**1.6 Arbitration Procedure.** If you or Epson commences arbitration, the arbitration shall be governed by the rules of JAMS that are in effect when the arbitration is filed, excluding any rules that permit arbitration on a class or representative basis (the "JAMS Rules"), available at <http://www.jamsadr.com> or by calling 1-800-352-5267, and under the rules set forth in this Agreement. All Disputes shall be resolved by a single neutral arbitrator, and both parties shall have a reasonable opportunity to participate in the

selection of the arbitrator. The arbitrator is bound by the terms of this Agreement. The arbitrator, and not any federal, state or local court or agency, shall have exclusive authority to resolve all disputes arising out of or relating to the interpretation, applicability, enforceability or formation of this Agreement, including any claim that all or any part of this Agreement is void or voidable. Notwithstanding this broad delegation of authority to the arbitrator, a court may determine the limited question of whether a claim or cause of action is for an IP Claim, which is excluded from the definition of "Disputes" in Section 1.1 above. The arbitrator shall be empowered to grant whatever relief would be available in a court under law or in equity. The arbitrator may award you the same damages as a court could, and may award declaratory or injunctive relief only in favor of the individual party seeking relief and only to the extent necessary to provide relief warranted by that party's individual claim. In some instances, the costs of arbitration can exceed the costs of litigation and the right to discovery may be more limited in arbitration than in court. The arbitrator's award is binding and may be entered as a judgment in any court of competent jurisdiction.

You may choose to engage in arbitration hearings by telephone. Arbitration hearings not conducted by telephone shall take place in a location reasonably accessible from your primary residence, or in Orange County, California, at your option.

a) Initiation of Arbitration Proceeding. If either you or Epson decides to arbitrate a Dispute, both parties agree to the following procedure:

(i) Write a Demand for Arbitration. The demand must include a description of the Dispute and the amount of damages sought to be recovered. You can find a copy of a Demand for Arbitration at <http://www.jamsadr.com> ("Demand for Arbitration").

(ii) Send three copies of the Demand for Arbitration, plus the appropriate filing fee, to: JAMS, 500 North State College Blvd., Suite 600 Orange, CA 92868, U.S.A.

(iii) Send one copy of the Demand for Arbitration to the other party (same address as the Dispute Notice), or as otherwise agreed by the parties.

b) Hearing Format. During the arbitration, the amount of any settlement offer made shall not be disclosed to the arbitrator until after the arbitrator determines the amount, if any, to which you or Epson is entitled. The discovery or exchange of non-privileged information relevant to the Dispute may be allowed during the arbitration.

c) Arbitration Fees. Epson shall pay, or (if applicable) reimburse you for, all JAMS filings and arbitrator fees for any arbitration commenced (by you or Epson) pursuant to provisions of this Agreement.

d) Award in Your Favor. For Disputes in which you or Epson seeks \$75,000 or less in damages exclusive of attorney's fees and costs, if the arbitrator's decision results in an award to you in an amount greater than Epson's last written offer, if any, to settle the Dispute, Epson will: (i) pay you \$1,000 or the amount of the award, whichever is greater; (ii) pay you twice the amount of your reasonable attorney's fees, if any; and (iii) reimburse you for any expenses (including expert witness fees and costs) that your attorney reasonably accrues for investigating, preparing, and pursuing the Dispute in arbitration. Except as



agreed upon by you and Epson in writing, the arbitrator shall determine the amount of fees, costs, and expenses to be paid by Epson pursuant to this Section 1.6d).

e) Attorney's Fees. Epson will not seek its attorney's fees and expenses for any arbitration commenced involving a Dispute under this Agreement. Your right to attorney's fees and expenses under Section 1.6d) above does not limit your rights to attorney's fees and expenses under applicable law; notwithstanding the foregoing, the arbitrator may not award duplicative awards of attorney's fees and expenses.

**1.7 Opt-out. You may elect to opt-out (exclude yourself) from the final, binding, individual arbitration procedure and waiver of class and representative proceedings specified in this Agreement by sending a written letter to the Epson Address within thirty (30) days of your assent to this Agreement (including without limitation the purchase, download, installation of the Software or other applicable use of Epson Hardware, products and services) that specifies (i) your name, (ii) your mailing address, and (iii) your request to be excluded from the final, binding individual arbitration procedure and waiver of class and representative proceedings specified in this Section 1. In the event that you opt-out consistent with the procedure set forth above, all other terms shall continue to apply, including the requirement to provide notice prior to litigation.**

**1.8 Amendments to Section 1.** Notwithstanding any provision in this Agreement to the contrary, you and Epson agree that if Epson makes any future amendments to the dispute resolution procedure and class action waiver provisions (other than a change to Epson's address) in this Agreement, Epson will obtain your affirmative assent to the applicable amendment. If you do not affirmatively assent to the applicable amendment, you are agreeing that you will arbitrate any Dispute between the parties in accordance with the language of this Section 1 (or resolve disputes as provided for in Section 1.7, if you timely elected to opt-out when you first assented to this Agreement).

**1.9 Severability.** If any provision in this Section 1 is found to be unenforceable, that provision shall be severed with the remainder of this Agreement remaining in full force and effect. **The foregoing shall not apply to the prohibition against class or representative actions as provided in Section 1.5. This means that if Section 1.5 is found to be unenforceable, the entire Section 1 (but only Section 1) shall be null and void.**

Parent topic: [Notices](#)

## Trademarks

EPSON®, Epson Smart Panel®, and Perfection® are registered trademarks and EPSON Exceed Your Vision is a registered logomark of Seiko Epson Corporation.

Windows is a registered trademark of Microsoft Corporation in the United States and/or other countries.

Apple, App Store, macOS, and OS X are trademarks of Apple Inc., registered in the U.S. and other countries.

Google® is a registered trademark and Android™ and Google Play™ are trademarks of Google LLC.

General Notice: Other product names used herein are for identification purposes only and may be trademarks of their respective owners. Epson disclaims any and all rights in those marks.



**Parent topic:** [Notices](#)

## Copyright Notice

All rights reserved. No part of this publication may be reproduced, stored in a retrieval system, or transmitted in any form or by any means, electronic, mechanical, photocopying, recording, or otherwise, without the prior written permission of Seiko Epson Corporation. The information contained herein is designed only for use with this Epson product. Epson is not responsible for any use of this information as applied to other products.

Neither Seiko Epson Corporation nor its affiliates shall be liable to the purchaser of this product or third parties for damages, losses, costs, or expenses incurred by purchaser or third parties as a result of: accident, misuse, or abuse of this product or unauthorized modifications, repairs, or alterations to this product, or (excluding the U.S.) failure to strictly comply with Seiko Epson Corporation's operating and maintenance instructions.

Seiko Epson Corporation shall not be liable for any damages or problems arising from the use of any options or any consumable products other than those designated as Original Epson Products or Epson Approved Products by Seiko Epson Corporation.

Seiko Epson Corporation shall not be held liable for any damage resulting from electromagnetic interference that occurs from the use of any interface cables other than those designated as Epson approved Products by Seiko Epson Corporation.

This information is subject to change without notice.

[libTIFF Software Acknowledgment](#)

[A Note Concerning Responsible Use of Copyrighted Materials](#)

[Copyright Attribution](#)

**Parent topic:** [Notices](#)

## libTIFF Software Acknowledgment

Copyright © 1988-1997 Sam Leffler

Copyright © 1991-1997 Silicon Graphics, Inc.

Permission to use, copy, modify, distribute, and sell this software and its documentation for any purpose is hereby granted without fee, provided that (i) the above copyright notices and this permission notice appear in all copies of the software and related documentation, and (ii) the names of Sam Leffler and Silicon Graphics may not be used in any advertising or publicity relating to the software without the specific, prior written permission of Sam Leffler and Silicon Graphics.

THE SOFTWARE IS PROVIDED "AS-IS" AND WITHOUT WARRANTY OF ANY KIND, EXPRESS, IMPLIED OR OTHERWISE, INCLUDING WITHOUT LIMITATION, ANY WARRANTY OF MERCHANTABILITY OR FITNESS FOR A PARTICULAR PURPOSE.

IN NO EVENT SHALL SAM LEFFLER OR SILICON GRAPHICS BE LIABLE FOR ANY SPECIAL, INCIDENTAL, INDIRECT OR CONSEQUENTIAL DAMAGES OF ANY KIND, OR ANY DAMAGES WHATSOEVER RESULTING FROM LOSS OF USE, DATA OR PROFITS, WHETHER OR NOT ADVISED OF THE POSSIBILITY OF DAMAGE, AND ON ANY THEORY OF LIABILITY, ARISING OUT OF OR IN CONNECTION WITH THE USE OR PERFORMANCE OF THIS SOFTWARE.

Parent topic: [Copyright Notice](#)

## A Note Concerning Responsible Use of Copyrighted Materials

Epson encourages each user to be responsible and respectful of the copyright laws when using any Epson product. While some countries' laws permit limited copying or reuse of copyrighted material in certain circumstances, those circumstances may not be as broad as some people assume. Contact your legal advisor for any questions regarding copyright law.

Parent topic: [Copyright Notice](#)

## Copyright Attribution

© 2020 Epson America, Inc.

11/20

CPD-59609

Parent topic: [Copyright Notice](#)