

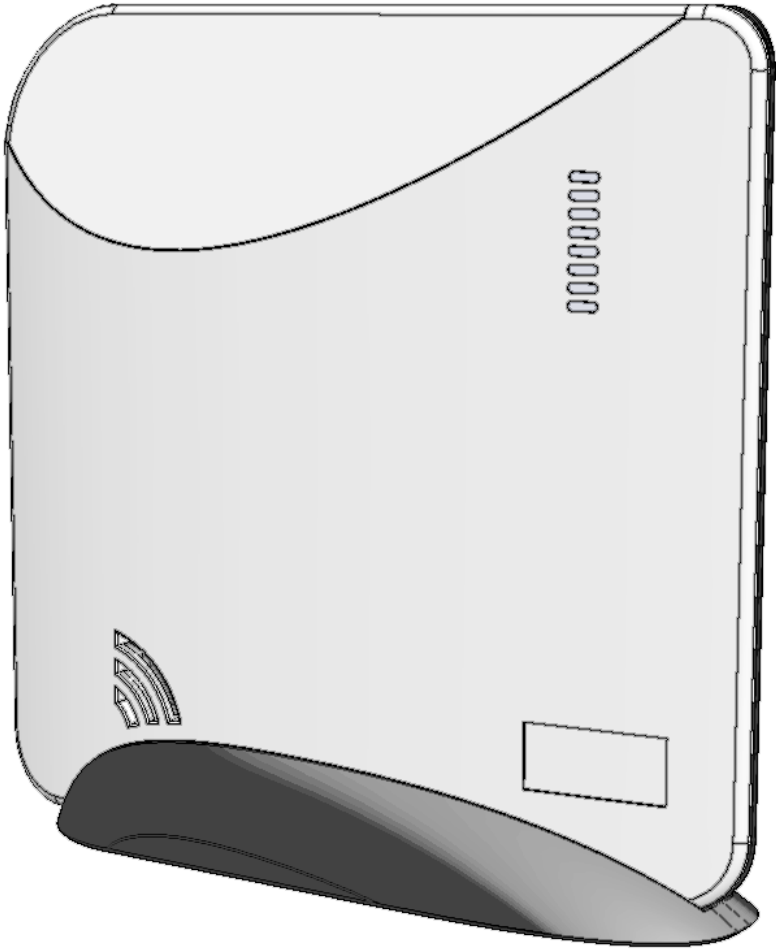

RE6100 Series Helix™ Security and Automation Platform



Meet Helix

Helix is a professional wireless security panel designed to deliver home security and automation services. A secured and supervised Ethernet connection comes standard. Optional Cellular and Wi-Fi cards provide primary or backup communication channels. Its long-range encrypted wireless receiver easily provides whole home coverage. Wireless arming stations and mobile devices uncouple Helix from the entry wall and allow it to be installed at a location convenient for Internet and power connections.



FEATURES

- Cellular, Wi-Fi, or Ethernet communication channels
- Control from a user's mobile device
- Industry-leading wireless range
- Up to 50 users
- Up to 96 zones
- 5 year warranty

ITEMS INCLUDED IN THE BOX

- The Helix panel
- Rechargeable backup battery
- 12-Volt power adapter
- 6-foot Ethernet cable
- Table-top mounting base
- A screw to secure the cover (required for UL installations)
- Installation guide
- Configuration guide
- Alarm dealer portal guide insert

EXPANSION CARDS FOR INTERNET CONNECTIVITY

- Wi-Fi™ Card
- CDMA Cellular Card (Verizon, Sprint)
- GSM Cellular Card (AT&T, T-Mobile)

OTHER EXPANSION CARDS

- Z-Wave™ Card
- Existing Security Sensor Translator Card (allows Helix to receive signals from existing wireless security sensors)
- Combo Z-Wave & Existing Sensor Translator Card

System Setup

1 Set up a new account

with ipDatatel by following the instructions on the included Alarm dealer portal guide insert. ipDatatel will need the Helix MAC address which is located on the bottom of Helix.

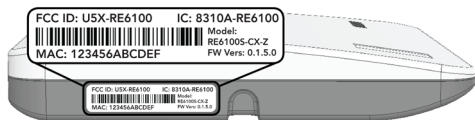

DO NOT PROCEED UNTIL YOU HAVE FINISHED STEP 1

2 Find a location for Helix, keeping in mind it needs AC power and at least one network connection.

Wireless Installation Guidelines

- Locate Helix centrally on the main floor.
- Avoid mounting Helix below ground level.
- Do not mount Helix near ducts, appliances, or other large metal objects.
- Do not mount Helix directly adjacent to other RF devices.

3 Mount Helix by sliding it downward into the table-top base. Alternatively, Helix can be mounted to a wall using the mounting holes in the back cover. You will need to remove the backup battery to reveal the lower mounting hole.

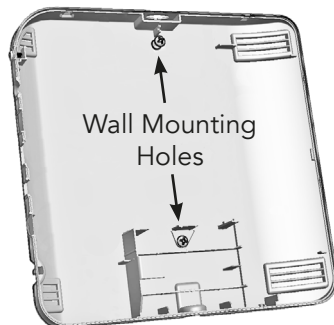

4 Connect Helix to the Internet by wiring the Helix Ethernet port to the home router, or by installing a Cellular or Wi-Fi expansion card (or any combination of the above). The Wi-Fi approach requires enrollment into the home Wi-Fi router.

- If you are using Wi-Fi, then connect the Helix Wi-Fi card to your existing home router by holding the Enroll/WPS button until Helix beeps twice (roughly ten seconds) and then pressing the WPS button on the router.

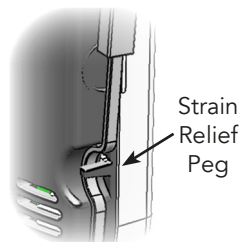

5 Power up Helix by inserting the power supply barrel into the power jack on the side of the Helix. Route the power cable under the strain relief peg.

UL Installation Requirements

- Install the cover-securing screw.
- Do not connect Helix to an AC power receptacle controlled by a switch.
- The power supply must be secured to an outlet if installed in the USA.
- The power supply must NOT be secured to an outlet if installed in Canada.

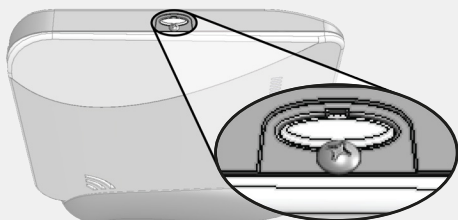

Cover Securing Screw

- 6 Enroll sensors and peripherals** by pressing the Enroll/WPS button on the side of Helix until it beeps once (roughly 3 seconds) and then sending an enrollment signal from the sensor or peripheral. Alternatively, a device can be enrolled by scanning its bar code using the HeliLink app or by entering its 8-character serial number. This can also be done manually by referring to the specific instructions provided with the device.

Enrollment Tips

- Enrollment signals are typically triggered by removing the battery tab or tampering the device. See the specific device manual for more information.
- The *HeliLink* mobile app can be used to enroll and configure sensors.
- Your dealer portal may provide a way to enter and exit wireless enrollment mode.
- Wireless enrollment mode will end 5 minutes after the last sensor is enrolled.
- Enrolling a HeliPad or other 2.4GHz peripheral will automatically end wireless enrollment mode.
- Tapping the Enroll/WPS button will end wireless enrollment mode.

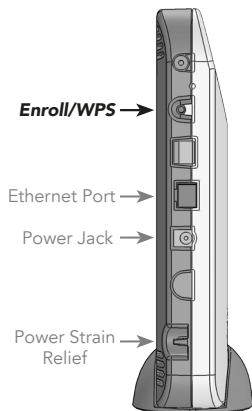

- 7 Install your sensors & peripherals** in desired locations around the house. Refer to the specific device manual for more information regarding installation and use.

Typical Burglary Protection Installation

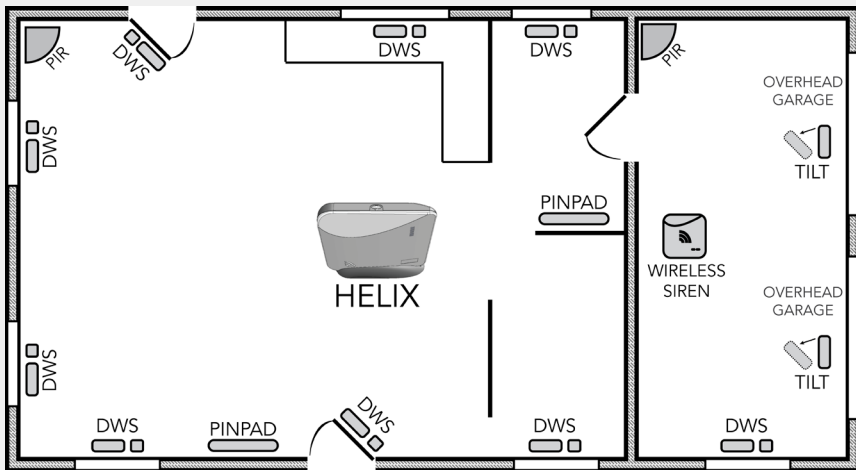

- 8 Configure Helix, sensors, and peripherals** using the HeliLink mobile app.

- 9 Finally, test the system** after finishing installation, enrollment, and configuration. Verify proper operation of all installed sensors and peripherals using the HeliLink app. All sensors and peripherals should score at least one bar on the RF signal strength indicator. See *Pro Tips - RF Signal Strength*.

Pro-Tips

Install an expansion card by first disconnecting AC power and the battery. Cellular cards must use slot 1 and square cards must use slot 3. Always refer to the specific card manual for a full list of installation requirements. Next, **carefully align** the nylon retention posts and 8-pin connector while pushing the card firmly onto Helix until all the posts are fully seated. Finally, reconnect the battery, AC power, and verify proper operation using the LED indicators on the expansion card.

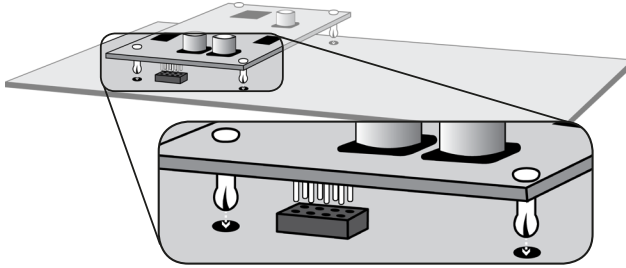
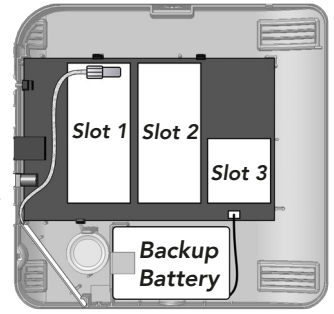

Cellular Antenna Installation

- Route the antenna wire near the Ethernet jack as shown above.
- Install the antenna with the feed wire on the top side as shown to the right.

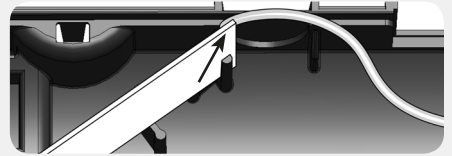

RF Signal Strength is an averaged signal-to-noise indication. Even in the absence of sensor transmissions, Helix experiences ambient RF energy (i.e. noise). The RF signal strength indication represents a sensor's signal relative to ambient noise. If multiple sensors score low signal strength, this could be due to one or more of the following.

1. **High ambient noise** - Ensure Helix is not mounted adjacent to other electronics.
2. **Helix isn't centrally located, or is mounted below ground** - Move Helix to a central location in the home that is above ground level.
3. **Helix is located near ducts, appliances, or other large metal objects** - Relocate Helix away from these types of objects.

Sensor Signal Strength Tips

- The signal strength scale is from 0 to 100 (0 to 5 bars).
- There is **nothing wrong** with a sensor that has at least one bar (e.g. a signal strength of at least 20).
- Signal strength readings are averaged. If you move Helix or a sensor, it takes some time for the signal strength readings to update. Tripping a sensor several times will help update a sensor's signal strength faster.
- Before mounting a sensor permanently, expose a slight portion of its mounting tape and apply it (**very lightly**) to the desired location. If it performs well, mount it permanently. If it performs poorly, try rotating it by 90 degrees.
- **Do not test a mounting location by tripping a sensor in your hand.** Holding a sensor changes how it radiates RF energy. Sometimes these "hand effects" help, and sometimes they hurt.

Wireless performance of door window sensors is optimized when mounted vertically near the top corner of the door.

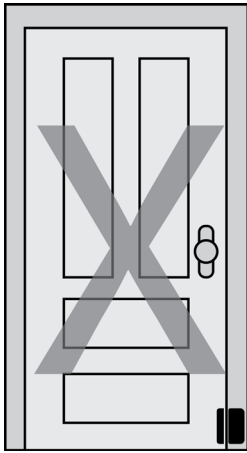

WRONG

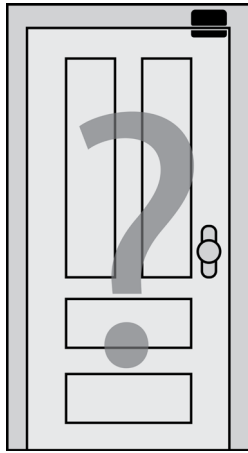

OK

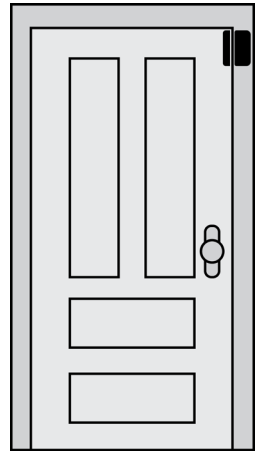

BEST

Routers, modems, and other electronic devices emit RF noise. For best results, avoid mounting Helix directly beside other electronic devices.

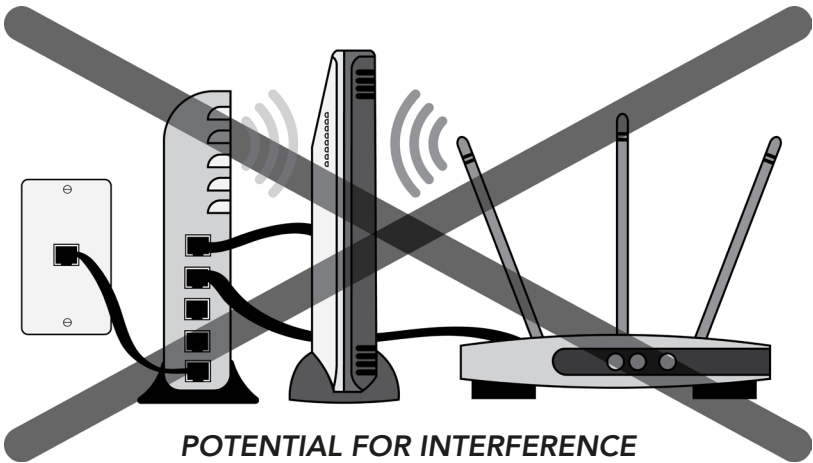

- Put some space between Helix and the home router. Helix includes a 6-foot cable for this purpose.

Trouble beeps can be suppressed so they only occur during a specific window of time each day.

- Use HeliLink app or your dealer portal to configure the trouble beep suppression period.
- Trouble beeps can be temporarily silenced for 24 hours using a HeliPad or Keyfob.

HeliLink can be used to enroll sensors by scanning their barcodes.

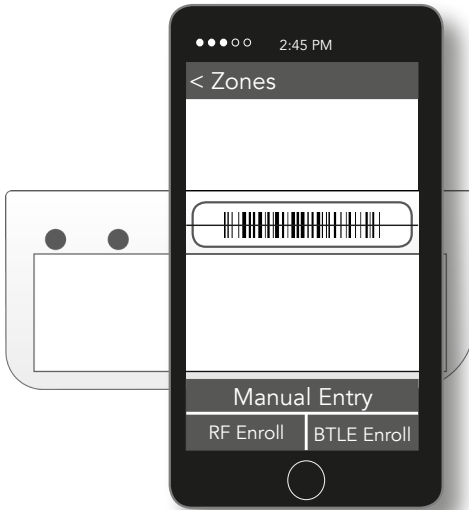

Smoke Alarms should be installed in accordance with Chapter 2 of “ANSI/NFPA 72: National Fire Alarm and Signaling Code” (National Fire Protection Association, Batterymarch Park, Quincy, MA 02169) when installed in the USA. Smoke alarms installed in Canada should be installed in accordance with “Standard for the Installation of Residential Fire Warning Systems, CAN/ULC-S540”.

Smoke Alarm Placement

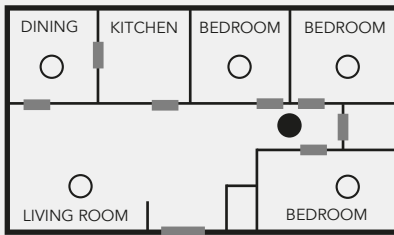

(Single Sleeping Area)

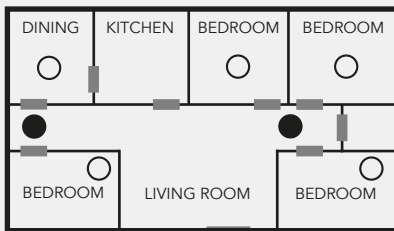

(Multiple Sleeping Areas)

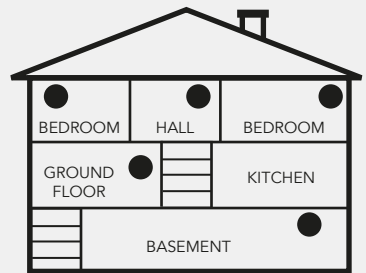
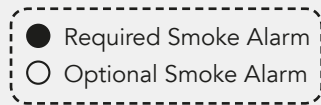

(Multi-Floor Home)

NOTE: Regulations pertaining to smoke alarm installations vary. Contact your local fire department for more information.

Should the battery need replacing, remove the cover, disconnect the old battery, and connect a new battery. The battery connector is polarized and can be inserted only one way into the Helix receptacle.

Emergency Planning

Emergencies happen, so have a plan.

Emergency Planning Tips

- Periodically discuss and rehearse emergency plans.
- Understand how to use your security system.
- Know the normal states of doors and windows: open, closed, or locked.
- Escape fast! (Do not stop to pack.)
- Use a different escape route if closed doors feel hot to the touch.
- Smoke is toxic. Stay low and breath strategically when escaping a burning building.
- Designate a nearby landmark as a safe family re-grouping location.
- Emphasize that no one should return to the premises if there is a fire.
- Call 911 as soon as possible but do it in a safe location.
- Do not enter the premises if you arrive and hear sirens. Call for emergency assistance from a safe location.

Using Helix

System Status Indication is provided via eight LEDs on the front of Helix. These LEDs may all be forced OFF to conserve battery power during an AC power failure.

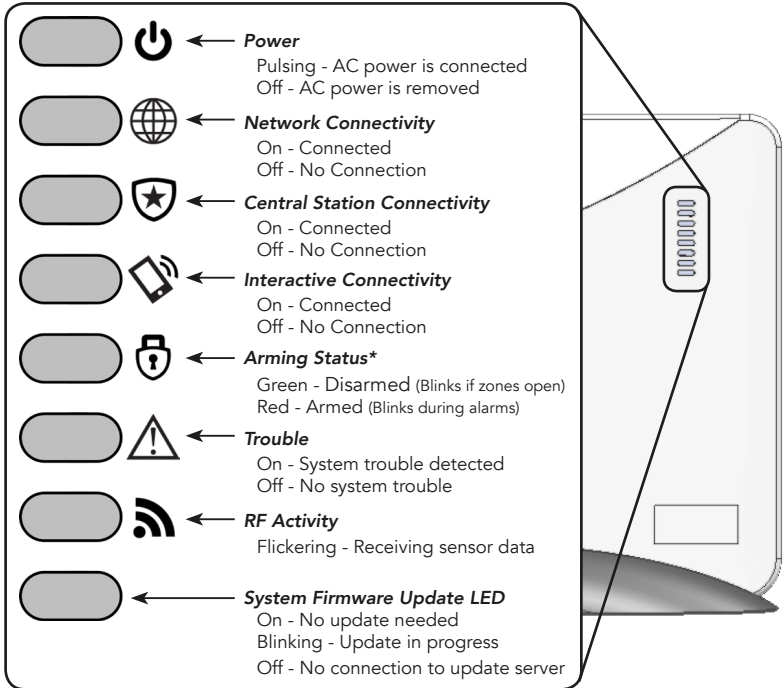



* This LED will toggle between green and red while wireless enrollment mode is active.

Using HeliPad (See the HeliPad™ manual for detailed operation)

Disarm the system by entering a valid user code on the number pad.

Arm Away by pressing ARM AWAY  until the HeliPad clicks.

Arm Stay by pressing ARM STAY  until the HeliPad clicks.

Trigger a panic alarm by pressing ARM STAY  & ARM AWAY  together until the display indicates a panic alarm.

View real-time system status using the HeliPad's display.

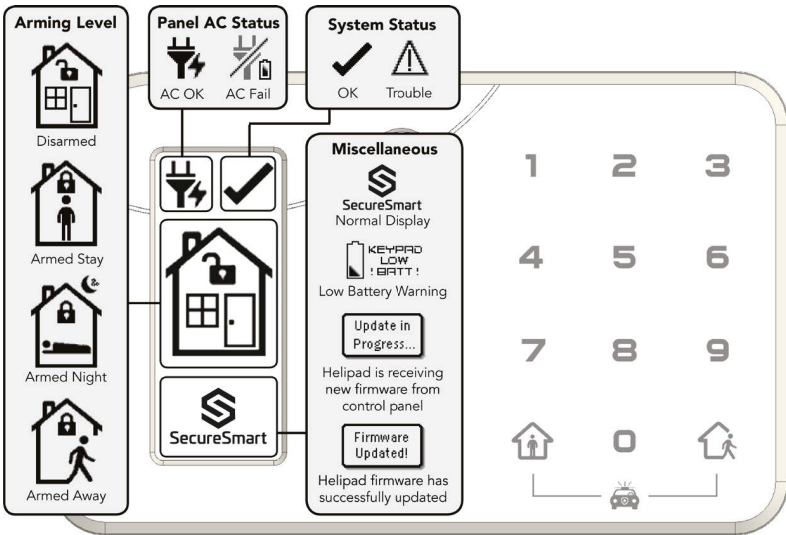

Using PINPad (See PINPad™ manual for detailed operation)

Disarm the system by entering a valid user code on the number pad.

Arm Away by pressing the "AWAY" button until the PINPad LED flashes red.

Arm Stay by pressing the "STAY" button until the PINPad LED flashes red.

Trigger a panic alarm by pressing the "STAY" & "AWAY" buttons together until the PINPad LED flashes red.



Connectivity Troubleshooting

Symptom	Troubleshooting Steps
Network Connectivity LED Off	<p>Ethernet Connections</p> <ol style="list-style-type: none">1. Ensure Ethernet cable is fully inserted in both Helix and router/modem. <p>Wi-Fi Connections</p> <ol style="list-style-type: none">1. Ensure the Wi-Fi card is properly installed, and the Power LED on the card is pulsing.2. Ensure Helix has been configured with the proper Wi-Fi credentials and the Wi-Fi LED on the expansion card is on solid. If the LED is blinking either the network is not in range, or the Wi-Fi credentials are incorrect (refer to <i>System Setup - Step 4</i>). <p>Cellular Connections</p> <ol style="list-style-type: none">1. Ensure Cellular card is properly installed, and the Power LED on the card is pulsing.2. Inspect the GSM or CDMA LED on the expansion card.<ul style="list-style-type: none">• A solid LED indicates Helix is connected to the network.• A flashing LED indicates Helix has found a tower, and is attempting to connect to the network. Wait until the LED is solid. If the LED has been double flashing for more than ten minutes, try power cycling Helix.
Central Station Connectivity LED Off	<ol style="list-style-type: none">1. Ensure the Network Connectivity LED is on. If it is off, see the network connectivity troubleshooting section above.2. Ensure port TCP 9999 is open in the router/modem settings.3. Ensure Helix is registered to an account on your dealer portal and the account is active.4. Ensure Helix has been configured with the proper central station reporting information: Account Number, Central Station Receiver Host and Port, Central Station Receiver ID and Line ID.
Interactive Connectivity LED Off	<ol style="list-style-type: none">1. Ensure the Network Connectivity LED is on. If it is off, see the network connectivity troubleshooting section above.2. Ensure port UDP 1234 is open in the router/modem settings.3. Ensure Helix is registered to an account on your dealer portal and the account is active.
System Firmware Update LED Off	<ol style="list-style-type: none">1. Ensure port UDP 1235 is open in the router/modem settings. Helix and peripherals will not be able to receive firmware updates if this port isn't available or is already in use.

System Maintenance

System testing should be performed after installation is completed and whenever a problem occurs.

Smoke and CO detectors should be tested after installed and weekly by pressing the test button on the detector. Helix will indicate it has properly received a test signal by sounding a temporal three sound for a Smoke detector or a temporal four sound for a CO detector.

Critical functions and communication links of the system are automatically monitored and exercised to detect trouble conditions.

Regulatory

UL SYSTEM REQUIREMENTS

Control Unit, consisting of:

- Base Panel: RE6100 series
- Backup Battery: RE029 (6V, 2.5Ah, NiMH)
- Power Supply: RE012-6 (In: 100-240VAC; Out: 12VDC, 1A)
- PINPad (RE652) or HeliPad (RE656), connected wirelessly
- Ethernet connection native to base panel or Cellular module (RE928RxS, RE928RxV, or RE927RxA)

Compatible ETL listed signal initiating devices:

- RE612 Smoke Detector
- RE613 CO Detector
- RE601 Door/Window Sensor
- RE622 NanoMax Door/Window Sensor
- RE610P Motion Detector

Optional devices, not ETL listed:

- Any of a wide array of CryptiX sensors.

UL1023 Household Burglar Alarm System:

- Control Unit
- At least one burglary signal initiating device
- Entry delay: 45 seconds or less
- Exit delay: 60 seconds or less
- Sensor supervisory: 24 hours or less
- Panel status volume: on
- Panel siren: on
- Auto force arm: on
- Siren timeout: 4 minutes or more

ORD-C1023-1974 Canadian Household Burglar Alarm System:

- Control Unit and installation as described for UL1023
- Power supply: RE012-6, Do NOT secure with a receptacle securing screw. Ne pas se connecter Helix à une prise contrôlée par un interrupteur.
- Siren timeout: 6 minutes or more

UL985 Household Fire Warning System:

- Control Unit
- At least one smoke signal-initiating device enrolled into "Fire" zone profile.
- Smoke supervision: on
- Panel siren: on
- Siren timeout: 4 minutes or more
- Panel status volume: on

ULC-5545-M89 Canadian Household Fire Warning System:

- Control Unit and installation as described for UL985
- Power supply: RE012-6, Do NOT secure with a receptacle securing screw. Ne pas se connecter Helix à une prise contrôlée par un interrupteur.
- Siren timeout: 6 minutes or more

Central Station Communicator Requirement is at least one of:

- UL1610 Central Station Burglar Alarm System: Ethernet connection native to base panel
-OR-
- UL1635 Digital Alarm Communicator System: Cellular module RE928RSS, RE928RSV, or RE927RSA
- RF supervision: 4 hours
- Communication interface supervision: on
- Entry delay plus reporting delay must not exceed 60 seconds.
- Reporting delay is 30 seconds.

Network Equipment:

- Use a UL 60950-1 listed broadband router/modem for the 10/100 Ethernet port or Wi-Fi connection

CE SYSTEM REQUIREMENTS

Access Levels:

- Access Level 1: Person with no access to the security system features.
- Access Level 2: Regular users with access to all features on the security system with a code.
- Access Level 3: Master and Alarm company users that can do everything a level 2 user can do and also change system settings (e.g. add, modify, or delete users).
- Access Level 4: Manufacturer of equipment access. Typically used for system updates.

User Codes:

- Four or more invalid code attempts will disable the interface and trigger a tamper condition.
- There are 10,000 unique 4-digit PIN codes.
- There are 16,777,215 unique identification codes for logical keys (Keyfobs).

Priority of Indicators:

- Fire alarm
- CO alarm
- Panic alarm
- Burglary alarm
- Tamper alarm
- Auxiliary alarm
- Freeze alarm
- Heat alarm
- Water alarm
- Tamper indication
- Fault indication

Ancillary Control Devices:

- Up to 8 PINPads (RE652)
- Up to 16 HeliPads (RE656) and/or mobile devices.
- PINPads and HeliPads can issue panic alarms.

Specifications

PHYSICAL

Housing Body Dimensions	8.9 x 8.9 x 1.5 inches (22.6 x 22.6 x 3.8 cm)
Housing Base Dimensions	8.2 x 1.3 x 2.7 inches (20.8 x 3.3 x 6.7 cm)
Weight with Battery	26.8 ounces (760 grams)
Mounting Fastener	#6 or #8 screws (not provided)

ENVIRONMENTAL

Operating Temperature	32 to 120 °F (0 to 49 °C)
Storage Temperature	-4 to 86 °F (-20 to 30 °C)
Maximum Humidity	85% non-condensing relative humidity

PANEL SPECIFICATIONS

Radio Frequencies	433.92MHz, 2.4GHz
Power Supply Part Number	RE012-6 (US), RE012-7 (AUS), RE012-8 (CE)
Input	100-240VAC, 50/60 Hz, 0.5A
Output	12VDC, 1A
Battery Part Number	RE029
Backup	24 hours minimum
Specifications	6VDC, 2.5Ah, NiMH
Battery Charger	25mA (Trickle), 95mA (Fast)
Current Draw	150mA (Normal), 300mA (Alarm)
Tamper Indications	Cover opening and Wall removal
Sensors	Up to 96 CryptiX Encrypted Wireless Security Zones
Interface Devices	Up to 8 PINPads (RE652) Up to 8 HeliPads (RE656) and/or mobile devices
Maximum Number of Users	50

CERTIFICATIONS

RE6100	UL1023, UL985, UL1635, ORD-C1023-1974, ULC-S545-M89, ETL, FCC, IC
RE6110	EN 60950-1, EN 300 220, EN 301 489, RCM
RE6120	EN50131-3, EN 60950-1, EN 300 220, EN 301 489, CE

Specifications subject to change without notice.

WARRANTY

Resolution Products, Inc. will replace products that are defective in their first five (5) years.

IC NOTICE

This device complies with Industry Canada license-exempt RSS standard(s). Operation is subject to the following two conditions:

- (1) This device may not cause interference, and
- (2) This device must accept any interference, including interference that may cause undesired operation of the device.

Le présent appareil est conforme aux cnr d'Industrie Canada applicables aux appareils radio exempts de licence. L'exploitation est autorisée aux deux conditions suivantes:

- (1) L'appareil ne doit pas produire de brouillage, et
- (2) L'utilisateur de l'appareil doit accepter tout brouillage radioélectrique subi, même si le brouillage est susceptible d'en compromettre le fonctionnement.

IC: 8310A-RE6100

FCC NOTICE

This device complies with Part 15 of the FCC rules. Operation is subject to the following two conditions:

- (1) This device may not cause harmful interference.
- (2) This device must accept any interference that may be received, including interference that may cause undesired operation.

Changes or modifications not expressly approved by the Resolution Products, Inc. could void the user's authority to operate this equipment.

FCC ID: U5X-RE6100

CE DECLARATION OF CONFORMITY

Hereby, Resolution Products, Inc. declares that this RE6120 is in compliance with the essential requirements and other relevant provisions of directive 1999/5/EC.

(This declaration can be translated to other languages via a myriad of translation tools found on the Internet.)