

Displacement Sensor

ZW-8000/7000/5000 series

Confocal Fiber Type Displacement Sensor

User's Manual

ZW-8000

ZW-7000

ZW-5000



Introduction

Thank you for purchasing the ZW-8000/7000/5000 Series.

This manual provides information regarding functions, performance and operating methods that are required for using the ZW-8000/7000/5000 Series.

When using the ZW-8000/7000/5000 Series, be sure to observe the following:

- The ZW-8000/7000/5000 Series must be operated by personnel knowledgeable in electrical engineering.
- To ensure correct use, please read this manual thoroughly to deepen your understanding of the product.
- Please keep this manual in a safe place so that it can be referred to whenever necessary.

User's Manual

Terms and Conditions Agreement
(Please Read)

Basic configuration

1

Installation and Connections

2

Operation during RUN Mode

3

Settings for Function

4

Convenient Functions

5

Offline Settings

6

Sensor controller operations

7

Troubleshooting

8

APPENDICES

9

Terms and Conditions Agreement

Read and understand this catalog.

Please read and understand this catalog before purchasing the products. Please consult your OMRON representative if you have any questions or comments.

Warranties.

• Exclusive Warranty.

Omron's exclusive warranty is that the Products will be free from defects in materials and workmanship for a period of twelve months from the date of sale by Omron (or such other period expressed in writing by Omron). Omron disclaims all other warranties, express or implied.

• Limitations.

OMRON MAKES NO WARRANTY OR REPRESENTATION, EXPRESS OR IMPLIED, ABOUT NON-INFRINGEMENT, MERCHANTABILITY OR FITNESS FOR A PARTICULAR PURPOSE OF THE PRODUCTS. BUYER ACKNOWLEDGES THAT IT ALONE HAS DETERMINED THAT THE PRODUCTS WILL SUITABLY MEET THE REQUIREMENTS OF THEIR INTENDED USE.

Omron further disclaims all warranties and responsibility of any type for claims or expenses based on infringement by the Products or otherwise of any intellectual property right. (c) Buyer Remedy. Omron's sole obligation hereunder shall be, at Omron's election, to (i) replace (in the form originally shipped with Buyer responsible for labor charges for removal or replacement thereof) the

non-complying Product, (ii) repair the non-complying Product, or (iii) repay or credit Buyer an amount equal to the purchase price of the non-complying Product; provided that in no event shall Omron be responsible for warranty, repair, indemnity or any other claims or expenses regarding the Products unless Omron's analysis confirms that the Products were properly handled, stored, installed and maintained and not subject to contamination, abuse, misuse or inappropriate modification. Return of any Products by Buyer must be approved in writing by Omron before shipment. Omron Companies shall not be liable for the suitability or unsuitability or the results from the use of Products in combination with any electrical or electronic components, circuits, system assemblies or any other materials or substances or environments. Any advice, recommendations or information given orally or in writing, are not to be construed as an amendment or addition to the above warranty.

See <http://www.omron.com/global/> or contact your Omron representative for published information.

Limitation on Liability; Etc.

OMRON COMPANIES SHALL NOT BE LIABLE FOR SPECIAL, INDIRECT, INCIDENTAL, OR CONSEQUENTIAL DAMAGES, LOSS OF PROFITS OR PRODUCTION OR COMMERCIAL LOSS IN ANY WAY CONNECTED WITH THE PRODUCTS, WHETHER SUCH CLAIM IS BASED IN CONTRACT, WARRANTY, NEGLIGENCE OR STRICT LIABILITY.

Further, in no event shall liability of Omron Companies exceed the individual price of the Product on which liability is asserted.

Suitability of Use.

Omron Companies shall not be responsible for conformity with any standards, codes or regulations which apply to the combination of the Product in the Buyer's application or use of the Product. At Buyer's request, Omron will provide applicable third party certification documents identifying ratings and limitations of use which apply to the Product. This information by itself is not sufficient for a complete determination of the suitability of the Product in combination with the end product, machine, system, or other application or use. Buyer shall be solely responsible for determining appropriateness of the particular Product with respect to Buyer's application, product or system. Buyer shall take application responsibility in all cases.

NEVER USE THE PRODUCT FOR AN APPLICATION INVOLVING SERIOUS RISK TO LIFE OR PROPERTY

OR IN LARGE QUANTITIES WITHOUT ENSURING THAT THE SYSTEM AS A WHOLE HAS BEEN DESIGNED TO ADDRESS THE RISKS, AND THAT THE OMRON PRODUCT(S) IS PROPERLY RATED AND INSTALLED FOR THE INTENDED USE WITHIN THE OVERALL EQUIPMENT OR SYSTEM.

Programmable Products.

Omron Companies shall not be responsible for the user's programming of a programmable Product, or any consequence thereof.

Performance Data.

Data presented in Omron Company websites, catalogs and other materials is provided as a guide for the user in determining suitability and does not constitute a warranty. It may represent the result of Omron's test conditions, and the user must correlate it to actual application requirements. Actual performance is subject to the Omron's Warranty and Limitations of Liability.

Change in Specifications.

Product specifications and accessories may be changed at any time based on improvements and other reasons. It is our practice to change part numbers when published ratings or features are changed, or when significant construction changes are made. However, some specifications of the Product may be changed without any notice. When in doubt, special part numbers may be assigned to fix or establish key specifications for your application. Please consult with your Omron's representative at any time to confirm actual specifications of purchased Product.

Errors and Omissions.

Information presented by Omron Companies has been checked and is believed to be accurate; however, no responsibility is assumed for clerical, typographical or proofreading errors or omissions.

Precautions on Safety

● **Symbols and the meanings for safety precautions described in this manual.**

In order for the product to be used safely, the following indications are used in this book to draw your attention to the cautions. The cautions with the indications describe the important contents for safety.



Caution



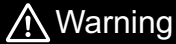

Indicates a potentially hazardous situation which, if not avoided, will result in minor or moderate injury, or may result in serious injury or death. Additionally, there may be significant property damage.



Warning

Indicates a potentially hazardous situation which, if not avoided, may result in minor or moderate injury or in property damage.

● **Meanings of Alert Symbols**

	Indicates general prohibitions for which there is no specific symbol.
	Indicates a potentially hazardous situation which, if not avoided, may result in minor or moderate injury or in property damage.
	Indicates the possibility of failure and fire.
	Indicates the possibility of explosion under specific conditions.
	Indicates the possibility of emitted light.

Warning

This product is not designed or rated for ensuring safety of persons either directly or indirectly. Do not use it for such purposes.



Do not disassemble the product. Doing so may cause electric shock due to the high voltage portion. Burn also may result due to high temperature.
Do not attempt to disassemble, deform by pressure, incinerate, repair, or modify this product.



Looking into emitted light continuously may cause visual impairment.
Do not look directly into emitted light.



If disassembled, the built-in light source may damage your eyes and skin.
Never disassemble this product.



Caution

Do not use it exceeding the rated voltage.
There is a possibility of failure and fire.



Do not connect amplifier units to AC power supply.
Risk of explosion.



Precautions for Safe Use

Please observe the following precautions for safe use of the products.

1. Installation Environment

- Do not use the product in environments where it can be exposed to inflammable/explosive gas.
- To secure the safety of operation and maintenance, do not install the product close to high-voltage devices and power devices.
- For adequate intake and/or exhaust, keep the Sensor Controller clear by 30 mm or more on its top, and by 10 mm or more from either side.
To secure the Sensor Head and cables connected safely, keep the front of the Sensor Controller clear by 65 mm or more.
- Always hook the upper edge of the slot on the Sensor Controller's back first onto the DIN track. After completely installing the Sensor Controller, make sure that it is securely fixed.
- When mounting the Sensor Controller using the screws, make sure the screw is tightened with a torque specified in this manual.
- Do everything possible to avoid installation in a location with vibration.
- Do not install the product near any devices that generate noise. If there is no choice but to install the product in a noisy environment, make sure to take noise prevention measures.

2. Power Supply and Wiring

- Take care when using a power supply with an overcurrent detector, because this sensor uses DC-DC converter for its power supply circuit and inrush current may activate the protective circuit for a power supply with an overcurrent detector.
Recommended power supply: S8VS-06024 (Omron, 24 VDC 2.5 A 60 W)
- The supply voltage must be within the rated range (24 VDC \pm 10 %).
- Reverse connection of the power supply is not allowed.
- Unstable voltage may cause unexpected operation of the sensor controller. If such condition is anticipated, use an UPS (Uninterruptible Power Supply).
Recommended UPS: S8BA Series (OMRON)
- Open-collector outputs should not be short-circuited.
- Keep the load current at or below the specification value.
- High-voltage lines and power lines must be wired separately from this product. Wiring them together or placing them in the same duct may cause induction, resulting in malfunction or damage.
- Use adequate safety measures, for example fail-safe circuits.
- Use a specified-sized wire when wiring. Do not connect wires other than those of the specification to the terminal block.
- Do not connect a wire with an only twisted end directly to a terminal block.
- For a power supply, use a DC power supply unit provided with a remedy, for example, safety ultralow voltage circuit, to prevent a high voltage from being generated.
- Route so that power supply wires are as short as possible.
- Use a power supply dedicated for this product, without sharing it with other products.
- Before performing any of the following activities, be sure to turn off the product, or breakdown may result.
 - Connecting or wiring cables
 - Connecting or disconnecting connectors
 - Installing or removing Calibration ROM
- Do not apply any loads to cables and connectors when wiring.
- When inserting or removing an EtherCAT cable, do not put any stress on the Calibration ROM.
- Before turning ON the power after the product is connected, make sure that the power supply voltage is correct, there are no incorrect connections (e.g. load short-circuit) and the load current is appropriate. Incorrect wiring may result in breakdown of the product.

- Handling fiber cables

Use them in compliance with the following. This may result in damage to the fiber cable.

- Fiber cable bend radiuses must be at least 20 mm.
- Do not yank hard on a fiber cable.
- Do not step on a fiber cable or place anything heavy on it.
- Do not apply any twisting stress to the fiber cable.
- Do not forcefully insert, or bend, or twist in a manner that would cause stress on the fiber connector when connecting it.
- Do not let bending cause stress at the root section of a fiber connector and connection.

3. Grounding

- Use a frame ground terminal of the specified size to be grounded. Do not connect a wire with an only twisted end directly to a terminal block.

Terminal screw: M4

Crimp-type terminal



- Use D-type grounding (ground resistance of 100 Ω or less). Make the ground point as close as possible and make the ground wire used as short as possible.
- Never share a ground wire with other equipment or connect to building beams to prevent the occurrence of a potential difference between grounds (between 0V).
- The power supply circuit of the Sensor Controller is not insulated from the internal circuits.
- When grounding the positive (+) terminal of the 24 VDC power supply, do not connect the Sensor Controller's frame ground terminal or PLC's frame ground terminal to ground. [(1), (2)]
The PC housing may be internally connected to the SG (0 V), in which case current will flow through the path shown below and may cause seizure.
- If there is no PC, or specifically there is no SG (0 V)/FG short-circuiting path, grounding the Sensor Controller's frame ground terminal will not cause seizure. Wire the PLC after checking the specification of your PLC.
- The dedicated RS-232C cable (ZW-XRS2/XPT2) has its cable shield isolated from the connector housing. [(3)]

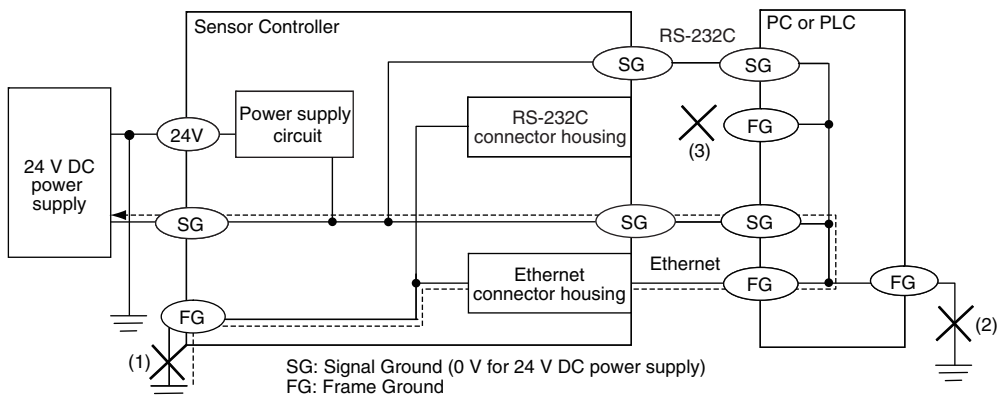

4. Regulations and Standards

- EN61326-1
- Electromagnetic environment : Industrial electromagnetic environment (EN/IEC 61326-1 Table 2)
- The following condition is applied to the immunity test of this product.
: There may be cases that current or voltage output fluctuate within $\pm 3\%$ F.S. when a sensor is experienced electromagnetic interference.

- EMC directive

No.2014/30/EU

- Notice for Korea Radio Law

A 급 기기 (업무용 방송통신기자재)

이 기기는 업무용 (A 급) 전자파적합기기로서 판매자 또는 사용자는 이 점을 주의하시기 바라며 , 가정외의 지역에서 사용하는 것을 목적으로 합니다.

5. Others

- Do not use this product for nuclear facilities, or safety circuits involving human lives.
- Do not attempt to disassemble, repair, modify, apply pressure to deform or burn up the body.
- Dispose of this product as industrial waste.
- Use exclusive devices, including a sensor head, Calibration ROM, fiber cable or RS-232C cable, to connect, or ignition, burst, false operation or breakdown may be caused.
- Do not cut fiber cable. Glass at the cut section may cause injury. Also, if cut, it will not work normally anymore.
- Whenever any trouble, including, strange odor smelled, the body overheated or smoke escaped, was found, immediately stop the operation, and consult an OMRON branch or sales office with the system shut down.
- Do not drop or make a strong impact on the unit.
- Before using any equipment provided with a lock mechanism, make sure that it has been locked.
- Do not look directly at emitted light.

Precautions for Correct Use

Please observe the following precautions to prevent failure to operate, malfunctions, or undesirable effects on product performance.

1. Installation Site

Do not install the product in locations subjected to the following conditions:

- Ambient temperature outside the rating
- Rapid temperature fluctuations (causing condensation)
- Relative humidity outside the range of 35 to 85 %
- Presence of corrosive or flammable gases
- Presence of dust, salt, or iron particles
- Direct vibration or shock
- Reflection of intense light (such as other laser beams, electric arc-welding machines or ultraviolet shine)
- Direct sunlight or near heaters
- Water, oil, or chemical fumes, spray or mist atmospherics
- Strong magnetic or electric field

2. Power Supply and Wiring

- When using a commercially available switching regulator, make sure that the FG terminal is grounded.
- If surge currents are present in the power lines, connect surge absorbers that suit the operating environment.
- Use the specified voltage. If voltage exceeding the rating or AC voltage is applied, circuit parts may be burnt or rupture.
- Cannot remove the Fiber interface of Sensor Head.
If you accidentally remove it, need to repair.
ZW-XF80□□R is suitable for the ZW-8000 series, ZW-XF70□□R is suitable for the ZW-7000 series, and ZW-XF50□□R for the ZW-5000 series. Only one cable can be extended.
- Be sure to use a Sensor Head and Calibration ROM with the same serial number. A pair with different serial numbers cannot operate normally.
- Use the configuration software with the combination specified in this manual, or the system may operate faultily.
- Do not shut down the power supply when saving any data into the memory built in the Sensor Controller, or the data may be corrupted.
- While a fiber cable is not in use, be sure to attach the included protective cap to the connector of the fiber cable. Leaving it with the protective cap not attached may result in a malfunction due to the adhesion of foreign matter.
- When connecting a sensor head that is a different model from the one that was first activated in the unit after being shipped from the factory and during the last time the sensor controller started running, be sure to initialize the settings while the sensor controller is connected to the sensor head.

3. Warming Up

After turning ON the power supply, allow the product to stand for at least 30 minutes before use. The circuits are still unstable immediately after the power supply is turned ON, so measured values may fluctuate gradually.

4. Maintenance and Inspection

- Do not use thinner, benzene, acetone or kerosene to clean the Sensor Head, fiber cable and Sensor Controller. If large dust particles adhere to the emitter/receiver of the Sensor Head or Sensor Controller, use a blower brush (used to clean camera lenses) to blow them off. Do not blow the dust particles with your mouth. To remove smaller dust particles, dirt, oil, and fat, wipe gently with a soft cloth (for cleaning lenses). Do not use excessive force to wipe off dust particles. Scratches on the emitter/receiver may cause false operations or measuring errors.
- Do not touch the end surface of a fiber cable, or the cable may be degraded in performance. Should the end surface be touched or soiled, wipe the dirt away using a commercially available cleaner exclusive for fiber or dry and soft cloth. Do not use a cloth moistened with alcohol, or the dirt may be reattached.
- Use the optional ZW-XC when cleaning the Sensor controller fiber connector. For ZW-7000, use a commercially available fiber cleaner. For how to clean the fiber connector using ZW-XCL, refer to the Cleaning the fiber connector and fiber cable using ZW-XCL (p.70).
- If you frequently insert and extract the Sensor Head, recommend to use the commercially available fiber cleaner which can use repeatedly. For commercially available fiber cleaner, refer to the p.40 on this manual.
- Clean the ventilation port periodically to prevent any build up of dirt and dust. If the ventilation port is blocked, heat builds up inside and can cause breakdown.

5. Sensing Objects

The product sometimes cannot accurately measure the following types of objects:

Transparent objects, objects with a low reflection factor, objects smaller than the spot diameter, objects with a large curvature, excessively inclined objects, target objects with a thin film on the surface etc.

6. Effect caused by peripheral lights

Do not install the Sensor Head in a place where strong light hits the laser emitter/receiver section of the Sensor Head. Also, if an object has a shiny surface, the light from the lighting will be reflected and a malfunction may occur. In such a case, prevent reflection by, for example, covering the light to stop reflection.

 Basic precautions for installation p.32

7. Influence by Air Turbulences

Slow air turbulences around the Sensor Head may disperse measured values.

To avoid these possible air turbulences, wrap the Sensor Head with an appropriate cover.

8. Operations Outside Measurement Range

Since this Sensor is highly sensitive, it may operate incorrectly beyond the limits of its measurement range. In such a case, shorten the exposure time or increase the noise cut level.

9. Maximum Number of Allowed Writes to EPROM in Sensor Controller

When Zero-Reset Memory mode is set to ON, the zero reset is written to EEPROM (non-volatile memory) in the Sensor Controller each time a zero reset is performed. The EEPROM can be written a maximum of 1,000,000 times. Pay attention to the maximum number of writes allowed when this is set to "ON."

 Setting the Zero Reset Memory p.172

10. Repair Support Range

Other parts replaced due to broken fibers, lens damage, chassis damage, etc. are not eligible for repair.

11. ZW-SPR Series Right Angle Section

Do not apply excessive force or deliver a strong impact on the right angle section of the tip that includes the emitter/receiver. Doing so could shift the connection of the linked straight section and cause the measurement performance to deteriorate.

12. Firmware

Please utilize Ver. 2.110 sensor controller firmware or above when using the ZW-SP series or ZW-SPR series with the ZW-7000□/5000□.

Refer to the "Firmware Update" page in this manual for details on how to update the version.

Editor's Note

● Meaning of Symbols

Menu items that are displayed on the main or sub-display, and windows, dialog boxes and other GUI elements displayed on the personal computer are indicated enclosed by brackets [].

● Visual Aids

Important

Indicates points that are important to achieve the full product performance, such as operational precautions.

Note

Indicates application procedures.



Indicates pages where related information can be found.

Optional

Indicates that the setting is optional in a configuration procedure.

Copyrights and Trademarks

- Sysmac is a trademark or registered trademark of OMRON corporation in Japan and other countries for our FA equipment products.
- Windows, Windows XP, Windows Vista, Windows 7, and Windows 8 are registered trademarks of Microsoft Corporation in the USA and other countries.
- EtherCAT® is registered trademark and patented technology, licensed by Beckhoff Automation GmbH, Germany.
- ODVA, CIP, CompoNet, DeviceNet, and EtherNet/IP are trademarks of ODVA.
- Microsoft product screen shots reprinted with permission from Microsoft Corporation.
- Other system names and product names that appear in this manual are the trademarks or registered trademarks of the respective companies.

Notice

- Photocopying, duplication, or copying of all or part of this manual without permission is prohibited.
- Please understand that the specifications and other contents of this manual are subject to change for improvement without notice.
- Every effort has been made to ensure the accuracy of the contents of this manual, but if you should notice any mistake, questionable section, or the like in this manual, please contact an OMRON branch or sales office. If you do so, please also tell us the manual number, which is found at the end of the manual.

Relevant Manuals

The following table provides the relevant manuals for the ZW-8000/7000/5000 series Confocal Fiber Type Displacement Sensor.

Read all of the manuals that are relevant to your system configuration and application before you use the ZW-8000/7000/5000 series Confocal Fiber Type Displacement Sensor.

Most operations are performed from the Sysmac Studio Automation Software. Refer to the “Sysmac Studio Version 1 Operation Manual (Cat. No. W504)” for information on the Sysmac Studio.

Purpose of use	Manual	
	ZW-8000/7000/5000 series Confocal Fiber Type Displacement Sensor User's Manual	ZW-8000/7000/5000 series Confocal Fiber Type Displacement Sensor User's Manual for Communications Settings
Overview of ZW-8000/7000/5000 series	●	
Setup and Wiring	●	
Basic Operation	●	
Function Setting	●	
Offline Setting	●	
Confirm the Menu List	●	
Connecting to the Sensor Controller	●	
Connecting to the Sensor Controller for Communication Settings		●
Overview of Communication Specifications		●
Parallel I/O		●
EtherCAT		●
EtherNet/IP		●
No-protocol		●
Specifications and External Dimensions	●	
Processing Item List		●
System Data List		●
Object Dictionary		●
Update the Firmware	●	
Troubleshooting	●	
Error Messages		●

Related Manuals

The following manual is related to Controllers. Use this manual for reference.

Manual name	Cat. No.	Model numbers	Application	Description
Sysmac Studio Version 1 Operation Manual	W504	SYSMAC-SE2□□□	Learning about the operating procedures and functions of the Sysmac Studio.	Describes the operating procedures of the Sysmac Studio.
Confocal Fiber Type Displacement Sensor ZW-8000/7000/5000 series User's Manual (This manual)	Z362	ZW-8000□ ZW-7000□ ZW-5000□	To learn how to set-up of Confocal Fiber Type Displacement Sensor of ZW-8000/7000/5000 series.	Describes how to set-up of Confocal Fiber Type Displacement Sensor of ZW-8000/7000/5000 series.
Confocal Fiber Type Displacement Sensor ZW-8000/7000/5000 series User's Manual for Communication Settings	Z363	ZW-8000□ ZW-7000□ ZW-5000□	To learn how to use communication settings of Confocal Fiber Type Displacement Sensor of ZW-8000/7000/5000 series.	Describes how to use communication settings of Confocal Fiber Type Displacement Sensor of ZW-8000/7000/5000 series.

Table of Contents

Editor's Note	11
Copyrights and Trademarks	11
Notice	11
Relevant Manuals	12
Related Manuals	13
Search from Settings	22

1. Basic configuration

1-1 ZW-8000/7000/5000 Series Displacement Sensors	24
1-2 Basic Operation Flow	25
Multi-task and Bank Data	27
1-3 Basic Operations for Displaying Measurement Results	29
Installation of Sensor Head	29
Attaching the strap to the Calibration ROM	33
Attaching the Strap to Protective Cap	34
Connecting the sensor controller and sensor head	35
Connection of Fiber Cable and Sensor Controller	36
Connection of Calibration ROM and Sensor Controller	38
Remove the Fiber cable	39
24 V input terminal block	42
Connecting to a Personal Computer	44
Starting Up Sysmac Studio Measurement Sensor Edition	47
Calibrating Sensor Head	48
Monitoring the Measurement Results	51

2. Installation and Connections

2-1 System Configuration	54
System Configuration	54
Connection Compatibility	55
2-2 Part Names and Functions	57
Sensor Head	57
Calibration ROM	58
Sensor Controller	59
2-3 Installation	63
Installation of Sensor Head	63

Installation of Sensor Controller	66
Attaching the strap to the Calibration ROM	69
Attaching the Strap to Protective Cap	69
Connection of Fiber Cable and Calibration ROM	69
Connection of Fiber Cable and Sensor Controller	69
Connection of Calibration ROM and Sensor Controller	69
Remove the Fiber cable	69
Cleaning the fiber connector and fiber cable using ZW-XCL	70
Extending fiber cable	74
Calibrating Sensor Head	77
2-4 Wiring	78
32-pole extension connector	78
Analog output terminal block	81
24 V input terminal block	82
Electrical Specifications	83
2-5 Installing the Sysmac Studio	85
2-6 Launching a project	86
Connecting to the sensor with Sysmac Studio Measurement Sensor Edition ..	86
Entering project information	87
2-7 Explanation of Screen Sections	88
PC tool	88
2-8 Saving a project	93
Saving a project	93
Exporting a project	93
Importing a project	93

3.Operation during RUN Mode

3-1 Setting the Measurement Start Timing	96
Internal Processing of Sensor Controller	96
Measurement Mode and Measurement Start Timing	97
3-2 Switching operation modes	98
3-3 Displaying Measured Values and Received Light Waveform	99
3-4 Perform the Zero Reset	100
Zero reset	100
3-5 Displaying measured values in graphs.	103
Specifying the sampling start and end conditions	105
Starting and ending sampling before and after the trigger condition is met ..	108
Adjusting the scale of the axis in a graph automatically according to the measure- ment values	108
3-6 Saving measured values in a file	109
Outputting the results of sampling as a file	109
Exporting the results of sampling	109

3-7 Displaying saved measured values	113
3-8 Performing internal logging	114
Internal logging by Sysmac Studio	114
Performing Internal Logging with Parallel I/O	117
Internal logging with non-procedural commands	118
3-9 Bank switching	119
Switching Banks	119
3-10 Operating with Sensor Controller	120

4.Settings for Function

4-1 Setting Sensing	122
Setting the Measurement Cycle	122
Setting the Area Mode	123
Setting the Material of the Target to Measure	125
Setting the Noise Cut Level	126
Setting Smoothing Size	127
Setting Start Direction of Count Measurement Surfaces	128
Setting Light Exposure Time Control Mode	129
Setting the Measurement Area	130
4-2 Setting Measurement Items	138
What is a Measurement Item?	138
Measuring the Height	138
Measuring the Thickness	140
Performing Calculations	141
4-3 Setting the Output Conditions	143
Setting Scaling	143
Setting Filters	152
Setting Hold	160
Setting the Zero Reset	169
4-4 Setting Threshold Value	174
Threshold Value Settings	174
4-5 Setting I/O	176
Setting when measurement is not possible	176
Settings for Processing When Measurement Is Not Possible	179
Assigning digital output	182
4-6 Setting the System	183
Setting the Key Lock	183
Setting the Number of Digits Displayed Past the Decimal Point	184
4-7 Saving The Settings	185
Saving the Bank/System Settings	185
Copying the Bank/System Settings	186
Initializing Settings	187

Clearing the Bank Settings	188
Setting the Bank Mode	188

5. Convenient Functions

5-1 Checking the Information of the Sensor	192
5-2 Storing the light reception wave form in a file	193
5-3 Recovering Calibration ROM data	195
5-4 Printing the contents of settings	196
5-5 Control input signal with PC tool	198
5-6 Viewing the Energization Time	199
5-7 Selecting Measured Values to be Externally Output	200
Assigning digital output	200
Assigning analog output	200

6. Offline Settings

6-1 Performing Settings Offline	202
6-2 Starting a Project in Offline Mode	203
6-3 Changing between Online and Offline	204
6-4 Offline Debugging of the Sensor Control Program and Sensor Operation	206

7. Sensor controller operations

7-1 Basic Operation	210
7-2 Search from Menu Tree	212
FUNC (adjustment) Mode Menu	212
RUN (operation) Mode Menu	221
7-3 Functions of Operating Keys	222
7-4 Digital Displays	223
7-5 Functions and Operations during Measurement	224
Switching the RUN (Run) Mode Display	224
7-6 Setting Sensing	229
Set the Measurement cycle	229
Setting the Material of the Target to Measure	230
Setting Start Direction of Count Measurement Surfaces	231
Setting Exposure Time Control Mode	232
Setting the Measurement Area	233
Setting AreaTracks	234
EdgeTracks	235
7-7 Setting Measurement Items	237
Measuring the Height	237
Measuring the Thickness	238

Calculating	239
7-8 Setting the Output Conditions	242
Setting the Filter	242
Setting Scaling	246
Setting Hold	251
Setting the Zero Reset	256
7-9 Setting the Banks	260
Switching Banks	260
Changing the Bank Mode	261
Copying the Bank Settings	262
Saving the Bank/System Settings	263
Clearing the Bank Settings	264
7-10 Setting Threshold Value	265
Teaching	265
Direct	267
7-11 Setting the System	268
Checking Information	268
Setting the Key Lock	269
Calibrating Sensor Head	270
Initializing Settings	271
Setting the Synchronous Measurement Mode	272
Setting the extension fiber cable length	273
7-12 Connecting Parallel I/O	274
7-13 Connecting with EtherCAT	275
7-14 Connecting with EtherNet/IP	276
7-15 Connecting by No-protocol Communications	277

8.Troubleshooting

8-1 Error Messages	280
Errors Common to All Communication States	280
8-2 Troubleshooting	282

9.APPENDICES

9-1 Specifications and External Dimensions	288
Sensor Head	288
Sensor controller	307
PC tools (Sysmac Studio)	314
Accessories	315
9-2 Laser safety	323
9-3 Firmware Update	324
Use Sysmac Studio Measurement Sensor Edition to update	324
Performing the Update on Warp Engine ZW-7	325

Index 329
Revision History..... 332

Search from Settings

Settings	Set by Sysmac Studio	Set by Sensor Controller
Setting the Material for the Target to Measure	p.125	p.230
Setting the Exposure Time Control Mode	p.122	p.237
Setting Exposure Time Control Mode	p.129	p.232
Measuring the Height	p.138	p.237
Measuring the Thickness	p.140	p.238
Calculating	p.141	p.239
Setting the Filter	p.152	p.242
Setting the Scaling	p.143	p.246
Setting the Hold	p.160	p.251
Setting the Zero Reset	p.169	p.256
Changing the Bank Mode	p.188	p.261
Copying the Bank/System Settings	p.186	p.262 (Bank Settings only)
Saving the Bank/System Settings	p.185	p.263
Clearing the Bank Settings	p.188	p.264
Checking Information	p.200	p.268
Setting Measurement Mode of the Sensor	p.96	p.272
Setting the Key Lock	p.183	p.269
Initializing Settings	p.187	p.271
Setting the Digital Output Data	p.132	*
Setting the Analog Output Data	p.132	*

*: Refer to “6-1 Parallel I/O connection” described in Displacement Sensor ZW-8000/7000/5000 series Confocal Fiber Type Displacement Sensor User’s Manual for Communications Settings (Z363).

Basic configuration

1-1 ZW-8000/7000/5000 Series Displacement Sensors	24
1-2 Basic Operation Flow	25
1-3 Basic Operations for Displaying Measurement Results	29

1-1 ZW-8000/7000/5000 Series Displacement Sensors

The ZW-8000/7000/5000 Series is a line of fiber coaxial displacement sensors.

They consist of Sensor Head and Sensor Controller, Calibration ROM, and exclusive setting PC tool which runs on personal computers for system settings and monitoring.

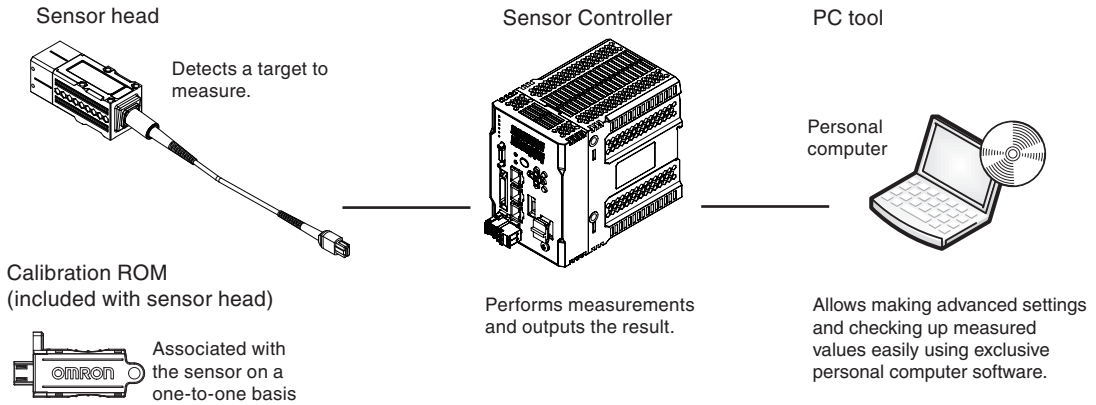

There are the following 3 types of sensor heads.

Sensor head type	Series	Model
Square-shaped straight type	ZW-S Series	ZW-S80□□/S70□□/550□□
Pen-shaped straight type	ZW-SP Series	ZW-SP80□□/SP70□□/SP50□□
Pen-shaped right angle type	ZW-SPR Series	ZW-SPR80□□/SPR70□□/SPR50□□

1-2 Basic Operation Flow

The following is the basic operation flow for ZW-8000/7000/5000 Series.

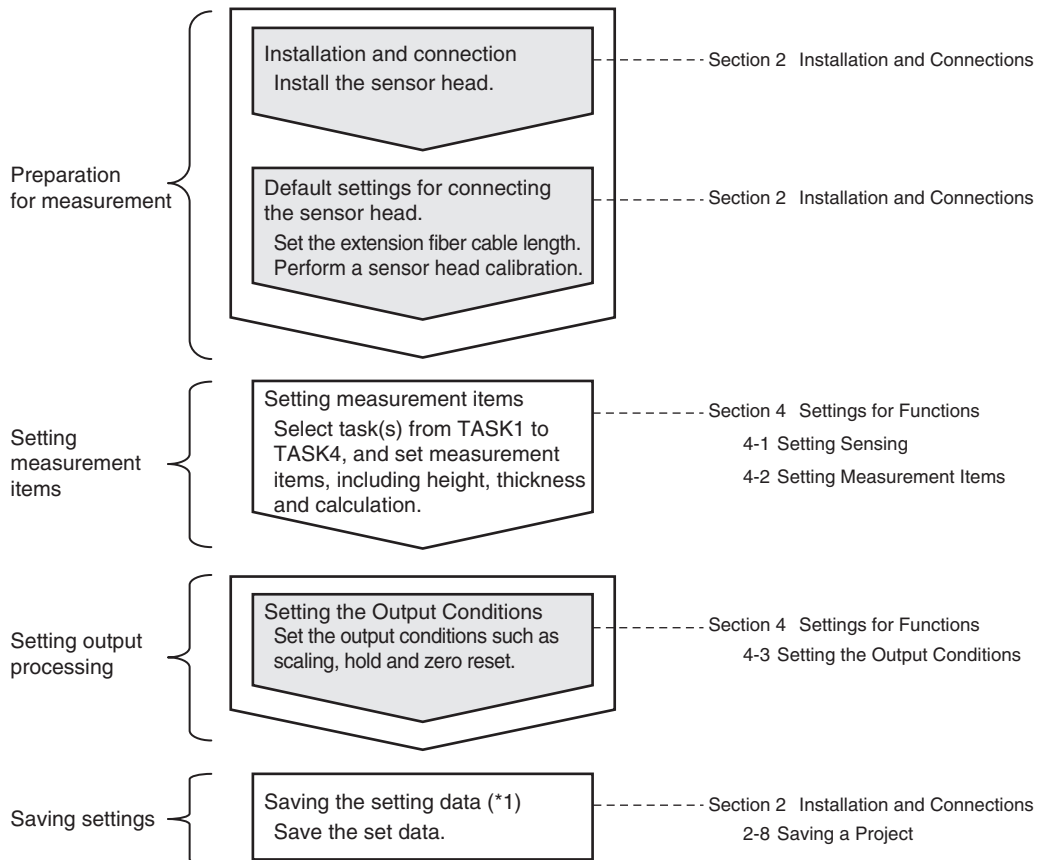

(*1) After you have made or changed settings, be sure to save the setup data. All set data will be cleared if you turn the power OFF without saving the data.

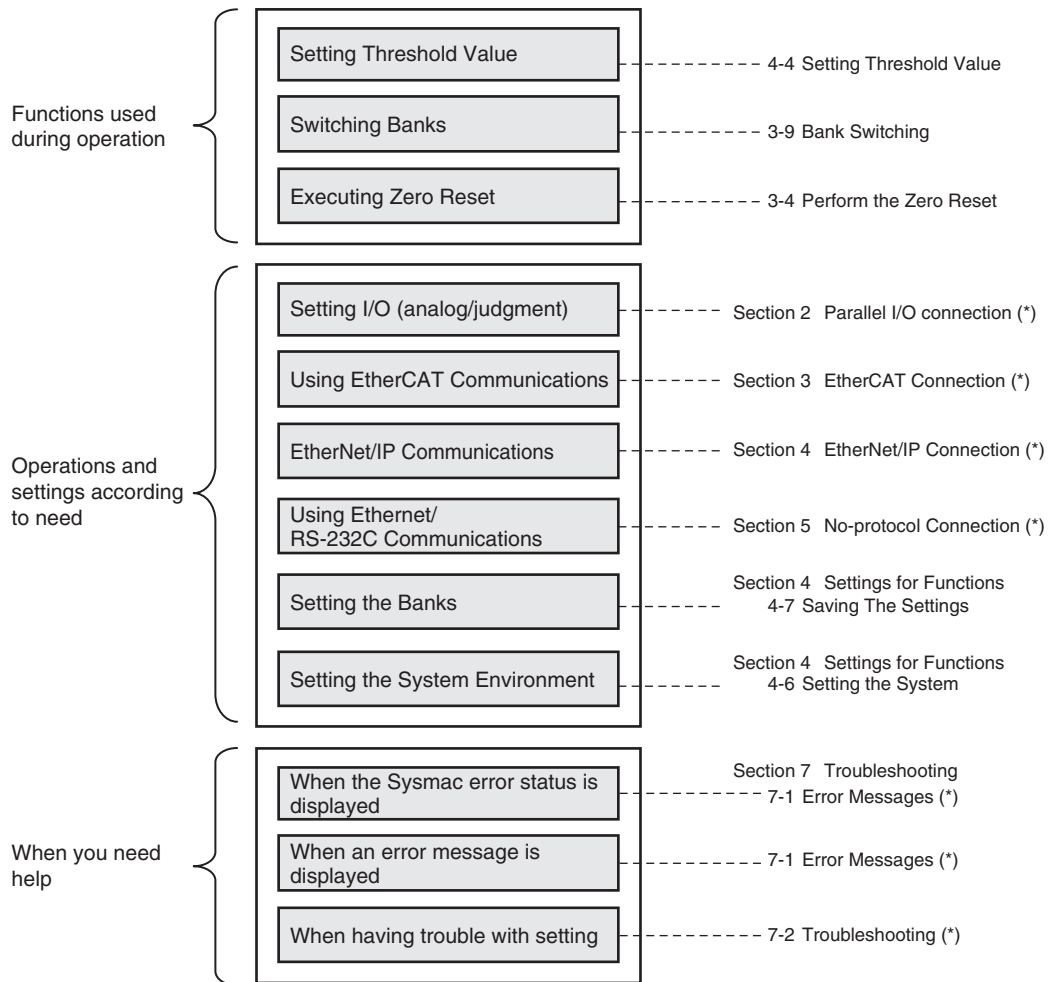

(*) Refer to the ZW-8000/7000/5000 series Confocal Fiber Type Displacement Sensor *User's Manual for Communications Settings* (Cat No. Z363).

Multi-task and Bank Data

Multi-task Function

With the ZW-8000/7000/5000 Series, you can set multiple measurement processing for one sensing setting. This measurement processing is called a “task (TASK).”

Example: When measuring height and side run-out at the same time

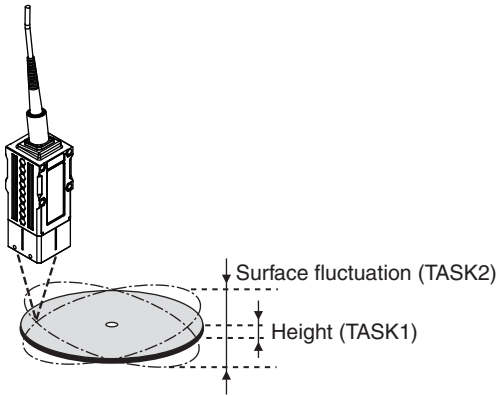

For tasks, TASK1 to TASK4 are available for registration.

You can measure and judge up to four characteristic points simultaneously because you can specify the desired measurement items such as height, thickness, and calculation for each task.

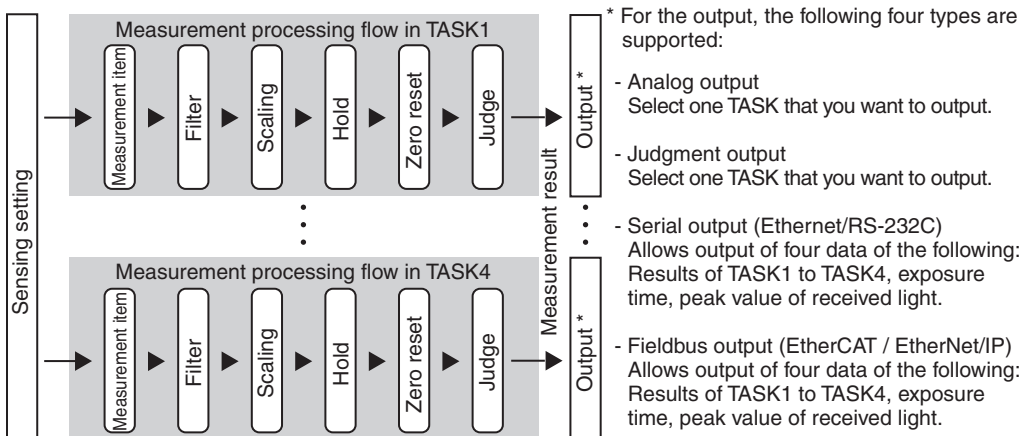

Bank Data

ZW-8000/7000/5000 Series can hold up to eight sets of sensing settings, which are called “bank (BANK)”. When the setup is changed, the bank can be switched externally.

What is Bank?

The sensing settings for measurement

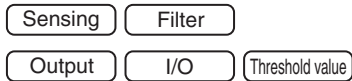

are held as one bank.

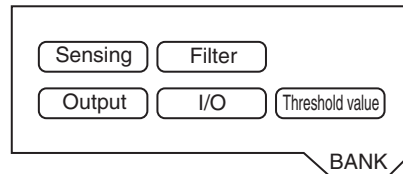

Example of switching bank for settings

If you register settings of various classes,

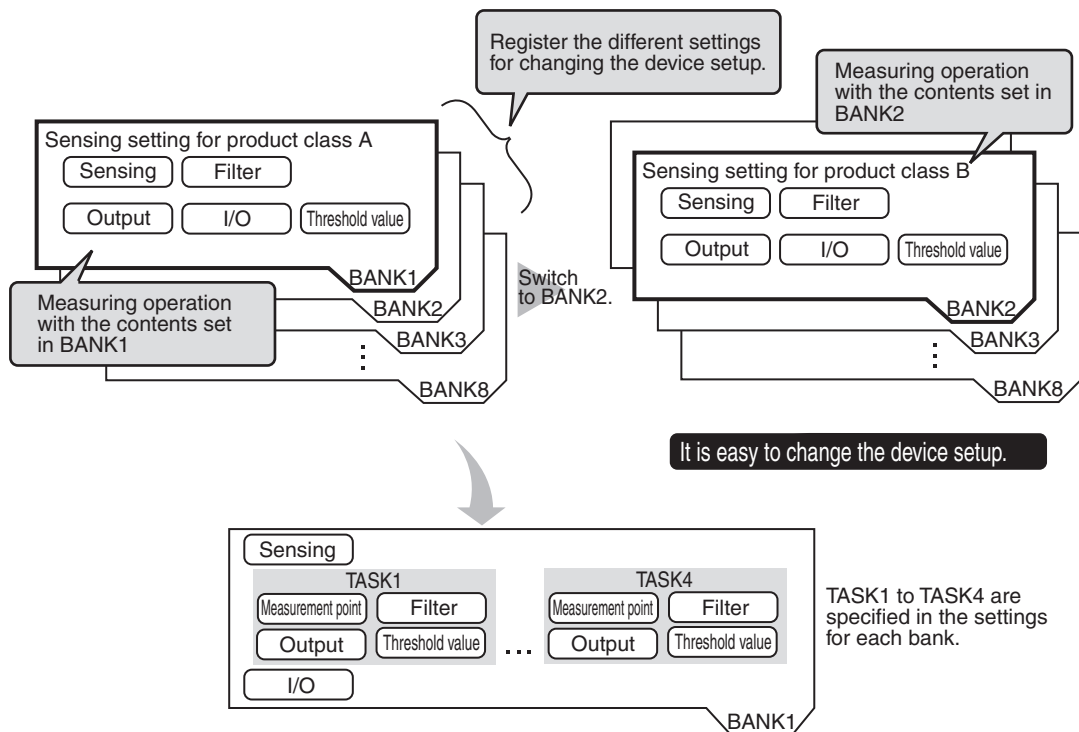

Important

- If you want to register multiple bank data having the same values set except for “threshold values (judgment values)”, by changing the mode of the bank, you can increase the number of banks from 8 to 32.

Setting the Bank Mode p.188

- The “output destination” (current output value/voltage output value) in the I/O setting parameters is set the same for all banks. The output destination cannot be set separately for individual banks.

“2-1 Parallel I/O connection” described in Displacement Sensor ZW-8000/7000/5000 series Confocal Fiber Type Displacement Sensor User’s Manual for Communications Settings (Z363)

1-3 Basic Operations for Displaying Measurement Results

This section describes a series of operations, from setting up the Sensor Head and Sensor Controller and connecting to the PC tool (Sysmac Studio), to calibrating the Sensor Head, through to monitoring the measurement results. For details, refer to the description of their respective chapters.

Installation of Sensor Head

Installation procedure

ZW-S Series

- 1 Place the Sensor Head with an appropriate distance from the target to measure, fixing it by tightening four M3 screw inserted into their respective installation holes.**

Tightening torque: 0.54 N · m

 9-1 Specifications and External Dimensions p.288

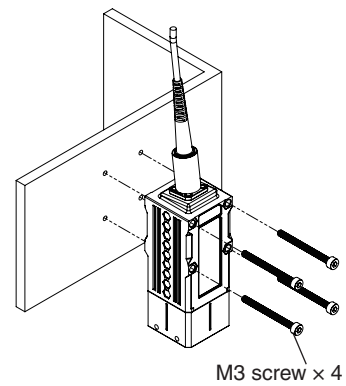

ZW-SP/SPR Series

When installing with accessory (installation plate)

- 1** Place the accessory (installation plate) between the sensor head and the object you want to fix the sensor head to.
- 2** Place the sensor head an appropriate distance from the target to measure, and then fix it by tightening four accessory screws (M2 × 10) inserted into their respective installation holes.

Tightening torque: 0.15 N · m

● ZW-SP Series

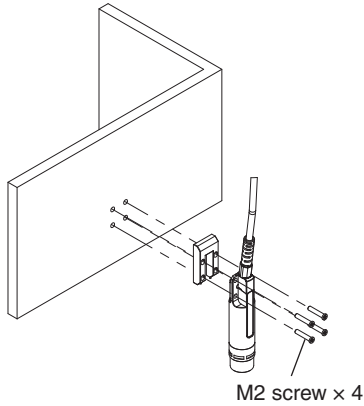

● ZW-SPR Series

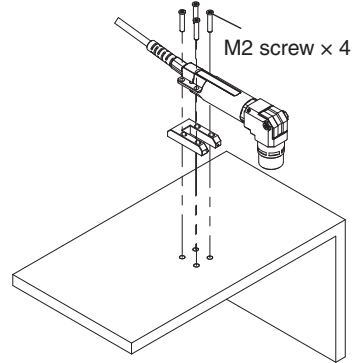

This installation method can be used to install sensor heads next to each other.

● ZW-SP Series

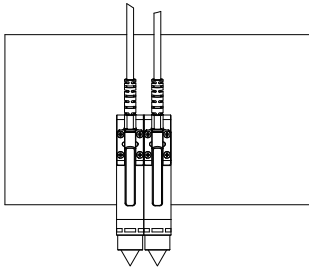

● ZW-SPR Series

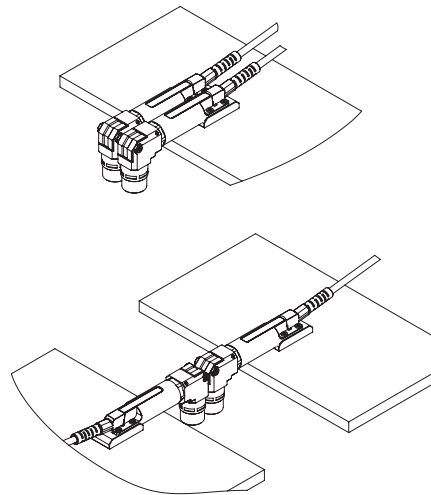

Important

For the location of screw holes, check the external dimensions in the appendices.

When installing with recommended installation jig (Misumi SHMPS12)

1 Place the sensor head between the 2 parts of the recommended installation jig (Misumi SHMPS12 series).

2 Fix it by tightening the M4 fixing screws.

Tightening torque: 1.2 N · m

● ZW-SP Series

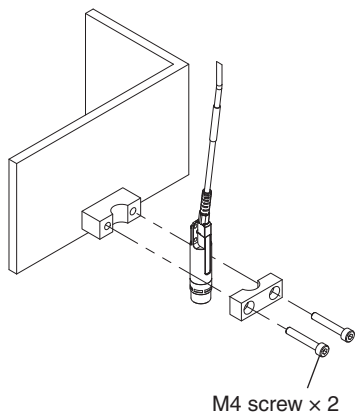

● ZW-SPR Series

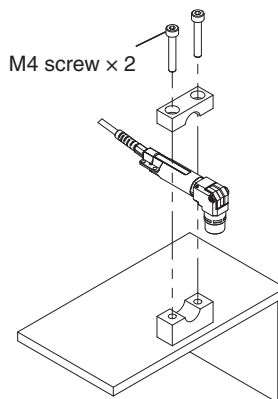

Fix the recommended jig within the shaded area in the figure below.

● ZW-SP Series

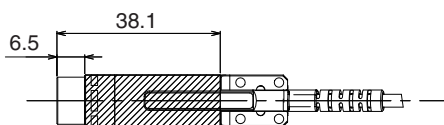

● ZW-SPR Series

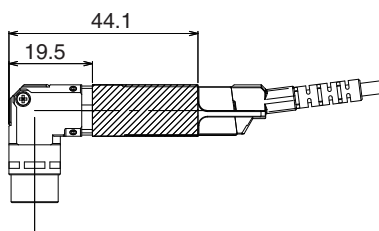

Prepare screws, as they are not supplied with Misumi installation jigs.

When installing with customer-manufactured jig

● ZW-SP Series

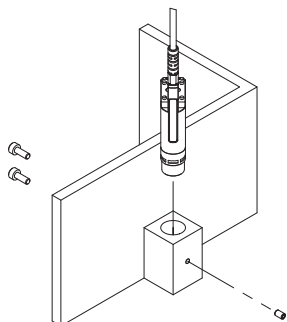

● ZW-SPR Series

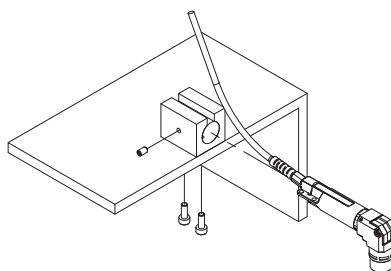

Installation precautions

Use flat head screws.

Fix it within the shaded area in the figure below.

Tightening torque: 0.15 N · m (M2 screw) or 0.5 N · m (M3 screw)

● ZW-SP Series

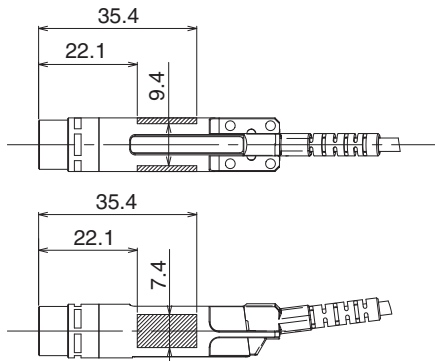

● ZW-SPR Series

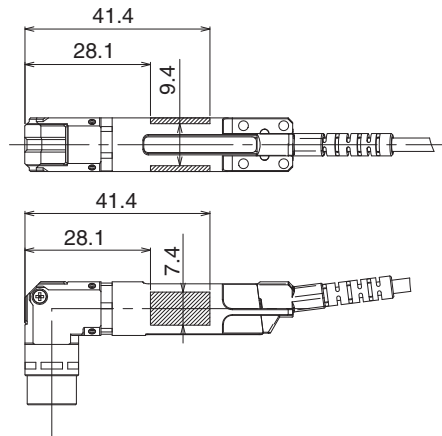

Important

- When tightened outside of the shaded area, damage may occur.
- Adjust settings while visually checking the position and brightness of a spot on an object with diffuse reflection. When measuring on a high-reflectivity object, such as a mirror or wafer, visual check may be difficult. Additionally, the measurement value which set out of the measurement region may be output.

Basic precautions for installation

Do not install the Sensor Head in a place where strong light hits the laser emitter/receiver section of the Sensor Head. Also, if an object has a shiny surface, the light from the lighting will be reflected and a malfunction may occur. In such a case, prevent reflection by, for example, covering the light to stop reflection.

These precautions apply to all sensor head types and all installation methods.

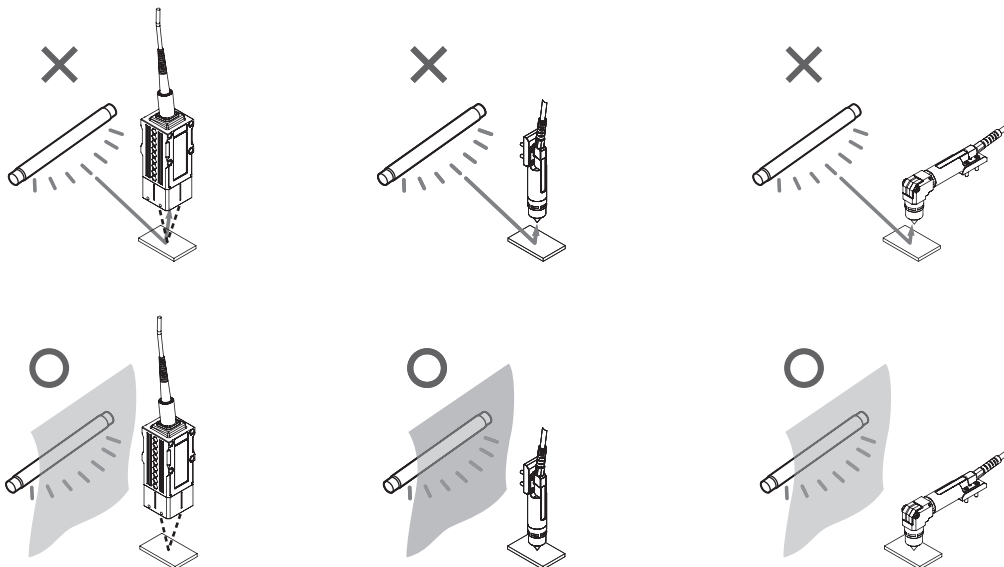

Attaching the strap to the Calibration ROM

1 Attach the supplied strap to the Calibration ROM.

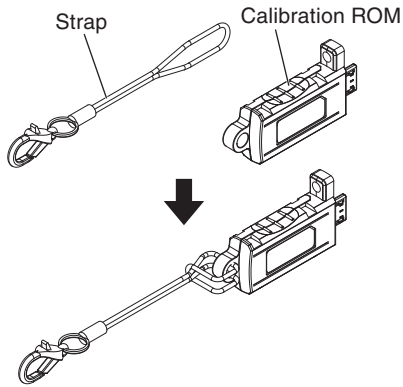

2 Attach the Calibration ROM to the fiber cable of the Sensor Head.

● ZW-8000 Series

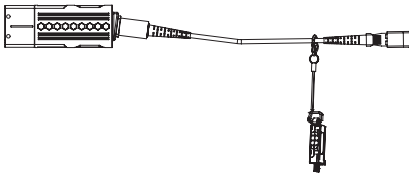

● ZW-7000 Series

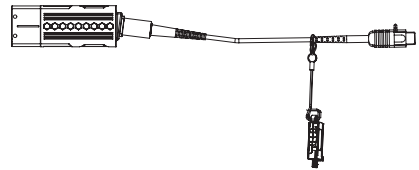

● ZW-5000 Series

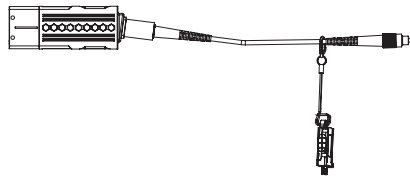

Attaching the Strap to Protective Cap

- 1** **ZW-8000 Series:** Attach the supplied protective cap to the fiber cable.
ZW-7000 Series: Attach the strap supplied with the protective cap to the fiber cable.
ZW-5000 Series: Attach the supplied protective cap to the fiber cable.

● ZW-8000/5000 Series

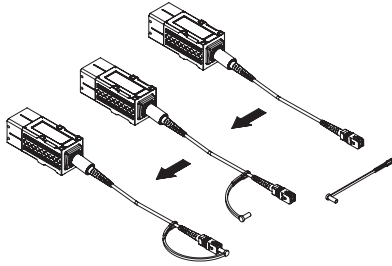

● ZW-7000 Series

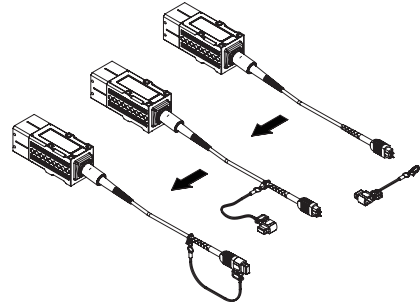

Important

- When attaching the protective cap with its strap to the fiber cable, be careful so as the protective cap or strap do not catch when you thread it.
- When removing the fiber cable from the Sensor Controller, make sure its protective cap is attached.
Leaving the cable unprotected can let dirt get on the end surface and cause performance deterioration.
- If you do not use the protective cap, store the cap.

Connecting the sensor controller and sensor head

Connect the fiber connector of Sensor Head to the fiber adapter of Sensor Controller.

1 Remove the Protective cap of Fiber cable.

- ZW-8000/5000 Series

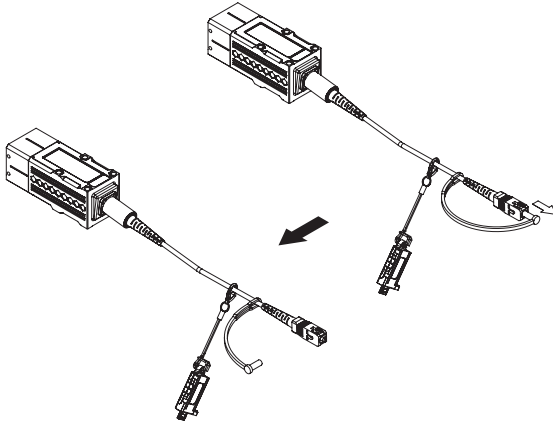

- ZW-7000 Series

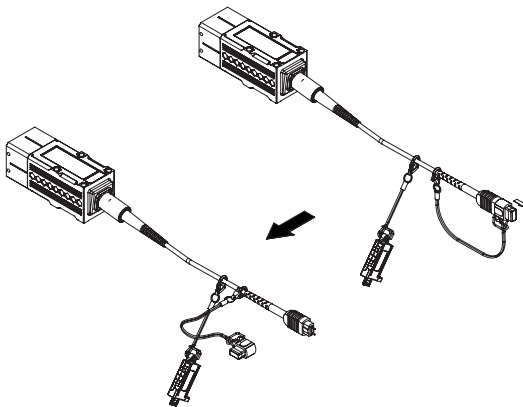

Connection of Fiber Cable and Sensor Controller

1 Connect the fiber cable to the Sensor Controller.

ZW-8000 Series

When connecting the fiber cable, mate the convex section of the fiber connector and the groove on the sensor controller fiber adapter.

Make sure to grasp the bushing section of the fiber connector when you connect to the Fiber cable.

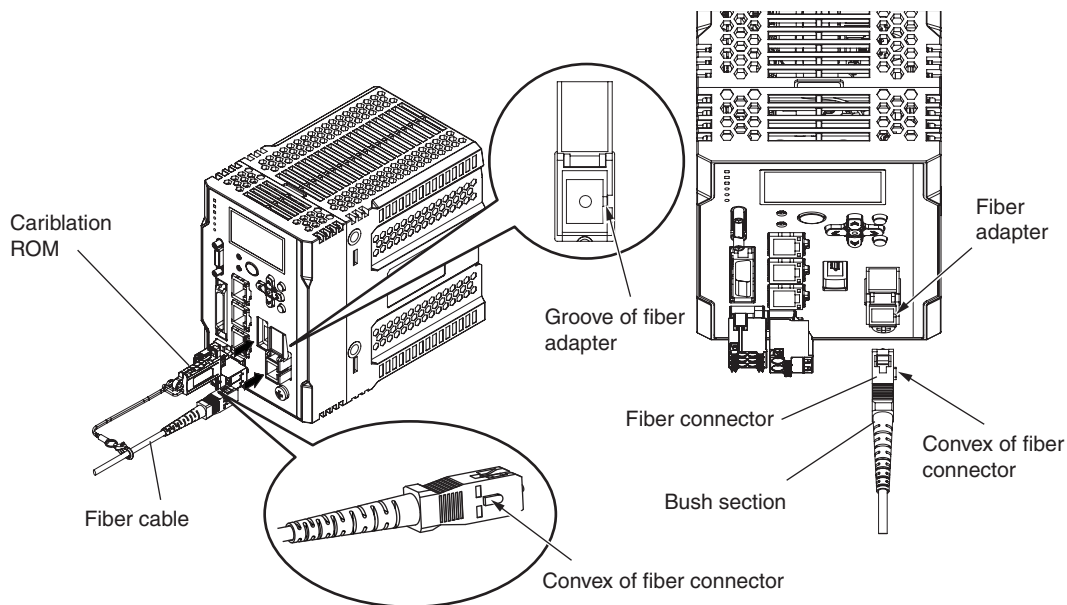

When install the Fiber cable

Grasp the black part of the fiber connector.
Mate the convex of the fiber connector with the groove on the fiber adapter, and insert.

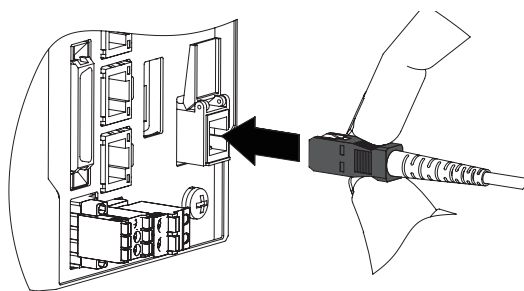

Important

If you grasp the bushing section of fiber connector, it cannot be connected correctly.

Connect the Fiber cable and Calibration ROM to the Sensor Controller.

Make sure to have the bush section of the Fiber cable when you connect to the Fiber cable.

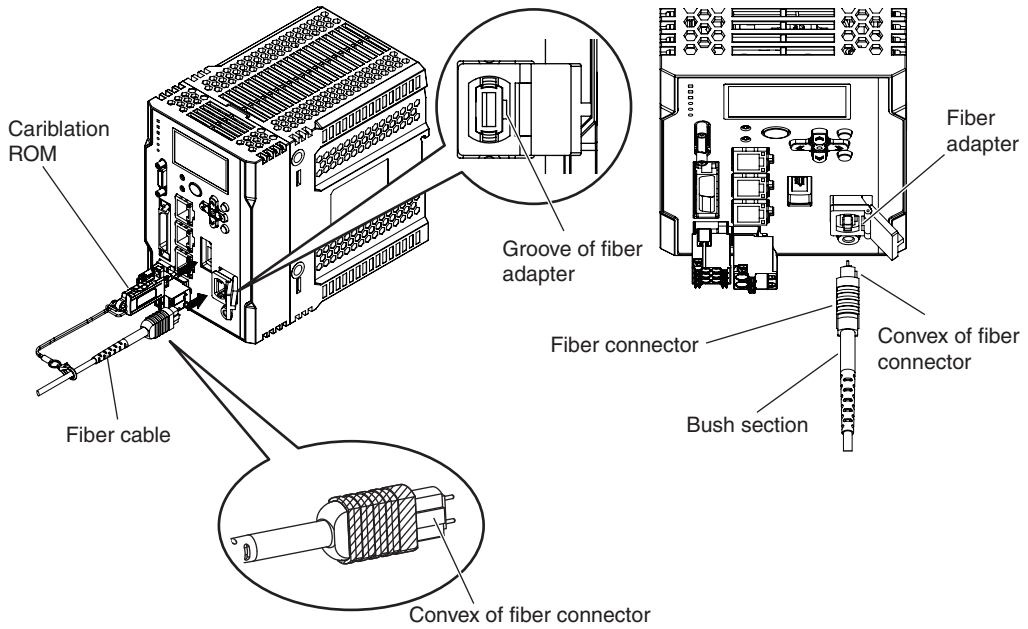

When install the Fiber cable

Grasp the bushing section of Fiber adapter.
Mate the Convex of fiber connector with the groove on the fiber adapter, and insert.

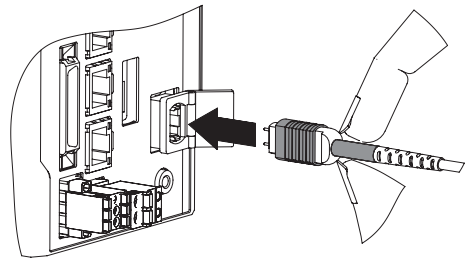

Important

If you grasp the fiber connector, it cannot be connected correctly.

When connecting the fiber cable, mate the convex section of the fiber connector and the groove on the sensor controller fiber adapter.

Mate the convex section of the fiber connector with the groove on the fiber adapter and turn the threaded section clockwise while pushing in (see figure 1).

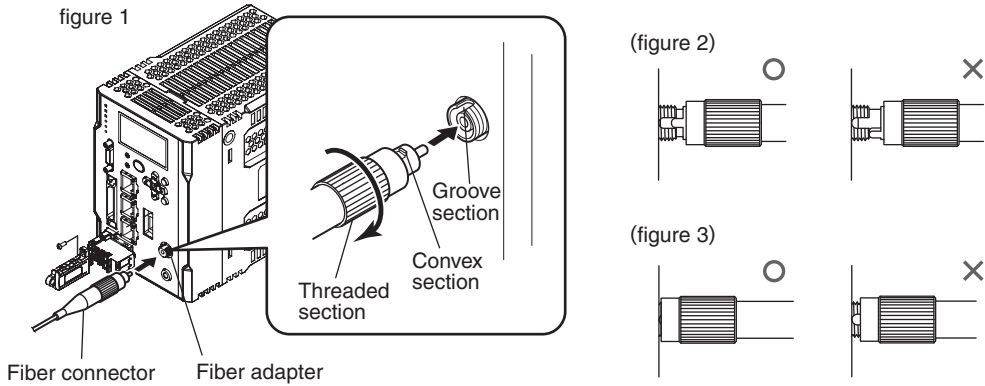

When the fiber insertion/fixing screw is not completely tightened, as is the case in the "No good" status in figure 2 and figure 3, optic signals cannot be transmitted and correct measurement is not possible. Always check that the system is in the "Good" status.

Connection of Calibration ROM and Sensor Controller

1 Connect the Calibration ROM to the Sensor Controller, and then tighten the supplied M2 screw.

Tightening torque: 0.15 N · m max.

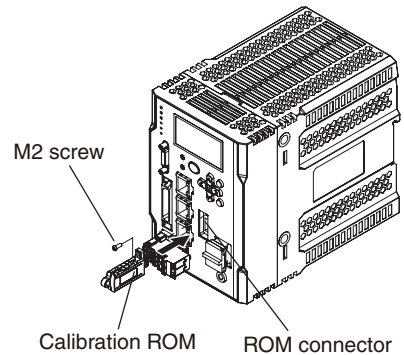

Important

- Before connecting or disconnecting the Calibration ROM, make sure that the Sensor Controller's power supply is turned OFF. The Sensor Controller may break down if the Calibration ROM is connected while the power is ON.
- Use with the Calibration ROM always connected. If the Calibration ROM is not connected, the error message "SYSERR" is shown in the main digital and "NO.ROM" is shown in the sub digital, where measurement is not possible.

Errors Common to All Communication States p.280

- If the Calibration ROM is lost or broken, as a provisional measure, the measurement can be resumed using the data of the previously read Calibration ROM. For the operating procedure, refer to page p.195

5-3 Recovering Calibration ROM data p.195

- Be sure to use a Sensor Head and Calibration ROM with the same serial number.
- A pair with different serial numbers cannot operate normally.
- Make sure to initialize the Sensor Controller when connecting a different type Sensor Head from that which was connected the previous time the Sensor Controller was launched.

For the initialization method, see below.

 Initializing Settings p.187

 Initializing Settings p.271

Remove the Fiber cable

For ZW-8000/7000 Series

- 1** When you remove the fiber cable, make sure to have the black part of the connector which indicated.

Have the fiber connector (black part) illustrated under figure, and then pull out the direction of the arrow.

ZW-8000 Series

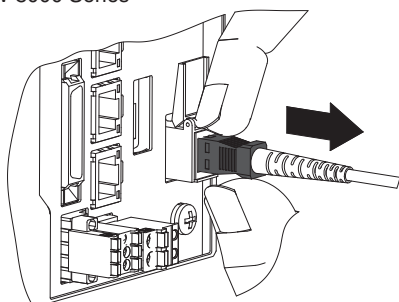

ZW-7000 Series

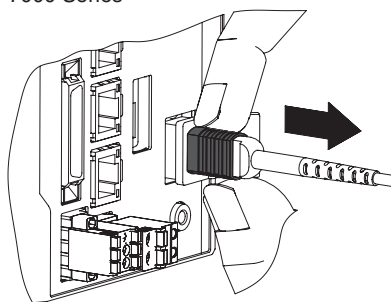

Important

If you have the bush section of Fiber cable, that part may be out of place. Make sure to have the fiber connector section.

For ZW-5000 Series

- 1 Turn the threaded section of the fiber cable counter-clockwise. When the screw comes off, pull the cable out.

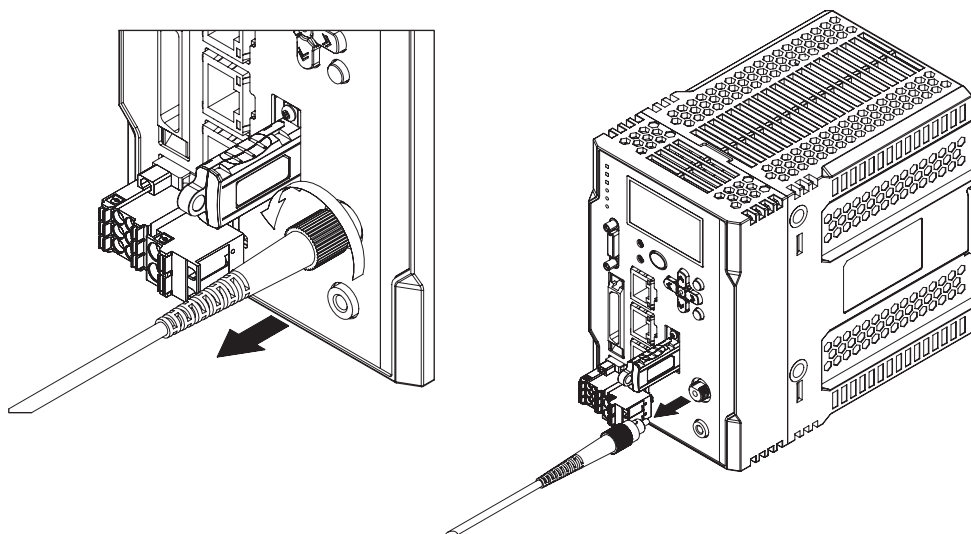

Important

• Handling fiber cables

Use them in compliance with the following. This may result in damage to the fiber cable.

- Fiber cable bend radiuses must be at least 20 mm.
 - Do not yank hard on a fiber cable.
 - Do not step on a fiber cable or place anything heavy on it.
 - Do not apply any twisting stress to the fiber cable.
 - Do not forcefully insert, or bend, or twist in a manner that would cause stress on the fiber connector when connecting it.
 - Do not let bending cause stress at the root section of a fiber connector and connection.
- Do not touch the end surface of a fiber cable, or the cable may be degraded in performance. Should the end surface be touched or soiled, wipe the dirt away using a commercially available cleaner exclusive for fiber or dry and soft cloth. Do not use a cloth moistened with alcohol, or the dirt may be reattached.
 - Use the optional ZW-XCL or a commercially available fiber cleaner when cleaning the sensor controller fiber connector. For how to clean the fiber connector using ZW-XCL, refer to the Cleaning the fiber connector and fiber cable using ZW-XCL.
 - If you frequently insert and extract the Sensor Head, recommend to use the commercially available fiber cleaner which can use repeatedly.

● ZW-7000 Series

Product name	Model	Manufacture
NEOCLEAN-M	ATC-NE-M1	NTT Advanced Technology Corporation

● ZW-8000/5000 Series

Product name	Model	Manufacture
OPTIPOP R1	ATC-RE-01	NTT Advanced Technology Corporation

- Contact

[Request for an Estimate]

URL http://www.ntt-at.com/product/optical_cleaner/Distributors.html

[Technical and other inquiries]

Company NTT Advanced Technology Corporation

Address Muza Kawasaki Central Tower, 1310
Omiya-cho Saiwai-ku, Kawasaki-shi,
Kanagawa, 212-0014, Japan

TEL +81 44 589 5894

URL http://www.ntt-at.com/product/optical_cleaner/Distributors.html

- When you remove the fiber cable from Sensor Controller, make sure to attach the protective cap. If you do not attach it, it is possible that some contaminants may have adhered and may cause degradation of performance.
- Calibrate the Sensor Head after removing and inserting a fiber cable.



Calibrating Sensor Head p.48

- For checking the fiber is broken, confirm the followings.

Confirm by looking the Sensor head is lighting with connecting to Sensor Controller. To put the diffraction, i.e.. a paper to around the measurement center of Sensor head, you can confirm by looking.

When the measurement of the high reflection, you may not confirm by looking due to adjustment of intensity automatically.

- Cleaning the fiber connector and fiber cable using ZW-XCL, follow the procedures.



Cleaning the fiber connector and fiber cable using ZW-XCL p.70

24 V input terminal block

Used for 24 VDC power supply.

Compatible wire specifications: Solid wire 0.2 to 2.5 mm²

Stranded wire 0.2 to 2.5 mm²

Stranded wire with rod terminal(no plastic sleeve) 0.25-2.5 mm²

Stranded wire with rod terminal(with plastic sleeve) 0.25-2.5 mm²

AWG 24-12

Pin processed length 10(±0.5) mm

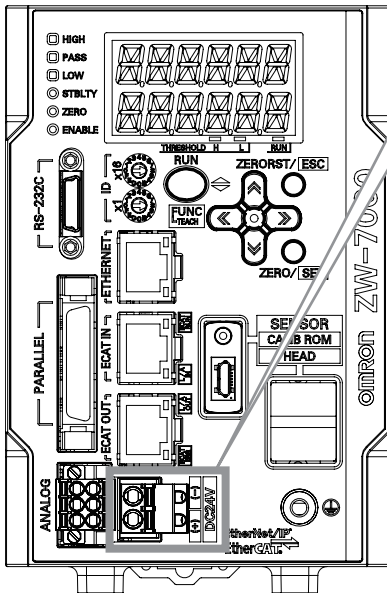

No.	Signal name
1	24 VDC (-)
2	24 VDC (+)

Class	Name	Description
Power Supply	24 VDC (+)	Terminal for external power supply (24 V)
	24 VDC (-)	Terminal for external power supply (0 V)

Important

- Wiring with the power on could result in a short-circuit or electric shock. Wire with the power off.
- Wire the power supply separate from other devices. Wiring together with other devices or using the same duct could cause a false operation or damage the sensor.
- Do not turn off the power during initial processing immediately after the Sensor Controller power is turned on, as the memory inside the Sensor Controller is being accessed. This may corrupt the data.
- Securely fasten the terminal block to prevent injury when you press in the release button with a screwdriver.
- Use the electric cable within 2m.

1 Remove 24 V input terminal block from the Sensor Controller.

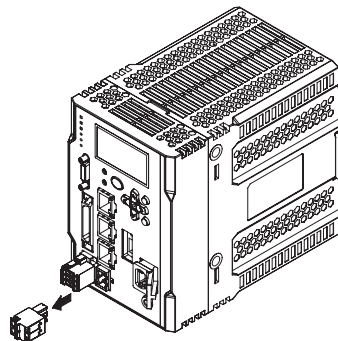

2 Insert the wire into the terminal hole.

- When you use a wire attached rod terminal, you can insert just with Push-IN.

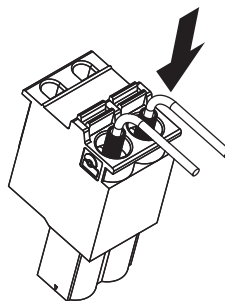

- When using single wire, or stranded wire Insert the wire deeply in to the terminal hole while pushing the release button on the side of terminal hole using a screwdriver.

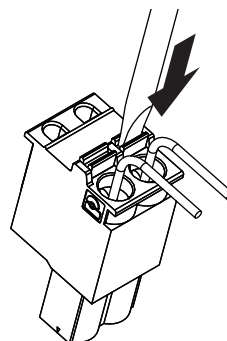

Important

- After the connection has been established, pull the wire gently, to make sure that the connection has been made securely.
- Being careful not to accidentally be injured when pushing the release button with a screwdriver, make sure to tightly secure to the terminal block.
- Do not use 24V power terminal board which is used in ZW-CE series.

3 Reinstall the 24 V input terminal block to the Sensor Controller.

 2 Installation and Connections p.53

Connecting to a Personal Computer

Connect a personal computer and the Sensor Controller through an Ethernet cable to perform sensor settings and monitoring from Sysmac Studio.

- 1 Insert one end of the Ethernet cable into the Ethernet connector of the controller.**
- 2 Insert another end of the Ethernet cable into the Ethernet connector of the external device.**

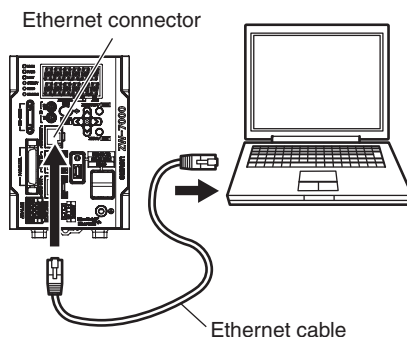

Important

Prepare commercially available Ethernet cable satisfying the following requirements:

- Category 5e or more, 30 m or less
- RJ45 connector (8-pin modular jack)
- For direct connection: Select cross cable.
- For connection through a network hub: Select straight cable.

After connecting an Ethernet cable between the Sensor Controller and a personal computer, set the IP address which is different from the Network address of Sensor Controller.

Note

By default, the Sensor Controller has an IP address of 192.168.250.50 and a subnet mask of 255.255.255.0. In this case, the network address is 192.168.250.0 and so specify 192.168.250. ** Default IP address of Sensor Controller is 192.168.250.50 and sub mask is 255.255.255.0. Since the network address is 192.168.250.0, specify 192.168.250.** (**=2 to 254 except 50.) to the IP address of your PC. for the IP address of the personal computer.

For Windows 7

- 1 Select [Control Panel] from the start menu.
The [Control Panel] dialog box appears.
- 2 Click [Network and Internet], and [View network status and tasks].

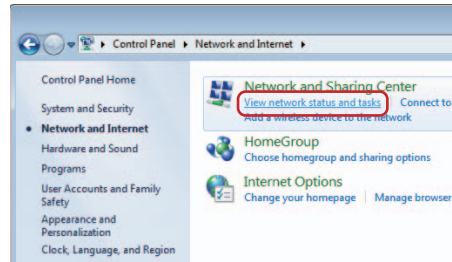

- 3 Click [Change adapter settings].

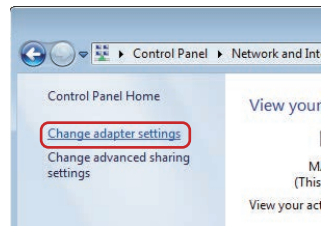

- 4 Right-click [Local Area Connection] and select [Properties] from the displayed menu.
The [Local Area Connection Properties] dialog box appears.
* Select "Ethernet" for Windows 10.

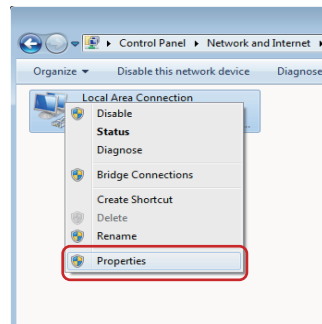

5 Under the [Network] tab, double-click [Internet Protocol Version 4 (TCP/IPv4)].

The [Internet Protocol Version 4 (TCP/IPv4) Properties] dialog box appears.

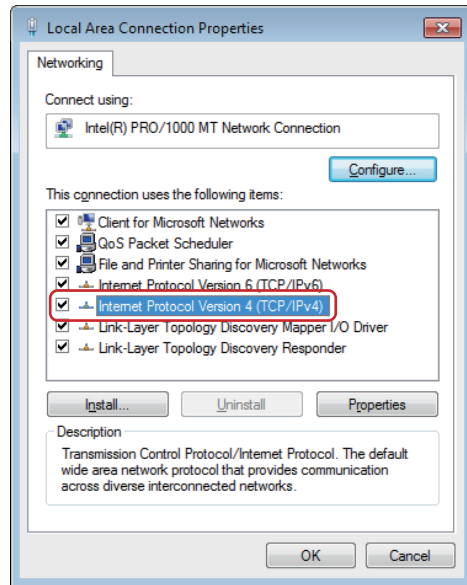

6 Click the [Use the following IP address] option and enter an IP address and subnet mask.

Example:

When matching the computer settings to the Sensor controller's network address and setting the following values:

IP address: 192.168.250.2

Subnet mask: 255.255.255.0

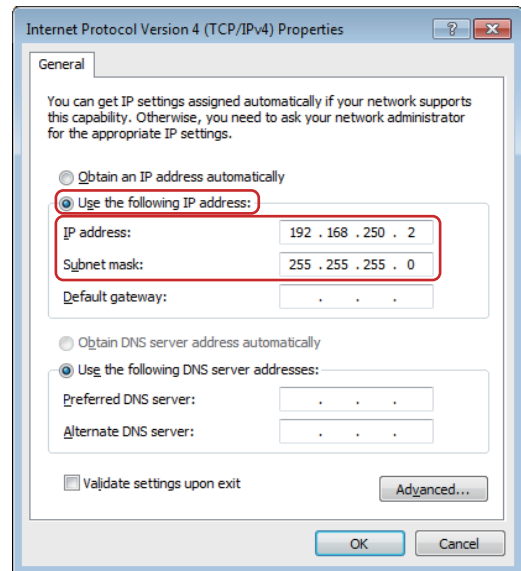

7 Click [OK] to complete the configuration.

Starting Up Sysmac Studio Measurement Sensor Edition

1 Start up Sysmac Studio.



2 Create a new project for the ZW.

From Category, select [Measurement Sensor] and from Device, select [ZW] to click the [Create] button.

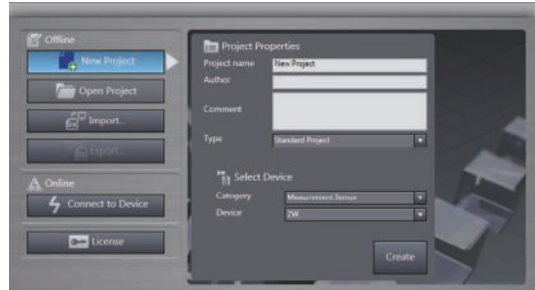

Note

If you have a previously created project, click [Open Project] to select the project.

2-8 Saving a project p.93

3 Select the [Specify a sensor] radio button to specify the IP address of the Sensor Controller to be connected.

Click the [Confirm] button to confirm the information of the Sensor Controller.

When connection with Sensor Controller is successful, Sensor Controller information is displayed.

Click [OK] button, the Sensing monitor window appears.

Sensing monitor pane p.90

When connecting online for the first time p.205

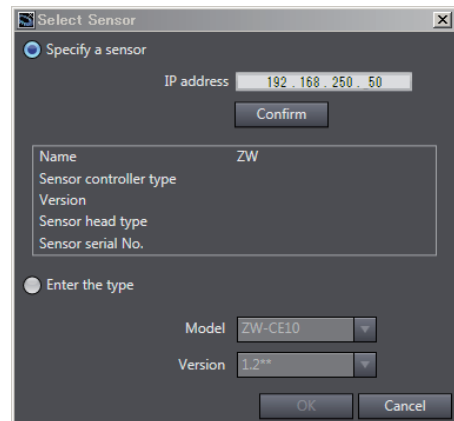

Note

By default, the Sensor Controller has an IP address of 192.168.250.50

3 Operation during RUN Mode p.95

Note

For the basic operations of Sysmac Studio, refer to “Sysmac Studio Version 1 Operation Manual” (W504).

Calibrating Sensor Head

Calibrate the Sensor Head by obtaining the dark data in the no-incoming light status.

- When removing and inserting a fiber cable from/to the Sensor Controller (Including the initial connection).
- When extending a fiber cable.
- When “Dark” is shown in the main display even though a measurement object exists in the measurement range.

The Sensor Head should be calibrated without any object within 20mm of the measurement range or with the tip of the Sensor Head shielded from light with an object with diffuse reflection.

Correct calibration is not possible with a transparent object, semi-transparent object, or mirror.

- Without any object within the measuring range

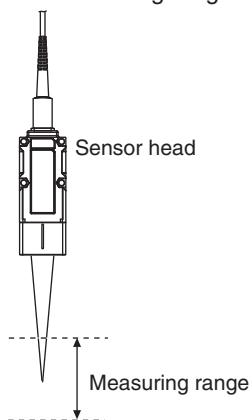

- With light shielded

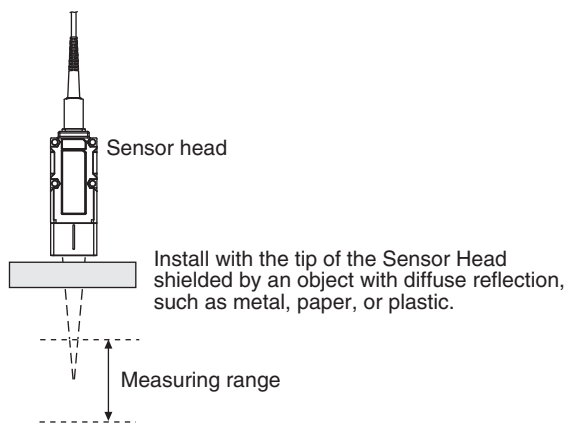

1 Set the operation mode to FUNC mode.

 3-2 Switching operation modes p.98

- ▶ **Multi View Explore** : [Device Group] | [(Sensor Name)] | [System] | [System Data] (double click)
- **Edit pane** : [Sensor Settings] icon ()

2 Select the cable length of the extension fiber cable.

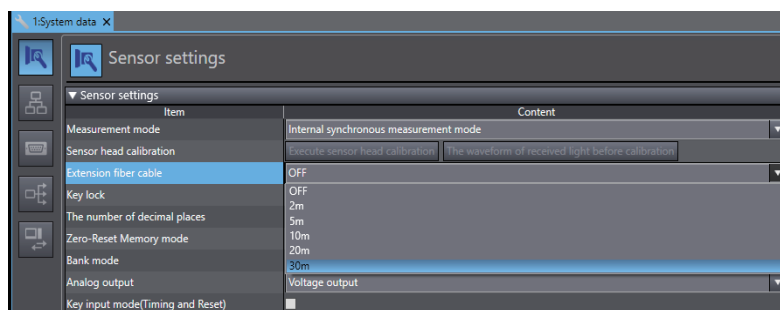

- 3 Click [Execute sensor head calibration].**
The sensor head calibration window appears.

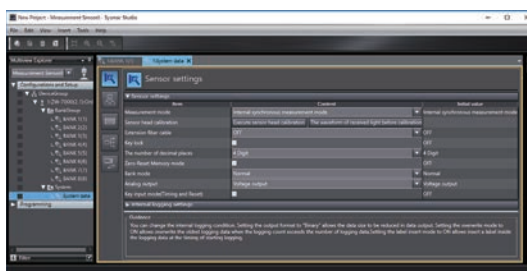

- 4 With no object in the measuring range, or with the tip of the sensor head shielded from light by an object that has the characteristics of diffusion reflection, click the [Execute sensor head calibration] button.**

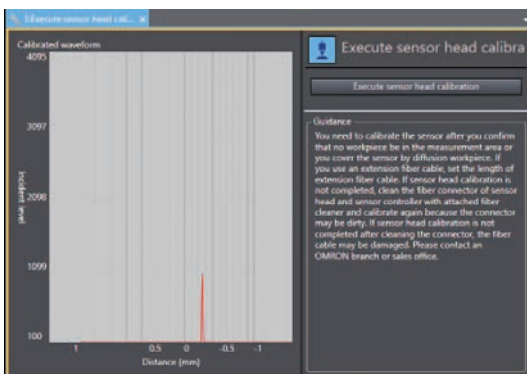

Important

- The calibration data is stored inside the Sensor Controller. Therefore, if the sensor head is calibrated once, as long as the fiber connection state does not change (if it is not disconnected from or connected to the Sensor Controller or an extension added), this operation is not needed each time. After removing/inserting a fiber cable from/to the Sensor Controller, or extending a fiber cable, be sure to calibrate the Sensor Head again.

When Sensor Head calibration fails

When sensor head calibration is performed in an inappropriate environment or with an extension fiber cable set incorrectly, an error message is displayed. In such a case, refer to the p.48, recheck your environment, and try again. If an error results even if Sensor Head calibration is done under the correct conditions, it is possible that some contaminants may have adhered to the Sensor Head part, or the fiber connector of the Sensor Controller. Clean the fiber cable or fiber connector referring to p.70. After cleaning the fiber or fiber connector, be sure to calibrate the Sensor Head again.

- Re-adjustment is obviously required when described the following, warning message appears on the Multi-view Explorer.
- When the Sensor head is not adjusted correctly.
- When the extender fiber cable is added.

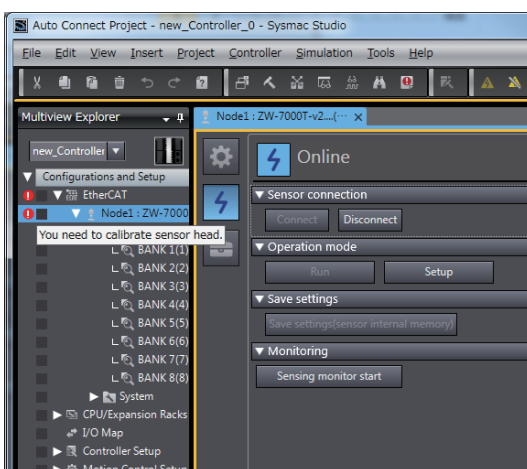

Note

Calibrating Sensor Head can also be set by the operating keys on the Sensor Controller.



Calibrating Sensor Head p.270

Monitoring the Measurement Results

After the completion of sensor head calibration, check that measurement is performed correctly.

► **Multi View Explore** : [Device Group] | [(Sensor Name)] (right-click)

1 Select [Sensing Monitor].

Open the sensing monitor window.

If the displayed measurement results are incorrect, refer to Chapter 8 Troubleshooting.

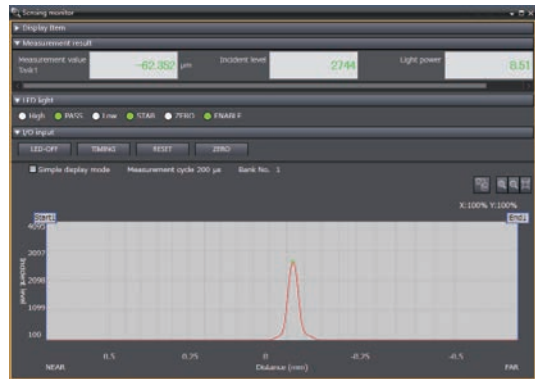

📖 5 Convenient Functions p.191

📖 8 Troubleshooting p.279

Note

If the resolution of PC is low, the light reception wave might not be displayed. In this case, close displayed items which are infrequently used such as display item, measurement result, LED light and I/O input.

MEMO

Installation and Connections

2-1 System Configuration	54
2-2 Part Names and Functions	57
2-3 Installation	63
2-4 Wiring	78
2-5 Installing the Sysmac Studio	85
2-6 Launching a project	86
2-7 Explanation of Screen Sections	88
2-8 Saving a project	93

2-1 System Configuration

System Configuration

Connecting with EtherCAT (when the master is NX/NJ Series)

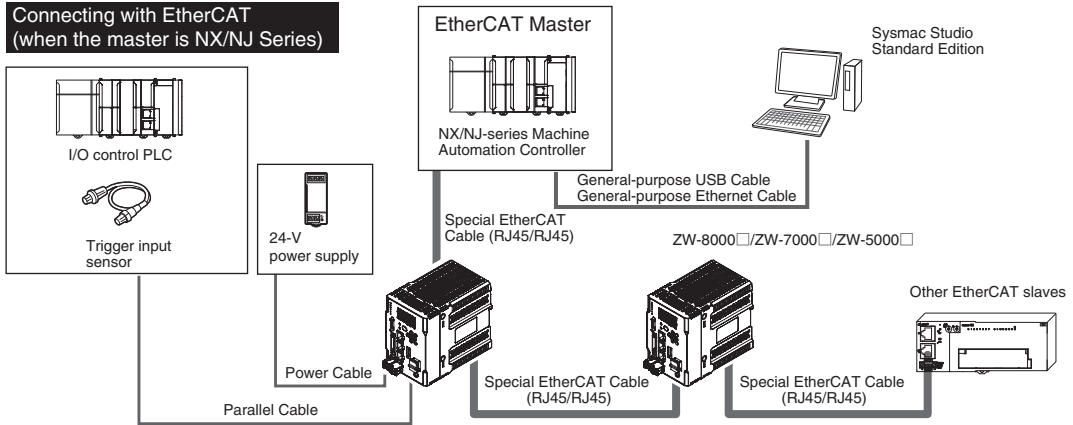

Connecting with EtherCAT (when the master is other than NX/NJ Series)

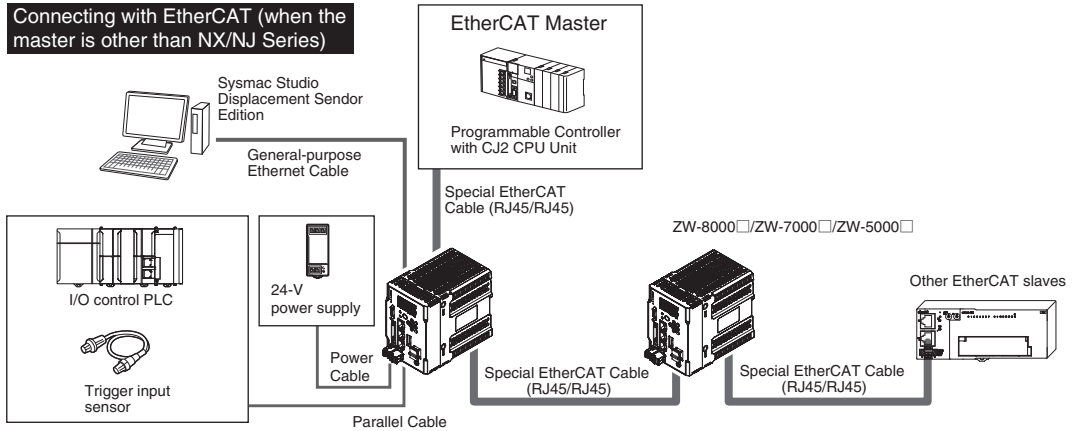

EtherNet/IP and No-protocol Ethernet Connections

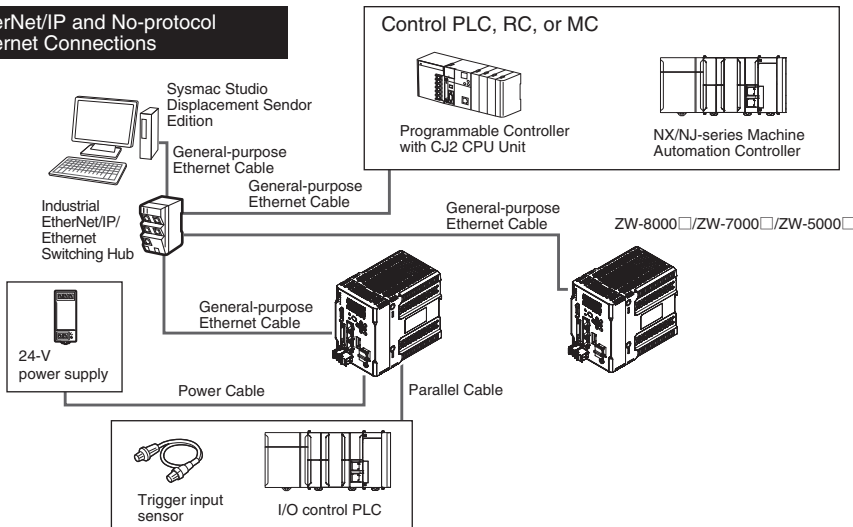

Connection Compatibility

Connected to ZW-8000□ ZW-7000□ ZW-5000□	Other connection				
	EtherCAT	EtherNet/IP	Ethernet (no-protocol)	RS-232C (no-protocol)	Parallel I/O Cable
EtherCAT	---	Not compatible	Compatible	Compatible	Compatible
EtherNet/IP	Not compatible	---	Compatible	Compatible	Compatible
Ethernet (no-protocol)	Compatible	Compatible	---	Compatible	Compatible
RS-232C (no-protocol)	Compatible	Compatible	Compatible	---	Compatible

Important

- EtherCAT and EtherNet/IP connections cannot be used at the same time.
- Can be connected simultaneously via Ethernet with PC tools (Sysmac Studio, SmartMonitorZW) and another device (PLC etc). Can be connected simultaneously via Ethernet with PC tools (Sysmac Studio, SmartMonitorZW) and another device (PLC etc). The port number for the PC tool is 9600 (fixed) and 9602 (fixed). When connecting different devices, set the port number to other than 9600 and 9602 (default value is 9601).

Product	Model	Application
ZW	ZW-8000□/7000□/ 5000□	This Displacement Sensor performs measurements.
PC Tool	Sysmac Studio Standard Edition <ul style="list-style-type: none"> • SYSMAC-SE200D (no licenses included (media only)) • SYSMAC-SE201L (1-license edition) • SYSMAC-SE2□□L (multilicense editions (3, 10, 30, or 50 licenses)) Sysmac Studio Measurement Sensor Edition <ul style="list-style-type: none"> • SYSMAC-NE00□L (1 or 3 licences) 	This is the setup application. It is part of the Sysmac Studio Package and it runs on Windows. The Sysmac Studio comes in two different editions. <ul style="list-style-type: none"> • Sysmac Studio Standard Edition The Sysmac Studio provides an integrated development environment for the NX/NJ series Controllers and other Machine Automation Controllers and EtherCAT Slaves. It supports setup, programming, debugging, operation, and maintenance. The Sysmac Studio Standard Edition DVD includes Support Software for EtherNet/IP, DeviceNet, serial communications, and PT screen design (CX-Designer). Refer to the Sysmac catalog (Cat. No. P072) for details. • Sysmac Studio Measurement Sensor Edition This license provides the functions that are required to set up ZW-8000/7000/5000 Series Vision Sensors from the Sysmac Studio. This model number is for the license only. You must also purchase the DVD for the Sysmac Studio Standard Edition Ver.1.15 or higher.
Special EtherCAT Cable	Refer to 10-1 Specifications and Dimensions	The Special EtherCAT Cable connects the Sensor to another Sensor or to another EtherCAT device.
General-purpose Ethernet cable	---	Prepare commercially available Ethernet cable satisfying the following requirements: <ul style="list-style-type: none"> • Category 5e or more, 30 m or less • RJ45 connector (8-pin modular jack) • For direct connection: Select cross cable. • For connection through an industrial switching hub: Select straight cable.
Special I/O Cable	For connecting to a PLC or programmable terminal <ul style="list-style-type: none"> • ZW-XPT2 For connecting to a PC <ul style="list-style-type: none"> • ZW-XRS2 	Connect the sensor with a PLC, programmable terminal, or personal computer etc..
Industrial EtherNet/IP / Ethernet Switching Hub	<ul style="list-style-type: none"> • W4S1-03B (3 ports type) • W4S1-05B • W4S1-05C (5 ports type) 	The Switching Hub connects multiple Sensors to one Touch Finder or one computer running PC Tool.

Product	Model	Application
EtherCAT Junction Slave	<ul style="list-style-type: none">• GX-JC03 (3 ports type)• GX-JC06 (6 ports type)	Used to connect multiple sensors or PLCs using EtherCAT.

2-2 Part Names and Functions

The following describes the names and functions of parts of the Sensor Head, Calibration ROM and Sensor Controller.

Sensor Head

● ZW-S80□□

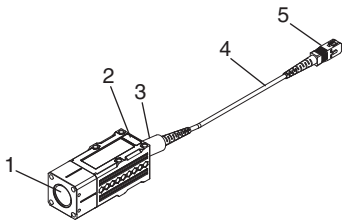

● ZW-SP80□□

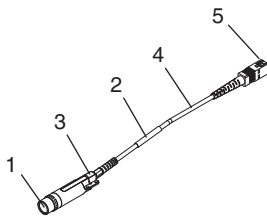

● ZW-SPR80□□

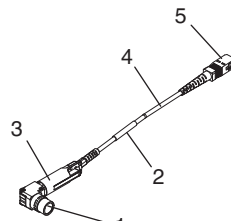

● ZW-S70□□

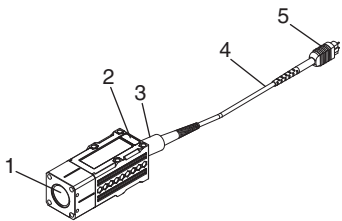

● ZW-SP70□□

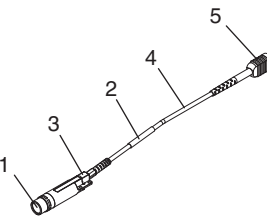

● ZW-SPR70□□

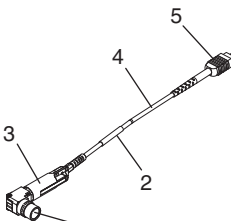

● ZW-S50□□

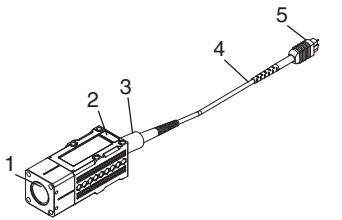

● ZW-SP50□□

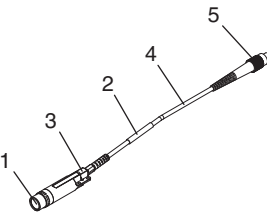

● ZW-SPR50□□

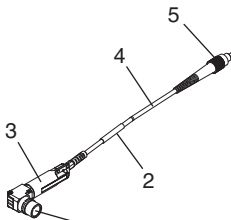

No.	Names	Functions
1	Projector/receiver	Projects and receives light.
2	Serial number.	Serial number. Only a Calibration ROM with the same serial number is available.
3	Fiber interface	Interfaces the Sensor Head and optical fiber. (Do not remove this fiber interface. If you remove it, repair may be needed.)
4	Fiber Cable	Sends or receives light signals to/from the Sensor Controller.
5	Fiber Connector	Couples the Sensor Controller and fiber cable.

Calibration ROM

This ROM is associated with the sensor on a one-to-one basis, and operates connected to the Sensor Controller.

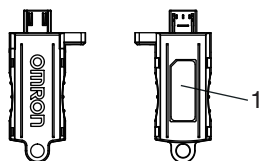

No.	Names	Functions
1	Serial number	Serial number. Only a Sensor Head with the same serial number is available.

Important

- Use with the Calibration ROM always connected. If the Calibration ROM is not connected, the error message “SYSERR” is shown in the main digital and “NO.ROM” is shown in the sub digital, where measurement is not possible.

 Errors Common to All Communication States p.280

- If the Calibration ROM is lost or broken, as a provisional measure, the measurement can be resumed using the data of the previously read Calibration ROM. For the operating procedure, refer to page p.195.

 5-3 Recovering Calibration ROM data p.195

Sensor Controller

Sensor Controller

ZW-8000 □

ZW-7000 □

<Front View>

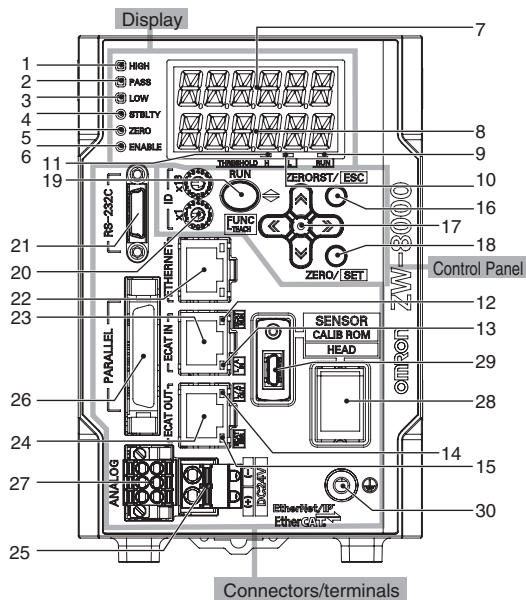

<Front View>

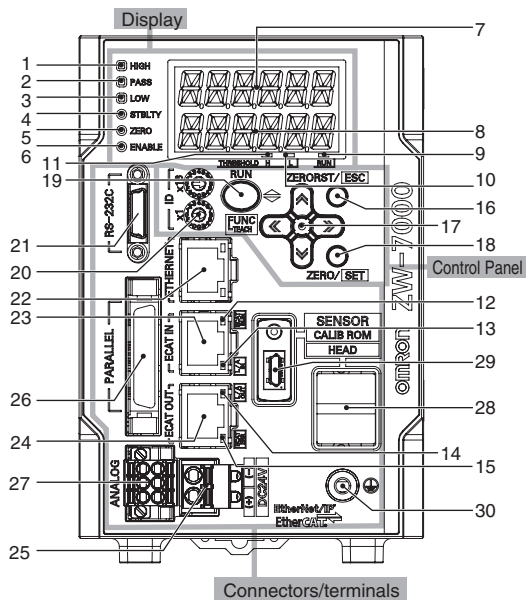

ZW-5000 □

<Front View>

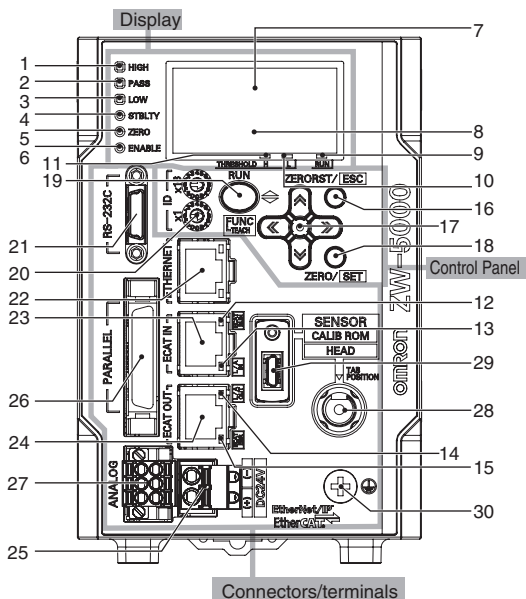

<Rear view>

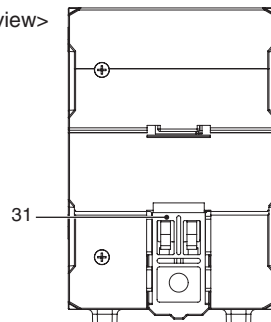

<Bottom view>

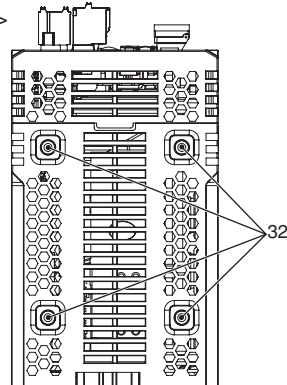

Front view

● Display

No.	Names (light color)	Functions
1	HIGH indicator (orange)	The HIGH indicator is lit while judgment is resulted in HIGH (HIGH threshold value < measured value).
2	PASS indicator (green)	The PASS indicator is lit while judgment is resulted in PASS (LOW threshold value ≤ measured value ≤ HIGH threshold value).
3	LOW indicator (orange)	The LOW indicator is lit while judgment is resulted in LOW (measured value < LOW threshold value).
4	STABILITY indicator (green)	The STABILITY indicator is lit while the measurement area 1 is within the measuring range. It goes out if a measured value is out of the measuring range.
5	ZERO indicator (green)	The Zero Reset indicator is lit while the zero reset function is enabled.
6	ENABLE indicator (green)	The ENABLE indicator lights when the Sensor is ready for measurement. It goes off when measurement is not possible (e.g. when the received light amount is excessive or insufficient, when the Calibration ROM is not connected, or when measurement is not being performed in FUNC mode).
7	Main display (white)	The main display shows measured values and/or function names.
8	Sub-display (green)	The sub-display shows additional information for measured values or setting values for functions.
9	RUN indicator (green)	The RUN indicator is lit in the RUN mode, and goes out in the FUNC mode.
10	THRESHOLD-L indicator (orange)	The LOW threshold value indicator is lit when the Sub-display indicates a LOW threshold value.
11	THRESHOLD-H indicator (orange)	The HIGH threshold value indicator is lit when the Sub-display indicates a HIGH threshold value.
12	ECAT RUN indicator (green)	ECAT RUN indicator lights up when EtherCAT communication is established.
13	L/A IN indicator (green)	L/A IN indicator lights up when connected with the EtherCAT device. Flashes when communication (data input) is performed.
14	L/A OUT indicator (green)	L/A OUT indicator lights up when connected with the EtherCAT device. Flashes when communication (data output) is performed.
15	ECAT ERROR indicator (red)	ECAT ERROR indicator lights up when an EtherCAT communication error occurs.

● Control panel

No.	Names	Functions
16	ZERORST/ESC key	<p>These keys function differently depending on operation modes.</p>  7-3 Functions of Operating Keys p.222
17	← (LEFT) key → (RIGHT) key ↑ (UP) key ↓ (DOWN) key	
18	ZERO/SET key	
19	Mode switching key	This key is used to switch between RUN (operation) mode and FUNC (adjustment) mode.
20	Node address setting switches (hexadecimal representation)	These switches are used to set the node address as an EtherCAT communications device. The setting range is 0x01(1) to 0xFF(255).

● Connectors/terminals

No.	Names	Functions
21	RS-232C connector	Connect the RS-232C cable when you are connecting the system with a PLC or personal computer through RS-232C. For the RS-232C cable, please use the following exclusive products: If you use a cable not included in the exclusive products, a false operation or breakdown may result. <ul style="list-style-type: none"> • For connecting to a PLC or programmable terminal: ZW-XPT2 • For connecting to a PC: ZW-XRS2
22	Ethernet connector	This connector is used to connect with a personal computer through Ethernet. For Ethernet cable, use a commercially available cable which satisfies the following conditions: <ul style="list-style-type: none"> • Category: 5e, or higher and Length: 30m or shorter. • RJ45 connector (8 pin registered jack) • When connect 1:1: select Ethernet crossover cable. • When connect by network HUB: select straight cable.
23	EtherCAT input connector	This connector is used to connect to EtherCAT-compatible devices. Use the recommended EtherCAT cable.
24	EtherCAT input output connector	This connector is used to connect to EtherCAT-compatible devices. Use the recommended EtherCAT cable.
25	24 V input terminal block	This connector is used to connect to Sensor Controller 24 VDC power supply. The length of Cables should be less than 30 m.
26	32-pole extension connector	<ul style="list-style-type: none"> • This connector connects the following output and input signals: <ul style="list-style-type: none"> • Output signal: Parallel I/Os, including output for judgment, ALARM, BUSY ENABLE, Bank Number, SYNCFLG/TRIGBUSY, STABILITY, LOGSTAT, LOGERR, TASKSTAT • Input signal: ZERO, RESET, TIMING, LIGHT OFF, LOGGING, Bank Number, SYNC/TRIG • Make sure to use the electric cable within 2m.
27	Analog output terminal block	This connector connects the output for analog voltage and analog current. Use the electric cable within 2m.
28	Fiber adapter	The fiber adapter connects the fiber connector.
29	ROM connector	The ROM connector connects the Calibration ROM.
30	Frame ground terminal	This is the connector for frame ground. It connects grounding wire.

Rear view

No.	Names	Functions
31	DIN track attachment hook	Used when fixing the Sensor Controller on DIN track.

Bottom view

No.	Names	Functions
32	Installation screw hole	Used when fixing the Sensor Controller with screws.

ECAT status indicator LED

LED name	Color	Status	Contents
ECAT RUN indicator	Green	OFF	Initialization status
		Blinking	Pre-Operational status
		Single flash	Safe-Operational status
		ON	Operational status
ECAT ERROR indicator	Red	OFF	No error
		Blinking	Communication setting error or PDO mapping error
		Single flash	Synchronization error or communications data error
		Double flash	Application WDT timeout
		ON	PDI WDT timeout
L/A IN indicator	Green	OFF	Link not established in physical layer
		Flickering	In operation after establishing link
		ON	Link established in physical layer
L/A OUT indicator	Green	OFF	Link not established in physical layer
		Flickering	In operation after establishing link
		ON	Link established in physical layer

Note

The timing of the flashing of the EtherCAT operation indicators is as follows:

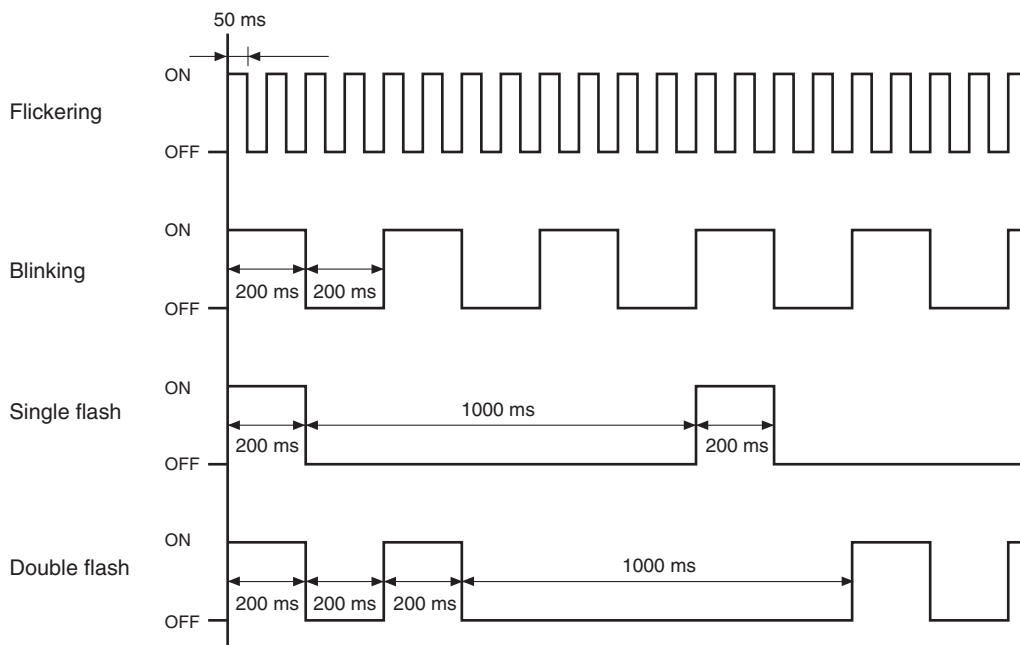

2-3 Installation

Installation of Sensor Head

 Installation of Sensor Head p.29

Measuring range

With the ZW-8000/7000/5000 series, the measurement center distance is expressed as 0 with the NEAR side as + and the FAR side as -.

● ZW-S series

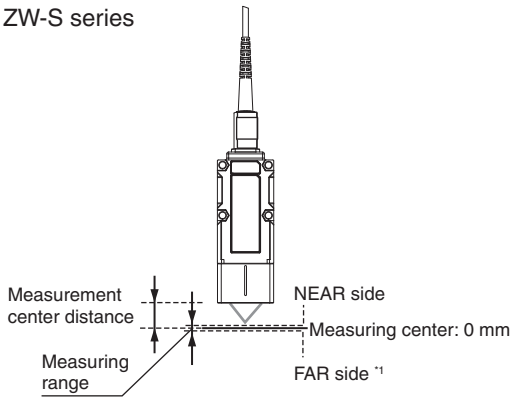

● ZW-SP series

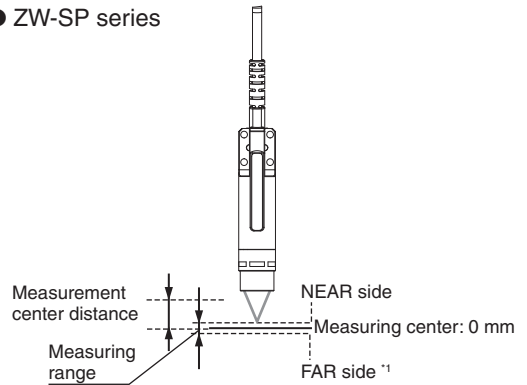

● ZW-SPR series

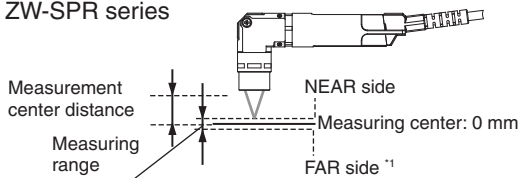

*1 With the ZW-8000/7000 series, the measurement area differs depending on the measurement cycle.

ZW-8000 series measurement cycle and measurement range

With the ZW-8000 series, the setting value of the measurement cycle changes in 1-us increments from 60 μ s to 100 μ s.

The near side is fixed, and the measurement range is shortened due to the measurement range ratio of each measurement cycle. The values for 100 μ s, 90 μ s, 80 μ s, 70 μ s and 60 μ s are as shown in the following chart.

Measurement cycle	Measurement range ratio	ZW-S8010		ZW-S8020		ZW-S8030		ZW-SP8007/SPR8007		ZW-SP8010/SPR8010	
		Near	Far	Near	Far	Near	Far	Near	Far	Near	Far
100 μ s	100 %	+0.5 mm	-0.5 mm	+1 mm	-1 mm	+2 mm	-2 mm	+0.3 mm	-0.3 mm	+0.7 mm	-0.7 mm
90 μ s	90 %	+0.5 mm	-0.4 mm	+1 mm	-0.8 mm	+2 mm	-1.6 mm	+0.3 mm	-0.24 mm	+0.7 mm	-0.56 mm
80 μ s	80 %	+0.5 mm	-0.3 mm	+1 mm	-0.6 mm	+2 mm	-1.2 mm	+0.3 mm	-0.18 mm	+0.7 mm	-0.42 mm
70 μ s	70 %	+0.5 mm	-0.2 mm	+1 mm	-0.4 mm	+2 mm	-0.8 mm	+0.3 mm	-0.12 mm	+0.7 mm	-0.28 mm
60 μ s	60 %	+0.5 mm	-0.1 mm	+1 mm	-0.2 mm	+2 mm	-0.4 mm	+0.3 mm	-0.06 mm	+0.7 mm	-0.14 mm

ZW-7000 series measurement cycle and measurement range

With the ZW-7000 series, the setting value of the measurement cycle changes in 1-us increments from 20 μ s to 28 μ s.

The measurement range of each setting value is as shown in the following chart.

Sensor Head Model	ZW-S7010		ZW-S7020		ZW-S7030		ZW-S7040		ZW-SP/SPR7007		ZW-SP/SPR7010	
	Near	Far	Near	Far	Near	Far	Near	Far	Near	Far	Near	Far
28 μ s or more	+0.5 mm	-0.5 mm	+1 mm	-1 mm	+2 mm	-2 mm	+3 mm	-3 mm	+0.3mm	-0.3mm	+0.7mm	-0.7mm
27 μ s	+0.5 mm	-0.47 mm	+1 mm	-0.95 mm	+2 mm	-1.9 mm	+3 mm	-2.85 mm	+0.3mm	-0.27mm	+0.7mm	-0.63mm
26 μ s	+0.5 mm	-0.43 mm	+1 mm	-0.9 mm	+2 mm	-1.8 mm	+3 mm	-2.7 mm	+0.3mm	-0.24mm	+0.7mm	-0.57mm
25 μ s	+0.5 mm	-0.4 mm	+1 mm	-0.85 mm	+2 mm	-1.7 mm	+3 mm	-2.55 mm	+0.3mm	-0.22mm	+0.7mm	-0.51mm
24 μ s	+0.5 mm	-0.34 mm	+1 mm	-0.73 mm	+2 mm	-1.46 mm	+3 mm	-2.19 mm	+0.3mm	-0.19mm	+0.7mm	-0.45mm
23 μ s	+0.5 mm	-0.28 mm	+1 mm	-0.61 mm	+2 mm	-1.22 mm	+3 mm	-1.83 mm	+0.3mm	-0.16mm	+0.7mm	-0.39mm
22 μ s	+0.5 mm	-0.22 mm	+1 mm	-0.49 mm	+2 mm	-0.98 mm	+3 mm	-1.47 mm	+0.3mm	-0.14mm	+0.7mm	-0.33mm
21 μ s	+0.5 mm	-0.16 mm	+1 mm	-0.37 mm	+2 mm	-0.74 mm	+3 mm	-1.11 mm	+0.3mm	-0.11mm	+0.7mm	-0.27mm
20 μ s	+0.5 mm	-0.1 mm	+1 mm	-0.25 mm	+2 mm	-0.5 mm	+3 mm	-0.75 mm	+0.3mm	-0.09mm	+0.7mm	-0.21mm

Mutual interference

When using two or more Sensor Heads in opposition to each other, mutual interference will not occur if other beam spots are outside the ■ areas in the following diagrams.

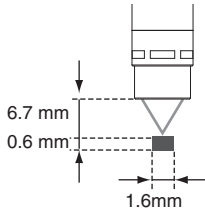

● ZW-S□010

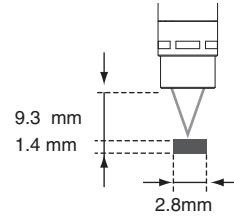

● ZW-S□020

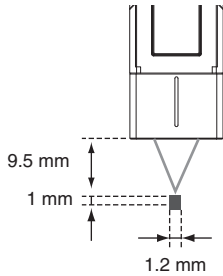

● ZW-S□030

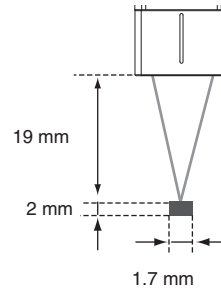

● ZW-S□040

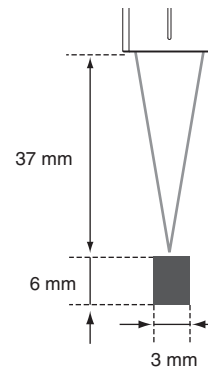
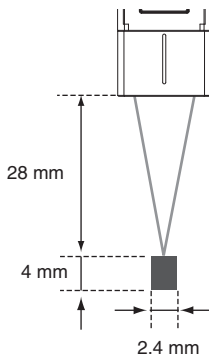

Installation of Sensor Controller

Precautions for installation

Install the Sensor Controller in the orientation indicated by the circle mark in the following figure. Do not install it laying on its side or upside down.

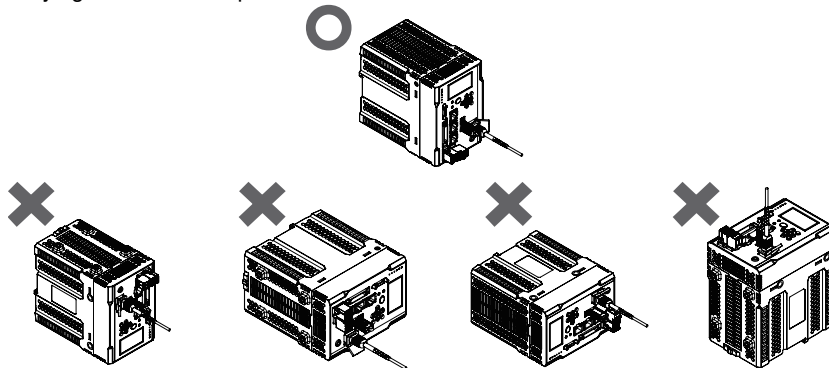

For adequate intake and/or exhaust, keep the Sensor Controller clear by 30 mm or more on its top, and by 10 mm or more from either side.

To secure the Sensor Head and cables connected safely, keep the front of the Sensor Controller clear by 65 mm or more.

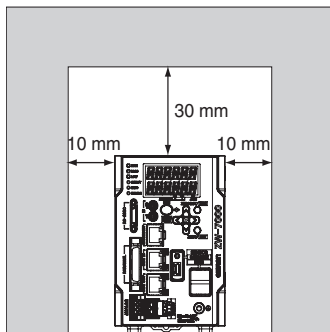

If more than one Sensor Controller must be placed in parallel, place them 10 mm or more apart each other, keep them clear by 30 mm or more on their top and 30 mm or more under them.

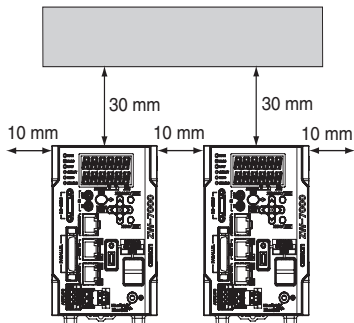

Important

Do everything possible to avoid installation in a location with vibration.

Installing on the DIN track

The following describes how to attach the Sensor Controller on a 35 mm-wide DIN track.

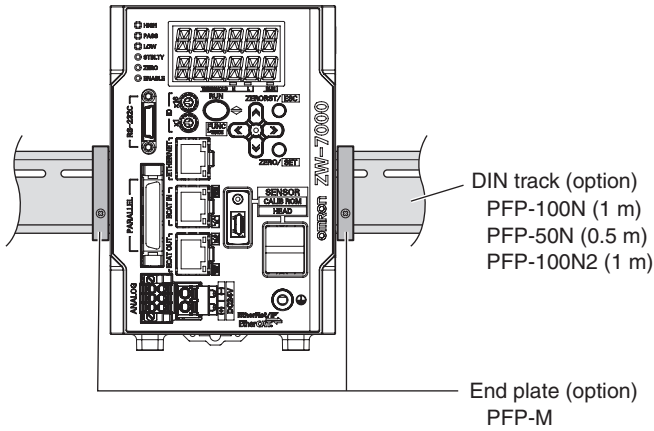

Installation procedure

- 1** Hook the upper edge of the Sensor Controller's back slot onto the upper edge of the DIN track.
- 2** Push the Sensor Controller down onto the DIN track until the DIN track attachment hook is locked. Push in until you hear a "click" sound.

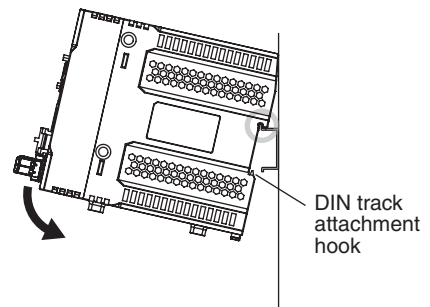

Important

Always hook the upper edge of the slot on the Sensor Controller's back first onto the DIN track. Hooking the Sensor Controller starting from the lower edge of the slot may impair the mounting strength. After completely installing the Sensor Controller, make sure that it is securely fixed.

Removal procedure

- 1** Pull DIN track attachment hook downwards using a slotted screwdriver or an equivalent.
- 2** Lift up the Sensor Controller from the lower side, and remove it from the DIN track.

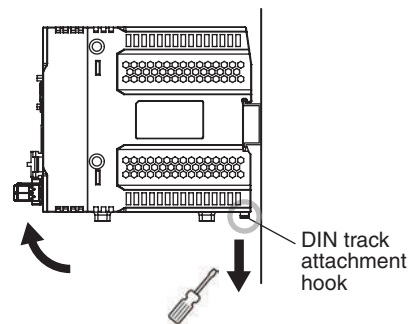

Installing on bottom

The following describes how to attach the Sensor Controller on its bottom.

1 Drill four installation holes on the base.

Important

For the location installation holes, see the external dimensions.

 9-1 Specifications and External Dimensions
p.288

2 Tighten four M4 screws to fix the Sensor Controller on the base.

Tightening torque: 1.2 N · m

Sensor Controller thread depth: 6 mm

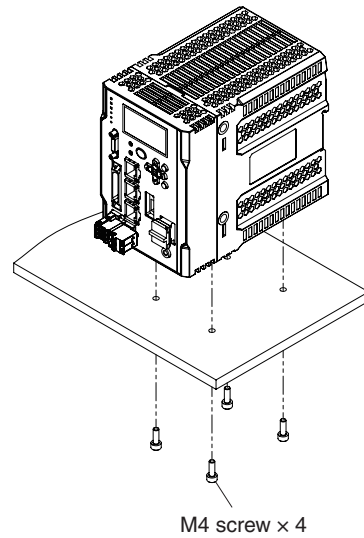

Attaching the strap to the Calibration ROM

 Attaching the strap to the Calibration ROM p.33

Attaching the Strap to Protective Cap

 Attaching the Strap to Protective Cap p.34

Connection of Fiber Cable and Calibration ROM

 Connecting the sensor controller and sensor head p.35

Connection of Fiber Cable and Sensor Controller

 Connection of Fiber Cable and Sensor Controller p.36

Connection of Calibration ROM and Sensor Controller

 Connection of Calibration ROM and Sensor Controller p.38

Remove the Fiber cable

 Remove the Fiber cable p.39

Cleaning the fiber connector and fiber cable using ZW-XCL

1 Taking out a cleaner

Don't dirty the top of the cleaner, and take one cleaner from the package.

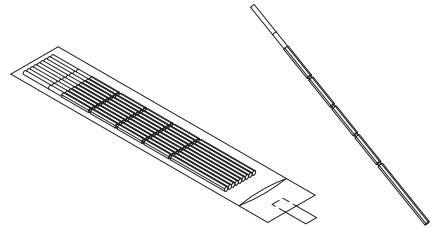

2 Cleaning the fiber connector face of the Controller side.

For ZW-8000 Series

Insert the cleaner end into the fiber connector or connection adapter, then turn it in the same direction about 3 times while pressing it against the side surface and end surface of the optical connector.

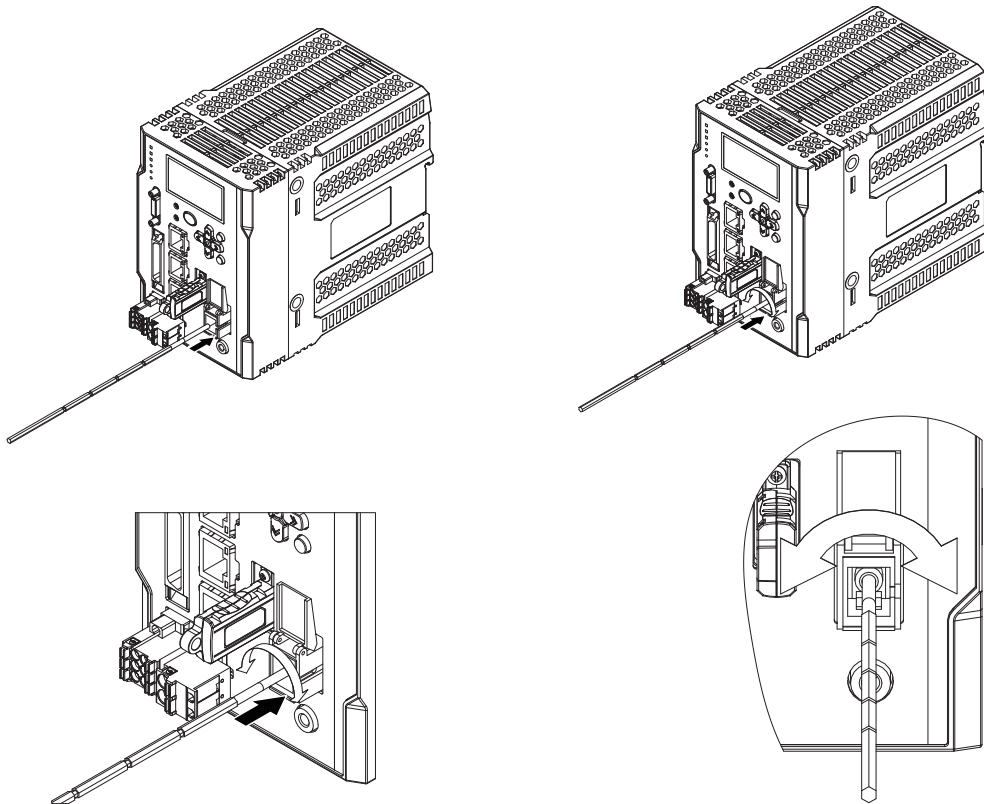

For ZW-7000 Series

Open the shutter of the fiber connector, and then wipe the fiber's face around three reciprocating.

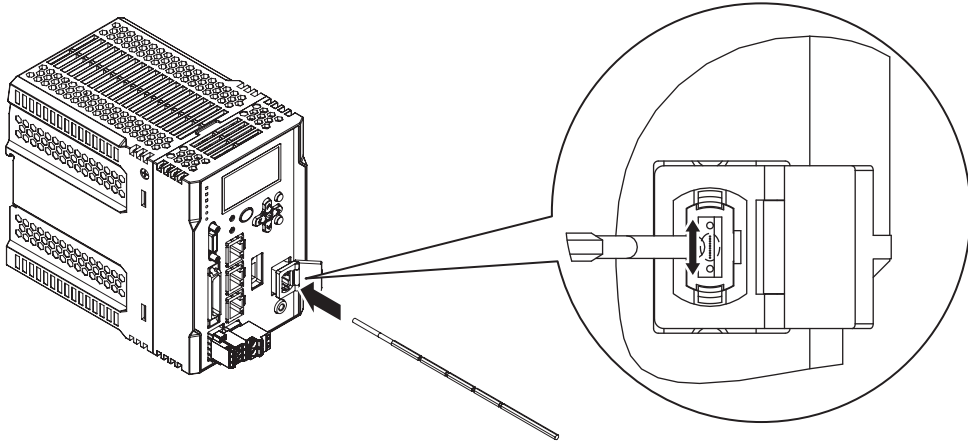
**For ZW-5000 Series**

Insert the cleaner end into the fiber connector or connection adapter, then turn it in the same direction about 3 times while pressing it against the side surface and end surface of the optical connector.

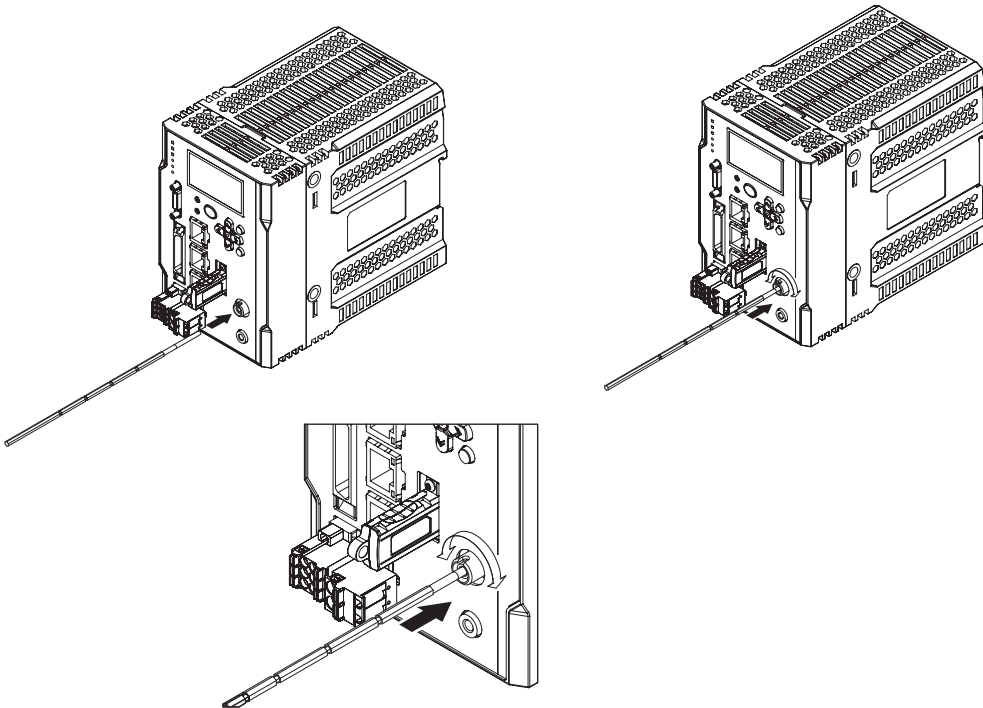

3 Cleaning the Sensor Head connection of the fiber cable

For ZW-8000 Series

Remove the cap from the fiber connector and wipe the fiber's face with about 3 passes.

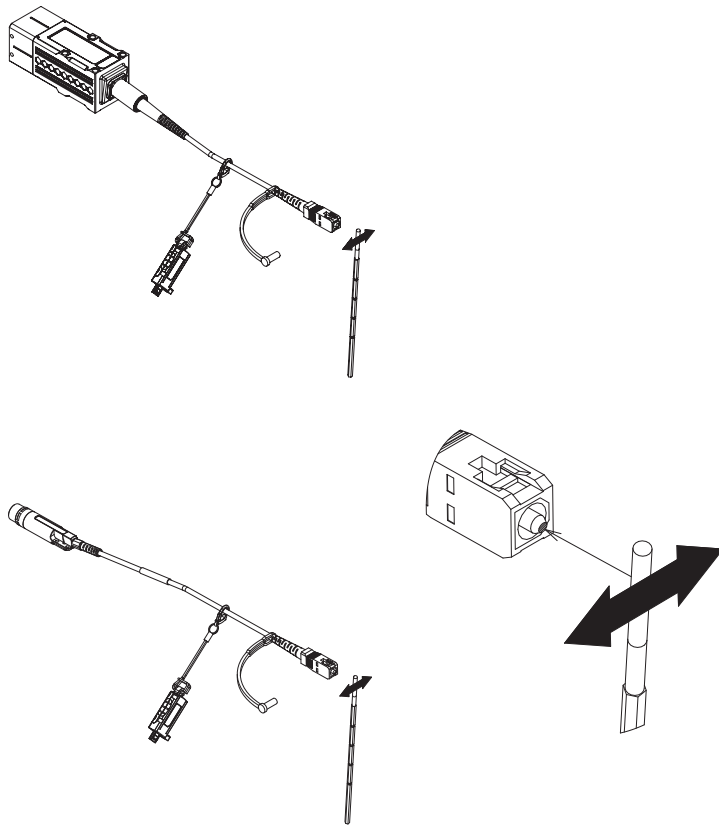

For ZW-7000 Series

Remove the cap from the fiber cable and wipe the entire end surface of the fiber connector with about 3 passes. Clean around the 2 guide pins as well.

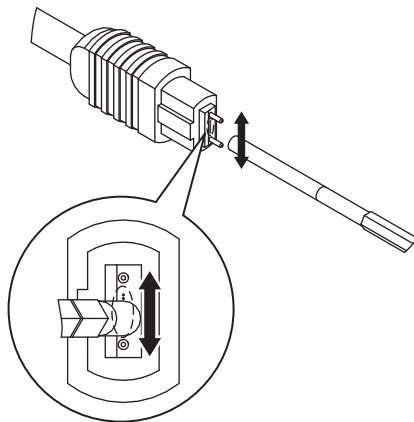

For ZW-5000 Series

Remove the cap from the fiber connector and wipe the fiber's face with about 3 passes.

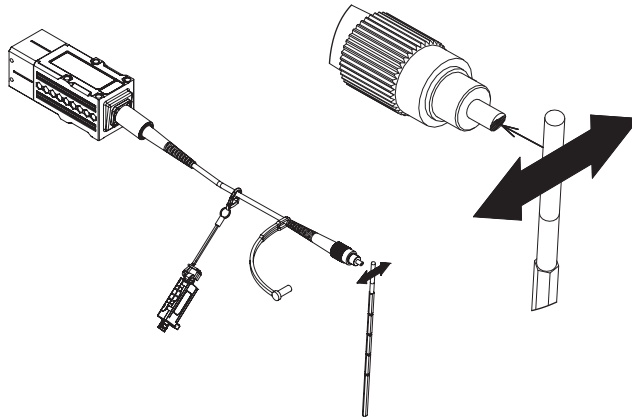

Important

- The cleaner can only be used one time. Reusing the cleaner may result in dirt or scratches on the end surface, causing malfunctions or measurement errors. Discard after use.
- When using a fiber cleaner, be sure to use the cloth (white end surface) on the cleaning section to clean.

Extending fiber cable

To extend the fiber cable on the Sensor Head, use an extension fiber cable and connecting adapter.

Important

When extending the fiber cable, be sure to set the fiber cable length and calibrate the Sensor Head after connecting the extension fiber cable.

ZW-8000 Series

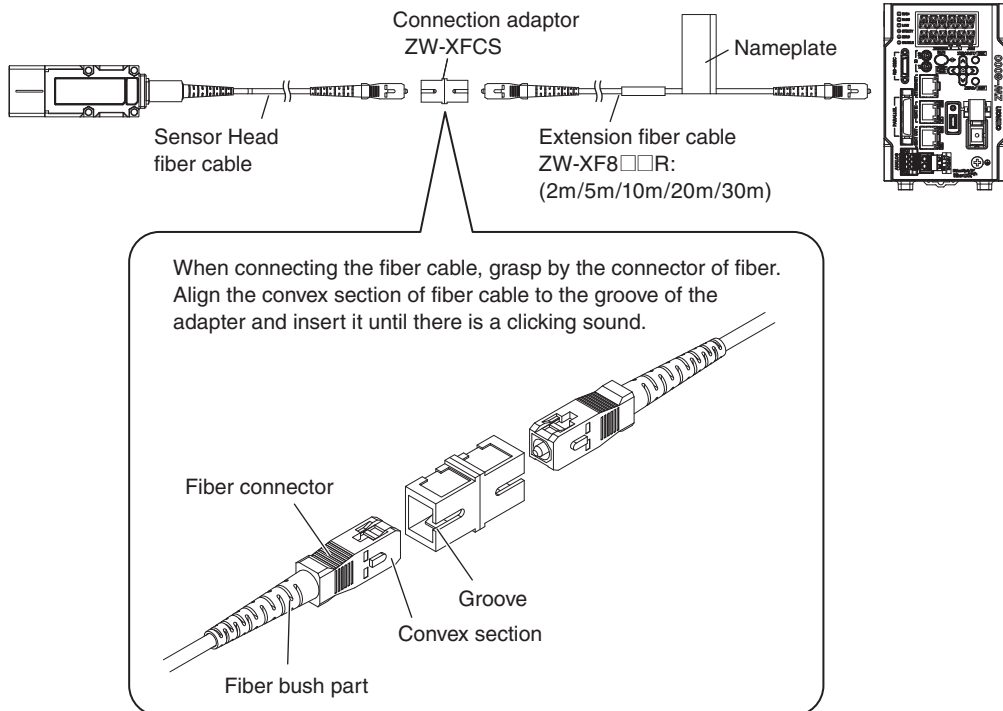

Extension fiber cable (option)

Model	Length
ZW-XF8002R	2m
ZW-XF8005R	5m
ZW-XF8010R	10m
ZW-XF8020R	20m
ZW-XF8030R	30m

Connecting adapter (option)

Model

ZW-XFCS

- The connection adapter comes packed together with the extension fiber cable.

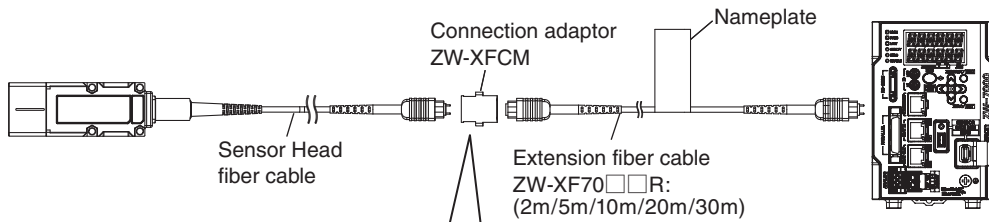

When connecting the fiber cable, grasp by the bushing part of fiber. Align the convex section of fiber cable to the groove of the adapter and insert it until there is a clicking sound.

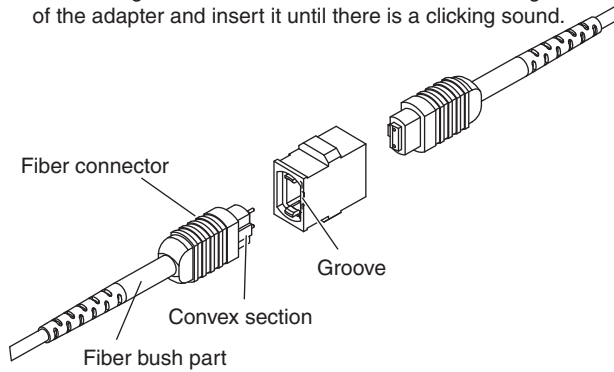

Extension fiber cable (option)

Model	Length
ZW-XF7002R	2m
ZW-XF7005R	5m
ZW-XF7010R	10m
ZW-XF7020R	20m
ZW-XF7030R	30m

Important

The ZW-XF70□□R must be installed in a certain direction. Always connect the side with the nameplate to the sensor controller.

Connecting adapter (option)

Model
ZW-XFCM

- The connection adapter comes packed together with the extension fiber cable.

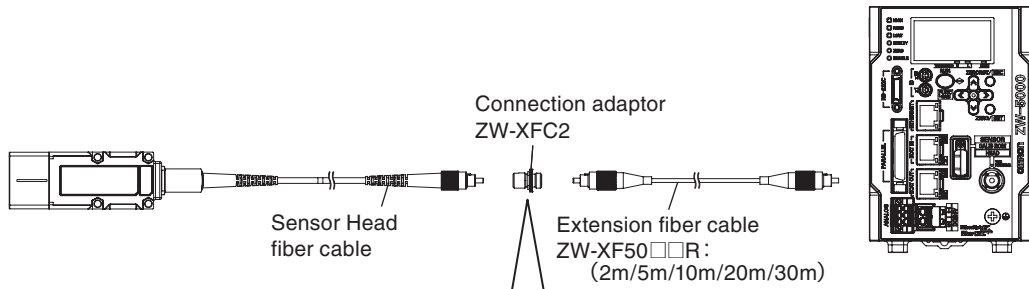

Mate the convex section of the fiber connector with the groove on the connection adaptor and turn the threaded section clockwise while pushing in.

Convex section Groove

When the fiber insertion/fixing screw is not completely tightened, as is the case in the "No good" status in the figure below, optic signals cannot be transmitted and correct measurement is not possible. Always check that the system is in the "Good" status.

Extension fiber cable (option)

Model	Length
ZW-XF5002R	2m
ZW-XF5005R	5m
ZW-XF5010R	10m
ZW-XF5020R	20m
ZW-XF5030R	30m

Connecting adaptor (option)

Model
ZW-XFC2

- The connection adaptor comes packed together with the extension fiber cable.

Important

- Handling fiber cables
Refer to the following for information on how to handle fiber cables.
 Remove the Fiber cable p.39

- The external fiber cable has a direction. Make sure to connect the name plate side to the Sensor Controller.
- If connected in the opposite direction, the optical signal will not be transmitted and the measurement will not be done correctly. Additionally, if force is applied to connect the standard fiber cable and extension fiber cable in the opposite direction, it may cause other failures.
- (For ZW-7000 Series) If you connect holding the fiber connector, it cannot be connected correctly.
- For how to use the supplied strap, refer to the following; Reference mark p.33.

 Attaching the strap to the Calibration ROM p.33

Important

- The connection adapter (ZW-XFCS/ZW-XFCM/ZW-XFC2) comes packed together with the extension fiber cable (ZW-XF□□□R).
- Never use any extension fiber cable and/or connecting adapter other than those specified in the above.
- Only one fiber cable is allowed to extend the normal fiber cable. Never use two or more extension fiber cable connected together.
- If an incorrect fiber cable length is set, correct measurement is not possible.
- Do not touch the fiber cable face of the Sensor Head. It may cause a degrading of its efficiency.
If you mistakenly touch or otherwise get dirt on the face, lightly wipe off the part using the following:
 - Optional item ZW-XCL
 - Commercially available fiber cleaner
 - A dry, soft cloth.
 Do not use a cloth dampened with alcohol.
Re-adhesion of dirt may occur.
- For cleaning the fiber connector of the Sensor Controller, use the optional item ZW-XCL or a commercially available fiber cleaner.
- When you remove the fiber cable from Sensor Controller, make sure to attach the protective cap. If you do not attach it, it is possible that some contaminants may have adhered and may cause degradation of performance.
- Calibrate the Sensor Head after removing and inserting an optical fiber.
- To check if the fiber is broken, verify the following points:
 - When you cannot views the right spot even place within measurement range an object which diffuses light, i.e. paper while connect the fiber cable correctly, the fiber cable may be damaged. In this case, need to repair. Contact your OMRON representative.
When inspect a object with high reflectivity, visually check may not be allowable. Use and conform a diffused object.

Calibrating Sensor Head

 Calibrating Sensor Head p.48

Note

Calibrating Sensor Head can also be set by the operating keys on the Sensor Controller.

 Calibrating Sensor Head p.270

2-4 Wiring

32-pole extension connector

Used for judgment output, control input, etc.

Compatible connector: FX2B series (Hirose Electric Co., Ltd.)

A parallel cable (ZW-XCP2E) for a 32-pole extension connector with 2 m wire is included.

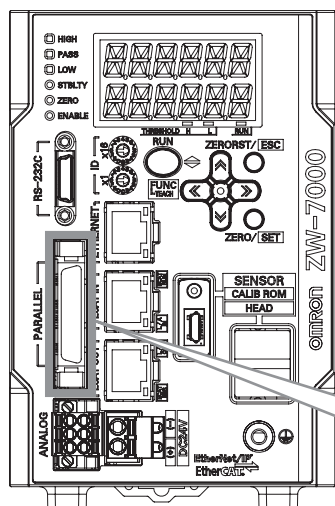

Color ⁽¹⁾	Signal name	No. ⁽²⁾		Signal name	Color ⁽¹⁾
Blue	COM_IN1	B16	A16	COM_IN2	Blue
Green	TIMING	B15	A15	SYNC/TRIG	Green
Yellow	RESET	B14	A14	NC	Yellow
Orange	ZERO	B13	A13	NC	Orange
Red	LIGHT OFF	B12	A12	NC	Red
Brown	COM_OUT1	B11	A11	COM_OUT3	Brown
Black	HIGH	B10	A10	STABILITY	Black
White	PASS	B9	A9	LOGERR	White
Gray	LOW	B8	A8	LOGSTAT	Gray
Purple	ALARM	B7	A7	SYNCFLG/ TRIGBUSY	Purple
Blue	BUSY	B6	A6	TASKSTAT	Blue
Green	ENABLE	B5	A5	COM_IN3	Green
Yellow	COM_OUT2	B4	A4	BANK_SEL1	Yellow
Orange	BANK_OUT1	B3	A3	BANK_SEL2	Orange
Red	BANK_OUT2	B2	A2	BANK_SEL3	Red
Brown	BANK_OUT3	B1	A1	LOGGING	Brown

*1 Indicates ZW-XCP2E wire color.

Important

Cut the unnecessary signal lines so that they do not touch other signal lines.

Class	Name	Description																																				
Parallel output	HIGH output	This outputs judgment results - HIGH (HIGH threshold values < Measured value).																																				
	PASS output	This outputs judgment results - PASS (LOW threshold values ≤ Measured value ≤ HIGH threshold values).																																				
	LOW output	This outputs judgment results - LOW (LOW threshold values > Measured value).																																				
	ALARM output	This turns ON when there is a system error.																																				
	BUSY output	This turns ON during sampling with the hold function enabled. It allows you to check whether or not the self-trigger is functioning correctly. It also turns ON during bank switching.																																				
	ENABLE output	This turns ON when the sensor is ready for measurement. This output is interlocked with the ENABLE indicator.																																				
	BANK_OUT output	This outputs the currently specified bank number. It expresses the bank number in combinations of BANK_OUT1, 2 and 3. <table border="1" data-bbox="488 556 1067 913"> <thead> <tr> <th>Bank Number</th> <th>BANK_OUT1</th> <th>BANK_OUT2</th> <th>BANK_OUT3</th> </tr> </thead> <tbody> <tr> <td>BANK1</td> <td>OFF</td> <td>OFF</td> <td>OFF</td> </tr> <tr> <td>BANK2</td> <td>ON</td> <td>OFF</td> <td>OFF</td> </tr> <tr> <td>BANK3</td> <td>OFF</td> <td>ON</td> <td>OFF</td> </tr> <tr> <td>BANK4</td> <td>ON</td> <td>ON</td> <td>OFF</td> </tr> <tr> <td>BANK5</td> <td>OFF</td> <td>OFF</td> <td>ON</td> </tr> <tr> <td>BANK6</td> <td>ON</td> <td>OFF</td> <td>ON</td> </tr> <tr> <td>BANK7</td> <td>OFF</td> <td>ON</td> <td>ON</td> </tr> <tr> <td>BANK8</td> <td>ON</td> <td>ON</td> <td>ON</td> </tr> </tbody> </table>	Bank Number	BANK_OUT1	BANK_OUT2	BANK_OUT3	BANK1	OFF	OFF	OFF	BANK2	ON	OFF	OFF	BANK3	OFF	ON	OFF	BANK4	ON	ON	OFF	BANK5	OFF	OFF	ON	BANK6	ON	OFF	ON	BANK7	OFF	ON	ON	BANK8	ON	ON	ON
	Bank Number	BANK_OUT1	BANK_OUT2	BANK_OUT3																																		
	BANK1	OFF	OFF	OFF																																		
	BANK2	ON	OFF	OFF																																		
	BANK3	OFF	ON	OFF																																		
	BANK4	ON	ON	OFF																																		
BANK5	OFF	OFF	ON																																			
BANK6	ON	OFF	ON																																			
BANK7	OFF	ON	ON																																			
BANK8	ON	ON	ON																																			
SYNCFLG/TRIGBUSY output	In the internal/PDO synchronized mode, this output operates as SYNCFLG. This turns ON when measurement synchronization processing is executed by SYNC input and the state changes to one where normal measurement values can be output. In the external synchronous measurement mode, this output operates as TRIGBUSY. This turns ON while a measurement by TRIG input is being performed. The next TRIG input cannot be turned ON until this turns OFF.																																					
STABILITY output	This turns ON when 1surface is within the measurement range. This output is interlocked with the STABILITY indicator.																																					
LOGSTAT output	This turns ON while internal logging is in execution.																																					
LOGERR output	This turns ON when internal logging fails. Turns ON when the maximum number of logging results are saved and you try to execute internal logging. If the LOGGING signal turns OFF, LOGERR signal is also turned OFF.																																					
TASKSTAT output	This turns ON when the measurement value is finalized.																																					

In FUNC mode, output of each signals are the followings;

- BUSY output Turns ON
- BANK_OUT Outputs the current bank number
- Other signals Turns OFF

Class	Name	Description																																				
Parallel input	ZERO input	This is used to execute and clear a zero reset.																																				
	RESET input	This resets all executing measurements and outputs. While a RESET is being input, judgment output conforms to the non-measurement setting. If this RESET input switches ON while the hold function is used, the state in effect before the hold function was set will be restored.																																				
	TIMING input	This is a signal input from an external device that is used to time the hold function with the continuous measurement function enabled. This is a signal input from an external device that is used to time the measurement with the trigger measurement function enabled.																																				
	LIGHT OFF input	This LIGHT-OFF signal puts out the white LED used for measuring. While LIGHT-OFF is being input, the analog output, binary output, and judgment output conform to the non-measurement setting.																																				
	BANK_SEL input	This is used for switching banks. Specify the bank number in combinations of BANK_SEL1, 2 and 3. However, if the bank mode is set to "JUDGMENT", the bank cannot be switched at the external signal input because the number of banks increases to 32. <table border="1" data-bbox="491 595 1071 952"> <thead> <tr> <th>Bank Number</th> <th>BANK_SEL1</th> <th>BANK_SEL2</th> <th>BANK_SEL3</th> </tr> </thead> <tbody> <tr> <td>BANK1</td> <td>OFF</td> <td>OFF</td> <td>OFF</td> </tr> <tr> <td>BANK2</td> <td>ON</td> <td>OFF</td> <td>OFF</td> </tr> <tr> <td>BANK3</td> <td>OFF</td> <td>ON</td> <td>OFF</td> </tr> <tr> <td>BANK4</td> <td>ON</td> <td>ON</td> <td>OFF</td> </tr> <tr> <td>BANK5</td> <td>OFF</td> <td>OFF</td> <td>ON</td> </tr> <tr> <td>BANK6</td> <td>ON</td> <td>OFF</td> <td>ON</td> </tr> <tr> <td>BANK7</td> <td>OFF</td> <td>ON</td> <td>ON</td> </tr> <tr> <td>BANK8</td> <td>ON</td> <td>ON</td> <td>ON</td> </tr> </tbody> </table>	Bank Number	BANK_SEL1	BANK_SEL2	BANK_SEL3	BANK1	OFF	OFF	OFF	BANK2	ON	OFF	OFF	BANK3	OFF	ON	OFF	BANK4	ON	ON	OFF	BANK5	OFF	OFF	ON	BANK6	ON	OFF	ON	BANK7	OFF	ON	ON	BANK8	ON	ON	ON
	Bank Number	BANK_SEL1	BANK_SEL2	BANK_SEL3																																		
	BANK1	OFF	OFF	OFF																																		
	BANK2	ON	OFF	OFF																																		
BANK3	OFF	ON	OFF																																			
BANK4	ON	ON	OFF																																			
BANK5	OFF	OFF	ON																																			
BANK6	ON	OFF	ON																																			
BANK7	OFF	ON	ON																																			
BANK8	ON	ON	ON																																			
LOGGING input	This is used to start and end internal logging.																																					
SYNC/TRIG input	In the internal/PDO synchronized mode, this is a signal input (SYNC input) used in order for the multiple ZWs to perform synchronization of measurements (image capture) at the same time. In the external synchronous measurement mode, this is a signal input (TRIG input) used in order to decide the measurement (image capture) timing.																																					

Analog output terminal block

Used for analog output.

Compatible wire specifications: Solid wire 0.2 to 1.5 mm²

Stranded wire 0.2 to 1.5 mm²

Stranded wire with rod terminal(no plastic sleeve) 0.25-1.5 mm²

Stranded wire with rod terminal(with plastic sleeve) 0.25-0.75 mm²

AWG 24-16

Pin processed length 10 (±0.5) mm

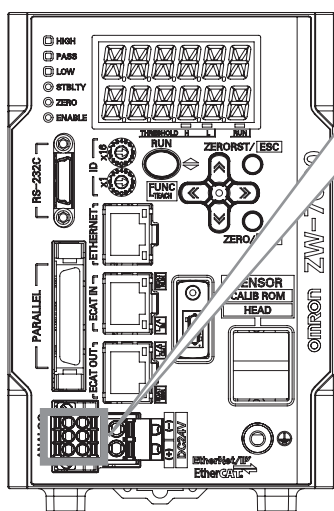

Signal name	No.	Signal name
OUT(V)	1 4	NC
OUT(A)	2 5	NC
OUT 0V	3 6	NC

Class	Name	Description
Analog output	OUT (V)	This outputs the measured value, from -10 V to +10 V as the voltage value. When measurement not possible: Approx. +10.8 V (default value; can be selected by user) Alarm: Approx. 10.8 V
	OUT (A)	This outputs the measured value, from 4 mA to 20 mA as the current value. When measurement not possible: Approx. +20.8mA (default value; can be selected by user) Alarm: Approx. +20.8 mA
	OUT 0V	0 V for analog voltage output.

Important

- Cut the unnecessary signal lines so that they do not touch other signal lines.
Make the wire length as short as possible. Do not use a wire length of over 30 m.
- Analog output is not possible under the following combination of conditions.
Measurement cycle is less than 40 μs.
EtherCAT output is enabled.
- Make sure to fix the terminal block to prevent be injure when pushing the release button with a screw driver.

- 1 Loosen the two fixing screws using a screwdriver to remove Analog output terminal block from the Sensor Controller.**

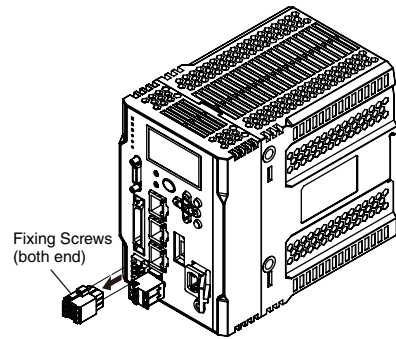

- 2 Insert the wire into the terminal hole.**

- When you use a wire attached rod terminal, you can insert just with Push-IN.

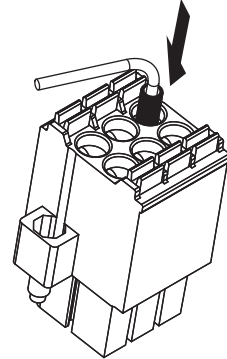

- When using single wire, or stranded wire Insert the wire deeply in to the terminal hole while pushing the release button on the side of terminal hole using a screwdriver.

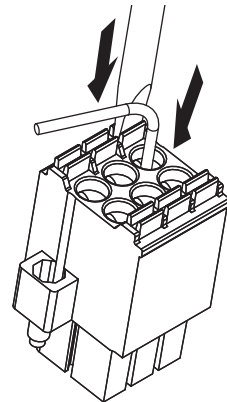

Important

- After the connection has been established, pull the wire gently, to make sure that the connection has been made securely.
- Being careful not to accidentally be injured when pushing the release button with a screwdriver, make sure to tightly secure to the terminal block.

- 3 Reinstall the Analog output terminal block to the Sensor Controller.**

24 V input terminal block

 24 V input terminal block p.42

Electrical Specifications

Input circuit

Item	Specifications	
Model	ZW-8000□/7000□/5000□	
Input type *1	For NPN connection	For PNP connection
Input voltage	24 VDC±10%(21.6 to 26.4 VDC)	24 VDC±10%(21.6 to 26.4 VDC)
Input current	7 mA Typ. (24 VDC)	7 mA Typ. (24 VDC)
ON voltage/ON current *2	19 V min./3 mA min.	19 V min./3 mA min.
OFF voltage/OFF current *3	5 V max./1 mA max.	5 V max./1 mA max.
ON delay	0.1 ms max.	0.1 ms max.
OFF delay	0.1 ms max.	0.1 ms max.
Internal circuit diagram *4		

*1 NPN/PNP dual type. According to the specifications of the external equipment, ensure proper wiring.

*2 ON voltage/ON current

This is the voltage value or current value that makes the signal go OFF to ON.

The ON voltage value becomes the potential difference between COM IN 1/2/3 and the input terminals.

*3 OFF voltage/OFF current

This is the voltage value or current value that makes the signal go ON to OFF.

The OFF voltage value becomes the potential difference between COM IN 1/2/3 and the input terminals.

*4 Below is a table giving the COM_IN (input common) and input signal connection correspondence.

Terminal name	COM_IN1	COM_IN2	COM_IN3
Input signal name	TIMING	SYNC/TRIG	BANK_SEL1
	RESET		BANK_SEL2
	ZERO		BANK_SEL3
	LIGHT OFF		LOGGING

Important

Chattering countermeasures

- Set the width of input signal filter (5μs to 1000μs) to prevent incorrect input due to chattering.
- Always use non-contact relays (SSR, PLC transistor output) for input signals. If contact relays are used, contact bouncing may turn ON a TIMING input again during measuring.

Output circuit

Item	Specifications	
Model	ZW-8000□/7000□/5000□	
Output type *1	For NPN connection	For PNP connection
Output voltage	21.6 to 30 VDC	21.6 to 30 VDC
Load current	50 mA max.	50 mA max.
ON residual voltage	2 V max.	2 V max.
ON leakage current	0.1 mA max.	0.1 mA max.
Internal circuit diagram *2		

*1 NPN/PNP dual type. According to the specifications of the external equipment, ensure proper wiring.

*2 Below is a table giving the COM_OUT (output common) and output signal connection correspondence.

Terminal name	COM_OUT1	COM_OUT2	COM_OUT3
Output signal name	HIGH	BANK_OUT1	STABILITY
	PASS	BANK_OUT2	LOGERR
	LOW	BANK_OUT3	LOGATAT
	ALARM		SYNCFLG/TRIGBUSY
	BUSY		TASKSTAT
	ENABLE		

Important

- Connect a load that matches the output specifications. Short-circuit can cause sensor breakdown.
- Keep the load current less than or equal to the specification value. Exceeding the specification value could cause damage to the output circuit.

2-5 Installing the Sysmac Studio

The PC Tool used to set up ZW-8000/7000/5000 Series Displacement Sensors is installed from the Sysmac Studio Installer. Refer to the *Sysmac Studio Version 1 Operation Manual* (Cat. No. W504) for the system requirements and installation procedure.

2-6 Launching a project

Connecting to the sensor with Sysmac Studio Measurement Sensor Edition

Creating a new project

Create a new project, add a sensor to the project, then start communicating with the sensor.

1 Start up the PC tool.

2 Create a new project.

Click [New Project] and select [Displacement Sensor] from [Category] under [Select Device], and [ZW] from [Device].

Then enter [Project name], [Author], and [Comment].

Click [Create] to create a blank project.

Note

If there are existing projects, click [Open Project]. A list of the projects is displayed. Select the project you want to open and click [Open]. If an existing project is opened, it starts up in offline mode. For the details of offline mode, see below.

 Chapter 6 Offline Settings p.201

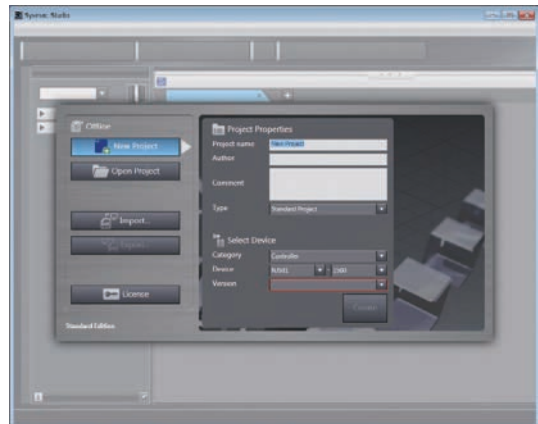

3 Specify the sensor to connect using one of the methods below.

- Directly specify the IP address of the sensor to connect.

Check the [Specify a sensor] box.

Directly enter the IP address. Click [Confirm], and then click [OK].

- When not connected with the sensor (offline)

When setting a project offline without

connecting to the actual sensor, check [Enter the type] to select.

Then, select the sensor model and software version to use and click [OK].

 Chapter 6 Offline Settings p.201

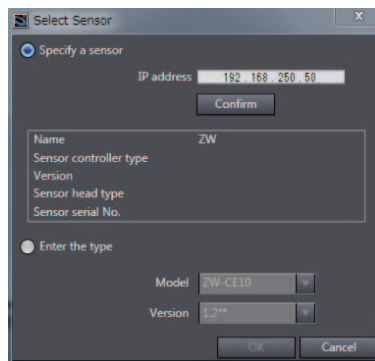

Note

By default, the Sensor Controller has an IP address of 192.168.250.50

 3 Operation during RUN Mode p.95

- 4** After the sensor is connected, the following window appears.
Sensing monitor window appears on the Edit pane. The sensor starts up in RUN mode.

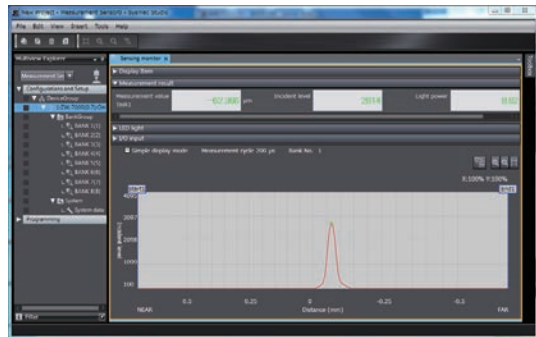

Adding a sensor to a project

After the project is created, additional sensors can be added to the project.

- ▶ **Multi-view explore** : [Device Group] (right click) | [Add] | [ZW]

Entering project information

Comments about the project can be entered.

- ▶ **Multi View Explore** : [Device Group] | [(Sensor Name)] (double click)
→ **Edit pane** : [General Settings] icon (⚙️)
- 1** Enter comments for the project in the [Comment] field.

2-7 Explanation of Screen Sections

PC tool

The following summarizes the names and functions of the window sections of Sysmac Studio.

Sysmac Studio Main window

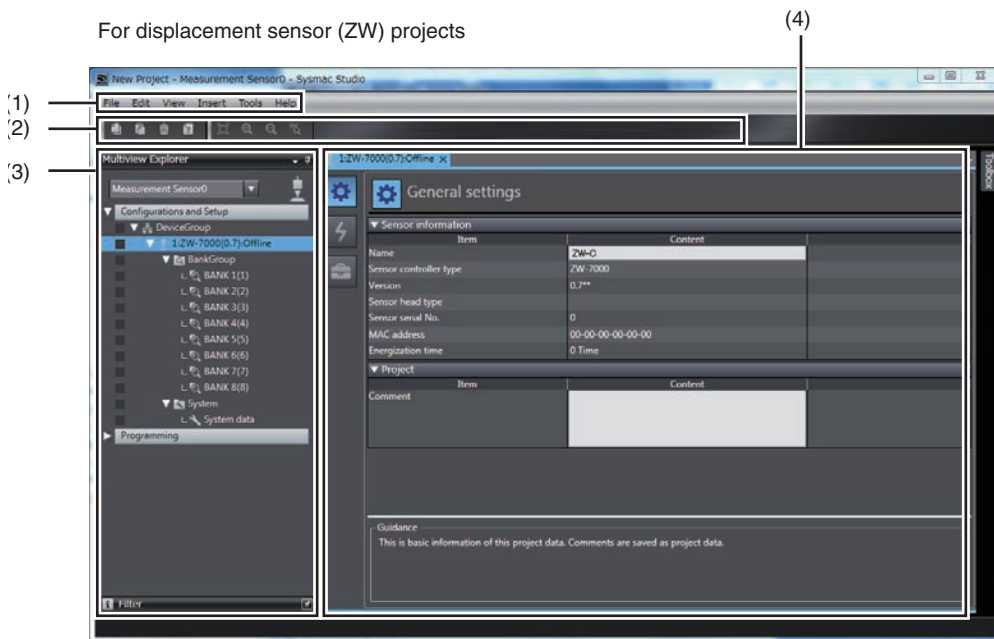

No.	Name	Description
(1)	Menu bar	Menu items that can be used with this tool is displayed.
(2)	Toolbar	Tool functions that can be used with this tool is displayed with icons.
(3)	Multi View Explore	Displays the data hierarchy of the sensor with a hierarchy tree. Double clicking each data displays Main pane, Bank data edit pane, and System data edit pane on the Edit pane.
(4)	Edit pane	Edits and displays data selected in the Multi View Explore. It mainly consists of Menu icon, setting items, and properties.

Display the edit window using the following procedures for a controller (NJ) project.

- ▶ **Multi view Explore** : [(EtherCAT)] (double click)
- ▶ **Multi view Explore** : [(ZW model name)] (double click)

Multi-view explore

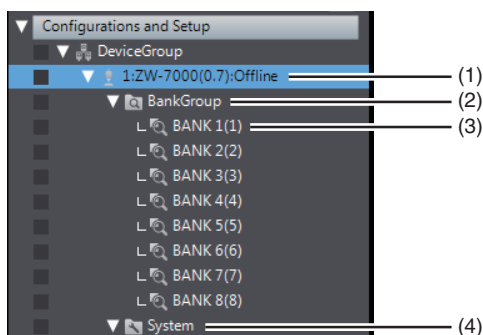

No.	Name	Description
(1)	Sensor model	Displays the sensor model. Displays online/offline status at the end.
(2)	Bank group	This is a group of bank data. Bank data can be registered up to 8 in NORMAL mode, and up to 32 in JUDGMENT VALUE mode.
(3)	Bank data	This is used to set functions to perform measurements. It consists of sensing setting, task setting, and I/O setting.
(4)	System data	System data common to all banks.

A list of menu items displayed with right click

Tree view items	Menu	Description
Device group	Add I ZW	Adds a sensor to the project.
	Paste	Pastes the copied sensor to the project.
	Rename	Changes the device group name.
Sensor model	Edit	Displays the main pane as the Edit pane.
	Delete	Deletes a sensor from the project.
	Copy	Copies a sensor.
	RUN	Switches the sensor to RUN mode.
	FUNC	Switches the sensor to FUNC mode.
	Online	Switches the connection status with the sensor to online.
	Offline	Switches the connection status with the sensor to offline.
	Sensing monitor	Displays the sensing monitor in the edit window.
	Trend monitor	Displays the trend monitor in the edit window.
	Save settings	Save the sensor settings data to nonvolatile memory.
	Initialize Sensor	Initialize the sensor.
	Restart	Restart the sensor.
	Print	Setting data is printed.
Bank data	Edit	Displays the bank data edit pane as the Edit pane.
	Copy	Copies a bank data.
	Paste	Overwrites the bank data. (*1)
	Initialize	Deletes (initializes) bank data.
	Rename	Changes the bank data name.
System data	Edit	Displays the system data edit pane as the Edit pane.
	Copy	Copies system data.
	Paste	Overwrites system data. (*1)

*1 Overwrite is possible between the same series of ZW (between ZW-C and ZW-CE series or between ZW-5□, ZW-7□ and ZW-8□ series).

Edit pane



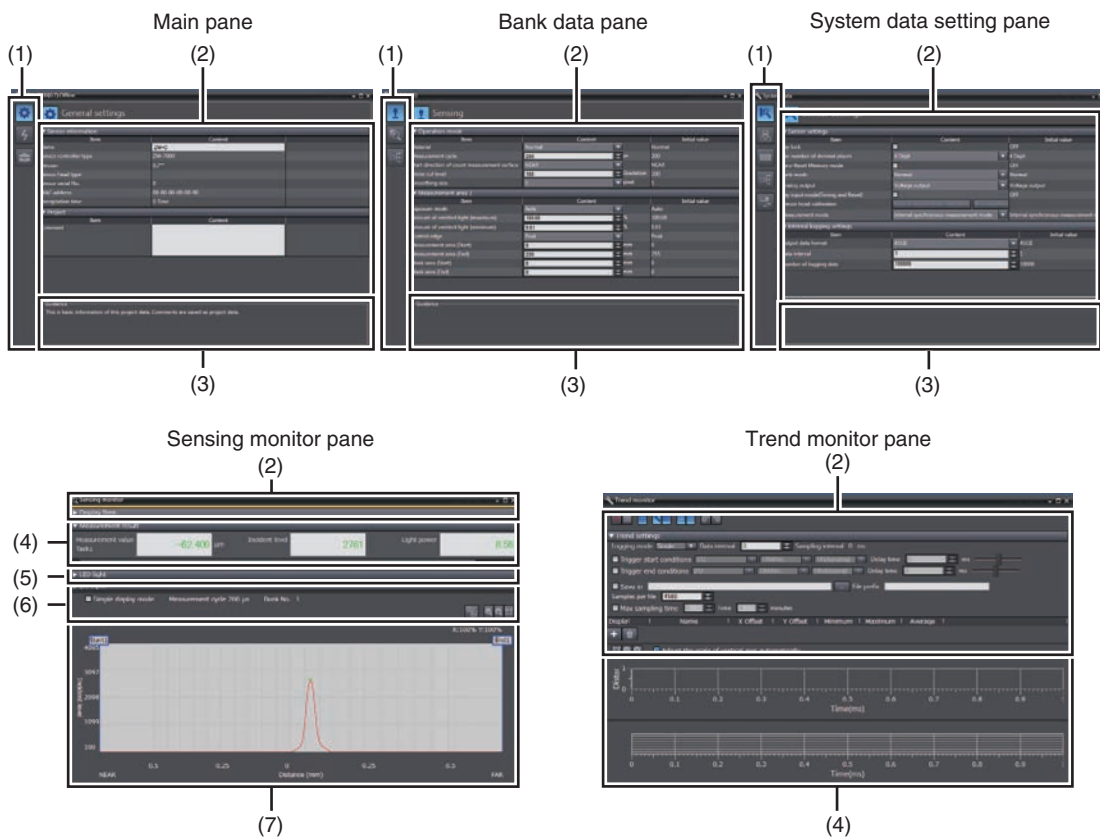







The Edit Pane changes as shown below based on what is selected in the Multi View Explore.



No.	Name	Description
(1)	Menu icon	Parameters to be edited on each edit pane can be changed.
(2)	Setting item	Each setting item can be edited.
(3)	Guidance	The description of the focused setting item is displayed.
(4)	Measurement value monitor	The selected measurement results or output values are displayed.
(5)	LED light	The status of each LED light is displayed when online.
(6)	I/O input	The status of I/O signals can be switched when online.
(7)	Line bright monitor	The line bright is displayed.

List of icons

(1) Menu icon

Edit pane type	Icon	Menu name	Description
Main pane		General settings	Sensor project information can be verified.
		Online	Switching between online and offline connections with the actual sensors, and switching the operating mode can be performed. Also, the internal logging process, saving set data, monitoring the measurement results can be performed.
		Tool	The initialization or upgrading the version of the actual sensor can be performed.
Bank data edit pane		Sensing	Switching the operation mode (1 area/2 area), and setting exposure time and measurement areas can be performed.
		Task 1	Allows you to perform setting to calculate the feature amounts of height, thickness and calculation using scaling, filter, and hold processes. Settings can be made individually for the task 1 to 4.
		I/O	Allow you to make settings for judgment output, and analog output.
System data setting pane		Sensor settings	Allows you to make sensor settings such as bank mode or analog output.
		Ethernet communication settings	Allows you to make settings for Ethernet communication.
		RS-232C communication settings	Allows you to make settings for RS-232C communication settings.
		Data output settings	Edit the data output settings.
		I/O setting	Specify the settings related to parallel input and output.

(2) Operation icons

Sensing monitor window



Icon	Name	Description
	Zoom in	Zoom in the line bright.
	Zoom out	Zoom out the line bright.
	Fit to frame	Change the size of the line bright so it fits the window size.
	Export	Saves the line bright being displayed.

Trend monitor window



Icon	Name	Description
	Start sampling	Starts the sampling.
	Stop sampling	Stops the sampling.
	Show grid	Displays gridlines.
	Show configuration	Displays the logging condition setting window.
	Show data table	Displays the data window to be logged.
	Show Analog Chart	Displays the analog chart window. The measurement value is displayed. The display can be turned on and off by pressing the button.
	Show Digital Chart	Displays the digital chart window. The status of the control signal is displayed. The display can be turned on and off by pressing the button.
	Import	Imports the exported measurement results and display them on each chart.
	Export	Exports the measurement results displayed on each chart.

2-8 Saving a project

Saving a project

Save the project being edited with the PC tool.
The project to be saved has the following information.

Configuration data	Description
Project information	Information on the sensor registered in this project.
Entire sensor information	Entire sensor information.
Tool setting information	Information on tool setting parameters for each sensor registered in this project.

Note

 3-2 Switching operation modes p.98

Important

- Save a project data when the setting of the Sensor Controller is changed. If the power is turned off without saving, the changed setting is cleared.

 Saving the Bank/System Settings p.185

1 Menu bar: Click [File] - [Save] to select.

Exporting a project

A project data (.smc) can be exported.
The exported data can be used by importing with the other personal computer's PC tool.

1 Menu bar: Click [File] - [Export] to select.

Importing a project

The exported data from other personal computers can be imported as project data.

1 Menu bar: Click [File] - [Import] to select.

MEMO

Operation during RUN Mode

3-1 Setting the Measurement Start Timing	96
3-2 Switching operation modes	98
3-3 Displaying Measured Values and Received Light Waveform	99
3-4 Perform the Zero Reset	100
3-5 Displaying measured values in graphs	103
3-6 Saving measured values in a file	109
3-7 Displaying saved measured values	113
3-8 Performing internal logging	114
3-9 Bank switching	119
3-10 Operating with Sensor Controller	120

3-1 Setting the Measurement Start Timing

Internal Processing of Sensor Controller

The Sensor Controller performs processing in the following 3 parts according to the logical beam sent from the Sensor Head. Since each part is performed in parallel inside the Sensor Controller, the measurement cycle is determined by the part with the longest processing time. When the measurement cycle is shortened, the logical beam exposure time shortens, so the measurement of targets to measure with lower reflectivity may become unstable.

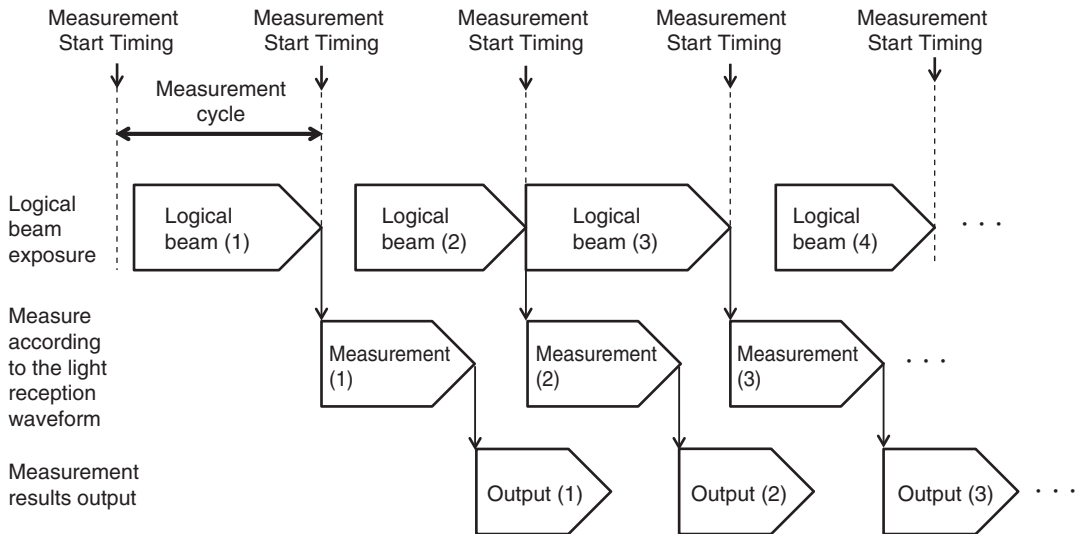

The Sensor Controller starts exposing logical beam when the measurement start timing is specified. When the light power is 100%, exposure starts when the measurement starts, but when the light power is less than 100%, there is a period with no exposure after the measurement starts. The exposure starts when the measurement starts and ends when the measurement cycle ends.

● light power is 100%

● light power is 50%

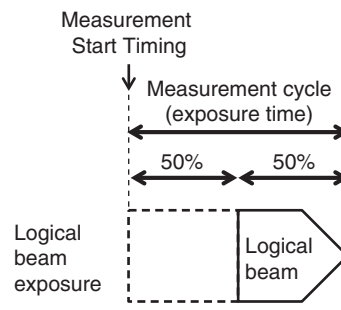
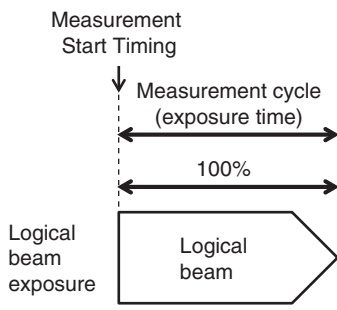

Measurement Mode and Measurement Start Timing

The procedure for specifying the measurement start timing can be selected from the following three modes. Use these modes to synchronize the measurement timing between sensors or to perform synchronization control with a servomotor or other external devices.

Item	Setting item	Setting value	Description
Sensor settings	Measurement mode	Internal synchronous measurement mode (initial value)	The measurement start timing is automatically determined according to the set measurement cycle intervals. Use this mode to perform measurements continuously with a sensor only or to shorten the measurement cycle as much as possible.
		External synchronous measurement	The measurement start timing is specified by TRIG input signals. Use this mode to perform measurements in synchronization with external signals from parallel I/O. One measurement is performed for each TRIG input signal. In the 2 area mode, measurements for 2 areas are performed continuously.
		PDO synchronized mode	The measurement start timing is determined by Sync0 signals automatically sent from the EtherCAT master. Use this mode to perform measurements by synchronizing the EtherCAT slave and EtherCAT master slave.

► **Multi View Explore** : [System] | [System Data] (double-click)
 → **Edit pane** : [Sensor Settings] icon 

1 Set [Measurement mode].

Important

- Measures one by one input the external Trigger signal in External synchronous measurement mode.
- Need to input the external Trigger signal depending on the setting content of the filtering process.
 Example)
 When you set the Average number to 128, need the external Trigger signal to input 128 counts.
- When you use the external synchronous measurement mode, the trend monitor graph is updated every 128 counts.
- When you set the Exposure control mode to Auto, multiple inputs of external Trigger signal are necessary after adjusting the measurement object within the measurement range for optimization of exposure status.
- The following items use parameters from External/PDO synchronous measurement mode, or outside of the Internal synchronous measurement mode so separate settings by mode is possible.

Item	Setting item
Average number of times	Average number of times
Differentiation filter	Differentiation cycle
Trigger delay mode	Delay time
	Sampling time

Note

3-1 EtherCAT Connection in Confocal Fiber Type Displacement Sensor ZW-8000/7000/5000 series User's Manual for Communication settings (Cat. No. Z363).

3-2 Switching operation modes

The Sensor Controller has two operation modes. One is RUN mode/Setup mode and the other is FUNC mode. Switch to the desired mode depending on purpose.

(The Sensor Controller always starts up in the RUN mode when the power is turned on.)

Item	Setting item	Mode	Description
Online	Operation mode	RUN	Switches to RUN (operation) mode. Normal operation mode.
		FUNC	Switches to FUNC mode. Mode for setting the measurement conditions.

► **Multi-view explorer** : [Device Group] | [(Sensor Name)] (double click)
 → **Edit pane** : [Online] icon (⚡)

1 Select the operation mode with [Operation mode].

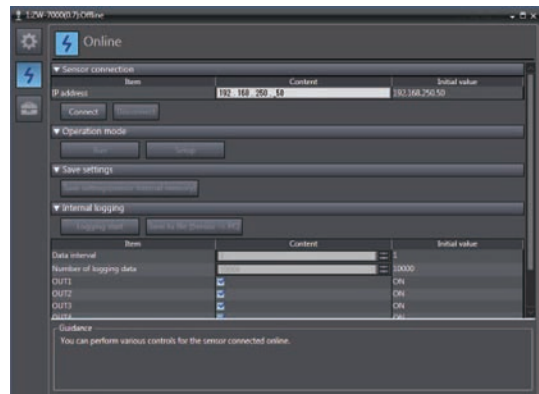

Important

When operating the Sysmac Studio, regardless of its operation mode (RUN or Setup), always set the operation mode of the Sensor Controller to RUN.

Note

The operation mode of the Sensor Controller can be switched only with a key operation.

 7-1 Basic Operation p.210

3-3 Displaying Measured Values and Received Light Waveform

The measurement values and received light waveform can be displayed.

► **Multi View Explore** : [Device Group] | [(Sensor Name)] (right-click)

1 Select [Sensing monitor].

On the edit pane, the [Sensing monitor] window appears.



2 According to the items for result display, add or delete [Display item].

Click the [add target data] icon ().

To delete the target data from the list, select the line, and then click [Delete].

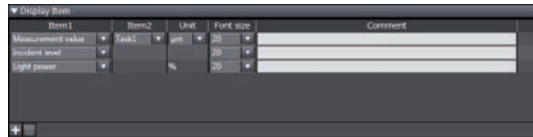

Item1	Item2	Unit	Description
Amount of received light	-	None	Amount of received light in a specified area.
Amount of emitted light	-	%	Amount of emitted light in a specified area.
Measurement value	TASK1/TASK2/TASK3/TASK4	μm, mm	Measurement value of a specified TASK.
Judgment upper limit value		μm, mm	Judgment upper limit value of a specified TASK.
Judgment lower limit value		μm, mm	Judgment lower limit value of a specified TASK.
Resolution		μm, mm	Resolution of a specified TASK.
Current value	-	mA	Output current value
Voltage value	-	V	Output voltage value
Absolute distance	-	μm, mm	Value of distance to a workpiece surface.
Current bank	-	-	Current bank number

Note

Can change the font size (9 to 40) for each item.
Also can enter comment and change the number of items displayed on each line.

Item	default value	Range
Font size	20	9 to 40
Number of displayed item by one line	2	1 to 5

3-4 Perform the Zero Reset

Zero reset

What is Zero Reset?

This function allows resetting the measured value to “0” at any timing during measurement in the RUN mode. The measured value can be displayed and output as a positive or negative deviation (tolerance) from the set reference value “0”.

Example 1: Use the height of the sensing object as a reference value and the deviation is the measured value.

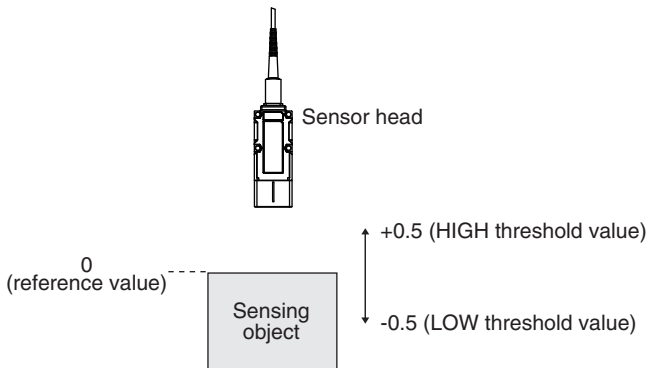

Example 2: Use the measured value according to the height of the sensing object (set 10 as an offset value)

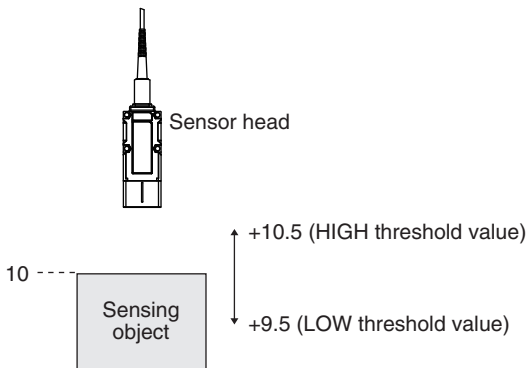

Example 3: Measure the level difference of the sensing object (execute zero reset at every measurement)

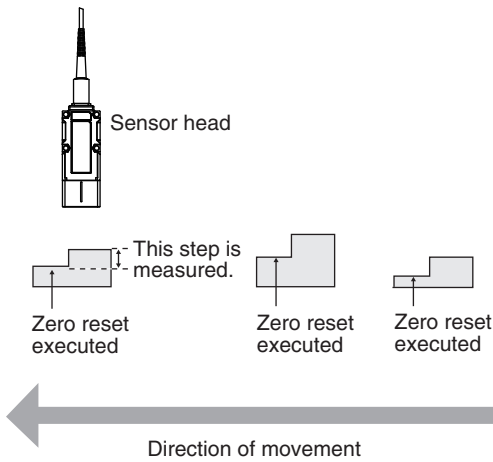

The zero reset function also allows setting the reference value to the hold value for a hold measurement or any value other than zero.

Setting the Zero Reset p.169 p.256

Executing Zero Reset

- 1 Place the reference sensing object in position.

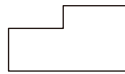

- 2 Press the key.

The ZERO indicator illuminates and the current measured value is registered as 0.

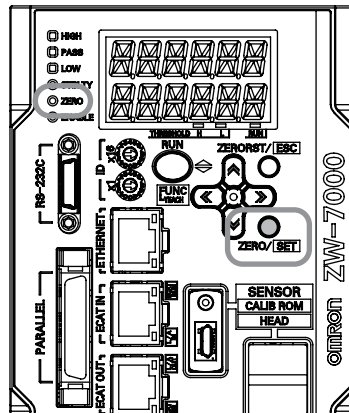



Important

- When a zero reset is executed, the analog output becomes the voltage or current value at the center of the two preset points. Analog output becomes roughly 0 V or 12 mA when focus is not set.

 “2-1 Parallel I/O connection” described in Displacement Sensor ZW-8000/7000/5000 series Confocal Fiber Type Displacement Sensor User’s Manual for Communications Settings (Z363)

- The Zero Reset function can also be executed by supplying a ZERO signal to the 32-pole extension connector.

 32-pole extension connector p.78

 “2-1 Parallel I/O connection” described in Displacement Sensor ZW-8000/7000/5000 series Confocal Fiber Type Displacement Sensor User’s Manual for Communications Settings (Z363)

- The Zero Reset function can also be executed by turning ON the EtherCAT ZERO input signal.

 “3-1 EtherCAT Connection” described in Displacement Sensor ZW-8000/7000/5000 series Confocal Fiber Type Displacement Sensor User’s Manual for Communications Settings (Z363)

Canceling Zero Reset

- 1 Press and hold the  key for two seconds.

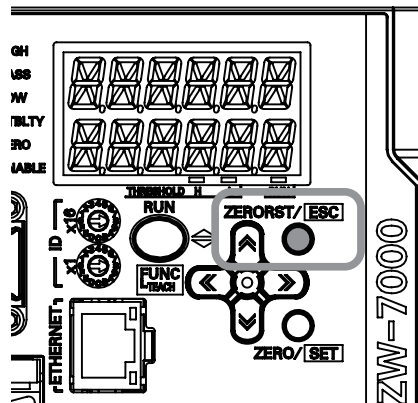

Important

- The Zero Reset function can also be executed by supplying a ZERO signal to the 32-pole extension connector.

 32-pole extension connector p.78

 “2-1 Parallel I/O connection” described in Displacement Sensor ZW-8000/7000/5000 series Confocal Fiber Type Displacement Sensor User’s Manual for Communications Settings (Z363)

- The canceling Zero Reset function can also be executed by turning ON the EtherCAT ZEROCLR input signal.

 “3-1 EtherCAT Connection” described in Displacement Sensor ZW-8000/7000/5000 series Confocal Fiber Type Displacement Sensor User’s Manual for Communications Settings (Z363)

3-5 Displaying measured values in graphs

The measured values can be displayed in graphs.

Important

This function can only be used with project of the displacement sensor (ZW).

With project of the controller (NJ), you can use the “Data trace” function to display graphs of measured values.

Allowable setting range of sampling interval is 500 μs to 100 ms.

If the sampling interval is short, can miss the measurement value depending on the loaded condition.

- ▶ **Multi View Explore** : [(ZW model name)] (double click)
 - **Edit pane** : [Online] icon (⚡)
 - **Online setting window** : [Monitoring]-[Trend monitor start]

- 1** Click [Trend monitor start].
The Trend Monitor window starts up.

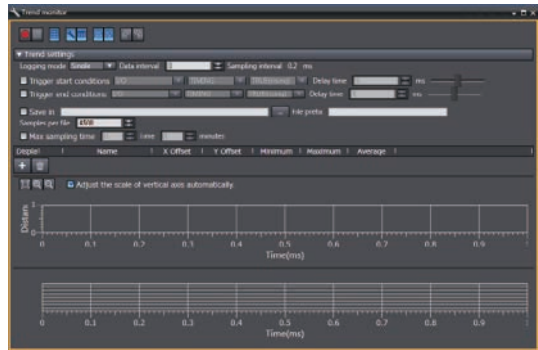
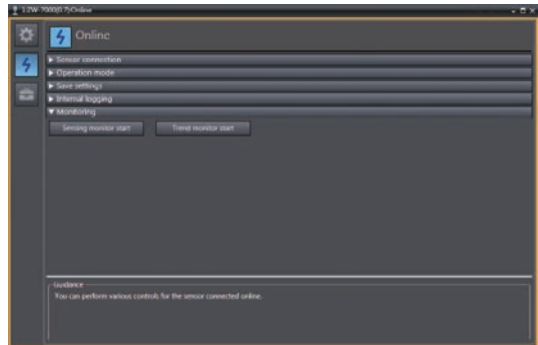

- 2** Add the data to monitor the trend for.
Add the data to monitor the trend for to the list.

Click the logging target data display icon (📄) to add to the list of data to be logged.

Click the add target icon (+)

A new target data line is added.

Display	Name	X Offset	Y Offset	Minimum	Maximum	Average
<input checked="" type="checkbox"/>	TASK1	0	0.000000			
<input checked="" type="checkbox"/>	PLAS1	0	0.000000			

Note

To delete target data from the list, select the line with the data to be deleted, then click the [Delete].
The maximum number to add the list is 20.

3 Select data to monitor the trend for.

Set data to monitor the trend for.

The types of data that can be set are as follows.

Item	Setting item	Description
Target data	OUT1	Measurement results assigned to OUT1
	OUT2	Measurement results assigned to OUT2
	OUT3	Measurement results assigned to OUT3
	OUT4	Measurement results assigned to OUT4
	TIMING	TIMING input signal (parallel I/O)
	ZERO	ZERO input signal (parallel I/O)
	BUSY	BUSY output signal (parallel I/O)
	ENABLE	ENABLE output signal (parallel I/O)
	HIGH	HIGH output signal (parallel I/O)
	PASS	PASS output signal (parallel I/O)
	LOW	LOW output signal (parallel I/O)
	TASKSTAT	TASKSTAT output signal (parallel I/O)
	LOGGING	LOGGING input signal (parallel I/O)
	LOGSTAT	LOGSTAT output signal (parallel I/O)
	LOGERR	LOGERR output signal (parallel I/O)
	STABILITY	STABILITY output signal (parallel I/O)
	RESET	RESET output signal (Parallel I/O)
	LIGHT_OFF	LIGHT_OFF input signal (parallel I/O)
BUFFER_ERR	Turn ON when dropping occurs. Dropping may occur depending on the load factor of PC when acquiring data from ZW-8000/7000/5000 series. If dropping occurs, increase the arguments of logging.	

4 Set the logging sampling interval.

Set the logging sampling interval for the target data.

Item	Setting item	Range	Description
Sampling setting	Logging sampling interval	* 1	Set the sampling interval for the target data.

* 1: The types of values that can be set vary depending on the measurement cycle being set.
Values outside the following range cannot be set.
0.5 [ms]/Measuring cycle [ms] to 100 [ms]/Measuring cycle [ms]

5 Click the Start icon () to start the sampling.

When the sampling starts, the sampled data is displayed in the graph.

Note

You can also specify the timing (start trigger, end trigger) for the graph display.

6 Click the End icon () to end the sampling.

When the sampling ends, the graph display stops too.

Specifying the sampling start and end conditions

You can specify the conditions for starting and ending sampling.

1 Check the Trigger start conditions/Trigger end conditions checkbox.

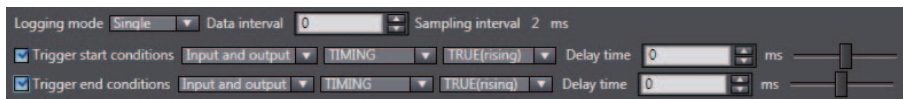

2 Select the trigger condition.

Item	Setting item	Range	Description
Trend setting	Trigger start conditions	I/O	Parallel I/O are specified as the trigger condition the following: TIMING, ZERO, BUSY, ENABLE, HIGH, PASS, LOW, TASKSTAT, LOGGING, LOGSTAT, LOGERR, STABILITY, RESET, LIGHT_OFF, BUFFER_ERR as the trigger condition.
		Data slope	Sets the change in the measurement values for OUT1 to OUT4 as the start condition. Sets the trigger level. The time the measurement value rises above this value or falls below it is set as the start condition.
		Data window (In)	Sets the change in the measured values for Out1 to Out4 as the start condition. When the measured value is inside the range, the start trigger is issued.
		Data window (Out)	Sets the change in the measured values for Out1 to Out4 as the start condition. When the measured value is outside the range, the start trigger is issued.
	Trigger end conditions	I/O	Specify parallel I/O (TIMING, ZERO, BUSY, ENABLE, HIGH, PASS, LOW, TASKSTAT, LOGGING, LOGSTAT, LOGERR, STABILITY, RESET, LIGHT_OFF, BUFFER_ERR) as the trigger condition.
		Data slope	Sets the change in the measurement values for OUT1 to OUT4 as the start condition. Sets the trigger level. The time the measurement value rises above this value or falls below it is set as the start condition.
		Data window (In)	Sets the change in the measured values for Out1 to Out4 as the start condition. When the measured value is in the range, the end trigger is issued.
		Data window (Out)	Sets the change in the measured values for Out1 to Out4 as the start condition. When the measured value is outside the range, the end trigger is issued.
		Number of data	The sampling data is counted from when the start condition is met and when the specified number of data points have been sampled, the end trigger is issued.

3 Select the trigger target.

Item	Setting item	Range	Description
Trigger target	I/O	TIMING	TIMING input signal (parallel I/O)
		ZERO	ZERO input signal (parallel I/O)
		BUSY	BUSY output signal (parallel I/O)
		ENABLE	ENABLE output signal (parallel I/O)
		HIGH	HIGH output signal (parallel I/O)
		PASS	PASS output signal (parallel I/O)
		LOW	LOW output signal (parallel I/O)
		TASKSTAT	TASKSTAT output signal (parallel I/O)
		LOGGING	LOGGING input signal (parallel I/O)
		LOGSTAT	LOGSTAT output signal (parallel I/O)
		LOGERR	LOGERR output signal (parallel I/O)
		STABILITY	STABILITY output signal (parallel I/O)
		RESET	RESET output signal (Parallel I/O)
		LIGHT_OFF	LIGHT_OFF input signal (parallel I/O)
		BUFFER_ERR	Turn ON when dropping occurs. Dropping may occur depending on the load factor of PC when acquiring data from ZW-8000/7000/5000 series. If dropping occurs, increase the arguments of logging.
	Data slope	OUT1	Measurement results assigned to OUT1
	Data window (in)	OUT2	Measurement results assigned to OUT2
Data window (out)	OUT3	Measurement results assigned to OUT3	
	OUT4	Measurement results assigned to OUT4	

4 Set the trigger condition.

- When the trigger target is “Data slope”

Trigger start conditions: Data slope TASK1 = 0.000000 Delay time 0 ms

Item	Setting item	Range	Description
Trigger condition	Condition	=	When the measurement results are the same value as the judgment value, the trigger condition is considered to have been met.
		≠	When the measurement results are a different value from the judgment value, the trigger condition is considered to have been met.
		>	When the measurement results are greater than the judgment value, the trigger condition is considered to have been met.
		≥	When the measurement results are greater than or equal to the judgment value, the trigger condition is considered to have been met.
		<	When the measurement results are less than the judgment value, the trigger condition is considered to have been met.
	≤	When the measurement results are less than or equal to the judgment value, the trigger condition is considered to have been met.	
	Judgment	-999.999999 to 999.999999 mm	This is the judgment value for the measurement results.

- When the trigger target is “Data window (In)”

Trigger start conditions: Data window(In) TASK1 -999.999999 999.999999 Delay time 0 ms

Item	Setting item	Range	Description
Trigger condition	Judgment value 1	-999.999999 to 999.999999 [mm]	When the measurement results are greater than or equal to judgment value 1 and less than or equal to judgment value 2, the trigger condition is considered to have been met.
	Judgment value 2	-999.999999 to 999.999999 [mm]	

- When the trigger target is “Data window (out)”

Item	Setting item	Range	Description
Trigger condition	Judgment value 1	-999.999999 to 999.999999 [mm]	When the measurement results are less than judgment value 1 or greater than judgment value 2, the trigger condition is considered to have been met.
	Judgment value 2	-999.999999 to 999.999999 [mm]	

- When the trigger target is “I/O”

Trigger start conditions: Input and output TIMING TRUE(rising) Delay time 0 ms

Item	Setting item	Range	Description
Trigger condition	Condition	TRUE (rising)	When the I/O signal rises, the trigger condition is considered to have been met.
		False (falling)	When the I/O signal falls, the trigger condition is considered to have been met.

Starting and ending sampling before and after the trigger condition is met

You can adjust how long to start or end the sampling before or after the condition for starting and ending sampling is met.

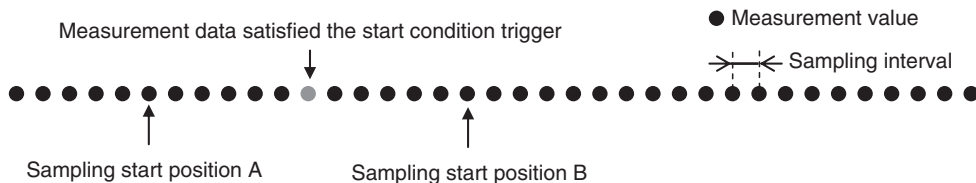

- **Sampling start position A**
To start sampling before the time when the trigger start condition is met, input a negative value for the delay time.
- **Sampling start position B**
To end sampling after the time when the trigger end condition is met, input a positive value for the delay time.

1 Input the delay time.

Trigger start conditions Data slope TASK1 = 0.000000 Delay time 0 ms

Item	Setting item	Range	Description
Trigger condition	Delay time	-9999 to 9999 ms	The sampling starts or ends at the time shifted by the set time from when the trigger condition is met.

Adjusting the scale of the axis in a graph automatically according to the measurement values

For the graph display of measurement values, you can adjust the scale of the vertical axis (distance) in a graph automatically according to the maximum and minimum values of measurement values.

1 Turn ON the [Adjust the scale of the axis automatically] checkbox.

To fix the scale of the vertical axis, turn OFF the checkbox.

2 Click the Start icon () to start the sampling.

When the sampling starts, the sampled data is displayed in the graph.

3-6 Saving measured values in a file

Data sampled with the trend monitor can be exported and imported as a CSV format file.

Outputting the results of sampling as a file

Sampled measured values can be saved as a CSV format file. A file is prepared each time the trigger condition is met.

- 1 Check the checkbox for the save destination.
- 2 Set the save condition.

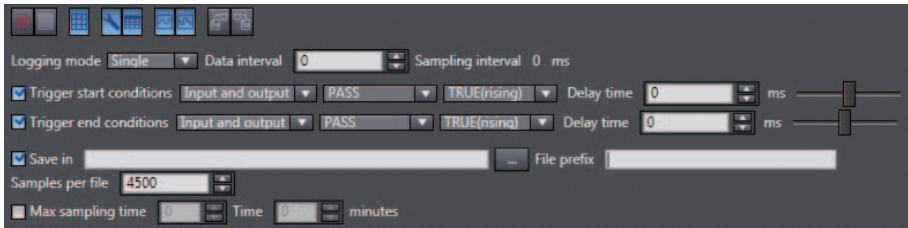

Item	Setting item	Range	Description
File settings	Logging mode	Single	When the trigger end condition is met, sampling stops.
		Continuous	Sampling does not stop until you press the End button. Each time the trigger start condition is met, a new file is prepared and saved.
	Logging sampling interval	(500μs/Measuring cycle-1 (rounded up to nearest integer)) to (100000μs/Measuring cycle-1 (rounded down to nearest integer))	This sets the interval to save the file. If 0 is set, the file is saved in each cycle.
	Save in	-	This is the folder to save the files in.
	File prefix	-	This is the prefix for the name of the file saved.
	Samples per file	100 to 10000000	This is the number of samples saved in one file. If more samples than this set number are taken, a new file is prepared.
Max sampling time	0:0 to 24:59	This indicates the upper limit on the interval for saving a file.	

Exporting the results of sampling

Sampled measured values can be exported as a CSV format file.

Item	Output items	Description
LoggingMode	Single Continuous	Indicates the sampling mode. Single or continuous
LoggingInterval	0 to 65535	Indicates the sampling interval.
TriggerStart	True False	Indicates whether the trigger start condition is "Enabled" or "Disabled".
TriggerStartType	IO DataSlope DataWindowIn DataWindowOut	Indicates the trigger start condition. IO: I/O result DataSlope: Data slope DataWindowIn: Data window (in) DataWindowOut: Data window (out)

Item	Output items	Description
TriggerStartObject	OUT1 OUT2 OUT3 OUT4 TIMING ZERO BUSY ENABLE HIGH PASS LOW TASKSTAT LOGGING LOGSTAT LOGERR STABILITY RESET LIGHT_OFF BUFFER_ERR	Indicates the target data for the trigger start condition.
TriggerStartConditions	EqualTo NotEqualTo AndMore MoreThan LessThan AndLess True (rising) False (falling)	Indicates the trigger start condition. EqualTo: = NotEqualTo: ≠ AndMore: ≥ MoreThan: > LessThan: < AndLess: ≤ True: Rising False: Falling
TriggerStartValue1	-999.999999 to 999.999999 mm	Indicates the judgment value for the trigger start condition. For data window (in/out), indicates the lower limit.
TriggerStartValue2	-999.999999 to 999.999999 mm	Indicates the judgment value for the trigger start condition. For data window (in/out), indicates the upper limit.
TriggerStartDelay	-999.999999 to 999.999999 mm	Indicates the delay time for the trigger start condition.
TriggerEnd	True False	Indicates whether the trigger end condition is "Enabled" or "Disabled".
TriggerEndType	IO DataSlope DataWindowIn DataWindowOut DataSize	Indicates the trigger end condition. IO: I/O result DataSlope: Data slope DataWindowIn: Data window (in) DataWindowOut: Data window (out) DataSize: Number of data points
TriggerEndObject	OUT1 OUT2 OUT3 OUT4 TIMING ZERO BUSY ENABLE HIGH PASS LOW TASKSTAT LOGGING LOGSTAT LOGERR STABILITY RESET LIGHT_OFF BUFFER_ERR	Indicates the target data for the trigger end condition.
TriggerEndConditions	EqualTo NotEqualTo AndMore MoreThan LessThan AndLess True (rising) False (falling)	Indicates the trigger end condition. EqualTo: = NotEqualTo: ≠ AndMore: ≥ MoreThan: > LessThan: < AndLess: ≤ True: Rising False: Falling

Item	Output items	Description
TriggerEndValue1	-999.999999 to 999.999999 mm	Indicates the judgment value for the trigger end condition. For data window (in/out), indicates the lower limit.
TriggerEndValue2	-999.999999 to 999.999999 mm	Indicates the judgment value for the trigger end condition. For data window (in/out), indicates the upper limit.
TriggerEndDelay	-999.999999 to 999.999999 mm	Indicates the delay time for the trigger end condition.
DataPointsvalue	1 to 2147483647	Indicates the data number of Trigger end condition.
ExternalFileStorage	Output destination of file.	Indicates the save destination of file (absolute path).
MaxSamplesPerFile	1 to 999999999	Indicates the number of samples in one file.
TargetDirectory		Indicates where the file is stored.
FilePrefix		Indicates the prefix.

- ▶ **Multi view Explore** : [(ZW model name)] (double click)
 → **Edit pane** : [Online] icon ()
 → **Online setting window** : [Monitoring]-[Trend monitor start]

- 1 Select [Trend Monitor].**
The Trend Monitor window starts up.
- 2 Execute the sampling.**

Note

 "2-1 Parallel I/O connection" described in Displacement Sensor ZW-8000/7000/5000 series Confo-cal Fiber Type Displacement Sensor User's Manual for Communications Settings (Z363)

- 3 After sampling execution, click the export icon ().**

4 Set the name of the export file.

The data is output in the following format.

LoggingMode	Single
LoggingInterval	3600
TriggerStart	True
TriggerStartType	DataSlope
TriggerStartObject	OUT1
TriggerStartConditions	EqualTo
TriggerStartValue1	1.1
TriggerStartValue2	
TriggerStartDelay	0
TriggerEnd	True
TriggerEndType	DataWindowIn
TriggerEndObject	OUT1
TriggerEndConditions	
TriggerEndValue1	-0.5
TriggerEndValue2	0.5
TriggerEndDelay	0
DataPointsValue	0
ExternalFileStorage	FALSE
MaxSamplesPerFile	4500
TargetDirectory	C:\Omron\Data\DataTrace\
FilePrefix	

Index	(DataName1)	(DataName2)
1	1.21314	1.21314
2	1.22098	1.22098
3	0.12334	0.12334
4	-0.1211	-0.1211
5	-1.23456	-1.23456
6	-1.22222	-1.22222

3-7 Displaying saved measured values

You can import a file to which measured values were exported and display those sampling results as a graph.

- ▶ **Multi view Explore** : [(ZW model name)] (double click)
- **Edit pane** : [Online] icon ()
- **Online setting window** : [Monitoring]-[Trend monitor start]

- 1 Select [Trend monitor start].**
The Trend Monitor window starts up.
- 2 Click the import icon ().**
- 3 Select the file to import.**
The file is imported and a graph displayed.

Note

The file of measurement values that are obtained from the internal logging function can be imported as well.

 3-8 Performing internal logging p.114

3-8 Performing internal logging

Up to 2000000 data of measurement values can be logged in the Sensor Controller's internal memory. Internal logging can be started or ended using Sysmac Studio, parallel I/O, or non-procedural communications commands.

The operating procedures for each method are shown below.

Function	Sysmac Studio	Parallel I/O	Non-procedural communications commands
Specify start timing	Press the "Logging Start" button.	LOGGING input ON	Send LS command
Specify end timing	Stops automatically after the specified number of logging data has been saved.	LOGGING input OFF	Send LE command
Terminate logging	After pressing the "Logging Start" button, press the displayed "Terminate" button	LOGGING input OFF	LE command
Output logging data	Press the "Save to file (Sensor → PC)" button.	Send LO/LG command	Send LO/LG command
Clear logging data	<ul style="list-style-type: none"> Automatically cleared after the "Logging Start" button is pressed if clear logging data is turned ON when logging starts Cleared when "Clear Logging Data" button is pressed 	Send LC command	Send LC command
Get logging information	Press the "Get logging information" button.	-	Send LI command

The settings that can be enabled for each method are shown below.

Function	Sysmac Studio	Parallel I/O	Non-procedural communications commands	
Overwrite mode	Sets the operation to be performed when the logging count exceeds the set number of logging data. OFF: Internal logging is stopped. ON : The oldest logging data is overwritten.	OFF	ON/OFF	ON/OFF
Label insert mode	Sets the operation to be performed when logging input is turned on. OFF: No operation. ON : When logging input is turned on, inserts label into logging data.	OFF	ON/OFF	ON/OFF
Output data format	-	ASCII	ASCII/Binary	ASCII/Binary

Important

Internal logging cannot be executed when in the following settings.

- When overwrite mode is ON or when the measurement cycle (internal synchronous measurement mode) is less than 40μs

Internal logging by Sysmac Studio

Data logging conditions and logging start/end timing can be set with Sysmac Studio.

- **Multi view Explore** : [(ZW model name)] (double click)
 - **Edit pane** : [Online] icon (🔌)
 - **Online setting window** : [Internal Logging]

1 Set the logging conditions.

Enter the [Data interval], [Number of logging data], and select the stored output data and whether to clear the stored logging data when logging starts.

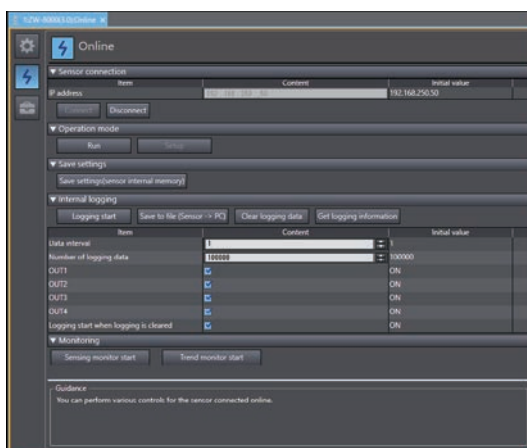

Item	Setting item	Range	Description
Data logging conditions	Data interval	1 to 1000	Set the data storage interval. If "1" is set, all measured data is stored, and "2" is set, one measurement value is stored every two measurement. If 0 is set, data is saved only when the hold value is applied.
	Number of logging data	1 to 200000	Set the number of data to store for the data that is assigned to each OUT.
	OUT1	OFF/ON	Set whether to store the measurement results for OUT1.
	OUT2	OFF/ON	Set whether to store the measurement results for OUT2.
	OUT3	OFF/ON	Set whether to store the measurement results for OUT3.
	OUT4	OFF/ON	Set whether to store the measurement results for OUT4.
	Logging start when logging is cleared	OFF/ON	Set whether to clear previously logged data when logging starts.

2 Click the [Logging start] button to start internal logging.

A confirmation message is displayed. Click [Yes] to start internal logging.

When the label insert mode is OFF, the internal logging data is automatically cleared before internal logging is started.

Once internal logging starts, another internal logging cannot be started until it ends.

If you want to stop logging partway, press the "Cancel" button of the following pop-up that is displayed during logging.

- Label insert mode not supported/
Label insert mode: OFF

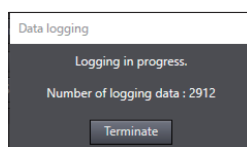

- Label insert mode: ON

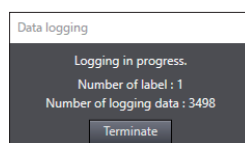

3 After internal logging ends, click the [Save to file (Sensor → PC)] to output the data to a file.

When saving to a file, set the saving start and end points on the following screens, and then press the "Save" button.

• Label insert mode: OFF

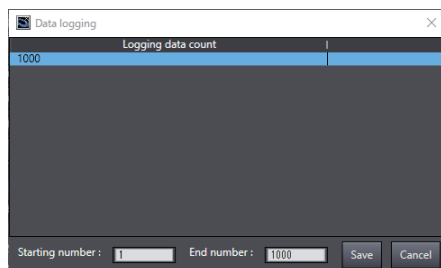

• Label insert mode: ON

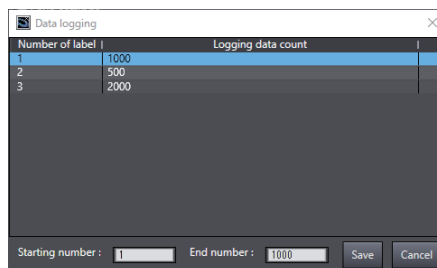

A CSV format file in the following format is output. Unit of each output values are the following:

Measure value: nm

Amount of emitted light: 0.01% (0.01 to 100.00%)

Amount of received light: Luminance level (0 to 4095)

LoggingMode	Internal			
Index	OUT1	OUT2	OUT3	OUT4
0	-1938	2823	9437	-2147483648
1	-1939	2764	9401	-2147483648
2	-1940	2773	9355	-2147483648
3	-1940	2807	9523	-2147483648
4	-1941	2794	9442	-2147483648
5	-1941	2817	9497	-2147483648

Performing Internal Logging with Parallel I/O

The logging start and end timings can be specified using LOGGING input signals from parallel I/O. When doing so, follow the procedure below to set the data logging conditions.

- ▶ **Multi view Explore** : [System] (double-click)
- **Edit pane** : [Sensor Settings] icon ()
- **Sensor settings window** : [Internal logging setting]

1 Set the logging conditions for internal logging.

There are three settings: Number of logging, number of logging decimation, and overwrite mode.

Item	Setting item	Setting value	Description
Internal logging setting	Number of logging data	0 to 2000000 (default value: 100000)	Set the number of data to save for each internal logging output data.
	Internal logging settings	0 to 1000 (default value: 1)	Set the interval of saving internal logging data. If 1 is set, all data is saved. If 2 is set, one measured data is saved every two measurements. If 0 is set, data is saved only when the hold value is applied.
	Overwrite mode	OFF (default value)/ON	Set whether to make the internal logging mode run in overwrite mode. Sets the operation to be performed when the logging count exceeds the set number of logging data. OFF: Internal logging is stopped. ON: The oldest logging data is overwritten.
	Label insert mode	OFF (default value)/ON	Set the operation to be performed when logging input is turned on. OFF: No operation. ON: When logging input is turned on, inserts label into logging data.

LOGERR signal is turned ON at the following cases:

- Overwrite mode is OFF
- 2,000,000 items have already been logged in the internal memory at the beginning of logging.

To continue to log regardless of the logging count while LOGGING input signal is turned ON, set as below:

- Number of logging data: 0
- Overwrite mode: ON

When the number of loggings reaches 2,000,000, past logging data is overwritten and logging continues on the latest data.

Overwrite mode and label insert mode cannot be used at the same time.

2 Set the output conditions of internal logging data.

Set the conditions for the external output using the non-procedural command LO.

Item	Setting item	Setting value	Description
Internal logging setting	Output data format	ASCII (default value)/ Binary	Select the output format for outputting internal logging data.

Note

For the response format of LO commands according to the output data format, refer to following page.



“5-1 Connecting by No-protocol Communications” described in Displacement Sensor ZW-8000/7000/5000 series Confocal Fiber Type Displacement Sensor User’s Manual for Communications Settings (Z363)

Internal logging with non-procedural commands

Non-procedural commands can be used to set data logging conditions or the logging start and end timings.

Note

For the details of command specifications, see the manual below.



“5-1 Connecting by No-protocol Communications” described in Displacement Sensor ZW-8000/7000/5000 series Confocal Fiber Type Displacement Sensor User’s Manual for Communications Settings (Z363)

3-9 Bank switching

Switching Banks

Switches banks.

- 1 Double click to open the bank group in the Multi View Explore.**
- 2 Select the bank data to switch and double click or right click it to select the Edit menu.**
The bank in the Bank data edit pane that is active on the Edit pane becomes the current bank.

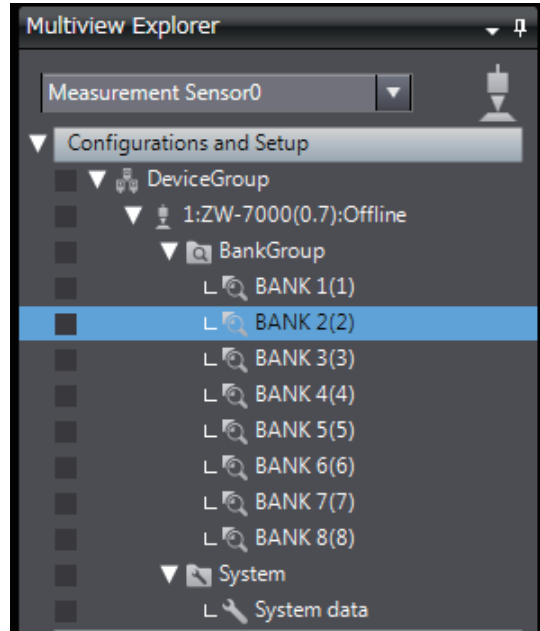

Important

You can also switch the bank by entering the non-procedural command.

-  "5-1 Connecting by No-protocol Communications" described in Displacement Sensor ZW-8000/7000/5000 series Confocal Fiber Type Displacement Sensor User's Manual for Communications Settings (Z363)

Note

Switching Banks can also be set by the operating keys on the Sensor Controller.

-  Switching Banks p.260

3-10 Operating with Sensor Controller

Other than using PC tools, ZW-8000/7000/5000 Series can also be operated using the operation keys on the Sensor Controller.

For details on how to operate with operation keys, see 7 Sensor controller operations p.209.

Settings for Function

4-1 Setting Sensing	122
4-2 Setting Measurement Items.....	138
4-3 Setting the Output Conditions	143
4-4 Setting Threshold Value	174
4-5 Setting I/O	176
4-6 Setting the System.....	183
4-7 Saving The Settings.....	185

4-1 Setting Sensing

Setting the Measurement Cycle

Set the measurement cycle. Extending the measurement cycle allows you to measure workpieces with lower reflectivity.

Item	Setting item	Setting value	Description
RUN mode	Measurement Cycle	Refer to the table below.	Set the measurement cycle.

Sensor Controller type	Extension fiber cable length	Minimum value (1 area mode) [μ s.]	Minimum value (2 area mode) [μ s.]	Maximum value [μ s.]	Initial value [μ s.]
ZW-8000□	none	60	150	7500	1000
	2 m			6500	900
	5 m			4500	800
	10 m			3500	700
	20 m			2500	600
	30 m			1500	500
ZW-7000□	none	20	40	400	200
	2 m			400	200
	5 m			400	200
	10 m			250	100
	20 m			160	80
	30 m			120	60
ZW-5000□	none	80	80	1600	800
	2 m			1600	800
	5 m			1450	700
	10 m			950	450
	20 m			550	250
	30 m			400	200

- ▶ **Multi View Explore** : [Bank Group] | [(Bank data name)] (double-click)
 - **Edit pane** : [Sensing setting] icon 
 - **Sensing settings window** : [Operating mode]

1 Set [Measurement cycle].

Important

If changing the extension fiber cable length setting causes the setting value of the measurement cycle to exceed the maximum value, the setting value is automatically changed to the maximum value.

Note

The measurement cycle can also be set by the operating keys on the Sensor Controller.



You can set the Measurement cycle by using key operation of the Sensor Controller p.222.

Setting the Area Mode

Area modes can be used selectively according to the target to measure.

Item	Setting item	Setting value	Description
RUN mode	Area Mode	1 area mode	Usually, select this setting.
		2 area mode	Select this mode when the measurement object is a transparent object and the reflection characteristics of the top surface and rear surface are very different. For example, if the received light amount of the rear surface is extremely large compared to the top surface, area 2 can be set to include only the light reception waveform of the rear surface so that the rear surface can be stably measured. This makes it possible to set the optimal exposure time for the rear surface.

- ▶ **Multi View Explore** : [Bank Group] | [(Bank data name)] (double-click)
 - **Edit pane** : [Sensing setting] icon()
 - **Sensing settings window** : [Operating mode]

1 Set [Area Mode].

Important

- When the 2 area mode is selected, [Measurement area 2] is added to the setting items for sensing setting.
- In the 2 area mode, the exposure time control mode and measuring area can be set for [Measurement area 1] and [Measurement area 2].
- In the 2 area mode, measurements are alternately performed for measuring area 1 and measuring area 2. Therefore, the measurement results are output with a measurement cycle that is twice as long as usual.

 Setting Light Exposure Time Control Mode p.129

 Setting the Measurement Area p.130



Item	Content	Initial value
Area mode	2 area mode	1 area mode
Material	Normal	Normal
Measurement cycle	EQ	200
Start direction of count measurement surface	NEAR	NEAR
Noise cut level	EQ	Gradation 100
Smoother size	5	5

- When using 2 area mode for the ZW-7000□/5000□, the following hardware and software are necessary.

Hardware: The serial number is one of the following or later.

ZW-5000□: 0645817 to

ZW-7000□: 0825817 to

* Serial number format

□ □ □ □ □ □ □

(1)(2)(3)(4)(5)(6)(7)

Digit	Meaning	Displayed characters
(1)	Sequential number from 0001	0001 to 9999
(2)		
(3)		
(4)		
(5)	Month of manufacture	1 to 9, X (October), Y (November), Z (December)
(6)	Year of manufacture	00 to 99
(7)	Last 2 digits of western year	

Software: Firmware version is 2.1 or later

Setting the Material of the Target to Measure

Select the appropriate linearity coefficient setting depending on the target to the measurement.

Item	Setting item	Setting value	Description
Operation mode	Material	Normal (default value)	A measurement can be performed at specific linearity regardless of the type of target to measure. Usually, select this setting.
		Mirror	This setting allows for high linearity measurement if the surface of the object gives a mirror-like reflection, such as with glass, wafer, or metallic luster objects.
		Rough	Selecting the mode when the surface is diffusing, possible to acquire the high linearity measurement of resin, ceramic, or etc.

- ▶ **Multiviewer Explore** : [Bank Group] | [(Bank data name)] (double-click)
 - **Edit pane** : [Sensing setting] icon ()
 - **Sensing settings window** : [Operating mode]

- 1** Select the material of the target to measure at [Material].

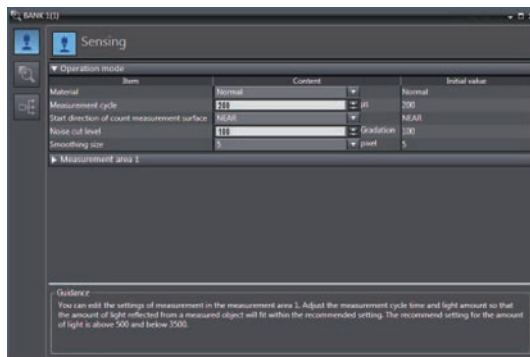

Important

This setting does not affect linearity.

Note

The material of the target to measure can also be set by the operating keys on the Sensor Controller.

 Setting the Material of the Target to Measure p.230

Setting the Noise Cut Level

The setting a larger value than the noise level, the noise can be cut.

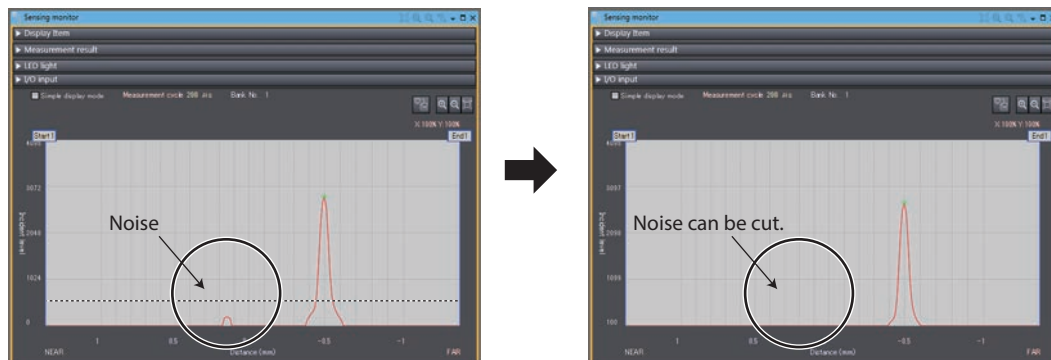

Item	Setting item	Setting value	Description
Operation mode	Noise cut level	0 to 1500 [Gradation] (default value :300(ZW-8000□), 100(ZW-7000□/5000□))	Set the number of gradations when noise is cut from the line bright.

- ▶ **Multiviewer Explore** : [Bank Group] | [(Bank Data Name)] (double click)
- **Edit pane** : [Sensing setting] icon ()
- **Sensing settings window** : [Operating mode]

1 Set [Noise cut level].

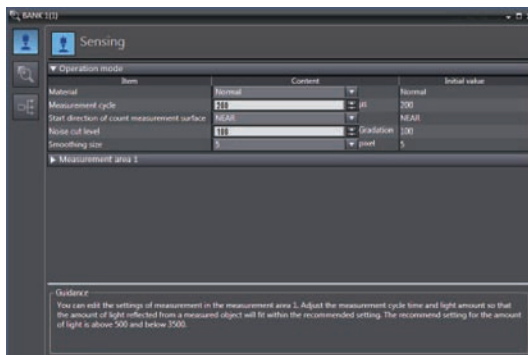

Setting Smoothing Size

When two measurement surfaces are close, the line bright may not be divided. The setting of smoothing size a smaller value, it becomes easy to divide.

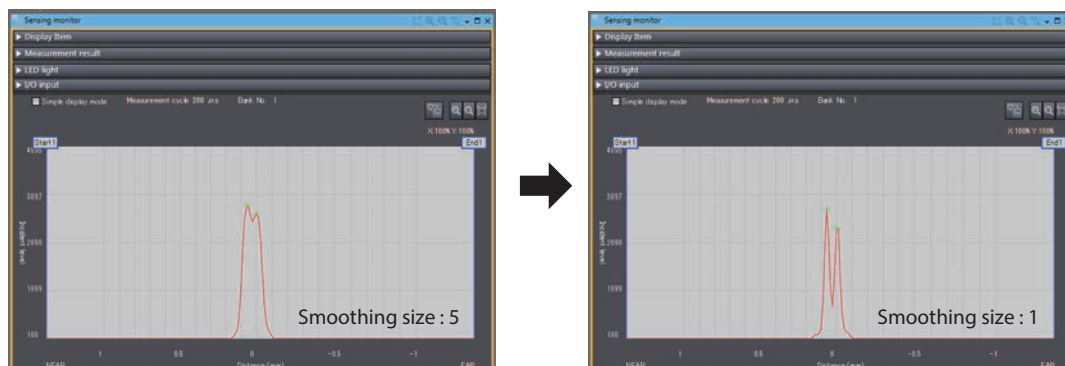

Item	Setting item	Setting value	Description
Operation mode	Smoothing size	1/3/5/7/9 [pixels] (Default value :5)	Set the pixel size to be used as the unit when smoothing the line bright.

- ▶ **Multiviewer Explore** : [Bank Group] | [(Bank Data Name)] (double click)
- **Edit pane** : [Sensing setting] icon ()
- **Sensing settings window** : [Operating mode]

1 Set [Smoothing size].

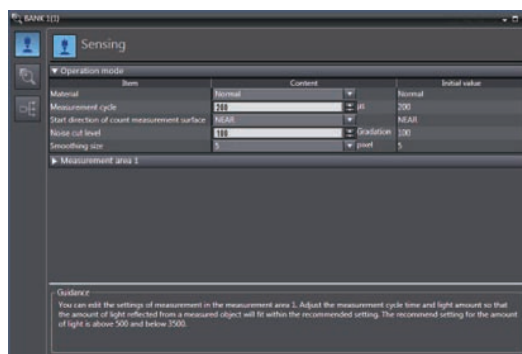

Important

Reducing the smoothing size may deteriorate measurement stability. If that happens, change the measurement surface setting or noise cut level.

Setting Start Direction of Count Measurement Surfaces

When a number of measurement surfaces exists, start direction can be selected from NEAR side or FAR side.

Example: NEAR

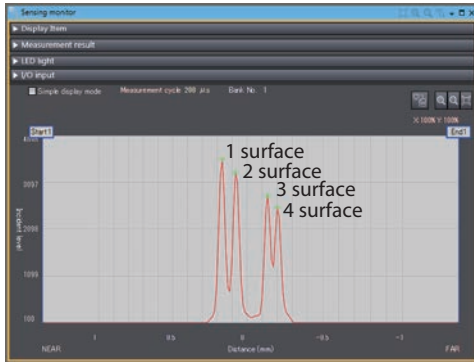

Example: FAR

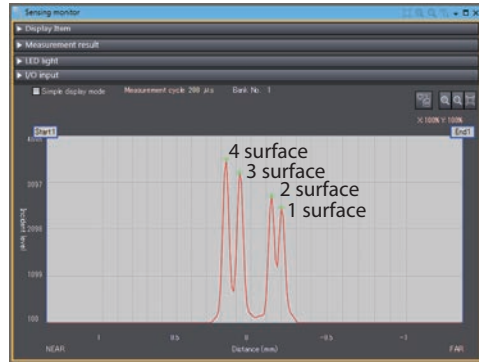

Item	Setting item	Setting value	Description
Operation mode	Start direction of count measurement surfaces	NEAR (default value)	Measurement surfaces are counted from NEAR side.
		FAR	Measurement surfaces are counted from FAR side.

Important

Surfaces will not be counted from the 5th surface onward.

Note

The setting of start direction of count measurement surfaces can also be set by the operating keys on the Sensor Controller.



Setting Start Direction of Count Measurement Surfaces p.231

Setting Light Exposure Time Control Mode

Set the amount of emitted light (maximum/minimum), amount of emitted light (fixed), and control edge.

Item	Setting item	Setting value	Description
Exposure time	Exposure control mode	Auto (default value)	Automatically sets the amount of emitted light within the range that does not exceed the specified upper limit. Usually, select this setting.
		Manual	Select this mode when you want to specify the amount of emitted light, and set the amount of emitted light (fixed value).
	Amount of emitted light (maximum)	0.01 to 100.00 (default value) [%]	When [Auto] is selected for light exposure control mode, set the upper limit value for the amount of emitted light. The amount of emitted light is set on the assumption that ([Measurement cycle]-3) μ s is taken as 100%.
	Amount of emitted light (minimum)	0.01 (default value) to 100.00 [%]	When [Auto] is selected for light exposure control mode, set the lower limit value for the amount of emitted light. The amount of emitted light is set on the assumption that ([Measurement cycle]-3) μ s is taken as 100%.
	Amount of emitted light (fixed)	0.01 to 100.00 (default value) [%]	When [Fixed] is selected for light exposure control mode, set the fixed value for the amount of emitted light. The amount of emitted light is set on the assumption that ([Measurement cycle]-3) μ s is taken as 100%.
	Control edge	Edge1/Edge2/Edge3/Edge4/Peak (default value)	Select the measurement surface target for light adjustment. Use this setting for multiple measurement surfaces. The peak is the surface of all measurement surfaces having the highest received light amount.

- ▶ **Multiviewer Explore** : [Bank Group] | [(Bank Data Name)] (double click)
 - **Edit pane** : [Sensing setting] icon ()
 - **Sensing settings window** : [Measurement area 1]

- 1** Select the light exposure control mode from [Light exposure control mode].

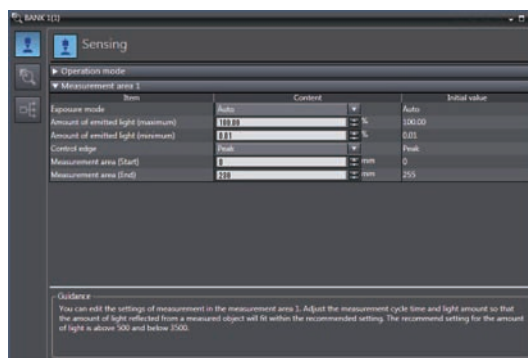

- 2** Set [Amount of emitted light] and [Control edge].

Note

- In the sensing monitor window, you can check whether the waveform of received light is obtained correctly as set up.



Displaying Measured Values and Received Light Waveform p.99

- The amount of emitted light cannot be exactly same as setting value [%] and actual control value [%] due to the control resolution difference of Sensor Controller (0.1[μs]). The minimum value of control resolution is 0.1[μs].
- When the amount of emitted light (maximum) [%]/100 for the measurement cycle [μs]* is set to fall below 10μs, the actual control amount of emitted light (maximum) is 10μs.

Setting the Measurement Area

Setting the start and end positions of the measurement area and mask area on the selected measurement area allows the area used for measurement to be limited.

Cutting out the areas where there is no measurement object makes it possible to measure the object with stability.

When the measurement object is set to “Glass,” measurement may not be performed correctly as measurement will be influenced by reflection from the rear surface. If this happens, set the measurement area of each measurement surface so that they can be correctly measured.

The measurement area can be set by dragging the start axis and end axis displayed on the sensing monitor screen.

Set the start and end positions of the measurement area so that the start position is greater than the end position.

Item	Setting item	Setting value	Description
Measurement area 1	Measurement area (start)	Measuring range of Sensor Head [mm]	Set the measurement start position for the selected measurement area. When the window for the selected measurement area is open, the start position can also be edited by dragging the start line on the line bright monitor.
	Measurement area (end)	Measuring range of Sensor Head [mm]	Set the measurement end position for the selected measurement area. When the window for the selected measurement area is open, the end position can also be edited by dragging the end line on the line bright monitor.
Measurement area 2 * Only in the 2 area mode	Measurement area (start)	Measuring range of Sensor Head [mm]	Set the measurement start position for the selected measurement area 2. When the window for the selected measurement area is open, the start position can also be edited by dragging the start line on the line bright monitor
	Measurement area (end)	Measuring range of Sensor Head [mm]	Set the measurement end position for the selected measurement area 2. When the window for the selected measurement area is open, the end position can also be edited by dragging the end line on the line bright monitor.

- ▶ **Multiviewer Explore** : [Bank Group] | [(Bank Data Name)] (double click)
 - **Edit pane** : [Sensing setting] icon
 - **Sensing settings window** : [Measurement area 1] or [Measurement area 2]

1 Set the values of [Measurement area (start)] and [Measurement area (end)].

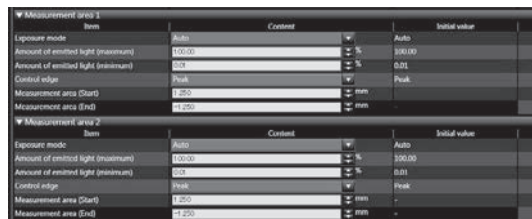

AreaTracks

When using the 2 area mode, by setting the reference edge and following edge, the measurement area of Area 2 can be automatically set to follow the workpiece even when it vibrates.

Below are examples of when the reference edge is set as the 1st edge and the following edge is set as the 2nd edge.

● When the workpiece is near the measurement center

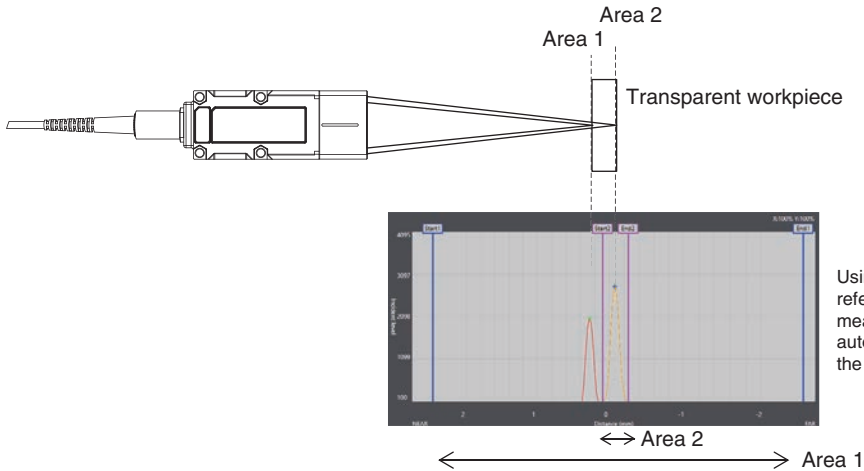

● When the workpiece is on the NEAR side

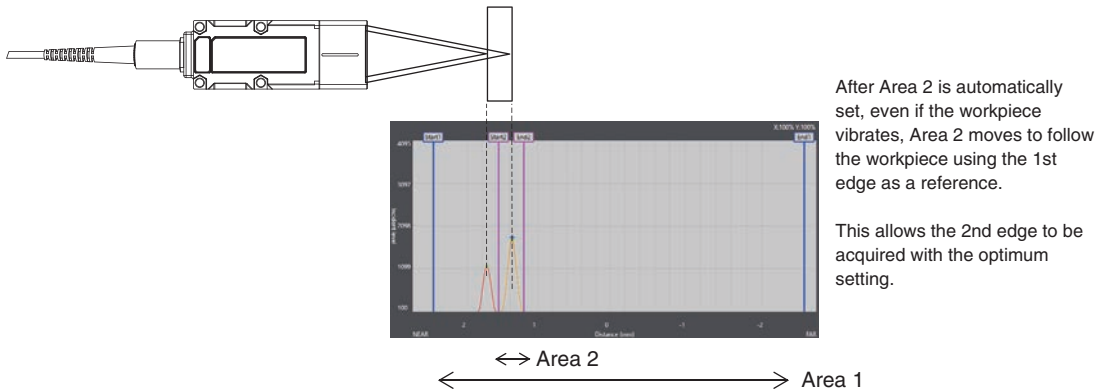

● When the workpiece is on the FAR side

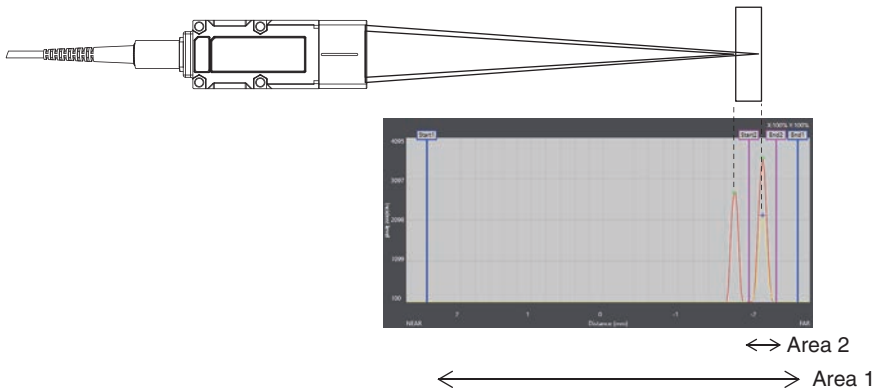

Item	Setting item	Setting value	Description
AreaTracks settings	AreaTracks	None (initial value)	Area follow is not set. Select this to set any desired value.
		Upper line	Follows the upper line of Area 2 only.
		Lower line	Follows the lower line of Area 2 only.
		Upper line and lower line	Follows the upper line and lower line of Area 2.
	Reference edge	Edge1/Edge2/Edge3/Edge4/peak (Initial value: Edge1)	Select the measurement surface of measurement area 1 to be used as the reference for automatic tracking. The peak is the surface of all measurement surfaces having the highest received light amount.
	Following edge	Edge1/Edge2/Edge3/Edge4/peak (Initial value: Edge2)	Select the measurement surface of measurement area 1 to be the target of automatic following. Measurement area 2 is automatically set based on the surface selected when [Area Teach] is clicked. The peak is the surface of all measurement surfaces having the highest received light amount.

- **Multi View Explorer** : [Bank Group] | [(Bank Data Name)] (double-click)
 → **Edit Pane** : [Sensing setting] icon ()
 → **Sensing settings window** : [measurement area 2] - [AreaTracks settings]

1 Set [AreaTracks].

2 Set [Reference edge] and [Following edge].

3 Click [Area Teach].

The area range suitable for measuring the following edge is automatically set as Area 2, then Area follow starts.

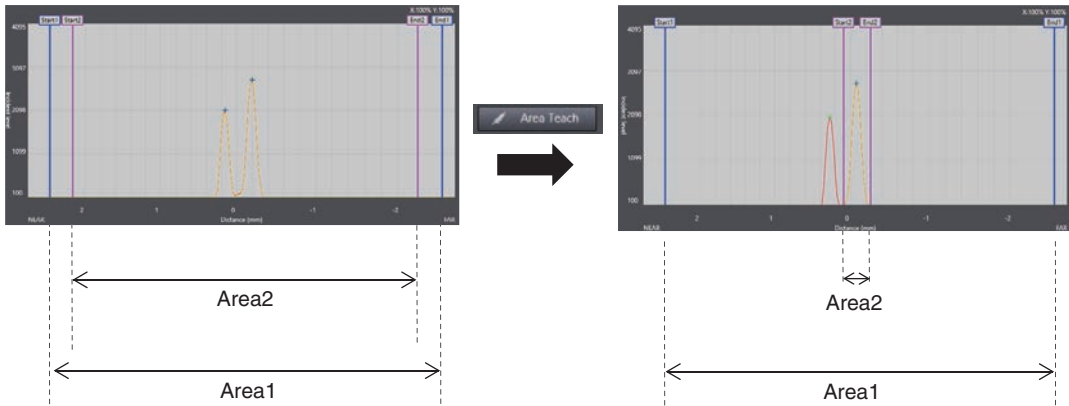

Important

An error occurs if Area Teach is executed under the following conditions.

- The reference edge or the following edge cannot be measured
- The reference edge number and the following edge number are the same

EdgeTracks

With ZW-8000□, when using 1 area mode, this function can be used to fix the edge number by setting the possible movement range (track area) of each edge.

This function can take stable measurements with no edge number deviation, even when an unstable edge is within the measurement range. This function cannot be used with ZW-7000□/5000□.

Example: When measuring target with multiple layers (4 edges)

● When not using EdgeTracks

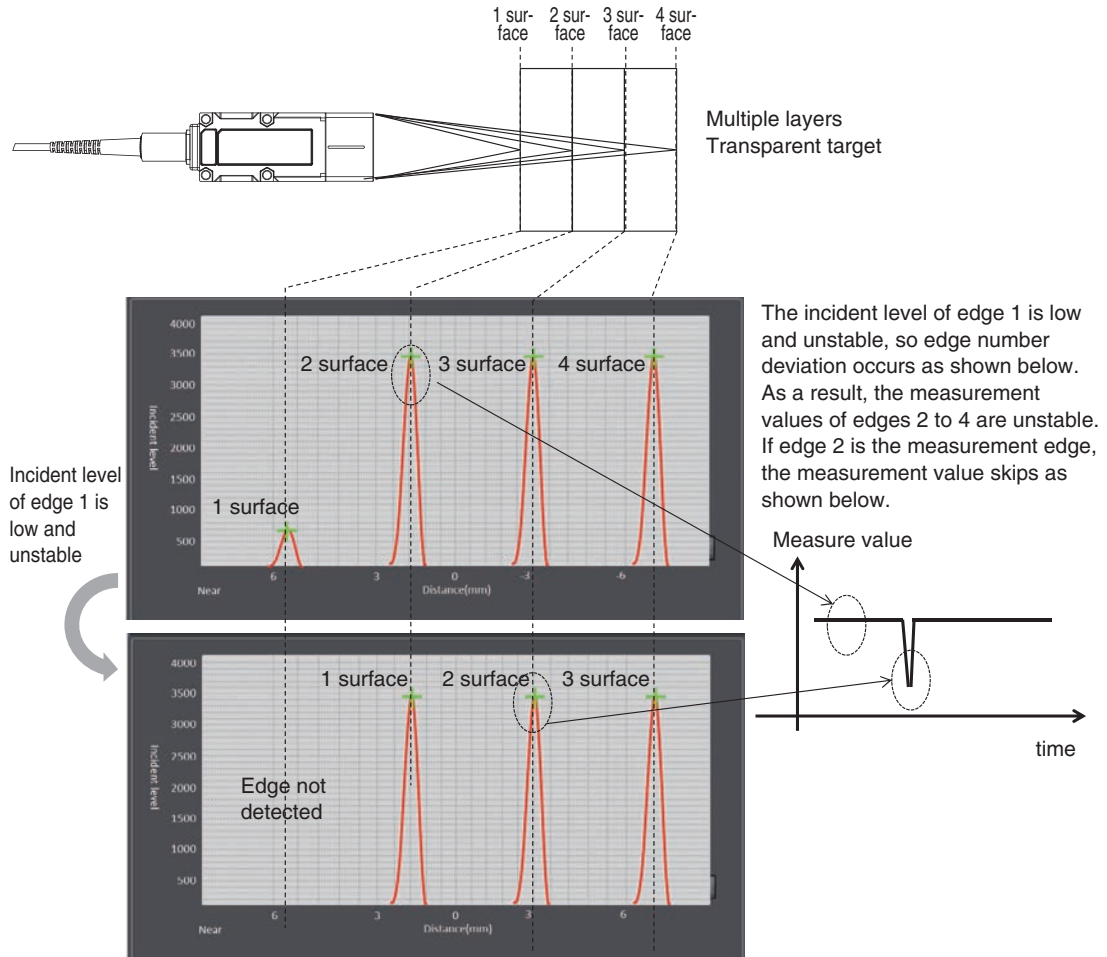

● When using EdgeTracks

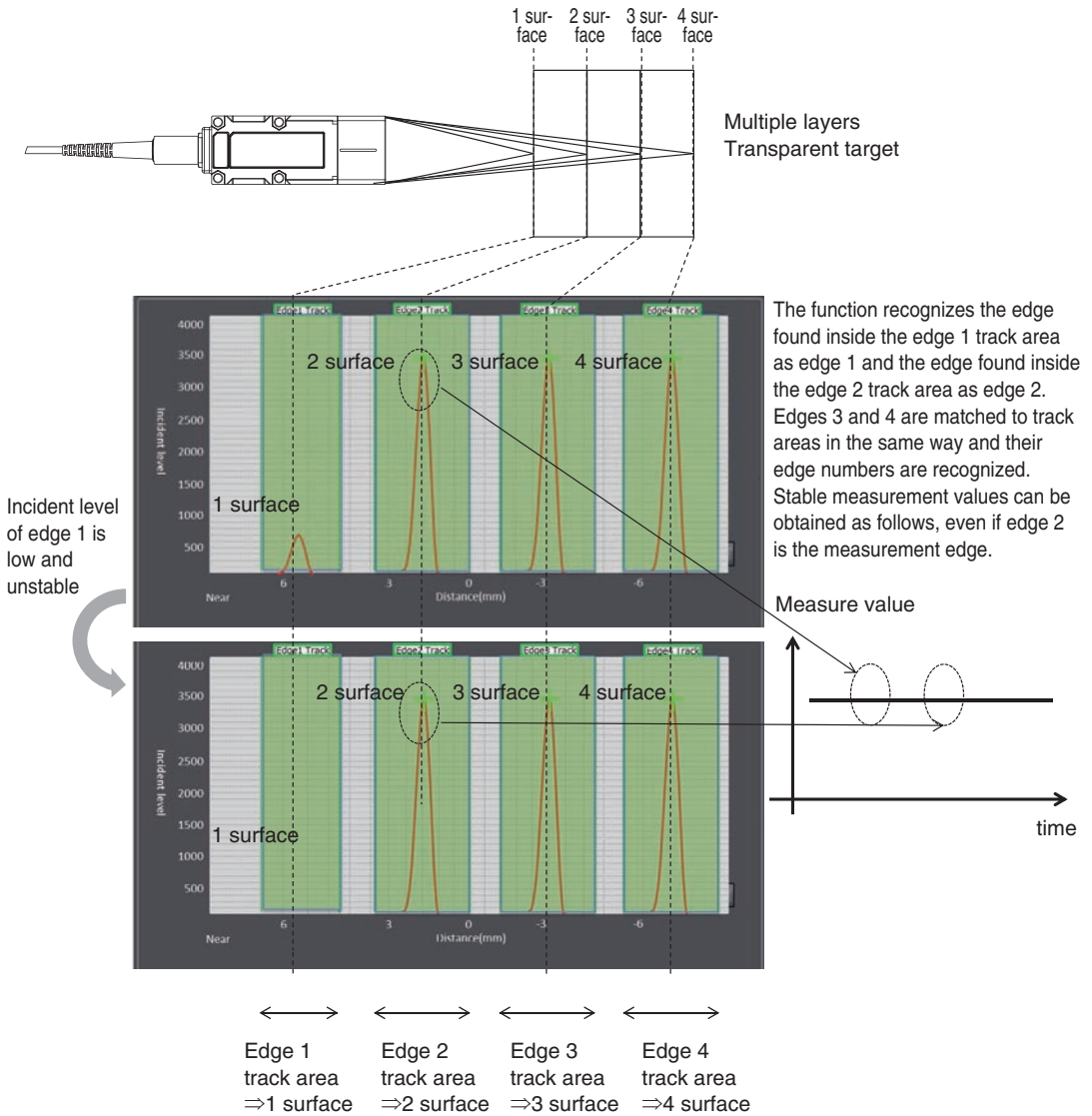

EdgeTracks automatically sets the track areas for each measurement cycle. Therefore, it automatically tracks, even when the measurement surface position changes due to target vibration, etc.

Example: When measuring transparent target (2 edges)

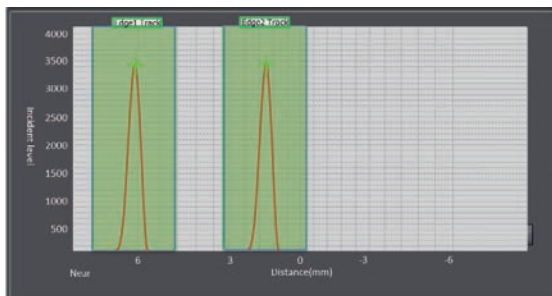
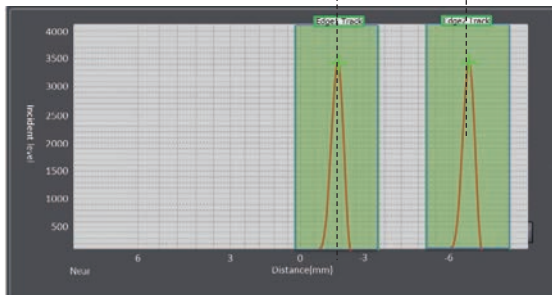
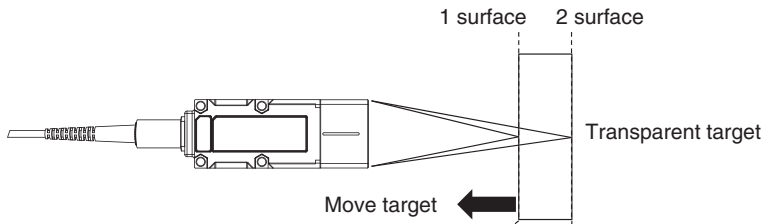

Even if the target is moved, the track areas are followed.

Item	Setting item	Setting value	Description
EdgeTracks	EdgeTracks	OFF/ON	Set EdgeTracks function ON/OFF.
	Edge1 track width	0.000 to 65.535 [mm]	Sets track effective width [mm] of edge 1. Recognizes the edge inside the track effective width as edge 1 after Area Teach is executed.
	Edge2 track width	0.000 to 65.535 [mm]	Sets track effective width [mm] of edge 1. Recognizes the edge inside the track effective width as edge 2 after Area Teach is executed.
	Edge3 track width	0.000 to 65.535 [mm]	Sets track effective width [mm] of edge 1. Recognizes the edge inside the track effective width as edge 3 after Area Teach is executed.
	Edge4 track width	0.000 to 65.535 [mm]	Sets track effective width [mm] of edge 1. Recognizes the edge inside the track effective width as edge 4 after Area Teach is executed.

- ▶ **Multiviewer Explore** : [BankGroup] | [(Bank Data Name)] (double click)
- **Edit pane** : [Sensing setting] icon ()
- **Sensing settings window** : [Measurement area 1] | [EdgeTracks]

1 Set [EdgeTracks].

Note

When the AreaTracks function is turned ON, the EdgeTracks function automatically turns OFF.



2 Set [Edge 1 track width], [Edge 2 track width], [Edge 3 track width], [Edge 4 track width].

The track width can be automatically set by clicking [Automatic edge track width setting].

3 Click [Area Teach].

Sets the track areas of edges detected when Area Teach is executed.

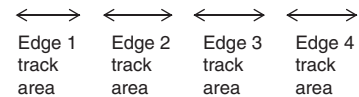
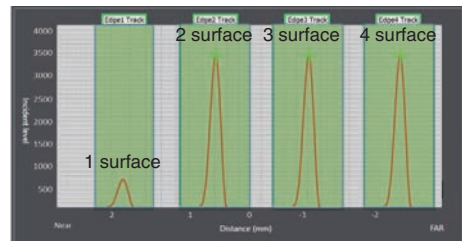
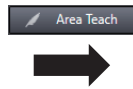
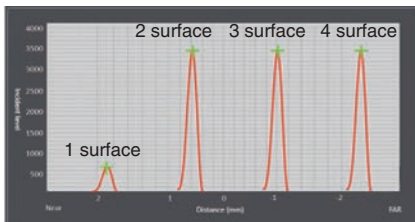

Important

- The track area can be set for a maximum of 4 surfaces within the measurement area.
- Exposure control mode: During automatic control, light adjustment is performed for the measurement surfaces that exist within the measurement areas. The EdgeTracks function is not applied.
- Measurement surface: When set to peak, the measurement surface with the highest amount of received light is selected from among all measurement areas.
Select either Edge1/Edge2/Edge3/Edge4 to use the EdgeTracks function.
- With ZW-7000□/5000□, this function is not available.
- If the following conditions occur when Area Teach is executed, an Area Teach error occurs.
 - When no surfaces are detected
 - When there are duplicate track areas
- If the following conditions occur after Area Teach is executed, the measurement value for each track area becomes the clamp value.
 - When multiple surfaces are detected in one track area
- If the following conditions occur after Area Teach is executed, a track area error occurs and the measurement value becomes the clamp value until Area Teach is executed again. Execute Area Teach again to recover the track areas.

When a track area error occurs, the track areas displayed in the Sysmac Studio sensing monitor window within the green boxes are no longer displayed.

- When no surfaces are detected
- When there are duplicate track areas

(Example: When the FAR side (figure 1) for the edge 1 track area and the NEAR side (figure 2) for the edge 2 track area overlap, the edge 1 track area and edge 2 track area become track area errors.)

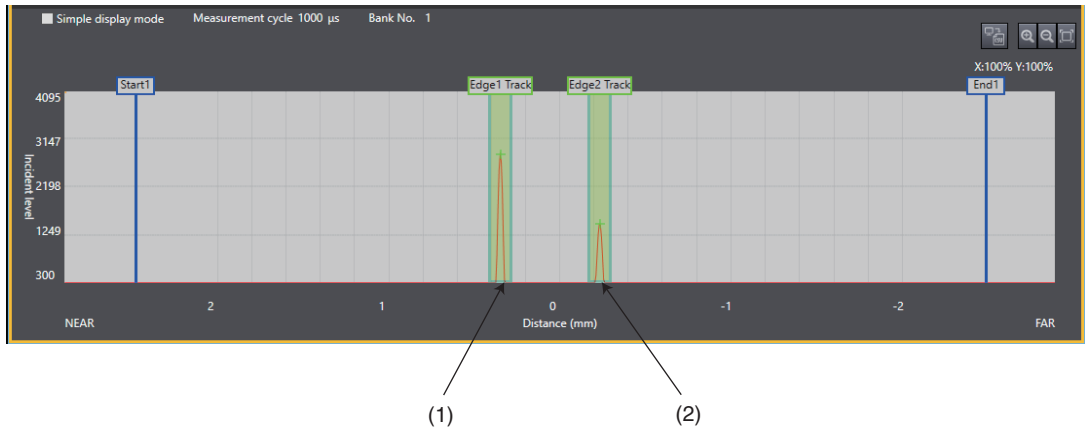

4-2 Setting Measurement Items

What is a Measurement Item?

Obtain the waveform data based on the specified sensing condition, and calculate the height/thickness of up to four surfaces included in the measuring range. Perform calculations using the output result of each task. Count the measurement surface closest to the Sensor Head first (default value). Count the measurement surface closest to the Sensor Head first (default value).

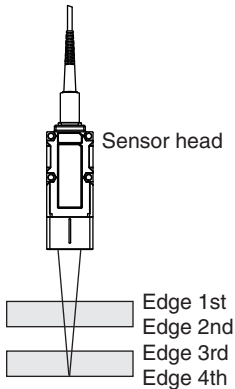

Note

The count direction for measurement surfaces can be changed.

 Setting Start Direction of Count Measurement Surfaces p.128

Measuring the Height

The setting for common height measurements as shown in the following diagram is registered for TASK1 in advance. In such a case, this setting is not required.

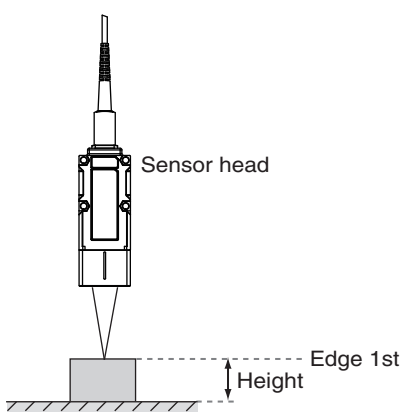

Set this item when measuring the height of an object below a transparent object as shown in the following diagram.

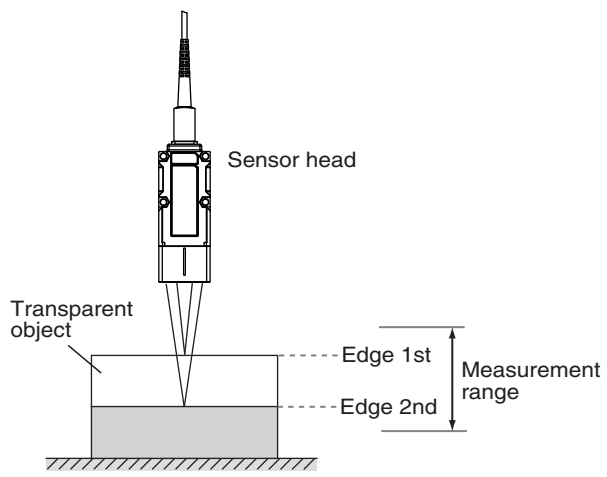

Item	Setting item	Setting value	Description
Height settings	Measurement surface	Edge1/Edge2/Edge3/Edge4/peak (default value)	The measurement surface targeted for measurement can be switched. The peak is the surface of all measurement surfaces having the highest received light amount.

- ▶ **Multi View Explorer** : [Bank Group] | [(Bank Data Name)] (double click)
 - **Edit pane** : [Task Settings] icon (🔍)
 - **Task Settings window** : [Measurement mode]

- 1 Select [Height] in [Measurement mode].
- 2 Select the measurement surface targeted for measurement from [Measurement surface].

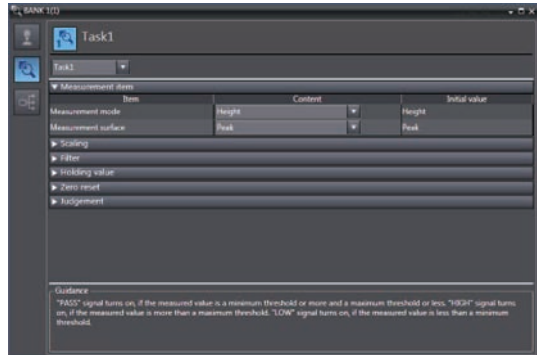

Note

- Height measurement can also be set by the operating keys on the Sensor Controller.
 - 📖 Measuring the Height p.237
- For the setting of measurement area to control of light adjustment, refer to the following:
 - 📖 Setting Light Exposure Time Control Mode p.129

Measuring the Thickness

If you have glass of known thickness, scaling can be adjusted referenced to that glass so that transparent objects can be measured more easily.

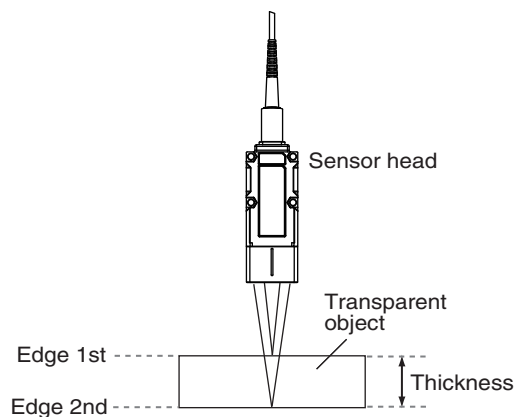

Item	Setting item	Setting value	Description
Thickness settings	Measurement surface 1	Edge1/Edge2/Edge3/Edge4/ Peak (default value)	The measurement surface (top surface) targeted for measurement can be switched. The peak is the surface of all measurement surfaces having the highest received light amount.
	Measurement surface 2	Edge1/Edge2 /Edge3/Edge4/ Peak (default value)	The measurement surface (rear surface) targeted for measurement can be switched. The peak is the surface of all measurement surfaces having the highest received light amount.

- ▶ **Multi View Explorer** : [Bank Group] | [(Bank Data Name)] (double click)
 - **Edit pane** : [Task Settings] icon (🔍)
 - **Task Settings window** : [Measurement mode]

- 1 Select [Thickness] in [Measurement mode].
- 2 Select the measurement surface (top surface) targeted for measurement from [Measurement surface 1].
- 3 Select the measurement surface (rear surface) targeted for measurement from [Measurement surface 2].

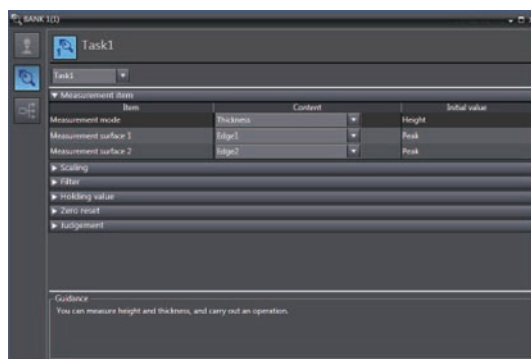

Important

- When the measurement surface setting is set to Peak for thickness measurement, the measurement may become unstable depending on the incident level on each surface. Change the measurement surface setting for each surface from Peak to 1/2/3/4.
- With the above procedure, the same area surface must be set for Measurement surface 1 and Measurement surface 2. Therefore, to set different area surfaces for Measurement surface 1 and Measurement surface 2, set the height measurement of each surface to two tasks and calculate the difference.

Note

- Thickness measurement can also be set by the operating keys on the Sensor Controller.

 Measuring the Thickness p.238

- For the setting of measurement area to control of light adjustment, refer to the following:

 Setting Light Exposure Time Control Mode p.129
Setting Exposure Time Control Mode p.232

Performing Calculations

Perform calculations using the results calculated by the tasks. The calculation formula is $mX+nY+K$.

Item	Setting item	Setting value	Description
Calculation	Parameter X	OFF (default value)/TASK1 to TASK4	The task to be calculated can be switched. When the TASK1 is selected, TASK1 is not displayed in the setting item.
	Parameter Y	OFF (default value)/TASK1 to TASK4	The task to be calculated can be switched. When the TASK1 is selected, TASK1 is not displayed in the setting item.
	Parameter K	-999.999999 to 999.999999 (default value: 0)	Set the offset value.
	Parameter m	-10.0 to 10.0 (default value: 0)	Set the coefficient value.
	Parameter n	-10.0 to 10.0 (default value: 0)	Set the coefficient value.

- **Multi View Explore** : [Bank Group] | [(Bank Data Name)] (double click)
 → **Edit pane** : [Task Settings] icon 
 → **Task Settings window** : [Measurement mode]

Select [Calculation] in [Measurement mode].

- 1 Select [Calculation] in [Measurement mode].
- 2 Select the task to be calculated from [Parameter X] and [Parameter Y].
- 3 Select the offset value from [Parameter K].
- 4 Select the coefficient from [Parameter m] and [Parameter n].

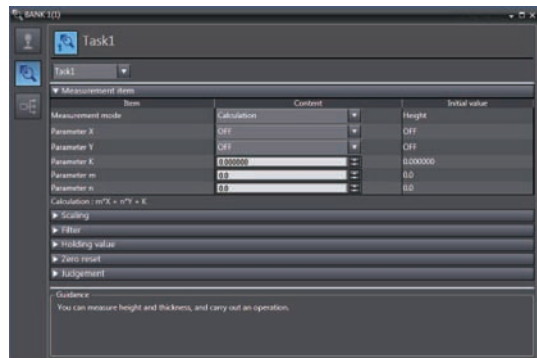
**Note**

Performing Calculations can also be set by the operating keys on the Sensor Controller.

 Calculating p.239

Important

Calculates using the measurement value of the last TASK.

The timing to update the measurement value of TASK is shifted one cycle by comparing the update timing of the measurement result of reference TASK.

Example)

TASK1: Height (Edge1)

TASK2: Height (Edge1)

TASK3: Calculation (X: TASK1, Y: TASK2, M: 1.9, K: 0.0)

Measurement count	TASK1	TASK2	TASK3
1st	0.200	0.100	0.000
2nd	0.310	0.110	0.100 *Calculates using 1st result of TASK1 and TASK2.
3rd	0.420	0.120	0.200 *Calculates using 2nd result of TASK1 and TASK2.
4th	0.530	0.130	0.300 * Calculates using 3rd result of TASK1 and TASK2.

4-3 Setting the Output Conditions

Setting Scaling

This setting is used when you want to correct any errors that are generated due to the installation status of the Sensor Head, and display the corrected value on the main display as a measured value.

There are three types of setting: "auto scaling" ("1-point scaling", "2-point scaling" and "Multi-point scaling") that automatically sets the correction value of a placed sensing object, "fixed scaling" that manually sets the correction value and "thickness scaling" that automatically sets the correction value of a placed sensing object (transparent object).

Important

The "Zero reset" p.100 settings return to the default settings when scaling is set. If scaling is set, perform a zero reset as necessary.

Performing Manual Scaling

Set the scaling by entering the correction value.

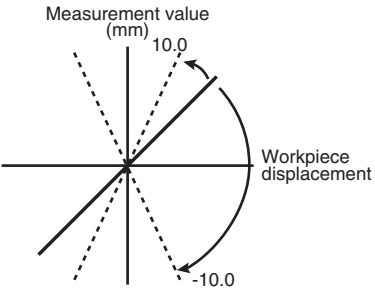
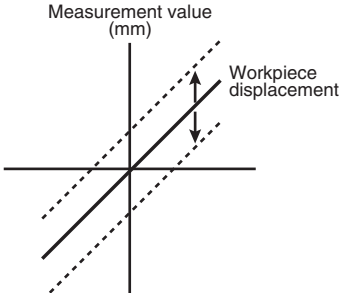
Item	Setting item	Setting value	Description
Scaling (Manual scaling)	Scaling	OFF (default value)/ON	Set scaling ON/OFF.
	Span	-10.0000 to 10.0000 (default value: 1.0000)	Set the inclination of the sensor characteristics as a coefficient. 
	Offset	-999.999999 to 999.999999 (default value: 0)	A fixed value is added to/subtracted from the measured value. 

- ▶ Multi View Explore : [Bank Group] | [(Bank Data Name)] (double click)
 - Edit pane : [Task Settings] icon (🔧)
 - Task Settings window : [Scaling]

- 1 Select [Scaling].
- 2 Enter the correction value to [Span] and [Offset].

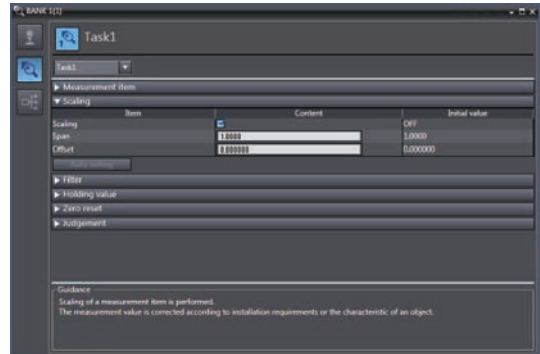

Note

Fixed scaling can also be executed by the operating keys on the Sensor Controller.

Performing Manual Scaling p.246

Automatically Setting Scaling

Performing 1-point Scaling

Measurement is performed at one position, and offset values are set for that measured value. The offset and increment/decrement inversion can be set.

Example: When displaying the distance to the sensing object

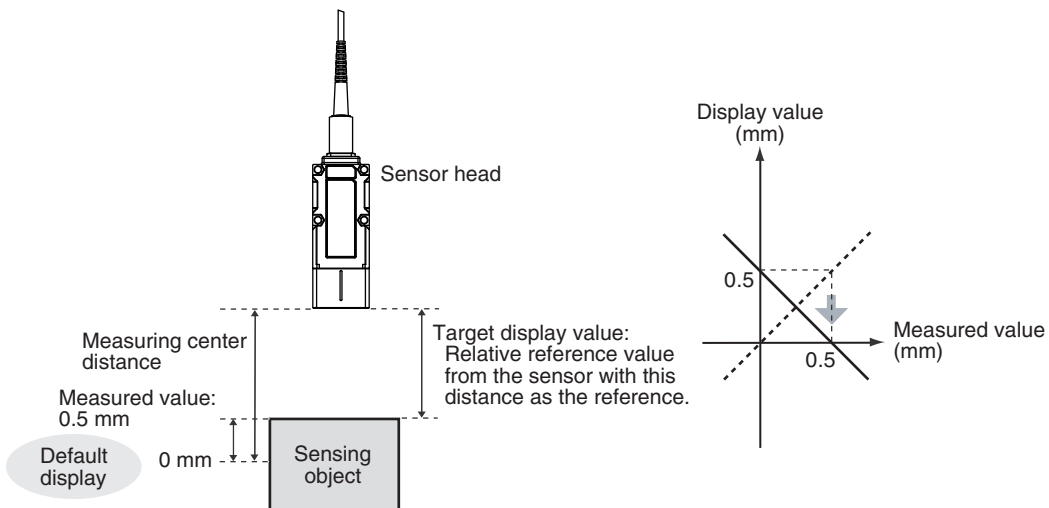

Item	Setting item	Setting value	Description
Actual scaling (one point)	Set value	-999.999999 to 999.999999 [mm]	Correct the measured value, and set the value to display.
	Scaling direction	Inverse change (Far side is positive)	The FAR side becomes a plus value.
		Forward change (Near side is positive)	The NEAR side becomes a plus value.

- ▶ **Multi View Explore** : [Bank Group] | [(Bank Data Name)] (double click)
 - **Edit pane** : [Task Settings] icon (🔧)
 - **Task Settings window** : [Scaling]

1 Set the [Scaling] to OFF.

2 Click [Auto setting].

The [Scaling] popup menu appears.

3 Select [Actual scaling (one point)], and click [Next >].

The [Scaling] popup menu display changes to [1st point settings], and the current measured value is displayed at [Current value].

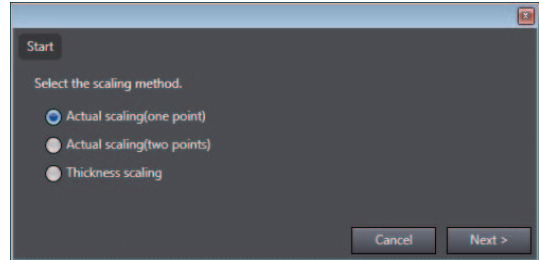

4 Click [STOP] to fix the [Current value], set [Set value] and click [Next >].

The [Scaling] popup menu display changes to [Direction settings].

Note

The [Current value] display is refreshed at a 100 ms cycle. When [STOP] is clicked, refreshing of the [Current value] display stops. Clicking the [STOP] button again resumes display refreshing.

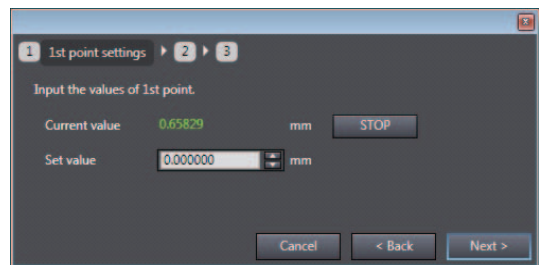

5 Set the change direction, and click [Next >].

The [Scaling] popup menu display changes to [Confirm the scaling parameters], and the span and offset values are displayed.

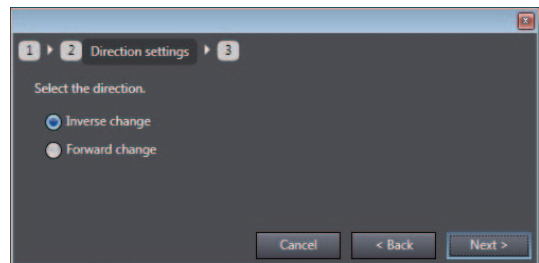

6 Click [OK].

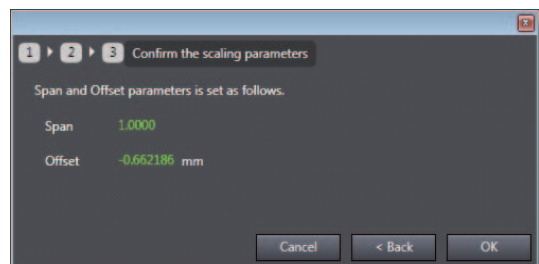

Note

1-point scaling can also be executed by the operating keys on the Sensor Controller.

Performing 1-point Scaling p.247

Performing 2-point Scaling

Measurement is performed at two positions, and offset values are set for those measured values.

Example: When correcting display values to match actual distances

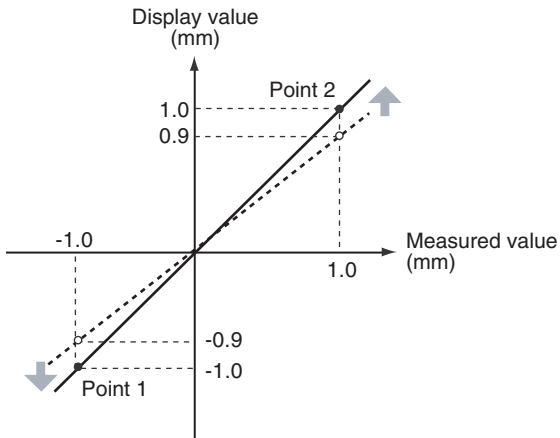

Item	Setting item	Setting value	Description
Actual scaling (two points)	Set value (1st point)	-999.999999 to 999.999999 [mm]	Correct the measured value of the 1st point, and set the value to display.
	Set value (2nd point)	-999.999999 to 999.999999 [mm]	Correct the measured value of the 2nd point, and set the value to display.

Important

Separate the two specified points by at least 1% of the rated measuring range for the connected Sensor Head.

For example, for the ZW-S7010, the two measured points must be separated by at least $1 \text{ mm} \times 0.01 = 0.01 \text{ mm}$ as the measuring range is $1 \text{ mm} (\pm 0.5 \text{ mm})$.

► **Multi View Explore** : [Bank Group] | [(Bank Data Name)] (double click)

→ **Edit pane** : [Task Settings] icon (🔧)

→ **Task Settings window** : [Scaling]

1 Set the [Scaling] to OFF.

2 Click [Auto setting].

The [Scaling] popup menu appears.

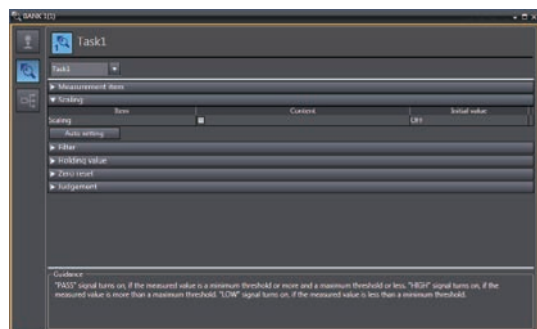

3 Select [Actual scaling (two points)], and click [Next >].

The [Scaling] popup menu display changes to [1st point settings].

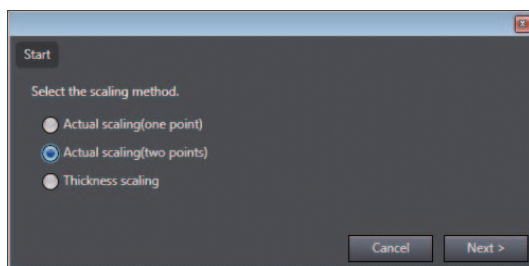

4 Set correction of the 1st point.

Click [STOP] to fix the [Current value], set [Set value] and click [Next >].

The [Scaling] popup menu display changes to [2nd point settings].

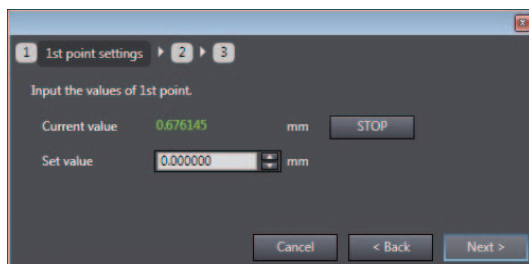

Note

The current measured value is displayed at [Current value], and is refreshed at 100 ms cycles. When [STOP] is clicked, refreshing of the [Current value] display stops. Clicking the [STOP] button again resumes display refreshing.

5 In the same way, set correction of the 2nd point.

When the change direction is set and [Next>] is clicked, the [Scaling] popup menu display changes to [Confirm the scaling parameters], and the span and offset values are displayed.

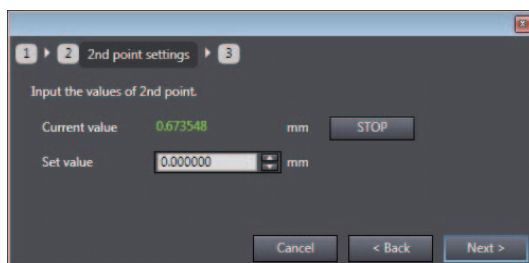

6 Click [OK].

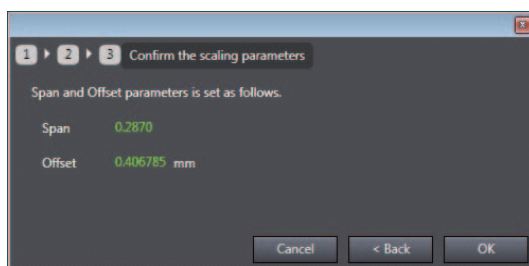

Note

2-point scaling can also be executed by the operating keys on the Sensor Controller.

 Performing 2-point Scaling p.248

Multi-point scaling

With ZW-8000□, measurements are taken at multiple locations and a precision stage is used to minimize the measurement error between the measurement value and the actual distance.

This function is enabled when nonlinearity occurs in the measurement error of the measurement value and the actual distance.

This function cannot be used with ZW-7000□/ZW-5000□.

Example: When correcting measurement values to match actual distances at 4 points

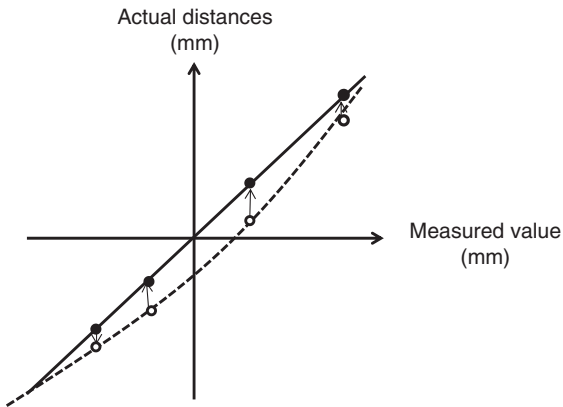

Item	Setting item	Setting value	Description
Scaling (Multi-point scaling)	Scaling points (n)	2 to 10 [point]	Set the points on which to execute scaling.
	Set value (1st point)	-999.999999 to 999.999999 [mm]	Correct the measured value of Point1, and set the ideal value to display.
	Set value (Point2 to Point(n-1))	-999.999999 to 999.999999 [mm]	Correct the measured value of Point2 to Point(n-1), and set the ideal value to display
	Measurement value (Point(n))	-999.999999 to 999.999999 [mm]	Correct the measured value of Point(n), and set the ideal value to display.

Important

Separate each distance between the N specified points by at least 1% of the rated measuring range for the connected Sensor Head.

For example, for the ZW-S8010, the two measured points must be separated by at least $1 \text{ mm} \times 0.01 = 0.01 \text{ mm}$ as the measuring range is $1 \text{ mm} (\pm 0.5 \text{ mm})$.

- ▶ **Multi View Explore** : [Bank Group] | [(Bank Data Name)] (double click)
- **Edit pane** : [Task Settings] icon (🔍)
- **Task Settings window** : [Scaling]

1 Click [Auto setting].

The [Scaling] popup menu appears.

* This cannot be selected when the scaling checkbox is checked.

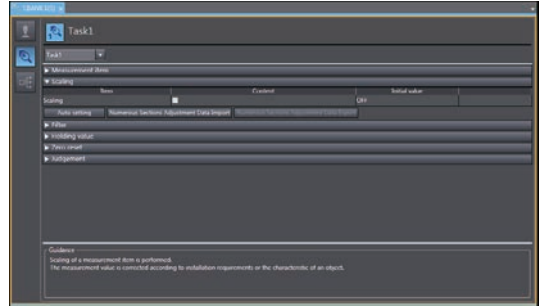

2 Select [Scaling Numerous Sections], and click [Next >].

The [Scaling] popup menu display changes to [Settings].

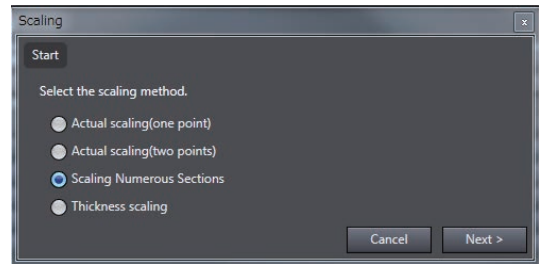

3 Set correction of the 1st point.

Click [STOP] to fix the [Current value], set [Setting value] and click [Next >].

The [Scaling] popup menu display changes to [Settings].

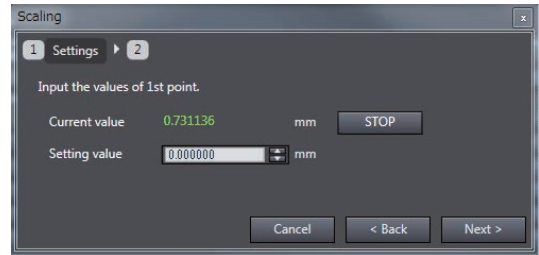

4 In the same way, set correction of Point2 to Point(n).

Click [STOP] to fix the [Current value] and set [Setting value].

Click [End] to end correction.

Click [Next>] to continue correction.

When correction ends, the display switches to show that input is finished.

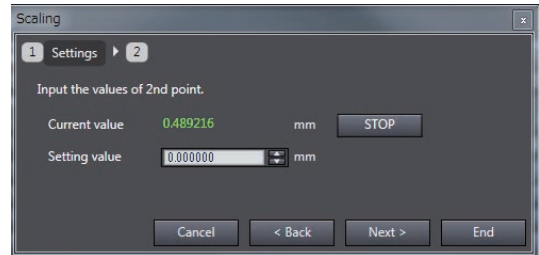

Important

Arrange the specified current values (measurement values) of Point2 to Point(n) so that they are in ascending or descending order.

An error will occur if this relationship is not adhered to.

	Ascending order	Descending order
Point1	-1.0000 mm	1.0000 mm
Point2	-0.9000 mm	0.9000 mm
.	.	.
.	.	.
Point(n)	1.0000 mm	-1.0000 mm

Note

The current measured value is displayed at [Current value], and is refreshed at 100 ms cycles. When [STOP] is clicked, refreshing of the [Current value] display stops. Clicking the [STOP] button again resumes display refreshing.

5 Click [OK].

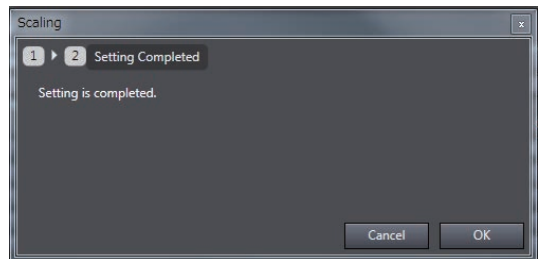

Note

- Multi-point scaling can also be executed by the operating keys on the Sensor Controller.



Multi-point scaling (ZW-8000□ only) p.249

- The set correction values can be exported by clicking [Numerous Sections Adjustment Data Export]. Also, any previously exported numerous sections adjustment data can be imported by clicking [Numerous Sections Adjustment Data Import].

Performing Thickness Scaling

The thickness is measured at one position and offset values are set for that measured value.

Item	Setting item	Setting value	Description
Thickness scaling	Setting value	-999.999999 to 999.999999 [mm]	Correct the measured value, and set the value to display.

- ▶ **Multi View Explore** : [Bank Group] | [(Bank Data Name)] (double click)
 - **Edit pane** : [Task Settings] icon ()
 - **Task Settings window** : [Scaling]

1 Set the [Scaling] to OFF.

2 Click [Auto setting].

The [Scaling] popup menu appears.

3 Select [Thickness scaling], and click [Next >].

The [Scaling] popup menu display changes to [Thickness settings].

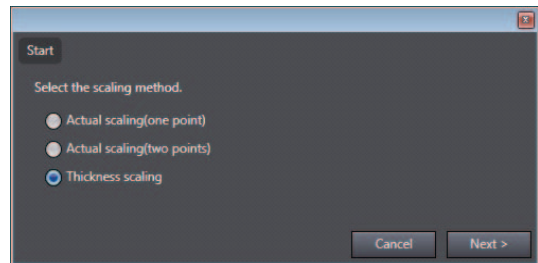

4 Click [STOP] to fix the [Current value], set [Set value] and click [Next >].

The [Scaling] popup menu display changes to [Confirm the scaling parameters], and the span and offset values are displayed.

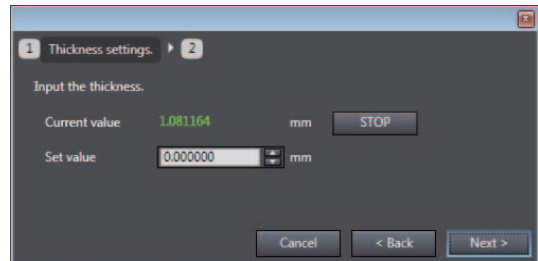

Note

The current measured value is displayed at [Current value], and is refreshed at 100 ms cycles. When [STOP] is clicked, refreshing of the [Current value] display stops. Clicking the [STOP] button again resumes display refreshing.

5 Click [OK].

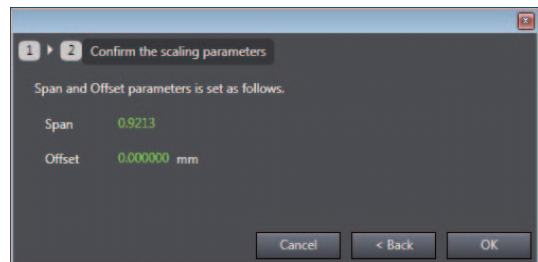

Note

Thickness scaling can also be executed by the operating keys on the Sensor Controller.

 Performing Thickness Scaling p.250

Setting Filters

Set the filter condition when filtering information obtained from the sensor before output. The following types of filters can be set depending on purpose.

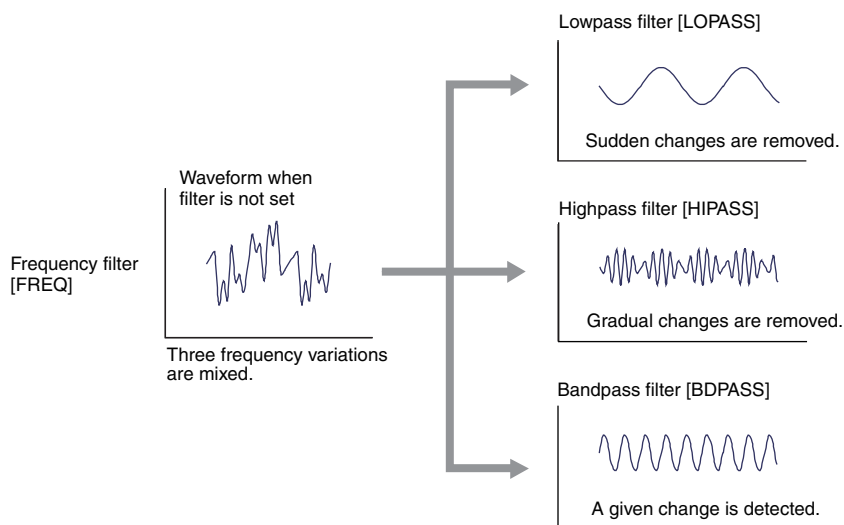
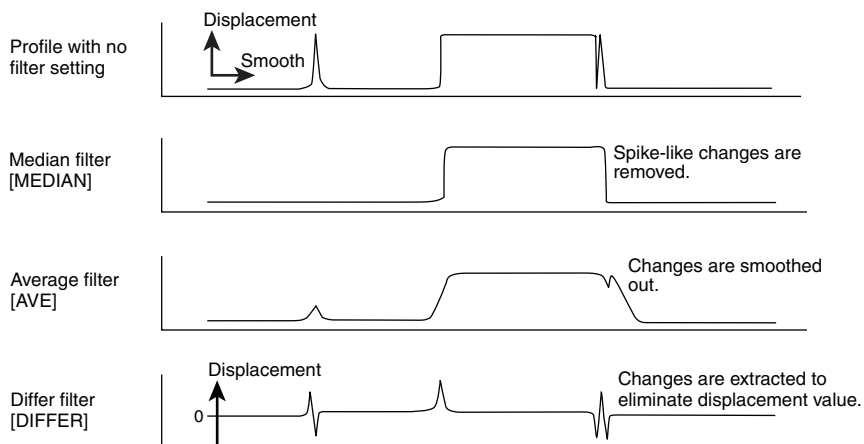

Setting the Median Filter

The intermediate value of multiple sets of data can be output as the measurement result.

Item	Setting item	Setting value	Description
Medial filter	Filter mode	OFF (default value)	Median filter is not used.
		3	Outputs the intermediate value of the last three measurements.
		9	Outputs the intermediate value of the last nine measurements.
		15	Outputs the intermediate value of the last 15 measurements.
		31	Outputs the intermediate value of the last 31 measurements.

- ▶ **Multi View Explore** : [Bank Group] | [(Bank Data Name)] (double click)
 - **Edit pane** : [Task Settings] icon (🔍)
 - **Task Settings window** : [Filter]

- 1 Select how many of the latest intermediate values to output from [Medial filter].

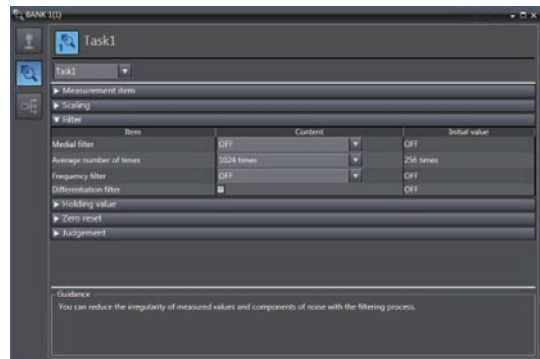

Note

The median filter can also be set by the operating keys on the Sensor Controller.

 Setting the Median Filter p.242

Setting the Average Filter

Output measured data as the average value of a preset count.

This is set in cases such as to reduce the fluctuation of measurement values and increase the static resolution.

Item	Setting item	Setting value	Description
Average number of times	Average	<ul style="list-style-type: none"> Internal synchronous measurement mode 1/2/4/8/16/32/64/128/256/512/1024(default value)/2048/4096/8192/16384 [times] 	Switches the average count.
		<ul style="list-style-type: none"> External/PDO synchronous measurement mode 1(default value)/2/4/8/16/32/64/128/256/512/1024/2048/4096/8192/16384 [times] 	

- ▶ **Multi View Explore** : [Bank Group] | [(Bank Data Name)] (double click)
 - **Edit pane** : [Task Settings] icon (🔍)
 - **Task Settings window** : [Filter]

- 1 Select how many times the latest measured values are to be averaged before output from [Average].

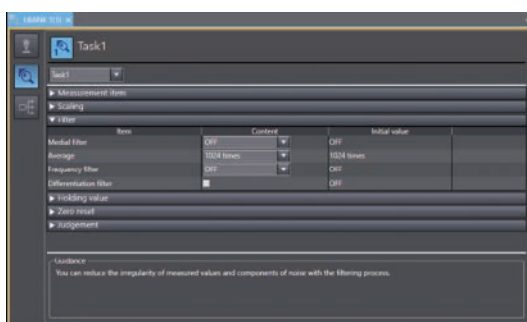

Important

When measurement is started, the measurement result is not updated and output until the measured values have been sampled for the preset average count.

Note

The average filter can also be set by the operating keys on the Sensor Controller.

 Setting the Average Filter p.243

Setting the Frequency Filter

Set a filter to ignore or detect the changes in a specific frequency in the measured data.

Item	Setting item	Setting value	Description
Frequency filter	Frequency filter	OFF (default value)	Frequency filter is not used.
		Lowpass filter: 0.040 to 23735.000 (default value: 0.040)	Ignores frequency components larger than the specified cut-off frequency. (Only gradual changes are captured.)
		Highpass filter: 3.000 to 23725.000 (default value: 23725.000)	Detects frequency components smaller than the specified cut-off frequency. (Sudden changes are captured.)
		Bandpass filter	Detects the frequency components between the cut-off frequency (lower limit) and the cut-off frequency (upper limit).
	Cutoff frequency	Refer to the table below.	Set this item when a low pass filter or a high pass filter is selected.
	Cutoff frequency (Upper limit)		Set this item when a band pass filter is selected.
Cutoff frequency (Lower limit)			

(1) List of lowpass filter cutoff frequencies [Hz]

Sensor Controller type	Extension fiber cable length	Lower limit value (1 area mode)	Lower limit value (2 area mode)	Upper limit value (1 area mode)	Upper limit value (2 area mode)	Initial Value
ZW-8000□	none	1	1	7909	3164	1
	2 m	1	1	7909	3164	1
	5 m	1	1	7909	3164	1
	10 m	1	1	7909	3164	1
	20 m	1	1	7909	3164	1
	30 m	1	1	7909	3164	1
ZW-7000□	none	1	1	23725	11862	2
	2 m	1	1	23725	11862	2
	5 m	1	1	23725	11862	2
	10 m	2	2	23725	11862	4
	20 m	3	3	23725	11862	5
	30 m	4	4	23725	11862	7
ZW-5000□	none	1	1	5931	5931	1
	2 m	1	1	5931	5931	1
	5 m	1	1	5931	5931	1
	10 m	1	1	5931	5931	1
	20 m	1	1	5931	5931	2
	30 m	1	1	5931	5931	2

(2) List of highpass filter cutoff frequencies [Hz]

Sensor Controller type	Extension fiber cable length	Lower limit value (1 area mode)	Lower limit value (2 area mode)	Upper limit value (1 area mode)	Upper limit value (2 area mode)	Initial Value
ZW-8000□	none	4	170	7909	3164	4
	2 m	4	170	7909	3164	4
	5 m	6	170	7909	3164	6
	10 m	8	170	7909	3164	8
	20 m	11	170	7909	3164	11
	30 m	17	170	7909	3164	17
ZW-7000□	none	64	638	23725	11862	64
	2 m	64	638	23725	11862	64
	5 m	64	638	23725	11862	64
	10 m	102	638	23725	11862	102
	20 m	160	638	23725	11862	160
	30 m	213	638	23725	11862	213
ZW-5000□	none	16	319	5931	5931	16
	2 m	16	319	5931	5931	16
	5 m	16	319	5931	5931	16
	10 m	19	319	5931	5931	19
	20 m	29	319	5931	5931	29
	30 m	40	319	5931	5931	40

(3) List of bandpass filter (lower limit) cutoff frequencies [Hz]

Sensor Controller type	Extension fiber cable length	Lower limit value (1 area mode)	Lower limit value (2 area mode)	Upper limit value (1 area mode)	Upper limit value (2 area mode)	Initial Value
ZW-8000□	none	4	170	7909	3164	4
	2 m	4	170	7909	3164	4
	5 m	6	170	7909	3164	6
	10 m	8	170	7909	3164	8
	20 m	11	170	7909	3164	11
	30 m	17	170	7909	3164	17
ZW-7000□	none	64	638	23725	11862	64
	2 m	64	638	23725	11862	64
	5 m	64	638	23725	11862	64
	10 m	102	638	23725	11862	102
	20 m	160	638	23725	11862	160
	30 m	213	638	23725	11862	213
ZW-5000□	none	16	319	5931	5931	16
	2 m	16	319	5931	5931	16
	5 m	18	319	5931	5931	18
	10 m	27	319	5931	5931	27
	20 m	47	319	5931	5931	47
	30 m	64	319	5931	5931	64

(4) List of bandpass filter (upper limit) cutoff frequencies [Hz]

Sensor Controller type	Extension fiber cable length	Lower limit value (1 area mode)	Lower limit value (2 area mode)	Upper limit value (1 area mode)	Upper limit value (2 area mode)	Initial Value
ZW-8000□	none	4	170	7909	3164	425
	2 m	4	170	7909	3164	425
	5 m	6	170	7909	3164	425
	10 m	8	170	7909	3164	425
	20 m	11	170	7909	3164	425
	30 m	17	170	7909	3164	425
ZW-7000□	none	64	638	23725	11862	1275
	2 m	64	638	23725	11862	1275
	5 m	64	638	23725	11862	1275
	10 m	102	638	23725	11862	1275
	20 m	160	638	23725	11862	1275
	30 m	213	638	23725	11862	1275
ZW-5000□	none	16	319	5931	5931	319
	2 m	16	319	5931	5931	319
	5 m	16	319	5931	5931	319
	10 m	19	319	5931	5931	319
	20 m	29	319	5931	5931	319
	30 m	40	319	5931	5931	319

- **Multi View Explore** : [Bank Group] | [(Bank Data Name)] (double click)
 → **Edit pane** : [Task Settings] icon (🔍)
 → **Task Settings window** : [Filter]

- 1 Select the frequency filter type from [Frequency filter].
- 2 Set the cutoff frequency from [Cutoff frequency]. When a band pass filter is selected, set [Cutoff frequency (upper limit)] and [Cutoff frequency (lower limit)].

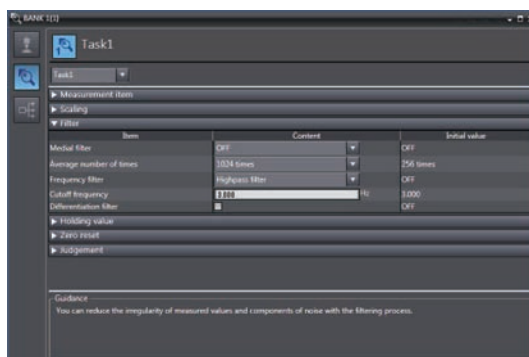

The range of cut-off frequency to be effective in operation varies depending on the setting of measurement cycle.

The relationship between the measurement cycle and the cut-off frequency range is shown in the table below.

Measurement cycle [μs]	Sampling Frequency [Hz]	Cut-off frequency range [Hz]			
		High-pass filter Band-pass filter		Low-pass filter	
		Lower limit	Upper limit	Lower limit	Upper limit
20	50000	1275	23725	20	23725
40	25000	638	11862	10	11862
60	16667	425	7907	7	7907
80	12500	319	5931	5	5931
100	10000	255	4744	4	4744
200	5000	128	2372	2	2372
300	3333	85	1581	1.5	1581
400	2500	64	1185	1	1185

Note

The frequency filter can also be set by the operating keys on the Sensor Controller.

 Setting the Frequency Filter p.244

Important

- If a value outside of the appropriate range is set, the frequency filter will be applied with the values included in the range.
- If the cut-off frequency values (upper/lower limits) are too close, the frequency bandwidth to be detected cannot be properly detected.
- If changing the extension fiber cable length setting causes the setting value of the cutoff frequency to fall outside the upper/lower limit value, the setting value is automatically changed to the value within the limit.

Important

Frequency filter is applicable the measurement result executed TRIG input/Sync0 signal even if select the External/ PDO synchronous measurement mode. In this case, the sampling interval of measured result is used the measurement cycle value which has been set and executed external TRIG input/Sync0 signal. The value is not dependent on the interval which is actually executed TRIG input/Sync0 signal.

Setting the Differentiation Filter

Set this filter to detect sudden changes in measured values occurring within an extremely short time. The differentiation filter detects changes in the measured value and current value before a comparison interval. The time of this comparison interval is defined as the differential cycle. (Default value: OFF)

Item	Setting item	Setting value	Description
Differentiation filter	Filter mode	OFF (default value)/ON	Set the differentiation filter ON/OFF.
	Differentiation cycle	• Internal synchronous measurement mode 0.02(default value) to 5000[ms]	Set the interval(time) which performs comparison with the current value.
		• External/PDO synchronous measurement mode 1(default value) to 50000[measurement count]	Set the interval(measurement count) which performs comparison with the current value.

- **Multi View Explore** : [Bank Group] | [(Bank Data Name)] (double click)
 → **Edit pane** : [Task Settings] icon (🔍)
 → **Task Settings window** : [Filter]

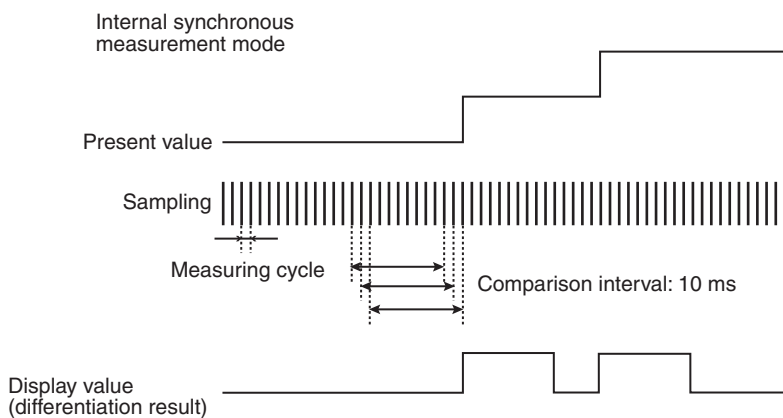

- 1** Select differentiation filter ON/OFF from [Differentiation filter].
- 2** Set the number of differential cycles from [Differentiation cycle].

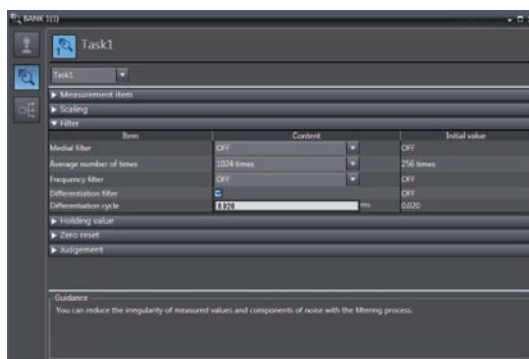

Note

The differentiation filter can also be set by the operating keys on the Sensor Controller.

Setting the Differentiation Filter p.245

Setting Hold

Set the hold conditions of the measured value.

The hold function holds (retain) any value from the measured values during the specific time (sampling period), such as the maximum or minimum value.

Setting the Hold Mode

Set the hold mode of the measured value.

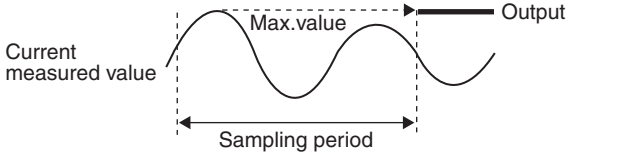
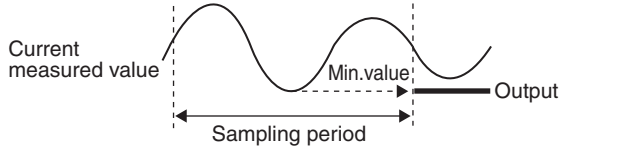
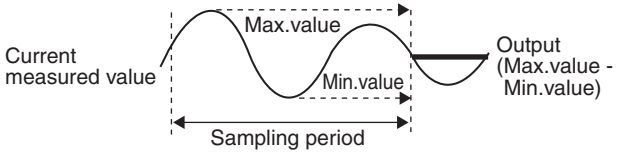
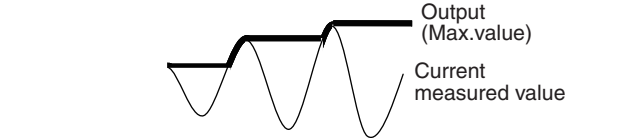
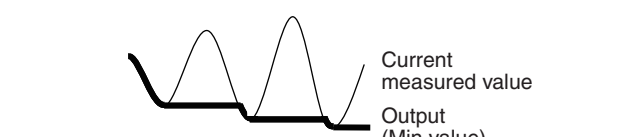
Item	Setting item	Setting value	Description
Hold	Hold mode	Peak	<p>Holds the “maximum value” of the sampling period. The current measurement value is output after Sampling, and then this state is held until the next sampling ends.</p> 
		Bottom	<p>Holds the “minimum value” of the sampling period. The current measurement value is output after Sampling, and then this state is held until the next sampling ends.</p> 
		Peak to Peak	<p>Holds the “difference between the maximum value and the minimum value” of the sampling period. Mainly select this when detecting vibration, for example. The current measurement value is output after Sampling, and then this state is held until the next sampling ends.</p> 
		Auto Peak	<p>Holds the “maximum value” of the measurement result. Output the measurement value at each updating of the Maximum value.</p> 
		Auto Bottom	<p>Holds the “minimum value” of the measurement result. Output the measurement value at each updating of the Minimum value.</p> 

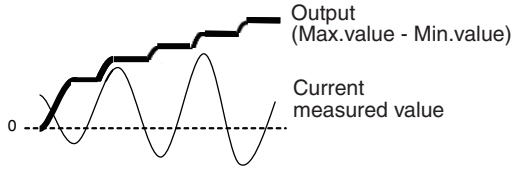
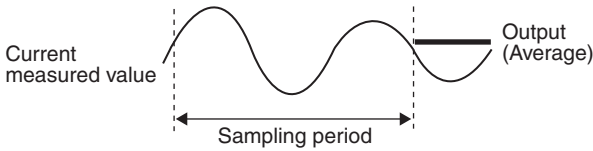
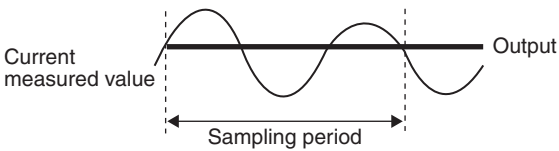
Item	Setting item	Setting value	Description
Hold	Hold mode	Auto Peak to Peak	<p>Holds the difference between the maximum and minimum values of the measurement result. Output the measurement value at each updating of the difference value Maximum and Minimum.</p>  <p>Output (Max.value - Min.value) Current measured value</p>
		Average	<p>Holds the "average of the measured value" of the sampling period. The current measurement value is output after Sampling, and then this state is held until the next sampling ends.</p>  <p>Current measured value Output (Average) Sampling period</p>
		Sampling	<p>Holds the measured value the moment that control enters the sampling period. The current measurement value is output after Sampling, and then this state is held until the next sampling is started.</p>  <p>Current measured value Output Sampling period</p>
		Through (default value)	<p>The hold function is not used. The measured value is always output.</p>

- ▶ **Multi View Explore** : [Bank Group] | [(Bank Data Name)] (double click)
- **Edit pane** : [Task Settings] icon (🔧)
- **Task Settings window** : [Hold]

1 Select the hold mode from [Hold mode].
Setting items for required parameters are displayed depending on the selected hold mode.

 Setting Triggers p.163

 Setting a Trigger Delay p.167

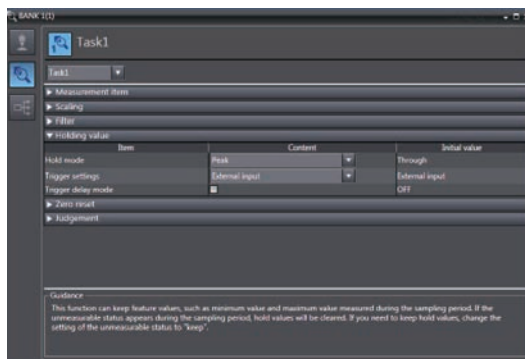

Note

The hold mode can also be set by the operating keys on the Sensor Controller.

 Setting the Hold Mode p.251

Hold clearing conditions

Held values can be cleared by the following operation.

- When FUNC (adjustment) mode/RUN (operation) mode is switched
- When hold RESET is entered (32-pole extension connector,  key)
- Hold RESET command is entered.

(Example) Peak

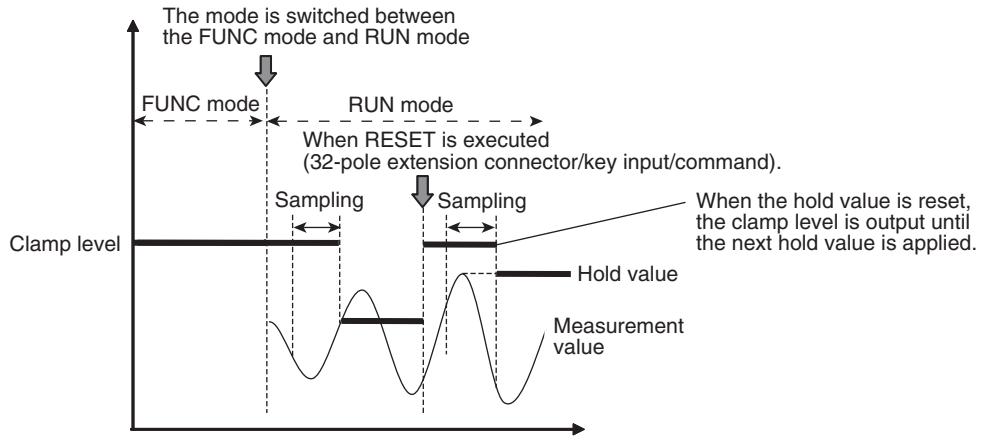

(Example) Auto Peak

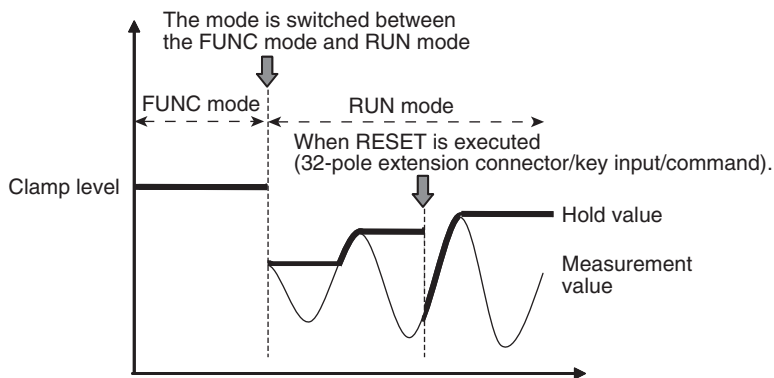

Important

If an abnormal measured value is obtained, the hold value is cleared. To not clear the hold value even if an abnormal measured value is obtained, set "KEEP" as the non-measurement setting.

 "2-1 Parallel I/O connection" described in Displacement Sensor ZW-8000/7000/5000 series Confocal Fiber Type Displacement Sensor User's Manual for Communications Settings (Z363)

Setting Triggers

Set how measurement start to end timing is to be input.

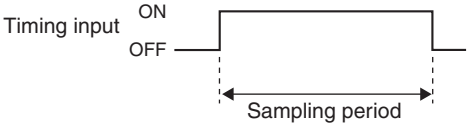
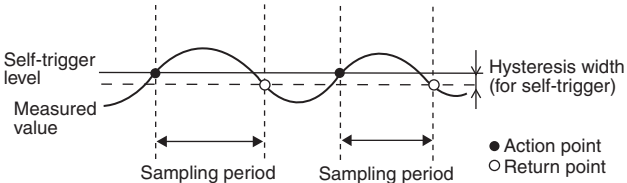
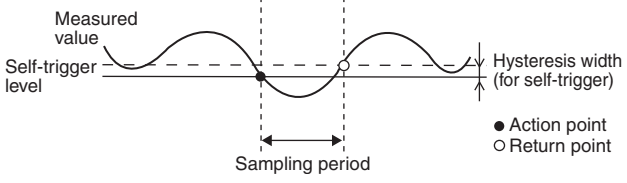
Item	Setting item	Setting value	Description
Trigger Set-tings	Trigger method	External input	<p>Enter the trigger for the start of sampling in "TIMING input" for the 32-pole terminal block. The period that the signal input to "TIMING input" is ON is the sampling period. The measurement values actually sampled vary according to the TIMING input mode setting.</p>  <p>Important</p> <p>When a delay time is set, input OFF and sampling period end are not synchronized. End timing is after the specified sampling period has elapsed.</p>
		Selfup trigger	<p>The period in which the measured value exceeds the preset self-trigger level is taken to be the sampling period. Hold measurement can be performed without a synchronous input.</p>  <p>Important</p> <p>When a delay time is set, the timing that the measured value falls below the self-trigger level and the sampling period end are not synchronized. End timing is after the sampling period has elapsed.</p>
		Selfdown trigger	<p>The period in which the measured value falls below the preset self-trigger level is taken to be the sampling period. Hold measurement can be performed without a synchronous input.</p>  <p>Important</p> <p>When a delay time is set, the timing that the measured value exceeds the self-trigger level and the sampling period end are not synchronized. End timing is after the sampling period has elapsed.</p>

Item	Setting item	Setting value	Description
Trigger Set-tings	Trigger method	Setting Valid value	<p>The period where the measurement value is a valid value is taken to be the sampling period</p> <p>● Operate point ○ Return point</p> <p>Important</p> <p>When the delay time is set, the timing when the measurement value becomes invalid value and when the sampling period is finished are not synchronized. Timing when the Setting Valid value finishes is after the sampling period passed.</p>
	Trigger level	-999.999999 to 999.999999 [mm] (default value: 0)	Set the self-trigger level when [SELF-UP] or [SELF-DOWN] are selected at [Trigger method].
	Trigger hysteresis	0 to 999.999999 [mm] (default value: 0.05% of measuring range)	Set the hysteresis width for the self-trigger when [SELF-UP] or [SELF-DOWN] are selected at [Trigger method].

- ▶ **Multi View Explore** : [Bank Group] | [(Bank Data Name)] (double click)
 - **Edit pane** : [Task Settings] icon (🔍)
 - **Task Settings window** : [Hold]

1 Set the hold mode.

📖 Setting the Hold Mode p.160

2 Select the trigger method from [Trigger method].

3 Enter [Trigger level] and [Trigger hysteresis] when [Selfup trigger] or [Selfdown trigger] are selected at [Trigger method].

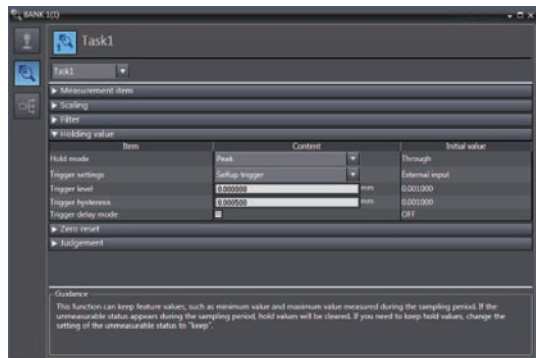

Important

Set "Trigger hysteresis" according to the fluctuation of the measured value near the trigger level. Hysteresis is applied simultaneously with start of measurement to prevent chattering of the TIMING input.

Note

The trigger can also be set by the operating keys on the Sensor Controller.

📖 Setting Triggers p.252

● Setting TIMING input mode

If you select External input as the trigger method, set the TIMING input mode. The data sampled when TIMING input is turned ON varies with each TIMING input mode.

Setting item	Setting value	Description
TIMING input mode	Specify timing to measure	<p>The data of which measurement has been completed while TIMING input was ON is sampled. The time from TIMING input to measurement value output is shorter compared to "Specify timing to exposure" mode, this is suitable for performing height measurements with the Sensor Head and measurement target in a resting state.</p> <p>Example of when the Hold mode is set to sample</p>
	Specify timing to exposure	<p>The data of which exposure has been completed while TIMING input was ON is sampled. Since measurement values of the intended locations on the measurement target can be obtained with TIMING input, this is suitable for performing shape measurements while moving the Sensor Head or measurement target.</p> <p>Example of when the Hold mode is set to sample</p>

- ▶ Multi View Explore : [Bank Group] | [(Bank Data Name)] (double click)
- Edit pane : [IO Settings] icon ()
- IO Settings window : [Control input]

1 Set the TIMING input mode.

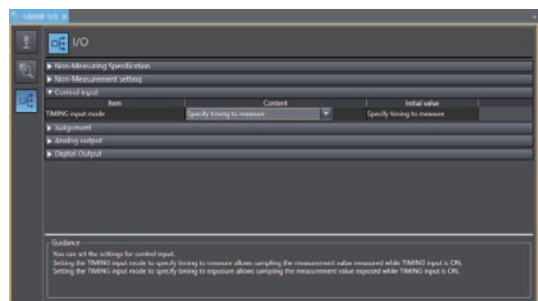

Performing Hold with a Key Input

The TIMING/RESET inputs can be held on the Sensor Controller by setting as follows.

Item	Setting item	Setting value	Description
Sensor settings	Timing/Reset key input	OFF (default value)/ON	Enables TIMING and RESET key inputs from the Sensor Controller.

 Setting the Hold Mode p.160

- ▶ **Multi-view explorer** : [System] (double-click)
→ **Edit pane** : [Sensor Settings] icon ()

1 Set the operating mode to the FUNC mode.

 3-2 Switching operation modes p.98

- 2 Select ON/OFF from [Key input mode(Timing and Reset)].

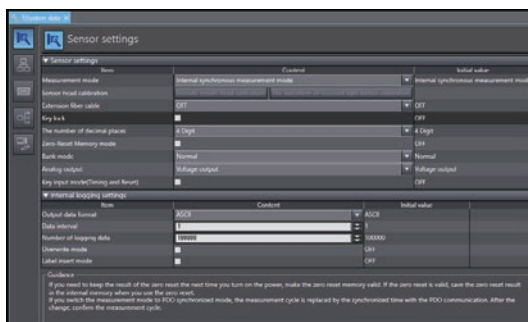

Note

The timing/reset key input can also be set by the operating keys on the Sensor Controller.

 Performing Hold with a Key Input p.253

Setting a Trigger Delay

Set this to ignore measure values following TIMING input to avoid the influence of bounding or mechanical vibration when a device is started up.

The delay time (the delay between timing input and the start of sampling) and the sampling time can be set.

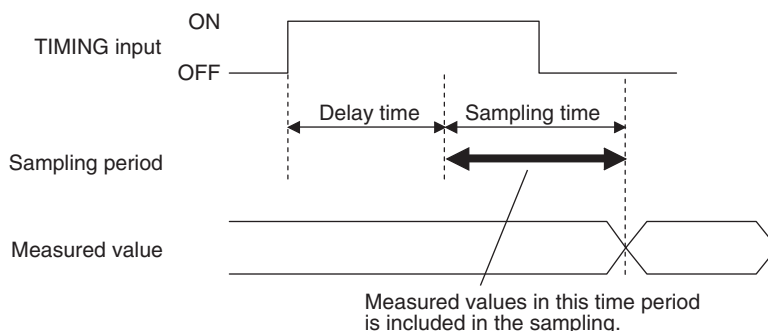

Item	Setting item	Setting value	Description
Trigger delay	Trigger delay mode	OFF (default value)/ON	Turns the trigger delay ON/OFF.
	Delay time	<ul style="list-style-type: none"> Internal synchronous measurement mode 0.02(default value) to 5000[ms] 	Sets the period(time) between when turns ON TIMING input and starts sampling.
		<ul style="list-style-type: none"> External/PDO synchronous measurement mode 1(default value) to 50000[count] 	Measures the measuring count between when turns ON TIMING input and starts sampling.
	Sampling time	<ul style="list-style-type: none"> Internal synchronous measurement mode 0.02 to 5000[ms] 100(default value) 	Set the time when perform the sampling.
<ul style="list-style-type: none"> External/PDO synchronous measurement mode 1(default value) to 50000[count] 		Set the measuring count when performs sampling.	

- ▶ **Multi View Explore** : [Bank Group] | [(Bank Data Name)] (double click)
- **Edit pane** : [Task Settings] icon 
- **Task Settings window** : [Hold]

1 Set the hold mode and trigger.

 Setting the Hold Mode p.160

 Setting Triggers p.163

2 Check the check box in [Trigger delay]-[Trigger delay mode].

3 Enter [Delay time] and [Sampling time].

Important

- Set so that the “delay time + sampling time” is shorter than the TIMING input interval. When the TIMING input turns ON again before the “delay time + sampling time” elapses, the TIMING input that is input later is ignored and is not reflected in sampling.
- The delay time and sampling time is rounded up by the measurement cycle unit.
- When 2 area mode is selected, the minimum values of the delay time and sampling time are twice as long as the measurement cycle.

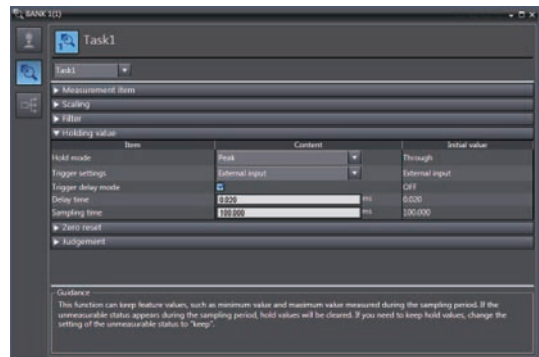

Note

The trigger delay can also be set by the operating keys on the Sensor Controller.

 Setting a Trigger Delay p.254

Setting the Zero Reset

Setting the Status

Set enable/disable of the zero reset function.

Important

The status is set for each task.

Item	Setting item	Setting value	Description
Zero reset	Status	OFF ON (default value)	Turn Zero reset ON/OFF.

- ▶ **Multi View Explore** : [Bank Group] | [(Bank Data Name)] (double click)
 - **Edit pane** : [Task Settings] icon (🔧)
 - **Task Settings window** : [Zero reset]

1 Select ON/OFF from [Status].

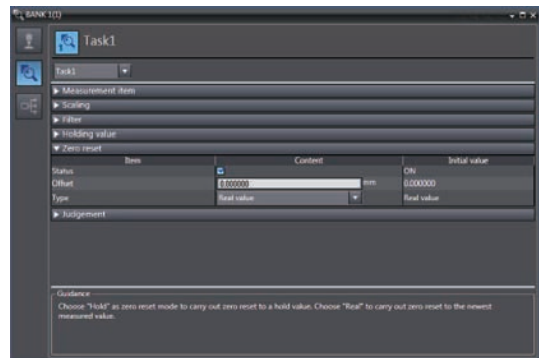

Note

The status can also be set by the operating keys on the Sensor Controller.

 Setting the Status p.256

Setting the Offset

Set this item to set the reference value by a zero reset to a value other than zero.

Item	Setting item	Setting value	Description
Zero reset	Offset	-999.999999 to 999.999999 [mm] (default value: 0)	Set the offset value.

- ▶ **Multi View Explore** : **[Bank Group] | [(Bank Data Name)] (double click)**
- **Edit pane** : **[Task Settings] icon** 
- **Task Settings window** : **[Zero reset]**

1 Set [Status] to ON.

 Setting the Status p.169

Important

Offset can be set only when [Status] is set to ON.

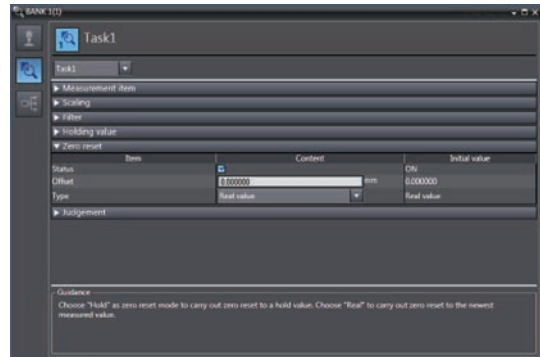

2 Enter an offset value at [Zero reset] - [Offset].

Note

The offset can also be set by the operating keys on the Sensor Controller.

 Setting the Offset p.257

Setting the Zero Reset Type

Set the zero reset type.

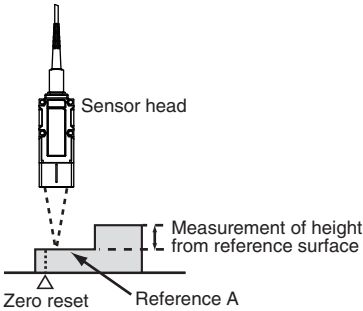
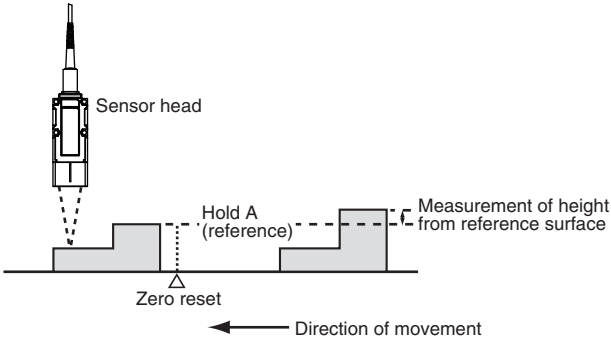
Item	Setting item	Setting value	Description
Zero reset	Type	Real value	Sets the measured value when a zero reset is executed to zero. 
		Hold value	Sets the measured value (hold value) when a zero reset is executed to zero. This is enabled when hold measurement is performed. 

▶ **Multi View Explore** : [Bank Group] | [(Bank Data Name)] (double click)

→ **Edit pane** : [Task Settings] icon (🔍)

→ **Task Settings window** : [Zero reset]

1 Set [Status] to ON.

 Setting the Status p.169

Important

The zero reset type can be set only when [Status] is set to ON.

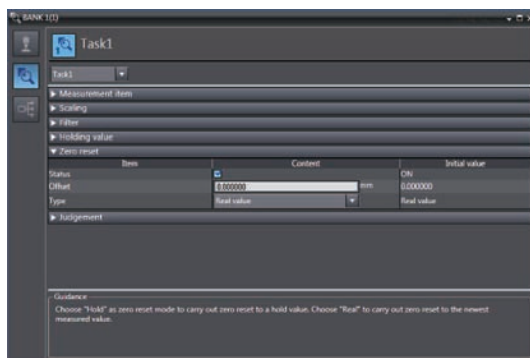

2 Select the zero reset type from [Type].

Note

The zero reset type can also be set by the operating keys on the Sensor Controller.

 Setting the Zero Reset Mode p.258

Setting the Zero Reset Memory

Select whether or not to hold the measured value zero reset level even if the power is turned OFF.

As shown in the figure below, use the zero reset memory still set to “OFF” when using this function to perform a zero reset at each measurement.

Example: When the level difference of a measurement target is measured

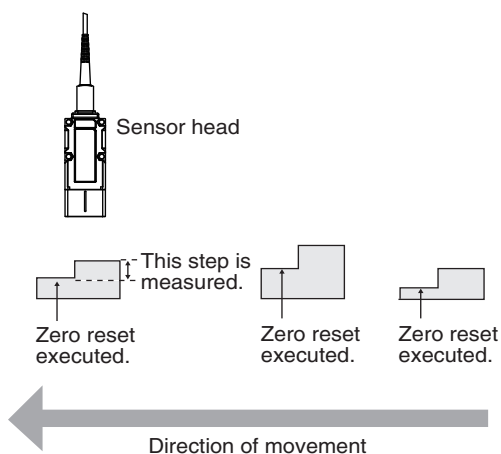



Item	Setting item	Setting value	Description
Sensor settings	Zero reset memory	OFF (default value)	The zero reset is canceled when the power is turned OFF.
		ON	The zero reset level is held even if the power is turned OFF.

Important

- When zero reset memory is set to “ON”, the zero reset is written to EEPROM (non-volatile memory) in the Sensor Controller each time that a zero reset is performed. The EEPROM can be written a maximum of 1,000,000 times. Pay attention to the maximum number of writing allowed when this is set to “ON.”
- Even if zero reset memory is disabled, the zero reset level will be held also when the setting is saved. In this instance, the zero reset will also be continued after a restart.

1 Set the operating mode to the FUNC mode.

 3-2 Switching operation modes p.98

- ▶ Multi View Explore : [System] (double-click)
→ Edit pane : [Sensor Settings] icon ()

2 Select ON/OFF from [Zero-Reset Memory mode].

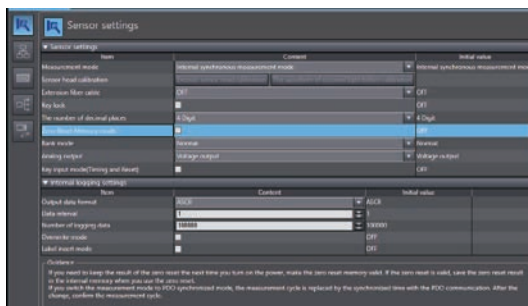

Note

The zero reset mode can also be set by the operating keys on the Sensor Controller.

 Setting the Zero Reset Memory p.259

4-4 Setting Threshold Value

Threshold Value Settings

Switch the Sensor Controller to the FUNC mode and set the range in order for the measured value to be judged as PASS.

Both HIGH and LOW threshold values are set.

As a judgment result, HIGH, PASS or LOW is output.

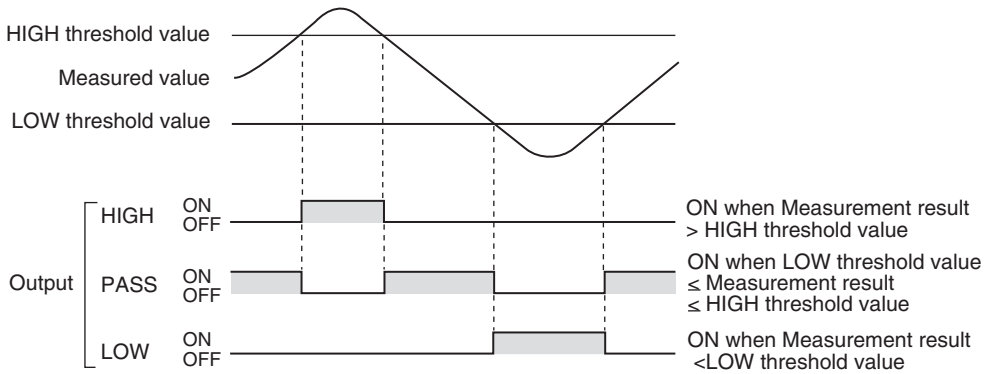

A judgment result appears on the Sensor Controller as follows.

- When the judgment result is “HIGH”: HIGH indicator lights up
- When the judgment result is “PASS”: PASS indicator lights up
- When the judgment result is “LOW”: LOW indicator lights up

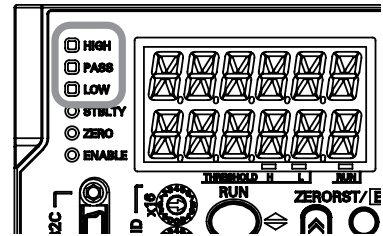

Item	Setting item	Setting value	Description
Judgment	LOW threshold	- 999.999999 to 999.999999 [mm] Factory default differs depending on the connected Sensor Head.	Set the lower limit (LOW) threshold value.
	HIGH threshold	- 999.999999 to 999.999999 [mm]	Set the upper limit (HIGH) threshold value.

- ▶ **Multi View Explore** : [Bank Group] | [(Bank Data Name)] (double click)
- **Edit pane** : [Task Settings] icon (🔍)
- **Task settings window** : [Judgment]

1 Enter the [LOW threshold] and [HIGH threshold].

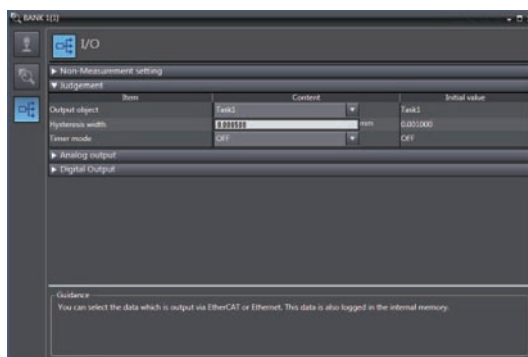

Important

- Hysteresis (hysteresis width) can also be set to threshold values. Set hysteresis when measured values are dispersed around a threshold value, and judgments are unstable, to prevent chattering.

📖 “2-1 Parallel I/O connection” described in Displacement Sensor ZW-8000/7000/5000 series Confocal Fiber Type Displacement Sensor User’s Manual for Communications Settings (Z363)

- Threshold values can also be adjusted by directly entering values in the RUN mode. This helps you to make fine adjustments without shutting down the system.

📖 Changing Threshold Values p.228

Note

Threshold Value Settings can also be set by the operating keys on the Sensor Controller.

📖 7-10 Setting Threshold Value p.265

4-5 Setting I/O

Setting when measurement is not possible

With ZW-8000□, non-measurement setting can be used to intentionally set the measurement value to the clamp value.

This function cannot be used with ZW-7000□/5000□

Example: When skipping occurs in the measurement values at the end of the target

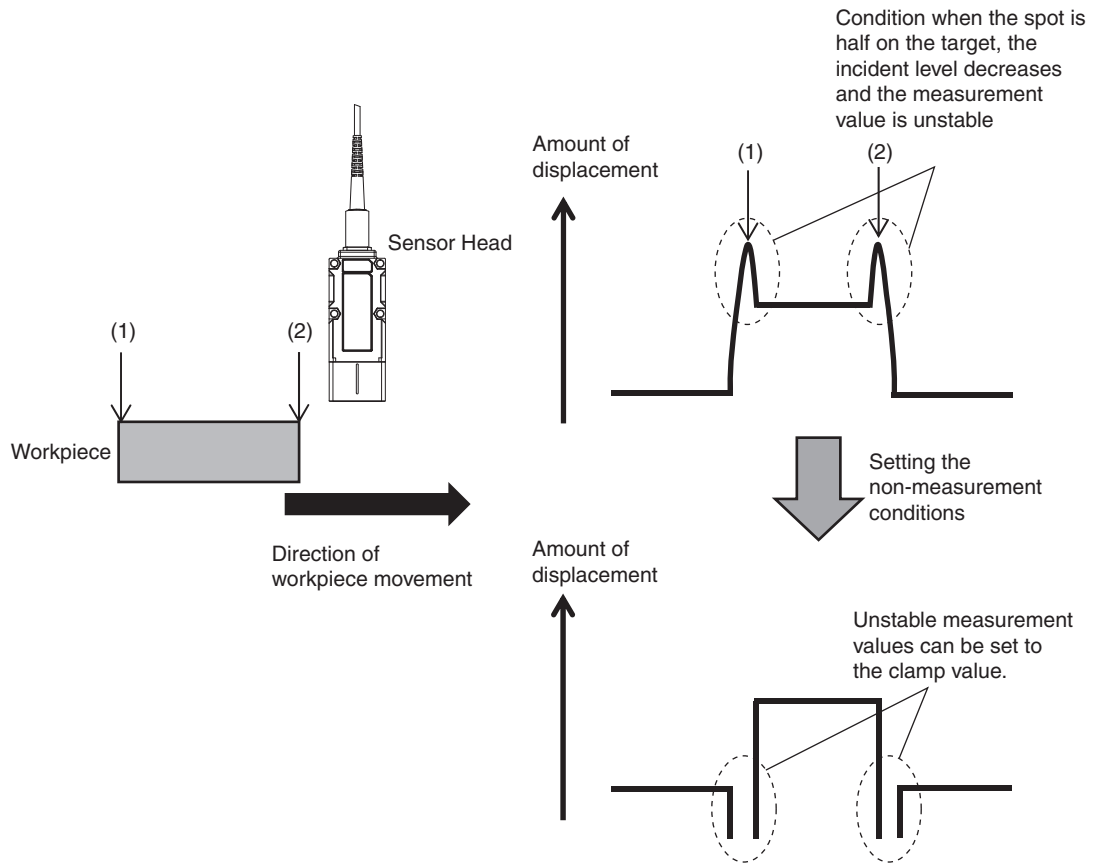

Important

The measurement value before the execution of filter processing is set to the clamp value.

Setting the non-measurement conditions

The measurement value can be set to the clamp value when there is an unexpected number of edges or reflection power due to the state of the light reception waveform.

At this time, "-----" is displayed on the controller's main display.

* With ZW-7000□/5000□, this setting is not possible.

Setting item	Setting value	Description
Reflection power	ON/OFF	When set to ON, the measurement value is set to the clamp value when less than the set reflection power threshold.
Reflective power threshold	1 to 1000	Set the reflection power threshold value. Reflection power is the strength of light returning from the workpiece.
Number of Edge	ON/OFF	When set to ON, if the set edge number condition is not met, the measurement value is set to the clamp value.
Condition for number of Edge	surface / 2 surface / 3 surface / 4 surface / Edge 5 or more	Set the edge number condition.
Comparison condition of number of Edge	(Condition for number of Edge) = (Observed number of Edge)/ (Condition for number of Edge) ≤ (Observed number of Edge)/ (Condition for number of Edge) ≥ (Observed number of Edge)	Set the edge number comparison condition.

1 Set the operating mode to the FUNC mode.

 3-2 Switching operation modes p.98

- ▶ **Multi View Explore** : [Bank Group] | [(Bank Data Name)] (double click)
 - **Edit pane** : [I/O Settings] icon 
 - **I/O Setting Screen** : [Non-Measuring Specification]

2 Set the condition of the non-measurement value at [Non-Measuring Specification].

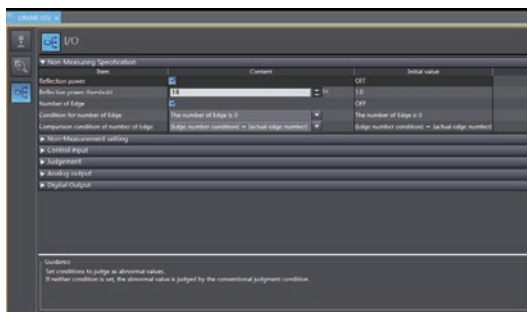

3 Set [Reflective power threshold], [Condition for number of Edge] and [Comparison condition of number of Edge].

Note

- Threshold Value Settings can also be set by the operating keys on the Sensor Controller.

 7-10 Setting Threshold Value p.265

- The edge number can be confirmed on the sensing monitor.
(Example: When measuring glass, 2 surfaces are detected as shown by the 2 arches shown below.)

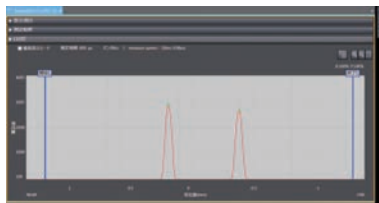

Settings for Processing When Measurement Is Not Possible

Setting operation when measurement is not possible

Set the output method when the sensor head temporarily enters a non-measurement state, for example, due to insufficient received light amount.

With ZW-8000□, the keep count and restore from clamp value count can be specified.

With ZW-7000□/5000□, the keep count and restore from clamp value count cannot be specified.

Example: When skipping occurs in the measurement values due to low incident level

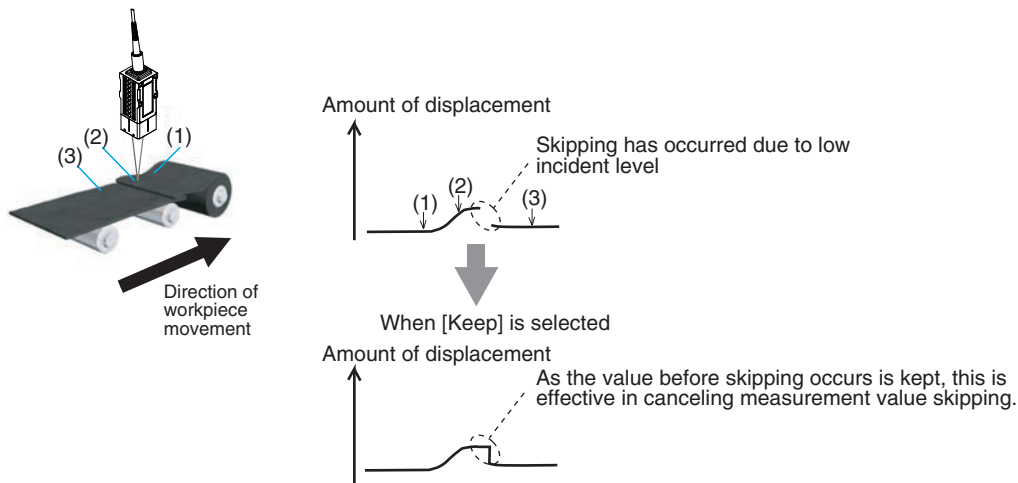

Important

- When performing hold measurement, the output before the initial hold value is applied is the same as that for “Clamp” even if “Keep” is set.
- When performing hold measurement, the keep count and restore from non-measurement state count cannot be specified.

Item	Setting item	Setting value	Description
Non-Measurement setting	Mode	Clamp	With analog output, the preset clamp value (abnormal value) is output. All judgment outputs become OFF.
		Keep	The measured value before the non-measurement state was entered is held and output.
	Keep count specification flag	ON	Specifies the keep count and restore from clamp value count. The mode setting is enabled during keeping. * This setting cannot be used with ZW-7000□/5000□.
		OFF	The immediately preceding measurement value is held and output, regardless of the non-measurement state count. * This setting cannot be used with ZW-7000□/5000□.
	Keep count	1 to 16382	Sets the keep count of the immediately preceding measurement value during non-measurement. * This setting cannot be used with ZW-7000□/5000□.
Number of restorations	1 to 16382	Sets the count of restorations from non-measurement state to measurement state. * This setting cannot be used with ZW-7000□/5000□.	

1 Set the operating mode to the FUNC mode.

 3-2 Switching operation modes p.98

- ▶ **Multi View Explore** : [Bank Group] | [(Bank Data Name)] (double click)
 - **Edit pane** : [I/O Settings] icon 
 - **I/O Setting Screen** : [Non-Measurement Setting]

2 Select the operation during non-measurement at [Non-Measurement Setting].

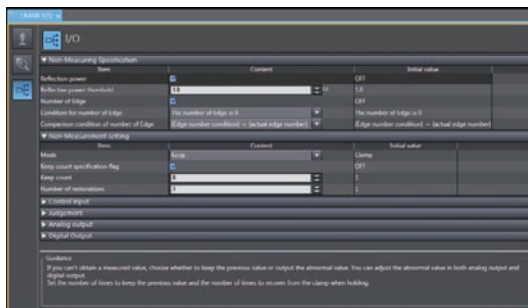

3 With ZW-8000, set [Keep count specification flag], [Keep count] and [Number of restorations].

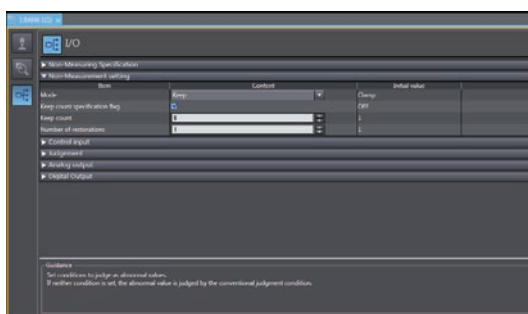

Note

The operations for when measurement is not possible can also be set with key operations on the Sensor Controller.

 Displacement Sensor ZW-8000/7000/5000 series Confocal Fiber Type Displacement Sensor User's Manual (Z362) "6-1 Connecting Parallel I/O"

Setting the Clamp Value

Set the clamp value to output when "Clamp" is selected as processing when measurement is not possible.

Item	Setting item	Setting value	Description
Analog output	Clamp output	When the analog output destination is set to current MIN (approx. 3.4mA)/4 to 20mA (1mA increments)/ MAX (default value: approx. 21mA) When the analog output destination is set to voltage MIN (approx. -10.8V)/-10 to +10V (1V increments)/ MAX (default value: approx. 10.8V)	Select the current value/voltage value at clamp output.
Digital output	Clamp output	-2147.483648(0x80000000) mm (default value) -999.999999(0xC4653601) mm 0 mm 999.999999(0x3B9AC9FF) mm 2147.483647(0x7FFFFFFF) mm	Set the digital value for clamp output.

1 Set the operating mode to the FUNC mode.

 3-2 Switching operation modes p.98

- ▶ **Multi View Explore** : [Bank Group] | [(Bank Data Name)] (double click)
 - **Edit pane** : [I/O Settings] icon 
 - **I/O Setting Screen** : [Analog output]

2 Select the output value at [Output value when clamp].

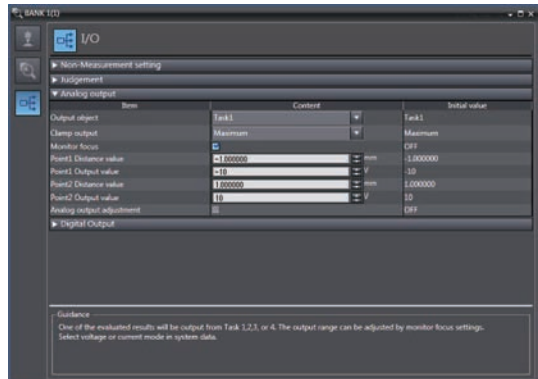

- ▶ **Multi View Explore** : [Bank Group] | [(Bank Data Name)] (double click)
 - **Edit pane** : [I/O Settings] icon 
 - **I/O Setting Screen** : [Digital output]

3 Select the output value at [Output value when clamp].

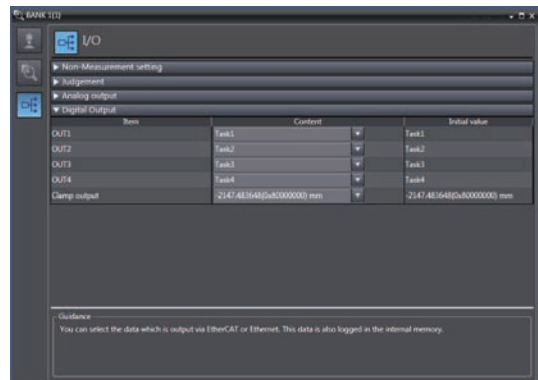

Note

Clamp values can also be set with key operations on the Sensor Controller.

 Displacement Sensor ZW-8000/7000/5000 series Confocal Fiber Type Displacement Sensor User's Manual (Z362) "6-1 Connecting Parallel I/O"

Assigning digital output

Set the measurement result for digital output.

This setting is applied to the OUT data of the Internal logging, Fieldbus (EtherCAT/Ethernet), and serial data.

Units for each setting values are as follows:

Measurement value	:nm
Amount of emitted light	:0.01% (0.01 to 100.00%)
Amount of received light	:Luminance level (0 to 4095)
Reflection power	:Lv(1 to 10000)

With ZW-8000□, the measurement state can be output.

The measurement state can be set to the non-measurement condition, and the reflection power and edge number judgment result can be checked.

The measurement state is output as the following bit assignments.

- 1st bit (lowest bit) :Reflection power judgment value
- 2nd bit :Edge number judgment value

The output data is output as a decimal number. If the output data is "2" for example, the 1st bit (lowest bit) is "0" and the 2nd bit is 1 (2'b10).

The measurement state at this time does not meet the edge number comparison condition and is less than the reflection power threshold.

Item	Setting item	Setting value	Description
Digital output	Output target* (OUT*)	None/TASK1/TASK2/TASK3/TASK4/ Amount of emitted light (Area1)/ Peak amount of received light (Area1)/ Light power (Area 1) / Peak amount of received light (Area 1)/ Incident level (1st edge of Area 1)/ Incident level (2nd edge of Area 1)/ Incident level (3rd edge of Area 1)/ Incident level (4th edge of Area 1)/ Light power (Area 2)/Peak amount of received light (Area 2)/Incident level (1st edge of Area 2)/Incident level (2nd edge of Area 2)/Incident level (3rd edge of Area 2)/Incident level (4th edge of Area 2) Measurement state (ZW-8000□ only) / Reflection power (ZW-8000□ only)	Set the Measurement result for digital output.

- ▶ **Multi View Explore** : [Bank Group] | [(Bank Data Name)] (double click)
- **Edit pane** : [I/O Settings] icon 
- **I/O Setting Screen** : [Digital output]

- 1** Select the measurement value in [Output target*(OUT*)].

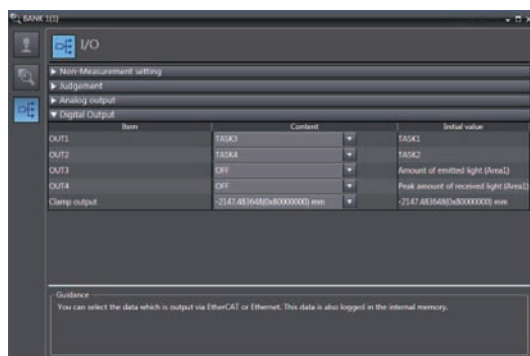

4-6 Setting the System

Setting the Key Lock

This function disables all key inputs on the Sensor Controller. Once the key lock is set, no key input will be accepted until the lock is released. This function is useful for preventing inadvertent changes to settings.

Item	Display Item	Setting value	Description
Sensor settings	Key lock	OFF (Initial value)	Cancels the key lock function.
		ON	Turns the key lock function ON.

Important

Note that, moving to the key lock setting menu or moving between menu hierarchies are possible even when the key lock function is ON by the operating keys on the Sensor Controller.

1 Set the operating mode to the FUNC mode.

 3-2 Switching operation modes p.98

▶ **Multi View Explore** : [System] (double-click)
→ **Edit window** : [Sensor Settings] icon ()

2 Select ON or OFF from [Keylock].

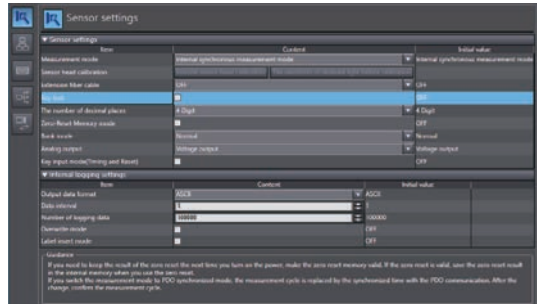

Note

Set the operation mode to the FUNC mode.

 Setting the Key Lock p.269

Setting the Number of Digits Displayed Past the Decimal Point

Set the number of digits displayed past the decimal point for when numerical values are displayed on the main display and sub-display of the Sensor Controller.

Item	Setting item	Setting value	Description
Sensor settings	The number of decimal places	0 Digit to 5 Digit (default value: 4 Digits)	Set the number of digits displayed past the decimal point for when numerical values are displayed on the Sensor Controller.

1 Set the operating mode to the FUNC mode.

 3-2 Switching operation modes p.98

- ▶ **Multi View Explore** : [System] (double-click)
- **Edit pane** : [Sensor Settings] icon 

2 Select the number of digits displayed past the decimal point from [The number of decimal places].

You can select from the above setting values.

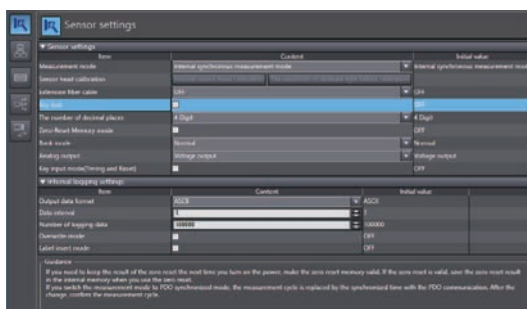

4-7 Saving The Settings

Saving the Bank/System Settings

Save the bank/system settings to the Sensor Controller.

Important

- The settings of all banks are saved regardless of the currently selected bank number.
- After you have made or changed settings, be sure to save the setup data. All settings will be deleted if you turn the power OFF without saving the data.

1 Set the operating mode to the FUNC mode.

 3-2 Switching operation modes p.98

- ▶ **Multi View Explore** : [(ZW model name)] (double click)
 - **Edit pane** : [Online] icon ()
 - **Online setting window** : [Save data]

2 Select [Save data (Sensor internal memory)].

Bank/system settings are saved to Sensor internal memory.

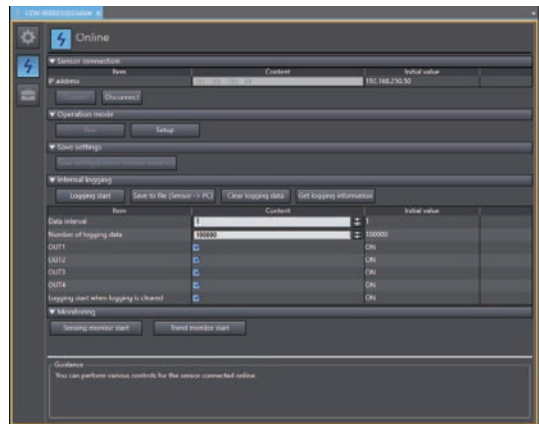

Note

- Settings can also be saved by selecting and right-clicking a [(ZW model)] from the Multi View Explore and selecting "Save settings" from the right-click menu.
- The bank/system settings can also be saved by the operating keys on the Sensor Controller.

 Saving the Bank/System Settings p.263

Copying the Bank/System Settings

Copy the selected bank setting to another bank.
Also, copy ZW system settings to a different ZW.

1 Set the operating mode to the FUNC mode.

 3-2 Switching operation modes p.98

2 Copy the bank data or system data.

Select the copy source bank data or system data from the Multi View Explore, and select [Copy] from the right-click menu.

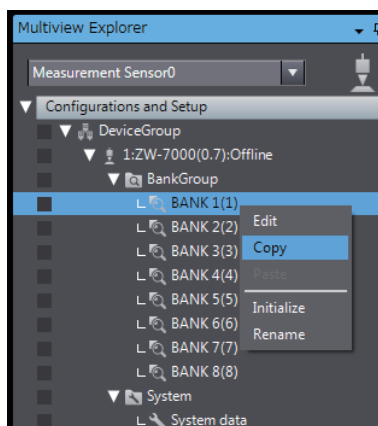

3 Paste the bank data or system data

Select the copy destination bank data or system data from the Multi View Explore, and select [Paste] from the right-click menu.

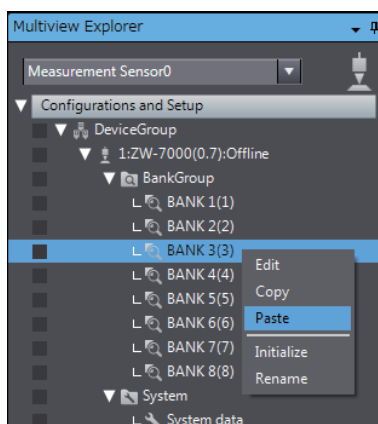

Note

The bank settings can also be copied by the operating keys on the Sensor Controller.

 Copying the Bank Settings p.262

Initializing Settings

Returns all banks/system settings to their default settings.

Important

- The settings of all banks/system settings are returned to the default settings regardless of the currently selected bank number.

► **Multi View Explore** : [(ZW model name)] (double click)
→ **Edit pane** : [Tool] icon 

- 1 Click [Sensor setup] - [Initialize sensor].
Initialization is executed.

Note

- Settings can also be initialized by selecting and right-clicking a [(ZW model)] option from the Multi View Explore and selecting "Initialize sensor" from the right-click menu.
- Operating key of Sensor Controller is allowable to initialize.
- Information for Sensor Head calibration is retained.



Initializing Settings p.271

Clearing the Bank Settings

Select a bank and initialize its settings.

1 Set the operating mode to the FUNC mode.

 3-2 Switching operation modes p.98

2 Select the bank data.

Select the bank data from the Multi View Explore, and select [Initialize] from the right-click menu.

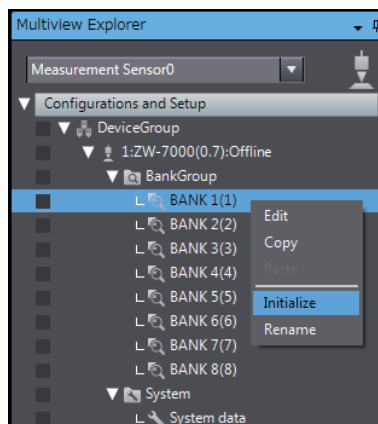

Note

The bank settings can also be cleared by the operating keys on the Sensor Controller.

 Initializing Settings p.271

Setting the Bank Mode

Select the bank contents to be obtained from the settings or judgment value.

All bank data will be initialized when the bank mode is switched.

Item	Setting item	Setting value	Description
Sensor settings	Bank mode	Normal (default value)	Sensing setting, measurement setting and I/O setting that are set in the FUNC mode are regarded as bank data. The number of banks is up to eight.
		Judgment value	Only the threshold value under the measurement setting is regarded as bank data. Other values are the same for all banks. The number of banks increases up to 32.

1 Set the operating mode to the FUNC mode.

 3-2 Switching operation modes p.98

- ▶ **Multi View Explore** : [System] (double-click)
- **Edit pane** : [Sensor Settings] icon 

2 Select the bank mode from [Bank mode].

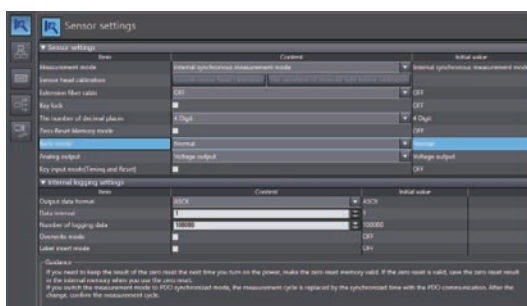

Note

The bank mode can also be set by the operating keys on the Sensor Controller.

 Changing the Bank Mode p.261

MEMO

Convenient Functions

5-1 Checking the Information of the Sensor	192
5-2 Storing the light reception wave form in a file	193
5-3 Recovering Calibration ROM data	195
5-4 Printing the contents of settings	196
5-5 Control input signal with PC tool	198
5-6 Viewing the Energization Time	199
5-7 Selecting Measured Values to be Externally Output	200

5-1 Checking the Information of the Sensor

Displays the information of the Sensor Controller and Sensor Head.

Item	Displayed item	Setting value	Description
General settings	Sensor information	Name	Displays the name of the Sensor Controller
		Sensor Controller type	Displays the model information of the Sensor Controller.
		Software Version	Displays the version information of the software of the Sensor Controller.
		Sensor head model	Displays the model information of the Sensor Head.
		Sensor serial No.	Displays the serial No. of the Sensor Head.
		MAC address	Displays the MAC address that is set.
		Energization time	Displays the energization time of the Sensor Controller.

- ▶ **Multi View Explore** : [(ZW model name)] (double click)
- **Edit pane** : [General Settings] icon (⚙️)

- 1 The Edit pane main pane is displayed in the Edit pane.
You can check the above information under [General settings] - [Sensor information].

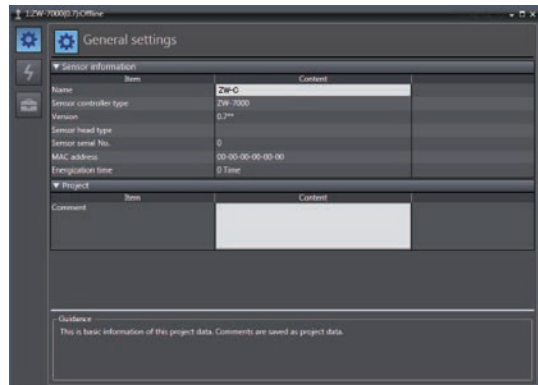

5-2 Storing the light reception wave form in a file

The light reception wave form can be stored in a file as a record of the measurement state.

Item	Output items	Description
RegionNo	Area1 / Area2	Indicates the measurement area. Area1: Measurement Area 1, Area2: Measurement Area 2
StartPosition	-3.750 to 3.750	Indicates the start position [mm] for the measurement area.
EndPosition	-3.750 to 3.750	Indicates the end position [mm] for the measurement area.

- ▶ **Multi view Explore** : [Device Group] | [(Sensor Name)] (right click) | [Sensing monitor]
- ▶ **Multiview Explorer** : [Device Group] | [(Sensor Name)] (double click)
- **Edit Window** : [Online]-[Monitoring]-[Sensing monitor start]

1 Select the line bright storage icon ().

Input the name of the file to export to.

A CSV format file in the following format is output.



For ZW-7000/5000

RegionNo	Area1 / Area2	
StartPosition	Measurement area (start)	
EndPosition	Measurement area (end)	
Position (pix)	Position (mm)*	Value
0	Pixel 0 position (mm)	(Amount of light received 0)
1	Pixel 1 position (mm)	(Amount of light received 1)
2	Pixel 2 position (mm)	(Amount of light received 2)
3	Pixel 3 position (mm)	(Amount of light received 3)
:	:	:
254	Pixel 254 position (mm)	(Amount of light received 254)
255	Pixel 255 position (mm)	(Amount of light received 255)

For ZW-8000

RegionNo	Area1 / Area2	
StartPosition	Measurement area (start)	
EndPosition	Measurement area (end)	
Position (pix)	Position (mm)*	Value
0	Pixel 0 position (mm)	(Amount of light received 0)
1	Pixel 1 position (mm)	(Amount of light received 1)
2	Pixel 2 position (mm)	(Amount of light received 2)
3	Pixel 3 position (mm)	(Amount of light received 3)
:	:	:
1022	Pixel 1022 position (mm)	(Amount of light received 1022)
1023	Pixel 1023 position (mm)	(Amount of light received 1023)

* The clamp value is output when outside the measuring range.

5-3 Recovering Calibration ROM data

If an abnormality occurs in the sensor's Calibration ROM, you can recover the backed up Calibration ROM data into the sensor.

1 Set the operating mode to the FUNC mode.

 3-2 Switching operation modes p.98

- ▶ **Multi view Explore** : [Device Group] | [(Sensor Name)] (double click)
→ **Edit pane** : [Tool] icon 

2 Click the [ROM recovery] in [Sensor setup]. Select the Calibration ROM backup data file.

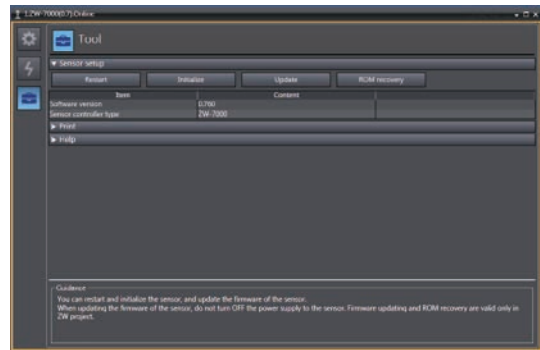

Important

- The Calibration ROM data is different for each sensor serial number. Select the backup file that matches the sensor serial number. Measurement will not be correct unless they match.
- As a temporary measure if the Calibration ROM is lost, or fails, the measurement can be restarted using the last loaded Calibration ROM data according to the following procedure.
<Operating procedures>
 - Hold the button while [NO.ROM] is displayed on the sub digital. Press the ZERO/SET key after [OK/CAN] is displayed.<Note>
 - Confirm that the serial number of the Calibration ROM which is loaded is the same as the serial number of the Sensor Head by checking the Controller Information.
 - If the serial numbers are not the same, measurement cannot be performed correctly.
 - When restarting the Sensor Controller, perform the same procedures again.
 - For a Displacement Sensor which has never been inserted or launched, this operation is disabled.

5-4 Printing the contents of settings

You can print the contents of bank data and system data settings.

Item	Setting item	Mode	Description
Print	Target data	All information	The sensor information, bank group data, and system data are all printed.
		Sensor information	The sensor information is printed.
		Bank Group	The bank group data (Banks 1 through 8) is printed.
		Bank Data	The specified bank data is printed.
		System Data	The system data is printed.
Bank number	1 to 8	If bank data is selected as target data, specify the bank number to print the data for.	

► **Multi view Explore** : [Device Group] | [(Sensor Name)] (right-click)

1 Select [Print].

The [Print] window is displayed on the Edit pane.

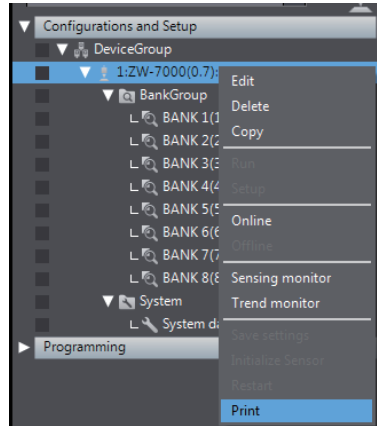

2 Select the data to print.

From [Target data], select the data to print. Select and expand the parameters to print.

If you click [Expand All], all the parameters are expanded.

To print the default values as well, check the [Display Default Values] checkbox.

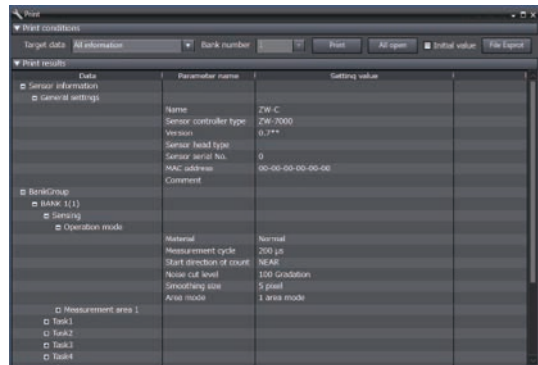

Important

Only the expanded parameters are printed.

Note

- The set contents of parameters can be output in CSV file format.

1 Click [File output] button.

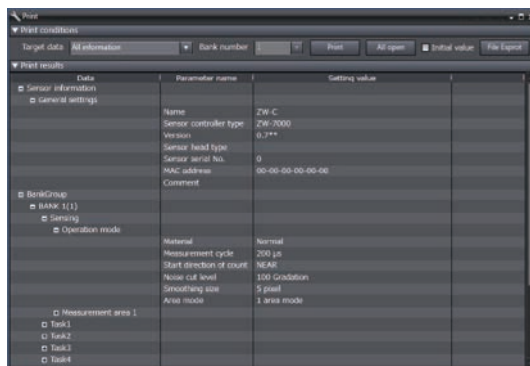

2 Enter the file name to save it to the desired folder.

The parameters are opened and output to the file.

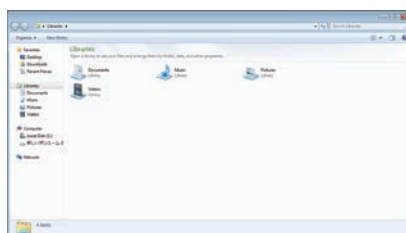

- CSV file output is as follows.

Item	Property Name	Target Data
Sensor information		
General settings		
	Name	ZW-7
	Sensor Controller model name	ZW7000
	Version	1.2**
	Head model name	0
	Head serial No.	00-00-00-00-00-00
	MAC address	
	Comment	
Bank group		
BANK 1(1)		
Sensing		
Operation mode		1 area
	Area mode	Normal
	Material	100 tones
	Background removal level	5 pixels
Measurement area1		

5-5 Control input signal with PC tool

Following input signal can be controlled with PC tool.

- LIGHT-OFF
- TIMING
- RESET
- ZERO

- ▶ **Multi view Explore** : [Device Group] | [(Sensor Name)] (right click) | [Sensing monitor]
- ▶ **Multi view Explore** : [Device Group] | [(Sensor Name)] (double click)
 → **Edit Window** : [Online]-[Monitoring]-[Sensing monitor start]

1 [I/O input] is opened.

2 If each button is clicked, the **Sensor Controller is controlled as corresponding input signal is turned ON.**

While the button is clicked, corresponding input signal is status ON.

If the button is clicked again, the input signal is turned OFF.

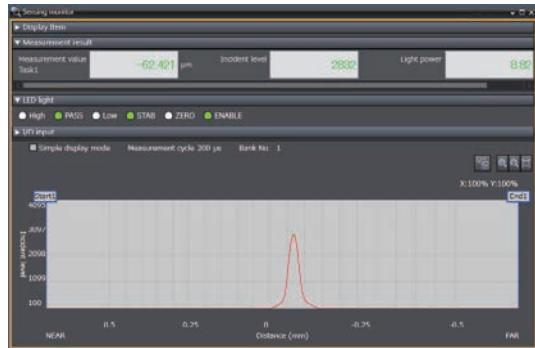

Button	Effect
LIGHT-OFF	The white LED is turned OFF.
TIMING	The TIMING input is turned ON.
RESET	The RESET input is turned ON.
ZERO	The ZERO input is turned ON.

Note

Some adjustments can only be made while in FUNC mode.
 When in RUN Mode, [I/O input] is not displayed.

5-6 Viewing the Energization Time

You can check the energization time of the sensor controller from the factory-installed.

Items	Specification
Display unit	"hour"
Update interval	1 "hour"

- ▶ **Multiview Explorer** : [(ZW model name)] (double click)
→ **Edit pane** : [General Settings] icon (⚙️)

- 1** The Edit pane main pane is displayed in the Edit pane.
You can view the energization time under [General settings] - [Sensor information].

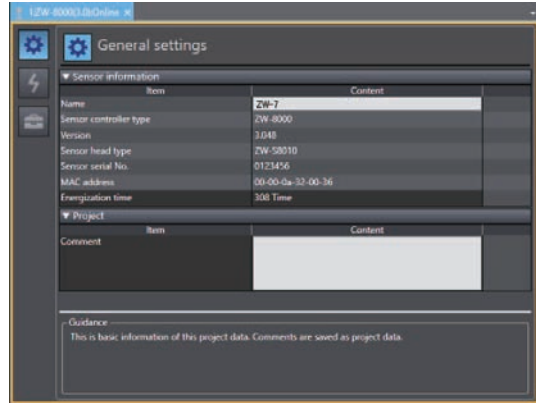

Important

With ZW-7000□, this function is not available when the factory-installed firmware version is 2.100 or earlier.

With ZW-8000□/ZW-5000□, this function is available for all versions.

When the firmware has been updated from the version 2.100 or earlier or when the energization time cannot be recorded due to a non-volatile memory hardware malfunction, "-----" is displayed in the Energization time field.

Note

The energization time can be viewed by key operations on the Sensor Controller.

 "Search from Menu Tree p.212"

5-7 Selecting Measured Values to be Externally Output

You can select the data to be output from the following routes:

- Analog output
- Digital output

Note

Selected data in Digital Output setting becomes the measurement object of the following functions:

The data selected in the Digital Output setting are to be output by internal logging, fieldbus output (EtherCAT/ EtherNet/IP), or serial data output.

Assigning digital output

Refer to the following chapter:



“2-1 Parallel I/O Connection” described in Displacement Sensor ZW-8000/7000/5000 series Confocal Fiber Type Displacement Sensor User’s Manual for Communications Settings (Z363)

Assigning analog output

Refer to the following chapter:



“2-1 Parallel I/O connection” described in Displacement Sensor ZW-8000/7000/5000 series Confocal Fiber Type Displacement Sensor User’s Manual for Communications Settings (Z363)

Offline Settings

6-1 Performing Settings Offline.....	202
6-2 Starting a Project in Offline Mode.....	203
6-3 Changing between Online and Offline.....	204
6-4 Offline Debugging of the Sensor Control Program and Sensor Operation.....	206

6-1 Performing Settings Offline

The personal computer tools set enables the user to perform settings offline without connecting an actual sensor.

Parameters set offline can be saved as project data just like parameters set online, and conditions set offline can be transferred to the sensor as desired.

The following functions are disabled during offline setting.

Item			Reference (Pages)	
Main screen	Online		Internal logging	p.114
			Trend monitor	p.103
	Tool		Sensor setup	p.187 p.195 p.324
Sensing monitor pane	Monitor		Measurement value monitor	p.90
			Line bright monitor	
			LED light	
			I/O input	
Bank data edit pane	Task	Filer	Scaling (automatic setting)	p.144
	I/O	Analog output	Analog output correction	

*: Refer to "2-1 Parallel I/O connection" described in Displacement Sensor ZW-8000/7000/5000 series Confocal Fiber Type Displacement Sensor User's Manual for Communications Settings (Z363).

6-2 Starting a Project in Offline Mode

To start a project in Offline Mode, select [Enter the type] on the Select Sensor Dialog Box after you create a project, then select the sensor type and version.

You cannot change the sensor type and version after you select them.

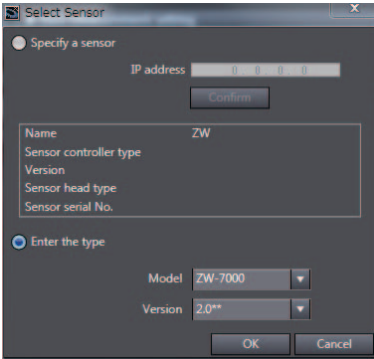

6-3 Changing between Online and Offline

Before you go offline, save all settings and parameter changes to the Sensor's internal memory. Saving your project does not save the data in the Sensor.

You can use the following two methods to change between offline and online.

- ▶ **Multi View Explore** : [(Sensor Name)] (right click) [Online]/[Offline]
- ▶ **Multi View Explore** : [Device group] | [(Sensor model)] (Double-click)
→ **Edit pane** : [Online] Icon | [Sensor connection] | [Connect] or [Disconnect]

- 1 To go offline, click [Disconnect]. To go online, click [Connect].

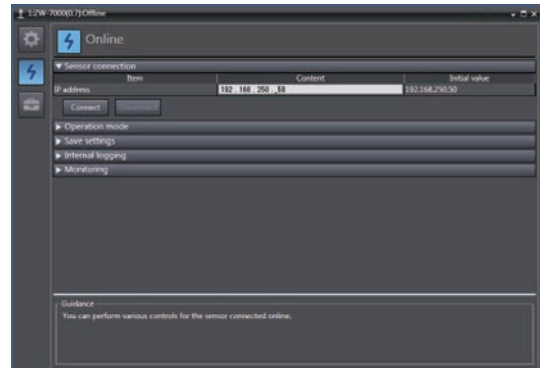

- 2 When you click [Connect], the Sensor Controller with the specified IP address is connected. When the connection is successful, Sensor Controller information is displayed.

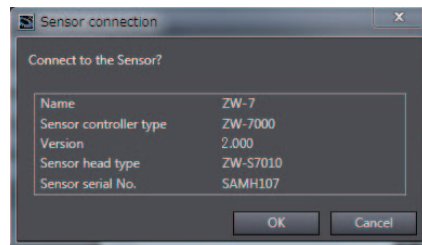

- 3 When you click [Connect], you must synchronize the data between the Sensor and the project.
When a project setting data is synchronized with Sensor Controller, select [Transfer to Sensor].
When synchronize a Sensor Controller's setting data with project, select [Transfer from Sensor].

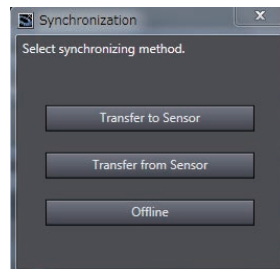

Note

 Saving the Bank/System Settings p.185, p.263
Saving a project p.93

Important

When Sysmac Studio and the sensor controller bank mode (refer to  Clearing the Bank Settings p.188) differ, the current bank number after project data synchronization is set to the initial value (1).

Note

When connecting online for the first time

- When connecting to a Sensor Controller online for the first time, the Calibration ROM data backup window appears.

If the Calibration ROM is lost, or it fails, the backed-up data can be recovered to the Sensor Controller.

Please keep the backed-up Calibration ROM data.

 5-3 Recovering Calibration ROM data p.195.

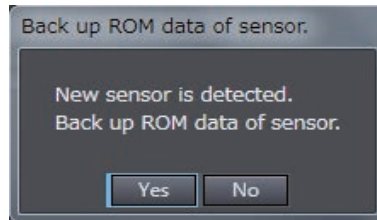

- When the Sensor Controller is in Setup mode; FUNC mode, online connection is disabled. Should switch to the RUN mode.

6-4 Offline Debugging of the Sensor Control Program and Sensor Operation

If an EtherCAT system is configured, you can perform a linked simulation between the sequence control of an NX/NJ-series Controller and the operation of an ZW Sensor.

The sensor control program can be debugged offline using measurement results saved by the data trace function.

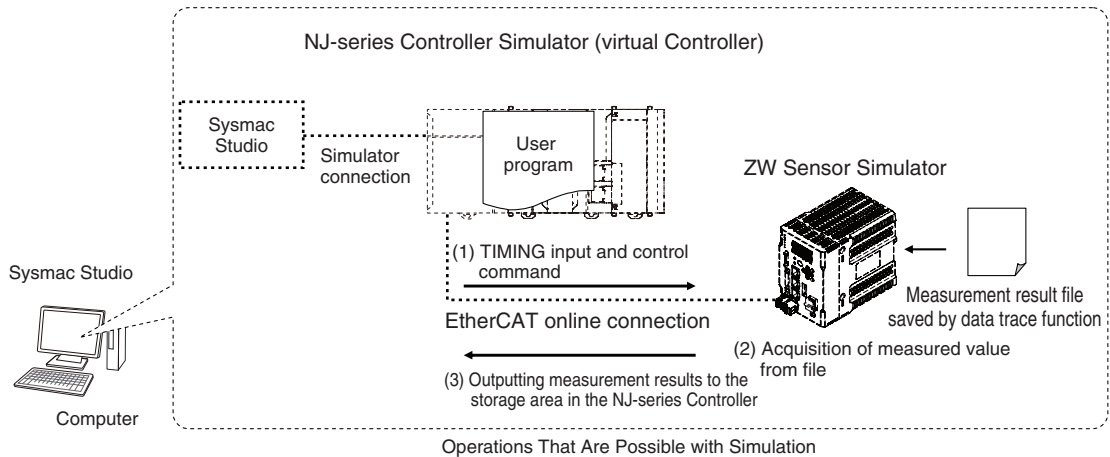

Note

Sensor measurement and other operation cannot be simulated. The measurement result acquired previously by the data trace function is output.

Important

Simulation is possible only on the Standard Edition of the Sysmac Studio.

Registering the ZW as an EtherCAT Slave

You use the Sysmac Studio (Standard Edition) to add the ZW to the EtherCAT slave configuration. Refer to the *Sysmac Studio Version 1 Operation Manual* (Cat. No. W504) for details on registering slaves. Only simplified procedures are provided here.

• Opening the Edit EtherCAT Configuration Tab Page

► Multi view Explore : [Configurations and Setup] | [EtherCAT] (Double-click)

• Registering a Slave Offline (Building the Network Configuration)

1 Use either of the following methods to add an ZW slave to the master.

- Drag [ZW-C7000□] from the [Toolbox] to the master in the Edit Network Configuration Tab Page, and then drop or double-click.

- 2 Select the ZW that was added to the Edit Network Configuration Tab Page and change the node address of the ZW to the node address that is set on the ZW hardware switches.

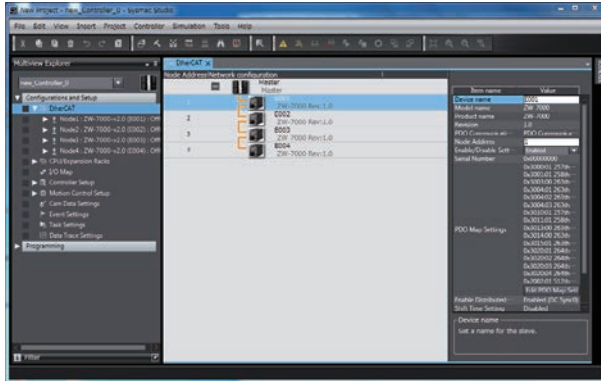

Setting Up the ZW

Set up the inspections in the ZW, e.g., set the inspection items.

- 1 Double-click the ZW that was added to the Edit Network Configuration Tab Page. The ZW Setup Pane is displayed for the Edit Pane. Make all of the required settings.

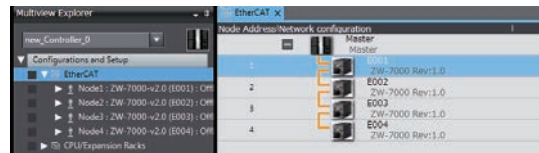

Executing the Simulation

- 1 Write and build the user program that will operate the machine. Refer to the *Sysmac Studio Version 1 Operation Manual* (Cat. No. W504) for details on programming.
- 2 Open the Edit screen. Right-click [(Sensor model)] in the Edit network configuration Tab page and select [Edit].

3 Specify the measurement result file for performing offline debugging.

Edit pane: [Tools] - [Simulation data] - [Specify a file]

Select the CSV file that is written in the following format.

You can also import files saved in the internal logging and trend graphs.

index, OUT1, OUT2, OUT3, OUT4

0,MV, MV, MV, MV

1,MV, MV, MV, MV

2,MV, MV, MV, MV

:

(MV: Measurement Value)

4 Select [Simulation] - [Execute].

The simulation will start.

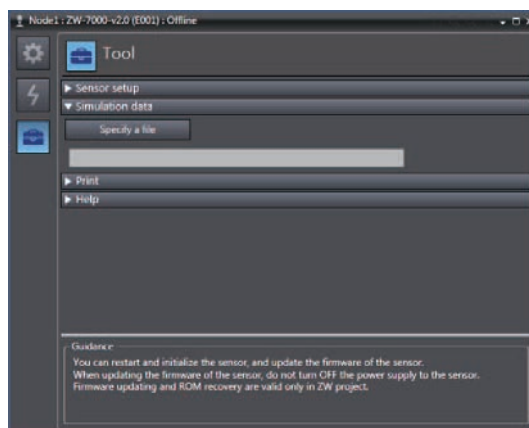

Refer to the *Sysmac Studio Version 1 Operation Manual* (Cat. No. W504) for the operating procedures for the Simulator.

Sensor controller operations

7-1 Basic Operation	210
7-2 Search from Menu Tree	212
7-3 Functions of Operating Keys	222
7-4 Digital Displays.....	223
7-5 Functions and Operations during Measurement	224
7-6 Setting Sensing	229
7-7 Setting Measurement Items.....	237
7-8 Setting the Output Conditions	242
7-9 Setting the Banks.....	260
7-10 Setting Threshold Value	265
7-11 Setting the System.....	268
7-12 Connecting Parallel I/O	274
7-13 Connecting with EtherCAT	275
7-14 Connecting with EtherNet/IP.....	276
7-15 Connecting by No-protocol Communications.....	277

7-1 Basic Operation

The ZW unit operation modes are FUNC (adjustment) mode and RUN (operation) mode.

RUN mode is used as the default operation mode.

FUNC mode is used when setting and adjusting various functions of the unit.

Use  key to switch between the operation modes.

The RUN indicator identifies the current operation mode.

 3-2 Switching operation modes p.98

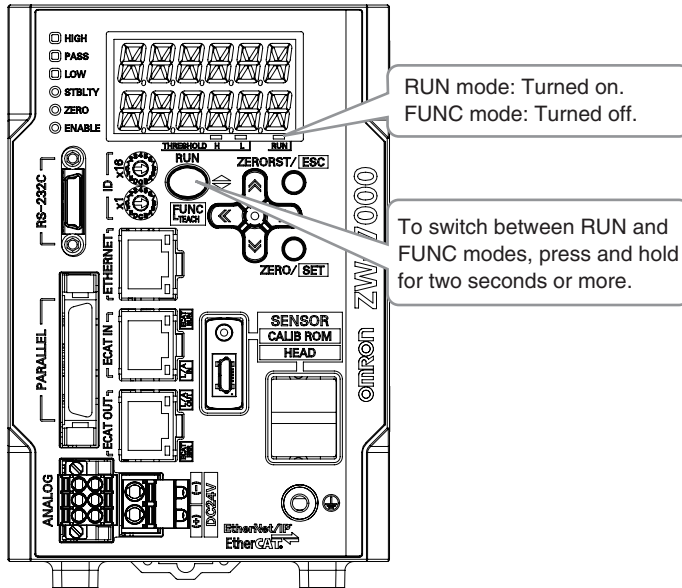

Entering Numerical Values

To enter numerical values, including parameters, for the sub-display, follow the steps below:

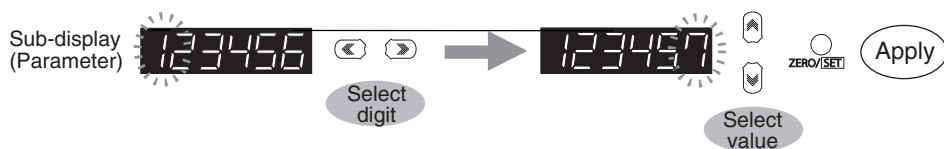

- (1) When entering numerical values, the sub-display displays the current setting value and its uppermost digit flashes.
- (2) Press the / keys to select a digit to enter a number.
Press the key on the rightmost digit to move blinking to the leftmost digit.
Press the key on the leftmost digit to move blinking to the rightmost digit.
- (3) Press the / keys to select a digit to enter a number.
- (4) Press the key to apply the entered value.

Positioning decimal point

To position a decimal point, follow the steps below:

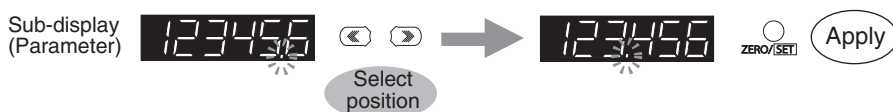

- (1) If a decimal point has been defined, it flashes on the sub-display.
- (2) Press the / keys to position the decimal point.
Position the decimal point at the rightmost digit to erase it.
Press the key on the rightmost digit to move blinking to the leftmost digit.
Press the key on the leftmost digit to move blinking to the rightmost digit.
- (3) Press the key to apply the position of the decimal point.

7-2 Search from Menu Tree

FUNC (adjustment) Mode Menu

⋯⋯⋯: This is displayed only when the 2 area mode is selected in [Measurement Area].

* default value

		Setting	Option/Setting Range	Pages	
Sensing setting [SENS]	Measurement cycle [CYCLE]	Measurement cycle [CYCLE]	Refer to explanation page of Measurement cycle	p.122	
	Material [OBJECT]	Material [OBJECT]	Normal [NORMAL]*/ Mirror surface [MIRROR]/ Diffusion surface [DIFF]	p.125	
	Area mode [REG.MOD]	Area mode [REG.MOD]	1 Area mode [1. MODE]*1/ 2 Area mode [2. MODE]	p.123	
	Amount of emitted light [LIGHT]	Area1 [REG.NO1]	Auto* [AUTO]	Upper limit [MAX] 0.01 to 100.00% (default value: 100%)	p.129
				Lower limit [MIN] 0.01 to 100.00% (default value: 0.01%)	
				Surface to be controlled [ADJ.SUR] Edge 1st [EDGE1]/Edge 2nd [EDGE2]/Edge 3rd [EDGE3]/Edge 4th [EDGE4]/Peak [PEAK]*	
			Fixed [FIXED]	Fixed value [FIXED] 0.01 to 100.00% (default value: 100%)	p.129
		Area2 [REG.NO2]	Auto* [AUTO]	Upper limit [MAX] 0.01 to 100.00% (default value: 100%)	p.129
				Lower limit [MIN] 0.01 to 100.00% (default value: 0.01%)	
			Surface to be controlled [ADJ.SUR] Edge 1st [EDGE1]/Edge 2nd [EDGE2]/Edge 3rd [EDGE3]/Edge 4th [EDGE4]/Peak [PEAK]*		
		Fixed [FIXED]	Fixed value [FIXED] 0.01 to 100.00% (default value: 100%)	p.129	
	Start direction of count measurement surfaces [SUR, DIR]	Start direction of count measurement surfaces [SUR, DIR]	NEAR [NEAR]*FAR[FAR]	p.231	
	Background removal level [NOISE]	Background removal level [NOISE]	0 to 1500 (default value: 300(ZW-8000□), 100(ZW-7000□/5000□))	p.126	
	Smoothing size [SMOOTH]	Smoothing size [SMOOTH]	1 pixel [1]/3 pixels [3]/5 pixels [5]*7 pixels [7]/9 pixels [9]	p.127	
	Measurement region [REGION]	Area1 [REG.NO1]	Start position [STR.POS]	-3750μm to 3750μm (default value differs depending on Sensor Head).	p.130
End position [END.POS]			-3750μm to 3750μm (default value differs depending on Sensor Head).	p.130	
Area2 [REG.NO2]		Start position [STR.POS]	-3750μm to 3750μm (default value differs depending on Sensor Head).	p.130	
		End position [END.POS]	-3750μm to 3750μm (default value differs depending on Sensor Head).	p.130	
AreaTracks [AREA.TR]	Follow mode [MODE]	OFF [OFF]* / Start [START] / End [END] / Start, End [ST ED]	p.130		
	Reference edge [REF.EDG]	Edge 1st [EDGE1]*/Edge 2nd [EDGE2]/ Edge 3rd [EDGE3]/Edge 4th [EDGE4]/Peak [PEAK]	p.130		
	Following edge [FOL.EDG]	Edge 1st [EDGE1]/Edge 2nd [EDGE2]*/Edge 3rd [EDGE3]/Edge 4th [EDGE4]/Peak [PEAK]	p.130		

The grayed-out settings can only be used with ZW-8000□.
 [---]: This is displayed only when the 2 area mode is selected in [Measurement Area].
 * default value

		Setting	Option/Setting Range	Pages		
Sensing setting [SENS] (cont'd)	EdgeTracks [EDGE.TR]	EdgeTracks [EDGE.TR]	OFF [OFF]/ON [ON]	p.133		
		Area Teach [TEACH]	---	---		
		Edge1 Track Width [TR.WID1]	0.000 to 65.535 mm (default value: 10% of measuring range)	p.135		
		Edge2 Track Width [TR.WID2]	0.000 to 65.535 mm (default value: 10% of measuring range)	p.135		
		Edge3 Track Width [TR.WID3]	0.000 to 65.535 mm (default value: 10% of measuring range)	p.135		
		Edge4 Track Width [TR.WID4]	0.000 to 65.535 mm (default value: 10% of measuring range)	p.135		
Measurement setting [MEAS]	TASK1 [TASK1]	Area [REGION]	Area 1 [REG.NO1]*/ Area 2 [REG.NO2]	p.233		
		Measurement item [ITEM]	Height * [HEIGHT]	Measurement surface [SUR]	Edge 1st [EDGE1]/Edge 2nd [EDGE2]/Edge 3rd [EDGE3]/Edge 4th [EDGE4]/Light Peak [PEAK] *	p.237
			Thick [THICK]	Surface 1 [TOP]	Edge 1st [EDGE1]/Edge 2nd [EDGE2]/Edge 3rd [EDGE3]/Edge 4th [EDGE4]/Light Peak [PEAK] *	p.238
				Surface 2 [END]	Edge 1st [EDGE1]/Edge 2nd [EDGE2]/Edge 3rd [EDGE3]/Edge 4th [EDGE4]/Light Peak [PEAK] *	
			Calculation [CALC]	Parameter K [PARAM.K]	-999.999999 to 999.999999 mm (default value: 0)	p.239
				Parameter m [PARAM.M]	-10.0 to 10.0 (default value: 0)	
				Parameter n [PARAM.N]	-10.0 to 10.0 (default value: 0)	
				Parameter X [PARAM.X]	None [OFF]*/TASK1 [TASK1]/TASK2 [TASK2]/TASK3 [TASK3]/TASK4 [TASK4]	
				Parameter Y [PARAM.Y]	None [OFF]*/TASK1 [TASK1]/TASK2 [TASK2]/TASK3 [TASK3]/TASK4 [TASK4]	
			None [NONE]	---	---	---
		Filter [FILTER]	Median [MEDIAN]	OFF [OFF]*/3 times [3]/9 times [9]/15 times [15]/31 times [31]	p.242	
			Average [AVE]	1/2/4/8/16/32/64/128/256/512/1024*/2048/4096/8192/16384	p.243	
			Differential [DIFFER]	Off [OFF]*/On [ON]	p.245	
			Differential cycle [CYCLE]	0.02 to 5000ms (default value: 0.02)		
			Frequency [FREQ]	Off [OFF]*/Lowpass [LO.PASS]/Highpass [HI.PASS]/Bandpass [BD.PASS]	p.244	
	Cutoff frequency [CUTOFF]		Refer to explanation page of Cutoff frequency			

The grayed-out settings can only be used with ZW-8000□.
 * default value

Setting	Option/Setting Range	Pages				
Measurement setting [MEAS] (cont'd)	TASK1 [TASK1] (cont'd)	Output [OUTPUT]	Scaling [SCALE]	Auto [AUTO]	-	p.246
			One-point scaling [1PT]	-		
			Direction [DIR]	Forward [FWD]*/Reverse [REV]		
			Two-point scaling [2PT]	-		
			Multi-point scaling [NPT]	PT1 to PT10		
			Manual [MANUAL]	-		
			Span [SPAN]	-10.0000 to 10.0000 (default value: 1.0000)		
			Offset [OFFSET]	-999.999999 to 999.999999 mm (default value: 0)		
			Thick [THICK]	-		
			Off [OFF]*	-		
			Hold [HOLD]	Type [TYPE]	Off [OFF]*/Peak [PEAK]/Bottom [BOTTOM]/Peak to peak [P-P]/Auto peak [A.PEAK]/Auto bottom [A.BOTTM]/Auto peak to peak [A.P-P]/Average [AVE]/Sampling [SAMPLE]	p.251
				Trigger [TRIG]	Timing [TIMING]*/Self up trigger [SELF-U]/Self down trigger [SELF-D]/Valid value [SELF-V]	p.252
				Trigger level [LEVEL]	-999.999999 to 999.999999 mm (default value: 0)	
				Trigger Hysteresis [HYS]	0 to 999.999999 mm (default value: 0.05% of measuring range)	
				Delay [DELAY]	Off [OFF]*/On [ON]	p.254
				Delay time [DLY.TIM]	0.02 to 5000ms (default value: 0.02)	
				Sampling time [SMP.TIM]	0.02 to 5000ms (default value: 100)	
			Zero reset [ZERO]	Type [TYPE]	Real value [REAL]*/Hold value [HOLD]	p.258
				Offset [OFFSET]	-999.999999 to 999.999999 mm (default value: 0)	p.257
				Status [STATUS]	Off [OFF]/On [ON]*	p.256

The grayed-out settings can only be used with ZW-8000□.
* default value

Setting	Option/Setting Range	Pages
Measurement setting [MEAS] (cont'd)		
TASK1 [TASK1] (cont'd)		
Threshold [JUDGE]		
Teaching [TEACH]		
High threshold [H.JUDGE]	-999.999999 to 999.999999 mm (default value: +25% of measuring range)	p.265
Low threshold [L.JUDGE]	-999.999999 to 999.999999 mm (default value: -25% of measuring range)	
Direct [DIRECT]		
High threshold [H.JUDGE]	-999.999999 to 999.999999 mm (default value: +25% of measuring range)	p.267
Low threshold [L.JUDGE]	-999.999999 to 999.999999 mm (default value: -25% of measuring range)	
TASK2 [TASK2]	(Same content as TASK1) Default value of measurement item is [NONE]	
TASK3 [TASK3]	(Same content as TASK1) Default value of measurement item is [NONE]	
TASK4 [TASK4]	(Same content as TASK1) Default value of measurement item is [NONE]	
I/O setting [I/O]		
Non-measurement setting [HLD.RST]		
Non-measurement setting [HLD.RST]	Keep [KEEP]/Clamp [CLAMP]*4	*1
Keep count specification flag [KEEP.EN]	OFF[OFF]/ON[ON]*	*1
Keep count [KEEP.CN]	1 to 16382 (default value: 8)	*1
Number of restorations [RESR.CN]	1 to 16382 (default value: 1)	*1
Non-Measuring Specification [CLP.CON]	-	*1
Number of Edge [SFC.NUM]	ON[ON]/OFF[OFF]*	*1
Reflection power [REF.POW]	ON[ON]/OFF[OFF]*	*1
TIMING input mode [TIM.MOD]		
Judgment [JUDGE]		
Output target [OUTPUT]	TASK1 [TASK1]*/TASK2 [TASK2]/TASK3 [TASK3]/TASK4 [TASK4]	*1
Hysteresis [HYS]	0 to 99.9999 mm (default value: 0.05% of measuring range)	*1
Timer [TIMER]	Off* [OFF]/Off delay [OFF.DLY]/On delay [ONDLY]/One shot [1SHOT]	*1
Timer time ³ [TIME]	0.2 to 5000 ms (default value: 0.2)	

*1. For more detail, refer to the following.



"6-1 Connecting Parallel I/O" described in Displacement Sensor ZW-8000/7000/5000 series Confocal Fiber Type Displacement Sensor User's Manual for Communications Settings (Z363)

*2. Only [OFF] is allowable in External/PDO synchronized mode.

*3. First enter the number and set the decimal point.

*4. KEEP is the initial value for ZW-8000 and CLAMP is the initial value for ZW-7000/5000.

		Setting	Option/Setting Range	Pages
I/O setting [I/O]	Digital output [DIGITAL]	Output data 1 [OUT1]	OFF[OFF] / TASK1 [TASK1]* / TASK2 [TASK2] / TASK3 [TASK3] / TASK4 [TASK4] / Amount of emitted light [LIGHT] (Area1) / Peak amount of received light (Exposure control edge) [PEAK.CT] (Area1) / Peak amount of received light (1st surface) [PEAK.1] (Area1) / Peak amount of received light (2nd surface) [PEAK.2] (Area1) / Peak amount of received light (3rd surface) [PEAK.3] (Area1) / Peak amount of received light (4th surface) [PEAK.4] (Area1) Amount of emitted light [LIGHT] (Area2) / Peak amount of received light (Exposure control edge) [2.PEAK.C] (Area2) / Peak amount of received light (1st surface) [2.PEAK.1] (Area2) / Peak amount of received light (2nd surface) [2.PEAK.2] (Area2) / Peak amount of received light (3rd surface) [2.PEAK.3] (Area2) / Peak amount of received light (4th surface) [2.PEAK.4] (Area2) Measurement state[MS.CON] (ZW-8000□ only) Area1 Reflection power[REF.PW1](ZW-8000□ only)/ Area2 Reflection power[REF.PW2](ZW-8000□ only)	*1
			OFF[OFF] / TASK1 [TASK1] / TASK2 [TASK2]* / TASK3 [TASK3] / TASK4 [TASK4] / Amount of emitted light [LIGHT] (Area1) / Peak amount of received light (Exposure control edge) [PEAK.CT] (Area1) / Peak amount of received light (1st surface) [PEAK.1] (Area1) / Peak amount of received light (2nd surface) [PEAK.2] (Area1) / Peak amount of received light (3rd surface) [PEAK.3] (Area1) / Peak amount of received light (4th surface) [PEAK.4] (Area1) Amount of emitted light [LIGHT] (Area2) / Peak amount of received light (Exposure control edge) [2.PEAK.C] (Area2) / Peak amount of received light (1st surface) [2.PEAK.1] (Area2) / Peak amount of received light (2nd surface) [2.PEAK.2] (Area2) / Peak amount of received light (3rd surface) [2.PEAK.3] (Area2) / Peak amount of received light (4th surface) [2.PEAK.4] (Area2) Measurement state[MS.CON] (ZW-8000□ only) Area1 Reflection power[REF.PW1](ZW-8000□ only)/ Area2 Reflection power[REF.PW2](ZW-8000□ only)	*1

(cont'd)

*1. For more detail, refer to the following.



"6-1 Connecting Parallel I/O" described in Displacement Sensor ZW-8000/7000/5000 series Confocal Fiber Type Displacement Sensor User's Manual for Communications Settings (Z363)

* default value

Setting	Option/Setting Range	Pages		
I/O setting [I/O]	Digital output [DIGITAL]	Output data 3 [OUT3]	OFF[OFF] / TASK1 [TASK1] / TASK2 [TASK2] / TASK3 [TASK3]* / TASK4 [TASK4] / Amount of emitted light [LIGHT] (Area1) / Peak amount of received light (Exposure control edge) [PEAK.CT] (Area1) / Peak amount of received light (1st surface) [PEAK.1] (Area1) / Peak amount of received light (2nd surface) [PEAK.2] (Area1) / Peak amount of received light (3rd surface) [PEAK.3] (Area1) / Peak amount of received light (4th surface) [PEAK.4] (Area1) Amount of emitted light [LIGHT] (Area2) / Peak amount of received light (Exposure control edge) [2.PEAK.C] (Area2) / Peak amount of received light (1st surface) [2.PEAK.1] (Area2) / Peak amount of received light (2nd surface) [2.PEAK.2] (Area2) / Peak amount of received light (3rd surface) [2.PEAK.3] (Area2) / Peak amount of received light (4th surface) [2.PEAK.4] (Area2) Measurement state[MS.CON] (ZW-8000□ only) Area1 Reflection power[REF.PW1](ZW-8000□ only)/ Area2 Reflection power[REF.PW2](ZW-8000□ only)	*1
		Output data 4 [OUT4]	OFF[OFF] / TASK1 [TASK1] / TASK2 [TASK2] / TASK3 [TASK3] / TASK4 [TASK4]* / Amount of emitted light [LIGHT] (Area1) / Peak amount of received light (Exposure control edge) [PEAK.CT] (Area1) / Peak amount of received light (1st surface) [PEAK.1] (Area1) / Peak amount of received light (2nd surface) [PEAK.2] (Area1) / Peak amount of received light (3rd surface) [PEAK.3] (Area1) / Peak amount of received light (4th surface) [PEAK.4] (Area1) Amount of emitted light [LIGHT] (Area2) / Peak amount of received light (Exposure control edge) [2.PEAK.C] (Area2) / Peak amount of received light (1st surface) [2.PEAK.1] (Area2) / Peak amount of received light (2nd surface) [2.PEAK.2] (Area2) / Peak amount of received light (3rd surface) [2.PEAK.3] (Area2) / Peak amount of received light (4th surface) [2.PEAK.4] (Area2) Measurement state[MS.CON] (ZW-8000□ only) Area1 Reflection power[REF.PW1](ZW-8000□ only)/ Area2 Reflection power[REF.PW2](ZW-8000□ only)	*1
		Clamp value [CLAMP]	0x7FFFFFFF[MAX] / 999999999[99999] / 0 [0] / -999999999 [-99999] / 0x80000000[MIN]*	*1

(cont'd)

*1. For more detail, refer to the following.



"6-1 Connecting Parallel I/O" described in Displacement Sensor ZW-8000/7000/5000 series Confocal Fiber Type Displacement Sensor User's Manual for Communications Settings (Z363)

* default value

		Setting	Option/Setting Range	Pages		
I/O setting [I/O] (cont'd)	Analog output [ANALOG]	Output destination *1 [V OR C]	Output destination [V OR C]	Voltage output *1/Current output	*2	
		Output target [OUTPUT]	Output target [OUTPUT]	Off [OFF]/TASK1 [TASK1] *1/ TASK2 [TASK2]/TASK3 [TASK3]/ TASK4 [TASK4]	*2	
		Monitor focus [FOCUS]	Focus [FOCUS]	Off [OFF] *1/On [ON]	*2	
			Focus current/ voltage 1 [CUR1]/ [VOLT1]	Current: 4/5/6/7/8/9/10/11/12/13/14/15/ 16/17/18/19/20mA (default value: 4mA) Current: -10/-9/-8/-7/-6/-5/-4/-3/-2/-1/ 0/1/2/3/4/5/6/7/8/9/10V (default value: -10V)		
			Measurement value 1 [MEAS1]	-999.999999 to 999.999999 mm (default value: -0.5)		
			Focus current/ voltage 2 [CUR2]/ [VOLT2]	Current: 4/5/6/7/8/9/10/11/12/13/14/15/ 16/17/18/19/20mA (default value: 20mA) Current: -10/-9/-8/-7/-6/-5/-4/-3/-2/-1/ 0/1/2/3/4/5/6/7/8/9/10V (default value: 10V)		
				Measurement data2 [MEAS2]	-999.999999 to 999.999999 mm (default value: 0.5)	
			Calibration [CALIB]	Calibration [CALIB]	Off *1/On	*2
				Calibration current/ voltage 1 [CUR1]/ [VOLT1]	Current: 4/5/6/7/8/9/10/11/12/13/14/15/ 16/17/18/19/20mA (default value: 4mA) Current: -10/-9/-8/-7/-6/-5/-4/-3/-2/-1/ 0/1/2/3/4/5/6/7/8/9/10V (default value: -10V)	
				Calibration value 1 [ADJ1]	-999 to 999 (default value: 0)	
		Calibration current/ voltage 2 [CUR2]/ [VOLT2]	Current: 4/5/6/7/8/9/10/11/12/13/14/15/ 16/17/18/19/20mA (default value: 20mA) Current: -10/-9/-8/-7/-6/-5/-4/-3/-2/-1/ 0/1/2/3/4/5/6/7/8/9/10V (default value: 10V)			
			Calibration value 2 [ADJ2]	-999 to 999 (default value: 0)		
	Clamp value: [CLAMP]	Clamp value: [CLAMP]	Current output: MIN[MIN] (approx. 3.4mA)/4mA/5mA/.../19mA/20mA/ MAX[MAX] (approx, 20.8mA) (default value: MAX) Current output: MIN[MIN] (approx. -10.8V)/-10V/-9V/.../9V/10V/ MAX[MAX] (approx.10.8V) (default value: MAX)	*2		

*1. The same "OUTPUT" is set for all banks. The output destination cannot be set separately for individual banks.

*2. For more detail, refer to the following.



"6-1 Connecting Parallel I/O" described in Displacement Sensor ZW-8000/7000/5000 series Confocal Fiber Type Displacement Sensor User's Manual for Communications Settings (Z363).

The grayed-out settings can only be used with ZW-8000□.
* default value

		Setting	Option/Setting Range	Pages	
I/O setting [I/O] (cont'd)	Data output setting [COM.OUT]	Data output destination [OUTPUT]*	Off [OFF]*/Ethernet[ETN]/ RS232C[RS232C]	-	
		Output data format [FORMAT]	ASCII[ASCII]*/Binary[BINARY]	-	
		Number of integer digits [INT.NUM]	1 / 2 / 3 / 4 / 5*	-	
		Fractional digits [DEC.NUM]	0 / 1 / 2 / 3 / 4 / 5 / 6*	-	
		Leading zeros suppressed [ZEROSP]	Off* /On	-	
		Field separator [FIELD]	None [NO]*/Comma [COMMA]/ Tab [TAB]/Space [SPACE]/ CR[CR]/LF[LF]/CR+LF[CRLF]/ Semicolon [SEMICO]	-	
		Record separator [RECORD]	None [NO]*/Comma [COMMA]/ Tab [TAB]/Space [SPACE]/ CR[CR]/LF[LF]/CR+LF[CRLF]/ Semicolon [SEMICO]	-	
	Condition for measurement state [MS.CON]	Number of Edge [SFC.NUM]	0 surface [0EDGE]/1surface [1EDGE] / 2 surface[2EDGE] /3 surface [3EDGE]/ 4 surface[4EDGE] /Edge 5 or more[5ED.OVR]	-	
		Condition for number of Edge [SFC.CON]	Equal to the specified number of Edge[EQRL]/Greater than the specified number of Edge[GRT.THN]/ Less than the specified number of Edge[LES.THN]	-	
Bank setting [BANK]	Bank change [BK.CHG]	Bank number [BANK]	Bank1 [BANK1] to Bank8 [BANK8] (default value: Bank1) Up to Bank32 can be selected when the bank mode is "Judgment value".	p.260	
		Bank mode [BK.MODE]	Bank mode [BK.MODE]	Normal [NORMAL]*/ Judgment value [JUDGE]	p.261
		Bank copy [BK.COPY]	Copy source [FROM]	Bank1 [BANK1] to Bank8 [BANK8]	p.262
			Copy destination [TO]	Bank1 [BANK1] to Bank8 [BANK8]	
	Bank clear [BK.CLR]	Bank clear [BK.CLR]	Ok [OK]/Cancel [CAN]	p.264	
System setting [SYSTEM]	Sensor head Calibration [H.CALIB]	Sensor head calibration [H.CALIB]	OK [OK]/Cancel [CAN]	p.270	
	Save [SAVE]	Save [SAVE]	OK [OK]/Cancel [CAN]	p.263	
	Initialization [INIT]	Initialization [INIT]	OK [OK]/Cancel [CAN]	p.271	
	Synchronous measurement mode [TRIGGER]	Synchronous measurement mode [TRIGGER]	Internal synchronous measurement mode [AUTO]*/External synchronous measurement mode [PARA.IN] /PDO synchronous measurement mode [ECT.PDO]	p.96	
	Extension fiber cable length [CABLE]	Extension fiber cable length [CABLE]	NONE [NONE]*/2m[2M]/ 5m[5M]/10m[10M]/ 20m[20M]/30m[30M]	p.273	
	Internal logging setting [LOGING]	Save interval [INTRVL]	Save interval [INTRVL]	0 to 1000 (default value: 1)	p.114
		Save count [COUNT]	Save count [COUNT]	0 to 999999 (default value: 100000)	p.114
		Output data format [FORMAT]	Output data format [FORMAT]	ASCII [ASCII]*/ Binary [BINARY]	p.114
Overwrite mode [OVR.WRT]		Overwrite mode [OVR.WRT]	Off [OFF]*/On [ON]	p.114	
	Label insert mode [LABEL]	Label insert mode [LABEL]	Off [OFF]*/On [ON]	p.114	

Setting	Option/Setting Range	Pages			
System setting [SYSTEM] (cont'd)	Communications [COM]	RS-232C [RS232C]	Data length [DATA]	7bit [7BIT]/8bit [8BIT]*	*1
			Parity [PARITY]	None [OFF]*/Odd [ODD]/Even [EVEN]	
			Stop bit [STOP]	1bit [1BIT]*/2 bit [2BIT]	
			Baud rate [BAUD.RT]	9600/19200/38400*/57600/115200	
			CS/RS [CS/RS]	Off [OFF]*/On [ON]	
System setting [SYSTEM] (cont'd)	Communications [COM]	Ethernet [ETN]	IP address 1 [IPADDR] [IP1]	1 to 223 (default value: 192)	*2
			IP address 2 [IP2]	0 to 255 (default value: 168)	
			IP address 3 [IP3]	0 to 255 (default value: 250)	
			IP address 4 [IP4]	1 to 254 (default value: 50)	
			Subnet mask1 [SUBNET] [SUB1]	0 to 255 (default value: 255)	
			Subnet mask2 [SUB2]	0 to 255 (default value: 255)	
			Subnet mask3 [SUB3]	0 to 255 (default value: 255)	
			Subnet mask4 [SUB4]	0 to 255 (default value: 0)	
			Protocol selection [PROTCL]	Off [OFF]/ TCP/Server [TCP.SV]*/ TCP/Client [TCP.CL]/UDP [UDP]	
			Output IP address 1 [OUTIP] [IP1]	1 to 223 (default value: 192)	
			Output IP address 2 [IP2]	0 to 255 (default value: 168)	
			Output IP address 3 [IP3]	0 to 255 (default value: 250)	
			Output IP address 4 [IP4]	1 to 254 (default value: 100)	
			Port numbers [PORT.IN]	0 to 65535 (default value: 9601)	
			Output destination port No. [PORT.OT]	0 to 65535 (default value: 9601)	
System setting [SYSTEM] (cont'd)	Communications [COM]	Delimiter [DELIMI]	Delimiter [DELIMI]	CR [CR] */LF [LF]/CR+LF [CRLF]	*1
		Fieldbus [MEMLINK]	Fieldbus [MEM.LINK]	Off [OFF]/ EtherNet/IP [EIP]/ EtherCAT [E-CAT]*	-
		GATE signal ON time [GATE.TM]	GATE signal ON [GATE.TM]	0 to 100 (default value: 1)	-

*1. For more detail, refer to the following.

 "6-4 Connecting by No-protocol Communications" described in Displacement Sensor ZW-8000/7000/5000 series Confocal Fiber Type Displacement Sensor User's Manual for Communications Settings (Z363).

*2. For more detail, refer to the following.

 "6-3 Connecting with EtherNet/IP" described in Displacement Sensor ZW-8000/7000/5000 series Confocal Fiber Type Displacement Sensor User's Manual for Communications Settings (Z363)

* default value

		Setting	Option/Setting Range	Pages	
System setting [SYSTEM] (cont'd)	Width of input signal filter [FLT.WDT]	Width of input signal filter [FLT.WDT]	5 μs[5US]/10 μs[10US]/20 μs[20US]/50 μs[50US]/100 μs[100US]*)/200 μs[200US]/500 μs[500US]/1000 μs[1000US]	*1	
	Key lock [LOCK]	Key lock [LOCK]	Off [OFF]*/On [ON]	p.269	
	Zero reset MEMORY [ZER.MEM]	Zero reset memory [ZER.MEM]	Off [OFF]*/On [ON]	p.259	
	TIMING/RESET key input [KEY.IN]	TIMING/RESET key input [KEY.IN]	Off [OFF]*/On [ON]	p.253	
	Controller information [C.INFO]	Software version [VER]	Software version [VER]	Displays the version.	p.268
		MAC Address [MAC.ADR]	MAC Address [MAC.ADR]	Displays the current MAC address.	
		Error history [ERR.LOG]	Error history [ERR.LOG]	Clears/displays the error history.	-
		Error history display [LOG.DSP]	Error history display [LOG.DSP]	No.01 to No.64 (default value: No.01)	-
		Error clear [LOG.CLR]	Error clear [LOG.CLR]	OK [OK]/Cancel [CAN]	-
	Energization time (h) ² [RUN.TIM]	Energization time (h) ² [RUN.TIM]	Energization time (h)	p.199	
Sensor head information [H.INFO]	Model [MODEL]	Model [MODEL]	Displays the model.	p.268	
	Serial No. [SER.NO]	Serial No. [SER.NO]	Displays the serial No..		

*1. For more detail, refer to the following.



"6-1 Connecting Parallel I/O" described in Displacement Sensor ZW-8000/7000/5000 series Confocal Fiber Type Displacement Sensor User's Manual for Communications Settings (Z363).













*2. "- - - - -" is displayed when the cumulative energization time flag written in the backup ROM is OFF.

RUN (operation) Mode Menu

Setting [DISPLAY]	Option/Setting Range [DISPLAY]	Pages
Task for displayed target [DISP]	TASK1/TASK2/TASK3/TASK4	p.227
HIGH threshold value [H.JUDGE]	Sysmac Studio: -999.99 to 999.999 Sysmac Studio: -999.999999 to 999.999999	p.228
LOW threshold value [L.JUDGE]	Sysmac Studio: -999.99 to 999.999 Sysmac Studio: -999.999999 to 999.999999	p.228
Decimal point digit [DEC.NUM]	0[0DIG]/1 [1DIG]/2 [2DIG]/3 [3DIG]/4 [4DIG]/5 [5DIG]	p.227







7-3 Functions of Operating Keys

The following table lists the names and functions of the operating keys on the Sensor Controller:

Name		Function	
		RUN (operation) Mode	FUNC (adjustment) Mode
← (LEFT) key → (RIGHT) key	 	Changes sub-display content.	Functions differently depending on the settings. <ul style="list-style-type: none"> • Function display switching • Numerical value digit selection • Setting cancellation
↑ (UP) key ↓ (DOWN) key	 	 key: Executes TIMING input.  key: Executes RESET input. * These keys are available only if key inputs for the hold functions have been enabled in the FUNC mode.  Performing Hold with a Key Input p.166	Functions differently depending on the settings. <ul style="list-style-type: none"> • Selection menu switching • Setting value selection
Mode switching key		Press and hold for two seconds or more to enter FUNC mode. <ul style="list-style-type: none"> • For operating mode switching, "SWITCH" is displayed on the main display and "OK/CAN" is displayed on the sub-display. Press the ZERO/SET key to switch the mode.  If you press for less than two seconds, the display shifts to RUN mode task switching and the threshold value setting menu.	Press and hold for two seconds or more to enter RUN mode. <ul style="list-style-type: none"> • For operating mode switching, "SWITCH" is displayed on the main display and "OK/CAN" is displayed on the sub-display. Press the ZERO/SET key to switch the mode.  <ul style="list-style-type: none"> • When the mode is switched from FUNC mode to RUN mode, "SAVE" is displayed on the main display and "OK/CAN" is displayed on the sub-display. Press the ZERO/SET key to save the settings and switch the operating mode.  Press the ZERORST/ESC key to switch the operating mode without saving the settings. If you press for less than 2 seconds, the display shifts to RUN mode task switching and the threshold value setting menu. Also, this starts teaching to set threshold values when setting a threshold value.
ZERO/SET key		Executes a zero reset.	Functions differently depending on the selections. <ul style="list-style-type: none"> • Application of selection conditions and numerical values • Switching to lower menus
ZERORST/ESC key		Hold down for at least two seconds to cancel a zero reset.	Functions differently depending on the selections. <ul style="list-style-type: none"> • Cancellation of selection conditions and numerical values • Switching to upper menus Hold down for at least two seconds to jump to the top menu on the FUNC mode.

7-4 Digital Displays

The theme displayed on the main or sub-display varies depending on the currently selected operating mode. The following table lists the theme displayed, when turning the Sensor Controller ON, or in the RUN or FUNC mode.

Operation mode	Main display (upper line, in white)	Sub-display (lower line, in green)
When turning ON	The Sensor Controller model name, "ZW-8/ZW-7/ZW-5" appears.	During the initialization, "INIT" is displayed. When starting, after "START", a progress bar is displayed. It takes about ten seconds for "START" to be displayed.
The system enters the RUN mode after displaying "INIT" for a few seconds.		
RUN mode	The task measurement result appears. The task to display can be toggled.  Changing Display Details p.227	Press the  /  key to cycle through the sequence of the HIGH and LOW threshold values, analog output (voltage/current), judgment result, resolution (the max. and min. values for 1-min measured value), amount of emitted light, distance (Sensor Head to the object to measure), effective bank, displayed task, in descending or ascending order. Online status, Link status, Tag link status, Internal logging status, and Amount of received light in descending or ascending order.
Press and hold the  key for two seconds or more to switch between the RUN and FUNC modes.		
FUNC mode	Press the  /  keys to cycle through the function names in descending or ascending order.	When reaching the lowest layer, the setting value displayed on the main display appears.

Alphabetical and symbolic notation

Alphabet characters and symbols are displayed on the main and sub-display as follows:

A	B	C	D	E	F	G	H	I	J	K	L	M
<i>A</i>	<i>b</i>	<i>C</i>	<i>d</i>	<i>E</i>	<i>F</i>	<i>G</i>	<i>H</i>	<i>I</i>	<i>J</i>	<i>K</i>	<i>L</i>	<i>M</i>
N	O	P	Q	R	S	T	U	V	W	X	Y	Z
<i>N</i>	<i>O</i>	<i>P</i>	<i>Q</i>	<i>R</i>	<i>S</i>	<i>T</i>	<i>U</i>	<i>V</i>	<i>W</i>	<i>X</i>	<i>Y</i>	<i>Z</i>
-	/	%	Resolution									
<i>-</i>	<i>/</i>	<i>%</i>	<i>Resolution</i>									

7-5 Functions and Operations during Measurement

Switching the RUN (Run) Mode Display

In the RUN mode, you can switch the measured value display by pressing the \leftarrow / \rightarrow keys during the operation. You can check the threshold value and analog output value while displaying the measured value on the main display.

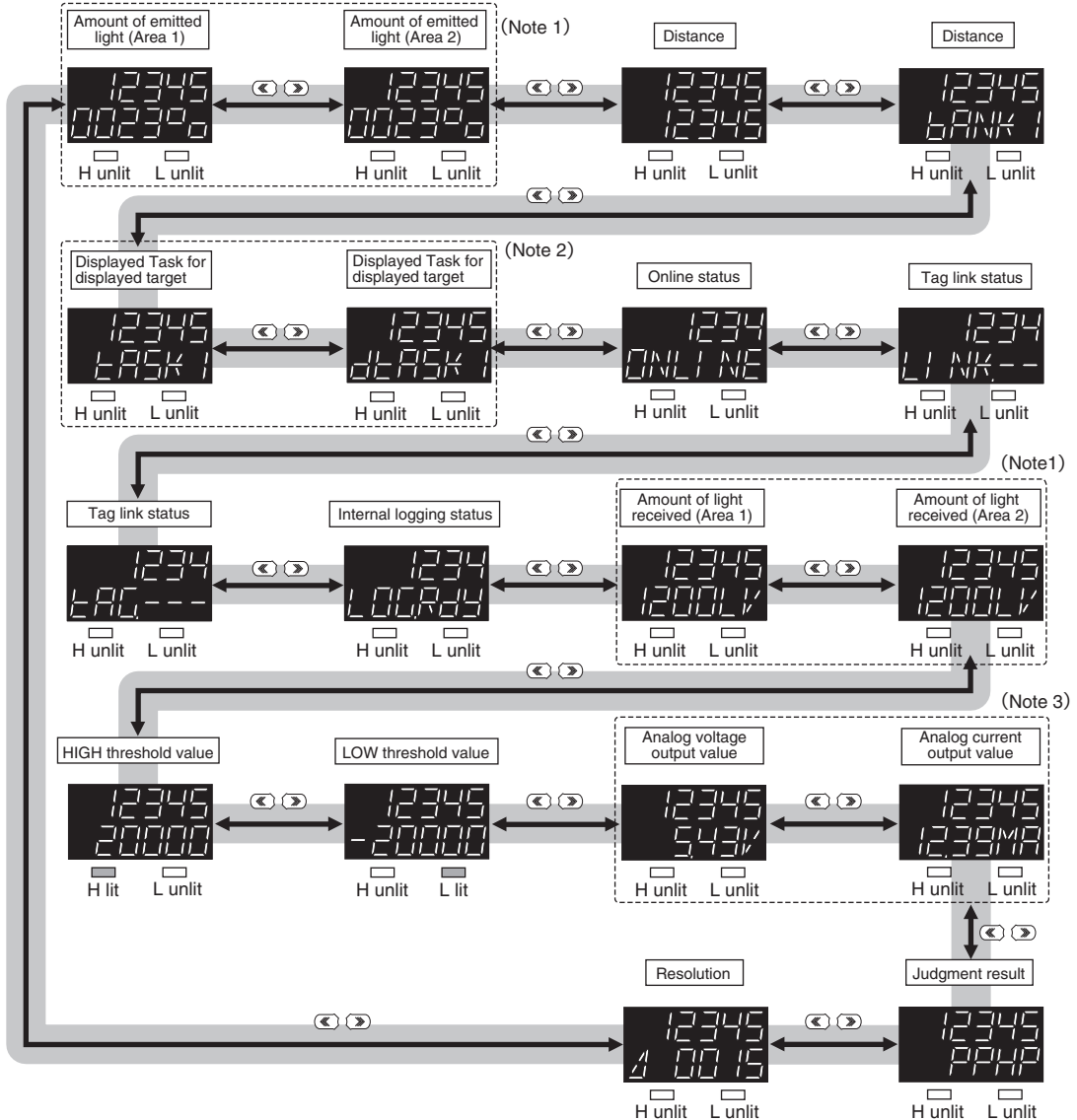

The above display screenshots are only samples and may differ from actual displays.

(Note 1) The display for Area 2 is displayed only when the 2 area mode is selected.

(Note 2) An output item not selected on the analog output (Voltage output/Current output) is displayed as "-----" on the sub-display. For example, if "Voltage output" is selected on the analog output, the analog current output value is displayed as "-----" on the sub-display.

(Note 3) "Displayed task" can be selected from TASK1 to TASK4. "Task for displayed target" is displayed as "dTASK□." □ indicates the task number. (Refer to p.227 for the task for displayed target.)) If the task for displayed target is TASK2, for example, "TASK1," "dTASK2," "TASK3" and "TASK4" will be displayed.

Details Displayed on the Main Display

The measured values always appear on the main display.

The measured values are initialized as follows:

- Reference value "0": Measurement center distance
- + display: NEAR (close range) side
- - display: FAR (far range) side

However, in the following cases, the measurement values are not displayed.

- When the amount of light received is inadequate, "DARK" is displayed; when the sensor is saturated, "BRIGHT" is displayed.
- When there is no surface present to measure, "NO.SRFC" is displayed.
- When the white LED used for measuring is OFF, "LEDOFF" is displayed.
- When the measurement surface is far outside the measurement range or if no hold value is finalized when hold is set, then "-----" is displayed.
- When the Head adjustment is required, i.e. adding or changing the extension fiber cable, displays "H.CALIB".

Details Displayed on the Sub-display

The items listed in the following table appears on the sub-display.

Press the ◀ / ▶ keys to toggle the display.

Display Details	Description
Threshold	Displays the HIGH and LOW threshold values for tasks for displayed target. THRESHOLD-H indicator lights for the HIGH threshold value. THRESHOLD-L indicator lights for the LOW threshold value.
Analog output	Displays the voltage or current value output in analog format. The display details for the output destination setting are different for voltage output and for current output. (Values displayed here are reference values only. These values differ from actual analog output values.)
Judgment result	The judgment result for each task appears. The TASK1, 2, 3 and 4 judgment results are displayed starting from the left. H: HIGH P: PASS L: LOW E: ERROR
Resolution	Displays the fluctuation width (peak to peak) of the measured value over a fixed amount of time.
Amount of emitted light	Displays the current amount of emitted light. The time is displayed in the range 0.01 to 100.00 %.
Distance	Displays the distance from the Sensor Head to a target to measure.
Effective bank	Displays the current bank number.
Displayed task	Displays the currently selected task number from TASK1 to TASK4. The measured value for the selected task appears on the main display.
Ethernet communication status	Whether Ethernet communications are possible is displayed. ONLINE: Communication possible OFFLINE: Communication not possible
Ethernet link status	Whether the Ethernet connection is enabled is displayed. LINK.OK: Connection established LINK.--: Connection not established
Tag link status	The status of EtherNet/IP tag link communication is displayed. TAG.INI: Initializing TAG.OK: Tag connection established TAG.--: Tag connection not established TAG.ER1: Tag link abnormality TAG.ER2: Other abnormality
Internal logging status	Displays the status of operation internal logging. LOG.RDY : Internal logging stopped state (When ZW start, When internal logging data is cleared, When internal logging stopped) LOG.RUN : Internal logging in progress LOG.END : Internal logging ended state(When internal logging is automatically ended)
Peak amount of received light	Displays the current peak amount of received light. They are shown within the range of 0 to 4095.















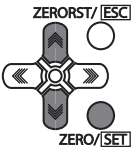

Changing Display Details

The measurement result displayed on the main display in RUN mode can be selected from TASK1 to 4. The number of digits displayed can also be changed.

Setting [DISPLAY]	Option [DISPLAY]
Task for displayed target [DISP]	TASK1/TASK2/TASK3/TASK4
Decimal point digit [DEC.NUM]	0 [0DIG]/1 [1DIG]/2 [2DIG]/3 [3DIG]/4 [4DIG]/5 [5DIG]

As an example, here is an explanation of the procedure for setting TASK2 as the task to be displayed target.

Operating procedure

Steps	Key operation	Display	Description
1			Press the  key in the RUN mode to display the setting menu.
2			Press the  /  keys to select "DISP" and press the  key.
3			Select the task to be the displayed target. The current setting value is displayed on the sub-display. Press  /  key to enter editing mode and the sub-display blinks. Select "TASK2" and press the  key.
4			Press the  key to leave the setting menu.

Changing Threshold Values

The threshold value for the task displayed on the main display in the RUN mode can be changed.



















Important

To change the target task, change the task displayed on the main display.

 Changing Display Details p.227

As an example, here is an explanation of the procedure for setting the HIGH threshold value by entering "1.000" directly.

Operating procedure

Steps	Key operation	Display	Description
1			Press the  key in the RUN mode to display the setting menu.
2			Press the  /  key to select H.JUDGE, then press the  key.
3			Set "1.000" as the HIGH threshold value. The current measured value is displayed on the main display and the current set threshold value is displayed on the sub-display. (At this time, the THRESHOLD-H indicator lights up.) Press  key to enter the editing mode, and the sub-display blinks. To edit numerical values, use the  /  /  /  keys. Input "1.000", then press the  key.
4			Press the  key to leave the setting menu.

































7-6 Setting Sensing

Set the Measurement cycle

 Setting the Measurement Cycle p.122

As an example, here is an explanation of the procedure for setting the measurement cycle to "400 ms".

Operating procedure













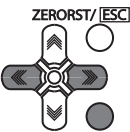







Steps	Key operation	Display	Description
1	 	  	Press and hold the  key for two seconds or more to enter the FUNC mode. To save the setting, refer to "7-3 Functions of Operating Keys" (p.222).
2	 		Press the  /  keys to select "SENS" and press the  key.
3	 		Press the  /  keys to select "CYCLE" and press the  key.
4	 		Set the measurement cycle. Press  key to enter the editing mode, and the sub-display blinks. To edit numerical values, use the  /  /  /  keys. In this example, select "000400" and press the  key.
5	 	  	Press and hold the  key for two seconds or more to enter the RUN mode. To save the setting, refer to "7-3 Functions of Operating Keys" (p.222).

Setting the Material of the Target to Measure

 Setting the Material of the Target to Measure p.125

As an example, here is an explanation of the procedure for the "MIRROR" setting as the material.

Operating procedure











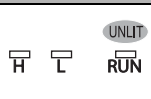





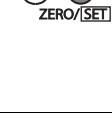

Steps	Key operation	Display	Description
1			Press and hold the  key for two seconds or more to enter the FUNC mode. To save the setting, refer to "7-3 Functions of Operating Keys" (p.222).
2			Press the  /  keys to select "SENS" and press the  key.
3			Press the  /  keys to select "OBJECT" and press the  key.
4			Select the material. NORMAL: Normal MIRROR: Mirror DIFF: Diffusion surface The current setting value is displayed on the sub-display. Press  /  key to enter editing mode and the sub-display blinks. In this example, select "MIRROR" and press the  key.
5			Press and hold the  key for two seconds or more to enter the RUN mode. To save the setting, refer to "7-3 Functions of Operating Keys" (p.222).

Setting Start Direction of Count Measurement Surfaces

 Setting Start Direction of Count Measurement Surfaces p.128

As an example, here is an explanation of the procedure for setting start direction of count measurement surface to "NEAR".

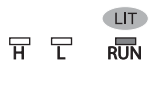
Operating procedure























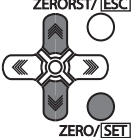





Steps	Key operation	Display	Description
1	 FUNC L-TEACH		Press and hold the  key for two seconds or more to enter the FUNC mode. To save the setting, refer to "7-3 Functions of Operating Keys" (p.222).
2			Press the  /  keys to select "SENS" and press the  key.
3			Press the  /  keys to select "SUR.DUR" and press the  key.
4			Select the material. NEAR: NEAR direction FAR: FAR direction The current setting value is displayed on the sub-display. Press  key to enter editing mode and the sub-display blinks. In this example, select "NEAR" and press the  key.
5	 FUNC L-TEACH		Press and hold the  key for two seconds or more to enter the RUN mode. To save the setting, refer to "7-3 Functions of Operating Keys" (p.222).

Setting Exposure Time Control Mode

 Setting Light Exposure Time Control Mode p.129

As an example, here is an explanation of the procedure for setting the exposure time control mode to "AUTO" and control edge of light adjustment to "measurement area 1".

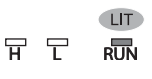
Operating procedure













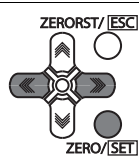





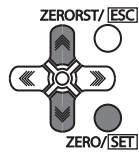

Steps	Key operation	Display	Description
1			Press and hold the  key for two seconds or more to enter the FUNC mode. To save the setting, refer to "7-3 Functions of Operating Keys" (p.222).
2			Press the  /  keys to select "SENS" and press the  key.
3			Press the  /  keys to select "LIGHT" and press the  key.
4			Select the exposure time control mode. AUTO: Automatic MANUAL: Fixed The current setting value is displayed on the sub-display. Press  /  key to enter editing mode and the sub-display blinks. In this example, select "AUTO" and press the  key.
5			Set the Control edge. In this example, "ADJ.SUR" is displayed on the main display, and the current setting value is displayed on the sub-display. Press  key to enter the editing mode, and the sub-display blinks. To edit numerical values, use the  /  /  /  keys. In this example, select "EDGE1" and press the  key.
6			Press and hold the  key for two seconds or more to enter the RUN mode. To save the setting, refer to "7-3 Functions of Operating Keys" (p.222).

Setting the Measurement Area

 Setting the Measurement Area p.130

As an example, here is an explanation of the procedure for selecting "2 area mode" for area mode setting.

Operating procedure











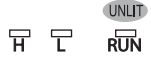

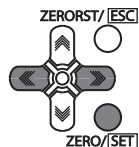









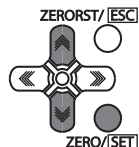

Steps	Key operation	Display	Description
1			Press and hold the  key for two seconds or more to enter the FUNC mode. To save the setting, refer to "7-3 Functions of Operating Keys" (p.222).
2			Press the  /  keys to select "SENS" and press the  key.
3			Press the  /  keys to select "REG.MODE" and press the  key.
4			Set the Area mode. 1.MODE: 1 Area mode 2.MODE: 2 Area mode Current setting value is displayed on the sub-display. Press  /  key to enter editing mode and the sub-display blinks. In this example, select "2.MODE" and press the  key.
5			Press and hold the  key for two seconds or more to enter the RUN mode. To save the setting, refer to "7-3 Functions of Operating Keys" (p.222).

Setting AreaTracks

 AreaTracks p.131

As an example, here is an explanation of the procedure for setting the upper line and lower line of the following edge to follow the reference edge.

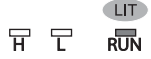
Operating procedure

Steps	Key operation	Display	Description
1	 RUN FUNC L-TEACH		Press and hold the  key for two seconds or more to enter the FUNC mode. To save the setting, refer to "7-3 Functions of Operating Keys" (p.222).
2	 ZERO/SET/ESC		Press the  /  keys to select "SENS" and press the  key.
3	 ZERO/SET		Press the  /  keys to select "AREA.TR" and press the  key.
4	 ZERO/SET		Press the  /  keys to select "MODE" and press the  key.
5	 ZERO/SET/ESC		Set the Area mode. 1.MODE: 1 Area mode 2.MODE: 2 Area mode Current setting value is displayed on the sub-display. Press  /  key to enter editing mode and the sub-display blinks. In this example, select "StEd" and press the  key.
6	 RUN FUNC L-TEACH		Press and hold the  key for two seconds or more to enter the RUN mode. To save the setting, refer to "7-3 Functions of Operating Keys" (p.222).

EdgeTracks

 EdgeTracks p.133

As an example, here is an explanation of the procedure for using the EdgeTracks function with the following track widths.











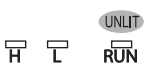











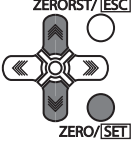



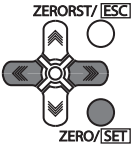



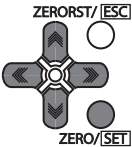

Edge1 track width:100um





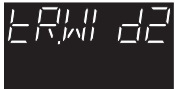





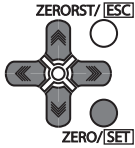





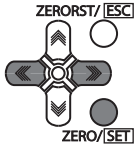



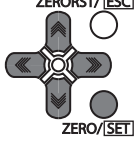





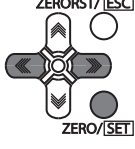



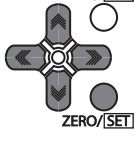

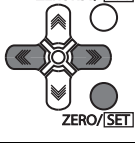

Edge2 track width:200um

Edge3 track width:300um

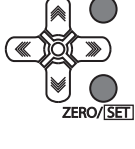
Edge4 track width:400um

Operating procedure

Steps	Key operation	Display	Description
1			Press and hold the  key for two seconds or more to enter the FUNC mode. To save the setting, refer to "7-3 Functions of Operating Keys" (p.222).
2			Press the  /  keys to select "SENS" and press the  key.
3			Press the  /  keys to select "EDGE.TR" and press the  key.
4			Select EdgeTracks ON/OFF. Current setting value is displayed on the sub-display. Press  /  key to enter editing mode and the sub-display blinks. In this example, select "ON" and press the  key.
5			Set the edge 1 track width. Press the  /  keys to select "TR.WID1" and press the  key.
6			Set "100". The current setting value is displayed on the sub-display. The sub-display blinks and the system enters editing mode. To edit numerical values, use the  /  /  /  keys. Input "100", then press the  key.
7			Set the edge 2 track width. Press the  /  keys to select "TR.WID2" and press the  key.

Steps	Key operation	Display	Description
8			Set "200". The current setting value is displayed on the sub-display. The sub-display blinks and the system enters editing mode. To edit numerical values, use the  /  /  /  keys. Input "200", then press the  key.
9			Set the edge 3 track width. Press the  /  keys to select "TR.WID3" and press the  key.
10			Set "300". The current setting value is displayed on the sub-display. The sub-display blinks and the system enters editing mode. To edit numerical values, use the  /  /  /  keys. Input "300", then press the  key.
11			Set the edge 4 track width. Press the  /  keys to select "TR.WID4" and press the  key.
12			Set "400". The current setting value is displayed on the sub-display. The sub-display blinks and the system enters editing mode. To edit numerical values, use the  /  /  /  keys. Input "400", then press the  key.
13			Execute TEACH. Press the  key.
14			"OK/CAN" is displayed on the sub-display. Press the  key to execute teaching or  key to cancel. When teach is successful, "LCK.OK*" is displayed. When teach fails, "LCK.ERR" is displayed. Make sure the measurement surface is present and execute teach again. When the measurement surface is present, the STABILITY indicator is lit during RUN mode. ? * The successful edge count is displayed. If edges 1 through 3 are successful, "LCK.3OK" is displayed.
15			Press and hold the  key for two seconds or more to enter the RUN mode. To save the setting, refer to "7-3 Functions of Operating Keys" (p.222).

























7-7 Setting Measurement Items

Measuring the Height

 Measuring the Height p.138

As an example, here is an explanation of the procedure for measuring the height of the surface (2nd surface) below a transparent object (as shown in the diagram on p.138).

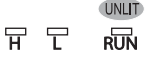
Operating procedure















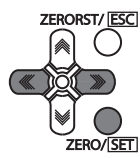









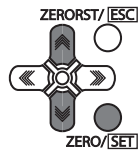

Steps	Key operation	Display	Description
1			Press and hold the  key for two seconds or more to enter the FUNC mode. To save the setting, refer to "7-3 Functions of Operating Keys" (p.222).
2			Press the  key to select MEAS, then press the  key.
3			Press the  key to select TASK1, then press the  key.
4			Press the  keys to select "ITEM" and press the  key.
5			Press the  keys to select "HEIGHT" and press the  key.
6			Select the measurement surface. EDGE1 to EDGE4: 1st surface to 4th surface PEAK: Peak "SUR" is displayed on the main display and the current setting value is displayed on the sub-display. Press  key to enter editing mode and the sub-display blinks. In this example, select "EDGE2" and press the  key.
7			Press and hold the  key for two seconds or more to enter the RUN mode. To save the setting, refer to "7-3 Functions of Operating Keys" (p.222).

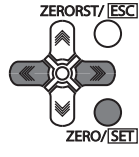
Measuring the Thickness

 Measuring the Thickness p.140

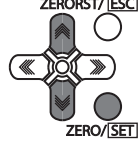
As an example, here is an explanation of the procedure for measuring the thickness from the top surface of glass on which specular reflection occurs as the 1st surface to the 2nd surface (as shown in the diagram on p.140).

Operating procedure

Steps	Key operation	Display	Description
1			Press and hold the  key for two seconds or more to enter the FUNC mode. To save the setting, refer to "7-3 Functions of Operating Keys" (p.222).
2	Set the material of the target to "MIRROR." Optional  Setting the Material of the Target to Measure p.230 If the target object is a transparent object, such as glass, on which specular reflection occurs, set the material of the measurement object to "MIRROR" to obtain more accurate measurement result.		
3	Set the surface to "SUR.1ST."		
3-1			Press the  key to select MEAS, then press the  key.
3-2			Press the  key to select TASK1, then press the  key.
3-3			Press the  keys to select "ITEM" and press the  key.
3-4			Press the  keys to select "THICK" and press the  key.
3-5			Select "SUR1." Press the  keys to select "TOP" and press the  key.
3-6			Select the measurement surface. EDGE1 to EDGE4: 1st surface to 4th surface PEAK: Peak The current setting value is displayed on the sub-display. Press  key to enter editing mode and the sub-display blinks. In this example, select "EDGE1" and press the  key.
4	Set the surface2 to "SUR.2ND."		

Steps	Key operation	Display	Description
4-1			Press the key to return to the previous menu.
4-2			Select "SUR2." Press the / keys to select "END" and press the key.
4-3			Select the measurement surface. The current setting value is displayed on the sub-display. Press / key to enter editing mode and the sub-display blinks. In this example, select "EDGE2" and press the key.
5	Scaling setting Setting Scaling p.143		
6			Press and hold the key for two seconds or more to enter the RUN mode. To save the setting, refer to "7-3 Functions of Operating Keys" (p.222).

Calculating

Performing Calculations p.141

As an example, here is an explanation of the output of the calculation result below.

(Example)

When calculating the amount of convexity and concavity on the object surface from the difference between the average value and the peaks and outputting this to TASK3

TASK1: Surface peak hold











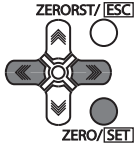





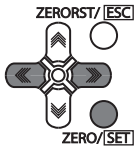







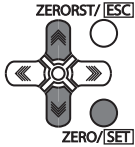



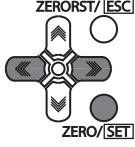



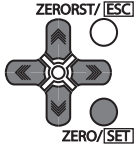

















TASK2: Surface average hold

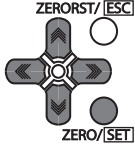

















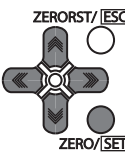









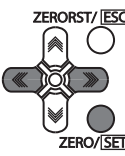



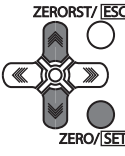







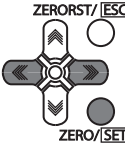

TASK3: TASK1 - TASK2 setting

- PARAMETER K: 0
- PARAMETER m: 1
- PARAMETER n: -1
- PARAMETERX: TASK1
- PARAMETERY: TASK2

Operating procedure

Steps	Key operation	Display	Description
1			Press and hold the key for two seconds or more to enter the FUNC mode. To save the setting, refer to "7-3 Functions of Operating Keys" (p.222).

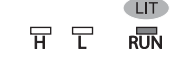
Steps	Key operation	Display	Description
2			Press the  /  key to select MEAS, then press the  key.
3	Sets the surface peak hold for TASK1 and the surface average hold for TASK2.  Setting Hold p.160		
4			Press the  /  keys to select "TASK3" and press the  key.
5			Press the  /  keys to select "ITEM" and press the  key.
6			Press the  /  keys to select "CALC" and press the  key.
7			Select "PARAM.K" for the parameter type. Press the  /  keys to select "PARAM.K" and press the  key.
8			Set the parameter to "0". The current setting value is displayed on the sub-display. Press  key to enter the editing mode, and the sub-display blinks. To edit numerical values, use the  /  /  /  keys. Input "0", then press the  key.
9			The decimal point is displayed. Press the  /  key to move the decimal point. Determine the decimal point and then press the  key.
10			Press the  key to return to the previous menu.
11			Select "PARAMm" for the parameter type. Press the  /  keys to select "PARAM.M" and press the  key.
12			Set the parameter to "1". The current setting value is displayed on the sub-display. Press  key to enter the editing mode, and the sub-display blinks. To edit numerical values, use the  /  /  /  keys. Input "1", then press the  key.

Steps	Key operation	Display	Description
13			Press the  key to return to the previous menu.
14			Select "PARAMn" for the parameter type. Press the  /  keys to select "PARAM.N" and press the  key.
15			Set the parameter to "-1". The current setting value is displayed on the sub-display. Press  key to enter the editing mode, and the sub-display blinks. To edit numerical values, use the  /  /  /  keys. Input "-1", then press the  key.
16			Press the  key to return to the previous menu.
17			Select "PARAM.X" for the parameter type. Press the  /  keys to select "PARAM.X" and press the  key.
18			Set the parameter to "TASK1". The current setting value is displayed on the sub-display. Press  /  key to enter editing mode and the sub-display blinks. Select "TASK1" and press the  key.
19			Press the  key to return to the previous menu.
20			Select "PARAMY" for the parameter type. Press the  /  keys to select "PARAM.Y" and press the  key.
21			Set the parameter to "TASK2". The current setting value is displayed on the sub-display. Press  /  key to enter editing mode and the sub-display blinks. Select "TASK2" and press the  key.
22			Press and hold the  key for two seconds or more to enter the RUN mode. To save the setting, refer to "7-3 Functions of Operating Keys" (p.222).

7-8 Setting the Output Conditions

Setting the Filter











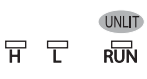

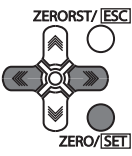



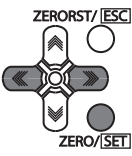



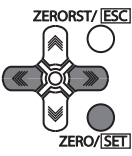

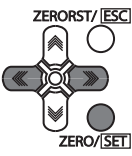

 Setting Filters p.152

Setting the Median Filter

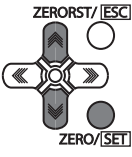
 Setting the Median Filter p.153

As an example, here is an explanation of the procedure for selecting the “5” median filter setting.

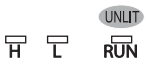
Operating procedure











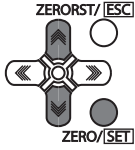

Steps	Key operation	Display	Description
1			Press and hold the  key for two seconds or more to enter the FUNC mode. To save the setting, refer to "7-3 Functions of Operating Keys" (p.222).
2			Press the  key to select MEAS, then press the  key.
3			Press the  keys to select "TASK1" and press the  key.
4			Press the  keys to select "FILTER" and press the  key.
5			Select "MEDIAN" as the filter type. Press the  keys to select "MEDIAN" and press the  key.
6			Select the filter mode from the following: OFF / 3 / 5 / 9 / 15 / 31 The current setting value is displayed on the sub-display. Press  key to enter editing mode and the sub-display blinks. In this example, select "5" and press the  key.
7			Press and hold the  key for two seconds or more to enter the RUN mode. To save the setting, refer to "7-3 Functions of Operating Keys" (p.222).

Setting the Average Filter

 Setting the Average Filter p.154

As an example, here is an explanation of the procedure for selecting the “128” average count setting.

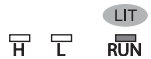
Operating procedure











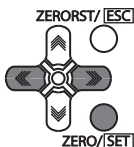



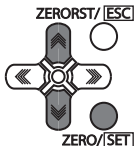



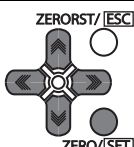



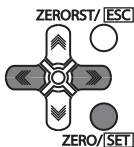

Steps	Key operation	Display	Description
1 to 4			For moving to “FILTER”, see steps 1 to 4 on p.242.
5			Select “AVE” as the filter type. Press the  /  keys to select “AVE” and press the  key.
6			Select the average count. The current setting value is displayed on the sub-display. Press  /  key to enter editing mode and the sub-display blinks. In this example, select “128” and press the  key.
7			Press and hold the  key for two seconds or more to enter the RUN mode. To save the setting, refer to “7-3 Functions of Operating Keys” (p.222).

Setting the Frequency Filter

 Setting the Frequency Filter p.155

As an example, here is an explanation of the procedure for selecting the “LOPASS” setting for the frequency filter type, and the “1Hz” cut-off frequency filter setting.

Operating procedure











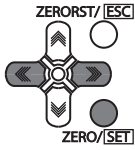



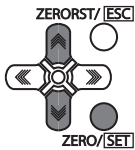







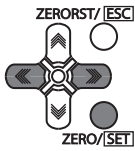

Steps	Key operation	Display	Description
1 to 4			For moving to “FILTER”, see steps 1 to 4 in p.242.
5			Select “FRQNCY” as the filter type. Press the  /  keys to select “FREQ” and press the  key.
6			Select the frequency filter type. LO.PASS: LOWPASS FILTER HIPASS: HIGHPASS FILTER BD.PASS: BANDPASS FILTER Select “LOPASS” as the frequency filter type. The current setting value is displayed on the sub-display. Press  /  key to enter editing mode and the sub-display blinks. In this example, select “LO.PASS” and press the  key.
7			Set the cut-off frequency. “CUTOFF” is displayed on the main display and the current setting value is displayed on the sub-display. Press  key to enter the editing mode, and the sub-display blinks. To edit numerical values, use the  /  /  /  keys. In this example, input “1”, then press the  key.
8			The decimal point is displayed. Press the  /  key to move the decimal point. Determine the decimal point and then press the  key.
9			Press and hold the  key for two seconds or more to enter the RUN mode. To save the setting, refer to “7-3 Functions of Operating Keys” (p.222).

Setting the Differentiation Filter

 Setting the Differentiation Filter p.159

As an example, here is an explanation of the procedure for selecting the “200 μs” number of differential cycles.

Operating procedure

Steps	Key operation	Display	Description
1 to 4			For moving to “FILTER”, see steps 1 to 4 in p.242.
5			Select “DIFFER” as the filter type. Press the  /  keys to select “DIFFER” and press the  key.
6			Enable the differentiation filter. The current setting value is displayed on the sub-display. Press  /  key to enter editing mode and the sub-display blinks. Select “ON”, then press the  key.
7			Set the number of differential cycles. “CYCLE” is displayed on the main display and the current setting value is displayed on the sub-display. Press  key to enter the editing mode, and the sub-display blinks. To edit numerical values, use the  /  /  /  keys. In this example, input “10”, then press the  key.
8			The decimal point is displayed. Press the  /  key to move the decimal point. Determine the decimal point and then press the  key.
9			Press and hold the  key for two seconds or more to enter the RUN mode. To save the setting, refer to “7-3 Functions of Operating Keys” (p.222).













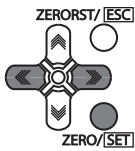



















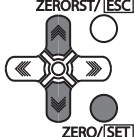

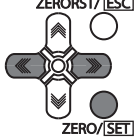

Setting Scaling

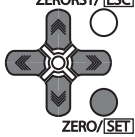
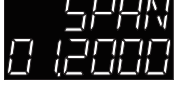

Performing Manual Scaling

 Performing Manual Scaling p.143

As an example, here is an explanation of the procedure for setting the manual scaling type to “SPAN” and the inclination coefficient to “1.2”.

Operating procedure

Steps	Key operation	Display	Description
1			Press and hold the  key for two seconds or more to enter the FUNC mode. To save the setting, refer to "7-3 Functions of Operating Keys" (p.222).
2			Press the  /  keys to select “MEAS” and press the  key.
3			If "TASK 1" is displayed, press the  key. If "TASK 1" is not displayed, press the  /  key to select "TASK 1", and then press the  key.
4			Press the  /  keys to select “OUTPUT” and press the  key.
5			Press the  /  keys to select “SCALE” and press the  key.
6			Select “MANUAL” as the scaling type. The current setting value is displayed on the sub-display. Press the  /  keys to enter the editing mode, and the sub-display blinks. Select “MANUAL” and press the  key.
7			Set the manual scaling type. SPAN: Span OFFSET: Offset In this example, press the  /  keys, select “SPAN” and press the  key.
8			Set the inclination coefficient. The current setting value is displayed on the sub-display. Press the  key to enter the editing mode, and the sub-display blinks. To edit numerical values, use the  /  /  /  keys. In this example, select “1.2” and press the  key.











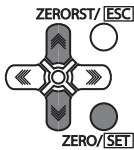



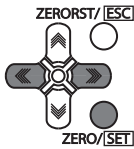





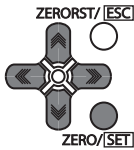

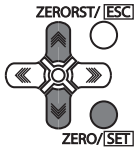

Steps	Key operation	Display	Description
9			Press and hold the  key for two seconds or more to enter the RUN mode. To save the setting, refer to "7-3 Functions of Operating Keys" (p.222).

Automatically Setting Scaling

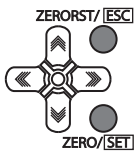
Performing 1-point Scaling

 Performing 1-point Scaling p.144











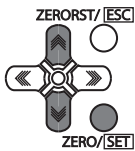



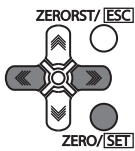





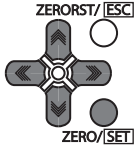



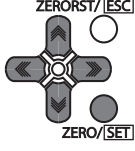

Operating procedure

Steps	Key operation	Display	Description
1 to 5			For moving to "SCALE", see steps 1 to 5 in p.246.
6			Select "AUTO" as the scaling type. The current setting value is displayed on the sub-display. Press  key to enter editing mode and the sub-display blinks. Select "AUTO" and press the  key.
7			Select "1POINT". Press the  keys to select "1PT" and press the  key.
8			Press the  key when the main display shows "POINT1".
9			The current measured value is displayed on the main display and the current setting value is displayed on the sub-display. To edit numerical values, use the  keys. Enter the setting value and then press the  key.
10			Set the increment/decrement direction. "DIRECT" is displayed on the main display and the incremental/decremental directions ("FWD": the NEAR side as + and "REV": the FAR side as +) are displayed on the sub-display. Press  key to enter editing mode and the sub-display blinks. Enter the setting value and then press the  key.
11			"OK/CAN" is displayed on the sub-display. Press the  key to execute scaling or  key to cancel.
12			Press and hold the  key for two seconds or more to enter the RUN mode. To save the setting, refer to "7-3 Functions of Operating Keys" (p.222).

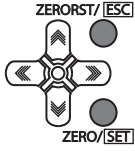
Performing 2-point Scaling

 Performing 2-point Scaling p.146











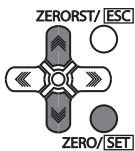



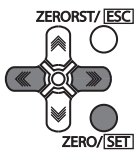





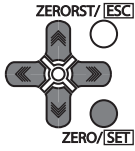





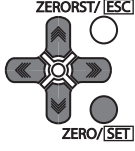



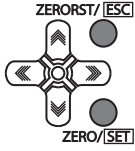

Operating procedure

Steps	Key operation	Display	Description
1 to 5			For moving to "SCALE", see steps 1 to 5 in p.246.
6			Select "AUTO" as the scaling type. The current setting value is displayed on the sub-display. Press  key to enter editing mode and the sub-display blinks. Select "AUTO" and press the  key.
7			Press the  keys to select "2PT" and press the  key.
8			Press the  key when the main display shows "POINT1".
9			Set the measured value of point 1. The current measured value is displayed on the main display and the current setting value is displayed on the sub-display. To edit numerical values, use the  keys. Enter the setting value and then press the  key.
10			Press the  key when the main display shows "POINT2".
11			Set the measured value of point 2. To edit numerical values, use the  keys. Enter the setting value and then press the  key.
12			"OK/CAN" is displayed on the sub-display. Press the  key to execute scaling or  key to cancel.
13			Press and hold the  key for two seconds or more to enter the RUN mode. To save the setting, refer to "7-3 Functions of Operating Keys" (p.222).

Multi-point scaling (ZW-8000□ only)

 Multi-point scaling p.148











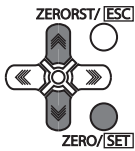



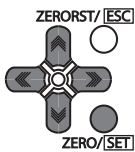

Operating procedure

Steps	Key operation	Display	Description
1 to 5			For moving to "SCALE", see steps 1 to 5 in p.246.
6			Select "AUTO" as the scaling type. The current setting value is displayed on the sub-display. Press  key to enter editing mode and the sub-display blinks. Select "AUTO" and press the  key.
7			Press the  keys to select "NPT" and press the  key.
8			Press the  key when the main display shows "POINT1".
9			Set the measured value of point 1. The current measured value is displayed on the main display and the current setting value is displayed on the sub-display. To edit numerical values, use the  keys. Enter the setting value and then press the  key.
10			Press the  key when the main display shows "POINT2".
11			Set the measured value of point 2. To edit numerical values, use the  keys. Enter the setting value and then press the  key.
12			"OK/CAN" is displayed on the sub-display. When continuing to set the next point measurement value, press the  key. When ending all point measurement value settings, press the  key. Repeat steps 10 to 12 until reaching a maximum of point 10.
13			When pressing the  key in step 12 or point 10 setting completes, "OK/CAN" is displayed on the sub-display. When continuing to set the next point measurement value, press the  key. When ending all point settings, press the  key.
14			Press and hold the  key for two seconds or more to enter the RUN mode. To save the setting, refer to "7-3 Functions of Operating Keys" (p.222).

Performing Thickness Scaling

 Performing Thickness Scaling p.151

Operating procedure

Steps	Key operation	Display	Description
1 to 5			For moving to "SCALE", see steps 1 to 5 in p.246.
6			<p>Select "THICK" as the scaling type. The current setting value is displayed on the sub-display.</p> <p>Press  key to enter editing mode and the sub-display blinks. Select "THICK" and press the  key.</p>
7			<p>The current measured value is displayed on the main display and the current setting value is displayed on the sub-display.</p> <p>Press  key to enter the editing mode, and the sub-display blinks.</p> <p>To edit numerical values, use the ,  keys.</p> <p>Enter the setting value and then press the  key.</p>
8			<p>"OK/CAN" is displayed on the sub-display.</p> <p>When continuing to set the next point measurement value, press the  key. When ending all point settings, press the  key.</p>
9			<p>Press and hold the  key for two seconds or more to enter the RUN mode.</p> <p>To save the setting, refer to "7-3 Functions of Operating Keys" (p.222).</p>













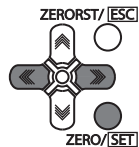









Setting Hold

Setting the Hold Mode

 Setting the Hold Mode p.160

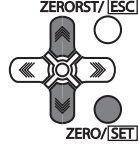
As an example, here is an explanation of the procedure for selecting the “PEAK” hold mode setting.

Operating procedure











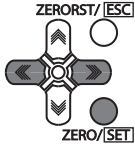

Steps	Key operation	Display	Description
1			Press and hold the  key for two seconds or more to enter the FUNC mode. To save the setting, refer to "7-3 Functions of Operating Keys" (p.222).
2			Press the  key to select MEAS, then press the  key.
3			Press the  key to select TASK1, then press the  key.
4			Press the  keys to select “OUTPUT” and press the  key.
5			Press the  keys to select “HOLD” and press the  key.
6			Press the  keys to select “TYPE” and press the  key.
7			
8			Press and hold the  key for two seconds or more to enter the RUN mode. To save the setting, refer to "7-3 Functions of Operating Keys" (p.222).

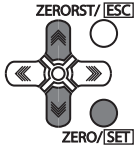
Setting Triggers

 Setting Triggers p.163

As an example, here is an explanation of the procedure for selecting the “TIMING” trigger type setting.

Operating procedure

Steps	Key operation	Display	Description
1 to 5			For moving to “HOLD”, see steps 1 to 5 in p.251.
6			Press the  /  keys to select “TRIG” and press the  key.
7			Set the trigger method. TIMING: External SELF-U: SELF-UP SELF-D: SELF-DOWN SELF-V: VALID VALUE “TYPE” is displayed on the main display and the current setting value is displayed on the sub-display. Press  /  key to enter editing mode and the sub-display blinks. In this example, select “TIMING” and press the  key.
8			Press and hold the  key for two seconds or more to enter the RUN mode. To save the setting, refer to "7-3 Functions of Operating Keys" (p.222).

Performing Hold with a Key Input

Press the / key on the Sensor Controller to enable the TIMING or RESET input.

- TIMING input is ON while the key is pressed.
- RESET input is ON when the key is pressed.

Note that the key input is disabled in the default setting. Set the following when using this function.

Steps	Key operation	Display	Description
1			Press and hold the key for two seconds or more to enter the FUNC mode. To save the setting, refer to "7-3 Functions of Operating Keys" (p.222).
2			Press the / keys to select "SYSTEM" and press the .
3			Press the / keys to select "KEY.IN" and press the .
4			Enable the key input. The current setting value is displayed on the sub-display. Press / key to enter editing mode and the sub-display blinks. Select "ON" and press the .
5			Press and hold the key for two seconds or more to enter the RUN mode. To save the setting, refer to "7-3 Functions of Operating Keys" (p.222).

Note











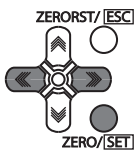



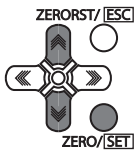



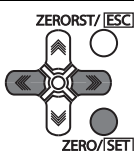
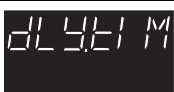



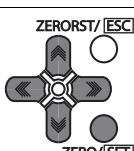







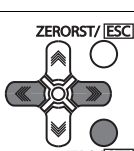





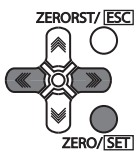

The above settings are also possible using the personal computer tools.

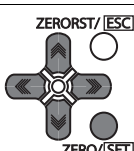





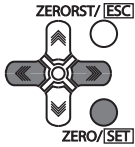

Performing Hold with a Key Input p.166

Setting a Trigger Delay

 Setting a Trigger Delay p.167

Operating procedure

Steps	Key operation	Display	Description
1 to 5			For moving to "HOLD", see steps 1 to 5 in p.251.
6			Press the  /  keys to select "DELAY" and press the  key.
7			Enable the delay. "DELAY" is displayed on the main display and the current setting value is displayed on the sub-display. Press  /  key to enter editing mode and the sub-display blinks. Select "ON" and press the  key.
8			Select the delay time. Press the  /  keys to select "DLY.TIM" and press the  key.
9			Set the delay time. The current setting value is displayed on the sub-display. Press  key to enter the editing mode, and the sub-display blinks. To edit numerical values, use the  /  /  /  keys. In this example, input "10", then press the  key.
10			The decimal point is displayed. Press the  /  key to move the decimal point. Determine the decimal point and then press the  key.
11			Press the key to return to the previous menu.
12			Select the sampling time. Press the  /  keys to select "SMP.TIM" and press the  key.
13			Set the sampling time. The current setting value is displayed on the sub-display. Press  key to enter the editing mode, and the sub-display blinks. To edit numerical values, use the  /  /  /  keys. In this example, input "10", then press the  key.

Steps	Key operation	Display	Description
14			<p>The decimal point is displayed. Press the /  key to move the decimal point. Determine the decimal point and then press the  key.</p>
15			<p>Press and hold the  key for two seconds or more to enter the RUN mode. To save the setting, refer to "7-3 Functions of Operating Keys" (p.222).</p>













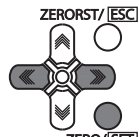











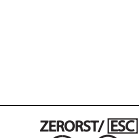

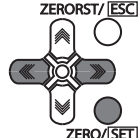

Setting the Zero Reset

Setting the Status

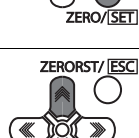
 Setting the Status p.169

As an example, here is an explanation of the procedure for selecting the “ON” (Enabled) zero reset type setting.

Operating procedure











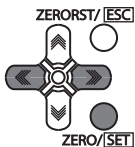



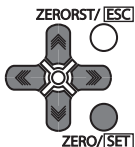



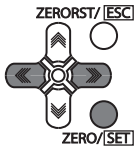

Steps	Key operation	Display	Description
1			Press and hold the  key for two seconds or more to enter the FUNC mode. To save the setting, refer to "7-3 Functions of Operating Keys" (p.222).
2			Press the  key to select MEAS, then press the  key.
3			Press the  key to select TASK1, then press the  key.
4			Press the  keys to select “OUTPUT” and press the  key.
5			Press the  keys to select “ZERO” and press the  key.
6			Press the  keys to select “STATUS” and press the  key.
7			Set zero reset ON/OFF. The current setting value is displayed on the sub-display. Press  key to enter editing mode and the sub-display blinks. In this example, select “ON” and press the  key.
8			Press and hold the  key for two seconds or more to enter the RUN mode. To save the setting, refer to "7-3 Functions of Operating Keys" (p.222).

Setting the Offset

 Setting the Offset p.170

As an example, here is an explanation of the procedure for selecting the “10 mm” reference value setting.

Operating procedure











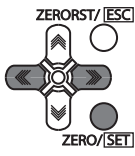

Steps	Key operation	Display	Description
1 to 5			For moving to “ZERO”, see steps 1 to 5 in p.256.
6			Press the  /  keys to select “OFFSET” and press the  key.
7			Change the offset value. The current setting value is displayed on the sub-display. Press  key to enter the editing mode, and the sub-display blinks. To edit numerical values, use the  /  /  /  keys. In this example, input “10”, then press the  key.
8			The decimal point is displayed. Press the  /  key to move the decimal point. Determine the decimal point and then press the  key.
9			Press and hold the  key for two seconds or more to enter the RUN mode. To save the setting, refer to “7-3 Functions of Operating Keys” (p.222).

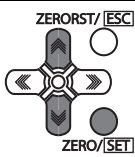
Setting the Zero Reset Mode

 Setting the Zero Reset Type p.171

As an example, here is an explanation of the procedure for selecting the “REAL” zero reset type setting.

Operating procedure











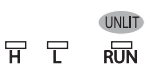









Steps	Key operation	Display	Description
1 to 5			For moving to “ZERO”, see steps 1 to 5 in p.256.
6			Press the  /  keys to select “TYPE” and press the  key.
7			Select the zero reset mode. REAL: Real HOLD: Hold Select “REAL” as the zero reset type. The current setting value is displayed on the sub-display. Press  /  key to enter editing mode and the sub-display blinks. In this example, select “REAL” and press the  key.
8			Press and hold the  key for two seconds or more to enter the RUN mode. To save the setting, refer to "7-3 Functions of Operating Keys" (p.222).

Setting the Zero Reset Memory

 Setting the Zero Reset Memory p.172

As an example, here is an explanation of the procedure for selecting the “ON” (enabled) zero reset memory setting.

Operating procedure

Steps	Key operation	Display	Description
1			Press and hold the  key for two seconds or more to enter the FUNC mode. To save the setting, refer to "7-3 Functions of Operating Keys" (p.222).
2			Press the  /  keys to select “SYSTEM” and press the  key.
3			Press the  /  keys to select “ZER.MEM” and press the  key.
4			Select zero reset memory ON/OFF. The current setting value is displayed on the sub-display. Press  /  key to enter editing mode and the sub-display blinks. In this example, select “ON” and press the  key.
5			Press and hold the  key for two seconds or more to enter the RUN mode. To save the setting, refer to "7-3 Functions of Operating Keys" (p.222).

















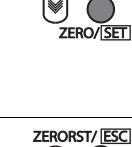



7-9 Setting the Banks

Switching Banks

 Switching Banks p.119

As an example, here is an explanation of the procedure for setting BANK2.

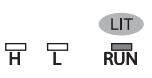
Operating procedure













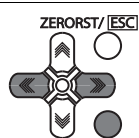



Steps	Key operation	Display	Description
1			Press and hold the  key for two seconds or more to enter the FUNC mode. To save the setting, refer to "7-3 Functions of Operating Keys" (p.222)
2			Press the  key to select BANK, then press the  key.
3			Press the  key to select BK.CHG, then press the  key.
4			Select BANK2 for the bank number. The current setting value is displayed on the sub-display. Press  key to enter editing mode and the sub-display blinks. Select "BANK2" and press the  key.
5			"OK/CAN" is displayed on the sub-display. Press the  key to save the settings or the  key to cancel.
6			Press and hold the  key for two seconds or more to enter the RUN mode. To save the setting, refer to "7-3 Functions of Operating Keys" (p.222).

Changing the Bank Mode

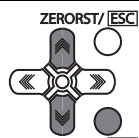
 Setting the Bank Mode p.188

As an example, here is an explanation of the procedure for selecting the “NORMAL” bank mode setting.

Operating procedure

Steps	Key operation	Display	Description
1			Press and hold the  key for two seconds or more to enter the FUNC mode. To save the setting, refer to "7-3 Functions of Operating Keys" (p.222)
2			Press the  key to select BANK, then press the  key.
3			Press the  keys to select “BK.MODE” and press the  key.
4			Select the bank data. NORMAL: NORMAL JUDGE: JUDGMENT The current setting value is displayed on the sub-display. Press  key to enter editing mode and the sub-display blinks. In this example, select “NORMAL” and press the  key.
5			Press and hold the  key for two seconds or more to enter the RUN mode. To save the setting, refer to "7-3 Functions of Operating Keys" (p.222).



















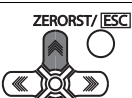

Copying the Bank Settings

Copy the selected bank setting to another bank.

 Copying the Bank/System Settings p.186

As an example, here is an explanation of the procedure for copying the BANK1 setting to BANK4.

Operating procedure

Steps	Key operation	Display	Description
1			Press and hold the  key for two seconds or more to enter the FUNC mode. To save the setting, refer to "7-3 Functions of Operating Keys" (p.222)
2			Press the  key to select BANK, then press the  key.
3			Press the  key to select "BK.COPY" and press the  key.
4			Select "BANK1" as the bank setting to be copied. "FROM" is displayed on the main display and the current setting value is displayed on the sub-display. Press  key to enter editing mode and the sub-display blinks. Select "BANK1" and press the  key.
5			Select "BANK4" as the target to copy the bank setting. "TO" is displayed on the main display and the current setting value is displayed on the sub-display. Press the  keys to enter the editing mode, and the sub-display blinks. Select "BANK4" and press the  key.
6			Press and hold the  key for two seconds or more to enter the RUN mode. To save the setting, refer to "7-3 Functions of Operating Keys" (p.222).

Saving the Bank/System Settings













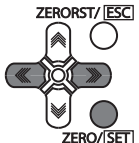

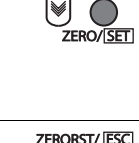

Save the bank/system settings to the Sensor Controller.

Important

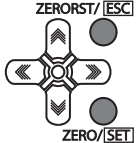
- The settings of all banks are saved regardless of the currently selected bank number.
- After you have made or changed settings, be sure to save the setup data. All settings will be deleted if you turn the power OFF without saving the data.

Here is an explanation of the procedure for saving the bank/system settings.

Operating procedure

Steps	Key operation	Display	Description
1			Press and hold the  key for two seconds or more to enter the FUNC mode. To save the setting, refer to "7-3 Functions of Operating Keys" (p.222).
2			Press the  /  keys to select "SYSTEM" and press the  key.
3			Press the  /  keys to select "SAVE" and press the  key.
4			"OK/CAN" is displayed on the sub-display. Press the  key to save the settings or the  key to cancel.
5			Press and hold the  key for two seconds or more to enter the RUN mode. To save the setting, refer to "7-3 Functions of Operating Keys" (p.222).

Clearing the Bank Settings



























Clear (initialize) the setting of the currently selected bank.

 Clearing the Bank Settings p.188

Important

Operations on the Sensor Controller do not initialize system settings and settings displayed in RUN mode.



Operating procedure

Steps	Key operation	Display	Description
1	 	  	Press and hold the  key for two seconds or more to enter the FUNC mode. To save the setting, refer to "7-3 Functions of Operating Keys" (p.222)
2			Press the  /  key to select BANK, then press the  key.
3			Press the  /  keys to select "BK.CLR" and press the  key.
4			"OK/CAN" is displayed on the sub-display. Press the  key to clear the settings or the  key to cancel.
5	 	  	Press and hold the  key for two seconds or more to enter the RUN mode. To save the setting, refer to "7-3 Functions of Operating Keys" (p.222).

7-10 Setting Threshold Value

 4-4 Setting Threshold Value p.174

There are two ways of setting the threshold value.

Method	Operating key	Description
TEACHING		Perform the measurement and set the result as the threshold value. This is a convenient way when the upper or lower limit sample is available.
Direct		Set the threshold value by entering the numerical values directly. This is a convenient way when you know the dimensions of a quality product or when adjusting the threshold value set by teaching.





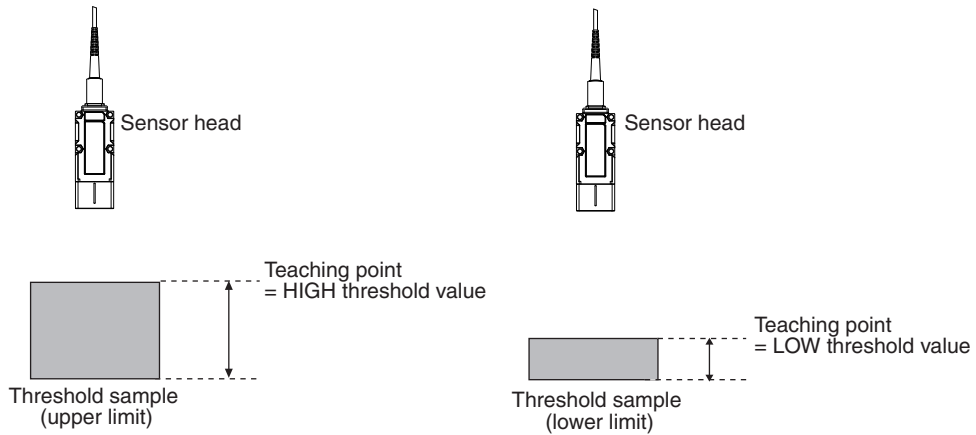







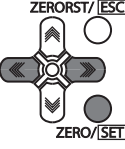

















Teaching

Perform the measurement and set the result as the threshold value.

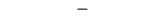

The existing settings for hold, trigger, and scaling are also reflected in the measurement during teaching.

As an example, here is an explanation of the procedure for setting the current measured value as a HIGH threshold value.











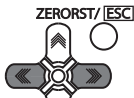







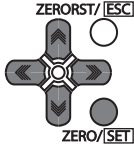
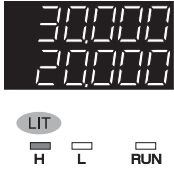

Steps	Key operation	Display	Description
1			Press and hold the  key for two seconds or more to enter the FUNC mode. To save the setting, refer to "7-3 Functions of Operating Keys" (p.222)
2			Press the  /  key to select MEAS, then press the  key.
3			Press the  /  key to select TASK1, then press the  key.
4			Press the  /  key to select JUDGE, then press the  key.
5			Press the  /  key to select TEACH, then press the  key.
6			Select HIGH THRESHOLD as the threshold value type. Press the  /  key to select H.JUDGE, then press the  key.
7			
8			Press the  key to start a teaching. When the key is pressed, the current measurement value of the main digital is displayed on the lower line.
9			Press and hold the  key for two seconds or more to enter the RUN mode. To save the setting, refer to "7-3 Functions of Operating Keys" (p.222).

Direct

Set the threshold value by entering the numerical values directly.

As an example, here is an explanation of the procedure for setting a HIGH threshold value by entering "20.000" directly.

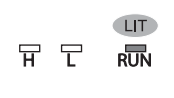
Operating procedure

Steps	Key operation	Display	Description
1 to 4			For moving to JUDGE, see steps 1 to 4 on p.266.
5			Press the  /  key to select DIRECT, then press the  key.
6			Select HIGH THRESHOLD as the threshold value type. Press the  /  key to select H.JUDGE, then press the  key.
7			Set "20.000" as the HIGH threshold value. The current measured value is displayed on the main display and the current set threshold value is displayed on the sub-display. (At this time, the THRESHOLD-H indicator lights up.) Press  key to enter the editing mode, and the sub-display blinks. To edit numerical values, use the  /  /  /  keys. Enter "40.000" and press the  key.
8			Press and hold the  key for two seconds or more to enter the RUN mode. To save the setting, refer to "7-3 Functions of Operating Keys" (p.222).

7-11 Setting the System

Display/set the system environment.















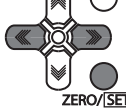





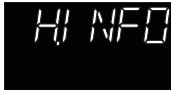





Checking Information

Display the set measuring cycle and information of the Sensor Controller and Sensor Head.

 Checking the Information of the Sensor p.192

As an example, here is an explanation of the procedure for displaying the serial No. of the Sensor Head.

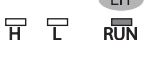
Operating procedure

Steps	Key operation	Display	Description
1	 FUNC TEACH		Press and hold the  key for two seconds or more to enter the FUNC mode. To save the setting, refer to "7-3 Functions of Operating Keys" (p.222)
2	 		Press the  /  keys to select "SYSTEM" and press the  key.
3			Select the information to display. C.INFO: CONTROLLER INFORMATION H.INFO: SENSOR HEAD INFORMATION In this example, press the  /  keys, select "H.INFO" and press the  key.
4			When the Controller information and Sensor Head information have been changed, select the additional information to display: VER: Controller version information MAC.ADR: Controller MAC address MODEL: Sensor Head model information SER.NO: Sensor Head serial No. In this example, press the  /  keys, select "SER.NO" and press the  key.
5	-		"SER.1" is displayed on the main display and the higher-order digit of the serial No. is displayed on the sub-display.
6	 		When the  /  key is pressed, "SER.2" is displayed on the main display and the lower-order digit of the serial No. is displayed on the sub-display.
7	 FUNC TEACH		Press and hold the  key for two seconds or more to enter the RUN mode. To save the setting, refer to "7-3 Functions of Operating Keys" (p.222).

Setting the Key Lock













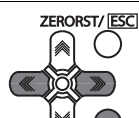



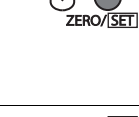

 Setting the Key Lock p.183

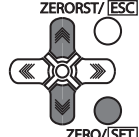
Important

Note that, moving to the key lock setting menu or moving between menu hierarchies are possible even when the key lock function is ON.

Here is an explanation of the procedure for turning the key lock ON.











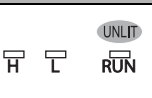





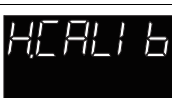

Operating procedure

Steps	Key operation	Display	Description
1			Press and hold the  key for two seconds or more to enter the FUNC mode. To save the setting, refer to "7-3 Functions of Operating Keys" (p.222)
2			Press the   keys to select "SYSTEM" and press the  key.
3			Press the   keys to select "LOCK" and press the  key.
4			Select key lock ON/OFF. The current setting value is displayed on the sub-display. Press the   keys to enter the editing mode, and the sub-display blinks. In this example, select "ON" and press the  key.
5			Press and hold the  key for two seconds or more to enter the RUN mode. To save the setting, refer to "7-3 Functions of Operating Keys" (p.222).

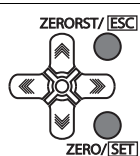
Calibrating Sensor Head

 Calibrating Sensor Head p.77

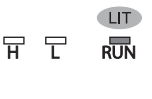
Operating procedure

Steps	Key operation	Display	Description
1	 RUN FUNC TEACH		Press and hold the  key for two seconds or more to enter the FUNC mode. Press the  key after [SWITCH] and [OK/CAN] are displayed. To save the setting, refer to "7-3 Functions of Operating Keys" (p.222)
2	 ZERORST/ESC ZERO/SET		Press the  /  keys to select "SYSTEM" and press the  key.
3	 ZERORST/ESC ZERO/SET		Press the  /  keys to select "H.CALIB", then press the  key.
4	 ZERORST/ESC ZERO/SET		"OK/CAN" is displayed on the sub-display. Press the  key to execute calibration or the  key to cancel.
5	 RUN FUNC TEACH		Press and hold the  key for two seconds or more to enter the RUN mode. To save the setting, refer to "7-3 Functions of Operating Keys" (p.222).













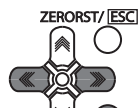



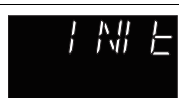

Important When Sensor Head calibration fails

If the Sensor Head is calibrated in an inappropriate environment, an error is displayed on the main display. In such a case, return to the previous screen using  key. Then refer to the p.48, recheck your environment, and try again. If an error results even if Sensor Head calibration is done under the correct conditions, it is possible that some contaminants may have adhered to the Sensor Head part, or the fiber connector of the Sensor Controller. Clean the fiber cable or fiber connector referring to p.70.

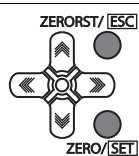
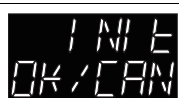
Initializing Settings

 Initializing Settings p.187













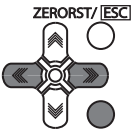



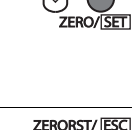

Operating procedure

Steps	Key operation	Display	Description
1			Press and hold the  key for two seconds or more to enter the FUNC mode. To save the setting, refer to "7-3 Functions of Operating Keys" (p.222)
2			Press the  /  keys to select "SYSTEM" and press the  key.
3			Press the  /  keys to select "INIT" and press the  key.
4			"OK/CAN" is displayed on the sub-display. Press the  key to restore the default values, or  key to cancel.
5			Press and hold the  key for two seconds or more to enter the RUN mode. To save the setting, refer to "7-3 Functions of Operating Keys" (p.222).

Setting the Synchronous Measurement Mode

 3-1 Setting the Measurement Start Timing p.96

Operating procedure

Steps	Key operation	Display	Description
1			Press and hold the  key for two seconds or more to enter the FUNC mode. To save the setting, refer to "7-3 Functions of Operating Keys" (p.222)
2			Press the  /  keys to select "SYSTEM" and press the  key.
3			Press the  /  keys to select "TRIGER" and press the  key.
4			Select the Trigger mode. AUTO: Internal synchronous measurement mode PARA.IN: External synchronous measurement mode ECT.PDO: PDO synchronous measurement mode The current settings are displayed on the sub digital. Press the  /  keys to enter the editing mode, and the sub-display blinks. In this example, select "PARA.IN" and press the  key.
5			Press and hold the  key for two seconds or more to enter the RUN mode. To save the setting, refer to "7-3 Functions of Operating Keys" (p.222).













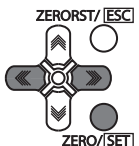





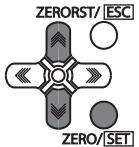

For more detail, refer to the following.

 7-1 Connecting Parallel I/O in Confocal Fiber Type Displacement Sensor.

Setting the extension fiber cable length

Here is an explanation of the procedure for setting the extension fiber cable length to "10m".

Operating procedure

Steps	Key operation	Display	Description
1			<p>Press and hold the  key for two seconds or more to enter the FUNC mode.</p> <p>To save the setting, refer to "7-3 Functions of Operating Keys" (p.222)</p>
2			<p>Press the /  keys to select "SYSTEM" and press the  key.</p>
3			<p>Press the /  keys to select "CABLE" and press the  key.</p>
4			<p>Select the extension fiber cable length. The current setting value is displayed on the sub-display.</p> <p>Press /  key to enter the editing mode and the sub-display blinks.</p> <p>In this example, select "10M" and press the  key.</p>
5			<p>Press and hold the  key for two seconds or more to enter the RUN mode.</p> <p>To save the setting, refer to "7-3 Functions of Operating Keys" (p.222).</p>

7-12 Connecting Parallel I/O

For details on Connecting by Connecting Parallel I/O, refer to the following manual.



“6-1 Connecting Parallel I/O” described in Displacement Sensor ZW-8000/7000/5000 series Confocal Fiber Type Displacement Sensor User’s Manual for Communications Settings (Z363)

7-13 Connecting with EtherCAT

For details on Connecting by Connecting with EtherCAT, refer to the following manual.



“6-2 Connecting with EtherCAT” described in Displacement Sensor ZW-8000/7000/5000 series Confocal Fiber Type Displacement Sensor User’s Manual for Communications Settings (Z363)

7-14 Connecting with EtherNet/IP

For details on Connecting by Connecting with EtherNet/IP, refer to the following manual.



“6-3 Connecting with EtherNet/IP” described in Displacement Sensor ZW-8000/7000/5000 series
Confocal Fiber Type Displacement Sensor User's Manual for Communications Settings (Z363)

7-15 Connecting by No-protocol Communications

For details on Connecting by No-protocol Communications, refer to the following manual.



“6-4 Connecting by No-protocol Communications” described in Displacement Sensor ZW-8000/7000/5000 series Confocal Fiber Type Displacement Sensor User's Manual for Communications Settings (Z363)

MEMO

Troubleshooting

8-1 Error Messages	280
8-2 Troubleshooting	282

8-1 Error Messages

Errors Common to All Communication States

These errors occur in common regardless of communication state. When these errors occur, the ALARM output of parallel I/O turns ON, and "SYSERR" and error code are displayed on the main and sub-displays, respectively.

The acquired error number of EI command is showed in the number in parentheses.

Error Code	Name	Description	Cause	Remedy
BRK.ROM (02)	Linearity correction data error	The linearity correction data is corrupted.	Calibration ROM damage	Check to make sure that the Calibration ROM is correctly inserted. If correctly inserted, the Calibration ROM or displacement sensor may be broken. Please contact an OMRON branch or sales office. (*1)
NO.ROM (03)	Linearity correction data read error	Reading of the linearity correction data was not executed correctly.	Calibration ROM not inserted	
BRK.SYS (07)	System setting error	The system settings saved to the Sensor Controller are corrupt.	The displacement sensor power was turned OFF during saving/loading of system settings.	After holding down the Mode switching key, press the ZERO/SET key to clear the system settings and the bank data, and then resume the starting process.
BRK.BNK (08)	Bank data error	The bank data saved to the Sensor Controller is corrupt.	The displacement sensor power was turned OFF during saving/loading of bank data.	
BRK.TIM (12)	Energization time error	The energization time data saved to the Sensor Controller is corrupt.	The energization time is corrupt due to a hardware malfunction.	After holding down the Mode switching key, press the ZERO/SET key to resume. (The energization time function becomes disabled.)
OVER.IP (23)	IP address overlap error	The same address as that of the displacement sensor exists on the network. Note: If a network hub is not used, this error may not appear.	The settings of IP addresses are invalid.	Change the IP address so that the IP address does not overlap with devices on the network.
MIS.IP (25)	Ethernet communication parameter error	An invalid IP address is set.	Invalid IP address setting	Change to the correct IP address.
MIS.TYP (60)	Type mismatch	The Sensor Head and Sensor Controller types do not match.	The Sensor Head and the Sensor Controller are not the correct pair. Both must be either the ZW-8000 series or ZW-7000 series or ZW-5000 series.	Replace with the correct Calibration ROM. After replacing the Calibration ROM, turn ON the measurement sensor power again.
MIS.SET (61)	Set model mismatch	For the set model type, the Sensor Controller and Calibration ROM are not matched.	A Calibration ROM except ZW-7000 series is inserted.	Insert the Calibration ROM for ZW-7000 series, and then retry to turn ON the Displacement Sensor.
MIS.BNK (81)	Bank data error	The opened bank data is abnormal.	Occurs as a result of software downgrade.	To recover from the error, press and hold ↑ key or ↓ key to clear the bank data.

If an error code other than the one listed above is displayed, the displacement sensor may be broken. Please contact an OMRON branch or sales office.

- *1: As a provisional measure, the measurement can be resumed using the data of the previously read Calibration ROM.
 <Operation method>
 With error code NO.ROM displayed on the sub-display, hold down the Mode switching key, and then when [OK/CAN] is displayed, press the ZERO/SET key.
 <Cautions>
 - When using this method, always check the serial number of the previously read Calibration ROM in "controller information," then check that it matches the Sensor Head side serial number. Measurement will not be correct unless they match.
 - When restarting the main unit, perform the same operations again.
 This operation is disabled for a displacement sensor into which no Calibration ROM has ever been inserted and started up.

For the displayed or output error messages in each communication, refer to the following manual.



“7-1 Error Messages” described in Displacement Sensor ZW-8000/7000/5000 series Confocal Fiber Type Displacement Sensor User’s Manual for Communications Settings (Z363)

8-2 Troubleshooting

This section describes how to temporarily remedy hardware-related trouble.
Check the items below before sending the hardware for repair.

Error type	Phenomenon	Cause	Countermeasure	Pages
Startup error	Device restarts during operation.	The power supply device is not connected correctly.	Check if the power supply device conforms to the power supply specifications.	p.6
		The power supply capacity is insufficient.		
	[NO.ROM] is displayed on the main digital.	The Calibration ROM is not connected.	Connect the Calibration ROM. If the Calibration ROM is lost, or it fails, perform the temporary solution indicated on p.195 and then contact your OMRON representative.	p.35
Sensor Head calibration error	Sensor Head calibration fails.	The connection between the Sensor Controller and the Sensor Head or the extension fiber cable is not normal.	Confirm that the Sensor Controller, Sensor Head, and extension fiber cable are connected correctly.	p.36
		Foreign matter is adhering to the fiber cable end surface.	Clean the Sensor Controller, Sensor Head, and end surface of the extension fiber cable connector.	p.70
		The extension fiber cable is not set properly.	Confirm that the set length of the extension fiber cable matches the length of the connected extension fiber cable.	p.273
		The fiber cable is disconnected.	The Sensor Head and extension fiber cable need to be replaced or repaired. Please contact an OMRON branch or sales office.	–
Display error	The main display remains on "-----".	TIMING input is not ON.	Turn the TIMING input ON.	p.78
		The trigger level is not appropriately set for self-trigger.	Set the self-trigger level to an appropriate value.	p.163 p.252
		Refer to the section of "[DARK] is displayed on the main digital."		–
	The main display becomes "SYSERR."	A system error has occurred.	Identify the cause of the error based on the error code displayed on the sub-display and take an appropriate action.	p.280
	The sub-display displays "LCK.ERR".	The EdgeTracks teach has failed.	Make sure the measurement surface is present and execute teach again. When the measurement surface is present, the STABILITY indicator is lit during RUN mode.	p.235

Error type	Phenomenon	Cause	Countermeasure	Pages
Measurement error	[DARK] is displayed on the main digital.	Amount of the light is insufficient.	Set the Exposure time to be long or reduce Noise Cut Level within the range of Noise Level.	p.122 p.126
		The target is not in the measurement range.	Check the measurement range and measurement area settings of the Sensor Head, then place the target.	p.63 p.130
		The connection of the Sensor Controller and the Sensor Head or the extension fiber cable is not normal.	Confirm the connection of fiber cable.	p.69
		Calibration of Sensor Head is not performed correctly.	Retry to execute the calibration of Sensor Head.	p.77
		Some contaminants may be adhered.	Clean the fiber cable.	p.69
	[BRIGHT] is displayed on the main digital.	Light amount is saturated.	Short the Exposure time.	p.129
	[NO.SRFC] is displayed on the main digital.	There is no surface to measure.	Change the settings so as to measure a surface that has been detected.	p.140
		The input values of the calculation formula are not applied.	Confirm the TASK measurement value set in parameter X and Y.	p.141
		The Area Teach has failed when using EdgeTracks.	Confirm the set track width conditions and state of the light reception waveform on the sensing settings window.	p.99
		A specific measurement surface does not exist when using EdgeTracks.	Be sure that all surfaces are within the measurement areas.	p.133
		The track area could not be followed due to a "DARK" state when using EdgeTracks.	Execute Area Teach again.	p.133
	[H.CALIB] is displayed on the main digital.	The calibration of Sensor Head is not performed correctly.	Perform the calibration of the Sensor Head again.	p.48
	The measurement value is unstable even if the workpiece and/or Sensor head is stationary. A measurement value is output even if there is no workpiece in the measurement area.	Control edge in Exposure time or surface setting for measurement is not correct.	Change the Control edge or surface setting in Exposure time from Peak to each surface, 1 to 4.	p.129 p.140
		Calibration of Sensor Head is not performed correctly.	Retry to execute the calibration of Sensor Head.	p.48
		There is a problem with the connection between the Sensor Controller and the Sensor Head or the extension fiber cable.	Check the fiber cable connections.	p.39
		The surface of fiber cable is dirty.	Clean the surface.	p.69
		Intense ambient light is present.	<ul style="list-style-type: none"> Shield the ambient light. Shorten the Measurement cycle or increase the background removal level so it is higher than the Noise level. 	p.122
		Receiving light from the opposite Sensor.	Adjust the mounting position of Sensor Head so as not to receive the light from the opposite Sensor.	p.65
		When measuring on a high-reflectivity object out of the measurement range, this cause a wrong operation.	Shorten the Measurement cycle (Exposure time) or increase the background removal level so it is higher than the Noise level.	p.126

Error type	Phenomenon	Cause	Countermeasure	Pages
Measurement error	The logical beam is not emitted from the Sensor Head.	The connection between the Sensor Head and the Sensor Controller or the connection with the extension fiber cable is not normal.	Check the fiber cable connections.	p.69
		The fiber cable is disconnected.	The Sensor Head needs to be repaired. Please contact an OMRON branch or sales office. For Sensor Head repair, return as a set with the Calibration ROM.	–
	The logical beam does not come out of the Sensor Controller.	The LIGHT OFF input line is short-circuited.	Check the wiring.	p.78
	The measured values fluctuate gradually.	The operating ambient temperature of Sensor Head or Controller is fluctuating.	<ul style="list-style-type: none"> • Maintain a certain operating ambient temperature. • Execute zero reset periodically using the standard object. 	p.100 *1
		The warm-up time is inadequate.	Wait 30 minutes after switching ON the power before using.	p.9
	The measured values differ from the intended values.	The scaling has not been done correctly.	Check the scaling setting.	p.143 p.246
		The zero reset value is not correct.	Set the zero reset correctly.	p.169 p.256
		The serial numbers of the Sensor Head and Calibration ROM do not match.	Confirm the serial numbers match.	–
		EdgeTracks has not been set correctly.	Execute Area Teach again.	p.133
	Input error	No input signal received.	Cables are not connected correctly.	Check the input circuit and the wiring for proper connection.
The signal line is disconnected.				
Output error	The judgment result cannot be output to an external device.	Cables are not connected correctly.	Check the output circuit and the wiring for proper connection.	p.78
		The signal line is disconnected.		
		The signal logic is not correct.	Check the logic of the signal.	–
		The RESET input line is short-circuited.	Check the input circuit and the wiring for proper connection.	p.78
		The non-measurement setting is set to "CLAMP", and measurement cannot be performed.	Set the non-measurement setting correctly. By selecting the non-measurement setting to "KEEP", the judgment result before measurement is disabled can be output.	*1
	The analog output is not correct.	Cables are not connected correctly.	Check the output circuit and the wiring for proper connection.	p.81
		The signal line is disconnected.		
		The voltage and current values are off the meter.	Set the correct monitor focus based on the measured value.	*1
	An oscilloscope or a high-speed A/D board is being used.	Use of these devices may reduce the resolution. Change the monitor focus to minimize the effect.	*1	

Error type	Phenomenon	Cause	Countermeasure	Pages
Communication error	RS-232C communication cannot be established.	Cable wiring is wrong. Cables are not connected correctly.	Check the wiring to ensure proper connection.	–
		Communication settings are wrong.	Set the same communication setting for both the Sensor Controller and the external devices.	*2
	Ethernet communication cannot be established.	The Ethernet cable is not connected correctly.	Use a cross cable when connecting the controller directly with the personal computer.	–
		The IP address and subnet mask are not set correctly.	Set the IP address of the Sensor Controller and subnet mask correctly. * The setting change is applied after restarting.	p.44 *2
		The Sensor Controller and an external device are not connected at a 1:1 ratio.	Connect the Sensor Controller and an external device at a 1:1 ratio.	–
		The Ethernet cable is disconnected or about to be disconnected.	Check if the Ethernet cable is disconnected.	–
		The industrial switching hub is faulty (when the switching hub is used).	Check if the industrial switching hub is faulty.	–
		The security setting is not appropriate.	Check if the communication is blocked due to the firewall setting on the external device.	–
	Communication cannot be established by EtherCAT.	The node address setting switch is not set correctly.	Check to make sure that the node address setting switch is set correctly.	p.60
		Devices are not connected correctly to the EtherCAT connector (input/output).	Check to make sure that devices are connected correctly to the EtherCAT connector (input/output).	p.61
Other	Key input is not allowed.	The key lock setting is turned ON.	Turn OFF the key lock setting.	p.183 p.269

*1 Refer to "2-1 Parallel I/O connection" described in Displacement Sensor ZW-8000/7000/5000 series Confocal Fiber Type Displacement Sensor User's Manual for Communications Settings (Z363).

*2 Refer to "5-1 No-protocol Communications" described in Displacement Sensor ZW-8000/7000/5000 series Confocal Fiber Type Displacement Sensor User's Manual for Communications Settings (Z363).

MEMO

APPENDICES

9-1 Specifications and External Dimensions	288
9-2 Laser safety	323
9-3 Firmware Update	324

9-1 Specifications and External Dimensions

Sensor Head

Specifications

● ZW-S8010/S8020/S8030/SP8007/SP8010/SPR8007/SPR8010

	ZW-S8010	ZW-S8020	ZW-S8030	ZW-SP8007	ZW-SP8010	ZW-SPR8007	ZW-SPR8010
Sensor controller	ZW-8000□						
Sensor head type	Square-shaped straight type			Pen-shaped straight type		Pen-shaped right angle type	
Measurement center distance ^{*1}	10 mm	20 mm	30 mm	7 mm	10 mm	7 mm	10 mm
Measuring range ^{*2}	±0.5 mm	±1 mm	±2 mm	±0.3 mm	±0.7 mm	±0.3 mm	±0.7 mm
Static resolution ^{*3}	0.002 μm	0.004 μm	0.008 μm	0.002 μm	0.003 μm	0.003 μm	0.005 μm
Linearity ^{*4}	±0.3 μm	±0.6 μm	±1.3 μm	±0.3 μm	±0.45 μm	±0.45 μm	±0.7 μm
Spot diameter ^{*5}	4 μm dia.	7 μm dia.	10 μm dia.	7 μm dia.	10 μm dia.	8 μm dia.	11 μm dia.
Measuring cycle ^{*6}	60 μs to 7,500 μs						
Operating ambient illumination	Illumination on object surface max.30000 Lx: (incandescent light)						
Ambient temperature range	Operation: 0 to 50°C, Storage: -15 to +60°C (No freezing and condensation)						
Ambient humidity range	Operation/storage: 35 to 85% (No condensation)						
Degree of protection	IP40 (IEC60529)						
Vibration resistance (destructive)	10 to 150 Hz (half amplitude 0.35 mm), 80 mins in each of X/Y/Z directions						
Shock resistance (destructive)	150 m/s ² , 6 direction, 3 times each (up/down, left/right, forward/backward)						
Temperature characteristic ^{*7}	0.6 μm/°C (0.2 mm/°C)	1.1 μm/°C (0.5 mm/°C)	1.8 μm/°C (1.0 mm/°C)	0.8 μm/°C (0.4 mm/°C)	0.8 μm/°C (0.4 mm/°C)	0.8 μm/°C (0.4 mm/°C)	0.8 μm/°C (0.4 mm/°C)
LED safety	Risk Group 3 (IEC62471)						
Material	Chassis: aluminum die cast Fiber cable sheath: PVC Calibration ROM: PC			Chassis: SUS Fiber cable sheath: PVC Calibration ROM: PC Mounting Plate: Aluminum		Chassis: SUS, aluminum Fiber cable sheath: PVC Calibration ROM: PC Mounting Plate: Aluminum	
Fiber cable length	0.3 m, 2 m (flex-resistant cable)						
Fiber cable minimum bend radius	20 mm						
Insulation resistance (Calibration ROM)	Between case and all terminals: 20 MΩ (by 250 VDC)						
Dielectric strength (Calibration ROM)	Between case and all terminals: 1000 VAC, 50/60 Hz, 1 min						
Weight	Fiber cable length 0.3m Approx. 170g Fiber cable length 2m Approx. 180g			Fiber cable length 0.3m Approx. 27 g Fiber cable length 2m Approx. 37 g		Fiber cable length 0.3m Approx. 31 g Fiber cable length 2m Approx. 41 g	

	ZW-S8010	ZW-S8020	ZW-S8030	ZW-SP8007	ZW-SP8010	ZW-SPR8007	ZW-SPR8010
Accessories	1 Calibration ROM fixing screws (M2 × 5 mm), Fiber cable protective cap (1), Strap (1), Instruction Manual, Precautions			Installation plate (1), 4 unit fixing screws (M2 × 10 mm), 1 Calibration ROM fixing screw (M2 × 5 mm), Fiber cable protective cap (1), Strap (1), Instruction Manual, Precautions			

- *1: Indicates the distance from the front of the sensor head. The pen-shaped right angle type has a maximum individual difference of ±0.15 mm in the distance from the front of the sensor head.
- *2: The measurement range is higher 100 μs than measurement cycle.
- *3: Capacity value when OMRON standard mirror surface target is measured at the measurement center distance as the average of 16,384 times
When connected with the Sensor Controller for the Export Control Trade Ordinance (ZW-8000T), the minimum resolution is 0.25 μm, regardless of the Sensor head or setting condition.
- *4: Material setting for the OMRON standard mirror surface target: Error from an ideal straight line when measuring on mirror surface.
- *5: Capacity value defined by 1/e² (13.5%) of the peak optical intensity of the measurement wavelength.
- *6: When an extension fiber cable of 2 m or longer is connected, the setting range of the measurement cycle (exposure time) changes. For details, refer to "Setting the Measurement Cycle" p.122 in this manual.
- *7: Actual value of the change in measurement value at the measurement center distance when fastened with an aluminum jig between the Sensor Head and the target, and with the Sensor Head and the Sensor Controller set in the same temperature environment.
The value in parentheses is the actual value when using an SUS304 jig.
When measuring the thickness, the value is calculated from the difference between the heights of the surface and rear surface, so there is no effect on the temperature change.

● ZW-S7010/S7020/S7030/S7040/SP7007/SP7010/SPR7007/SPR7010

	ZW-S7010	ZW-S7020	ZW-S7030	ZW-S7040	ZW-SP7007	ZW-SP7010	ZW-SPR7007	ZW-SPR7010
Sensor controller	ZW-7000□							
Sensor head type	Square-shaped straight type				Pen-shaped straight type		Pen-shaped right angle type	
Measurement center distance *1	10 mm	20 mm	30 mm	40 mm	7 mm	10 mm	7 mm	10 mm
Measuring range *2	±0.5 mm	±1 mm	±2 mm	±3 mm	±0.3 mm	±0.7 mm	±0.3 mm	±0.7 mm
Static resolution *3	0.004 μm	0.008 μm	0.016 μm	0.024 μm	0.004 μm	0.006 μm	0.006 μm	0.009 μm
Linearity *4	±0.45 μm	±0.9 μm	±2.0 μm	±3.0 μm	±0.45 μm	±0.7 μm	±0.7 μm	±1.1 μm
Spot diameter *5	50 μm dia.	70 μm dia.	100 μm dia.	120 μm dia.	130 μm dia.	170 μm dia.	150 μm dia.	190 μm dia.
Measuring cycle *6	20 μs to 400 μs							
Operating ambient illumination	Illumination on object surface max.30000 Lx: (incandescent light)							
Ambient temperature range	Operation: 0 to 50°C, Storage: -15 to +60°C (No freezing and condensation)							
Ambient humidity range	Operation/storage: 35 to 85% (No condensation)							
Degree of protection	IP40 (IEC60529)							
Vibration resistance (destructive)	10 to 150 Hz (half amplitude 0.35 mm), 80 mins in each of X/Y/Z directions							
Shock resistance (destructive)	150 m/s ² , 6 direction, 3 times each (up/down, left/right, forward/backward)							
Temperature characteristic *7	0.6 μm/°C (0.2 μm/°C)	1.1 μm/°C (0.5 μm/°C)	1.8 μm/°C (1.0 μm/°C)	2.1 μm/°C (1.2 μm/°C)	0.8 μm/°C (0.4 μm/°C)	0.8 μm/°C (0.4 μm/°C)	0.8 μm/°C (0.4 μm/°C)	0.8 μm/°C (0.4 μm/°C)
LED safety	Risk Group 3 (IEC62471)							
Material	Chassis: aluminum die cast Fiber cable sheath: PVC Calibration ROM: PC				Chassis: SUS Fiber cable sheath: PVC Calibration ROM: PC Mounting Plate: Aluminum		Chassis: SUS, aluminum Fiber cable sheath: PVC Calibration ROM: PC Mounting Plate: Aluminum	
Fiber cable length	0.3 m, 2 m (flex-resistant cable)							
Fiber cable minimum bend radius	20 mm							
Insulation resistance (Calibration ROM)	Between case and all terminals: 20 MΩ (by 250 VDC)							

	ZW-S7010	ZW-S7020	ZW-S7030	ZW-S7040	ZW-SP7007	ZW-SP7010	ZW-SPR7007	ZW-SPR7010
Dielectric strength (Calibration ROM)	Between case and all terminals: 1000 VAC, 50/60 Hz, 1 min							
Weight	Fiber cable length 0.3m Approx. 170g Fiber cable length 2m Approx. 180g				Fiber cable length 0.3m Approx. 27 g Fiber cable length 2m Approx. 37 g		Fiber cable length 0.3m Approx. 31 g Fiber cable length 2m Approx. 41 g	
Accessories	1 Calibration ROM fixing screws (M2 × 5 mm), Fiber cable protective cap (1), Strap (2), Instruction Manual, Precautions				Installation plate (1), 4 unit fixing screws (M2 × 10 mm), 1 Calibration ROM fixing screw (M2 × 5 mm), Fiber cable protective cap (1), Strap (2), Instruction Manual, Precautions			

- *1: Indicates the distance from the front of the sensor head. The pen-shaped right angle type has a maximum individual difference of ±0.15 mm in the distance from the front of the sensor head.
- *2: The measurement range is higher 28 μs than measurement cycle.
- *3: Capacity value when OMRON standard mirror surface target is measured at the measurement center distance as the average of 16,384 times
When connected with the Sensor Controller for the Export Control Trade Ordinance (ZW-7000T), the minimum resolution is 0.25 μm, regardless of the Sensor head or setting condition.
- *4: Material setting for the OMRON standard mirror surface target: Error from an ideal straight line when measuring on mirror surface.
- *5: Capacity value defined by $1/e^2$ (13.5%) of the peak optical intensity of the measurement wavelength.
- *6: When an extension fiber cable of 10 m or longer is connected, the setting range of the measurement cycle (exposure time) changes. For details, refer to "Setting the Measurement Cycle" p.122 in this manual.
- *7: Actual value of the change in measurement value at the measurement center distance when fastened with an aluminum jig between the Sensor Head and the target, and with the Sensor Head and the Sensor Controller set in the same temperature environment.
The value in parentheses is the actual value when using an SUS304 jig.
When measuring the thickness, the value is calculated from the difference between the heights of the surface and rear surface, so there is no effect on the temperature change.

● ZW-S5010/S5020/S5030/SP5007/SP5010/SPR5007/SPR5010

	ZW-S5010	ZW-S5020	ZW-S5030	ZW-SP5007	ZW-SP5010	ZW-SPR5007	ZW-SPR5010
Sensor controller	ZW-5000□						
Sensor head type	Square-shaped straight type			Pen-shaped straight type		Pen-shaped right angle type	
Measurement center distance *1	10 mm	20 mm	30 mm	7 mm	10 mm	7 mm	10 mm
Measuring range	±0.5 mm	±1 mm	±2 mm	±0.3 mm	±0.7 mm	±0.3 mm	±0.7 mm
Static resolution *2	0.004 μm	0.008 μm	0.016 μm	0.004 μm	0.006 μm	0.006 μm	0.009 μm
Linearity *3	±0.45 μm	±0.9 μm	±2.0 μm	±0.45 μm	±0.7 μm	±0.7 μm	±1.1 μm
Spot diameter *4	9 μm dia.	13 μm dia.	18 μm dia.	13 μm dia.	18 μm dia.	15 μm dia.	20 μm dia.
Measuring cycle *5	80 μs to 1,600 μs						
Operating ambient illumination	Illumination on object surface max.30000 Lx: (incandescent light)						
Ambient temperature range	Operation: 0 to 50°C, Storage: -15 to +60°C (No freezing and condensation)						
Ambient humidity range	Operation/storage: 35 to 85% (No condensation)						
Degree of protection	IP40 (IEC60529)						
Vibration resistance (destructive)	10 to 150 Hz (half amplitude 0.35 mm), 80 mins in each of X/Y/Z directions						
Shock resistance (destructive)	150 m/s ² , 6 direction, 3 times each (up/down, left/right, forward/backward)						
Temperature characteristic *6	0.6 μm/°C (0.2 μm/°C)	1.1 μm/°C (0.5 μm/°C)	1.8 μm/°C (1.0 μm/°C)	0.8 μm/°C (0.4 μm/°C)	0.8 μm/°C (0.4 μm/°C)	0.8 μm/°C (0.4 μm/°C)	0.8 μm/°C (0.4 μm/°C)
LED safety	Risk Group 3 (IEC62471)						
Material	Chassis: aluminum die cast Fiber cable sheath: PVC Calibration ROM: PC			Chassis: SUS Fiber cable sheath: PVC Calibration ROM: PC Mounting Plate: Aluminum		Chassis: SUS, aluminum Fiber cable sheath: PVC Calibration ROM: PC Mounting Plate: Aluminum	
Fiber cable length	0.3 m, 2 m (flex-resistant cable)						

	ZW-S5010	ZW-S5020	ZW-S5030	ZW-SP5007	ZW-SP5010	ZW-SPR5007	ZW-SPR5010
Fiber cable minimum bend radius	20 mm						
Insulation resistance (Calibration ROM)	Between case and all terminals: 20 MΩ (by 250 VDC)						
Dielectric strength (Calibration ROM)	Between case and all terminals: 1000 VAC, 50/60 Hz, 1 min						
Weight	Fiber cable length 0.3m Approx. 170g Fiber cable length 2m Approx. 180g			Fiber cable length 0.3m Approx. 29 g Fiber cable length 2m Approx. 39 g		Fiber cable length 0.3m Approx. 33g Fiber cable length 2m Approx. 43g	
Accessories	1 Calibration ROM fixing screws (M2 × 5 mm), Fiber cable protective cap (1), Strap (1), Instruction Manual, Precautions			Installation plate (1), 4 unit fixing screws (M2 × 10 mm), 1 Calibration ROM fixing screw (M2 × 5 mm), Fiber cable protective cap (1), Strap (1), Instruction Manual, Precautions			

- *1: Indicates the distance from the front of the sensor head. The pen-shaped right angle type has a maximum individual difference of ±0.15 mm in the distance from the front of the sensor head.
- *2: Capacity value when OMRON standard mirror surface target is measured at the measurement center distance as the average of 16,384 times
When connected with the Sensor Controller for the Export Control Trade Ordinance (ZW-5000T), the minimum resolution is 0.25 μm, regardless of the Sensor head or setting condition.
- *3: Material setting for the OMRON standard mirror surface target: Error from an ideal straight line when measuring on mirror surface.
- *4: Capacity value defined by $1/e^2$ (13.5%) of the peak optical intensity of the measurement wavelength.
- *5: When an extension fiber cable of 5 m or longer is connected, the setting range of the measurement cycle (exposure time) changes. For details, refer to "Setting the Measurement Cycle" p.122 in this manual.
- *6: Actual value of the change in measurement value at the measurement center distance when fastened with an aluminum jig between the Sensor Head and the target, and with the Sensor Head and the Sensor Controller set in the same temperature environment.
The value in parentheses is the actual value when using an SUS304 jig.
When measuring the thickness, the value is calculated from the difference between the heights of the surface and rear surface, so there is no effect on the temperature change.

External Dimensions

● ZW-S8010/S8020/S8030

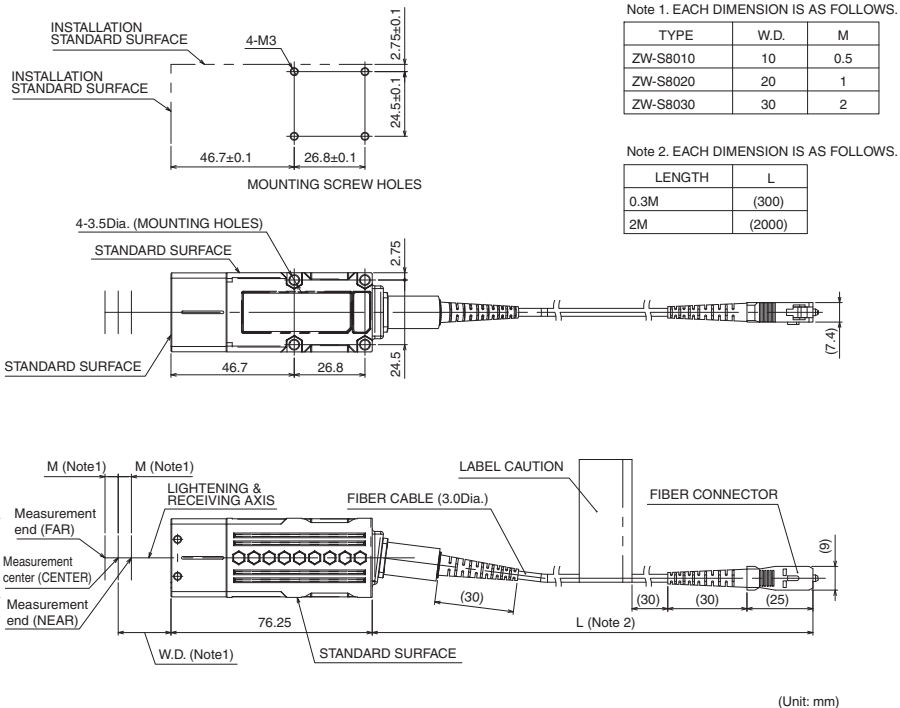

● ZW-SP8007

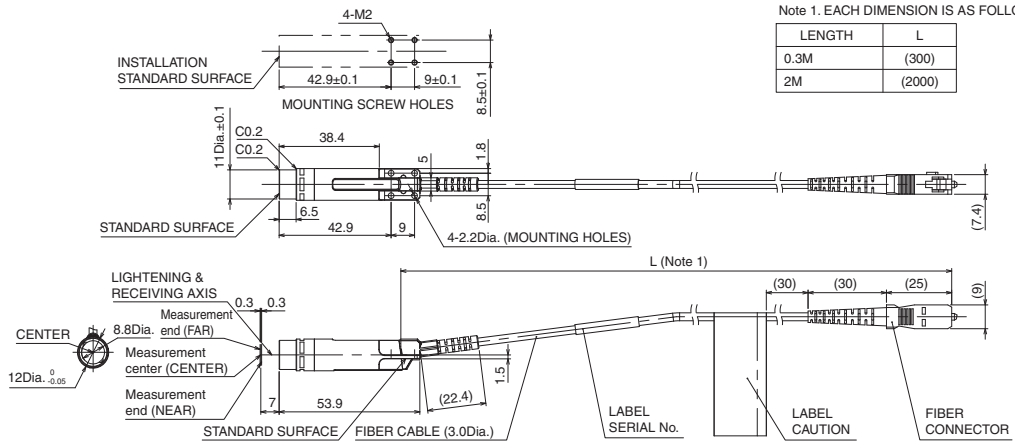

Note 1: EACH DIMENSION IS AS FOLLOWS.

LENGTH	L
0.3M	(300)
2M	(2000)

<MOUNTING PLATE>
MATERIAL: ALUMINUM

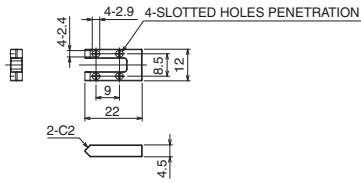

(Unit: mm)

<USE SITUATION OF MOUNTING PLATE>
SENSOR HEAD IS FASTENED WITH MOUNTING PLATE BY USING THE ACCESSORY SCREWS

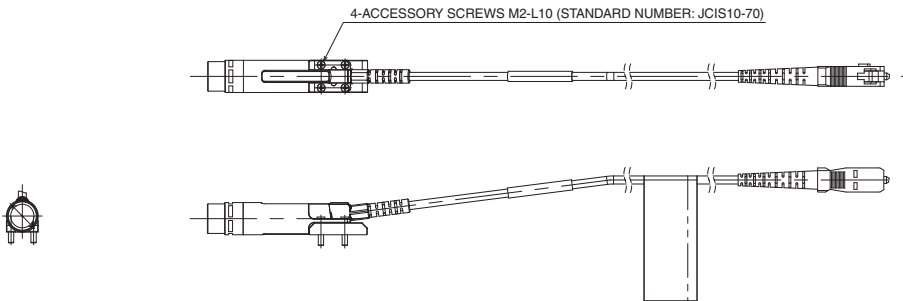

● ZW-SP8010

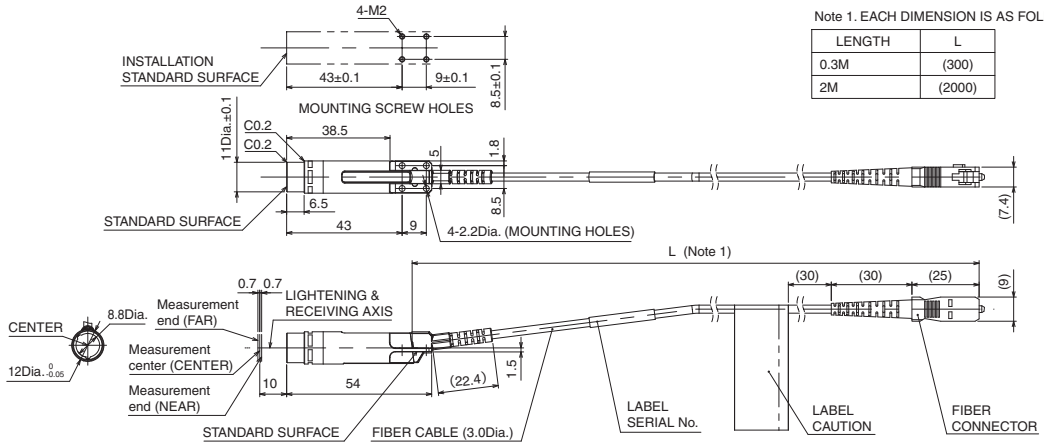

<MOUNTING PLATE>
MATERIAL: ALUMINUM

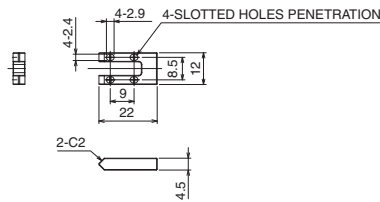

(Unit: mm)

<USE SITUATION OF MOUNTING PLATE>
SENSOR HEAD IS FASTENED WITH MOUNTING PLATE BY USING THE ACCESSORY SCREWS

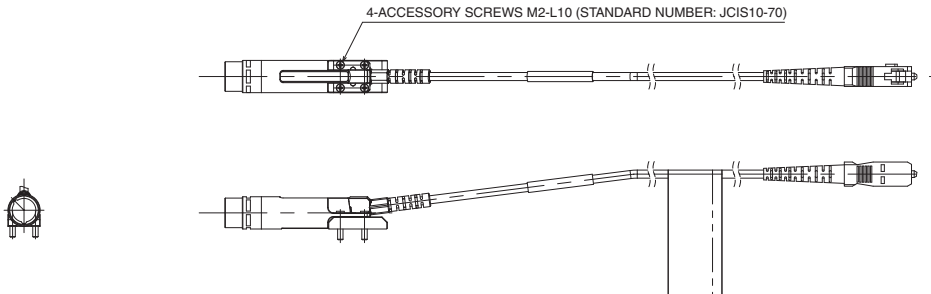

● ZW-SPR8007

Note 1. EACH DIMENSION IS AS FOLLOWS.

LENGTH	L
0.3M	(300)
2M	(2000)

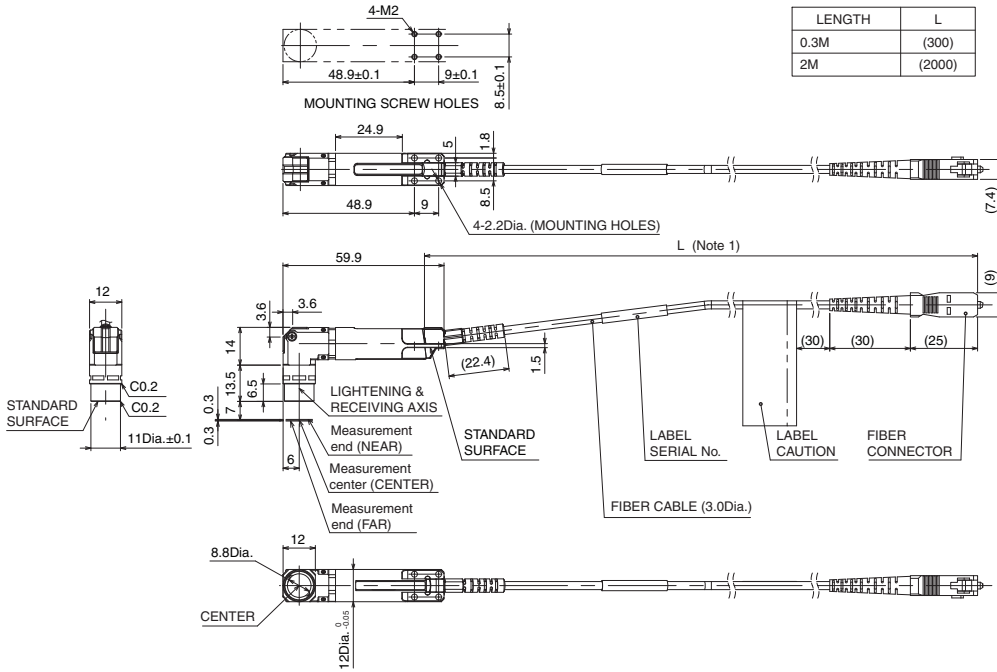

<MOUNTING PLATE>
MATERIAL: ALUMINUM

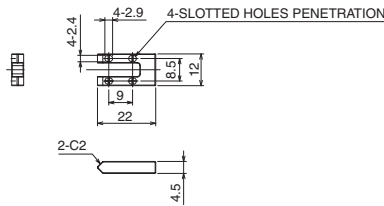

(Unit: mm)

<USE SITUATION OF MOUNTING PLATE>
SENSOR HEAD IS FASTENED WITH MOUNTING PLATE BY USING THE ACCESSORY SCREWS

4-ACCESSORY SCREWS M2-L10 (STANDARD NUMBER: JCIS10-70)

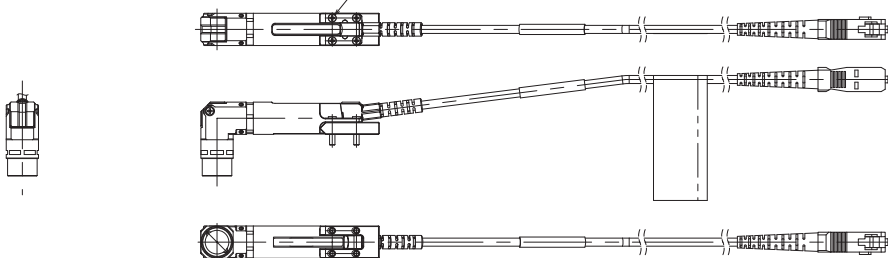

● ZW-SPR8010

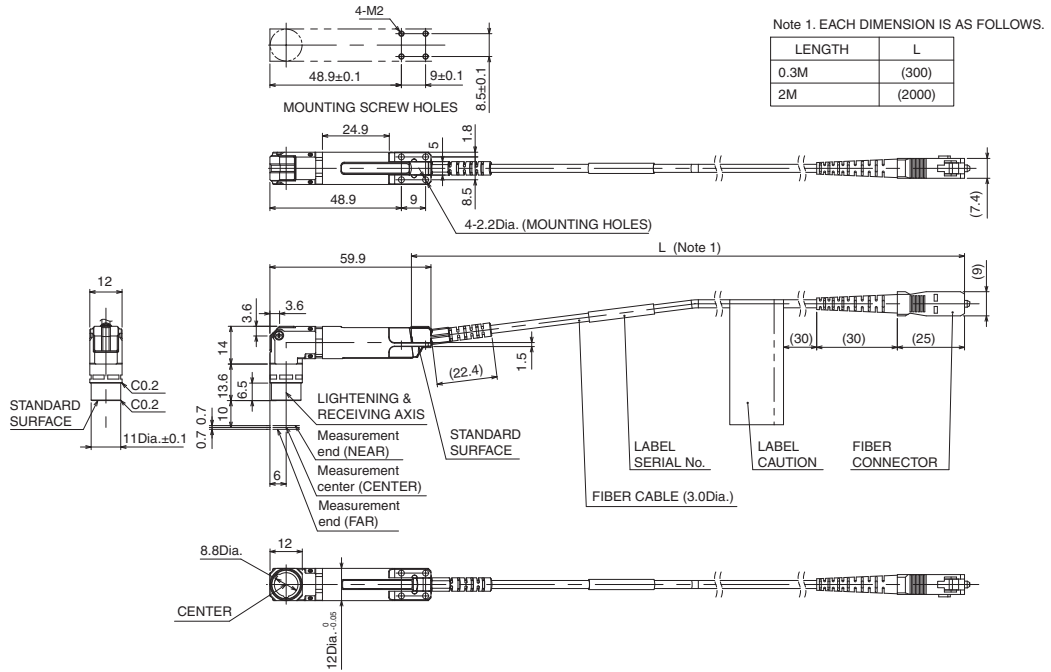

<MOUNTING PLATE>
MATERIAL: ALUMINUM

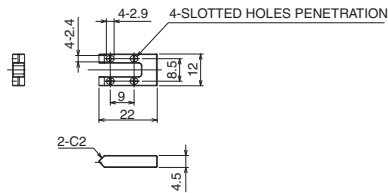

<USE SITUATION OF MOUNTING PLATE>
SENSOR HEAD IS FASTENED WITH MOUNTING PLATE BY USING THE ACCESSORY SCREWS

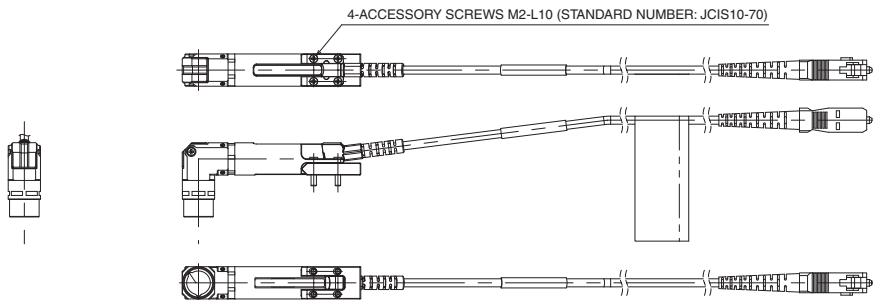

● ZW-S7010/S7020/S7030/S7040

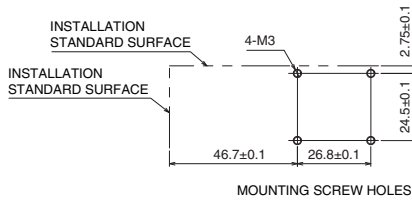

Note 1. EACH DIMENSION IS AS FOLLOWS.

TYPE	W.D.	M
ZW-S7010	10	0.5
ZW-S7020	20	1
ZW-S7030	30	2
ZW-S7040	40	3

Note 2. EACH DIMENSION IS AS FOLLOWS.

LENGTH	L
0.3M	(300)
2M	(2000)

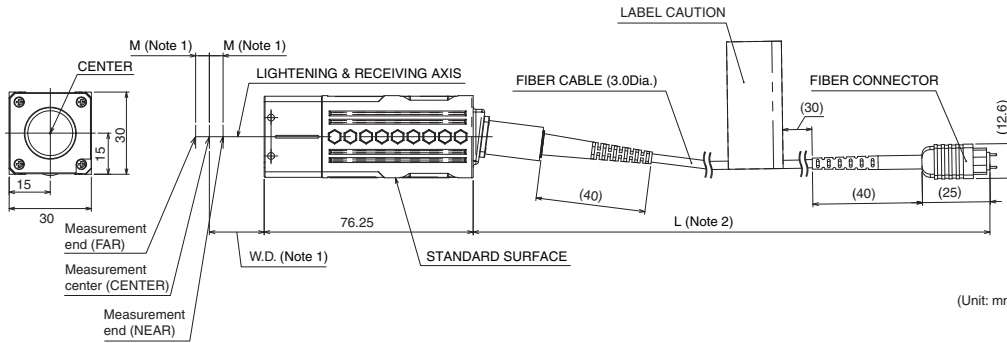
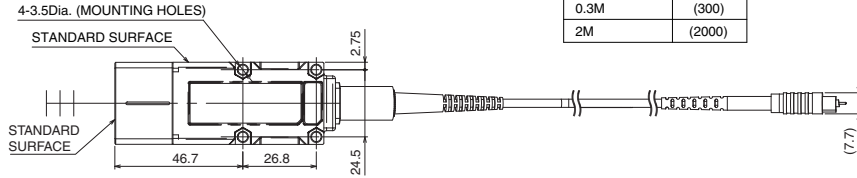

(Unit: mm)

● ZW-SP7007

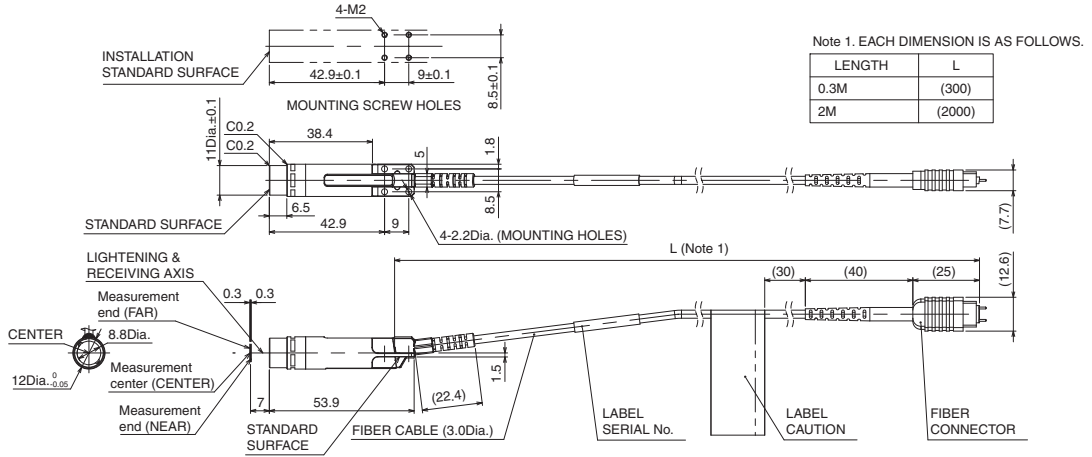

<MOUNTING PLATE>
MATERIAL: ALUMINUM

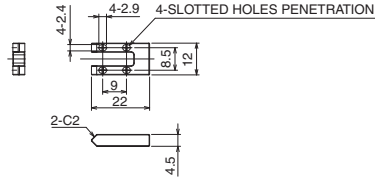

(Unit: mm)

<USE SITUATION OF MOUNTING PLATE>
SENSOR HEAD IS FASTENED WITH MOUNTING PLATE BY USING THE ACCESSORY SCREWS

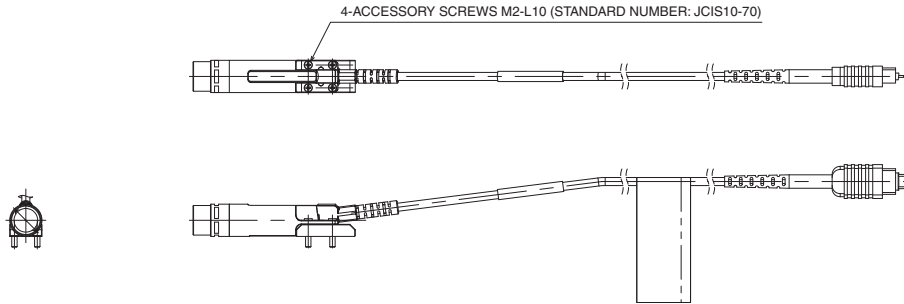

● ZW-SP7010

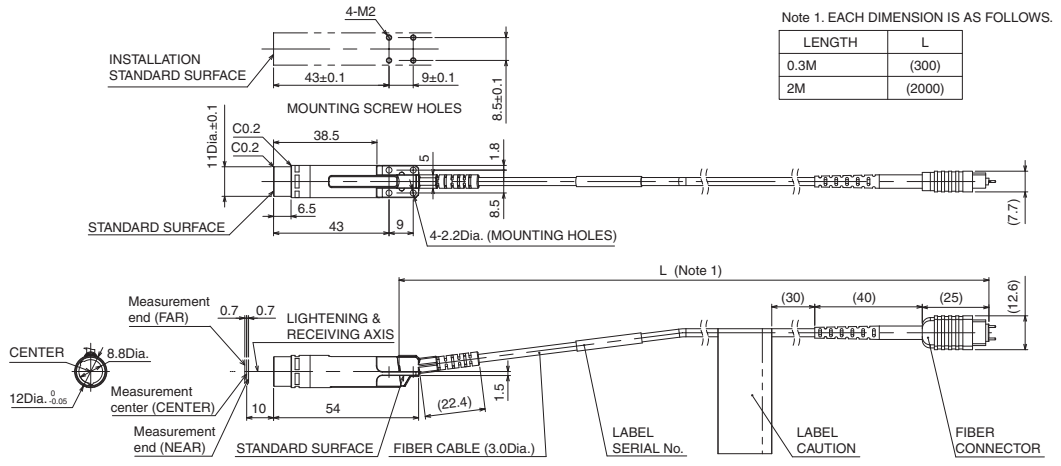

<MOUNTING PLATE>
MATERIAL: ALUMINUM

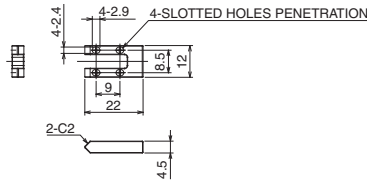

(Unit: mm)

<USE SITUATION OF MOUNTING PLATE>
SENSOR HEAD IS FASTENED WITH MOUNTING PLATE BY USING THE ACCESSORY SCREWS

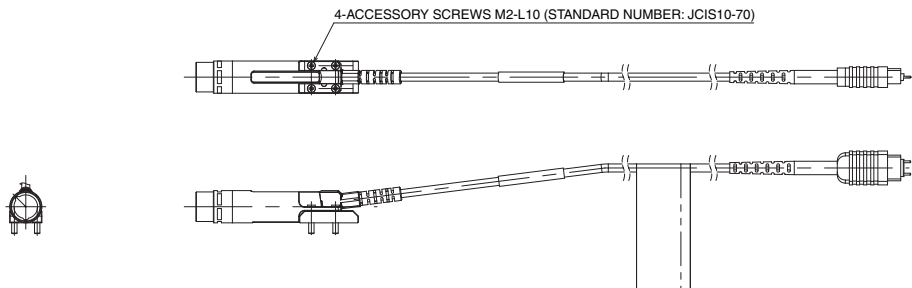

● ZW-SPR7007

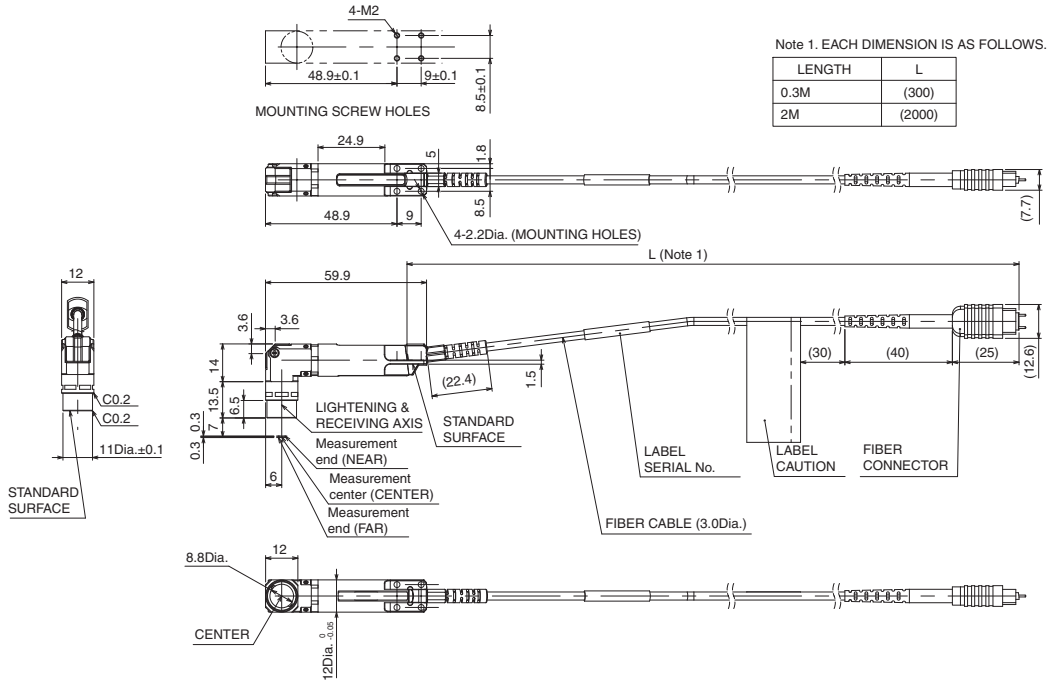

Note 1. EACH DIMENSION IS AS FOLLOWS.

LENGTH	L
0.3M	(300)
2M	(2000)

<MOUNTING PLATE>
MATERIAL: ALUMINUM

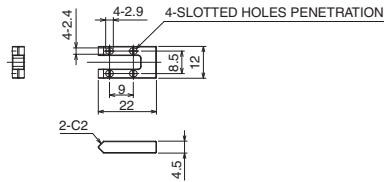

(Unit: mm)

<USE SITUATION OF MOUNTING PLATE>
SENSOR HEAD IS FASTENED WITH MOUNTING PLATE BY USING THE ACCESSORY SCREWS

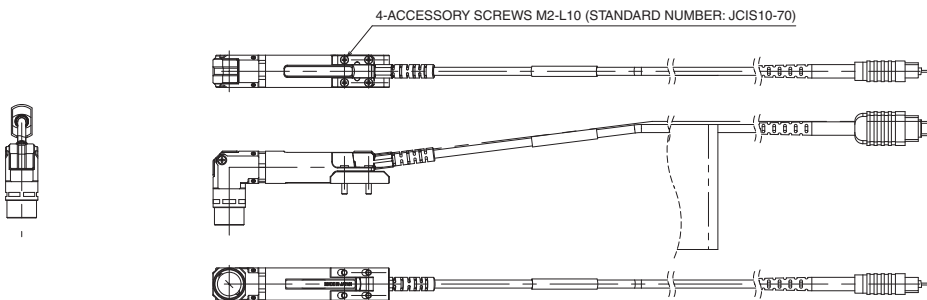

● ZW-SPR7010

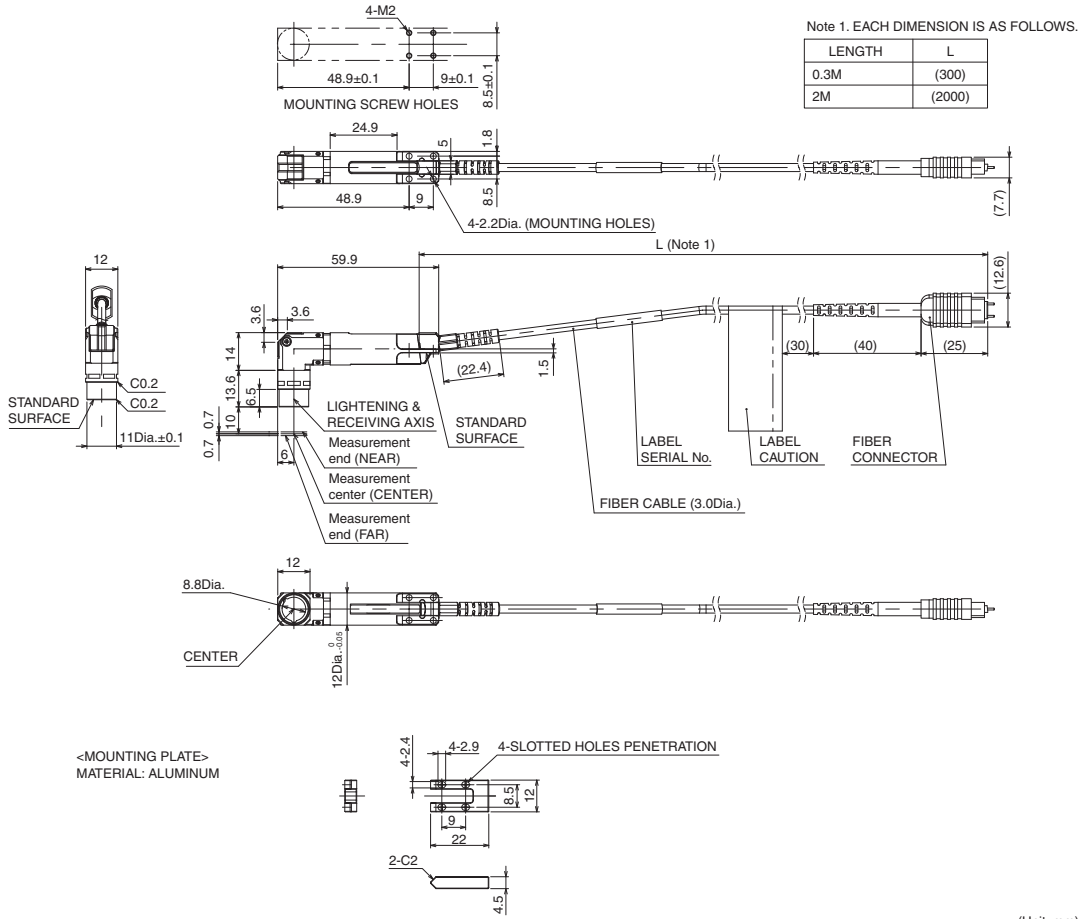

● ZW-S5010/S5020/S5030

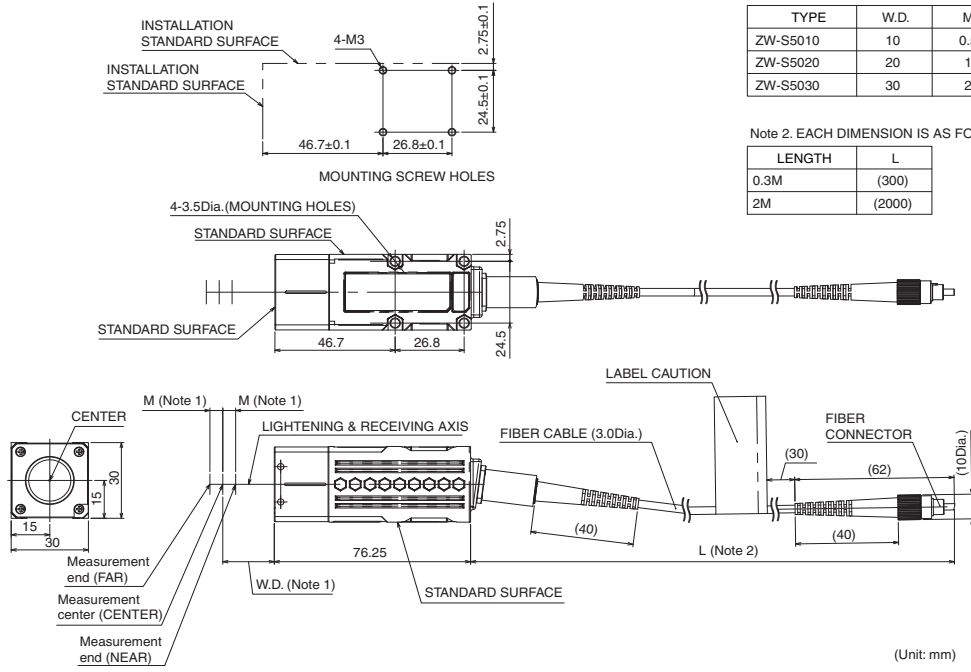

Note 1. EACH DIMENSION IS AS FOLLOWS.

TYPE	W.D.	M
ZW-S5010	10	0.5
ZW-S5020	20	1
ZW-S5030	30	2

Note 2. EACH DIMENSION IS AS FOLLOWS.

LENGTH	L
0.3M	(300)
2M	(2000)

(Unit: mm)

● ZW-SP5007

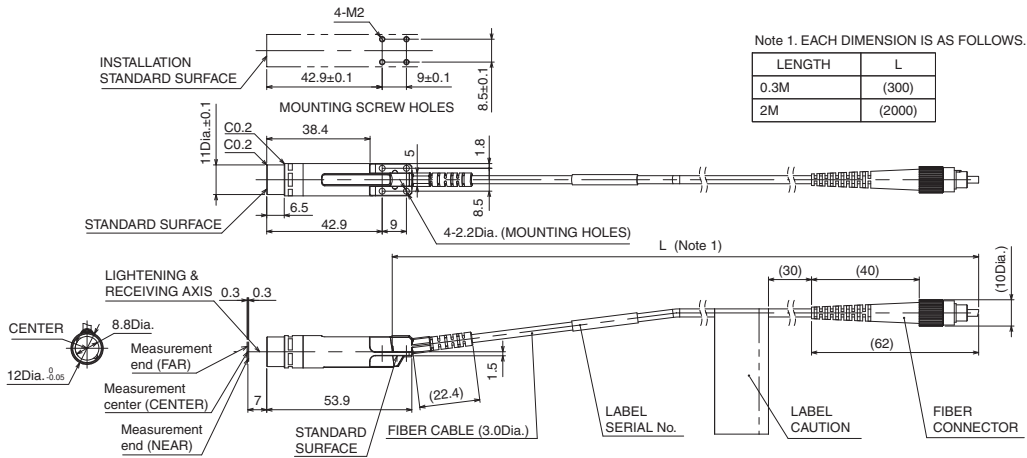

<MOUNTING PLATE>
MATERIAL: ALUMINUM

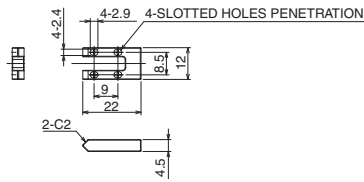

(Unit: mm)

<USE SITUATION OF MOUNTING PLATE>
SENSOR HEAD IS FASTENED WITH MOUNTING PLATE BY USING THE ACCESSORY SCREWS

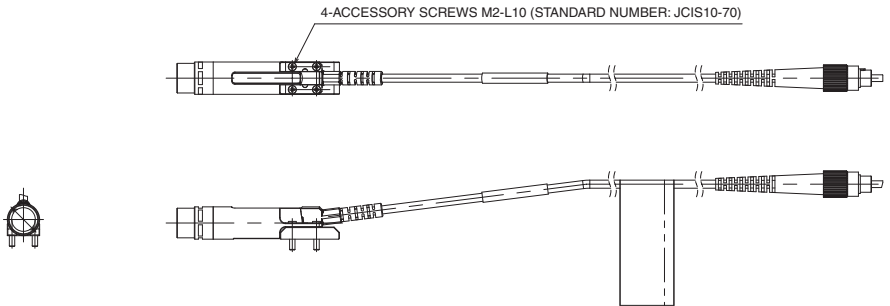

● ZW-SP5010

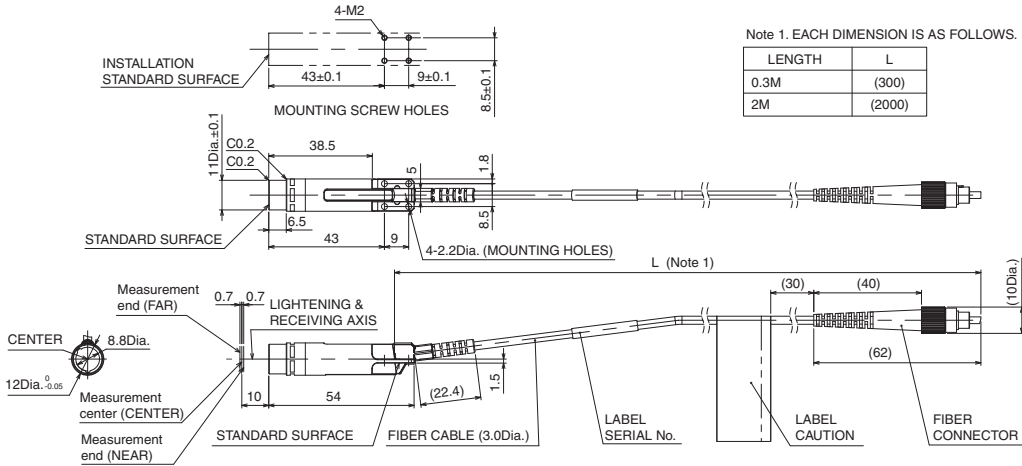

<MOUNTING PLATE>
MATERIAL: ALUMINUM

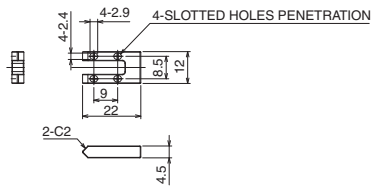

(Unit: mm)

<USE SITUATION OF MOUNTING PLATE>
SENSOR HEAD IS FASTENED WITH MOUNTING PLATE BY USING THE ACCESSORY SCREWS

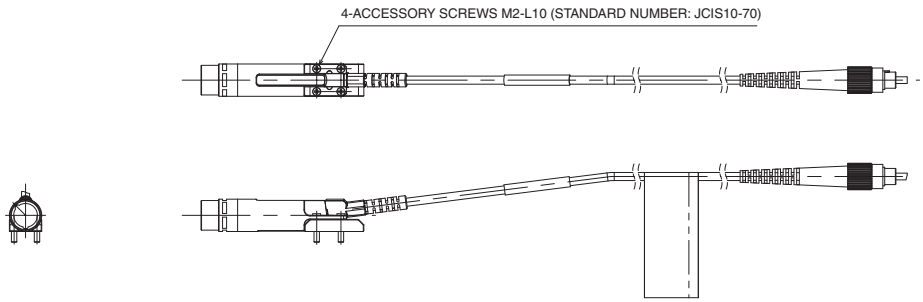

● ZW-SPR5007

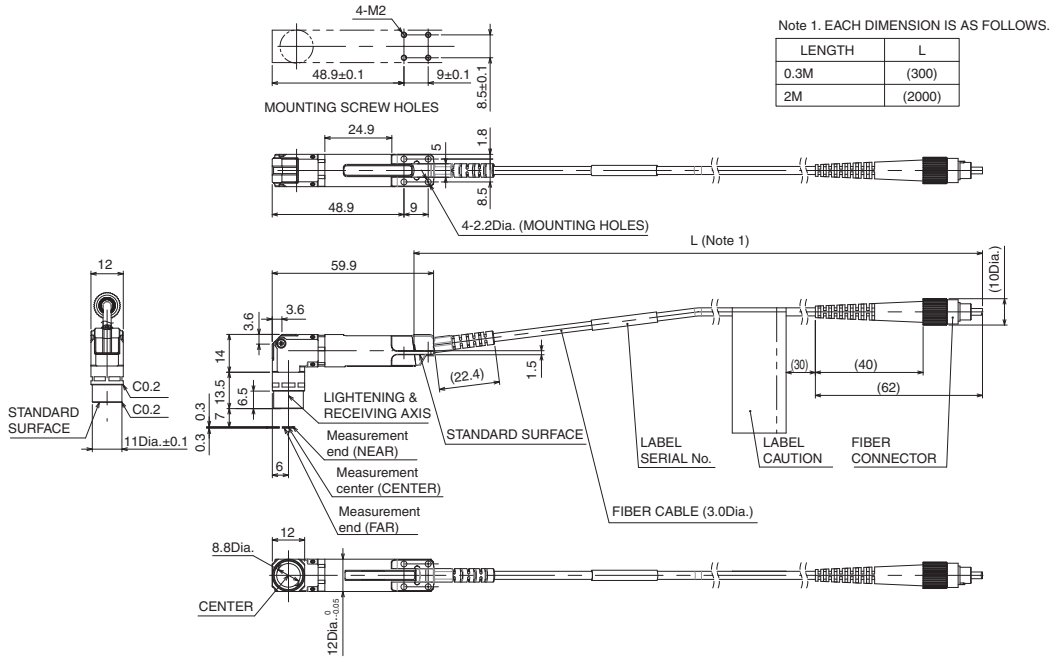

Note 1. EACH DIMENSION IS AS FOLLOWS.

LENGTH	L
0.3M	(300)
2M	(2000)

<MOUNTING PLATE>
MATERIAL: ALUMINUM

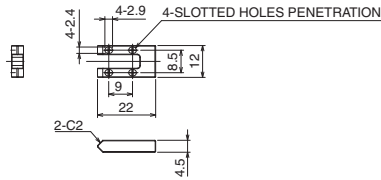

(Unit: mm)

<USE SITUATION OF MOUNTING PLATE>
SENSOR HEAD IS FASTENED WITH MOUNTING PLATE BY USING THE ACCESSORY SCREWS

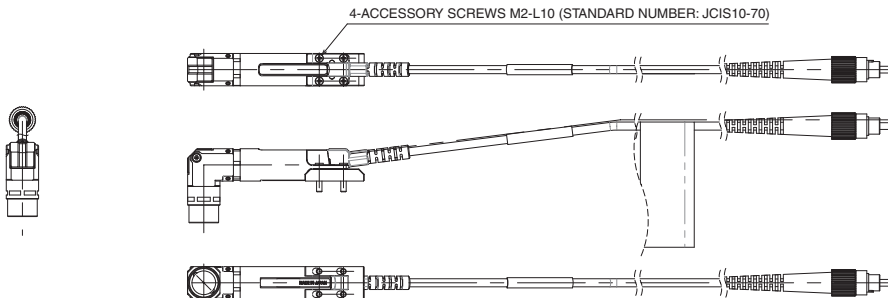

● ZW-SPR5010

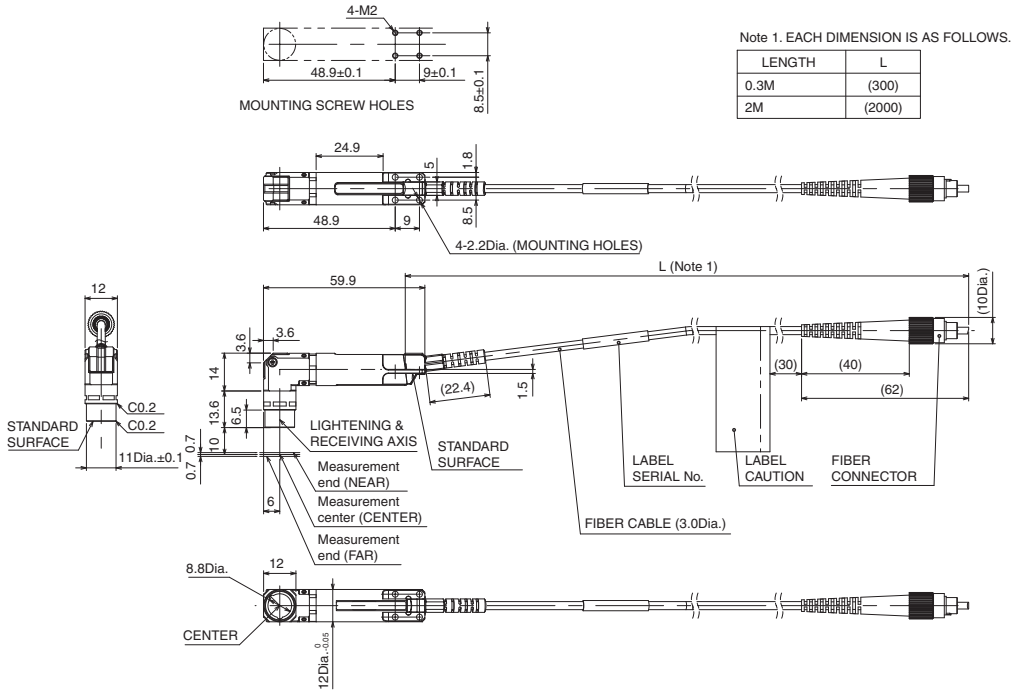

<MOUNTING PLATE>
MATERIAL: ALUMINUM

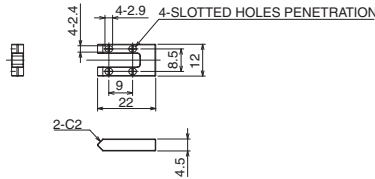

(Unit: mm)

<USE SITUATION OF MOUNTING PLATE>
SENSOR HEAD IS FASTENED WITH MOUNTING PLATE BY USING THE ACCESSORY SCREWS

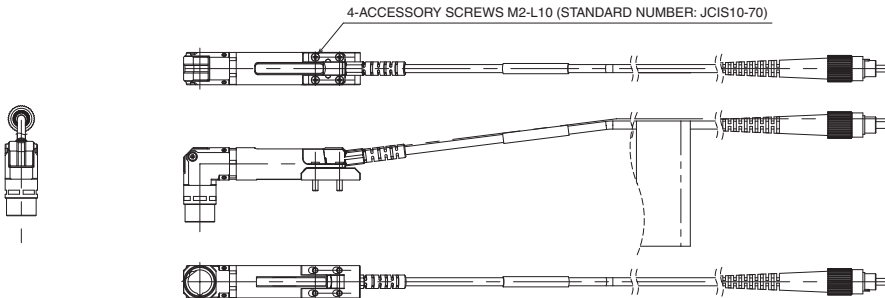

● Calibration ROM *

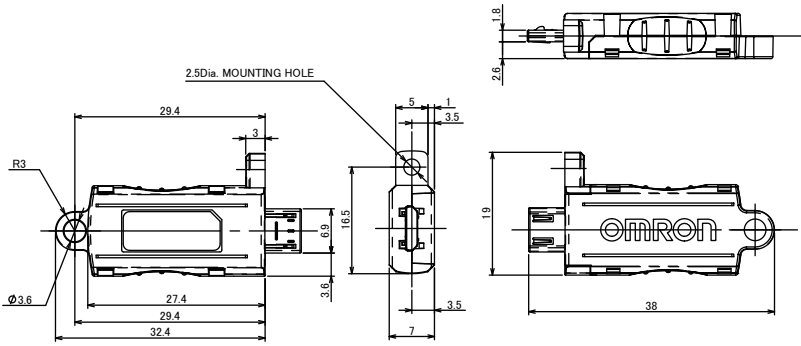

(Unit: mm)

* This comes with the Sensor Head. Be sure to use a Calibration ROM together with the Sensor Head with the same serial number.

Sensor controller

Specifications

Item	Specifications		
	ZW-8000□	ZW-7000□	ZW-5000□
Input/output type	NPN/PNP dual type		
Number of connected sensor heads	1		
Sensor head compatibility	ZW-S80□□/ ZW-SP80□□/ ZW-SPR80□□	ZW-S70□□/ ZWSP-70□□/ ZW-SPR70□□	ZW-S50□□/ ZW-SP50□□/ ZW-SPR50□□
LED safety	Risk Group 3 (IEC62471)		
Segment Display	Main display	11-segment white display, 6 digits	
	Sub-display	11-segment green display, 6 digits	
Indicator	Status indicators	HIGH (orange), PASS (green), LOW (orange), STABILITY (green), ZERO (green), ENABLE (green), THRESHOLD-H (orange), THRESHOLD-L (orange), RUN (green)	
	EtherCAT indicator	ECAT RUN (green), L/A IN (Link/Activity IN) (green), L/A OUT (Link/Activity OUT) (green), ECAT ERR (red)	

Item		Specifications						
		ZW-8000□	ZW-7000□	ZW-5000□				
External I/F	Ethernet	100BASE-TX/10BASE-T, Non-procedure (TCP/UDP), EtherNet/IP						
	EtherCAT	EtherCAT exclusive protocol 100BASE-TX						
	RS-232C	Max. 115,200 bps						
	Analog output terminal block	Analog voltage output (OUT V)	-10 V to +10 V, output impedance: 100 Ω					
		Analog current output (OUT A)	4 mA to 20 mA, max. load resistance: 300 Ω					
	32-pole expansion connector	Judgment output (HIGH/PASS/LOW)	Transistor output system Output voltage: 21.6 to 30 VDC Load current: 50 mA or less Residual voltage when turning ON: 2 V or less Leakage voltage when turning OFF: 0.1 mA or less					
		Busy output (BUSY)						
		Alarm output (ALARM)						
		Enable output (ENABLE)						
		Sync flag output (SYNFLG)						
		Trigger busy output (TRIGBUSY)						
		Logging state output (LOGSTAT)						
		Logging error output (LOGERR)						
		Stability output (STABILITY)						
		Task state output (TASKSTAT)						
		LIGHT OFF input (LIGHT OFF)				DC input system Input voltage: 24 VDC ± 10% (21.6 to 26.4 VDC) Input current: 7 mA Type. (24 VDC) ON voltage/ON current: 19 V/3 mA or more OFF voltage/OFF current: 5 V/1 mA or less		
		Zero reset input (ZERO)						
		Timing input (TIMING)						
	Reset input (RESET)							
	Sync input (SYNC)							
	Trigger input (TRIG)							
	Logging input (LOGGING)							
	Bank	Currently selected bank output (BANK_OUT 1 to 3)	Transistor output system Output voltage: 21.6 to 30 VDC Load current: 50 mA or less Residual voltage when turning ON: 2 V or less Leakage voltage when turning OFF: 0.1 mA or less					
	Bank Selection input (BANK_SEL 1 to 3)	DC input system Input voltage: 24 VDC ± 10% (21.6 to 26.4 VDC) Input current: 7 mA Type. (24 VDC) ON voltage/ON current: 19 V/3 mA or more OFF voltage/OFF current: 5 V/1 mA or less						

Item		Specifications		
		ZW-8000□	ZW-7000□	ZW-5000□
Main functions	Exposure time	Automatic/Fixed		
	Measuring cycle *1	60 μs to 7,500 μs	20 μs to 400 μs	80 μs to 1,600 μs
	Material setting	Standard/Mirror/Rough surfaces		
	Measurement item	Height/Thickness of transparent object/Calculation		
	Filtering	Median/Average/Differentiation/High pass/Low pass/Band pass		
	Output	Scaling/Different holds/Zero reset/Logging for a measured value/Keep, Clamp		
	Display	Measured value/Threshold value/Analog output voltage or current value/ Judgment result/Resolution/Light power/Internal logging condition /Peak amount of received light		
	Number of configurable banks	NORMAL mode: Max. 8 banks JUDGMENT mode: Max. 32 banks		
	Task process	Multi-task (up to 4 tasks per bank)		
	System	Save/Initialization/Display measured information/Communication settings/Sensor head calibration/Key-lock/Zero reset memory/Timing input		
Rating	Power supply voltage	21.6 to 26.4 VDC (including ripple)		
	Current consumption	700 mA or less	800 mA or less	
	Insulation resistance	Across all lead wires and FG terminal: 20 MΩ (by 250 VDC)		
	Dielectric strength	Between all lead wires and FG terminal: 500 VAC, 50/60 Hz, 1 minute		
Environmental resistance	Degree of protection	IP20 (IEC60529)		
	Vibration resistance (destructive)	10 to 55 Hz (half amplitude 0.35 mm), 50 mins in each of X/Y/Z directions		
	Shock resistance (destructive)	150 m/s ² , 6 direction, 3 times each (up/down, left/right, forward/backward)		
	Ambient temperature range	Operation: 0 to 40°C, Storage: -15 to +60°C (No freezing and condensation)		
	Ambient humidity range	Operation/storage: 35 to 85% (No condensation)		
Grounding		D-type grounding (grounding resistance of 100 Ω or less) Note: For conventional Class D grounding		
Material		Chassis: PC		
Weight		Approx. 950g (main unit only), Approx. 150 g (Parallel cable)	Approx. 900g (main unit only), Approx. 150 g (Parallel cable)	
Accessories		Parallel cable (ZW-XCP2E) 10 Fiber cleaners (ZW-XCL) Instruction Manual Member registration sheet Precautions		Parallel cable (ZW-XCP2E) 10 Fiber cleaners (ZW-XCL) Fiber adapter cap Strap Instruction Manual Member registration sheet Precautions

The Export Trade Control Order compatible Sensor controller (ZW-8000T/7000T/5000T) is available.

When using this Sensor Controller, the minimum resolution is 0.25 μm regardless of the connected Sensor Head and setting conditions.

*1: When an extension fiber cable of 2 m or longer (on the ZW-8000 series), 10 m or longer (on the ZW-7000 series) or 5 m or longer (on the ZW-5000 series) is connected, the setting range of the measurement cycle (exposure time) changes. For details, refer to "Setting the Measurement Cycle" p.122 of this manual.

Status indicators

Mode	Status		Display	Output		Input		RS-232C/ Ethernet
			11-segment display	ANALOG Output	Judgment output (HIGH/PASS/LOW)	LIGHT OFF	Zero reset	
RUN (operation)	Normal measurement		Measurement result	Output according to measurement result	Judgment result	Enabled	Enabled	Enabled
	Non-measurement	KEEP	Previous value					
FUNC (adjustment)		CLAMP	–	Output at clamp level (approx. -10.8 V)	Output OFF	Disabled	Disabled	Disabled
			Display according to menu					
System error			“SYS.ERR” blinks	Voltage: 0 V output Current: 12 mA output		Disabled		Enabled Commands are accepted but not executed.
When starting			“START”	Output at clamp level (approx. -10.8 V)				Invalid

External Dimensions

● ZW-8000 □

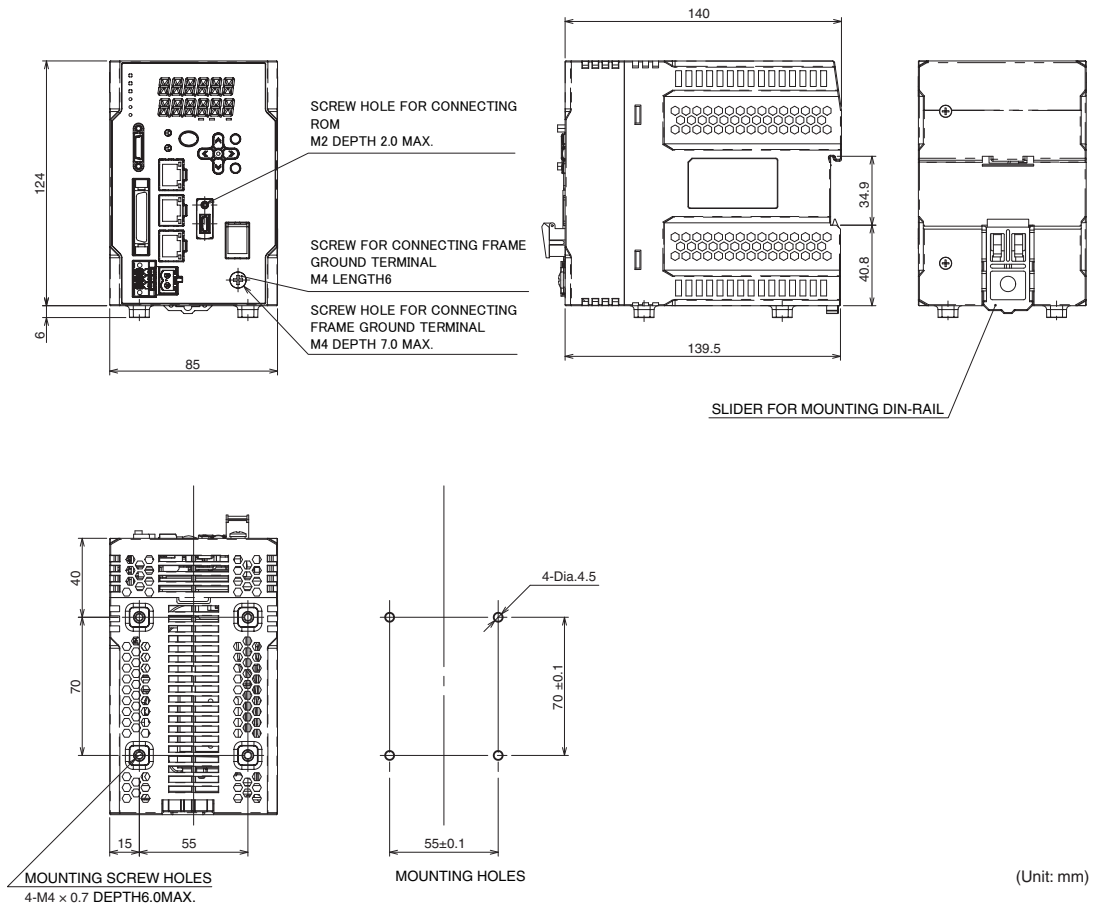

● ZW-7000 □

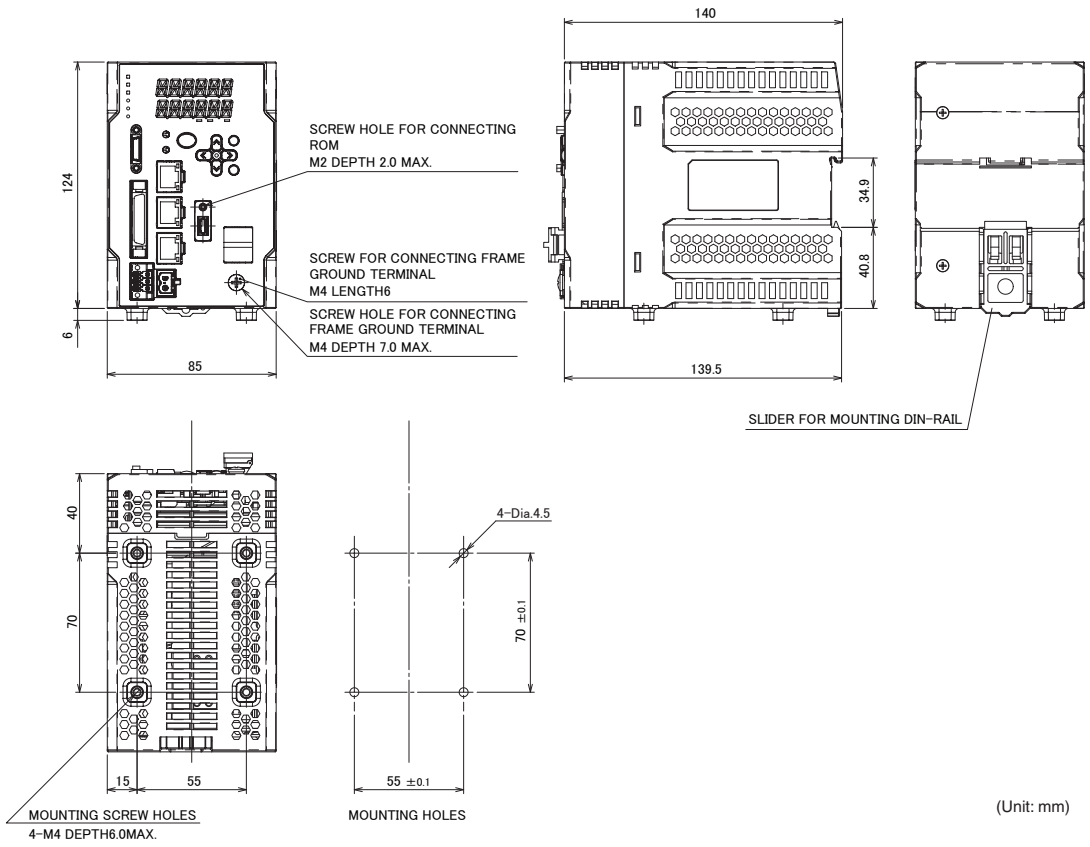

● ZW-5000 □

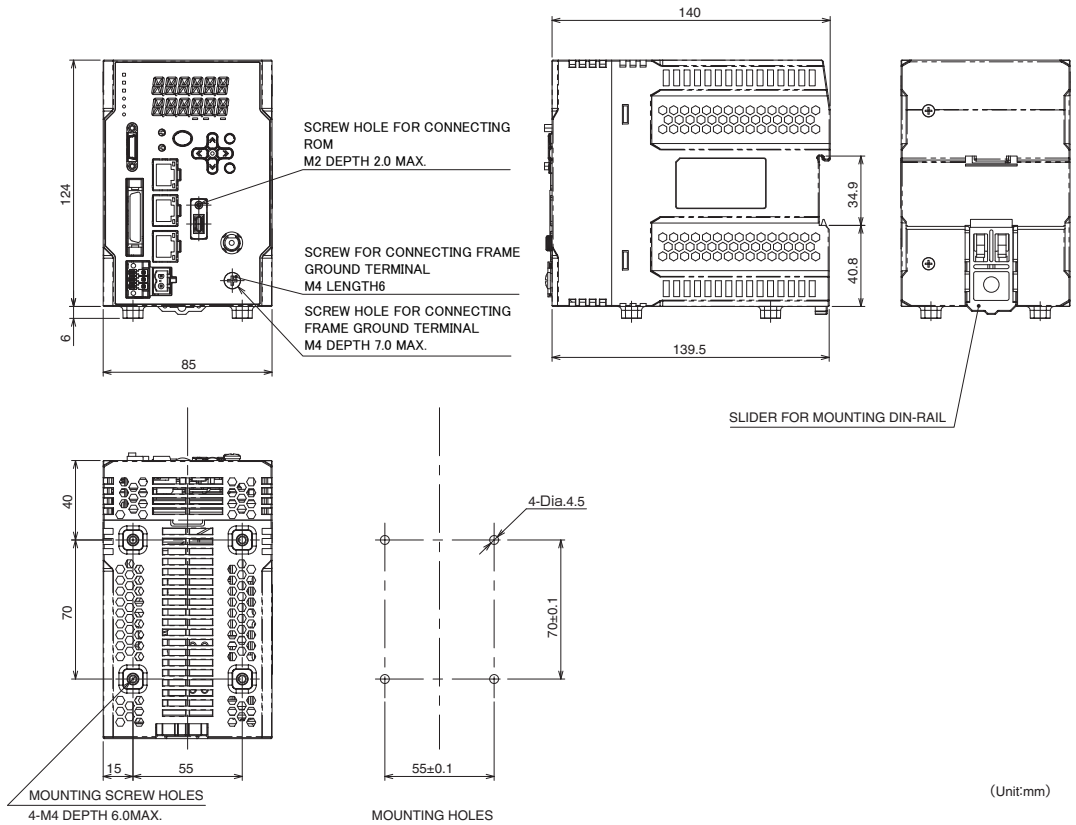

EtherCAT communications specifications

Item	Specifications
Communications standard	IEC 61158 Type12
Physical layer	100BASE-TX (IEEE802.3)
Connector	RJ45 × 2 EtherCAT IN: EtherCAT input EtherCAT OUT: EtherCAT output
Communications media	Twisted pair cable Category 5 or higher (Straight, double-shielded cable comprising aluminum tape and braid is recommended.)
Communications distance	Distance between nodes: 100 m max.
Process data	Variable PDO mapping
Mailbox (CoE)	Emergency message, SDO request, SDO response, SDO information
Distributed block	Synchronization by DC mode
LED display	L/A IN (Link/Activity IN) × 1 L/A OUT (Link/Activity OUT) × 1 ECAT RUN × 1 ECAT ERR × 1

PC tools (Sysmac Studio)

Item	Operating environment*3
Operating system (OS)*1 Japanese or English	Windows 7 (32-bit/64-bit version) Windows 8 (32-bit/64-bit version) Windows 8.1 (32-bit/64-bit version) Windows 10 (32-bit/64-bit version)
CPU	Windows computers with Intel® Celeron® processor 540 (1.8 GHz) or faster CPU. Intel® Core™ i5 M520 processor (2.4 GHz) or equivalent or faster recommended.
Main memory	2 GB min. 4 GB min. recommended
Hard disk	Minimum 4.6 GB of Hard disk space is required to install.*2
Display	XGA 1024 × 768, 16,000,000 colors WXGA 1280 × 800 dots or higher resolution is recommended.
Disk drive	DVD-ROM drive
Communication port	USB2.0 compatible USB port or Ethernet port*4
Supported languages	Japanese, English, German, French, Italian, Spanish, simplified Chinese, traditional Chinese, Korean

*1: Note about Sysmac Studio compatible operating systems:

The required system and hard disk capacity differs according to the system environment.

*2: Separate logging memory is required to use the file logging function.

*3: Describes System Requirements and notes of Sysmac Studio Measurement Sensor Edition.

For details on System Requirements and notes of Sysmac Studio Measurement Sensor Edition, refer to Sysmac Studio Version 1 Operation Manual.

*4: For information on how to connect a personal computer with the controller or other hardware and information on required cables, refer to manuals for each hardware.

Features of each edition

Item	Standard Edition	Measurement sensors Edition
Connection target	NX/NJ series machine automation controllers NY series industrial PCs	ZW series measurement sensors
Connection I/F	Ethernet/USB	Ethernet
Control target	NX/NJ series machine automation controllers NY series industrial PCs and all connected EtherCAT devices (ZW series measurement sensors included)	ZW series measurement sensors
Firmware update	×	○
Calibration ROM data recovery	×	○
Offline debugging	○	×

Accessories

Extension fiber cable

● ZW-XF8002R/XF8005R/XF8010R/XF8020R/XF8030R

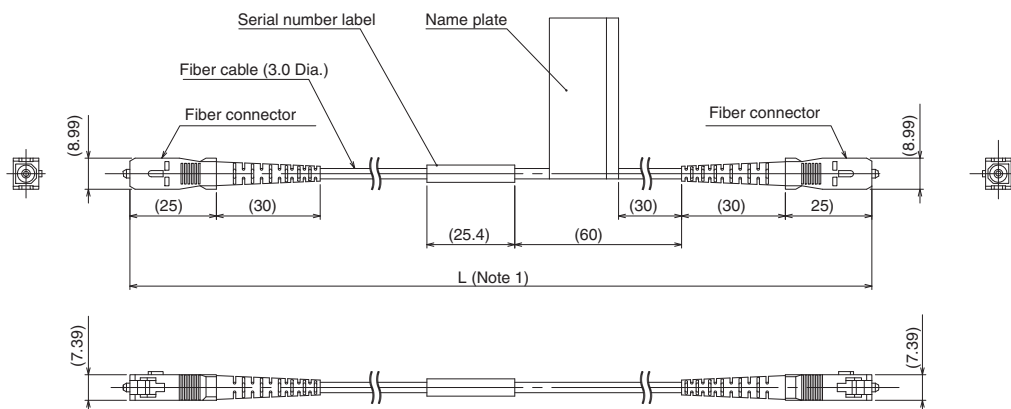

Connection adapter: ZW-XFCS

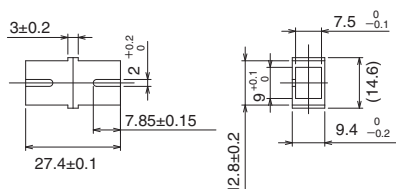

Note1. The following table lists cable lengths per models.

Type	Specification	L(mm)
ZW-XF8002R	2m	2000+40/0
ZW-XF8005R	5m	5000+100/0
ZW-XF8010R	10m	10000+200/0
ZW-XF8020R	20m	20000+400/0
ZW-XF8030R	30m	30000+600/0

Item	Specifications				
	ZW-XF8002R	ZW-XF8005R	ZW-XF8010R	ZW-XF8020R	ZW-XF8030R
Applicable Sensor Controller	ZW-8000□				
Applicable Sensor Head	ZW-S80□□/SP80□□/SPR80□□				
Ambient temperature	Operation: 0 to 50°C, Storage: -15 to +60°C (with no icing or condensation)				
Ambient humidity	Operation, storage: 35 to 85% (with no icing or condensation)				
Vibration resistance (destructive)	10 to 55 Hz (half amplitude 0.35 mm), 50 mins in each of X/Y/Z directions				
Shock resistance (destructive)	150 m/s ² , 6 direction, 3 times each (up/down, left/right, forward/backward)				
Fiber length	2 m	5 m	10 m	20 m	30 m
Material	Cable sheath: PVC, Connector: PBT, Connection adapter: PBT				
Fiber cable minimum bending radius	20 mm				
Weight	Approx. 25 g	Approx. 40 g	Approx. 70 g	Approx. 130 g	Approx. 200 g
Accessories	Connection adapter (ZW-XFCS), 2 Fiber cable protective cap. Instruction Sheet, Precautions				

Important

- Secure a minimum bending radius (R) for the fiber cable that is at least as large as the specification value. A bending radius smaller than the specification value could cause damage to the fiber cable.
- When an extension fiber cable of 2 m or longer is connected, the setting range of the measurement cycle (exposure time) changes. For details, refer to "Setting the Measurement Cycle" p.122 in this manual.

● ZW-XF7002R/XF7005R/XF7010R/XF7020R/XF7030R

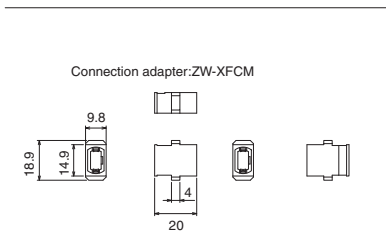
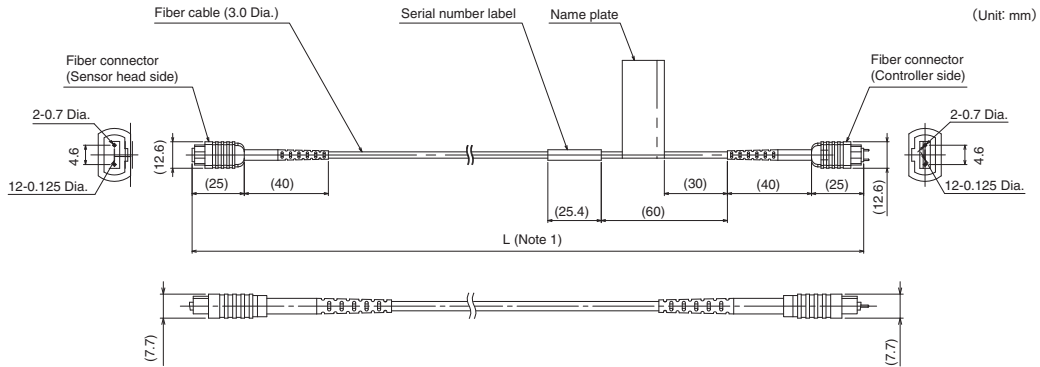

Note 1. The following table lists cable lengths per models.

Type	Specification	L (mm)
ZW-XF7002R	2m	2000+40/0
ZW-XF7005R	5m	5000+100/0
ZW-XF7010R	10m	10000+200/0
ZW-XF7020R	20m	20000+400/0
ZW-XF7030R	30m	30000+600/0

Item	Specifications				
	ZW-XF7002R	ZW-XF7005R	ZW-XF7010R	ZW-XF7020R	ZW-XF7030R
Applicable Sensor Controller	ZW-7000□				
Applicable Sensor Head	ZW-S70□□/SP70□□/SPR70□□				
Ambient temperature	Operation: 0 to 50°C, Storage: -15 to +60°C (with no icing or condensation)				
Ambient humidity	Operation, storage: 35 to 85%RH (with no icing or condensation)				
Vibration resistance (destructive)	10 to 55 Hz (half amplitude 0.35 mm), 50 mins in each of X/Y/Z directions				
Shock resistance (destructive)	150 m/s ² , 6 direction, 3 times each (up/down, left/right, forward/backward)				
Fiber length	2 m	5 m	10 m	20 m	30 m
Material	Cable sheath: PVC, Connector: PBT, Connection adapter: PEI				
Fiber cable minimum bending radius	20 mm				
Weight	Approx. 25 g	Approx. 45 g	Approx. 70 g	Approx. 120 g	Approx. 160 g
Accessories	Connection adapter (ZW-XFCM), 2 Fiber cable protective cap, 2 straps. Instruction Sheet, Precautions				

Important

- Secure a minimum bending radius (R) for the fiber cable that is at least as large as the specification value. A bending radius smaller than the specification value could cause damage to the fiber cable.
- When an extension fiber cable of 10 m or longer is connected, the setting range of the measurement cycle (exposure time) changes. For details, refer to "Setting the Measurement Cycle" p.122 in this manual.

● ZW-XF5002R/XF5005R/XF5010R/XF5020R/XF5030R

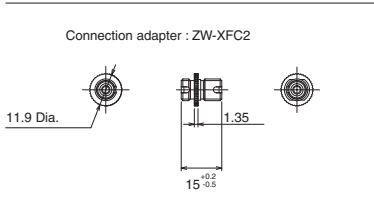
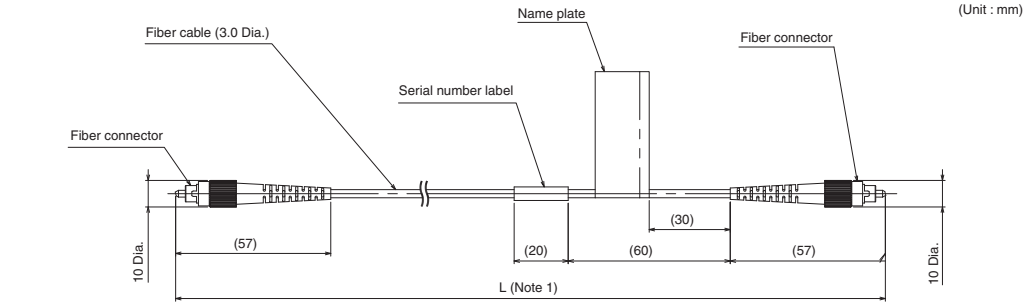

Note 1. The following table lists cable lengths per models.

Type	Specification	L(mm)
ZW-XF5002R	2m	2000+200/0
ZW-XF5005R	5m	5000+200/0
ZW-XF5010R	10m	10000+200/0
ZW-XF5020R	20m	20000+500/0
ZW-XF5030R	30m	30000+500/0

Item	Specifications				
	ZW-XF5002R	ZW-XF5005R	ZW-XF5010R	ZW-XF5020R	ZW-XF5030R
Applicable Sensor Controller	ZW-5000□				
Applicable Sensor Head	ZW-S50□□/SP50□□/SPR50□□				
Ambient temperature	Operation: 0 to 50°C, Storage: -15 to +60°C (with no icing or condensation)				
Ambient humidity	Operation, storage: 35 to 85% (with no icing or condensation)				
Vibration resistance (destructive)	10 to 55 Hz (half amplitude 0.35 mm), 50 mins in each of X/Y/Z directions				
Shock resistance (destructive)	150 m/s ² , 6 direction, 3 times each (up/down, left/right, forward/backward)				
Fiber length	2m	5m	10m	20m	30m
Material	Cable sheath: PVC, Connector: Brass, Connecting adapter: Brass				
Fiber cable minimum bending radius	20mm				
Weight	Approx. 25g	Approx. 35g	Approx. 55g	Approx. 100g	Approx. 140g
Accessories	Connection adapter (ZW-XFC2), 2Fiber cable protective cap, Instruction Sheet, Precautions				

Important

- Secure a minimum bending radius (R) for the fiber cable that is at least as large as the specification value. A bending radius smaller than the specification value could cause damage to the fiber cable.
- When an extension fiber cable of 5 m or longer is connected, the setting rage of the measurement cycle (exposure time) changes. For details, refer to "Setting the Measurement Cycle" p.122 in this manual.

Connection adapter (for connecting fiber cable)

● ZW-XFCS

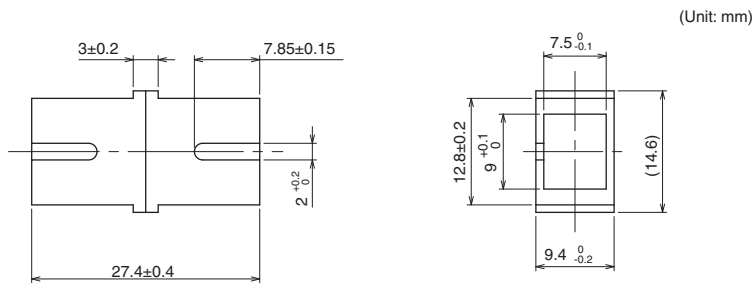

The connection adapter (ZW-XFCS) comes packed together with the extension fiber cable (ZW-XF80□□R), but the connection adapter alone can be purchased for maintenance.

ZW-8000 Series p.74

● ZW-XFCM

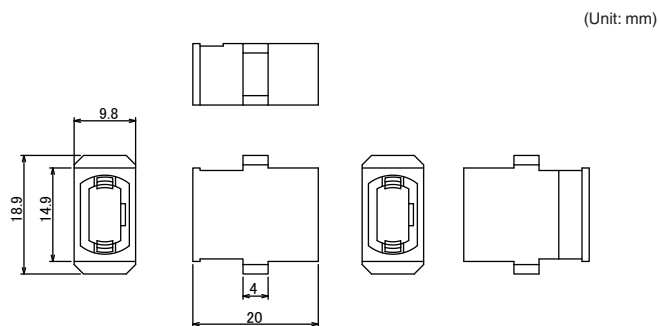

The connection adapter (ZW-XFCM) comes packed together with the extension fiber cable (ZW-XF70□□R), but the connection adapter alone can be purchased for maintenance.

ZW-7000 Series p.75

● ZW-XFC2

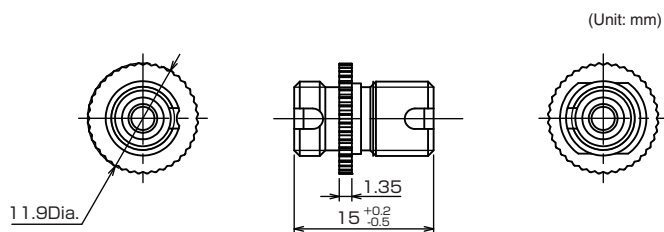

The connection adapter (ZW-XFC2) comes packed together with the extension fiber cable (ZW-XF50□□R), but the connection adapter alone can be purchased for maintenance.

Extending fiber cable p.76.

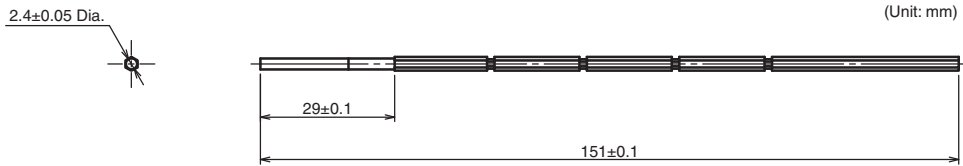

Fiber connector cleaner

● ZW-XCL



Item	Specifications
Applicable item	<ul style="list-style-type: none"> • Grooves of the Sensor Head • Fiber connector of Sensor Controller • Tip of the extension fiber cable
Packed quantity	10 pcs/set
Number of times cleanable	Once
External size	Length 180 mm, 2.4 mm Dia.
Operating ambient temperature range	5 to 35°C
Operating ambient humidity range	40 to 80%
Storage ambient temperature range	5 to 35°C
Storage ambient humidity range	40 to 80%
Material	Nylon plastic, polyolefin plastic, polyester
Weight	20 g
Accessories	Note on use

EtherCAT cable

Product name		Manufacturer	Cable length (m) *1	Model
Size/number of cores (number of pairs): AWG22 × 2P	Cable with connector at both ends (RJ45/RJ45) 	OMRON	0.3	XS5W-T421-AMD-K
			0.5	XS5W-T421-BMD-K
			1	XS5W-T421-CMD-K
			2	XS5W-T421-DMD-K
			5	XS5W-T421-GMD-K
			10	XS5W-T421-JMD-K
	Cable with connector at both ends (M12/RJ45) 	OMRON	0.3	XS5W-T421-AMC-K
			0.5	XS5W-T421-BMC-K
			1	XS5W-T421-CMC-K
			2	XS5W-T421-DMC-K
			5	XS5W-T421-GMC-K
			10	XS5W-T421-JMC-K
Size/number of cores (number of pairs): AWG24 × 4P	Cable	Hitachi Metals, Ltd.		NETSTAR-C5E SAB 0.5 × 4P *2
		Kuramo Electric Co., LTD.		KETH-SB *2
		SWCC SHOWA CABLE SYSTEMS CO., LTD.		FAE-5004 *2
	RJ45 connector	Panduit Corp.		MPS588 *2
Size/number of cores (number of pairs): AWG22 × 2P	Cable	Kuramo Electric Co., LTD.		KETH-PSB-OMR *3
	RJ45 assembled type connector 	OMRON		XS6G-T421-1 *3

*1: This cable is available in 0.3, 0.5, 1, 2, 3, 5, 10, and 15 m lengths. For details, refer to the *industrial Ethernet connector catalog* (CDJC-006).

*2: Use of the above combinations of EtherCAT cables and RJ45 connector is recommended.

*3: Use of the above combinations of EtherCAT cables and RJ45 assembled type connector is recommended.

RS-232C cable

● ZW-XPT2 (for PLC/programmable terminal connection)

(Unit: mm)

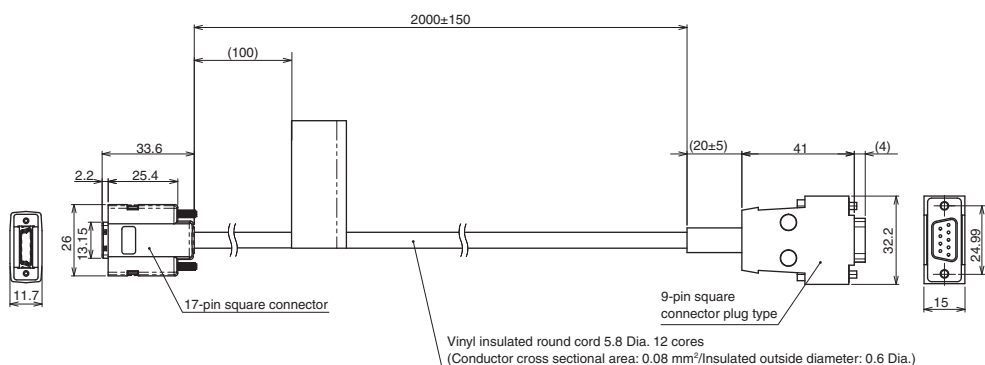

● ZW-XRS2 (for PC connection)

(Unit: mm)

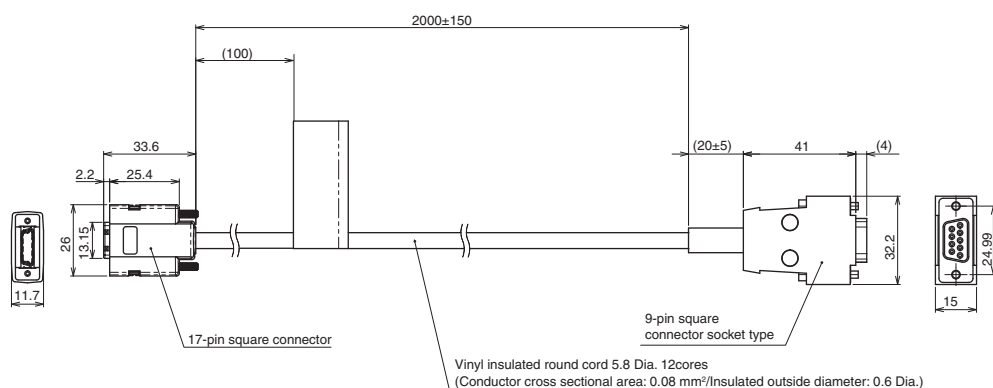

Item	Specifications	
	ZW-XPT2	ZW-XRS2
Applicable Controller	ZW-8000□/7000□/5000□	
Ambient temperature	Operation: 0 to 50°C, Storage: -15 to +60°C (No freezing and condensation)	
Ambient humidity	Operation/storage: 35 to 85% (No condensation)	
Dielectric strength	1000 VAC, 50/60 Hz, 1 min	
Insulation resistance	20 MΩ (by 250 VDC megger)	
Vibration resistance (destructive)	10 to 55 Hz (half amplitude 0.35 mm), 50 mins in each of X/Y/Z directions	
Shock resistance (destructive)	150 m/s ² , 6 direction, 3 times each (up/down, left/right, forward/backward)	
Material	Cable sheath: PVC	
Cable minimum bending radius	35 mm	
Weight	Approx. 150 g	
Accessories	Instruction Manual	

Important

Secure a minimum bending radius (R) for the cable that is at least as large as the specification value. If the bending radius is smaller than the specification value, this can cause damage to the cable.

Parallel cable

● ZW-XCP2E

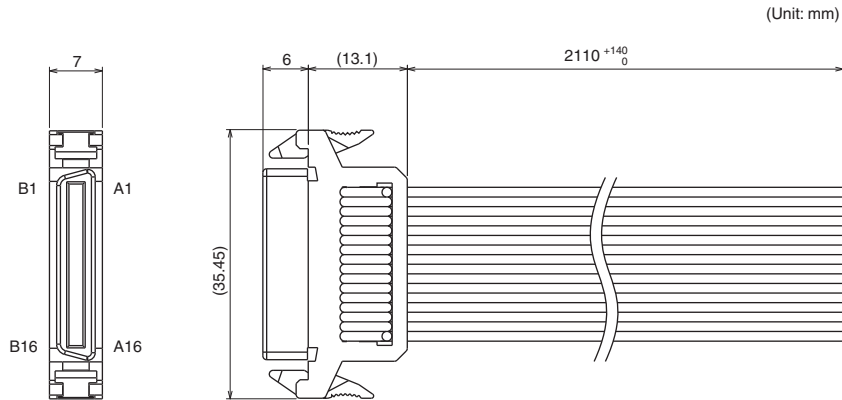

Item	Specifications
Applicable Controller	ZW-8000□/7000□/5000□
Ambient temperature	Operation: 0 to 50°C, Storage: -15 to +60°C (No freezing and condensation)
Ambient humidity	Operation/storage: 35 to 85% (No condensation)
Dielectric strength	1000 VAC, 50/60 Hz, 1 min
Insulation resistance	20 MΩ (by 250 VDC megger)
Vibration resistance (destructive)	10 to 55 Hz (half amplitude 0.35 mm), 50 mins in each of X/Y/Z directions
Shock resistance (destructive)	150 m/s ² , 6 direction, 3 times each (up/down, left/right, forward/backward)
Material	Cable sheath: PVC
Cross section of flat cable	AWG28
Core wire pitch	1.27 mm
Cable minimum bending radius	5.5 mm
Weight	Approx. 150 g
Accessories	Instruction Manual

Important

Secure a minimum bending radius (R) for the cable that is at least as large as the specification value. If the bending radius is smaller than the specification value, this can cause damage to the cable.

9-2 Laser safety

The radiation level of the laser beam used on the ZW-8000□ is less of the limit value of a Class 1 laser product that is regarded as safe and therefore there is no danger under normal conditions of use. However, for devices that use lasers, it is required that laser safety measures are specified and conforms to regulations in Japan and other countries.

1. Japan

Safety measures that users must implement according to the laser product Class are specified on the JIS C6802?2014 standard. The ZW-8000□ is categorized as a Class 1 device. The following label is attached to the product.



2. USA

When using devices within this product installed is exported to the U.S., the devices must conform to the U.S. FDA (Food and Drug Administration) laser regulations. The ZW-8000□ is classified as Class 1 by the standard of IEC 60825-1 according to deviations of Laser Notice No. 50 of this standard. This product has been reported to CDRH (Center for Devices and Radiological Health).

A certification label in accordance with FDA's technical standards is attached on the side of the product unit.

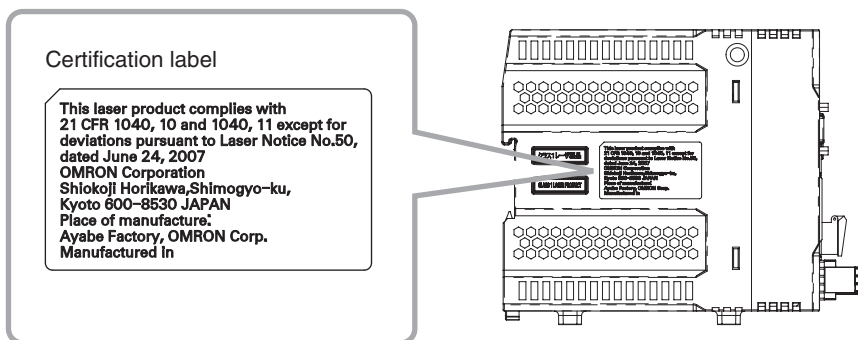

3. Other countries other than the U.S.

The ZW-8000□ is categorized as a Class 1 device as stipulated in IEC/EN60825-1: 2014.



9-3 Firmware Update

For information on how to obtain the latest version of the firmware, please contact your OMRON sales representative.

After obtaining the latest version of the firmware, follow the procedure below to update the firmware.

Important

Do not turn OFF the power supply to the Sensor Controller during updating. The Sensor Controller would no longer start up properly.

Use Sysmac Studio Measurement Sensor Edition to update

- ▶ Multi View Explore : [Device Group] | [(Sensor Name)] (double click)
→ Edit pane : [Tools] icon ()

- 1 Click [Sensor setup] - [Update], and select the update file.

The update file extension is “.BIN”. When the file is selected, the [FirmwareWriteInWindow] popup is displayed.

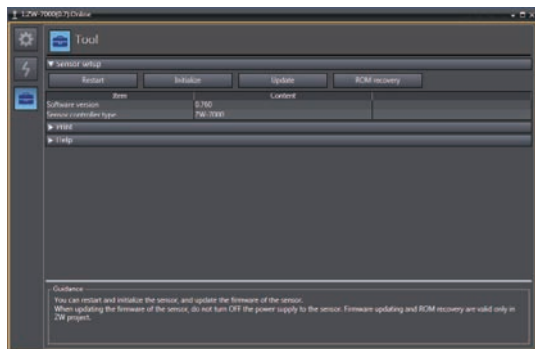

Important

The current firmware version is displayed at [Sensor setup]. Be sure to check the version before updating the firmware.

- 2 Click [Start the update.].

A message to confirm to start the update appears.

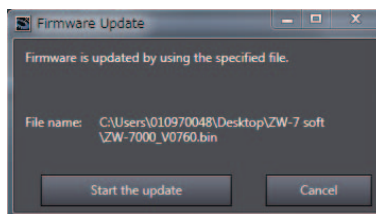

Important

When you click [Start the update.], if the “Different format” message is displayed, this means that the format information for the connected Sensor Controller and the specified file do not match. If this happens, never continue with the firmware update. The Sensor Controller breaks down and no longer starts up properly.

3 Check the content of the message, and click [OK].

The firmware update is started.

A progress bar is displayed during update processing. Wait for the [Firmware Write Completed] popup to be displayed. (The update takes several minutes to complete.)

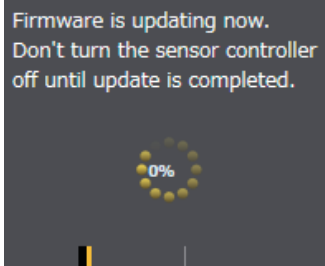

Important

- Errors may occur on the Sensor Controller during updating, but just wait for the update to complete.
- If the update progress bar stops midway or the update does not end even after ten minutes, there is the possibility that the update has failed. In this case, contact an OMRON branch or sales office about the firmware version before update and the firmware version in the write file.

4 Click [Close].

The firmware update is completed.

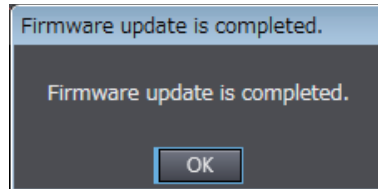

Performing the Update on Warp Engine ZW-7

The most recent version of the software and PC Tool can be downloaded from the following website for OMRON members. Refer to the Member Registration Sheet that is enclosed with the Sensor.

<http://www.fa.omron.co.jp/zw>

Connect the the PC which is installed Warp Engine ZW-7 to ZW via Ethernet before operating.

Important

- Use Warp Engine ZW-7 for updating ZW-8000/5000 series.
- Only start Warp Engine ZW-7 when the computer has recognized the Sensor Controller normally.
- When using Warp Engine ZW-7 on the same PC as Sysmac Studio Measurement Sensor Edition 7, do not change the current IP address and subnet mask being used. If you are using a different personal computer, refer to “5-1 Connecting by No-protocol Communications” described in Displacement Sensor ZW-7000/5000 series Confocal Fiber Type Displacement Sensor User’s Manual for Communications Settings (Z363) and change the IP address and the subnet mask of the Sensor Controller.
- ZW-8000 firmware updates cannot be performed using Warp Engine ZW-7 Ver. 2.0 or earlier.

- 1 From the personal computer's Start menu, select [All Programs] - [OMRON] - [ZW] - [Warp Engine ZW-7].

The [Warp Engine ZW-7] screen is displayed.

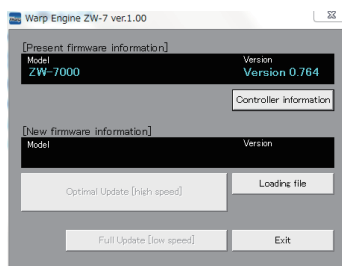

If Warp Engine ZW-7 fails to start up, a message and then the following screen is displayed.

In this case, set the connection port.

- 2 If necessary, click [Full Update(Low speed)].

The model name and version of the currently connected Sensor Controller are displayed.

- 3 Click [Loading file], and select the file to write to.

The model name and version of the Sensor Controller held in the file are displayed.

- 4 Click [Optimal Update(High speed)].

A message to confirm to start the update appears.

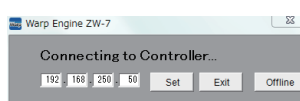
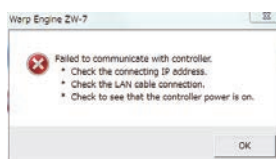

Important

- When you click [Full Update(Low speed)], if the "Different format" message is displayed, this means that the format information for the connected Sensor Controller and the specified file do not match. If this happens, never continue with the firmware update. The Sensor Controller breaks down and no longer starts up properly.
- The update time can be shortened by selecting [Optimal Update(High speed)], which will update only necessary items. If you select [Full Update(Low speed)], the update time will be longer because all files will be updated. Normally Optimal Update(High speed) is recommended.

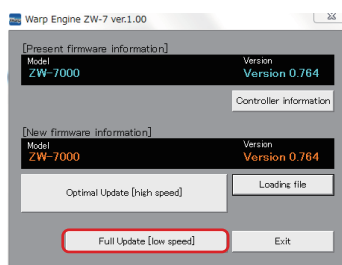

5 Check the content of the message, and click [OK].

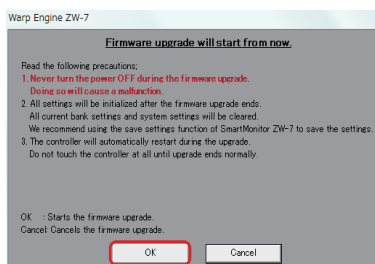

The firmware update is started.

A progress bar is displayed during update processing. Wait for the successful end message box to be displayed. (The update takes several minutes to complete.)

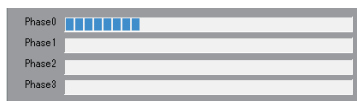

Important

- Errors may occur on the Sensor Controller during updating, but just wait for the update to complete.
- If the update progress bar stops midway or the update does not end even after ten minutes, there is the possibility that the update has failed. In this case, contact an OMRON branch or sales office about the firmware version before the update and the one in the write file.

6 When the update is successfully completed, a message appears. Click [OK].

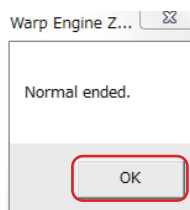

7 Click [Finish] and exit Warp Engine ZW-7.

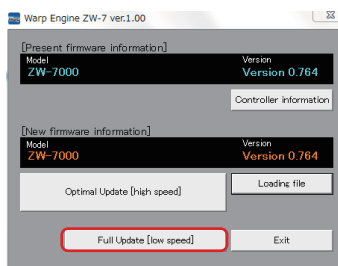

MEMO

Index

Numeric			
24 V input terminal block	61		
Wiring	42, 82		
32-pole extension connector	61		
Signal functions	79		
Terminal functions	78		
Wiring	78		
A			
Analog output	226		
Analog output terminal block	61		
Terminal functions	81		
Wiring	81		
B			
Bank	28		
Bank Settings			
Clearing	188		
Copy	186		
Saving the Bank/System Settings	185		
C			
Calibration ROM			
Connecting	33, 44, 47		
Names of parts	58		
Connection adapter	75, 318		
D			
Digital Displays	223		
Alphabetical notation	223		
Changing Display Details	227		
Changing Threshold Values	228		
Entering Numerical Values	211		
Positioning decimal point	211		
DIN track attachment hook	61, 67		
Displayed task	226		
Distance	226		
E			
Edit pane	90		
Effective bank	226		
Electrical Specifications			
Input circuit	83		
Output circuit	84		
ENABLE indicator	60		
Error Messages			
Common	280		
Ethernet connector	61		
Explorer pane	89		
Exposure time	226		
Extension fiber cable	315		
F			
Fiber cable			
Connect	39		
Extend	74		
Filters	152		
Average Filter	154		
Differentiation Filter	159		
Frequency Filter	155		
Median Filter	153		
FUNC (adjustment) mode	210		
H			
HIGH indicator	60		
Hold			
Clearing conditions	162		
Performing with Key Input	253		
Trigger	163		
Trigger Delay	167		
I			
Icons	91		
Installation screw hole	61		
J			
Judgment result	226		
L			
LEFT/RIGHT key	60, 222		
LOW indicator	60		
M			
Main display	60, 225		
Measuring range	63		
Mode switching key	60, 222		
Multi-task Function	27		
N			
Non-Measurement setting	179		
Clamp Value	180		
O			
Offline	206		
Offline, Debugging	203		
Offline, Settings	202		
Operating Keys	222		
Operation modes	98		
P			
Parallel cable	322		
PASS indicator	60		
PC tool	55, 314		
Project			
Export	93		
Import	93		
Launching	86		
Save	93		
R			
Resolution	226		
RS-232C connector	61		
RUN (operation) mode	210		
RUN indicator	60		
S			
Scaling	143		
1-point Scaling	144		
2-point Scaling	146		
Manual Scaling	143		
Thickness Scaling	151		

Sensor Controller	
External Dimensions	311
Installing on bottom	68
Installing on the DIN track	67
Names of parts	59
Precautions for installation	66
Specifications	307
Sensor Head	
Calibrate	48, 51
External Dimensions	291
Installation	29, 63
Interference	65
Measuring range	63
Names of parts	57
Precautions for installation	32
Specifications	288
Setting Exposure Time Control Mode	126, 127, 128, 129
Setting Measurement Items	138
Calculation	141
Height	138
Thickness	140
Setting the System	192
Setting Threshold Value	174
Direct	174, 267
Teaching	265
STABILITY indicator	60
Sub-display	60
Sysmac Studio Main Window	88
Sysmac Studio Measurement Sensor	
Edition	55
Sysmac Studio Standard Edition	55
Sysmac Studio, Installing	85
Sysmac Studio, window sections	88
System Configuration	54
<hr/>	
T	
Threshold	226
THRESHOLD-H indicator	60
THRESHOLD-L indicator	60
<hr/>	
U	
UP/DOWN key	222
<hr/>	
Z	
ZERO indicator	60
Zero reset	100, 169
Cancel	102
Execute	101
Offset	170
Type	171
ZERO/SET key	60, 222
ZERORST/ESC key	60, 222

Revision History

A manual revision code appears as a suffix to the catalog number at the bottom of the front and back covers of this manual.

Cat. No. Z362-E1-05

↑
Revision code

Revision code	Date	Revision Contents
01	April 2016	First edition.
02	July 2016	Add the PDO synchronization mode and correct error sentences.
03	April 2017	Compatible with ZW-5000 series and correct error descriptions.
04	May 2017	Correct error descriptions.
05	May 2018	Compatible with ZW-8000 series and correct error descriptions.

OMRON Corporation Industrial Automation Company
Kyoto, JAPAN

Contact: www.ia.omron.com

Regional Headquarters

OMRON EUROPE B.V.

Sensor Business Unit

Carl-Benz-Str. 4, D-71154 Nufringen, Germany
Tel: (49) 7032-811-0/Fax: (49) 7032-811-199

OMRON ASIA PACIFIC PTE. LTD.

No. 438A Alexandra Road # 05-05/08 (Lobby 2),
Alexandra Technopark,
Singapore 119967
Tel: (65) 6835-3011/Fax: (65) 6835-2711

OMRON ELECTRONICS LLC

2895 Greenspoint Parkway, Suite 200
Hoffman Estates, IL 60169 U.S.A.
Tel: (1) 847-843-7900/Fax: (1) 847-843-7787

OMRON (CHINA) CO., LTD.

Room 2211, Bank of China Tower,
200 Yin Cheng Zhong Road,
PuDong New Area, Shanghai, 200120, China
Tel: (86) 21-5037-2222/Fax: (86) 21-5037-2200

Authorized Distributor:

© OMRON Corporation 2016-2018 All Rights Reserved.
In the interest of product improvement,
specifications are subject to change without notice.

Cat. No. Z362-E1-05

0518