

H.264 Network DVR

User Manual

GUI Display with USB Mouse Control

Please read instructions thoroughly before operation and retain it for future reference.

For the actual display & operation, please refer to your DVR in hand.

IMPORTANT SAFEGUARD



CAUTION

RISK OF ELECTRIC SHOCK



CAUTION:

To reduce the risk of electric shock, do not expose this apparatus to rain or moisture. Only operate this apparatus from the type of power source indicated on the label. The company shall not be liable for any damages arising out of any improper use, even if we have been advised of the possibility of such damages.



The lightning flash with arrowhead symbol, within an equilateral triangle, is intended to alert the user to the presence of uninsulated "dangerous voltage" within the product's enclosure that may be of sufficient magnitude to constitute a risk of electric shock to persons.



This exclamation point within an equilateral triangle is intended to alert the user to the presence of important operating and maintenance (servicing) instructions in the literature accompanying the appliance.



All lead-free products offered by the company comply with the requirements of the European law on the Restriction of Hazardous Substances (RoHS) directive, which means our manufacture processes and products are strictly "lead-free" and without the hazardous substances cited in the directive.



The crossed-out wheeled bin mark symbolizes that within the European Union the product must be collected separately at the product end-of-life. This applies to your product and any peripherals marked with this symbol. Do not dispose of these products as unsorted municipal waste. Contact your local dealer for procedures for recycling this equipment.



This apparatus is manufactured to comply with the radio interference requirements.

Federal Communications Commission Interference Statement

This equipment has been tested and found to comply with the limits for a Class A digital device, pursuant to Part 15 of the FCC Rules. These limits are designed to provide reasonable protection against harmful interference when the equipment is operated in a commercial environment. This equipment generates, uses, and can radiate radio frequency energy and, if not installed and used in accordance with the instruction manual, may cause harmful interference to radio communications. Operation of this equipment in a residential area is likely to cause harmful interference in which case the user will be required to correct the interference at his own expense.

Trademark Acknowledgements

iPhone® is the registered trademark of Apple Inc.

BlackBerry® and related trademarks, names and logos are the property of Research In Motion Limited and are registered and/or used in the U.S. and countries around the world. Used under license from Research In Motion Limited.

Microsoft®, Windows®, Internet Explorer®, Mozilla® Firefox®, Google Chrome™, QuickTime®, Windows® Mobile & Symbian® mentioned in this document are the registered trademarks of their respective holders.

Disclaimer

The information in this manual was current when released. We reserve the right to revise or remove any content in this manual at any time. We do not warrant or assume any legal liability or responsibility for the accuracy, completeness, or usefulness of this manual. For the actual display & operation, please refer to your DVR in hand. The content of this manual is subject to change without notice.

Grounding

This is a Safety Class 1 Product (provided with a protective earthing ground incorporated in the power cord). The mains plug shall only be inserted in a socket outlet provided with a protective earth contact. Any interruption of the protective conductor inside or outside of the instrument is likely to make the instrument dangerous. Intentional interruption is prohibited.

Water & Moisture

Do not expose this product to dripping or splashing and that no objects filled with liquids, such as vases, shall be placed on the product.

MPEG4 Licensing

THIS PRODUCT IS LICENSED UNDER THE MPEG-4 VISUAL PATENT PORTFOLIO LICENSE FOR THE PERSONAL AND NON-COMMERCIAL USE OF A CONSUMER FOR (i) ENCODING VIDEO IN COMPLIANCE WITH THE MPEG-4 VISUAL STANDARD ("MPEG-4 VIDEO") AND/OR (ii) DECODING MPEG-4 VIDEO THAT WAS ENCODED BY A CONSUMER ENGAGED IN A PERSONAL AND NON-COMMERCIAL ACTIVITY AND/OR WAS OBTAINED FROM A VIDEO PROVIDER LICENSED BY MPEG LA TO PROVIDE MPEG-4 VIDEO. NO LICENSE IS GRANTED OR SHALL BE IMPLIED FOR ANY OTHER USE. ADDITIONAL INFORMATION INCLUDING THAT RELATING TO PROMOTIONAL INTERNAL AND COMMERCIAL USES AND LICENSING MAY BE OBTAINED FROM MPEG LA, LLC. SEE [HTTP://WWW.MPEGLA.COM](http://www.mpegla.com).

GPL Licensing



This product contains codes which are developed by Third-Party-Companies and which are subject to the GNU General Public License ("GPL") or the GNU Lesser Public License ("LGPL").

The GPL Code used in this product is released without warranty and is subject to the copyright of the corresponding author.

Further source codes which are subject to the GPL-licenses are available upon request.

We are pleased to provide our modifications to the Linux Kernel, as well as a few new commands, and some tools to get you into the code. The codes are provided on the FTP site, and please download them from the following site or you can refer to your distributor:

http://download.dvrtw.com.tw/GPL/076D_Series/arm-linux-2.6.tar.gz

TABLE OF CONTENTS

1. BEFORE USING THIS DVR	1
1.1 Package Content	1
1.2 Front Panel	1
1.3 Rear Panel	1
2. CONNECTION AND SETUP	3
2.1 SATA HDD Installation.....	3
2.2 Camera Connection	4
2.2.1 Normal Camera Connection	4
2.2.2 PTZ Camera Connection	5
2.3 DVR Power On	6
2.4 Date and Time Setting.....	7
2.5 Clear Hard Disk.....	8
2.6 Password Setting	8
3. GUI DISPLAY WITH USB MOUSE CONTROL	9
3.1 Connect USB Mouse.....	9
3.2 Quick Menu Bar	9
3.2.1 Channel Switch.....	10
3.2.2 PTZ Control Panel	10
3.3 Main Menu	11
4. BASIC OPERATION	12
4.1 Live Page	12
4.2 Record Icon.....	12
4.3 Playback	13
4.3.1 Playback Control.....	13
4.3.2 Event Search	14
4.3.3 Audio Playback	14
4.4 User Level Switch	14
4.5 System Sources Reallocation	15
5. FREQUENTLY-USED FUNCTIONS	16
5.1 Quick Search	16
5.2 Record	17
5.2.1 Quick record setting.....	17
5.2.2 Detailed record setting.....	18
5.3 Schedule Setting	19
5.3.1 Record Timer	19

5.3.2	Detection Timer.....	20
5.3.3	Alarm Timer	20
5.4	Detection Setting.....	21
5.5	PTZ Camera Setting	22
5.6	System Setting	23
5.6.1	Password Setting.....	23
5.6.2	System Upgrade.....	23
5.6.3	Backup & Restore Configurations.....	24
5.6.4	Video Backup.....	24
5.6.5	Record Log Backup	26
5.6.6	Clear All HDD Data	27
5.7	Network.....	27
5.7.1	STATIC	27
5.7.2	PPPOE	28
5.7.3	DHCP	29
5.7.4	DDNS	29
5.8	Event Notifications	30
5.8.1	FTP.....	30
5.8.2	E-MAIL.....	31
5.9	VGA Output Resolution Support	31
5.10	System Sources Reallocation	32
6.	REMOTE OPERATION.....	33
6.1	Supplied Licensed Software.....	33
6.1.1	Installation & Network Connection.....	33
6.1.2	Control Panel Overview	35
6.1.3.	General Operation	37
6.1.4.	E-Map	41
6.2	Web Browser	46
6.2.1	Event Download & Playback.....	48
APPENDIX 1	SPECIFICATIONS.....	49
APPENDIX 2	COMPATIBLE USB FLASH DRIVE LIST	51
APPENDIX 3	COMPATIBLE SATA HDD LIST	52
APPENDIX 4	MAIN MENU STRUCTURE	53
APPENDIX 5	DVR BATTERY REPLACEMENT	55
APPENDIX 6	PIN CONFIGURATION.....	56

1. BEFORE USING THIS DVR

1.1 Package Content

➤ Standard Package

- | | |
|---|--|
| <input type="checkbox"/> DVR | <input type="checkbox"/> HDD screws |
| <input type="checkbox"/> Adapter & Power cord | <input type="checkbox"/> CD Manual |
| <input type="checkbox"/> IR Remote Controller | <input type="checkbox"/> Manual for IR Remote Controller |

1.2 Front Panel

1) LED Indicators

 HDD is reading or recording.

 DVR is powered on.

2) II (▲) / ■ (▼) / ◀ (◀) / ▶ (▶)

Press ▲ / ▼ / ◀ / ▶ to move up / down / left / right.

In the playback mode:

Press “ II ” to pause playback.

Press “ ■ ” to stop playback.

Press “ ▶ ” to fast forward.

Press “ ◀ ” to fast rewind.

3) MENU

Press “MENU” to enter the main menu.

4) ENTER

Press “ENTER” to confirm the setting.

5) LIST (Event List Search)

Press to quickly search the recorded files by event lists: RECORD / MOTION / ALARM / TIME, or select FULL to show all the event logs.

To quickly search the time you want, select “QUICK SEARCH”. Set the time range you want, and select “SUBMIT” to play the recorded video clip during the specified time.

6) PLAY







Press to playback the latest recorded data.

7) SLOW

In the playback mode, press to show slow playback.

8) ZOOM

Press to enlarge the picture of selected channel in the FRAME or FIELD recording mode.

- 9) SEQ
Press to display each channel in full screen one by one starting from CH1. When the last channel is displayed, it will repeat from CH1 again. To exit this mode, press “SEQ” again.
- 10) 
Press to show the 4-channel display mode.
- 11) CH1 ~ 4
Press the channel number keys to select the channel to display.
- 12) AUDIO (SLOW + ZOOM)
Press “SLOW” + “ZOOM” to select live or playback audio from audio channel 1~4.
- | | |
|---|--|
|  Live audio from audio channel 1~4
(indicated in white) |  Playback audio from audio channel 1~4
(indicated in yellow) |
|  Audio channel unselected | |
- 13) P.T.Z. ( + SEQ)
Press “” + “SEQ” at the same time to enter / exit the PTZ control mode.
- 14) USB port
There are two USB ports on the front panel, one for connecting your USB mouse for mouse control, and the other one for connecting your USB flash drive for video backup.

Note: It's not allowed to have two USB mice or two USB flash drives connected on the front panel.

For the compatible USB flash drive list, please refer to “APPENDIX 2 COMPATIBLE USB FLASH DRIVE LIST” at page 51.

1.3 Rear Panel

- 1) VIDEO IN (1 ~ 4): Connect to the video connector of a camera.

Note: The DVR will automatically detect the video system of the camera, please make sure that the cameras are properly connected to the DVR and power-supplied before the DVR is turned on.

- 2) AUDIO IN (1 ~ 4)

Connect to the audio connector of a camera if the camera supports audio recording.

Note: To make a video backup with audio, make sure the camera which supports the audio function is connected to the video-in channel and audio-in channel. For example, the audio data from audio CH1 will be recorded with the video data from video CH1.

- 3) AUDIO OUT

Connect to a speaker with 1 mono audio output.

Note: To know how many audio outputs your DVR supports, please refer to its specifications.

- 4) MONITOR
Connect to a CRT monitor for video output.
- 5) VGA
Connect to a LCD monitor directly.
- 6) EXTERNAL I/O
This port is used to connect external devices (such as speed dome cameras or external alarm, etc).
For detailed I/O port PIN configuration, please refer to “APPENDIX 6 PIN CONFIGURATION” at page 56.
- 7) LAN
Connect to Internet by LAN cable.
- 8) DC 19V
Connect to the supplied adapter.
- 9)  Power Switch
Switch to “I” to turn on the power, and “O” to turn off the power.

2. CONNECTION AND SETUP

Before the DVR is powered on, make sure you have installed a hard disk and connected at least one camera. For details, please refer to the following sections.

Note: The DVR is designed to automatically detect the video system of the connected cameras (NTSC or PAL). To make sure the system detection is correct, please check if the cameras are connected to the DVR and power-supplied before the DVR is powered on.

2.1 SATA HDD Installation

A SATA HDD must be installed before the DVR is powered on.

Note: It's recommended to clear all data in the hard disk when the DVR is powered on and the date & time are set correctly to ensure the recorded data are not mixed with other data previously saved in the same hard disk. For details, please refer to "5.6.6 Clear All HDD Data" at page 26.

Step1: Loosen the screws on the upper cover and remove it from the DVR. Find the two HDD brackets located on the DVR base.

Step2: Get a compatible HDD, and connect it to the power connector and data bus connector.

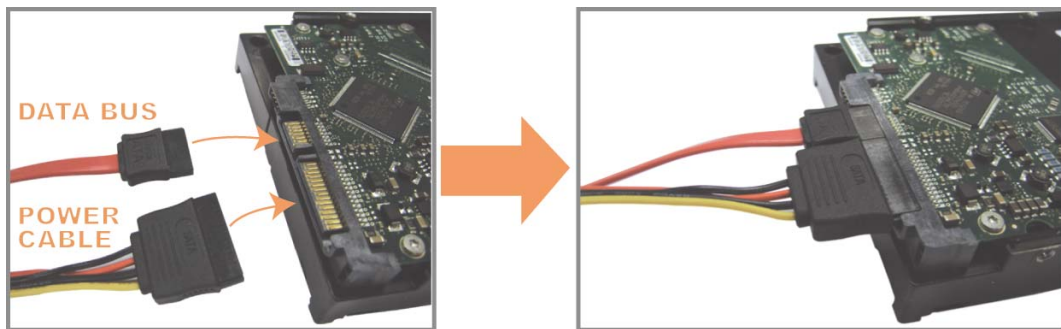

Step3: Make sure the PCB side is facing up, and place the HDD between the HDD brackets on the DVR base as shown below.

Make sure the other side of the HDD is contacted with the DVR base for heat conduction.



Step4: Align the screw hole on the each bracket with the screw hole on the each side of the HDD as shown below, and fix the HDD to the bracket with a HDD screw supplied.

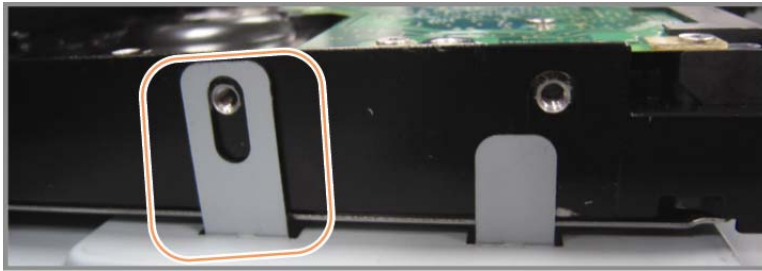

Step5: Close the upper cover of the DVR, and fasten all the screws you loosened in Step 1.

2.2 Camera Connection

The cameras must be connected and power-supplied before the DVR is powered on. Connect the camera with the indicated power supply. Then, connect the camera video output to the DVR video input port with a coaxial cable or RCA cable with BNC connectors.

Note: For detailed DVR video input ports, please refer to "1.3 Rear Panel" at page 1.

2.2.1 Normal Camera Connection

Note: For detailed camera installation and connection, please refer to its own user manual.

1) Connecting to DVR video input

Connect the camera video output to the DVR video input port with a coaxial cable or RCA line with BNC connector.

2) Connecting to DVR audio input (Optional)

Connect the camera audio output to the DVR audio input port with a coaxial cable or RCA cable with BNC connectors.

3) Connecting to power

Connect the camera with indicated power supply and make sure it's power-supplied.

2.2.2 PTZ Camera Connection

The following description is taking our brand's PTZ camera as an example.

For DVR setting to control the PTZ camera, please refer to "5.5 PTZ Camera Setting" at page 22. For detailed PTZ camera control and operation, please refer to its own user manual.

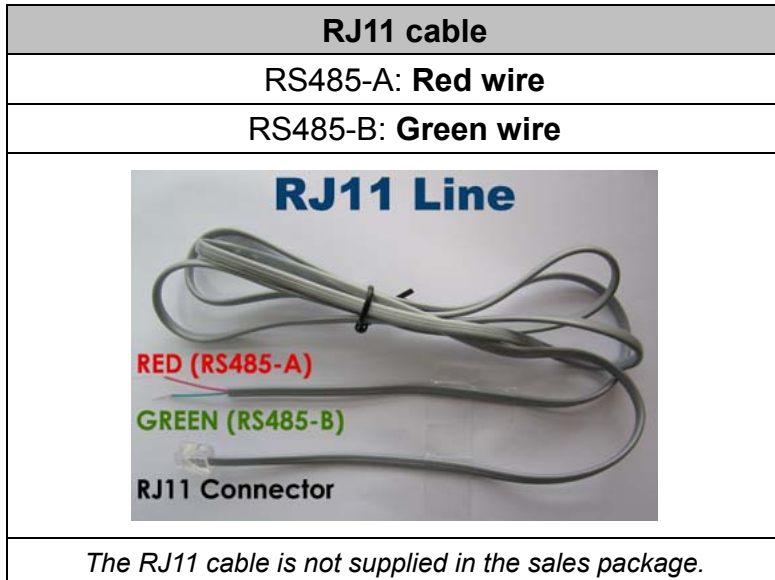

STEP 1: Get a RJ11 cable with the proper length to your connection.

Different RJ11 connector may have different wire layout, so the connection might be different. If you cannot control the DVR after connection, please reverse the RJ11 cable connection with the DVR.

STEP 2: Remove one end of the insulating coating of the RJ11 cable.

Remove one end of the insulating coating of the RJ11 cable to find the RS485-A and the RS485-B wires, and remove the insulating coating to reveal the naked wires for further connection.

STEP 3: Twist the RS485-A and RS485-B wires of the RJ11 cable and the speed dome camera together.

Twist the RS485-A (red) and RS485-B (green) wires of the RJ11 cable to the RS485-A (brown) and RS485-B (orange) wires of the speed dome camera. To protect the naked wires, use the insulation tape to cover on the twisted wires.

STEP 4: Connect the other end of the RJ11 cable to DVR.

Solder the RS485-A (red) and RS485-B (green) wires of the RJ11 cable to the corresponding pins on the solder side of the optional D-Sub connector.

For DVR PIN configuration, please refer to "APPENDIX 6 PIN CONFIGURATION" at page 56. For connection details, please check with your installer.

STEP 5: Set the speed dome camera at the DVR side.

- Go to “ADVANCED CONFIG” → “DEVICES” to set the speed dome camera.
- a) Select the device to “PTZ”.
 - b) Set the ID to the value the same as the one set in the speed dome camera.
The default ID of the camera is 000.
 - c) Select the protocol to “NORMAL”.
 - d) Set the baud rate to the value the same as the one set in the speed dome camera. The default baud rate of the camera is 2400.

ADVANCED CONFIG				
CAMERA	CH1	CH2	CH3	CH4
DETECTION	DEVICE			PTZ
ALERT	ID			000
NETWORK	PROTOCOL			NORMAL
DISPLAY	RATE			2400
RECORD				
DEVICES				
EXIT				

2.3 DVR Power On

This device should be operated only with the type of power source indicated on the manufacturer’s label. Connect the indicated AC power cord to the power adapter, and plug into an electrical outlet. Then, move the power switch to “I” to power on the DVR.

Note: Before the DVR is powered on, make sure the cameras are connected and power-supplied for the detection of the camera video system to be correct, and check the monitor (either LCD or CRT monitor) is connected to the DVR before the DVR is powered on for correct video output detection.



Note: To ensure that your DVR works constantly and properly, it's recommended to use an UPS, Uninterruptible Power Supply (Optional), for continuously operation.

2.4 Date and Time Setting

Before operating your DVR, please set the date and time on your DVR **FIRST**.

Note: Please DO NOT change the date or time of your DVR after the recording function is activated. Otherwise, the recorded data will be disordered and you will not be able to find the recorded file to backup by time search. If users change the date or time accidentally when the recording function is activated, it's recommended to clear all HDD data, and start recording again.

Note: For the first time to use the DVR, please power it on for at least 48 hours continuously after the date & time is set correctly. It helps to prevent DVR time from resetting after the disconnecting of DVR power. If the DVR time resets after the disconnecting of DVR power, for example, caused by a power outage, the battery might run out and please replace the battery as described in "APPENDIX 5 DVR BATTERY REPLACEMENT" at page 55.

Right-click to enter the DVR password with the password keypad. The default administrator password is 0000. The status will be changed from  (key lock) to  (administrator). Then, right-click to show the main menu, and select "QUICK START" → "TIME SETUP" to set the date & time.

QUICK START	
GENERAL	DATE 2009 / NOV / 17
TIME SETUP	TIME 15 : 35 : 53
EXIT	

2.5 Clear Hard Disk

It's recommended to clear all data in the hard disk for the first time to user this DVR to ensure the recorded data are not mixed with other data previously saved in the same hard disk.

Right-click to show the main menu, and select "SYSTEM" → "SYSTEM INFO" → "CLEAR HDD". The DVR will reboot when HDD data are cleared.

SYSTEM		
TOOLS	BAUD RATE	2400
SYSTEM INFO	HOST ID	000
BACKUP DATA (USB)	AUTO KEY LOCK	NEVER
BACKUP LOG (USB)	CLEAR HDD	HDD-0
	RESET DEFAULT	SUBMIT
	REMOTE CONTROL ID	000
	SERIAL TYPE	RS485
	VIDEO FORMAT	NTSC
	VERSION	1008-1004-1004-1001
EXIT		

2.6 Password Setting

Right-click to show the main menu, and select "SYSTEM" → "TOOLS" to change the DVR password.

There are two user levels: ADMIN & OPERATOR. For details, please refer to "4.4 User Level Switch" at page 14.

SYSTEM		
TOOLS	LANGUAGE	ENGLISH
SYSTEM INFO	ADMIN PASSWORD	SETUP
BACKUP DATA (USB)	OPERATOR PASSWORD	SETUP
BACKUP LOG (USB)	UPGRADE	SUBMIT
	BACKUP CONFIG	SUBMIT
	RESTORE CONFIG	SUBMIT
EXIT		

3. GUI DISPLAY WITH USB MOUSE CONTROL

3.1 Connect USB Mouse

Connect your USB mouse to one of the USB ports on the DVR front panel, and check if there's a mouse icon (🖱️) on the screen, indicating the USB mouse is detected properly. Move your mouse to enter the DVR password with the password keypad. The default administrator password is **0000**. The status will be changed from 🔒 (key lock) to 🗝️ (administrator), and the quick menu bar appears on the left side of the screen.

Note: There are two user levels for DVR access which can be set in the main menu "SYSTEM" → "TOOLS". For details, please refer to "4.4 User Level Switch" at page 14.

Password Input

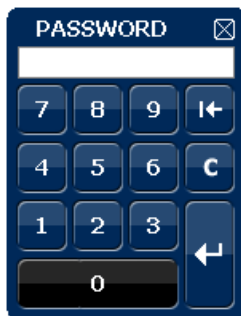

Quick Menu: Close







3.2 Quick Menu Bar

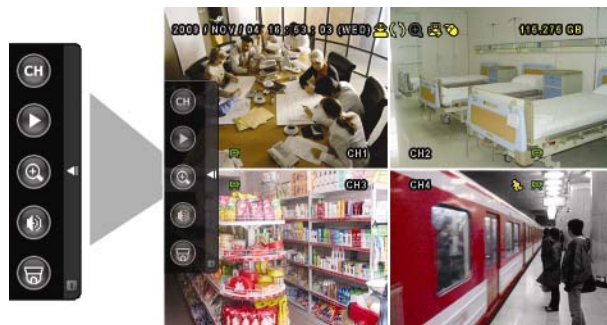

Move to the arrow mark to extend the quick menu bar and show the five functions as follows:



Quick Menu: Open



-  Click to show the channel switch panel and select the channel you want. For details, please refer to "3.2.1 Channel Switch" at page 10.

-  Click to display the playback control panel, and click  to play the latest recorded video clip, or click  to enter the search list. For details, please refer to "4.3 Playback" at page 13.

-  Switch to the channel you want first, and click  to enter the zoom-in mode. In this mode, click and drag the red frame on the bottom left of the screen to move to the place you want to see. To exit this mode, click .



-  Click to select the audio channel you want:
 In the live mode, only the live audio channels can be selected.
 In the playback mode, live and playback audio channels can be selected.
-  Click to enter the PTZ mode and show the PTZ camera control panel. For details, please refer to “3.2.2 PTZ Control Panel” at page 10.
-  Click to show the power off panel to either halt or reboot the system.

3.2.1 Channel Switch

Click  on the quick menu bar to display the panel as follows:

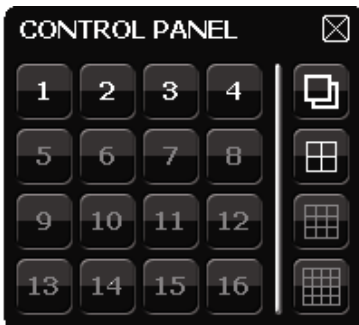
Note: The buttons available depend on the model you have.





1~4	Video Channel Number	Click to switch to the channel you want in full screen.
	Sequence Display	Click to display each channel in full screen one by one starting from CH1. When the last channel is displayed, it will repeat from CH1 again. When this function is on,  will be shown on the status bar.
	Quad Display	Press to show the 4-channel display mode.





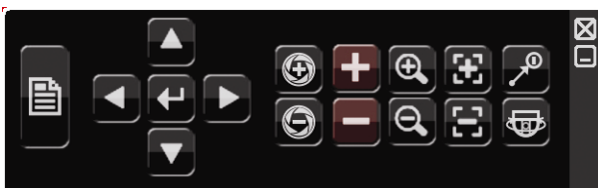

3.2.2 PTZ Control Panel

Note: In the PTZ control mode, hot point is supported to move the camera view to the specified point after a click.

Click  on the quick menu bar to display the panel as follows:



	Camera Menu	Click to enter the camera main menu. For details about each camera menu, please refer to its own user manual.
	Enter	Click to confirm your selection / enter the menu.

	Up / Down / Left / Right	Click to move your selection up / down / left / right, or change settings.
	Iris + / Iris -	This two buttons are designed for the PTZ camera which uses Pelco-D to control. To know the actions after clicking Iris + and Iris -, please refer to the camera's user manual.
	Zoom in / out max	Click to zoom in on the image to the largest / zoom out on the image to its original size.
	Zoom in / out	Click to zoom in / out the image.
	Focus near / far	Click to adjust the focus of the image.
	Auto mode	Click to activate the auto function. Before using it, you need to assign a specific function that will be enabled when "AUTO" is clicked. For details, please refer to the user manual of the PTZ camera.
	Preset point	Click to enter the PTZ preset point you want to see.







3.3 Main Menu

Right-click anywhere on the screen to show the main menu as follows, and right-click again to exit.

For details about the menu structure, please refer to "APPENDIX 4 MAIN MENU STRUCTURE" at page 53.

Main Menu



	QUICK START	Click to set the status display, image settings, and date & time.
	DATE SETUP	Click to set the date display and daylight saving.
	SYSTEM	Click to set the system configurations.
	EVENT INFORMATION	Click to enter the event search menu.
	ADVANCED CONFIG	Click to set CAMERA, DETECTION, ALERT, NETWORK, DISPLAY, RECORD and DEVICES.
	SCHEDULE SETTING	Click to set record timer, detection timer & alarm timer.

4. BASIC OPERATION

4.1 Live Page



Icon	Function	Icon	Function	Icon	Function
	Live audio channel (1~4)		Playback audio channel (1~4)		Audio channel off
	Digital zoom on		Digital zoom off		Timer recording
	Network disconnected		Internet connected		LAN connected
	USB mouse connected		USB flash drive / device connected		No USB device connected
	Key lock		PTZ mode on		HDD overwrite
	Administrator		Operator		Sequence
	Motion		Recording		Alarm
	Record mode: Frame		Record mode: Field		Record mode: CIF

4.2 Record Icon

1) Manual Recording

By defaults, manual recording is on () when the DVR is powered on and a HDD is installed.

2) Event Recording

When the motion detection or alarm is on, the motion icon () or alarm icon () shows on the screen for any motion or alarm event.

3) Timer Recording

When timer recording is on, you will see "" on the screen.

4) HDD Overwritten

By defaults, the HDD overwritten function is set to ON, and "" will be shown on the screen.

4.3 Playback

Click “▶” on the quick menu bar to display the playback control panel, and click ▶ to play the latest recorded video clip, or click 📄 to enter the search list.



Note: There must be at least 8192 images of recorded data for playback to work properly. If not, the device will stop playback. For example, if the IPS is set to 30, the recording time should be at least 273 seconds (8192 images / 30 IPS) for the playback to work properly.

Note: During playback, the image size of the recording (FRAME, FIELD or CIF) will be shown on the screen.

4.3.1 Playback Control

▶▶	Fast Forward	Increase the speed for fast forward. Click once to get 4X speed forward and click twice to get 8X speed, etc., and the maximum speed is 32X.
◀◀	Fast Rewind	Increase the speed for fast rewind. Click once to get 4X speed rewind and click twice to get 8X speed, etc., and the maximum speed is 32X.
▶ / ⏸	Play / Pause	Click to play the latest recorded video clip immediately, and click again to pause. In the pause mode, click ▶▶ once to get one frame forward, and click ◀◀ to get one frame rewind.
■	Stop	Click to stop the video playback.
▶▶▶	Slow Playback	Click once to get 1/4X speed playback, and click twice to get 1/8X speed playback.
◀ / ▶	Previous / Next Hour	Click to jump to the next / previous time interval in an hour, for example, 11:00 ~ 12:00 or 14:00 ~ 15:00, and start playing the earliest event video clip recorded during this whole hour.
A↔B	Repeat	Click to set point A and point B in a video clip, and the system will play only the specified range in that clip.
📄	Backup	Click to open the backup menu for video backup.

4.3.2 Event Search

Click  to quickly search the recorded files by event lists: RECORD / MOTION / ALARM / TIME, or select FULL to show all the event logs.

To quickly search the time you want, select “QUICK SEARCH”. Set the time range you want, and select “SUBMIT” to play the recorded video clip during the specified time.

4.3.3 Audio Playback

In the playback mode, click  on the quick menu bar as many times as needed to select live or playback audio from audio channel 1~4.



Live audio from audio channel 1~4 (indicated in white).





Playback audio from audio channel 1~4 (indicated in yellow).





Audio channel unselected

Note: To make a video backup with audio, make sure the camera which supports the audio function is connected to the video-in channel and audio-in channel. For example, the audio data from audio CH1 will be recorded with the video data from video CH1.

4.4 User Level Switch

In the key lock mode () , move your USB mouse to display the password input keypad. There are two user levels for accessing the DVR: Administrator () & Operator () .

When the administrator password is entered,  will be shown on the status bar of the screen and all operations are allowed. The default administrator password is 0000.

When the operator password is entered,  will be shown on the status bar of the screen, and the main menu is **NOT** allowed to access. The operator user level needs to be set in the main menu “SYSTEM” → “TOOLS”.

To switch between these two user levels, click the current user level icon to switch to the key lock mode, and move your mouse to show the password input keypad, and enter the password of the user level you want.

4.5 System Sources Reallocation

Go to “QUICK START” → “GENERAL”, and select “PRIORITY” to reallocate the system sources to live display and record.

There are two options for this function: RECORD FIRST / DISPLAY FIRST.

QUICK START		
GENERAL	CHANNEL TITLE	ON
TIME SETUP	EVENT STATUS	ON
	DATE DISPLAY	ON
	MOUSE SENSITIVITY	- + _____
	PRIORITY	RECORD FIRST
	RECORD CONFIG	SETUP
EXIT		

RECORD FIRST: When this option is selected, Full D1 at real-time record on all channels is available, and the VGA output resolution is fixed to 1024 x 768.

DISPLAY FIRST: When this option is selected, three VGA output resolutions will be available to choose (1024 x 768 / 1280 x 1024 / 1600 x 1200), but Full D1 real-time recording on all channels will not be available.

5. FREQUENTLY-USED FUNCTIONS

5.1 Quick Search

Press "LIST" on the DVR front panel to enter the time search menu as follows:

EVENT INFORMATION						
HARD DISK CHANNEL			ALL HDD			
			<input checked="" type="checkbox"/> 01 <input type="checkbox"/> 02 <input type="checkbox"/> 03 <input type="checkbox"/> 04			
<input type="button" value="◀"/> 2009 <input type="button" value="▶"/>		NOV				
SUN	MON	TUE	WED	THU	FRI	SAT
1	2	3	4	5	6	7
8	9	10	11	12	13	14
15	16	17	18	19	20	21
22	23	24	25	26	27	28
29	30					
<div style="display: flex; justify-content: space-between;"> 00 06 12 18 24 </div>						
15 : 20			SUBMIT			

Step1: Select the hard disk and channel including the video data you want to search.

Step2: Select the month including the video data you want to search from the calendar, and the date with recorded data will be highlighted.

Step3: Select the date you want from the calendar, and the time with recorded data will be highlighted from the time scale bar.

Step4: To immediately play the video clip, click "SUBMIT".

To choose the start time for video playback, move your mouse cursor to the highlighted time, and click to confirm the time when the time display below is the time you want. The video playback is activated right away when you confirm the time.

5.2 Record

5.2.1 Quick record setting

Right-click to display the main menu, and select “QUICK START” → “GENERAL” → “RECORD CONFIG”.

Click “SETUP” to enter the setting page individually for manual record, event record and timer record.

QUICK START	
GENERAL	CHANNEL TITLE ON
TIME SETUP	EVENT STATUS ON
	DATE DISPLAY ON
	MOUSE SENSITIVITY - +
	PRIORITY RECORD FIRST
	RECORD CONFIG SETUP
EXIT	

- a) Select the record type you want to set.
- b) In “CHANNEL”, select “ALL” to apply the changes here to all channels.

QUICK START				
MANUAL	EVENT	TIMER		
CHANNEL		IMAGE SIZE	I.P.S.	QUALITY
ALL		FRAME	120	SUPER BEST
				EXIT

Or, select “BY CHANNEL” to set the image size, image per second & image quality individually for each channel.

QUICK START				
MANUAL	EVENT	TIMER		
CHANNEL		IMAGE SIZE	I.P.S.	QUALITY
CH1		FRAME	30	SUPER BEST
CH2		FIELD	15	SUPER BEST
CH3		CIF	30	HIGH
CH4		FRAME	30	SUPER BEST
AVAILABLE IPS: CIF 180 / FIELD 90 / FRAME 45				
			APPLY	EXIT

5.2.2 Detailed record setting

Right-click to display the main menu, and select “ADVANCED CONFIG” → “RECORD”.

Note: Please DO NOT change the date or time of your DVR after the recording function is activated. Otherwise, the recorded data will be disordered and you will not be able to find the recorded file to backup by time search. If users change the date or time accidentally when the recording function is activated, it's recommended to clear all HDD data, and start recording again.

ADVANCED CONFIG		
CAMERA	MANUAL RECORD	ON
DETECTION	EVENT RECORD	ON
ALERT	TIMER RECORD	ON
NETWORK	PRE-ALARM RECORD	ON
DISPLAY	OVERWRITE	ON
RECORD	EVENT RECORD ALL CH	OFF
DEVICES	KEEP DATA LIMIT (DAYS)	OFF
	RECORD CONFIG	SETUP
EXIT		

1) MANUAL RECORD

Set the manual recording function on / off.

2) EVENT RECORD

Set the event recording function on / off.

3) TIMER RECORD

Set the timer recording function on / off.

4) PRE-ALARM RECORD

Select to enable or disable the pre-alarm function (ON / OFF).

When pre-alarm and event recording functions are both activated, the DVR will record 8MB data before an alarm / motion event is triggered.

5) OVERWRITE

Select “ON” to overwrite previous recorded data in your HDD when the HDD is full. When this function is on and the HDD is full, the DVR will clear 8GB data from the oldest for continuous recording without notice.

6) EVENT RECORD ALL CH

Select to record all channels (ON) or record the channel with an event only (OFF) for any event.

7) KEEP DATA LIMIT (DAYS)

Assign the maximum recording days from 01 to 31 after which all the recorded data will be removed, or select “OFF” to disable this function.

8) RECORD CONFIG

Please refer to “5.2.1 Quick record setting”.

5.3 Schedule Setting

Right-click to display the main menu, and select “SCHEDULE SETTING”.

5.3.1 Record Timer

Click “RECORD”. In “RECORD TIMER”, select “ON” to enable record timer, and select the day and time for this function.

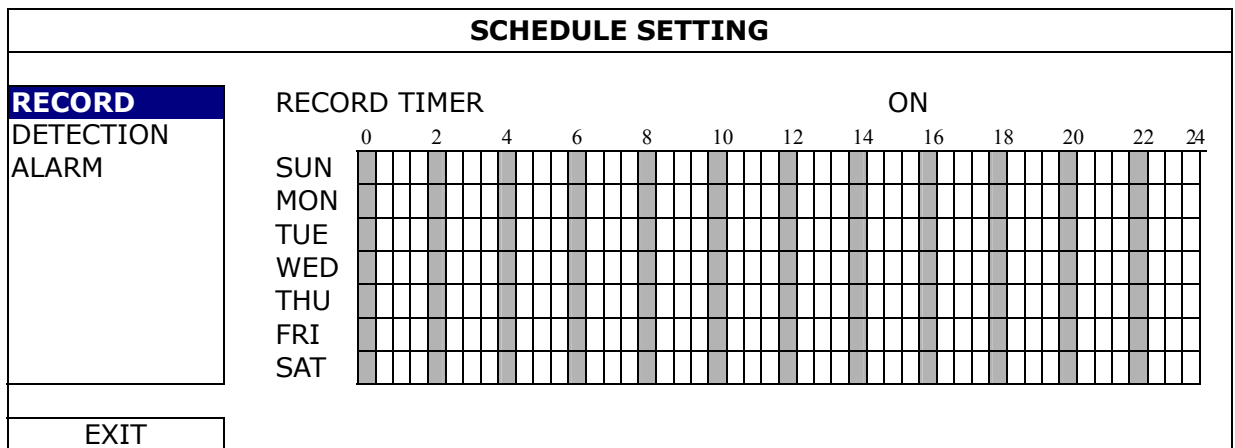

X axis: 0 ~ 24 hours. Each time bar is 30 minutes.

Y axis: Monday ~ Sunday.

5.3.2 Detection Timer

Click “DETECTION”. In “DETECTION TIMER”, select “ON” to enable record timer, and select the day and time for this function.

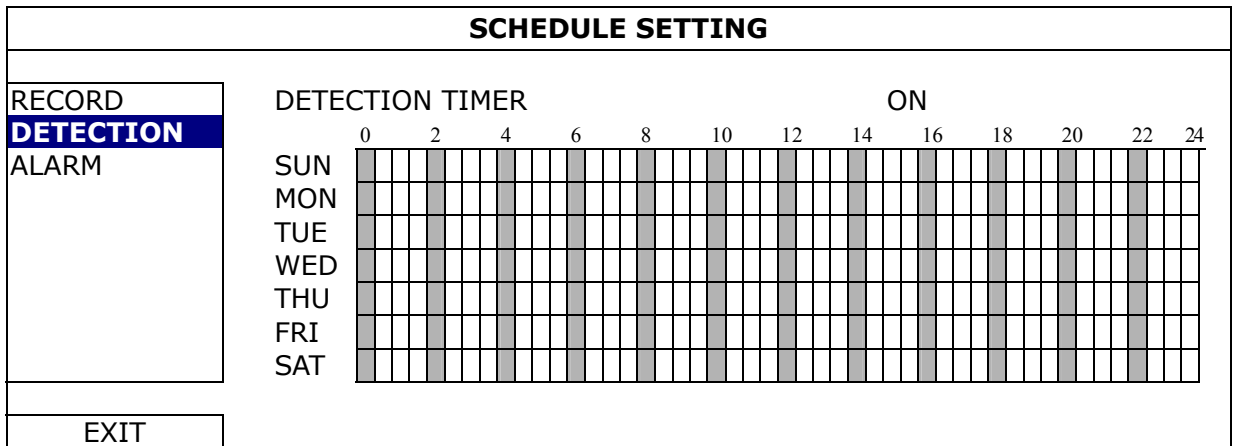

X axis: 0 ~ 24 hours. Each time bar is 30 minutes.

Y axis: Monday ~ Sunday.

5.3.3 Alarm Timer

Click “ALARM”. In “ALARM TIMER”, select “ON” to enable record timer, and select the day and time for this function.

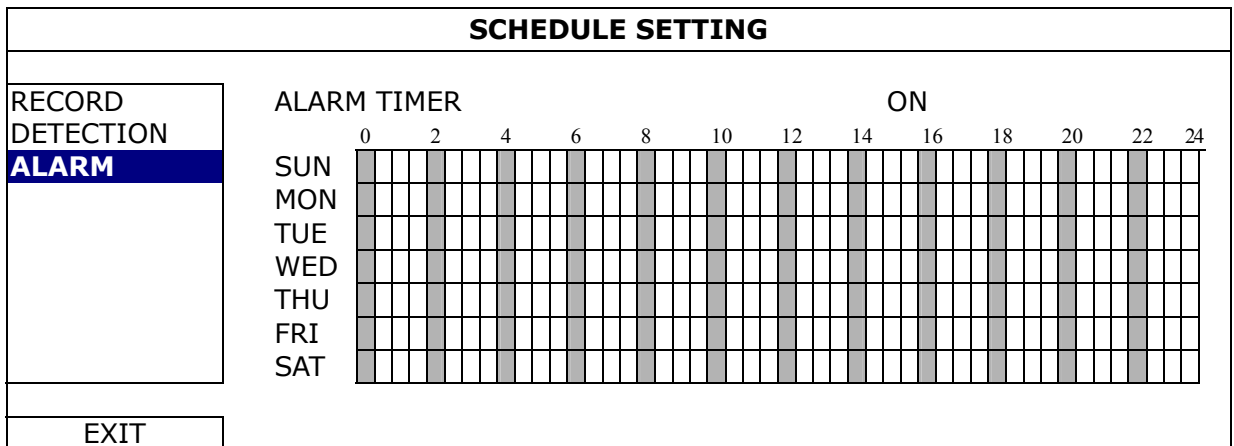

X axis: 0 ~ 24 hours. Each time bar is 30 minutes.

Y axis: Monday ~ Sunday.

5.4 Detection Setting

Right-click to display the main menu, and select “ADVANCED CONFIG” → “DETECTION”.

ADVANCED CONFIG				
CAMERA	CH1	CH2	CH3	CH4
DETECTION	LS			07
ALERT	SS			03
NETWORK	TS			02
DISPLAY	MOTION			OFF
RECORD	ALARM			OFF
DEVICES	AREA			EDIT
EXIT				

1) LS (Level of Sensitivity)

“LS” is to set the sensitivity of comparing two different images. The smaller the value is, the higher sensitivity for motion detection. The highest sensitivity setting is 00, and the lowest sensitivity setting is 15. The default value is 07.

2) SS (Spatial Sensitivity)

“SS” is to set the sensitivity for detecting the size of one object (the number of the grids) on the screen. The smaller the value is, the higher sensitivity for motion detection.

The highest sensitivity setting is 00, and the lowest sensitivity setting is 15. The default setting is 03.

Note: The default setting of SS is 03, which means once an object is detected more than 3 grids, the system will get triggered. So the value of SS must be less than the number of grids that you set up for the motion detection area.

3) TS (Time of Sensitivity)

“TS” is to set the sensitivity regarding how long one object stays in the detection area and triggers the recording. The smaller the value is, the higher sensitivity for motion detection.

The highest sensitivity setting is 00, and the lowest sensitivity setting is 15. The default setting is 02.

4) MOTION

Select if you want to activate the motion detection function for the selected channel (ON/OFF).

5) ALARM

Select N.C./ N.O depending on your installation need. The default alarm value is OFF.

6) AREA

Click “EDIT” to set the motion detection area.

There are 16 × 12 grids per camera for all channels. Pink blocks represent the area that is not being detected while the transparent blocks are the area under detection.

5.5 PTZ Camera Setting

Right-click to display the main menu, and select “ADVANCED CONFIG” → “DEVICES”.

ADVANCED CONFIG				
CAMERA DETECTION ALERT NETWORK DISPLAY RECORD DEVICES	CH1	CH2	CH3	CH4
	DEVICE			PTZ
	ID			00
	PROTOCOL			NORMAL
	RATE			2400
EXIT				

1) DEVICE

For the PTZ camera, select “PTZ”.

2) ID

Click the current value to set the ID number (0 ~ 255) for the connected PTZ camera if necessary.

Make sure the ID setting of the camera is the same as the setting here, or the DVR will not be able to control the device.

Note: To know the default ID of the PTZ camera, please refer to its user manual.

3) PROTOCOL

Select NORMAL (our protocol), P-D (PELCO-D) or P-P (PELCO-P) protocol.

4) RATE

Select the baud rate for the connected PTZ camera (2400 / 4800 / 9600 / 19200 / 57600 / 115200).

Make sure the baud rate setting of the camera is the same as the setting here, or the DVR will not be able to control the device.

Note: To know the default baud rate of the PTZ camera, please refer to its user manual.

5.6 System Setting

5.6.1 Password Setting

Right-click to display the main menu, and select “SYSTEM” → “TOOLS”.

SYSTEM		
TOOLS	LANGUAGE	ENGLISH
SYSTEM INFO	ADMIN PASSWORD	SETUP
BACKUP DATA (USB)	OPERATOR PASSWORD	SETUP
BACKUP LOG (USB)	UPGRADE	SUBMIT
	BACKUP CONFIG	SUBMIT
	RESTORE CONFIG	SUBMIT
EXIT		

1) ADMIN PASSWORD

Click “SETUP” to change the administrator password. The default administrator password is **0000**.

When you’re prompted to enter the DVR password, enter the administrator password, and  will be shown on the status bar of the screen and all operations are allowed.

2) OPERATOR PASSWORD

Click “SETUP” to set or change the operator password. .

When you’re prompted to enter the DVR password, enter the operator password, and  will be shown on the status bar of the screen and the main menu is **NOT** allowed to access.

5.6.2 System Upgrade

Note: DVR system upgrade might cause all HDD data cleared when your current system version is too old from the latest version. Therefore, before upgrading the DVR system, check your current firmware version with your installer or distributor, and make video backup if necessary.

Right-click to display the main menu, and select “SYSTEM” → “TOOLS” → “UPGRADE”.

Save the upgrade files obtained from your installer or distributor in a compatible USB flash drive, and insert it into the USB port at the front panel.

Then, click “SUBMIT” to start upgrading.

Note: Before using the USB flash drive, please use your PC to format the USB flash drive to FAT32 format first. For the list of compatible USB flash drives, please refer to "APPENDIX 2 COMPATIBLE USB FLASH DRIVE LIST" at page 51.

5.6.3 Backup & Restore Configurations

Right-click to display the main menu, and select "SYSTEM" → "TOOLS" → "BACKUP CONFIG" or "RESTORE CONFIG".

These two functions allows users to keep the current configurations after DVR upgrade, or copy one DVR configurations to another DVR if necessary.

Insert a compatible USB flash drive into the USB port *before upgrading DVR*, and select "SUBMIT" in "BACKUP CONFIG" to copy the current DVR configurations to a file "System.bin" and save to your USB flash drive.

To restore DVR configurations after upgrading DVR, insert the USB flash drive including "System.bin" to the USB port, and select "SUBMIT" in "RESTORE CONFIG".

5.6.4 Video Backup

Right-click to display the main menu, and select "SYSTEM" → "BACKUP DATA (USB)".

Insert a compatible USB flash drive to the USB port at the front panel.

Note: Before using the USB flash drive, please use your PC to format the USB flash drive to FAT32 format first. For the list of compatible USB flash drives, please refer to "APPENDIX 2 COMPATIBLE USB FLASH DRIVE LIST" at page 51.

SYSTEM	
TOOLS SYSTEM INFO BACKUP DATA (USB) BACKUP (DVD) BACKUP LOG (USB)	START DATE 2009/NOV/19 START TIME 08:30:21 END DATE 2009/NOV/19 END TIME 17:59:29 CHANNEL <input checked="" type="checkbox"/> 01 <input type="checkbox"/> 02 <input type="checkbox"/> 03 <input type="checkbox"/> 04 HARD DISK ALL HDD BACKUP SUBMIT REQUIRE SIZE: 554MB SUBMIT
EXIT	AVAILABLE SIZE: 3788.0MB

- 1) START DATE / START TIME
Select the start date & time.
- 2) END DATE / TIME
Select the end date & time.
- 3) CHANNEL
Click to select the channel(s).
- 4) HARD DISK
Select the hard disk containing the video data you need or "ALL HDD".
- 5) BACKUP
Click "SUBMIT" to start backup.
- 6) REQUIRE SIZE
To know the size of the expected backup video before backup, click "SUBMIT" to start calculating.

■ Backup File Playback

During the backup process, a file player installer "PLAYER.EXE" will also be copied into your USB flash drive, and you will see the message "CHECK PLAYER" shown on the screen.

Insert your USB flash drive to your PC. Install the file player "PLAYER.EXE", and double click a backup file to play it directly in your PC and see if the backup is successful.

Note: The supported PC operating systems are Windows 7, Vista & XP.

5.6.5 Record Log Backup

Right-click to display the main menu, and select “SYSTEM” → “BACKUP LOG (USB)”
 This function is used to backup the record log list.

Insert a compatible USB flash drive to the USB port at the front panel.

Note: Before using the USB flash drive, please use your PC to format the USB flash drive to FAT32 format first. For the list of compatible USB flash drives, please refer to “APPENDIX 2 COMPATIBLE USB FLASH DRIVE LIST” at page 51.

SYSTEM	
TOOLS SYSTEM INFO BACKUP DATA (USB) BACKUP DATA (DVD) BACKUP LOG (USB)	START DATE 2009/NOV/19 START TIME 08:30:21 END DATE 2009/NOV/19 END TIME 17:59:29 CHANNEL <input checked="" type="checkbox"/> 01 <input type="checkbox"/> 02 <input type="checkbox"/> 03 <input type="checkbox"/> 04 DATA TYPE SETUP BACKUP SUBMIT
EXIT	

- 1) START DATE / START TIME
 Select the start date & time.
- 2) END DATE / TIME
 Select the end date & time.
- 3) CHANNEL
 Click to select the channel(s).
- 4) DATA TYPE
 Click “SETUP” to select the event type you want: MANUAL / MOTION / ALARM / SYSTEM / TIMER, or select “SELECT ALL” to choose all event types.
- 5) BACKUP
 Click “SUBMIT” to start backup. You’ll see a log file (.csv) in the flash drive.

5.6.6 Clear All HDD Data

Right-click to show the main menu, and select “SYSTEM” → “SYSTEM INFO” → “CLEAR HDD”.

SYSTEM		
TOOLS	BAUD RATE	2400
SYSTEM INFO	HOST ID	000
BACKUP DATA (USB)	AUTO KEY LOCK	NEVER
BACKUP LOG (USB)	CLEAR HDD	HDD-0
	RESET DEFAULT	SUBMIT
	REMOTE CONTROL ID	000
	SERIAL TYPE	RS485
	VIDEO FORMAT	NTSC
	VERSION	1008-1004-1004-1001
EXIT		

Select the HDD you want to clear, and click “YES” to confirm or “NO” to cancel.

It's recommended to clear all data in the hard disk when:

- It's the first time to use this DVR to ensure the recorded data are not mixed with other data previously saved in the same hard disk.
- DVR date and time are changed accidentally when the recording function is activated. Otherwise, the recorded data will be disordered and you will not be able to find the recorded file to backup by time search.

5.7 Network

5.7.1 STATIC

ADVANCED CONFIG					
CAMERA	NETWORK	SNTP	FTP	E-MAIL	DDNS
DETECTION	NETWORK TYPE	STATIC			
ALERT	IP	192.168.001.010			
NETWORK	GATEWAY	192.168.001.254			
DISPLAY	NETMASK	255.255.255.000			
RECORD	PRIMARY DNS	168.095.001.001			
DEVICES	SECONDARY DNS	139.175.055.244			
	PORT	0080			
EXIT					

1) NETWORK TYPE

Select the network type as STATIC and set all the information needed in the DVR.

2) NETWORK INFORMATION (IP / GATEWAY / NETMASK)

Key in all the network information obtained from your ISP (Internet Service Provider).

3) DNS (PRIMARY DNS / SECONDARY DNS)

Key in the IP address of the domain name server obtained from your ISP (Internet Service Provider).

4) PORT

The valid number ranges from 1 to 9999. The default value is 80. Typically, the TCP port used by HTTP is 80. However in some cases, it is better to change this port number for added flexibility or security.

5.7.2 PPPOE

Note: When PPPOE configuration is completed, please move to “DDNS” to configure the DDNS service.

ADVANCED CONFIG	
CAMERA	NETWORK SNTP FTP E-MAIL DDNS
DETECTION	NETWORK TYPE PPPOE
ALERT	IP 192.168.001.010
NETWORK	GATEWAY 192.168.001.254
DISPLAY	NETMASK 255.255.255.000
RECORD	PRIMARY DNS 168.095.001.001
DEVICES	SECONDARY DNS 139.175.055.244
	PORT 0080
	USER NAME OFFICE
	PASSWORD ●●●●●●
EXIT	

1) NETWORK TYPE

Select the network type as PPPOE and set all the information needed in the DVR.

2) DNS (PRIMARY DNS / SECONDARY DNS)

Key in the IP address of the domain name server obtained from your ISP (Internet Service Provider).

3) PORT

The valid number ranges from 1 to 9999. The default value is 80. Typically, the TCP port used by HTTP is 80. However in some cases, it is better to change this port number for added flexibility or security.

4) USER NAME / PASSWORD

Set “username” and “password” subscribed from your ISP supplier.

5.7.3 DHCP

Note: When DHCP configuration is completed, please move to “DDNS” to configure the DDNS service.

ADVANCED CONFIG	
CAMERA	NETWORK SNTP FTP E-MAIL DDNS
DETECTION	NETWORK TYPE DHCP
ALERT	IP 192.168.001.010
NETWORK	GATEWAY 192.168.001.254
DISPLAY	NETMASK 255.255.255.000
RECORD	PRIMARY DNS 168.095.001.001
DEVICES	SECONDARY DNS 139.175.055.244
	PORT 0080
EXIT	

1) NETWORK TYPE

Select the network type as DHCP.

2) DNS (PRIMARY DNS / SECONDARY DNS)

Key in the IP address of the domain name server obtained from your ISP (Internet Service Provider).

3) PORT

The valid number ranges from 1 to 9999. The default value is 80. Typically, the TCP port used by HTTP is 80. However in some cases, it is better to change this port number for added flexibility or security.

5.7.4 DDNS

You need to additionally set DDNS when your network type is PPPOE or DHCP.

We have our own DDNS server for quick DDNS service configuration. You don't need to additionally apply a DDNS service.

- To use our own DDNS server, select “default” in “SYSTEM NAME”.
- The default host name is the MAC address of the DVR.
Then, note down the whole address under “CURRENT HOST ADDRESS”, such as *MAC000E5318B3F0@ddns.dvrtw.com.tw*. This is the default IP address used to access your DVR remotely.

Note: Please at least use the default address to access your DVR remotely once. This is to ensure our DDNS server has your DVR registered. Then, you may change the host name to a more meaningful name to memorize later here.

Note: If you want to additionally apply a DDNS service instead of using ours, please refer to <http://www.surveillance-download.com/user/CMS.pdf> and check "Appendix 2" for details.

ADVANCED CONFIG																										
CAMERA DETECTION ALERT	<table border="1"> <thead> <tr> <th>NETWORK</th> <th>SNTP</th> <th>FTP</th> <th>E-MAIL</th> <th>DDNS</th> </tr> </thead> <tbody> <tr> <td>DDNS</td> <td></td> <td></td> <td></td> <td>ON</td> </tr> <tr> <td>SYSTEM NAME</td> <td></td> <td></td> <td></td> <td>default</td> </tr> <tr> <td>HOST NAME</td> <td></td> <td></td> <td></td> <td>MAC000E5318B3F0</td> </tr> <tr> <td>EMAIL</td> <td></td> <td></td> <td></td> <td>EMPTY</td> </tr> </tbody> </table>	NETWORK	SNTP	FTP	E-MAIL	DDNS	DDNS				ON	SYSTEM NAME				default	HOST NAME				MAC000E5318B3F0	EMAIL				EMPTY
NETWORK	SNTP	FTP	E-MAIL	DDNS																						
DDNS				ON																						
SYSTEM NAME				default																						
HOST NAME				MAC000E5318B3F0																						
EMAIL				EMPTY																						
NETWORK																										
DISPLAY RECORD DEVICES																										
EXIT	CURRENT HOST ADDRESS MAC000E5318B3F0@ddns.dvrtw.com.tw																									

5.8 Event Notifications

It's available to set event notifications to FTP / E-Mail from this DVR.

Note: This function requires Internet access. Please make sure your Internet access is available for this function to work properly.

5.8.1 FTP

When this function is enabled and an event occurs, a html file including a link will be sent to the specified FTP site. Click the link to access to this DVR and check the event recording.

ADVANCED CONFIG																																				
CAMERA DETECTION ALERT	<table border="1"> <thead> <tr> <th>NETWORK</th> <th>SNTP</th> <th>FTP</th> <th>E-MAIL</th> <th>DDNS</th> </tr> </thead> <tbody> <tr> <td>FTP ALERT</td> <td></td> <td></td> <td></td> <td>ON</td> </tr> <tr> <td>USER NAME</td> <td></td> <td></td> <td></td> <td>MANAGER</td> </tr> <tr> <td>PASSWORD</td> <td></td> <td></td> <td></td> <td>●●●●●●</td> </tr> <tr> <td>SERVER</td> <td></td> <td></td> <td></td> <td>192.168.2.32</td> </tr> <tr> <td>PORT</td> <td></td> <td></td> <td></td> <td>0021</td> </tr> <tr> <td>DIRECTORY</td> <td></td> <td></td> <td></td> <td>UPLOAD</td> </tr> </tbody> </table>	NETWORK	SNTP	FTP	E-MAIL	DDNS	FTP ALERT				ON	USER NAME				MANAGER	PASSWORD				●●●●●●	SERVER				192.168.2.32	PORT				0021	DIRECTORY				UPLOAD
NETWORK	SNTP	FTP	E-MAIL	DDNS																																
FTP ALERT				ON																																
USER NAME				MANAGER																																
PASSWORD				●●●●●●																																
SERVER				192.168.2.32																																
PORT				0021																																
DIRECTORY				UPLOAD																																
NETWORK																																				
DISPLAY RECORD REMOTE																																				
EXIT																																				

5.8.2 E-MAIL

When this function is enabled and an event occurs, a html file including a link will be sent to the specified E-mail address. Click the link to access to this DVR and check the event recording.

ADVANCED CONFIG					
CAMERA	NETWORK	SNTP	FTP	E-MAIL	DDNS
DETECTION	E-MAIL ALERT				ON
ALERT	SMTP SERVER				SMTP.GMAIL.COM
NETWORK	PORT				465
DISPLAY	MAIL FROM				MANAGER
RECORD	SSL ENCRYPTION				ON
REMOTE	VERIFY PASSWORD				ON
	USER NAME				MANAGER
	PASSWORD				●●●●●●
	RECEIVER				SETUP
EXIT					

5.9 VGA Output Resolution Support

Users are allowed to change the resolution depending on their display monitor.

Right-click to display the main menu, and select “ADVANCED CONFIG” → “DISPLAY”.

ADVANCED CONFIG		
CAMERA	FULL SCREEN DURATION	03
DETECTION	DISPLAY COVERT	ON
ALERT	HDD DISPLAY MODE	HDD SIZE
NETWORK	VGA OUTPUT	1024 x 768
DISPLAY	ALPHA BLENDING	200
RECORD		
DEVICES		
EXIT		

Move to “VGA OUTPUT”, and select the VGA resolution you want. There are three options as follows:

- 1024 x 768 (default)
- 1280 x 1024
- 1600 x 1200

Note: To have the best image quality on your LCD monitor, make sure (1) the selected DVR VGA output resolution is supported by your monitor, and (2) the VGA output settings on both the LCD monitor and DVR are consistent. If the image is not positioned or scaled properly, please go to your monitor’s menu for adjustment. For details, please refer to the user manual of your LCD monitor.

5.10 System Sources Reallocation

This function is used to reallocate the system sources to live display & record.

There are two options for this function: RECORD FIRST / DISPLAY FIRST.

QUICK START		
GENERAL	CHANNEL TITLE	ON
TIME SETUP	EVENT STATUS	ON
	DATE DISPLAY	ON
	MOUSE SENSITIVITY	- █ + _____
	PRIORITY	RECORD FIRST
	RECORD CONFIG	SETUP
EXIT		

RECORD FIRST: When this option is selected, Full D1 at real-time record on all channels is available, and the VGA output resolution is fixed to 1024 x 768.

DISPLAY FIRST: When this option is selected, three VGA output resolutions will be available to choose (1024 x 768 / 1280 x 1024 / 1600 x 1200), but Full D1 real-time recording on all channels will not be available.

6. REMOTE OPERATION

You can also control the DVR remotely via the supplied licensed software “Video Viewer”, Internet Explorer web browser, and Apple’s QuickTime player.

Note: For more details about mobile surveillance via your smart phones, please visit our official website www.eagleeyesctv.com, or download the instructions of EagleEyes installation and configuration from www.surveillance-download.com/user/eagleeyes_quick.pdf.

6.1 Supplied Licensed Software

The sections below describe frequently-used functions of the Video Viewer. For details about this software and network settings, please download its extended user manual from the following link:

<http://www.surveillance-download.com/user/CMS.pdf>

6.1.1 Installation & Network Connection

1) Install the software

Step1: Place the supplied CD into your CD-ROM or DVD-ROM drive. The program will be automatically run.

Step2: Click “Download The Latest Version” under “Licensed Software AP” to download the latest version of Video Viewer from the Internet.

Step3: Follow the on-screen instructions to finish the installation. When the installation is completed, a shortcut icon “” will be placed on your PC desktop.



2) Network Connection

➤ Local Connection (via LAN)



LAN is used when it’s the first time to remotely access the DVR and you need to configure the network setting of your DVR based on your network type in advance.

a) Connect the DVR to your PC via a RJ45 network cable. The default DVR values are as follows:

Item	Default Value
IP address	192.168.1.10
User name	admin
Password	admin
Port	80



- b) Set the PC's IP address as "192.168.1.XXX" (1~255, except 10) in order to make the PC and DVR under the same domain.
- c) Double-click  icon on your PC desktop to enter the control panel. By defaults, the "Address Book" panel will be displayed on the right side of the control panel.
- d) Click  →  to key in the default IP address, user name, password, and port number of the DVR you intend to connect.

OR



- Click  →  to search the available IP address(es) of other DVR(s) under the same domain as your PC's IP address. The found address(es) will be listed, and can be added into the address book by clicking .
- e) Double-click the IP address you just added into the address book to log in.

➤ Remote Connection (via Internet)

When the network configuration of your DVR is completed, you can access your DVR remotely via Internet.

- a) Double-click  icon on your PC desktop to enter the control panel. By defaults, the "Address Book" panel will be displayed on the right side of the control panel.
- b) Click  →  to key in the IP address, user name, password, and port number of the DVR you intend to connect.







OR

- Click  →  to search the available IP address(es) of other DVR(s) under the same domain as your PC's IP address. The found address(es) will be listed, and can be added into the address book by clicking .
- c) Double-click the IP address you just added into the address book to log in.

6.1.2 Control Panel Overview







Two control panels are available and can be switched depending on your use habit.





Simplified Version (Default)

-  Address Book
-  Miscellaneous Control
-  Log
-  Record
-  Snapshot
-  Information
-  DVR Control

Event Notification & Quick Checklist 



-  Version
-  Minimize
-  Full Function Display Switch
-  Close Program
-  180° Counterclockwise Image Rotation
-  Snapshot

-  Close All Display Views
-  Close Current View
-  Original Size
-  Full Screen
-  Display Mode Switch

 Audio Volume
(For selected models only)

Full Function Version

Event Notification & Quick Checklist

180° Counterclockwise Image Rotation

Snapshot

Information

Close Program

Simplified Display Switch

Minimize

Version



Close All Display Views

Close Current View

Original Size

Full Screen

Display View: 1-Cut

Display View: 4-Cut

Display View: 6-Cut

Display View: 9-Cut

Display View: 13-Cut

Display View: 16-Cut

Emap

Audio Volume
(For selected models only)

Record

Snapshot

Miscellaneous Control

Log









Setting

DVR Control

PTZ control



Main Button Overview

Button		Function	Description		
Simplified	Full Function				
		Address Book	Click to show the predefined IP address(es). You can add, remove or search the IP address to log in the DVR remotely.		
		Miscellaneous Control		Remote Config	Click to go into the detailed DVR setting.
				Record Setting	Click to go to the detailed record setting.
				Custom Setting	Click to choose the language of this program. The language change will take effect when this program is closed and executed again.
		Log	Click to view all event and recording logs, search the desired log(s) by date, or playback the		

Button		Function	Description
Simplified	Full Function		
			recording of the selected log.
		Record / Record Stop	Click to start / stop the manual recording.
		Snapshot	Click to take a snapshot of the current view. The snapshot will be saved in the path you specified in "Record Setting".
		Information	Click to show the current network connection details.
		DVR Control	Click to go to the DVR control panel to operate the DVR remotely.

6.1.3. General Operation

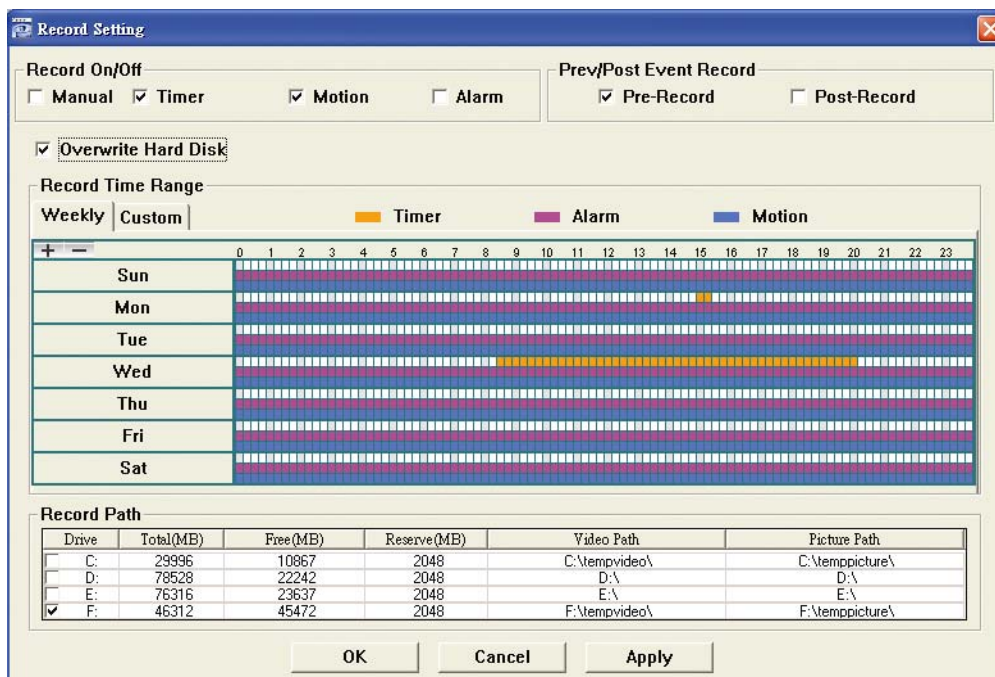

Record

To record remotely at the same time for any event or alarm at the DVR side, click  or  →  to go to the "Record Setting" page.





In the "Record Setting" page, you can set the following items:

- Record type
- Hard disk overwriting
- Pre- / post-alarm record
- Record time setting
- Record path

If “Manual” is checked, click  or  on the main control panel to start the manual recording immediately, and the recordings will be saved in the specified location.

If “Motion” and / or “Alarm” are checked, the recording function will also be enabled at the remote side when any event is triggered at the DVR side, and the recordings will be saved in the specified location.

Playback

To play a recording, click  or , and select the “Record” tab or “Backup” tab. A list of all the recordings will be shown by defaults, and you can also sort out the logs you want to speed up the search time.

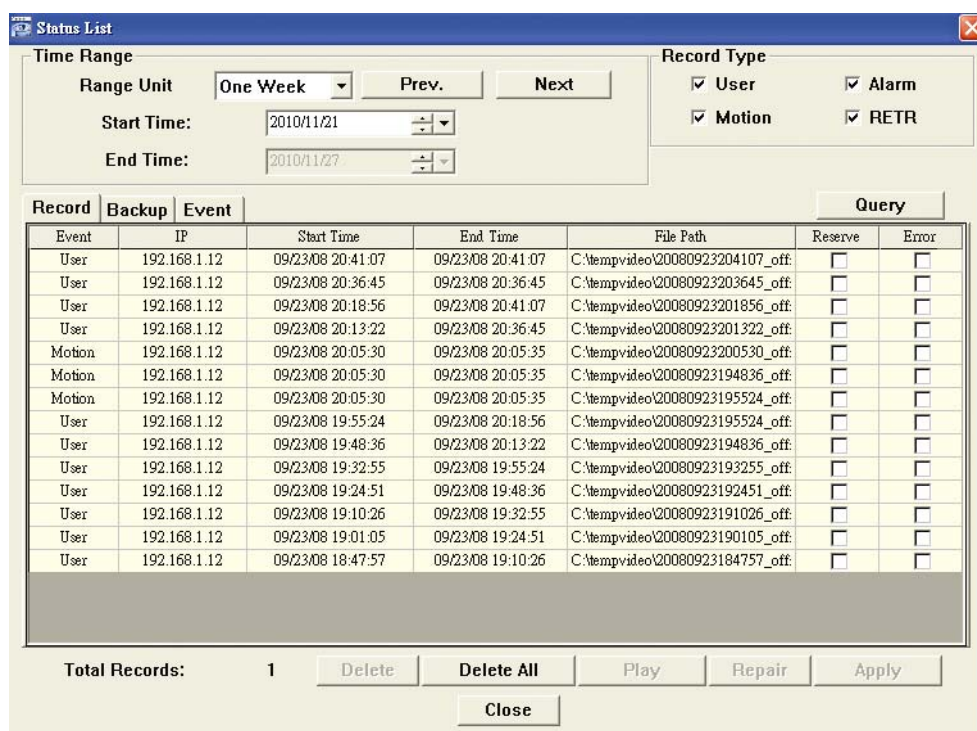

Status List

Time Range
 Range Unit: One Week Prev. Next
 Start Time: 2010/11/21
 End Time: 2010/11/27

Record Type
 User Alarm
 Motion RETR



Record Backup Event Query

Event	IP	Start Time	End Time	File Path	Reserve	Error
User	192.168.1.12	09/23/08 20:41:07	09/23/08 20:41:07	C:\tempvideo\20080923\204107_off.	<input type="checkbox"/>	<input type="checkbox"/>
User	192.168.1.12	09/23/08 20:36:45	09/23/08 20:36:45	C:\tempvideo\20080923\203645_off.	<input type="checkbox"/>	<input type="checkbox"/>
User	192.168.1.12	09/23/08 20:18:56	09/23/08 20:41:07	C:\tempvideo\20080923\201856_off.	<input type="checkbox"/>	<input type="checkbox"/>
User	192.168.1.12	09/23/08 20:13:22	09/23/08 20:36:45	C:\tempvideo\20080923\201322_off.	<input type="checkbox"/>	<input type="checkbox"/>
Motion	192.168.1.12	09/23/08 20:05:30	09/23/08 20:05:30	C:\tempvideo\20080923\200530_off.	<input type="checkbox"/>	<input type="checkbox"/>
Motion	192.168.1.12	09/23/08 20:05:30	09/23/08 20:05:35	C:\tempvideo\20080923\194836_off.	<input type="checkbox"/>	<input type="checkbox"/>
Motion	192.168.1.12	09/23/08 20:05:30	09/23/08 20:05:35	C:\tempvideo\20080923\195524_off.	<input type="checkbox"/>	<input type="checkbox"/>
User	192.168.1.12	09/23/08 19:55:24	09/23/08 20:18:56	C:\tempvideo\20080923\195524_off.	<input type="checkbox"/>	<input type="checkbox"/>
User	192.168.1.12	09/23/08 19:48:36	09/23/08 20:13:22	C:\tempvideo\20080923\194836_off.	<input type="checkbox"/>	<input type="checkbox"/>
User	192.168.1.12	09/23/08 19:32:55	09/23/08 19:55:24	C:\tempvideo\20080923\193255_off.	<input type="checkbox"/>	<input type="checkbox"/>
User	192.168.1.12	09/23/08 19:24:51	09/23/08 19:48:36	C:\tempvideo\20080923\192451_off.	<input type="checkbox"/>	<input type="checkbox"/>
User	192.168.1.12	09/23/08 19:10:26	09/23/08 19:32:55	C:\tempvideo\20080923\191026_off.	<input type="checkbox"/>	<input type="checkbox"/>
User	192.168.1.12	09/23/08 19:01:05	09/23/08 19:24:51	C:\tempvideo\20080923\190105_off.	<input type="checkbox"/>	<input type="checkbox"/>
User	192.168.1.12	09/23/08 18:47:57	09/23/08 19:10:26	C:\tempvideo\20080923\184757_off.	<input type="checkbox"/>	<input type="checkbox"/>

Total Records: 1 Delete Delete All Play Repair Apply Close

To immediately play a recording, select a log from the list, and click “Play”, or double-click the selected log.

Network Backup

Click  → , or click  to go into the “Backup” page as follows, and you can select a specific time range or event to make a video backup remotely.

The file(s) you backup will be from the currently selected IP address.

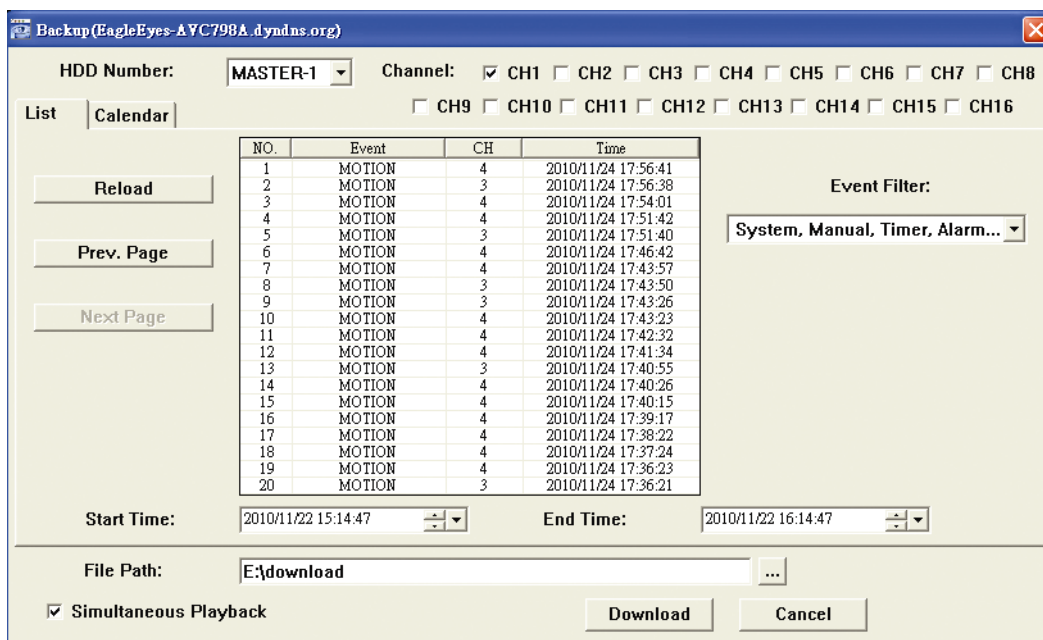

Function	Description
HDD Number / Channel	Specify the hard disk (HDD Number) and channel number (Channel) within which have the video data you need.
Download by Time	Specify the time range within which has the video data you want in the "Start Time" and "End Time" columns.
Download by Event	<p>Select an event log from the event list. This list shows all logs in the specified DVR from the latest to the earliest.</p> <ul style="list-style-type: none"> To quickly find the events you need, check or uncheck the event type "System" / "Manual" / "Alarm" / "Motion", and select the log you want. To view the earlier or later logs that are not shown in the current page, click "Prev. Page" or "Next Page". To refresh the event list, click "Reload".
File Path	Assign the location where the backup files are saved.
Simultaneous Playback	<p>To view the backup images simultaneously when the download process is in progress, select the checkbox "Simultaneous Playback". You will see the backup images while the images are being downloaded to the PC or notebook.</p> <p>To simply backup images without previewing, deselect the checkbox "Simultaneous Playback". You will only see a message box indicating the total time needed, the current status and the saving location.</p>
Download / Cancel	Click "Download" to start or "Cancel" to discard the video backup.

Firmware Upgrade

This function is used to grade your DVR for function scalability.

Note: Before using this function, make sure you have the correct upgrade files provided by your installer or distributor.

Step1: Click “”, and select the IP address of your device in the address book.

Step2: Click “” to show the upgrade page, “Update Server”.

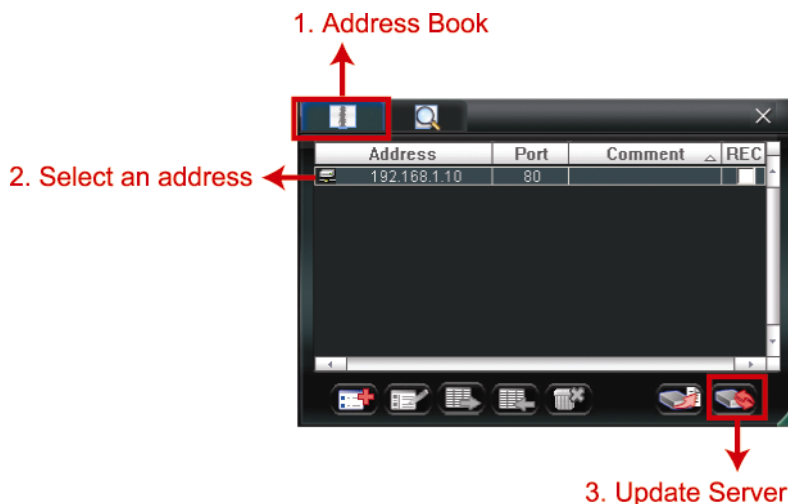

Step3: Click “Add” to browse to the upgrade files.

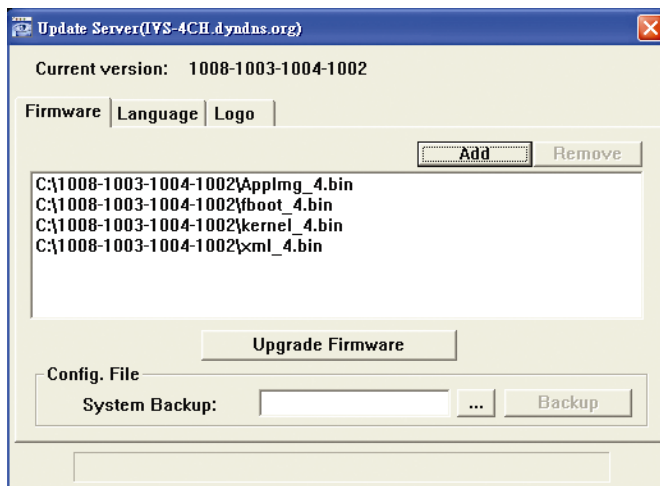

Step4: Click “Upgrade Firmware” to start firmware upgrade.

Note: It takes a few minutes to finish the upgrade process. Do not disconnect the power during firmware upgrade, or the upgrade may be failed. The device will reboot after the upgrade.

Step5: Select the IP address of the device and click “” again to check if the firmware is upgraded.



6.1.4. E-Map

Video Viewer is also a Central Management System (CMS) software, which allows network device control & management for up to 16 devices simultaneously.

Note: Before using this function, make sure Video Viewer is connected to all the devices (up to 16) you want to monitor.

E-Map is **ONLY** available when the control panel is switch to the full function version.

How to Add an E-Map Group

STEP1: In the simplified version, click “” to switch the control panel to the full function version, and click “” to enter the E-Map page as follows.

Note: To know where the buttons are, please refer to “Simplified Version (Default)” at page 35, and “Full Function Version” at page 36.



STEP2: Right-click to show the shortcut menu on the top-left panel, and select the E-Map group you want to add. There are three E-Map groups you can add: Google E-MAP, Single E-MAP, and Building E-MAP.

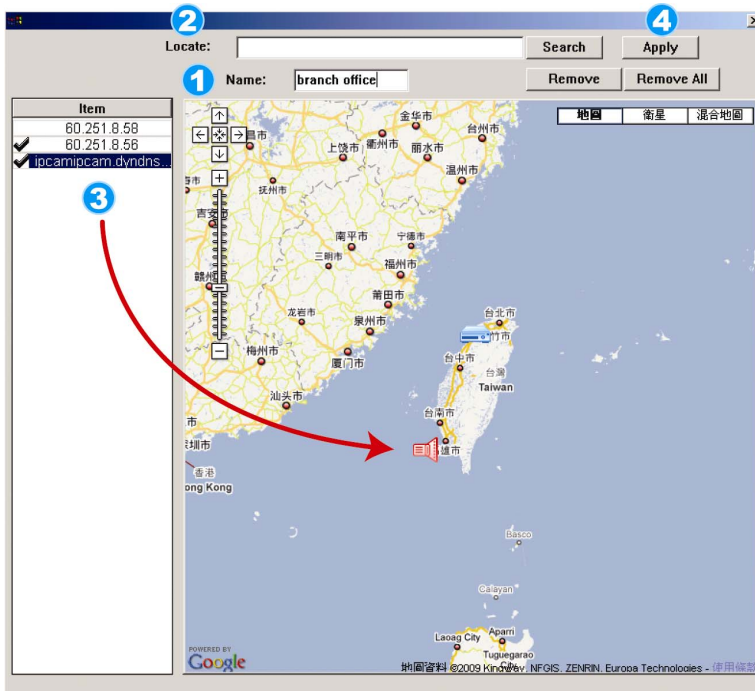

How to add a Google E-Map group:

- 1 Enter the name of this Google E-Map group.
- 2 Enter a specific address or landmark, and click "Search".
OR
Move to the map and drag to the location you want.
- 3 Click and drag the IP address to where it's located in the current level.
- 4 Click "Apply" to save and finish.

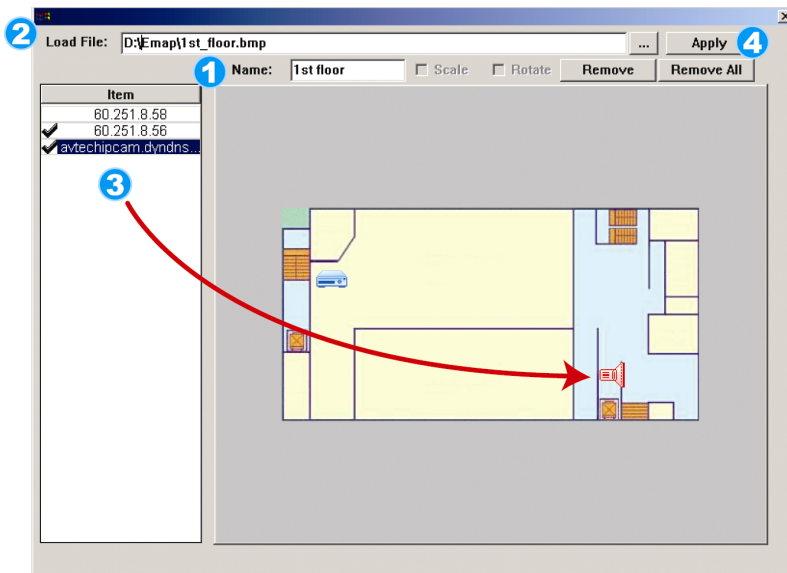

How to add a single E-Map group:

- 1 Enter the name of this single E-Map group.
- 2 Click "..." to browse the map file in BMP or JPEG.
- 3 Click and drag the IP address to where it's located in the current level.
- 4 Click "Apply" to save and finish.

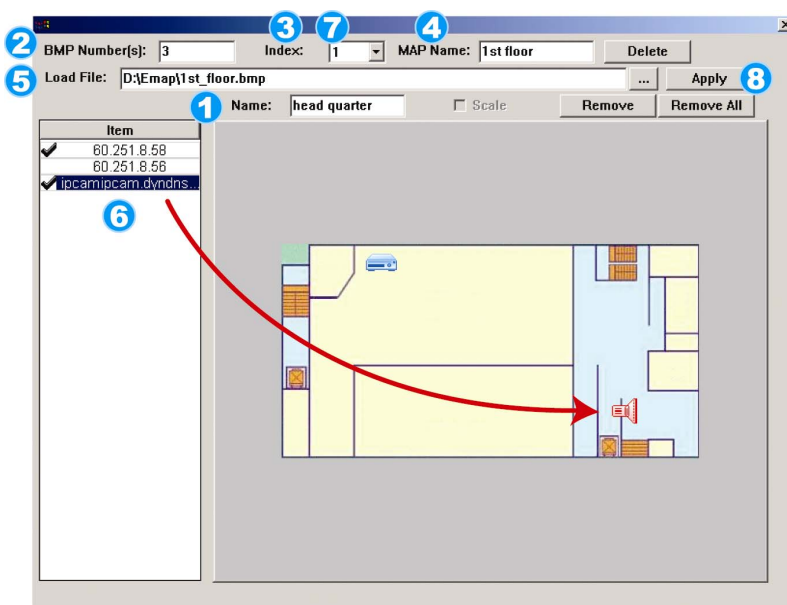



How to add a building E-Map group:

- 1 Enter the name of this building E-Map group.
- 2 Enter the total levels of this building.
- 3 Select the level of the building from the drop-down list.
- 4 Enter the name of the level.
- 5 Click "..." to browse the map file in BMP or JPEG.
- 6 Click and drag the IP address to where it's located in the current level.
- 7 Go back to STEP 3 to select other level of the building, and repeat from STEP 3 to 6 until the setup for all levels are finished.
- 8 Click "Apply" to save and finish.

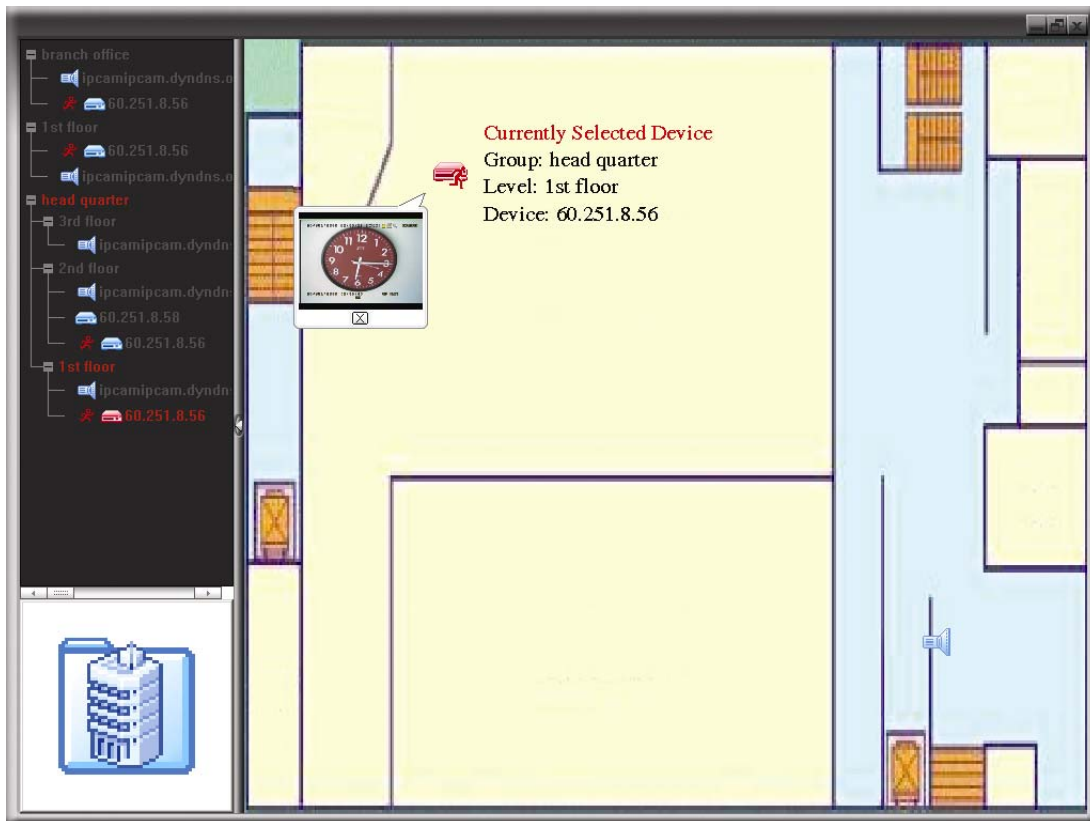
STEP3: When the E-Map group is created, you will see the tree on the top-left panel, showing all the devices you've added to this group.



Icon	Description
	The connected device is camera. When it's selected, it will become red.
	The connected device is DVR. When it's selected, it will become red.
	For any motion or alarm event, it will appear on the screen to catch your attention. To know what's happening quickly, double-click the device icon on the E-Map to show the live view.

How to Edit / Remove an Existing E-Map Group

➤ For Google E-Map Group

Right-click on the group name to show the shortcut menu list, and select "Edit E-MAP" or "Remove E-MAP" as needed.

You can also add a single E-Map group (Add Single E-MAP) or Building E-Map group (Add Building E-MAP) into the existing Google E-Map group.

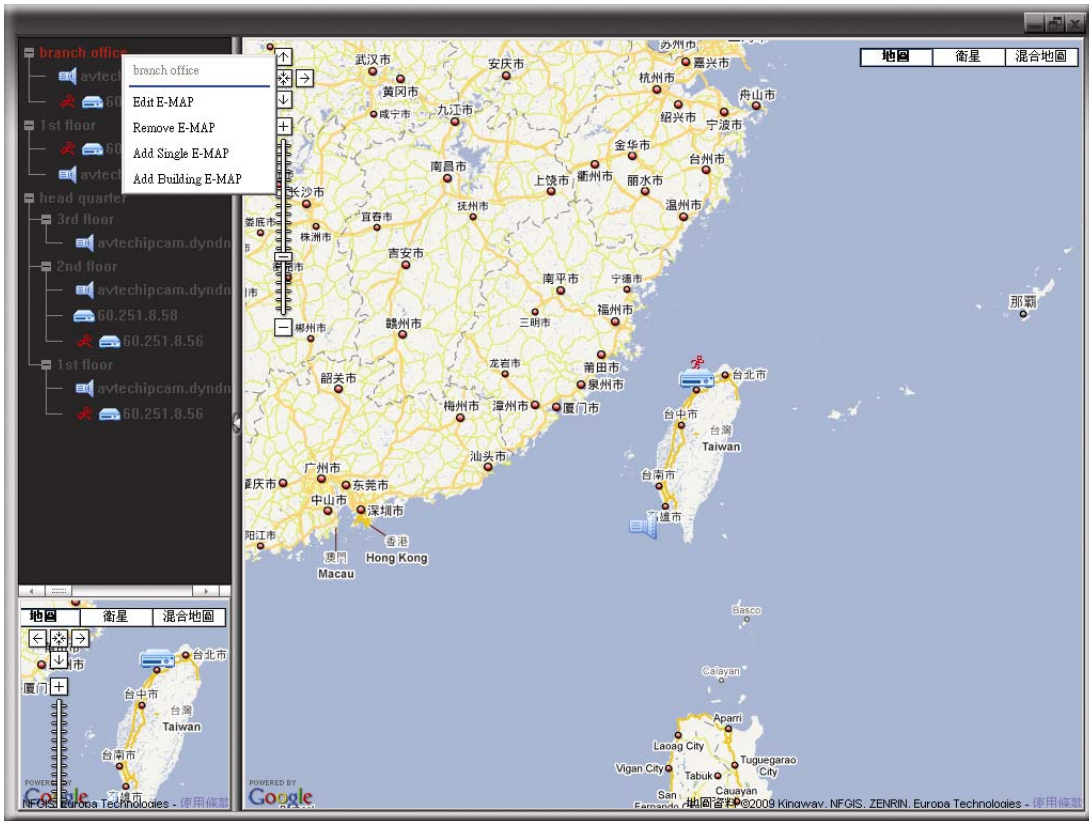

➤ For Single E-Map Group

Right-click on the group name to show the shortcut menu list, and select “Edit E-MAP” or “Remove E-MAP” as needed.

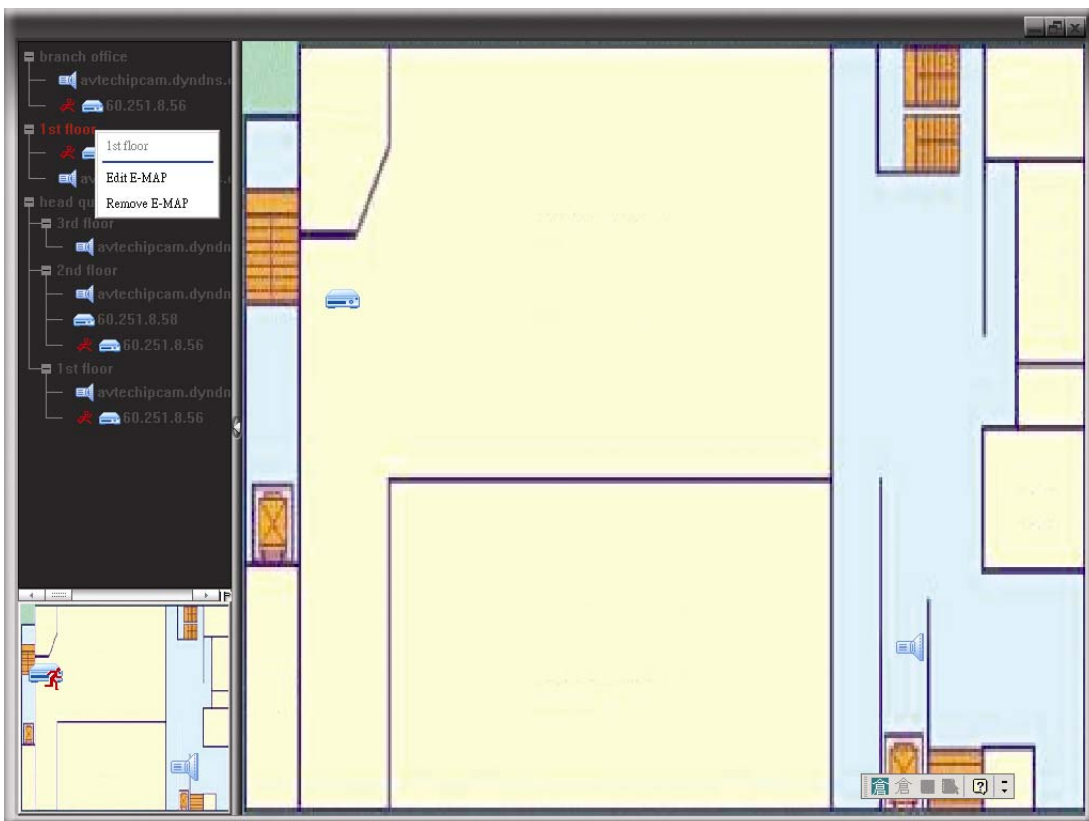

➤ For Building E-Map Group

Right-click on the group name to show the shortcut menu list, and select “Edit Building E-MAP” or “Remove E-MAP” as needed.

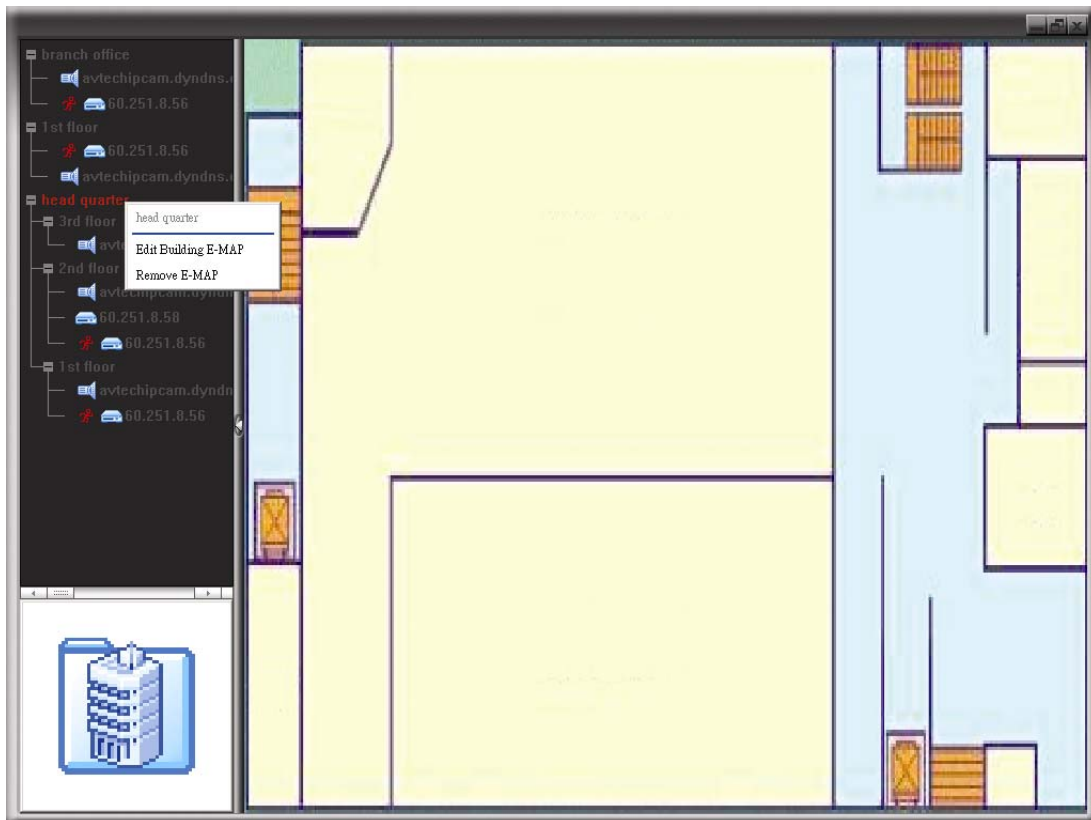

To edit or remove a certain level of the building E-Map group, right click on the level name, and select “Edit E-MAP” or “Remove E-MAP” as needed.

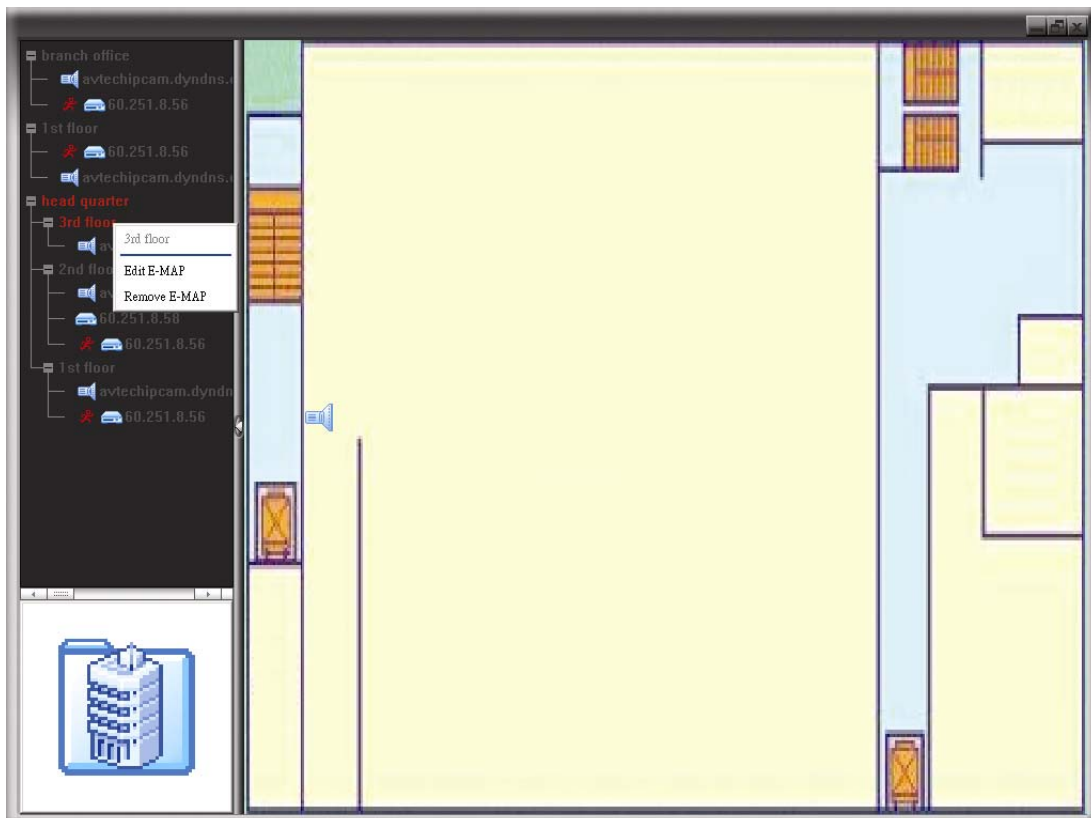

6.2 Web Browser

You can view the images or operate your DVR with a web browser, such as Internet Explorer, Mozilla Firefox or Google Chrome.

Note: The supported PC operation systems are Windows 7, Vista & XP.

Note: To use Mozilla Firefox or Google Chrome for remote access, please go to Apple's official website (<http://www.apple.com/quicktime/win.html>) to download and install QuickTime first.









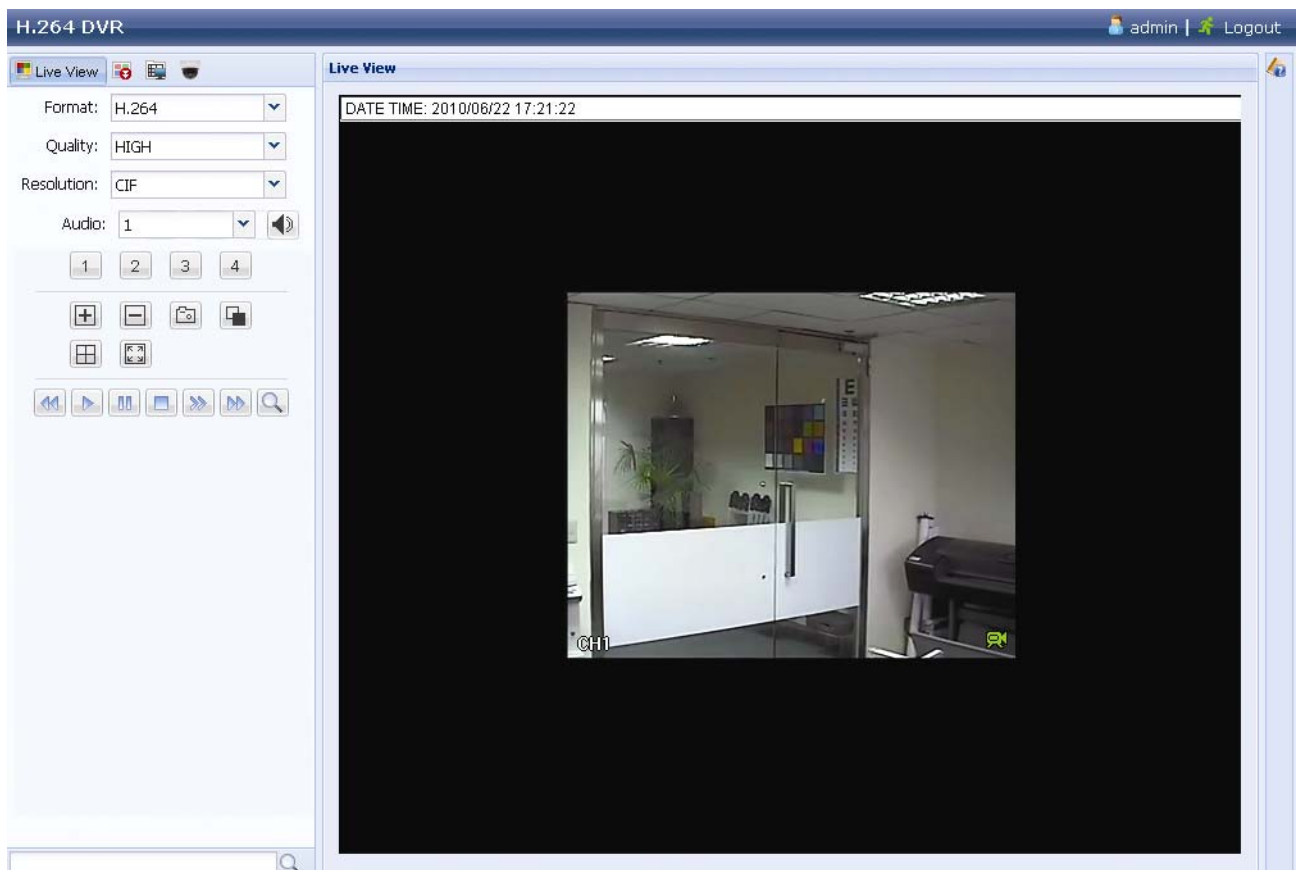







Note: The illustration below is just for your reference and may be different from what you actually see on your DVR. Some functions and buttons are for selected models only.

Step 1: Key in the IP address used by your DVR in the URL address box, such as 60.121.46.236, and press Enter. You will be prompted to enter the user name and password to access the DVR.

If the port number your DVR used is NOT 80, you need to key in the port number additionally. The format is *ipaddress:portnum*. For example, for IP address 60.121.46.236 and port No. 888, please key in "http://60.121.46.236:888" into the URL address box, and press "Enter".

Step 2: Enter the user name and password, the same as the ones used for video viewer login, and click "OK". You will see a similar screen as the following when the login information is correct.



Icon	Description
	Click to go to the live view of the DVR.
	Click to enter the playback panel where you can search or select the event you want to play and download to your PC simultaneously. For details, please refer to “6.2.1 Event Download & Playback” at page 48.
	Click to go to the detailed DVR setting.
	Click to enter the PTZ mode.
<p>Video / Audio Control</p> <p>Format</p>	<p><u>H.264 / QuickTime</u></p> <p>QuickTime is Apple Inc.’s multimedia software. You need to have QuickTime installed in you operation system first. When “QuickTime” is selected, you will be promoted to enter the user name and password to access the server of the DVR.</p>
<p>Quality</p>	<p><u>BEST / HIGH / NORMAL / BASIC</u></p> <p>Select the image quality.</p>
<p>Resolution</p>	<p>4CIF: 704*480 pixels / CIF: 352*240 pixels</p>
<p>Channel Control</p>	
<p>Channel Selection</p>	<p>Click one of the channel numbers to switch to the channel you want to see in full screen.</p>
<p></p>	<p>Click to go to the previous / next channel, or change setting.</p>
<p></p>	<p>Click to take a snapshot of the current view, and save it to the specified path in your PC set in  → “General”.</p>
<p></p>	<p>Click to display each channel one by one, starting from CH1. When the last channel is displayed, it will start from CH1 again.</p> <p>To exit from this display mode, press any other channel display button.</p>
<p></p>	<p>Click to show 4-cut display.</p>
<p></p>	<p><i>This button appears only when the resolution is “CIF”.</i></p> <p>Click to resize CIF to fit into the current live view size.</p>
<p>Playback Control</p>	
<p></p>	<p>Increase the speed for fast rewind. Click once to get 4X speed rewind and click twice to get 8X speed, etc., and the maximum speed is 16X.</p>
<p></p>	<p>Increase the speed for fast forward. Click once to get 4X speed forward and click twice to get 8X speed, etc., and the maximum speed is 16X.</p>
<p></p>	<p>Click to play the current video clip.</p>
<p></p>	<p>Click to pause the video playback.</p>
<p></p>	<p>Click to stop the video playback.</p>
<p></p>	<p>Click to play the video clip slowly, once to get 4X slower, twice get 8X slower.</p>
<p></p>	<p>Click to open the playback search panel.</p>

6.2.1 Event Download & Playback

Cut: 4

Mode: Time

HDD No.: HDD-0

Start Time: 2010/05/14

16 : 41 : 58

Channel: 1

Quick Search

The screenshot shows the 'H.264 DVR' interface. On the left, there are controls for 'Cut', 'Mode', 'HDD No.', 'Start Time', and 'Channel'. The main area is split into a 'Playback' control panel and a video window. The 'Playback' panel includes a 'Cut' dropdown, 'Mode' (Full List), 'Event' (Alarm, Manual, Mo...), and 'HDD No.' (HDD-0). Below this is a list of events with columns for 'Ch.' and 'Time'. The video window shows a black screen with a playback progress bar at the bottom indicating 13:00 to 14:00.

■ Event Icon

	Timer		Manual
	System		Motion

/	Close all / Close	Click to close the current playback video clip (in the red frame), or to close all playback video clips.
/	Previous / Next Hour	Click to jump to the next / previous time interval in an hour, for example, 11:00 ~ 12:00 or 14:00 ~ 15:00, and start playing the earliest event video clip recorded during this whole hour.
	Fast Forward	Increase the speed for fast forward. Click once to get 4X speed rewind and click twice to get 8X speed, etc., and the maximum speed is 32X.
	Fast Rewind	Increase the speed for fast rewind. Click once to get 4X speed forward and click twice to get 8X speed, etc., and the maximum speed is 32X.
	Play	Click to play the current video clip.
	Pause	Click to pause the video playback.
	Stop	Click to stop the video playback.
	Step	In the pause mode, click to get one frame forward.
	Snapshot	Click to take a snapshot of the current view, and save it to the specified path in your PC set in → "General".
	Download	Click to download the current video clip to the specified path in your PC.

APPENDIX 1 SPECIFICATIONS

		4CH DVR	
Video System		NTSC / PAL (auto detection)	
Video Compression Format		H.264	
Video Input (composite video signal 1 Vp-p 75Ω BNC)		4 channels	
Video Output (BNC)		Main Monitor: For stable display	
Video Output (VGA)		Built-in (Resolution support up to 1600 x 1200)	
Audio (Mono)	Input	4 audio inputs	
	Output	1 audio output	
Maximum Recording Rate	Frame	704×480 pixels with 120 IPS <NTSC> / 704×576 with 100 IPS <PAL>	
	Field	704×240 pixels with 120 IPS <NTSC> / 704×288 pixels with 100 IPS <PAL>	
	CIF	352×240 pixels with 120 IPS <NTSC> / 352×288 pixels with 100 IPS <PAL>	
Image Quality Setting		SUPER BEST / BEST / HIGH / NORMAL	
Hard Disk Storage**		Accommodates 1 SATA HDD	
Quick Search		Time / Motion / Alarm search mode	
SATA Interface		Built-in	
Recording Mode		Manual / Timer / Motion / Alarm / Remote	
Multiplex Operation		Live display / record / playback / backup / network operations	
USB Mouse Control		YES	
Motion Detection Area		16 × 12 grids per camera for all channels	
Motion Detection Sensitivity		3 adjustable parameters for accurate detection	
Pre-alarm Recording		YES	
Backup Device		USB 2.0 flash drive / Network	
Web Transmitting Compression Format		H.264	
Ethernet		10/100 Base-T. Supports remote control and live view via Ethernet	
Remote Surveillance (Operating System: Windows 7 / Vista / XP)	CMS:	Our self-developed and free software, "Video Viewer"	
	Web Browser:	Internet Explorer, Mozilla Firefox, Google Chrome, Safari & Opera	
	Media Player:	QuickTime	
	Max. on-line user:	10	
Network Protocol		TCP/IP, PPPOE, DHCP and DDNS	
Remote Independent Operation		YES	
Remote Live Audio		YES	
Remote Event Download & Playback		YES	
Event Notification		By FTP / E-Mail	
IR Remote Control		YES (IR receiver built-in)	
Mobile Surveillance		YES	
Picture Zoom		2X digital zoom	
PTZ Control		YES	
Alarm I/O		4 inputs, 1 output	

	4CH DVR
Key Lock (Password Protection)	YES
Local User Level	Administrator & Operator
Video Loss Detection	YES
Camera Title	Supports up to 12 letters
Video Adjustable	Hue / Saturation / Contrast / Brightness
Date Display Format	YY/MM/DD, DD/MM/YY & MM/DD/YY
Daylight Saving	YES
Power Source ($\pm 10\%$)	DC 19V
Power Consumption ($\pm 10\%$)	< 40 W
Operating Temperature	10°C ~ 40°C (50°F~104°F)
Dimensions (mm) ^{***}	343(W) × 59(H) × 223(D)
System Recovery	System auto recovery after power failure
Optional Peripherals	Keyboard controller

* The specifications are subject to change without notice.

** 1 HDD capacity up to 2TB

*** Dimensional Tolerance: $\pm 5\text{mm}$

APPENDIX 2 COMPATIBLE USB FLASH DRIVE LIST

Please upgrade the firmware of the DVR to the latest version to ensure the accuracy of the following table. If the USB flash drive is not supported by the DVR, the "USB ERROR" message will be shown on the screen.

Note: Please use your PC to format the USB flash drive as "FAT32".

Note: You can backup up to 2GB video data for one-time USB backup. To backup more data, please set the time & channel(s) you want, and start USB backup again.





MANUFACTURER	MODEL	CAPACITY
Transcend	JFV35	4G
	JFV30	8G
Kingston	DataTraveler	1G
PQI	U172P	4G
Apacer	AH320	2GB
	AH320A	8GB
	AH220	1GB
	AH320	4GB
A-data	RB-18	1GB
Sandisk	Cruzer Micro	2G
	Cruzer Micro	4G
	Cruzer4-pk	2G
Netac	U208	1G
MSI	F200	4G
SONY	Micro Vault Tiny 2G	2G
	Micro Vault Tiny 4G	4G
	Micro Vault Tiny	1G

APPENDIX 3 COMPATIBLE SATA HDD LIST

Please upgrade the firmware of the DVR to the latest version to ensure the accuracy of the following table.

MANUFACTURER	MODEL	CAPACITY	ROTATION
Seagate	ST3320613AS	320GB	7200 rpm
	ST33500320AS	500GB	7200 rpm
	ST3500410SV	500GB	7200 rpm
	ST3750330AS	750GB	7200 rpm
	ST31000525SV	1000GB	7200 rpm
	ST31000340AS	1000GB	7200 rpm
WD	WD3200AAKS	320GB	7200 rpm
	WD5000AACS	500GB	7200 rpm
	WD6400AAKS	640GB	7200 rpm
	WD7500AAKS	750GB	7200 rpm
	WD10EADS	1TB	7200 rpm
	WD15EADS	1.5TB	7200 rpm
	WD20EADS	2TB	7200 rpm
Maxtor	STM3500320AS	500GB	7200 rpm
	STM3750330AS	750GB	7200 rpm
HITACHI	HDT725032VLA360	320GB	7200 rpm
	HDS721010KLA330	1000GB	7200 rpm

APPENDIX 4 MAIN MENU STRUCTURE

	QUICK START	GENERAL	CHANNEL TITLE
			EVENT STATUS
			DATE DISPLAY
			MOUSE SENSITIVITY
			PRIORITY
			RECORD CONFIG
		TIME SETUP	DATE
			TIME
	DATE SETUP	DATE INFO	DISPLAY DATE OF MODE
			FORMAT
		DAYLIGHT	DAYLIGHT SAVING
	SYSTEM	TOOLS	LANGUAGE
			ADMIN PASSWORD
			OPERATOR PASSWORD
			UPGRADE
			BACKUP CONFIG
			RESTORE CONFIG
		SYSTEM INFO	BAUD RATE
	HOST ID		
	AUTO KEY LOCK		
	CLEAR HDD		
	RESET DEFAULT		
	REMOTE CONTROL ID		
	SERIAL TYPE		
	VIDEO FORMAT		
	VERSION		
	BACKUP DATA (USB)		
	BACKUP LOG (USB)		
	EVENT INFORMATION	QUICK SEARCH	
		EVENT SEARCH	
		HDD INFO	
		EVENT LOG	
	ADVANCED CONFIG	CAMERA	BRIGHTNESS
			CONTRAST
			SATURATION
			HUE
			COV.
			REC
		CHANNEL TITLE	
		DETECTION	LS
			SS
			TS
			MOTION
			ALARM
			AREA
		ALERT	EXT. ALERT
			INT. BUZZER
			KEY BUZZER
			VLOSS BUZZER
MOTION BUZZER			
ALARM BUZZER			
HDD BUZZER			
ALARM DURATION (SEC)			
HDD NEARLY FULL (GB)			
NETWORK	NETWORK		
	SNTP		
	FTP		

APPENDIX 4 MAIN MENU STRUCTURE

	ADVANCED CONFIG	NETWORK	E-MAIL
			DDNS
		DISPLAY	FULL SCREEN DURATION
			DISPLAY COVERT
			HDD DISPLAY MODE
			VGA OUTPUT
			ALPHA BLENDING
		RECORD	MANUAL RECORD
			EVENT RECORD
			TIMER RECORD
			PRE-ALARM RECORD
			OVERWRITE
			EVENT RECORD ALL CH
			KEEP DATA LIMIT (DAYS)
			RECORD CONFIG
		DEVICES	
	SCHEDULE SETTING	RECORD	
		DETECTION	
		ALARM	

APPENDIX 5 DVR BATTERY REPLACEMENT

DVR time reset after power failure, for example, caused by a power outage, will cause the disorder of the recorded data, and users may have problems in searching the event clip they want. To keep the DVR time from resetting, a non-chargeable lithium battery, CR2032, is installed in the DVR.

However, the DVR time might still get reset when the DVR battery is low or even running out of power. If so, please replace the DVR battery, CR2032, **right away** as instructed below.

➤ How to replace CR2032

Note: The lithium battery, CR2032, is a non-chargeable battery, and should be purchased separately. Please replace only with the same or equivalent type battery in case of danger.

Step1: Stop all DVR recording **immediately** to prevent the disorder of the recorded data. Then, back up the recorded data if necessary.

Step2: Power off the DVR, and disconnect the DVR power.

Step3: Remove the DVR cover, and find the battery on the mainboard.

Step4: Push the release as indicated below to remove the battery.



Type1

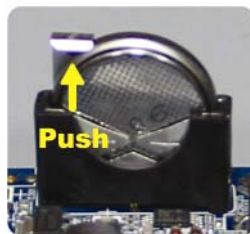

Type 2

Step5: Get a new battery and install it to its slot on the mainboard.

- For Type 1, install it with the side of “CR2032” facing up as shown above.
- For Type 2, install it without the side of “CR2032” facing you as shown above.

Step6: Replace the DVR cover and connect to power.

Step7: Set DVR date & time, and resume recording. For details, please refer to “2.4 Date and Time Setting” at page 7, and “5.2 Record” at page 17.

APPENDIX 6 PIN CONFIGURATION

PIN Connection Application

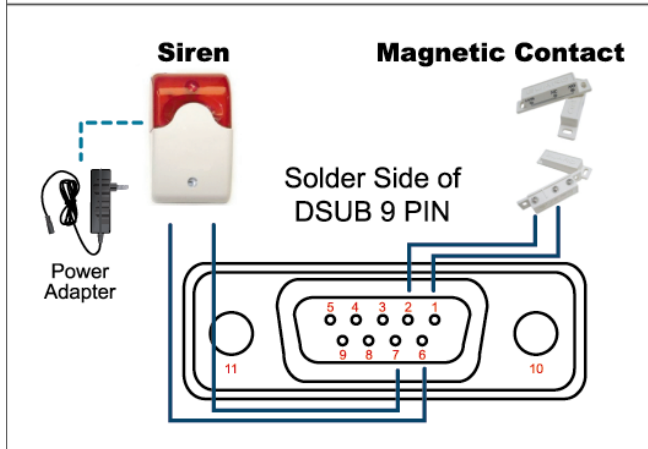

Siren:

When the DVR is triggered by alarm or motion, the COM connects with NO and the siren with strobe starts wailing and flashing.

Magnetic Contact:

When the magnetic contact is opened, the alarm will be triggered and the recording is on.

* The D-Sub connector shown above is optional.

PIN	FUNCTION	DESCRIPTION															
1~4	ALARM INPUT	<p>Connect ALARM INPUT (PIN1 – 4) and GND (PIN5) connector with wires. Once an alarm is triggered, the DVR will start recording and the buzzer will be on.</p> <table border="1"> <thead> <tr> <th>PIN</th> <th>Alarm</th> <th>Corresponding video channel</th> </tr> </thead> <tbody> <tr> <td>PIN 1</td> <td>1</td> <td>CH1</td> </tr> <tr> <td>PIN 2</td> <td>2</td> <td>CH2</td> </tr> <tr> <td>PIN 3</td> <td>3</td> <td>CH3</td> </tr> <tr> <td>PIN 4</td> <td>4</td> <td>CH4</td> </tr> </tbody> </table>	PIN	Alarm	Corresponding video channel	PIN 1	1	CH1	PIN 2	2	CH2	PIN 3	3	CH3	PIN 4	4	CH4
PIN	Alarm	Corresponding video channel															
PIN 1	1	CH1															
PIN 2	2	CH2															
PIN 3	3	CH3															
PIN 4	4	CH4															
5	GND	GROUND															
6	EXTERNAL ALARM COM	Under the normal operation, COM disconnects with NO. But when any alarm is triggered, COM connects with NO. Attention: The voltage restriction is under DC24V 1A.															
7	EXTERNAL ALARM NO	Under the normal operation, COM disconnects with NO. But when any alarm is triggered, COM connects with NO. Attention: The voltage restriction is under DC24V 1A.															
8	RS485-A																
9	RS485-B																
10~11	GND	GROUND															