

Information Manual

Underground Loops and Loop Detectors

DoorKing Plug-In Loop Detectors and Loop Accessories

Loop Info-R-1-18

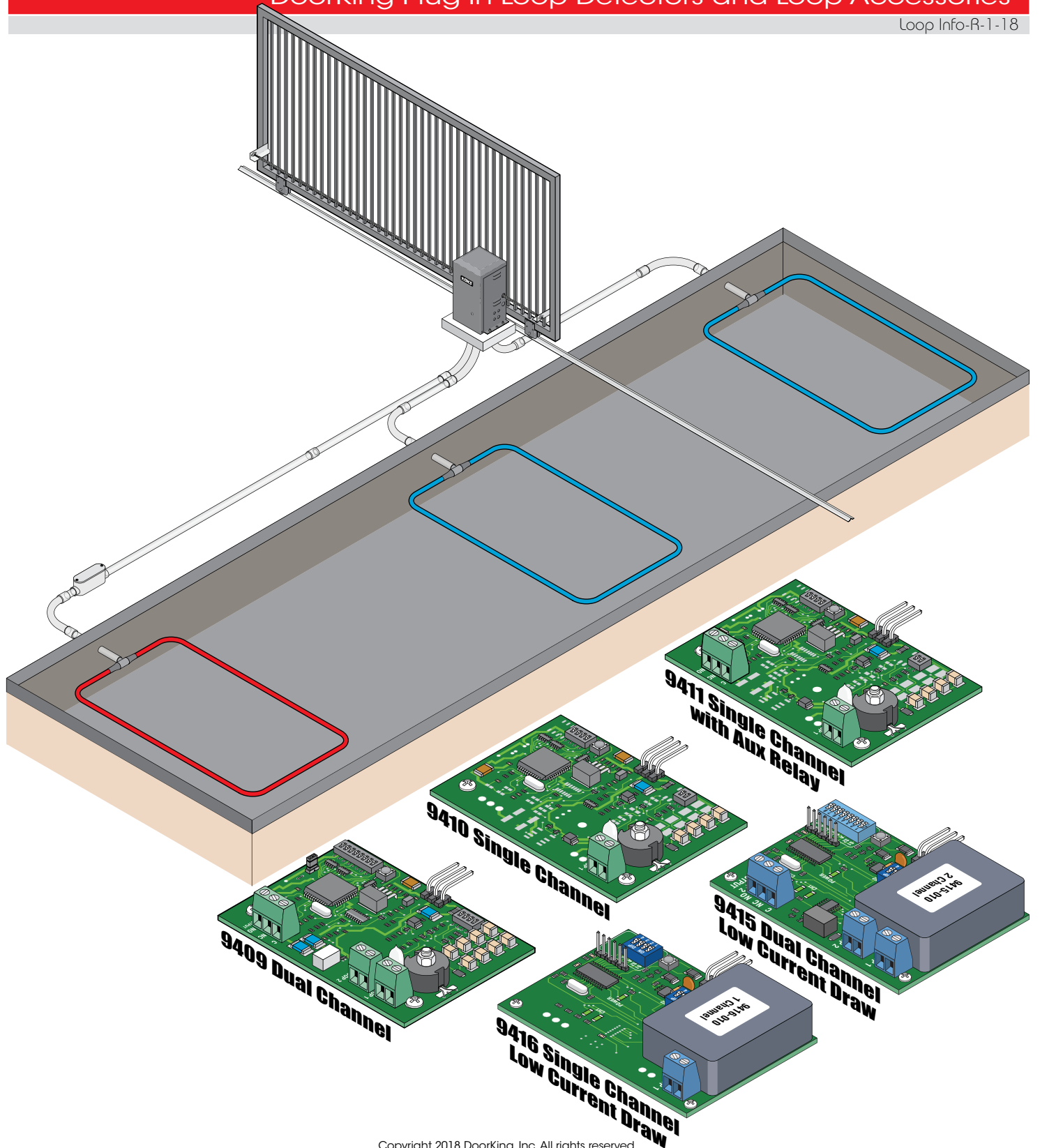

INTRODUCTION	2
Underground Loop	2
Lead-In Wire or Cable	2
Loop Detector	2
Design Facts	2-3
SECTION 1 - HOW THE LOOP SYSTEM WORKS	4
Field of Sensitivity	4
Height of Detection	4
Field Cancellation Effect	5
Field Enhancement Effect	5
Loop Phasing	6
Electrically Reverse the Phase of a Loop	6
Loop Detection Field Interference and Loop Placement	7
SECTION 2 - LOOP INSTALLATION GUIDELINES	8
Saw Cut Loop Guidelines	8-9
DoorKing Preformed Loop Guidelines	10
SECTION 3 - TYPICAL LOOP LAYOUT EXAMPLES	11
Slide Gates	11
Swing Gates	12
SECTION 4 - TROUBLESHOOTING LOOP SYSTEMS	13
Loop Diagnostics	13
Poor Connections	13
Shorted Loop Wire	13
Detector Adjustments	13
SECTION 5 - DOORING LOOP DETECTORS AND ACCESSORIES	14

INTRODUCTION

A loop detection system is a method of sensing vehicles and is typically used in automated gate applications to prevent a gate from automatically closing on a vehicle or to automatically open the gate when a vehicle is exiting a property. Vehicle loops can also be used to activate card readers, ticket spitters, etc. When properly installed, loops are an extremely reliable form of vehicle detection. The loop detection system operates by creating an electrical field of sensitivity that tunes to the surrounding environment. When a metallic object enters this electrical field, the loop detector senses a change in the field and generates an output, usually activating a relay in a gate operator or other access control device that controls the operation of the gate.

There are three basic components in a loop detection system:

- Underground loop
- Loop lead-in wire or cable
- Loop detector

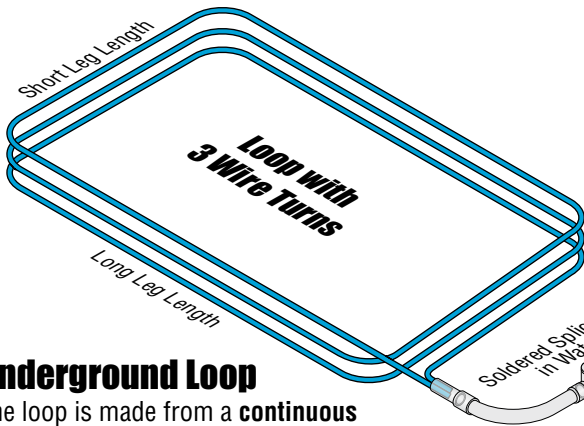

Underground Loop

The loop is made from a **continuous piece of wire (NO SPLICES)** that is coiled around for a number of turns in a square or rectangular pattern. The wire is embedded into pavement either as a preformed loop placed prior to paving, or into a saw cut that is cut into existing pavement. Both ends of this wire are then extended to the edge of the pavement.

Loop Lead-In Wire or Cable

The lead-in wire or cable extends the two ends of the loop wire back to the loop detector. On short runs (Loop is within ten feet from the loop detector), the two wires exiting the loop can be twisted together, run in conduit to the operator and connected directly to the loop detector.

The lead-in wire: DoorKing recommends that lead-in wire be twisted a minimum of six turns per foot.

The lead-in cable: If additional lead-in wire is required, DoorKing recommends that you use a shielded twisted pair (Insulated (floated) at one end and grounded at gate operator) with a direct burial rated jacket or be placed in PVC conduit. All splices must be soldered and placed in a watertight J-box.

Design Facts

Proper installation of the loops is essential for reliable functioning of the detector system. Most detector problems are caused by improper loop installation! **The geometry (size and shape) of the loop defines the detection zone characteristics.**

- Loop size may vary and will depend on lane width, traffic patterns, and types of vehicles to be detected.
- **The short leg of any loop used for vehicle detection should never be less than 18 in.** The height of detection is directly related to the length of the short leg of the loop. **A general rule of thumb to follow is that the height of detection is 1/2 to 2/3 the length of the short leg of the loop.**
- **Normal loops (4 ft x 8 ft) are used to detect motorcycles and automobiles. Minimum size for loops to detect typical vehicular traffic is 18 in x 48 in. It is always recommended to use a larger loop whenever possible.**
- Maximum "detection height" of a loop is 3 to 4', which may be achieved with a loop measuring 6' on the short leg.
- Loops can be saw cut into concrete or asphalt. They can be placed under brick pavers and asphalt or be imbedded in a poured concrete road surface.

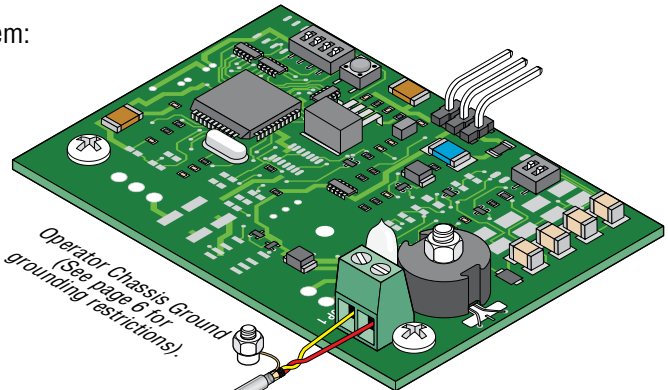

Loop Detector

The loop detector is the electronic component that controls the loop system. DoorKing offers loop detectors (Models 9409, 9410 and 9411) that plug directly into the gate operator control board, eliminating the wire harness and wiring connections other than the loop lead-in wires. These detector boards have a terminal strip where the loop lead-in wire connects. There are also various other types of standalone detectors available on the market that can be hard wired into the gate operator control board.

Loops that are physically adjacent to each other and operating on separate loop detectors may interfere (cross-talk) with each other if they are operating on the same frequencies. Changing the operating frequency on one of the loop detectors can eliminate this interference. (See page 7 for more information)

When connecting two loops to a single loop detector terminal, always connect the loops in series. If the loops are close together, the direction of the windings should be considered. Loops physically near each other and wound in the same direction electrically (i.e. both Clockwise or Counter-Clockwise) will cause field cancellation effects (a dead zone) between the loops. This may be desirable when two loops (reverse loops) are placed on each side of a sliding gate. Wiring the loops in this manner will allow the gate to slide between the two loops without causing the loops to detect the gate. If the loops are wound in electrically opposite directions (i.e. one Clockwise and one Counter-Clockwise), field enhancement will occur between the loops, effectively extending the field of sensitivity for the loop system. (See pages 5 and 6 for more information)

Determine the Number of Wire Turns Required for Each Loop

Loop area (Sq. Ft.) - Multiply loop width by loop length.

Loop Area in Square Feet	Number of Turns Required
6 - 12	6
12 - 60	4
60 - 240	3

Note: The number of turns should be increased by 1 turn if lead-in wire or cable length is 500 ft or greater.

- During the construction of new installations (i.e. concrete or asphalt), a pre-formed loop may be used as an alternate to the saw cut type. Pre-formed loops are typically encased in PVC or other durable materials to provide high reliability and long life. Sizes may vary depending on the source of the pre-formed loop. DoorKing offers a variety of pre-formed loops that come with 25 feet of lead-in wire. (See page 10 for more information)
- The loop will tune to its environment. Stationary or static metal objects, such as conduits, pipes, metal grates, etc., will not affect the loop field. **High voltage electrical power lines, either underground or overhead, can affect the loop field. In addition, fluctuating electrical fields, such as heating coils, can cause loop lock-ups and false detection.**
- A heavy grid of reinforcing bars (re-bar) may affect the loop field. To minimize this, **DO NOT place a loop directly on the rebar.** Support the loop 1 - 2 inches above the rebar. If possible, make cuts or bends in the rebar grid directly below the loop. Bars and electrical wires running at angles to the loop have less effect on the loop than those running parallel to the loop wires. (See page 10 for more information)
- If a single loop is used with a long lead-in cable (500 feet or greater), it is advisable to add an additional turn in the loop. This increases the ratio of the loop inductance to the total inductance, thereby improving loop sensitivity and overall loop system stability.
- The inductance of the loop (in micro henries) must fall within the tuning range of the loop detector for the loop system to operate properly. This is typically not a problem since most loop detectors have a very wide tuning range (20 - 2500 micro henries) and can accommodate most size loops.

To calculate the inductance of a loop use this formula:

$$\frac{[\text{Side 1} + \text{Side 2} + \text{Side 3} + \text{Side 4}] \text{ Number of Turns}^2}{2} = \text{Inductance}$$

Example: To calculate the inductance of a typical 6 x 8 foot loop with four turns of wire:

$$\frac{[6 + 8 + 6 + 8] 4^2}{2} = 224 \text{ Micro Henries}$$

SECTION 1 - HOW THE LOOP SYSTEM WORKS

Field of Sensitivity

A loop sets up an inductive field, called a field of sensitivity. This field of sensitivity completely surrounds the loop wires extending above, below, and on all sides of the loop. When a vehicle (or any metallic object) enters this field of sensitivity, the inductance of the loop changes as more of the inductive field is disrupted by the vehicle. Once the disruption of the inductive field is high enough, the loop detector senses this change and outputs a signal, usually in the form of a dry contact relay switch activation.

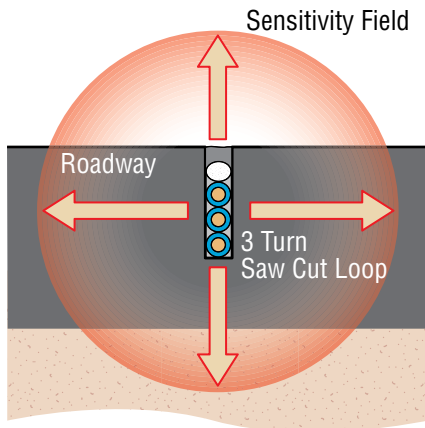

Cutaway of Underground Loop

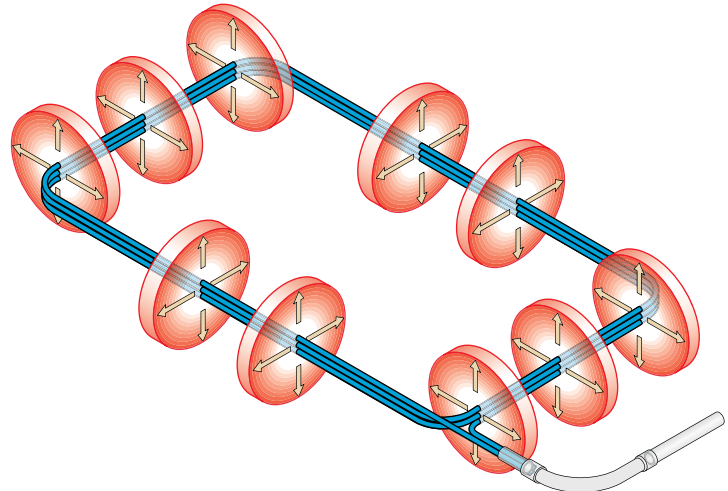

Inductive Field of Sensitivity

Height of Detection

The height of the field of sensitivity, and therefore the height of detection, is determined by the size of the loop. The height of detection is especially important when you need to detect a high bed truck, which requires more height than a passenger car. The height of detection above (and below) the loop is determined by the shortest leg of the loop. **The height of detection is equal to 1/2 to 2/3 the length of the SHORT LEG.** For example, a four-foot by eight-foot loop will give you approximately 2-1/2 feet of detection height, whereas a six-foot by eight-foot loop will give you approximately 4-feet of detection height. **The short leg of a loop used for vehicle detection should never be shorter than 18 in. The maximum "detection height" of a loop is 6-feet on the short leg. If larger loops are used, the "detectable height" of the loop will NOT increase.**

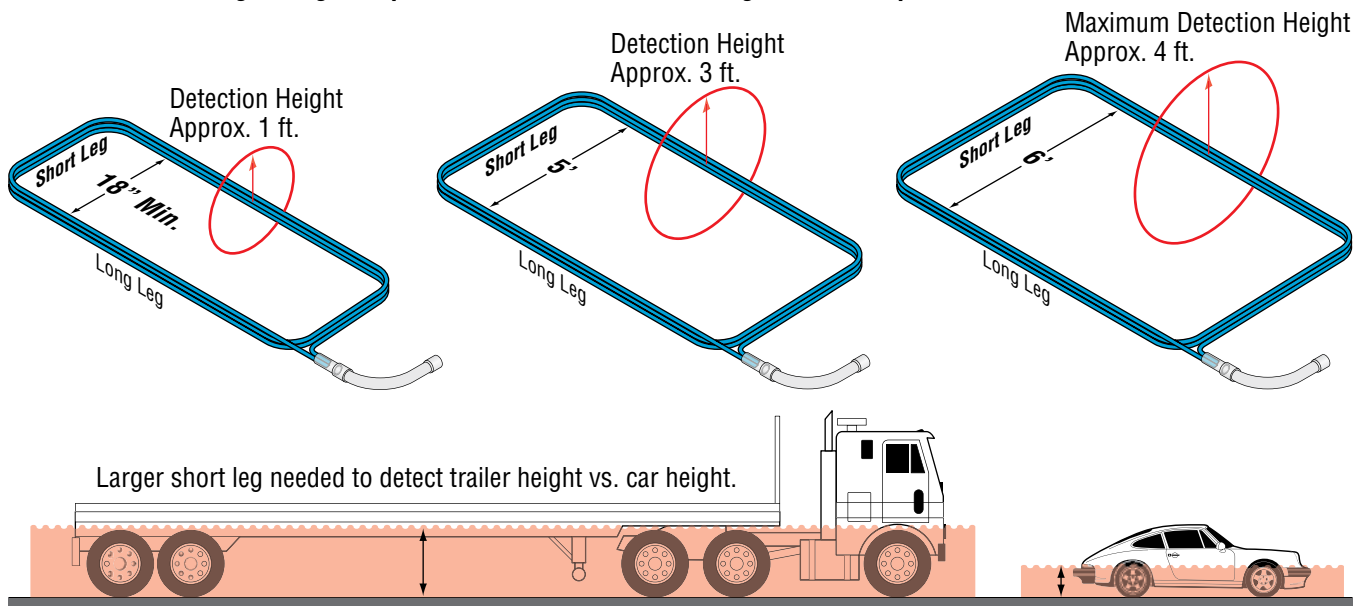

Field Cancellation Effect

Winding the loops in the same direction (Clockwise or Counter-Clockwise) electrically creates the effect of the electrical current passing through the closest edges of the loops in opposite directions. Since the electrical currents are flowing in the opposite directions, the inductive fields of sensitivity created have the same magnetic poles (North or South) toward each other. Since “likes” repel, the fields of sensitivity are pushed up and away from each other, creating a “**Dead Zone**”.

- The detection field shown is a relative profile of the detection height and will vary with the size of the loops, spacing between the loops, and the type of vehicle. The relative height over the two inside wires **increases** as the loops are moved closer together and decreases as the loops are moved apart.

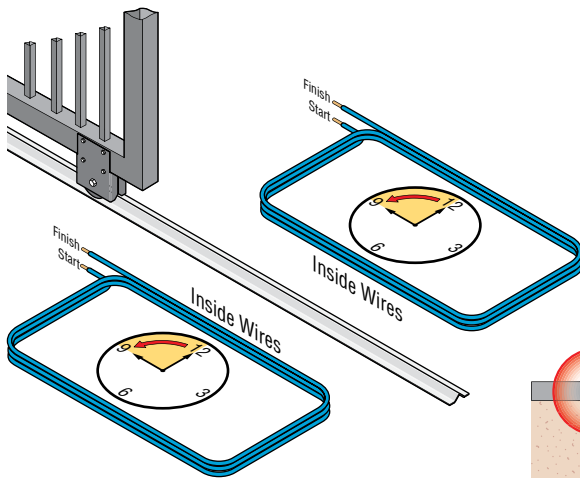

Both loops wound counter-clockwise.

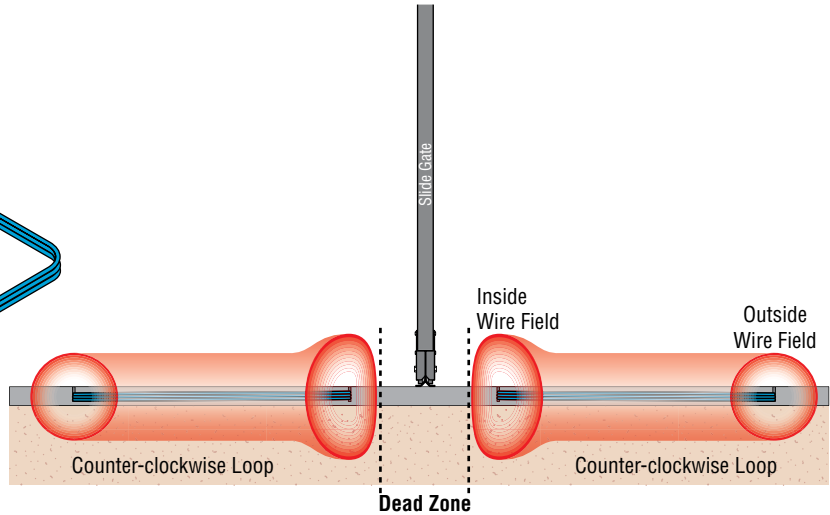

2 loops wound in the **same** direction **repel** the inside wire fields.

Field Enhancement Effect

Winding the loops in the opposite direction (Clockwise or Counter-Clockwise) electrically creates the effect of the electrical current passing through the closest edges of the loops in the same direction. Since the electrical currents are flowing in the same direction, the inductive fields of sensitivity created have opposite magnetic poles (North or South) toward each other. Since “unlikes” attract, the fields of sensitivity pull towards each other, creating a larger zone of detection. Winding the loops in electrically opposite directions could create an enhanced zone that would inhibit a slide gate from closing.

- The detection field shown is a relative profile of the detection height and will vary with the size of the loops, spacing between the loops, and the type of vehicle. The relative height over the two inside wires **decreases** as the loops are moved closer together and increases as the loops are moved apart.

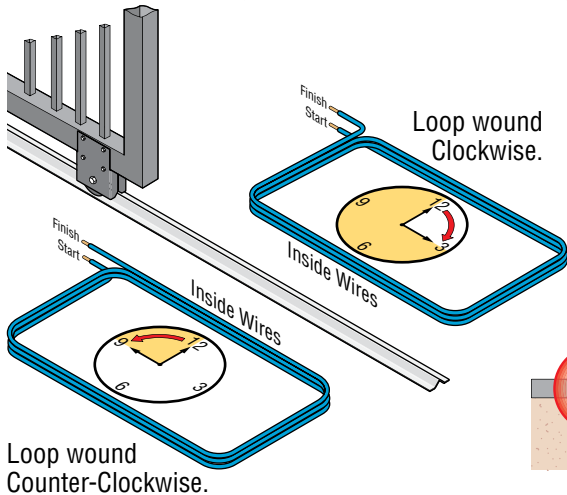

Loop wound Counter-Clockwise.

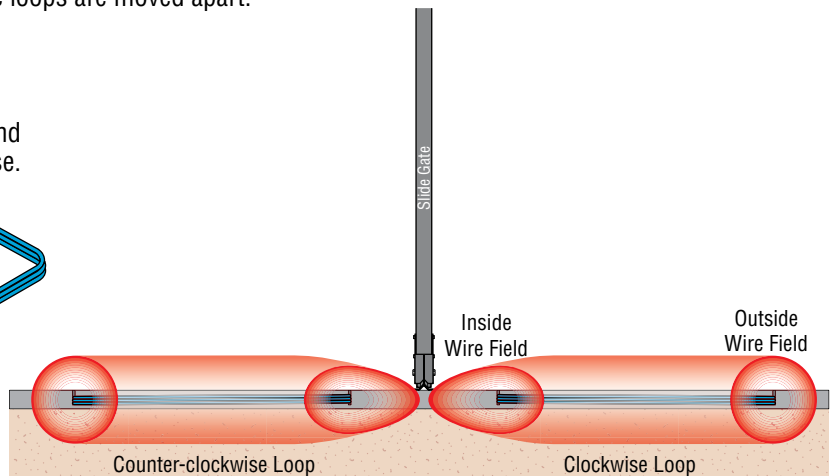

2 loops wound in **opposite** directions **attract** the inside wire fields.

Loop Phasing

It was mentioned previously that when two loops are wired to the same detector terminal, they must be the same size, same number of turns and the same distance from the gate. They must be connected in series and the direction in which each loop is wound is important for proper door or gate operation. It is also advisable to have the loop connections accessible for maintenance and repair. Route each of the loop lead-in wires all the way to the loop detector before wiring the loops together in series for easier access to the loop connections in future maintenance, rather than connecting them together in a water tight junction box in the ground and running a single lead-in cable to the loop detector.

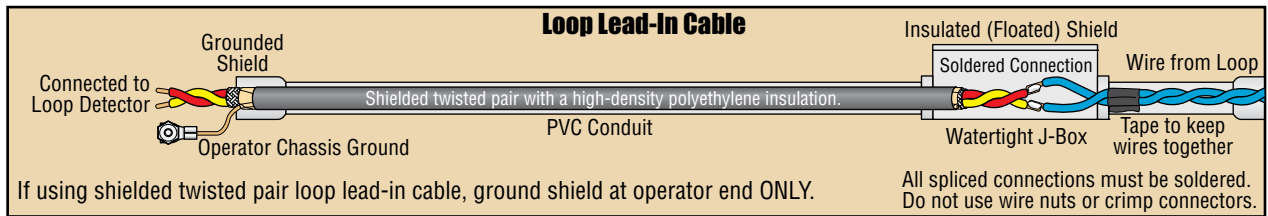
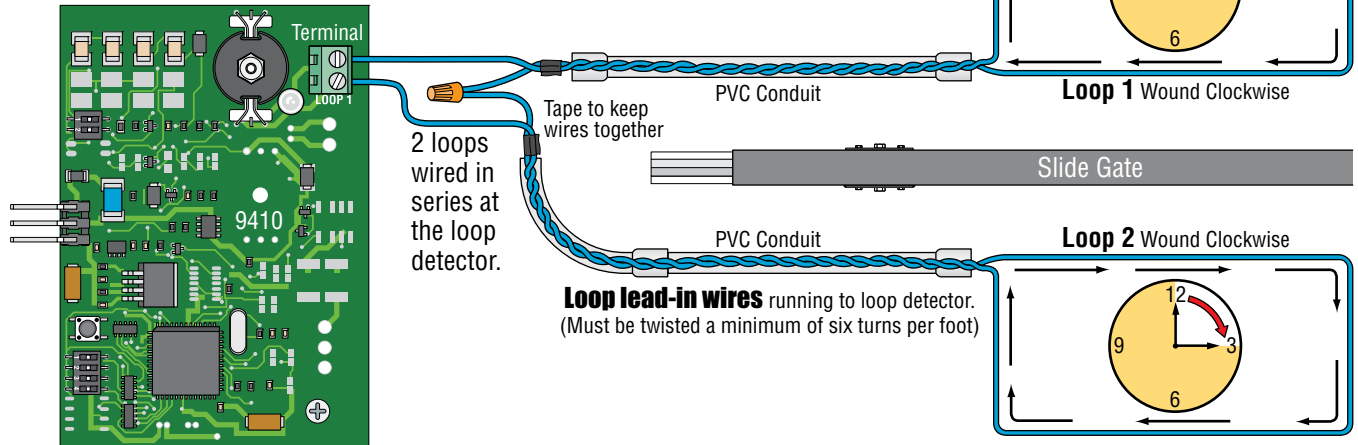

Electrically Reverse the Phase of a Loop

Phasing loops refers to the **direction that the electrical current flows through the loops**, and not necessarily the physical direction that the loop wire has been wound. For example, if two loops are installed and physically wound in a Clockwise direction, you can reverse the electrical current through one of the loops by simply reversing the connection where the loops are wired together. Doing this effectively changes the “electrical” direction that the loops are wound.

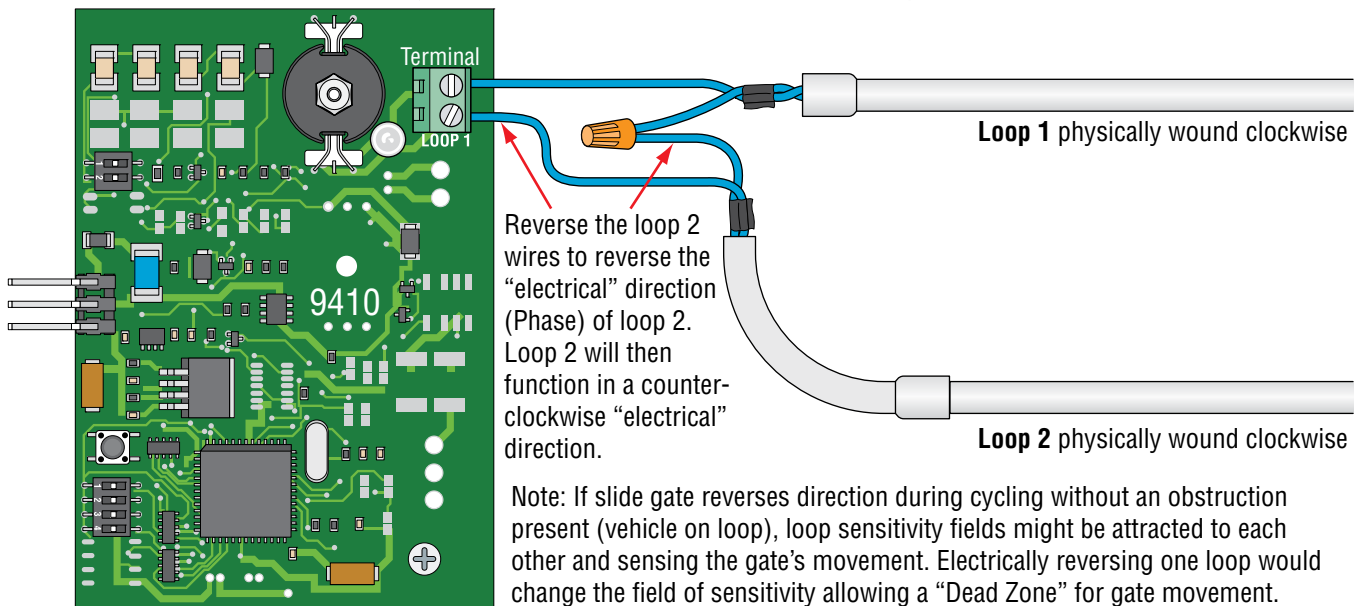

Loop Detection Field Interference and Loop Placement

Detection Field Around Loops

It is important that the loops are installed far enough away from all moving metal objects (gate) to keep the loop's detection fields clear. The 1/2 to 2/3 the length of the short leg of the loop will determine a detection field limit. Do not install the loop closer to the gate than the short leg of the loop otherwise the movement of the gate will interfere with the loop's detection field and the loop detector will give a "false call" and reverse the gate's direction in mid-cycle. **A simplified solution is to place loops AT LEAST 4 feet away from each other or the gate.**

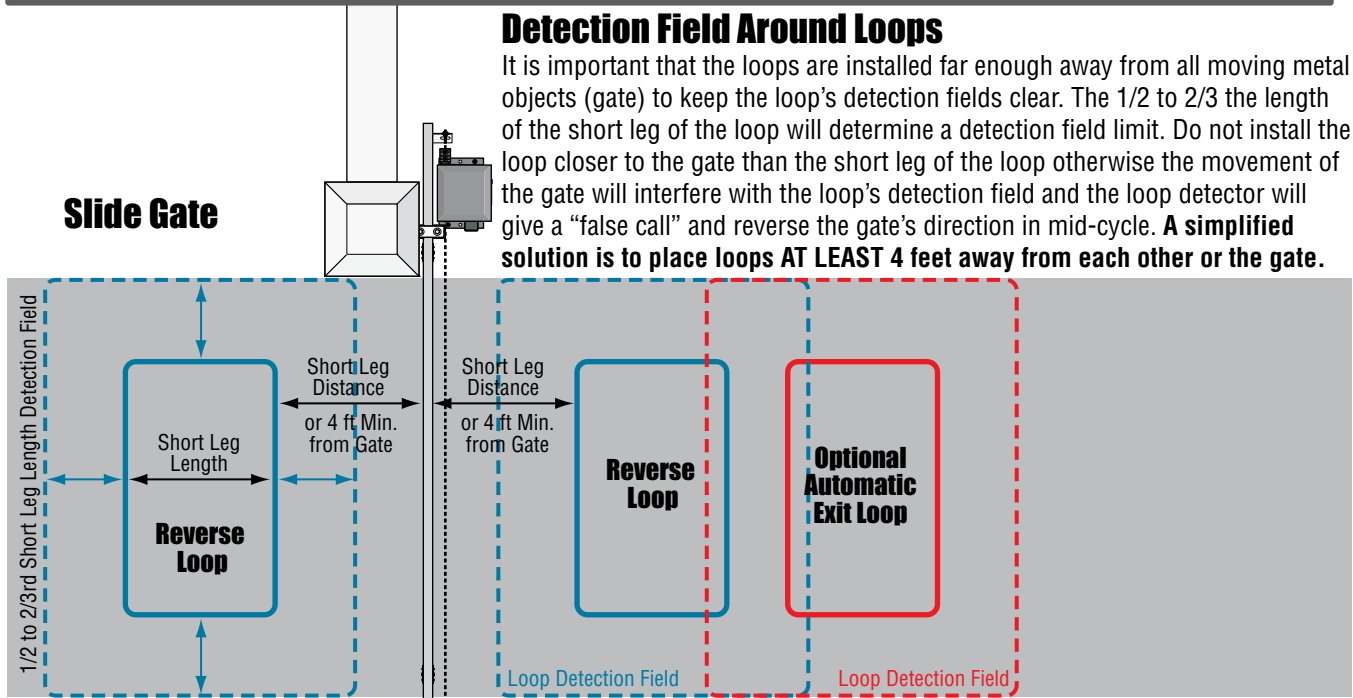

Drawings not to scale

When loop detection fields overlap, loop detectors **MUST** be on different frequencies or they will "cross-talk". (See below)

Swing Gate

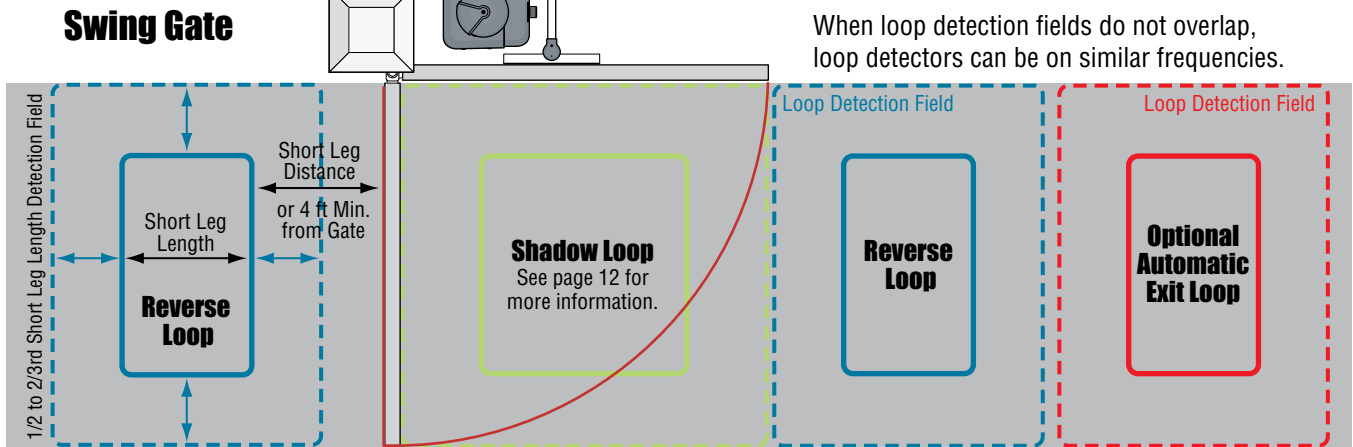

When loop detection fields do not overlap, loop detectors can be on similar frequencies.

Loop Detector Cross-Talk and False Calls

The actual loop operating frequency (in KHz) is a function of the frequency DIP-switches on the loop detector. A common problem with loops are when they are positioned too close to each other and their detection fields overlap. If the loops are on similar frequencies, this can cause "cross-talk" between the loops and "false calls" can occur in the loop detector. Changing the frequency of **one** loop (switching it's frequency as far away from the other loop's frequency as possible) will eliminate the "false calls". Switching the frequency of a loop **WILL NOT** affect the loop's detection height.

Frequency DIP-switches

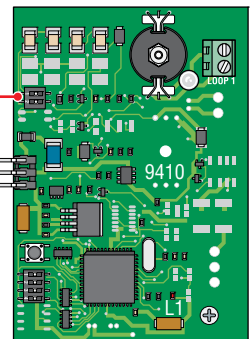

SECTION 2 - LOOP INSTALLATION GUIDELINES

In order to have a loop detection system operate as a reliable, high performance system, it is necessary to pay careful attention to the loop installation. The use of proper installation techniques and the proper type of wire can reduce frustration, aggravation, and unnecessary service calls.

Saw Cut Loop Guidelines

After determining the size, placement and number of turns of the loop:

(See below text and illustrations on the next page)

Depth of Saw Cut - The depth of the saw cut will vary depending on the number of wire turns, typically 1 1/2" for 1-3 turns and 2" for 4-6 turns. The backer rod should be at least 1 inch below the surface of the pavement. The saw cut must be free from loose debris which can damage the wire insulation. If the saw cut is too deep, the roadway under the saw cut may crack over time, creating a possible path for water into the road bed material. One guideline to consider would be to try not to exceed 50% of the overall pavement depth when cutting a slot for the loop wire. Greater depth should be used in softer pavement materials to protect the loop wire against damage from surface erosion and wear.

Shape of Loop - The loop is typically cut in a rectangle with 45° angled corners that eliminates the sharp edges that can eventually cut through the wire insulation. DO NOT allow the rectangular saw cuts to connect in the corners or the triangular pieces that are created will eventually break free from the roadway. Cut an exit slot with NO sharp angles for the wires where they leave the loop saw cut.

Types of Loop Wire - Moisture in the loop's wire insulation can cause significant changes in the dielectric constant resulting in excessive loop (frequency) drift. Choose a wire insulation that is impervious to moisture. **Typically 18 AWG Cross Linked Polyethylene (XLPE) insulated wire is used with COLD sealant because of the ease of installation. It is rated for direct underground burial which makes it very resistant to moisture absorption and provides good abrasion resistance.** 18 AWG Polyvinyl Chloride (PVC) insulation (TFFN, THHN, THWN) should ONLY be used with HOT sealant that will encapsulate the wires and protect them from all moisture. This wire is not rated for direct underground burial and will absorb moisture if not completely protected by the hot sealant. DO not use cold sealant with this type of wire because it will not completely encapsulate the wires. Any voids in the sealant will allow moisture next to the wire insulation that can cause a loop failure in time. **Either type wire must be wound with one continuous length, No splices are allowed.**

Backer Rod - The loop wires must be held securely in the bottom of the slot by means of a plastic foam type material called "Backer Rod". The recommended method of holding the loop wire in the slot is to use a series of one (1) inch long pieces of backer rod spaced approximately one (1) foot apart along the entire length of the saw cut and exit slot. Make certain to press the backer rod tightly into the slot. Use a wooden stick or other blunt instrument to avoid potential damage to the loop wire. If the backer rod is not pressed tightly into the slot, the loop wires will be loose in the slot and can cause false calls due to vibration or sudden movement.

Cold or Hot Sealants - Cold sealant is typically preferred because it is easier to use than hot sealant. It is pliable and will "Give" with temperature changes in the type of roadway used (Typically asphalt or concrete). When properly applied, the cold sealant should completely cover the loop wires and backer rod and level with the top of the roadway. Since the sealant forms a barrier between the wire and the environment, it is essential that the wires are completely covered. There must be NO voids where water can collect and freeze within the slot. The freeze/thaw cycling will eventually push the loop wires up and out of the slot where the voids exist resulting in a loop failure. Hot sealant must completely surround the loop wires and backer rod to protect them from moisture. Very close attention must be paid with this type of installation because any voids in the sealant can allow moisture next to the wire insulation causing a loop failure in time. Hard setting epoxies should not be used in softer material like asphalt.

Lead-In Wire - The lead-in wire is a continuation of the loop wire (No splicing) and is typically used when the distance between the loop and the detector is 100 ft or less. It must be tightly twisted together with a minimum of six turns per foot.

Lead-In Cable - If a lead-in cable is used (Typically for distances greater than 10 ft between the loop and the detector), it should be a shielded, twisted pair with a high-density polyethylene insulation. The shield should be floated, left unconnected and insulated at the spliced end and grounded to an earth ground (Operator's ground) at the detector end. Any other grounding arrangements can cause erratic system operation. (See page 6)

Splice Connections - 1. All splices must be soldered - do not use wire nuts or crimp connectors because the output from the loop detector to the loop is at very low voltage. This means that there is not enough power to go through a weak connection. **2.** Each splice point must be protected with a moisture proof seal. No splices are allowed in the loop itself. **Failure to observe these precautions are the two most common causes of loop related problems.**

Exit Slot - Where the loop wires leave the loop saw cut (NO sharp angles), they must be tightly twisted together with a minimum of six turns per foot. Use tape on the twisted end to hold the wires together. This prevents false calls from movement between the wires.

Cutaway of Underground Loops

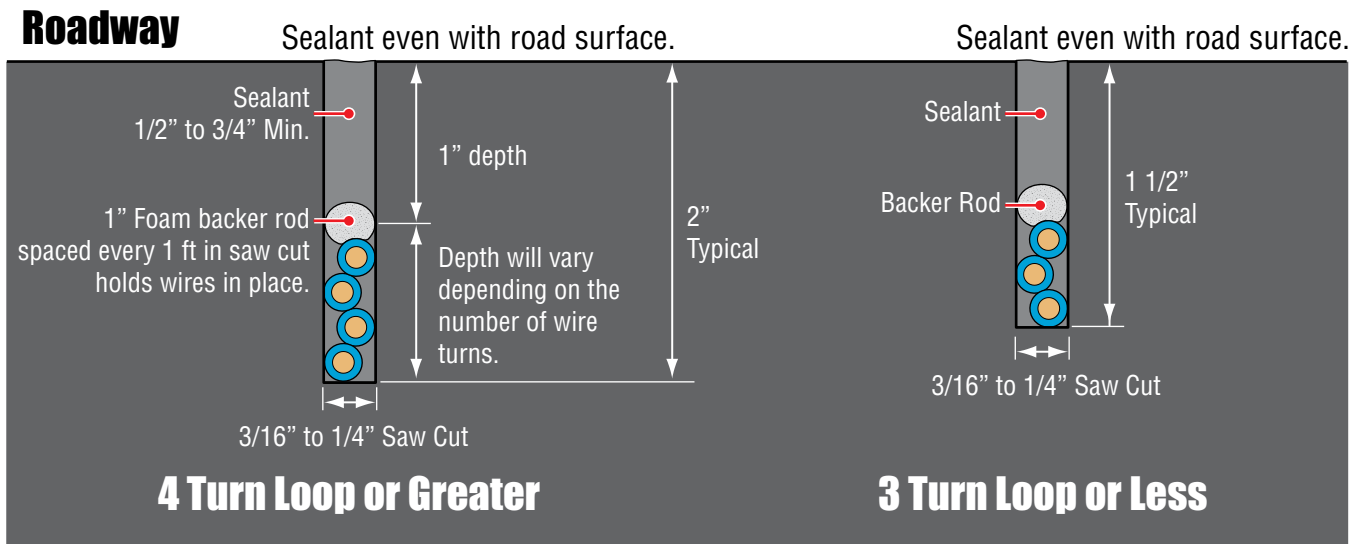

Drawings not to scale

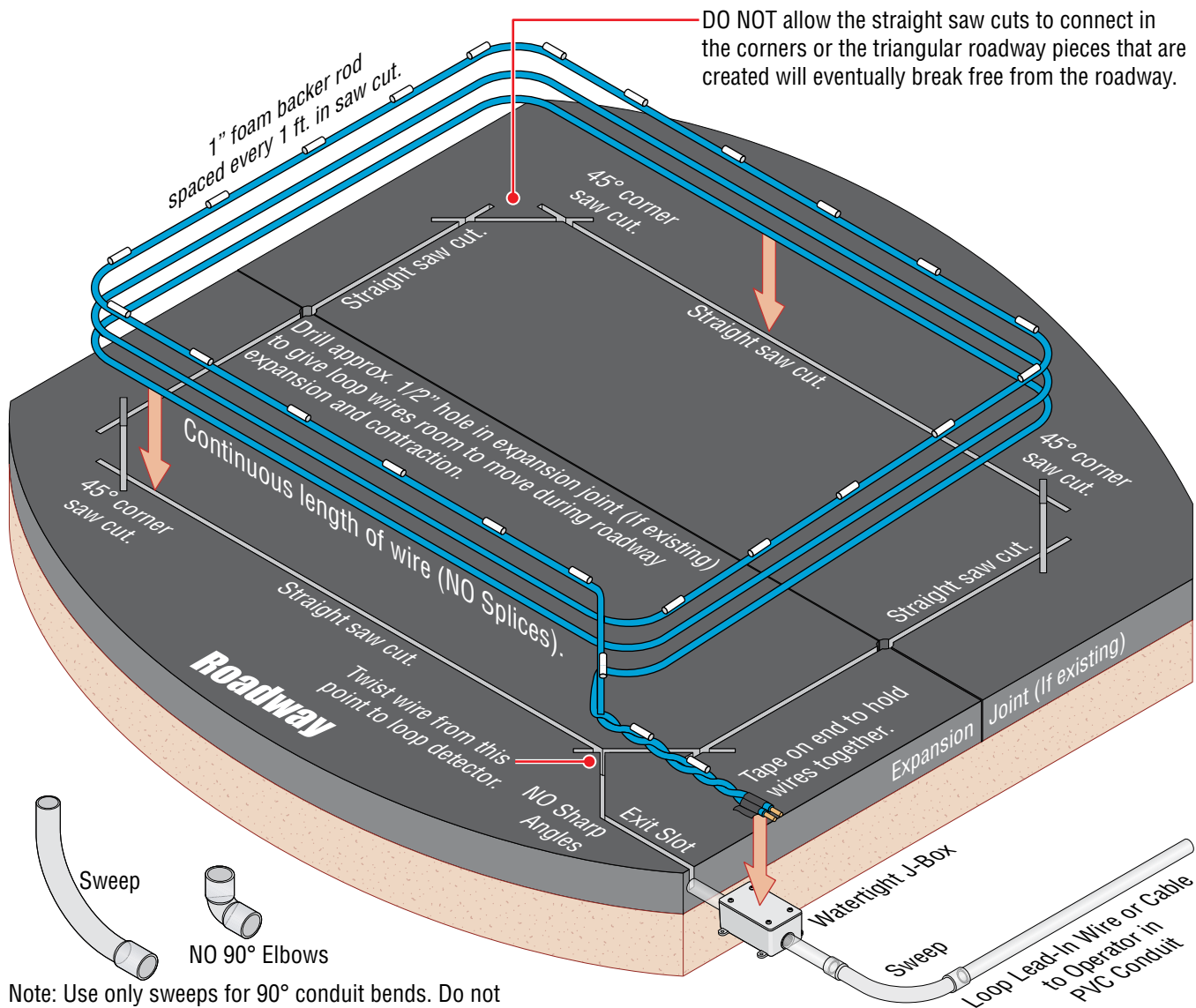

Note: Use only sweeps for 90° conduit bends. Do not use 90° elbows as this will make wire pulls very difficult and can cause damage to wire insulation.

DoorKing Preformed Loop Guidelines

- The same careful attention to proper installation guidelines described for saw cut loops also apply to the installation of DoorKing 4 ft x 8 ft preformed loops.
- Preformed loops should be imbedded 2 to 3 inches below the surface of the poured concrete pavement.

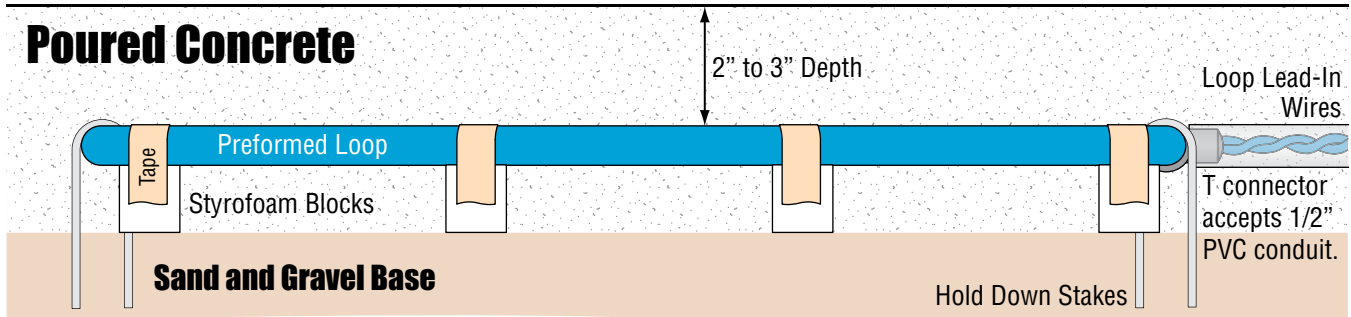

- Wire mesh or reinforcement in concrete should be cut away a minimum of 6 inches from the perimeter of the loop.

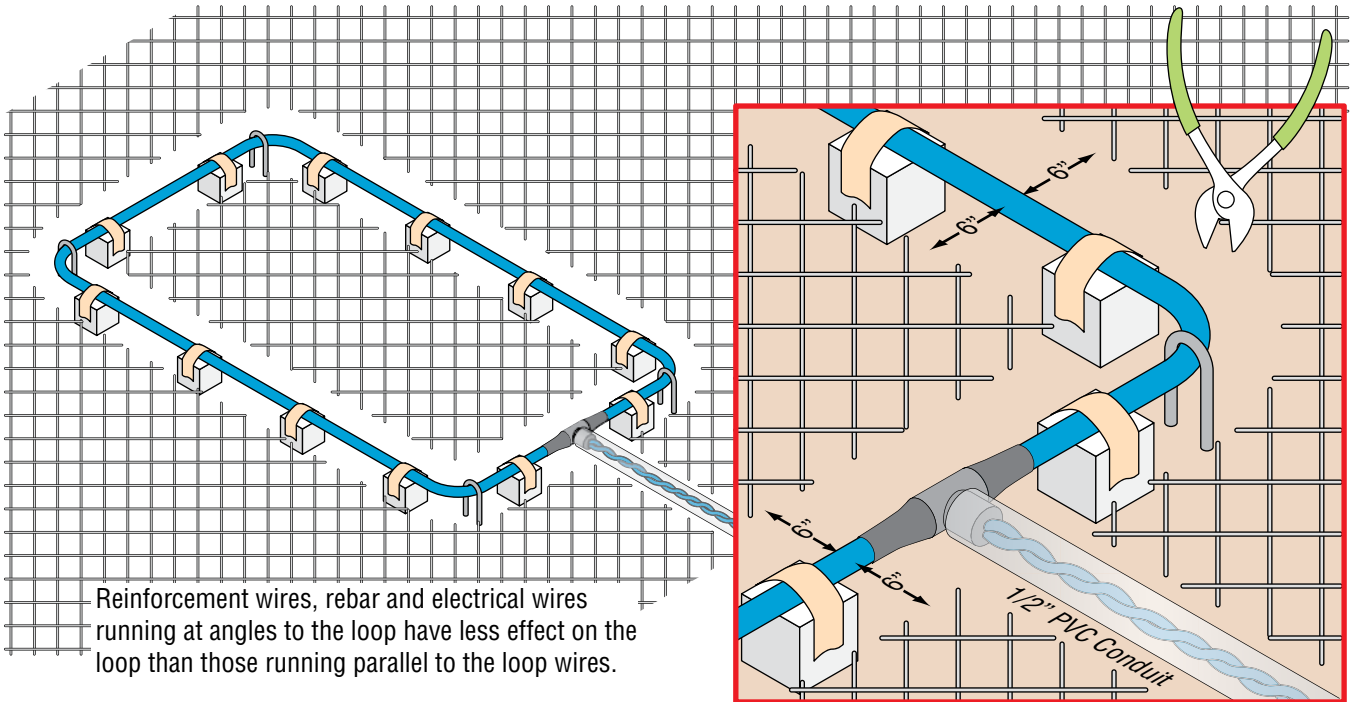

- If installed with asphalt pavement, cover the loop with 1-inch minimum of soil or sand to protect the loop from hot asphalt.

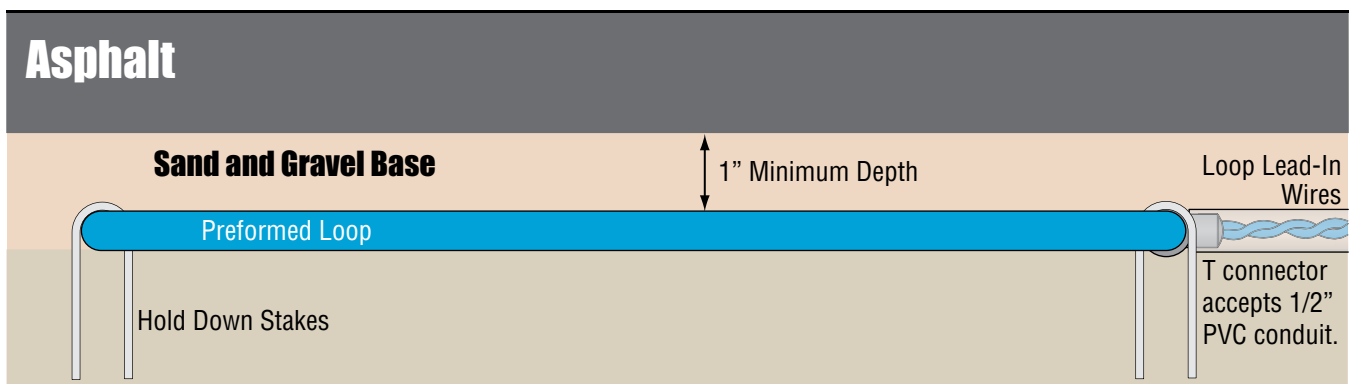

SECTION 3 - TYPICAL LOOP LAYOUT EXAMPLES

Slide Gates

Every slide loop installation is unique and may have specific problems that are not fully explained in this manual. DoorKing highly recommends that the loop system is installed by a professional installer who understands loop systems and can foresee any problems that might occur for your specific installation.

Slide gates require the use of two reversing loops wired in series to a single loop detector for maximum vehicular protection. Be sure that the two reverse loops are properly phased so that the gate can slide through the “dead zone”. The optional automatic exit loop requires a second loop detector.

Loop Lead-Ins

- Wire loop lead-in should be twisted 6 turns per foot. (Pages 3 and 6)
- Use wire loop lead-ins up to 100 ft. away from operator. (Page 2)
- Use cable loop lead-in farther than 10 ft. away from operator if required. (Pages 2 and 6)
- All wire connections must be soldered between underground loop wire and loop lead-ins. (Page 6)
- Series wired loop lead-ins should each be run to the operator before connecting them together for easy maintenance. (Page 6)

Automatic Exit Loop

- Install a separate loop detector.
- Minimum loop size is 18 in. x 48 in. (Pages 3 and 4) DoorKing preformed loops are 4 ft x 8 ft. (Page 10)
- Normally located 20-100 feet away from the gate so that the gate is open or opening as you drive up to it. Typically a loop lead-in cable will need to be installed. (Pages 2 and 6)
- Loop should be far enough away from the reverse loop to avoid any “cross-talk” or on a different loop detector frequency if detection fields overlap. (Page 7)

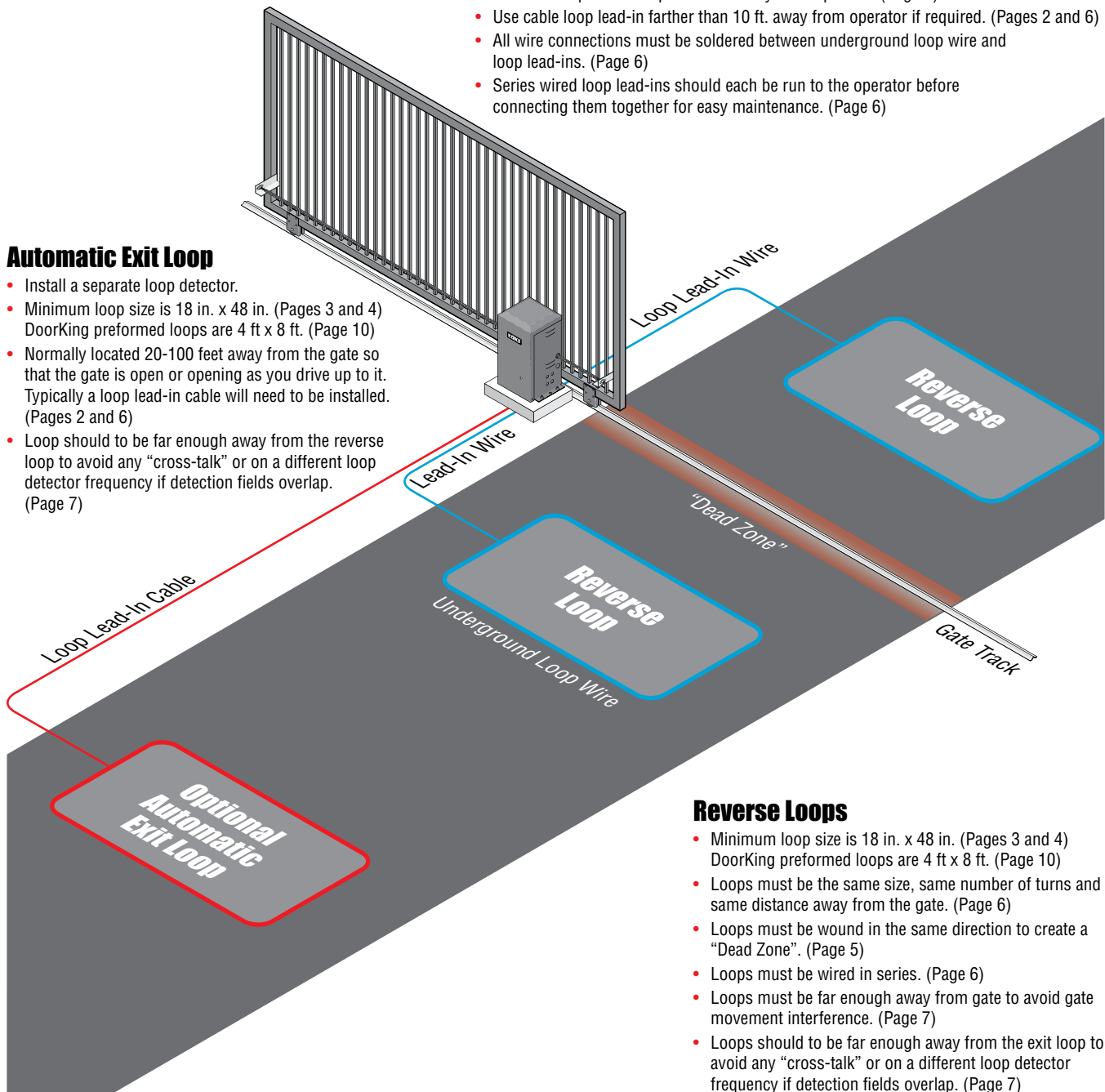

Reverse Loops

- Minimum loop size is 18 in. x 48 in. (Pages 3 and 4) DoorKing preformed loops are 4 ft x 8 ft. (Page 10)
- Loops must be the same size, same number of turns and same distance away from the gate. (Page 6)
- Loops must be wound in the same direction to create a “Dead Zone”. (Page 5)
- Loops must be wired in series. (Page 6)
- Loops must be far enough away from gate to avoid gate movement interference. (Page 7)
- Loops should be far enough away from the exit loop to avoid any “cross-talk” or on a different loop detector frequency if detection fields overlap. (Page 7)

Swing Gates

Every swing loop installation is unique and may have specific problems that are not fully explained in this manual. DoorKing highly recommends that the loop system is installed by a professional installer who understands loop systems and can foresee any problems that might occur for your specific installation. Swing gates typically use two reverse loops that are installed outside the swing path of the gate. This is necessary to avoid the loops detecting the gate swinging over them. This would be detected by the loops and cause the gate to reverse. However, this leaves a large unprotected area.

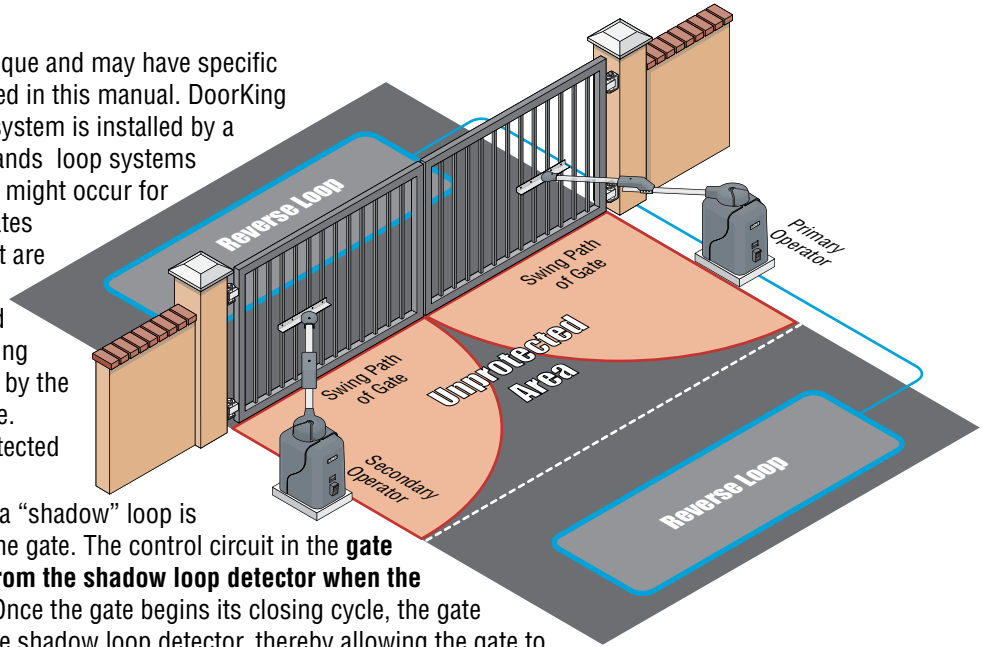

To eliminate the unprotected area, a “shadow” loop is installed under the swing path of the gate. The control circuit in the **gate operator will only accept inputs from the shadow loop detector when the gate is in the full open position**. Once the gate begins its closing cycle, the gate operator ignores any input from the shadow loop detector, thereby allowing the gate to pass over the shadow loop without reversing itself. **The reverse loops and shadow loop require a two-channel loop detector.** The optional automatic exit loop requires a separate single loop detector.

Reverse Loops

- Minimum loop size is 18 in. x 48 in. (Pages 3 and 4) DoorKing preformed loops are 4 ft x 8 ft. (Page 10)
- Loops must be the same size, same number of turns and same distance away from the gate. (Page 6)
- Loops must be wired in series. (Page 6)
- Loops must be far enough away from gate to avoid gate movement interference. (Page 7)
- Loops should be far enough away from the shadow loop and/or exit loop to avoid any “cross-talk” or on a different loop detector frequency if detection fields overlap. (Page 7)

Shadow Loop

- Minimum loop size is 18 in. x 48 in. (Pages 3 and 4) DoorKing preformed loops are 4 ft x 8 ft. (Page 10)
- Loop should stay inside swing path of gate.
- Loop should line up with open gate position.
- Loop should be far enough away from the reverse loops to avoid any “cross-talk” or on a different loop detector frequency if detection fields overlap. (Page 7)

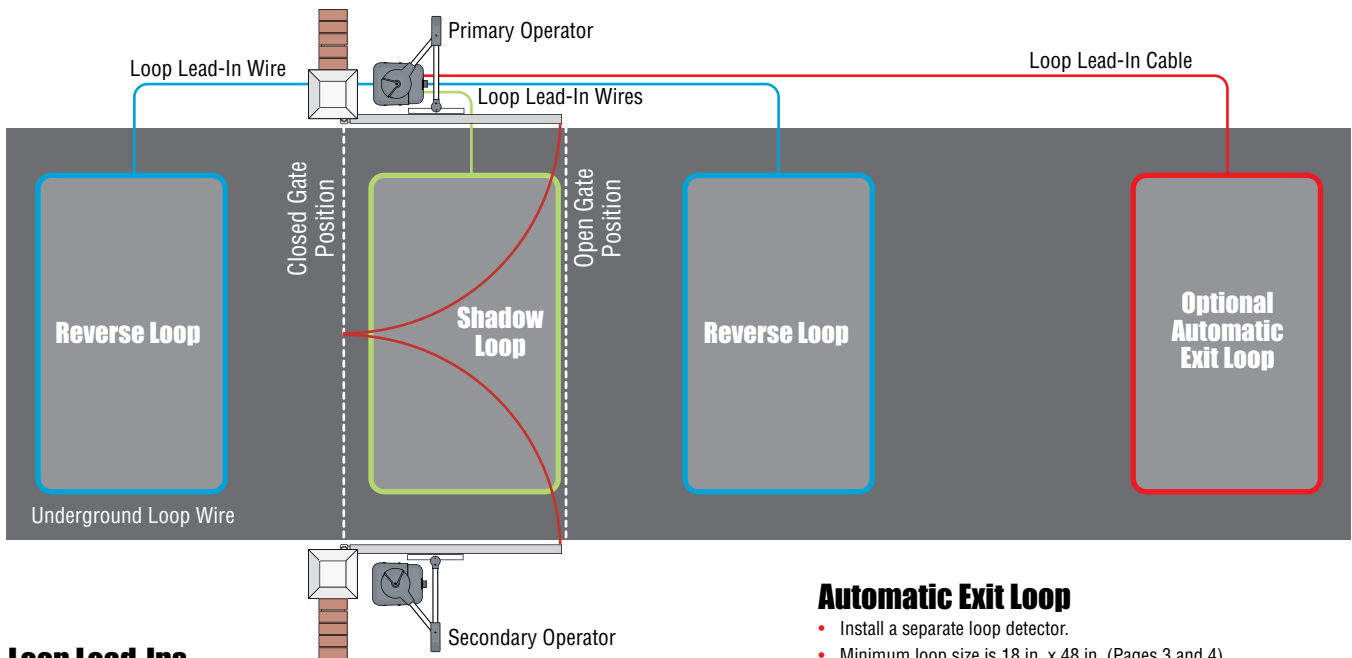

Loop Lead-Ins

- Wire loop lead-in should be twisted 6 turns per foot. (Pages 2 and 6)
- Use wire loop lead-ins up to 100 ft. away from operator. (Page 3)
- Use cable loop lead-in farther than 10 ft. away from operator if required. (Pages 2 and 6)
- All wire connections must be soldered between underground loop wire and loop lead-ins. (Page 6)
- Series wired loop lead-ins should each be run to the operator before connecting them together for easy maintenance. (Page 6)

Automatic Exit Loop

- Install a separate loop detector.
- Minimum loop size is 18 in. x 48 in. (Pages 3 and 4) DoorKing preformed loops are 4 ft x 8 ft. (Page 10)
- Normally located 20-100 feet away from the gate so that the gate is open or opening as you drive up to it. Typically a loop lead-in cable will need to be installed. (Pages 2 and 6)
- Loop should be far enough away from the reverse loop and/or shadow loop to avoid any “cross-talk” or on a different loop detector frequency if detection fields overlap. (Page 7)

SECTION 4 - TROUBLESHOOTING LOOP SYSTEM

Proper installation of the loops is essential for reliable functioning of the detector system. Loop detection systems, when properly installed, will provide one of the most reliable forms of vehicle detection available. Many loop system problems are caused by poor connections, splices, incorrect type of loop wire, or the loop wire shorting to ground all of which will cause intermittent operation or complete failure.

Loop Diagnostics

DoorKing loop detectors have a provision that provides loop diagnostics, which identifies if a problem has occurred in the detection system. The red surface mounted LED on the loop detector will illuminate when the detector senses a vehicle presence, and will go out when the vehicle leaves the field of sensitivity. If any problem occurs in the underground loop, lead-in cable, or in any of the connections, this LED will go into a fault mode by flashing. If the problem is a short or an intermittent poor connection, which corrects itself, the detector will return to normal operation, however the LED will continue to blink until it is manually reset or until power is removed from the system. If the LED is blinking, even if the detector is working properly, a problem exists and checks should be made for poor connections or shorts to ground.

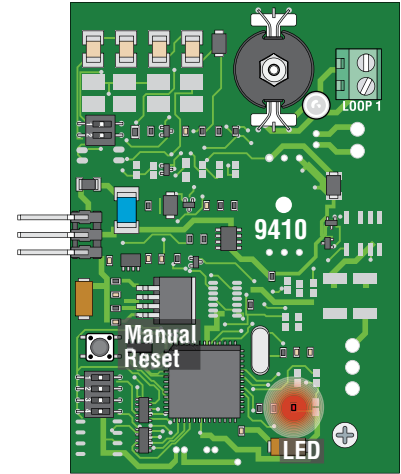

Poor Connections

A poor connection from the loop to the loop detector will generally cause an intermittent problem where the loop will “false call” or “lock on”. Often a crimp connection, wire nut, or similar type connector will operate when they are originally installed, but after a period of time the wires may corrode, or the connection will loosen. Vibrations from gate operators can cause these loose connections to be intermittent and generate false calls, or lock up the detector. Remember, the power through the loop is very low and does not have enough power (like 110 volt connection) to go through any type of corrosion or loose connection. **Be sure that all connections are soldered.**

Shorted Loop Wire

The loop wire shorting to ground is a very common problem. This is especially true when PVC wire (THHN, TFFN, etc.) is used for the ground loop or a splice was made underground. These type of problems will often cause problems when moisture is present. If there is a nick in the wire insulation, the loop will work when the ground is dry, but when moisture is present (rain, sprinklers, morning dew, etc.), the nick causes a short to ground. This can be checked by utilizing a megohm meter capable of testing up to 500 megohms (500 million ohms), such as a DoorKing meter P/N 9401-045 (A typical ohms meter will not read units as small as micro henries). Disconnect the loop wires from the loop detector. Place one of the meter leads to the loop wire and the other to earth ground. Resistance should be greater than 100 megohms. If resistance is between 100 and 50 megohms, the wire insulation has been nicked and the integrity of the loop is questionable. If the resistance is less than 50 megohms, the loop wire will have to be replaced.

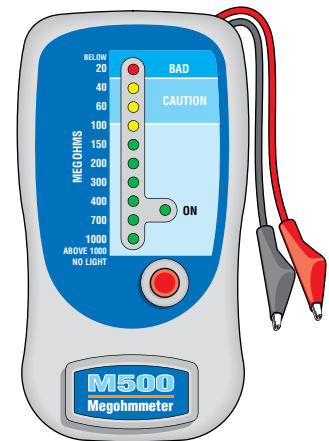

Loop Detector Adjustments

- Sensitivity sets how much moving metal must be present for the detector to send an output.
- Sensitivity Boost increases sensitivity by a factor of ten once a vehicle is detected. This locks in high bed trucks.
- Frequency sets the operating frequency of the loop. When two loops are operating in close proximity to each other, the frequency on each detector should be set differently. The loop with the longest length of wire should be set at the lowest frequency.
- Frequency Counter - Blinks out frequency on LED when the detector is powered up or reset button has been pressed.

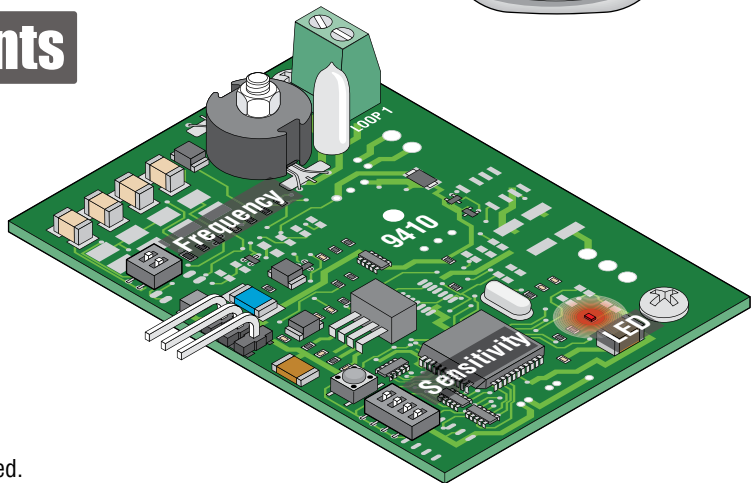

SECTION 5 - DOORKING LOOP DETECTORS AND ACCESSORIES

All loop detectors have the following features:

- Self-tuning circuitry. Automatically adjust for different loops and changes in weather.
- Sensitivity boost automatically increases sensitivity during detection. Prevents dropout from high bed vehicles.
- Four frequencies available.
- Four sensitivity levels available.
- Surface mounted LED's to indicate when power is applied to the detector and when the loop is triggered.

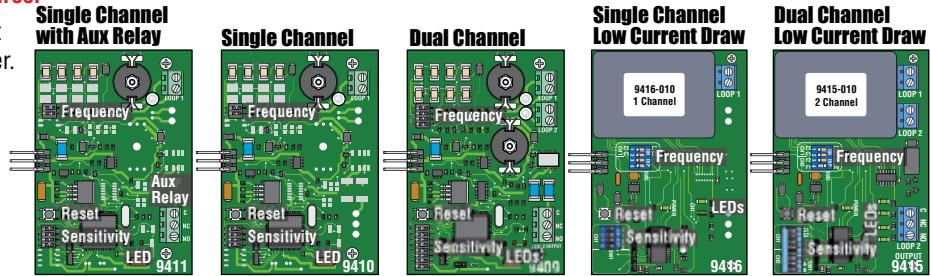

Part Number	Description
9410-010	Single channel plug-in detector board. Four different sensitivity and frequency settings. Sensitivity Boost feature, frequency counter, and Fast Trak feature.
9409-010	Two channel plug-in detector board. Four different sensitivity and frequency settings for each loop. Sensitivity Boost feature, frequency counter, and Fast Trak feature for each loop. Loop 1 output is feed directly into control board; loop two output is via a dry contact relay.
9411-010	Single channel with relay plug-in detector board. Four different sensitivity and frequency settings. Sensitivity Boost feature, frequency counter, and Fast Trak feature. Connect a device to aux relay terminal (dry relay contacts, normally open-NO or normally closed-NC) that will activate whenever the loop detector senses a vehicle in the Loop's detection field. Used with the 1600 barrier gate operators.
9415-010	Two channel low current draw plug-in detector board. Four different sensitivity and frequency settings for each loop. Sensitivity Boost feature, frequency counter, and Fast Trak feature for each loop. Loop 1 output is feed directly into control board; loop two output is via a dry contact relay. Specifically designed for the 6524 and 9024 solar powered gate operators but will work with other DoorKing operators. Not for use on solar powered 6003, 6004, 6005 & 6400 gate operators.
9416-010	Single channel low current draw plug-in detector board. Four different sensitivity and frequency settings. Sensitivity Boost feature, frequency counter, and Fast Trak feature. Specifically designed for solar powered 6524 and 9024 gate operators but will work with other DoorKing operators. Not for use on solar powered 6003, 6004, 6005 & 6400 gate operators.
9401-045	Megohm meter. Checks integrity of ground loops. Reads up to 500 megohms.
2600-771	Asphalt sealant, flat black, 10 oz. tube
2600-772	Concrete sealant, gray, 10 oz. tube.
9401-060	Pre-fabricated ground loop (BLUE), 24 foot circumference with 50-foot lead-in cable. Loop consist of three turns of THHN insulated 18 AWG stranded wire enclosed in PLIOVIC tubing allowing it to be formed to the size and shape required. A "T" connector allows the lead-in wire to be routed through a 1/2 inch PVC conduit.
9401-061	Pre-fabricated ground loop (BLACK), 24 foot circumference with 50-foot lead-in cable. Loop consist of three turns of THHN insulated 18 AWG stranded wire enclosed in PLIOVIC tubing allowing it to be formed to the size and shape required. A "T" connector allows the lead-in wire to be routed through a 1/2 inch PVC conduit.
9401-062	Pre-fabricated ground loop (RED), 24 foot circumference with 50-foot lead-in cable. Loop consist of three turns of THHN insulated 18 AWG stranded wire enclosed in PLIOVIC tubing allowing it to be formed to the size and shape required. A "T" connector allows the lead-in wire to be routed through a 1/2 inch PVC conduit.

18 AWG XLPE Loop Wire – Order by Part Number

Color	Black	Blue	Red
500 Feet	P/N 9402-076	P/N 9402-078	P/N 9402-080
1000 Feet	P/N 9402-077	P/N 9402-079	P/N 9402-081

Information Manual

Underground Loops and Loop Detectors

DoorKing Plug-In Loop Detectors and Loop Accessories

Loop Info-R-1-18



DoorKing, Inc.
120 S. Glasgow Avenue
Inglewood, California 90301
U.S.A.

Phone: 310-645-0023
Fax: 310-641-1586